

POPULAR ELECTRONICS

DECEMBER
1955

25
CENTS

In U.S. and Canada

HI-FI • AMATEUR RADIO • R/C • SWL • GADGETS

Useful Audio Oscillator
Electronic Xmas Toys
Improving Speakers
Slave Photoflash



by
h. h. Scott

Sensational FM Performance at a Best-buy Price

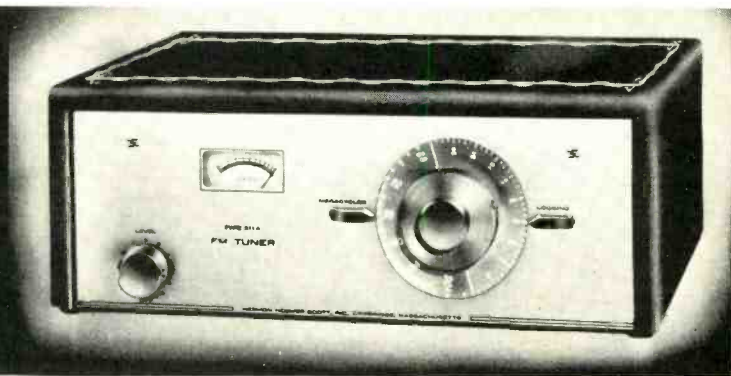

The 311 FM Tuner, \$99.95*

There are NO weak stations with this new tuner

- Terrific 3-microvolt sensitivity makes distant stations sound as clear and strong as those nearby.
- New wide-band FM design gives super-selectivity, to separate stations so close together you would ordinarily pass right over them.
- Wide-band circuitry insures rock-steady, drift-free reception, so you never need readjust tuning.
- Automatic gain control always keeps tuner perfectly adjusted, no matter how the signal varies.

TECHNICAL SPECIFICATIONS

2-megacycle wideband detector — 2 stages of full limiting — 80 db rejection of spurious response from cross-modulation by strong local signals — low-impedance output — equipped for multiplex — beautiful accessory case \$9.95*
*Slightly higher west of Rockies.

310 FM BROADCAST MONITOR TUNER

For perfectionists and connoisseurs, H. H. Scott offers the 310 FM tuner. High Fidelity Magazine says: The 310 "... is a tuner that seems as close to perfection as is practical at this time." The Audio League Report says: "The 310 is the most sensitive tuner we have yet tested." Price, including case \$149.95 East Coast; \$157.45 West Coast.

by
h. h. Scott

The Greatest Amplifier Buy You Have Ever Seen

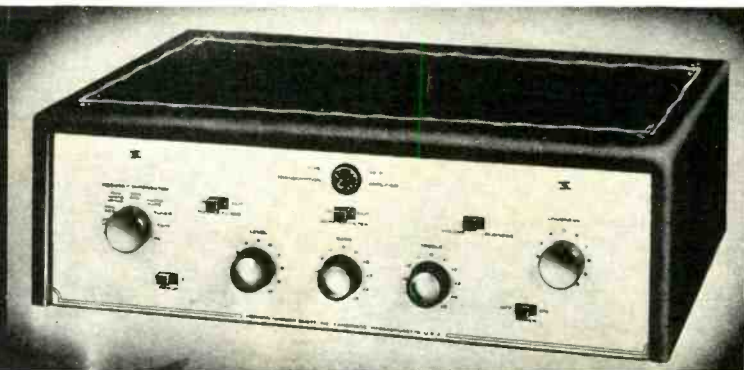

99-B Transcription Amplifier \$99.95*

Imagine! 22 watts — complete controls — only \$99.95

- The famous "99", a complete amplifier, now with twice the power — a brilliant 22 watts.
- Complete equalizer-preamplifier with five-position record compensator. Equalizes virtually all records.
- New adjustable rumble filter and record scratch filter reduce record noise and rumble.
- Two magnetic inputs, switched on panel, allow use of both changer and turntable.

- Special provisions for playback of pre-recorded tape through your 99-B.
- Continuously variable LOUDNESS compensation, with volume-loudness switch, gives perfect tonal balance at all listening levels.

TECHNICAL SPECIFICATIONS

Input selector switch for two magnetic pickups, crystal or constant amplitude pickup, three high-level inputs, and NARTB tape playback — frequency response flat from 20 cps to 30 kc — hum better than 80 db below maximum output — harmonic distortion less than 0.8% — first-order difference-tone intermodulation less than 0.3% — class A circuits throughout — easy panel mounting — beautiful accessory case \$9.95*
*Slightly higher west of Rockies.

FREE — valuable booklet on high-fidelity amplifiers!

Send this coupon, with your name and address, or write for FREE BOOKLET PE-1255 and complete catalog on amplifiers, tuners, turntables, and noise suppressors.

H. H. Scott, Inc., 385 Putnam Ave., Cambridge, Mass.

h. h. Scott

385 PUTNAM AVE. • CAMBRIDGE 39, MASS.

You Practice **SERVICING** with Kits I Send You

Nothing takes the place of PRACTICAL EXPERIENCE. That's why NRI training is based on LEARNING BY DOING. You use parts I send to build many circuits common to Radio and Television. With my Servicing Course you build the modern Radio shown at left. You build a Multimeter and use it to help make \$10, \$15 a week fixing sets in spare time while training. All equipment is yours to keep. Coupon below will bring book of important facts. It shows other equipment you build.



You Practice **BROADCASTING** with Kits I Send You

As part of my Communications Course I send you parts to build low-power Broadcasting Transmitter at left. Use it to get practical experience. You put this station "on the air" . . . perform procedures demanded of broadcasting station operators. An FCC Commercial Operator's License can be your ticket to a bright future. My Communications Course trains you to get your license. Mail coupon. Book shows other equipment you build for practical experience.



I Will Train You at Home in Spare Time to be a **RADIO-TELEVISION** Technician

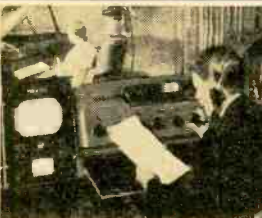

TELEVISION

Making Jobs, Prosperity

25 million homes have Television sets now. Thousands more sold every week. Trained men needed to make, install, service TV sets. About 200 television stations on the air. Hundreds more being built. Good job opportunities here for qualified technicians, operators, etc.



America's Fast Growing Industry Offers You Good Pay, Success

Training PLUS opportunity is the PERFECT COMBINATION for job security, advancement. When times are good, the trained man makes the BETTER PAY, gets PROMOTED. When jobs are scarce, the trained man enjoys GREATER SECURITY. NRI training can help assure you and your family more of the better things of life. Radio is bigger than ever with over 3,000 broadcasting stations and more than 115 MILLION sets in use, and Television is moving ahead fast.

J. E. SMITH, President
National Radio Institute
Washington, D. C.
Our 40th Year

N.R.I. Training Leads to Good Jobs Like These

I TRAINED THESE MEN

"I have progressed very rapidly. My present position is Studio Supervisor with KEDD Television, Wichita."—Elmer Frewaldt, 3026 Stadium, Wichita, Kans.

"Fix sets part time in my shop. Made about \$50 first three months of the year. Could have more but this is about all I can handle."—Frank Borer, Lorain, Ohio.

"I've come a long way in Radio and Television since graduating. Have my own business on Main Street."—Joe Travers, Asbury Park, New Jersey.

"I didn't know a thing about Radio. Now have a good job as Studio Engineer at KMMJ."—Bill Delzell, Central City, Nebraska.

BROADCASTING: Chief Technician, Chief Operator, Power Monitor, Recording Operator, Remote Control Operator. **SERVICING:** Home and Auto Radios, Television Receivers, FM Radios, P. A. Systems. **IN RADIO PLANTS:** Design Assistant, Technician, Tester, Serviceman, Service Manager. **SHIP AND HARBOR RADIO:** Chief Operator, Radio-Telephone Operator. **GOVERNMENT RADIO:** Operator in Army, Navy, Marine Corps, Forestry Service Dispatcher, Airways Radio Operator. **AVIATION RADIO:** Transmitter Technician, Receiver Technician, Airport Transmitter Operator. **TELEVISION:** Pick-up Operator, Television Technician, Remote Control Operator.



Start Soon to Make \$10, \$15 a Week Extra Fixing Sets

My training is practical, complete; is backed by 40 years of success training men at home. My well-illustrated lessons give you basic principles you need and my skillfully developed kits of parts "bring to life" things you learn from the lessons. I start sending you special booklets the day you enroll, that show you how to fix sets. Multimeter you build with my parts helps you discover and correct set troubles, helps you make money fixing neighbors' sets in spare time while training. Many make \$10, \$15 a week extra this way.

Mail Coupon — Find Out What Radio-Television Offer You

Act now to get more of the good things of life. I send actual lessons to prove NRI home training is practical, thorough. My 64-page book "How to be a Success in Radio-Television" shows what my graduates are doing and earning. It gives important facts about your opportunities in Radio-

Television. Take NRI training for as little as \$5 a month. Many graduates make more than the total cost of my training in two weeks. Mail coupon now to: J. E. SMITH, President, Dept. 5ND4, National Radio Institute, Washington 9, D. C. Our 40th year.

AVAILABLE to all qualified VETERANS UNDER G.I. BILLS

Good for Both—FREE

MR. J. E. SMITH, President, Dept. 5ND4
National Radio Institute, Washington 9, D. C.
Mail me Sample Lesson and 64-page Book, FREE.
(No salesman will call. Please write plainly.)

Name Age

Address

City Zone State

VETS write in date of discharge



Mail Today—Tested Way to Better Pay

POPULAR ELECTRONICS is published monthly by Ziff-Davis Publishing Company, William B. Ziff, Chairman of the Board (1946-1953), at 65 E. Lake St., Chicago 1, Ill. Entered as second class matter August 27, 1954 at the Post Office, Chicago, Illinois. SUBSCRIPTION RATES: One year U.S. and possessions, and Canada \$3.00; Pan-American Union Countries \$3.50; all other foreign countries \$4.00.

POPULAR ELECTRONICS

Registered U. S. Patent Office

DECEMBER 1955

VOL. 3-NUMBER 6

EDITOR
OLIVER READ, WIETI

MANAGING EDITOR
O. P. Ferrell

TECHNICAL EDITOR
H. S. Renne

FEATURE EDITOR
Norman Eisenberg

ASSOCIATE EDITORS
M. C. Magna
Charles Tepfer

ART EDITOR
A. J. Reich

CONTRIBUTING EDITORS
H. Bennett R. Legge
H. S. Brier H. Pollack
J. T. Frye R. P. Turner
L. E. Garner, Jr.

ART DEPARTMENT
Frank Sayles (Director)
J. A. Golonek M. Whelpley
W. K. Vahlsing

ADVERTISING DEPARTMENT
NEW YORK (MU 7-8080)
L. L. Osten—Adv. Dir.
Wm. G. McRoy—Adv. Mgr.
Bert Covit

CHICAGO (AN 3-5200)
Jim Weakley, Midwest Adv. Mgr.
LOS ANGELES (Mch. 9856)
John E. Payne



Copyright 1955
(All Rights Reserved)



Member
Audit Bureau of
Circulations

ZIFF-DAVIS PUBLISHING COMPANY
W. B. ZIFF (1898-1953) FOUNDER

Also Publishers of
RADIO & TELEVISION NEWS
Editorial and Executive Offices
366 Madison Ave., New York 17, N. Y.

PRESIDENT
B. G. DAVIS

VICE-PRESIDENTS
H. J. MORGANROTH M. FROELICH

SECRETARY-TREASURER
G. E. CARNEY

CIRCULATION MANAGER
M. MICHAELSON

BRANCH OFFICES
Chicago (1), 64 E. Lake St.
Los Angeles (14), Staller Center,
900 Wilshire Blvd.

SUBSCRIPTION SERVICE:
All communications concerning subscriptions should be addressed to Circulation Dept., 64 E. Lake St., Chicago 1, Ill. Include your old address as well as new—enclosing if possible an address label from a recent issue of this magazine. Allow at least 4 weeks for change of address.

CONTRIBUTORS:
Contributors are advised to retain a copy of their manuscripts and illustrations. Contributions should be mailed to the New York Editorial Office and must be accompanied by return postage. Contributions will be handled with reasonable care, but this magazine assumes no responsibility for their safety. Any copy accepted is subject to whatever adaptations and revisions are necessary to meet the requirements of this publication. Payment covers all author's, contributor's and copyright's rights, title, and interest in and to the material accepted and will be made at our current rates upon acceptance. All photos and drawings will be considered as part of material purchased.

CONTENTS

Electronic Toys for Christmas	E. G. Louis	23
Flight Doctor's Electronic Partner	R. E. Atkinson	34
Phantom Voice Speeds Operation of Automatic Elevator		37
21st Century Home		42
125-Watt Line Voltage Control		45
Battery Eliminator for the Lab	Harvey Pollack	46
An Amateur's Audio Oscillator	E. T. Kephart, W2SPV	50
Improving the "Novice C.W. Transmitter"	Albert S. Flood, Jr.	53
Slave Photoflash Trigger	Harvey Pollack	55
More Bandsread with the SW-54	Robert J. Murray, W1FSN	62
Extra Jobs for Your VOM	Rufus P. Turner	84
Index to Volume 3 (July-Dec., 1955)		126

POPULAR ELECTRONICS Audio and Hi-Fi Section

Disc and Tape Review	Bert Whyte	67
Christmas Record Buying Guide		69
Bargain Hi-Fi with Cheap Speakers	Jack Coriell	71
Tape Transport Mechanisms	Leon Wortman	74

DEPARTMENTS

Letters from Our Readers		10
What's the PE Answer		16
Transistor Topics		59
POP 'tronics Bookshelf		61
Carl & Jerry	John T. Frye	64
The Transmitting Tower	Herb S. Brier	80
Tuning the Short-Wave Bands	Hank Bennett	82
R/C Notes		87
After Class		88
Ama-Touring	Roger Legge	94
Tools & Gadgets		107
Tips and Techniques		117
Glossary of Electronic Terms		128

(Also see page 6)

Cover Painting by Ed Vallgursky

POPULAR ELECTRONICS



Train for Better
Jobs in

ELECTRICITY OR TELEVISION-RADIO

in Great
Shops of COYNE

GREAT OPPORTUNITY FIELDS

Conditions are changing. Many "one operation" jobs that have paid well will not last. *Don't be satisfied with a "no future" job.* Whether 17 or up to 45 years of age, train the Coyne way for a better job and a real future in **ELECTRICITY** or **TELEVISION-RADIO**, *fields that offer a world of opportunities.*

YOU can TRAIN in great CHICAGO SHOPS

Train on real, full-size equipment at COYNE where thousands of successful men have trained for over 56 years—largest, oldest, best equipped school of its kind—established in 1899. No advanced education or previous experience needed. **TRAINING APPROVED FOR VETERANS.**

B. W. COOKE, President

COYNE FOUNDED 1899
ELECTRICAL SCHOOL

A TECHNICAL TRADE INSTITUTE OPERATED NOT FOR PROFIT
500 S. PAULINA STREET, CHICAGO, Dept. 95-71H

ELECTRICITY ★ RADIO ★ TELEVISION ★ REFRIGERATION ★ ELECTRONICS

START NOW—PAY LATER—Finance Plan and Easy Monthly Payment Plan. Also part-time employment help for students.

Get FREE Book

Send coupon for 48 page illustrated book "Guide to Careers in Electricity and Television-Radio." No cost; no obligation; no salesman will call. Get vital facts now!

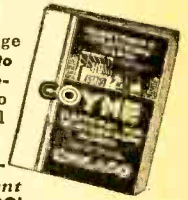

B. W. COOKE, President
COYNE ELECTRICAL SCHOOL
500 S. Paulina St., Chicago 12, Ill., Dept. 95-71H

Send **BIG FREE** book and details of your training offer. This does not obligate me and no salesman will call. I am interested in:

Electricity Television-Radio

Name _____

Address _____

City _____ State _____

COYNE offers
LOW COST

TELEVISION RADIO-ELECTRONICS

Training in
Spare Time **AT HOME**

The future is **YOURS** in TV-RADIO!

A fabulous field—good pay—fascinating work—a prosperous future! Good jobs, or independence in your own business!

Coyne brings you the first truly lower cost, MODERN—QUALITY Television Home Training; training designed to meet Coyne standards. Not an old Radio Course with Television "tacked on". Here is MODERN TELEVISION TRAINING including working knowledge of Radio. Includes UHF and **COLOR TV**. No Radio background or previous experience needed. Personal guidance by Coyne Staff. **Practical Job Guides** to show you how to do actual servicing jobs—**make money early in course.** With Coyne Television Home Training you pay only for your training, no costly "put together kits".

B. W. COOKE, President



Coyne—the Institution behind this training... the largest, oldest, best equipped residential school of its kind. Established 1899.

COYNE
ELECTRICAL SCHOOL

500 S. Paulina St., Dept. 95-HT7

A TECHNICAL TRADE INSTITUTE OPERATED NOT FOR PROFIT

SEND COUPON FOR FREE BOOK

and full details, including easy Payment Plan.

No obligation, no salesman will call.



COYNE ELECTRICAL SCHOOL
Television Home Training Div.
500 S. Paulina St., Chicago 12, Ill.,
Dept. 95-HT7

Send Free Book and details on Television Home Training. This does not obligate me and no salesman will call.

Name _____

Address _____

City _____ State _____

You Can Build A TRANSISTORIZED PHONO PRE-AMPLIFIER

with

 low noise 2N133
TRANSISTORS



This easy to make Transistorized Phono Pre-Amplifier will eliminate all hum and microphonics difficulties yet equal tube performance. The frequency response is compensated for use with a reluctance type pickup.

You can get everything you need to build this unit at your Raytheon Tube Suppliers including the efficient, low cost Raytheon 2N133 Transistors.

Write for FREE circuit information — Department P-8.

Get This RAYTHEON TRANSISTOR APPLICATIONS BOOK

116 pages — over 50 practical circuits including timers, receivers, oscillators etc. All using low cost Raytheon Transistors. Available from your Raytheon Tube Supplier or send 50¢ to Department P7.



Excellence in Electronics

RAYTHEON MFG. CO.

Receiving and Cathode Ray Tube Operations
Newton 58, Massachusetts

ITEMS OF INTEREST

"Cardboard Fidelity"	36
Armchair Loudspeaker	38
Radar Sidelight	38
RETMA Warranty	38
What Time Is It?	38
Automatic Wiring Machine	39
ERMA's Working in the Bank	39
Train Announces Itself	39
Spring-Driven Generator	40
Transistorized Golf Ball	40
Visitors See Assembly Line	40
Elgin "Any Shape" Battery	41
GOC Radar Hat	41
Miniature Rescue Radio	41
New TV Sets Set Record	41
TV Survives Flood Waters	41
Hi-Fi System Boosts Food Sales in Supermarket ..	70

NEW PRODUCTS

1956 Midwest TV Receiver	40
Tone Arm Eliminates Tracking Error in Record Playback	70
Cables for Hi-Fi Connections	79
Heathkit FM Tuner	79
60-Watt Power Amplifier	79
Loudspeaker Enclosures Assembled from Kits ..	73
Hi-Fi Tape Recorder Features Dual Track Opera- tion	73
Magnetic Pickup Boosts Flat Response to 30,000 Cycles	78
Printed Circuit Hi-Fi Amplifier	78

COMING NEXT MONTH

POPULAR ELECTRONICS

Hi-Fi in the Home of Martin Block

The hi-fi equipment used by a famous disc jockey and how he assembled it.

Loudspeakers—Fact and Theory

How a loudspeaker works, what assistance it needs to reproduce good music, and the difference between various types.

Electronic Coin Tossing

A novel and accurate method of simulating the toss of a coin electronically.

Building a Regenode Receiver

Transistorized Light Meter

Making a Cheap Self-Generating Photocell

Selecting Phonogenic Music

High-Fidelity Audio ■ Kits ■ Radio Control
■ Short-Wave Listening ■ What's New ■
How It Works ■ How to Make It ■ How to
Use It ■ Carl & Jerry ■ Tips & Techniques

IN THIS MONTH'S

RADIO & TELEVISION NEWS

(December)

Color TV Today

Facts to Know When Buying a Preamp

An Electronic Slide Rule

A Novel Push-Pull Speaker System

Shielding in Hi-Fi Equipment

Electronics Boom Seen

Need For Television Technicians To Rise

Industry Warned About Shortage Of Trained Men

TV SALES SET NEW RECORD

Sylvania Head Expects Huge Electronic Gains

Transistor Radios Developed

RCA HEAD PREDICTS SALES BOOM FOR COLOR TV SETS

VETERANS - - NON-VETERANS

Get Into The Field That's Making Headlines



L. C. Lane, B.S., M.A.
President, Radio-Television
Training Association,
Executive Director, Pierce
School of Radio & Television.

All over the nation the Television-Radio-Electronics industry is making News — News that means opportunity for YOU. You can cash in on the headlines. **I WILL TRAIN YOU AT HOME FOR A TOP-PAY JOB IN TELEVISION**

I will prepare you for a spot in America's fastest-growing industry. You can become a trained technician in your spare time without giving up your present job or social life. No experience needed.

LEARN BY DOING

As part of your training I give you the equipment you need to set up your own home laboratory and prepare for a top-pay job or set up your own business. You build and keep an Electromagnetic TV RECEIVER designed and engineered to take any size picture tube up to 21-inch. (10-inch tube furnished. Slight extra cost for larger sizes.) . . . also a Super-Het Radio Receiver, AF-RF Signal Generator, Combination Voltmeter-Ammeter-Ohmmeter, C-W Telephone Transmitter, Public Address System, AC-DC Power Supply. Everything supplied, including all tubes.

Combination Voltmeter-Ammeter-Ohmmeter



C-W Telephone Transmitter

Super-Het Radio Receiver



AF-RF Signal Generator



Public Address System

STUDY NEWEST DEVELOPMENTS

My training covers all the latest developments in the fast-growing Television-Radio-Electronics industry. You learn about FM — RADAR — COLOR TV — TRANSISTORS — PRINTED CIRCUITS, etc.

CHOOSE FROM THREE COMPLETE COURSES

covering all phases of Radio, FM and TV

1. Radio, FM and Television Technician Course — no previous experience needed.
2. FM-TV Technician Course — previous training or experience in radio required.
3. TV Cameraman and Studio Technician Course — advanced training for men with Radio or TV training or experience.

EXTRA TRAINING IN NEW-YORK CITY AT NO EXTRA COST!

After you finish your home study training in Course 1 or 2 you can have two weeks, 50 hours, of intensive Lab work on modern electronic equipment at our associate resident school, Pierce School of Radio & Television. THIS EXTRA TRAINING IS YOURS AT NO EXTRA COST WHATSOEVER!

FCC COACHING COURSE

Important for BETTER-PAY JOBS requiring FCC License! You get this training AT NO EXTRA COST! Top TV jobs go to FCC-licensed technicians.

VETERANS

My School fully approved to train Veterans under new Korean G. I. Bill. Don't lose your school benefits by waiting too long. Write discharge date on coupon.

EARN WHILE YOU LEARN

Almost from the very start of your course you can earn extra money by repairing sets for friends and neighbors. Many of my students earn up to \$25 a week . . . pay for their entire training with spare time earnings . . . start their own profitable service business.

FREE HOW TO MAKE MONEY IN TV **FREE** SAMPLE LESSON **FREE** "I'll send you my new 40-page book, 'How to Make Money in Television-Radio-Electronics,' a Free sample lesson, and other literature showing how and where you can get a top-pay job in Television.

MAIL THIS COUPON TODAY!

Mr. Leonard C. Lane, President
RADIO-TELEVISION TRAINING ASSOCIATION
Dept. E-12C, 52 East 19th Street, New York 3, N. Y.

Dear Mr. Lane: Mail me your NEW FREE BOOK, FREE SAMPLE LESSON, and FREE aids that will show me how I can make BIG MONEY IN TELEVISION. I understand I am under no obligation and no salesman will call.

(PLEASE PRINT PLAINLY)

Name _____ Age _____

Address _____

City _____ Zone _____ State _____

I AM INTERESTED IN:

- Radio-FM-TV Technician Course
- FM-TV Technician Course
- TV Cameraman & Studio Technician Course

VETERANS!

Write discharge date

NO SALESMAN WILL CALL

Radio Television Training Association

52 EAST 19th STREET • NEW YORK 3, N. Y.

Licensed by the State of New York • Approved for Veteran Training

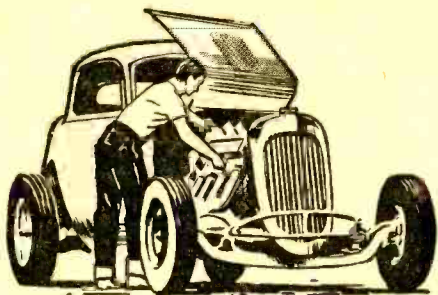

MECHANICAL SKILLS CAN GET YOU AHEAD IN THE U. S. AIR FORCE

Here's why —

If you're interested in mechanics, join the U. S. Air Force. As an Airman you may develop your technical ability and learn a skill that will pay well...and win you extra stripes. Such interesting career fields as Aircraft and Engine Maintenance, Rocket Propulsion and Intricate Equipment Maintenance are open to you, if you qualify. Don't delay — see your local Air Force Recruiter or mail the coupon, *today*.



**YOU GO
PLACES
FASTER
IN THE
U. S. AIR FORCE**

AIRMAN INFORMATION BRANCH
Box 2202, Wright-Patterson AFB
Ohio

M-19-PE2

Please send me more information on my opportunities as an Airman in the U. S. Air Force.

Name _____

Address _____

City _____ Zone _____ State _____

NOW! SAVE up to 50%

BUILD YOUR OWN

E-V HIGH FIDELITY Speaker Enclosure



EVERY PIECE PRECUT

in *Ready-to-Assemble* **KITS**

Now you can own an acoustically correct *Electro-Voice* high-fidelity folded-horn speaker enclosure for your home music system and *save up to one-half!* Build it yourself... seven models to choose from... wall types... corner types... for full range loudspeaker... for separate two, three and four-way speaker systems.

All parts are pre-cut—ready to assemble. Exterior surfaces are clear-grained birch. Easy, step-by-step instructions show you how to "Do-it-Yourself."

Beautiful furniture finish is easily obtained with an E-V Finishing Kit.* E-V Decorative Trim Kit* adds the final touch. (*Available separately.)



See your E-V Hi-Fi Distributor for Construction Books and K-D Kits—or write for Bulletin 211.



THE PATRICIAN IV KIT. An interior assembly kit for those desiring the finest. This augmented design of the Klipsch corner folded-horn bass section delivers an added full octave of bass. Designed for use with E-V Model 103C Patrician IV four-way driver components. For built-in installations or to be decorated as you choose. Finished size: 57½ in. high, 34½ in. wide, 26¾ in. deep. Shpg. wt. 150 lb.

Model KD1 Net, \$99.00



THE BARONET KIT. Phenomenal reproducer for such small size. This folded-horn corner enclosure is designed for use with E-V Model SP8B 8-in. Radax speaker. E-V T35 or T35B Super Sonax UHF driver can be added for a separate two-way system. Finished size: 23 in. high, 14 in. wide, 13 in. deep. Shpg. wt. 24 lb.

Model KD7 Net, \$24.00



THE ARISTOCRAT KIT. Folded-horn corner enclosure designed for 12-in. speakers and separate 2 and 3-way systems. For use with Electro-Voice SP12 or SP12B coaxial speakers, 12TRX or 12TRXB triaxial reproducers, and 108, 111 2-way and 108A, 111A 3-way systems. Smooth reproduction down to 35 cps, with remarkable purity and efficiency. Finished size: 29¾ in. high, 19 in. wide, 15¾ in. deep. Shpg. wt. 37 lb.

Model KD6 Net, \$36.00

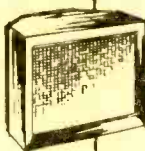

THE EMPIRE KIT. Economical, folded-horn enclosure for use in a corner or flat against one wall. Designed for 15-in. speakers and separate 2 and 3-way systems. Particularly effective when used with SP15B coaxial speaker, 15TRXB triaxial reproducer, or 116 2-way or 116A 3-way system. Recommended components for Regency kit may also be employed. Finished size: 29¾ in. high, 32 in. wide, 16 in. deep. Shpg. wt. 45 lb.

Model KD5 Net, \$48.00

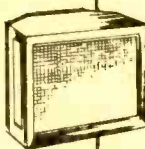

THE REGENCY KIT. Most popular low-boy style folded-horn enclosure that can be used in corner or flat against one wall. Improves the bass range and response of any 15-in. speaker. Makes an outstandingly efficient reproducer when used with E-V SP15 coaxial speaker, 15TRX triaxial reproducer or 114A 2-way or 114B 3-way system. Finished size: 29¾ in. high, 33½ in. wide, 19 in. deep. Shpg. wt. 70 lb.

Model KD4 Net, \$69.00

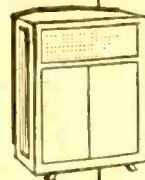

THE CENTURION KIT. Four-way system folded-horn, corner enclosure. Uses exclusive E-V "W" type single-path indirect radiator for propagation of extended bass. Sealed cavity behind 15 in. low-frequency driver cone promotes superlative transient response, subdues cone excursions, lowers distortion. For use with E-V Model 105 or Model 117 package of driver components. Finished size: 42½ in. high, 29 in. wide, 22½ in. deep. Shpg. wt. 75 lb.

Model KD3 Net, \$79.00



THE GEORGIAN KIT. An interior assembly kit that creates authentic Klipsch indirect radiator type corner folded-horn bass section for 15 in. 4-way speaker system. Exceeded in range only by the Patrician IV. For use with E-V Model 105 or Model 117 package of 4-way driver components. For built-in installations or to be decorated as you choose. Finished size: 38½ in. high, 26¾ in. wide, 22½ in. deep. Shpg. wt. 88 lb.

Model KD2 Net, \$58.00

KNOW YOUR P'S AND Q'S ABOUT GOOD TEST EQUIPMENT

only EMC
instruments
give you ...

Precision
components
and assembly
techniques
insuring
unexcelled

Performance
and accuracy
never before
at such a low

Price
with the
famous EMC
standards of

Quality
all of which means
you get a greater

Quantity
of modern equipment
for better,
faster servicing.



NEW RF Signal
Generator
EMC Model 501
with leads
\$37.90 (Wired &
Tested)
\$24.90 (Kit Form)

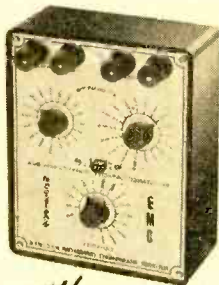

NEW Resistance-Capacity
Substitution Box
EMC Model 900
\$19.90 (Wired &
Tested)
\$10.25 (Kit Form)



Free

Yes, tell me more, send me — FREE — a
detailed catalog of the complete EMC line.

Name
Street
City State
PE-12

EMC ELECTRONIC MEASUREMENTS CORP.
280 LAFAYETTE STREET,
NEW YORK 12, NEW YORK

EXPORT DEPT. #370 BROADWAY, N. Y. 13, N.

LETTERS FROM OUR READERS

Radio Astronomy

■ We believe that radio-telescopes and radio-astronomy afford a good chance to combine two scientific and interesting hobbies. Is there anything worthwhile building?

BOB WYSE
IAN TAYLOR
RON BAIRD
MAURICE SMITH
Toronto, Canada

First, may we commend our Canadian readers upon their active interest in this brand new science. We have scheduled a feature article on this topic to explain it to readers unfamiliar with radio "static" being received from outer space. As far as building antennas or equipment to hear this "static" is concerned, we feel that such work might not prove very fruitful. Basically, it requires a supersensitive v.h.f. receiver, a very large antenna, and a very quiet receiving location.

Radio TV Servicing

■ Why not a column on servicing in POP'tronics? It could start out with simple techniques and then gradually work into the more difficult stages.

JOE MONAHAN
Lexington, Ky.

Frankly, Joe, a lot of readers have asked for the same thing. It was decided a long time ago that radio—and especially TV—servicing had no place in POP'tronics. We will publish construction information on test equipment and dope on how such equipment is used, but we earnestly recommend our sister publication, RADIO & TELEVISION NEWS, for servicing procedures.

Osmatogic Anode Bombardment

■ While studying isotrolysis nebergestic surge, it was discovered that the thermal-control varistor caused a pronounced osmatogical effect upon the bombardment of the anode. Is there a chance of getting knocked into the middle of next year by playing around with this sort of stuff?

CARL KOHLER
La Habra, Calif.

As far as humorist/cartoonist Kohler is concerned, the Editors agree that it couldn't happen to a nicer guy.

Transistor Pocket Receiver

■ How about instructions on how to make a transistor pocket radio in a plastic case.

LOUIS A. BELMONT
El Paso, Texas

Reader Belmont will find the discussion on page 59 of considerable interest. Several small plastic-case transistorized receivers are described which may be purchased from our advertisers at a reasonable cost. We also suggest that the Raytheon book on transistors be inspected for ideas on this subject.

Work over
300 projects
with your
wonderful **HOME**
LABORATORY

Use and keep **ALL** these units to get
all-important **PRACTICAL EXPERIENCE**

MEMBER OF NATIONAL
HOME STUDY COUNCIL

21 INCH

Build and keep D.T.I.'s **NEW**
2 Unit TV Set—ideas for cus-
tom installation. (D.T.I. also
offers home training with-
out the TV set.)

NOW... at home... get D.T.I.'s
amazingly effective **NEW** training in

TELEVISION

RADIO-ELECTRONICS! Nothing else like it for providing real **LABORATORY-TYPE** training at home. Get the kind of thorough, practical experience **YOU NEED** for the kind of progress **YOU WANT** in today's tremendous field of Television, Radio and Electronics. Qualify yourself for real money... interesting work... a wonderfully promising future. And when you finish, D.T.I.'s active Employment Service **HELPS YOU GET STARTED!** Or open your own profitable Television-Radio Service Business.

THOUSANDS OF SUCCESSFUL GRADUATES

Why has D.T.I. become one of the largest training organizations of its kind? Because it provides **EVERY MAJOR HOME TRAINING AID** to help make the subject **EASIER** to learn... **EASIER** to remember—the kind of training so helpful for **REAL PROGRESS**. Students get thorough, up-to-date, practical training that **TAKES ADVANTAGE** of new and improved training developments. Study the **ADVANTAGES** shown on this page. Think what they can mean to **YOU... TO YOUR FUTURE!** Or come to D.T.I.'s big Training Laboratories in Chicago. **MAIL COUPON TODAY** for complete facts—including valuable publication, "89 Ways to Earn Money in Television-Radio-Electronics." Also, valuable information for men subject to **MILITARY SERVICE**.

"One of America's Foremost Television Training Centers"

DeVRY Technical Institute

CHICAGO 41, ILLINOIS

Formerly DeFOREST'S TRAINING, INC.

MAIL COUPON TODAY

DeVRY TECHNICAL INSTITUTE
4141 Belmont Ave., Chicago 41, Ill. Dept. PE-12-B

I would like complete facts including "89 Ways to Earn Money in Television-Radio-Electronics."

Name _____ Age _____

Street _____ Apt. _____

City _____ Zone _____ State _____

D.T.I.'s training is available in Canada.

NEW!

Build and keep D.T.I.'s new **VACUUM TUBE VOLTMETER**... one of the most useful of all test instruments

5 INCH
'SCOPE'

ABOVE: Also build and keep his quality Oscilloscope—almost a "must" for Television servicing.

Remarkable NEW Styrene ELECTRO-LAB*

Insert pictorial diagram or transparent styrene case. (See insert.) Mount parts to follow patterns—using handy "snap in" fasteners. Eliminates wiring errors. Tops for speedy circuit changes... for providing maximum circuit experience in minimum time. Build and operate scores of interesting projects—such as the electronic circuit shown below.

*Trademark

PATENTS APPLIED FOR

Now you can have

BETTER MUSIC
WITH YOUR PRESENT
PHONOGRAPH

by installing the

SHURE "Twin Lever"
Cartridge



You can dramatically improve the tone quality of your present phonograph with the SHURE WC-10 "Twin-Lever" cartridge. With this remarkable new Ceramic Cartridge you can enjoy the luxury of fine music reproduction at low cost.

The WC-10 has a peak-free frequency response from 40 to 13,000 cps. It replaces most 3-speed, plastic cased cartridges, crystal or ceramic, turnover or single needle . . . and is quickly installed on any tone arm with standard 1/2" mounting centers.

The unique "Twin-Lever" design, with each needle on its own shaft, provides improved, individually correct compliance for each record speed.

Needle replacement can be accomplished in seconds—without tools—with the cartridge in the pickup arm.

WC-10 with two sapphire needles—LIST PRICE \$9.50

WC-10D with diamond needle for LP and sapphire needle for 78RPM—LIST PRICE \$34.00

Available from your local SHURE distributor

SHURE BROTHERS, INC., SALES DIVISION
225 W. HURON ST. • CHICAGO 10, ILL.

Please send me detailed information on the SHURE "Twin-Lever" Cartridge.

NAME

ADDRESS

CITY STATE

TLP

All-Band Preselector

■ Why doesn't some manufacturer put out an all-band preselector for the fellows with short-wave receivers. You can get a preselector for the ham bands, but nothing for the broadcast bands.

V. GILLESPIE
Marlboro, Mass.

The RME Company has informed us that they have stopped production of their all-band short-wave preselector. It was known as the DB-22A, and possibly a few are still around and can be purchased from second-hand equipment dealers. Mr. Soules of the Electro-Voice/RME organization has informed us that they do not plan on releasing a new preselector . . . although they may do so if demand appears to warrant such a design.

Photocell Fools Chickens

■ This is a photo of an electric eye gadget I adapted from your January article titled "Photoelectric Rifle Range." I have arranged the circuit so that a clock timer turns on the lights in the chicken house (we have 5000 laying hens) at 6 a.m. The lights stay on until the sunlight actuates



the photocell and shuts the lights off. The chickens need the additional light so that they can see to eat. I followed your instructions to the letter, except that I used a dime store magnifying glass to concentrate the light on the photocell.

RAY CAMPBELL
Sebastopol, Calif.

We greatly appreciate this letter from reader Campbell and want to assure all of our readers that we like to hear how they make out building construction projects which have been published in POPtronics.

Mobile Converter

■ How about a diagram on a mobile converter—one that requires a small amount of parts and funds?

DU WAYNE BOSTOW
Max, No. Dakota

We hope to publish detailed plans on such a converter in the near future.

-30-

POPULAR ELECTRONICS

ARE YOU TOO OLD TO LEARN?

not at all, scientists say

New tests show that: your ability to think increases with age; your powers of deduction are greater; your judgment is better.

In the I. C. S. files are thousands of cases of men and women of every age. Their successes, their promotions, their raises prove that men and women past school age can learn!

I. C. S. GIVES YOU EXPERT GUIDANCE FREE! Do you have the feeling you're "stuck" in your job? Your trained I. C. S. counselor will appraise your abilities, help you plan for the future.

IT'S NEVER TOO LATE TO GET STARTED! You study with I. C. S. at home, in your spare time. There's no interference with business or social activity. Famous I. C. S. texts make learning easy. Don't delay. Pick your field from the coupon below. And mail it today!



3 FREE BOOKS

36-page, pocket-size guide to advancement, a gold mine of tips on "How to Succeed." Big catalog outlining opportunities in your field of interest. Also sample lesson (Mathematics).

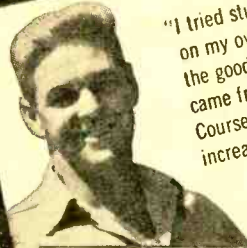

"I tried studying my work on my own, but I never got the good out of it that came from my I. C. S. Course. My salary has been increased 73.3%!"
E.L.B.
Ohio

"I am president of a small corporation. A year ago I enrolled with I. C. S. as the most practical means available to me to learn what I needed."

W.J.A.
Michigan



"It's been so long since I went to school, I've forgotten much. But now that I'm taking an I. C. S. Course, I have confidence in my ability again."

H.A.R.
New Jersey



Actual statements. Posed by models.

For Real Job Security—Get an I. C. S. Diploma! I. C. S., Scranton 9, Penna. Member, National Home Study Council

INTERNATIONAL CORRESPONDENCE SCHOOLS



BOX 99295L, SCRANTON 9, PENNA.

(Partial list of 277 courses)

Without cost or obligation, send me "HOW TO SUCCEED" and the opportunity booklet about the field BEFORE which I have marked X (plus sample lesson):

ARCHITECTURE and BUILDING CONSTRUCTION

- Air Conditioning—Refrig.
- Architecture
- Architectural Interior
- Building Contractor
- Building Maintenance
- Carpenter and Mill Work
- Estimating
- Heating
- Painting Contractor
- Plumbing
- Reading Arch. Blueprints

ART

- Cartooning
- Commercial Art
- Fashion Illustrating
- Magazine Illustrating
- Show Card and Sign Lettering
- Sketching and Painting

AUTOMOTIVE

- Auto Body Rebuilding
- Auto Elec. Technician
- Auto-Engine Tune Up
- Automobile

AVIATION

- Aeronautical Engineering Jr.
- Aircraft & Engine Mechanic

BUSINESS

- Advertising
- Bookkeeping and Accounting
- Business Administration
- Business Correspondence
- Public Accounting
- Creative Salesmanship
- Federal Tax
- Letter-writing Improvement
- Office Management
- Professional Secretary
- Retail Business Management
- Sales Management
- Stenographic-Secretarial
- Traffic Management

CHEMISTRY

- Analytical Chemistry
- Chemical Engineering
- Chem. Lab. Technician
- General Chemistry
- Natural Gas Prod. & Trans.
- Petroleum Engineering
- Plastics
- Pulp and Paper Making

CIVIL, STRUCTURAL ENGINEERING

- Civil Engineering
 - Construction Engineering
 - Highway Engineering
 - Reading Struct. Blueprints
 - Sanitary Engineering
 - Structural Engineering
 - Surveying and Mapping
- ### DRAFTING
- Aircraft Drafting
 - Architectural Drafting
 - Electrical Drafting
 - Mechanical Drafting
 - Mine Surveying and Mapping
 - Plumbing Drawing and Estimating
 - Structural Drafting
- ### ELECTRICAL
- Electrical Engineering
 - Electrical Maintenance
 - Electrician
 - Contracting
 - Lineman
- ### HIGH SCHOOL
- Commercial
 - Good English
 - High School Subjects
 - Mathematics

LEADERSHIP

- Foremanship
 - Industrial Supervision
 - Leadership and Organization
 - Personnel-Labor Relations
- ### MECHANICAL AND SHOP
- Gas—Electric Welding
 - Heat Treatment
 - Metallurgy
 - Industrial Engineering
 - Industrial Instrumentation
 - Industrial Supervision
 - Internal Combustion Engines
 - Machine Design-Drafting
 - Machine Shop Inspection
 - Machine Shop Practice
 - Mechanical Engineering
 - Quality Control
 - Reading Shop Blueprints
 - Refrigeration
 - Sheet Metal Worker
 - Tool Design
 - Toolmaking
- ### RADIO, TELEVISION
- Industrial Electronics
 - Practical Radio TV Eng'ing
 - Radio and TV Servicing
 - Radio Operating

STEAM AND DIESEL POWER

- Television Technician
 - RAILROAD
 - Air Brakes
 - Car Inspector
 - Diesel Locomotive
 - Locomotive Engineer
 - Section Foreman
- ### TEXTILE
- Combustion Engineering
 - Diesel—Elec.
 - Diesel Eng's
 - Electric Light and Power
 - Stationary Fireman
 - Stationary Steam Engineering
- ### MISCELLANEOUS
- Carding and Spinning
 - Cotton, Rayon, Woolen Mfg.
 - Finishing and Dyeing
 - Loom Fix'g
 - Textile Des'ing
 - Textile Eng'g
 - Throwing
 - Warping and Weaving
 - DOMESTIC REFRIGERATION
 - Marine Engineering
 - Ocean Navigation
 - Professional Engineering
 - Short Story Writing
 - Telephony

Name _____ Age _____ Home Address _____

City _____ Zone _____ State _____ Working Hours _____ A.M. to P.M. _____

Occupation _____

Canadian residents send coupon to International Correspondence Schools, Canadian, Ltd., Montreal, Canada. . . . Special tuition rates to members of the U. S. Armed Forces.

ALLIED'S OWN KNIGHT ELECTRONIC KITS... better by far...easiest to build...and you SAVE MORE



NEW!
Sensational Value
"Space Spanner"
Band-Switching
Receiver Kit

THRILLING SHORT WAVE AND BROADCAST

Model S-243 All-new 2-band receiver in easy-to-build kit form at a very low price. Pulls in thrilling short-wave (6 to 17 mc) and standard broadcast, plus amateur, aircraft, police and marine radio. Features special regenerative circuit; highly sensitive on broadcast band. Bandswitch selects broadcast or short wave. Has 4" PM speaker and beam-power output tube for plenty of volume; headphone connectors for weak signal listening; slide switch cuts out speaker. Employs 12AT7 regenerative detector and audio amplifier; 50C5 power output; 35W4 rectifier. Six controls; Bandsread; Main Tuning; Antenna Trimmer; Bandswitch; Regeneration; Audio Gain. Panel finished in attractive gray with black knobs. Includes all parts, punched chassis and tubes. 7 x 10 1/2 x 6"; for 110-120 v. 50-60 cycles AC or DC. Shpg. wt., 4 1/2 lbs.

Model S-243. Net F.O.B. Chicago, only.....\$13.95
Model J-110. Dual Headset for above. Net.....\$1.79
Model C-100. Antenna Kit for above. Net.....\$1.05

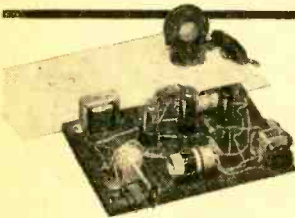

**Famous Knight
10-in-1 Electronic
Lab Kit**

Model S-265
\$12.45

BUILD ANY OF 10 FASCINATING PROJECTS

Instructive! Ideal for experimenters, beginners—fun to build! Construct a sensitive Broadcast Receiver; Amplifier (for phono or mike); Wireless Phono Oscillator; Home "Broadcast Station"; Code Practice Oscillator; Capacity-Operated Relay, or any one of four other fascinating projects. Kit includes mounting board, tubes, all parts, hardware, microphone, and 12-page builders' manual. For 110-120 v., 50-60 cycle AC. Shpg. wt., 10 lbs.

Model S-265. "10-in-1" Kit. Net F.O.B. Chicago...\$12.45
Model J-112. Headphone. Net.....98c
Model P-003. Phototube for Photo Relay project. Net. 2.00
Model H-024. 4-Prong Socket for Phototube. Net.....8c

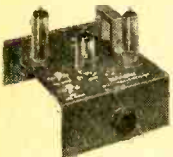

**Knight Wireless
Broadcaster Kit**

Model S-705
\$8.75
Featured in
"Popular Electronics"
May 1955 issue

Highly efficient wireless broadcaster for "broadcasting" with phonograph or mike to any standard radio up to 50 ft. away with no connection to set. Use with crystal or magnetic cartridge or mike (crystal or high-impedance dynamic). Delivers clear, well-modulated signal with minimum distortion. 4 1/2 x 5 x 6". A fascinating project. For 110-120 v., 50-60 cycles AC or DC. Complete with tubes, chassis, all parts and easy instructions. Shpg. wt., 3 lbs.

Model S-705. Wireless Broadcaster Kit. Net.....\$8.75
Model S-556. Crystal Microphone. Net.....\$3.95

KNIGHT Kits are the last word in electronic design, fascinatingly easy to build, satisfying to use. They're a pleasure to assemble—you just follow the outstanding easy "Step-and-Chek" instructions. All **KNIGHT** Kit parts are premium quality to assure top performance. **ALLIED**—the reliable name in Electronics—offers you the very best equipment in **KNIGHT** Kits—and **SAVES YOU MONEY!**



**Knight Vacuum Tube
Voltmeter Kit (VTVM)**
NEWEST PRINTED CIRCUIT

Model F-125 New, stable, accurate. Entire chassis is a printed circuit board. Maximum convenience in arrangement of scales and controls. With peak-to-peak scale for FM and TV work. Ranges: AC peak-to-peak volts, 0-4-40-140-1400-4000; AC rms volts and DC volts, 0-1-5-5-15-50-150-500-1500; ohms, 0-1000, 10K, 100K; 1-10-100-1000 megs; db scale, -10 to +5. Complete kit, ready for easy assembly. Shpg. wt., 6 lbs. Prices are net F.O.B. Chicago.

\$24.95

Model F-125. Printed Circuit VTVM Kit. Net.....\$24.95
Model F-126. Hi-Voltage Probe; extends DC to 50,000 v. .450
Model F-127. Hi-Freq. Probe; extends AC to 250 megs..3.45



**Popular Knight
10-Watt Hi-Fi
Amplifier Kit**

Model S-234
\$20.95

Famous for wide response, smooth reproduction, low cost. Frequency response: ± 1 db, 30-20,000 cps at 10 watts. Harmonic distortion less than 0.5% at 10 watts. Intermod. distortion less than 1.5% at full output. Controls: on-off, volume, bass, treble. Input for crystal phono, tuner. Chassis punched for preamp kit. Matches 8 ohm speakers. 14 lbs.

Model S-234. Amplifier Kit. Net F.O.B. Chicago.....\$20.95
Model S-235. Preamp Kit for above. Net.....2.75

ALLIED RADIO

Allied Radio Corp., Dept. 79-M-5
100 N. Western Ave., Chicago 80, Illinois

Please ship me the following **KNIGHT** Kits:.....

My check , money order , for \$..... enclosed.

Name.....

Address.....

City.....Zone.....State.....

SAVE! Order from ALLIED today!

CREI prepares you quickly for success in

The future is in your hands!

The signs for the future are plain for trained men in the electronics industry. It is a tremendous industry, and—at the *present time* there are more jobs than there are trained men to fill them. But—when there's a choice between a trained and untrained applicant, the trained man will get the job.

- BROADCASTING
- TELEVISION
- MANUFACTURING
- COMMUNICATIONS
- SERVICING
- AERONAUTICAL ELECTRONICS

CREI Home Study . . .

The Quick Way to Get There



Since 1927, CREI has given thousands of ambitious young men the technical knowledge that leads to more money and security. The time-tested CREI procedure can help you, too—if you really want to be helped. CREI lessons are prepared by experts in easy-to-understand form. There is a course of instruction geared to the field in which you

want to specialize. You study at your convenience, at your rate of speed. Your CREI instructors guide you carefully through the material, and grade your written work personally (not by machine).

Industry Recognizes CREI Training

CREI courses are prepared, and taught with an eye to the needs and demands of industry, so your CREI diploma can open many doors for you. Countless CREI graduates now enjoy important, good-paying positions with America's most important companies. Many famous organizations have arranged CREI group training for their radio-electronics-television personnel. To name a few: All America Cables and Radio, Inc.; Canadian Broadcasting Corporation; Columbia Broadcasting System; Hoffman Radio Corporation; Glenn L. Martin Company; Magnavox Company; Pan American Airways, Atlantic Division; Radio Corporation of America; Trans-Canada Air Lines; United Air Lines. Their choice for training of their own personnel is a good cue for your choice of a school.

Benefits Felt Right Away

Almost immediately, you feel the benefits of CREI training. Your employer, when informed of your step toward advancement (only at your request), is certain to take new interest in you and in your future. What you learn in CREI Home Study can start helping you do a better job immediately.

PAYS FOR ITSELF QUICKLY. Your very first raise could repay your investment in CREI training, and leave you a profit the very first year. Your increases in pay thereafter are all pure profit, and you'll be prepared for many more promotions and pay raises in the future years of your life.

CREI also offers

Residence Instruction

at the same high technical level—day or night, in Washington, D.C. New classes start once a month. If this instruction meets your requirements, check the coupon for Residence School catalog.

INFORMATION FOR VETERANS. If you were discharged after June 27, 1950—let the new G.I. Bill of Rights help you obtain residence instruction. Check the coupon for full information.

Get this fact-packed booklet—it's free

Called "Your Future in the New World of Electronics," this free illustrated booklet gives you the latest picture of the growth and future of the gigantic electronics world. We'll promptly send your copy. The rest—your future—is up to you.

MAIL THIS COUPON . . . TODAY!

To help us answer your request intelligently, please give the following information:

EMPLOYED BY

TYPE OF PRESENT WORK

SCHOOL BACKGROUND

ELECTRONICS EXPERIENCE

IN WHAT BRANCH OF ELECTRONICS ARE YOU MOST INTERESTED?

CAPITOL RADIO ENGINEERING INSTITUTE

Accredited Technical Institute Curricula—Founded in 1927
3224 16th St., N.W., Dept. 1212-B, Washington 10, D. C.

Send booklet "Your Future in the New World of Electronics" and course outline.

- CHECK FIELD OF GREATEST INTEREST
- PRACTICAL RADIO ELECTRONICS ENGINEERING
 - BROADCAST RADIO ENGINEERING (AM, FM, TV)
 - PRACTICAL TELEVISION ENGINEERING
 - AERONAUTICAL ELECTRONICS ENGINEERING

Name

Street

City

Zone..... State.....

Check: Home Study Residence School Korean Veteran



WHAT'S THE PE ANSWER?

Crossover Networks for Loudspeakers

The reason for my letter is to ascertain whether or not your magazine has published any data on the construction of a crossover network, and whether reprints of this article (if any) are available. I would also greatly appreciate any guide as to sources of information on this subject.

WILLIAM HEARN
San Francisco, Calif.

No material on this subject has appeared in POPULAR ELECTRONICS as yet, but we do have material on hand which will be published in the near future. Our sister publication, RADIO & TELEVISION NEWS, has published two articles on the subject: "Dividing Networks," December 1949; and "Coaxial Speaker Dividing Networks," July 1953.

The actual design of a specific network depends on a number of factors, such as the crossover frequency, output transformer tap, speaker impedances, etc. An extremely simple network which will be satisfactory in many cases is given in Fig. 1(A). A slightly more

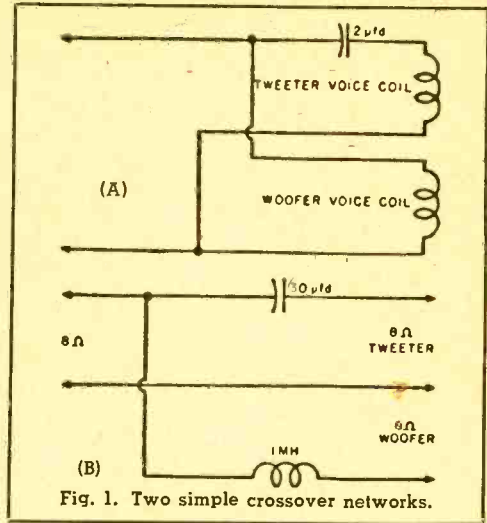

Fig. 1. Two simple crossover networks.

complicated and more effective circuit is given in Fig. 1(B). The inductance must have a low d.c. resistance.

Geiger Tube Substitute

With regard to your article, "Home-Built 700 Volt Geiger Counter," in the July, 1955, issue of POPULAR ELECTRONICS, I would like some information on a proposed circuit change. Would it be possible to substitute a 1B85 GM tube for the 75NB3 without a change in the circuit and/or cir-

Make SURE, SAFE INSULATED ELECTRICAL CONNECTIONS

The New SUPER ~~CLAMP~~ Hand Tool

The ONE Tool for ALL Wire Sizes used in Home Wiring, Appliances, Automobiles.

DOES ALL THESE THINGS BESIDES

CRIMPS Solderless Terminals and Connectors without solder or tape for safe connections.

CUTS Wire, making clean, sharp cut through Insulation and Conductor.

STRIPS Wire sizes #22-#10. Gauges assure proper length for sure, safe crimp.

SHEARS Bolts and screws without damaging threads — no filing or hack sawing.

ORDER DIRECT—USE COUPON

Satisfaction guaranteed or money back. Send check or money order for \$3.95. (Ohio residents add 12c sales tax.)

T. W. Berger, Inc.
National Distributor Consumers and Dealers
AIRCRAFT-MARINE PRODUCTS, Inc.
1315-E American Bldg., Cincinnati 2, Ohio

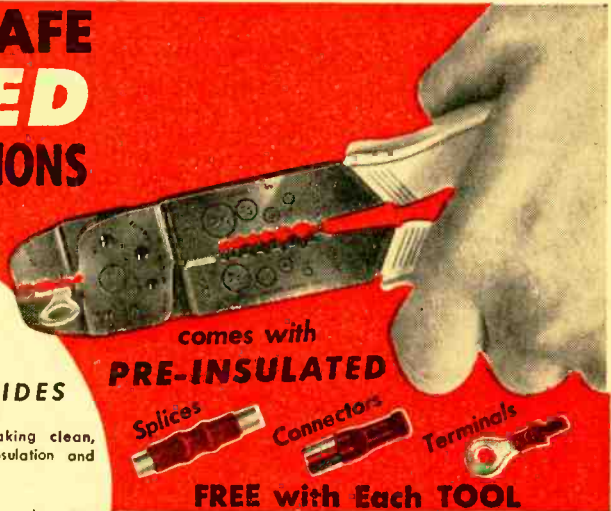

FREE with Each TOOL

T. W. Berger, Inc.
National Distributor Champ Tool
1315-E American Bldg., Cincinnati 2, Ohio
Send me post paid the new super Champ Hand Tool. I am enclosing \$3.95. (Ohio residents add 12c sales tax.)
 check money order

NAME
ADDRESS
CITY.....ZONE.....STATE.....

Only
\$3.95
Post Paid

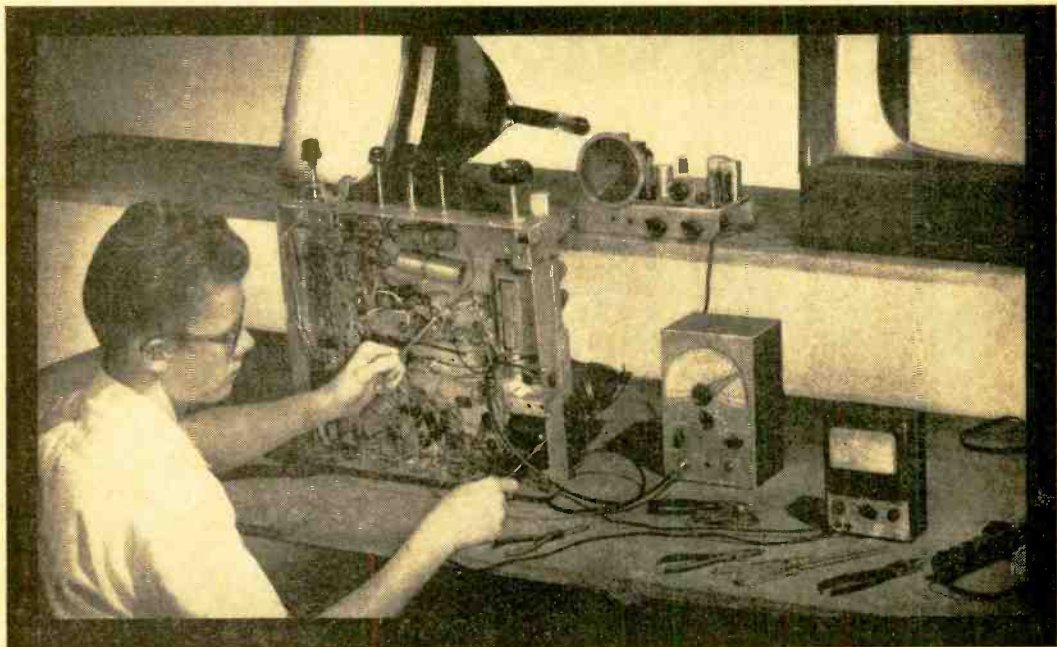

NOW...RCA trains you at home to be an expert technician in

RADIO TV ELECTRONICS • TV SERVICING • COLOR TV SERVICING

NOW THREE HOME STUDY COURSES

... prepared by instructors of RCA Institutes in cooperation with technicians, engineers, and training specialists of RCA. Clearly written... easy to understand... the same high caliber instruction as given in resident classrooms of RCA INSTITUTES.

● **COURSE I—RADIO-TELEVISION ELECTRONICS**—starts you from the ground up to a solid working knowledge of electronics. Without any previous experience, you get a thorough training in radio theory and servicing techniques for AM, FM, home and car radios... plus an introduction to the fundamental theory and practices of television.

● **COURSE II—TELEVISION SERVICING**—prepares you to advance from radio into the expanding field of television servicing as a well-trained service technician. If you have completed Course I or are now working in the field of radio or TV, Course II will show you the many special techniques of trouble-shooting, aligning, checking, and repairing modern black and white TV sets.

NEW TV KIT AVAILABLE WITH

COURSE II—there is no better way to learn than by *doing* and RCA Institutes has developed a large-screen TV KIT available to home study students to build while taking Course II. It has the most modern up-to-date circuitry, actually enabling you to apply at home all the latest servicing techniques.

● **COURSE III—COLOR TELEVISION SERVICING**—covers all phases of color servicing techniques. It is a practical, down-to-earth course in color theory as well as how-to-do-it servicing procedure. A natural move "up" from Course II or for those now employed in TV.

SINCE 1909, RCA INSTITUTES has trained thousands for successful careers in electronics. Many gradu-

ates have established their own paying business. Now this opportunity is available to you at home.

"PAY-AS-YOU-LEARN" PLAN... you pay for one study group at a time, as you progress through the course. Tuition costs are amazingly low. For full details, mail coupon.

A SERVICE OF RADIO CORPORATION OF AMERICA—RCA INSTITUTES is licensed by the N. Y. State Education Department... recommended by radio and television service organizations.

SEND FOR FREE CATALOG NOW



RCA Institutes, Inc., Home Study, PE-125
350 West Fourth Street, N. Y. 14, N. Y.
Without obligation, send me FREE CATALOG on Home Study Courses in Radio, Television and Color TV. No salesman will call.

Name Please Print

Address

City Zone State



RCA INSTITUTES, INC.
A SERVICE OF RADIO CORPORATION OF AMERICA
350 WEST FOURTH STREET, NEW YORK 14, N. Y.

HERSHEL SPECIALS

All New MYSTERY PACKAGE of ELECTRONIC PARTS

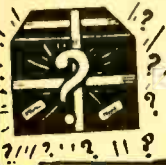

Worth \$40.00

Our Price
\$3.95

It's the surprise of your life! 20 pounds of brand new usable Govt surplus. The ideal gift for home, etc.

We save ship parcel post to save you more money!
Ship Wt. 20-lb.

KIT SPECIALS

KIT 1, HARDWARE
Over 1,000 pcs. Assorted. For Radio & TV **99c**

KIT 2, CERAMICONS
100 Assorted. 75 mmfd. to 6,000 mmfd. **\$2.50**

KIT 4, Rotary Switches
25 Assorted. Terrific Buy! **\$2.50**

KIT 5, RESISTORS
100 Assorted. 1 ohm to 15 meg. 1/2 to 5 watts **\$1.75**

HI GAIN DYNAMIC MIKE KIT

Uses UTC Transformer and Western Electric Mike. Ideal for Home, PA, CAP, Recording, Mobile Equip. .50 DB/ft. 7500 CPS. Diagram Furnished **\$1.95**

PHOTO ELECTRIC CELL

95c CE Vacuum Cell used in AMPRO Sound Projector. Also useful for opening garage doors and Alarm Systems.

MAKE YOUR XMAS

GIFT SELECTION EARLY

KIT 6, RF CHOKES
25 Assorted Range from .5MH to 25MH **95c**

KIT 7, TOGGLE AND SLIDE SWITCHES
25 Assorted. D.P.S.T.—D.P.D.T. S.P.S.T., etc. **\$3.25**

KIT 8, PAPER AND CAN CONDENSERS
25 Assorted. Range from 4Mfd—150V to 80Mfd.—450V. **\$2.75**

KIT 9, KNOBS
100 Assorted. Push-On and Set Screw types **\$1.75**

KIT 10, MICAS AND SILVER MICAS
100 Assorted. Range from 10mmfd. to 7500mmfd. **\$2.50**

KIT 11, BATH-TUB OIL CONDENSERS
25 Assorted. Range from .1 Mfd. to 2 Mfd. up to 600 VDC. **\$1.50**

KIT 12, HI WATTAGE RESISTORS
20 Assorted. Range from .75 ohm to 20,000 ohm. 10 up to 200 watts. **\$3.25**

KIT 13, TUBE SOCKETS
50 Assorted. 4-5-6-7-8-9 pin types **\$2.50**

SQUIRREL CAGE BLOWER

28V 7500 RPM Will operate AC-DC 110 Volts with 120 ohm 100 watt resistor 7" x 4" x 4" **\$3.95**

VARIABLE CONDENSERS YOUR CHOICE

95c
TYPE A 100 MMFD—Double Spaced size 2 3/4" x 1 1/2" H. Hammarlund Mfg. 1/4" Shaft 0-10 Manual for coil tuning, etc. 3 for \$1.00

OIL CONDENSER

\$1.65
2 Mfd. 3000 VDC. Paranol Oil W Mounting Brackets New. removed from equip. Size 4 3/4" x 4 1/4" x 2 1/4"

ARC-5 COMMAND TRANSMITTER YOUR CHOICE

\$6.95
2.1 to 3 MC. 7.1 to 9.1 MC. Brand New in Carton with tubes. HOTTEST BUY IN THE COUNTRY

AUDIO CHOKE

4500 ohm Ideal for radio control, airplanes, boats, etc. Size 1 1/2" x 5/8" x 5/8". Wt. 1/2 oz. **95c**

TERMS: Cash with order or 25% DOWN—BALANCE C.O.D. ALL PRICES NET F.O.B. DETROIT MINIMUM ORDER \$2.00

HERSHEL RADIO CO.

5249 GRAND RIVER
Detroit 8, Michigan
Phone TYler 8-9400

circuit components. If not too drastic a change is required, would you please advise me of such.

LARRY STANGE
29 Palms, Calif.

The 1B85 GM tube requires 900 volts for normal operation, and so cannot be substituted directly for the type 75BN3, which operates at 700 volts. Extensive circuit changes in the switching circuit (S1) and the use of a different switch would be necessary to obtain 900 volts.

Shorted Line Bypass Capacitor

In the September issue of PE, "Carl & Jerry" referred to a shorted primary bypass capacitor as producing a shock hazard between chassis and an external ground. Would not the same situation arise because of the fact that the center tap of the high-voltage secondary is also grounded?

EDWARD IANNI
Philadelphia, Pa.

No. The shock hazard arises from the fact that the chassis is connected to the hot side of the line if a short occurs as indicated. Thus, a person connected to an external ground, such as a damp floor, water pipe, radiator, etc., will be exposed to the full line voltage if he touches the chassis.

Power Transformer Ratings

One of the many "puzzlers" that I have come across is the following problem on transformers. In a TRF tuner using a 6BA6, 12AU7 and 5V3GT, a transformer rated as 250-0-250 volts (r.m.s.) at 40 ma. is specified for the power supply section. I looked over several jobbers' catalogs (as one POPULAR ELECTRONICS article suggested), and found a Thordarson 22R00 rated at 250-0-250 volts at 40 ma.; 5 volts at 2 amp.; 6.3 volts at 2.0 amp. I have no question about the high voltage or rectifier windings, but according to the tube manual, a 6BA6 and 12AU7 in parallel require only 0.6-amp. current for the heaters. This means 1.2-amp. overload on the tube heaters, or am I wrong? I cannot find a 500-volt c.t. power transformer with a 0.6-amp. rating for the heater windings.

WALLACE IZUO
Honolulu, T. H.

A rating of 2.0 amperes for a 6.3-volt heater winding means that this winding can provide up to 2.0 amperes without overheating. It does not mean that it will force 2.0 amperes through any combination of tube heaters connected across it. If a tube is rated at 6.3 volts, 0.3 ampere, it will draw only 0.3 ampere when connected across the 6.3-volt transformer winding, regardless of the current rating of the winding.

Line Bypass Capacitors

What does the manufacturer gain by bypassing each side of the line with a .05- μ fd. capacitor? It must be a considerable advantage to warrant such practice and I'd like to know what it is.

CARL WILSON
Oxnard, Calif.

The purpose of the capacitor on either side of the 117-volt line is to bypass noise impulses and stray r.f. signals to ground. Such capacitors should be of high quality, because line voltage may be across one or the other when the equipment is in operation, and a short in the capacitor could be a short across the line.

INTERESTED IN RADIO-TV-ELECTRONICS?

THEN YOU WILL WANT TO KNOW

**WHAT IS
The FCC?**



CARL E. SMITH, E.E.
President

It's amazing what the future holds for you in this modern world of electronics. Let me send you the entire story—FREE!

- How to pass the FCC Exam.
- A Sample FCC lesson.
- Money making FCC License Information.

I can train you to pass the Valuable FCC exam in a minimum of time—if you have any practical radio experience—a fair knowledge of mathematics—and are mechanically inclined.

JOIN THE LIST OF SUCCESSFUL ELECTRONIC TECHNICIANS HERE'S PROOF

	License	Time
✓ Harry G. Frame, Box 429, Charleston, W. Va.	2nd Class	13 weeks
✓ Charles Ellis, Box 449, Charles City, Iowa	1st Class	28 weeks
✓ Omar Bibbs, 1320 E. 27th St., Kansas City, Mo.	1st Class	34 weeks
✓ Kenneth Rue, Dresser, Wisconsin	2nd Class	20 weeks
✓ B. L. Jordan, Seattle, Washington	1st Class	20 weeks

AND THOUSANDS MORE!



NATIONAL HOME
STUDY COUNCIL

Approved Member

**THROUGH US—START BUILDING FOR A
PROFITABLE LIFETIME PROFESSION**

HOW CAN I GET A VALUABLE
FCC COMMERCIAL OPERATOR'S **LICENSE**
My Passport To Future Security

GET THESE FREE



These Three Booklets Tell You

- 1 Where to apply to take FCC Examinations.
 - 2 Scope of knowledge required.
 - 3 Necessary FCC exam preparation.
 - 4 Positive knowledge check.
- And additional data of great value.

Your Guarantee—

WE GUARANTEE to train and coach you at home until you pass the all-important FCC examination . . . If you fail to pass after completing our course, we will continue your training without additional cost until you successfully obtain your commercial license—provided you first sit for this examination within 90 days after completing our course.

**EMPLOYERS MAKE JOB OFFERS
EVERY MONTH!**

**YOUR FCC TICKET IS RECOGNIZED
BY MOST EMPLOYERS IN THE
ELECTRONICS FIELD AS PROOF OF
YOUR TECHNICAL ABILITY.**

**PAVE THE WAY FOR YOUR SHARE
OF THE BETTER THINGS IN LIFE.**

CLEVELAND INSTITUTE OF RADIO ELECTRONICS
4900 Euclid Ave. Cleveland 3, Ohio

MAIL COUPON TODAY

CLEVELAND INSTITUTE OF RADIO ELECTRONICS
4900 EUCLID AVE., DESK **FE-7**
CLEVELAND 3, OHIO
(ADDRESS TO DESK NO. TO AVOID DELAY)
I want to know the facts, without obligation, how I can get my FCC ticket in a minimum of time. Rush me your FREE booklet "How to Pass FCC License Examination" (does not cover exams for Amateur License) as well as sample FCC-type exam and the amazing new booklet, "Money-Making FCC License Information." PLEASE PRINT CLEARLY

NAME AGE

ADDRESS

CITY STATE

PASTE ON A 2 CENT POSTCARD OR SEND AIRMAIL
Special tuition rates to members of the U. S. Armed Forces

LIFETIME GUARANTEED TUBES

BRAND NEW PICTURE TUBES

• RCA Licensed.
• One Year Unconditional Guarantee.

Type	Price	Type	Price
10BP4	\$11.90	17BP4	\$20.63
12LP4	14.38	19AP4	24.81
14BP4	16.85	21AP4	28.79
16RP4	19.38	21EP4	28.79
16LP4	19.38	24AP4	42.50

Picture Tubes shipped F.O.B. Harrison, N.J.

NEW INDOOR ANTENNA

Both UHF and VHF. Brings better reception than most outdoor antennas. Use on top of TV.
List Price \$9.95. \$3.99 each

YOUR PRICE \$3.29 each Lots of 3

FREE BONUS BOX With Every \$25 Order

- 1 RCA Cheater Cord
- 10 Assorted resistors
- 10 Assorted 2 Color "blank" tube cartons
- 1 6B2GT tube
- 1 6AU6 tube
- 1 6CB6 tube

FREE CLOCK RADIO

With Every \$125 Purchase Within 30 Days Wakemaster clock radio with famous Sessions clock movement wakes you up to music or alarm. May be used outright from MAJOR BRAND for \$17.95. In ivory or rust.

FREE GIFT CERTIFICATE*

Worth \$5 toward the purchase of any of our merchandise on future orders will be sent with any order of \$50 or more. *Free Gift Certificate cannot be used to obtain another certificate unless order is \$55 or more.

WE PAY ALL POSTAGE on orders shipped in USA, Territories and APO's. Send only purchase price of merchandise. Please include approximate postage on foreign shipments. All orders subject to prior sale. Add 25c handling on orders under \$5.00. Quantity users write for special discount.

Write For FREE Tube List-Order Blank—and FREE Sample Tube Carton. We want Y-O-U On Our Mailing List!

• We guarantee to replace tubes labeled MAJOR BRAND forever. Each Tube Individually Boxed And Guaranteed For Life • Over A Half Million Tubes Always In Stock • Immediate Shipment • Free Postage On All Orders With Full Remittance.

HERE'S HOW LIFETIME GUARANTEED TUBES

• There are fewer "call backs" • There are no "out of date" tubes "Peak Performance" testing in our fully equipped Testing Department before shipment guarantees quality.

OZ4		3CB6		52		6L7		7C7		7D7		14B6	
1A4P	.43	304	.46	6B4G	.52	6N7	.42	7E5	.45	14Q7	.50	14Q7	.50
1A7GT	.33	3Q5GT	.57	6B6	.69	6N7	.40	7E6	.55	19GG6G	1.15	19GG6G	1.15
1B3GT	.65	3S4	.47	6BA6	.47	6Q7	.40	7E7	.70	19T8	.65	19T8	.65
1CSGT	.44	3V4	.47	6C5	.47	6S4	.40	7E7	.70	19T8	.65	19T8	.65
1D5GP	.43	5BQ7	.89	6C7	.80	6S4	.40	7E7	.70	19T8	.65	19T8	.65
1E7GT	.41	4B27	.95	6BE6	.45	6S7	.45	7F7	.59	24A	.39	24A	.39
1G6GT	.41	5AW4	.75	6BF5	.40	6S7	.45	7F7	.59	24A	.39	24A	.39
1H4G	.43	5J6	.63	6BF6	.50	6S7	.45	7F7	.59	24A	.39	24A	.39
1H5GT	.47	5T4	.69	6BG6G	1.15	6S7	.45	7F7	.59	24A	.39	24A	.39
1J6GT	.47	5U4G	.43	6BM6	.50	6S7	.45	7F7	.59	24A	.39	24A	.39
1L4	.45	5U8	.74	6B6	.47	6S7	.45	7F7	.59	24A	.39	24A	.39
1L6	.55	5V4G	.59	6B6	.47	6S7	.45	7F7	.59	24A	.39	24A	.39
1L4A	.57	5Y3	.31	6B6	.47	6S7	.45	7F7	.59	24A	.39	24A	.39
1L4G	.47	5Y4G	.36	6B6	.47	6S7	.45	7F7	.59	24A	.39	24A	.39
1L8A	.57	5Z3	.41	6B6	.47	6S7	.45	7F7	.59	24A	.39	24A	.39
1LC5	.49	6A7	.57	6B6	.47	6S7	.45	7F7	.59	24A	.39	24A	.39
1LC6	.47	6A8	.45	6B6	.47	6S7	.45	7F7	.59	24A	.39	24A	.39
1LD5	.57	6A8A	.43	6B6	.47	6S7	.45	7F7	.59	24A	.39	24A	.39
1LE3	.57	6A7	.67	6B6	.47	6S7	.45	7F7	.59	24A	.39	24A	.39
1LQ5	.57	6A7A	.43	6B6	.47	6S7	.45	7F7	.59	24A	.39	24A	.39
1LH4	.64	6A7A	.79	6B6	.47	6S7	.45	7F7	.59	24A	.39	24A	.39
1LN5	.47	6A7G	.69	6B6	.47	6S7	.45	7F7	.59	24A	.39	24A	.39
1NSGT	.50	6A7G	.69	6B6	.47	6S7	.45	7F7	.59	24A	.39	24A	.39
1RS	.50	6A7G	.69	6B6	.47	6S7	.45	7F7	.59	24A	.39	24A	.39
1S5	.42	6A5	.54	6D6	.48	6S7	.45	7F7	.59	24A	.39	24A	.39
1T4	.50	6A5	.54	6D6	.48	6S7	.45	7F7	.59	24A	.39	24A	.39
1U4	.42	6A5	.54	6D6	.48	6S7	.45	7F7	.59	24A	.39	24A	.39
1U5	.42	6A5	.54	6D6	.48	6S7	.45	7F7	.59	24A	.39	24A	.39
1V2	.65	6A5	.54	6D6	.48	6S7	.45	7F7	.59	24A	.39	24A	.39
1X2	.61	6A5	.54	6D6	.48	6S7	.45	7F7	.59	24A	.39	24A	.39
2A3	.55	6A5	.54	6D6	.48	6S7	.45	7F7	.59	24A	.39	24A	.39
2A5	.57	6A5	.54	6D6	.48	6S7	.45	7F7	.59	24A	.39	24A	.39
2A7	.55	6A5	.54	6D6	.48	6S7	.45	7F7	.59	24A	.39	24A	.39
3A4	.51	6A5	.54	6D6	.48	6S7	.45	7F7	.59	24A	.39	24A	.39
3A5	.50	6A5	.54	6D6	.48	6S7	.45	7F7	.59	24A	.39	24A	.39
3A5	.45	6A5	.54	6D6	.48	6S7	.45	7F7	.59	24A	.39	24A	.39
3A6	.48	6A5	.54	6D6	.48	6S7	.45	7F7	.59	24A	.39	24A	.39
3BC5	.54	6A5	.54	6D6	.48	6S7	.45	7F7	.59	24A	.39	24A	.39
3BN6	.70	6A5	.54	6D6	.48	6S7	.45	7F7	.59	24A	.39	24A	.39

This Ad Is Worth M-O-N-E-Y. Clip out this ad and attach it to your order. Three 6SN7G's will be shipped FREE with any order of \$10 or more.

Write Dept. 12 PE

MAJOR BRAND TUBE CO.

Romano Bldg. ESsex 4-1106 Harrison, N. J.



- READS DIRECTLY ON METER**
- FILAMENT CONTINUITY
 - LEAKAGE
 - INTERMITTENT CONDITIONS OF SHORTS OR OPENS
 - SHORTED ELEMENTS
 - GAS CONTENT
 - QUALITY ON A "BAD-GOOD" SCALE
 - OPEN ELEMENTS (CHECKS ACTUAL RESISTANCE OF WELD INDICATING QUALITY OF WELD)
- For further information write

Because You Asked for It!

NEW! DIFFERENT! HOLLYWOOD

CRT DYNAMIC RESTORER

ONLY \$49.95 AT YOUR DISTRIBUTORS

STANDARD RETMA WARRANTY

NO MORE NEON LAMPS!

READS ALL CONDITIONS ON A HIGHLY SENSITIVE, ILLUMINATED METER

- ELIMINATES OXIDATION
- RESTORES EMISSION
- WELDS OPEN ELEMENTS
- REMOVES SHORTS AND LEAKAGE —DISPERSES GAS

SPECIALLY DESIGNED TRANSFORMER PRODUCES MOST SUCCESSFUL CATHODE WELD

ANOTHER HOLLYWOOD FIRST!
New KILOVOLTAGE measures to 30 KV. Instrument complete with HV PROBE **\$995**

HOLLYWOOD INSTRUMENT CO.

206 S. MAIN ST. ROYAL OAK, MICHIGAN

ORIGINAL DESIGNERS OF CRT RESTORING INSTRUMENTS, MFRS. OF MIDWEST CATHODE BEAMER

POPULAR ELECTRONICS



Get more money!
More security! More out of life!



Learn TELEVISION • RADIO • ELECTRONICS

Get the best!

Get National Schools' SHOP-METHOD HOME TRAINING!

Start now! Why wait around for that raise or promotion that may never come? Get started *now* in high-paying TV-Radio-Electronics! National Schools' SHOP METHOD Home Training prepares you for success in a top-salary job or in your own business. You learn *all three*... Television, Radio, Electronics... in one complete course. Our Shop-Tested lessons and manuals help you master all phases in shortest possible time! Send coupon, find out today!

WHY NATIONAL SCHOOLS LEADS THE FIELD

Located in the "Television Center" of the world, our staff is in close touch with latest developments and opportunities. We give you personalized job placement assistance. We also give you confidential help with both technical and personal problems relating to your training. We show you how to make Part Time Earnings as you progress. Whether you live 30 miles away, or 3,000, you will always be pleased with our prompt, friendly service!

DRAFT AGE? Our home training helps you achieve specialized ratings and higher pay grades if you go in service.

We send you this precision-tested Multitester! Plus parts to build Oscillators, Receivers, Signal Generator, Continuity Checker, Combination Short Wave and Standard

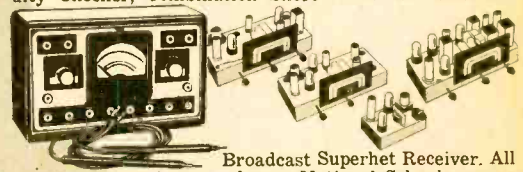

Broadcast Superhet Receiver. All this equipment is part of your National Schools course. **NO EXTRA CHARGES!** Send coupon for free books!

NATIONAL SCHOOLS, world-famous technical trade school. Now entering our 50th year!



NATIONAL SCHOOLS TECHNICAL TRADE TRAINING SINCE 1905

LOS ANGELES 37, CALIFORNIA
In Canada: 811 W. Hastings St., Vancouver, B. C.

- APPROVED FOR G. I. TRAINING
- BOTH HOME STUDY AND RESIDENT COURSES OFFERED

30 MILLION TV SETS

need regular repair! Color TV means more sets than ever before. NOW is the golden opportunity to cash in on this multi-billion-dollar industry. Or "write your own ticket" in broadcasting, manufacturing, and other specialized phases!

**YOUR AGE
IS NO
OBSTACLE!**



**Send for
FREE LESSON!**
FREE BOOK & SAMPLE LESSON
will convince you!
SEND COUPON TODAY!

MAIL NOW TO OFFICE NEAREST YOU!

(mail in envelope or paste on postal card)

NATIONAL SCHOOLS, DEPT. R2G-125

4000 SOUTH FIGUEROA STREET OR 323 WEST POLK STREET
LOS ANGELES 37, CALIFORNIA CHICAGO 7, ILLINOIS

Please rush **FREE BOOK**, "My Future in Radio-Television-Electronics," and **FREE LESSON** at once. I understand there is no obligation, and no salesman will call.

NAME _____ BIRTHDAY _____ 19 _____

ADDRESS _____

CITY _____ ZONE _____ STATE _____

Check if interested **ONLY** in Resident Training at Los Angeles.

VETERANS: Give date of discharge _____

Now! Your choice of backings

each with "Scotch" Brand's proven potent oxide



Famous acetate-backed "Extra Play" Tape 190 new economy price saves you 28%.

Here's your chance to buy the magnetic tape everyone's talking about—at a special *new economy price!* It's popular "SCOTCH" Brand "Extra Play" Magnetic Tape 190, first long play tape on the market and *still* the best seller. With 50% more recording time on every reel...higher fidelity...strength to spare...high potency oxide... "SCOTCH" "Extra Play" Magnetic Tape 190 has been making recording history. Buy now and save 28% on every reel!



New polyester-backed (Made from DuPont's "Mylar"*) "Extra Play" Tape 150— for extra strength.

Years ago "SCOTCH" Brand pioneered tough polyester-backed magnetic tape for experimental government orders. Now *you* can enjoy the *same* benefits of "SCOTCH" Brand research and development with new "Extra Play" Magnetic Tape 150. "SCOTCH" Brand's extra-strength polyester backing assures you long-lasting recordings...perfect tape performance in all weather, all climates—(It's "Weather-Balanced"! "SCOTCH" Brand's exclusive high-potency oxide coating guarantees you superior recording quality on any machine.

**"Mylar" is a registered Du Pont trade-mark.

Both of these
SCOTCH Brand Magnetic Tapes
offer "Loop-Lok" Reel and
famous high-potency oxide

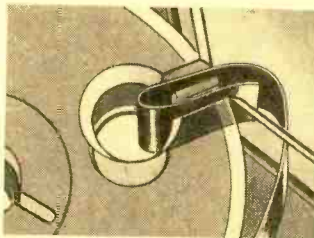

EASIER THREADING with new "Loop-Lok" Reel! Saves time . . . saves tape! It's "SCOTCH" Brand's exclusive "Loop-Lok" reel. Just loop tape around the new-design center pin for instant threading. Tape locks tight without troublesome wrap-around, releases fast at end of reel.

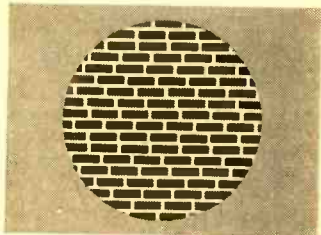

CRISP, BRILLIANT SOUND thanks to newest oxide coating! By laying fine-grain oxide particles in a neat, orderly pattern (as shown here), "SCOTCH" Brand is able to pack in thousands more particles than standard long play tapes—to produce a super-sensitive magnetic recording surface.

SCOTCH BRAND *Extra Play* Magnetic Tapes

The term "SCOTCH" and the plaid design are registered trademarks for Magnetic Tape made in U.S.A. by MINNESOTA MINING AND MFG. Co., St. Paul 6, Minn. Export Sales Office: 99 Park Avenue, New York 16, N.Y. © 3M Co.



POPULAR ELECTRONICS

Electronic Toys for Christmas

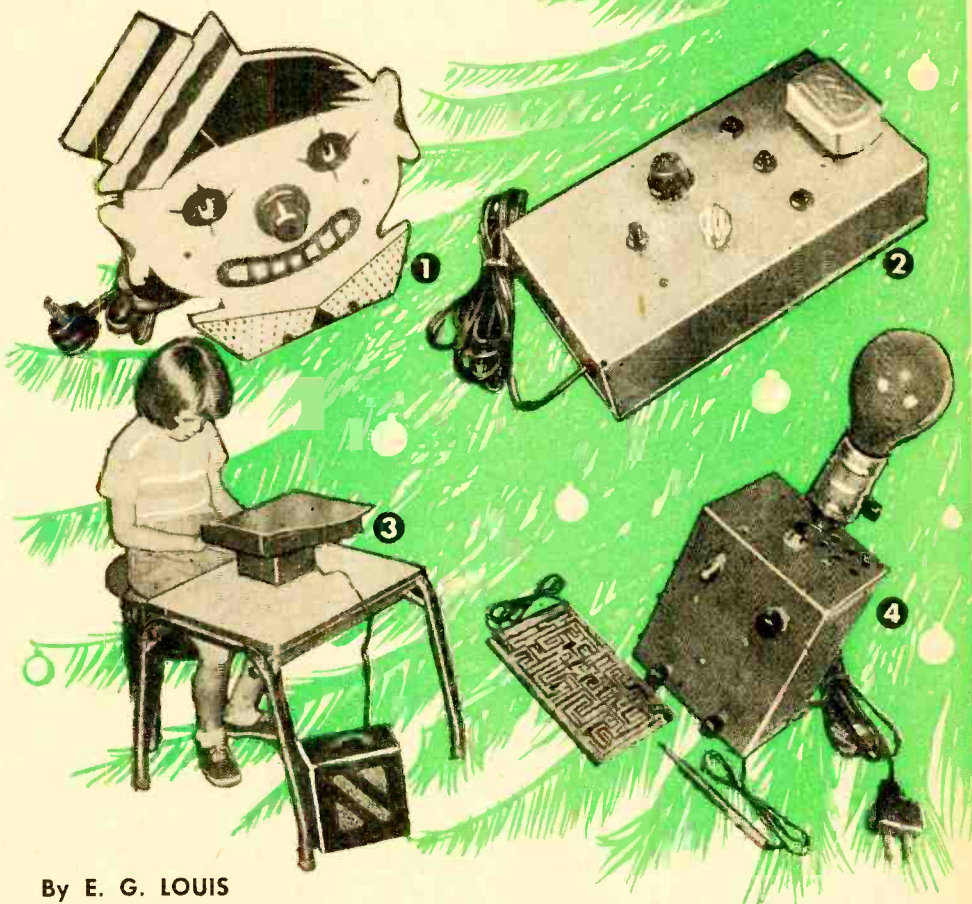

By E. G. LOUIS

Long winter evenings are no problem with these four projects to fall back on—they are all entertaining and instructive

ELECTRONIC toys have tremendous appeal for youngsters of all ages; they combine the newness and "mystery" of science with real play value. Most electronic toys fall into a few simple categories . . . code practice oscillators and blinkers for the novice ham, simple receivers, record players, and electronic oscillator "musical" instruments. But here are four electronic toys which are off the beaten track. They

are both fun to assemble and fun to use, and will bring many hours of pleasure to the user . . . even if he doesn't know an electron from a resistor!

Each toy is described as a separate project, with each designed to have maximum appeal for a particular age group . . . ranging from the very young to mature adults. All four toys are inexpensive and share the common characteristics of

simple design, reliability, and ease of construction.

The "Winking Clown" (Proj. 1) appeals to the very young—those from one to five years of age—but also has some appeal for older children. For the budding young rocket engineer or nuclear scientist, the

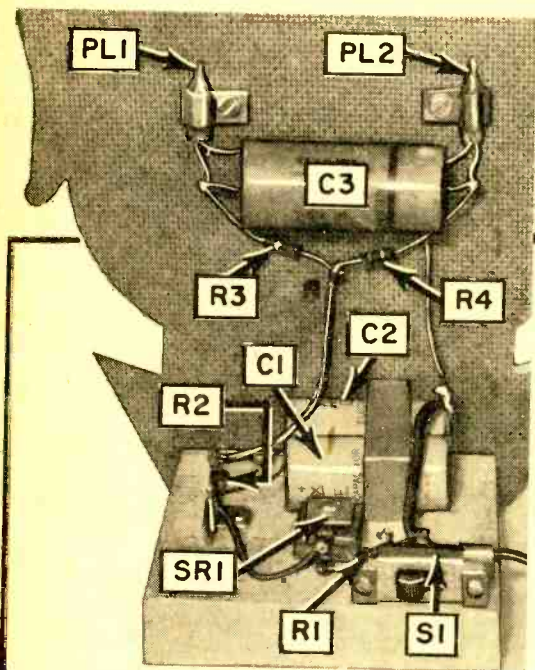
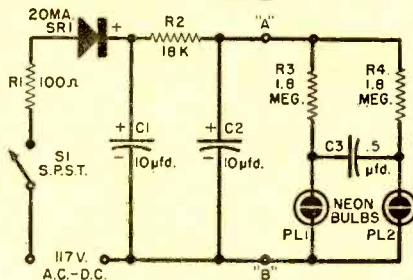
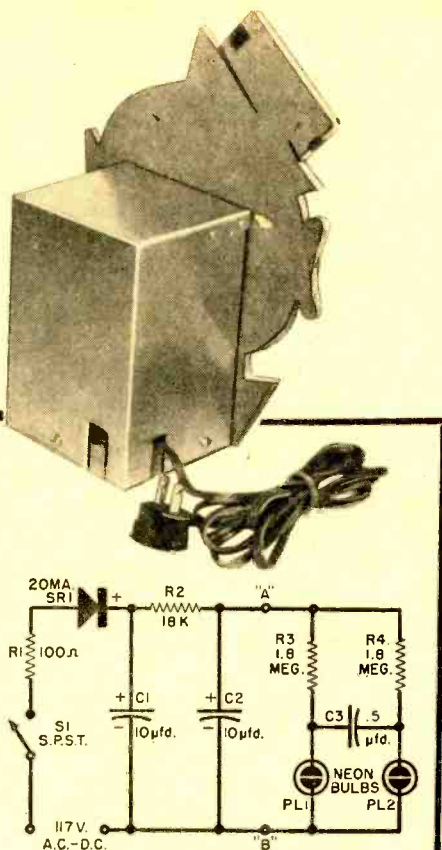

Fig. 1 (above). Rear view of "Winking Clown" with protective cover removed and the various components identified.

Fig. 2 (top, rt.). Rear view of clown with the protective metal cover in place.

Fig. 3 (ctr., rt.). Schematic diagram and parts list for the complete project.



- C1, C2—10- μ fd., 150-volt electrolytic capacitor
 C3—0.5- μ fd., 200-volt paper capacitor
 PL1, PL2—Type NE-2 neon bulb
 R1—100-ohm, $\frac{1}{2}$ -watt resistor
 R2—18,000-ohm, $\frac{1}{2}$ -watt resistor
 R3, R4—1.8 megohm, $\frac{1}{2}$ -watt resistor
 S1—S.p.s.t. slide switch
 SR1—20-ma. selenium rectifier
 1—Line cord and plug
 1—Small metal box for back cover (see text)
 2—Cable clamps for $\frac{1}{4}$ " cable
 1—2-terminal tie point
 1—10" x 10" piece of $\frac{1}{8}$ " Masonite or $\frac{1}{4}$ " plywood
 Misc. solder, wire, screws, brackets, scrap wood, paint, etc.
 Catalog price of parts, approx. \$4.50

"Gadget Box" (Proj. 2) will attract much interest; fun for children in the four to eight age group, it is a good project if a well-stocked junk box is available. With the appeal of an electronic instrument, but the simplicity of an inexpensive toy, the "Electronic Piano" (Proj. 3) is designed to be of maximum interest to the seven to twelve year group, and is also attractive to both younger and older children. Finally, the "Electronic Maze" (Proj. 4) should appeal to everyone from eight to eighty; depending on the individual maze board used, the game may be made simple enough for a young child or difficult enough to serve as a test of skill for the personnel department of an industrial concern.

Project 1—"Winking Clown"

In operation, the "Winking Clown" (Proj. 1) alternately winks his orange glowing eyes as long as power is supplied. Since power consumption is negligible, the soft glow of his eyes may well serve as a good night light for the children's room. The Clown makes a good *double-purpose* project; although the completed toy has maximum appeal for the very young, assembling the project could furnish considerable entertainment to an eleven or twelve-year-

old, who could build the project for a younger brother or sister.

Construction Hints: The circuit for the Clown is given in Fig. 3. Only inexpensive, readily available parts are used. Wiring is straightforward and non-critical. The Clown's face is cut from plywood or hard-board (Masonite) using a jig saw, scroll saw, or similar tool. An original design may be preferred to the one shown for a timely toy, a Santa Claus "face" may be used for Christmas, a rabbit's head for Easter, a cut-out of Uncle Sam for the Fourth of July, or a witch's head, pumpkin, or skull for Halloween. Two narrow slots, approximately $\frac{3}{16}$ " x $\frac{1}{2}$ ", are cut out for the neon bulbs, *PL1* and *PL2*, which are held in place by small cable clamps and screws. Slots may be either horizontal or vertical . . . or round holes may be used if preferred. The face is painted with ordinary paint or enamel . . . the model was painted with fingernail polish!

After the parts are installed according to the diagram (observe proper polarity when wiring the selenium rectifier, *SR1*, and the electrolytic capacitors, *C1* and *C2*), a protective back cover should be added to keep curious fingers out of the wiring. If a battery-operated version is preferred, the line cord, selenium rectifier (*SR1*), power supply resistors and capacitors, *R1*, *R2*, *C1* and *C2*, may be left out. Simply install a 90-volt B battery, with switch, connecting the positive lead at point "A" and the negative lead at point "B" in the circuit (Fig. 3). A Burgess type N60 is a suitable battery.

How the Clown Works: Referring to Fig. 3, resistors *R1* and *R2*, capacitors *C1* and *C2*, and the selenium rectifier *SR1* all form a simple d.c. power supply. *R1* protects the selenium rectifier from burning out during the initial charging of *C1*. Rectifier *SR1* converts the applied a.c. power to pulsating d.c. by half-wave rectification, and resistor *R2*, together with capacitors *C1* and *C2*, form a simple filter to smooth the pulsating d.c., removing all ripple. All of these components may be replaced by a battery, if desired. The "heart" of the circuit is an interlocked relaxation oscillator consisting of *R3*, *R4*, *C3*, and the two neon bulbs.

In operation, when power is applied to the relaxation oscillator circuit, one of the two neon bulbs will "fire" first. Let's say it's the right-hand bulb. Once the bulb fires, it acts almost like a short circuit, and *C3* is charged through *R3* and the bulb. While *C3* is charging, there is insufficient voltage available across the left-hand bulb to fire it. Once *C3* is charged, however, the left-hand bulb will fire, virtually shorting the right-hand bulb and extinguishing it,

then discharging *C3* and charging it through *R4* with a charge of opposite polarity. Once *C3* is charged again (but with opposite polarity), the right-hand bulb will fire, extinguishing the left-hand bulb. This action continues as long as sufficient voltage is applied to fire the bulbs.

The rate of charge and discharge, and hence the rapidity of "winking," depends on the applied voltage and on the values of *R3*, *R4*, and *C3*. As these components are made larger, the Clown "winks" more slowly. As they are made smaller, the Clown "winks" more rapidly. As long as *R3* equals *R4*, each "eye" stays "open" about the same length of time; but if these two resistors are made unequal, one "eye" will remain "open" longer.

Project 2—"Gadget Box"

With a "Gadget Box" similar to the one shown in Fig. 4 in his hands, plus his innate imagination, a child can pilot a submarine in the dark depths of the sea, can control a powerful nuclear power plant, or can fly a rocket ship through the far reaches of outer space. As he manipulates



Fig. 4. Using "Gadget Box"—a trip to the moon, perhaps? There's no limit to the imagination of youngsters playing with Project 2.

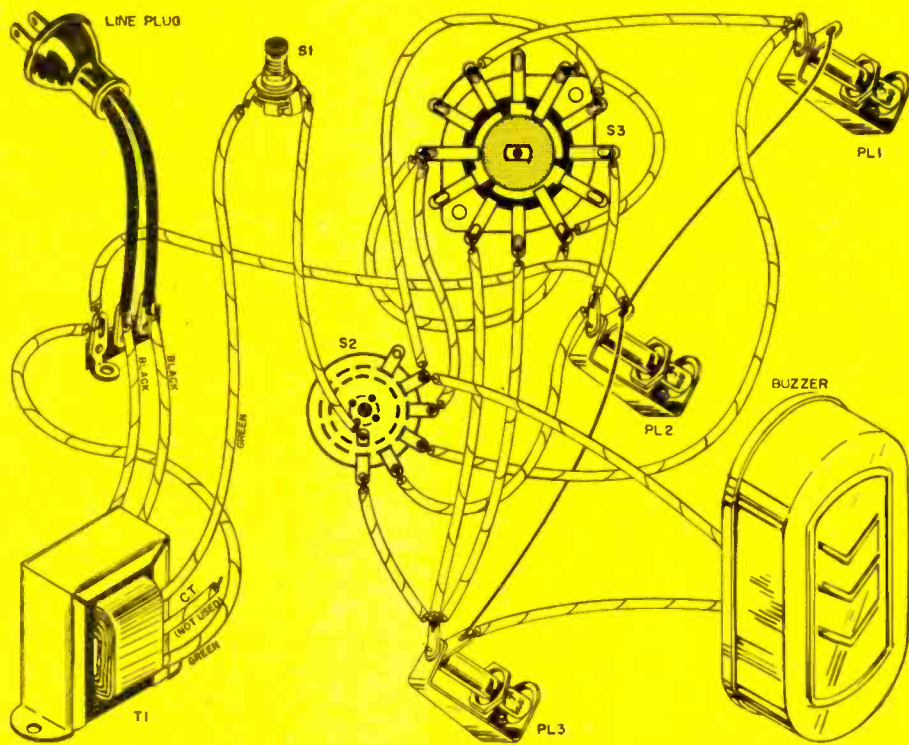

Fig. 5 (top). Pictorial diagram of the author's version of the "Gadget Box."

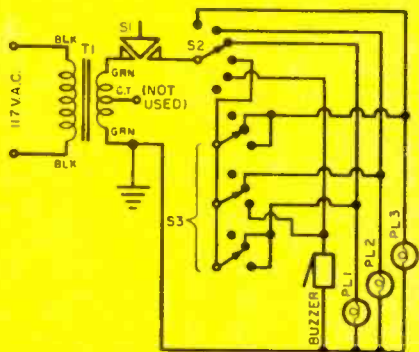

Fig. 6 (left). Suggested schematic and parts list. Many versions can be built, depending on the components available.

- Buzzer—6-8 volt buzzer (Edwards No. 725 or equivalent)
- PL1, PL2, PL3—6-8 volt pilot lamp (No. 40 or equivalent)
- S1—S.p.s.t. push-button switch, normally open
- S2—S.p. 6-pos. water switch (Mallory 32112) or equivalent, only 6 positions used
- S3—4-p. 3-pos. single-gang switch (Mallory 3243) or equivalent
- T1—Filament transformer, 6.3 volts @ 1 amp.
- 3—Miniature screw base pilot light sockets
- 1—5" x 9½" x 2½" aluminum chassis and bottom plate
- 1—Line cord and plug
- 2—Knobs
- 1—3-point terminal strip
- Misc. wire, solder, hardware, etc.
- Catalog price of parts, approx. \$4.50

the switches and controls, vari-colored lights flash on and off, buzzers sound, and all sorts of interesting and mystifying actions can take place.

Construction Hints: The circuit used in the author's model is given in Fig. 6, but it should be used only as a general guide. Ransack the junk box for rotary switches, push-button and toggle switches, buzzers, bells and pilot lamp bulbs. Mount the components on an old chassis or in an empty cigar box, and connect the switches, buzzers and pilot lamps together so that varying units are switched on and off as the controls are manipulated. A small filament or bell-ringing transformer serves as the power source. The completed model should be sealed against unauthorized tampering. Use a bottom plate on a chassis . . . or, if a cigar box is employed as a "cabinet," use the bottom as the front panel, then seal the cover closed after the wiring is completed and checked for operation.

Fig. 7. Below-chassis view of the author's "Gadget Box" after the wiring has been completed. It is essential that a durable protective cover be installed on the bottom to prevent wandering fingers from coming in contact with parts connected directly to power line.

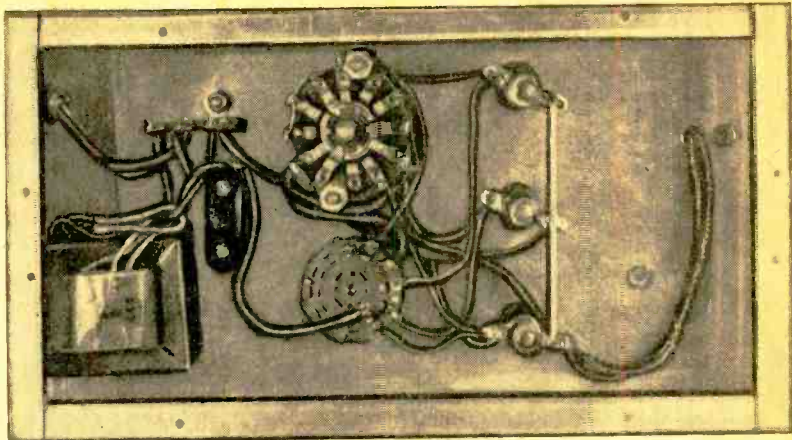

For maximum effect, the pilot lamp bulbs (*PL1*, *PL2*, etc.) should be in several colors . . . use fingernail polish or a commercial dial light coloring kit. The bulbs are mounted in rubber grommets on the front panel . . . save pilot light jewels and brackets for other projects! If sockets are available, use them, but connections to the pilot lamp bulbs can also be made by soldering leads directly to the metal shell and center terminal.

Project 3—"Electronic Piano"

Electronic "musical instruments" are always popular, not only with children, but with adults as well. The majority of electronic musical toys consist of a variable-frequency audio oscillator coupled to an audio amplifier and loudspeaker. Often only a single note can be sounded at a time. But the "Electronic Piano" shown in Fig. 8 uses a somewhat different approach. An efficient *vibration pickup* serves to couple the output of a toy piano to the input of a compact audio amplifier which, in turn, drives a remote loudspeaker. Thus, the desirable features of both "standard" and "electronic" musical instruments are combined in one unit. The operator has full control over volume and tone, as in an all-

electronic instrument, but—at the same time—the versatility and simplicity of a mechanical instrument are achieved.

Construction Hints: A toy piano serves as the "heart" of the instrument. This may be either a new unit, picked up at a local toy store, or a discarded and broken toy which, nonetheless, can be rehabilitated with a coat or two of paint and a nail or two installed at appropriate places. In order to keep the assembly and wiring simple, a commercially available *printed-circuit* audio amplifier is used. To this are attached the line cord, output transformer (*T1*) and speaker, and the special vibration pickup.



Fig. 8. Interior view of the toy piano, with an enlarged view of the phonograph pickup used to pick up the vibrations of the sounding pins. The pickup can be located approximately in the position indicated by the arrow, but exact position should be determined experimentally so that optimum volume and tonal quality are obtained from the instrument.

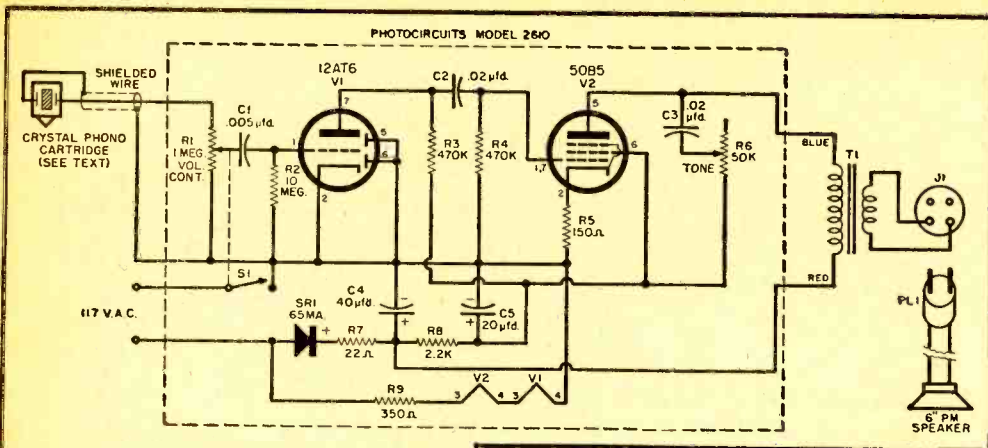

- C1*—0.005- μ fd. disc ceramic capacitor
- C2, C3*—0.02- μ fd. disc ceramic capacitor
- C4, C5*—Dual electrolytic capacitor, 40/20 μ fd., 150/150 volts
- J1—4-prong jack
- PL1—Matching plug for J1
- R1*—1-megohm potentiometer (volume control), audio taper, with switch S1
- R2*—10-megohm, $\frac{1}{2}$ -watt resistor
- R3, R4*—470,000-ohm, $\frac{1}{2}$ -watt resistor
- R5*—150-ohm, $\frac{1}{2}$ -watt resistor
- R6*—50,000-ohm carbon potentiometer, tone control
- R7*—22-ohm, $\frac{1}{2}$ -watt resistor
- R8*—2200-ohm, $\frac{1}{2}$ -watt resistor
- R9*—350-ohm, 10-watt wire-wound resistor
- S1*—S.p.s.t. switch (on volume control R1)
- SR1*—65-ma. selenium rectifier
- T1—Output transformer, 2000 ohms to voice coil
- V1*—Type 12AT6 tube
- V2*—Type 50B5 tube
- 1—Line cord and plug
- 1—6" PM loudspeaker and wall baffle
- 1—Toy piano (see text)
- 1—Crystal phonograph cartridge
- 1—Kitchen cabinet handle
- 1—Small wooden box (approx. 4 $\frac{3}{4}$ " x 4 $\frac{3}{4}$ " x 3 $\frac{1}{2}$ ")
- 2*—7-pin miniature tube sockets
- Misc. solder, wire, hardware, etc.

Catalog price of parts, approx. \$18.50

*Components marked with asterisk are included in Photocircuits Model 2610 printed circuit audio amplifier. If kit is not available locally, contact Photocircuits Corp., Glen Cove, N. Y.

Fig. 9. Schematic diagram and parts list for the "Electronic Piano." The dotted box encloses the printed circuit amplifier.

in a small wooden box. Essential dimensions for the box are given in Fig. 10, while the completed assembly, after attachment to the piano body, is shown on page 23. Mounting holes for the amplifier board, as well as holes for the volume and tone control shafts, may be located by holding the amplifier board against the box. Vent holes are provided near the top of the box, rubber feet on the bottom. The small box may be made from scrap wood if desired . . . the one shown in the model was cut down from an *El Producto* "Queens" wooden cigar box, then given a coat of dark stain.

Mount the amplifier board on small spacers, as shown in Fig. 11. Take care that no "hot" terminals may be touched anywhere outside the box. Cover the bottom of the box with protective screening or perforated hardboard when all wiring (including connections to the vibration pickup) is completed and checked. Ventilation is necessary, but the wiring should be protected from inquisitive fingers to avoid possible shock. The large series heater resistor (R9) should be bent away from the electrolytic capacitor C4-C5 before the amplifier is used as electrolytics are sensitive to excessive heat and may dry out rapidly.

The vibration pickup consists of a small crystal phonograph cartridge mounted inside the body of the piano. Experiment with the location of this pickup. Sometimes best results are obtained when the pickup is mounted on the top board (where the "tone bars" are located), sometimes when mounted on the bottom board of the piano. The efficiency of the vibration pickup is increased appreciably by adding a small weight. To make the weight, select a small common nail with a diameter small enough to fit in the needle chuck of the phonograph cartridge. Wrap No. 14 gauge

The complete wiring diagram is given in Fig. 9 (including the schematic of the amplifier).

If a second-hand toy piano is to be used, make sure the "tone bars" are not bent or broken before progressing too far with the assembly job. Also inspect the hinges of the small "hammers" attached to each playing key. If any of these hinges are broken, repair with cloth tape.

The amplifier board, output transformer (T1) and output jack (J1) are mounted

Fig. 10 (right). Layout for the wooden box which is used to house the audio amplifier.

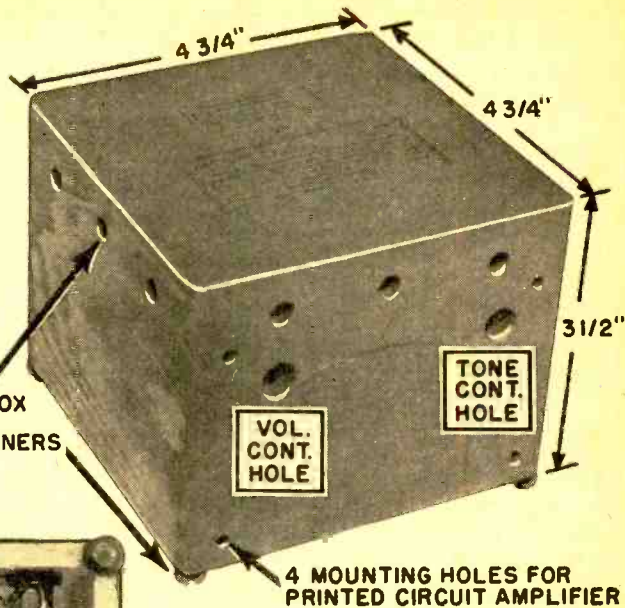
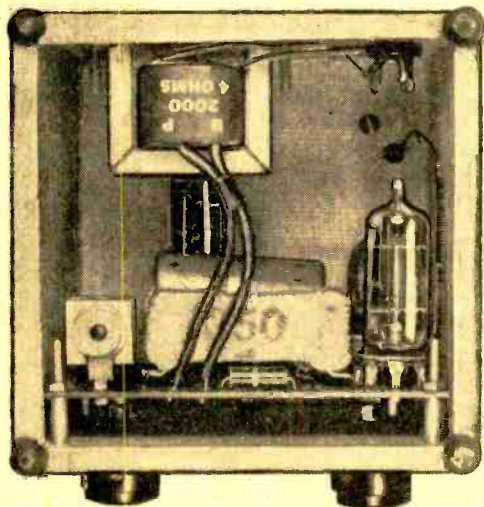

Fig. 11 (below). Bottom view of amplifier box showing amplifier board and output transformer in place. If commercial printed circuit amplifier is not used, the layout may vary considerably from this one.



DRILL 1/4" DIA. VENT HOLES AROUND TOP OF BOX
RUBBER FEET ON CORNERS

VOL. CONT. HOLE

TONE CONT. HOLE

4 MOUNTING HOLES FOR PRINTED CIRCUIT AMPLIFIER

is the operation of the vibration pickup. But before discussing this, let's review, briefly, the operation of the audio amplifier circuit.

A portion of the audio signal appearing across volume control $R1$ is coupled through capacitor $C1$ to the grid of the first amplifier stage $V1$. Resistor $R2$ serves as the grid resistor for this stage and the large value (10-megohm) used here sets up *contact bias* for the tube. An amplified audio signal appears across plate load resistor $R3$ and is coupled through capacitor $C2$ to the grid of the power output stage. $R4$ serves as the grid return resistor for this stage, with unbypassed cathode resistor $R5$ furnishing operating bias. The power output stage, $V2$, is matched to the low-impedance loudspeaker voice coil by means of output transformer $T1$. Capacitor $C3$, together with tone control resistor $R6$, forms a lossy type of tone control. As the value of $R6$ is reduced, $C3$ becomes more and more effective in bypassing high-frequency signals.

copper busbar along about half an inch of the nail, then flow solder over the wire and nail to form a solid piece. Bend the free end of the nail so that the weighted portion lies parallel to the phono cartridge when the nail is inserted in the needle chuck. A shielded single conductor lead connects the phono cartridge to the input of the amplifier. The cartridge itself is held in place with two small screws through its regular mounting holes.

A separate loudspeaker is used. This is mounted in a small cabinet or box and connected to the amplifier proper by means of a piece of ordinary lamp cord and a small plug. A wall speaker baffle makes an admirable cabinet when equipped with a kitchen cabinet handle (for carrying) and rubber feet. However, any small box may be used for a speaker baffle.

How The Piano Works: The only thing really unusual about the Electronic Piano

D.C. operating voltages are furnished by a conventional half-wave rectifier power supply circuit using a selenium rectifier ($SR1$, Fig. 9) and an RC filter consisting of electrolytic capacitors $C4$ and $C5$ and resistor $R8$. Resistor $R7$ is not essential to the filtering action but is provided to protect the selenium rectifier against a heavy current surge as $C4$ is charged when the unit is first turned on. A series heater connection is used, with $R9$ serving to limit heater current.

Referring back to the vibration pickup, the vibrations of the piano (as a note is

struck) are transferred to the outer case of the crystal cartridge. The cartridge case tends to vibrate *around* the interior crystal cell, which resists this vibration by means of its own inertia, *plus the inertia of the added weight*. A twisting or bending action is thus set up, which results in the generation of a small audio voltage, much in the same way that an audio voltage is generated when the crystal cell is vibrated by a needle riding in the groove of a phonograph record. It is this audio voltage that is applied to the amplifier, permitting electronic amplification of the sounds produced by the toy piano.

Project 4—"Electronic Maze"

More of a game than a toy, the "Electronic Maze" (see page 23) offers a challenge to adult and child alike. By simply changing the playing board, the game may be made simple enough for an eight-year-old or so difficult that even a highly skilled technician would have difficulty completing a play with a "perfect" score. In more conventional "maze" games, the player has but a single task . . . to find his way through the maze successfully. To make things a little more exciting, a time limit may be imposed. But with the Electronic Maze, the player's path is beset with "danger," for not only must he find his way through the maze, but he must stick to the straight and narrow. *If he touches either "wall" of the maze in trying to find his path, he's immediately caught by an electronic sentry.*

Construction Hints: The complete game is made up of three independent pieces: (1) the electronic sentry box, with its tell-tale red warning light, (2) the maze board on which the game is played, and (3) the scribe which the player uses for tracing his path. The complete circuit diagram, showing how the three pieces are connected, is given in Fig. 12.

Assembling the Sentry Box: The sentry box is an adaptation of a sensitive electronic relay circuit described in an earlier issue of POPULAR ELECTRONICS (see "Keep Dry With This Rain Alarm," page 58, June, 1955). The original circuit has been modified to provide a "self-latching" action to prevent cheating.

Only standard, readily available parts are used. Construction is simple and straightforward, and the wiring and layout are both non-critical. The average worker should have no difficulty assembling a duplicate unit in one or two evenings or on a weekend. The tube socket, relay, and terminal strips are mounted on a small alu-

- C1—20- μ d., 150-volt electrolytic capacitor
 PL1—25-watt, 117-volt red bulb
 R1—10-megohm, $\frac{1}{2}$ -watt resistor
 R2—1500-ohm, 1-watt resistor
 R3—3000-ohm wire-wound potentiometer (sensitivity)
 R4, R5—10-megohm, $\frac{1}{2}$ -watt resistor (a single 22-megohm, $\frac{1}{2}$ -watt resistor may be used if it is available)
 R6—6800-ohm, 1-watt resistor
 RL1—S.p.d.t. 5000-ohm plate circuit relay (Potter and Brumfield Type LB5 or LMS or equivalent)
 SO1—Standard lamp socket (switch optional)
 S1—S.p.s.t. push-button switch, normally open (reset)
 S2—S.p.s.t. toggle switch (power)
 V1—117L7/M7 tube
 1—Pair of insulated binding posts
 1—Scribe (sharpened nail cemented in short piece of tubing with flexible lead attached)
 1—Maze board (see text); in the model, a KEPCO printed-circuit kit was used (Keil Engineering Products, 4356 Duncan Ave., St. Louis 10, Mo.)
 1—Line cord and polarized plug
 1—Metal utility cabinet, 3" x 4" x 5"
 1—Aluminum subchassis, 3 $\frac{1}{2}$ " x 5 $\frac{1}{4}$ "
 1—Octal socket
 1—Small knob (sensitivity)
 2—2-jug terminal strips
 6—Rubber grommets
 Misc. solder, flexible wire, screws, etc.
 Catalog price of parts, approx. \$12.50

Fig. 12. Schematic diagram and parts list for Project 4—the "Electronic Maze."

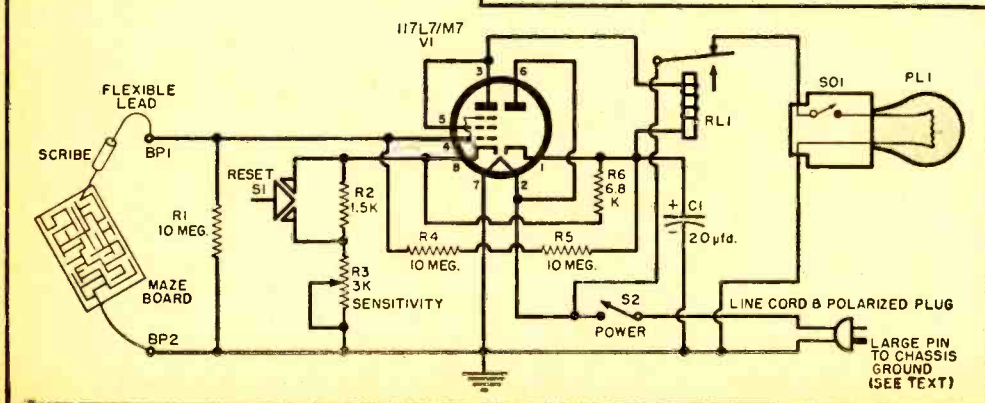

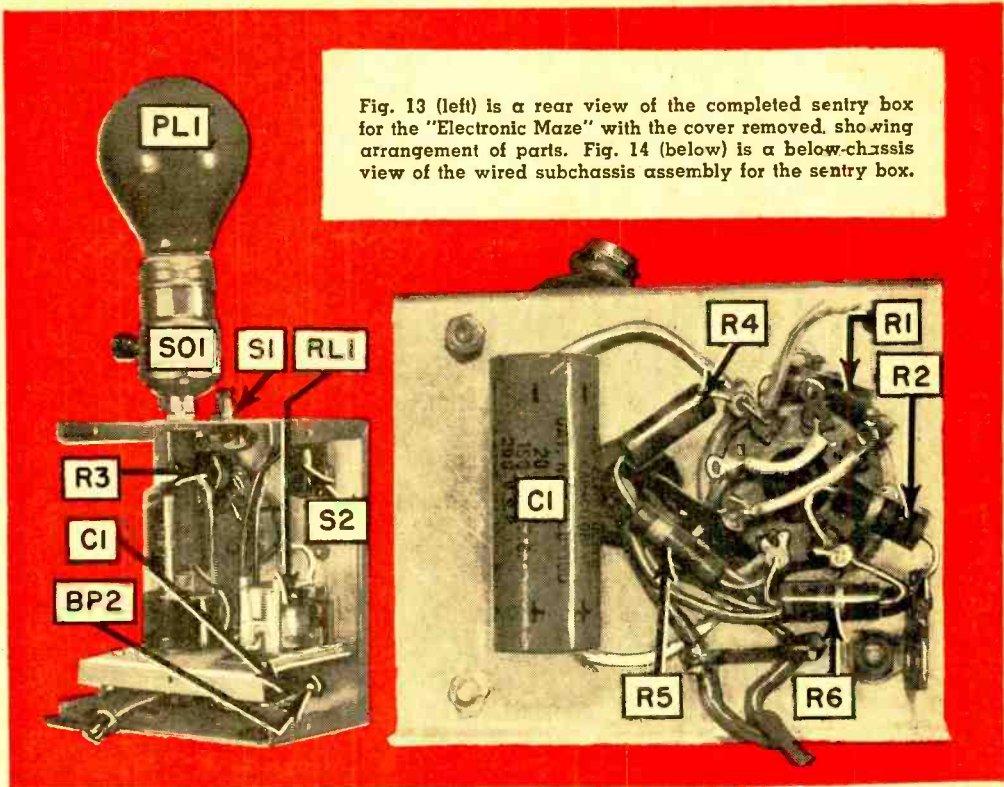

Fig. 13 (left) is a rear view of the completed sentry box for the "Electronic Maze" with the cover removed, showing arrangement of parts. Fig. 14 (below) is a below-chassis view of the wired subchassis assembly for the sentry box.

minum subchassis, with most of the circuit wiring completed before the subchassis is mounted in the cabinet. Above- and below-chassis views of the wired subchassis are given in Figs. 13 and 14 respectively.

A commercially available metal cabinet was used to house the model, but a cabinet of metal or wood can easily be made. In either case, be sure to provide good ventilation for the 117L7/M7 vacuum tube, which gets quite hot in operation. In the model, adequate ventilation is provided by holes in the back and top of the cabinet which, together, give a sort of "chimney" cooling effect. Since the completed game will probably be played on a table, be sure to install soft rubber feet on the sentry box. Thick rubber grommets, mounted in appropriate-sized holes, are good substitutes if conventional rubber feet are not available.

In order to keep the circuit simple and inexpensive, a "transformerless" power supply has been used. With such an arrangement, one side of the power line is connected to circuit ground. Many commercial a.c.-d.c. radio receivers and inexpensive record players use a similar circuit arrangement. Unfortunately, where a conventional line plug is used, it is possible to insert the plug in a wall socket in such a way that the chassis becomes "hot" with

respect to earth ground. Therefore, a *polarized plug* should be used on the line cord, with the thicker pin connected to circuit ground. If a polarized plug is not available, one can be made by soldering a small piece of wire around the *edge* of one of the pins of a standard plug. On the other hand, a preferable arrangement is to use a 1:1 "isolation" transformer which can be installed between the line connection and the power input to the sentry box to prevent possible shock. A 25-watt isolation transformer should be satisfactory.

With the subchassis wiring completed and double-checked for errors, the subchassis and controls may be installed in the cabinet. The lamp socket (SO1) and reset push-button switch (S1) are mounted on the top of the cabinet. The two binding posts, the sensitivity control (R3), and the power switch (S2) are mounted on the front panel.

The Maze Board: The "maze" itself is a non-conducting (insulated) path through a solid sheet of conducting material. It may be made up in any one of several ways and using an almost infinite variety of designs. The maze board used with the model is shown in Fig. 16 and was etched from a copper-clad phenolic sheet using "printed circuit" techniques. A *Kepra* printed circuit

kit furnished the component materials. Two other techniques might be used. One method is to cement a sheet of aluminum or copper foil to a sheet of plastic, then to cut out the desired path using a razor blade or sharp knife. Still another technique is to "paint" the desired pattern on a phenolic or plastic board using a silver conducting paint (such as *General Cement No. 21-1 Silver Print*).

Regardless of the method used to make up the maze board, several general "rules" should be followed. First, the basic design must be chosen for the players' abilities. For children, leave a fairly broad path and keep the maze simple; for adults, a relatively narrow path may be used, together with a fairly complicated maze. The game may be made even more interesting if the width of the path varies over different parts of the board. Secondly, remember that all parts of the conducting wall must be connected together electrically. As a maze is designed, sections of the conducting surface may be isolated. These may be connected together later by means of jumpers across the back of the board, passing through holes to the different conductors. With care, it is possible to design a maze

with only two isolated conducting surfaces, which may be tied together with a single jumper. The design shown in Fig. 16 represents such a maze.

The Scribe: The scribe used with the model was made up by cementing a sharpened nail in a short piece of plastic tubing. A flexible lead was soldered to the nail before it was cemented in place. As in the case of the maze board, any one of several methods may be used for making up the scribe. Basically, the scribe is a sharpened conductor with an insulating plastic shell, and with a flexible lead to connect it to the sentry box. An old ball-point pen, if it has a plastic outer shell, could be made into a satisfactory scribe.

How the Electronic Maze Works: It's not necessary to know how the circuit operates in order to enjoy playing with the Electronic Maze. However, the majority of PE readers are as much interested in "How It Works" as they are in "How to Build It," so here goes. . . .

In playing the game, the player uses a metallic scribe to trace a path through a maze with conducting "walls." He is not allowed to touch a wall. If he does so, he closes an electrical circuit, causing a relay

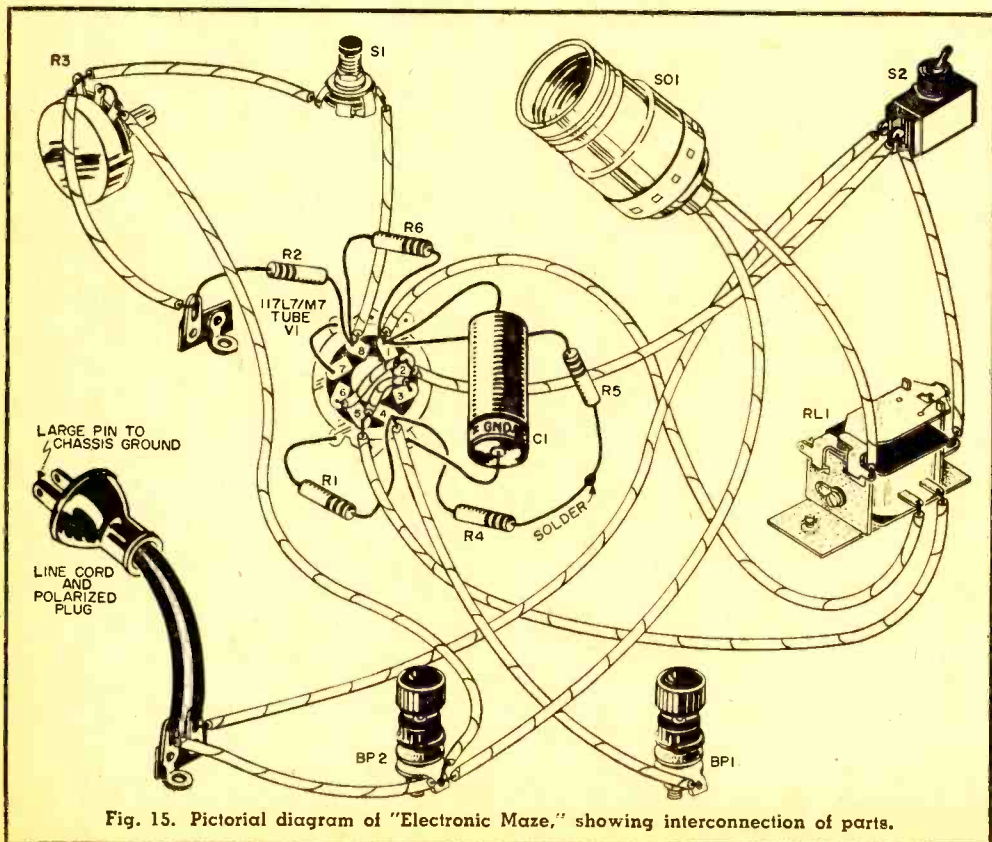
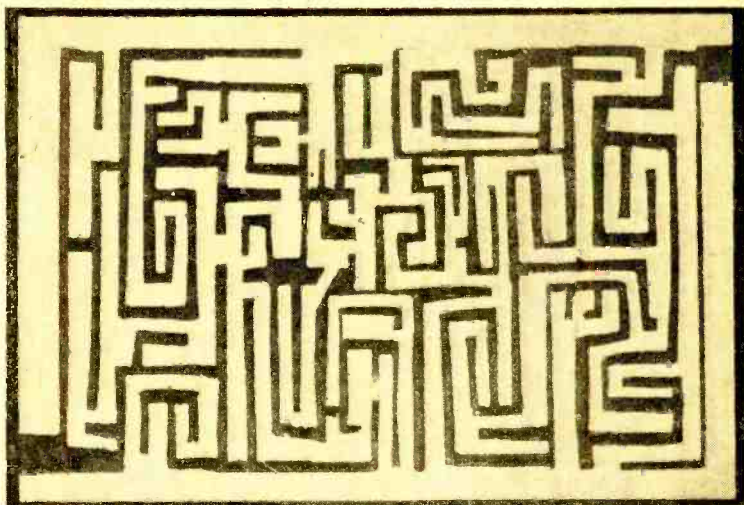

Fig. 15. Pictorial diagram of "Electronic Maze," showing interconnection of parts.

Fig. 16. Maze board used with the author's model. Over-all dimensions are approximately 3" x 4½". This is intended merely as a guide—a large variety of other designs may be easily worked out.



to operate and lighting a "tell-tale lamp." To prevent cheating, the relay locks on until reset by a push-button switch. In order to obtain the locking action and to insure positive operation even if the walls are touched quite lightly, a sensitive electronic relay is used as a sentry.

Referring to Fig. 12, the 117L7/M7 tube is a multi-purpose vacuum tube, containing a beam power amplifier and a diode rectifier within a single envelope. The screen grid and plate of the amplifier section are tied together to provide triode operation. The diode section is used as a half-wave rectifier to supply a d.c. operating voltage for the amplifier, with electrolytic capacitor *C1* serving as a filter.

In operation, cathode resistors *R2* and *R3*, together with bleeder resistor *R6*, develop sufficient bias to limit plate current below the value needed to operate the relay (*RL1*). The bias is balanced by a positive voltage applied to the grid of the tube through a high-resistance voltage divider consisting of *R1*, *R4*, and *R5*. This positive bias permits sufficient plate current to flow to hold the relay closed, but not enough to close it.

Since more current is required to close a relay than to hold it closed, the relay will stay either "locked" open or "locked" closed until the bias is upset. To close the relay initially, push-button switch *S1* (reset) is pressed, shorting cathode resistor *R2*, and dropping the cathode bias enough to permit the relay to close. The relay then remains closed as long as the binding posts connected to grid and to ground, respectively, remain open. A momentary short here, as occurs when the scribe touches a "wall" of the maze, reduces the positive bias on the grid of the tube, and allows the

cathode bias to take over, reducing plate current and opening the relay. On opening, the relay applies voltage to the red bulb ("tell-tale lamp") installed in socket *SO1*. The relay remains open even after the short between the binding posts is removed, until the reset switch *S1* is depressed.

Playing the Game: With the wiring completed and double-checked for errors, install the 117L7/M7 tube in its socket, a 25-watt red lamp bulb in its socket, and close the case. Connect the maze board to *BP2*, using a flexible wire. The scribe is connected to *BP1*. With the unit plugged in to a wall receptacle and the power turned "on," allow a few minutes warm-up. Adjust the sensitivity control (*R3*) until the bulb lights (making sure that the socket switch is closed). Now, depressing the reset switch (*S1*), turn the sensitivity control back until the relay pulls in and the light goes out. Proper adjustment is reached when the relay holds in on release of the reset button. The game is now ready to be played.

The task confronting the player is to trace through the maze board, using the scribe, without touching any walls. To heighten interest, a time limit may be imposed. To provide a competitive game for several players, points may be scored for each second under the allotted time which the player does not require, and deducted for each second past the allotted time needed to complete the maze. Additional points are deducted each time the red light flashes . . . or, to make the game really "tough," the player is required to start over whenever he's "caught" by the electronic sentry.

Familiarity with the Electronic Maze will make it easy to devise many variations of the basic game.

Flight Doctor's Electronic Partner



By R. E. ATKINSON

THE pilot races his airplane down the runway, pulls it into the air, and points its nose high above the horizon. Out of the corner of his eye, he watches the pointer on the altimeter face whirl around five times as fast as the second hand on a watch. He sweeps his eyes across the dials on the instrument panel, conscious of the fact that the characteristics of the atmosphere which supports the airplane and gives him life are changing rapidly. The little hands on several of the clock-like instruments before him move slowly to new positions and warn him of adverse changes in engine temperature and loss of power. He reaches down and adjusts controls to bring the engines back to normal.

"But there are no dials to measure the physical and functional changes that are taking place simultaneously in the body and mind of the pilot. He has no one to guide him down and bring him home if he fails or

if his mental or physical functions become impaired. His only guide to his own condition is his sense of well-being which characteristically gives him an exaggerated sense of bodily health in the presence of the oxygen deficiency that waits at high altitudes to ensnare pilots in a trap of death. Impending unconsciousness due to lack of oxygen is accompanied by bodily comfort, absence of pain or distress, and a rise in spirits. The pilot's future and that of his airplane are dependent upon his perception of his own impairment, but the impairment destroys his perceptive abilities."

From Commander Norman Lee Barr (MC) of the United States Navy comes this insight into a major problem facing pilots of the new rocketing jets. The need for a sys-



Left, technician inspects transmitter used during flight. Installed in the aircraft, it transmits physiological data about the pilot. Information is processed through several stages, including a mixer, modulator, oscillator, r.f. amplifier, and power amplifier. Signals are handled on the ground by specially designed antennas and receivers. Ultra-high-frequency FM circuits permit accurate calibration of the entire system.

Right, signals received on ground are recorded as a pattern on graph paper. Data reveals pilot's physical condition.

U. h. f. equipment reveals to ground medical observers what happens to pilot during flight

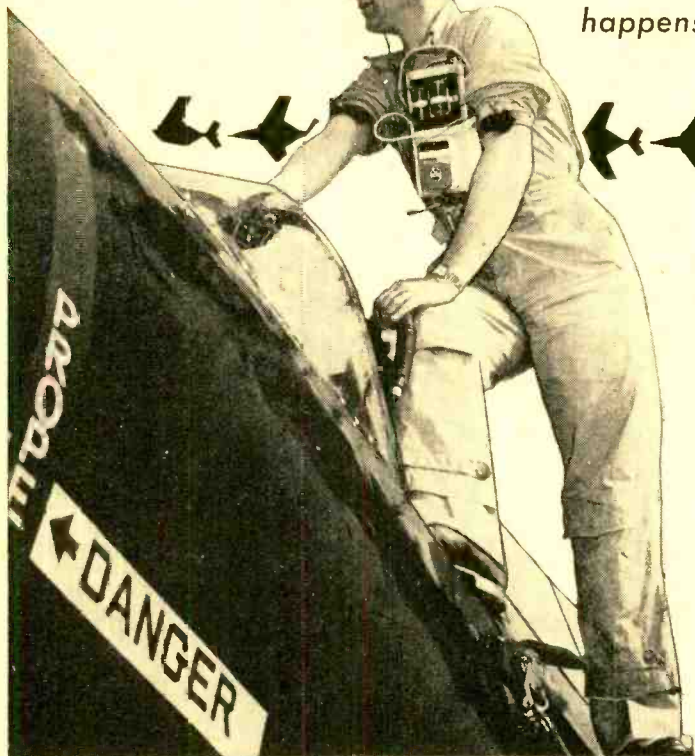

Transducer, worn by pilot, contains pickup electrodes to detect heart and brain reactions during flight. Additional electrodes, at selected points on body, detect other physical changes. Leads connect signals to preamplifiers and transmitter.

Below, complete receiving station comprises many recording devices to handle data. Observers can tell, two minutes in advance, when pilot will "black out" from lack of oxygen.

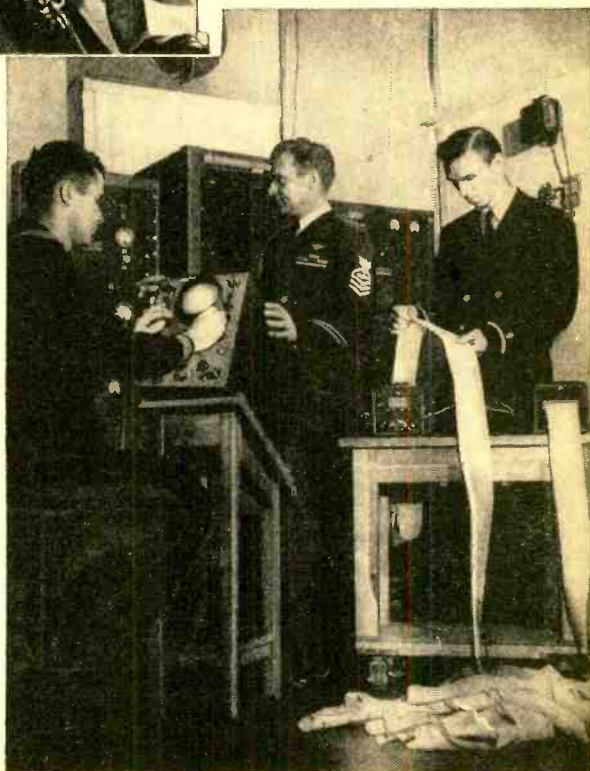
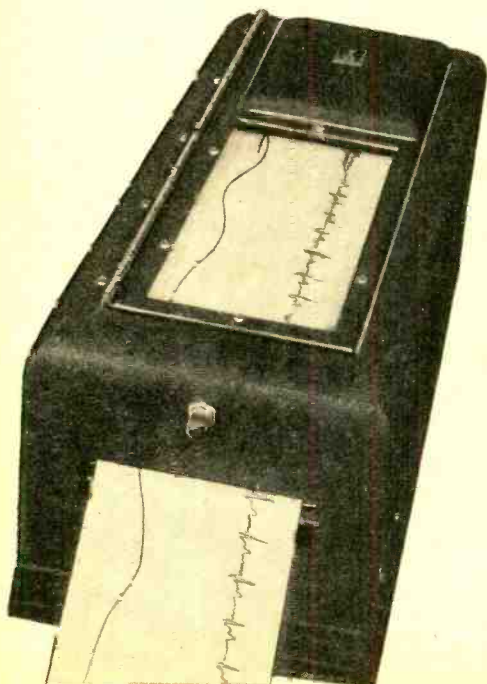

tem to observe the physical condition of pilots while they are in the air is clearly demonstrated, according to Commander Barr, by accident records which show that approximately 65% of aircraft accidents are attributed to pilot failure.

At the Naval Medical Research Institute, Bethesda, Maryland, Commander Barr directs a group of scientists seeking solutions to problems of air safety. They are perfecting an electronic system which broadcasts vital data about the effect of physical stress on a pilot rocketing through the sky to medical observers far below.

One of their tasks is to define human tolerance to the physical forces and environment of high-speed and high-altitude flight. Another is to develop, test, and evaluate equipment for bolstering these tolerances.

Four-Part Radio System

The complete system, as developed, is composed of four parts: a set of transducers which collects information from the pilot and his equipment and converts it into electrical energy suitable for radio transmission; an ultra-high-frequency FM radio transmitter; an ultra-high-frequency radio receiver; and recording and presentation equipment.

Patient experimentation is required to

eliminate some of the problems which make it difficult to obtain accurate recordings. For example, it is not easy to find lead wire that will not resonate, or whose shielding will not resonate, with one or more of the many sound frequencies found in aircraft cockpits. Sympathetic vibration of the current-carrying wire, or its shield, in a magnetic field converts the sound energy into electrical energy and superimposes it upon the electrical current being carried by the wire. The Naval Medical Research Institute solved this problem by keeping the electrical leads as short as possible and testing many types and sizes of wire until one was found that was not resonant with the sounds in the particular cockpit in question. This yielded electrocardiograms actually more free of microphonics than many taken in offices and clinics on the ground.

A physician making continuous measurements of a flying pilot's physical condition can read and interpret the warning signals received by radio from the plane, and can call for immediate action to safeguard pilot and airplane. In addition, this system offers a means for the routine investigation of normal physiological functioning under all conditions of modern flight as well as a means for testing the adequacy of supporting equipment.

-30-



"Cardboard Fidelity"

THIS NOVEL SPEAKER SYSTEM may serve as a substitute for the beginner interested in

hi-fi but lacking expensive woods for a cabinet. It is made from 4"-diameter cardboard mailing tubes. Four speakers of the same size are attached to the tops of the tubes.

Different tones can be accentuated by cutting these tubes to different lengths. A square hole is cut near the bottom of each

tube and a sound-absorbent material, such as cotton, is placed in the bottom of the tube. After the speakers are cemented in place at the other end, screen flock is

placed over the tops of the speakers to keep out dust. "Plio-bond" cement is very good for cementing the speakers to the tubes.

Each of the speakers used in the installation shown has a voice coil impedance of 16 ohms. Wired in parallel, they provide 4 ohms—which matches the output of the amplifier used. To make sure all the speakers are phased properly, the two voice coil leads of each speaker are touched to a 1-volt battery. The cones should all move in the same direction, or "in phase"; if one cone moves out of phase with respect to the others, the connections to its voice coil should be reversed.

To complete the speaker assembly, the tubing may be wrapped with colored wallpaper to suit the decor of the room; "South Sea" wallpaper and a few turns of rope make a salty piece of furniture for the den or patio. Four circular pieces of wood, each the size of the tube openings, are screwed to a wooden base. The tubes (with the speakers cemented to their tops) are then fitted over the circular pieces of wood and glued in place.

While the fidelity of the system won't equal that of more expensive installations, this cardboard rig is bound to attract attention aurally as well as visually.

-30-

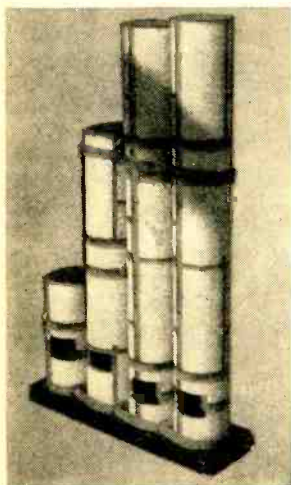

PHANTOM VOICE

Speeds Operation of Automatic Elevator

HELPING PASSENGERS run automatic elevators is a new *Westinghouse* audio device which reproduces messages in the elevator car as required by traffic conditions. Known as the "Phantom Voice," this sound system responds to relay-controlled signals so arranged as to activate a pre-recorded tape for playback when the message on the tape is needed.

Several tapes, each with a different message, are used. They play through an amplifier which drives a loudspeaker installed in the elevator car.

The system is fully automatic, requiring no operating supervision. Said to cost less than the salary paid to an elevator operator, the "Phantom Voice" announces each floor as well as the offices on it. It also announces: "This car up" or "Going down," whichever the case may be.

Other messages, suited to the occasion, are intended to remind passengers to follow correct procedures. These reminders include: "Press your floor button, please"; and "Car has stopped because the red emergency stop button was pressed . . . if emergency has passed, pull button out"; or "Automatic protective device has stopped the car . . . please press the alarm bell to notify the engineer." *Westinghouse* officials believe this last message will almost never be used, but have included it for reassuring passengers "just in case."

Responsible for the development of the system is the Elevator Division of *Westing-*

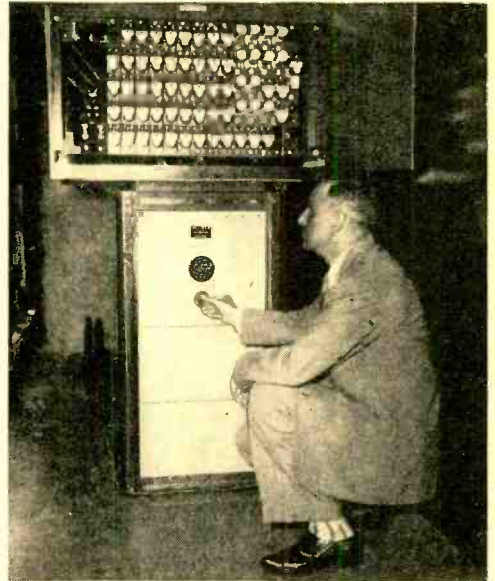

Danilo Santini, who developed the "Phantom Voice," throws switch to activate the system. Tapes and amplifiers are inside cabinet. Top deck houses relays and electronic timers which select messages to be played.

house Electric Corp., 40 Wall St., New York 5, N.Y. The first model has been installed in an office building at 99 Park Ave., New York, N.Y., owned by the *Tishman Realty & Construction Corp.* —30—

Simplified block diagram shows relation between new audio system and automatic elevator.

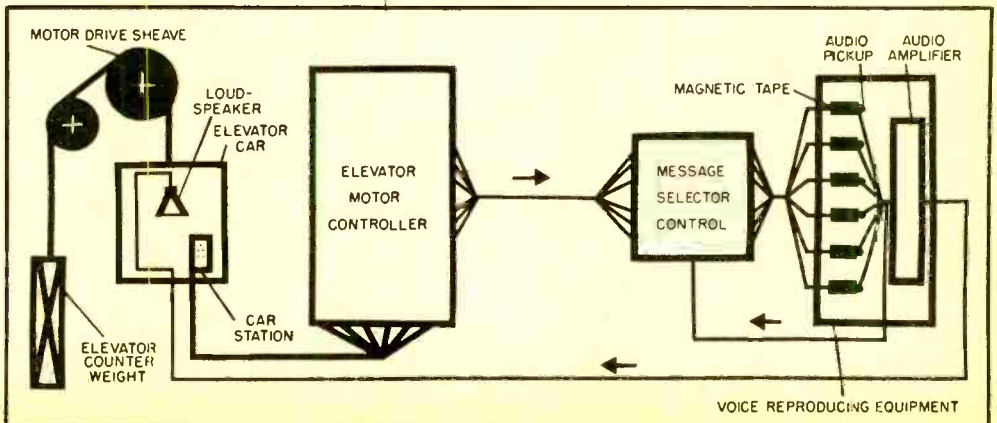



Radar "Sidelight"

THE *General Electric Company* uses fluorescent lighting tubes to demonstrate the u.h.f. radio beam pattern radiated by the multi-million-watt FPS-6 radar. A study of radar beam effects is being made by *G.E.* engineer Zenn Zenon, shown on ladder holding another lighted fluorescent tube. The FPS-6 is a height-finding radar unit constructed for the U.S. Air Force. Typical of all modern radar equipment, the antenna is housed in a ball-like radome.

What Time Is It?

DAN NOBLE, President of *Motorola, Inc.*, will be glad to tell you the time precisely to the second and directly from the Naval Observatory radio station. Engineers at

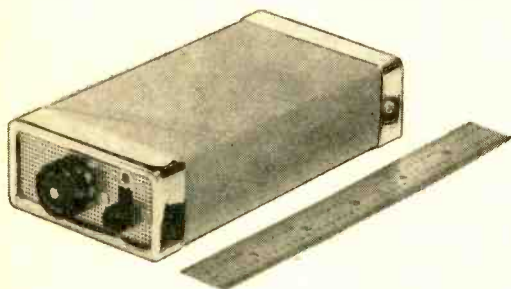

Motorola have developed a 13-ounce receiver fixed-tuned to the 121.95-kc. broadcasts from NSS. The receiver demonstrates the advantages of transistors and is believed capable of operating for ten years without failure or servicing other than battery replacement. Three inches wide, five inches long, and only one and one-quarter inches thick, the receiver is complete with antenna, batteries, loudspeaker, and volume control. Circuitwise, it consists of three r.f. stages, detector, audio stage, and separate b.f.o. stage to modulate the c.w. NSS signals. Power is supplied by two penlite cells at 3 volts and 3 milliamperes.

Armchair Loudspeaker

VISITORS to the Dusseldorf radio and TV exhibition were delighted to find a comfortable armchair fitted out with two small loudspeakers. The "listening chair" was developed by *Telefunken* to promote the sale of LP records. Because of the limited range of the loudspeakers, it is possible for several people to be sitting in the same room and all listening to different recordings. *Telefunken* now visualizes a possible market for "listening chairs" in homes of TV viewers, in addition to hotel lobbies, record shops, etc.

RETMA Warranty

OWNERS OF RADIO and television receivers may have noticed a guarantee marked on their sets and referred to as a RETMA warranty. This has caused many owners to question the meaning of the term. When used, it does not mean that the Radio-Electronics-Television Manufacturers Association has guaranteed the set, but that the manufacturer has guaranteed it as recommended by the RETMA. Some manufacturers still continue the use of this warranty, although the RETMA has withdrawn its sponsorship of the practice.

The purpose of this warranty was to insure uniformity throughout the industry and to give the manufacturers a guideline to follow. Identification of the warranty with RETMA was often misinterpreted as meaning that the RETMA organization itself stood behind the guarantee, which it did not. Each builder was expected to guarantee his own product. Those sets which still carry this imprint are guaranteed by the manufacturer under the same terms once recommended by the RETMA.



Automatic Wiring Machine

BELL TELEPHONE LABORATORIES has perfected an ambidextrous machine capable of automatically wiring complex electronic chassis. The machine can neither see nor hear, but can feel and follow instructions fed to it from a punched tape with great accuracy. A series of relays acts as a "brain" for the machine which then controls the cams and gears, enabling it to make perfect solderless wrapped electrical connections. The view at the right shows a five-tube radio receiver wired with new solderless connections also proposed by the *Bell Telephone Laboratories*. A plastic mounting board holds the wiring studs. Same receiver circuit in left hand uses soldered connections.

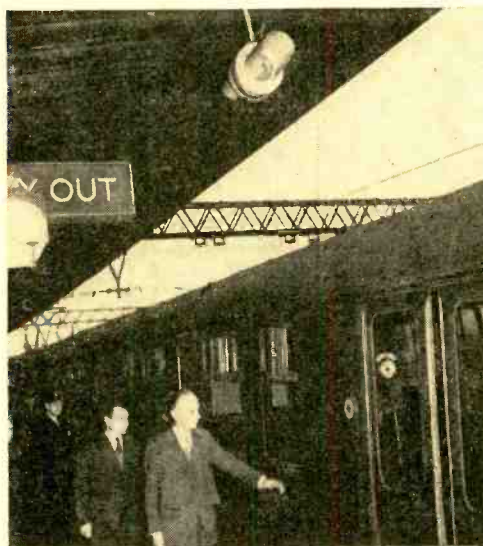

Train Announces Itself

A SPECIAL TAPE RECORDER has been installed at the busy London, England, railway station called "Stratford." The appropriate announcement can be preselected by an operator in the signal tower. When this occurs, the playback head of the tape recorder moves to one of 25 different tracks on the three-inch wide tape, and the loudspeakers announce the incoming train. As the train passes into the platform, it operates an adjustable time delay relay which allows the doors to open automatically and then announces that the train is ready at the platform. Provisions are made to delete certain announcements during the rush hours and also to warn the operator if an "unscheduled" train approaches the wrong platform. This system was developed by the *General Electric Co. Ltd.* for the Signal Engineer, British Railways.

ERMA's Working in the Bank

THE GENTLEMAN at the right is sorting the wires attached to magnetic drums the size of small oil drums which temporarily store information for ERMA—Electronic Recording Machine, Accounting. This computer was designed particularly to service bank bookkeeping operations. ERMA credits individual accounts with deposits, debits withdrawals, remembers details of all transactions, maintains customers' correct balances, accepts stop-payment orders, and prevents overdrawing. Finally, at the month's end, it automatically calculates service charges and prints a complete statement. ERMA uses 34,000 crystal diodes, 8000 vacuum tubes, and contains one million feet of wiring. Perfected by the Stanford Research Institute, it will be used by the Bank of America in their main California offices.





Visitors See Assembly Line

AS AN ADDED ATTRACTION at the Dusseldorf Radio-TV and Phonograph Exhibition, *Telefunken* reconstructed a portion of its TV tuner assembly line. Visitors to the exhibition were able to see how tuners are carefully assembled in the average factory. Interest in TV reception is rapidly mounting in western Germany, and although production of sets is low according to American figures, the outlook is most promising.

Spring-Driven Generator

THE STAFF OF the Armour Research Foundation has proposed that a research program be directed towards the development of a tiny generator driven by a spring mechanism. Such a generator could be the size of a watchworks and would supply burn-out-proof power for transistorized portable radios, hearing aids, or other electronic equipment. The "idea clinic" of the Armour Foundation has also mentioned the likelihood of a 200-volt battery with the physical size of an ordinary flashlight cell. This battery could be constructed from metallic discs separated by paper wafers carrying the battery electrolyte. Edges of the paper and the stack of discs would be impregnated with a suitable plastic. Armour is looking for sponsors of these, and many more, creative ideas.

Transistorized Golf Ball

LATEST in the way of inventions to ease the burdens of modern man is a non-losable golf ball. At least, this is the suggestion of *Motorola, Inc.*, who has subminiaturized a radio transmitter until it will easily fit within a golf ball. Using a circuit designed around a single transistor, the "golf ball" radiates a sufficiently strong radio signal to be picked up by a portable, pocket-sized receiver. Rotating the receiver as a direction finder enables the player to find the lost ball. *Motorola* has stressed that the "golf ball" is not on the market and readers should not expect to find it in local sporting goods stores. However, for those golfers whose method of scoring is to count the number of balls they lose, it is something to dream about. Undoubtedly it will be called a "duffer's blessing."



1956 Midwest TV Receiver

THE MOST ADVANCED TV receiver ever produced by the *Midwest Radio & Television Corp.* is included in their 1956 mail-order line. Of special interest is an unusual speaker mounting on either side of the TV picture. Placing the speakers at an angle is claimed to provide a good balance of sound at normal listening and viewing distances. Other features of the *Midwest* "Super-Constellation Low Boy" are: top tuning, local-distant switch, all-channel tuner (from 2 to 83), aluminized picture tube, full-range tone control, built-in antenna, automatic focus, etc.

Of particular interest to readers of *POPULAR ELECTRONICS* is the fact that *Midwest* gives a free servicing manual with every set. All *Midwest* TV receivers are sold on a 30-day trial basis. A 10% deposit brings any one of the sets to a potential purchaser on an open account. Balance is due within 30 days after receipt of the receiver. Further information may be obtained by writing to *Midwest Radio & Television Corp.*, Dept. 7, 909 Broadway, Cincinnati, Ohio.

GOC Radar Hat

MEMBERS OF THE Ground Observer Corps will soon be equipped with a simple electronic device to detect low-flying aircraft. Mounted on a helmet to provide "sense" of direction, the unit consists of a u.h.f. horn-type antenna, crystal detector, and transistorized pulse amplifier. When an aircraft approaches a GOC observation post at night or during cloudy weather, it will probably use various types of height-finding radar. The GOC "hat" intercepts this radio-frequency energy, detects it, and feeds the signal to a pair of headphones worn by the observer. Designed by the Air Research and Development Command, the GOC "hat" will weigh less than 20 ounces and work with a low battery drain.



TV Survives Flood Waters

MR. AND MRS. WILLIAM HOUSTON of Pleasant Valley, N. Y., were obviously distressed when their summer cottage collapsed during the mid-August floods. Two days later, after the waters had receded, their 17" *Sylvania* TV set was found over a mile from its original site. It was buried in mud and had been under 15 feet of water for two days. The only damage was the warped top of the case. Mr. Houston cleaned it out, let it dry for a day and plugged it in.

Elgin "Any Shape" Battery

THE *Elgin National Watch Company* is planning to make available to the general public an unusual miniature battery. Although the first models were half-circle units, about the diameter of a dime and three times as thick, *Elgin* has indicated that the battery can be formed into any convenient shape. The output voltage will be between 1.15 and 1.35 volts. Secret of this battery is the use of the soft, silvery



metal "indium" as an anode. The value of indium as an anode material had not previously been discovered. It is claimed that a "wristwatch" battery of this size will not leak or produce gas, and will deliver a constant voltage for two or more years without deterioration.

Miniature Rescue Radio

A TINY V.H.F. TRANSCEIVER designated as the AN/URC-11 has been developed by the ARDC Headquarters of the U.S. Air Force. It is half as large as rescue radios now in

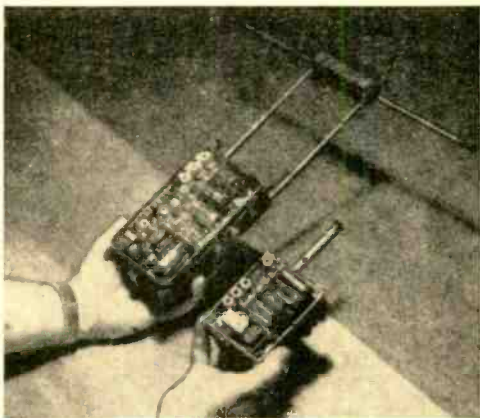

use by Air Force personnel. Following a forced landing or bail-out, the pilot merely connects the 2½-lb. mercury battery to the URC-11 transmitter and broadcasts information on his condition and position. The URC-11 will also emit a continuous tone to enable rescue aircraft to "fix" his location. Two-way communication is possible with the URC-11, which uses six subminiature tubes and under average conditions will transmit from 50 to 100 miles. The photo above shows the new unit being compared with an older and much larger model of rescue transceiver.

New TV Sets Set Record

THE RETMA has announced that for the first seven-month period of 1955 a total of 3,549,877 new TV receivers was sent to dealers. This is 600,000 more receivers than in 1954 and 200,000 more than in the record year 1953.

21st Century



Fletcher ranch-house is last word in contemporary design. Custom-made family car matches futuristic features of home. Designed by Jack Fletcher, car has 1941 chassis and 1951 engine.

Utilizing advanced electronic devices, this residence may well forecast the home of the future

Jack Fletcher at the controls. Speaker shown is part of intercom. Built-in hi-fi system can furnish music to all parts of the house.



ULTRA-MODERN—in fact, downright futuristic—is a recent version of “the house that Jack built.” Located on Inman Road in West Covina, Calif., the home of the Jack Fletchers is a veritable dream-house of push-button electronic marvels. The house, and almost everything in it, was conceived and designed by Fletcher and engineered by John Scott Campbell.

Built into the house, for example, is a closed circuit television system which serves as a baby-sitter. By means of TV cameras placed in strategic spots in and around the house, the Fletchers can keep a constant watch on their two youngsters. Whatever the children are doing is displayed on three TV screens, located respectively in the living room, kitchen, and master bedroom.

Controls for the TV system are built right into the walls as part of a complete video and sound installation that includes—naturally—an elaborate hi-fi system, capable of sending music to all parts of the house.

One of the most startling innovations is in the kitchen of this next-century dwell-

Home



Proud builder and owner holds up his cordless floor lamp. Bulb lights without cord, plug, or socket. Inductive unit located in lamp base operates this unique device.



Solar heat in winter and increased wind velocity for breezes in summer are made possible by manner in which house was designed. Hi-fi speaker in corner is only one of several.

ing. Beneath the veneer of what appears to be an ordinary wooden cabinet are seven coils of wire. These coils furnish a magnetic field which, in turn, creates eddy currents in an aluminum cooking pan that interact to lift the pan up into space. Completely stable, the pan floats about two inches in the air. The currents also generate heat which warms the pan and cooks the food in it, while the top of the "stove" remains cold. When a switch is shut "off," the pan drops down onto the surface.

The "silent servant" idea has been perfected to an art in this house. For instance, there's a "light-anticipation" system installed throughout the building, so that when one walks through a doorway the lights turn on in the room or hallway just ahead. The floor lamps operate without cords, plugs, or sockets; using magnetic induction, electronic units in the lamp bases turn them on or off. Completely automatic windows are another contribution to this lazy man's paradise; if rain or

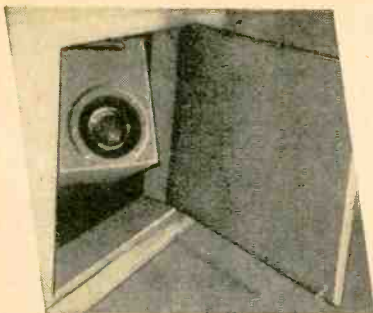

wind disturbs a solenoid control, the windows close automatically!

A tamperproof electrical lock guards the entrance to this palace of wonders. The lock is opened by a simple key whose design may be any of more than 1000 patterns, preselected by the owner. Inserting any but the correct pattern into the lock will set off an alarm.

Non-electronic marvels are the "peek-a-boo" walls. Specially designed wooden and glass panels admit light and ventilation, yet limit unwanted vision from the outside. This eliminates the need for drapes and curtains but does serve to assure indoor privacy.

"Step-down" bathtubs, bathroom sinks built in miniature to accommodate children, an outdoor swimming pool, and ingenious use of colors and fabrics in the interior add to the beauty and utility of this "Twenty-First Century Home." -50-



Magnetic fields (whose coils are beneath wooden surface) lift pan in the air and cook food in it.



TV camera (top) watches children. These electronic "eyes" are located in various parts of house. Screen (bottom) shows parents what children are doing at all times.

Mrs. Fletcher waves goodbye through "Weatherbrain" window. Glass panels, under solenoid control, slide shut automatically during rain or windstorm. Windows may also be handled manually.

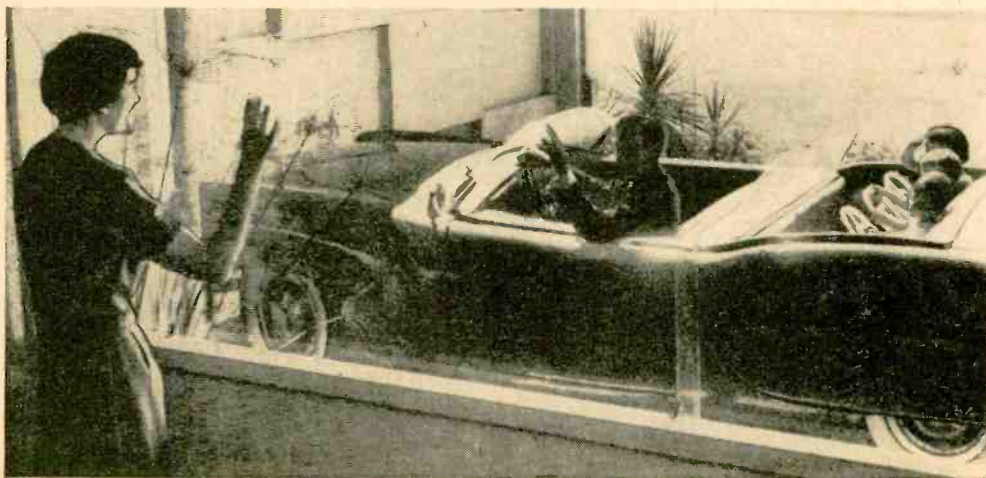

Continuously variable control uses available \$8.50 autotransformer

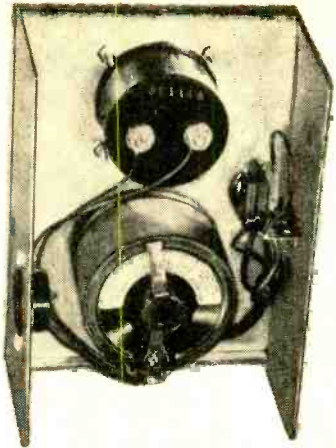

Behind-the-panel view at left shows simplicity of wiring. Meter could be added at later date if constructor does not want to make investment.

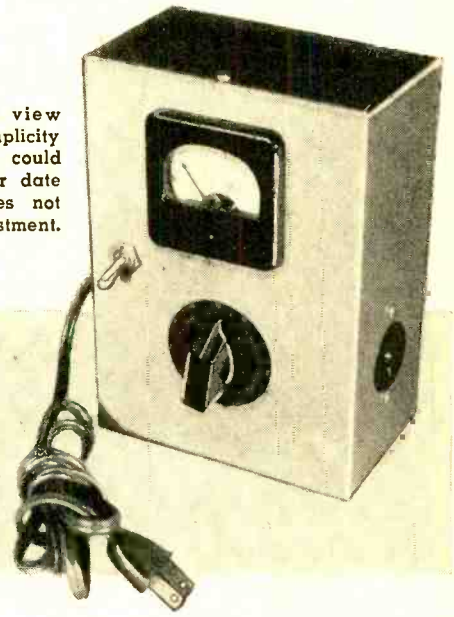

125 - Watt LINE VOLTAGE CONTROL

IN MANY FORMS of electronic experimentation and testing, the technician must be able to vary the power-line voltage smoothly over a continuous range. Accompanying illustrations show a handy, inexpensive a.c. control box made with the small-sized Superior Type 10 "Powerstat."

Experimenters will find many uses for this circuit. Voltage control over the range of 0 to 126 volts is possible with "Powerstat."

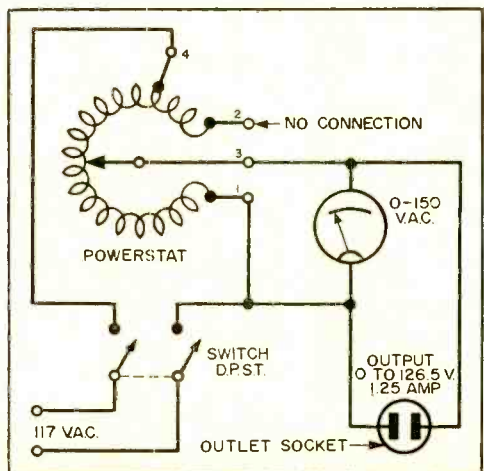

The "Powerstat" is a continuously variable autotransformer, 3 1/8" in diameter and 2 1/16" deep, which is mounted in a 7" x 5" x 3" aluminum box, together with a 2 1/2" 0-150 a.c. voltmeter, toggle switch, and output receptacle. The meter eliminates all guesswork by giving a continuous indication of output voltage at all settings of the "Powerstat."

Smooth control of voltage is afforded from zero to 126.5 volts (when the line voltage is 115 volts) at 1.25 amperes. At any other line voltage (up to a maximum of 120 volts), the maximum output voltage is 1.1 times the line voltage.

Experimenters wondering how the voltage from the "Powerstat" can be greater than the input should look at the wiring schematic. Notice that the a.c. 117-volt line is connected across terminals 1 and 4. Therefore, between these terminals, the voltage output will vary between 0 and 117 volts. Between terminals 4 and 2, the windings of the "Powerstat" act as an autotransformer and increase the voltage output by adding their small induced voltage to the 117 volts already impressed on the output line. In any case, the "Powerstat" will only handle about 125 watts and should not be used for applications drawing more than this power.



Battery Eliminator for the Lab

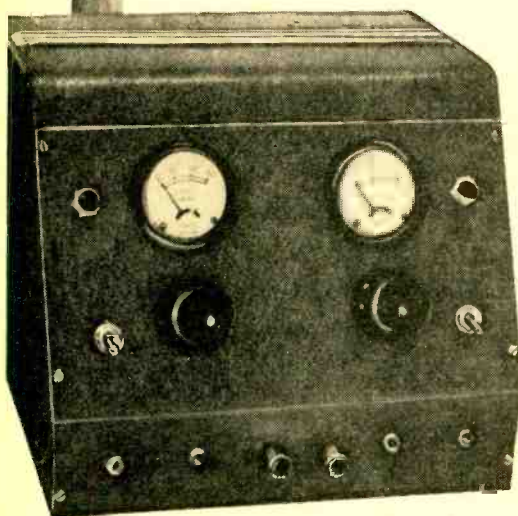

Over-all view of the complete "A" and "B" eliminator gives an idea of its professional appearance.

By HARVEY POLLACK

Run-down or dead batteries will no longer be a problem with this easy-to-construct eliminator on the workbench

PORTABLE, battery-operated equipment has become ever more popular during the last few years. Now, in addition to ordinary portable radios, one may see more and more devices like portable Geiger counters, metal locators, amateur transmitters and receivers, test equipment for strobe flash and regular flash guns, radio-sonde, etc., in use by experimenters, R/C plane and boat enthusiasts, and hobbyists of all kinds. While these devices are being built, repaired, or even when they are in use, there is usually an urgent need for some kind of battery substitute of flexible design which will produce the same output voltage and current as the batteries it replaces.

The "A" and "B" eliminator to be described in this article meets the most exacting specifications one could propose for a dry-battery substitute. At its "A" terminals, any voltage from 1.0 volt to 10 volts of pure d.c. at any current from 0.05 amp. (50 ma.) to 0.30 amp. (300 ma.) is available; the "B" supply provides exceptionally well filtered d.c. from 0 to 150 volts at any current from 0 ma. to 0.08 amp. (80 ma.). The hum level is so low that it was just barely audible with the gain turned full up when the eliminator was used to run a three-stage, high-gain audio amplifier system.

Voltage and current outputs designed into the eliminator enable the user to operate any device having one of the following tube line-ups:

1. One to seven of the 1.4-volt types in parallel (1R5, 1S4, 1V4, etc.). Although the supply is rated conservatively at 300 ma., the author has had seven miniature tubes connected and operating in parallel from it for several hours without any noticeable heating. The control resistor has been cal-

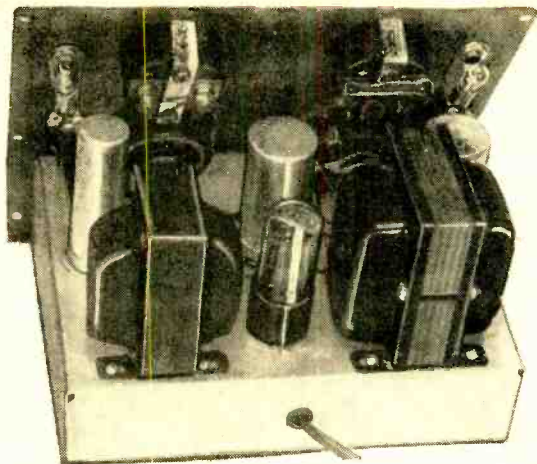

Top view of chassis is shown with cabinet removed. Power transformer is at right, choke at left, and 6X5GT tube in between.

Under-chassis view. Selenium rectifier is in center, fuses are at the front.

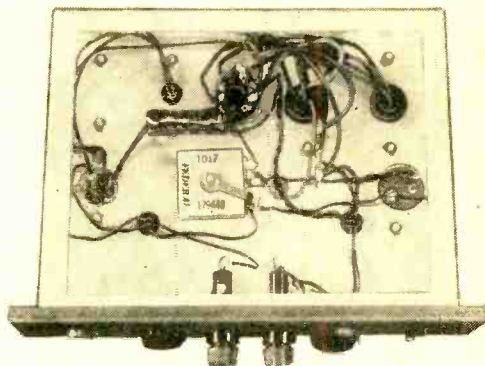

culated to provide only 1.5 volts even when a single tube acts as the load, so that any combination between these ranges is easily supplied proper filament power.

2. Up to five of the 2.0-volt types in parallel (1H4, 1N5, etc.).

3. Series string of two to six of the 1.4-volt types.

4. Series string of two to five of the 2.0-volt types, if current ratings of all tubes are the same.

Design and Construction

Since this was to be a shop instrument in full view of the public, it was built in a very nice cabinet with a view to achieving pleasing appearance in addition to the suggestion of competence. Details for construction in this cabinet are given here and in the parts list, but the unit will work just as well if it is built on an open chassis or even on a breadboard. The photographs and illustrations provide all the details which are necessary for its exact duplication.

The circuits are novel in several respects: any ordinary radio power transformer will serve as the source of power as long as it has a high-voltage winding (about 300 volts r.m.s. each side of center-tap), a 5-volt filament winding, and a 6.3-volt filament winding. The high voltage is rectified, filtered, and reduced in value to provide a variable "B" output from zero to about 150 volts. Thus, the eliminator can replace a 45-volt "B" battery, two in series (90 volts), any 67½-volt "B" battery, 90-volt combinations, and 135-volt packs. This "B" circuit is more or less conventional but it does include plenty of filtering.

Required "A" battery voltage is obtained in an interesting fashion: the 6.3-volt fila-

ment winding and the 5-volt winding are connected in series (after being properly phased) to provide about 11 volts r.m.s. This output is then rectified by the full-wave selenium bridge, and filtered by a total of 3000 μ f. of filter capacitance and a variable filter resistor which—in addition to its action in helping to remove hum—also serves as the output voltage control. A 500-ohm bleeder resistor keeps the output peak voltage down to 10 volts with no load, thus protecting the "A" voltmeter if the supply is turned on with nothing connected to it.

In the author's model, both output circuits were fused, the "A" circuit with a ¼-amp. fuse and the "B" circuit with a ½-amp. fuse. Fuses are always desirable, even if you never blow them! They constitute insurance purchasable for about 15 cents!

Phasing the Filament Windings

Before beginning the wiring of the "A" eliminator, the 5 and 6.3-volt filament windings must be phased so that their voltages add up rather than subtracting from each other. To do this, first separate all the leads of the transformer so that they cannot touch each other during the test. Connect a temporary line cord to the primary winding leads (usually black leads) but do not apply power, then connect an a.c. voltmeter with a range up to at least 15 volts to one 5-volt lead (usually yellow) and to one 6-volt lead (usually green). Finally, connect together the remaining 5-volt and 6-volt wires (remaining yellow and green leads). If an a.c. voltmeter is not available, a 12-volt automobile head lamp may be substituted as the measuring device.

Now apply power. If the phasing is cor-

rect, the voltage will be about 12 volts (or the lamp will light to full brilliance); if it is incorrect, the voltage reading will be quite low and the lamp will light dimly or not at all. After the test is finished, twist the two joined leads together so that they can be easily found later on.

The wiring is straightforward and uncomplicated. If a metal cabinet or chassis is used, the B- may be made the chassis ground. In any event, all other terminals (the B+, the A+ and the A-) must be insulated from the metal. Watch for the correct polarity of electrolytic capacitors (see schematic diagram) and make certain that neither of the two "A" capacitor cans is grounded. In the model shown here, one of these has a "negative can"; to avoid grounding it, this capacitor can was mounted on a small Lucite plate raised off the chassis by two rubber grommets. The other capacitor had no connection to the can, so that it was mounted directly on the chassis. The units specified in the parts list are for underchassis mounting and present no problems in this respect. When installing the meters, observe polarity to avoid damaging them.

Testing the Unit

If the builder follows the step-by-step procedure given below, he will be assured of avoiding damage to any of the components in the power supplies:

1. Do not apply power. Rotate both controls fully counterclockwise. Connect an ohmmeter across the "A" output jacks and observe its action. It should jump up to practically zero resistance as the big filter capacitors charge up, then slowly drop down toward the other end of the scale. The needle will never reach infinite resistance due to the normal leakage through the filter capacitors, but the final resistance reading should be that of the 500-ohm bleeder resistor, R5. Now, turn on the "B" switch.

2. Do not apply power. Rotate R3 fully clockwise. The performance should be similar to that described in (1), except that the final value of resistance should be that of resistor R3 (5000 ohms). Turn the "B" switch off, remove ohmmeter leads.

3. Both switches should be off. Plug the unit into a convenient 117-volt a.c. receptacle and turn on the "A" switch, S1. (Both controls should still be in the fully counterclockwise position). The "A" pilot light should come on and the "A" voltmeter should read about 9½ volts. Without removing power, plug in the "A" leads and connect a 600-watt heating coil, flatiron, or toaster across the leads. The "A" voltmeter should drop down to about 1 volt with this load. *Do not rotate the "A" control at this point in a clockwise direction or the 250-ma. fuse may blow.*

(Continued on page 125)

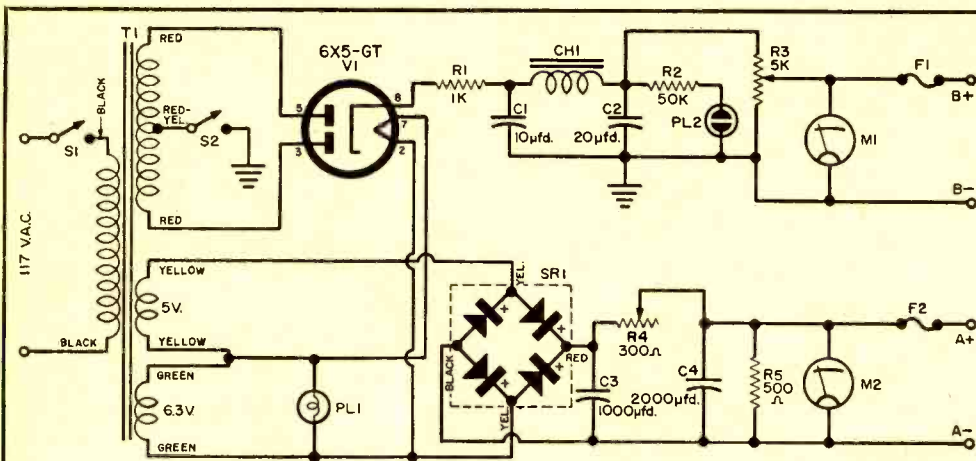

Schematic diagram of the complete unit. Parts list is continued on the facing page.

C1, C2—10/10/10- μ fd., 450-volt elec. capacitor (two sections in parallel for C2)
 C3—1000- μ fd., 15-volt elec. capacitor (Cornell-Du-bilier Type 1510 or equivalent)
 C4—2000- μ fd., 15-volt elec. capacitor (Cornell-Du-bilier Type 1520 or equivalent)
 CH1—12 hy. @ 80 ma. filter choke (any value from 10 to 30 henrys may be used)
 F1—½-ampere fuse and holder
 F2—¾-ampere fuse and holder

M1—0-10 volt d.c. meter (Emico Type 2140 or equivalent)
 M2—0-150 volt d.c. meter (Emico Type 2143 or equivalent)
 PL1—6-volt pilot light and socket
 PL2—NE-51 neon bulb and socket
 R1—1000-ohm, 10-watt wire-wound resistor
 R2—50,000-ohm, ½-watt resistor
 R3—5000-ohm, 50-watt rheostat (Ohmite J-0330, Mal-lory 50K 5000P or equivalent)

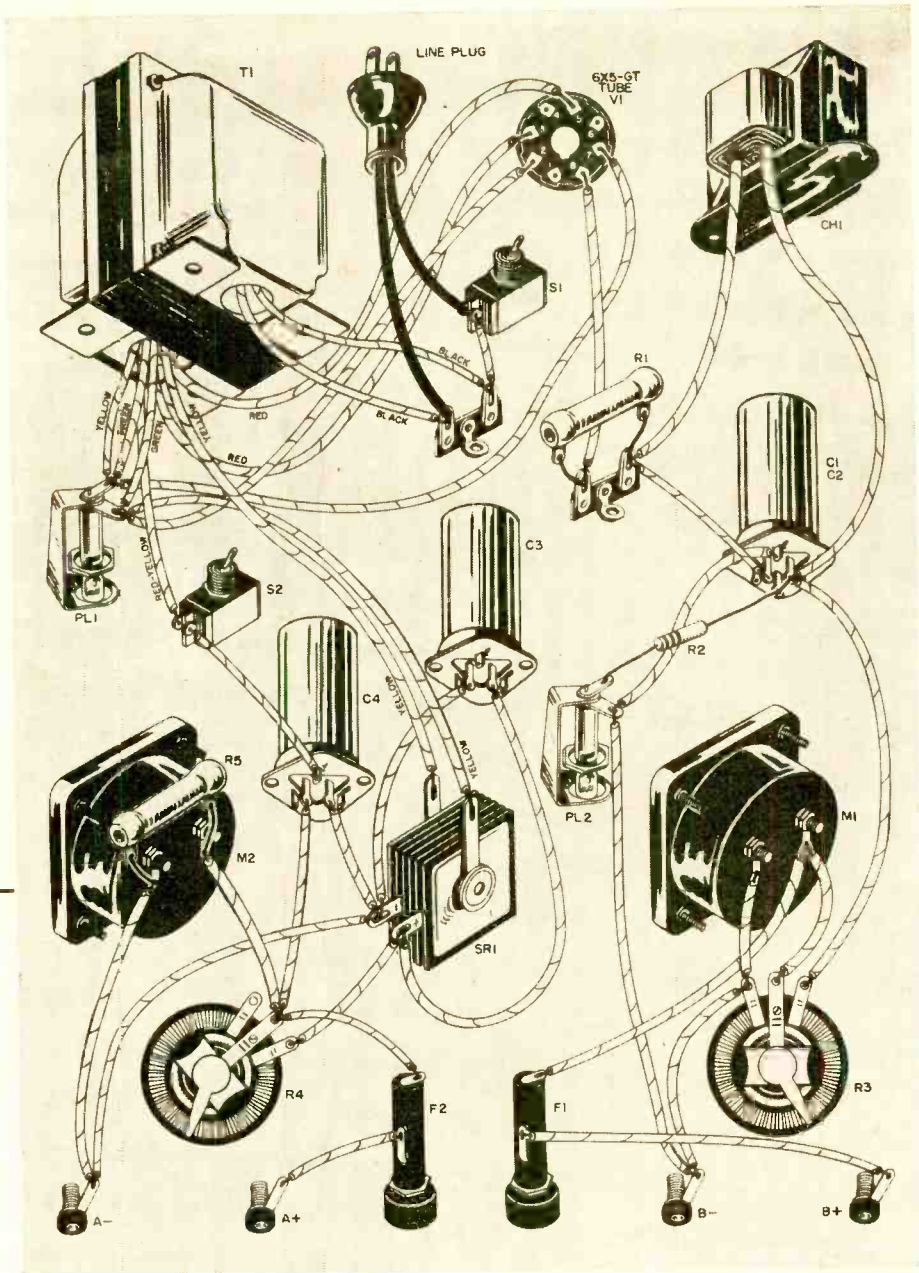

Pictorial diagram of the battery eliminator and continuation of parts list.

- R4—300-ohm, 50-watt rheostat (Ohmite J-0323, Mal-lory 50K 300P or equivalent)
 R5—500-ohm, 5-watt wire-wound resistor
 S1, S2—S.p.s.t. toggle switch
 SR1—Bridge-type selenium rectifier, 25 volts at 700 ma. (Federal Type 1017 or equivalent)
 T1—Power transformer, 520 volts c.t. @ 80 ma., 5 volts @ 2 amp., 6.3 volts @ 3 amp. (Stancor PC-8404 or equivalent); ratings are approximate
 V1—6X5GT tube
 1—Line cord and plug
 1—Cabinet sloping panel, 8" x 10" x 8", wrinkle

- finish (Par-Metal SF-501 or equivalent)
 1—Aluminum chassis, 7" x 9" x 2"
 4—Plastic head banana jacks, two red and two black
 2—Sets of test leads, 1½' long, one red and one black, with banana plugs on one end and plastic handle alligator clips on other end
 2—Black knobs, setscrew type, for ¼"-diameter shaft
 Misc. wire, solder, terminal strips, etc.

Catalog price of components, approx. \$39.00

An Amateur's Audio



Oscillator

By E.T. KEPHART, W2SPV

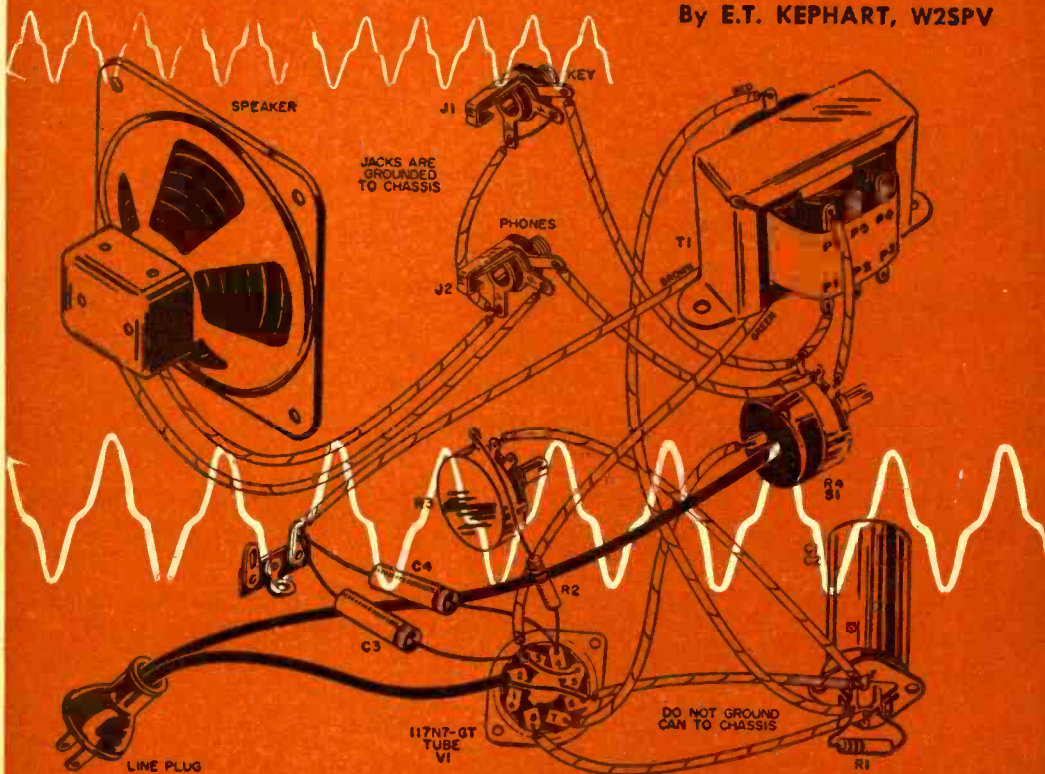

Pictorial diagram of the useful audio or code practice oscillator.

Built by W2SPV for code practice lessons, this self-contained audio source has many useful applications in the ham shack

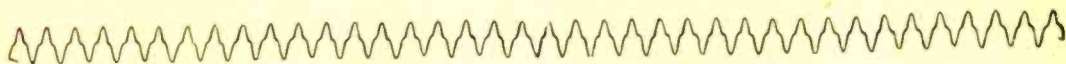

HERE IS A USEFUL TOOL for amateurs, both old-timers and beginners. Advanced operators can use this versatile audio oscillator as a signal generator to check their transmitters; as a source of constant modulation, it beats whistling into a mike. Use it, too, as an audio source for modulated c.w. Most amateurs have found that, for obtaining DX under difficult conditions, code is better than voice; m.c.w. is often better than ordinary c.w. When not on the air, the oscillator can be used for code practice, either to increase one's own speed or to help a beginner.

Although this audio oscillator is easy to build and not very expensive, it is unusually flexible. It provides a pleasant audio tone whose pitch is variable over about one octave. The output may be either continuous or keyed. Sound can be produced directly by an internal speaker or by headphones. The signal can be fed to other equipment for testing or transmitter modulating purposes. Amplitude of the output can be varied to suit the application. Appearance of the finished unit is commercial. Although it can be operated from either a.c. or d.c. power lines, the oscillator is safer to use than some a.c.-d.c. equipment; the cabinet is insulated from the power line and no voltage except the signal output appears at the headphone or key jacks.

Circuit Details

The design of the oscillator is a well-tested one, using a 117N7GT combination diode and beam power amplifier tube. (See the schematic diagram.) Heater voltage is obtained directly from the power line. The diode section of the tube is used as a half-wave rectifier, with the filter, *C1*, *R1* and *C2*, to provide d.c. voltage for the oscillator proper.

A Hartley oscillator circuit is used, with the beam power tube section of the 117N7GT connected as a triode (plate and screen tied together). Tank circuit for the oscillator consists of *C3* and the primary of *T1*, with feedback from plate to grid produced by the coupling between the two parts of the transformer winding. Grid leak bias is provided by *C4* and *R2-R3*.

Since *C4* and *R2-R3* in series are connected across part of the oscillator tank (through *C2*), varying *R3* changes the frequency of the signal produced. In the original unit, with nominal component values as specified, the frequency range was from 800 to 1700 cps. Actual frequencies obtained in another unit may be slightly different because of normal commercial variations in actual values of components, particularly the capacitors. Substituting a different type of transformer, even one for the same impedances

- C1*, *C2*—20/20 μ d., 150-volt dual elec. capacitor with insulated mounting plate (Mallory FP-208)
- C3*, *C4*—02- μ d., 400-volt paper capacitor
- I1*, *I2*—Closed circuit phone jack (Switchcraft Type 12A)
- R1*—250-ohm, 5-watt wire-wound resistor (Sprague Koolohm Type 5KT)
- R2*—3300-ohm, 1-watt composition resistor
- R3*—10,000-ohm potentiometer (IRC Type Q or equivalent)
- R4*—300-ohm wire-wound potentiometer
- S1*—S.p.s.t. switch mounted on *R4* (IRC Type 51)
- T1*—4-watt universal output transformer (Stancor Type A-3856)
- V1*—117N7GT type tube
- 1—3" replacement speaker (Oxford Model 3AMS)
- 1—Octal socket (Cinch-Jones Type 8EM)
- 1—6' line cord and plug
- 1—Metal cabinet, 4" x 5" x 6" (Bud Type CU-729)
- 1—Chassis, 4 1/8" x 3 3/4" x 1 1/2" (Bud CB-1627)
- 2—Knobs (ICA Type 1081)
- 1—Single insulated tie point (Cinch-Jones Type 51)
- 2—Grommets, 3/8" o.d. x 1/4" i.d. (General Cement Type 1040)
- 1—Piece of metal screening (see text)
- 6-32 x 1/4" machine screws, nuts, wire, and solder as required

Wiring diagram and parts list. Note that the case is not grounded to the negative return. The only ground in this unit is through the phone jacks as shown below.

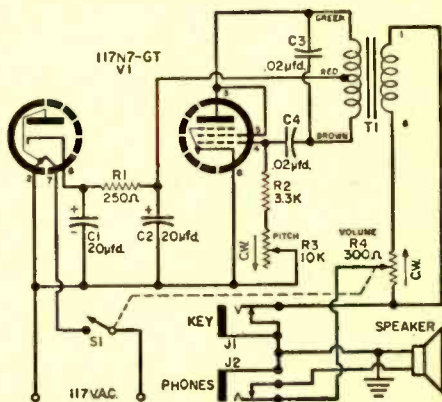

as the transformer specified, also would change the frequencies obtained.

The secondary of *T1* furnishes an output signal isolated from both a.c. and d.c. supply voltages. Volume control *R4* adjusts the signal to the desired level. With no plug inserted in closed-circuit jack *J1*, a continuous output signal is provided. With a key connected through a plug in this jack, the output can be keyed. If no plug is in jack *J2*, the output is fed to the speaker. A plug inserted in *J2* will disconnect the speaker and can feed the output to a pair of headphones or other equipment.

Metal Work

A suitable cabinet for the oscillator is the *Bud* type CU-729, which is 4" x 5" x 6". The chassis used was a *Bud* type CB-1627, 4 1/8" x 3 3/4" x 1 1/2". If preferred, cabinet and chassis can be fabricated from aluminum or other sheet metal. The photographs on these pages may be followed in drilling the chassis and the front and rear panels of the cabinet. Mounting nuts of potentiometers *R3* and *R4* hold the chassis to the front panel.

The commercial appearance of the unit is enhanced by engraving the necessary lettering as shown; the cost is only a few cents a letter. A small sheet of metal screening mounted between the speaker and the front of the cabinet improves appearance and protects the cone of the speaker from damage.

Placement of the parts is not particularly critical because of the low signal frequency, but the arrangement shown in the photographs makes most of the connecting wires

fairly short. The speaker should be mounted so that its terminals are next to jacks *J1* and *J2*. To keep power line voltage off of the cabinet, use an insulated mounting plate for electrolytic filter capacitor *C1* and *C2*. Jacks *J1* and *J2* are automatically grounded to the cabinet when mounted. To make the connection as effective as possible, remove some of the paint from the front panel where the jacks make contact.

Wiring the Components

Wire the components as shown in the pictorial wiring diagram and the schematic. Most of the wiring is point-to-point. One insulated single-lug tie point is used, for the junction of *C3*, *C4*, and the brown lead from *T1*. The tie point can be seen in some of the photographs, at the end of *C3* and *C4* near the front panel. *Caution*: Do not allow any of the bare wiring to touch the chassis or cabinet.

Notice how the line cord is connected to the switch. Following the schematic diagram, it would seem natural to break one leg of the line and insert the switch between the two parts of that leg. Instead, the switch is connected at the end of the line cord and connections to terminals 2 and 7 on the tube socket are made to the two parts of one leg. Electrically, the effect is exactly the same, but this arrangement keeps together the two wires running to the switch and makes the wiring look neater.

Using the Oscillator

After the wiring has been completed and checked, insert the tube in its socket and
(Continued on page 127)

These two views show the location of the components above and below the chassis.

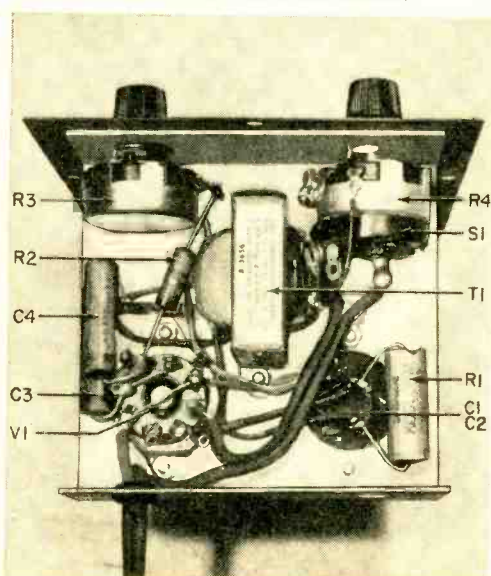
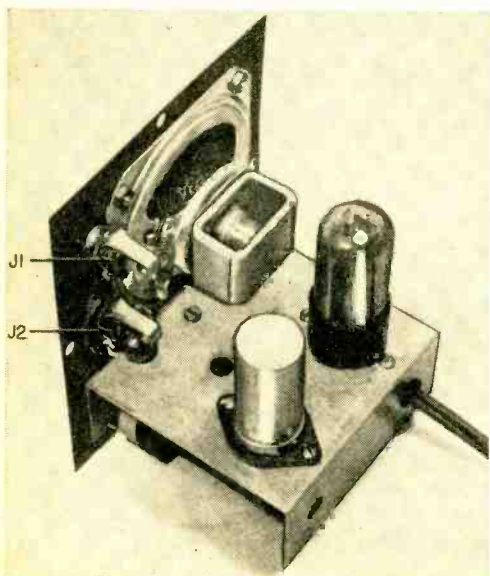

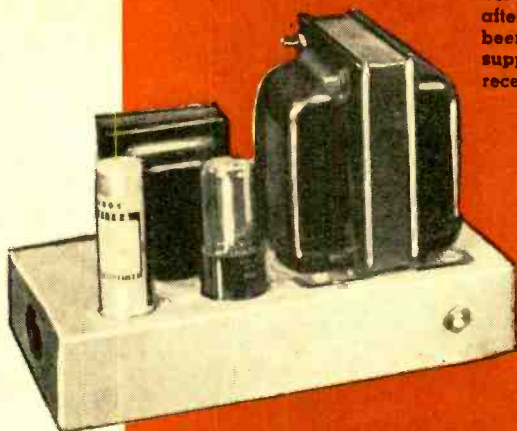

View of the transmitter (right) after 6L6G amplifier stage has been added. The 400-volt power supply (left) is constructed of receiver replacement parts.

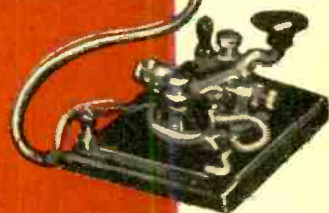

Improving

the

"Novice C.W. Transmitter"

By ALBERT S. FLOOD, Jr.

THE power-handling capabilities of the Novice transmitter described by Rufus P. Turner in the article entitled "Build This Novice Transmitter," which appeared in the February, 1955, issue of POPULAR ELECTRONICS, can be increased several times by adding a power amplifier to it. Adding the extra stage is economical because all of the original parts—except the coils—are used.

Modifying the Circuit

Circuit changes and added parts are included within the dashed lines of Fig. 1. To make the modification, remove the coil socket from the top of the original chassis and remount it in a hole punched in the center of the right-hand lip of the chassis. Mount an octal tube socket in the old coil-socket hole, putting a solder lug under the nut on each mounting screw. Then drill a $\frac{3}{8}$ "-diameter hole in the front right-hand corner of the chassis. Insert a $\frac{3}{8}$ " rubber grommet in the hole to accommodate the pilot bulb PL1.

Referring to the 6L6G socket, ground pin 2 and connect pin 7 to the ungrounded 6.3-volt input terminal. Disconnect the 100- μ fd. capacitor C6 from the stator terminal of the variable capacitor C7, and connect it to pin 5 of the socket. Also, between pin 5 and the nearest grounding lug, connect an 18,000-ohm, 1-watt resistor (R3).

Then, connect a .005- μ fd., 1000-volt fixed capacitor (C10) between pin 3 of the socket and the stator terminal of C7 from which C6 was removed. One end of a 2.5-mhy r.f. choke (RFC3) should go to pin 3. Connect the other end of RFC3 to an insulated tie point for support or to one side of the No. 40 or No. 47 current-indicating bulb (PL1). From the other side of the bulb, run a wire to the 400-volt B+ terminal at the back of the transmitter.

Instead of mounting another insulated binding post for the 400-volt terminal, the author disconnected the toggle switch from the old B- terminal and used that binding post for the purpose. The grounded

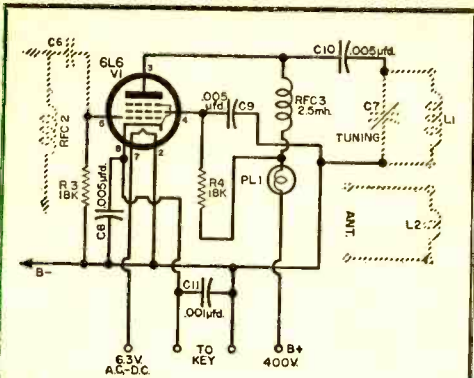

Fig. 1

C8, C9—0.005- μ fd. mica or ceramic capacitor
C10—0.005- μ fd. mica capacitor with 1000-volt rating

C11—.001 μ fd. mica capacitor
PL1—Pilot bulb, 6.3-volt, 150-ma.
R3, R4—18,000-ohm, 1-watt carbon resistor
V2—6L6G tube

Also required are the items of miscellaneous hardware, sockets, etc., to add this stage to the existing transmitter. All components, with the exception of the coils listed below, are identical to those used in the design of the original transmitter. The phantom lines in the wiring schematic (Fig. 1 above) illustrate how the circuit is "opened" and the 6L6G amplifier inserted to add more power.

NEW COIL TABLE

80 Meters:

L1—16 turns of No. 18 wire, $2\frac{1}{4}$ " dia., space-wound to occupy a winding length of $1\frac{1}{4}$ "
L2—6 turns of No. 18 wire, wound $\frac{1}{4}$ " below L1; space-wound to occupy a winding length of $\frac{1}{2}$ "

40 Meters

L1—6 turns of No. 18 wire, $2\frac{1}{4}$ " dia., space-wound to occupy a winding length of $\frac{1}{2}$ "
L2—3 turns of No. 18 wire, wound $5/16$ " below L1; space-wound to occupy $\frac{1}{4}$ "

Coils are wound on $2\frac{1}{4}$ " dia. by $4\frac{1}{8}$ ", ribbed, 4-prong, plug-in forms (BUD or ICA). The top end of L1 terminates in socket pin 1; bottom terminates in pin 4. Top of L2 terminates in pin 2; bottom terminates in pin 3. Drill small holes through walls of form to pass ends of wire before starting to wind coils.

filament terminal now serves as the common filament and B- terminal. Leave the switch mounted on the front of the chassis to fill the hole.

If desired, a small socket may be used to make connections to bulb PL1. However, if care is used, the wires can be soldered directly to the base of the bulb. Push the bulb through the rubber grommet so that its tip protrudes above the grommet slightly. Be careful not to allow the bulb connections to touch the chassis; otherwise, the power supply will be short-circuited.

Returning to the 6L6G socket, bypass pin 4 to the chassis with a .005- μ fd. capacitor (C9). Also, connect an 18,000-ohm, 1-watt resistor (R4) between the junction of RFC3 and PL1. Bypass pin 8 of the socket to ground via a .005- μ fd. capacitor (C8), and connect a wire between pin 8 and the ungrounded terminal of the key jack. Bypass the jack terminal to ground with a .001- μ fd. capacitor (C11).

Referring to the coil socket in its new position, reconnect the wires removed from it before moving it: thus, pin 1 goes to the stator of C7, pin 4 to the frame of C7, and pins 2 and 3 to the antenna terminals.

Finally, new coils must be wound to carry the added power output of the 6L6G compared to that of the 6AQ5. Complete specifications are given in the coil table. These coils are designed to have approximately the same inductance and coupling between the windings as the original ones.

Tuning the Transmitter

A power supply capable of delivering approximately 400 volts at a minimum of 100 milliamperes and 6.3 volts at 1.5 amperes is required to operate the transmitter. The 250 volts for the 6AQ5 is obtained from a tap on its bleeder resistor. This resistor may be a 20,000-ohm, 50-watt unit with a movable slider connected across the output terminals of the supply. If a d.c. voltmeter

(Continued on page 124)

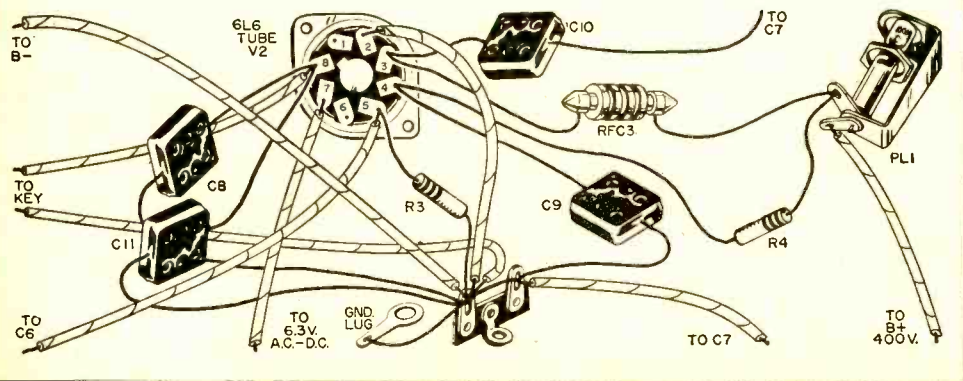

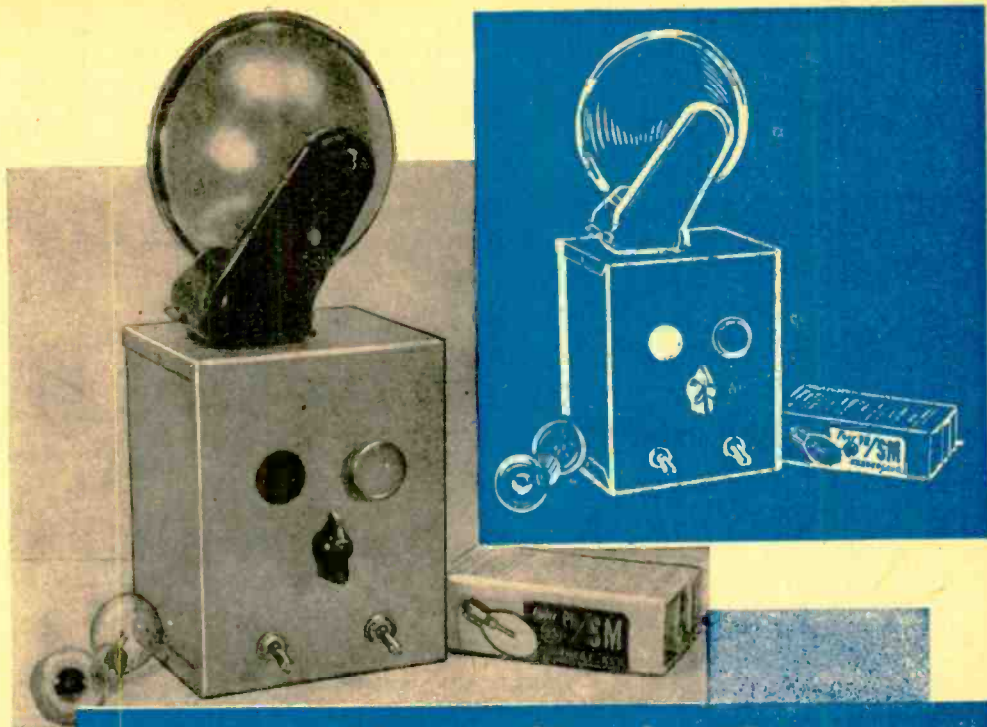

Slave Photoflash Trigger

By HARVEY POLLACK

Many photographers will welcome this valuable aid when taking flash pictures

DESIGNED to avoid entangling camera extensions and flash failures due to overloaded flash-gun batteries, the "slave" photoflash trigger unit described here will fire up to four other lamps distributed around a room from the light energy of the camera gun. No connection is needed between the camera and the "slave" unit; through the use of a high-speed electronic circuit, reliable triggering of the auxiliary flash lamps is realized even when pictures are taken by synchronized flash at rapid shutter speeds.

When photographs of large groups of people are to be taken or when the room size requires additional coverage, the photographer usually places flash-lamp reflectors in strategic positions to improve the uniformity of illumination. Since practically all such pictures are taken by synchronized flash at relatively high shutter speeds, it is essential that all the lamps reach their peak at almost the same instant in time. Without a slave unit, a long and unmanageable extension cord from the primary flash gun is required; furthermore, unless the flash batteries are really

in top shape, the overload of too many flash lamps demanding high current at the same time may prevent any of them from firing! A small SM or SF type requires a peak surge current of 3 amperes for dependable operation.

In the circuit described in this article, an 868 gas-filled phototube catches the light from the primary flash even before it reaches peak, instantly igniting a 2050 thyatron; it is the surge current through the thyatron which fires the slave lamps, the action being so fast that the peaks are reached within less than 1/500 of a second of each other!

The photographs and illustrations provide most of the information needed to proceed with the construction of the unit. With regard to the metal work, the following steps are strongly recommended because of the small—but important—differences which exist between listed parts and the equivalent components that the reader may procure.

1. Drill the holes for the two switches on the front apron first. These should be placed as far apart as possible to minimize the danger of accidental operation of the wrong switch. Mount the switches so that the *S1* toggle is *up* for the "on" condition and the *S2* toggle is *down* for "on."

2. Punch the tube holes next, placing the 868 phototube as far forward as it will go without interfering with or touching the solder lugs of *S2*. If a somewhat larger

chassis and cabinet are used, this presents no problem; but in the case of the compact unit shown, great care in planning and layout were necessary. The sockets recommended in the parts list require a 1 1/4" hole for the four-prong socket (868) and a 1" hole for the octal socket (2050). These holes are punched one behind the other, allowing ample room between them for the bulge in the thyatron envelope.

3. Place the filament transformer atop the chassis roughly in the position shown in the photographs, mark its mounting centers, and drill No. 27 holes (for 6-32 mounting screws). Next drill the lead-down holes (3/8" in diameter) below the point where the leads emerge from the filament transformer; 3/8" rubber grommets are inserted in the lead-down holes. Also, drill a 3/8" hole in the center of the rear apron for a third grommet through which the 117-volt line cord goes, a No. 27 drill hole for the long machine screw which supports the stacked selenium rectifiers off to one side of the rear apron, and another hole of the same size near *S1* to secure one of the two-lug terminal strips. The other terminal strip is secured by the screw that holds the far end of the 868 socket in place.

4. Once all the foregoing components are in place, the wiring should be started. One two-lug strip anchors the line cord and the other provides a pair of ground points. The chassis is *not* grounded, so bare wires must not be permitted to touch it. It is suggested that all subchassis wiring be completed at this point, bringing up the leads which go to the bull's eye indicator lamp, the output socket, and the "compensation" control through the grommets, tagging them for proper identification. Make the wires longer than necessary so that they may subsequently be trimmed to size.

Circuit diagram and parts list.

C1, C2, C3—8- μ f., 450-v.v. electrolytic capacitor

PL1—6- or 7-watt, 117-volt pilot lamp and candelabra base assembly

PL2—SM or SF flash lamp (see text)

R1, R3, R4—25,000-ohm, 1/2-watt resistor

R2—25,000-ohm carbon potentiometer, linear taper

R5—3.3-megohm, 1/2-watt resistor

SO1—117-volt a.c. receptacle, or other socket to fit flash-lamp assembly (see text)

S1, S2—S.p.s.t. toggle switch

SR1, SR2—65-ma. selenium rectifier, 130-volt r.m.s.

T1—Filament transformer, 6.3-volt @ 0.6-amp. secondary

V1—Type 868 phototube

V2—Type 2050 thyatron

1—Line cord and plug

1—4-prong socket

1—Octal socket

4—3/8"-diameter rubber grommets

2—2-lug terminal strips

1—Pointer knob

1—Aluminum open-end chassis, 3 3/4" x 4 1/8" x 1"

1—Aluminum utility cabinet, 6" x 5" x 4"

Misc. wire, solder, screws, etc.

Catalog price of parts, approx. \$16.00

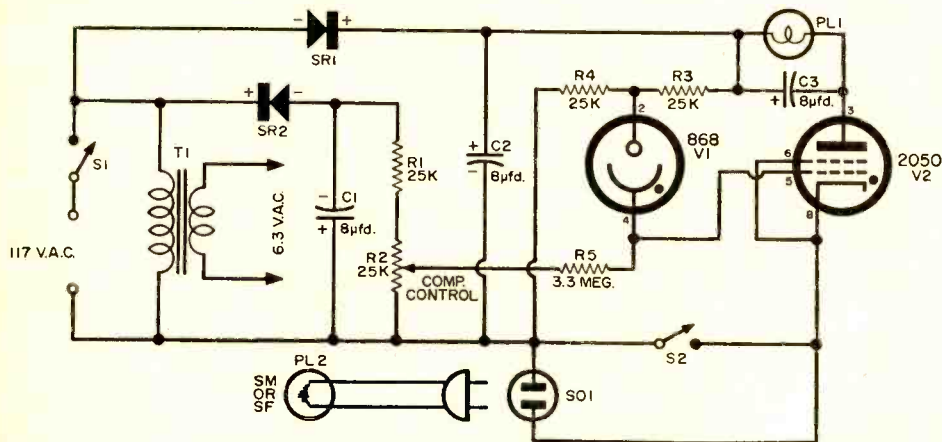

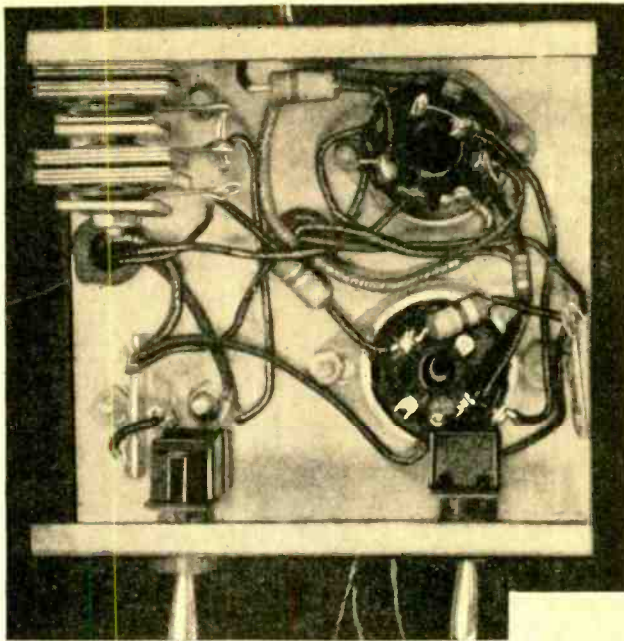

Under-chassis view. The two selenium rectifiers are at the upper left, and the two toggle switches at the bottom.



Above-chassis view. The 868 phototube is in front with the 2050 thyratron behind. Filament transformer is at right.

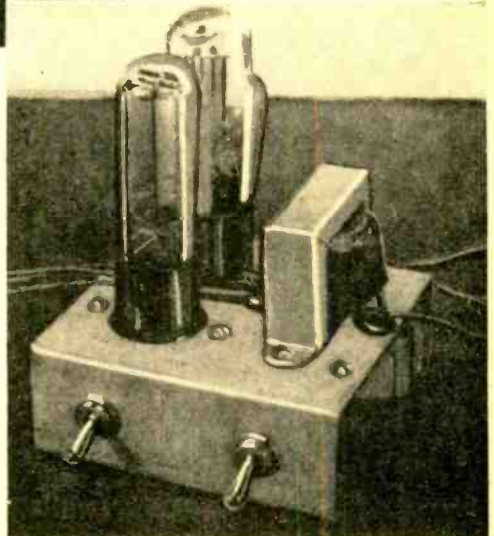

5. As the chassis is secured to the cabinet by means of the switches alone, these cabinet holes must be drilled precisely to match those on the chassis. The phototube window must be located directly in front of the sensitive element. Other holes may be located to suit convenience and esthetic sense. Since the writer uses flash reflectors having standard line cords and plugs, the output socket at the top of the cabinet is a receptacle of this type. Any type of connector, single or multiple, may be installed with equal facility.

6. If capacitors $C2$ and $C3$ are made 40 μ fd. rather than 8 μ fd., up to 16 or more flash lamps may be fired simultaneously.

Adjustment and Use

Set the trigger cabinet on floor, chair, or table where there is an unobstructed "light line" between the phototube window and the primary flash gun. Both switches should be *down* and the compensation control fully counterclockwise. With both toggles down, $S1$ cuts off a.c. power from the unit and $S2$ short-circuits the output socket so that the auxiliary flash cannot be fired inadvertently. This is the reason for mounting $S2$ in the inverted position. To most users, a down-toggle means "off" or "safety"; in this case, although the down-toggle closes the contacts of $S2$, it keeps the flash lamps safe by short-circuiting them.

1. Insert one or more flash lamps in the output socket or sockets. SM, SF, No. 5, or No. 11 types may be used although the first two are recommended because of their long peaks.

2. Close $S1$ and allow about 30 seconds for warm-up time.

3. Rotate the compensation control knob ($R2$) clockwise until the bull's-eye indicator lamp flashes on. This indicates that normal room light is triggering the thyratron.

4. Back off the compensation control until the indicator lamp just goes out and remains extinguished. The room lights have now been compensated for; any additional illumination will again trigger the thyratron. This may be tested by lighting a match a few inches from the window; the indicator should fire briefly, then go out.

5. When ready to take pictures, flip $S2$ up. This removes the short circuit from

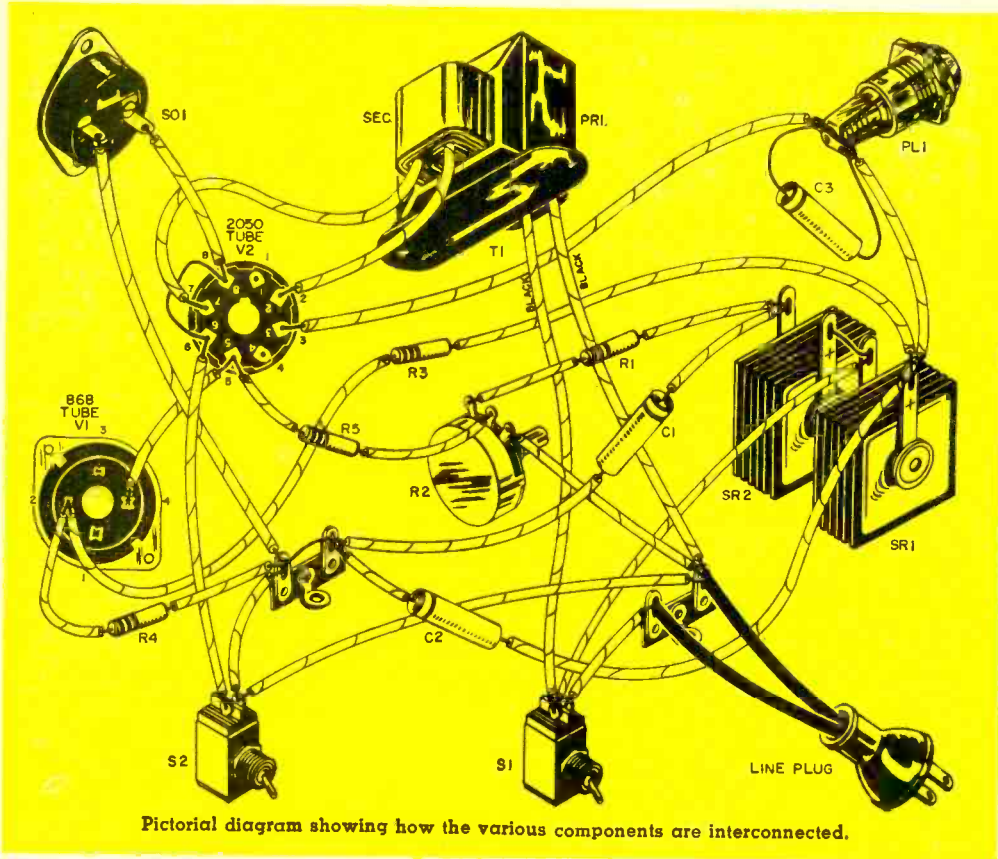

the output socket; the primary flash will now fire the slave lamps instantaneously. Once a photo is taken, flip *S2* to the down position at once before inserting flash bulbs for the next round.

Circuit Operation

Selenium rectifier *SR2* provides negative bias which prevents the 2050 from ionizing, the tube behaving like a switch in its "off" position. The compensation control governs just how much bias is applied to keep the thyatron from firing with normal room lights yet remain quiescent in a highly sensitive condition. When light from the primary flash lamp reaches the phototube, a small current flows through *R5*—causing a voltage drop which cancels some of the "holding" bias and allows the thyatron to fire instantaneously. (The firing time lag is a little more than one microsecond!) Capacitor *C1* filters the bias voltage while resistor *R1* forms a voltage divider with the compensation control to limit the range of bias adjustment and provide a more sensitive control.

SR1 applies d.c. plate potential to the thyatron and the phototube. A fraction of a second after power is applied, *C2* charges

to about 135 volts and holds its charge until firing time. At the instant the thyatron ionizes, *C2* releases its charge through the flash lamp circuit, sending a very heavy surge of current through the lamp, the thyatron, and *C3*. The fuse element of the flash lamp burns out as the lamp produces its brilliant flash of light. *C3* has two functions. First, it is a surge bypass capacitor; without it the surge path through the lamp filament has too high a resistance. In addition, it serves to extinguish the thyatron when negative bias is restored. *R3* and *R4* form a voltage divider which reduces the potential applied to the anode of the gas phototube to a safe value. This tube has a peak plate voltage rating of 100 volts.

A few words of caution might be in order regarding the last sentence in step (5) under "Adjustment and Use," i.e., returning *S2* to the down position after firing one or more lamps. This is important! With both switches up, jiggling a new flash lamp in its socket in attempting to insert it sets up transient voltages which may trip the thyatron even though its bias voltage is below cutoff. Always flip *S2* downward after each flash, insert the new lamps, then flip it up again.

Transistor Topics

Raytheon's "Transistor Applications"

If you have not already done so, we want to urge all experimenters interested in transistors to purchase this book. It is undoubtedly the most valuable book on transistors available to the public. Priced at fifty cents, and found at practically all radio parts jobbers and distributors, this 116-page volume contains 53 features and pertinent data on most of the Raytheon transistors.

The major portion of "Transistor Applications" consists of reprints of articles featuring transistors in one way or another. Included are receivers, audio amplifiers, oscillators, photo timers, monitors, Geiger counters, phase inverters, etc. Most of the original articles either appeared in our sister publication, RADIO & TELEVISION NEWS, or in RADIO-ELECTRONICS. Many of them, we are pleased to note, were written by POP'tronics Contributing Editors, Lou Garner and Rufus Turner.

Regardless of your interest in transistors, you should find something of value in this book. It covers theory with heavy emphasis on application, practical usage, and design principles. Readers that recall the valuable Raytheon contest a few years ago to popularize transistors will be pleased to note that the suggestions of the winners are also published in this book.

For fifty cents, it's the biggest bargain in radio and electronics today.

Transistorized Pocket Receivers

In response to numerous requests from readers of POP'tronics, we have summarized below the characteristics of several small broadcast receivers using transistors. All of these receivers are miniature in size, are built into plastic cases, and are available at very moderate prices. The listing below is arranged by alphabetical order of manufacturer or distributor.

Eastern Audio Kit

The Eastern Audio transistor kit utilizes two stages of transistor audio amplification. A crystal diode detector is coupled to a tunable loopstick. The latest model of this receiver is built around a printed circuit wiring board. This design method simplifies wiring and construction.

Employing a second stage of audio amplification enables the antenna for the Eastern Audio receiver to be relatively small, and in

many cities this receiver will operate using a short whip antenna. As is true of most of the transistor receivers described here, it is mounted in an "impact-resistant" plastic case. The battery supply consists of two small penlite cells.

The Eastern Audio receiver is sold for \$12.95—minus the 8000-ohm special earphone. This

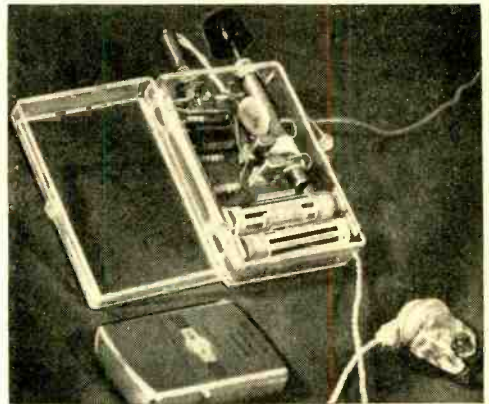

earphone is sold separately for \$3.95. It is a special unit with a molded plastic channel that fits comfortably into the average ear. The high impedance of the earphone provides extra volume output from the transistor in the last audio stage. Further details may be obtained from Eastern Audio, Box 115, Huntington Station, New York.

Lafayette KT-80

This kit wins honors for the lowest cost among the miniature transistorized broadcast receivers. Employing a very simple crystal diode and single stage of audio circuit, the receiver can bring in stations 50 miles away when used with a good antenna. An unusual feature is the double-tuned antenna stage. Rotating the core of a loopstick will select the stations and use of a miniature 365- μ fd. variable capacitor in the antenna lead will peak the response.

The Lafayette KT-80 is built into a small plastic case measuring 3" x 2" x 1". Plugging into the phone tips completes the circuit to the collector of the transistor, thus eliminating need for an off/on switch. The kit can be assembled in about one hour.

Cost of this kit including single earphone is \$6.54. The KT-80 is also sold for \$4.95 minus the earphone.

Lafayette KT-68

This pocket radio is essentially a two-transistor and one-crystal-diode receiver featuring regeneration. The advantages offered by regeneration in transistor circuitry are tremendously important. Some transistor radios are simply crystal diode detectors followed by one or more stages of audio amplification. The *Lafayette KT-68* employs one transistorized stage of audio and a combination diode/transistor stage for regeneration and detection. Effective use of regeneration produces more circuit gain and hence louder signals, and greatly improves selectivity or station separation.

The KT-68 is assembled on a small perforated Bakelite board which is then fitted into a plastic case. The coil used to secure regeneration is a modified Ferri-loopstick. A few extra turns are wound around one end of the coil and are left loose so that they may be varied after the receiver has been completely assembled. This coil is the only "non-standard" item used in the receiver. The remaining components are all standard and the KT-68 can be put together in about two hours.

One extra advantage of regeneration not mentioned above is an increase in sensitivity. With a long antenna, the output is greater and the number of stations noticeably increased. Short antennas can be used in the larger cities where broadcast stations employ fairly high power.

The KT-68 is sold as a kit for \$13.75, including the small dynamic earphone. *Lafayette* (100 Sixth Ave., New York 13, N. Y.) will also have the kit available without the earphone for \$11.80.

TraDyne Transistor Radio

Probably the most interesting thing about the *TraDyne* is the use of a printed circuit board. Since it comes pre-etched and with holes drilled through it to mount all components, the wiring time is reduced by a very sizable amount. The instructions are clear-cut, and the finished package receiver in its plastic case is neat and novel enough to be demonstrated with pride to your friends.

Other important features of the *TraDyne* are: plug-in earphone using a miniature jack

and plug; ear-loop earphone which some people may find more comfortable; miniature alligator clips affixed to short lengths of flexible lead, thus enabling easy attachment to handy metallic objects for antenna and ground connections; and single-knob tuning



adjustment. Batteries and transistor are soldered into the circuit. The latter was not identified by the manufacturer.

Circuitwise, the *TraDyne* is similar to most crystal diode/transistor BC receivers, except that the cathode of the diode is attached to the L/C circuit (instead of the other way around as in the *Lafayette KT-80*), and a subminiature 4.0- μ fd. capacitor is used to couple the diode to the base of the transistor.

The *TraDyne* (11 West Monument Ave., Dayton 2, Ohio) is sold for \$9.95 as a kit (complete with earphone), or \$12.95 wired and tested by the manufacturer. If you have never worked with a printed circuit board, you will find the construction of this receiver a rewarding experience.

Next Month

Rufus Turner has promised to send us a few schematic diagrams of low-voltage a.c. power supplies. We feel that these units will gradually replace batteries in transistor experimental work.

-50-

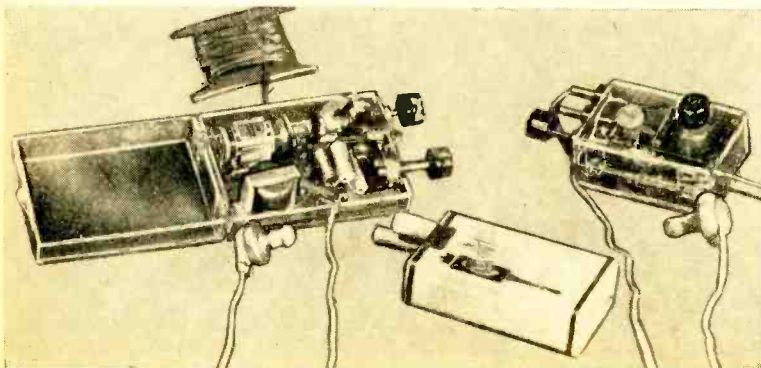

At the left is the Lafayette KT-68 kit using regenerative detection. A KT-80 is on the right. The package of cigarettes lends an idea of size.

BOOKSHELF

"ELECTRONIC AND RADIO ENGINEERING" by Frederick E. Terman. Published by McGraw-Hill Book Co., 330 West 42 St., New York 36, N. Y. 1078 pages. Cloth bound. Price, \$12.50.

This is the fourth edition of one of the most valuable and authoritative reference texts in the field of radio and electronics. Little doubt can be laid to the statement that well over half the engineers and technicians in this country have grown up on "Terman," or have his books close at hand for reference during their daily work.

The present edition is divided into three distinct parts. The first treats transmission lines; the second deals with electronic devices and applications; the last is concerned with radio communications.

As of this writing, practically none of the material included in the book is out of date. This is quite an accomplishment in a science where new advances are made almost weekly. The book's timeliness is evidenced, for example, by references made by Dr. Helliwell (who prepared most of the section on wave propagation) to articles and papers that are scheduled to appear in early 1956!

Recommended: for every serious student of radio and electronics.

"BASIC SYNCHROS AND SERVO-MECHANISMS" by Van Valkenburgh, Nooger & Neville, Inc. Published by John F. Rider Publisher, Inc., 480 Canal St., New York 13, N. Y. 2 volumes, 271 pages. Paper bound. Price, \$5.50.

These two volumes are an extension of the "basic electricity and electronics" series issued by the publisher a few months ago and reviewed in earlier issues (May and June, 1955). The present books utilize the same approach and treatment as their predecessors: the text is written with flawless clarity and simplicity, and the drawings are clear, imaginative, and abundant.

The subject matter deals with synchros and servomechanisms, control devices used widely in modern equipment and industrial applications. Complexity of theory and the design and structure of actual units are carefully explained. Many practical proj-

ects for the experimenter are included.

Volume 1 covers fundamentals and simple equipment; volume 2 advances to such devices as error detectors, amplidyne, and anti-hunt systems. Both volumes are indexed for convenience. Either volume may be purchased separately for \$2.75.

Recommended: for purchasers of "Basic Electricity" and "Basic Electronics" from the same publisher; also for the student, experimenter, ham, or technician who needs good, solid information on the subject.

"ELECTRONIC MUSICAL INSTRUMENTS" by Richard H. Dorf. Published by Radio Magazines, P.O. Box 629F, Mineola, N. Y. 321 pages. Cloth bound. Price, \$7.50.

Many members of the POP'tronics editorial staff admit to a less-than-complete knowledge of music. Apparently, however, it is going to be necessary for them to become as familiar with tremolo, formants, and diapason as they are with resistance, inductance, and capacitance. In part, this is due to the increased use of electronics in generating music, as well as in recording or amplifying it for home consumption.

This book will help clear the air surrounding electronic musical instruments. It tells what devices exist and how they operate, and explains the circuitry used within each. Also presented are suggested circuits and related material involved in building one's own electronic organ. The means by which a musical tone can be generated by an electronic circuit is not only fascinating, but can provide the experimenter with hours of activity.

Recommended: as a thorough study of the "new" junction between music and electronics; especially for the person involved in electronics, and wanting information on organs, tone generators, etc.

Free Literature Roundup

VALUABLE INFORMATION for uranium prospectors is available free upon request from Precision Radiation Instruments, Inc., 4223 W. Jefferson Blvd., Los Angeles 16, Calif. This company will send you a 20-page, pocket-sized booklet entitled "64 Questions and Answers on Geiger Counters and Scintillators." Written in layman's terms, it covers claim-staking, assaying, surveys, and use of instruments.

TRANSFORMERS for all purposes are described in a 24-page catalog, available on request from the Chicago Standard Transformer Corp., Addison and Elston Aves., Chicago 18, Ill. This catalog covers 543 transformers and related components. -30-

More

BANDSPREAD

with the SW-54

By ROBERT J. MURRAY, W1FSN

Adding an external capacitor and vernier dial to existing circuit provides bandspread

OWNERS of the *National* SW-54 receiver will be interested to know that they can obtain finer tuning in the novice and s.w. broadcast bands. The modification is merely one of adding a small variable two-gang capacitor in parallel with the present main tuning capacitor gang. An inde-

pendent vernier dial is attached to the external "bandspread" capacitor.

On the 80-meter band, a 180° rotation of the new capacitor will tune through about 165 kc. On 40 meters it will cover 112 kc., on 20 meters about 805 kc., on 15 meters about 320 kc., and on 10 meters at least 870 kc. This additional bandspreading will permit the finest tuning necessary on any of these bands.

Purchase a *National* VHF-1D tuning capacitor and mount it on a strip of heavy aluminum, bent and drilled as shown on page 63. Although any dial can be used on this external bandspreading capacitor, the author found the *National* type AM dial to be very satisfactory. This dial has a 5:1 vernier ratio for smooth tuning.

After the aluminum strip has been bent and holes drilled to mount the capacitor, hold it against the side of the SW-54 cabinet and mark two holes for mounting the strip. Also, at this time, mark two holes which will be used to pass the connecting wires through to the main tuning capacitor gang in the receiver.

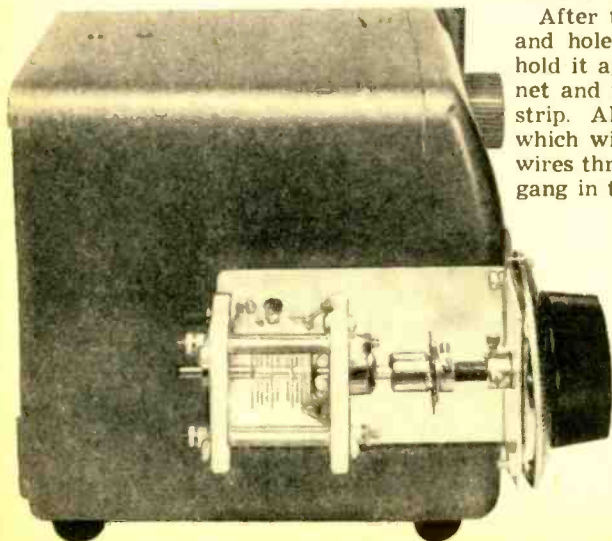

A *National* VHF-1D capacitor is mounted on an aluminum bracket and bolted to the side of the SW-54 receiver. The vernier dial attached to the capacitor provides a fine tuning adjustment.

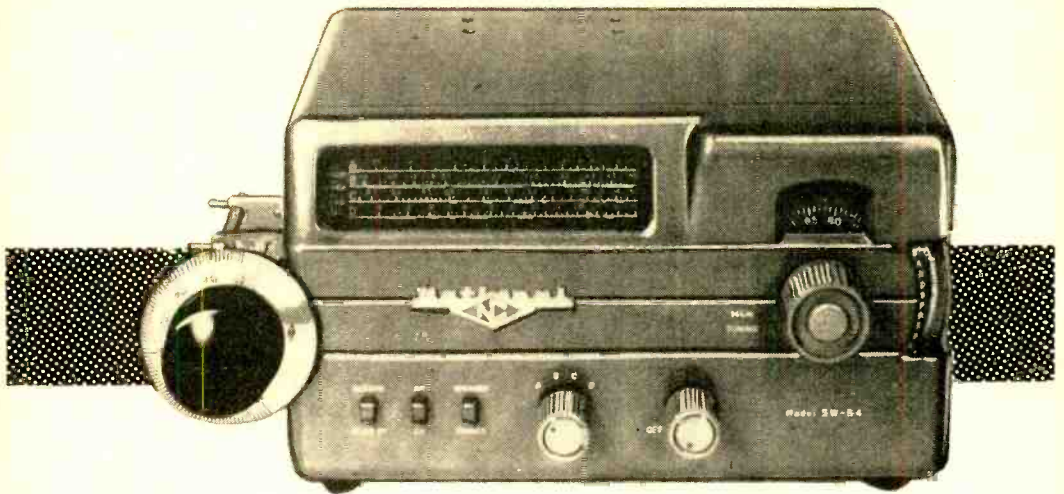

Solder three wires to the main tuning capacitor gang. Electrically they will be attached as shown in the wiring diagram at right. One wire is soldered to the frame of the ganged capacitor and the other two wires go to the oscillator and detector tuning sections, respectively. Thread these wires through the holes in the cabinet wall. Each wire should be well insulated with a small piece of vinylite tubing of the appropriate diameter.

To insure perfect grounding of the rotor of the VHF-1D capacitor, a small wiper was cut from a thin (0.005") sheet of old phosphor bronze. The wiper can be cut out with an ordinary pair of sewing scissors. Attach it to the front ceramic plate of the capacitor with a 4-40 screw and nut. The wiper should contact the first rotor plate and should be cut out so that it passes around the shaft of the capacitor. A rough sketch of the wiper is seen at right.

Mount the VHF-1D capacitor to the aluminum bracket by removing one of the small brackets normally used for mounting a tube socket and transferring it to a point diagonally opposite the other bracket on the ceramic end plate. Bolt the whole assembly to the side of the cabinet. Mount the vernier dial to the aluminum bracket and attach the tuning capacitor to the dial through a flexible shaft coupling and a short length of 1/4" rod.

After the VHF-1D tuning capacitor has been mounted and connected into the circuit, it will be noted that the tuning calibration is slightly offset. This can be adjusted by trimming the high-frequency ends of each tuning range to a signal of known frequency. Although the VHF-1D capacitor will not cover one complete ham band, it will provide that little bit of extra band-spread that novices and SWL's find so valuable.

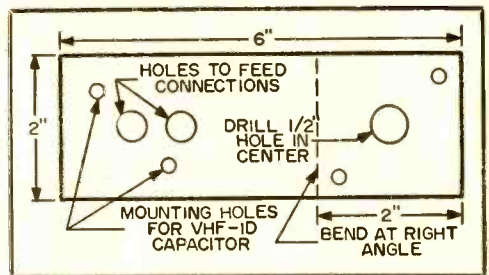

Angle bracket to mount the capacitor.

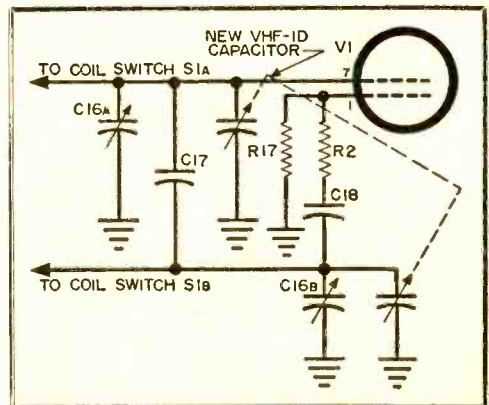

Wiring diagram above shows circuit location of additional tuning capacitor.

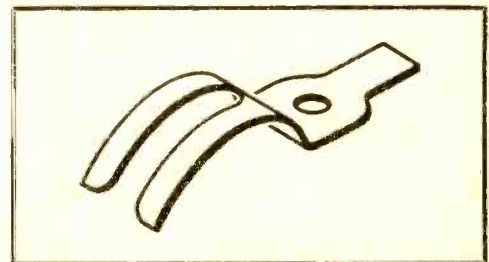

An enlarged view of the spring wiper.

CARL & JERRY

By

JOHN T. FRYE

Santa's Little Helpers

THE cosy warmth of the basement laboratory felt good to Carl as he stepped in out of the crisp December weather. He removed his steaming glasses and peered owlishly at his buddy, Jerry, sitting at the workbench busily engaged in doing something with a large box of dial lamp bulbs, several short lengths of insulated flexible wire, some little jars of colored liquid, and a soldering iron.

"What're you up to?" Carl demanded. "Getting homesick for the June fireflies and trying to make up some synthetic ones?"

"That's not too far off," Jerry grunted, without looking up. "I'm cooking up some miniature Christmas tree lights for our tree."

"How?" Carl asked.

"Well, what I'm really doing is connecting 20 of these No. 40 panel lamps in a series string to be connected across the light line. That way, the 120 volts in the line divides up so that each bulb has six volts across it. Since the bulbs are rated at 6 to 8 volts, this should allow them to operate for a long time without burning out. I could just as well have used No. 47 bulbs, which are identical electrically but have bayonet instead of screw bases. However, I was able to buy this large box of No. 40's at a bargain. For that matter, No. 44 bulbs could also have been used to get a little more light; but since they draw 250 milliamperes of current instead of the 150 ma. drawn by the No. 40's and get quite a bit hotter, the lower-current bulbs will be safer to use."

"Since No. 40's and No. 47's draw the same current, you could mix them in the same string; but No. 44's could not be mixed with either of the other two types. Check?"

"Check," Jerry nodded.

"How far apart will the bulbs be?"

"A foot and a half. That's why I'm cutting these 18" lengths of wire, stripping about $\frac{1}{8}$ " of insulation off both ends, and then tinning the ends. When this is done, I'll simply solder a tinned wire end to the tip of one of the bulbs with the wire pointing straight down away from the bulb. On the other end of this wire, I'll solder the screw base of a second bulb with the glass bulb pointing away from the wire. A second wire will be soldered to the tip of the second bulb and dressed parallel to the other wire. The base of a third bulb, lying next to the first bulb, will be soldered to the free end of this last wire, and so on. When I get through, I'll have a row of ten bulbs at the top and ten bulbs at the bottom all neatly connected in series by zigzag lengths of wire. Two longer lengths of wire can be run from an a.c. plug to the base of the first bulb and the tip of the last one to make the

string ready to be connected to the line."

"You're not going to leave those 'hot' connections exposed, I hope," Carl said with a quick frown.

"Well hardly! Each bulb base will be completely covered with a neat wrapping of this thin plastic tape that extends from well up on the glass to down below the tip and holds the two wire leads firmly together. The tape adds very little bulk, really sticks, and is rated at several thousand volts of insulation."

"Won't clear bulbs look kind of monotonous?"

"They're not going to be clear. That's why I bought this dial lamp coloring kit. It has little jars of liquid red, green, blue, and amber coloring material as well as a jar of solvent. All I have to do is dip a bulb in the proper coloring solution, and presto, I have a red, a green, a blue, or an amber colored bulb. If I get tired of one color, I can use the solvent to remove it and start all over. I think I'll make up several strings and dip all the bulbs of one string in the same color. After all, a whole string draws less than 20 watts; so power consumption is no item. Just once I'd like to see a tree really full of colored lights."

"Are you just dreaming about how these lights will look or have you seen such trees?"

"I've seen them. John Crump, who works in the engineering department of the *RMB Company*, has been using strings like these for five years, and they really look swell. It's surprising how much light those little bulbs throw; yet they are small enough so that they really *decorate* a tree instead of covering it up. What's more, they are the easiest things in the world to put on the tree or take off. They are so light that they can be put on the tips of the smallest branches."

"How about burn outs? Replacing a bulb would require unwrapping the tape, unsoldering the wires, and soldering in a new bulb. You could, of course, locate a burned-out bulb with a pair of insulation-piercing probes and an ohmmeter; but it seems to me that would be a good bit of trouble if these bulbs burn out as fast as the common series-string type do."

"That's the good part: they don't. John tells me he has been using the same half-dozen strings for five years, and not a single bulb has conked out in all that time. He mentioned one rather funny thing, though. He says the bulbs colored blue get noticeably hotter than those colored red or amber. We decided that the blue coloring doesn't transmit the heat radiated by the filament as well as the red and amber coloring does."

"Okay, I'm sold, and you're a genius," Carl

exclaimed. "How's about helping me with *my* Christmas problem? Two years ago Dad and I built a life-size Santa and put it out in the front yard. The eyes of Santa lighted up whenever he was awake—which oddly enough was just about time the little kids came past on the way home from school—and they thought he was real cool. Last year I put an intercom unit in Old Nick's tummy, and he was even more popular because he could listen and talk back, although I'm afraid his 'ho-ho-hoing' was a bit on the treble side. This year I've got to come up with something new. Modern kids demand constant progress, and unless Santa has learned some new tricks since last Christmas, they're going to think the old boy is pretty stupid."

"Hm-m-m, we should be able to dream up something," Jerry murmured slowly as he closed his eyes to think better. "I think I've got it! Use extension cords to put the mike of the tape recorder and a small speaker connected to its external speaker jack inside Santa along with the intercom unit. Then you can use the intercom to persuade each kid to tell Old Santa what he wants for Christmas. As he starts to talk, you take down the list on tape."

"I'm with you so far. Go on."

"Well, you could put out a spiel to the effect that Old Santa wants to be real sure he remembers the list of each kid. Since he is really modern, he has worked out a system whereby he quick-freezes the words of the child as he hears them and then stores the frozen messages away in his ice-chest until he is ready to pack his bag for the Christmas Eve trip. If any child doubts all this, Santa will be quite willing to take the frozen message out of the ice-chest and thaw it out so the child can hear his own voice giving the list—over the speaker connected to the tape recorder, naturally. You'll need a couple of sound effects to go along with this business. There should be some sort of tinkling sound to accompany the 'freezing' of the messages, and then there ought to be a sizzling sputtering sound when they are being 'thawed out.'"

"Now, wait just a little minute. You know as well as I do how hard it is to locate a short

recorded section on a tape when you're in a hurry. By the time I found a particular message and thawed it out, the kid himself would be frozen in his tracks waiting to hear it."

"I've thought of that, too. Don't try to record all the messages on one long roll of tape. Instead, cut up a roll of inexpensive tape into 5' lengths and hang them neatly over a tie rack. Then, when a child wants to tell Santa all about it, you simply thread the end of one of these tapes into the recording slot and between the pressure rollers. While you are recording, the tape will simply feed through and either bunch up on top of the recorder or slide off on the floor. Five feet of tape at 3¼ inches per second will give each kid about 15 seconds to make his wants known—which is plenty long enough unless his parents are richer than yours and mine are. As the recording is finished, write the child's name on the back of the leading end with a china marking pencil and hang it up so his name can be easily read. Then, when any moppet wants proof that his message to Santa is still safely on file, you can pick out the proper tape quickly and start it through the recorder."

"What a brain!" Carl exclaimed admiringly, as he roughly brushed Jerry's flat-top haircut. "And I've got a little scheme of my own. After Christmas is over, we can take those recordings and have them rerecorded on small disc records and sell them at a good profit to the parents of the children as keepsakes."

"We *could*, but I'm sort of agin it," Jerry said slowly. "Maybe the old Christmas spirit has got me, but somehow I don't want any part of commercializing Christmas any more than it is. If any parents want to have recordings made at their own cost, that would be quite all right; but let us just take our reward in the form of the fun we'll have amusing the children."

"Right!" Carl quickly agreed, "and I'm ashamed I even thought of it."

-30-

"... Santa will be quite willing to take the frozen message out of his ice-chest and thaw it out so that the child can hear his own voice giving the Christmas list—over the small speaker connected to the tape recorder . . ."



No Better Way To Say MERRY CHRISTMAS...



A GOLD MINE OF INFORMATION

- High Fidelity Audio
 - Amateur Radio
 - Radio Control
 - Television
- Short Wave Listening
 - How It Works
 - How To Make It
 - How To Use It
- Tips and Techniques
- Games and Puzzles

**POPULAR
ELECTRONICS**

This year—give

POPULAR ELECTRONICS

—the world's most valuable magazine for the electronics hobbyist . . . experimenter, Hi-Fi enthusiast and radio amateur.

POPULAR ELECTRONICS is the perfect gift—easy to order . . . inexpensive . . . sure of a warm welcome every month of the year.

Each issue features an exciting array of easy-to-understand construction articles—plus complete coverage of all that's new and exciting in the wonderful world of electronics—including TV, radio, Hi-Fi, radio control, recordings, radar and “ham” activities.

SPECIAL GIFT RATES

First 1-Year Gift Subscription . . \$3.00

Second 1-Yr. Gift Subscription . 2.00

Each additional 1-Year Gift . . 1.50

An attractive gift card will be mailed to your friends announcing your gift in time for Christmas.

Fill in and mail the convenient postpaid order envelope facing this page for your own or gift subscriptions. List additional gift orders on an extra sheet of paper.

(Your own new or renewal subscription may be included)

366 MADISON AVENUE, NEW YORK 17, N. Y.

POPULAR ELECTRONICS

POPULAR ELECTRONICS

Audio and Hi-Fi Section

- 67 Disc and Tape Review
Bert Whyte
- 69 Christmas Record Buying Guide
- 71 Bargain Hi-Fi with Cheap Speakers
Jack Coriell
- 74 Tape Transport Mechanisms
Leon Wortman
- plus New Audio and Hi-Fi Products
(pages 70, 73, 78 and 79)

Disc and Tape Review

IT GOES without saying that records represent the ideal Christmas gift for the hi-fi enthusiast. It is equally true, I'm afraid, that record buying at Christmas time is most hectic, and oftentimes the recipient of a gift record receives some low-fi cornball in which he has no interest whatsoever. You can use the following Christmas Record Buying Guide for gifts or show it to those you expect to present you with records. I will guarantee two things in this guide . . . all the records listed will be hi-fi in sound quality, and although the repertoire will vary widely for differing tastes, none of the records will be dull. Most of these listings will be just that . . . a listing and a brief comment. But I feel we should investigate a little more thoroughly certain works which have long been identified with Christmas time. (No, I don't mean *Rudolph the Red-nosed Reindeer*.)

By BERT WHYTE

Handel's *Messiah*

Certainly Handel's *Messiah* is synonymous with Christmas. Throughout the length and breadth of the land . . . in the vaulted vastness of echoic stone cathedrals in the great cities to white clapboard, high-steepled little country churches . . . the *Messiah* will be heard many times in this joyous season. And it is an inspiring work, one of the bulwarks in the repertory of sacred music. Up until a year or so ago, it was not served too well on records. The addition of several new recordings in quick succession have corrected this neglect. All told, there are now eight complete recordings available in the LP catalog. Of these, only three can be described as modern hi-fi recordings. Of the others, two may be dismissed as abortive "cheapies" and the rest have interest either historically or performancewise.

Record of the Month

KODALY—*Hary Janos Suite*
BARTOK—*Music for Strings,*
Percussion and Celests

George Solti conducting the
London Philharmonic Orchestra
London LL1230, 12" LP,
RIAA curve, \$3.98

A good performance of the Bartok, but the prize on this disc is the Hary Janos Suite. This is very witty, very satirical music . . . modern and full of dissonance, to be sure, but I guarantee that it's easy on the ear. In the various sections are to be heard some of London's most spectacular hi-fi sound. Full blown trumpets and trombones of weighty power, very crisp, clean percussion . . . especially snares and cymbals . . . an awesome roll on the bass drum, and a terrific dynamic range characterize this exceptional recording.

The oldest of the group is the reading by Sir Thomas Beecham on Victor LCT6401. Limited as it is in frequency response and dynamic range and dry acoustics, it is nonetheless the finest performance on records. Sir Thomas, a firm traditionalist in this work, gives a performance which can best be described as inspired. In his loving hands, the *Messiah* is a tremendously exciting and moving experience. His tempi, phrasing, deftness with large choral masses, and the choral/orchestral textures he achieves add up to a supreme example of conductorial virtuosity. If only this great performance had the advantage of modern hi-fi sound . . . one could apply that overworked term "definitive" with just reason!

Now we come to the recording which for a long time was the only *Messiah* available on LP. It is the Sir Malcolm Sargent-Huddersfield Choral Society recording on Columbia SL-151. This is a good traditional type performance with splendid work by the Huddersfield group, which has sung the work every year in England for many, many years. The sound is definitely not hi-fi in quality, but is not offensively bad, merely lacklustre.

Note this next recording very carefully . . . it is a modern hi-fi *Angel* recording of the *Messiah* employing the same Sir Malcolm Sargent and the same Huddersfield Choral Society. Do not let some record clerk confuse you or con you into buying the older recording. As in their earlier effort, the forces here give a similar performance, but it is amazing how the magic of hi-fi sound brings everything to life! Where before there was the typical choral/orchestral blur and fusion, on this disc it is minimal, and for the most part all is quite articulate. Generally, good orchestral/choral balance is maintained, frequency and dynamic range is quite wide, little choral "blast" distortion is heard, and the spacious acoustics add to the feeling of presence.

On Westminster WAL-308, conductor Hermann Scherchen, the London Symphony Or-

chestra and the London Philharmonic choir give what is undoubtedly the most unusual performance on LP. Striking away from the traditionally large orchestra and chorus, Scherchen attempts a performance as it might have been heard in Handel's time. A small, chamberlike orchestra is employed as well as a small intimate-sized choir. Original instrumentation is used (i.e., recorders instead of transverse flute). The results are a baroque-like clarity and definition of orchestral and choral textures, quite different from the grandiose masses of sound we have come to associate with the *Messiah*. It may be interesting as an academic exercise but the traditionalists have been howling that it isn't the *Messiah* they like, and frankly I am inclined to agree with them. One has but to listen to the famed *Hallelujah* chorus to learn that much of the glory and the drama of the massed voices is missing in this small-boned version. Certainly credit must accrue to Westminster for making an original version available to musicologists, who will also enjoy the superb, clean hi-fi reproduction.

The final *Messiah* on our list is the recording of choice as far as I'm concerned. This is the Sir Adrian Boult-London Philharmonic performance on London LLA-19. It is known as the original "Dublin" version, which was the first *large scale* performance and differs from the "traditional" versions only in that certain cuts have been restored. Because of this, the London set (as well as the Sir Thomas Beecham set) is on four LP's while all the other versions occupy three LP's. The Boult performance is very close to the mastery of Beecham's, except for more hurried tempi and a tendency to overemphasize dynamics in certain sections. All his forces do admirable work. The soloists are good if not outstanding, the LPO plays with beautiful tone and precision, and the London Philharmonic choir is superbly trained and disciplined. But it is in the sound department that the recording really shows its superiority. This is typical first-class London sound. Strings are smooth and clean, brass is properly bright and brazen, woodwinds have crisp definition, and the tympani are sharply accented. Choral/orchestral balance is even-scaled throughout the work; and in spite of some huge dynamics, the choir never blurs or "muddies-up" and isn't "blast" conspicuous. Frequency range is ultra-wide as are the dynamics, and above all, the work has been recorded under nearly ideal acoustic conditions so that a most extraordinary sense of "liveness" prevails. Needless to say, with this magnificent hi-fi sound, the *Hallelujah* chorus is quite thrilling.

Christmas Carols

Every year, inevitably, some people want to know if there are any hi-fi Christmas carols. The answer is: there are so many on the market that space would not permit a description of them all. With the considerations of performance and sound in mind, my two favorites remain the carols as rendered by the Robert Shaw Chorale on Victor and a charming album of lesser known carols on the Haydn Society label.

Herewith begins the Christmas Record Buying Guide. Music will be separated into various categories and within the categories some further subdivision may take place.

Baroque Music

VIVALDI—12 Violin Concertos

Reinhold Barchet, violin
Rolf Reinhardt conducting
Pro Musica String Orchestra, Stuttgart
VOX DL173, 3-12" LP

A handsomely conceived album which contains superb violin artistry, good orchestral playing and wide-range convincing string tone.

J. S. BACH—The Brandenburg Concerti (complete)

Felix Prohaska conducting
Vienna State Opera Orchestra
BACH GUILD 540/2, 3-12" LP

Probably the best performance now on records, with crisp, clean sound to match.

CORELLI—Concerti Grossi (complete)

Dean Eckertsen conducting
Tri-centenary String Orchestra
VOX P17893, 3-12" LP

Although this performance is by a "pickup" recording orchestra, the results are very worthwhile, especially with the excellent sound.

SCARLATTI—Good Humored Ladies (ballet suite)

Roger Desormiere conducting
Paris Conservatory Orchestra
LONDON, LL624, 12" LP

A very gay and charming work, played with abundant polish and enthusiasm, and productive of some stirring hi-fi sound.

17th Century Organ Music

Gustav Leonhardt, Organ
BACH GUILD 529, 12" LP

No huge pedals here for lovers of the booming bass, but exceptional hi-fi reproduction on a fine old organ.

Romantic Period

RACHMANINOFF—Symphony #2

William Steinberg conducting
Pittsburgh Symphony Orchestra
CAPITOL P8293, 12" LP

A fabulous recording of a work which has wide appeal. There is superb string tone here, some of the best on record.

RACHMANINOFF—Piano Concerto #2

Geza Anda, Pianist
Galliera conducting
Philharmonia Orchestra
ANGEL 35093, 12" LP

One of the smoothest and most satisfying interpretations available. Finely balanced sound.

TCHAIKOVSKY—The Nutcracker Ballet (complete)

Antal Dorati conducting
Swan Lake Ballet
The Sleeping Beauty
Minneapolis Symphony Orchestra

This is Mercury Records' fabulous triumvirate of the three major Tchaikovsky ballets, recorded complete for the first time. There is sound quality of fantastic realism. A must as a gift for the balletomane or as a family gift.

BEETHOVEN—Symphonies #6 and #7

Paul Paray conducting
Detroit Symphony Orchestra
MERCURY

Some may take issue at including Beethoven in the "romantic" section, but be that as it may, these two works are here afforded the best recorded sound along with splendid, vigorous performances.

R. STRAUSS—Also Sprach Zarathustra

Fritz Reiner conducting
Chicago Symphony Orchestra
VICTOR LM1306, 12" LP

Victor's first effort with its newly acquired Chicago orchestra, the result is a stunning recording and performance. Opening contrabass passages on the record at 32 cycles and real test of low-frequency speaker response.

R. STRAUSS—Death and Transfiguration

Til Eulenspiegel
William Steinberg conducting
Pittsburgh Symphony Orchestra
CAPITOL P8291, 12" LP

Steinberg is a good man for this type of work, and these are the best sounding versions now available.

WAGNER—Overtures

Paul Paray conducting
Detroit Symphony Orchestra
MERCURY 50021, 12" LP

In material like *Die Meistersinger*, etc., Paray imbues these warhorses with new life, aided by hi-fi sound of exceptional clarity.

VERDI—Requiem

Victor de Sabata conducting chorus and orchestra of La Scala Milan
ANGEL 3520-B, 2-12" LP

Fire-breathing performance of this very dramatic work, with best sound to date.

TCHAIKOVSKY—Mantred Symphony

Paul Kletski conducting
Philharmonic Orchestra
ANGEL 135167, 12" LP

A little-known work, it has much of the fire and excitement of the *Fourth*, *Fifth* and *Sixth Symphonies*. A real hi-fi treat here and good performance.

TCHAIKOVSKY—Concerto in D for Violin

Zino Francescatti, violin
Dimjtri Mitropoulos conducting
New York Philharmonic Orchestra
COLUMBIA ML4965, 12" LP

This is combined with Mendelssohn concerto on the flip side. With the excellence of sound and interpretation, it makes an exceptional buy.

R. STRAUSS—Der Rosenkavalier (complete opera)

Erich Kleiber conducting
Vienna Philharmonic with soloists, chorus, etc.
LONDON LLA-22, 4-12" LP

The definitive version of this great opera. Outstanding in every department. For an opera-loving friend, you couldn't find a better gift.

SIBELIUS—Symphony #3 and #7

Antony Collins conducting
London Symphony Orchestra
LONDON LL1008, 12" LP

Help your Sibelius-loving friends celebrate his 90th birthday with a gift of these two outstanding works. Collins does an excellent job, especially in the *Third* and the sound should win new supporters for this composer.

GLIERE—Symphony #3—Ilya Mourametz

Herman Scherchen conducting
Vienna State Opera Orchestra
WESTMINSTER WAL-210, 2-12" LP

You may never have heard of this one, but by all means investigate! It will floor even the most jaded audiophile with its myriad hi-fi effects.

FRANCK—Symphony in D

Paul Paray conducting
Detroit Symphony Orchestra
MERCURY 50023, 12" LP
Wilhelm Furtwangler conducting
Vienna Philharmonic
LONDON LL-967, 12" LP

Two are listed here as it is practically a toss-up between them. In either case, there are fabulous performances and sound of compelling realism.

MAHLER—Symphony #1

Rafael Kubelik conducting
Vienna Philharmonic
LONDON LL1107, 12" LP

In spite of the stern competition of the Bruno Walter reading, I like this the best after repeated listening. Recorded with sound of stunning impact.

LISZT—Les Preludes

Paul Paray conducting
Detroit Symphony Orchestra
MERCURY 50036, 12" LP

A warhorse and cornball, I'll admit, but wait until you hear the tremendous tympani blasts!

Modern Music

Les Six

ANGEL 13515-B, 2-12" LP

This is a sort of minor anthology on the members of the avant-garde group of French composers known as Les Six. Comprising this group were such stalwarts as Darius Milhaud, Honneger and George Auric, with three lesser known composers. Good representative sampling of their works and good sound.

STRAVINSKY—L'Histoire du Soldat

Mario Rossi conducting
VANGUARD 452, 12" LP

Of the several new versions, including Stravinsky's own, this has the virtues of a good performance with some very thrilling hi-fi sound, and is the version of choice.

(Continued on page 112)

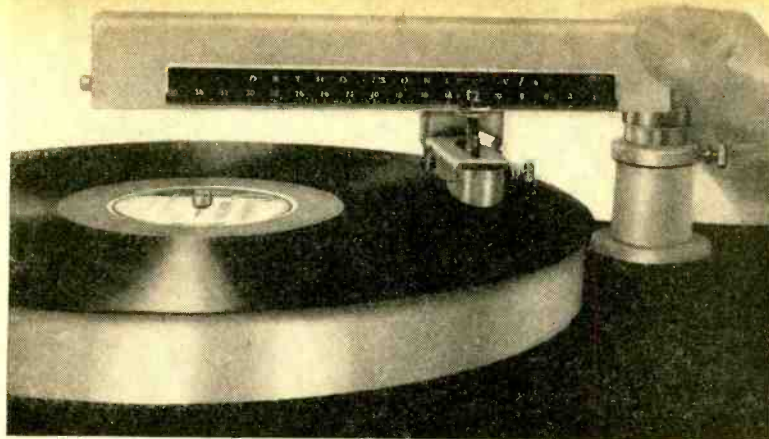

Stylus travels in straight line with this tone arm. Indexing scale aids in cueing. Arm fits any turntable; accepts all standard type pickups.

Tone Arm Eliminates Tracking Error in Record Playback

THE FIRST TONE ARM that permits a phono stylus to travel in a perfectly straight line across a record, the "Ortho-Sonic V/4" is reputed to eliminate tracking error completely during disc playback. This arm, readily adapted to standard turntables, carries its pickup assembly in such a manner as to track the record grooves in the same path followed by the cutting stylus when the record was made.

Discs are cut by a stylus moving in a straight line from the record's edge to its center. Conventional tone arms guide the playback stylus on the arc of a circle, and the degree of difference between the straight line and the arc is the tracking error. The better arms compensate for this error and reduce its effects to a minimum. (See *POPULAR ELECTRONICS*, October, 1955, pp. 75-79). But the V/4 arm eliminates the tracking error altogether.

Developed and manufactured by *Bard Record Co., Inc.*, 66 Mechanic St., New Rochelle, N. Y., the V/4 is said to overcome many problems involved in tone arm design. For example, once the pickup is in-

stalled, it is never touched by hand. A slight tilt of the arm's pickup housing places the stylus on the record or removes it. This feature reduces the chance of record scratch by a carelessly handled pickup. It also assures accurate cueing. The V/4 arm itself never moves; the pickup housing remains in the same position relative to the turntable when it has been tilted back. In addition, a calibrated index scale pin-points any desired portion of a record.

Size of the V/4 appears to be convenient for all applications. Its length of 9 $\frac{1}{4}$ " is suitable for home use in playing 10" or 12" records, as well as for studio use in playing professional transcriptions up to 16".

Correct stylus pressure is obtained by adjusting a thumb screw inserted in the housing. Practically any make of pickup may be inserted. Changing from one cartridge to another can be accomplished in a few seconds, and without any tools. The arm can be installed, in most cases, with a screwdriver.

Net price is \$44.50. For additional information, write to the manufacturer. —30—

Hi-Fi System Boosts Food Sales in Supermarket

"Good music is good for the grocery business," according to the owner of *Nasser's Supermarket* in Mesa, Arizona. This store reports a 50% increase in sales as a result of installing a store-wide hi-fi music system. Mr. Nasser says that his supermarket ". . . attracts more customers, and the customers spend more time in the store." The result has been more items purchased per customer.

So successful has been his present installation that Mr. Nasser plans to double the present quantity of speakers in the near future to obtain even better musical coverage. The installation was handled by *Automation Laboratories*, of Phoenix, Arizona, using standard *General Electric* hi-fi components such as speakers and pickups.

Sixteen *G.E.* 12" coaxial speakers are recessed in the ceiling of the store's grocery and meat departments. The entire ceiling serves as an infinite baffle of highly damped acoustical tile. Response has been measured as "flat to 25 cycles," and 20 cycles has been reached in special effects demonstrations. The system's preamplifier controls and allied equipment are installed in the owner's office.

This supermarket owner had long recognized the value of creating a pleasant atmosphere in his market by providing a musical background for his customers. But the startling increase in business developed, he says, only after a public address system of conventional design was replaced by the hi-fi system. —30—

This portable enclosure attached to a tape recorder measures one foot square and seven inches in depth. It uses a modified five-inch speaker and issues sound that will amaze listeners.

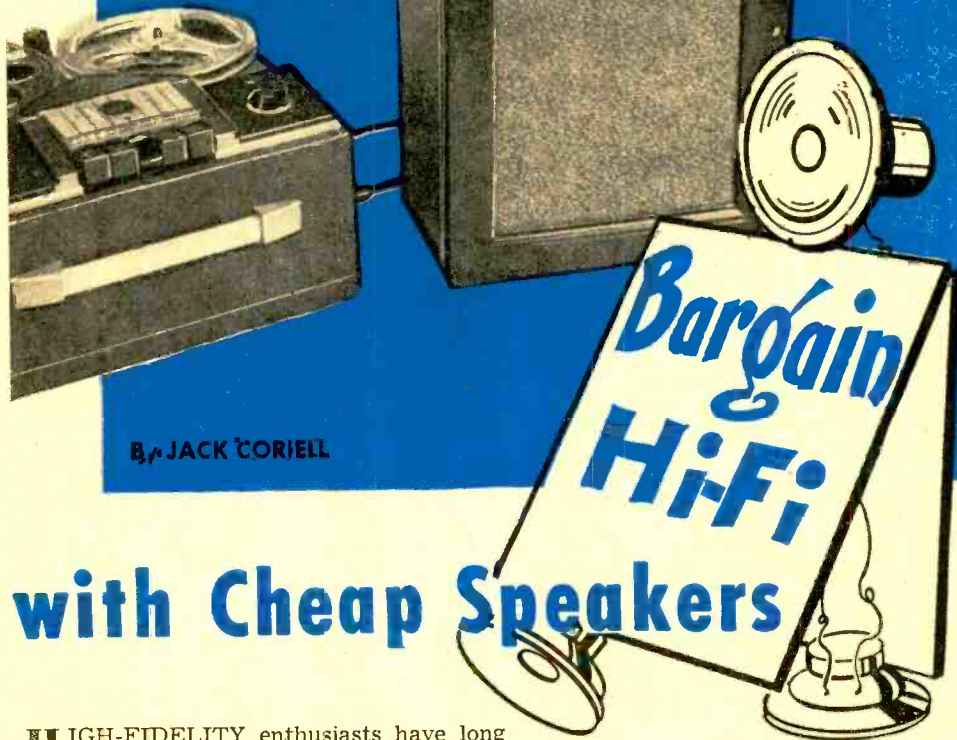

By JACK CORIELL

with Cheap Speakers

HIGH-FIDELITY enthusiasts have long been aware that the loudspeaker is usually the weakest link in the hi-fi chain. This fact has been especially annoying to the home experimenter, since the complicated construction of speakers has limited him to working on enclosures. In order to get good results, even the most avid tinkerer has been forced to start with a reasonably expensive unit.

Using the modification to be described here, bargain counter or junk-box speakers can be converted into hi-fi speaker systems covering a wide range of uses. Small speakers mounted in very compact portable enclosures will do wonders for improving the sound of tape recorders or TV sets. Larger speakers can be converted into low-cost hi-fi systems of excellent performance and very compact size.

Hi-Fi Conversion Principle

With this modification, the loudspeaker operates as it does in conventional systems with one important exception. Normally, the stiffness of the outside edge of the speaker cone is a considerable part of the resistance to motion of the cone. In the

modified system, this stiffness is made very low, and in its place is added the elastic behavior of air in the unusually small enclosure behind the cone.

This simple substitution has several important advantages. First, the elasticity of the air in the enclosure provides a nearly perfect means for keeping the cone and voice coil from moving too far. Ordinary cone-edge stiffness introduces both distortion and unwanted resonances while doing the job, but the resilience of the air introduces neither.

Second, the amount of springiness of the air behind the speaker is determined by the size of the enclosure, and is directly controlled by the builder. This means that he can choose the bass frequency at which the speaker response drops off, and therefore get the utmost from the bass ability of the speaker. Often a cheap speaker converted as shown here will give better bass performance than a much better speaker in an ordinary enclosure, simply because the better speaker is being held back by too much stiffness.

Finally, one of the by-products is that the finished enclosure is much smaller than most other types of enclosures. Since the shape of the enclosure is not critical, speakers can be built into bookcases or other spaces in the average home.

Are there any drawbacks to the system? Yes, of course. But compared to the improvement, they are minor indeed. While this system will allow the utmost bass response possible from a speaker, it does not change the structure of the magnet and voice coil, and attempting to extend the bass range too far will lead to trouble.

Since the cone edges are cut in converting the speaker, the performance of the cone at maximum power may be poor. Even without strengthening the cone, however, the author's conversions have all been entirely satisfactory. Lacquering the cone, which helps to put the final resonance in the correct range, strengthens the cone and usually eliminates any possibility of difficulty. And, of course, once a speaker has been modified, it won't work properly in a conventional mounting.

Modifying a Speaker

It's a good idea to try a 5" or 6" speaker the first time. This gives one an opportunity to see how the system works. An enclosure for this size of speaker is easy to build from scrap wood.

Give the speaker cone a coat of plastic spray in order to strengthen and add to its stiffness. Don't overdo the spraying, for too heavy a coat will make the cone heavy, and affect the high-frequency response.

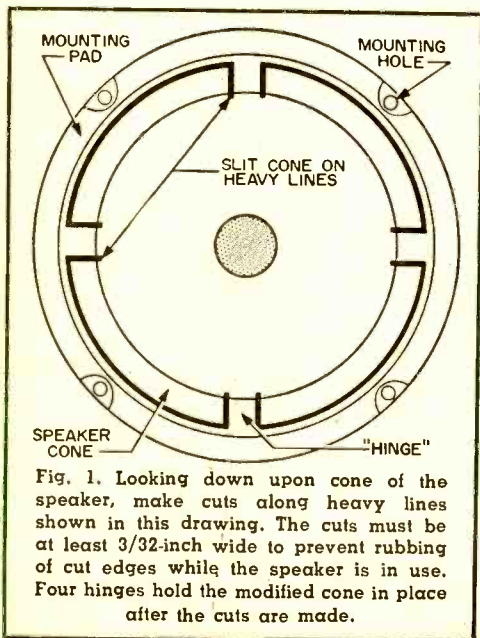
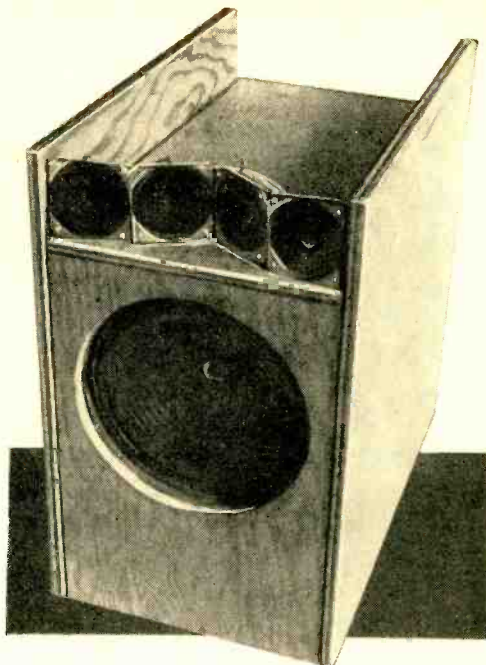

Fig. 1. Looking down upon cone of the speaker, make cuts along heavy lines shown in this drawing. The cuts must be at least 3/32-inch wide to prevent rubbing of cut edges while the speaker is in use. Four hinges hold the modified cone in place after the cuts are made.



This living room speaker installation is in the last stages of construction. Built to match an end table, it features a 12-inch speaker and four high-frequency speakers fanned to distribute high notes more evenly. Response of this unit is 50 to 17,000 cycles.

The speaker's resonant frequency is then lowered by cutting the edge of the cone to allow it to move more freely. The diagram in Fig. 1 shows how to cut, leaving "hinges" at four points to hold the cone in position. Make these hinges just wide enough (about 1/2" to 3/4") to hold the cone steady, yet allow the maximum of freedom of motion in and out.

Make the cuts with a razor blade broken to provide a thin point. First do the hinges, cutting out a narrow strip of the cone at each side (about 3/32") to allow movement without rubbing. Then make the cuts around the edges, the inside of the narrow strips first, so that it is unnecessary to work on the edge of the cone after it is loose. With the heavy cone paper of larger speakers, a pair of fine-point manicure scissors may be easier to work with.

The construction of the enclosure is simple. All that is required is a tight and rigid box of the proper inside volume, and a hole for the speaker. The speaker is screwed directly over the hole inside of the box, and the wires for the speaker can be brought out through holes in which they fit snugly. For large enclosures, 3/4" plywood is best because of its rigidity, but smaller boxes

(Continued on page 106)

Loudspeaker Enclosures Assembled from Kits

A COMPLETE LINE of "do-it-yourself" kits for building *E-V* high-fidelity speaker enclosures at substantial savings over prices for their factory-built counterparts has been introduced by *Electro-Voice, Inc.*, Buchanan, Mich.

Kits for seven *E-V* models are available, for full-range loudspeakers as well as separate 2-, 3-, and 4-way speaker systems. Included are the *E-V* "Patrician" and "Georgian" interior horn units as well as the "Baronet," "Aristocrat," "Regency," "Empire," and "Centurion" models.

Every piece in each kit is precut and ready for assembly. Exterior surfaces are clear-grained birch, a hard wood that takes a good finish. Kits include glue, screws, nails, and an illustrated instruction book.

Various furniture finishes can be obtained by using an *E-V* "Finishing Kit." Handles and metal trim from an appropriate "Decorative Trim Kit" add the final touch. The instruction book for any particular enclosure is available separately at nominal cost from *E-V* distributors for those who care to purchase their own materials. For further information, write to the manufacturer requesting Bulletin No. 211. —30—



Hi-Fi Tape Recorder Features Dual Track Operation

DUAL TRACK OPERATION and push-button track reversal are featured in *DeJUR* Amsco's new line of high-fidelity tape recorders. "Track reversal" permits recording or playback on either track of a tape without rewinding or rethreading.

A heavy-duty, reversible hysteresis motor—said to be the first used in a medium-priced recorder—provides speeds of either 3¾ or 7½ inches per second. Instantaneous starts and stops are facilitated by electromagnetic clutches and brakes.

All functions of the recorder are controlled by switchboard relay operation. Separate erase and record-playback heads are used for each track. A loudness control is provided for playback. The input selector switch allows three signal sources to remain permanently connected.

Two models are available. The TK-820 includes a cardioid microphone with matching line transformer, a 6-watt playback amplifier and speaker system, and carrying case. Net price is \$379.50.

Model TM-819A is the tape recorder chassis only. Intended for custom installation, it requires an external power amplifier and speaker for playback. Net price is \$299.50.

Both models boast the following frequency response: at 7.5 i.p.s., 40 to 16,000

cps., ± 2 db; at 3.75 i.p.s., 50 to 10,000 cps., ± 2 db. Signal-to-noise ratio is 55 db. Pre-amplifier, equalization, bias, erase, and operating power circuits are included in both models. For additional information, write to *DeJUR Amsco Corp.*, Long Island City 11, N. Y. —30—



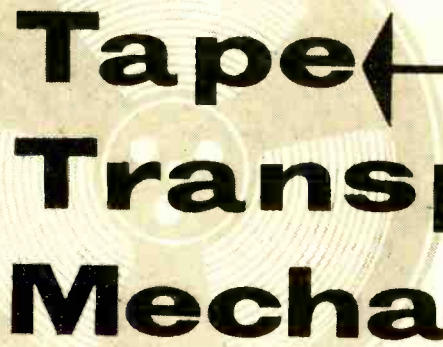

Tape Transport Mechanisms

By LEON WORTMAN

PREVIOUS articles in this series have discussed the recording, playback, and erasure of magnetic tape. How the tape is moved from reel to reel, past the record and playback heads, will be explained in this article.

The mechanical section of the tape equipment which does this job is known as the *tape transport mechanism*. This mechanism is to magnetic tape recorders what the turntable is to the phonograph. Some transports are quite complex; others are very simple. Possibly as a matter of engineering approach, one manufacturer produces one type of design, while another does things differently. Regardless of variations, all tape transport mechanisms perform the same basic function: the movement, or transportation, of magnetic tape from one side of the machine to the other, passing the tape across the head (or heads) to permit recording, playback, and erasure.

Differences may be seen in details of design, construction, and assembly of such parts as levers, push-rods, pucks, belts, solenoids, and switches. Sometimes the results are at the extreme ends of the "good-bad" performance rating chart. Mostly, however, they are astonishingly similar, with only laboratory instruments capable of detecting differences.

How a Transport Functions

Illustrated on page 76 is the "Telectro-tape" Model 880. This is a low-priced unit which illustrates the basic and simple equipment containing all the functions of fast forward, fast rewind, record, erase, and playback. Refer to the drawing on page 76 as you read the following:

The full (supply) reel of magnetic tape is placed on spindle-pulley "G." The end of the tape is threaded between head "A" and pressure pad "B," which keeps the tape in intimate contact with "A." It is further threaded between pinch roller "C," made of rubber for good traction, and "D," the capstan, a metal shaft extending up from the center of flywheel "E" of which it is an integral part. The diameter of capstan "D" is one of the factors determining the linear speed of the tape, always expressed in the United States as inches per second. In Europe it is expressed as meters per second. Some tape mechanisms provide a tape speed change in their two- and three-speed models by furnishing the user with a metal sleeve which can be slid over the capstan. This effectively increases the diameter of the capstan and the circumferential velocity, and therefore the velocity of the tape with which it is in contact.

Threading of the tape is continued onto the "take-up" reel on spindle-pulley "H." When the power is turned on, motor "F" turns the flywheel through drive belt "O." When either the record or playback switch is thrown, "C" moves to pinch the tape securely against the capstan. This action puts the tape in motion. Drive belt "L" makes spindle-pulley "H" rotate, "taking up" the tape pushed through by the capstan. Friction at "G" holds the tape taut enough as it is fed to the head from the "supply" reel so that the tape doesn't just float around free.

When the "idle" or "standby" switch is thrown, the pinch roller and pressure pad are relaxed, leaving the tape free and sta-

Knowing how tape transports work can help the recording enthusiast choose wisely when buying a tape recorder

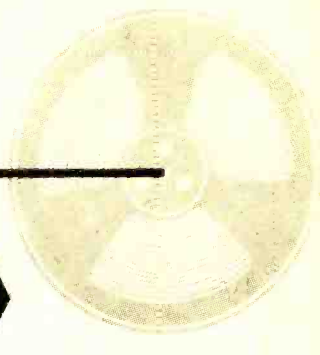

tionary. By swinging "N" either to the right or to the left, tension is increased on one or the other of drive belts "I" or "L" by pressure from wheels "J" or "M." This results in an extremely fast movement of the tape for high-speed wind from "C" to "H" or fast rewind the other way.

Some equipment achieves these actions through solenoids which are electrically actuated by switches. Other equipment uses push buttons which move mechanically linked rods to set things in motion. However it is done, it is a variation or a complication of the basic technique just described.

Motor Noises

Most readers are familiar with the problems of *wow* and *rumble* in a record player or changer. The wow is heard as a slow change in pitch, as though the record were

being alternately dragged and shoved. Caused by a periodic change of speed of the turntable, wow can make listening to music quite unbearable.

Equally annoying is rumble, a mechanical transmission of low-frequency vibrations to the stylus of the phono pickup. Rumble modulates the motion of the stylus as it travels in the moving record groove. To the listener's ears, it sounds like an extreme amount of banging and "powing," especially when the sound system is efficient at the very bass end of the spectrum. Often, the effect of rumble is to make listening downright impossible.

In tape transport mechanisms, too, wow may occur. It can be caused by an improperly balanced flywheel, an eccentric or off-center capstan, pinch roller, or motor shaft. A listening test using music with sustained tones, and which has been recorded on a tape machine known to be free of wow, will quickly determine the presence and severity of the wow. When it is present, the pitch of sustained musical notes will waver "up" or "down."

Rumble doesn't appear in tape transport mechanisms inasmuch as there is no stylus and pickup, but tape units may be subject to another noise: *flutter*. Where rumble is a modulation very low in frequency, flutter is relatively high in frequency. The more extended the range of the high-frequency response of the tape machine, the more difficult flutter becomes to design out of the equipment! It can be caused by so many things that only a few can be discussed here.

Flutter can be created by a defective reel of magnetic tape material with microscopic imperfections—hills and valleys in its oxide coating or in its synthetic backing. These cause the tape to "bounce" across the record or playback heads, thus modulating the frequency and the amplitude of the magnetic recording. This same high-frequency "bounce" can result from a dragging "supply" or "take-up" reel, exerting a "jerking" effect rather than a smooth tension on the



The quality of the recording being made by this tape enthusiast depends largely on the machine's transport mechanism and on its electronic units.

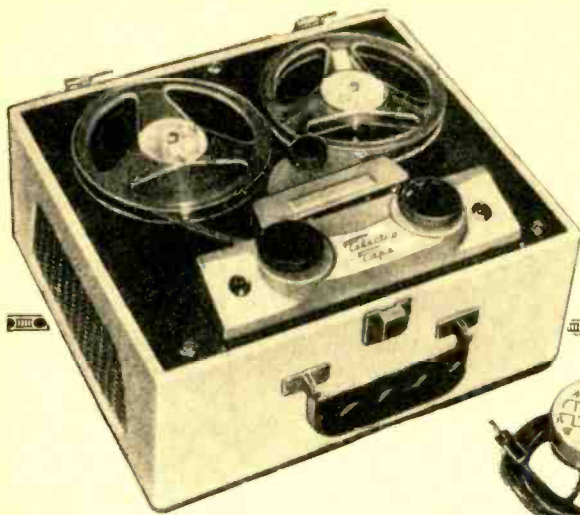

Two approaches possible in setting up one's own tape system are represented by the models shown here. Left, a complete recorder with built-in playback amplifier and speaker (Telectro Model 880). Right, a transport mechanism (Fen-Tone Brenell). Often called a "tape deck," this type of unit requires a matching preamplifier-equalizer. Playback may be through the amplifier and speaker of one's own hi-fi set.



slack of the tape. A poorly adjusted or worn pressure pad, a badly manufactured capstan, a sticky pinch roller, gummy guide posts, hacked up rubber puck wheels and drive belts, for example, can cause it.

To the listener's ears, flutter comes out of the loudspeaker as a most unpleasant sound, described by audio enthusiasts as "unclean" sound. It might also be described by the general term "distortion." But because it is usually about 3000 cps, it is not like the harmonic distortion most familiar in high fidelity. It is an elusive "horror," appearing at times to be quite intense, and barely perceptible at others. It has to be quite strong to be perceived on a speech recording. Assuming the worst imaginable condition during a playback of speech re-

cordings, the effect would be similar to the imagined sound of Donald Duck talking under water!

One recommended procedure for determining the presence or absence of flutter without the use of a flutter meter is to obtain a tape recording of a chamber group (a piano should be a prominent part of the ensemble) of known good quality. Set the volume control at a high level and listen for distortion, especially on sustained piano passages. Slowly lower the volume to the point where the ear has to be pressed against the loudspeaker grille to hear all the sound. Listen closely for the distortion. "Flutter" will manifest itself most apparently on the sustained tail or decaying sound of a struck piano key or plucked

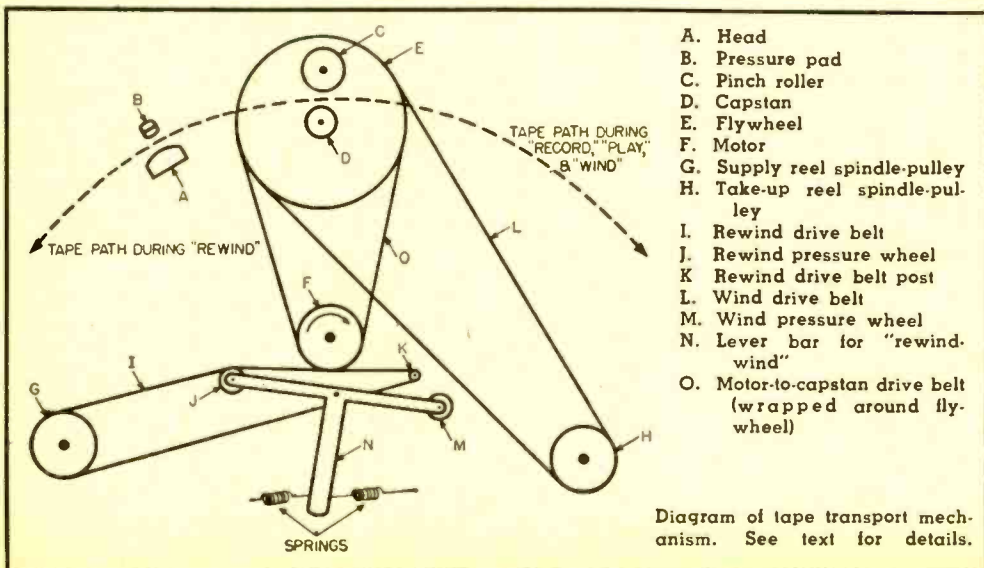

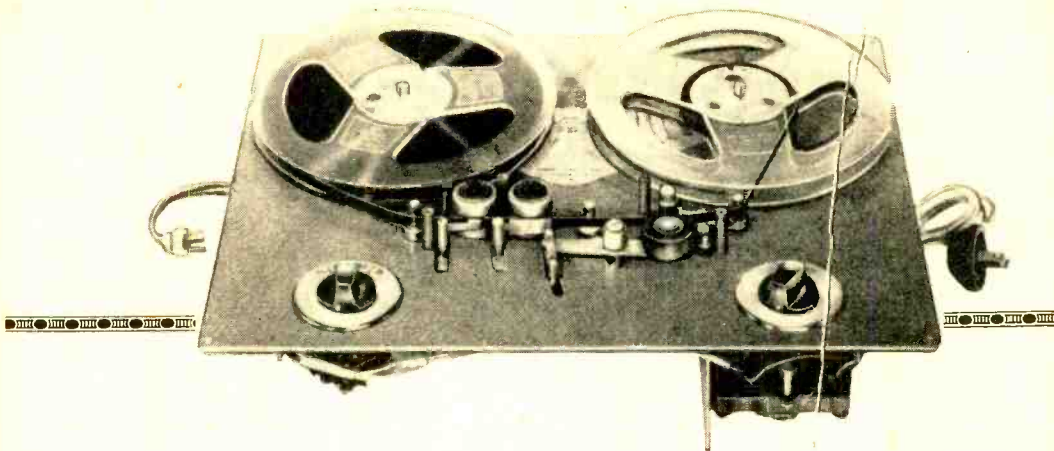

string of a violin or cello. The sound is unclear, unnatural or even raspy. It will make a musician-listener say: "That doesn't sound like a piano!"

Listen for "flutter" in shopping for a tape recorder, especially if the recorder is to be used for music. If it is there, it is probably built into that individual tape recorder, not necessarily into the whole line of the particular manufacturer.

Choosing a Recorder

How does one choose a tape recorder that will provide just what one wants? There are several questions which first must be answered by the user. They are very fundamental but important. For instance, what does the user want a tape recorder for? What does he plan to do with it? Is the quality of music vital, or is speech quality good enough? How much can he pay?

If the user wants a magnetic tape recorder exclusively for speech—as a clergyman might for sermon preparations, a lawyer for client interviews, a doctor for case studies, a teacher or drama student for self-improvement—or just for plain old-fashioned family fun, his search is an easy one. Here the requirements are best expressed as "it should sound like me." The prices paid for such loosely specified equipment are quite low, competitive in fact with complete phonographs. If the user is primarily a music student or listener who wants a machine with which to build a private collection of tape music, he must move more carefully and be prepared to spend more than a member of the other group.

Needless to say, one can buy either "Cadillac" or "Ford" type machines, money being the only consideration. However "Fords" outnumber the "Cadillacs" sold in the tape recorder field, too. Here is a list of questions that every prospective purchaser of a magnetic tape recorder should

TAPE RECORDER CHECK LIST

1. Do I need a complete tape recorder (built-in power amplifier and speaker), or do I want a tape "deck" (transport, bias-erase oscillator, and preamp) to integrate with the amplifier and speaker of an already existing sound system?
2. Do I want the equipment primarily for speech reproduction or for top quality music reproduction? If the latter, then close attention must be paid to such factors as frequency response, "wow" and "flutter" specifications, etc.
3. Are portability, size, and weight important factors?
4. How much continuous, uninterrupted recording and playing time must I have: ½ hour? 1 hour? In this connection, can adapters be fitted that accommodate larger reels?
5. Can the tape equipment be integrated with a hi-fi system without too much additional bother and expense, using the signal sources in the system (phono, tuner, TV, etc.) to record programs as well as using the playback facilities (amplifier and speaker) for monitoring and listening?
6. Will the tape equipment accommodate an extension speaker?
7. Are service facilities available locally for maintenance and repairs? If not, what arrangements can be made to cover the warranty period as well as the post-warranty period when breakdowns may occur?

ask himself. The answers he gives will provide him with the basic groundwork for a shopping excursion into the fascinating land of tape recorder showrooms and an eventual purchase which should make him feel that he has made the right choice.

Finally, the answers to these questions must be reconciled with: "How much can I afford to pay?" Only the individual can know that one. Chances are, whatever unit he buys for whatever purpose, he will soon join the hundreds of thousands of tape enthusiasts who agree: "It's worth it!" —30—

Magnetic Pickup Boasts Flat Response to 30,000 Cycles

A FREQUENCY RESPONSE that is completely flat up to 30,000 cycles is claimed for the new "Fluxvalve" magnetic phono pickup, announced by *Pickering & Co., Inc.*, Ocean-side, Long Island, N. Y. Combined with

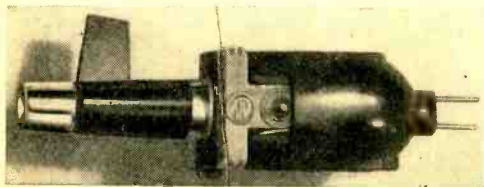

this response are high compliance, relatively high output, easily replaced styli, and rugged construction.

According to the manufacturer, the operating range of the best LP records extends to 15,000 cycles. However, pickups that cut off near this point produce peaks in response, and/or mechanical resonances—undue vibrations of the stylus at particular frequencies. Such peaks or resonances "color" the quality of the sound over the entire range and also tend to wear off the high-frequency grooves on the record. Consequently, if the pickup's response is flat to well beyond 20,000 cycles, such peaks and resonances can be kept out of the operating range. This results in much "cleaner" sound and practically eliminates wearing the top "sheen" off the disc.

To achieve this wide range requires a stylus with high compliance, or one that is extremely light and very easily pushed from side to side. Design of the "Fluxvalve" is said to achieve just this. All moving parts, including the stylus, are enclosed in a small plastic insert. This also facilitates stylus changing: all that need be done is to pull out the used insert and slide in

the new one, requiring only a few seconds and no tools.

The magnet, coil, and magnetic gap are all contained within the main housing of the cartridge, completely encapsulated in tough plastic. The magnetic field or "flux" extends from the lip out into space around the stylus tube. When the tube vibrates from side to side, following the record grooves, it varies the magnetic flux. These changes generate electrical voltages in the coil that come out of the pickup as the signal, corresponding to what is recorded.

Other features, specified by the manufacturer, are: tracking force of 2 to 5 grams, depending on the arm used; output of about 25 millivolts at normal recording levels;

and medium-high impedance, requiring a loading resistance of about 47,000 ohms. The mounting clip, which serves as the turnover device to change from a micro-groove to 78-rpm stylus, fits all tone arms, including those of record changers as well as professional types.

The new cartridge is available with two diamond styli (Model 350DD, net price \$63.00), or with a diamond stylus for microgroove discs and a sapphire for standard records (Model 350DS, net price \$49.50). Diamond replacement styli assemblies for either LP or 78's sell for \$21.00 each, while a sapphire replacement—for 78's only—sells for \$7.50. For additional information, write to the manufacturer. —30—

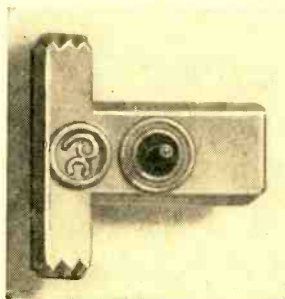

Printed Circuit Hi-Fi Amplifier for Low-Cost Installations

A RADICAL INNOVATION in low-priced high-fidelity amplifiers has been announced by

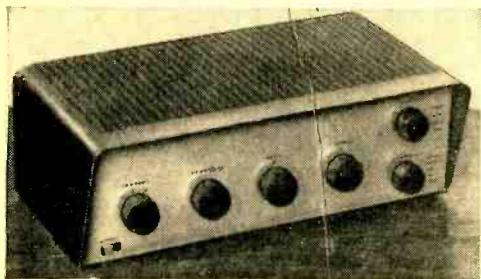

Harman-Kardon, Inc. of Westbury, L. I., N. Y. Employing printed circuits throughout, the "Prelude," Model PC-200, features dip-soldered, copper-clad, laminated phe-

nolic board for all wiring. Moreover, the set is so constructed that mechanical disassembly can be made whenever necessary.

Rated at 10-watts output, the "Prelude" includes a preamplifier with inputs for phono, tuner, and tape. Correct preamplifier equalization for tape recorder heads is provided. A tape output, unaffected by the tone controls, is also furnished.

Full record equalization with separate roll-off and turnover controls, a four-position dynamic loudness contour control, bass and treble controls, and a rumble filter are among the additional features of this unit. A matte black cage and safety interlock power cord are included in the consumer price of \$55.00. For further information, write to the manufacturer. —30—

60-Watt Power Amplifier

CONTENDING THAT A 60-WATT power amplifier will produce better sound at all listening levels, *McIntosh Laboratory, Inc.*, 320 Water St., Binghamton, N. Y., has introduced such a unit. The Model MC-60 is said to provide excellent low-volume fidelity as well as to deliver all the power demanded by any crescendo, cleanly and without distortion.

Frequency response at full output is reported as 20 to 20,000 cycles with less than 1/2% distortion. Noise and hum level is better than 90 db below the rated output. A gain control is provided.

The MC-60 uses for its power output stage two type 6550 tubes in push-pull. This recently developed tube provides high power reserves for smooth output at all levels, and peak-handling capacities of 100 watts.

Priced at approximately \$200.00, the MC-60 is intended for use with a separate pre-

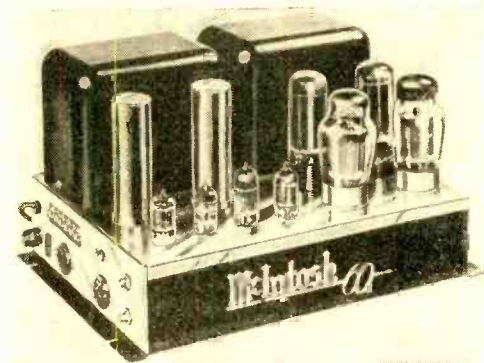

amplifier or audio control unit, such as the *McIntosh* C-4 or C-8. Similar components of comparable quality may also be used. An illustrated brochure, containing full details, is available from the manufacturer. -30-

Heathkit FM Tuner

LATEST ADDITION to the well-known line of "Heathkit" components for the home builder is a high-fidelity FM tuner. Designated as Model FM-3, the "do-it-yourself" kit contains all parts and instructions needed for assembling a tuner of modern design and advanced circuitry.

High gain and stable operation are claimed for this unit, which incorporates its own power supply and has provision for low-level or high-level outputs. Sensitivity is reported as being better than 10 μ v. for 20 db of quieting.

Other features include automatic gain control, a highly stabilized oscillator, and illuminated tuning dial. Educational treatment of the construction manual simplifies

assembly for the newcomer to electronics. The i.f. and ratio transformers are pre-aligned, and the front-end tuning unit is preassembled and aligned.

Tube line-up comprises a 6BQ7A as a cascode-type r.f. stage, a 6U8 oscillator-



mixer, two 6CB6's as i.f. amplifiers, a 6AL5 ratio detector, a 6C4 audio amplifier, and a 6X4 rectifier. Price is \$24.50. For further information, write to the *Heath Company*, Benton Harbor 10, Mich. -30-

Cables for Hi-Fi Connections

HI-FI COMPONENTS may be interconnected readily and securely with the aid of "unit-connectors" recently announced by *V & H Sales Co.*, Long Hill Branch, Bridgeport, Conn. A "unit-connector" consists of a length of shielded, low-capacitance wire, whose ends are permanently fitted with standard *RCA*-type phono plugs.

Signal leads for extra long runs may be assembled by using a double-female "connector-coupling," which accepts phono plugs at both its ends. Plugs are presoldered and are protected by a "molded-on" plastic jacket.

Cables are available in lengths of three feet (65 cents each); five feet (75 cents each); and seven feet (85 cents each). A

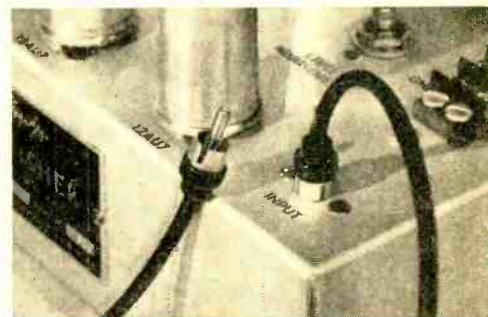

kit of three (one length each) sells for \$2.00. The double-female couplings sell for 55 cents each, or two for \$1.00.

Also available, on special order, are cables of any length specified by the buyer, as well as cables with only one end fitted to a plug. For additional information, write to the manufacturer. -30-

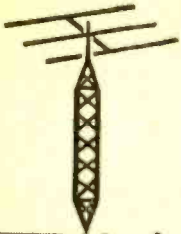

THE TRANSMITTING TOWER

Herb S. Brier, W9EGQ

LAST MONTH, we learned how an antenna works and how to calculate the length of a half-wave antenna using the formula: length (in feet) = $468,000/\text{frequency (kc.)}$. This month, we will discuss methods of transferring energy between an antenna and your receiver and transmitter.

The simplest way to do this is to bring one end of the antenna into the radio room and connect it directly to the equipment. How well this works depends largely on local conditions. Bringing an end of the antenna into the room unavoidably places it close to

antenna impedance to a value more easily matched by the transmitter output circuit. Naturally, this expedient reduces antenna efficiency.

From the above, it is obvious that dragging the end of the antenna into your radio shack is not the ideal way to feed it, especially if you operate from the basement or from a lower floor of a tall apartment building, although it will work if nothing better can be arranged. A much better arrangement is to erect the antenna in the most favorable position available and connect it to the equipment inside your station via a *transmission line*.

Transmission Lines

There are two types of radio-frequency transmission lines. One consists of two conductors separated from each other by air or other low-loss insulating material. It does not radiate the power it carries because the currents and voltages on the two conductors



Eddy Boothe, W8UJW, Sinks Grove, W. Va., has worked 40 states with his Heathkit AT-1 transmitter and a two-tube "Ocean Hopper" receiver.

utility wires, buildings, rain gutters, and trees, all of which will absorb part of your transmitted signal. In addition, the bends in an antenna needed to get one end of it into the room do not improve its efficiency.

In spite of these disadvantages, an end-fed, 125-130' antenna (half-wave on 80 meters) often works quite well in the 80-meter Novice band. It is long enough so that its center section, which does most of the radiating, can be kept straight and reasonably high and away from power-absorbing objects. It will also work on the higher frequency bands but probably not as well as on 80 meters, because deviations from ideal conditions degrade antenna performance more rapidly as frequency is increased.

Unfortunately, not all transmitters can cope with the high end impedance of such an antenna without the aid of an antenna-matching network. For simplicity, a compromise length of approximately 85 feet is often recommended because it reduces the



Mike Wenninger, W9ASK, River Forest, Ill., who started his amateur career as a Novice, has worked all states and 13 countries on three continents. He uses a Bandmaster transmitter, running 40-50 watts, and an NC-125 receiver.

are equal and opposite; therefore, the fields around them cancel each other instead of being radiated. The second type of transmission line is coaxial cable. In coaxial cable, one conductor is in the form of a hollow tube which completely surrounds the other one, forming a shield that confines the radio-frequency energy inside the cable.

All transmission lines have a self-impedance, called the *surge* or *characteristic impedance*, which is determined by the con-

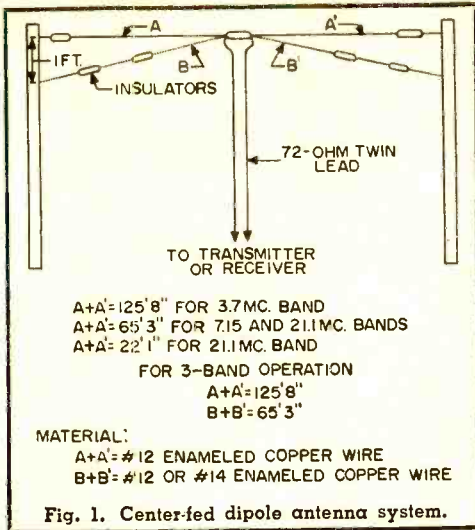

struction of the line, the diameter of the conductors, their spacing, and the type of insulation between them. Most common values of impedance of twin-conductor lines are 75, 150, 300, and 600 ohms. Coaxial cables are available with impedance ratings of between 35 and 100 ohms, with 52- and 75-ohm lines being most common. Any transmission line works most efficiently when feeding into a load resistance equal to its surge impedance.

Center-fed Dipole

While a transmission line can be efficiently connected to an antenna at any point, if it is done correctly, "center feed" has a number of advantages. It is at least as efficient as any other type and is easy to adjust. Also, the center impedance of a half-wave antenna is approximately 70 ohms, which can be matched directly by a transmission line of the same impedance. The combination forms a *matched-impedance, center-fed dipole*, an antenna that is hard to beat for simplicity and efficiency. (See Fig. 1.)

A disadvantage to a conventional dipole of this type is that it becomes two end-fed antennas in parallel on even harmonics of

its fundamental frequency. The resulting large mismatch (over 30:1) between the transmission line and the antenna feed point causes much of the power fed into the line to be dissipated as heat. Therefore, over-all antenna efficiency is low at these frequencies.

At odd harmonics, however, the center impedance of the antenna again becomes low, and power is efficiently transferred between the line and the antenna. As 21 mc. is the third harmonic of 7 mc., a 7-mc. center-fed dipole will work well on both bands.

"All-Band" Novice Antenna

By feeding 3.7- and 7-mc. dipoles from a single transmission line, an efficient antenna system for the 3.7-, 7-, and 21-mc. Novice bands will result. See Fig. 1 for details. On the 3.7-mc. band, the long antenna performs normally, with the short one going along just for the ride. But on 7 and 21 mc., the impedance of the long antenna becomes so high that it accepts little power from the transmission line, and the shorter antenna does the work. Besides, the little power that the long antenna does accept is radiated; so it is not wasted.

As indicated in Fig. 1, the ends of the two antennas may be fastened a foot or so apart on the same supports, and the combination may be fed with lightweight, 70-75 ohm TV "twin lead." Tape it to the center insulator in such a manner that its weight is not supported by the connections to the antenna. Otherwise, they will soon break. Fifty-two-ohm or 75-ohm coaxial cable may also be used with little difference in results, except that its added weight will sag the center of the antenna more. Bring the line away at right angles to the antenna for as long a distance as possible before bending it parallel to the antenna.

A half-wave antenna radiates its maximum signal broadside to its length and its minimum signal off the ends; therefore, if you have any choice in the matter, run the antenna at right angles to the directions you are most interested in working. For a symmetrical radiation pattern, make both ends the same height; otherwise, the pattern will be displaced towards the low end. Strive for an antenna height of at least 30 feet for best

(Continued on page 121)

Members of the Lake County Amateur Radio Club man the control station at the \$20,000,000 explosion and fire at Whiting, Ind., August 28. They directed activities of 25 mobile and portable stations, providing emergency communications between the fire fighters and disaster workers. Left to right are: W9TWU, W9WOY, W9VVA, and W9WKN. (Photo taken by WN9TQX).

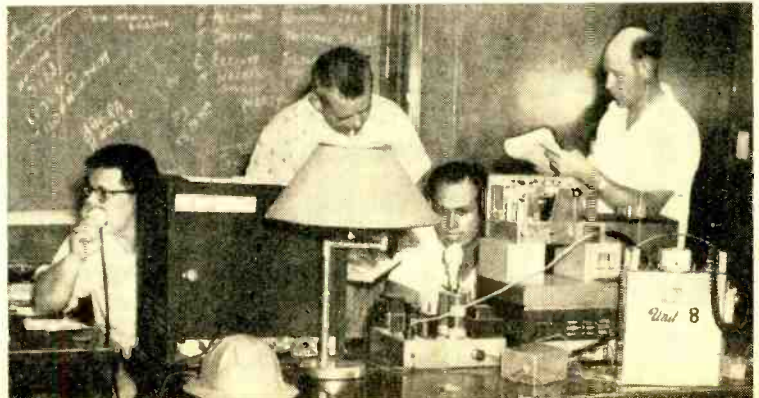

Tuning the Short-Wave Bands

=with Hank Bennett



IT IS SOMETIMES SAID that December is one of the best months of the year for radio receiving and DX'ing purposes, because of the short days and long nights. For the DX'er on the broadcast band, it is really ideal. The transatlantic stations can be heard as early as middle afternoon by those who possess a good antenna/ground system, and, as a rule, there are no atmospheric (QRN) to mar otherwise perfect reception. Such stations as ZBM1 in Hamilton, Bermuda, on 1235 kc., and WIND, the Air Force station in French Morocco, on 1582 kc., are sometimes heard in the course of a winter evening. ZQI, Kingston, Jamaica, often overrides Chicago's WGN on 720 kc.

Reception on the shorter waves is equally as good. There is even less chance for QRN to be noted, and the possibilities of hearing untold distances are good. Signals of *Radio Moscow*, *Tokio*, *Delhi*, and other stations thousands of miles away can be brought into your shack by careful tuning. At times, some of the larger stations can be picked up at will.

During the early morning hours transpacific stations can frequently be noted, the more commonly reported ones being Wellington, Shepparton, and the Indonesians. Our friends to the south can usually be tuned best during the evening hours; such stations being *Radio Rumbos* in Venezuela; the Brazilians, and HCJB in Quito, Ecuador. Some of the patient DX'ers will pull in the South Africans during late evening hours with setting-up exercises in the Afrikaans language. One easily heard African is *Radio Brazzaville* in French Equatorial Africa. Nearly every country that broadcasts scheduled programs on s.w. has—at one

time or another—programs in English. It may only be a newscast, or a short musical interlude, or an announcement giving the station call, location, or a run-down on future programs.

Airline Stations

As we have often mentioned in our correspondence, some countries can be heard only via the airways stations. Countries such as the Gold Coast, Rio de Oro, Curacao, and St. Vincent can best be heard on the airlines channels. Some of these countries also have short-wave outlets, but they may be inoperative at the moment, or of such low power that they serve no purpose other than for strictly local consumption. We hope, in this article, to show you when and how you can log some of these rarer countries, and even how to obtain verifications from them.

Short-wave reception is usually considered to be confined to the commonly known s.w. bands, i.e., the 49, 41, 31, 25, 19, and 16-meter bands. In the course of the past few years, many stations have begun operating in between these standard s.w. bands. Peking, for instance, has a transmitter on 10,300 kc. A few stations can be noted between 8800-9100 kc. Many of the South Americans, especially in Colombia and Venezuela operate in the 60-meter band, roughly at 4800-5100 kc., with others even further down in frequency around 3200-3500 kc. Just recently a pair of Venezuelans opened up in the lower portion of the 2000-kc. band.

But in between these newer s.w. channels are frequencies reserved for telephone stations, ship stations, and airlines. The telephone stations can be easily identified by their running marker tapes which usually transmit a message of this generalized type: "This is a telephone station of the (country or name of company) transmitting for circuit adjustment purposes." Ship stations can be found in the region of 2500-2590 kc. and can be identified by alternate speech and tone signals that resemble a telephone busy signal.

The airlines can be found in a number of places and at nearly any time of day or night. Roy Waite, the Amateur Section Editor for the Newark News Radio Club writes that he has recently logged on a frequency of 8913 kc.: Kindley, Bermuda; Churchill, Manitoba; Frobisher, Baffin Island, Gander, Newfoundland; and Shannon, Ireland. These were heard between 1155 and 1520. On 8820 kc., he has logged Roberts Field, Liberia; Accra, Gold Coast; and Dakar, French West Africa. Many

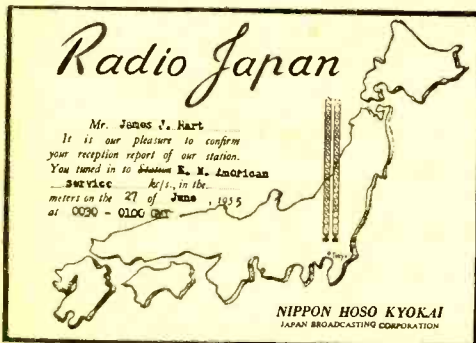

One side of this Radio Japan QSL card gives confirmation data; the reverse side is a reproduction of a water color of Mt. Fujiyama. It was sent to James J. Hart, Irvington, N. J.

were tuned on 5626½ kc. between 1651 and 2008 including Sondestrom, Greenland; Santa Maria, Azores; Goose Bay, Labrador.

Roy also points out that, unlike regular s.w. broadcasting stations, the airline stations do not maintain a regular schedule. It is a case of sticking with a frequency, once it is located. From time to time, various stations will be noted. Their transmissions, for the most part, are brief, as are the identities. Some identify by call letters, others by location. Many of the stations operate only on c.w., especially the most elusive Rio de Oro. The ones given above, however, were all logged on voice.

When writing for verifications, the best idea is to prepare a card, on which you have shown the time heard, whatever you could catch concerning the message, frequency, and—when possible—the station or plane that was on the other end. Prepare the card in such fashion that all the engineer at the station has to do is sign it and return it. Send enough return postage; the best bet is an International Re-

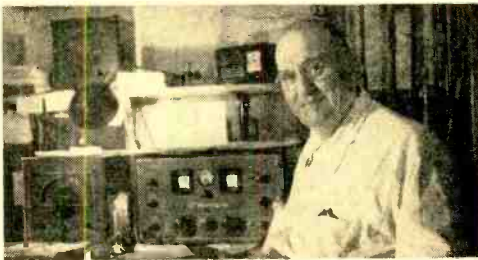

The layout of Harry J. Hibbard, 21 Willard St., New Bedford, Mass., is complete with a Hammarlund HQ-140 receiver and RME DB-22A preselector.

ply Coupon, obtainable at your Post Office. Also mention that you are writing for a verification and, in closing, thank them for it.

A handbook of some sort is recommended, should you plan to do any amount of listening to the airlines. An airline guide would serve the purpose with its listing of flights to and from certain points. An excellent guide is the "ABC World Airways Guide", available from the *Thomas Skinner Co., Ltd.*, 111 Broadway, New York, N. Y. It sells for one dollar and contains information on flights the world over.

Other channels on which overseas stations can be heard are 8871, 8862, 8837, 5619, and 5604 kc. The 5604-kc. channel is a good one for stations in the Middle East, while 8837 and 5619 kc. are good for stations in the West Indies and Central America.

Try some of these channels and let your Editor know of your results. If trouble develops, write to me, or to Roy Waite at 38 Hannum Avenue, Ballston Spa, New York.

In addition to thanking Roy, we wish to thank Walter Betzendal, Moorestown, N. J., and Charles McCormick, Jr., Baltimore, Md., for their assistance in preparing this article.

Station Reports

A few months ago, we discontinued listing contributors because we felt that it took too much space. Well, Ye Olde S.W. Editor

found out the hard way that many readers were disappointed. So, once again, we will endeavor to list the names of contributors and their home towns. You will find them on page 116. Exact addresses can be had by dropping a card to the S.W. Editor.

Now into this month's batch of mail. All times are EST, based on the 24-hour clock.

Argentina—An easy catch for the past few months has been *Radio Del Estado*, LRA, 9690 kc.; heard well at 2000-2200 when they



Shown above is the SWL card of Fred Kellogg, Box 525, Urania, Louisiana.

sign off with their Anthem and "Lights Out." The fights can be noted Saturdays around 2130. (DC)

Australia—*Radio Australia*, 9615 kc., Melbourne, is heard in Eastern USA in English at 0655-0845, with news at 0715. For Western USA, it is heard at 0714-0815 and 1850-2015, with news at 0730. On Saturdays at 2000, the "Australian DX'ers Calling" program is heard. (CG)

Brazil—*PRA8*, 11,865 kc., *Radio Clube de Pernambuco*, Recife, is good at 1745-1830 with music and religious programs, and announces as "Estacoes da *Radio Clube de Pernambuco em onda media e curta.*" (PM)

British Honduras—*Radio Belize*, ZIK2, 3300 kc., can be heard at 2000. Despite the low power and frequency, this station appears to be widely heard. (BW)

Canada—The new English schedule for *Radio Canada* is: to USA at 2015-2045 on CKCX, 15,190 kc., and CKLO, 9630 kc.; to Australia at 0345-0415 on CKLO, 9630 kc., and CKNA, 5970 kc.; to Europe at 1530-1600 on CKCS, 15,320 kc., and CHOL, 11,720 kc. All transmissions are daily. (PJ)

Egypt—Cairo, on 9790 kc., is often heard at 1900-2000 s/off, identifying as *Huna el Kahera*. The program is Oriental music with Arabic announcements. (FK)

Cairo is also noted Saturdays from 1200-1400 on 9475 kc., and evenings on 11,670 kc. They QSL promptly. (MF)

El Salvador—YSS, 9555 kc., can be heard around 2000 in English with what appears to be English lessons. (JR)

England—The General Overseas Service is noted on 15,310 kc. at 1600-1815 and on 11,930 kc. at 1815-2200. Every Tuesday, the request program "Listener's Choice" can be heard at 1715-1745 on 15,310 kc. (JB)

(Continued on page 112)

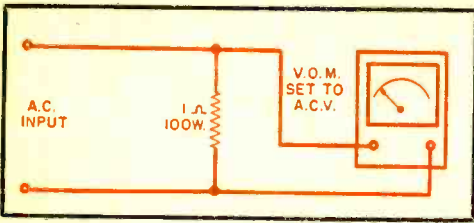

Fig. 1. Setup for measuring a.c. amperes. Resistor is connected in parallel with VOM to convert it temporarily to a.c. ammeter.

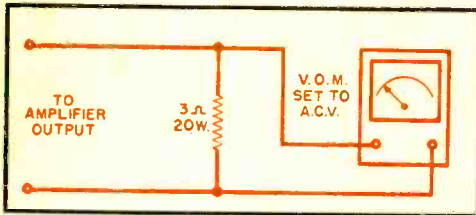

Fig. 2. Checking output watts of audio amplifier. This circuit replaces speaker.

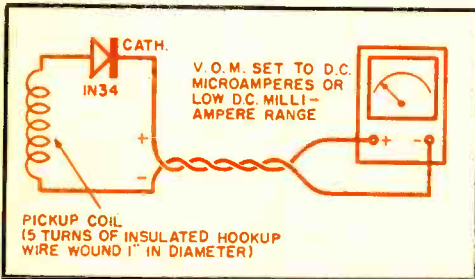

Fig. 3. Using the VOM as an r.f. indicator.

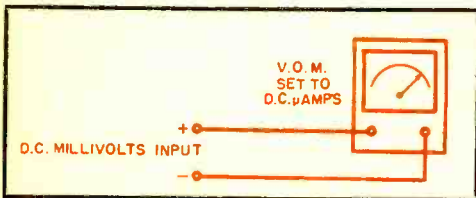

Fig. 4. The d.c. microammeter range of the VOM may be used to measure d.c. millivolts.

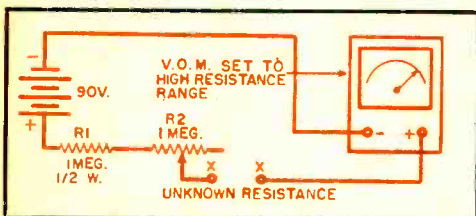

Fig. 5. Extending ohmmeter range by means of a battery, resistor and potentiometer.

EXTRA JOBS

THE volt-ohm-milliammeter, known in shop talk simply as "VOM," is the basic electronic test instrument. It often is called a "multimeter." This should be the first test instrument bought by the beginner. Most experienced radio men use the VOM as often as any other piece of test equipment.

As its name indicates, the main job of the VOM is to measure volts, ohms, and milliamperes. A standard VOM will check a.c. and d.c. volts, d.c. microamperes, d.c. milliamperes, d.c. amperes, and ohms. It can be made to do a few additional jobs important to the electronic worker. For example, a standard VOM can be adapted to measure a.c. amperes, audio watts, and d.c. millivolts. It can also be rigged up to check r.f. in the adjustment of a radio transmitter, and to read the capacitance (in microfarads) of capacitors. Another simple scheme makes it possible to measure resistances 10 times higher than the greatest value ordinarily handled by the meter. This article tells how to do these extra jobs.

Measuring A.C. Amperes: Very few multimeters have ampere ranges. The measurement of a.c. amperes is necessary when checking the heater current of tubes, current drain of electrical appliances, operating current of a.c. control devices, etc.

Figure 1 shows how a resistor is connected in parallel with the VOM to convert it temporarily to an a.c. ammeter. The VOM is set to read a.c. volts, and its voltage scales will show amperes directly.

The shunt resistor is a 1-ohm, 100-watt unit (*Ward Leonard* Type 100F). This set-up is used like any other ammeter. Amperes are read simply from the a.c. voltage scales. Thus: 1 volt indicates 1 ampere; 5½ volts, 5½ amperes, etc. The top current value handled by this arrangement will be 10 amperes. Higher values will overheat the resistor. For safety, the resistor should be mounted on a fireproof base or inside a ventilated metal case.

FOR YOUR VOM

A standard volt-ohm-milliammeter can be adapted to measure a. c. amperes, check capacitors, and do many other useful jobs

Measuring Audio Watts: Figure 2 shows how the VOM may be arranged to measure the output power (in watts) of an audio amplifier. This circuit replaces the speaker and allows a noiseless test to be made. Many speakers now have 3.2-ohm voice coils, so a 3-ohm load resistor is used in the circuit. Three ohms is the closest value to 3.2 ohms obtainable in a stock resistor.

The 3-ohm resistor used is a 20-watt power-type unit (*Ward Leonard Type 20F*). It is simply connected in parallel with the VOM which is again set to read a.c. volts. To use this instrument: (1) Connect the leads labeled **TO AMPLIFIER OUTPUT** to the output terminals of the amplifier in place of the voice coil of the loudspeaker. (2) Switch on the amplifier. (3) Feed a signal from an audio oscillator into the amplifier input. (4) Read the a.c. voltage indicated

by the VOM. (5) Locate this voltage value as nearly as possible in the left-hand column of Table 1 and read the power in watts in the right-hand column. (6) Repeat the test at different settings of the amplifier volume control to see how the power output changes. The circuit will check power up to about 20 watts.

Fig. 6 (right). Circuit for measuring all capacitors except electrolytics. Shown below is a pictorial diagram of the setup.

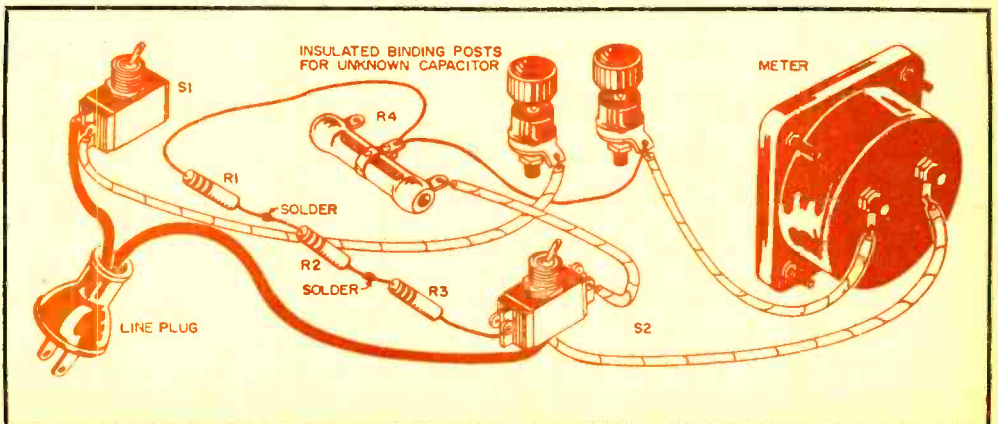
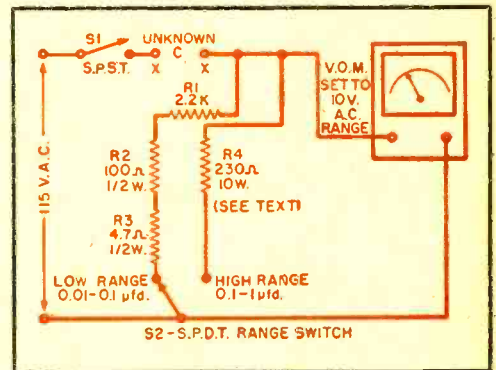

VOLTS	WATTS (approx.)	VOLTS	WATTS (approx.)
0.5	0.083	5	8.33
0.547	0.1	5.19	9
1	0.33	5.47	10
1.22	0.5	5.5	10.1
1.5	0.75	5.75	11
1.73	1	6	12
2	1.33	6.24	13
2.45	2	6.48	14
2.5	2.08	6.5	14.1
3	3	6.71	15
3.46	4	6.93	16
3.5	4.08	7	16.3
3.87	5	7.14	17
4	5.33	7.35	18
4.24	6	7.5	18.75
4.5	6.75	7.55	19
4.58	7	7.75	20
4.89	8	8	21.3

Table 1. Relationship of voltages to watts when using the VOM to measure audio watts.

The voltage values given in Table 1 are those which correspond exactly to the wattages. In some cases, it will be impossible to read the voltage this accurately on the meter scale. For example, 3.87 volts (corresponding to 5 watts) cannot be read this precisely on most VOM scales, but 3.9 volts may be estimated as a near value and this difference will cause only a very small difference in the measured wattage. Obviously, the use of a 3.0-ohm instead of 3.2-ohm resistor introduces an error.

Use as R.F. Indicator: When adjusting a radio transmitter, it is handy to have a

RANGE A		RANGE B	
Volts	μ fd.	Volts	μ fd.
1	0.01	1	0.1
1.5	0.015	1.5	0.15
2	0.02	2	0.2
2.5	0.025	2.5	0.25
3	0.03	3	0.3
3.5	0.035	3.5	0.35
4	0.04	4	0.4
4.5	0.045	4.5	0.45
5	0.05	5	0.5
5.5	0.055	5.5	0.55
6	0.06	6	0.6
6.5	0.065	6.5	0.65
7	0.07	7	0.7
7.5	0.075	7.5	0.75
8	0.08	8	0.8
8.5	0.085	8.5	0.85
9	0.09	9	0.9
9.5	0.095	9.5	0.95
10	0.10	10	1.0

Table 2. Relationship between voltages and microfarads using VOM to check capacitors.

meter to show the presence of r.f. energy. Figure 3 shows how the VOM can be used. A small coil (five turns of insulated wire wound on a 1"-diameter form, or simply wound tightly without a form) is used to pick up the r.f. energy. A 1N34 crystal diode rectifies the r.f. and the resulting direct current deflects the VOM, which is set to its d.c. microampere range or to one of its d.c. milliamperage ranges.

Measuring D.C. Millivolts: The d.c. microammeter range of the VOM may be used to measure d.c. millivolts. The VOM instruction book should show the number of millivolts corresponding to full-scale deflection of the microammeter.

When the millivolts deflection is not stated in the meter literature, look up the meter circuit resistance (ohms) for the microampere range, and multiply this by 0.001 times the full-scale microamperes to find full-scale millivolts. **EXAMPLE:** The meter reads 50 microamperes at full scale and has a resistance of 2000 ohms. The number of millivolts at full scale = $2000 \times 0.001 \times 50 = 2000 \times 0.05 = 100$ mv.

Extending Ohmmeter Range: An external battery, resistor, and potentiometer can be used (as shown in Fig. 5) to extend the ohmmeter range of the VOM. With the *Simpson Model 260* meter, for example, this setup extends the $R \times 10,000$ resistance range from 0-20 megohms to 0-200 megohms—ten times. Similar arrangements can be used with other VOM's.

To use this arrangement: (1) Set the meter to its $R \times 10,000$ range. Touch the meter test leads together and set the meter to zero ohms. Do not disturb this setting of the zero adjuster. (2) Connect the meter into the circuit, as shown in Fig. 5. (3) Short-circuit terminals X-X and reset the meter to zero ohms by adjusting potentiometer R_2 . (4) Connect the unknown resistance to terminals X-X. Read the resistance value from the meter scale and multiply by 10.

Checking Capacitors: All capacitors *except electrolytics* may be measured with the setup shown in Fig. 6. This arrangement allows microfarads to be read from the 10-volt scale of the VOM. Table 2 shows the simple relationship between voltages and microfarads.

The instrument is operated from the a.c. power line, so care must be exercised in its use to prevent electric shock. Always throw switch $S1$ to its OFF position before connecting or removing a capacitor. In the author's arrangement, R_4 consisted of an IRC Type ABA 250-ohm, 10-watt unit with the slider set at 230 ohms.

In the Low position of the RANGE switch (S_2), capacitances between 0.01 and 0.1
(Continued on page 127)

R/C NOTES

WELL, DECEMBER IS HERE with its raw rains and snow and, unless you live in one of the lucky sunshine states, you're not giving your R/C models much action. So, like your editor, you're thinking back over the various R/C meets attended this past season. One in particular that stands out for your editor was the *Third Annual Long Island Sound Hydro Championships* sponsored by the "Screamin' Demons" of Long Island.

Quite a few hardy R/C flyers turned out for the meet, which was finally held on October 1 after having been cancelled the week before because of rain. Among the R/C entrants in this class AAA meet was Paul Strauss of Glen Cove, who is shown (below) with his *Sikorsky S39* scale model flying boat. Although Paul didn't put this model into the air on that day, it has some features worth pointing out.

Note the ingenious method used to control the twin rudders and elevator. Originally devised by Bill Jöhnke, well known in R/C circles (no pun intended), this system raises the elevator automatically whenever the rudder is deflected, neutralizing the tendency of the plane to lose altitude when it goes into a turn. Paul is adjusting the rudder control rod, which is coupled to the *Dmeco* servo motor in the center fuselage compartment. The other photo shows the *ECC* single-channel receiver in the forward compartment.

SHOWN ABOVE is the new reed unit conversion kit manufactured by the *CG Electronics Company*, 305 Dallas N.E., Albuquerque, New Mexico. This is a compact assembly consisting of either a two- or three-resonant-reed relay plus secondary relays and filter network. Designed to be used with *CG's* single-channel tone receiver, such units will work very well with other commercial tone receivers,

or you may build your own transistorized reed relay receiver from the plans which accompany each unit. The additional sec-

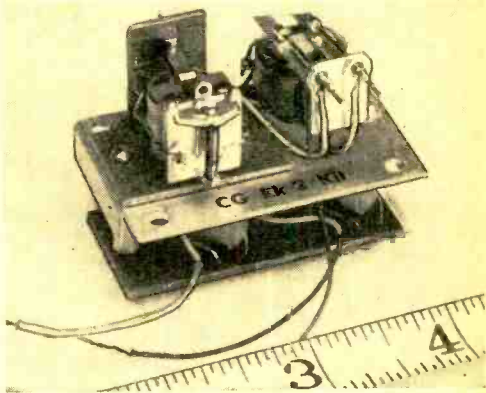

ondary relay is obtained from the regular receiver; hence the use of only one secondary relay on the two-reed resonant unit. Price for the two-reed assembly is \$24.95.

OF SPECIAL INTEREST to the home gadgeteer is the radically new electric motor manufactured by the *Kinder Company*, Box 686, South Milwaukee, Wis. Measuring $1\frac{1}{2}'' \times 1\frac{1}{4}'' \times 1\frac{1}{8}''$, and weighing 3 ounces, this motor features 1% speed regulation from idling to full load over a voltage range of from 4.6 to 6.4 volts. Normal load current drain is 40 ma.; four pen cells are sufficient for many hours of running.

IF YOU LIVE in Miami, Florida, or close to it, don't forget the *Second King Orange Internationals* from Dec. 30 to Jan. 2. Charles Quick, 1896 N.W. 36th St., is C. D. —50—



AFTER CLASS

THE AMPLIFYING TRIODE

THE GENESIS of electronics as we know it today is marked by one of the greatest inventions of all time—the vacuum triode. With the advent of the three-element tube came vastly widening horizons; amplification, sustained electronic oscillation, and hitherto unreachable high frequencies emerged from the realm of wishful thinking to become commonplace operations feasible even for the novice.

A triode is conventionally pictured as shown in Fig. 1(A). The emitter of electrons is the cathode (*K*), the electron "catcher" is the plate (*P*), and between the two is the sieve-like structure called the control grid (*G*). If the plate is made positive with respect to the cathode, electrons move in a stream from the emitter to the "catcher," producing the tube's *plate current* (I_p). This current flows back to the source (*Ebb*) via the *plate load resistor* (R_L) as in Fig. 1(B). The arrows show the direction of the electrons through the tube and the load while E_o signifies the voltage drop in the load resistor.

In this fundamental arrangement, the tube behaves like an ordinary diode. If the source (*Ebb*) were a.c., it could rectify the current so that a d.c. voltage drop would appear across R_L ; but, as *Ebb* is already d.c., the tube does nothing more than add some resistance to the circuit.

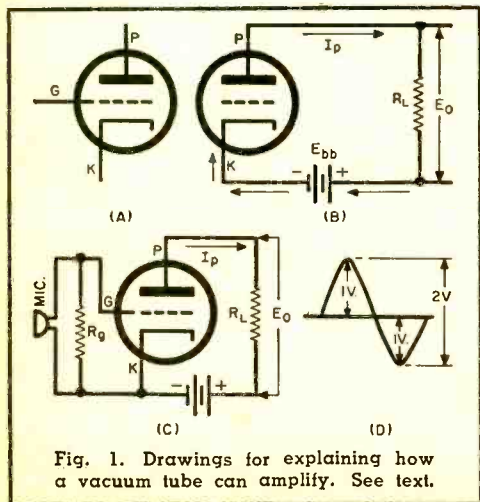

Fig. 1. Drawings for explaining how a vacuum tube can amplify. See text.

Now suppose we add a microphone and a resistor (R_g) in the manner illustrated in Fig. 1(C). If no sound is fed to the microphone, the tube performs just as it did before. When a pure tone, such as a soft whistle, is allowed to act on the microphone, it generates an alternating voltage, say about 2 volts from peak to peak (Fig. 1(D)) which causes a current to flow

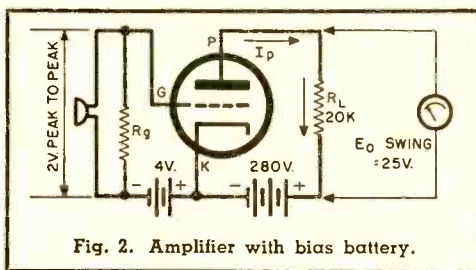

Fig. 2. Amplifier with bias battery.

through R_g , producing a 2-volt a.c. drop across this resistor. Since the grid and cathode of the tube are connected across R_g , the same voltage is being applied between these two electrodes.

The grid is helically wound fine wire close to and surrounding the cathode. Its position endows it with powers that are somewhat "dictatorial"—it can exercise appreciably more control over the plate current than the plate itself can. If it becomes negative, as it does on the lower peak of the wave in Fig. 1(D), it repels electrons and reduces the plate current (I_p) flowing through the tube and the load resistor (R_L). With diminished current, the drop across R_L also decreases.

All this is desirable for amplification, as we shall soon see, but a complication arises when we consider what happens as the grid is driven positive by the upper half of the "whistle-wave." Once the grid becomes positive with respect to the cathode, it becomes a catcher of electrons in its own right and begins to steal these essential particles from the plate stream. This results in severe distortion in the sound.

The problem is easily overcome by adding another small battery of, perhaps, 4 volts connected as illustrated in Fig. 2 so that the grid is always maintained at a po-

(Continued on page 104)

LAFAYETTE HEADQUARTERS FOR POPULAR ELECTRONICS KITS!

HARD TO GET PARTS FOR KITS - WE HAVE THEM!

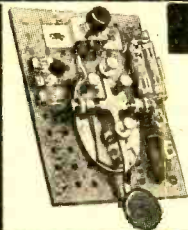

TRANSISTOR CODE PRACTICE OSCILLATOR KIT

For those interested in mastering the International code, an audio tone oscillator is essential. The circuit of this transistorized feedback oscillator has the simplicity of the neon glow, the signal strength of the vacuum tube, and requires only two penlite cells for weeks of service. It may be used for solo practice, or two may send and receive with the same unit. Kit comes complete with Transistor, Telegraph Key, Resistors, Condensers, Masonite Board, etc., and Schematic Diagram.

KT-72 Net 2.99
Cannon ECI—Single Headset Net 1.13

3 TRANSISTOR PUSH-PULL AUDIO AMPLIFIER FOR SPEAKER OPERATION



With the New Lafayette KT-69-Kit you can now build a self-powered, push-pull Class "B" transistor audio amplifier for speaker operation, having a frequency response of 100-8000 cps. The Argonne Transistor transformers were especially designed for transistor circuits. Kit comes complete with 3 transistors, push-pull input and output transformers, chassis, 3 "x 1/2" x 1" condensers, resistors, battery holders, etc., schematic diagram.

KT-69 Complete with batteries.....Net 17.95

NOTE: Input impedance 1000 ohms. For high impedance inputs matching transformer is needed (AR-100); for magnetic input use preamp (KT-71).

TWO TRANSISTOR PREAMP KIT



With the Lafayette KT-71 you can now build a simple Transistor preamp in a matter of hours. The overall result will be a noiseless, humless and virtually distortionless amplifier. The complete unit is mounted on an aluminum chassis size 3"x4"x1". The Kit comes complete with two transistors, condensers, resistors, battery holders, batteries, etc., and schematic diagram.

KT-71 Complete KitNet 8.95

LAFAYETTE GEIGER COUNTER KIT WITH HIGH SENSITIVITY VICTOREEN TUBE 1B85

Lafayette Geiger Counter Kit with High Sensitivity Victoreen 1B85 tube, makes this one of the most outstanding kit buys in the country. This tube is used only in the most expensive equipment. Easy to build, at only a fraction of the price, of commercial instruments of this type. Just turn it on, flip the high voltage switch and listen to the clicks. Kit includes all parts, tube, carrying case, 22 1/2" and 1 1/2" volt Batteries. Complete instructions for quick assembly. Shpg. wt., 1 1/2 lbs.



KT-75 Net 14.95

A new light weight Dynamic Ear Phone.
Fits right into the ear. Excellent sensitivity of 65 db. Ideal for use with miniature sets, hearing aids, transistor pocket radios.
DC resistance 2000 ohm, impedance 5000 ohm with 3 ft. of plastic cord.
MS-72 Net 1.95
MS-100 Impedance 8 ohm for Silent Radio or TV viewing.
Net..... 1.95

MINIATURE CRYSTAL MICROPHONE

Here's a typical Lafayette special for the experimenter, student or dealer. An extremely sensitive and small crystal microphone used in hearing aids and other small apparatus. Can be used as lapel mike—miniature transmitter mike for concealed locations, etc. Its size and performance gives it joint versatility. Brand new. Size only 1 3/4" Diam. x 5/16" deep. Imported to save you money.
MS-108 Net 1.95

TRANSISTOR POCKET RADIO RECEIVER KIT

Utilizing One Transistor and Crystal Diode Detector with New Miniature 365 mmf Variable Condenser.

Here is an ideal low cost transistor pocket radio kit for students, hobbyists and the experimenter, who desire to obtain a practical knowledge of transistorized circuits. The circuit utilizes a Forri-Loopstick and a specially designed miniaturized 365 Variable Condenser permitting the entire receiver to be built in a plastic case size 3"x2"x1". The 1N84 Crystal Diode is used as a detector, the transistor is connected as a grounded emitter amplifier. This receiver with a 50 foot antenna and good ground will bring in good reception over a 50 mile radius. The kit comes complete with transistor, crystal diode, battery holders, resistors, condensers, resistors, plastic case, etc., plus a 115 page book, showing more than 50 practical transistor circuits and How-To-Do-It-Instructions.

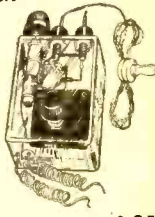

KT-80 Complete Kit (less earphones) 4.95
1 Miniature Crystal Ear Receiver MS-111 1.49

TRANSISTOR TELEPHONE PICK-UP AMPLIFIER KIT TWO CAN LISTEN ON SAME PHONE CONVERSATION

With this Ingenious Kit you can build a tiny transistorized telephone pick-up amplifier with which two people can listen in on telephone conversations without the need of an extension phone. Also serves as a high gain amplifier to feed into a tape recorder, for recording telephone conversations. Can also be used as a portable amplifier with crystal microphone and matching transformer when desired. The circuit utilizes a transformer coupled audio for high gain and two R-C coupled stages. Kit comes complete with 2 Transistors, Transistor Audio Transformer, Condensers, Resistors, etc., and Plastic Case. Size: 2 1/2" x 1 1/2" x 3/2" and batteries



KT-76 Complete Kit (Less Earphones) Net 9.95
MS-16 Telephone Pick-Up Net 2.95
MS-111 Miniature Crystal Ear Receiver Net 1.49
MS-260 New Super Power Dynamic Earphone. Ideal for Transistor Circuits. Net 3.95

2 TRANSISTOR POCKET RADIO KIT

Packed into a 2 1/2"x3 1/2"x1 1/4" plastic case. This Two Transistor plus crystal diode radio kit offers many surprises, utilizing a regenerative detector circuit with transformer coupled audio stage, gives you high gain and excellent selectivity. Pulls in distant stations with ease with more than ample earphone volume. Kit comes complete with two transistors, crystal diode, loopstick, Argonne transistor audio transformer, resistors, condensers, plastic case, etc., including schematic and instructions.



KT-68A Complete Kit less earphones. 11.80
MS-260 New Super Power Dynamic Earphone. Ideal for Transistor Circuit Imp. 800 ohm, D.C. 2000 ohm 3.95

CRYSTAL MICROPHONE

COMPARE IT WITH ANY MIKE AT 2 TO 3 TIMES THE PRICE

A quality crystal Microphone for PA systems, house recorders, etc. Frequency response 30 to 10,000 cycles. Output level -52 db. Provides ample output for use with low gain amplifiers. Complete with 5 ft. of shielded cable. Shpg. wt., 3 1/2 lbs.

4.25
PA-24 - in lots of 3, each 3.95 singly, each 4.25

TRANSISTOR 455 KC I.F.

Specially designed for transistor circuits, only square by 3/4" high.
MS-125
In lots of 10, each 79¢
Single, Each 89¢

RAYTHEON TRANSISTOR

CK722
P-N-P
99¢

TRANSISTOR LOOP ANTENNA

Fixed inductance tapped to match 600 ohm input. Covers 540-1650 kc with 365 mmf variable cond. size 9/16 x 4 3/8"
MS-166 Net 1.25

TRANSISTOR OSCILLATOR COIL

Supplies local OSC. energy to mixer stage. 1F 455 kc. Use with 365 mmf cond. 9/16 x 4 3/8"
MS-165 Net 49¢

TRANSISTOR TYPE 2N107

P-N-P
\$1.25

MINIATURE 365 mmf VARIABLE COND.

only 3/16" thick
Ideal for transistorized and miniature builders. Capacity 10 to 365 mmf. 1/2" square, 160° rotation. Bushing and shaft 7/8" long.
MS-215 Net 69¢

send for FREE CATALOG

Lafayette Radio
100 SIXTH AVE. NEW YORK, N.Y.
Include postage with order

Build YOUR OWN HEATHKITS

INTERESTING—EDUCATIONAL



work has already been done for you. No cutting, drilling, or painting required. All parts furnished including tubes. Knowledge of electronics, circuits, etc., not required to successfully build Heathkits.

Heathkits are fun to build with the simplified easy-to-follow Construction Manual furnished with every kit. Only basic tools are required, such as soldering iron, long-nosed pliers, diagonal cutting pliers, and screwdriver. All sheet metal

New charcoal gray baked enamel panel with highly readable white lettering.

New PRINTED CIRCUIT VACUUM TUBE VOLTMETER KIT

The VTVM is the standard basic voltage measuring instrument for radio and TV servicemen, engineers, laboratory technicians, experimenters, and hobbyists. Because of its extremely high input resistance (11 megohms) the loading effect on the circuit being measured, is virtually negligible. The entire instrument is easy to build from a complete kit, with a detailed step-by-step Construction Manual. Featured in this instrument is an easy-to-wire fool-proof printed circuit board which cuts assembly time in half.

CIRCUIT AND RANGES: Full wave AC input rectifier permits 7 peak-to-peak voltage ranges with upper limits of 4000 volts peak-to-peak. Just the ticket for you TV servicemen. Seven voltage ranges, 1.5, 5, 15, 50, 150, 500 and 1500 volts DC and AC RMS. Peak-to-peak ranges 4, 14, 40, 140, 400, 1400, and 4000 volts. Ohmmeter ranges X1, X10, X100, X1000, X10K, X100K, X1 meg. Additional features are a db scale, center scale zero position, and a polarity reversal switch.

IMPORTANT DESIGN FEATURES: Transformer operated—1% precision resistors—6AL5 and 12AU7 tubes—selenium power rectifier—individual AC and DC calibrations smoother improved zero adjust control action—new panel styling and color—new placement of pilot light—new positive contact battery mounting—new knobs—test leads included. Easily the best buy in kit instruments.

New peak-to-peak meter scale—new color harmony—new control knobs.

New printed circuit board for faster, easier construction—exact duplication of Laboratory development model.



Model V-7

\$24.50

Shpg. Wt. 7 lbs.

New easy-to-read open panel layout. On-on switch incorporated in selector switch.

Heathkit HANDITESTER KIT



MODEL M-1
\$14.50

Shpg. Wt. 3 lbs.

The Heathkit Model M-1 Handitester readily fulfills all requirements for a compact, portable volt-ohm-milliammeter. Its small size permits the instrument to be tucked into your coat pocket, tool box or glove compartment of your car. Always the "handitester" for those simple repair jobs. Packed with every desirable feature required in an instrument of this type. AC or DC voltage ranges, full scale 10, 30, 300, 1000 and 5000 volts. Ohmmeter ranges 0-3000 ohms and 0-300,000 ohms. DC milliammeter ranges 0-10 milliamperes and 0-100 milliamperes. Uses 400 microampere meter—1% precision resistors—hearing aid type ohms adjust control—high quality Bradley rectifier. Test leads are included.

Heathkit MULTIMETER KIT



MODEL MM-1
\$29.50 Shpg. Wt. 6 lbs.

Here is an instrument packed with every desirable service feature and all of the measurement ranges you need or want. High sensitivity 20,000 ohms per volt DC, 5000 ohms per volt AC. Has the advantage of complete portability through freedom from AC line—provides service ranges of direct current measurements from 150 microamperes up to 15 amperes—can be safely operated in RF fields without impairing accuracy of measurement.

Full scale AC and DC voltage ranges of 1.5, 5, 50, 150, 500, 1500, and 5000 volts. Direct current ranges are 150 microamperes, 15, 150, and 500 milliamperes and 15 amperes. Resistances are measured from .2 ohms to 20 megohms in three ranges and db range from -10 to +65 db. Ohmmeter batteries and necessary test leads are furnished with the kit.

HEATH COMPANY
A SUBSIDIARY OF DAYSTROM, INC.
BENTON HARBOR 5, MICHIGAN



New
PRINTED
CIRCUIT

Heathkit 3" OSCILLOSCOPE KIT

Ideal for individual home work, shop, ham shack, or as extra instrument for outside servicing.

Compact size, light weight, portable — perfect for service work or field operation.

New, modern styling, modern panel with gray lettering, white case — gray knobs and red and black terminal posts.

New printed circuit for constant circuit performance, rugged component mounting — assembly time cut in half!

Measures only 11 3/4" x 6 3/4" x 10 1/2" and weighs only 11 pounds.

USE: This brand new Utility Scope was designed especially for servicemen and radio amateurs, and is adaptable for use in all general Scope applications. Perfect for modulation monitoring, etc. Use it to tackle alignment or adjustment problems. Equally valuable in breadboard work. A must for ham shack or for outside servicing.

DESCRIPTION: Front panel controls of the Model OL-1 are "bench tested" for ease of operation and convenience. Sharp focusing 3" CRT. Printed circuit for ease of assembly and constant performance. Assembly time cut in half! High quality electronic components used. Sensitive hor. and vert. amplifiers with broad freq. response; cathode follower for isolation. Push-pull hor. and vert. output to deflection plates. Int., 60 cycle, or ext. sync. Sweep freq. range 10-100,000 cycles. Direct connection to deflection plates. Provision for Z axis input. Uses 3GP1 CRT, 4-12AU7 hor. and vert. amplifiers, 1-12AX7 sweep gen., 1-6X4 LV rect., and 1-1V2 HV rect. The Heathkit Model OL-1 is a real standout value at only \$29.50, and is another example of the famous Heathkit combination; quality plus economy.

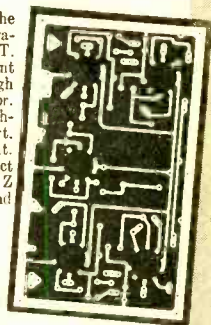

Model
OL-1

\$29.50

Shpg. Wt.
15 lbs.

Heathkit SIGNAL GENERATOR KIT

USE: This instrument is "serviceman engineered" to fill the requirement for a reliable basic service instrument at moderate cost. Frequency coverage extends in five bands from 160 Kc to 110 Mc on fundamentals, and dial is calibrated to 220 Mc for harmonics. Free-wound and pre-aligned coils make calibration unnecessary for service applications.

DESCRIPTION: The Heathkit Model SG-8 Signal Generator provides a stable modulated or unmodulated RF output of at least 100,000 microvolts which can be controlled by both a continuously variable and a fixed step attenuator. Internal modulation is at 400 cycles, or can be externally modulated. AF output of 2-3 volts is also available for audio testing. Uses dual purpose 12AU7 as Colpitts RF oscillator and cathode follower for stable, isolated, low impedance output, and type 6C4 tube for 400 cycle oscillator. Operation of the SG-8 is well within the frequency limits normally required for service work. Modern styling features high definition white letters on charcoal gray panel with re-designed control knobs. Modern professional appearance and Heathkit engineering know-how combine to place this instrument in the "best buy" category. Only \$19.50 complete.

New, modern panel and knob styling — professional appearance and professional performance.

Broad frequency coverage — fundamentals from 160 KC to 110 MC in 5 bands — up to 220 MC on calibrated — various harmonics.

Cathode follower output for good isolation — fixed step and continuously variable attenuation.



Output selection — internal modulation, pure r.f., or audio output.

MODEL SG-8 **\$19.50**

Shpg. Wt.
8 lbs.



MODEL
AM-1

\$14.50

Shpg. Wt.
2 lbs.

Heathkit ANTENNA IMPEDANCE METER KIT

The Model AM-1 Antenna Impedance Meter makes an ideal companion unit for the GD-1B Grid Dip Meter or a valuable instrument in its own right. Perfect for checking antenna and receiver impedance and match for optimum system operation. Use on transmission lines, half-wave, folded dipole, or beam antennas. Will double as monitor or relative field strength meter. Covers freq. range of 0-150 Mc and impedance range of 0-600 ohms. Uses 100 microampere meter and special calibrated potentiometer. A real buy at only \$14.50 complete.

Heathkit GRID DIP METER KIT

Amateurs and servicemen have proven the value of this grid dip meter many times over. Indispensable for locating parasitics, neutralizing, and aligning filters and traps in TV or Radio and for interference problems. The Model GD-1B covers from 2 Mc to 250 Mc with 5 pre-wound coils. Featuring a sensitive 500 microampere meter and phone jack, the GD-1B uses a 6AF4 or 6T4 tube. An essential tool for the ham or serviceman.



MODEL
GD-1B

\$19.50

Shpg. Wt.
4 lbs.

ACCESSORIES: Low freq. coverage to 355 KC with two extra coils and calibration curve. Set No. 341A for GD-1B and set No. 341 for GD-1A. Shipping weight 1 lb. Only \$3.00.

HEATH COMPANY
A SUBSIDIARY OF DAYSTROM, INC.
BENTON HARBOR 5 MICHIGAN

New Heathkit VFO KIT

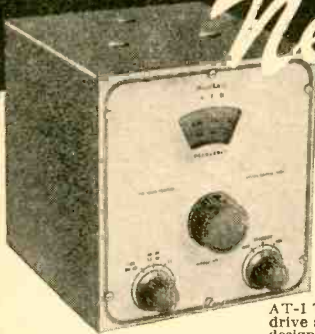

MODEL VF-1
\$1950
 Ship. Wt. 7 lbs.

- Smooth acting illuminated and precalibrated dial.
- 6AU6 electron coupled Clapp oscillator and OA2 voltage regulator.
- 7 Band coverage, 160 through 10 meters—10 Volt RF output.
- Copper plated chassis—aluminum cabinet—easy to build—direct keying.

Here is the new Heathkit VFO you have been waiting for. The perfect companion to the Heathkit Model AT-1 Transmitter. It has sufficient output to drive any multi-stage transmitter of modern design. A terrific combination of outstanding features at a low kit price. Good mechanical and electrical design insures operating stability. Coils are wound on heavy duty ceramic forms, using Litz or double cellulose wire coated with polystyrene cement. Variable capacitor is of differential type construction, especially designed for maximum bandspread and features ceramic insulation and double bearings.

This kit is furnished with a carefully precalibrated dial which provides well over two feet of calibrated dial scale. Smooth acting vernier reduction drive insures easy tuning and zero beating. Power requirements 6.3 volts AC at 45 amperes and 250 volts DC at 15 milli. Just plug it into the power receptacle provided on the rear of the AT-1 Transmitter Kit. The VFO coaxial output cable terminates in plastic plug to fit standard 1/2" crystal holder. Construction is simple and wiring is easy.

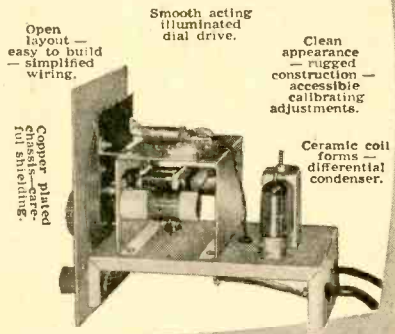

- Open layout—easy to build—simplified wiring.
- Smooth acting illuminated dial drive.
- Clean appearance—rugged construction—accessible calibrating adjustments.
- Copper plated chassis for shielding.
- Ceramic coil forms—differential condenser.

Heathkit AMATEUR TRANSMITTER KIT



MODEL AT-1
\$2950
 Ship. Wt. 16 lbs.

SPECIFICATIONS:
 Range 80, 40, 20, 15, 11, 10 meters.
 6AG7 Oscillator-multiplier.
 6X4 Amplifier-doubler.
 5U4G Rectifier.
 105-125 Volt A.C. 50-60 cycles 100 watts. Size: 8 1/4 inch high x 13 1/4 inch wide x 7 inch deep.

Here is a major Heathkit addition to the Ham radio field, the AT-1 Transmitter Kit, incorporating many desirable design features at the lowest possible dollar-per-watts price. Panel mounted crystal socket, stand-by switch, key click filter, A. C. line filtering, good shielding, etc. VFO or crystal excitation—up to 35 watts input. Built-in power supply provides 425 volts at 100 MA. Amazingly low kit price includes all circuit components, tubes, cabinet, punched chassis, and detailed construction manual.

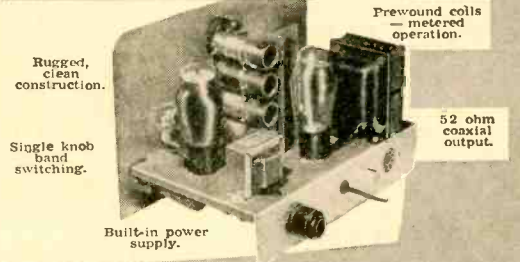

- Rugged, clean construction.
- Crystal or VFO excitation.
- Single knob band switching.
- Built-in power supply.
- Prewound coils—metered operation.
- 52 ohm coaxial output.

Heathkit COMMUNICATIONS RECEIVER KIT

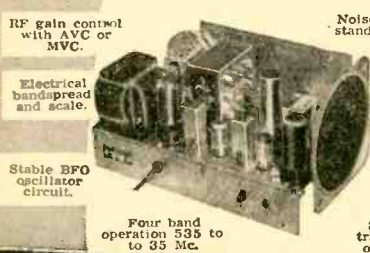

- RF gain control with AVC or MVC.
- Electrical bandspread and scale.
- Stable BFO oscillator circuit.
- Four band operation 535 to 35 Mc.
- Noise limiter—standby switch.
- 1/2 inch PM Speaker Headphone Jack.
- Six tube transformer operation.

SPECIFICATIONS:
 Range.....535 Kc to 35 Mc
 12BE6 Mixer-oscillator
 12BA6 I. F. Amplifier
 12AV6 Detector—AVC—audio
 12BA6 B. F. O. oscillator
 12A6 Beam power output
 5Y3GT Rectifier
 105-125 volts A. C. 50-60 cycles, 45 watts.

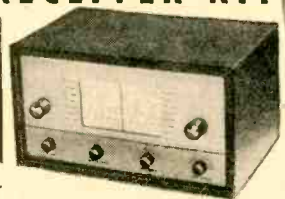

MODEL AR-2
\$2550
 Ship. Wt. 12 lbs.
CABINET:

A new Heathkit AR-2 communications receiver. The ideal companion piece for the AT-1 Transmitter. Electrical bandspread scale for tuning and logging convenience. High gain miniature tubes and IF transformers for high sensitivity and good signal to noise ratio. Receiver at a very substantial saving. Supplied with all tubes, punched and formed sheet metal parts, speaker, circuit components, and detailed step-by-step construction manual.

Proxylon impregnated fabric covered plywood cabinet. Ship. weight 5 lbs. Number 91-10, \$4.50.

HEATH COMPANY
 A SUBSIDIARY OF DAYSTROM, INC.
 BENTON HARBOR 5, MICHIGAN

AMA-TOURING

with Roger Legge



PHONE DX is scarce on the 3-mc. band, but there is some to be heard. Most of the stations on the band are U.S. stations, contacting other stations in this country. However, if you listen at the right time and place, there is foreign DX to be heard.

The 3-mc. band covers 3.50 to 4.00 mc., with the U. S. phone band at 3.80 to 4.00 mc.—the 75-meter phone band. Canadian phones have an extra 50 kc., 3.75 to 3.80 mc. U. S. Novice licensees may operate between 3.70 and 3.75 mc. on c.w. Most other c.w. stations, including many foreign stations, operate at the low end of the band, 3.50 to 3.70 mc., the 80-meter c.w. band.

The best phone DX heard recently on the 75-meter band is from New Zealand. The ZL's come through occasionally around 0600-0700 EST in the East, and 0400-0700 PST in the Western states. They seem to be picked up principally during an ionospheric disturbance, when reception is poor on the higher bands. The ZL's are generally heard just below the edge of the U.S. phone band, around 3.77 to 3.80 mc. Stations observed include: ZL1ACG, ZL1BY, ZL1WW, ZL2BG, ZL2RR, ZL2RT, ZL3JA and ZL3RK. An occasional VK from Australia may also be heard.

Reception of European phones in the United States is infrequent, but a few may be heard

DX FORECAST FOR DECEMBER

From	In Eastern & Central USA (EST)			In Western USA (PST)		
	14 mc.	21 mc.	28 mc.	14 mc.	21 mc.	28 mc.
Central & South America	0600-0900	0700-1700	0800-1600	0600-1900	0700-1700	0800-1600
Europe & North Africa	0630-0800 1200-1400	0800-1200	0900-1100	—	0730-0900	—
Central & South Africa	1300-1700	0700-1600	0800-1500	1500-1700	0700-1600	0900-1400
Near & Middle East	1200-1400	0800-1100	—	—	0730-0900	—
Far East	—	1600-1800	—	1800-2000	1400-1800	1500-1700
Australia & New Zealand	0830-0930	1500-1900	1600-1800	1900-2100	1100-1900	1400-1800

The 24-hour clock system is used for these forecasts. Hours from midnight until noon are shown as 0000 to 1200, hours from 1 p.m. to midnight as 1300 to 2400. EST represents Eastern Standard Time; PST is Pacific Standard Time, three hours later than EST.

SENSATIONAL RECORD CHANGER SALE

DO IT YOURSELF KITS: Send for complete catalog of all types radio, TV, Hi-Fi tuners & amplifiers & test equipment.

45 RPM SPINDLES

VM . . . \$2.69 Garrard . \$3.37
Webster \$3.89 Collaro . \$3.75

RECORD CHANGER BASES & BOARDS

Bases—\$3.89
Mounting Boards—\$1.95
For changers listed to right

TRIPLE PLAY CART.

TYPE
GE RPX050 **\$5.94**

Free Hi-Fi equip. avail.

WEBSTER 3 speed intermix Model 140 changer. Hi-Fi Ronette cartridge with dual sapphire needles. Automatic shutoff. Heavy duty 2 pole motor. Plays 7-10-12" records automatically. Regularly \$37.50. NOW

\$22.95

WEBSTER 3 speed changer Model 140GE, with GE Reluctance RPX050 cartridge. Intermix, heavy duty 4 pole motor, automatic shutoff. Regularly \$40.00. NOW

\$26.95

GARRARD RC80 3 speed changer. One of the finest British changers. Automatic shutoff, weighted turntable, 4 pole motor, complete with plug in heads. Regularly \$49.50. NOW

\$42.95

COLLARO RC54 3 speed intermix British changer, Automatic shutoff, weighted turntable, with plug in head. Regularly \$48.75. NOW

\$37.50

WITH RONETTE DUAL SAPPHIRE STYLI HI-FI CARTRIDGE—\$39.95

Send postcard for our free Hi-Fi catalog

All merchandise is brand new, factory fresh and guar. Mail & phone orders filled upon receipt of certified check or MO of 20% of the items as a deposit, balance C.O.D., F.O.B. factory N. Y. Prices and specifications subject to change without notice.

AIREX RADIO CORP., 171 Washington St., N. Y. 7, N. Y. CO 7-5218

OLSON RADIO FOR GREATEST BUYS IN RADIO AND TV SUPPLIES



**Philmore Transistor
Battery Radio Kit**
STOCK NO. **\$585**
KB-12..... KIT
Reg. \$9.75—3 for \$16.50

Germanium Diode crystal detector combined with transistor audio amplifier stage to provide loud, clear reception of your local radio stations. One single standard 1 1/2 volt penlite cell supplies all of the power and will last almost indefinitely. Perfect gift. Special high efficiency coil and variable condenser assure sharp tuning. Designed for use with double 2,000 ohm headphones (see below). Housed in an attractive plastic case—3 3/4" x 2 1/2" x 1 1/4". Weighs only 4 oz. with battery. Supplied with detailed, illustrated assembly instructions, from which anyone can build and complete this set within a few hours. Solder, hookup wire, headphones and battery not supplied. Shpg. wt. 2 lbs.

2000 OHMS HEADPHONES
Stock No. X-542..... Pr. \$1.95

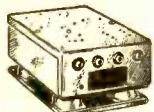

**INTERPHONE
AMPLIFIER**
Stock No. **\$199**
AM-15 3 FOR
EA. \$5.00

Signal Corps No. BC-700. Brand new in factory sealed cartons. Original cost \$32.00. Contains a wealth of valuable parts including 5 x 2 1/2 x 8" aluminum case, 354 tube, socket, condensers, resistors, 4 jacks, input and output transformers, battery holders, etc. For operation on 2 flashlight cells and one 67 1/2 volt battery. Ready to operate or can be rewired for many other uses, such as: baby-sitter, amplifier, SW or BC receiver, transceiver, crystal set audio amplifier, etc. The polished case alone is worth more than the \$1.99. Get yours—while they last. Circuit diagram and instruction book included. Shpg. wt. 5 lbs.

Royal Dynamic Microphone

REG. \$12.00

STOCK No. **\$298**
M-89 Ea.



With Built-in Western Electric Unit

Olson is the first to bring you this new pencil type microphone. Genuine Western Electric Dynamic unit is internally coupled to an ounce High Impedance Transformer. Matches any amplifier which is designed for crystal, dynamic or ribbon mike. Only 1 1/2" dia. Base swivels and is removable so mike can be hand held. Satin grey finish with 5 ft. shielded cable. Shpg. wt. 3 lbs.

NEW CRYSTAL SET KIT



STOCK NO. **\$150**
KB-1 KIT

New—Uses
GE Germanium Diode

Easily assembled by even a child in minutes. Contains germanium core tuned coil and knob, bypass condenser, variable tuning condenser, IN-64 General Electric Diode Detector, phone clips and transparent hinged case. Covers complete frequency range from 400 to 3000 KC which permits reception of local weather stations, aircraft beacons, standard broadcast, police calls, amateur aircraft and many others. Unique design still permits complete coverage of standard broadcast only, if desired. Supplied complete with all parts and detailed illustrated instructions, less only wire and solder. For best results use headphones listed above. Shpg. wt. 2 lbs.

30-POWER 3-SECTION TELESCOPE



Regular **\$12.50**
Stock No. **\$599**
X-529

Fine optically ground and polished lenses coated for better light transmission. Long wearing brass draw tubes highly polished chrome-plated. Collapses to 8 1/2" long—extends to 13 1/4". Ideal for hunting, star gazing, sight seeing, camping, exploring, sailing, etc. Shpg. wt. 3 lbs.

**OLSON'S GREATEST
TAPE RECORDER VALUE**



Reg. \$129.50
Brand New

FREE! Five 1200' reels of recording tape with every recorder ordered.

STOCK NO. **\$7995**
AM-8

2-SPEED • 2-TRACK •
FEATURES NEW "PLUG-IN"
RECORDING HEAD

One of the very few tape recorders with precision die cast construction. Other features include the exclusive "Tape Guide" for perfect alignment, and the pre-equalized heavy duty amplifier. Latest Model Electro-Voice crystal mike included. Entire outfit is guaranteed to be distortion-free and deliver super-sensitive performance at either speed. Lowest wow and flutter, highest signal-to-noise ratio of any model three times the price. Records and plays back at 3 7/8 or 7 5/8 inches per second. Handles both 5" and 7" reels. Records up to 3 hours on one reel. Multiple input-output recording from mike, radio, TV or phono. Provisions for external speakers or monitoring headphone. Rec. response 50 to 7500 cps. Employs a full size tube amplifier. Carrying case is finished in two-tone pin striped forest green. Operates on 115 Volt AC 60 cy. Case size 14 1/4 x 11 1/2 x 8 1/2". Weighs 24 lbs. Shpg. wt. 30 lbs.

**FIRST QUALITY PLASTIC BASE
RECORDING TAPE**



1200' on 7" Dia. Reel
Lots of
12, Ea.

STOCK NO. X-249 \$2.19
Single, ea. \$1.79
Lots of 6, ea. \$1.79

This famous brand tape regularly sells for \$5.50. It is perfect in every respect. This quality tape is famous for its low noise level and uniform output. Rec. response 50 to 15,000 cps. Red oxide base—1/4" wide. Reg. \$1.25 seven inch plastic reel included—fits all recorders. Shpg. wt. (one doz.) 10 lbs.

The Royal Monarch

AUTOMATIC RECORD CHANGER



3-SPEED—ALL SIZES
MADE IN ENGLAND
Reg. List \$69.95
Reg. Wholesale \$41.97

SPECIAL **\$2895**

STOCK NO. RP-5.....
Equipped with Dual Crystal Turnover
Cartridge with 2 Sapphire Needles.

"The Changer that outdoes all other changers" • Plays Intermittent 7-10-12" records • "GOLDIST" selector enabling 7", 10", and 12" records to be automatically selected and played at 3 1/2, 4 1/2 or 7 1/2 rpm • 12" record capacity—7 REELS in any order • PICK-UP automatically returns to rest and motor switches itself off after last record • Reversible dual sapphire stylus cartridge delivers full tonal range to over 10,000 cps • "Rotocorn" equipped. Control for ON-OFF, REJECT • Turntable heavily weighted, covered with rubber mat and runs in friction-free ball-bearing race • Oversize 4-pole induction motor • Base is mounted on suspension springs. 115 V. AC 60 cy. Shpg. wt. 15 lbs.

MAHOGANY MOUNTING BASE
STOCK NO. CA-3, 5 lbs..... \$4.95



**"GOLDEN GATE EIGHT"
8" HI-FI SPEAKER**
with "Dispenser" Sound

Reg. \$12.50
STOCK NO. S-229.....
\$495 2 FOR
Ea. \$9.50

Finely finished in all gold lacquer. Outperforms many 12" units. Employs 2 concentrically mounted cones for extremely smooth reproduction at high or low volume. Small cone in center of large cone is called a "Whizzer" and provides extended treble response, good overall balance and wide dispersion angle. Equipped with heavy duty 5 magnet with cover. Power handling capacity 8-10 watts. Response 40-12,500 cps. Speaker cone 8" dia., voice coil 8 ohms. Shpg. wt. 3 lbs.

1/4" ELECTRIC DRILL

STOCK NO. **\$996**
TL-41



With Hand-type Chuck

**BRAND NEW—FACTORY SEALED
CARTONS—100% GUARANTEED**

Precision Electric Drill with cast handle and gear box and spun-steel housing. Has a capacity of 1/4" in steel and 1/2" in hardest wood. No-load speed is 1600 RPM and full-load speed is 900 RPM. Armature is dynamically and statically balanced for vibrationless operation. Armature is wound with triple formex wire. Gears are hobbed steel. Perfectly balanced pre-rip handle. Trigger switch can be locked down. Packed in factory sealed cartons with manufacturer's guarantee. Equipped with 6 ft. heavy duty Belden cord and rubber plug. Precision built three-jaw hand-type chuck. Shpg. wt. 6 lbs.

**DELUXE COMPLETE REAR
DECK AUTO SPEAKER KIT**



FOR ALL
MAKE CARS
Complete With
6" x 9" Speaker

STOCK NO. **\$591**
RA-139 3 KITS FOR \$16.00
KIT
Contains everything needed to easily install a 6" x 9" year set speaker in any car: A Rear Deck Grill, a 6" x 9" PM Speaker, Switch Kit, All Hardware, Wire and instructions. Reg. Price \$14.95. Shpg. wt. 4 lbs.



**POWER LINE
NOISE FILTER
KIT**

STOCK NO. **\$195** 3 FOR
KB-25 Ea. \$4.50

Reduces or eliminates radio and TV frequency interference caused by various electrical appliances and interference. Adjustable "Re-traps-out" interference to receiver or at the interference source. Compact, only 2 1/2" x 4 x 1" with dual hinges for mounting. Handles up to 300 watts. Complete with all parts, wire, solder, unpunched chassis and detailed illustrated instructions—takes just a few minutes to assemble. Shpg. wt. 1 lb.



**"No Ghost" Electronic
TV Antenna**

\$199 3 FOR
\$5

STOCK NO. X-526
Eliminates TV Antenna. Reg. \$7.95. New—Different—Really Good—FOR VHF, UHF, COL-O-R TV AND AM-FM RADIO. ELIMINATES GHOSTS—SNOW—DIFT—PUZZ—FLUTTER & INTERFERENCES. Contains variable tuning circuits with calibrated visual indicator. Its 10-position circuit is intended, by a process of matching, mismatching or damping, to serve to resonate the impact circuit to bring in the strongest, clearest signal and to trap out unwanted electrical interferences. Shpg. wt. 1 lb.

HOW TO ORDER

Mail your order to 280 E. Market St., Akron, Ohio. Send return mail order (add for postage 5c for each dollar's worth ordered)—10c for each dollar's worth if you are more than 1,000 miles away! OLSON REFUNDS EVERY CENT NOT USED. Do not send no money—we'll ship C.O.D. and you pay mail or express for merchandise and postage. ALL MERCHANTS 100% GUARANTEED. PLEASE—MINIMUM ORDER \$3.00.

OLSON BARGAIN STORES IN:

- CHICAGO—623 W. Randolph St.
- CLEVELAND—2020 Euclid Ave.
- PITTSBURGH—5918 Penn. Ave.
- MILWAUKEE—423 W. Michigan
- BUFFALO—711 Main Street

SEND FOR NEW FREE CATALOG

OLSON RADIO WAREHOUSE 280 E. MARKET ST. AKRON 8, OHIO

NOW!

Step ahead faster as an INDUSTRIAL ELECTRONICS TECHNICIAN

Turn your experience into a big, new better-paying career!

Day by day industrial plants are adding more electronic devices—for sorting, counting, checking almost any control job you can name. Cash in on industry's great need for men who can keep these devices in top working order. Make more money, feel more secure, doing work that is second nature to you. With what you already know about electronics you have a long head start in a field just beginning to boom. GET INTO IT RIGHT NOW with the help of



PRACTICAL INDUSTRIAL ELECTRONICS LIBRARY

No long sessions on math or theory! These 4 practical volumes show you how to keep the plant's electronic equipment working . . . how to locate and correct tube and circuit troubles . . . how to install, service, and maintain even brand new equipment without being stumped by new circuits.

FREE TRIAL—EASY TERMS

4 volumes (1390 pp., 1050 illus.)
Chute's Electronics in Industry

Miller's Maintenance Manual of Electronic Control

Markus & Zelfuff's Handbook of Industrial Electronics Circuits

Henny & Fahnestock's Electron Tubes in Industry

McGraw-Hill Book Co.
327 W. 41 St., NYC 36

Send me the Practical Industrial Electronics Library for 10 days' examination on approval. In 10 days I will send \$2.50, then \$4.00 a month until \$22.50 is paid. (A saving of \$3.50 under the regular price of \$26.00.) Otherwise I will return books Postpaid.

(Print) Name
Address
City Zone State
Company
Position Dept. PEL-12
This offer applies in U.S. only.

NOW!

Build your own ELECTRONIC LIGHT-ACTUATED CONTROLLER

- Cut out TV commercials
- Control lighting at home or store
- Operate safety controls
- Install garage door opening system
- Hundreds of practical uses

Easy to Assemble. No technical expertise required. Compact, lightweight, designed for high efficiency, low cost and long life. No additional parts needed.

All Parts Guaranteed. Kit includes X-L Photoconductor, printed circuit board, resistors, thyatron trigger tube, capacitor, and sensitive 10 amp. relay. Non-filament type tube eliminates burn-outs. Optical system not required in most uses. School inquiries invited.

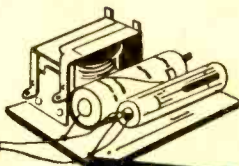

NEW!
SENSATIONAL!
Printed Circuit
Photo-Controller Kit
1956 Model
only \$10.95

ALPHATOM ELECTRONICS

317 South Western Avenue

Chicago, Illinois

ALPHATOM ELECTRONICS
317 SOUTH WESTERN AVE.
CHICAGO, ILLINOIS

Gentlemen: Please send () photo-controller kits. Enclosed is check or money order for \$.....

NAME
ADDRESS
CITY STATE

ORDER TODAY!

around 2300 to 0100, especially during one of the DX contests when the Europeans are looking for W and VE contacts on this band for additional points in the contest. Europeans heard in the Eastern states include: CT1BS, CT1CL, CT1QF, DL4OV, EA2CQ, G3COJ and HB9MX. These stations operate around 3.76 to 3.80 mc. when contacting U.S. stations.

Stations from the Caribbean area may also be heard on the 75-meter phone band, generally around 2300 or later, and also around 0600. Those observed include amateurs from CO, HC, HP, HR, KP4, KG4, KV4, VP1, VP6, VP7, VP9 and XE.

The winter months are best for DX on 75 meters, so now is the time to look for it.

Antarctic Amateur Stations

Two amateur radio stations sponsored by the Navy will be in operation in the Antarctic next spring as morale boosters for the 150 volunteer Seabees who will "winter over" during the Antarctic night of March to October, 1956. Two additional Navy amateur stations are expected to go on the air by March, 1957.

The FCC has assigned the call sign KC4USA to the station which will operate from the planned Little America base at Kainan Bay, Antarctica. KC4USV will be located at an Air Operating Facility to be built at McMurdo Sound. Both stations will begin operating about March 1, 1956. In March, 1957, when Admiral Byrd Station is constructed in Marie Byrd Land, KC4USB will operate from there. A South Pole Station will also be established, and KC4USN will operate from there. The FCC has authorized the Navy to use call signs in the block KC4USA to KC4USZ in the Antarctic in the event additional amateur stations become feasible.

With these stations, Navy radiomen hope to bridge the 10,000 miles to the United States, permitting members of the U.S. Antarctic Expedition to talk to their families, relatives and friends via the amateur radio stations in this country. (Elwood Deibert, Pa.)

21-Mc. Phone DX

This band opened up in early September and has been providing good reception since then from Africa, Europe and Latin America. All times are 24-hour EST.

AFRICA

Angola—CR6AO was heard on 21.235 mc. at 1330. CR6BO, 21.215, and CR6BX, 21.17, were observed at 1600.

Belgian Congo—OQ5BQ on 21.205, OQ5HL on 21.14, and OQ5RU on 21.15, have been heard around 1430.

Canary Islands—EA8AX, 21.20, and EA8BQ, 21.50, were picked up at 0730.

Kenya—VQ4RF has one of the best signals from Central Africa. He is heard frequently around 21.20 mc. at 1300 to 1500. Other Kenya stations noted are: VQ4AO, 12.15; VQ4AR, 21.20; and VQ4EK, 21.22 mc. (Kurt Meyers, Ohio; RL)

Liberia—EL3A was heard on 21.19 mc. at 1330. (Meyers)

Morocco—CN8MM is observed around 21.20 mc. from as early as 0700 to as late as 1700. CN8MP was heard on 21.17 at 1700. (Meyers)

ESSE DECEMBER SPECIALS

LEEDS & NORTHRUP

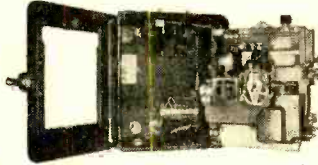

MICROMAX RECORDERS

Strip type recorders used for controlling and recording a wide variety of processes. Used originally for temp. range of 350-550 degrees C. May be changed for other applications. Operated on Wheatstone bridge principle using AC galvanometer movement. Original cost several times our price. Units were removed from demilitarized equipment which in many cases was new, but all instruments sold as used and guaranteed. Money back if not satisfied. PRICE ea. **\$179.50**



RL-42-B Antenna

Reel/Motor

—\$2.50

Used originally for remote controlling of automatic trailing wire antenna. Motor is 1/2 HP. 24 V. DC with oil-less steel bearings. The gear train, breaking and disconnect mechanism, reversible and variable speed motor makes this an ideal unit for conversion to coil winders, etc. Ship. wgt. approx. 5 lbs. PRICE, Used...\$2.50 New... **\$3.95**



DUAL FREQUENCY LIGHT WEIGHT TRANSMITTER For The RC Models

The transmitter which has found much favor for use with radio controlled models. Dry Battery operated dual transmitter housed in 8 1/2" dia. transparent plastic ball operating on 55.5 and 56.75 Mc. Uses 3A5 output tubes. Wgt. of transmitter portion approx. 6 lbs. Originally used in the center of a 6 ft. by 30 ft. plastic screen and towed in back of a plane for gunnery practice, the transmitter portion comes with the screen target which will also find numerous uses. Shipped brand new in original wood box. Shipping wgt. 75 lbs. **\$7.95**



BC-357 MARKER BEACON RECEIVER

This is the one the boys are using for garage door openers and other radio remote control. Contains a Bix35 plate sensitive relay which is actuated on reception of a 75 Mc. signal. Tubes included. Used but good working condition. Ea. **\$3.75**

Only

\$4.95

BC-455-B

Receiver



Ideal receiver for mobile or fixed operation with excellent sensitivity and frequency stability. New surplus release order—new supply will not last long at this price. For 6-9.1 Mc. operation. Complete with tubes and guaranteed. Less dynamotor. PRICE, Used, ea....\$4.95 New, ea.... **\$6.95**

R-1/ARR-1 RECEIVER—\$2.95



Described in "Radio TV News" Jan. 1949 for use as 220 Mc. converter. Essentially a two stage RF acorn tube superhet converter as it now stands. Also can be used for a preselector. Small enough for mobile only 3 1/2" W x 3" H x 10" D. Rugged Aluminum construction. Has four 954 acorn tubes. Filaments now operate on 12 or 24 volts by merely throwing switch in unit or can be easily modified for 6 V. operation. Dial is calibrated in range of 231-258 Mc. Operation can be changed for use from 50 to possibly 300 Mc. Wgt. of unit 4 lbs. Cover not shown but included. Complete with conversion as written in above mag. Brand new demilitarized (bakelite coil solder strip purposely broken) units. PRICE, Brand new..... **\$2.95**

ARR-1 Antennas for above receiver and frequencies. New, ea. **\$1.25**

Co-axial antenna relay for use with above or other transmitter-receiver combinations. New, ea. **\$1.25**



BC-366 JACK BOX, NEW

29c ea. Lots of 10 or more

Aluminum box 3 1/4" x 4 1/4" x 2 1/4" in size containing volume control, 2-pole 5 pcs. sw. and microphone and headset jack. Ideal remote for your mobile equipment. Detachable 11 pin plug allows for easy servicing. Brand new, individually boxed. 10 for \$2.90 or **35c**

Ea. **\$1.00**



TELEGRAPH KEY, J-47

Brand new Signal Corp key mounted on 2 1/2" x 5" bakelite base. Heavy silver contacts. Ea. **\$1.00**

BATTERY CHARGER

(ED33511)



Mfgd. by Ward-Leonard Electric Co. Type 16888.19. 115 V. DC. Charging rates 14 Amps. max. Complete with cord, kit of spare parts. Brand new, perfect condition. Overseas packed. For 6 to 15 2-Volt cells. Acquisition cost to Government \$300 each. Size approx. 12" wide x 20" high x 10" deep. Wgt. of unit 45 lbs. **\$12.50**

BRAND NEW—Price, ea.... **\$12.50**

Battery charger (ED33510), similar to above except Charging rates 30 Amps. max. Size approx. 20" wide x 20" high x 10" deep. Wgt. of unit 65 lbs. **\$14.95**

BRAND NEW—Price, ea.... **\$14.95**

TEST BENCH CIRCUIT

BREAKER

Heinemann 2163M4 1.25 amp. 117.5 V. 2-pole A.C. Curve 3 size 5/4" x 4" x 3". Ideal to mount into your service bench for radio service to protect the set in case of shorts. Brand New Ea. **\$2.95**



VARIABLE CONDENSER

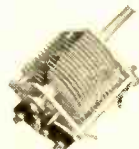

Gold plated frequency meter type of 245 mmfd. cap. with 27 plates, midget type. Heavily constructed for mechanical ruggedness and greater frequency stability. Approx. 3" x 2 1/2" x 1 3/4" overall size with 1 1/4" shaft extension 1/4" dia. shaft. Shipping wgt. 1 lb. Brand New each **\$1.25**

525 FT. TELEPHONE WIRE

A 525 ft. roll of 7 strand (4 steel & 3 copper) three conductor U. S. Army WT-1/U Communications wire. The steel strands give this wire a high breaking strength with adequate conductivity. Weatherproof black insulated. All new wire. 525 ft. roll— **\$4.95**

Ea. **\$4.95**

CITIZENS BAND ANTENNA

NEW

Easily mounted mobile rooftop type antenna for use between 440-500 Mc. Rubber gasket included insures watertight seal. Matches RG8U or other 52 ohm co-ax line. Co-axial angle and cable connector included and alone worth the price. New Ea. **79c**

ESSE RADIO CO.

42 WEST SOUTH STREET

INDIANAPOLIS 25, INDIANA

Remit shipping charge and instructions with all orders, otherwise order will be shipped express collect. All items guaranteed to your satisfaction or money refunded if returned within 10 days of receipt. Minimum order \$5.00.



THE ONLY STUDIO QUALITY RECORDER UNDER \$300!

Tape recorder performance that can't be matched in any other make for less than \$600! 40-16,000 cps \pm 2 db at 7½ ips (50-10,000 cps \pm 2 db at 3¾ ips), noise down 55 db, wow and flutter less than 0.1% NARTB professional equalization, instant track switching (using 4 heads, 2 for each track), piano key operation. Tape deck ready for plugging into hi-fi system only \$299.50 audiophile net. In case with power amplifier, 5 speakers and wide-range dynamic mike, \$379.50.

WRITE FOR
COMPLETE
SPECIFICATIONS
DeJUR-AMSCO
CORPORATION

Dept. PE-2,
Long Island City 1, N. Y.

NOTHING COMPARES WITH A

DeJUR 
Dual Professional
TAPE RECORDER



UNIVERSAL TV . . . Famous for 25 Years
Thousands of Successful Grads

ELECTRONICS—the world's GREATEST new industry is years ahead of its manpower supply. **ELECTRONICS JOBS ARE SEEKING TRAINED TECHNICIANS**, an acute shortage of which exists today. Big companies are actually pirating men from one another because there aren't enough trained electronics experts to go around to fill the many jobs.

Wide Scope Electronics Course at UNIVERSAL:

Embraces Radio, Monochrome-Television, Color TV, Industrial Electronics, Industrial Television, Atom-electronics and Automation. Automation, a terrific new field, embraced at UTS.

25 Years EXCLUSIVELY in Electronics:

For a quarter of a century UNIVERSAL TV has been training and placing grad technicians in fascinating big-pay jobs from coast to coast. You can start earning as much as \$150 per week; no limit as time goes on, or you can open your own business.

UNIVERSAL not a Johnny-come lately school:

Not a home study or correspondence training, but a "genuine" old established resident school staffed by expert instructors and headed by America's first TV broadcasters. Costs so little to prepare yourself for life. Many middle age trainees attend; go into successful business. No previous experience needed. Approved for vets and non-vets. Send coupon for FREE BOOK on TV & electronic opportunities.

WRITE FOR

**FREE
CATALOG**

— FILL OUT COUPON —

UNIVERSAL TV SCHOOL

1222E Admiral Boulevard, Kansas City, Missouri

PLEASE SEND ME INFORMATION FREE. Age _____

Name _____

Address _____

City _____ State _____

Check here if Korean Veteran

Northern Rhodesia—VQ2FU has been heard on 21.19 at 1500.

South Africa—The South Africans have been coming through well at 1200 to 1400, including the following: ZS1BV, 21.22; ZS1JA, 21.23; ZS5JY, 21.195; ZS5MP, 21.22; ZS5NZ, 21.235; ZS6CT, 21.16; ZS6EW, 21.175; ZS6FS, 21.21; ZS6OY, 21.245; ZS6TC, 21.125; ZS6TE, 21.19; ZS6WS, 21.135. (*Meyers, RL*)

Southern Rhodesia—ZE2JE on 21.19, ZE2JK on 21.215, and ZE2KR on 21.12 were heard at 1400.

Southwest Africa—ZS3G has one of the best signals from Africa. He is heard well on about 21.21 mc. around 1300. Others noted are: ZS3AB, 21.19, and ZS3B, 21.15 mc.

Spanish Morocco—EA9EE, Ceuta, has been heard on 21.22 at 1500 in contact with a W7 station.

Tangier—CN2AD was observed on 21.21 mc. at 0700.

EUROPE AND NEAR EAST

Channel Islands—GC4LI, Jersey, was heard on 21.29 at 1600.

Finland—OH1RU, 21.15, and OH5NM, 21.17, were noted at 0800.

Germany—DL7BA, Berlin, was picked up on 21.18 at 1330. Others heard were: DJ1NO, 21.17; DL1HH, 21.22; DL3XS, 21.215; DL4BX, 21.17; and DL6QW, 21.14 mc.

Israel—4X4BO was noted on 21.245 at 1330; 4X4DK, Jerusalem, is heard on 21.34 at 1500.

Malta—ZB1AJX is now on 21.20 mc. at 1330.

Netherlands—PA0ALO, 21.195 mc., has one of the best signals from Europe, even though he uses only 50 watts.

Spain—EA7EM, 21.23, and EA7EU, 21.195, were noted at 1200.

NORTH AND SOUTH AMERICA

Barbados—VP6FR, 21.205, and VP6WR, 21.20, are heard well around 1600.

Chile—CE's heard 1300 to 1700 are: CE2AA, 21.17; CE2GG, 21.145; CE3CZ, 21.16; and CE3JJ, 21.235 mc.

Guantanamo Bay—KG4AM has been picked up on 21.20 at 16.45. (*Meyers*)

KG4AR, 21.26, was heard at 1500.

Guatemala—TG9AD, 21.185 and TG9AZ, 21.19, were heard well at 1930.

Haiti—HH7NM was observed on 21.205 at 1400, giving his address as P.O. Box 332, Port-au-Prince. HH7RM, Mobile, is now on 21.14 at 1500.

Honduras—HR3HH, 21.20 mc., is one of the strongest and most frequently heard stations from Latin America. He uses a 500' V beam. Others heard from Honduras are: HR1JZ, 21.235; HR1LW, 21.195; and HR4WH, 21.16 mc.

Netherlands West Indies—PJ2AL, Aruba, was picked up on 21.40 at 1300. (*Emmet Riggle, Ohio*)

PJ2CL, Curacao, was heard on 21.23 at 1630.

Panama—HP2ER, an infrequently heard Panama district, was noted on 21.21 at 1600.

Surinam—PZ1RM appears to be the only PZ on the 21-mc. band. He was observed on 21.15 at 1700.

Uruguay—CX5AF was heard on 21.20 mc. He also operates CZ5ZAF mobile. (*Jimmy Duncan, Ky.*)

The New Model 670-A

SUPER METER

A COMBINATION

VOLT-OHM MILLIAMMETER
plus CAPACITY REACTANCE
INDUCTANCE AND DECIBEL
MEASUREMENTS



ADDED FEATURE:

Built in ISOLATION TRANSFORMER reduces possibility of burning out meter through misuse.

SPECIFICATIONS:

D.C. VOLTS: 0 to 7.5/15/75/150/750/1,500/7,500 Volts
A.C. VOLTS: 0 to 15/30/150/300/1,500/3,000 Volts
OUTPUT VOLTS: 0 to 15/30/150/300/1,500/3,000 Volts
D.C. CURRENT: 0 to 1.5/15/150 Ma. 0 to 1.5/15 Amperes
RESISTANCE: 0 to 1,000/100,000 Ohms 0 to 10 Megohms
CAPACITY: .001 to 1 Mfd. 1 to 50 Mfd. (Good-Bad scale for checking quality of electrolytic condensers.)
REACTANCE: 50 to 2,500 Ohms 2,500 Ohms to 2.5 Megohms
INDUCTANCE: 15 to 7 Henries 7 to 7,000 Henries
DECIBELS: -6 to +18 +14 to +38 +34 to +58

The Model 670-A comes housed in a rugged crackle-finished steel cabinet complete with test lead and operating instructions.

28⁴⁰

The new streamlined model TC-55

TUBE TESTER

QUICKLY AND EFFICIENTLY TESTS RADIO AND TV TUBES INCLUDING: SEVEN PIN MINIATURES; EIGHT PIN SUBMINARS, OCTALS AND LOCTALS; NINE PIN NOVALS

YOU CAN'T INSERT A TUBE IN THE WRONG SOCKET.

It is impossible to insert the tube in the wrong socket when using the new Model TC-55. Separate sockets are used, one for each type of tube base. If the tube fits in the socket it can be tested.

"FREE-POINT" ELEMENT SWITCHING SYSTEM.

The Model TC-55 incorporates a newly designed element selector switch system which reduces the possibility of obsolescence to an



absolute minimum. Any pin may be used as a filament pin and the voltage applied between that pin and any other pin, or even the "top-cap."

CHECKS FOR SHORTS AND LEAKAGES BETWEEN ALL ELEMENTS. The Model TC-55 provides a super sensitive method of checking for shorts and leakages up to 5 Megohms between any and all of the terminals.

ELEMENTAL SWITCHES ARE NUMBERED IN STRICT ACCORDANCE WITH R.M.A. SPECIFICATION.

One of the most important improvements, we believe, is the fact that the 4 position fast-action snap switches are all numbered in exact accordance with the standard R.M.A. numbering system.

Thus, if the element terminating in pin No.7 of a tube is under test, button No. 7 is used for that test.

The Model TC-55 comes complete with operating instructions and charts. Use it on the bench—use it for field calls. A streamlined carrying case, included at no extra charge, accommodates the tester and book of instructions.

26⁹⁵

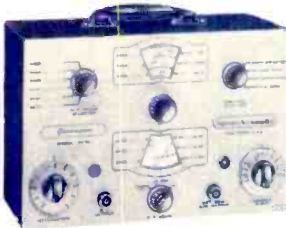

THE NEW MODEL TV-50
7 Signal Generators in One!

GENOMETER

- ✓ Bar Generator
- ✓ R. F. Signal Generator for A.M.
- ✓ R. F. Signal Generator for F.M.
- ✓ Audio Frequency Generator
- ✓ Cross Hatch Generator
- ✓ Color Dot Pattern Generator
- ✓ Marker Generator

R. F. SIGNAL GENERATOR: The Model TV-50 Genometer provides complete coverage for A.M. and F.M. alignment. Generates Radio Frequencies from 100 Kilocycles to 80 Megacycles on fundamentals and from 60 Megacycles to 180 Megacycles on powerful harmonics.

VARIABLE AUDIO FREQUENCY GENERATOR: In addition to a fixed 400 cycle sine-wave audio, the Model TV-50 Genometer provides a variable 300 cycle to 20,000 cycle peaked wave audio signal.

BAR GENERATOR: The Model TV-50 projects an actual Bar Pattern on any TV Receiver Screen. Pattern will consist of 4 to 16 horizontal bars or 7 to 20 vertical bars.

CROSS HATCH GENERATOR: The Model TV-50 Genometer will project a cross-hatch pattern on any TV picture tube. The pattern will consist of non-shifting, horizontal and vertical lines interlaced to provide a stable cross-hatch effect.

DOT PATTERN GENERATOR (FOR COLOR TV): Although you will be able to use most of your regular standard equipment for servicing Color TV, the one addition which is a "must" is a Dot Pattern Generator. The Dot Pattern projected on any color TV Receiver tube by the Model TV-50 will enable you to adjust for proper color convergence.

MARKER GENERATOR: The Model TV-50 includes all the most frequently needed marker points. The following markers are provided: 189 Kc., 282.5 Kc., 456 Kc., 800 Kc., 1000 Kc., 1400 Kc., 1600 Kc., 2000 Kc., 2500 Kc., 3579 Kc., 4.5 Mc., 5 Mc., 10.7 Mc., (3579 Kc. is the color burst frequency.)

The Model TV-50 comes absolutely complete with shielded leads and operating instructions. Only...

\$47⁵⁰

SHIPPED ON APPROVAL NO MONEY WITH ORDER — NO C.O.D.

We invite you to try before you buy any of the models described on this and the following page. If after a 10 day trial you are completely satisfied and decide to keep the Tester, you need send us only the down payment and agree to pay the balance due at the monthly indicated rate. (See other side for time-payment schedule details.)

NO INTEREST OR FINANCE CHARGES ADDED!

If not completely satisfied, you are privileged to return the Tester to us, cancelling any further obligation.

SEE OTHER SIDE

CUT OUT AND MAIL TODAY! ▶

FIRST CLASS

Permit No. 61430

New York, N. Y.

BUSINESS REPLY CARD

No Postage Stamp Necessary if Mailed in the U. S.

POSTAGE WILL BE PAID BY —

VIA AIR MAIL

MOSS ELECTRONIC DIST. CO., INC.

3849 TENTH AVENUE

NEW YORK 34, N. Y.

The New Model 70

REG. U. S. PAT. OFFICE

UTILITY TESTER



THE MOST VERSATILE ALL-AROUND TROUBLE SHOOTER EVER PRODUCED!

FOR REPAIRING:

✓ ALL ELECTRICAL APPLIANCES and MOTORS

The electrical circuits and parts in

✓ AUTOMOBILES and TRUCKS

✓ * ALL TV TUBES

AS AN ELECTRICAL TROUBLE SHOOTER THE MODEL 70:

- Will measure the actual current consumption of any appliance or utility either A.C. or D.C. and will measure it while the unit is in operation. The reading will be direct in amperes. The appliance or utility may be plugged directly into the front panel receptacle. Current Range is 0-15 Amperes.
- Incorporates a sensitive direct-reading resistance range which will accurately measure all resistances commonly used in electrical appliances, motors, etc. This range also will enable continuity checks and tests for shorts and opens.
- Leakage circuit will indicate all resistances from zero ohms to 5 Megohms (5,000,000 ohms).
- Will measure the actual voltage and indicate whether the current is A.C. or D.C. Voltage Ranges: 0-15 0-150 0-300.
- Will test Toasters, Irons, Broilers, Heating Pads, Clocks, Fans, Vacuum Cleaners, Refrigerators, Lamps including Fluorescents, Fuses, Switches, Thermostats, etc.
- Will test ALL MOTORS — single phase, multi-phase, universal, squirrel cage, induction, in fact every type of motor from fractional H.P. to 2 H.P.
- Will instantly locate opens, shorts and grounds.

* AS A TV TUBE TESTER:

The majority of inoperative tubes stop functioning due to open filaments, inter-element shorts and other faults which can be located by the continuity and leakage method. Please note, the Model 70 will not test the quality of a tube (an emission tester such as our MODEL TC-55 is required for that purpose), but the Model 70 will test ALL the tubes used in your TV set for open filaments, burned out tubes, etc. A safe-guard resistor included in the circuit network of the Model 70 limits the output to approximately one one-thousandth of an ampere. This insures positive safety for the non-technical user and also eliminates the possibility of ever burning out a tube under test. The Model 70 is capable of testing every type of tube used in any and ALL TV sets (including picture tubes).

Compact — Measures 3 1/8" x 5 7/8" x 2 1/4".

AS AN AUTOMOTIVE TESTER THE MODEL 70 WILL TEST:

- Both 6 Volt and 12 Volt Storage Batteries
- Generators
- Starters
- Distributors
- Ignition Coils
- Regulators
- Relays
- Circuit Breakers
- Cigarette Lighters
- Stop Lights
- Condensers
- Directional Signal Systems
- All Lamps and Bulbs
- Fuses
- Heating Systems
- Horns

Also, will locate poor grounds, breaks in wiring, poor connections, etc.

The Model 70 comes housed in a round-cornered, molded bakelite case. Complete with all test leads and a profusely illustrated book written in plain, easy-to-understand language. Only

15⁸⁵

SHIPPED ON APPROVAL NO MONEY WITH ORDER — NO C. O. D.

MOSS ELECTRONIC DISTRIBUTING CO., INC.
Dept. D-186, 3849 Tenth Avenue, New York 34, N. Y.

Please send me the units checked. I agree to pay down payment within 10 days and to pay the monthly balance as shown. It is understood there will be no finance, interest or any other charges, provided I send my monthly payments when due. It is further understood that should I fail to make payments when due, the full unpaid balance shall become immediately due and payable.

- | | |
|----------------------------------------------------------------------------------------------------------------------------------|-----------------------------------------------------------------------------------------------------------------------------------|
| <input type="checkbox"/> Model 70 . . . Total Price \$15.85
\$3.85 within 10 days. Balance \$4.00
monthly for 3 months. | <input type="checkbox"/> Model 670-A . . . Total Price \$28.40
\$7.40 within 10 days. Balance
\$3.50 monthly for 6 months |
| <input type="checkbox"/> Model TC-55 . . . Total Price \$26.95
\$6.95 within 10 days. Balance \$5.00
monthly for 4 months. | <input type="checkbox"/> Model TV-50 . . . Total Price \$47.50
\$11.50 within 10 days. Balance
\$6.00 monthly for 6 months. |

Name _____

Address _____

City _____ Zone _____ State _____

We invite you to try before you buy any of the models described on this and the preceding page. If after a 10 day trial you are completely satisfied and decide to keep the Tester, you need send us only the down payment and agree to pay the balance due at the monthly indicated rate.

**NO INTEREST
OR FINANCE
CHARGES ADDED!**

If not completely satisfied, you are privileged to return the Tester to us, cancelling any further obligation.

**SEE OTHER
SIDE**

◀ CUT OUT AND MAIL TODAY!

14-Mc. Phone DX

The latest reports received on this band are as follows (all times 24-hour EST):

AFRICA

Algeria—FA8BE, Oran, is now on 14.14 mc. at 1900. (*Steve Terry, Ill.*)

Belgian Congo—OQ5AH was heard on 14.16 at 0030. (*Jim Moore, Calif.*)

OQ5FN 14.135 was observed at 1615. (*Riggle*)

Ethiopia—ET2AB has been heard on 14.175 at 2330. (*Riggle*)

Gold Coast—ZD4BR at Takoradi was noted on 14.15 at 1900. (*Riggle*)

Madagascar—FB8BC, Tananarive, is now on 14.18 at 2330. (*Riggle*)

Marion Island—ZS2MI was heard on 14.19 mc. at 0915. (*Riggle*)

This is a sub-Antarctic island in the South Indian Ocean, 1200 miles southeast of Cape-town. ZS2MI is operated by personnel at the meteorological station on the island.

South Africa—ZS2DY, 14.18, and ZS5QG, 14.19, were heard at 0800. (*Meyers*)

Southwest Africa—ZS3E was observed on 14.10 at 1600. (*Riggle*)

ASIA AND OCEANIA

Australia—Reception from Australia has improved and the VK's have been coming through quite well around 0700-0800, including the following: VK2SA, 14.18; VK3AHC, 14.15; VK3AZ, 14.17; VK3AJL, 14.18; VK3RE, 14.18; VK5MS, 14.16; VK6FD, 14.20; VK6KJ, 14.11; VK6MO, 14.12; and VK7AZ, Tasmania. (*Eddie Smith, Ga.; Meyers, Riggle, Terry*)

Burma—XZ2KU was picked up on 14.12 at 0800. (*Herbie Krueyer, Texas*)

XZ2TK was heard at 2000. (*Gene Williams, N. Y.*)

Fiji Islands—VR2AS, 14.165, has been noted at 0030. (*Moore*)

Hongkong—VS6CW, 14.12, was logged in Ohio at 0815. (*Terry*)

Israel—4X4DX was heard on 14.15 at 1500. (*Wilkins*)

4X4FK is now on 14.18 at 1500. (*Krueyer*)

Johnston Island—KJ6FAB advises that KJ6BG, KJ6BH and KJ6BJ are also active from there. The island, 820 miles southwest of Honolulu, is 1 mile long and $\frac{1}{4}$ mile wide.

Laos—XW8AIB was heard on 14.23 mc. at 1145. (*Moore*)

Laos stations are now officially licensed, so U.S. amateurs are permitted to contact them.

Palestine—ZC6UNJ has been observed on 14.20 at 0800. (*Krueyer*)

Samoa—ZM6AT is heard on 14.16 at 0100. (*Wilkins*)

Tern Island—KH6ABH QSL'd with an attractive card. The present operator is returning to the states, and the station will be off for several months. Reports should be sent c/o P.O. Box 4010, Honolulu. Tern Island is 500 miles northwest of Honolulu and has a population of 14.

EUROPE

Austria—OE5CK and OE5JK, both on 14.13 mc., were heard at 0150. (*Moore*)

Iceland—TF2WAS, another station at Keflavik Airfield, was observed on 14.19 at 1200.

December, 1955

Of this you can be sure... *there is no finer* Record Changer than the **Collaro** RC-54

Automatic Intermix

- + Supplied with pre-cut Mounting Board, Power Cord and Audio Cable.
- + Automatically Intermixes All Size Records without Presetting.
- + Rapid, 7-second Change-over Cycles
... and other outstanding features



You can SEE it at your Sound Dealer.

You can READ about it in our Folder.

Mail This Coupon Today

ROCKBAR CORPORATION, Dept. PM-18
215 East 37th St., New York 16, N. Y.

Please send Literature describing the
Collaro RC-54 Record Changer.

NAME _____

ADDRESS _____

CITY _____ ZONE _____ STATE _____

Some make more, some less; T. THORN reports:

\$690 gross in single
MONTH
IN MY OWN BUSINESS!



Start your own business!

Here's YOUR chance to start a money-making, year-round business of your own and make the success you've dreamed about.

R. O. Donnelly took in \$40 in seven hours. O. W. Ware landed a \$750 hotel job. J. S. Corbit grossed \$279.50 his first month. Homes, hotels, offices, clubs, offer you big profit possibilities. Auto upholstery also.

NO SHOP OR OFFICE NECESSARY. You clean furniture on customers' premises. No hauling. No high rents. Supplies inexpensive; operate from your home. What you take in is mostly profit.

● If you want to be your own boss—free from layoffs, strikes and bosses, we will help you to start and succeed. Don't delay...read the facts, then decide for yourself.

MAIL COUPON TODAY FOR FREE BOOK

● **VON SCHRADER MFG. CO.**
● W 44 "D" Pl., Racine, Wisconsin

● Without obligation rush your **FREE** booklet about
● how I can start my own permanent, profitable
● electric Upholstery Cleaning business.

● Name _____
● Address _____
● City _____ Zone _____ State _____

BARGAINS FOR EXPERIMENTERS

TECHNICIANS	HOBBYISTS	INDUSTRY
BUILD YOUR OWN HI-FI BRAND NEW WESTINGHOUSE AMPLIFIERS PUSH-PULL 6LA LESS TUBES AND POWER SUPPLY. USES 2-6L6. 6S37, 1-6S07...\$6.95	EAR PHONES, WESTERN ELECTRIC TYPE. Single...\$1.29 Double...2.49	CONDENSERS—15 BATHTUB & OIL FILT. UP TO 2 MF 600V. LIST VALUE \$22.00 10 MF 400 V. \$2.60 LIST 69¢
GERMANIUM DIODES IN 65 BUILD YOUR OWN CRYSTAL SETS ...89¢ COIL FORMS—CERAMIC—1/2" DX 3 1/4" 5 FOR \$1.00	ANTENNA INSULATORS—15¢ RESISTORS—34 ASSORTED 1/2 WATT, 2 MICA CONDENSERS ON TERMINAL STRIP \$7.99 VALUE...49¢	EXPERIMENTERS' DELIGHT—200 USABLE ELECTRONIC PARTS, COILS, SOCKETS, CONDENSERS, TRANSFORMERS, RESISTORS, RELAYS, TUBES, SWITCHES ETC. LIST OVER \$100.00. ONLY \$14.95 100 PART KIT...\$7.95
NEAT ALUMINUM BOXES 3" x 4 1/2" x 2 1/4". ALSO 28 PARTS...49¢	SOCKETS OCTAL 50 FOR \$1.00 R.F. CHOKES AND COILS 30 FOR \$1.00	OIL CONDENSERS— 4 MF 800 WV...39¢ 2 MF 600 WV...29¢ 5 MF 600 WV...19¢ MICRO SWITCHES—ASSORTED 5 FOR \$1.50
VOLUME CONTROLS—25 ASSORTED. INCLUDES WIREWOUNDS \$30.68 VALUE. YOU PAY LESS THAN A DIME EACH...\$2.35	PANEL LAMPS— JEWEL TUBE...35¢ CONDENSERS—27 ASSORTED MICAS IN BAKELITE TERMINAL STRIP, 6 RESISTORS \$12.00 VALUE...69¢ CONDENSERS—50 ASSORTED WORTH \$15.00...\$1.50 RELAYS—5 ASSORTED. WORTH \$22.00...\$1.95 CONDENSERS—5 ASSORTED TRANSMITTING MICAS UP TO 2500 VOLT. WORTH \$24.00...\$1.50 PHONE JACKS...13¢ PHONE PLUGS...29¢ ROTARY SWITCHES...5 FOR \$1.00	NEON LAMPS...39¢ RESISTORS WIREWOUND—5 TO 25 WATT...25 FOR \$1.95
MAGNET ALNICO 5—3 OZ. 69¢; 15 LB. \$12.50 ALUMINUM PANEL KIT—3 PCS. UP TO 12" x 20" \$2.69 TOGGLE SWITCHES—Assorted. 5 FOR \$1.00 10% DISC. ON ORDERS OVER \$15.00	TV CAMERA...\$295.00	MICROPHONE MINTATURE DYNAMIC CAN BE USED WITHOUT BATTERIES 1 1/2 x 5/8...\$1.49
UNIVERSAL LABORATORIES 13624 GRATIOT DETROIT 5, MICHIGAN	TV CAMERA...\$295.00	CAMERA TRIP RELAY...\$1.95 BOXES & CHASSIS—6 AS SORTED...\$2.98 TV CAMERA...\$295.00

Isle of Man—GD2FRV has been noted on 14.14 at 0100. (Wilkins)

San Marino—I1ZTX/M1 was heard at 0300 operating from San Marino. (WN5KNE/DL4)

Scotland—GM3GLM is now on 14.17 at 1400. (Duncan)

Sweden—SM3EP, 14.16, and SM5XP, 14.13, were heard at 2330. (Riggle)

NORTH AND SOUTH AMERICA

Bolivia—CP5EK, Cochabamba, has been picked up on 14.26 at 1800. (Wilkins)

Canadian Arctic—VE8SP, Nottingham Island, was heard on 14.18 at 1600. He said that he had arrived by icebreaker and would be there for a year. There are ten people on the island, five whites and five Eskimos. VE8PX, Resolution Island, was heard on 14.185 at 1600. K2IIO/VE8, Baffin Island, 14.18 mc., is on at 1930. W5KIQ/VE8, Baffin Island, was heard on 14.195 at 1730.

Guadeloupe—FG7XB has been observed on 14.10 at 1730 in French. (Terry)

St. Pierre—FP8AP was noted on 14.163 mc. at 1700. (Terry)

DX on Other Bands

7-Mc. Phone: KM6AX, Midway Island, is heard on 7.265 at 0400. (RL)

VK2AGU, 7.085, was picked up at 0615; VK4WI, 7.095, has been heard at 0730. (Riggle) DJ1BZP, 7.067, was observed at 2330.

3-Mc. CW: ZD2AF, Lagos, Nigeria, 3.503 mc., was contacted at 2330. He uses 1 kw. (W3YVJ) -30-

Last-Minute Flashes!

The 28-mc. band has opened up and is providing good reception from Africa and Latin America. Stations heard include: VQ2FU, Northern Rhodesia, 28.32 mc.; ZS3E, Southwest Africa, 28.24; ZS6AFF and other ZS's from South Africa; CN8CS, CX2AF, CX4AB, HR3HH, PJ2AF, PJ2AP, and many LU's. Watch this band for lots of DX.

The 21-mc. band continues to provide exceptional reception from Africa. Additional stations heard are: FF8AK, French West Africa, 21.20 mc.; FQ8AG, French Equatorial Africa, 21.16 mc.; VQ3DQ, Tanganyika, 21.18 mc.; VQ5EK and VQ5FS in Uganda, both on 21.23 mc.; EL3A, Liberia; KT1WX, Tangier; OQ5CX, OQ5HH, ZS3BC. (RL)

The Europeans are heard irregularly on 21 mc., but are picked up very well on days when they do come through. GD6IA, Isle of Man, was heard on 21.15 mc. at 0900 with excellent strength. (E. G. Riggle)

British North Borneo is on the air. ZC5CT was heard on 14.14 mc. at 1100, working many W6's. The operator is VS4CT. He said that cards should go via the VS2 Bureau. (Jim Moore)

OK1KTW, Czechoslovakia, has been observed on 14.16 mc. at 1500. (Curt Swenson)

ZL2BE, New Zealand, was heard on 21.16 at 1700. (Kurt Meyers)

VK9BD, Papua, was noted on 21.25 mc. (Bob Wilkins)

FREE GIFT COUPONS

FREE COUPON for exciting gifts for every dollar you spend. Electrical appliances, etc. for use in home, sale over counter. Send for FREE PREMIUM CATALOG... order now... start collecting these valuable coupons!

SAVE ON PARTS & TUBES

BIG MONEY AT STANLEY

- 900,000 Radio & TV Tubes
- Individually Boxed
- One year RTMA guarantee
- Same day service

FREE with \$3 order or more!

Practical, All Purpose ELECTRIC TESTER

Equipped with genuine GE neon glow lamp. Tests leads from 90 volts to 500 volts, AC or DC. Use it in the home, factory, shop, garage, etc.

TYPE	PRICE	TYPE	PRICE	TYPE	PRICE	TYPE	PRICE
024	.45	6AL7GT	.70	6SA7GT	.50	12SA7	.52
183GT	.79	6A5S	.80	6SC7	.50	12SH7	.47
1L4	.55	6AS6	2.00	6S7	.43	12SJ7GT	.50
1L6	.60	6AS7G	2.25	6SH7	.45	12SK7	.50
1L44	.66	6AT6	.40	6S7GT	.45	12SL7GT	.69
1L64	.66	6AUSGT	.70	6SK7	.50	12SN7GT	.60
1L66	.66	6AUS	.46	6SL7GT	.70	12SQ7GT	.44
1L65	.66	6AV5GT	.85	6SN7GT	.60	14A5	.59
1L63	.66	6AX5GT	.59	6SQ7GT	.44	14A7	.45
1L65	.66	6B4G	.90	6V6GT	.48	14B6	.40
1L4	.66	6BA6	.49	6W4GT	.40	14Q7	.52
1LMS	.49	6BC5	.55	6W6	.60	19B6G6	1.18
1NSGT	.55	6BE6	.50	6W6GT	.56	19J6	.66
1R2	.66	6BG6G	1.18	6X4	.35	19T8	.70
1R5	.67	6BH6	.61	6X5	.39	25A7GT	1.50
154	.65	6BJ6	.49	6X5GT	.35	25AV5GT	.80
155	.65	6BK5	.70	6X8	.55	25BQ6GT	.90
1T2	.65	6BK7A	.78	6Y6G	.63	25Y5	.45
1U5	.50	6BN6	.59	7A4-XXL	.47	25Z5	.38
1V1	.57	6BL7GT	.77	7A5	.55	25Z6GT	.42
1X2A	.79	6BO6GT	.88	7A6	.47	35A5	.48
2021	1.00	6BQ7A	.80	7A7	.45	35B5	.52
2V2G	.80	6BZ7	.90	7A8	.46	35C5	.51
2X2A	1.00	6BY5G	.60	7A9	.41	35GT	.48
3D6	.45	6C4	.39	7B7	.47	35W4	.39
3L4	.80	6C5	.36	7C8	.47	35Y4	.40
302	.62	6C6	.50	7C4	.40	35Z3	.41
3Q5GT	.63	6C6B	.55	7C5	.44	35Z5GT	.39
3D6	.65	6C6DG	1.18	7C6	.45	50B5	.52
6K7	.57	6D6	.55	7F8	.70	50C5	.51
6J5	.54	6E5	.46	7Y4	.35	50L6GT	.45
657	.5V-G	6F6	.40	12AT6	.46	75	.44
7E5	.39	6H6GT	.40	12AT7	.68	77	.39
5Y4G	.64	2.00	12AUG	.46	78	.39	
5Z3	.47	6J5GT	.40	12AU7	.60	80	.35
5Z4	.59	6J7	.45	12AV6	.46	83V	.60
6A7	.59	6K7	.40	12AX7	.70	117L7GT	
6A8	.48	6K6GT	.39	12AY7	.90		
6AF4	.80	6L7	.44	12B6	.48	117N7GT	2.00
6AG5	.56	6N7	.61	12B4	.70	117P7GT	2.00
6AM6	.80	6Q7	.45	12BE6	.50		
6AK5	.80	654	.48	12BW7	.70	117Z3	.37
6AL5	.44	657G	.47	12BY7	.68	117Z6GT	.65

WELLER DUAL-LITE SOLDER GUN KIT. 100 watt gun provides the proper heat for most applications. Dual spotlight illuminates work. Kit includes Gun, wire soldering brush, soldering aid, Kester solder. **\$5.83**

Pocket AC-DC MULTITESTER \$9.45
Lots of 3. Hi-accuracy precision VOM-1000 Ohms per V. Reads AC & DC volts 0. 3, 25, 250, 1000 V. DCMA: 0.1, 10, 100MA. Ohms 1, 10, 100K. Size: 1 1/4 D, 4 5/8 L, 3/4 W. Test Leads. **\$5.95**

Sheldon Picture Tube Brightener \$1.19 ea. Lots of 3, \$1.09
TV and Radio Controls. 5K-50K-100K-500K-200K, 1 meg. less switch. Your choice.ea. .19
With switch, long shaft. 1/2 meg.-1 meg.ea. .39
70° Coarse Yokes. TV deflection yoke. New type for anti-anastigmatic focusing. With leads. List \$10.30.ea. 2.99
KNOB KIT. 25 asst. knobs for radio, TV, auto work. ea. kit .89
6 FT. EXTENSION CORD. UL approved. Double outlet.ea. 1.99
Molded rubber plug.ea. Lots of 5, ea. .19
UNIVERSAL 4-Prong Auto Radio Vibrator. For 90% of 6 volt auto sets.ea. Lots of 10, ea. 1.29

SPEAKERS Terrific Savings!

4" PM. Matching output transformer.ea. \$1.57
6" PM. For radios, small PA systems. Lots of 10, ea. **2.09**
8" PM. For radios, small PA systems. Lots of 10, ea. **3.29**



FREE with each \$25 or more order! 5-Pc. Sylvania Repair Kit. Value \$4.95. Includes: flashlight head, Phillips screwdriver, flat head screwdriver, alignment tool and polystyrene case.

Special Purpose Transmitting and Cathode Ray TUBES

TERMS: 25% deposit required on all orders, balance COD. Save COD charges, send full remittance plus postage with order. All unused money refunded with order. NO MINIMUM ORDER.

TUBE SPECIALS
Till Jan. 1st
3L4 .80
302 .62
3Q5GT .63
3D6 .65
6K7 .57
6J5 .54
657 .5V-G
7E5 .39
5Y4G .64
5Z3 .47
5Z4 .59
6A7 .59
6A8 .48
6AF4 .80
6AG5 .56
6AM6 .80
6AK5 .80
6AL5 .44

Stanley ELECTRONICS CORP.

935 MAIN AVENUE - PASSAIC, N. J.

Dept. PE-12

GRGregory 1-2498

Hi-Fi record reproduction requires a PRECISION turntable...

THE NEW PRESTO Pirouette T-18

made by the world's largest maker of precision recording equipment.

- Improves record performance tremendously...delivers professional broadcast quality!
- Simple operation—a sideways flick of the control lever selects 3 speeds—33 1/3, 45, 78 rpm.
- Quiet insured! Precision deepwell turntable bearing.
- Quality plus! Extra heavy weight, cast aluminum 12" table covered with non-slip cork.
- Beautiful design—smart telephone black and brushed chrome finish.
- Easy to install...only rectangular cut-out needed. Easy to buy at only \$53.50.



Presto Pirouette T-18H Turntable
The history-making T-18 with hysteresis motor...a magnificent hi-fi instrument. \$108.



Presto Pirouette T-68 Turntable
The 16" version of Presto's flick-shift T-18...for homes with fine hi-fi collections. \$79.50.



Presto Pirouette T-68H Turntable
A 16" flick-shift turntable with hysteresis motor...a new pinnacle in hi-fi. \$134.

Styled by Bruce Kamp, leading industrial designer

PRESTO RECORDING CORPORATION

PARAMUS, NEW JERSEY

Export Division: 25 Warren Street, New York 7, N. Y.

Canadian Division: Instantaneous Recording Service, 42 Lombard Street, Toronto



REVOLUTIONARY 3-SPEED MECHANISM

The Pirouette is a miracle of precision design on the inside, embodying the exclusive "flick shift" speed mechanism, with 3 idler wheels mounted on a single movable plate. Insures professional speed accuracy and trouble-free performance.

Send this coupon for more information

PRESTO RECORDING CORP.
Hi-Fi Sales Division, Dept. PE-12
Paramus, New Jersey

Rush catalog sheets on the new PRESTO Pirouette T-18, T-18H, T-68, T-68H turntables and name of nearest PRESTO distributor.

Name _____
Address _____
City _____ Zone _____
State _____

COUPON

UNIVERSITY LOUDSPEAKERS, INC. Desk T-1
 80 South Kensico Avenue, White Plains, N. Y.

Gentlemen:

Please send me information about P·S·E (University's Progressive Speaker Expansion plan for High Fidelity speaker systems).

I don't believe that P·S·E can do all you claim for it. According to you P·S·E will solve almost all my loudspeaker problems forever. That's a bold statement; I hope you can back it up.

You say that now I can buy a speaker and never worry about it becoming obsolete, or improve my present system without discarding what I have... that University speaker components, enclosures and networks have been so uniquely designed that it's possible to start an excellent basic system, at low cost, and add to it later—while enjoying immediate listening satisfaction. This is sensational!

Please send further information; mind you at no cost to me; absolutely free.

NAME _____
 ADDRESS _____
 CITY _____ STATE _____

PRINTED CIRCUIT KITS

PRECISE PHOTOGRAPHIC PROCESS

Make professional quality circuits of your own design without photographic equipment or experience

KEPRO Kits feature presensitized copper-clad laminates requiring only exposure development prior to etching. This simple inexpensive processing gives experimenters, hams and engineers alike a chance to investigate all phases of etched circuits—from experimental designs to production prototypes.

P-101 PROFESSIONAL KIT—Features 36 sq. inches (2 sheets) presensitized copper-clad phenolic, all processing chemicals, developing & etching trays, printing frame, mechanical negative materials. Ready for use. **5.40**

L-505 PRINTED CIRCUIT LAB—A complete laboratory for the experimenter or industrial. P.C. sockets, connectors, hardware, a large quantity of presensitized single & double copper-clad phenolic, a photo-layout kit, negative material, glass processing trays, printing frame, photo-flood lamp, safe light, all processing chemicals, and more. **31.50**

S-101 STANDARD KIT—Uses a manual method of applying a liquid etchant resist. 2 sheets copper-clad phenolic, etching tray, applicator, all chemicals, etc. **3.45**

If not available from your jobber, order direct F.O.B.

KEIL ENGINEERING PRODUCTS

4356 Duncan Ave. St. Louis 10, Mo.

After Class

(Continued from page 88)

tential of 4 volts negative with respect to the cathode. Thus, an input wave of 1 volt positive and 1 volt negative (i.e., 2 volts peak-to-peak) can never overcome the negative bias applied by the battery, even on positive peaks. For a setup like this, using proper terminology, we say that the grid is biased 4 volts negatively and that the signal swing is 2 volts peak-to-peak.

Meanwhile, what is happening to the plate current (I_p) and the voltage drop in the load resistor (E_o)? Tube manufacturers express the relationships between E_{bb} , I_p , and E_g (grid voltage) in the form of graphs called "average plate characteristics" which are published in all tube manuals. Assume that we are dealing with a 6J5 triode. We want to find out what output voltage (E_o) is obtained when the input voltage swings over 2 volts peak-to-peak. Obtaining this information involves the use of the average plate characteristics and a construction called a load line. These matters will be discussed more fully in the future; for now we will merely present the values, assuming $E_{bb} = 280$ volts, $E_g = 4$ volts, $R_L = 20,000$ ohms, and a signal swing of 2 volts.

When the signal swings the bias to -3 volts on its positive peak, the voltage across the load resistor is 110 volts. When the signal swings the bias to -5 volts on its negative peak, the voltage across the load resistor is 85 volts. Thus, input signal swing $E_i = 2$ volts, and output signal swing $E_o = 25$ volts (110-85). Since 25 volts is $12\frac{1}{2}$ times larger than 2 volts, the circuit is said to have a voltage gain of 12.5.

In summary, the foregoing explanation shows that the triode grid is a controlling element, somewhat like a valve in a water pipe that can be operated by the lightest of finger pressure yet governs the flow of thousands of gallons of water per minute.

The following quiz is intended as a self check. Answers are on page 127.

QUIZ

1. In the circuit of Fig. 2, what kind of current flows through the load resistor when there is no sound input to the microphone—pure d.c., pulsating d.c., or a.c.?
2. What kind of current is I_p when an a.c. signal voltage is applied to the grid, assuming all other conditions to be the same as in the preceding question?
3. If the bias on a tube is -8 volts and the applied signal is 6 volts peak-to-peak, what are the two limits of the grid voltage swing?
4. When a certain tube is excited by an input signal of 3 volts peak-to-peak, the voltage drop across R_L swings between 100 and 175 volts. What is the gain of this circuit?

BUILD 16 PRINTED CIRCUIT and METAL CHASSIS RADIO CIRCUITS

ONLY **\$19.95** COMPLETE

WITH THE NEW DELUXE 1956 PROGRESSIVE RADIO "EDU-KIT"

- Absolutely No Knowledge of Radio Necessary
- Learn Practical Radio Theory and Construction
- No Additional Parts Needed
- Excellent Background for Television
- Build 16 Receiver, Transmitter, Code Oscillator, Signal Tracer, Signal Injector Circuits
- 30 Day Money-Back Guarantee
- Free Soldering Iron, Tester & Other Extras
- School Inquiries Invited
- Used in 79 Countries
- Learn High Fidelity



Reg. U. S. Patent Office

FREE
Radio-Television
Servicing Literature
on request
(See Coupon below)

WHAT THE "EDU-KIT" OFFERS YOU

You will learn how to build radios, using regular punched metal chassis and professional radio schematics. You will learn how to wire and solder radio circuits. You will learn the basic principles involved in radio. You will build sixteen receiver, transmitter, code oscillator, signal tracer and signal injector circuits, and learn how to operate them. You will learn the principles of RF and AF amplifiers, detectors, RF and AF oscillators, rectifiers, etc. You will learn how to service and troubleshoot radios. You will build a Printed Circuit Signal Injector, and learn the principles and practical aspects of this revolutionary new method of radio building. You will learn and practice code, using the Progressive Code Oscillator. You will receive instructions for F.C.G. Novice License. In brief, you will receive practical basic training in Radio, worth many times the small price you pay.

THE EDUCATIONAL RADIO KIT FOR EVERYONE

You do not need the slightest background in radio or science. The "Edu-Kit" is designed for the complete beginner. It is used by young and old, by radio schools and clubs, by Armed Forces personnel and Veterans. No instructor is required. The "Edu-Kit" Instruction Manuals are exceedingly clear and complete in all details.

"EDU-KIT" IS USED THROUGHOUT THE WORLD

The Progressive Radio "Edu-Kit" is used in every state of the U.S.A., the District of Columbia, Alaska, Virgin Islands, Puerto Rico, Hawaii, Guam and the Canal Zone. It is used in 79 countries in all parts of the world, including Canada, Philippines, Korea, South Africa, Saudi Arabia, Venezuela, Israel, France, England, Japan, India, etc. The "Edu-Kit" is very popular with American servicemen stationed overseas.

THE PROGRESSIVE RADIO "EDU-KIT" IS COMPLETE

You will receive every part necessary to build sixteen different radio circuits. You will receive all tubes, tube sockets, variable, electrolytic and paper condensers, resistors, tie strips, coils, hardware, tubing, Printed Circuit materials, punched metal chassis, Instruction Manuals, etc. No solder or wire included. In addition, you receive an electric soldering iron as well as a Radio and Electrical Tester. All parts are guaranteed, brand new, carefully selected and matched. The "Edu-Kit" now also contains lessons for servicing with the Progressive Signal Tracer and the Progressive Signal Injector. High Fidelity, F.D.C. Novice instructions, Quizzes, Printed Circuit instructions.

"EDU-KIT" Now Includes PRINTED CIRCUITRY in addition to Regular Wired Punched Metal Chassis Construction

At no increase in price, the "Edu-Kit" now includes Printed Circuitry. You build a Printed Circuit Signal Injector, a unique servicing instrument that can detect many Radio and TV troubles. This revolutionary new technique of radio construction is now becoming popular in commercial radio and TV sets as well as in hearing aids, computers, business machines, etc.

A Printed Circuit is a special insulated board on which has been deposited a conducting material, which takes the place of wiring. The various parts are merely plugged in and soldered to terminals.

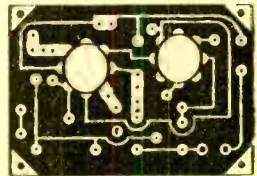

"LEARN BY DOING"— THE PROGRESSIVE TEACHING METHOD

The Progressive Radio "Edu-Kit" uses the principle of "Learn by Doing." Therefore you will build radio circuits, perform jobs, conduct experiments, and make repairs in order to illustrate the principles which you learn. You begin by examining the various radio parts, which are individually packaged and identified. You then learn the function, theory, wiring of these parts. Then you build a simple radio. With this first set you will enjoy listening to regular broadcast stations, learn theory, practice Testing and Troubleshooting. Then you construct a more advanced radio, learn more advanced theory and techniques. Gradually, in a progressive manner, and at your own rate, you will find yourself constructing more advanced multi-tube radio circuits, and doing work like a professional Radio Technician. The "Edu-Kit" Instruction Manuals are exceptionally clear in their explanations, illustrations and diagrams. In addition to regular wired punched metal chassis radios, you now learn about Printed Circuits and actually build a Printed Circuit Signal Injector. These sets operate on 105-125 V. AC-DC.

LEARN TROUBLESHOOTING AND SERVICING

You will learn how to recognize and repair troubles. You will build and learn to operate the Progressive Signal Tracer and the Progressive Signal Injector. You receive a Radio and Electrical Tester. You learn how to use these instruments for radio testing and repairs. While you are learning in this practical way, you will be able to do many a repair job for your neighbors and friends, and charge fees which will far exceed the cost of the "Edu-Kit."

MAIL TODAY — ORDER SHIPPED SAME DAY RECEIVED — 30 DAY MONEY-BACK GUARANTEE

FREE EXTRAS

- included with "EDU-KIT"
- Radio & Electrical Tester
 - Electric Soldering Iron
 - Tester Instruction Manual
 - Television Book
 - High Fidelity Guide
 - Quizzes
 - Consultation Service

- Send "Edu-Kit" Postpaid. I enclose full payment of \$19.95 (U.S.A. only).
- Send "Edu-Kit" Postpaid. I enclose full payment of \$20.95 (Outside U.S.A.).
- 210-250 V. Foreign Line Voltage Adapter for "Edu-Kit"—\$2.50.
- Send "Edu-Kit" C.O.D. I will pay \$19.95 plus postage (U.S.A. only).
- I wish additional information describing "Edu-Kit". No Obligation.
- Send me FREE Radio-TV Servicing Literature. No Obligation.

Name

Address

PROGRESSIVE "EDU-KITS" INC.

497 Union Ave., Room 515-D, Progressive Bldg., Brooklyn 11, N. Y.

it's easy... it's exciting

TO BE A HAM!



**GREAT NEW BOOK
TELLS YOU HOW**

**"So You Want to
Be a Ham"**

by Robert Hertzberg
W2DDJ

Know the thrill of being a Ham! Span continents, talk to people in foreign countries, "chew the fat" with fellow hams, help in times of disaster. This new book shows you easier than ever before, how you can be a ham operator. Gets you off to the best start—shows you how easy it is to learn the code and get your ticket; how to select equipment at lowest cost; how to be an amateur equal to the best; how to capitalize on ham knowledge in military or civilian careers. Written by an outstanding expert—practical, easy to understand. 12 fact-packed chapters; 196 exciting pages; 130 illustrations; 5 1/2 x 8 1/2".
Order HAM-1, only..... **\$250**

**Order today from
HOWARD W. SAMS & CO., INC.**
Dept. 14-M5, 2201 E. 46th St., Indianapolis 5, Ind.

CONSTRUCTION DATA

for the famous

STANCOR-WILLIAMSON
•
STANCOR-WILLIAMSON
ULTRA-LINEAR
•
CHICAGO SUPER-RANGE
100 WATT

HI-FI AMPLIFIERS

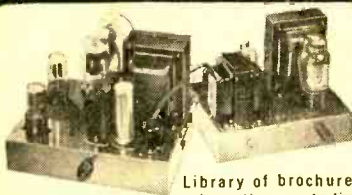

Library of brochures showing schematics, parts lists, chassis layout diagrams and other construction information on these well-known, popular amplifiers. Write for your free library to:

FREE:

CHICAGO STANDARD TRANSFORMER CORP.

3589 Elston Avenue

Chicago 18, Illinois

Bargain Hi-Fi

(Continued from page 72)

can be made of any available wood half an inch thick or more. Save work by making it easy to remove one face of the box, for it will be necessary to open the box when adding or removing the damping material.

The enclosure should be constructed to provide a certain cubic volume inside the housing. A 5" speaker requires 545 cubic inches of volume behind the speaker, a 6" speaker needs 864 cubic inches, an 8" speaker must have 2582 cubic inches, and the average 12" speaker will call for 3456 cubic inches. The enclosure can be built in any physical shape as long as it holds the speaker and provides the cubic content for the speaker size noted above.

Adding Damping Material

The last step of the process is the addition of damping material. Glass wool makes the best material for damping. Rock wool (of the long-fibred type) can be used satisfactorily. Whichever is used, trial and error is required to find out how much of it to put in. The glass or rock wool is wrapped loosely in cheesecloth pillows to prevent its getting into the speaker. Put the pillows in loose on the bottom, and stapled or tacked to the top, mostly (but loosely) filling the inside of the box.

There are two ways of determining the right amount of damping material in the exposure. The first—and best—way is to hook an audio oscillator to the input of the amplifier the speaker is to be used with, and swing it slowly past the resonant frequency. When just the right amount of damping is employed, there will be no audible increase in the tone at resonance, and it will also be noted that the response below resonance has come up to the response at higher frequencies. With too much damping, there is a general reduction of bass response. With too little, the speaker will boom at the resonant frequency.

The second method of checking is to hook a resistor of a few thousand ohms across the input to the amplifier, and then connect and disconnect a flashlight battery across this resistor. Add damping slowly just up to the point where the "boom" disappears, leaving only a crisp click.

This speaker system will have somewhat less bass response than a bass reflex or horn type enclosure, which is due to the lower efficiency of the direct radiator systems at low frequencies. When a moderate amount of bass boost is used, however, it will be discovered that just as much bass comes out, and that it has none of the boominess characteristic of systems in all but the most expensive installations. —50—

TOOLS & GADGETS

RADIO "EDU-KIT"

The 1956 model of the *Progressive* "Edu-Kit" is now being distributed by the manufacturer. It includes printed circuitry and all the necessary materials and instructions for building 16 different radio circuits, such as a signal injector, signal tracer, receiver, transmitter and code oscillator.

All parts are carefully selected and matched, and brand-new. The "Edu-Kit" is sold exclusively through the mail with an unconditional 30-day money-back guarantee. Free literature and radio-TV servicing manuals are available on request. Write to *Progressive "Edu-Kits" Inc.*, 497 Union Ave., Brooklyn 11, N. Y.

SENSITIVE GEIGER COUNTER

Model AE100, available from *General Electronic Equipment Company*, Glendale and Mantua Sts., Easton, Pa., is said to



be a supersensitive Geiger counter, including a 900-volt halogen-quenched type of Geiger tube which protects against burn out, it will readily detect the presence of uranium or other ores having radioactive properties. Price of the Model AE100, completely wired and with all batteries and tube, is given as \$32.95. Battery life is exceptionally long.

Model AEK100 is the identical instrument in kit form and also includes batteries and tube, headphone and shoulder carrying strap. Price for the kit is given as \$19.65.

TV INTERFERENCE FILTER

TV reception can be improved with the new *Capcon* "Printed-Circuit High-Pass Filter." Usable on any television set, it eliminates or suppresses TV picture interference from ignition, diathermy, amateurs, industrial equipment, neon signs, electrical appliances and other extraneous signals. It

will cut out all interfering signals below 54 mc.

Retailing at only \$1, the filter is completely enclosed in a transparent plastic case. Convenient leads are attached for rapid and easy installation. For additional details or literature, write to the manufacturer: *Capcon, Inc.*, 25 Willett St., New York 2, N. Y.

FLOOR-MOUNTED FOOTSWITCH

Vemaline Products Company, Hawthorne, N. J., has announced a newly developed footswitch

which features floor mounts.

The Model FS 15AM was designed for normal and heavy duty switching. Constructed of cast aluminum housing, it is said to withstand any kind of abuse. The actuating treadle operates

with a light foot pressure, while the rubber foot tread on top prevents the operator's foot from slipping.

Model FS 15AM may be mounted on the floor or to a piece of machinery. Contact rating can be made up for 1, 6, and 15 amp. standard. Over-all size is 3 $\frac{3}{4}$ " long, 3" wide, and 1 $\frac{1}{8}$ " high. It is available with or without cord and series plug, and in a variety of wiring plans.



AUDIO GENERATOR KIT

This new "Heathkit" Model AG-9 audio generator kit features step-tuning from 10 cps to 100 kc. with three rotary switches that provide two significant figures and

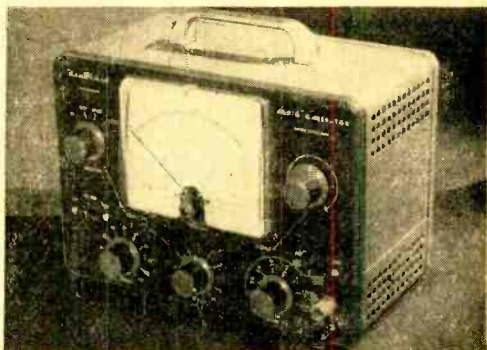

multiplier. Distortion is less than .1%, and frequency accurate to within $\pm 5\%$.

Output is monitored on a large 4 $\frac{1}{2}$ " meter that reads voltage or db. Both variable and step-type attenuation are pro-

vided; the meter reads zero-to-maximum at each attenuator position. Output ranges (and therefore meter ranges) are 0-.003, .01, .03, .1, .3, 1, 3 and 10 volts. For further information, write to *Heath Company*, Benton Harbor, Mich.

VARIABLE TRANSFORMER

Ideal for hobbyists, model railroaders, home workshops, etc., the "Adjust-A-Volt"



100BU variable transformer is intended for low-wattage applications (50-100-500 watt loads). It is designed for use as the variable a.c. voltage component to replace inefficient, space-

stealing rheostats in electric and electronic equipment. Small and compact, it is easily installed in back-of-panel position, and ventilation is not a problem.

A toroidally wound, hydrogen annealed auto-transformer, the Type 100BU will smoothly and continuously deliver any output voltage from zero to above line voltage. The extra long brush spring

allows free action and maintains constant brush pressure. For further details, contact the manufacturer: *Standard Electrical Products Co.*, 2240 E. Third St., Dayton, Ohio.

SAFETY POWER-PANEL

For excessive loads on a power line, *Goodwill Manufacturing Company* has introduced a portable "Safety Power-Panel." Its express purpose is to facilitate the use of appliances, motors, drills and auxiliary lighting through a multiple outlet circuit breaker, without blowing fuses.

There are three distinct models, with two or three circuit outlets, and with safety-

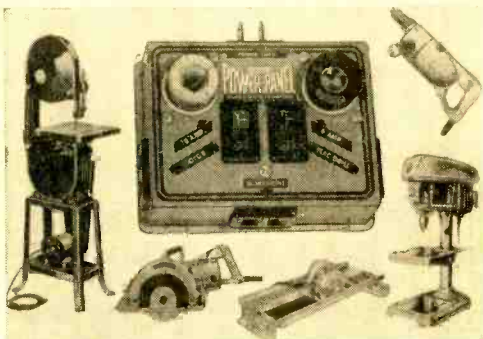

control toggle switches for operating high-amperage motors. Circuits are protected by a 6-ampere fuse for small power tools and a 10-ampere time delay fuse for maximum 3/4-hp. a.c. motor operation. Complete information is available from *Goodwill Manufacturing Company*, Dept. 16, 1219 S. Laramie Ave., Chicago 50, Ill.

CATHODE-RAY TUBE CHECKER KIT

Rapid and complete picture tube testing is possible with the "Heathkit" Model CC-1 cathode-ray tube checker kit, either in the



set, on the workbench, or in the carton. Featuring the Shadowgraph test (a spot of light on the screen) to indicate whether or not the tube is capable of functioning, it tests for shorts, leakage, and emission.

YOUR COPIES OF

**POPULAR
ELECTRONICS**

ARE VALUABLE!

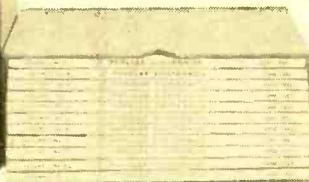

**Keep them neat . . . clean . . .
Ready for INSTANT REFERENCE!**

Now you can keep a year's copies of **POPULAR ELECTRONICS** in a rich-looking leatherette file that makes it easy to locate any issue for ready reference. Specially designed for **POPULAR ELECTRONICS**, this handy file—with its distinctive, washable blue Kivar cover and 16-carat gold leaf lettering—not only looks good but keeps every issue neat, clean and orderly. So don't risk tearing and soiling your copies of **POPULAR ELECTRONICS**—always a ready source of valuable information. Order several of these **POPULAR ELECTRONICS** volume files today. They are \$2.50 each, postpaid—3 for \$7.00, or 6 for \$13.00. Satisfaction guaranteed, or your money back. Order direct from:

JESSE JONES BOX CORP., DEPT. PE
Box 5120, Philadelphia 41, Pa.
(Established 1843)

TELTRON TUBES

Guaranteed! Lowest Prices Ever!

All tubes individually boxed . . . unconditionally guaranteed for one year.

**FREE!
BONUS
OFFER!**



Model 625K

This Ebro Tube Tester is yours FREE when you buy \$199 worth of tubes or more within 60 days at Teltron. May be bought outright from Teltron for \$34.95.

We now have a full stock of T.V. picture tubes.

You can order any size at \$1.25 per inch. All tubes RCA licensed and guaranteed for one year.

TYPE	PRICE	TYPE	PRICE	TYPE	PRICE	TYPE	PRICE	TYPE	PRICE
OZ4	.45	8AQ5	.48	6CUG	.95	7F7	.59	25L6GT	.41
1A7GT	.53	8AR5	.48	6D6	.59	7F8	.77	25BQ6GT	.82
1B3GT	.62	8A55	.52	6E5	.60	7N7	.52	25W4GT	.43
1H3GT	.51	8AT6	.37	6F5	.44	12AT6	.37	25Z5	.55
1L4	.51	8AUSGT	.60	6F6	.42	12AT7	.71	25Z6GT	.36
1L6	.51	8AU6	.43	6H6	.50	12AU7	.58	35A5	.48
1LC6	.49	8AV5GT	.60	6J5	.49	12AV6	.42	35B5	.48
1NSGT	.51	8AV6	.37	6J6	.61	12AV7	.73	35C5	.48
1R5	.51	8AX4GT	.60	6K5	.60	12AX4GT	.60	35L6GT	.41
1S5	.43	8AX5GT	.60	6K6GT	.39	12AX7	.61	35W4	.33
1T4	.51	8BAG	.56	6K7	.40	12AZ7	.61	35Y4	.42
1U4	.51	8BA7	.58	6L6	.78	12B4	.72	35Z3	.42
1U5	.43	8BC5	.48	6Q7	.40	12BA6	.46	35Z3	.42
1K2	.65	8BC7	.75	654	.41	12BA7	.58	35Z5GT	.33
3A5	.65	8BE6	.46	65K7	.65	12BE6	.46	37	.59
3Q4	.53	8BF5	.48	658GT	.65	12BH7	.61	43	.55
3Q5GT	.61	8BF6	.48	65A7	.45	12BY7	.65	45	.55
354	.48	8BG6G	1.18	65J7	.45	12H6	.60	50A5	.49
3V4	.48	8BH6	.51	65N7GT	.60	12J5	.40	50B5	.48
5R4	.95	8BUE	.51	65Q7	.40	12K7	.40	50L6GT	.50
5U4G	.43	8BR5	.75	6T8	.71	12Q7	.48	50X6	.53
5V4	.49	8BK7	.78	6U8	.76	12S47	.45	75	.44
5Y3	.30	8BL7GT	.78	6V3	.80	12SJ7	.45	77	.55
5Y4G	.37	8BN6	.90	6V3	.80	12SK7	.45	80	.40
6AR	.40	8BQ6GT4	.83	6V6GT	.48	12SL7	.60	84	.46
6AB4	.43	8BQ7	.85	6W4GT	.43	12SN7GT	.56	117GT	1.20
6AC7	.65	8BY5G	.60	6X4	.37	12SQ7	.38	117L7GT	1.20
6AG5	.52	8BZ7	.95	6X5GT	.38	1447	.43	117N7GT	1.20
6H4GT	.65	6C4	.41	6X8	.80	14B6	.36	117P7GT	1.20
6AF4	1.02	6C5	.46	6Y6	.61	14Q7	.52	117Z3	.33
6AK5	.96	6CB6	.51	7A8	.46	19B6G	1.48	117Z6GT	.65
6AL5	.43	6CD6G	1.63	7C5	.44	19T8	.71	1629	.39

We have thousands of tube types too numerous to list here. On ordering types not listed take 75% off current list price for cost of tube.

FREE

\$7.20 list value Bonus Box of three 6SN7 tubes and 25 assorted resistors with each order of \$25 or more.

SAME DAY SERVICE

48 hour Postal Delivery to West Coast.

Repeated by Popular Demand Specials to Jan. 1st

132	.65	.85
504G	.43	.39
6AU6	.43	.39
6AL5	.43	.39
6BQ6GT	.83	.77
6BB6	.51	.47
6ED6G	1.63	.99
6SN7GT	.60	.55
6V4GT	.43	.39
12AT7	.71	.67
12AU7	.58	.54
12SK7	.45	.41
12SQ7	.38	.33
50L6GT	.50	.47

NEW LIBERAL TERMS!

No minimum order. All postage paid on orders over \$10.00 in U.S.A., A.P.O.'s and Territories, 10% deposit on C.O.D.'s. 25% handling charges on orders under \$5.00. To our Canadian and foreign friends, please send approximate freight—excess will be refunded. Orders subject to prior sale. **WE WANT NEW ACCOUNTS.** If you are rated, your credit is good with us. We are "Eico" distributors. Write us about special deals on test equipment.

TELTRON ELECTRIC COMPANY

428 HARRISON AVE. DEPT. PE-12 Phone HUmboldt 4-9848 HARRISON, N. J.

INDUSTRIAL ELECTRONIC— AUTOMATION TECHNICIANS Desperately Needed!



Never in history has there been such a tremendous demand for Electronic technicians at the servicing, maintenance and assistant Engineering level, in all fields of electronics. Industries, Businesses, large and small are turning to Electronically controlled machinery . . . **AUTOMATION!**

Whether it's a Robot airplane, an automobile plant with an integrated line of machines, a Sensing Device, Computing System or Communications—each re-

quire electric power applied through automatically controlled processes. This means there are positions open at all levels and phases for Electronic Technicians.

- TOP PAY
- UNLIMITED OPPORTUNITY
- SECURE FUTURE

Bailey electronic students learn Industrial Television on specially designed equipment such as this panelboard, which is a multiple camera and screen control. The Bailey Electronic course includes an outstanding comprehensive program in radio and TV receives servicing.

Let us send you FREE, without obligation, complete details of our Resident Electronic Training Program—originated by Bailey Schools—acclaimed by Electronic Engineers. See how you save time as you learn—by doing with intensive laboratory work on the most recently developed Electronic equipment, plus classroom required physics, mathematics, etc.

We help you find part time work while in our school—help place you with America's leading companies after graduation. Act now—mail coupon today!

VETERAN APPROVED

Bailey Technical Schools
1626 S. Grand • St. Louis 4, Mo.

MAIL TODAY

Please mail immediately this free booklet without obligation.

FREE BOOKLET

Name _____

Address _____

City _____

State _____



ELECTRONIC SUPPLIES

Attn.—Lab.—School—Experimenters

ELECTRONIC OPPORTUNITY KIT

Gov't Acquisition Cost over \$300—a wonderful opportunity to acquire a valuable selection of useful electronic components for a tiny fraction of actual cost. We include a parts list. No Junk—no "Operation Cleansweep." These parts are all currently for sale in our cash & carry store. What you get: 1 Crystal Diode; 1 Relay; 1 matching Audio Transformer; 24 Ceramicon's; 1 UHF Chassis, incomplete, New; 2 min IP Xformers; 6 Wafer Switches; 17 Hi Pass Filters; 1 Planetary Drive; 3 Submin. Air Trimmers; 12 Miscell Coils (Receiving & TV); 3 Min. Tube Shields; 6 pots (WW & Carbon) 3 Bathub Cond; 1-6.3V Dis. Xformer; 1 Choke (150 MA); 3 Term'l Bds—Silver Plated Term'l's; 10 Ass'd Tube Sockets (Lo-Loss) no wafers; 1 Fusepost; 1 Toggle Switch; 25 1/2-2W Resistors (insulated); 25 Ass'd Tubulars; 1 Variable Condenser; 4 Electrolytics (Fresh); 3 instrument Knobs; 3 25W Rheostats (Ohmite or H.H.); 25 Miscs (current); 1 Line Cord; 1 DC Ammeter; Min. Xformer (transformer circuits); 1 Min. Hear. Aid output Xformer; 1 60 Cycle Power Xformr; with file, winding; 1 Hook Wire; 1 Plug-In Coil; 1 Navy Test Probe; 1 Control Box; 1 Remote w/Schematic.

187 PIECES—Our SURPLUS retail prices for ONE (1) of these is \$5.00. WE BELIEVE THIS IS REALLY AN OPPORTUNITY KIT **\$7.95**

OSCILLOSCOPE

Model 830

Mfd for U. S. Navy

Combines a highly efficient conventional 3" oscillograph, with a thyratron linear sweep and synchronized sweep frequency modulator or wobblator. Operates from 115VAC-60 cycles. The perfect instrument for labs, schools, etc. Has all features of high priced lab scopes, including instruction book, at less than price of a kit. All tested.

SIZE: 10x7 1/2 x 14. Wt.: 23 lbs.

\$29.95 complete

F.O.B. N.Y. (express only)

WESTERN ELECTRIC Stepper Switch 4.5-12VDC Coil-45 Steps New \$7.95

Include Postage With Order

REX RADIO SUPPLY

88 CORTLAND STREET

NEW YORK 7, N. Y.

LEARN

RADAR MICROWAVES TRANSMITTERS CODE TV RADIO

Phila. Wireless Technical Institute
1533 Pine St. Philadelphia 2, Penna.

A Non-Profit Corp. Founded in 1908

Write for free catalog "P"



AUDIO Hi-Fi
the **TONE-MASTER**

SELF powered, transistorized audio SINE WAVE generator—approx. 1200 cycle tone—variable from 0 to over .5 volts RMS output—connects directly to HiZ mike input—check AM modulation and speech equipment—ideal for audio enthusiasts—housed in compact molded case (2 3/4" x 4 1/8" x 2 5/8") with lithographed front face.

Lakeshore INDUSTRIES
MANTOWOC WISCONSIN

\$12.95

Lightweight, and housed in an attractive portable case, the Model CC-1 tests all electromagnetic deflection picture tubes normally encountered in TV servicing. It supplies all operating voltages to the tube under test, and indicates the condition of the tube on a large "good—bad" scale. For further details, write to *Heath Company*, Benton Harbor, Mich.

ROTATING TRAYS

Trays of the "Kari-All" are like the seats on a ferris wheel—always facing up. Parts stored in them are visible at all times, and a flick of the finger brings any tray desired to the top. Automatic braking action keeps heavy parts from revolving to the bottom. Made of steel, this device may

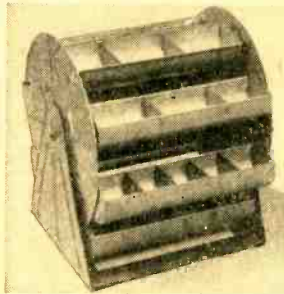

be fastened to the wall or workbench. Rounded troughs eliminate the problem of small parts getting stuck in corners, and weld and rivet construction has been used throughout. For additional information, write to the manufacturer, *Peters Manufacturing Co.*, Kawkawlin, Mich.

RUGGED MINIATURE JACK

Lifting capacity of *General Hardware Mfg. Co.'s* No. 7 machinist's jack is over 1000 lbs., yet it weighs a mere 6 ounces, measures only 4" high when fully open, and has a 1" screw adjustment. Rugged enough to be useful for leveling machinery of all types in plants and workshops, it also makes a decorative paperweight.

The No. 7 jack has a cast iron base with a tilting swivel head and adjustable steel



screw. Permanent positioning is obtained by means of an adjusting pin and lock nut. This handy unit can be found at hard-

ware stores and industrial supply houses for approximately 90 cents.

"SUPER CHAMP" HAND TOOL

The "Super Champ" hand tool can be a valuable aid in installing or repairing electrical wiring in radios, TV sets, home appli-

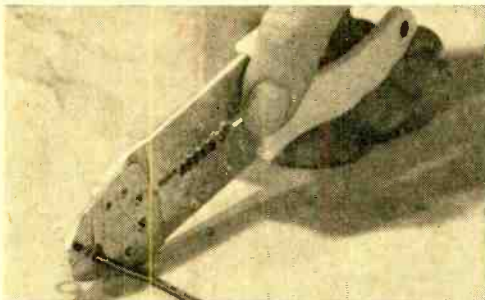

ances, automobiles, etc. It does away with friction tape, flux, soldering iron and wire cutters, for it cuts the wire—making a clean, sharp cut through insulation and conductor. It strips wire. And it crimps solderless, pre-insulated terminals, connectors and splices, making a sure, safe connection.

This tool can also shear stove bolts and screws without damaging the threads and without leaving a burr which would require filing. A stud gauge is die-cut into the face of the tool to serve as a handy, easy-to-read guide for judging stud, bolt and screw sizes. It is available from *T. W. Berger, Inc.*, 1315-PE American Building, Cincinnati 2, Ohio, and is priced at \$3.95, postpaid.

TUBE TESTER

Tube tester kit 327A, announced by the *General Electronic Equipment Company*,

Mantua and Glendale Sts., Easton, Pa., will test all tubes in use in all current model radio, FM and television sets. Free point selector system circuitry assures against obsolescence, and double fuses for both the meter and transformer give unusual protection against meter burn out and instrument damage.

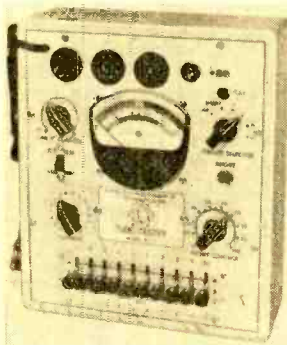

Complete in build-it-yourself form, kit 327A contains illustrated detailed instructions on assembly and wiring, and includes a loose-leaf tube chart book. Price is given as \$33.95.

FIX TV SETS TWICE AS FAST!

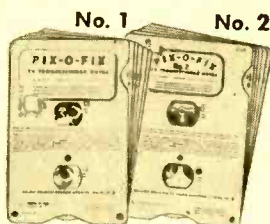

**CUT TIME
IN HALF on
2 jobs out of 3**

Now! Handle television receiver troubles by easy picture analysis. Let these famous PIX-O-FIX Guides tell you what is wrong... then show exactly how to fix it.

PIX-O-FIX TV TROUBLE- FINDER GUIDES

Just turn the PIX-O-FIX dial until the picture in its window shows the same trouble symptoms (wavy lines, snow, no raster, "squeezing" distortion, etc., etc.) as the picture on the TV set you're repairing. PIX-O-FIX then tells the possible trouble causes and gives step-by-step repair instructions. It's as easy as that!

The two PIX-O-FIX units, No. 1 and No. 2 cover 47 different television troubles... just about anything you're likely to be called on to fix. No. 1 identifies 24 of the most common troubles and gives 192 causes and 253 remedies. No. 2 covers 23 more advanced troubles not included in No. 1. Together, they are a comprehensive guide to quick "picture analysis" servicing of any TV set... AND THE PRICE IS ONLY \$2.00 FOR THE TWO. Use coupon.

DON'T THROW OLD RADIOS AWAY!



This giant book shows exactly how to fix them... without a lot of previous experience!

There's a "secret" to repairing old radios fast and profitably... and this big **RADIO TROUBLESHOOTER'S HANDBOOK** is it!

Just look up the old make and model you want to fix. This 3½ pound 744-page Ghirardi handbook tells what the trouble is likely to be... AND SHOWS YOU EXACTLY HOW TO FIX IT. No useless testing! No wasted time! Even beginners can handle jobs "slick as a whistle." *The only guide of its kind*... cuts repair time in half!

Includes are common trouble symptoms and remedies for over 4,800 old models of home and auto radios and record changers. Actual case histories cover practically every model made by 202 manufacturers between 1925 and 1942—Air-line, Apex, Arvin, Atwater Kent, Belmont, Bosch, Brunswick, Clarion, Crosley, Emerson, Fada, G.E. Kolster, Majestic, Motorola, Philco, Pilot, RCA, Silvertone, Sparton, Stromberg AND DOZENS MORE. Gives how-to-do-it data on SPECIFIC jobs—NOT general theory. Includes hundreds of pages of invaluable tube and component data, service short cuts, etc. Price \$6.50. 10-day free trial.

USE COUPON TO ORDER!

Dept. PE-125, Rinehart & Co., Inc.
232 Madison Ave., New York 16, N. Y.

Enclosed is \$2.00 for PIX-O-FIX Nos. 1 and 2. You guarantee to refund my money if I return them in 10 days.

Send book **RADIO TROUBLESHOOTER'S HANDBOOK** for 10 days **FREE EXAMINATION**. If I like book, I will promptly send \$6.50 (plus postage) in full payment. Otherwise I will return book and owe you nothing.

Name _____

Address _____

City, Zone, State _____

RINEHART BOOKS ARE SOLD BY LEADING BOOKSTORES



Here's your chance to "cash in!" Over \$2,500,000 in Government Bonuses have been paid for URANIUM discoveries in the past 2 years. Currently \$150,000 a month is paid to people just like you. Precision Geiger Counters and Scintillators are the finest instruments made for URANIUM prospecting. These highly sensitive instruments are compact, lightweight and ruggedly built for field use. Prices start at \$29.95.

CONTACT YOUR NEAREST DEALER or write direct to factory for FREE 12-PAGE CATALOG, describing URANIUM and Metal detectors.

PROSPECTORS  RELY ON...

PRECISION RADIATION INSTRUMENTS, INC.
4223PT W JEFFERSON BLVD. • Los Angeles 16, California
WORLD'S LARGEST MANUFACTURER OF RADIATION INSTRUMENTS



CAMEL'S-HAIR BRUSHES! 20 for \$1.00 SURPLUS



Imagine! Never used Camel's-hair Brushes that cost many, many times this low price. You actually buy these brushes at less than the cost to manufacturer. For use in the home, office, shop or store.

For touch-up, pasting, drawing, lens cleaner, typewriter cleaner, cleaning precision instruments, guns, tools, sporting equipment and hundreds of other uses. Assorted sizes. Money back if not satisfied. 20 brushes \$1.00, 42 brushes \$2.00. Supply limited. Order NOW! Add 10c postage.

MATTHEW DAY CO., INC.

13 E. MADISON ST. DEPT. B-664 DUMONT, N.J.

HANDY-WALKIE HAND

- Scouting Trips
- Sporting Events
- Parks & Beaches
- Fishing Expeditions
- Camping Trips

RADIO

Completely Assembled
Complete with Batteries
Nothing Else to Buy

Complete \$11.95

4 in 1 TRANSISTOR RADIO KIT

Builds: • Transistor Radio Receiver • Germanium Diode Radio Set • Code practice blinker light • Morse code practice key

Shipped postpaid when payment accompanies order, otherwise C.O.D. Features: no soldering complete with transistor & earphone; uses flashlight batteries. Complete \$10.95

Write for our latest literature **MARVIN ELECTRONICS** 2907 E. 79th St., Chicago, Ill.

Catalog of 3000 Novelties 10c

Send 10c for amazing catalog of novelties, live animals, scientific supplies, hobbies, funmakers, planes & boats, looms, magic tricks, joke articles, unusual seeds, gadget time-savers, cameras, optical goods, projectors, movies, lucky jewelry, religious novelties, disguises, musical instruments, stamps, coins, puzzles, fortune tellers, radios, auto & bike accessories, telescopes, magnifiers, compasses, banks, smokers' gadgets, artists' supplies, printing sets, engines, motors, shockers, knives, billfolds, fireworks, guns, rifles, sports, books, games, plants, etc. Send name, address & 10c to **JOHN SMITH & CO., Dept. 108 Detroit 7, Michigan**

Disc and Tape Review

(Continued from page 69)

Pulcinella and The Fairy Kiss
Igor Markevitch conducting
Radiodiffusion Francaise Orchestra
ANGEL 35143, 12" LP

Not as well known as Stravinsky's other works, it is very light and charming music, the *Fairy Kiss* being derived from Tchaikovsky themes which are easily recognizable. Superb strings and other good sound.

RESPIGHI—Feste Romane and Church Windows
Antal Dorati conducting
Minneapolis Symphony Orchestra
MERCURY 50046, 12" LP

Surely one of the loudest phonograph records ever produced! This is one of the most extraordinary hi-fi recordings of all time. Tremendous trumpets, drums, gongs, organ. It will positively delight any hi-fi nut.

RAVEL—Daphnis and Chloe (complete ballet)
Antal Dorati conducting
Minneapolis Symphony Orchestra
MERCURY MG 50048, 12" LP

One of the most beautiful of all ballets and yet with some very exciting passages. This recording is nearly definitive as to performance and is unlikely to be surpassed in sound.

PROKOFIEV—Buffoon Suite #1
Vladimir Golschmann conducting
St. Louis Symphony Orchestra
CAPITOL P8257, 12" LP

Also called *Chout*, this is a little-known but very exciting work. One of Capitol's best recordings with plenty of dazzling hi-fi effects.

MUSSORGSKY—A Night on Bald Mountain; Other Works

Stokowski and his Orchestra
VICTOR LM1816, 12" LP

Perhaps this doesn't belong in the modern section, but that's academic. The fantastic music is a specialty of Stokowski, and he gives a reading which is hair-raising. Outstanding sound quality.

Fiesta Mexicana

Frederick Fennell conducting
Eastman Rochester Symphonic Band
MERCURY 40011, 12" LP

The *Fiesta* is tremendously exciting, as you can well imagine, with over 30 different percussion instruments being employed! The opening bells and the smashing impact of tympani and bass drum are especially notable and will give even the biggest speaker systems a workout! —30—

Tuning the Short-Wave Bands

(Continued from page 83)

Hungary—Radio Budapest, 11,910 kc., has English news at 2310. This is the best channel for reception on the West Coast. (RR)

India—"All India Radio," Delhi, has English at 2130-2145, then goes into an Asian language until 2200; it fades out by 2200 or shortly after. Their signature tune is noted when transmission opens. (DE)

Indo-China—Radio France-Asie, Saigon, schedules English at 0315-0340 for Europe on 17,785 kc.; at 0345-0615 on 15,430 kc. for Australia and S. E. Asia; and at 0900-0945 on 9775 kc. for India and Asia. (SS)

Italy—Rome, 11,825 kc. (a new channel?), has language around 1900, English at 1910, news at 1915, French at 1930; it leaves the air abruptly at 1950 after bird whistle identification. (JR)

Japan—JOB3, Tokyo, 9675 kc., has English news at 1115, in language after 1200, and signs off at 1215. S/on in language at 1230, French at 1245, English news at 1300. S/off at 1330, return at 1400. JOA4, 11,705 kc., is dual to

9675 kc. at 1215 s/off and 1230 s/on. (JR)

Lebanon—Beirut, Lebanon, has a new English period running daily at 1030-1330 on 9610 kc. (MG)

Luxembourg—Your Editor wrote to *Radio Luxembourg* for their latest schedule and received, in return, a verification. Several DX'ers have complained that the verifications received are not verifications at all, but rather acknowledgment that their reports have been received. One fellow writes that after he received such a letter he rewrote to the station and fully explained that he was seeking a verification. A few days later, he had received it. Apparently the station is understaffed momentarily; give it time, or a second report, and you'll undoubtedly succeed in getting a veri.

Malaya—*Radio Malaya*, Kuala Lumpur, VS2K6, 6025 kc., verified and said that they no longer have printed QSL cards or pictures of the station. This 5-kw. station is heard at 0530-0647, then fades out. Singapore was noted on 15,300 kc. and 15,085 kc. with a BBC-relay that closed at 125. (ER)

Mozambique—CR7BU, 4920 kc., Lourenco Marques, has been tuned at 2332-0000 with popular dance music. Announcements and commercials are in English. Not usually audible until *Radio Caracas*, Venezuela, leaves this channel. (PM)

Netherlands—*Radio Nederland* broadcasts daily except Monday to North America, New Zealand, and Australia on 6025 kc. (PGD) and 9590 kc. (PCJ) at 2130-2210. The programs are all in English. They send a beautiful QSL card. (LM)

New Caledonia—*Radio Noumea*, 6035 kc., can be noted from 0500-0530. They close with "Silent Night" played on an organ. Program is popular dance music on records. (PM)

New Guinea—The new xmt'r is in operation at Biak on 9545 kc. and has been heard from 0700-0900 with American music from 0820. The s/off is in Dutch and English. They ask that reports be sent to *Dutch Radio*, P. O. Box 505, Biak, Netherlands New Guinea. (RR, DA)

New Zealand—The latest schedule from Wellington is: to Australia at 1500-0100 on ZL19, 11,830 kc., and ZL18, 9520 kc. (also at 0115 to s/off.); to Pacific Islands at 1200-1530, 1545-0100, and 0115-s/off on ZL20, 6020 kc., ZL3 on 11,780 kc., and ZL7 on 6080 kc. Close-down is at 0545 on weekdays, 0620 on Saturdays, 0500 on Sundays. *Radio New Zealand's* two transmitters each run 7500 watts. Two channels are used simultaneously and the present antennas are beamed at Australia and the Pacific Islands. DX'ers are catered to in the program "This Radio Age," heard at 0430-0500 on the first Wednesday of each month. The "Mailbox" session is noted on Fridays at 0415-0430. Mailing address is: The Director, *Radio New Zealand*, P. O. Box 2396, Wellington, New Zealand. (MP)

Norway—*Radio Norway* broadcasts daily to North America on 6130 kc. (LKJ), 7210 kc. (LLS), and 9610 kc. (LLG) at 2000-2100. Announcements are in English and Norwegian. They usually have a section of music by Norwegian artists or Norwegian folk music; this program lasts 15-20 minutes. (LM)



UNTIL DEC. 25th ONLY
LEKTRON SPECIALTIES



PLAYS SANTA CLAUS!

DOUBLE BONUS OFFER

ON EVERY ORDER OF \$10 OR MORE

BONUS #1 Your choice of ANY KIT FREE	+	BONUS #2 \$10 worth of a wide variety of electronic parts (Wt. 7 lbs.)	=	\$11 WORTH OF ELECTRONIC EQUIPMENT WITH EVERY \$10 ORDER	FREE
------------------------------------------------	---	----------------------------------------------------------------------------------	---	--------------------------------------------------------------------	------

FREE, USEFUL XMAS GIFT WITH ANY SIZE ORDER! THOUSANDS OF "KIT KING" KITS SOLD—NOT ONE RETURNED!

- 65 TUBULAR CONDENSERS. 25 values. .00035 to 1 mf. up to 1600V. Moulded. \$1.00/lot. Wt. 2 lbs. Reg. \$10.
- 10 TWIST LOCK ELECTRO-LYTICS. 5 to 100mf, up to 450V. Each can different values. All multiple sections. Wt. 3 lbs. Reg. \$18.
- 1000 PCS. SPAGHETTI-NEW KIT! Precut for shop use. Lenses to 4". 8 sizes. 13 thru 3/4". Ass'd. colors, irregular. Wt. 1/2 lb. Reg. \$187.
- 8 PC. NUTDRIVER KIT. Plastic handle; 3/16, 7/32, 1/4, 5/16, 11/32, 3/8, 7/16, 1/2, 5/8, 3/4, 1, 1 1/4, 1 1/2, 1 3/4, 2, 2 1/2, 3, 3 1/2, 4, 4 1/2, 5, 5 1/2, 6, 6 1/2, 7, 7 1/2, 8, 8 1/2, 9, 9 1/2, 10, 11, 12, 13, 14, 15, 16, 17, 18, 19, 20, 21, 22, 23, 24, 25, 26, 27, 28, 29, 30, 31, 32, 33, 34, 35, 36, 37, 38, 39, 40, 41, 42, 43, 44, 45, 46, 47, 48, 49, 50. Wt. 1/2 lb. Reg. \$18.
- 200 COIL FORMS, ceramic and bakelite. 25 sizes, styles. Some worth \$2. \$20 \$1 value. Wt. 2 lbs.
- 60 CARBON RESISTORS. Imagine! 85 values, famous Allen Bradley, tool 15 ohms to 10 megs; 1/2, 1 & 2 w. Many types. Wt. 1/2 lb. Reg. \$18.
- 30 BATHUB & TUBULAR OILS. Outstanding buy! 15 values. 0.05 to 1000 uf. up to 1000V. Wt. 3 lbs. Reg. \$25.
- 50 RF COILS & CHOKES. Shop asst. -20 types. Osc. peaking RF. slug-tuned. \$1 Wt. 1 lb. Reg. \$21.
- 50 TUBE SHIELDS. Wide asst. miniature & GT tube shields. Wt. 2 lbs. Reg. \$9.
- 30 VARIABLE CONDENSERS. Up to 300mmf. Singles & duals; ceramic & mica types. 12 values. Wt. 1/2 lb. Reg. \$19.
- 18 ROTARY SWITCHES. Scoop! Single & dual gangs. Experimenters, note! Wt. 2 lbs. Reg. \$14.
- 60 MICA CONDENSERS. Rare buy! Postage stamp type, 25 values. .0001 to .01 mf. Many sizes, 450V. too! \$1 Wt. 1/2 lb. Reg. \$17.
- 61 CERAMIC CONDENSERS. Tubular, button, disc types. 20 radio-TV values. 5mmf to .01mf. Wt. 1/2 lb. Reg. \$13.
- TEN 25 ft. ROLLS WIRE. Plastic & cloth insulated. Solid & stranded, #18 to 24. Ass'd. colors. Wt. 1 lb. Reg. \$5.
- 30 DISC CONDENSERS, ceramic. Scoop! 4.7mmf to .01 mf. 12 values; 500 to 1000V. Duals, too! Service men's must! Wt. 1/2 lb. Reg. \$12.
- 10 PANEL LITE ASSEMBLIES. 6 Ass'd. colored jewels; Dialco, etc. Some w/built-in 110VAC neon lamp. Wt. 1/2 lb. Reg. \$12.
- 25 INSTRUMENT KNOBS. Ass'd. bakelite round, knurled, pointer, skinned. Ept. type. Set-screw & brass in. Ass't. Wt. 2 lbs. Reg. \$12.
- 13 PC. TWIST DRILL KIT. Rare value! 1/16 thru 3/4", fine tempered steel, plastic case. To fit 1/2" chuck. Wt. 1 lb. Reg. \$3.
- 150 COMPONENTS. Wow! Wire; electrolytic; paper, moulded; statite tubulars; disc ceramics; micas; resistors. Ceramic leads. Wt. 1 lb. Reg. \$18.
- 25 STEATITE TUBULAR COND. by Elmenco. Better than moulded! Oil filled, statite cases; ass'd. values. 0.05 to 0.1 mf. 0 or 1000V. Wt. 1 lb. Reg. \$9.
- 2000 PCS. HARDWARE. Screws, nuts, lugs, grommets, etc. Wt. 3 lbs. Reg. \$11.
- 4 POPULAR DIODES. Exclusive! 1N23, 1N48, 1N58, 1N81. In poly bag. \$1 must! Reg. \$6.28.
- 10 TUBULAR ELECTRO-LYTICS. 10 values; 5 to 40 mf, to 500V. Multiple sections, too! Wt. 2 lbs. Reg. \$18.
- 75 KNOBS for Radio, TV, Lab. Some worth 25¢. Fuse & set-screw. 15 styles. Wt. 1 lb. Reg. \$8.
- 70 TERM. POSTS & STRIPS. Ass'd. binding posts, screw & solder lug strips (1 to 9 terms.) Wt. 1/2 lb. Reg. \$5.
- 15 VOLUME CONTROLS. More for less! 10 values. Concentric & WW, too! Some w/switch. Wt. 1 lb. Reg. \$13.
- 125 CARBON RESISTORS. 10 values! 100 ohms to 1 meg; 1/4, 1/2, 1 & 2 w. Many 5%. American made! Wt. 1 lb. Reg. \$2.
- 20 POWER RESISTORS. Wirewound. 20 values to 10,000 ohms; 5 to 50W; candlestick tubular. Wt. 1 lb. Reg. \$12.
- 30 TUBE SOCKETS, USA first! Subminiatures, 7 & 9-pin. Miniatures, 7, 9-pin. Radio, TV, lab must! Wt. 1 lb. Reg. \$9.
- 100 CERAMIC INSULATORS. Hams, note! Wide asst. standoff, panel, bushings. \$1 Wt. 3 lbs. Reg. \$15.
- 15 PRECISION RESISTORS. 0.1 to 1 meg. Carbon-film & WW. 15 values. 1% tol. 1/2 to 2 w. Wt. 1/2 lb. Reg. \$18.
- 10 T O G G L E . P U S H SWITCHES. Builders' special! Wide variety. SPST, etc. up to 15A, w/10 "ON-OFF" \$1 plates. Wt. 1 lb. Reg. \$8.
- 6 PC. SCREWDRIVER KIT. Shockproof plastic handle, tempered steel drivers. All different; in plastic case. Wt. 1/2 lb. Reg. \$3.
- 50 SOCKETS & RECEPTA-CLES. Wide variety. For AC lamps, pilot lights, audio, UHF power. Wt. 3 lbs. Reg. \$12.

HOW TO ORDER Check items wanted. Return entire ad with check or MO (incl. sufficient postage; excess returned. C.O.D. orders 25% down. Rated, NET 30.

LEKTRON SPECIALTIES E 12
28 Gardner Street Chelsea 50, Mass.

NAME (please print)
STREET
CITY ZONE STATE

Enclosed \$..... merch. \$..... postage. Ship C.O.D.
WRITE FOR OUR NEW CHRISTMAS BULLETIN!

MAGIC of remote RADIO CONTROL

For model airplanes, boats, cars, etc. No operator's license required. FREE—SEND FOR FCC FORM 505

RADIO CONTROL BEGINNERS' SPECIAL. Wired & Tested Powerful 1-Tube TRANSMITTER plus 5 Case PLUS Series 1-Tube RECEIVER PLUS popular ESCAPEMENT. Complete. Ready to operate, less batteries. \$29.95

GYRO RADIO CONTROL TRANSMITTERS. 27.255 Mc. Most POWERFUL 5 Watt TRANSMITTER—LOWEST PRICE. Famous 2 Tube MAC II circuit, with GYRO MAGIC TUNING INDICATOR. Completely Tested, includes: 9 1/2 ft. sect. Antenna, Remote "Clicker" Keying Switch, Sierler, Beaut Cabinet 12x7x6, with built-in 2V Storage Battery, Vibrator Supply, Battery Charger. **GYRO MODEL XI TRANSMITTER** Guaranteed. Complete. \$39.50



RADIO CONTROL TRANSMITTER & RECEIVER KIT—27 1/2 mc. Band—License Free. All Parts & Diagr. (test tubes & crystal to build Powerful 5 Watt Transmitter Unit & 2-Tube Receiver w. SIGMA RELAY, wound coils, drilled bases. \$9.95

- | | |
|------------------------------------------------------------------------------------------------------------|-------|
| LORENZ 2-TUBE RECEIVER KIT with Tubes and Relay | 13.95 |
| SIGMA 4F RELAY: 8,000 ohm, 54.25; R/C Escapement | 3.95 |
| MCENTREE'S "RADIO-CONTROL HANDBOOK" | 2.25 |
| CRYSTALS: 27.255 Mc. Petersen Z9A 53.95; HOLDER | 1.15 |
| Supersensitive RELAY: 5000 ohm 1/2 Ma. | 2.50 |
| RELAY CONTROL—w. Sigma 10K Relay, Hi-impedance Audio Choke, Thermal Switch, Alnico Magnet, Neon Lamp, etc. | 1.25 |
| Electronic STROBOSCOPE—Stops motion—Complete | 17.95 |
| CRYSTAL SET KIT w. EARPHONE | 2.61 |
| TELEPHONE PICK-UP KIT (P.E. Sept. '55) w. Case, TRANSISTORS, Pick-up Coil, etc. \$9.95; PICK-UP COIL alone | 3.50 |
| 100 Standard Assorted CARBON RESISTORS | 1.25 |
| SUBMINI PARTS: RELAY 5000 ohm \$4.95; ESCAPEMENT Phone PLUG 51 pr. pots many sizes | 3.95 |
| EARPHONES HI-impedance \$1.95; 25 MF 3V Condensers | 1.50 |
| MINI VIBRATOR SUPPLY 6V input 90VDC, 15 Ma. | 3.45 |
| TUBES: XFG1, RK61, 3A4, 5A5, 1A4, 1S4, 354, 3V4, 3Q4, 6K4. | 6K4 |
| TRANSISTORS: New Top Brand N.P. \$2.50, New Diodes | .45 |
| BOOK: "TRANSISTORS," \$2.00; 2-0 V. CHARGER KIT | 4.95 |
| Storage BATTERIES: Min. 6V, N76 \$2.45; 2V, 27A II | 2.75 |
| ALL MATERIALS GUARANTEED—FREE CATALOG (1 pr.) Save C.O.D. fees, include postage, excess refunded. | |

GYRO ELECTRONICS CO.

325 CANAL STREET W., NEW YORK 13, N. Y. Worth 6-1290

GIANT CATALOG

NEW LISTINGS—1956 ELECTRONIC SPECIALS

Listing thousands of surplus electronic and mechanical bargains for experimenters, hobbyists, engineers—10c coin or stamps.

- | | |
|------------------------------|------------------------|
| Rectifiers @ 29c ea. | Transformers @ 49c ea. |
| Controls @ 29c ea. | Bulbs @ 2c ea. |
| Switches @ 6c ea. | Motors @ 99c ea. |
| Automatic Steppers @ 95c ea. | |

ROTARY MOTOR

Ideal for Door Openers, Air Shutter Controls, Gate Closers, Etc.



12 V.D.C. gear-motor converted for 115 vac. 3/4" dia. x 1" L. Shaft 1.5 RPM @ 75 inch lbs. Two self contained relays for automatic stop and reversal for three variable pre-set positions over 180 degrees. (May be bypassed for 360 degree rotation.) Meas. 4 1/2 x 5 1/4". Precision built for U.S.A.F. by White Rodgers. Send only \$8.75 plus postage for motor and voltage converter (115 VAC to 12 VDC). Send 10c in coin or stamps for latest catalog listing motors, rectifiers, timers, transformers, counters, electro mechanical equipment.

SOUNDTRONICS • 632 ARCH ST., Dept. P-7, PHILADELPHIA, PA.

R/C BIBLIOGRAPHY

A handy index to all radio control articles which have appeared in Popular Electronics and eight other magazines.

Indexes boats, planes, vehicles, receivers, transmitters, actuators, general articles, and gadgets. Makes each article available even to page number.

Punched for 5 1/2 x 8 1/2" loose leaf binder. Acceptance has made price reduction possible. Now only \$1.00.

Just off the press—Catalog 56-1. 20 pages, fully illustrated. Lists hundreds of R/C kits and components. It's free.

ACE RADIO CONTROL

Box 301 Higginsville, Mo.

LEARN

MEAT CUTTING



Train quickly in 8 short weeks at Toledo for a bright future with security in the vital meat business. Big pay, full-time jobs—HAVE A PROFITABLE MARKET OF YOUR OWN! Pay after graduation. Diploma given. Job help. Thousands of successful graduates. Our 32nd Year! Send NOW for FREE catalog. No obligation. G. I. Approved. NATIONAL SCHOOL OF MEAT CUTTING, Dept. 59-D, Toledo 4, Ohio

Pakistan—Karachi, 11,845 kc., is very strong at 2000 with English announcements. They are prompt with their QSL cards. (MF)

Rumania—Radio Bucharest, 9570 kc., s/off in English at 2225, and identity tone stays on until 2230. Following program is in language. (DB)

South Korea—The American Forces Korea Network operates via Radio Station Vagabond at Seoul, on 6985 kc., with 250 watts. All transmissions are in English at 1630-1230. Station operates dual with the b.c.b. outlet and is not identified separately. Identity on the hour and half-hour is: (a) "This is AFKN, the American Forces Korea Network"; (b) net cue (four ascending tones); (c) a spot announcement "This is Vagabond," followed by a time check. (SS)

Spain—Madrid, 9360V, usually has a program of Music of Spain at 1830. Signal strength is nearly always good. (FB)

Sweden—The schedule of Radio Sweden from Stockholm, valid to April, 1956, is as follows: to Eastern North America at 0700-0715 on 11,705 kc. (SBP), and at 1930-2000 and 2100-2145 on 9620 kc. (SBU). (DS, RR)

Switzerland—The complete current schedule from Radio Switzerland is as follows: to North America on HER3, HER4, HER5 at 2030-2215, 2315-0000; to South Africa on HER7 at 0945-1130; to Eastern Australia and New Zealand on HER5, HER6, HEU7 at 0215-0400; to Western Australia and the Far East on HER5, HER6, HEU7 at 0400-0445; to Southeast Asia and Japan on HER6, HEU7, HER7 at 0745-0930; to India and Pakistan on HER5, HEU7 at 0945-1130; to the Middle East on HER5, HER6 at 1145-1330; to the United Kingdom and Ireland on HER3 and HER5 at 1345-1530. Frequencies used are: HER3—6165, HE13—7210, HER4—9535, HEU3—9665, HE15—11,715, HER5—11,865, HER6—15,305, HEU6—15,315, HEU7—17,720, HER7—17,784 kc. A "DX Program" is featured the first Thursday of each month. During the North American transmission, it can be heard from 2100-2115 and 2345-0000. (KM)

Venezuela—The Venezuelan 3000-kc. stations have been reassigned channels ending in 5 kc., and some have moved to the 2000-kc. band. Here is the revised list of assignments: Radio Monagas, Maturin, YVRA, 2360 kc.; Radio Girardot, Maracay, YVLG, 2440 kc.; Radio Carora, Carora, YVMU, 2470 kc.; Radio Cabimas, Cabimas, YVMK, 2480 kc.; Radio Libertador, Caracas, YVKT, 3245 kc.; La Voz de El Tigre, El Tigre, YVOL, 3255 kc.; Ecos del Torbes, San Cristobal, YVQC, 3265 kc.; Radio Mara, Maracaibo, YVMC, 3275 kc.; Radio Puerto Cabello, Puerto Cabello, YVLE, 3285 kc.; Radio Trujillo, Trujillo, YVOG, 3295 kc.; La Voz de la Patria, Caracas, LVKX, 3305 kc.; Radio Maracay, Maracay, YVLI, 3315 kc.; Radio Carupano, Carupano, YVQG, 3325 kc.; Ondas Portenas, Puerto La Cruz, YVQN, 3335 kc.; Radio Tropical, Caracas, YVKP, 3345 kc.; Radio Valencia, Valencia, YVLD, 3355 kc.; La Voz de la Fe, Maracaibo, YVMI, 3375 kc.; Emisoras Unidas, Barcelona, YVQI, 3385 kc.; and Radio Universidad, Merida, YVOJ, 3395 kc. A few of the stations may not have moved to their new channels as yet. (RL)

ARE THESE IN YOUR ATTIC?

WANTED



Berliner Gramophone (illustrated).

Toy Gram-ophone or Phonograph (illustrated).

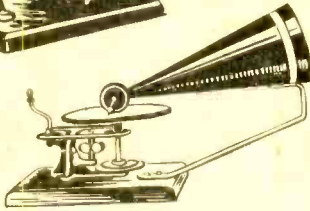

ALSO

WANTED . . .
 Columbia Grand Graphophone.
 Hill Talking Machine.
 Improved Gramophone (Zon-o-phon).
 Eagle Graphophone.
 Victor Models A, B, C & D.
 Friend Talking Machine.
 Columbia AY Disc Graphophone.
 Edison Concert Phonograph.
 Edison and Columbia Coin Machines.
AND Miscellaneous disc and cylinder phonographs with "outside" horns.

Send snapshot and description to
POPULAR ELECTRONICS, Box 50
 366 Madison Ave., N. Y. 17, N. Y.

SAVE *over* 50%

BUILD YOUR OWN Superb Lifetime HI-FI SYSTEM

and COMPLETE HOME
 ENTERTAINMENT
 UNIT

FREE

"Guide to Hi-Fidelity."
 Valuable booklet gives you expert inside info on Hi-Fi. Shows how to save hundreds of dollars on finest system you can assemble.

ONLY \$10.00

Gets you started. Rush coupon for details.

TRANSVISION, INC., NEW ROCHELLE, N. Y. Dept. P.E. 12

Rush FREE "Guide to High Fidelity" and complete details on "Build Your Own" Hi-Fi System.

Name

Address

City State

Get This Valuable Book

FREE



Just for Examining COYNE'S New 6-Volume Set

"Applied Practical Radio-Television"

ON 7 DAY FREE TRIAL!



Yes, you get this big, brand new book, "150 Radio-Television Picture Patterns and Diagrams Explained", absolutely FREE! Just off the press! Gives complete wiring circuits and diagrams on the latest Radio and Television Sets. Easy-to-read, large 8½ x 11" pages, with full instructions on how to read and use the diagrams. A "must" in every Radio and Television service-man's repair kit. You get this valuable book as a FREE Gift for asking to see Coyne's great new 6-book set, "Applied Practical Radio-Television"!

Here's "Know-How" That Makes You Worth More!
 Coyne's great new 6-volume set gives you all the answers to servicing problems—quickly! For basic "know-how" that is easy to understand, you'll find everything you want in volumes 1 to 5 which contain over 5000 practical facts and data. They cover every step from principles to installing, servicing, trouble-shooting and aligning all types of radio and TV sets. So up-to-date it includes COLOR TV and UHF, adaptors and converters. Also covers very latest information on TRANSISTORS.

900-Page Television Cyclopeda Included
 And then, for speedy on-the-job use, you get volume 6—the famous COYNE TELEVISION CYCLOPEDIA. It answers today's television problems on servicing, alignment, installation and others. In easy-to-find ABC order, cross indexed. Use this 6 volume TV-RADIO LIBRARY free for 7 days; get the valuable Servicing Book ABSOLUTELY FREE!

SEND NO MONEY! Just mail coupon for 6-volume set on 7 days free trial. We'll include book of 150 TV-Radio Patterns & Diagrams. If you keep the set, pay \$3 in 7 days and \$2 per month until \$22.50 plus postage is paid. (Cash price \$20.95). Or you can return the library at our expense in 7 days and owe nothing. **YOU BE THE JUDGE.** Either way, the book of TV-Radio Patterns is yours FREE to keep! Offer is limited. Act NOW!

FREE BOOK—FREE TRIAL COUPON!

Coyne Electrical School, Educational Book Pub. Div., Dept. C5-PE
 500 S. Paulina St., Chicago 12, Ill.

YES! Send 6-volume "Applied Practical Radio-Television" for 7 days FREE TRIAL per your offer. Includes TV-Radio Patterns, & Diagram Book FREE.

Name Age

Address

City Zone State

Where Employed
 Check here if you want library sent CGD. You pay postman \$20.95 plus COD postage on delivery. 7-day money-back guarantee.

COYNE

Educational Book Publishing Division

ELECTRICAL SCHOOL

500 S. Paulina St., Dept. C5-PE Chicago 12, Ill.

INSIST ON ACME BATTERY HOLDERS

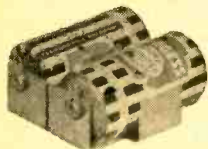

No. 10A



No. 14

The following Acme Battery Holders are stock sizes. Many other batteries, aside from those listed, will fit our holders.

1 for 1 miniature pencil .25	*12A for 2 large batteries .40
2 for 2 miniature pencils .50	(solder lugs at one end only)
(4 connection type)	13 for 1 22 $\frac{1}{2}$ v. such as Burgess U-15, etc. .30
*2A for 2 miniature pencils .40	14 for 2 22 $\frac{1}{2}$ v. as above .50
(solder lugs at one end only)	15 for 3 22 $\frac{1}{2}$ v. as above .85
3 for 3 miniature pencils .65	16 for 1 Burgess 22ZP1, etc. .35
4 for 4 miniature pencils .85	17 for 1 30v. such as Eveready 506E, etc. .50
5 for 1 regular pencil .30	18 for 2 30v. as above .75
6 for 2 regular pencils .50	19 for 1 30v. such as Eveready 413, etc. .35
(4 connection type)	20 for 2 30v. as above .60
*6A for 2 regular pencils .40	21 for 2 regular pencils with switch .65
(solder lugs at one end only)	22 for 2 medium C cells with switch .65
7 for 3 regular pencils .65	23 for 2 large D cells with switch .65
8 for 4 regular pencils .85	27 for 3 medium cells .75
9 for 1 med. battery (size C) .30	28 for 3 large cells .75
10 for 2 medium batteries .50	31 for 1 15v. cell .35
(4 connection type)	44 for 1 RM-12 Malory .30
*10A for 2 medium batteries .40	
(solder lugs at one end only)	
11 for 1 lge. battery (size D) .30	
12 for 2 large batteries .50	
(4 connection type)	

If not available at your dealer, order by mail. Add 5¢ for each holder. No C.O.D.

- A complete range of voltages available.
- Approved fibre insulation at all connections.
- Spring tempered aircraft aluminum.
- Pre-tinned copper solder lugs for easy soldering.
- Mounting holes provided on all holders.
- For use wherever dry cell battery power is needed.
- Used in Geiger Counters, Radios, Window Displays, Toys, Meters, Lights, Automobiles, and many other uses.

Dealers, Jobbers, Manufacturers—Write for Prices and Delivery.

ACME MODEL ENGINEERING CO.

8120 7th Ave. Room 312 Brooklyn 9, N. Y.

Short-Wave Notes

Here are some notes on s.w. stations which are planning to increase power, change frequency, go on the air, or start services to certain areas. Further details are requested:

Germany—*Deutsche Welle* is planning two 100-kw. s.w. xmtrs for 1956.

Netherlands—PCJ is to put into service a new 100-kw. s.w. xmtr soon after February 1, 1956.

Portugal—*Radio Club Portugues* has a 10-kw. station under construction. It will operate on 21,580 kc.

Spain—*Red de Emisoras del Movimiento* (R.E.M.) has a 20-kw. station planned for Madrid.

French Cameroon—The station will be improved in January, 1956, and new wavelengths will be adopted.

Gold Coast—*Radio Accra* will install a new 20-kw. xmtr shortly.

Portuguese Guinea—Plans are to increase power on 5838 kc. to 5 kw.

Nigeria—3970 kc. is being tested. Time may still be 0900-1700. Power, 2500 watts.

Ivory Coast—They will experiment on 4824 kc. with 3000 watts.

Sao Tome—Plans are to establish a 10-kw. s.w. transmitter.

Afghanistan—*Radio Kabul* has two 100-kw. xmtrs under construction.

Jordan—A 5000-watt xmtr is being planned for s.w. to parallel the m.w. outlet.

Burma—Three 50-kw. xmtrs are planned for February, 1956.

Portuguese India—Goa is planning 10-kw. xmtrs for 15,235, 17,795, and 21,685 kc.

South Korea—A powerful s.w. xmtr which will have at least one beam to North America is planned.

Barbadoes—The station operates on 7547 kc. during the beginning of March and August and again about the middle of November. Power is 5000 watts. (MS)

-30-

NEW! PRINTED CIRCUIT Transistor Radio

Pocket size—works anywhere

- Features P-N-P Junction Transistor
- Permeability tuning, Diode detection
- Printed circuit eliminates extra wires
- Batteries last for months
- Expensive hearing aid headset included
- Furnished complete, nothing else to buy

Here is a powerful, completely portable radio, employing the latest type of transistor audio amplification and printed circuitry. Tiny size, only 2 $\frac{3}{8}$ "x 3 $\frac{1}{2}$ "x 3 $\frac{3}{4}$ " fits in pocket or purse. Uses so little current, batteries last for months. Kit can be assembled by anyone with just a soldering iron. Or furnished complete and tested, ready to use. Guaranteed to work. Comes complete with plastic case, batteries, headset, all parts. Nothing else to buy. Send for yours, today!

Send no money. Just pay postman \$9.95 plus C.O.D. charges, or send check or money order for \$9.95 and we pay postage.

TRADYNE, INC., 11 W. MONUMENT AVE., DAYTON 2, OHIO Dept. E-3



Only \$9.95 Postpaid
in kit form
or wired and tested
for only \$12.95

GET INTO ELECTRONICS

You can enter this uncrowded, interesting field. Defense expansion, new developments demand trained specialists. Study all phases radio & electronics theory and practice: TV, FM, broadcasting, servicing; aviation, marine, police radio. 18-month course. Graduates in demand by major companies. H. S. or equivalent required. Begin Jan., March, June, Sept. Campus life. Write for Catalog.

VALPARAISO TECHNICAL INSTITUTE

Dept. PE Valparaiso, Indiana

SHORT-WAVE CONTRIBUTORS

Bobby Wilkins (BW), Honey Grove, Texas.
Charles Goodsole (CG), Grand Island, N. Y.

David Anderson (DA), Ferndale, Calif.

DuWayne Boston (DB), Max, N. D.

Donald Cader (DC), Oakland, Calif.

David Essenreich (DE), Greenville, Ill.

Dale W. Smith (DS), no address available

Emmet Riggle (ER), Massillon, Ohio

Floyd Backus (FB), Richmond, Va.

Fred Kellogg (FK), Urania, La.

John Beaver (JB), Pueblo, Colo.

Joie Jones (JJ), Abilene, Texas

J. Art Russell (JR), Sacramento, Calif.

Kurt Meyers (KM), Columbus, Ohio

Louis Marcarelli (LM), Medford, Mass.

M. P. Frutchey (MF), Winter Park, Fla.

Mike Gulley (MG), San Antonio, Texas

Martin Potter (MP), London, Ontario

Mario Stutterheim (MS), Baltimore, Md.

Paul Mathieu (PM), Southbridge, Mass.

Roger Legge (RL), McLean, Va.

Rolan Riker (RR), San Bernardino, Calif.

Simon Scheiner (SS), Margate, N. J.

TIPS and TECHNIQUES

ASBESTOS BLOCK PRESERVES BENCHES

A piece of $\frac{1}{4}$ " or $\frac{1}{2}$ " asbestos in block form, about 6" square, will prevent your workbench from overheating. Material being worked on can also be protected this

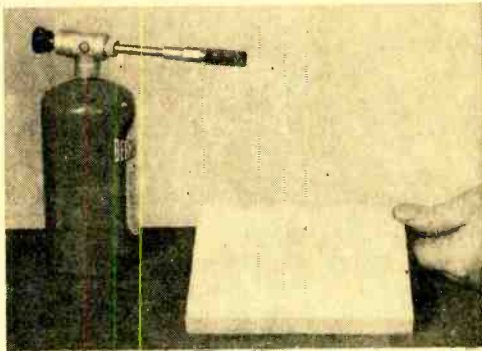

way; small items may be placed directly on the asbestos block while the torch and alloy are held in the user's hands.

LINE TEST ADAPTER

Often it is necessary to check a.c. line voltage, if only to make sure that power is available at a particular receptacle. But regular test prods don't fit too well into the narrow receptacle slots, and inserting wires or strips of metal in the receptacle may be dangerous, possibly causing shorts and increasing the possibility of shock.

Line voltage tests can be simplified by making a "line test adapter" to fit your

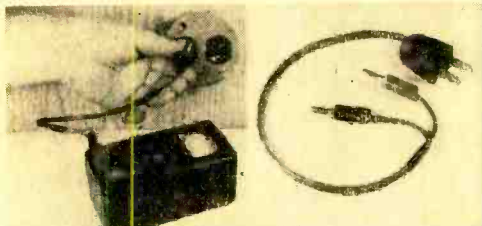

multitester. Use a short piece of line cord, a plug, and two connectors, assembled as shown. This particular adapter is equipped with banana plugs, but phone tips may be used if required by your meter.

Proper use of the adapter is shown in the photograph. The meter plugs of the adapter

Can you think faster than this machine?

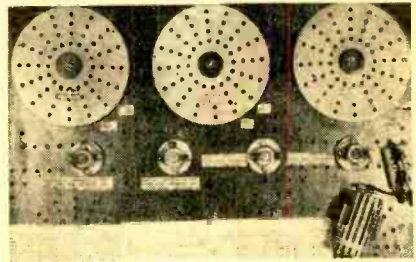

Control Panel of GENIAC set up to do a problem in check valve research.

Be careful before you answer. GENIAC the first electrical brain construction kit is equipped to play tic-tac-toe, cipher and encipher codes, convert from binary to decimal, reason (in syllogisms) as well as add, subtract, multiply and divide. Specific problems in a variety of fields—actuarial, policy claim settlement, physics, etc. can be set up and solved with the components. Connections are solderless and are completely explained with templates in the manual. This covers 83 circuits and shows how new ones can be designed.

You will find building and using GENIACS a wonderful experience; one kit user wrote us: "this kit has opened up a new world of thinking to me." You actually see how computing, problem solving, and game play (Tic-tac-toe, nim, etc.) can be analyzed with Boolean Algebra and the algebraic solutions transformed directly into circuit diagrams. You create from over 400 specially designed and manufactured components a machine that solves problems faster than you can express them.

Schools and colleges, teachers of science or math, engineering, philosophy or psychology will find these excellent demonstrators of circuitry, solutions in symbolic logic, theory of numbers, cybernetics, and automation.

Note: Teachers take advantage of our 10% discount to educational institutions and for group purchases.

FREE CONSULTATION SERVICE FOR AMATEUR RESEARCHERS

We will help you plan your reading and research projects on computers using Geniac, at no extra charge.

Complete question and answer service available to kit buyers.

Each kit is a self contained course with materials and books.

Complete guarantee on all materials if not satisfactory returnable for full refund in one week.

SEND for your GENIAC kit now. Only \$19.95 with over four hundred components and parts, fully illustrated manual and wiring diagrams. We guarantee that if you do not want to keep GENIAC after one week you can return it for full refund plus shipping costs.

----- MAIL THIS COUPON -----

SCIENCE KITS, Department PES,
Oliver Garfield Co., 126 Lexington Ave., New York 16, N. Y.

Please send me:

- 1 GENIAC Electric Brain Construction Kit and Manual.
 - \$19.95 (East of Mississippi)
 - \$20.95 (Elsewhere in United States)
 - \$21.95 (Outside the United States)

1 Catalog of Science Kits

Returnable in seven days for full refund if not satisfied.

I enclose \$..... in full payment.

My name and address are attached.

NEW!

**WORLD'S SMALLEST PRECISION
SUPER POWER
2 Transistor Radio**

- Printed circuit with power pack.
- Plays Instantly, No warm-up.
- "Impact-resistant" plastic case.

Not a toy! Professionally engineered precision high-powered set, guaranteed to far out-perform any 1 transistor set. Tunes local broadcast stations with clear tone. No "ground" connections or cumbersome aerial wires. Features permeability tuning, diode detection, hermetically sealed transistors. Full size 2" x 3" x 3/4". Smaller than a cigarette pack. Operates months on 2 pen cells. Plays anywhere; at beach, on boat, ball game or golf course.

Lets you listen to programs in full privacy. Ideal for Civil Defense receiver. Exclusive 430 printed circuit with power pack shows many hook-ups.

Ideal Xmas Gift!

Eastern Audio Research Corp.
P.O. Box 2, Huntington Sta., N.Y.

**COMPLETE
RADIO KIT \$9.95**
p.p.d.
Exclusive 8,000 ohm 2005 hearing aid ear set \$3.95
Send only \$1. Pay postman balance plus COD charges.

NEW! PERSONAL POCKET RADIO

**LISTEN WHILE YOU
WALK, RIDE, WORK!**



Slips in any pocket—Wt. only 6 ozs. Size 2 3/4" x 4 3/4" x 1 3/8". Beautiful Black Gold plastic case. NO HOOKUPS—NO WIRES—NO PLUG-INS! Self contained with hour life flashlight batteries. (Available anywhere) and BUILT-IN ANTENNA!

GUARANTEED RECEPTION OF RADIO STATIONS TO 50 miles—up to 1500 miles for powerful stations! Has new Patented Super-regenerative Diatriode tube and transformer audio stages for sharp selectivity and sensitivity! Easy to use top controls (while walking). Almost invisible plastic foam personal earplug lets you alone listen while you walk, visit, work, ride or sleep—anytime—anywhere. **GUARANTEED to work—1 Year guarantee.**

SEND ONLY \$5.00 (Ck. Mo) and pay postman \$14.95 plus postage on delivery or send \$19.95 for postpaid delivery. Get YOUR Tinytone REAL pocket radio now and be ready to listen to Civil Defense alarms, news, music, sports, etc. on a moment's notice. Not a kit! Shipped complete with batteries—Order now—today.

WESTERN RADIO Dept. APL-12 Kearney, Nebraska

VHF AM-FM RADIO

Supersensitive sub-miniature tube set receives television, FM broadcast, CAP, and amateurs without antenna or ground. Tunes from 75 mc. to 150 mc. Similar models available in frequency bands from 27 mc. to 225 mc. Pocket size—measures only 2" x 2" x 2 1/2" —highest quality components used. Specify battery or AC model. Use with any magnetic headphone or can be connected to audio amplifier for loudspeaker operation. Thousands in use by amateurs, experimenters, and civil defense. Factory wired and tested chassis complete with special tube only \$5.99 postpaid. In kit form \$3.98. Postage extra on COD orders. New transistor audio amplifier for extra loud reception only \$2.00 including transistor.

SPRINGFIELD ENTERPRISES
Springfield Gardens 13, N. Y.

Box 54-E

MAGNETS

ASSORTED MAGNETS with big list of handy uses.....5 for \$1
POWERFUL POCKET MAGNET ideal for testing metals.....\$1
RETRIEVING MAGNET pulls tools, etc., from tank or lake.....\$4
HOT PAD MAGNETS to insert in your own hot pads......8 for \$1
BULLETIN BOARD MAGNETS to "pin-up" memos, etc......8 for \$1
EXPLORE, LEARN—Electricity, Magnetism, Electro-Magnets, Complete Kit & Instructions with 22 experiments and models.....\$3.98
Free Catalog. 100% Satisfaction Guaranteed.....POSTPAID
PARK MAGNETS, 13511, 1557 Greenbay Rd., Highland Park, Ill.

INVENTORS

Learn how to protect your invention. Specially prepared "Patent Guide" containing detailed information concerning patent protection and procedure with "Record of Invention" form will be forwarded to you upon request—without obligation.

CLARENCE A. O'BRIEN & HARVEY JACOBSON
Registered Patent Attorneys

59K District National Bldg. Washington, S. D. C.

are inserted in the "a.c. voltmeter" jacks of the multitester, and the instrument is set to a range *higher than 120 volts*. Then the line plug is inserted in the receptacle to be checked, and line voltage is measured. When checking duplex receptacles, the line plug should be tried in both sides.

INEXPENSIVE PUSH-BUTTON /SWITCH

If you need a simple push-button switch in a hurry, here's how to make one from a spring-type clothespin. First, take apart the clothespin. Mount one piece on a small block of wood, using screws at each end, and a soldering lug under each screw head. Next, drill pilot holes to avoid splitting the narrow wood. Drill two holes in the other piece of the clothespin, located so that they

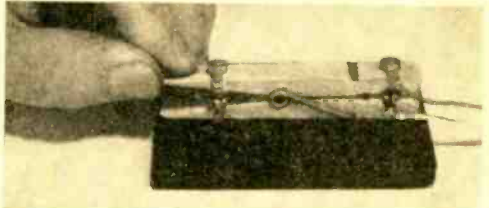

fall opposite the mounting screws when the clothespin is reassembled. Then mount small machine screws and soldering lugs in each hole.

Reassemble the clothespin, attach lead wires, and you're ready for business! Use one set of screws as the "normally open" contacts, the other set as the "normally closed" contacts. By tying the two lower lugs together with a jumper, you can make a s.p.d.t. switch.

The completed switch also makes an inexpensive "hand key" for code practice.

"TWO FOR ONE"

Small filter chokes connected in parallel will serve in place of a single large choke if the parts box fails to yield a choke of ample capacity. Two 60-ma. chokes were wired in parallel to provide the 120-ma. ca-

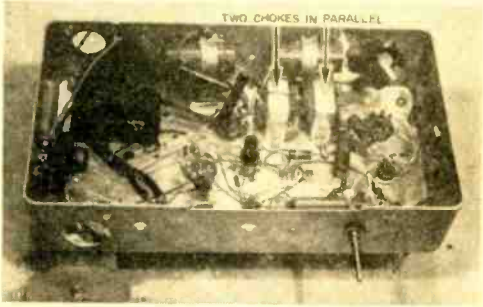

capacity required for the power supply of the radio illustrated.

In some cases, radio supply houses offer bargains in smaller-size filter chokes where-by two chokes can be purchased for less

than the cost of a single, larger capacity choke. The chokes used in this manner should be of equal capacity and resistance to avoid overloading any single unit.

ADD VISE TO PORTABLE DRILL

A drill vise may be clamped to a light drill stand with only a mounting base by blocking up the base and using longer mounting screws. This arrangement leaves space for "C" clamps beneath the base. The drill vise shown is 10½" by 2½" with a circular piece of ⅜" brass mounted for drilling. Such a setup can make for faster and more accurate work.

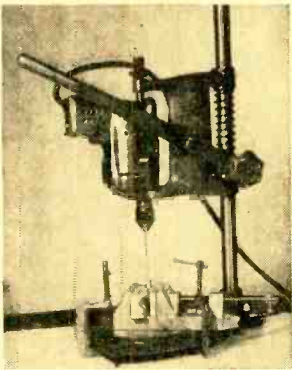

HUM-FREE POWER SUPPLY

An improperly located power supply filter choke may sometimes introduce hum in radio and amplifier circuits due to the manner in which the field of the power transformer affects the filter choke. To determine the best location for the filter choke,

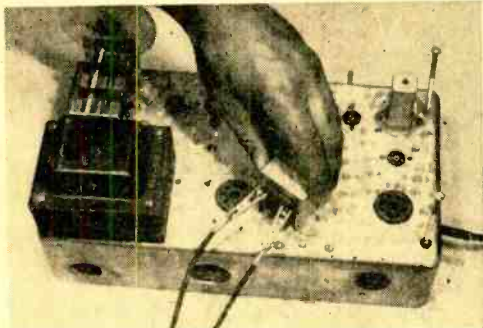

first clip a set of headphones across the choke terminals. Then, with the primary of the power transformer connected to the a.c. line, move the choke about the chassis until a position is found where no hum is heard in the headphones.

Select the most convenient hum-free location for permanent mounting of the filter choke. Do not use any direct connection between the power transformer and choke while making this test, and be sure that the secondary of the power transformer is disconnected.

BOTTLE CAPS MAKE KNOBS

Plastic bottle caps can be turned into decorative knobs for radio and electronic equipment. Just pack a bottle cap with plastic wood and carefully force the cap on

STOP! STOP!

DON'T PASS THESE BARGAINS BY!

AT THE
World's Largest Distributor
of Amateur Radio Equipment

Quality

GOVERNMENT SURPLUS!
(In Original Cartons - Complete With Tubes)

✓ BC-455 Receiver

6 tubes, tunes 6-9.1 mc. Excellent for 40M band. Very stable. Cat. No. XA 084.

Only \$6.95

✓ BC-458A VFO

Radio Xmtr., excellent for single sideband VFO. Tunes 5.3-7 mc. Cat. No. XA 082.

Only \$7.95

✓ BC-459A VFO

T-22/ARC-5 Xmtr. Tunes 7-9.1 mc. Excellent as VFO for 40M. Extremely stable. Cat. No. XB 083.

Only \$7.95

✓ PC-8417 Transformer (Stancor)

Pri: 117 VAC. Sec: 220V CT @ 50 MA. For receiver power supply (BC-455 above) and other Command Receivers. 6.3V—6 amp, 25.2V—5 amp. Cat. No. 13B156.

Only \$4.44

NOW AVAILABLE . . .

The New & Improved
65A GLOBE SCOUT

Completely Bandswitching
65 watt Xmtr.



Only \$7.95 per mo. — pay just \$10.00 down

Cash price: \$99.95

FREE 1956 CATALOG

Listing over 15,000 top-values!

SAVE
UP TO
50%
on
Guaranteed
Recond.
Equipment

Ask
About
WRL's
New
Code
Oscillator
Kit

Send
for WRL's
Wall-
Sized
**RADIO
MAP**
(only 25c)



All Prices Subject To Change Without Notice!



WORLD RADIO LABS
3415 WEST BROADWAY
COUNCIL BLUFFS, IOWA

PE-12

- Please rush me your latest **FREE Catalog!**
Send me complete information on your
 Brand New Govt. Surplus Eqpt. 65A
Globe Scout Recond. Eqpt. List Code
Oscillator Kit Radio Map (25c)

Name: _____

Address: _____

City & State: _____

EXCITING HIGH FIDELITY
From your HOME TAPE RECORDER

FROM **\$19.95** COMPLETE

30 thru 15,000 cycles at 7.5 I.P.S. to Input of Home Music System

DYNAMŪ
CONVERSION KIT

FOR YOUR Pentron, Revere, RCA, Wilcox Gay, Knight, Concertone, etc.
 Ask your dealer or write!

Write: **DYNAMŪ, Maico Bldg., Minneapolis, Minn.**

LMB BOX CHASSIS

Precision Engineered

Flangelocking 65 sizes and shapes for the laboratory, manufacturer, industrial, experimenter, builder, and general application where metal boxes are required. Stocked by all electronic and geophysical distributors. Send for free catalog.

LMB 1011 VENICE BLVD. LOS ANGELES 15, CALIF.

INVENTORS

Send for **PATENT INFORMATION** Book and **INVENTOR'S RECORD** without obligation

GUSTAVE MILLER
 126-PE WARNER BUILDING WASHINGTON 4, D. C.

REGISTERED PATENT ATTORNEY
 ASSOCIATE EXAMINER U.S. PAT. OFF. 1922-1929
 Patent Attorney & Advisor U. S. NAVY DEPT. 1930-1947
PATENT LAWYER

NEW! WRIST RADIO

Amazingly powerful! Plays while you wear it. 400-mile reception using just its own antenna. No connection needed to ground, aerial, lamp, telephone, etc. Tunes entire broadcast band with sharp selectivity. **BUILD YOUR OWN**—New book has complete instructions. How-to-do-it book \$1.98 postpaid. Also a basic kit consisting of attractive pre-drilled case, "outline" chassis, and all necessary hardware \$2.98 ppd. Combination of book and basic kit. **SPECIAL \$3.98 postpaid. C.O.D.'s \$1 deposit.** Huckert Electronics, Box 7400-L6, Washington 4, D.C.

1N34A CRYSTAL DIODES @ 49c Ea. or 5 for \$2.00.

Phone Amplifier @ \$3.99 Ea. or 10 for \$37.50. Aluminum polished enclosed chassis—on and off volume control—Tone control—Selenium rectifier—Audio output Transformer for 3.2 ohms V.C.-25L6 Tube.

Surprise package for beginners of more than 2 lbs. of parts and tubes from our R & D labs, \$1.00.

MacFARLANE INDUSTRIES
 P. O. Box 208 Culver City, California

EASY TO LEARN CODE

Learn or increase speed with an Instructograph—the Radio-Telegraph Code Teacher that takes the place of an operator-instructor and enables anyone to master code without further assistance. Available tapes from beginners alphabet to typical messages on all subjects. Speed range 5 to 40 WPM. Always ready—no QRM. Thousands have "acquired the code" with the Instructograph System. Write today for convenient rental and purchase plans.

INSTRUCTOGRAPH COMPANY
 4713-P Sheridan Road, Chicago 40, Illinois

the control shaft. Leave it in this position until the filling has hardened.

Knobs fitted to fluted and step-cut control shafts in this manner seldom require a retaining screw. For round shafts, it is a



simple matter to drill and tap a filled cap for a retaining screw. The cap from a shaving cream can and a tooth paste tube provided the control knobs for the electronic photo timer illustrated.

LAMP AIDS CHASSIS WORK

A small desk or sewing lamp, using a 7½-watt bulb, will light up dark corners of radio and TV chassis. Purchased at most chain or hardware stores, such lamps rest on a flat surface, although a lamp with a plastic base, socket, and shield may be hung safely over wires and parts. The lamp shield can be turned around the bulb as desired.

BOOSTER FOR BUILT-IN ANTENNAS

A sheet of metal fastened to the bottom of a radio cabinet will sometimes serve as a booster for the conventional built-in antenna. The sheet metal may be attached to the cabinet by whatever means is convenient, but it must not contact any part of the radio chassis. Lining the inside top and sides of the radio cabinet with aluminum foil will serve the same purpose. In both

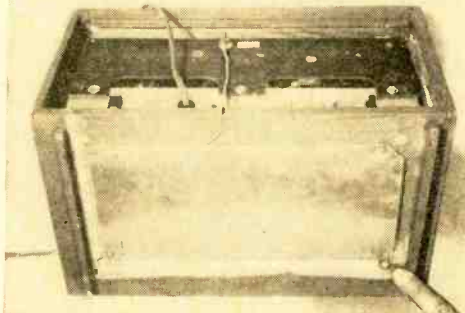

cases, the metal is attached to the antenna post with a short length of hook-up wire. Either method provides increased signal pickup without the disadvantage offered by a dangling length of wire.

The Transmitting Tower

(Continued from page 81)

results. But do not fret too much if you do not make it. My own dipole is only 24' high, and I have worked all states many times with it on 80 meters, using a transmitter power of 50 watts or less.

Shortened Dipoles

Of the many other antenna systems that might be described, one of special interest to amateurs with limited space is the center-loaded dipole. It is half the length of a standard half-wave antenna, but is made electrically resonant to the desired frequency by inserting a low-loss loading coil in its center. Except for a slight loss in efficiency it performs just like a full-size dipole.

Suitable coils for use in shortened dipoles have been advertised in recent issues of POPULAR ELECTRONICS and are available from most amateur parts distributors.

Canadian Regulations

As promised last month, here is a brief outline of the amateur licensing situation in Canada. Only British subjects are eligible for amateur licenses, which are issued in two classes. The first one authorizes code operation on all amateur frequencies and phone on amateur frequencies above 50 mc., plus phone in the 27- and 28-mc. bands after six months of licensed operation. After a year of actual operation under the terms of this license, the amateur may apply for an advanced radio-telephone license, which authorizes phone operation in the low-frequency amateur phone bands.

Prerequisites for the first license are the ability to send and receive the International Morse Code at a speed of 10 wpm for three consecutive minutes without error, pass an oral examination on Canadian amateur regulations, elementary radio theory, and the tuning and operation of amateur equipment, including methods of avoiding off-frequency operation and interference to other services. In addition, the applicant must draw, upon request, a diagram of a simple code and phone transmitter, a power supply using full-wave rectification and an adequate filter system, a simple superheterodyne receiver, frequency meter, wave trap, key-click filter, and over-modulation meter—and be able to explain their operation.

The code test for the advanced license is at a speed of 15 wpm, and more comprehensive answers to the oral questions—which stress radiophone techniques—are required.

Seventy-five per cent is a passing grade for the oral part of the examinations. An applicant who fails an examination may try again in three months. A 50-cent fee is charged for each examination.

Examinations are held at frequent intervals at the district offices of the Radio Division, Department of Transport, and special arrangements are made for those who—for valid reasons—are unable to appear at one of them for an examination.

December, 1955

LEARN basic electricity electronics THE EASY "PICTURE BOOK" WAY!



Just Released: The fabulous
ILLUSTRATED Training Course
now used by the U. S. Navy!

You Learn by Pictures

Over 25,000 Navy trainees have already learned Basic Electricity and Basic Electronics this easy, "Picture Book" way! Now, for the first time, YOU can master the basics of Electricity and Electronics with this same "Learn-by-Pictures" training course! Over 1,700 simple, easy-to-understand drawings explain every section—these "teaching" pictures actually make up more than half the *entire* course! No other Basic Electricity or Basic Electronics course in America uses this revolutionary illustrative technique! You learn faster and easier than you'd dream possible!

A Complete Idea on Every Page

Here's how this easy, illustrated course works: *every page* covers one complete idea! There's at least one big illustration on that same page to explain it! What's more, an imaginary instructor stands figuratively at your elbow, doing "demonstrations" that make it even *easier* for you to understand. Then, at the end of every section, you'll find *review pages* that highlight the important topics you've just covered. You build a thorough, step-by-step knowledge at your own pace—as fast as you yourself want to go!

Everyday, English—A Course Anyone Can Understand

Sponsored by the Navy to turn out trained technicians in record time, this modern course presents Basic Electricity and Basic Electronics in a simple way that *everyone* can grasp—regardless of previous education! Every phase is made *instantly* clear—explained in plain, down to earth English—with *hundreds* of easy-to-understand illustrations to help you!

10 Complete Volumes

Volumes 1 and 2 of "Basic Electricity" cover DC components and circuits; Volumes 3 and 4 cover AC components and circuits; Volume 5 covers AC and DC motors and machinery.

Volume 1 of "Basic Electronics" covers Diodes & Power Supplies; Vols. 2 and 3 cover Amplifiers & Oscillators; Vols. 4 and 5 cover Transmitters & Receivers.

Home Study Without Correspondence

This course is so *different*, so *complete*—there's no need for the usual letter writing, question and answer correspondence! Learn at home—at your own pace!

10 Day Examination—Money Back Guarantee

Send today for these exciting new training courses—you *risk nothing!* When you receive the volumes, examine them in your own home for 10 full days. If, at the end of that time, you're not completely satisfied, simply return the books to us and we'll gladly *refund your full purchase price!* Total cost for either 5-volume course is only \$9.00! In Canada, prices approximately 5% higher.

ORDER TODAY!

These books are sold by electronics parts jobbers and book stores. If YOUR dealer doesn't have these books, mail this coupon to us!

JOHN F. RIDER PUBLISHER, INC.
480 Canal Street, N.Y.C.

I have enclosed \$..... Please send me
 5-vol. Basic Electricity set @ \$9 set
 5-vol. Basic Electronics set @ \$9 set
 Both sets. I understand I may return the books in 10 days, and receive a complete refund of the full purchase price if I am not satisfied.
Add state or city sales tax where applicable.

Name.....
Address.....
City & State..... P-7

CIVIL DEFENSE POCKET RADIO
 NO TUBES - BATTERIES OR ELECTRIC PLUG-INS NEEDED!
 Ordinary radios MAY BE USELESS DUE TO RUN DOWN BATTERIES OR POWER FAILURES during atomic attacks but this NEW CD Perma-Crystal Diode Pocket Radio operates during power blackouts. Receives regular radio stations and CIVIL DEFENSE BROADCASTS. Works anywhere when used as directed. COMPLETE SELF-CONTAINED SPEAKER PHONE. GUARANTEED TO WORK and should last for years. BE PREPARED—GET YOUR CD POCKET RADIO NOW!
SEND ONLY \$1.00 (cash, ck. mo) and pay postman \$3.99 C.O.D. POSTAGE or send \$4.99 for postpaid delivery. COMPLETE READY TO PLAY WITH CIVIL DEFENSE INSTRUCTIONS. By mail from—
 MIDWAY COMPANY, Dept. CPL-14, Kearney, Neb.



WANT A BETTER JOB? BECOME AN ELECTRONIC ENGINEER
 ONLY 32 MONTHS TO EARN A BACHELOR OF SCIENCE DEGREE IN ELECTRONIC ENGINEERING
 Class enrollment limited to allow for individual instructions. Chartered by state of California. Nonprofit-nonsectarian, co-educational—established 26 years.
APPROVED FOR VETS—ENROLL NOW!
 SEND FOR FREE CATALOG
PACIFIC STATE UNIVERSITY
 1516 S. WESTERN AVE. LOS ANGELES, CALIF.

WALKIE-TALKIE
 Build a real wireless portable radiophone for the 2 meter amateur band with the following precision components. Factory wired and tested transceiver chassis complete with special dual tube \$4.50. UTC "bouncer" mike transformer \$.98. High output carbon mike \$1.49. Super Alnico headphone \$1.25. 2" x 5" x 9" aluminum case \$2.00. Wiring diagram \$.50. Uses standard batteries available at your local radio store. Please include 5% for postage. COD's require \$1.00 deposit.
SPRINGFIELD ENTERPRISES
 Box 54-E Springfield Gardens 13, N. Y.

POPULAR ELECTRONICS KITS
 AN AMATEUR'S AUDIO OSCILLATOR.....\$12.50
 SLAVE PHOTOFLASH TRIGGER..... 9.90
 BATTERY ELIMINATOR FOR THE LAB..... 18.35
 See us about parts for SOLAR BATTERY • WINKING CLOWN • GADGET BOX • ELECTRONIC-PIANO • ELECTRONIC MAZE, and other kits.
ALGERADIO ELECTRONICS CO.
 236 N. Franklin St. Hempstead, N. Y.

INVENTORS

When you are satisfied that you have invented a matter of value—write me, without obligation, for full information on what steps you should take to secure a Patent.

PATRICK D. BEAVERS

Registered Patent Attorney

1098 Columbian Building Washington 1, D. C.

SOLAR BATTERIES
 now available. \$2.00 each. Electric energy direct from the sun. Power for transistor radios, microphones, photo cells, exposure meters, hearing aids and the like, direct from the sun. No batteries needed. Light from a 60 watt lamp will furnish enough power to operate our famous MYSTERY BUTTON as a telephone. A KIT of one solar battery, one mystery button, and one hearing aid type ear phone. ALL for only \$4.95. Also 5000 word booklet on mystery button and an 8 page booklet on transistors included with order.
ELECTRONIC PRODUCTS CO., St. Charles 12, Ill.



Get Your F.C.C. LICENSE Quickly!
 Guaranteed preparation. In a MINIMUM OF TIME. For F.C.C. commercial operator examinations. Our highly specialized training is available by correspondence, or in resident classes in
WASHINGTON, D. C. and HOLLYWOOD, CALIF.
 Write for our free booklet with complete details.
GRANTHAM School of Electronics
 Dept. 12, 821 19th Street, N.W., Washington, D.C.

Licenses must be renewed annually, and there is a \$2.50 annual fee for the station license. For further information and the address of the nearest district office, write to: Radio Division, Department of Transport, Ottawa, Ontario.

Recent FCC Releases

Amateur radio communication with the following countries is still forbidden: Cambodia (F18, XU); Indonesia (PK, YB-YH); Iran (EP, EQ); Korea (HL, HM); and Viet Nam (F18, XV, 3W). Amateur service still has not been organized in Jordan (JY) and Roumania (YO, YR). Laos (XW) and Thailand (HS) no longer prohibit amateur radio-communication.

Except between amateur stations in the United States and Canada, Chile, Cuba, Ecuador, Liberia, and Peru, international third-party communications are strictly forbidden; however, third-party communications are permitted between all amateur stations authorized by the United States (identified by call signs beginning with W or K), except those whose call signs begin with KA2 to KA9, inclusive.

News from Our Readers

Perry Baling, W8VYU, Massillon, Ohio, writes: "You do not need high power to get out. I used 5-watts input to a 117L7 (Radio & Television News, June, 1953) in my Novice transmitter, and I got reports equal to other Novices running 30 to 70 watts. I am now running 10 watts to a 6L6 transmitter, because I burned out the 117L7 and have not yet replaced it. But I don't notice any difference in my reports. . . . In my six months as a Novice and a General, I have worked 26 states, my best DX being California—2400 miles. My antenna is a dipole fed with 75-ohm ribbon, and my receiver is a *Hallicrafters* S-19.

Eddy Boothe, WN8UJW, Sinks Grove, W. Va., is another W8 who has the knack of getting the most out of simple equipment. He writes: "I got my license last December, and after tinkering with a home-built 6V6 transmitter for about three months, I finally got on the air with a *Heath* AT-1 transmitter. My receiver is a two-tube *Allied Radio* "Ocean Hopper," which I bought from a friend. He did not recommend it very highly, but I have been very pleased with its operation. . . . with this equipment, I have worked 40 states, using crystal frequencies of 3735 and 7183 kc. I do most of my DX'ing between 4:00 and 6:30 a.m. I also like to "rag chew" when conditions are good. I am now away from home at college, so I will not be able to work all states before my Novice license expires in December."

Larry Basinger, W4EJA, 525 Harding Ave., Louisville 9, Ky., (phone: Atwood 6164), offers to help anyone to obtain his amateur license. He also has a lot of workbench space where equipment can be built or worked on. . . . Rod has a *Heathkit* AT-1 transmitter and three antennas—a 33' vertical, and two end-fed wires, one 135' long and the other 33'

long. In about a year, he has had 450 contacts in 27 states, Puerto Rico, and Canada. In a second communique, he reported on building an 807 amplifier for his transmitter and buying an SX-96 receiver.

Ed, W9MWY, reports that Butler University, Indianapolis, Ind., offers a radio theory course which will carry the student from elementary concepts to sufficient radio knowledge to pass the written examination for a 2nd Class commercial radio operator license, and—of course—the General Class amateur examination. Classes will be held in the evening, starting after the first of the year, and it is not necessary to be a student

HELP WANTED!

Starting with this issue, the Transmitting Tower will list each month the names and addresses of prospective amateurs requesting help in obtaining their licenses. To have your name listed, send your request to: Herb S. Brier, W9EGQ, c/o POPULAR ELECTRONICS, 366 Madison Ave., New York 17, N. Y.

Frank P. Mechler, 222-23 Kingsbury Ave., Flushing 64, N. Y., wants someone to give him the Novice examination.

Robert Montalro, 2783 Broadway, New York 23, N. Y. (phone: UN-57320, Ext. 67).

N. DuVall, Western Reserve Rd., Route #3, Canfield, Ohio.

William Caesar, 390 Parkside Ave., Brooklyn 26, N. Y.

Peter Vergados, 32 Brentwood St., Allston 34, Mass., wants suggestions on the type of transmitter to start with.

Lyle Strassle, 76 Fillmore Ave., Salamanca, N. Y. (phone: 751).

Jack E. Morris, 5751 Dean Way, Riverside, Calif.

Linda Lawler (14), 2338 North 71 St., Omaha, Neb., and **Myra Lester** (14), 2033 North 70 St., Omaha, Neb., want help in obtaining their Novice licenses and would appreciate a few pen pals.

Bob McConnell, P.O. Box 1276, Southern Pines, N. C., and **Barry Portnoy** (14), 2724 Heath Ave., New York 63, N. Y., (phone: Kingsbridge 8-0362), need help with the code.

If you requested help before October 1 and did not receive it, and if your name is not listed above, please write again.

of the university to enroll for the course. For full information, write to: Robert Montgomery, Butler University, Jordan Conservatory, Indianapolis, Ind.

Also in Indiana, the Michiana Amateur Radio Club, 505 North Lafayette St., South Bend, sponsors both code and theory classes for prospective amateurs in conjunction with the local vocational high school. A card to the Secretary will get full details.

Frank F. Longenecker, 1742 North Mariposa, Apt. 5, Hollywood 27, Calif., writes: "I am an old gent, 63, who became an SWL because of poor health limiting my activities. I have been doing a bit of technical study in various texts and am beginning to understand radio more or less. I am also trying to learn

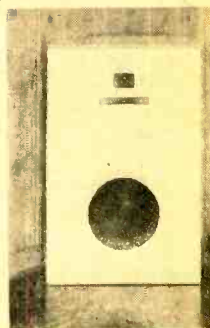

Designed and manufactured by the originator of the Klipschorn speaker system, the Shorthorn is second only to the Klipschorn system in performance. Using coordinated acoustic elements, including filters, it offers exceptionally smooth response, free from distortion. Back loading horn extends bass range without resonance.

Available in kit form, with or without drive system. Prices from \$39 for the do-it-yourself horn kit to \$209 for assembled horn with Klipsch Ortho 3-way drive system installed. Write for literature.

KLIPSCH & ASSOCIATES

HOPE, ARKANSAS



TV TELLS HOW TO ANSWER RADIO RADIO T.V. QUESTIONS SERVICE LIBRARY

HERE IS LATE INFORMATION IN A HANDY FORM FOR RADIO AND TELEVISION REPAIRMEN, SERVICEMEN AND STUDENTS

AUDELS T.V. RADIO SERVICE LIBRARY — Over 1500 Pages — 1085 Illustrations & Diagrams. 1001 Important Facts & Figures on Modern T.V., Radio, Electronic Devices at your fingers ends. Highly Endorsed.

INCLUDES TRANSISTORS

& Transistor Circuits, Rectifiers, Record Changers, P.A. Systems, Tape Recorders, Phonograph Pick-ups, F.M., Auto Radio, Radio Compass, Short Wave, Radar, etc.

ASK TO SEE IT! IT WILL PAY TO KNOW—

The Basic Principles — Construction — Installation — Operation — Repairs — Trouble Shooting. Shows How to get Sharp, Clear, T.V. Pictures. Install Aerials—How to Test. Explains Color Systems, Methods of Conversion, Terms, etc. Includes Ultra High Frequency — Valuable for Quick Ready Reference and Home Study.



\$6 COMPLETE 2 VOLUMES

Get this information for yourself 7 DAY TEST—PAY ONLY \$1 MO.

MAIL ORDER

AUDEL Publishers, 49 W. 23 St., New York 10, N.Y. Mail AUDELS T.V. RADIO SERVICE LIBRARY (2 Volumes) \$6 on 7 days free trial. If O. K. I will remit \$1 in 7 days and \$1 monthly until \$6 is paid. Otherwise I will return them.

Name _____
Address _____
Occupation _____
Employed by _____ PE



Geiger Counter Kit

Combine fun with profit! Now you can build a professional model that would ordinarily sell for at least \$99.50. Comes complete with meter, latest 2 tube printed circuitry, best sensitivity, 3 position range switch, phones and flashing neon light. Compact size of 4 1/2" x 8" x 4" is best for field use. Kit includes all necessary parts, ore sample and detailed instructions. Fully guaranteed. Free literature. Order now, immediate delivery!

\$49.50

Complete with Meter
F.O.B. L.A.

SIERRA SCIENTIFIC CO. 5415 York Blvd., Dept. 3
Los Angeles 42, Calif.

Shrinks Hemorrhoids New Way Without Surgery

Science Finds Healing Substance That
Relieves Pain — Shrinks Hemorrhoids

For the first time science has found a new healing substance with the astonishing ability to shrink hemorrhoids and to relieve pain—without surgery.

In case after case, while gently relieving pain, actual reduction (shrinkage) took place.

Most amazing of all—results were so thorough that sufferers made astonishing statements like "Piles have ceased to be a problem!"

The secret is a new healing substance (Bio-Dyne*) —discovery of a world-famous research institute.

This substance is now available in *suppository* or *ointment form* under the name *Preparation H*. * Ask for it at all drug counters—money back guarantee.

*Reg. U.S. Pat. Off.

TRANSISTOR WIRELESS MIKE

Now available after years of research is the first low cost transistor wireless mike. Actually a complete miniature wireless transmitter that will send your voice through any standard broadcast radio up to 50 feet. Can be used as a wireless intercom. No license or permit required. Ultra-compact unit fits in pocket with self contained long life battery. Skillfully constructed from the finest sub-miniature components. Complete ready-to-operate unit only \$7.98 postpaid. Absolutely nothing else to buy. In kit form \$8.98.

Postage extra on COD orders and \$1.00 deposit required.

SPRINGFIELD ENTERPRISES

Box 54-E Springfield Gardens 13, N. Y.

INVENTORS

If you believe that you have an invention, you should find out how to protect it. We are registered Patent Attorneys. Send for copy of our Patent Booklet "How to Protect Your Invention," and an "Invention Record" form. No obligation. They are yours for the asking.

McMORROW, BERMAN & DAVIDSON

Registered Patent Attorneys

349-E Victor Building Washington I, D. C.

RADIO COURSES

FCC LICENSE PREPARATION

- COMMERCIAL
- AMATEUR
- CODE BRUSH-UP
- THEORY

TELEVISION AND RADIO SERVICING

Personal Counseling Approved for Veterans

**YMCA TRADE & TECHNICAL
SCHOOL of N. Y.**

15 West 63 St. New York 23, N. Y.

EN 2-8117

Catalog P. E.



53rd
Year

the code by listening to my *Hallicrafters S-40B* . . . I'd like to read something about what a chap can do for a receiving antenna if he lives in an apartment where the only antenna he can have is a few feet of wire tossed on the floor. Even with only that much, I get London, Moscow, Buenos Aires, Tokyo, etc. Still I want more. A bit greedy. I imagine many Novices who live in apartment buildings have the same problem, and I would like to hear how they solve it." (So would I and would be glad to print a few good ideas on the subject in *THE TRANSMITTING TOWER*—*Herb*.)

The Coast Guard needs hams! Donald R. Rimbach, Commander, Flotilla 1210, United States Coast Guard Auxiliary, Third Coast Guard District, (home address: 42-48 147 St., Flushing, N. Y.), writes, "Flotilla 1210 is an operational unit associated with the U. S. Coast Guard, assisting it in the performance of its duties. For this reason, it is planned to include in our organization hams who operate fixed or mobile stations. I would like to hear from interested amateurs or amateur clubs near College Point, Malba, Whitestone, Beechhurst, Bayside, and Flushing."

Dick Tahk, WN1CVG, Brickett Hill Road, RFD #4, Concord, N. H., says, "Thanks to *W1GDO* and *W1BXU* for the help and the interest in my station. I have a *Johnson* Adventurer transmitter, and in the past six days, I have worked 11 states. I would like to hear some talk about organizing a Novice Net among the many New Hampshire Novices."

Bettie Zimmerman, KN9BAO, 1920 Maple Ave., Noblesville, Ind., says, "I am very happy with my 6146 transmitter. All my reports have been good—mostly 599. I still get pretty shaky and think ahead of the word I am sending and misspell a few, which tickles everyone. I had my first solid contact last Saturday with *W9LDB*. I am now studying for my 'General.' Sure hope I get it!"

Merry Christmas to you all. Let us hear of your experiences and problems. 73,

Herb, W9EGQ

Improving Novice Transmitter

(Continued from page 54)

is not available, set the slider to approximately 25% of the resistor length (5000 ohms) from the B+ end.

Plug the appropriate coil and crystal into their respective sockets, and plug the key into its jack. Set *C7* to maximum capacity and press the key. Rotate *C7* towards minimum capacity until the bulb *PL1* dims sharply. It may go out entirely. Leave *C7* at this position and release the key. Pull the power plug from the wall socket. Connect the antenna feeders to the antenna terminals and replace the power supply plug in the wall socket.

Allow the transmitter heaters to warm up and then press the key. Retune *C7* for a dip in the brightness of *PL1*. The dip should

be less pronounced than before. Optimum loading will be indicated if the bulb dims just perceptibly as C7 is tuned. Always operate the transmitter with C7 tuned for the dip. Should there be two settings of C7 which cause a sharp dimming of the bulb, always choose the one at which the capacitor plates are most nearly fully meshed.

This tuning method is another way of doing the job described in the original article, in which a small tuning loop held close to the coil was used as a resonance indicator. It assumes that the antenna used is a half-wave doublet fed in the center through a low-impedance feed line. Other types of antennas may require an external antenna coupler in order to put power into the antenna. As Mr. Turner mentioned, details on such devices are available in any amateur handbook.

-30-



Battery Eliminator

(Continued from page 48)

4. Substitute a resistor of about 200 ohms for the heavy load just described. Slowly rotate the "A" control in a clockwise direction. The "A" meter should climb easily to 10 volts with plenty of room left on the voltage control. These tests, if successful, show that the instrument is capable of handling any of the tube line-ups described earlier.

5. Only one step is required to test the "B" supply. With the "B" control still fully counterclockwise, turn on the "B" switch, S2. The "B" neon indicator lamp should glow. Now, rotate the "B" control slowly clockwise. The "B" voltmeter should climb easily to 150 volts.

Using the Eliminator

In actual use, two precautions should always be observed before putting the equipment to work. First, always connect the loads to the power leads with the power of the eliminator turned off; this applies to both the "A" and "B" sections. Second, before applying power, make sure both voltage controls are fully counterclockwise.

Now the "A" switch may be turned on and the "A" voltage control adjusted for the desired voltage. Allow about 20 seconds for the 6X5GT rectifier in the "B" supply to warm fully. Then turn on the "B" power, adjusting the "B" control for the desired voltage. Should either the "A" load or the "B" load accidentally become disconnected during use, remove all power and reconnect the leads, allowing about five seconds for the "A" capacitors to discharge.

-30-

Beginners

ELECTRONIC KIT

"AS DESCRIBED IN NOVEMBER
POPULAR ELECTRONICS"

35 EXPERIMENTS



Including:

- RADIOS
- OSCILLATORS
- POWER SUPPLIES
- TEST SETS
- AMPLIFIERS
- ELECTRONIC ORGAN
- CODE SET
- MANY OTHERS

Detailed thoroughly understandable
INSTRUCTION MANUAL
also includes interesting basic theory

Complete, No Extras To Buy

Duo Tube & Socket Selenium Rectifier Tuning Condenser Crystal Detector Potentiometer	Neon Lamp Headset Resistors Capacitors Hardware
--------------------------------------------------------------------------------------------------	-------------------------------------------------------------

\$9.95 prepaid, or

Only \$1 with order pay postman
\$8.95 plus charges

ELECTRO KIT
Box 3468 Dept. PE-8 Maplewood 17, Mo.

BA's NEW 1956

FREE CATALOG

YESSIR-IT'S THE KING-SIZE CATALOG-
 164 KING-SIZED (8 1/4 x 10 1/2) PAGES
 OFFERS MORE ITEMS PER PAGE--IT'S EASIER TO USE...IT'S EASIER FOR YOU TO ORDER





COMPLETE GUIDE TO EVERYTHING IN RADIO, TV, ELECTRONICS

100'S OF BRAND NEW ITEMS LISTED HERE FOR THE VERY FIRST TIME

INCLUDES 21 BIG PAGES OF BARGAINS NOT FOUND IN ANY OTHER CATALOG

BURSTEIN-APPLEBEE CO.
 Dept. PE-1012-14 McGee St., Kansas City 6, Mo.
 Send Free B-A Catalog No. 561.

Name.....

Address.....

City..... State.....

INDEX

TO VOLUME 3

July-Dec., 1955

AMATEUR RADIO

An Amateur's Audio Oscillator (Kephart) . . . 50 Dec.
 More Bandspread with the SW-54 (Murray) . . . 62 Dec.
 Improving the "Novice C. W. Transmitter" (Flood) . . . 53 Dec.
 Tech-Band Converter (Goode) . . . 48 Nov.

BOOK REVIEWS

Atomic Radiation Detection and Measurement (Renne) . . . 35 July
 Atoms Today and Tomorrow (Hyde) . . . 104 Nov.
 Basic Vacuum Tubes and Their Uses (Rider & Jacobowitz) . . . 100 Aug.
 Basic Synchros and Servomechanisms (Van Valkenburgh, Nooger & Neville, Inc.) . . . 61 Dec.
 Electricity (de Ville) . . . 100 Aug.
 Electronic and Radio Engineering (Terman) . . . 61 Dec.
 Electronic Musical Instruments (Dorf) . . . 61 Dec.
 Pay As You See TV (Kamen) . . . 100 Aug.
 Probes (Zucconi & Clifford) . . . 28 Oct.
 Technical Dictionary (Coyne Electrical School) . . . 22 Sept.
 The ABC of Color TV (Cisin) . . . 26 Oct.
 The New High Fidelity Handbook (Greene & Haddcliffe) . . . 22 Sept.
 The Uranium Prospector's Guide (Ballard & Conklin) . . . 35 July
 TV & Radio Tube Substitution Guide (Cisin) . . . 104 Nov.
 TV Repair Questions and Answers on Front Ends (Platt) . . . 100 Aug.
 Uranium Official Yearbook . . . 35 July
 Your Tape Recorder (Robert & Mary Marshall) . . . 26 Oct.

DEPARTMENTS

The Transmitting Tower (Brier) . . . 80 Dec.
 68 Aug., 62 Sept., 66 Oct., 62 Nov.,
 Ama. Touring (Legge) . . . 94 Dec.
 67 July, 70 Aug., 67 Sept., 68 Oct., 116 Nov.,
 Tuning the Short-Wave Bands (Bennett) . . . 82 Dec.
 64 July, 71 Aug., 64 Sept., 70 Oct., 60 Nov.,
 Carl & Jerry (Frye) . . . 64 Dec.
 88 July, 66 Aug., 60 Sept., 64 Oct., 64 Nov.,
 Disc and Tape Review (Whyte) . . . 67 Dec.
 87 July, 77 Aug., 69 Sept., 73 Oct., 77 Nov.,
 Tape Recorders (Whyte) . . . 86 July

ELECTRONIC GADGETS

B-C Flash Gun (Clark) . . . 58 Nov.
 Build a "Decision Meter" (Frantz) . . . 42 Oct.
 Build an Electroscop (Turner) . . . 39 July
 Build Your Own Applause Meter (Garner) . . . 47 Aug.
 Dimming Fluorescent Lamps (Carter) . . . 49 Sept.
 Electronic Sterilizer (Garner) . . . 39 Oct.
 Electronic Toys for Christmas (Louis) . . . 23 Dec.
 Electronic "Whistler" (Turner) . . . 57 Aug.
 Introduction to "Puzzle-tonics" (Pollack) . . . 52 Nov.
 Light-Operated Relay Using a CdS Photocell (Lubin & Samuelson) . . . 52 Sept.
 Multi-Voltage Power Supply (Kaufman) . . . 54 Oct.
 New Antenna Peps Up Old Radio (Morgan) . . . 36 Sept.
 One-Tube "Wallop" (Turner) . . . 51 Oct.
 Photoelectric Intrusion Alarm (Dexter) . . . 45 Oct.
 Positive Flash-Gun Tester (Pollack) . . . 46 Aug.
 Reflex Receiver (Krauss) . . . 43 Nov.
 Slave Photoflash Trigger (Pollack) . . . 55 Dec.
 Talking with Light (Part 2) (Robberson) . . . 42 July
 The \$1.60 Signal Generator (Tooker) . . . 64 Aug.
 The Permanent Electric Clock (Tooker) . . . 70 Nov.
 The Radio Add-On Unit (Davidson) . . . 48 Sept.
 Using the CdS Photocell (Lubin & Samuelson) . . . 42 Aug.
 Voice-Operated Alarm (Green) . . . 50 July
 125-Watt Line Voltage Control . . . 45 Dec.

FEATURE ARTICLES

Automatic Factories (Louis) . . . 21 Aug.
 Behind the U.L. Label (Morgan) . . . 31 Aug.
 CIC—Navy's Electronic Clearinghouse (Morgan) . . . 29 Nov.
 Electronic Fish-Finders . . . 27 Aug.
 Flight Doctor's Electronic Partner (Atkinson) . . . 34 Dec.
 Kilovolt Nuclear Battery . . . 34 Sept.
 Learning Electronics in Resident Schools (Eisenberg) . . . 32 Oct.

Training for Electronics by Home Study (Eisenberg) . . . 33 Nov.
 Transoceanic Cable . . . 38 Sept.
 21st Century Home . . . 42 Dec.
 Your Career in Electronics (Eisenberg) . . . 29 Sept.

GEIGER COUNTERS

Build Your Own Geiger Counter Probe (Robertson) . . . 54 Aug.
 Home-Built 700 Volt Geiger Counter . . . 28 July
 Listing of Geiger Counter Manufacturers . . . 103 July
 The Scintillation Counter (Bukstein) . . . 36 July
 Market Survey of Geiger Counters . . . 21 July
 The Bakersfield Uranium Rush (Sands) . . . 17 July

HI-FI

AMPLIFIERS

Making an Etched Preamp (Carter) . . . 87 Nov.
 Recorder and Amplifier Mixer (Garner) . . . 81 July
 Square-Wave Converter (Carter) . . . 86 Aug.

PHONO

Choosing a De Luxe Hi-Fi Tone Arm (Fantel) . . . 75 Oct.
 Diamond Styli for Hi-Fi (Marcus) . . . 88 Oct.
 Professional Turntables for Home Use (Fantel) . . . 80 Oct.
 What You Should Know About Record Players (Fantel) . . . 71 Sept.

SPEAKERS AND SPEAKER HOUSINGS

Birth of a Loudspeaker . . . 79 Aug.
 Bagain Hi-Fi with Cheap Speakers (Coriell) . . . 71 Dec.
 How to Add Extension Speakers . . . 56 July
 S2 Speaker Baffle (Weems) . . . 79 Nov.

TAPE RECORDING

Basic Tape recorder Maintenance (Coriell) . . . 82 Nov.
 Leader and Timing Tape . . . 76 July
 Live Sound to Magnetic Tape (Wortman) . . . 85 Oct.
 Recorders of Yesteryear (Garrahan) . . . 74 July
 Tape Playback and Erasure (Wortman) . . . 90 Nov.
 Tape Transport Mechanisms (Wortman) . . . 74 Dec.
 What About Tape Recorders (Wortman) . . . 86 Sept.

MISCELLANEOUS

Build Your Own Hi-Fi Tuner (Garner) . . . 80 Sept.
 Christmas Record Buying Guide . . . 69 Dec.
 Distortion in Hi-Fi Equipment (Crowhurst) . . . 82 Aug.
 (Part 2) 70 July, (Part 3)
 The Meaning of Frequency Response (Crowhurst) . . . 84 Nov.
 (Part 1) 77 Sept., (Part 2) 92 Oct., (Part 3)
 What is an Audio Watt? (Coriell) . . . 84 Aug.

MISCELLANEOUS

Electronics Controls City Traffic . . . 69 July
 Electronics Important to Satellite . . . 59 Oct.
 Micro-Miniature Tubes . . . 41 Nov.
 "Nobody Here But Us Termites" (Ames) . . . 49 July
 Our First Anniversary (Read) . . . 31 Oct.
 Over the Horizon Transmission . . . 39 Aug.
 Save Your Old Tubes . . . 96 Sept.
 Scheme and Variations (Kohler) . . . 84 July
 Science Meters a Heart Muscle . . . 34 Aug.
 Simple Audio Frequency Meter . . . 78 July
 Phantom Voice Speeds Operation of Automatic Elevator . . . 37 Dec.
 The Versatile "Electro-Kit" . . . 100 Nov.
 TV for Parking Lots . . . 41 Aug.
 Ultrasonic Drill . . . 101 Nov.

RADIO CONTROL

Field Strength Meter for R/C (Runge) . . . 48 Oct.
 Printed Circuitry for R/C (Runge) . . . 74 Aug.
 Rejuvenate R/C Batteries (Runge) . . . 60 July

THEORY AND INSTRUCTION

Checking a Typical Clock Radio (Leeper) . . . 52 Aug.
 Experiments with Simple Solar Batteries (Turner) . . . 66 Nov.
 Extra Jobs for Your VOM (Turner) . . . 84 Dec.
 How to Keep Your Portable in Operation . . . 62 July
 Lingo of the Schematic (Berry) . . . 44 Aug.

TRANSISTORS

Mr. Meticulous Makes Transistors . . . 37 Aug.
 Transistorized Sine-Wave Generator (Garner) . . . 43 Sept.
 Transistorized Telephone Pickup (Berry) . . . 46 Sept.

WORKSHOP PRACTICES

Battery Eliminator for the Lab (Pollack) . . . 46 Dec.
 Easily Built Chassis Rack (Garner) . . . 72 Nov.
 How to Use Decals . . . 54 July
 Jig Makes Solder Gun Tips (Pollack) . . . 62 Aug.
 Stroboscope for the Electronic Workshop (Pollack) . . . 55 Sept.
 Thin-Skin Chassis Cuts Costs (Saunders) . . . 90 Aug.

GLOSSARY OF ELECTRONIC TERMS

This glossary, which is being published in serial form, started in August. It consists of a selected group of definitions taken from the booklet "A Dictionary of Electronic Terms," published by Allied Radio Corp., 100 N. Western Ave., Chicago, Ill. The complete dictionary, containing over 3500 terms, is available from Allied at 25 cents a copy.

lateral recording—A phonograph record in which the needle moves from side to side during playback, while the groove depth is essentially constant.

lattice-wound coil—A honeycomb coil. A coil wound in a manner to reduce distributed capacitance and have the appearance of lattice-work.

LC ratio—Inductance in henrys, divided by capacitance in farads.

lead (pronounced "leed")—(1) A connecting wire, such as a test lead, battery lead, etc. (2) Of two alternating electrical quantities of the same frequency, the one that reaches a particular cyclic point first is said to lead the other.

lead-in (pronounced "leed-in")—The conductor or conductors that connect the antenna proper to electronic equipment.

leakage inductance—A self-inductance caused by leakage flux generated in the winding of a transformer. Leakage inductance creates a condition which would be identical to the insertion of an inductance in series with the winding. It therefore causes reactance (**leakage reactance**) which cuts down transformer efficiency as frequency is increased.

leakage resistance—The resistance of the path over which leakage current flows. It is normally a high value.

lightning arrester—A protective device which prevents lightning from striking an antenna.

light relay—A photoelectric device in which a change in light intensity closes a relay.

limiter—That part of an FM receiver which removes amplitude variations from the FM signal by cutting off all peaks exceeding a certain amplitude.

line filter—A device inserted between the line cord plug of a radio receiver and the power line to block noise impulses which otherwise enter the receiver from the power line. It contains one or more choke coils and capacitors.

line impedance—Impedance as measured across the terminals of a transmission line.

litz wire—Wire made up from a number of fine, separately insulated strands specially braided or woven together for reduced skin effect and hence lower resistance to high-frequency currents. The full name is litzendraht wire.

load—(1) The power that a device delivers. (2) A device placed in a circuit to absorb power or convert it. That which is operated.

local oscillator—The oscillator of a superheterodyne receiver. Any oscillator incorporated into an electronic system.

long-play—In common usage, LP. A 10" or 12" phonograph record that operates at a speed of 33 $\frac{1}{3}$ rpm. The sound-carrying grooves are very finely cut, and commonly referred to as "microgroove."

loopstick antenna—A relatively new type of built-in receiving antenna widely used in broadcast receivers. Loopstick antennas consist of a coil wound on an iron core and approximately two feet of pickup wire. In some types the inductance is adjusted by

sliding the coil along the core; other types have a movable core for adjustment of inductance. Loopsticks are installed in the antenna circuit as are loop antennas. They are sometimes preferred to loop antennas, since they provide excellent signal pickup, are non-directional, and occupy minimum space.

loudness level—The intensity level in decibels of a pure 1000-cycle tone that seems equivalent in loudness to the sound under consideration. Also called **equivalent loudness level**.

magic eye—A cathode-ray tuning indicator tube.

magnet—A body which attracts iron and steel, and if free to move, sets itself in a definite direction due to the influence of the earth's magnetic field.

magnetic field—A region in space surrounding a magnet or a conductor through which current is flowing.

magnetostriction oscillator—A highly stable oscillator in which grid and plate coils are wound on the two halves of an iron rod. Plate current causes a deformation in the length of the rod. This displacement produces grid voltage which further excites the plate oscillation.

magnet wire—Insulated copper wire in sizes commonly used for winding coils used in electromagnetic devices such as transformers, choke coils and relays.

marker beacon—Radio transmitters located between radio-range stations of airways, enabling pilots to determine their locations.

mast—A vertical metal pole serving as an antenna support or as the antenna proper.

master—The negative phonograph record produced directly from the original recording as one step in the manufacture of commercial records.

master oscillator-power amplifier—An electronic combination of a vacuum-tube oscillator followed by a r.f. amplifier stage. Abbreviated **M.O.P.A.**

megacycle—One million cycles per second.

megohm—One million ohms. Abbreviated **meg(s)**.

meter—(1) A device that measures and registers the integral of an electric quantity. Example: a watt-hour meter. (2) Any type of electric measuring instrument such as a voltmeter, ammeter, wattmeter, ohmmeter. (3) The basic unit of length in the metric system, equal to 39.37 inches.

mica capacitor—A fixed capacitor employing mica as the dielectric.

microgroove—A very small groove which permits greater recording time on phonograph records. Records with microgrooves accommodate needles with .001" radius, while standard records take a .003" needle.

microphonic—A condition in which mechanical movement of some radio part other than a microphone causes corresponding variations in circuit current. A radio tube is microphonic if a pinging sound is heard in the loudspeaker when the side of the tube is tapped with a finger; the tapping is then setting the internal elements into vibration. If sound waves from the loudspeaker are producing this vibration of tube elements, the sound will be sustained as a howl.

microvolts per meter—A measure of the intensity of the signal produced by a radio transmitter at a given point. Stronger signals are expressed as millivolts per meter.

microwaves—Electromagnetic waves whose frequencies are higher than 300 mc.

mismatch—The condition in which the impedance of a source does not match or equal the impedance of the connected load. This reduces power transfer by causing reflection.

mixer—(1) A device ordinarily consisting of one or more potentiometers for combining the audio-frequency output signals of two or more microphones or other audio-frequency signal sources in any desired proportion at the input of a main audio-frequency amplifier. (2) That stage in a superheterodyne receiver in which the incoming modulated radio-frequency signal is combined with the signal from the local oscillator to produce the intermediate-frequency signal.

modulation—The process in which the amplitude, frequency, or phase of a carrier wave is varied with time in accordance with the waveform of an intelligence signal. Velocity modulation is the bunching of electrons in a beam.

modulation percentage—The modulation factor multiplied by 100 for expressing as a percentage.

Morse Code—A system of dot and dash signals used in the transmission of messages by radio or wire telegraphy. The **International Morse Code** (also called the **Continental Code**) is used universally for radio telegraphy, while the **American Morse Code** is used only for wire telegraphy.

mosaic—In television, the light-sensitive surface of an iconoscope or other television camera tube. The surface is made up of minute elements which are photosensitive. Electrons scanned across the area produce current proportional at each instant to the intensity of light striking the point then being scanned.

motorboating—Feedback occurring in pulses at a low audio-frequency rate in an audio-frequency amplifier or radio receiver. Resembles sounds made by a motorboat.

multimeter—A test instrument having a number of different ranges for measuring voltage, current, and resistance. Multitesters and volt-ohm-milliammeters are of this type.

multiplier—A resistor used in series with a voltmeter or ohmmeter to increase the range of the meter.

multivibrator—A relaxation oscillator similar to the Eccles-Jordan trigger circuit. Two triodes are capacitance-coupled, grid of each to plate of the other, so that the tubes operate alternately. Various sawtooth or square-wave voltages may be taken from different pairs of electrodes. Used in pulse and sweep applications and as sources of harmonics.

mumetal—A metallic alloy having special magnetic properties. Its permeability is high and its hysteresis loss is low. An excellent material for shielding.

natural frequency—The lowest resonant frequency of an antenna or circuit.

needle—(1) That part of a phonograph pickup which converts the variations in the record grooves into mechanical movements which are in turn converted into audio-frequency signals by the pickup element. The needle must be carefully shaped to follow faithfully the high-frequency variations in the grooves without causing excessive record wear. (2) The indicating pointer of an instrument.

needle scratch—Noise components in the output of a phonograph pickup due to friction of the needle riding in the groove.

needle talk—Sounds produced by variations of the phonograph needle and/or other associated parts of a phono pickup—and heard directly from the pickup, not through the amplifier. Also called **needle chatter**.

negative bias—The use of a voltage which makes the

control grid of a radio tube negative with respect to the cathode.

negative feedback—A circuit arrangement by which a signal is fed back from the plate circuit to the grid circuit 180° out of phase with input signal, thus decreasing the amplification. It is used in audio-frequency circuits to reduce distortion. Also called **inverse feedback**.

neon oscillator—A relaxation oscillator comprising gas lamp, capacitor and resistor. Output is sawtooth.

noise—Interference characterized by undesirable random voltages caused by an internal circuit defect or from some external source. In television, this type of interference results in a multitude of black and white spots distributed over the entire picture. It is often called "snow." In radio receivers, noise appears as an audible hissing sound heard along with desired radio programs.

noise limiter—A circuit that cuts off noise peaks which are stronger than the highest peak in the desired signal being received.

noise suppression—A circuit used in a receiver or amplifier to reduce noise. For example, noise suppression in a receiver reduces noise output during periods of no-signal reception, or between stations. Noise suppressor circuits in amplifiers reduce noise output resulting from old, scratchy or noisy records.

non-inductive resistor—A wire-wound resistor constructed to have practically no inductance.

non-linear—Not directly proportional and hence producing a curve instead of a straight line when plotted on a graph.

nucleonics—The science dealing with protons or neutrons in the nucleus of the atom, or with all phenomena associated with the atomic nucleus.

octave—The interval between two frequencies having a ratio of 2:1. The reference frequency for music in the United States is 440 cycles and is the musical note A. In Europe, the note A is 435 cycles.

ohm—The practical unit of electrical resistance. It is that resistance in which one volt will maintain a current of one ampere.

ohmmeter—An instrument for measuring resistance. It consists essentially of a milliammeter in series with a suitable d.c. voltage and suitable series resistors.

Ohm's law—A fundamental electrical law which expresses the relationship between voltage, current, and resistance in a d.c. circuit, or the relationship between voltage, current and impedance in an a.c. circuit.

ohms-per-volt—A sensitivity rating for voltage-measuring instruments, obtained by dividing the resistance of the instrument in ohms at a particular range by the full-scale voltage value at that range. The higher the ohms-per-volt rating, the more sensitive is the meter.

open-circuit jack—A jack whose circuit contacts are normally open, and close through a properly connected plug.

open-circuit voltage—The voltage at the terminals of a battery or other voltage source when no current is flowing, i.e., when no load is connected across the voltage source.

open core—An iron core fitting inside a coil but having no external return path, so that the magnetic circuit has a long path through air.

optimum coupling—The degree of coupling in a doubly tuned r.f. amplifier that provides maximum transfer of signal energy from one circuit to the other.

(To be continued next month)

Classified

RATE: 50c per word—minimum 10 words

FOR SALE

DIAGRAMS for repairing radios \$1.00, Television \$2.00. Give; make, model. Diagram Service, Box 672-PE, Hartford 1, Conn.

DIAGRAMS: Counters, Timers, Organs, Intercoms, etc., \$1.00 each. List Free. Parks, 104-A S. E. 57th, Portland 15, Oregon.

ELECTRIC Pencil: Engraves all Metals, \$1.50. Beyer Mfg., 10511-P Springfield, Chicago 43.

BUY Surplus Radio electronic Equipment parts, Jeep, boat machinery tools, hundreds others. Direct from Government at tremendous Savings. List \$1.00. Box 169ZFA, East Hartford 8, Conn.

PLANS for Piddlers, \$1.00 each. 1. Emergency light plant, 300 watts, 110 volts, AC. Made from rebuilt car generator and lawn mower engine. 2. Push-button controls on your overhead garage door using simple hand tools and parts usually found around the home workshop. J. Bennett, 2461 Lucas Drive, Beaumont, Texas.

RADIO Plans—Pocket F-M, Four Band, Oscillator, All Three Only 20¢ And Stamped Envelope. Printed Circuit Television Antenna \$1.98, See POPULAR ELECTRONICS, Sept. Page 117. Ekeradio, 646 North Fair Oaks, Pasadena, California.

MAKE Your Own Elec. Appliance Tester. Diagram \$1.00 Walt's, 601 Leslie, Woodriver, Ill., Dept. P. E.

24 PAGE Plans "20 Crystal Sets" (SW record 5800 miles) 25¢—catalog. Laboratories, 328-L Fuller, Redwood City, California.

PRINTED Circuit Kits, Supplies. List Free. Moenco, Box 42, Haddon Heights, N. J.

ELECTRIC Guitars, Amplifiers, parts, wholesale, Free Catalog. Carvin, PE, Covina, Calif.

CODE Oscillator, Guaranteed, \$4.00 Postpaid or C.O.D. Details Free. Stout, 2241A, E. Broadway, Muskegon, Michigan.

TRANSISTOR Radio Kits from \$5.95. Pocket and Portable. Kits include directions, all parts, drilled case, solder and precut wire. Free literature. Highland Electric, Box 533E, Pasadena, Calif.

BATTERY Rejuvenator. Triples portable radio and R/C battery life. Guaranteed, \$3.95 complete. New Techniques, 1514 West Eleventh, Brooklyn 4, New York.

SUPERSENSITIVE VHF radio receives television, FM broadcast, special services and amateurs without antenna or ground. Factory wired and tested chassis including special tube \$5.98. In kit form \$3.98. Thousands in use by experimenters, amateurs, civil defense. Transistor audio stage complete with transistor for extra loud reception only \$2.00 extra. Springfield Enterprises, Box 54-E12, Springfield Gardens 13, New York.

WALKIE-talkie. Build wireless portable radiophone for less than \$10.00. Plans for variable frequency and crystal control types, only 50¢ for both. Springfield Enterprises, Box 54-E12, Springfield Gardens 13, New York.

SECRET Beam Transmitter, New Surplus, Five Mile Range, White & Infrared Beam, Portable, Works on flashlight batteries. Complete with Signal Gun, Gunstock, Tripod, Infrared Goggles, Remote Control, Carrying Case, Manual. Government paid over \$50. Yours for only \$10 Postpaid or \$3 Bal. C.O.D. Illustrated Signal Corps Manual 50¢. Surplus Box 118, Jersey City 4, N. J.

WANTED

CYLINDER and old disc phonographs. Edison Concert, Balmoral, Conqueror, Opera, and Oratorio models. Berliner Gramophones and Zono-ophones, Columbia disc and cylinder. Graphophones, Bettini micro-reproducer. Want old catalogues and literature on early phonos prior to 1919. Will pay cash or trade late hi-fi components. POPULAR ELECTRONICS, Box 50.

INVENTIONS WANTED

INVENTIONS wanted. Patented; unpatented. Global Marketing Service, 2420 77th, Oakland 5, Calif.

HELP WANTED

JOBS to \$1500 Monthly. All Trades. So. America, The Islands, U. S. Fare Paid. Application Forms. Free Information. Write Dept. 72E. National, 1020 Broad, Newark, N. J.

EARN Extra Money Selling Advertising Book Matches. Free Sample Kit furnished. Matchcorp, Dept. EZ-4, Chicago 32, Illinois.

INSTRUCTION

RADAR—Correspondence Course including, Loran, Sonar and Microwave, now being offered. Inquire Progressive Electronics Institute, P. O. Box 27764, Los Feliz Station, Los Angeles 27, Calif.

BUSINESS OPPORTUNITIES

TO \$50.00 Weekly. Sparetime, Home Operated Mail-order Business. Successful "Beginner's" Plan. Everything Supplied. Lynn, 10420-E National, Los Angeles 34.

VENDING Machines—No Selling. Operate a route of coin machines and earn amazing profits. 32-page catalog free. Parkway Machine Corporation, Dept. 12, 715 Ensor St., Baltimore 2, Md.

WHETHER you have ever had any experience in the Fire Extinguisher Field—or whether you haven't—be sure and write us for the facts about this New Company that gives you the biggest opportunity a Man ever had to build up a Business of his own, with protected, exclusive Territory. The "Fire King" Company, Inc., Dept. 16, Littleton, Colorado.

FREE Booklet "Money-Making Facts" tells mechanically-inclined men how to start sparetime business at home. Lee Foley Company, Columbia Heights, Minnesota.

\$200 weekly cleaning Venetian Blinds. Free, revealing book. Burt, 2434 BU, Wichita 13, Kansas.

\$100 WEEK Spare Time—Home Fire Alarm—Details Free. Epco, Box 135, South Norwalk, Conn.

TAPE RECORDERS

TAPE Recorders, accessories. Best buys. Boynton Studio, 10 PE Pennsylvania, Yonkers, New York.

RECORDERS and tapes at lowest prices. Kerstin, 215 E. 88, N. Y. C. 28.

TAPE Recorders, Tapes, Accessories. Unusual values. Dressner, Box 66E, Peter Stuyvesant Station, N. Y. 9.

PRE-RECORDED tape for listening and dancing featuring Hammond Organ. 3' sample reel \$1.00. Tape Toons, Dept. PE, Smithtown, N. Y.

MANUFACTURING

BECOME Manufacturer! Complete Manufacturing-selling instructions, consultations. Jary Associates, 268-EL, New York 5.

MINERALS & PROSPECTING

GEIGER Counter and Metal Detector Kits. Inexpensive, Educational. Free Literature. Electronic Applications, Dept. B, 5024 Lee Highway, Arlington 7, Va.

SCINTILLATION Counter. Ultra-sensitive. For information write Ute Company, Inc., 200 So. 4th, Montrose, Colorado.

STAMPS AND COINS

FREE! Catalog! About stamps. Illustrated. Free! The Stampmart, Hartford 1, Conn.

ARTS AND CRAFTS

FREE! Leathercraft Catalog. Do-It-Yourself! Tandy Leather, Box 397 C-4, Tulsa, Okla.

FREE "Do-It-Yourself" Leathercraft Catalog. Tandy Leather Company, Box 791-H12, Fort Worth, Texas.

MISCELLANEOUS

FREE Condenser & Resistor Code Chart! Get yours now Plus new value-packed catalogue! K. & L. Radio Parts Co., 1406 Venice Blvd., Los Angeles 6, California.

TUBES—TV, Radio, Transmitting, special purpose types—Bought, Sold, Exchanged. Send details to B. N. Gensler W2LNI, 512 Broadway, New York 12, N. Y.

NO Luck finding a book publisher? Write for free booklet—EL. Vantage, 120 W. 31, New York.

TARGET Knife, Malayan Throwing Style, 10 inches long, Leather wrapped handle, Instructions. \$1.00 or six for \$5.00 Postpaid. Surplus Box 118, Jersey City 4, New Jersey.

DETECTIVES—Experience unnecessary. Excellent opportunity. Detective Particulars Free. Write, Wagoner, 125-X West 86th, N. Y.

CRYSTAL Photocells, extremely sensitive type CL-1. \$2.50 Postpaid. Horton, 267 West Eleventh Street, New York City, 14.

RECORDING Tape. Brand New—plastic base—standard brand—7 inch reel. \$2.50 postpaid. Horton, 267 W. Eleventh Street, New York City, 14.

STEPPING RELAY 24 vac coils. Separate reset coil. Single pole, 50 throw or 2 pole, 25 throw. Perfect for model trains, automatic door openers, remote control—hundreds of uses. **New \$3.95. Good used \$2.00.** Shipped post paid. 10 circuit schematics included.

HOT SPOT DETECTOR, INC.

214 Third Street Des Moines, Iowa

ATTENTION

- **Hobbyists**
- **Club Members**
- **Study Groups**

Subscriptions to **POPULAR ELECTRONICS** at special bulk rates are available to club members, study groups, employee groups, schools, etc.

For information, write to:

POPULAR ELECTRONICS

Dept. 1016

366 Madison Ave. New York 17, N. Y.

FREE • You're Invited to "Test-Read"

The latest, biggest issue of **HI-FI MUSIC at HOME**, the magazine that covers BOTH recorded music and hi-fi equipment.

If you have never seen a copy, or if you haven't seen it recently, by all means take advantage of this opportunity to "test-read" the latest issue. No charge, no obligation. The fascinating features of this handsome magazine include:

- Illustrated reviews of 100 top-choice records and tapes
- Record Ratings, as to the composition, performance, audio quality
- News and pictures of the studios and the people who make music
- How-to-do-it articles on equipment, installations, improvements
- Home Workshop Projects — ideas for things you can build yourself
- "Inside Information" on the latest hi-fi equipment
- Buy, Sell, and Swap section for bargain hunters
- More than 125 photographs and drawings

Bring yourself up-to-date on the progress of this large-size, fast-growing magazine, devoted to records, tape, and FM. See how thoroughly it covers BOTH music and equipment. Mail this coupon to get the latest, biggest issue absolutely FREE!

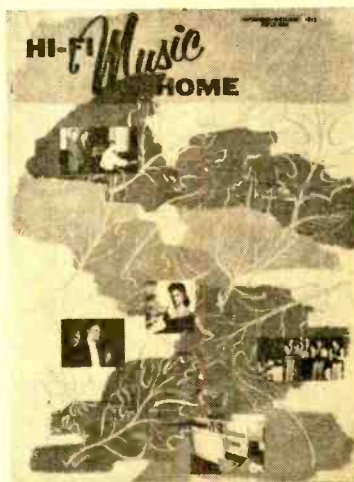

MILTON B. SLEEPER, Publisher
Hi-Fi Music At Home, 207-C East 37th Street, New York 16

I want to "test-read" the big, new issue. Please send me a copy WITHOUT CHARGE, and bill me for a subscription to start with the next issue following:

3 years (18 issues) \$6.00 1 year (6 issues) \$3.00
Add \$1.00 per year for foreign postage

If I find that HI-FI MUSIC at HOME has what I want, I will pay the bill within 10 days after I receive my FREE copy. Otherwise, I will notify you within that time, and you will cancel the entire charge, but I will keep my FREE copy.

NAME _____
STREET _____
CITY _____ ZONE _____ STATE _____

**Build the instruments
the professionals specify...
BUILD EICO KITS—SAVE 50%**

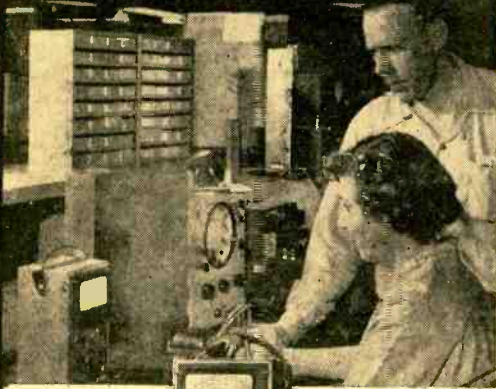

**Vacuum Tube
Voltmeter
KIT \$25.95
Wired \$39.95**

**EICO VTVMs
in use in labs
of Stromberg-
Carlson
Rochester, N.Y.**

EICO test instrument kits are complete and professional from circuitry to front panel—are utilized by TV leaders like Stromberg-Carlson, CBS-Columbia, Emerson, etc., leading electronic schools and universities, and over 60,000 radio-electronic servicemen coast to coast.

Exclusive "Beginner-Tested" step-by-step instructions make it easy, educational and enjoyable to build EICO Kits. Only basic tools, no electronics knowledge required. *You build 'em in one evening—they last a lifetime.* Exclusive 5-way Guarantee on instructions, components, performance, lifetime service and calibration. No wonder there are over 1/2-million in use the world over!

42 models to choose from. There is an EICO Distributor in your neighborhood. Write for his address & FREE CATALOG PE-11.

Prices 5% higher
on West Coast © 55

EICO

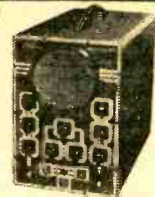

**5" Push Pull
Oscilloscope
KIT \$44.95
Wired \$79.95**



**6V & 12V Battery
Eliminator & Charger
KIT \$29.95
Wired \$38.95**

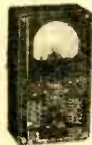

**1,000 Ohms/Volt
Multimeter
KIT \$12.90
Wired \$14.90**

84 Withers Street
Brooklyn 11, N. Y.

ADVERTISER'S INDEX

ADVERTISER	PAGE NO.
Ace Radio Company	114
Acme Model Engineering Co.	116
Airfax Radio	94
Alperadio Electronics Co.	122
Allied Radio Corp.	14
Alphatom Electronics	96
Audel Publishers	123
Bailey Technical Schools	109
Beavers, Patrick D.	122
Berger, T. W., Inc.	16
Burstein-Applebee Co.	125
Capitol Radio Engineering Institute	15
Chicago Standard Transformer Co.	106
Cleveland Institute of Radio Electronics	19
Coyne Electrical School	5, 115
Day, Matthew Co., Inc.	112
DeJur Amsco Corp.	98
DeVry Technical Institute	11
Dynatrans	118
Dynamu Magnetronics Corp.	120
Electro Devices, Inc.	125
Electronic Instrument Co., Inc. (EICO)	132
Electronic Measurements Corp.	10
Electronic Products Co.	122
Electro-Voice	9
Esse Radio Co.	97
G & H Wood Products Co., Inc.	4th Cover
Grantham School of Electronics	122
Grove Electronics	108
Gyro Electronics Co.	114
Heath Company	90, 91, 92, 93
Hershel Radio Co.	18
Hollywood Instrument Co.	20
Hot Spot Detector Inc.	131
Huckert Electronics	120
Instructograph Co.	120
International Correspondence Schools	13
Jones Box Corp.	108
K&L Radio Parts Co.	127
Keil Engineering Products Co.	104
Klipsch & Associates	123
LMB	120
Lafayette Radio Corp.	89
Lakeshore Industries	110
Lektron Specialties	113
McGraw Hill Book Co., Inc.	96
McMorrow, Berman & Davidson	124
MacFarlane Industries	120
Major Brand Tube Co.	20
Marvin Electronics	112
Midway Company	122
Miller, Gustave	120
Minnesota Mining & Mfg. Co.	22
Moss Electronics Dist. Co., Inc.	99, 100
National Radio Institute	3
National School of Meat Cutting	114
National Schools	21
O'Brien, Clarence & H. B. Jacobson	118
Olson Radio Warehouse	95
Pacific State University	122
Park Magnets	118
Philadelphia Wireless Technical Institute	110
Popular Electronics	66, 131
Precision Radiation Instruments, Inc.	108
Presto Recording Corp.	103
Progressive "Edu-Kits" Inc.	105
RCA Institutes	17
Radio-Television Training Association	7
Raytheon Mfg. Co.	6
Rex Radio Supply	110
Rider, John F. Publishing Co., Inc.	121
Rinehart Books	111
Rockbar Corporation	101
Sams, Howard W.	106
Science Kits	117
Scott, Herman Hosmer	2nd Cover
Shure Brothers	12
Sierra Scientific Co.	124
Sleeper, Milton B., Publisher	131
Smith, Johnson & Co.	112
Soundtronics	114
Siera Electronic Supply	112
Sprayberry Academy of Radio	3rd Cover
Springfield Gardens Enterprises	118, 122, 124
Stanley Electronics Corp.	103
Teltron Electric Co.	109
Tradyne, Inc.	116
Transvision, Inc.	115, 127
U. S. Air Force	8
Universal Labs	102
Universal Television Schools	98
University Loudspeakers	104
Valparaiso Technical College	116
Von Schrader Mfg. Co.	102
Western Radio	118
Whitehall Pharrnacoal Co.	124
World Radio Labs	119
YMCA Trade Schools	124

Learn **PRACTICAL RADIO-TV**
with **25 BIG KITS**

of equipment I send you while
you train with me . . . for valuable
shop bench experience . . .

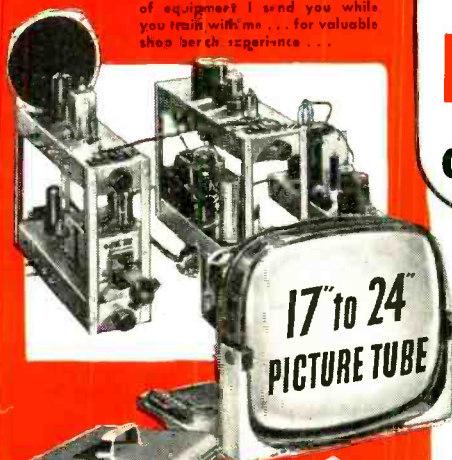

The new Sprayberry Training Television receiver, built and tested in sections.

I now offer this fine modern oscilloscope.

You build this powerful 2 Band superhet radio receiver.

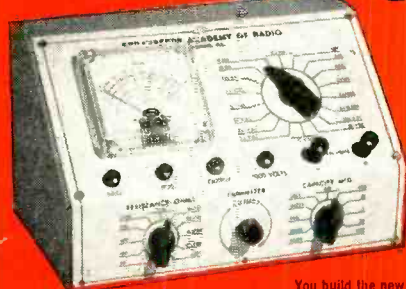
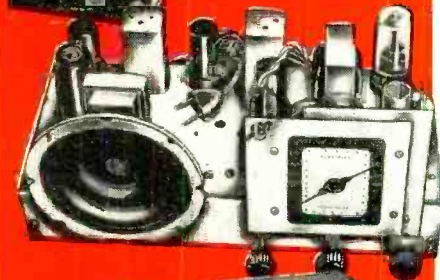

You build the new Sprayberry Tester . . . 18-range Volt-Ohm-Milliammeter readings.

In addition to modern lesson training, I also give you plenty of home practice on actual Radio-Television equipment . . . you will build and use the units shown here plus many more. All this equipment is yours to keep . . . keep everything you need to set up your shop.

Prepare for a Good Paying Job—Or Your Own Business

**"I Will Train You at Home in
RADIO-TELEVISION
on Liberal No Obligation Plan!"**

New Equipment! New Lessons! Enlarged Course! The true facts are yours in my big new catalog . . . YOURS FREE . . .

JUST MAIL COUPON!



Frank L. Sprayberry
President, Sprayberry
Academy of Radio

I can train and prepare you in as little as 10 months to step into the big opportunity Radio-Television service field. Train *without* signing a binding contract . . . without obligating yourself to pay any regular monthly amounts. You train entirely at home in spare hours . . . you train as fast or as slowly as you wish. You'll have your choice of **THREE SPRAYBERRY TRAINING PLANS** . . . planned for both beginners as well as the more experienced man. Get the true facts about the finest most modern Radio-Training available today . . . just mail the coupon for my big new 56 page fact-filled catalog plus sample lesson—both **FREE**.

Train the Practical Way—with Actual Radio-Television Equipment

My students do better because I train both the mind and the hands. Sprayberry Training is offered in 25 individual training units, each includes a practice giving kit of parts and equipment . . . all yours to keep. You will gain priceless practical experience building the specially engineered Sprayberry Television Training Receiver, Two-Band Radio Set, Signal Generator, Audio Tester and the new Sprayberry 18 range Multi-Tester, plus other test units. You will have a complete set of Radio-TV test equipment to start your own shop. My lessons are regularly revised and every important new development is covered. My students are completely trained Radio-Television Service Technicians.

NEWEST DEVELOPMENTS

Your training covers U H F, Color Television, F.M., Oscilloscope Servicing, High Fidelity Sound and Transistors.

See for Yourself . . . Make Your Own Decision . . . Mail Coupon Today!

The coupon below brings you my big new catalog plus an actual sample Sprayberry Lesson. I invite you to read the facts . . . to see that I actually illustrate every item I include in my training. With the facts in your hands, you will be able to decide. *No salesman will call on you.* The coupon places you under no obligation. Mail it now, today, and get ready for your place in Radio-Television.

SPRAYBERRY ACADEMY OF RADIO

111 North Canal Street, Dept. 105-F, Chicago 6, Illinois

Mail This Coupon For Free Facts and Sample Lesson



SPRAYBERRY ACADEMY OF RADIO
Dept. 105-F, 111 N. Canal St., Chicago 6, Ill.

Please rush all information on your ALL-NEW Radio-Television Training Plan, I understand this does not obligate me and that no salesman will call upon me. Include New Catalog and Sample Lesson **FREE**.

Name _____ Age _____

Address _____

City _____ Zone _____ State _____

CABINART '56 - HI FI CABINET KITS



**MODEL 27K
MODEL 28K**
matched equipment
and speaker
cabinets

**HI FI
wall storage
units**

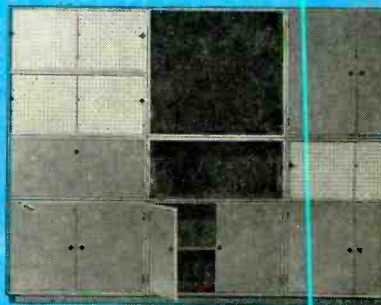

**Model K-3
newest Rebel*
corner folded horn kit**



... all you need is a screwdriver!

Machined wood pieces key exactly to each other! Pre-shaped, pre-drilled, pre-engineered and not a scrap of sawdust left over!

THE REBEL K-3

Identical acoustically with the KR-3, first and largest of the Klipsch-designed Rebel series of corner folded horns. Using the mirror images of room walls at a corner, the K-3 extends bass down nearly to 30 cycles! Two companion Rebel kits are more economical but only in price and size.



K-3 . . . \$54.00

Prices slightly higher west and south

THE "ST" SERIES

Wall storage units . . . ten basic Cabinart designs in kitform or assembled, ready to finish. Each is tailored to the needs of hi-fi installations. The Series includes a *nine cubic foot bass reflex cabinet*.

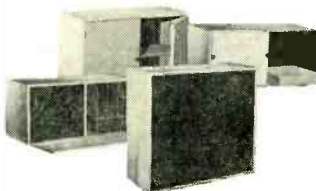

**Prices from
\$21.00 to \$36.00**

FURNITURE KITS

The new 27K and 28K typify Cabinart kit utility and economy. Both point up the unique design functions necessary to the correct hi-fi installation.



**Equipment Cabinet
\$51.00**



**Bass Reflex
\$39.00**

WRITE FOR THE NAME OF YOUR NEAREST DEALER AND MAIL ORDER HOUSE.

kits by



... the pioneers in radio furniture
for high fidelity.

99 NORTH 11th STREET, BROOKLYN 11, NEW YORK

* Trademark

WRITE

1. Equipment Storage
2. Equipment/Speaker Enclosure Kits
3. The Rebel Speaker
4. Wall Storage Cabinets
5. Accessories By Cabinart

