

POPULAR ELECTRONICS

AUGUST
1955

25
CENTS

In U.S. and Canada

HI-FI • RADIO AMATEURS • R/C • SWL • AUDIO



- Behind the U. L. Label
- Use Cadmium Photocells
- Geiger Counter Probes
- R/C Printed Circuitry

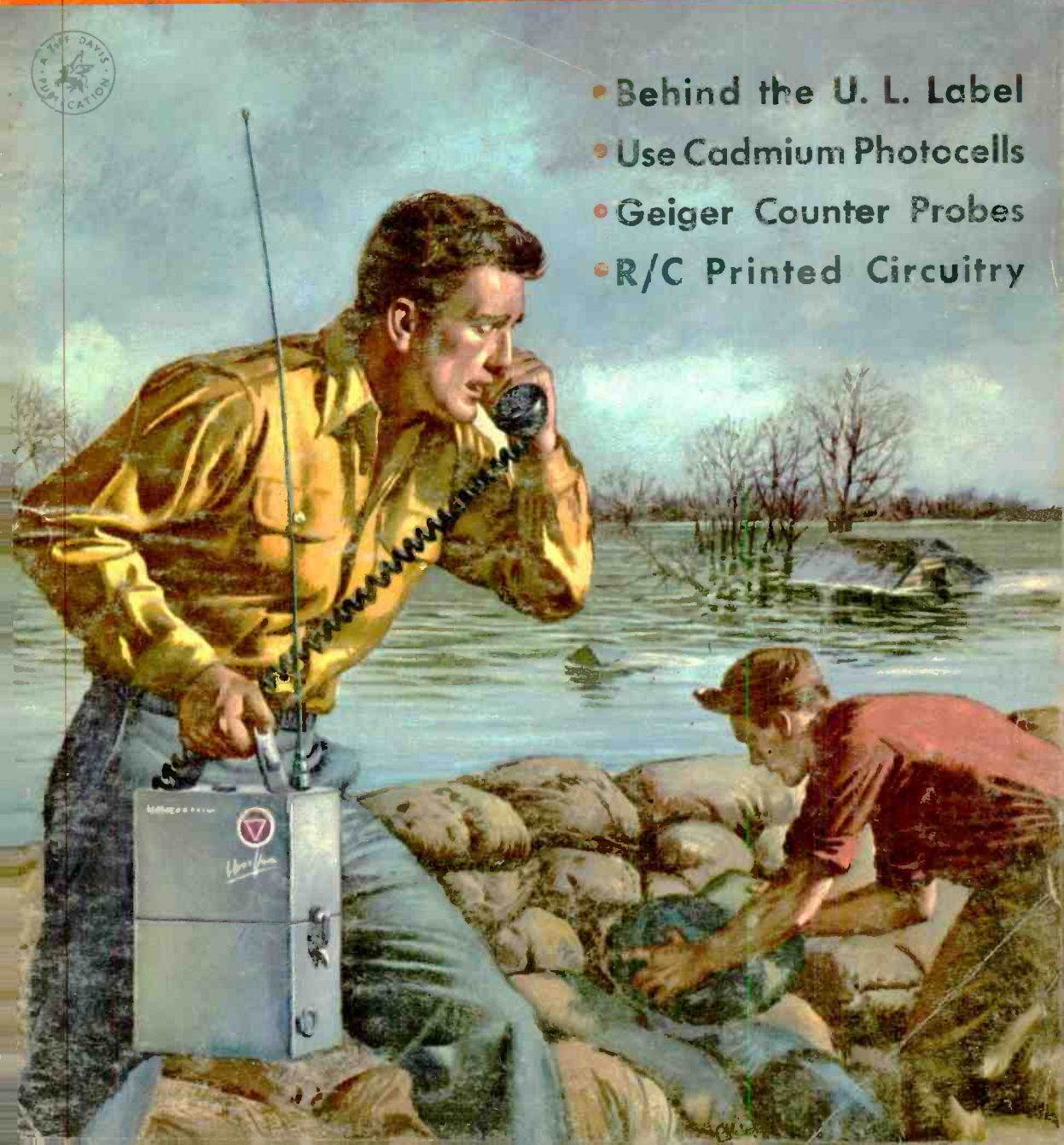

FREE CATALOG

OF GEIGER AND SCINTILLATION COUNTERS FOR URANIUM PROSPECTING

PRICES START AS LOW AS \$21.95!

When prospecting for uranium, your chances of making a "strike" can be no better than the equipment you use. When you're in the field, you must depend on your instruments, so it pays to get the best! Shown here is but a small sample of the huge assortment of sensitive, high-quality Geiger and Scintillation Counters made by EL-TRONICS. Send now for FREE catalog which shows and describes the complete EL-TRONICS line of precision instruments for locating uranium. You're sure to find the most dependable equipment to fit your own particular needs at the price you can afford.



**GEIGER
COUNTER
PR-5A
\$99⁹⁵**

EL-TRONICS

HAS BEEN FAMOUS FOR OVER 20 YEARS!

Top engineering know-how has made EL-TRONICS a leader in the nucleonic field for over 20 years. You are guaranteed the world's most rugged, highest-quality and durable Geiger and Scintillation Counters available. For FREE illustrated catalog, just mail the coupon with your name and address *today*. Or order any counter shown here on our guarantee of satisfaction or money back.



**SCINTILLATION
COUNTER
PR-31
\$499⁹⁵**



**POCKET
GEIGER
PR-1
\$21⁹⁵**



**GEIGER
COUNTER
PR-4
\$49⁹⁵**



**GEIGER
COUNTER
PR-7
\$200⁰⁰**

MAIL COUPON FOR FREE CATALOG

URANIUM PROSPECTORS SUPPLY CO., Dept. PE-8
1420 Walnut St., Philadelphia 23, Pa.

Please send me ABSOLUTELY FREE your catalog of sensitive, precision-made EL-TRONICS Geiger and Scintillation counters.

I enclose \$..... (check or money-order). Please send me Geiger or Scintillation Counter Model..... as illustrated in your ad. If I am not completely satisfied, I may return the instrument within 10 days for full refund.

Name..... (Please print)

Address.....

City..... Zone..... State.....

**URANIUM PROSPECTORS
SUPPLY COMPANY**

A Division of National Merchandising Corp.
1420 Walnut St., Philadelphia 23, Pa.



You Build **THIS TRANSMITTER**
with Parts I Send



I WILL TRAIN YOU FOR
YOUR FCC LICENSE

LEARN COMMUNICATIONS by Practicing at Home in Spare Time

Use parts I send for Actual Experience

My Training Leads to Jobs Like These

BROADCASTING: Chief Technician, Chief Operator, Power Monitor, Remote Control Operator, **SHIP AND HARBOR RADIO:** Chief Operator, Radiotelephone Operator, **GOVERNMENT RADIO:** Operator in Army, Navy, Coast Guard, Forestry Service, Dispatcher, **POLICE RADIO:** Transmitter Operator, Service Technician, **AVIATION RADIO:** Plane Radio Operator, Airport Transmitter Operator, **TELEVISION:** Pickup Operator, Voice Transmitter Operator, TV Technician.



The Communication Course I offer you is backed by NRI's 40 year record of training men at home. My well-illustrated lessons give you the basic principles you must have to assure success. My skillfully developed kits "bring to life" what you learn from my lessons, give you practical experience on circuits common to BOTH Radio and Television. You build the low-power Broadcasting Transmitter shown above (at left). You put this station "on the air," and conduct procedures required of Broadcasting Station operators. My book shows other valuable equipment you build and keep.

mitter Operators. Remote Control Operators, Service and Maintenance Technicians, etc. Mail Coupon. Find out, without obligation, what I offer. NRI training can assure you more of the better things of life; can help you qualify for high pay and promotion when times are good, enjoy greater security when jobs are scarce. Progressive, ambitious men consider Radio-Television an outstanding field for their life's work. My 64-page book, "How to Be a Success in Radio-Television," gives important facts about America's fast growing industry, shows what my graduates are doing and earning. You see equipment you practice with at home. Also, you get actual sample lesson. see how easy it is to learn at home. I send both FREE.



J. E. SMITH
PRESIDENT
National Radio Institute
For 40 years, the leader in training men at home.

I TRAINED THESE MEN AT HOME



"I have progressed very rapidly. My present position is Television Studio Supervisor with KEDD Television, Wichita." — Elmer Frelwadt, 3026 Stadium, Wichita, Kansas.



"I did not know a thing about Radio before I enrolled for your training. Now I have a job as Studio Engineer at Radio Station KMMJ." — Bill Dellzell, Central City, Nebr.

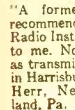

"A former employer recommended National Radio Institute training to me. Now employed as transmitter operator in Harrisburg." — Albert Herr, New Cumberland, Pa.

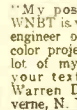

"My position with WNBT is video control engineer on the RCA color project. I owe a lot of my success to your textbooks." — Warren Deem, Malvene, N. Y.



"Am with WCOC. Happy with my job. NRI course can't be beat. Passed exam for 1st class Radio-telephone license with no trouble." — Jesse W. Parker, Meridian, Miss.

AVAILABLE TO VETERANS UNDER G. I. BILLS



I Also Have a Course in Radio-TV SERVICING



If you prefer a career in Radio-Television Servicing, I'll train you at home for it. Course includes many Kits of parts. My book shows that many make \$10, \$15 a week EXTRA fixing sets while training.

Television's Rapid Growth Making Good Jobs, Prosperity

Radio is bigger than ever with over 3000 Broadcasting Stations on the air making good jobs for Chief Operators, Recording and Remote Control Operators, Power Monitors, Technicians, etc. Now there's Television, too. About 200 TV Stations are on the air with many more being built, construction of hundreds of additional stations authorized, and new TV Station applications being filed every month. Think of the demand this is creating from coast to coast for Pickup and Voice Trans-

Get Facts Now—Mail Coupon

You don't have to leave home or give up your job to take NRI courses. Many of my graduates make more than the total cost of my training in a few weeks. Mail coupon now. J. E. SMITH, President, National Radio Institute, Dept. 5HD4 Washington 9, D.C. OUR 40th YEAR.

Send for FREE 64 Pg. Book

Mr. J. E. SMITH, President, Dept. 5HD4
National Radio Institute, Washington 9, D. C.

Mail me 64-page Book FREE. (No salesman will call. Please write plainly.)

Name _____ Age _____

Address _____

City _____ Zone _____ State _____

VETS write in date of discharge

APPROVED MEMBER, NATIONAL HOME STUDY COUNCIL

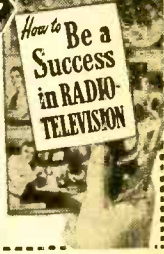

POPULAR ELECTRONICS is published monthly by Ziff-Davis Publishing Company, William B. Ziff, Chairman of the Board (1945-1953), at 64 E. Lake St., Chicago 1, Ill. Entered as second class matter August 27, 1954 at the Post Office, Chicago 1, Illinois. SUBSCRIPTION RATES: One year U.S. and possessions, and Canada \$3.00; Pan-American Union Countries \$3.50; all other foreign countries \$4.00.

POPULAR ELECTRONICS

Registered U. S. Patent Office

CONTENTS

Automatic Factories.....	E. G. Louis	21
Electronic Fish-Finders.....		27
Behind the U.L. Label.....	E. D. Morgan	31
Science Meters a Heart Muscle.....		34
"Mr. Meticulous" Makes Transistors.....		37
"Over the Horizon" Transmission.....		39
TV for Parking Lots.....		41
Using the CdS Photocell.....	Marvin Lubin and Wallace Samuelson	42
Lingo of the Schematic.....	George Berry	44
Positive Flash-Gun Tester.....	Harvey Pollack	46
Build Your Own Applause Meter.....	Louis E. Garner, Jr.	47
Checking a Typical Clock Radio.....	H. Leeper	52
Build Your Own Geiger Counter Probe.....	Carter Robertson	54
Electronic "Whistler".....	Rufus P. Turner	57
Jlg Makes Solder Gun Tips.....	Harvey Pollack	62
The \$1.60 Signal Generator.....	Frank H. Tooker	64
Carl & Jerry.....	John T. Frye	66
Printed Circuitry for R/C.....	Paul F. Runge	74
Thin-Skin Chassis Cuts Costs.....	Richard C. Saunders	90

POPULAR ELECTRONICS Audio and Hi-Fi Section

Disc and Tape Review.....	Bert Whyte	77
Birth of a Loudspeaker.....		79
Distortion in Hi-Fi Equipment (Part 3).....	Norman H. Crowhurst	82
What Is an Audio Watt?.....	Eugene F. Coriell, Major, USAF	84
Square-Wave Converter.....	Howard J. Carter	86

DEPARTMENTS

From the M. Ed. of POP'tronics.....		8
Letters from Our Readers.....		10
The Transmitting Tower.....	Herb S. Brier	68
Ama-Touring with Roger Legge.....		70
Tuning the Short-Wave Bands.....	Hank Bennett	71
R/C Notes.....		73
After Class.....		88
What's the PE Answer?.....		96
POP'tronics Bookshelf.....		100
Tools & Gadgets.....		106
Tips and Techniques.....		109
Glossary of Electronic Terms.....		124
Standardized Wiring Diagram Symbols.....		126

(Also see page 6)

Cover Painting by Ed Valigursky

AUGUST 1955

VOL. 3 - NUMBER 2

EDITOR
OLIVER READ, WIETI

MANAGING EDITOR
O. P. Ferrell

TECHNICAL EDITOR
H. S. Renne

FEATURE EDITOR
Norman Eisenberg

ASSOCIATE EDITORS
M. C. Magna
Charles Tepfer

ART EDITOR
A. J. Reich

CONTRIBUTING EDITORS
J. T. Frye L. E. Garner, Jr.
H. Bennett R. P. Turner
R. Legge H. Pollack
H. S. Brier

ART DEPARTMENT
Frank Sayles (Director)
J. A. Golaneck M. Whelpley

ADVERTISING DEPARTMENT
NEW YORK (MU 7-8080)
L. L. Osten—Adv. Dir.
Wm. G. McRoy—Adv. Mgr.
T. Suito

CHICAGO (AN 3-5200)
James Weakley

LOS ANGELES (Mich. 9856)
John E. Payne—W. J. Fitzgerald



Copyright 1955
(All Rights Reserved)

**ZIFF-DAVIS
PUBLISHING COMPANY**

W. B. ZIFF (1898-1953) FOUNDER

Also Publishers of
RADIO & TELEVISION NEWS

Editorial and Executive Offices
366 Madison Ave., New York 17, N.Y.

PRESIDENT
B. G. DAVIS

VICE-PRESIDENTS
H. J. MORGANROTH M. FROELICH

SECRETARY-TREASURER
G. E. CARNEY

CIRCULATION MANAGER
M. MICHAELSON

BRANCH OFFICES
Chicago (1), 64 E. Lake St.
Los Angeles (14), Stotler Center,
900 Wilshire Blvd.

SUBSCRIPTION SERVICE:

All communications concerning subscriptions should be addressed to Circulation Dept., 64 E. Lake St., Chicago 1, Ill. Include your old address as well as new—enclosing if possible an address label from a recent issue of this magazine. Allow at least 4 weeks for change of address.

CONTRIBUTIONS:

Contributors are advised to retain a copy of their manuscripts and illustrations. Contributions should be mailed to the New York Editorial Office and must be accompanied by return postage. Contributions will be handled with reasonable care, but this magazine assumes no responsibility for their safety. Any copy accepted is subject to whatever adaptations and revisions are necessary to meet the requirements of this publication. Payment covers all author's contributor's, and contestant's rights, title, and interest in and to the material accepted and will be made at our current rates upon acceptance. All photos and drawings will be considered as part of material purchased.

POPULAR ELECTRONICS



Train for Better
Jobs in

ELECTRICITY OR TELEVISION-RADIO

in Great
Shops of COYNE

GREAT OPPORTUNITY FIELDS

Conditions are changing. Many "one operation" jobs that have paid well will not last. *Don't be satisfied with a "no future" job.* Whether 17 or up to 45 years of age, train the Coyne way for a better job and a real future in **ELECTRICITY** or **TELEVISION-RADIO**, fields that offer a world of opportunities.

YOU can TRAIN in great CHICAGO SHOPS

Train on real, full-size equipment at COYNE where thousands of successful men have trained for over 56 years—largest, oldest, best equipped school of its kind—established in 1899. No advanced education or previous experience needed. TRAINING APPROVED FOR VETERANS.

B. W. COOKE, President

COYNE
ELECTRICAL SCHOOL

FOUNDED 1899

A TECHNICAL TRADE INSTITUTE OPERATED NOT FOR PROFIT
500 S. PAULINA STREET, CHICAGO, Dept. C5-71H

ELECTRICITY ★ RADIO ★ TELEVISION ★ REFRIGERATION ★ ELECTRONICS

COYNE offers
LOW COST

TELEVISION RADIO-ELECTRONICS

Training in
Spare Time AT HOME

The future is YOURS in TV-RADIO!

A fabulous field—good pay—fascinating work—
a prosperous future! Good jobs, or independence
in your own business!

Coyne brings you the first *truly lower cost*, MODERN—QUALITY Television Home Training; training designed to meet Coyne standards. Not an old Radio Course with Television "tacked on". Here is MODERN TELEVISION TRAINING including working knowledge of Radio. Includes UHF and **COLOR TV**. No Radio background or previous experience needed. Personal guidance by Coyne Staff. **Practical Job Guides** to show you how to do actual servicing jobs—*make money early in course*. With Coyne Television Home Training you pay only for your training, *no costly "put together kits"*.

B. W. COOKE, President



COYNE
ELECTRICAL SCHOOL

500 S. Paulina St., Dept. C5-HT7, Chicago 12
A TECHNICAL TRADE INSTITUTE OPERATED
NOT FOR PROFIT

*Coyne—the Institution behind this
training... the largest, oldest, best
equipped residential school of its
kind. Established 1899.*

START NOW—PAY LATER—Finance Plan
and Easy Monthly Payment Plan. Also part-
time employment help for students.

Get FREE Book

Send coupon for 48 page
illustrated book "Guide to
Careers in Electricity and Tele-
vision-Radio." No cost; no
obligation; no salesman will
call. Get vital facts now!



B. W. COOKE, President
COYNE ELECTRICAL SCHOOL
500 S. Paulina St., Chicago 12, Ill., Dept. C5-71H

Send **BIG FREE** book and details of your
training offer. This does not obligate me and
no salesman will call. I am interested in:

Electricity Television-Radio

Name _____

Address _____

City _____ State _____



SEND COUPON FOR FREE BOOK

and full details,
including easy
Payment Plan.

**No obligation, no
salesman will call.**

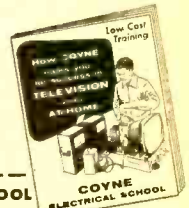

COYNE ELECTRICAL SCHOOL
Television Home Training Div.
500 S. Paulina St., Chicago 12, Ill.,
Dept. C5-11T7

Send Free Book and details on Television
Home Training. This does not obligate me and
no salesman will call.

Name _____

Address _____

City _____ State _____

BUILD YOUR OWN AMATEUR TRANSMITTER

from this easy to assemble kit!

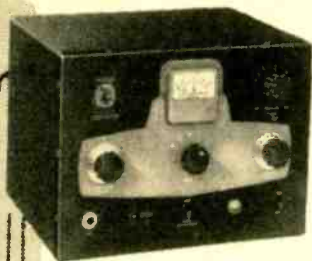

Start your hobby off right with this professional CW transmitter kit. 50 Watts input on 80, 40, 20, 15 and 11-10 meters. Packs enough power for world-wide radio contacts with just a simple antenna. No antenna tuner needed—single knob band-switching—crystal controlled oscillator—powerful 807 transmitting type output tube. Easy to build—safe to operate! Kit is furnished complete with built-in power supply, tubes, cabinet, wiring instructions and antenna suggestions.

Cat. No. 240-181-1—Viking "Adventurer" Kit, less crystal and key \$54.95

JOHNSON KEYS AND PRACTICE SETS

STANDARD KEY—Heavy die cast base. Smooth adjustable bearings. Provision for plugging in semi-automatic keys. Contacts are 1/8" coin silver. A high quality key at a low cost. 114-310 . . . \$2.60 Net Price

PRACTICE KEY—an inexpensive practice key—perfect in design for the average beginner. All the metal parts are nickel plated except the base. Furnished with an adjustable key arm spring and smooth action bearings. Contacts are of 1/8" coin silver. 114-300 . . . \$1.75 Net Price

PRACTICE SET—Constant frequency buzzer and key on a 4" x 6" molded Bakelite base. May be used singly or in pairs for code practice. 114-450 . . . \$4.25 Net Price



For more information on the Viking "Adventurer" or Johnson's complete line of keys—see your electronic parts distributor or write to:



E. F. JOHNSON COMPANY

3013 Second Ave. S. W., Waseca, Minn.

ITEMS OF INTEREST

Morse Code Converter.....	26
"Brain" Is Smallest and Fastest.....	30
Electronic Juggler.....	30
Liquid Chemical Provides First Aid for Electronic Circuits.....	36
Electronic Analyzer Diagnoses Car Ailments.....	61

NEW PRODUCTS

Unique Features, Advanced Design in Hi-Fi Units..	26
A.C.-D.C. Converter.....	30
Powerful Wireless Intercom.....	36
Electrostatic Tweeter.....	40
Enclosure Has Adjustable Port.....	40
Filter Eliminates TVI.....	55
Unbreakable TV Lamp.....	55
Low-Cost Intercom.....	56
Plastic Tape Reels.....	56
Short-Wave Hi-Fi Tuner.....	56
Indoor Rotating Antenna.....	61

COMING NEXT MONTH POPULAR ELECTRONICS

CIC—"The Navy's Electronic Clearinghouse"

Extra Jobs for the VOM

Stroboscope for the Electronic Workshop

The Big Ear

Picking Your Record Player or Changer

Building a Miller Hi-Fi Tuner

High-Fidelity Audio ■ Kits ■ Radio Control

■ Short-Wave Listening ■ What's New ■

How It Works ■ How to Make It ■ How to

Use It ■ Carl & Jerry ■ Tips & Techniques

IN THIS MONTH'S RADIO & TELEVISION NEWS

(August)

Techniques of Recording Wildlife

An Amateur U.H.F. Transceiver

Marine Electrolysis

Frequency-Modulated Wireless Record Player

QRM? Get Looped!

Transistorized Headlight Dimmer



When Nick Pakinas started my RTTA Radio-FM-Television Course his 7-year-old daughter, Sharon, kept right up with him as he progressed in his lessons in their home in Bothell, Washington.

Today, Sharon — shown here in a photograph reproduced from the pages of the Seattle Post-Intelligencer — is the youngest FCC-licensed amateur radio operator in the Pacific Northwest, and possibly the nation.

**If Sharon can do it, why can't you?
The answer is . . . YOU CAN!**

YOU
GET ALL
THE
EQUIPMENT
SHOWN
AND
MORE!

PREPARE FOR A BRIGHTER FUTURE

You can hold down a full-time job and still train AT HOME by the same successful methods I used to help hundreds of men—many with no more than grammar school training — master television!

GOOD SPARE TIME EARNINGS

Almost from the very start you can earn extra money while learning by repairing radio-TV sets for friends and neighbors. Many of my students earn up to \$25 a week . . . pay for their entire training from spare time earnings . . . start their own profitable service business.

Cut out this Coupon and Mail It Now!

No salesman will call

Radio Television Training Association

52 EAST 19th STREET • NEW YORK 3, N. Y.

Licensed by the State of New York • Approved for Veteran Training

August, 1955

MY TRAINING IS SO SIMPLIFIED EVEN A THIRD-GRADER CAN MASTER IT!

If you've been looking for a chance to improve yourself—to get into a high-paying field with a good future—but have been putting it off because you don't think you have enough schooling, or enough time, here is your chance to make your dreams come true.



L. C. Lane, B.S., M.A. President, Radio-Television Training Association. Executive Director, Pierce School of Radio & Television.

Sharon Pakinas was only in the Third Grade when she studied her father's course from RTTA and passed the FCC Examination for an amateur radio operator's license. Many of my students have had no more than a grammar school education. My easy-to-understand lessons especially prepared for home study make it possible for students with no previous experience to become skilled television technicians.

VETERANS!

My School Fully Approved to Train Veterans under new Korean G.I. Bill. Write discharge date on coupon.

Mr. Leonard C. Lane, President
RADIO-TELEVISION TRAINING ASSOCIATION
Dept. E-8, 52 East 19th Street, New York 3, New York

Dear Mr. Lane: Mail me your NEW FREE BOOK, FREE SAMPLE LESSON, and FREE aids that will show me how I can make BIG MONEY IN TELEVISION. I understand I am under no obligation and no salesman will call.

(PLEASE PRINT PLAINLY)

Name _____ Age _____

Address _____

City _____ Zone _____ State _____

I AM INTERESTED IN:

- Radio-FM-TV Technician Course
- FM-TV Technician Course
- TV Cameraman & Studio Technician Course

VETERANS!

Write discharge date

At Last!

a complete **TUBE TESTER**

\$24.90
for only



New EMC Model 208*
*Pat. Pending tests all
tube types quickly . . .
easily . . . accurately
. . . in the field or shop.

The sensational new EMC
Model 208* gives you
for the first time a
complete precision tube
tester for less
than \$25.00.

With it you can quickly
and accurately test
all tube types
for quality as well
as shorts, leakages,
filament continuity
and opens.

MODEL 208 TUBE TESTER
(COMPLETELY WIRED AND TESTED)
Only \$24.90

MODEL CRA (PICTURE TUBE
ADAPTOR OF MODEL 208) \$4.50

Write to Dept. PE-8 today for complete catalog
of precision test equipment.

CHECK THIS EXCLUSIVE COMBINATION OF FEATURES:

- Lowest market price
- Completely portable
- Checks all popular octal, loctal, miniature and noval base tubes
- Flexible switching system assures complete testing of all present and future tubes types
- Elements numbered according to RTMA base system
- Individual sockets for each tube type
- Checks completely for quality as well as shorts, leakages, filament continuity or opens between any two tube elements
- Visual line voltage check with adjustable control assures accurate quality testing
- Matches and checks HI-FI tubes such as 1614, KT 66, and 5881
- Space saving, high impact case, 5 1/4 x 6 3/4 x 2 1/4"
- Comes complete with detailed instruction book and tube listings.

An Invaluable tool for: Servicemen, radio hams, HI-FI fans, students, hobbyists.

EXPORT DEPT.
136 LIBERTY ST. N. Y. 6, N. Y.
**ELECTRONIC
MEASUREMENTS
CORPORATION**
370 BROADWAY
NEW YORK 13, N. Y.

EMC

FROM THE **M. Ed.**
OF **POP'tronics**

WITHIN the next two months, a "survey" will be made of the readership of "POP'tronics." Its purpose will be to determine individual reader preferences among the articles that have been published in our magazine, and to find out what readers would like to see in future issues. Obviously, in a magazine whose distribution is in excess of 300,000, this poses quite a problem; but to those who may receive these survey inquiries, may we stress that all answers are important. In fact, your one vote in any direction pro or con your favorite topic or pet peeve may influence editorial judgment. Careful consideration should be given all the questions of the survey; whenever possible, take into account the opinions of your friends and associates. Thoughtful opinions with solid backgrounds will permit a speedier analysis and a quick application of the ideas found to be most desirable.

The Editors are always interested in reader letters and comments, whatever the subject. Among our audience, there will be many who will recall writing to us some months ago for specific articles—which may now be included in this very issue. Articles such as the "Electronic Whistler" (page 57) and "Build Your Own Applause Meter" (page 47) were originally requested by readers and designed according to their specifications. Forthcoming articles on transistors, printed circuits, ham radio receivers and transmitters will all be derived from reader requests. May we have yours?

In general, reader interest can be ranked in the following subject order: high fidelity (leading subject by a wide margin), ham or novice radio, electronic gadgetry (such as the "Theremin," Geiger counters, "Whistler," etc., but now leaning towards small computers and games), R/C, basic electronic instruction and experiments, and finally, SWL. This list excludes general interest topics which appear to have a widespread appeal.

o.p.f.

POPULAR ELECTRONICS

INVENTORS

If you believe that you have an invention, you should find out how to protect it. The first step is to have a search made of the prior pertinent U. S. patents. If a report on this search indicates that the invention appears patentable you can apply for a patent, and the specifications and claims should be prepared.

The firm of McMorrow, Berman & Davidson, with offices in Washington, D. C., is qualified to take the necessary steps for you. We can make a preliminary search on your invention, advise you whether we think it can be patented, and prepare your application for patent.

Unless you are fully familiar with the U. S. Patent Laws, we recommend that you engage the services of a Registered Patent Attorney to protect your interests. The patent laws are *your* laws. A patent gives you the right to prevent others from making, using or selling the invention claimed in your patent for a period of 17 years.

Use these patent laws for your protection. Investigate whether your invention can be patented. If you have what you believe to be an invention, we suggest that you have this firm make a search for you.

Send for a copy of our Patent Booklet entitled "How To Protect Your Invention," containing information about patent protection and patent procedure. Along with this we will also send you an "Invention Record" form, for your use in writing down and sketching details of your invention. We will mail them promptly. No obligation. They are yours for the asking.

McMORROW, BERMAN & DAVIDSON

Registered Patent Attorneys

PATENTS • COPYRIGHTS • PATENTS

349-B VICTOR BUILDING, WASHINGTON 1, D. C.

Long-Play (33 $\frac{1}{3}$ RPM) Hi-Fidelity

10 ALL-TIME GREAT JAZZ CLASSICS

LETTERS FROM OUR READERS

INFO ON CARDIOLOGY NEEDED

■ I was quite interested in the short article on cardiology (April issue), and should like to know the address of the National Heart Institute. . . . I am gathering information on electrocardiographs for a thesis I am writing. Any information will be gratefully accepted.

DAVID L. BLAIR
Kingston, Ontario

The National Heart Institute is located at 9000 Wisconsin Ave., Bethesda, Md. Readers who may have additional information for Mr. Blair can reach him at 26 Nelson St., Kingston, Ontario, Canada.

PHONO TRANSMITTER

■ Please send me plans for a phonograph record transmitter or tell me where I can get such plans.

DALE CITRON
Chillicothe, Mo.

A suitable unit is described fully in our March, 1955, issue ("A Modern Wireless Record Player," pages 49-52). In addition, details on a "Home Broadcaster" were given in our November, 1954, issue. To obtain back copies, send 30 cents for each issue desired to our Circulation Department, 64 East Lake St., Chicago 1, Ill.

ELECTRONIC "DREAM FARM"

■ Your article in the March issue on "Electronic Miracles of the Future" was all right, but it didn't have anything on farming by push button. My dream farm includes a tractor equipped with power steering, a truck tractor with hydraulic drive and high power generator which could be run from the power take-off. This would be used to power a radio-control receiver. Also, there would be a television transmitter for sending picture signals to a receiver in an air-conditioned room where the R/C transmitter, controls, and operator would all be located.

I read the other day that two TV hams were using oscilloscope tubes for camera tubes. Or an RCA camera tube could be used to see everything from the tractor seat that an operator on the tractor would normally see, and to send the picture signals—via the TV transmitter on the tractor—to the receiver.

About a 3- or 4-channel R/C unit would do—one channel for steering, another for throttle, one for the power-lift, and one for the setting of the automatic transmission; also one for the starter.

I forgot to mention that two or three camera tubes would be needed to see in front and behind and wherever the operator might need to look. How's that for dreaming?

Incidentally, why aren't the majority of R/C fans using more powerful transmitters? I

(Continued on page 14)

POPULAR ELECTRONICS

Long Playing

A Treasury of Jazz
FEATURING
Charlie Parker
Teddy Wilson
Coleman Hawkins
Eddie Condon
Dizzy Gillespie
Jack Teagarden
Pee Wee Russell
Erroll Garner
Sidney Bechet
Art Tatum

AND DOZENS OF OTHER "GREATS"!

Playing
Jelly Roll Blues
Honeysuckle Rose
Basin St. Blues
Relaxin' at Camarillo, etc.



Not \$1 Each—
But \$1 for ALL TEN

YES, you get ALL TEN of these "all-time great" jazz masterpieces for just \$1.00, no strings attached! We make this amazing offer to show you the quality of these Jazztone Society recordings, obtainable nowhere else! Every jazz era, every jazz style, virtually the whole history of jazz can be traced in the wide range of these selections. But only by hearing, these dazzling recorded performances can you appreciate their technical and artistic excellence, their wonderful high fidelity.

How the Jazztone Society Operates

You are not obligated ever to buy another record from us. You do have the right to try any of the Society's monthly selections you wish. You receive prior notice of these and pay nothing in advance. Those you want are sent to you for FREE trial. After 5 days, the records you decide to keep are billed you at the special Members' low price of just \$2.75, plus a few cents shipping, for each 12-inch long-playing record (average playing time one full hour). You save over 40% of the usual retail price! Start your jazz library with these 10 classics for only \$1.00. Mail coupon with a dollar now while supply lasts! Money-back guarantee.

THE JAZZTONE SOCIETY, INC., Dept. PE-8
43 West 61st Street, New York 23, N. Y.

Enclosed is \$1 in full payment for the recordings of 10 jazz classics listed. Enroll me as a Trial Member. Privileges: No purchase obligation ever! Advance notice of releases. 5-day free trial on any discs. I may reject records before or after receipt; may cancel membership at any time. For future l.p. discs I keep, I'll pay only \$2.75 each, plus shipping . . . saving 40% off usual retail price!

Name

Address

City..... Zone..... State.....

Canada address: 105 Bond St., Toronto 2, Ont.

LIMIT: One sample package per customer.

FIX TV AND RADIO SETS RIGHT AWAY

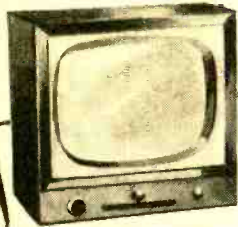

—even if you never fixed a lamp or doorbell before!

McGraw-Hill's Amazing New Low-Cost Instruction Manual Skips Hard-to-Understand

"Theories" and "Formulas." Tells How-to-do-it in PLAIN ENGLISH!

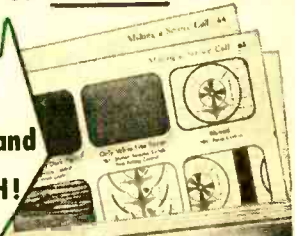

WHY hasn't somebody done this BEFORE? That's what you'll exclaim the minute you start browsing through this amazing new one-volume instruction manual in TV and radio repair.

For here at last a well-known EXPERT has found a way to tell you in PLAIN ENGLISH how to fix almost ANY radio or television set. (And he even tells you where you can go to have the extra-tough jobs done FOR you . . . at reduced professional rates.) Right from the very first chapters you can start doing simple repairs . . . and before you're HALF way through the manual, you can fix HALF the television and radio sets that you encounter. In just a few weeks you can start fixing your own and friends' sets . . . get a service shop job . . . even start your own money-making business at home.

Why It's So EASY to Understand

You get no complicated formulas, algebra, laboratory experiments. Instead you deal *only* with the parts that go wrong in sets—how to recognize the trouble—and what to do about it. "Easy as A-B-C" directions and 700 clear photos, diagrams, and drawings

Tells HOW To "Cash In" ON THE BIG DEMAND FOR RADIO-TV REPAIRMEN

Over 25 million TV sets . . . over 100 million radios! Make nice extra money just fixing sets for friends and neighbors in your spare time . . . or start your own full-time repair business. Book tells exactly how to get started; which tubes to stock; how to make a service call. Actually start fixing sets and making money before you're half-way through book.

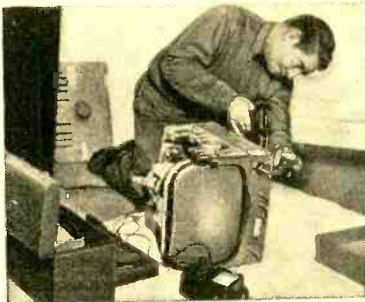

Save Money on Your Own Set

Save \$50 to \$100 a year just in installing, repairing and servicing your own TV set. Book tells which controls to adjust or tubes to replace if picture is entirely dark — blurred — split — distorted — off center — tilted — wiggles and wobbles — too pale — too black — jitters — snow effects — drifts — etc., etc.

show you exactly WHAT and HOW to fix, step-by-step. The author is Associate Editor of *Electronics* Magazine. He spent FOUR years making this one-volume manual practical and easy-to-understand—even for an "unhandy" beginner.

Here's everything you need to know about *where* and *how* to buy tubes and parts, where and how to get an official circuit diagram for any receiver; how to choose and use basic tools; how to test tubes WITHOUT a tube tester; how to use 58 common TV controls; how to "diagnose" and "cure" common radio and TV troubles; how to fix loudspeakers, phono pickups; how to install and check antennas; and much, much more.

SEND NO MONEY

Examine this book for 10 days BEFORE you decide if you wish to own it. Try it out FREE on your own or a neighbor's set. See how simple and easy it makes nearly every repair job. Make it *pay for itself* in 10 days or don't keep it! Mail coupon to: McGraw-Hill Book Co., Inc., Dept. PEL-8, 327 West 41st St., New York 36, N. Y.

TELEVISION AND RADIO REPAIRING

TRY IT FREE ON YOUR OWN SET FOR 10 DAYS

PARTIAL CONTENTS

How to Remove and Replace Tubes
 • Testing Tubes without a Tester
 • Using a Table Tester • Power Supply Troubles • How to Test and Replace Resistors, Controls, Switches, Condensers, Coils, Transformers • Loudspeakers • Phono Pickups and Needles • Antennas . . . MUCH MORE.

"Written as simply and clearly as possible. A natural for the beginner."
 —Radio & TV News
 "Prepared for people who know absolutely nothing about radio or use of tools."
 —Radio Electronics
 "Unique in its ability to explain servicing in easy-to-understand terms."
 —Electrical South

FREE 10-DAY TRIAL COUPON

McGraw-Hill Book Co., Inc., Dept. PEL-8
 327 West 41st St., New York 36, N. Y.

Please send me, for 10 days' FREE EXAMINATION, your one-volume "Television and Radio Repairing," by John Markus. If not delighted, I may return book, pay nothing. Otherwise, I will send only \$1.95 plus few cents delivery; then 3 monthly installments of \$2.00 each.

Name

Address

City Zone State PEL-8

SAVE MONEY. Check here if enclosing full price of \$7.95 with coupon. Then WE will pay for delivery. Same 10-day return privilege. (Offer good in U.S.A. only.)

Put your electronic skills to work

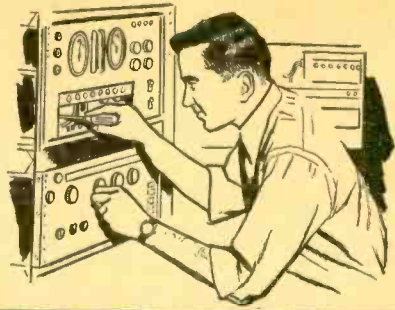

You may train with the U. S.
Air Force in one of these
interesting specialties

Radio and Radar Maintenance • Mis-
sile Guidance Systems • Armament
Systems • Weapons • Training Devices
Maintenance • Wire Maintenance

Young men who are interested in electronics, mechanics, or other technical specialties have an interest in the U. S. Air Force. As an Airman, you may have an opportunity to develop your technical ability and learn an interesting, exciting, and good paying skill. Act today and put your skills to work tomorrow. Put them to work where they'll do the most good...put your skills to work in the U. S. Air Force.

AIRMAN INFORMATION BRANCH
Personnel Procurement Division
Box 2202, Wright-Patterson AFB
Dayton, Ohio

E-10-PE

Please send me more information on my opportunity as an Airman in the U. S. Air Force.

Name _____ Age _____

Address _____

City _____ Zone _____ State _____

You go places — faster in the U. S. Air Force

ARE YOU TOO OLD TO LEARN?

not at all, scientists say

New tests show that: your ability to think increases with age; your powers of deduction are greater; your judgment is better.

In the I. C. S. files are thousands of cases of men and women of every age. Their successes, their promotions, their raises prove that men and women past school age can learn!

I. C. S. GIVES YOU EXPERT GUIDANCE FREE! Do you have the feeling you're "stuck" in your job? Your trained I. C. S. counselor will appraise your abilities, help you plan for the future.

IT'S NEVER TOO LATE TO GET STARTED! You study with I. C. S. at home, in your spare time. There's no interference with business or social activity. Famous I. C. S. texts make learning easy. Don't delay. Pick your field from the coupon below. And mail it today!



3 FREE BOOKS

30-page, pocket-size guide to advancement, a gold mine of tips on "How to Succeed." Big catalog outlining opportunities in your field of interest. Also sample lesson (Mathematics).

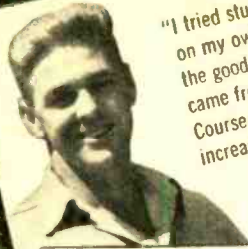

"I tried studying my work on my own, but I never got the good out of it that came from my I. C. S. Course. My salary has been increased 73.3%!"
E.L.B.
Ohio

"I am president of a small corporation. A year ago I enrolled with I. C. S. as the most practical means available to me to learn what I needed."

W.J.A.
Michigan



"It's been so long since I went to school, I've forgotten much. But now that I'm taking an I. C. S. Course, I have confidence in my ability again."

H.A.R.
New Jersey



Actual statements.
Posed by models.

For Real Job Security—Get an I. C. S. Diploma! . . . Easy-pay Plan . . . I. C. S., Scranton 9, Penna.

INTERNATIONAL CORRESPONDENCE SCHOOLS

ICS

BOX 99295G, SCRANTON 9, PENNA.

(Partial list of 277 courses)

Without cost or obligation, send me "HOW TO SUCCEED" and the opportunity booklet about the field BEFORE which I have marked X (plus sample lesson):

ARCHITECTURE AND BUILDING CONSTRUCTION

- Air Conditioning—Refrig.
- Architecture
- Architectural Interior
- Building Contractor
- Building Maintenance
- Carpenter and Mill Work
- Estimating
- Heating
- Painting Contractor
- Plumbing
- Reading Arch. Blueprints

ART

- Cartooning
- Commercial Art
- Fashion Illustrating
- Magazine Illustrating
- Show Card and Sign Lettering
- Sketching and Painting

AUTOMOTIVE

- Auto Body Rebuilding
- Auto Elec. Technician
- Auto-Engine Tune Up
- Automobile

AVIATION

- Aeronautical Engineering Jr.
- Aircraft & Engine Mechanic

BUSINESS

- Advertising
- Bookkeeping and Accounting
- Business Administration
- Business Correspondence
- Public Accounting
- Creative Salesmanship
- Federal Tax
- Letter-writing Improvement
- Office Management
- Professional Secretary
- Retail Business Management
- Sales Management
- Stenographic-Secretarial
- Traffic Management

CHEMISTRY

- Analytical Chemistry
- Chemical Engineering
- Chem. Lab. Technician
- General Chemistry
- Natural Gas Prod. & Trans.
- Petroleum Engineering
- Plastics
- Pulp and Paper Making

CIVIL, STRUCTURAL ENGINEERING

- Civil Engineering
- Construction Engineering
- Highway Engineering
- Reading Struct. Blueprints
- Sanitary Engineering
- Structural Engineering
- Surveying and Mapping

DRAFTING

- Aircraft Drafting
- Architectural Drafting
- Electrical Drafting
- Mechanical Drafting
- Mine Surveying and Mapping
- Plumbing Drawing and Estimating
- Structural Drafting

ELECTRICAL

- Electrical Engineering
- Electrical Maintenance
- Electrician Contracting
- Lineman

HIGH SCHOOL

- Commercial Good English
- High School Subjects
- Mathematics

LEADERSHIP

- Foremanship
- Industrial Supervision
- Leadership and Organization
- Personnel-Labor Relations

MECHANICAL AND SHOP

- Gas—Electric Welding
- Heat Treatment Metallurgy
- Industrial Engineering
- Industrial Instrumentation
- Industrial Supervision
- Internal Combustion Engines
- Machine Design-Drafting
- Machine Shop Inspection
- Machine Shop Practice
- Mechanical Engineering
- Quality Control
- Reading Shop Blueprints
- Refrigeration
- Sheet Metal Worker
- Tool Design Toolmaking

RADIO, TELEVISION

- Industrial Electronics
- Practical Radio, TV Eng'ing
- Radio and TV Servicing
- Radio Operating

TELEVISION Technician

RAILROAD

- Air Brakes Car Inspector
- Diesel Locomotive
- Locomotive Engineer
- Section Foreman

STEAM AND DIESEL POWER

- Combustion Engineering
- Diesel—Elec. Diesel Eng's
- Electric Light and Power
- Stationary Fireman
- Stationary Steam Engineering

TEXTILE

- Carding and Spinning
- Cotton, Rayon, Woolen Mfg.
- Finishing and Dyeing
- Loom Fixing Textile Des'ing
- Textile Eng'g's Throwing
- Warping and Weaving

MISCELLANEOUS

- Domestic Refrigeration
- Marine Engineering
- Ocean Navigation
- Professional Engineering
- Short Story Writing
- Telephony

Name _____ Age _____ Home Address _____

City _____ Zone _____ State _____ Working Hours _____ A.M. to P.M. _____

Occupation _____

Canadian residents send coupon to International Correspondence Schools, Canadian, Ltd., Montreal, Canada. . . . Special tuition rates to members of the U. S. Armed Forces.

**Build the instruments
the professionals specify...
BUILD EICO KITS—SAVE 50%**

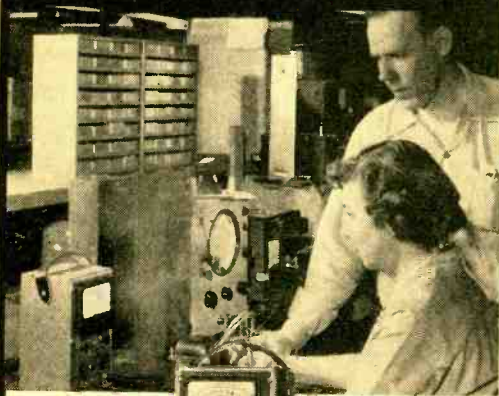

Vacuum Tube
Voltmeter
KIT \$25.95
Wired \$39.95



EICO VTVMs
in use in labs
of Stromberg-
Carlson,
Rochester, N.Y.

EICO test instrument kits are complete and professional from circuitry to front panel—are utilized by TV leaders like Stromberg-Carlson, CBS-Columbia, Emerson, etc., leading electronic schools and universities, and over 60,000 radio-electronic servicemen coast to coast.

Exclusive "Beginner - Tested" step-by-step instructions make it easy, educational and enjoyable to build EICO Kits. Only basic tools, no electronics knowledge required. *You build 'em in one evening—they last a lifetime.* Exclusive 5-way Guarantee on instructions, components, performance, lifetime service and calibration. No wonder there are over 1/2 million in use the world over!

42 models to choose from. There is an EICO Distributor in your neighborhood. Write for his address & FREE CATALOG PE-8.

Prices 5% higher
on West Coast © 55

EICO®

5" Push Pull
Oscilloscope
Kit \$44.95
Wired \$79.95



6V & 12V Battery
Eliminator & Charger
KIT \$29.95
Wired \$38.95



5,000 Ohms/Volt
Multimeter
KIT \$12.90
Wired \$14.90

84 Withers Street
Brooklyn 11, N. Y.

Letters from Our Readers

(Continued from page 10)

wouldn't dream of using less than 50 watts. And 1000 watts would be better.

CHARLES R. NICHOLS
Como, Texas

There is certainly food for thought in your suggestions, Mr. Nichols. Regarding the power used on R/C equipment, however, FCC regulations provide that non-licensed R/C operators may use R/C equipment that has a maximum power input of five watts to the final stage for crystal-controlled transmitters used on 27.255 mc. Ten watts is permitted on the 460-468 mc. band. Equipment used on the ham bands is restricted by ham standards, but higher maximum powers are permitted. For model control, of course, you need power to control only as far as you can see, so why use more when a little will do?

HI-FI INFORMATION

■ I have recently become interested in hi-fi systems. In searching for information so that I may best determine what I like and can afford, I find that most available data is highly technical and complicated. Can you mention sources from which a very "green" novice can gain basic information? I imagine what I am searching for could be referred to as a "Hi-Fi Primer."

K. I. TRENER
Phoenix, Arizona

All the information that we have published thus far, as well as scads of information to be published in the future, is directed toward satisfying the need you mention. In addition, there are several excellent books on the subject of hi-fi which have been published recently. A few of these have been reviewed in POPULAR ELECTRONICS and many more will be discussed in future issues. Offhand, a few representative titles come to mind: "High Fidelity Home Music Systems" by William R. Wellman, published by D. Van Nostrand Co., New York, N. Y.; "Home Music Systems" by Edward Tatnall Canby, published by Harper Brothers, New York, N. Y.; and "The New High Fidelity Handbook" by Irving Greene and James Radcliffe, published by Crown Publishers, New York, N. Y.

SUBSTITUTE FOR RUBBER GROMMET

■ The other night I was putting a new line cord on my short-wave receiver, and I was at a loss as to what to do for a rubber grommet to lead the cord out through the chassis. I didn't want to wait until the next day to put one on, so I hunted around the house for something to use, and came across a "Spoolie" hair curler. It looked good and served the purpose.

DICK SIMKINS
Sepulveda, Calif.

CONVERTING 78 PHONO

■ After reading Arthur Trauffer's piece on "Converting Your 78 Phono to LP," (May issue), I agree with him that 78's are getting to be out-

POPULAR ELECTRONICS

you are invited by *Electro-Voice*
to...

WIN!

1 "WEEK-END WITH HIGH FIDELITY!"



WIN!

2 LIFETIME OF HIGH FIDELITY MUSIC!

As always, Electro-Voice is FIRST! Now E-V sponsors this unique and exciting contest, that you might hear (perhaps win) today's finest matched high fidelity sound systems. Contest starts August 1, 1955.

WIN this "double-size" first PRIZE!

- 1** WEEK-END WITH HIGH FIDELITY ALL-EXPENSE-PAID week-end trip for two . . . from wherever you enter the contest to Electro-Voice—the Home of High Fidelity!
- 2** LIFETIME OF HIGH FIDELITY MUSIC with your own incomparable *Patrician* and the beautiful *Peerage* console and equipment.

and LOOK...9 more PRIZES, wonderful to WIN!

3 Second Prizes . . . magnificent E-V 15TRX 15-in. three-way speakers!

3 Third Prizes . . . outstanding E-V 12TRX 12-in. three-way speakers!

3 Fourth Prizes . . . powerful E-V 12TRXB 12-in. three-way speakers!

WIN the Incomparable *Patrician* 4-way audio reproducer!

WIN the beautiful *Peerage* console and equipment!

IT'S EASY!
HERE'S ALL YOU DO!
(A) Hear E-V high fidelity demonstrated. (B) Fill in and mail the official entry blank, provided by E-V Distributor. Contest closes at midnight, September 30, 1955.

E-V Electro-Voice

ELECTRO-VOICE, INC., BUCHANAN, MICHIGAN

ELECTRO-VOICE, INC., BUCHANAN, MICH.

Gentlemen: I want a chance to win. Please send me the names of nearest participating E-V Distributors.

Name

Address

City Zone State

My nearest large trading center is

moded. I am particularly interested in a 78 phono in which the record turntable itself is spun around by the motor. This is not the same as the one described in Mr. Trauffer's article. How can I cut the 78-rpm speed down to 45 rpm on mine?

Also, Mr. Trauffer did not mention how the pickup arm is supposed to fall on a 45-rpm record which is only 7" in diameter. The 78-rpm record may be 10" or 12" in diameter. What changes could be made in this respect?

STAN GRYGATIS
Troy, N. Y.

The phono unit described by Mr. Trauffer used a shaft which rotated against an idler wheel. It was only by changing the diameter of this shaft that the speed of the phono could be altered. In the case of a unit such as you describe, which is apparently a direct-drive system, the only way to change the speed is to change the motor itself.

In any event, when the phono has been converted from 78 to 45 rpm, the arm must be placed on a 45-rpm record manually.

QUERY ON THEREMIN

■ I am writing to inquire if you have ever in the past published a schematic for the construction of a theremin? If not, could you supply me with the address of R. A. Moog Co., which I believe manufactures a theremin commercially?

R. A. AUSTIN, JR.
New York, N. Y.

In our April issue, the lead article contained complete instructions and plans for building your own theremin. A copy of this issue may be obtained by sending 30 cents to our Circulation Department at 64 E. Lake St., Chicago 1, Ill. The theremin manufactured by R. A. Moog Co. was described in the January, 1954, issue of our sister publication, RADIO & TELEVISION NEWS; the address of this organization is 51-09 Parsons Blvd., Flushing 55, N. Y.

TRANSISTORS IN R/C RECEIVER

■ Would it be possible to make a transistor-powered R/C receiver? If so, will you please publish a diagram in a future issue.

LUCIAN DRESSI
Oshawa, Ontario, Canada

A forthcoming article will give plans for a two-stage R/C receiver using a transistor in one stage. The set will not use transistors in both stages because it is difficult to obtain a transistor which will operate as amplifier and detector at 27 mc. Most transistors operate only in the audio range and slightly above.

TAPE RECORDING

■ It was a pleasure to read your May issue, especially the two articles on "Tape Types and Timing" and "Tape Recorders." They were very timely for me, as I plan to buy a tape recorder. I have heard someone mention a tape recorder that would record on both sides of the tape. I understand that you can record on the top and

bottom of one side and in either direction, depending on the tape recorder used, but I don't know about recording on both sides of the tape. Can you clear this up?

WILLIAM C. MADISON
New York, N. Y.

As far as we know, there is no tape-recording unit that will record on both sides of the same tape. The possibility of bleed through the tape is too high for this type of operation.

SURPLUS SET CONVERSION

■ I have an Army surplus tuning unit, Model BC 746-B, 3825 kc., and would like to know if there is any way I can connect this to a Zenith AM-FM receiver. If there is no way, can you tell me how I can put this unit to use?

JACK M. WILLIAMS
Misenheimer, N. C.

It is difficult for us to visualize the purpose of connecting the BC-746-B to your AM-FM radio. Almost all war surplus radio and electronic equipment now on the market is highly specialized and we sincerely doubt the value of buying "bargain" units that are impossible to convert to a useful application.

CAREERS IN ELECTRONICS

■ I have noticed that many of your readers are interested in a course in electronics. I am, too. Could you run articles explaining the various courses available from the mail order schools? Costs could be discussed along with the subjects covered, etc. Another question I have is . . . what does the title "Electronic Engineer" encompass?

H. EUGENE HARDY
South Gate, Calif.

See our article entitled "Planning To Be An Electronic Engineer" which appeared in the June issue, and watch for future articles covering the training of electronic technicians.

R/C BOATS

■ With reference to the article in your May issue entitled "The Boom In R/C Boats," I am interested in obtaining the name and address of the manufacturer of the "Chris Craft Corvette."

RICHARD A. STRAUSS
Detroit, Mich.

This model is made by Sterling Models, 1530-34 N. Hancock St., Philadelphia, Pa.

POCKET TAPE RECORDER

■ With reference to the pocket tape recorder described in your April issue, how is playback accomplished?

R. L. ANTHONY
Hyde Park, N. Y.

Recorded material from the "Midgetape" may be heard through an earphone or any external amplifier. An accessory amplifier with a 2"

POPULAR ELECTRONICS

RAYTHEON TRANSISTOR APPLICATION BOOK

Now
Available
to
You!

ONLY 50¢



It contains complete information including wiring diagrams, illustrations, parts lists, everything you need for building over 50 types of transistorized equipment — using low-cost Raytheon Transistors.

Whether you are an engineer, an experimenter or a hobbyist, you'll find many circuits of interest to you — the complete "how-to-do-it" on such items as timers, receivers, oscillators, geiger counter, metal locators, plus many other practical and useful transistor applications.

Your Raytheon Tube Supplier now has a limited quantity of this new book. Buy your copy from him or direct from Raytheon. Simply send 50¢ to Department P7.



Excellence in Electronics

RAYTHEON MANUFACTURING CO.

Receiving and Cathode Ray Tube Operations, Newton 58, Massachusetts

RELIABLE SUBMINIATURE AND MINIATURE TUBES • SEMICONDUCTOR DIODES AND TRANSISTORS
NUCLEONIC TUBES • RECEIVING AND PICTURE TUBES • MICROWAVE TUBES

**A NEW dimension
in listening
pleasure!**

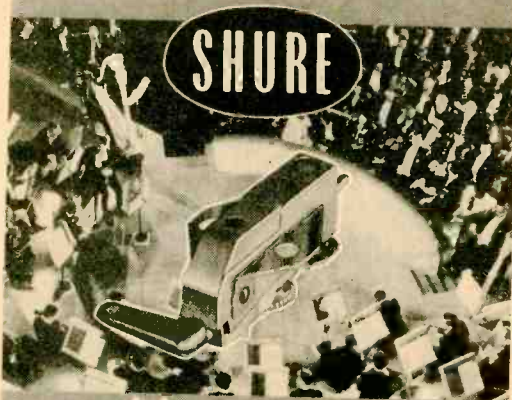

Music Lovers
CARTRIDGE

... for the realism of concert-hall performance in your home

The "MUSIC LOVERS" Cartridge is a new, 3-speed, dual-needle ceramic cartridge, designed to enhance the quality of all the popular high fidelity equipment in use today. Feeds directly into magnetic or ceramic inputs, allowing the full advantages of compensation circuits.

- Eliminates induced hum
- Eliminates "drag" caused by magnetic attraction to steel turntables
- Increases record and needle life
- Has higher output
- Response not affected by load resistance
- 10-second needle replacement
- Individual needle compliance

FREE! Comparative analysis booklet on the "Music Lovers" Cartridge

SHURE BROTHERS, INC.

225 W. HURON ST. • CHICAGO 10, ILLINOIS

Please send analysis booklet on your "MUSIC LOVERS" cartridge

NAME.....

ADDRESS.....

CITY..... ZONE..... STATE.....

speaker is also available from the manufacturer. The amplifier may be plugged into the same jack that is used for the headphone.

LICENSING OF AMATEURS

■ I would appreciate it very much if you could supply me with any information which might be helpful in obtaining an amateur license.

ARTHUR R. HALL
New York, N. Y.

In this issue of POPULAR ELECTRONICS, we are introducing a column by Herb Brier entitled "The Transmitting Tower." You will probably find the answers to most of your questions in this column, which appears on page 68. For additional information, we suggest that you write to the American Radio Relay League, West Hartford 7, Conn.

ELECTRON MICROSCOPE

■ Concerning your article on the electron microscope (May, 1955), how much of the magnetic lens system is enclosed in a vacuum? What other parts are enclosed in a vacuum, and how is the object inserted into the electron beam? Can you furnish me with additional information or the source of such information on this device?

DON ADAMS
Sigourney, Iowa

Aside from the information contained in the article as it appears in our May issue, we have no additional data on this subject. It is possible that further information can be obtained from Mr. Ken Kilbon, RCA Laboratories, Princeton, N. J.

CITIZEN'S BAND

■ I would like to know if it is permissible to be a holder of a citizen's band license and an amateur's license at the same time. Also, you made a mistake in your article on the "Lorenz 61." You said "... on the license-free band of 27.255 mc ...". A license is necessary, although you do not have to take an examination to get it.

MELVIN STEWART
Pensacola, Fla.

There is no such thing as a citizen's band license. Anybody can use the citizen's band, provided that the equipment used is licensed. Necessary forms may be obtained from the FCC.

AUDIO AND HI-FI SECTION

■ How about combining all the material on audio and hi-fi into one big section in each issue of the magazine? I realize that this will mean more editorial headaches, but it will certainly prove a convenience for readers who are hungry for news and technical info on hi-fi.

KENNETH D. SHAY
Denver, Colo.

In response to this and similar requests, we are doing exactly as suggested, starting with this issue.

The New Model 70 UTILITY TESTER

FOR REPAIRING ALL ELECTRICAL APPLIANCES MOTORS • AUTOMOBILES • TV TUBES

As an electrical trouble shooter the Model 70:

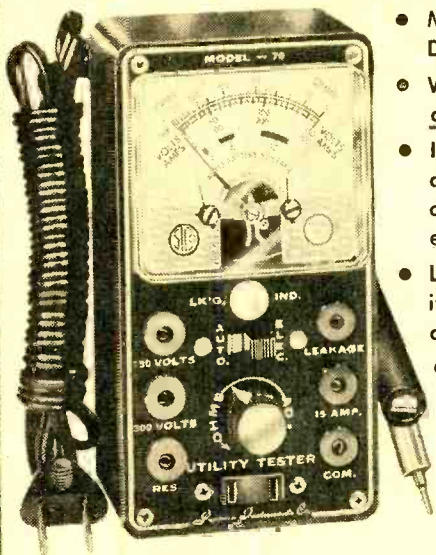

- Measures A.C. and D.C. Voltages, A.C. and D.C. Current, Resistances, Leakage, etc.
- Will measure current consumption while the appliance under test is in operation.
- Incorporates a sensitive direct-reading resistance range which will measure all resistances commonly used in electrical appliances, motors, etc.
- Leakage detecting circuit will indicate continuity from zero ohms to 5 megohms (5,000,000 ohms).
- Will test toasters, Irons, Broilers, Heating Pads, Clocks, Fans, Vacuum Cleaners, Refrigerators, Lamps, Fluorescents, Fans, Switches, Thermostats, etc.
- Will test all TV tubes for open filaments, inter-element shorts, burned out tubes, etc.

As an Automotive Tester the Model 70 will test:

- Both 6 Volt and 12 Volt Storage Batteries • Generators • Starters • Distributors • Ignition Coils • Regulators • Relays • Circuit Breakers • Cigarette Lighters • Stop Lights • Condensers • Directional Signal Systems • All Lamps and Bulbs • Fuses • Heating Systems • Horns • Also will locate poor grounds, breaks in wiring, poor connections, etc.

Handsome round-cornered molded bakelite case, 3 1/8" x 5 7/8" x 2 1/4". Complete with all test leads. Also included is a 64 page book giving detailed instructions for testing all electrical appliances, automotive equipment, TV tubes, etc. Only

15⁸⁵

SHIPPED ON APPROVAL NO MONEY WITH ORDER — NO C. O. D.

Try it for 10 days before you buy. If completely satisfied then send \$3.85 and pay balance at rate of \$4.00 per month for 3 months — No Interest or Finance Charges Added! If not completely satisfied, return to us, no explanation necessary

MOSS ELECTRONIC DIST. CO., INC.

Dept. D-152 3849 Tenth Ave., New York 34, N. Y.

Please rush 1 Model 70 I agree to pay \$3.85 within 10 days after receipt and \$4.00 per month thereafter

Name _____

Address _____

City _____ Zone _____ State _____

How a Capacitor Works

(Continued from the April issue)

Far too many beginners in electronics forget that in the final analysis there is no such thing as a "fixed capacitor." The term is only relative as many a circuit designer chasing "bugs" has discovered to his sorrow.

The capacitance value stamped on a capacitor is only a nominal value. This is usually the specified value at the standard measurement temperature of 25°C (77F). Sometimes as in the case of ceramic capacitors it may be the minimum acceptable value at this temperature.

Sometimes a tolerance on the capacitance value at this temperature is stamped on a capacitor; sometimes it is not. The term "tolerance" means simply that the capacitor must be within the specified percentage of its nominal value at the specified reference temperature.

For example, when paper tubular capacitors are not otherwise marked or color coded, the customary manufacturer's capacitance tolerances by RETMA standards for values up to .0019 μF is -25%, +60%; from .002 to .009 μF , -20%, +40%; from .01 to .09 μF , $\pm 20\%$; from .1 to 1.0 μF , -10%, +20%, and above 1 μF $\pm 10\%$. This means that a capacitor marked .005 μF for example, will actually measure anywhere from .004 to .007 at 25°C (77F).

Now let's look at this capacitor when it is heated up to 85°C (185F) in a television set. If it is impregnated with stabilized wax, it will drop by about 8% in capacitance from its original room temperature value. On the other hand, if it is impregnated with mineral oil, its capacitance may increase by about 2%. If it is impregnated with a typical polyester material as in many types of solid-dielectric paper tubulars, it will increase by about 9%. If it is impregnated with Sprague's new HCX hydrocarbon impregnant, the result will be a far more stable, solid-dielectric capacitor which will increase in capacitance by about only 1% as a result of this rise in temperature.

The changes in capacitance quoted are typical for the material mentioned. Some production units will have slightly less change in capacitance while others, of course, will have slightly more. Capacitors made with plastic dielectric films will also change in value as the temperature shifts up and down, the amount depending on the particular plastic film and impregnant used.

This may help explain to you why one paper capacitor will work perfectly well in a circuit while another will not, even though both "look alike."

Getting back to the subject of capacitance tolerance, let's look at dry electrolytic capacitors. Here the permissible deviation at room temperature from the stamped value is even wider. General industry practice on aluminum electrolytics permits a tolerance of -15%, +250% at rated voltages up to 50 volts d-c; of -10%, +100% at voltages from 51 to 350 volts; and of -10%, +50% at rated working voltages of 351 to 500 volts d-c. And electrolytic capacitors too, change in capacitance value with change in temperature. Furthermore, differences in electrolyte and paper spacers will give different answers for two capacitors of the same voltage rating of the same manufacture made to two different performance specifications.

Let's take a typical 40 μF 150 volt d-c capacitor. It may actually measure 45 μF at room temperature, and will measure 40 μF at freezing (0°C or +32F). It may increase to 49 μF when the set is heated up to +85°C (185F). As the equipment in which it is used grows older, its capacitance value will decrease with age and may be down about 10% after three or four years of use.

—To be continued in October issue—

This informative message is No. 5 of a Series contributed by Sprague, the world's largest manufacturer of capacitors. Write Sprague Products Co., N. Adams, Mass., for complete Sprague catalog.



automatic factories

IMAGINE a giant factory occupying many city blocks. Raw materials—plastics, enamels, steel, and copper—move in a steady stream through the entrance. Finished products—radio and television receivers, washers, irons, and other appliances—roll out at the other end of the factory. *The time is 1955. Employment: 12,000 workers, operating on a single 8-hour shift, five-day week.*

Let's take a small step into the future. Again, imagine a vast factory covering many city blocks. Raw materials move into the entrance in a steady flow; finished consumer products stream from the exit. Production capacity is tremendous, five to ten times that of the former factory. *The time is 1975. Employment: 12 workers, operating in three shifts. The factory, however, operates 24 hours a day, seven days a week. Impossible? Not in the least—it's almost here.*

In the middle of the 18th century, the slow changes in the way man manufactured his goods—which had been evolving for years—took on definite shape and form. These changes accelerated until by the middle of the 19th century almost all the major producers of manufactured goods had completely altered their methods. The alteration was a simple and logical one—the substitution of mechanical power for human muscle.

Of course, mechanical power had been used before, but not to so large an extent. Much earlier, man had relied on his muscles alone, aided by the few simple tools he could produce. Later, he had learned to

Electronics leads the way as man enters a new era of industrial progress—the age of automation

use the muscles of domesticated animals. Still later, man learned to utilize water power. Finally, steam and electricity began to take the place of human and animal power.

Although these changes in production techniques took place over a period of many years and, for that matter, are still taking place in remote corners of the world, their impact on man's productivity and on his standard of living was so great that they have represented an "Industrial Revolution." Another Industrial Revolution is now taking place. Like the first one, the changes it brings will probably occur over a period of years rather than overnight. And, like the first one, the new Industrial Revolution is likely to bring vast increases in man's productivity and in his standard of living.

Just as the first Industrial Revolution substituted mechanical power for human muscle, the second Industrial Revolution is the substitution of automatic controls and electronic "brains" for human brains in the performance of routine activities.

Let us imagine how an automatic factory might evolve in the manufacture of a simple product like a metal disc.

First, going back to before the days of chemical and mechanical power, we find

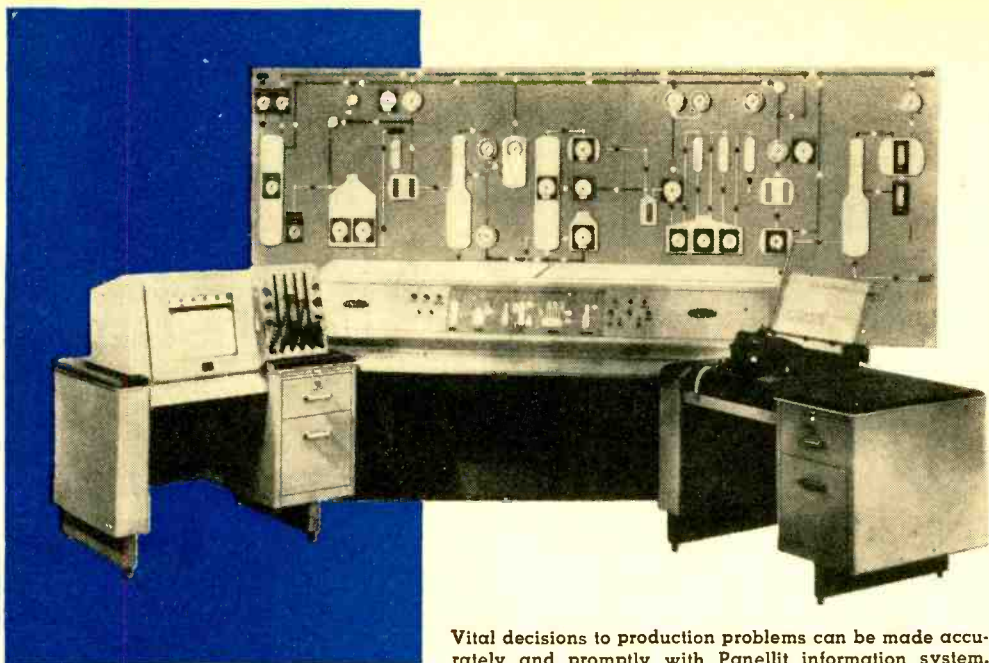

Vital decisions to production problems can be made accurately and promptly with Panellit information system.

that a man might produce a metal disc by using a simple punch, a die, and a hammer. The punch, die, and hammer are all produced laboriously by hand. He places a sheet of metal over the die, sets the punch in position, and strikes repeated blows until the disc is punched out. Since he can deliver only a limited amount of power with each hammer stroke, several strokes are necessary to punch out the disc. Production is not very fast—perhaps *one disc per minute*.

Realizing that greater production would be possible if he could punch out a disc with every stroke, the man uses a heavy weight in place of the light hammer and sets up a jig so that a horse or mule walking on a treadmill will alternately lift and drop the weight. He increases production by several hundred per cent, and now produces *several discs per minute*.

When steam, water power, and electricity become available, man recognizes that he now has sufficient power to punch out a number of discs with a single stroke if he uses a multiple punch and die. After setting up the machine, he need only feed in large sheets of metal and each stroke of the punch press produces dozens, or even hundreds, of discs. Production again increases, and a single man now produces *hundreds of discs per minute*.

However, a large punch press is a dangerous machine. If the man operating it doesn't move his hands quickly enough, he could be seriously injured when the punch

comes down. So, for safety's sake, the machine is operated considerably slower than its maximum rate. But—as *electronic controls are developed*, man soon learns to protect himself. By placing a source of light on one side of the punch press and a photoelectric relay on the other, he can add a safety control which prevents the operation of the machine if his hands are in the way. He now operates the machine at a faster rate and produces *thousands of discs per minute*.

Logically, the next step is to provide mechanical hands which feed the metal plates into position automatically as the punch moves up. With this arrangement, the operating speed of the machine is increased still further, for mechanical hands move more rapidly than human hands. Since little time is required to load the feed rack, one man can operate several machines and can now produce *tens of thousands of discs per minute*.

Having gone this far, it is a comparatively simple matter to add a conveyor belt and additional automatic machines to feed the metal plates from a vast stockpile of raw material to the feed racks of individual punch presses. Since the man no longer

→
Micromatic "robot" hones gears automatically. It stores prefabricated parts and feeds them to honer (1). Parts are gauged (2). Result is checked by control unit (3) and shown on signal panel (4). Gates (5) pass parts to containers.

has to load the feed racks of individual machines, he can operate a great battery of punch presses—and one man now produces *hundreds of thousands, or even millions, of discs per minute!*

And a simple type of automatic factory has been evolved!

However, the automatic factory of the future will not be quite so simple. Instead, a group of machines producing a single part, such as the metal disc, will be only a small part of the entire factory. In an automobile factory, for example, automatic machines will turn out complete engines, working from basic raw materials and metal ingots. Other automatic machines will mount these engines in chassis which, in turn, have been assembled by still other automatic machines. It is possible to build a complete factory for the automatic assembly of a television receiver, an electric range, a refrigerator, or any similar item. Machines will carry out test and inspection

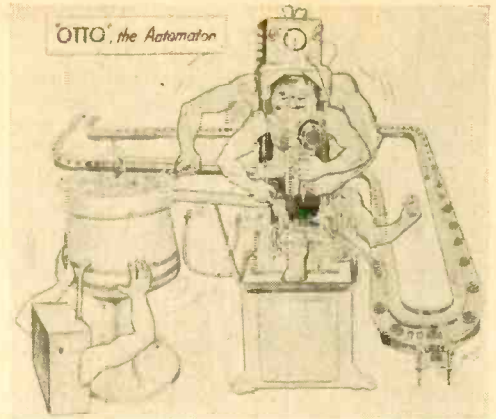

Cartoon of microhoning machine depicts its many automatic and simultaneous operations.

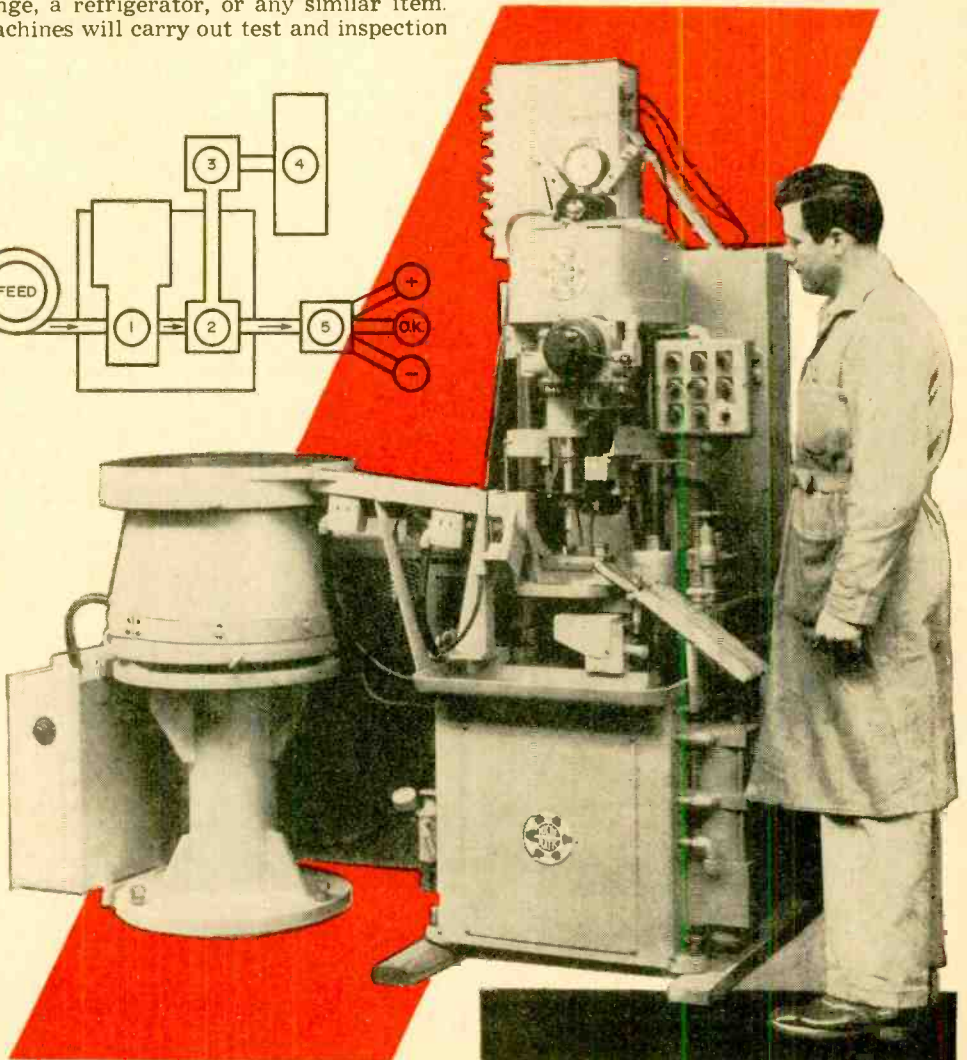
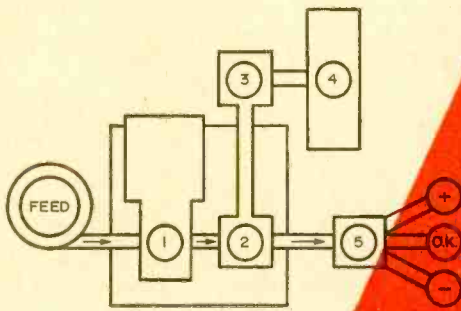

operations as well as assembly, insuring high quality products. Only a few human "supervisors" will be required, and their function will be merely to oversee the operation, to make repairs if a machine should break down, and to insure that no interruptions occur in the smooth flow of production.

If the rejection rate should be high in an automatic factory, it would indicate that some part of the factory was not functioning properly. In such a case, the electronic "inspector" would order an automatic test of machines in the production line. The faulty machine, once located, would be switched out of the production line automatically and a spare unit operated in its place until the human "supervisors" could repair the defective "worker."

Fields of Application

Even precision machine work may be carried out by automatic machinery. One company has developed a milling machine with an electronic "brain" consisting of a tape recorder and electronic controls. To set up this machine for operation, a highly skilled, precision machinist first guides the milling machine to produce a single part. While he does this, all movements of the machine are accurately recorded on tape. Finally, the machine is used to turn out exact duplicates of the original part automatically by playing the tape over and over. It is possible to adapt lathes, shapers, and other machine tools to operate with tape recorder "machinists."

Chemical plants and refineries are especially well suited to automatic production. The flow of chemicals through pipes can be controlled easily by valves. Mixing, heating, and other processes are easily carried out using automatic and remote controls. A single operator may "supervise" a large chemical plant by means of push buttons and knobs, keeping a close check on production with his hundreds of meters and gauges. Automatic operation is especially desirable where dangerous materials are handled as well as explosives, acids, poisonous gases, and radioactive substances.

Look underneath the chassis of an older television receiver. You'll see a "rat's nest" of wires and parts. But even such complicated devices as television receivers may be turned out in a matter of seconds by means of automatic machinery. Printed circuit techniques are used. The entire circuit is reduced to a simple drawing that can be reproduced on a metalized plastic plate by a photo-etching process. These boards are then passed down an assembly line where automatic robot machinery inserts resistors, capacitors, and other components in their proper positions in the circuit. The entire chassis board is soldered in a single dipping operation.

The National Bureau of Standards, working under the code name of "Project Tinkertoy," has developed still another technique for the automatic production of electronic equipment. Individual electronic circuits are built up from small ceramic cells. These may be manufactured, checked, and assembled into electronic circuits in a continuous flow by automatic machinery. The completed circuits may be tested automatically, with defective units thrown aside. Only a few changes in the machinery are necessary to switch over from producing radio or television receivers for civilian consumption to manufacturing complex radar equipment and specialized military gear for national defense.

Automatic equipment may be used for testing and inspecting all types of manufactured articles, from checking the color on a painted toy to the weight and contents of canned goods, from inspecting bottles of liquid for foreign matter to the accuracy of precision machine parts, from the thickness of metal plating to the operation of a complete engine. In some cases, automatic machinery may be used for making simple repairs.

Effect on Future of Mankind

Of course, such a radical change in production is bound to have a great effect on mankind. It will mean the availability of a greater variety of products of consistently high quality, more leisure time for individuals, and a greater variety of jobs. Differences between "unskilled," "semi-skilled" and "skilled" workers will disappear because most factory workers will be skilled technicians, enjoying good wages, interesting work, and short hours.

There will be a demand for highly skilled machinists and precision workers to make "master" tapes for the control of machine tools. More engineers will be needed to design and to build automatic machinery. And there will be a great demand for technicians and operators to "supervise" and to maintain the automatic factories.

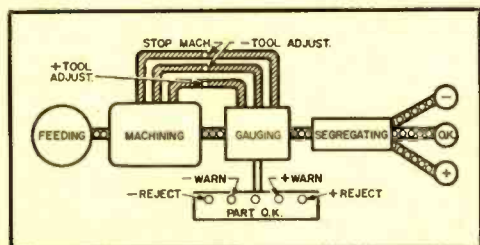
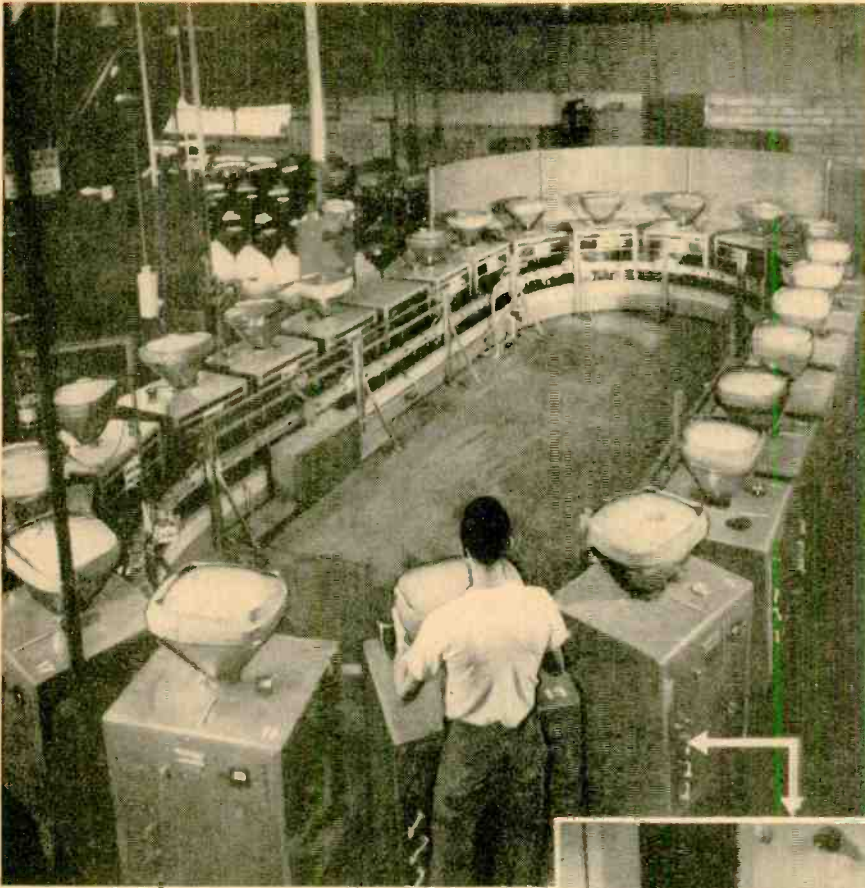

Diagram of basic "post-process control." Machine will be stopped automatically if tools fail or if tolerances are violated.



Automatic aluminizing of TV picture tubes at RCA plant using Stokes automation. Close-up at right shows how fixed ramps on the track trip various levers. This action controls the operation of other machines.

While there may be some temporary unemployment in a few industries, this will soon be taken up by the increase in production and the new industries which will spring up. For, just as the first Industrial Revolution caused a temporary loss of employment in one or two industries, it eventually resulted in a higher over-all standard of living for mankind, in more employment, and in more leisure for the average man. And the Second Industrial Revolution, like the first one, will not happen overnight—it will be spread over many years, with the newer industries, employing relatively few workers, changing over first.

With automatic factories and machines having such a tremendous impact on human activity, you would expect a new term to describe this field. There is one. Watch for it; you'll see it often in the future: *Automation!*

-30-

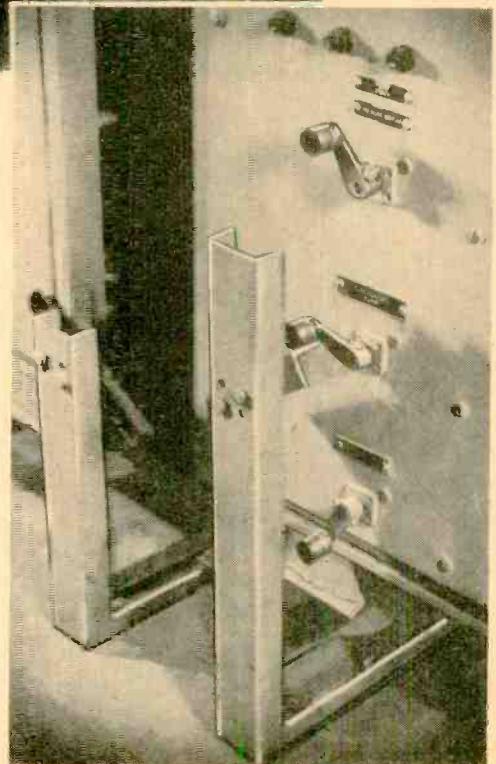

Morse Code Converter



ACCURACY AND SPEED are features of the "Trak" code converter, the first successful operating instrument that can convert Morse code signals either from the air or perforated tape, and translate them automatically into a printed message on a standard teletypewriter printer.

An all-electronic converter, the device accepts signals from a radio receiver at any speed from 10 to 600 words per minute. It then translates the signals into suitable electric pulses for a standard teleprinter which prints the message text. The converter works equally well on signals produced by hand or machine keying. It also will scan undulated inked tape by means of a sweep scanner. Similarly, its output can operate reperforator equipment or key land-line loops to remote teleprinter units.

"Trak" instantly adjusts to different speeds of code transmission, automatically compensating for changes of pace. Special memory circuits permit it to "copy behind" in the same way as a human operator would. The development of the device was largely the work of William Reid-Smith-Vaniz, Jr. (shown in photo) of C. G. S. Laboratories, Inc., Stamford, Conn. —30—



Unique Features, Advanced Design in Hi-Fi Units

INTENDED FOR CUSTOM HI-FI installations are the A-440A preamplifier-equalizer and the A-340A power amplifier, introduced by *Altec Lansing Corp.* Although the two units are designed to be used together, they may be interchanged with similar units of comparable quality for satisfactory results.

The A-440A features a hinged door that hides all controls except the "on-off" volume knob. With the door open, all controls are accessible. On the inside of the door are printed instructions for selecting record equalization settings, of which 25 are available. Another facility allows any input circuit to provide programing for tape recording while monitoring from the tape playback head; this permits listening to a program on tape while it is still being recorded. The unit is self-powered, and each of five inputs has its own level control.

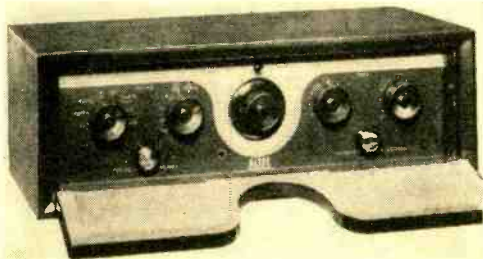

Also included are separate bass and treble controls, and provision for changing from "volume" to "loudness" control. Fre-

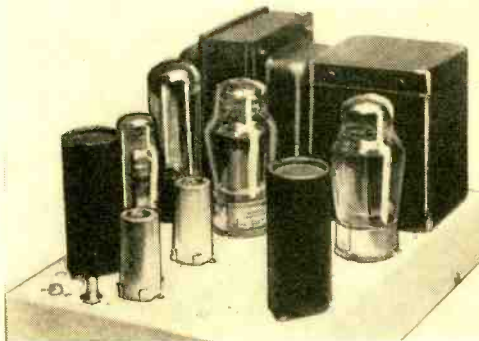

quency response is reported as 5 to 100,000 cycles \pm 1 db. Net price is \$139.00.

The A-340A power amplifier features a newly developed output circuit that uses type 6550 power tubes. These tubes, which have a capacity of 100 watts, do not require balancing. They enable the A-340A to deliver 35 watts with less than 0.5% distortion. Frequency response is said to be 5 to 100,000 cycles \pm 1 db. Net price is \$159.00.

For more data, write to manufacturer at 161 Sixth Ave., New York 13, N. Y. —30—

ELECTRONIC FISH-FINDERS



Ultrasonic beams penetrate ocean depths; their echo signals provide valuable data on fish and other undersea objects

FISH may travel in schools but they are not learning enough to beat new electronic devices that locate them silently and accurately. Electronic "fish-finders"—once an experimental novelty—are now being used widely by commercial fishermen to great advantage. Many leading manufacturers, in response to increased demand, are producing and promoting these devices enthusiastically.

Fish-finders work in a way very similar to sonar systems, popularly termed "under-sea radar." Ultrasonic impulses of electronically generated energy are transmitted through the water. Upon contacting fish, the energy is reflected back to the ship as an echo signal. This signal is then translated by indicating units into information that reveals the location of the fish.

The successful results obtained with these devices when used by commercial fishing enterprises seem to justify their initial cost. For example, using *Minneapolis-Honeywell's* "Sea Scanar," the whaler "Nahmint"—out of British Columbia—caught 539 whales during a recent season. According to the harpoon gunner, a large part of this catch would not have been made without the scanner unit.

Captain Henry Rollins of the "Malolo"—out of Newport News, Va.—commenting on the *Edo* "Fishscope," reports: "On my first trip with the 'Fishscope'—the first in our area—we had made a set and were dragging down with the rest of the fleet. The scope showed a real good concentration of fish, but after ten minutes it disappeared.

"I turned and headed right back through that school and after an additional 30 minutes hauled back with 14,000 pounds. The rest of the fleet held their original course, and when they hauled back two hours later each boat had only 1000 to 3000 pounds. After that, my only trouble was the other boats pressing in on me as they knew I was only fishing when I saw fish. That problem is solved now. They all have their own 'Fishscopes'."

Depth-Sounding and Navigation Aid

In addition to locating sea food, most fish-finders are readily adaptable for other related applications, such as depth-sounding and locating submerged objects. The *Bendix DR-12*, for instance, furnishes two scanning beams, selected by the operator. A wide beam is used for locating fish,

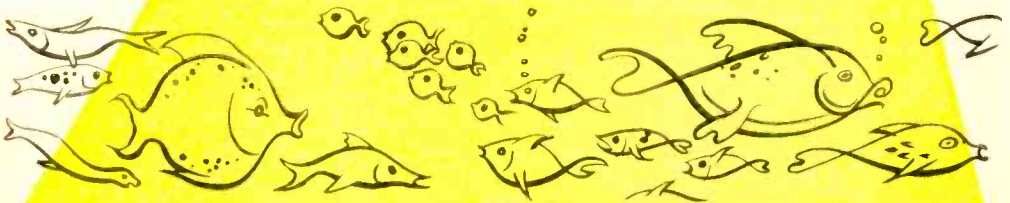

Panoramic view of undersea area is obtained with "Sea Scanar." As its "eye" automatically sweeps back and forth over a 180° angle, fish and other underwater objects show up as pips of light on screen of cathode-ray tube. Range and scanning angle are selected by operator.

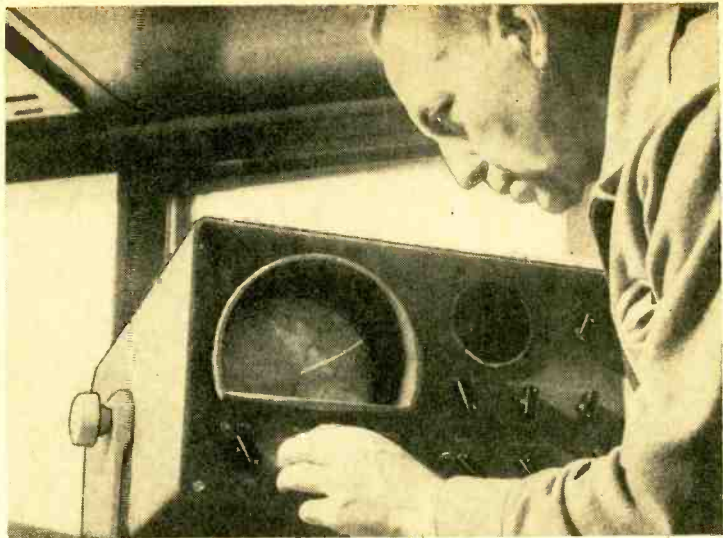

while a narrow beam provides an ideal scan for navigation.

Similarly, RCA's "Fischlupe" provides subsurface information and is so sensitive that it detects and shows whether the indication on the CRT scope is being caused by a single fish or a school.

Unique for its size and weight is Raytheon's "Fathometer." This device, said to be the world's smallest portable electronic unit of its kind, can be employed in a rowboat and is especially recommended for use in rivers, lakes, and shoal waters.

Size, complexity, capability, and price of these units vary considerably, depending on their intended use. The following is a list of typical manufacturers of such equipment, together with representative commercial models which are currently available.

Bendix Aviation Corp., Pacific Division, N. Hollywood, Calif.—The "Fish Magnifier" is an attachment for use with various models of the *Bendix* Depth Recorder. It provides a magnified view of any underwater section already detected on the recorder. Indications are by stylus traces on a chart. Ranges are available up to 25 fathoms (150 feet).

Edo Corporation, College Point, L. I., N. Y.—The "Fishscope" shows pips on the screen of a 7" CRT indicator. Any 10-fathom sector can be magnified 25 times. Maximum range is 250 fathoms. Components are self-contained and can be readily interchanged.

Minneapolis-Honeywell Regulator Co., Marine Equipment Division, Seattle, Wash.—The "Sea Scanar" presents a "plan position indicator" (PPI) type



A 25% increase in size of catches is reported by E. Smola of Virginia. Below, school of fish appears on screen of Edo "Fishscope."

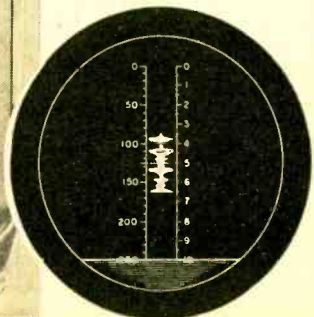

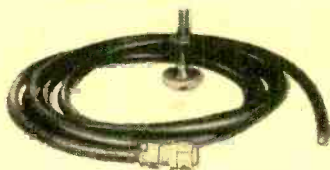
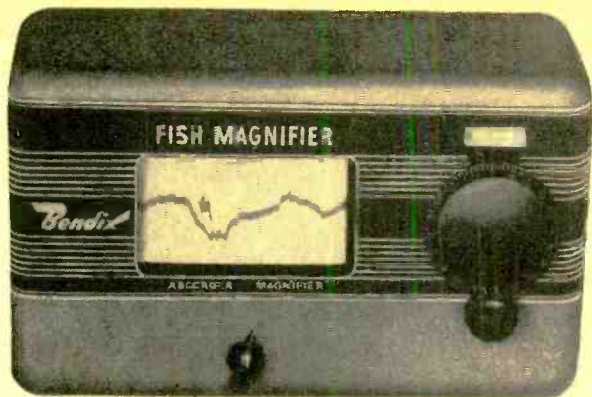
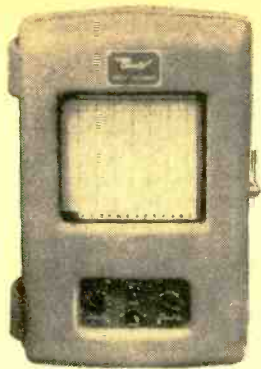

Permanent record of area scanned is available using Bendix equipment. Pattern made on chart by moving stylus indicates presence of undersea objects.

display on a CRT screen. Effectively a "picture" of the area being scanned, this display is accompanied by audible echo signals as in a standard sonar system. Range is over 265 fathoms.

RCA Radiomarine Corp. of America, New York, N. Y.—The "Fischlupe" provides horizontal traces on the screen of a 7" CRT indicator. An expanded view of any 8-fathom vertical section is available. Range is 320 fathoms.

Raytheon Manufacturing Co., Waltham, Mass.—The "Fathometer" presents stylus traces on a chart. This portable unit will operate for eight hours on a single 6-volt storage battery. Its range is 40 fathoms.

Additional information on any of these models may be had by writing to the individual manufacturer.

-30-

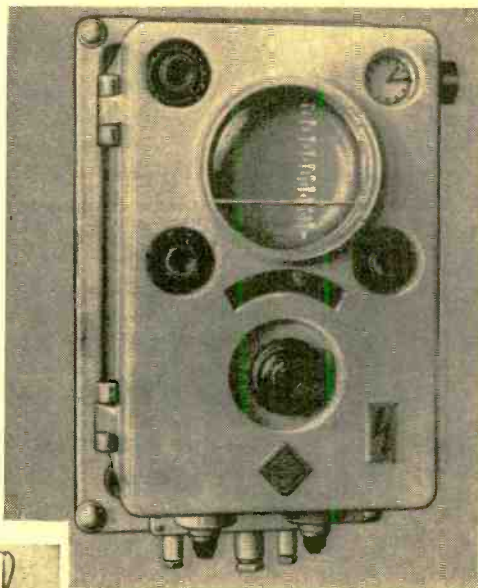

Fish and other undersea objects show up clearly on the RCA "Fischlupe." Indications on the screen of the cathode-ray tube are in the form of short horizontal traces. Any 8-fathom sector can be magnified to provide more accurate data.

Smallest portable fish-finder is Raytheon's "Fathometer." Within its limitations, this unit performs the same functions as more powerful devices. It is intended for use in lakes, rivers, and shoal waters. Indications are made by stylus traces on chart.

Electronic Juggler

SCIENCE'S FIRST "Electronic Juggler" was a stellar attraction at the U. S. Department of Commerce's exhibit at the German

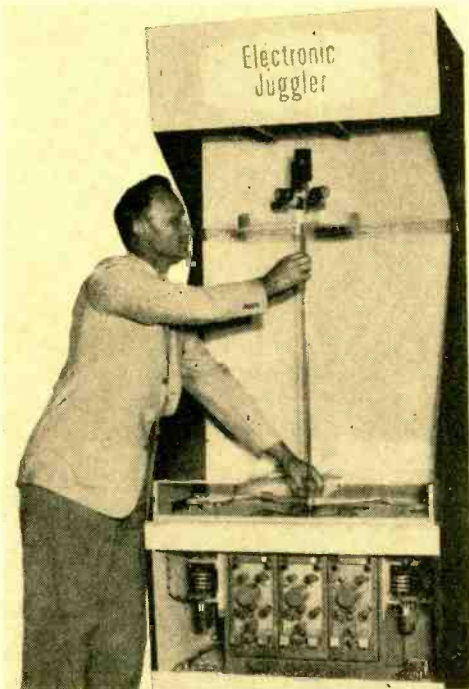

Industries Fair held recently in Hanover, Germany.

Built by *Reeves Instrument Corporation*, of New York City, the "juggler" is a machine that demonstrates the abilities of analog computers. It contains its own electronic brain, eyes, nerves, and arm muscles, all of which combine to hold a steel rod in

perfect balance. Until balance is achieved, the machine quivers, jiggles, and jumps. A servomechanism finally gives the cue that the rod is balanced.

The "juggler" will then hold the rod in perfect balance indefinitely without support of any kind. Should a current of air or some other force make the rod sway or start to fall, a computer will instantly determine how far the balancing cup—in which the rod stands—should be moved to keep the rod in an upright position. The computer then transmits its solution to the servomechanism, which automatically moves the balancing cup as required.

Engineers say that this demonstration of continuous "juggling" symbolizes the power of computers to perform feats of automatic control in industry. —30—



A.C.-D.C. Converter

SAID TO INCREASE the efficiency of an electric shaver up to 60%, a new model of the "Bing Crosby Shavex" converts alternating current (a.c.) to direct current (d.c.). Announced by the *Shavex Company* of Los Angeles, Calif., it uses miniature components and is U. L.-approved.



Priced at \$7.95, the "Shavex No. 911" should be available wherever electric shavers are sold. —30—



"Brain" Is Smallest and Fastest

A MINIATURE ELECTRONIC "BRAIN," claimed to be smaller, lighter, simpler, and faster than any yet revealed, has been announced



by the *Philco Corporation*, Philadelphia, Pa. Named "Transac" (short for Transistor Automatic Computer), the device operates at phenomenal speeds, can control the most complex mechanisms, and yet is about half the size of a shoe box. It can be operated on ordinary batteries.

"Transac" can multiply two 6-digit numbers, such as $956,845 \times 934,564$, and give the correct answer in 48 one-millionths of a second. Applications include its use in digital computers and automatic control equipment in business, industry, and the armed forces. Because of its size and speed, the unit is said to presage mass production of transistorized computers, as well as to provide a long step toward the development of what scientists call a "universal computer." —30—

BEHIND THE U.L. LABEL

By E. D. MORGAN

Equipment is tested, dropped, pounded, and burned before it is rated as safe and tagged with the Underwriters' okay.

A FAMILIAR SIGHT on much electrical and electronic equipment used today is an *Underwriters' Laboratories* label. Exactly what is implied by the use of this label, however, is often misunderstood.

Underwriters' Laboratories, Inc. is a non-profit organization sponsored by the National Board of Fire Underwriters. Its function is to test and inspect materials and equipment to prevent loss of life and property from fire, crime and casualty hazards. To do this adequately, it subjects devices to grueling tests. Only the hardest designs survive and earn the right to the coveted label of acceptance.

It is important to point out that *U. L.* approval does not guarantee quality of performance. The testing is concerned primarily with the safety aspects of equipment. Thus, the label on an approved radio receiver, for instance, does not im-

ply that it will perform better than one not so approved. It does mean, though, that the chance of setting a house on fire is negligible if the approved model is used.

No conceivable method of testing is overlooked. Much of the test equipment is of *U. L.*'s own design and they dream up diabolical plans to subject samples to the meanest treatment possible. They try to anticipate all of the mistakes that could be made by a consumer. Appliances are left on for weeks and electric heater cords are twisted and untwisted thousands of times.

Television cabinets get a thorough pounding before they receive *U. L.* approval. A large picture tube can be a deadly weapon when broken, as it hurls tiny fragments of glass in all directions. To insure against injury, the safety screen on the front must be capable of with-

Electronic equipment is often used by U.L. technicians. Here, the split-second operation of a burglary detection system is photographed. Accuracy is assured by using a cathode-ray oscilloscope, a beat-frequency generator, and various meters.



Television sets are subjected to a thorough going-over by Underwriters' Laboratories, Inc. engineers. Special attention is paid to shock hazards and to overheating problems. Cabinets are pounded and safety glass hit with steel balls in test.

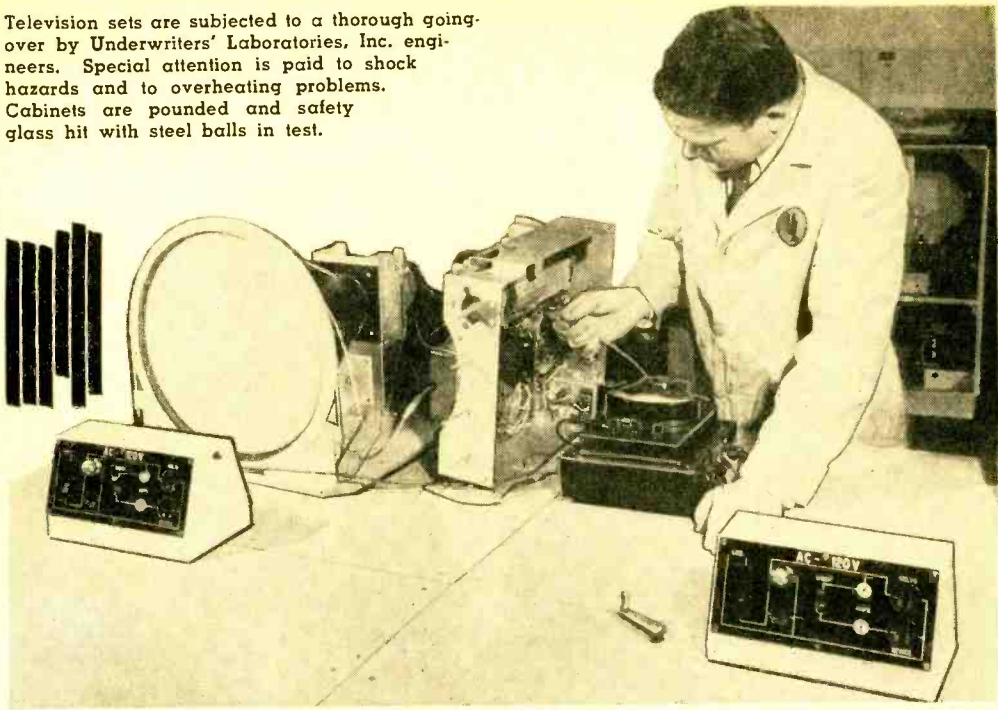

standing such shattering. A pound-and-a-quarter steel ball is hurled at the set to determine its fitness for this purpose.

To determine whether a safe is fire-proof and burglar-proof, *U. L.* employs its own staff of "arsonists" and "safecrackers." These men are masters at their trades and tackle a new item with drills, sledges, torches, and explosives. Just to make sure, the safes are dropped onto concrete from a second-story level, then placed in a 2000° F furnace for an hour or so. If the internal temperature goes high enough to turn valuable papers brown, what is left of the safe is returned to the maker with regrets.

Fire doors are tested in large gas furnaces where flames lick at them until they are red-hot. Then a fire hose is intermittently played on the other side of the door. Acceptable fire barriers must pass the fire endurance as well as the hose stream tests.

U. L.'s Growth

The organization had its unique start when bulbs were installed at the first Chicago World's Fair in 1893. These became the Fair's chief attraction—as well as its greatest hazard. Fires, started by the not-yet-perfected lamps and wiring, were commonplace. This led a group of New England insurance interests to authorize William H. Merrill, a young engineer, to investigate the situation. He re-

sponded to each fire alarm at the fairgrounds. If the cause were electrical, he would try to locate the defective device and determine why it failed.

Because of Merrill's insistence on thorough testing before the lamps were installed, and correcting their faults before offering them to the public, *Underwriters' Laboratories, Inc.* was born the following year. Merrill was its first president.

Since then, *U. L.* has mushroomed. Over 375,000 products have been found acceptable under its rigorous standards. Testing laboratories are located in Chicago, New York and San Francisco, with representatives in nearly 200 cities insuring that the standards are upheld at the factories. The work is financed solely by charges made to manufacturers for the inspection of their equipment.

Annual lists are published giving the manufacturers' names and their approved products. Four main lists are prepared which cover: electrical equipment; fire protection equipment; gas, oil and miscellaneous appliances; and accident hazard, automotive equipment and burglary protection.

Good will and impeccable honesty is the main stock-in-trade of this organization. *U. L.* never solicits business, but industry has learned that it is well worth the effort to make sure its products deserve the *U. L.* label.

An enclosed heavy-duty switch is tested in one of U.L.'s many laboratories. Equipment such as this is operated repeatedly under excessive loads before it is approved and given the U.L. label.

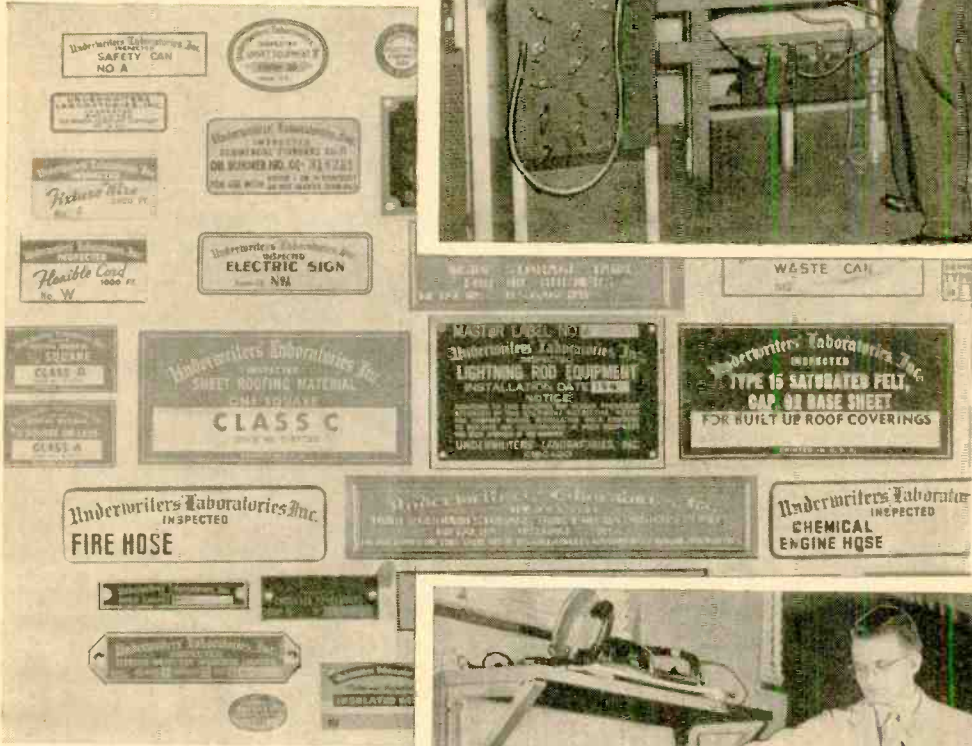
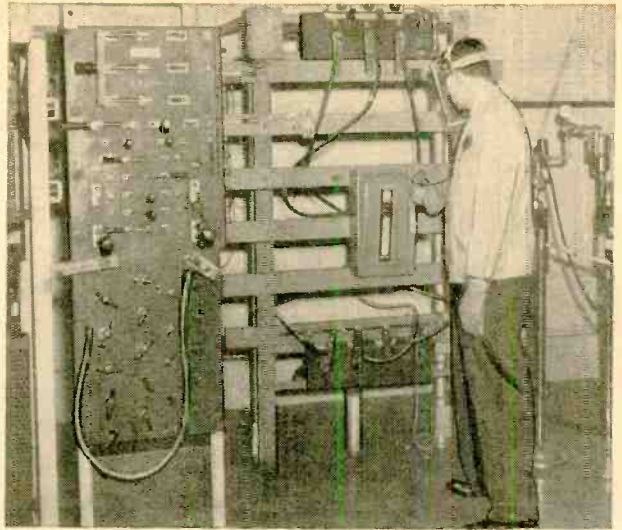

These are only a few of the authorized labels used by U.L. to designate approved equipment. An item bearing such a label has met specifications and passed severe tests.

Automatic flatiron is dropped four times during continuous operation test of 500 hours. Temperatures of various parts as well as operation of the thermostat are also checked.

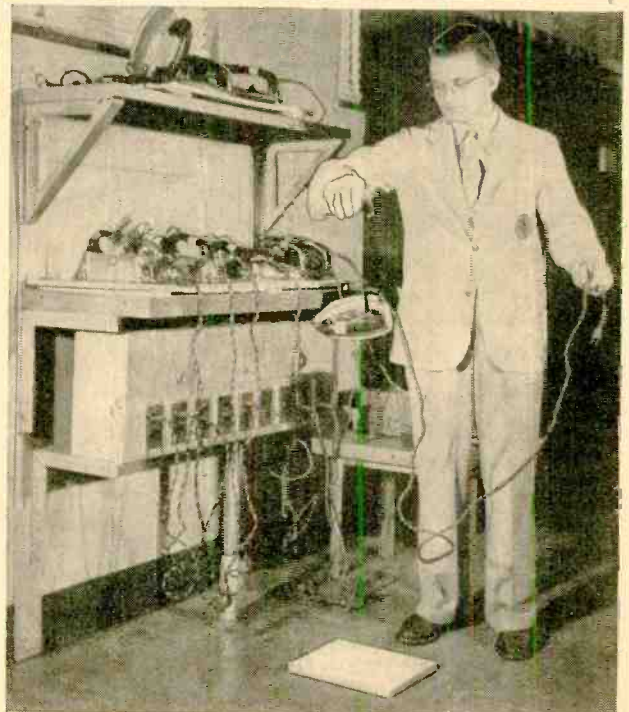

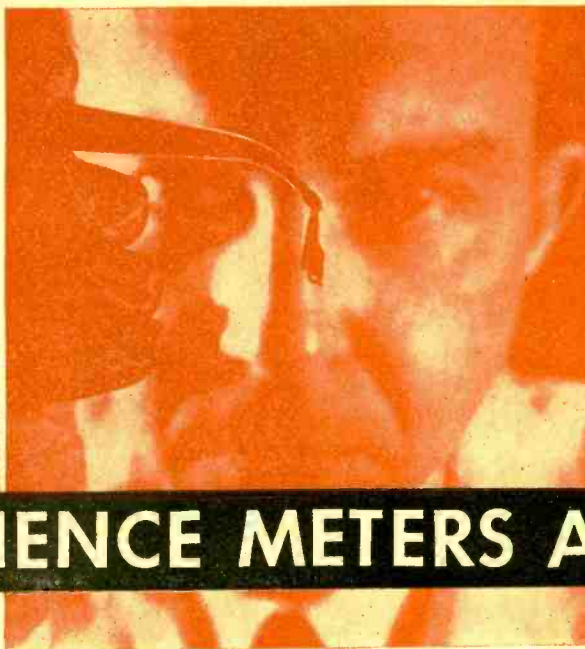

Shown here is the dissected papillary muscle of a cat. Attached to one end of the muscle is a loop of silk thread.

SCIENCE METERS A HEART

ANSWERS to the riddle of what causes a heart disease may come within our own lifetime, thanks to the studies now being conducted with the aid of special electronic equipment.

Medical authorities have learned, for example, that the heart is a natural electronic pump. Electrical impulses stimulate its action. Even when the life vitality is ebbing out of an isolated and dying segment of heart muscle, scientists can renew its vigor for a time by injecting into it controlled bursts of electrical energy.

To simulate an important life process, scientists of the Cornell Medical School at New York Hospital devised the electronic and chemical apparatus shown here, and have conducted experiments that reveal new data about the heart.

Electronics serves two purposes in this work: first, an electrical shock is given to the muscle; second, electronic instruments measure and record the results.

One very important advantage in using electrical shock to stimulate excitable tissue is that the shock can be graded accurately in strength. Once the shock is of threshold strength, further increase does not increase the response. In other words, there is a limit to the amount of muscle movement brought about electrically.

In the experiment shown here, a thyatron stimulator called an "Electrodyne" was used to produce pulses of very small voltages. At times, less than one volt was enough to produce results.

The stimulated muscle contracts and

pulls, by means of a thread fastened to it, the wire of an electronic strain gauge.* A record of this action is made by a direct-writing electrocardiograph. One of the design features of this device is its push-pull input circuit which has excellent rejection of 60-cycle a.c. interference. The sensitivity of the recording instrument is adjusted so that the needle will draw a diagram of convenient size.

Ten seconds before the electrocardiogram is produced, showing how a certain drug effects the heart muscle, the level of fluid in the chamber is lowered about 1 cm. below the base of the muscle to prevent the short-circuiting of the recording electrodes by the fluid, as well as to prevent the introduction of too large a shock artifact in the recording.

The photographs here show how this apparatus is used to measure the effect of drugs on the heart. But this is only one of the experiments made possible with this apparatus. The over-all study concerns one of the most important of all physiological reactions . . . for, while you have two legs, two arms, and many "spare" systems, your life depends on the continued electrical activity of the heart. —30—

* The strain gauge is a resistance wire placed in one arm of a Wheatstone bridge circuit. The bridge is initially balanced. If a strain is placed on the gauge, its resistance changes and unbalances the bridge, the degree of unbalance being an indication of the extent of the force exerted on the resistor wire. The amount of unbalance may be measured by a galvanometer (in this case, an electrocardiograph). Here the unbalance indicates the pull on a silk thread connected to a contracting bit of heart muscle.

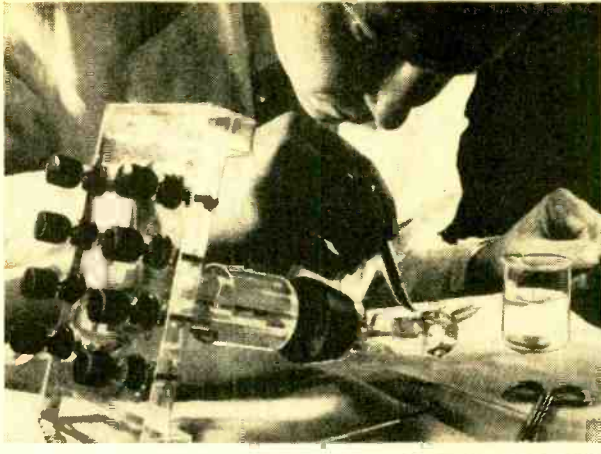

Muscle is placed between electrodes in plastic holder at left. Silk thread is attached to electronic strain gauge for recording muscle's contractile force.

Close-up view, below, shows heart muscle between electrodes with thread going off to strain gauge.

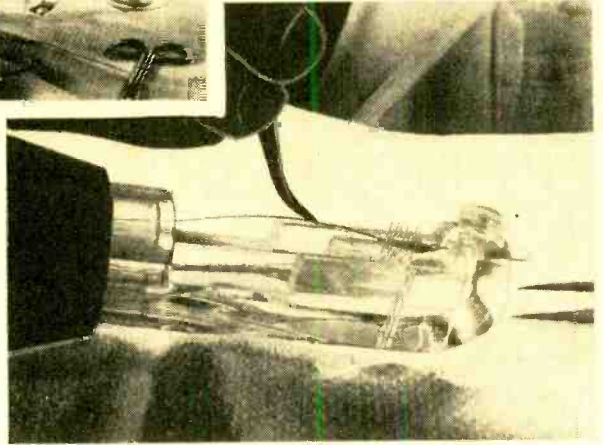

MUSCLE

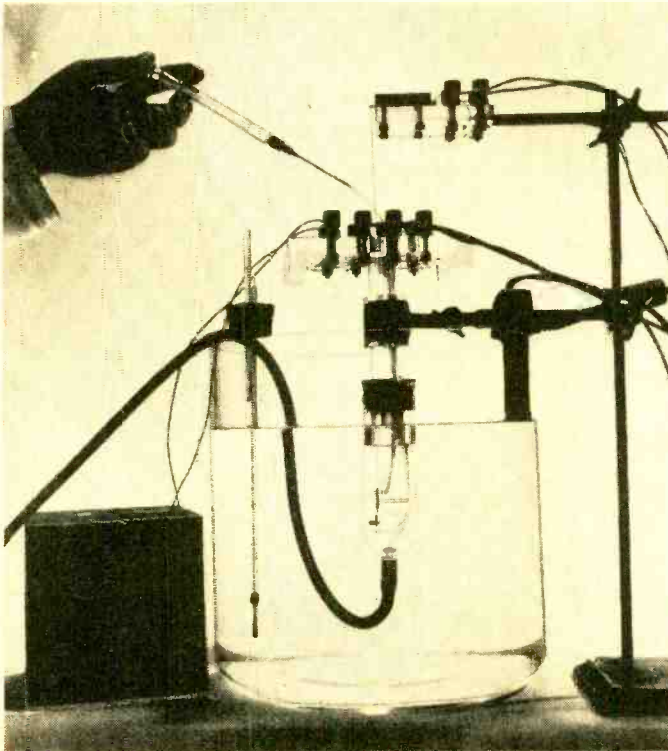

Finally, a glass holder is filled with solution through which oxygen is bubbled, and heart muscle is stimulated electrically. Drugs such as digitalis are added. Recording instruments indicate effect of drugs upon electrical potentials developed by heart muscles during contraction, and on its contractile force. New heart medicines are tested electronically in similar manner.



Liquid Chemical Provides First Aid for Electronic Circuits

ELECTRONIC EQUIPMENT often suffers from one basic difficulty—failure of contacting surfaces on control mechanisms. Oxidation and carbonization may cause high resistance connections, intermittent op-

tion displays no resistive, conductive, or capacitive values even when used in critical v.h.f. and u.h.f. circuits.

Smoother and quieter operation of small motors and converters has been achieved by applying "Contact" with the motors running. Servicing of controls such as rheostats and potentiometers is aided by use of the liquid. The arm of such a control may become oxidized, carbonized, or otherwise coated with poor conducting material. Loose pieces of carbon in carbon-type controls often stick to the control surfaces. A few drops of the solution clean the contact arm and remove the loose particles. At the same time, the coating of "duralube" is provided. The application of "Contact" on delicate mechanisms such as timers, counters, computers,



A few drops of the chemical will clean and restore the switch contacts in this tuner.

eration, pitting, and arcing. In many cases, the first and obvious approach to this problem has been to replace the defective parts. But any replacements, after exposure to the same operating conditions, will probably suffer the same defects.

To solve this problem, one manufacturer, *Beaver Laboratories*, has produced a cleansing and restorative liquid called "Contact"—a colloidal solution with a hydrocarbon carrier base. Its capillary action enables it to penetrate into ordinarily inaccessible places.

This solution cleans contacts and moving parts instantly. It also deposits a coating of "duralube," a hard-bonding dry lubricant which plates the contacting surface and resists corrosion, heat and cold.

The non-flammable cleansing action of "Contact," combined with the restorative action of the "duralube" contained within it, has many uses in electronics. The solu-



Cleaning the shaft of a potentiometer.

and thermostats is recommended by the manufacturer as the "ounce of prevention that prevents pounds of replacements."

As a "get-acquainted" offer, *Beaver Laboratories* will send out free samples of "Contact." To get a sample, send 15 cents to cover mailing and handling costs direct to the manufacturer, Dept. 3B, 86-51 Palo Alto St., Hollis 23, N. Y. —30—



Powerful Wireless Intercom

NO INSTALLATION OR CONNECTING WIRES are needed with the wireless intercom which has just been introduced by *Semco Electronics Corp.*, manufacturer of the "Page Boy" electronic "baby sitter."

This two-way communication system has a range of up to several miles and is said to be the most powerful wireless intercom yet designed. Each unit is housed in a mahogany or ivory Plastikon cabinet of sufficient weight to prevent sliding. The "press-to-talk" control can be manipulated with finger-tip pressure. List price is \$69.95 per pair in mahogany, \$74.95 in ivory.

For further information, write to *Semco Electronics Corp.*, 17 Warren St., New York, N. Y. —30—



"Mr. Meticulous" Makes Transistors

This robot-like machine builds the delicate junction transistor and then runs a series of tests on it—all within one minute

A MACHINE that can perform more than 15 intricate steps automatically in making experimental transistors—the solid pea-sized amplifiers that have most of the advantages of vacuum tubes—is now in development at Bell Telephone Laboratories. It is familiarly known as "Mr. Meticulous."

In less than one minute, this unique machine will take a tiny bar of a special semi-conducting material, such as germanium or silicon—a bar almost as thin as a human hair—examine it carefully for electrical characteristics, and accept or reject it. If it accepts the bar, the machine will fix a fine gold wire to a critical point on the bar

Bell Labs scientist R. P. Riesz checks operation of "Mr. Meticulous." Machine produces four-element junction transistors, never gets tired, makes no errors.



within an accuracy of 1/20,000 of an inch. Then, still within one minute, it connects this wire to one of the four wires leading out of the transistor; flips the bar end over end; repeats the entire operation with another wire on the opposite side; and finally runs a series of electrical tests on the completed transistor.

Junction Transistors for Research

Transistors for research purposes must be of the highest precision and accuracy. When fashioned by human hands over any extended period of time, some transistors are produced which are substandard and useless for research purposes. This is the result of fatigue on the part of the technician. But "Mr. Meticulous" never gets tired, never loses his precision or accuracy. His hand never shakes and his highly organized electronic "brain" rarely has mental lapses.

Originated by R. L. Wallace of *Bell Telephone Laboratories*, the machine may some day be a pilot model for industrial machines to be used in assembly line transistor manufacture. At this stage, however, "Mr. Meticulous" is primarily a laboratory device designed to aid research on so-called "junction" transistors.

The commonest form of the junction transistor is a three-layer "sandwich" of germanium sealed in a metal can a fraction of an inch in diameter. Wire leads connect to each of the three layers and extend outside the can. This transistor performs the same functions as some vacuum tubes—for example, it amplifies radio signals.

The new type of transistor assembled by "Mr. Meticulous" (although he can build other junction types as well) has a fourth wire which is attached to the central layer. For this reason it is called a "tetrode" or four-element junction transistor. Such tet-

rode transistors are very promising for use at relatively high frequencies and for broadband applications such as television and large bundles of telephone conversations.

How "Mr. Meticulous" Works

To utilize "Mr. Meticulous," an operator first places an *n-p-n* "sandwich" of germanium—as short as the head of a match and only a little thicker than a human hair—into a clamp on the machine. The machine then presses a very thin strand of gold wire against the bar and the wire edges along the bar with minute steps of 1/20,000 of an inch; after each step, the device takes a quick electrical look to see whether it has reached the thin (1/10,000 of an inch) central layer of germanium to which it must bond the wire. As soon as the wire touches this layer, the machine starts measuring width until the wire reaches the far side of the layer. The machine then decides whether the bar is satisfactory. If it is not, it can be automatically rejected.

If the bar is acceptable, "Mr. Meticulous" retraces his steps to the other side of the central layer and counts forward a predetermined number of steps. At this point, a shot of electric current is used to attach the wire to the germanium. The machine then attaches this wire to one of the four leads of the transistor itself, and rotates the bar of germanium end over end. It automatically goes through the same series of operations on the other side of the bar.

Finally, the machine runs a series of electrical tests to determine whether the completed transistor has the proper operating characteristics for research purposes. If the transistor fails any of the tests, it can be automatically rejected. If it passes, "Mr. Meticulous" puts it aside as finished business and goes on to the next bar of transistor material.

-30-

Enlarged view of a completed transistor, shown beneath the edge of a U. S. dime, highlights the unit's tiny and delicate structure. The wire in the photo is almost as thin as a human hair.

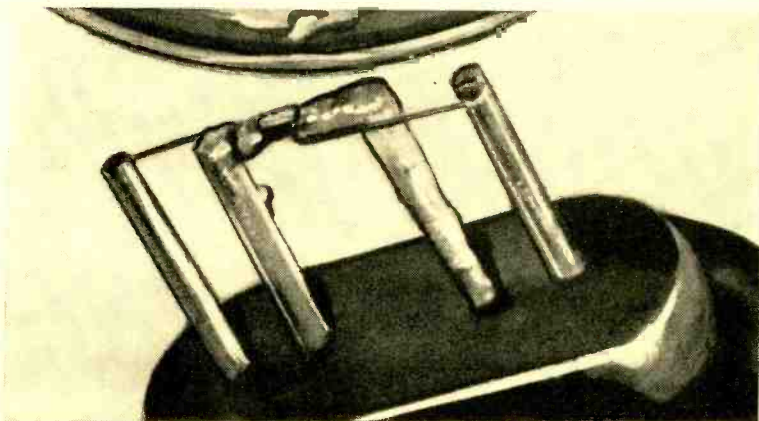

"OVER THE HORIZON" TRANSMISSION

Super-powered transmitters beam TV and phone signals up to 200 miles without help from relay stations

DIRECT television and multichannel telephone transmission through space for as much as 200 miles—without relay stations and at ultra-high frequencies—is now a reality, according to announcements by *Bell Telephone Laboratories* and the Massachusetts Institute of Technology. Video and audio information can both be sent "over the horizon" on u.h.f. channels in an extension of a transmission technique recently applied to the continental defense system.

Over-the-horizon transmission means that longer communications bridges are possible over water and rugged terrain. In the present microwave radio relay network across the United States, relay stations are only about 30 miles apart.

Standard AM radio broadcasting employs waves that follow the earth's curvature. But waves used in television and telephone relays were presumed to travel in a straight line. For many years, "line of sight" transmission between antennas placed on towers on the horizon (about 30 miles apart) was thought to be the only practical means of transmitting by radio the wide bandwidth needed for television and multichannel telephone service.

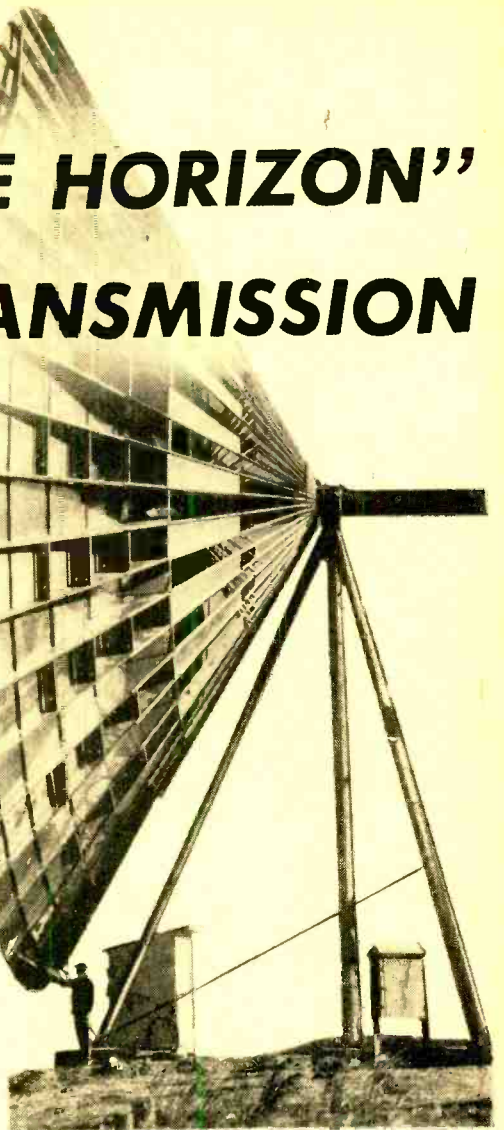

This was disproved after years of research at M. I. T. and *Bell Telephone Laboratories*. The *Bell Laboratories'* research stemmed from *Bell's* success with transcontinental microwave systems for carrying telephone conversations, radio and television programs from coast to coast, and their continued interest in radio propagation. The M. I. T. interest was stimulated by work for the Government in radar and overseas broadcasting.

Scientists knew that ultra-high frequencies traveled "over the horizon" under certain conditions but believed them to be too weak and undependable for practical use. In the course of investigating occasional in-

interference attributed to these waves, however, the scientists discovered that many actually overshot the relay towers they were aimed at and arrived at farther points with remarkable consistency.

The next step was to provide reliable long-distance transmission "over the horizon." Engineers did this by erecting larger antennas and using higher power than is employed in the conventional microwave system. Thus, they put to use the weaker signals that drop off a straight radio beam beyond the horizon and are reflected or scattered to distant points by the atmosphere.

The effect of the new system is very much like that of a powerful searchlight which casts a beam in a straight line. A searchlight aimed at the sky can be seen from the ground miles away, even when the searchlight is behind a hill. This is possible because some of the light is reflected and scattered by the atmosphere.

In order to make use of over-the-horizon transmission, 10-kw. transmitters and 60'-diameter antennas are being employed, representing 20,000 times the power and 30 times the antenna area used in the present transcontinental microwave system. It was found necessary to employ the lower frequencies (in the u.h.f. band) to develop

with available equipment sufficient power to attain a satisfactory degree of reliability.

Even after scientists learned that transmission was possible "over the horizon," they were not certain that this medium would support the broad band of frequencies needed for multichannel telephone or television transmission. In the fall of 1953, they found that they could transmit 12 voice channels "over the horizon." Television was first successfully transmitted this way in 1954 between *Bell's* Holmdel, N. J., laboratory and the M. I. T. Round Hill Research Station near New Bedford, Mass., a distance of 188 miles.

Bell and M. I. T. scientists emphasize that this success with over-the-horizon transmission will probably result in a supplement to—rather than a replacement of—line-of-sight radio relay systems.

Over-the-horizon signals are not to be confused with a similar type of transmission known as "ionospheric scatter," which is useful in long-distance transmission of telegraph signals at relatively low frequencies. Unlike ionospheric signals, the over-the-horizon technique provides signals that are useful for the wide bandwidths required for a television picture or by many telephone channels.

-30-

Electrostatic Tweeter

DESIGNED AS A LOW-COST high frequency reproducer, the SKL-100 electrostatic tweeter uses the electrical forces developed between the two plates of a capacitor as the source of its audio output. A thin diaphragm of polystyrene is covered on one side with gold leaf, while the other surface rests against a perforated metallic plate. The gold leaf and the plate are connected through a suitable network to the amplifier output.

This type of speaker requires a bias d.c. voltage to stress the dielectric which is, in turn, modulated by the audio a.c. signal. The SKL-100 covers the frequency range above 5000 cps. "Highs" are distributed over a wide angle by the louvred deflection

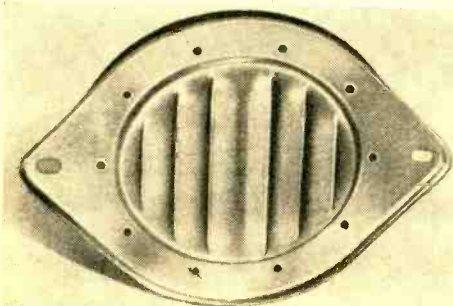

plate. Data on this unit, which retails at \$5.00, are available from *Kingdom Products, Ltd.*, 23 Park Place, New York 7, N. Y.

-30-

Enclosure Has Adjustable Port

THE NEW "TUNE-A-PORT" speaker enclosure may be adjusted by the user for best tonal output by means of two external knobs that raise or lower the port opening. This bass reflex type cabinet accommodates 12" or 15" single-unit, coaxial, or triaxial loudspeakers. Ten thousand cubic inches of space are enclosed within its padded interior. Over-all size is 36" high by 24"



wide by 17" deep. Retail price is \$69.50. For complete details, write to the manufacturer, *Standard Wood Products Corp.*, 47 W. 63rd St., New York 23, N. Y.

-30-



Empty spaces in 225' x 300' parking lot are readily spotted on television screen.

TV for Parking Lots



ONE OF THE newest applications of closed-circuit television is in a parking lot. Mounted atop a light standard is a compact, lightweight "TV eye" camera. It is connected to a 21" receiver located in the lot's entrance booth. When a motorist drives into the lot, the attendant need only glance at his TV screen to locate a vacant space. The "TV eye" may be rotated to provide a complete view of all sections of the parking field.

The installation shown here is used by the *Downtown Merchants Association*, Oakland, Calif. Photo at top is an actual shot of part of the parking area, as seen by the attendant on his screen. The TV set is housed in the hut shown in the center photo, while the simplified block diagram (right) shows how the system works. Note provisions for controlling pan and tilt of the TV camera. Below is an over-all view of the parking lot, which has become a more orderly and safer place with the aid of electronics.

-30-

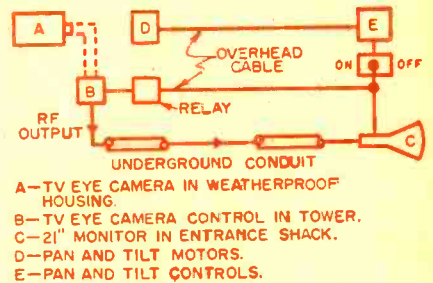

Underchassis view of light-operated relay. The photocell and lens assembly, which makes use of a rubber attachment plug, is mounted on the left chassis flange.

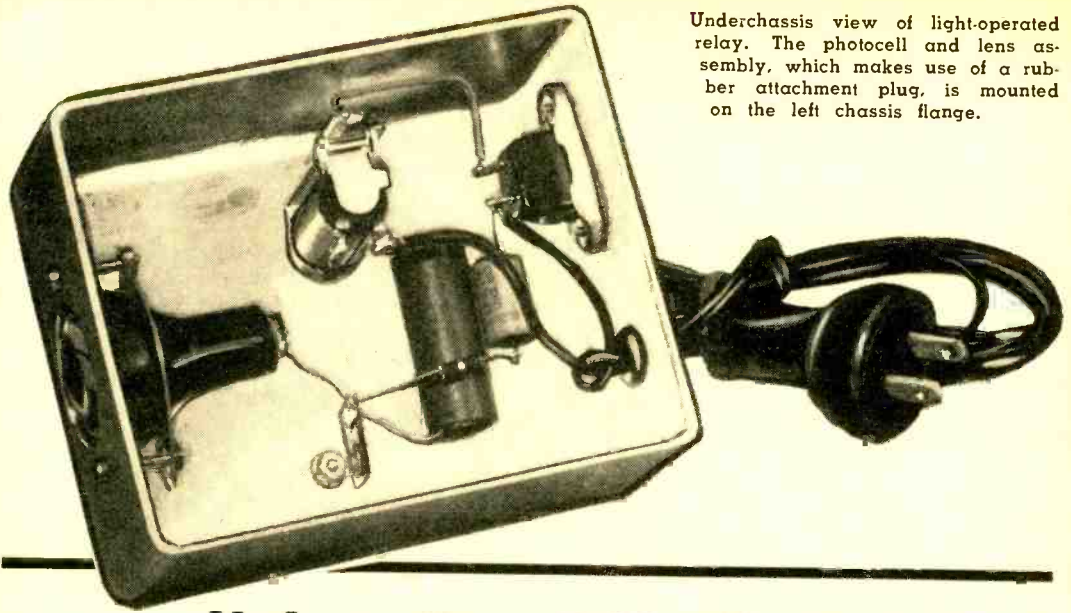

Using the CdS Photocell

PHOTOELECTRIC devices have myriads of uses in homes, public buildings and factories. They may be used to open doors, count objects, warn of smoke or fire, or serve as intrusion alarms—to mention only a few applications. They are essentially rugged and reliable, and have met with widespread acceptance.

There is one fundamental disadvantage inherent in the majority of the phototubes and photocells presently available, namely, their low output current. To be useful, the output of the light detector must operate a relay, counter, or other device. Because of the low current, an amplifier is normally used to boost the output sufficiently to be of value. The addition of the amplifier complicates the unit.

Recently, a new type of photocell was introduced which has sufficient output, with proper illumination, to operate a sensitive relay or counter directly. Known as the cadmium sulphide photocell, it is a photoresistive type, i.e., its resistance changes when it is illuminated. The sensitive element, a crystal of cadmium sulphide, has a very high resistance (ranging from hundreds of megohms to as high as tens of thousands of megohms) when it is dark. Its resistance decreases very rapidly as more and more light strikes it. Thus, if a voltage is applied to the cell, the amount of cur-

By **MARVIN LUBIN**
WALLACE SAMUELSON

Light-operated relay employing the new CdS (cadmium sulphide) photocell has a number of uses

rent flowing through it will be an indication of light intensity. Under proper conditions, this current may be sufficient to operate a sensitive relay.

A basic circuit for this type of device is shown in Fig. 1. Voltage is applied across the series combination of the photocell and a load. When the cell is dark, the resistance is high and current flow is very small. Under illumination, current flow increases.

This photocell is the basis of the very simple, easily built, light-operated device shown in Fig. 2. Here the operating voltage is obtained by rectifying the line voltage (117 volts, 60 cycles) to give about 130 volts, d.c. Since the current drain is very small, the rectifier, *SRI*, can have a rating of only 20 ma., although a unit with a

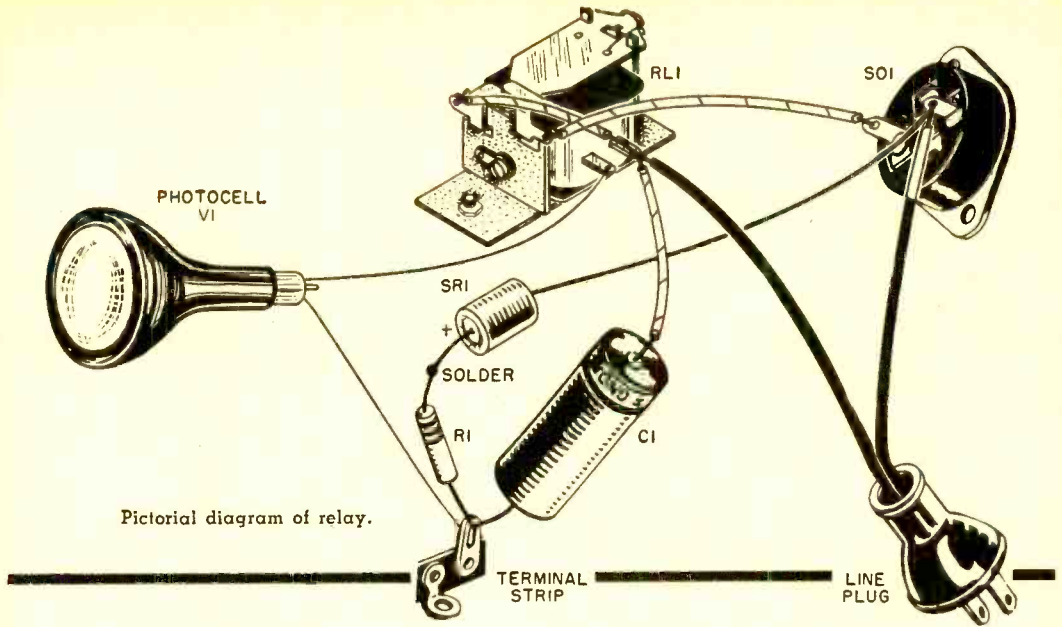

Pictorial diagram of relay.

larger rating may be used if desired. Several alternate relays are given in the parts list; any relay with an 8000-10,000 ohm coil which will operate on 1 to 3 ma. is satisfactory. One advantage of this device is its very low power drain when the photocell is dark. Under this condition, power consumption is negligible.

Construction is extremely simple, as can be seen from the photograph. Any chassis of convenient size may be used. Mounting of parts is not at all critical, as long as the line voltage is well isolated from the chassis.

The cadmium sulphide cell employed in

this unit is very small, which means that it will not intercept much light. Therefore, a lens system was added to concentrate the available light on the photocell. A novel
(Continued on page 121)

- RI—4700 ohm, 1/2 w. res.
- CI—20 μ d., 150 v. elec. capacitor
- SRI—20 ma., 130 v. selenium rectifier
- RY1—S.p.s.t. relay, 8000-10,000 ohm coil (Sigma 4F; Relay Service Co. RS Midget*; Potter & Brumfield SSSD)
- VI—Cadmium sulphide photocell (Standard Electronics CdS-3 Type DR-1.5 ma.)**
- SO1—Chassis type a.c. socket (Cinch-Jones 2R2)
- 1—Rubber handle plug
- 1—Line cord and plug
- 1—Lens, 1 1/4" diam., 1" focal length
- 1—Single lug tie point
- 1—4" x 6" x 2" chassis base
- Misc. screws, wire, solder, etc.

* Available from Relay Service Company, 1310-12 North Pulaski Rd., Chicago 51, Ill., at \$3.30 each. Specify Part No. R-1000A for s.p.s.t. NC contacts, Part No. R-1000B for s.p.s.t. NO contacts, and Part No. R-1000C for s.p.d.t. contacts. This latter relay is \$3.50.

** Available from Standard Electronics Div. of Hupp Corporation, P.O. Box 513, Carlisle, Pa., at \$3.95 each.

Total cost of parts, approx. \$11.90

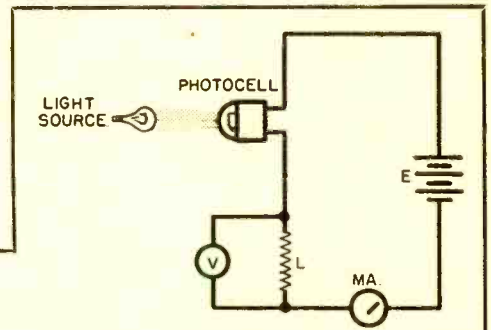

Fig. 1. Circuit showing basic operation.

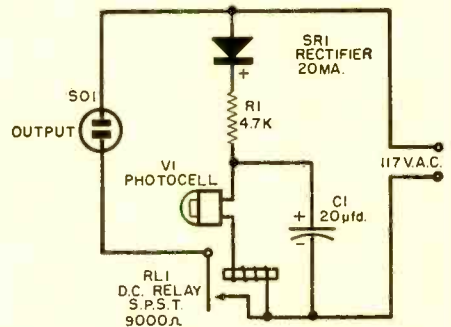
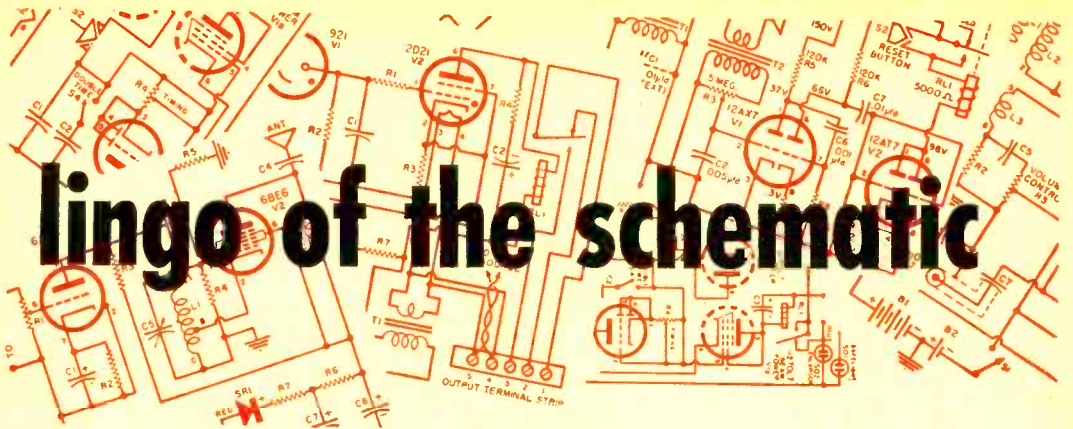

Fig. 2. Schematic diagram of the relay.



lingo of the schematic

By **GEORGE BERRY**

*Strictly for the beginner;
the how and why of radio
or electronic schematics
plus pictorial vs. wiring*

IF YOU enjoy building and experimenting with electronics, but still feel a bit shaky about wiring up circuits directly from the schematic diagram, take heart. Pictorial diagrams are all right to start with, but they are not as easy to follow as they look. But schematic diagrams are actually much easier to understand than they would seem to be. Most of them are a lot simpler than, say, a road map, and easier to figure out than a diagram of an end-run play in football.

Let's assume you already recognize the standard symbols for the common parts—tube, capacitor, resistor, and coil . . . battery, headphones, antenna, and ground. Once you have some idea of what these different gadgets do, it's almost impossible to mistake what the symbols mean. They were designed that way.

The idea of the schematic diagram is simply to show *what is connected to what*, in the simplest, most direct manner possible. You can take a schematic and compile from it a list of what connections to make. Then you can follow that list with a soldering iron and pliers and the circuit will be all wired up. Experienced people, including engineers, usually do this mentally while they are working.

Let's take an example, say, the simplest possible one-tube radio receiver. This set will work, incidentally, but don't build it except for practice. A very few more parts would make a vastly better set, but that

would spoil the neat simplicity of our example. The schematic is shown in Fig. 1. Now let's proceed through the mental processes that go with wiring it up.

First, mount on a board those parts which ought to be screwed down. That means the tube socket and the tuning capacitor. Let's use a big board and set the batteries on it too, so that it can be carried around. There are few sounds as discouraging as the "clunk" of a heavy B battery plunging to the floor, accompanied by the ripping noise of taut wires pulling radio parts out by the roots.

The coil can be screwed down, too, if it has a bracket. Some screw terminals or Fahnestock clips for the antenna, ground, and headphones need to be fastened on as well. Now we are ready to wire. Starting at the left, we see that the antenna terminal, one end of the coil, and one side of the tuning capacitor *C2* should all be connected together. Do so. Next, and rather naturally, the ground terminal, the other end of the coil, and the other side of the tuning capacitor *C2* all go together. The frame side of *C2* is always the ground side. Now note that the little mica capacitor *C1* and the resistor *R1* are connected directly

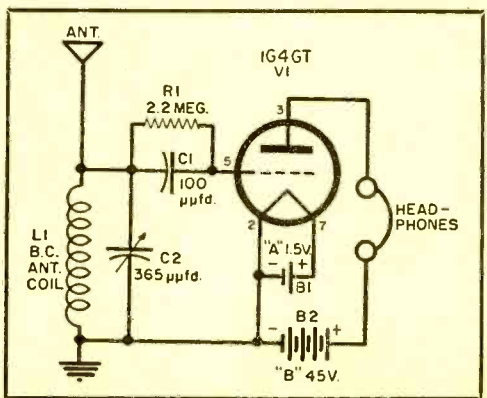

across each other. Let's solder them together, and then see where the combination goes . . . one end goes to pin No. 5 on the tube socket while the other end goes to the tuning capacitor—that side which is connected to the antenna.

Where do the other socket terminals go? Well, No. 3 goes directly to one side of the phones. While we are at it, let's take care of the other side of the phones. A long wire goes to the positive side of the B battery; make it red for "+". Now there are only two connections left on the socket. Pin No. 2 goes to the negative side of the A battery, so let's solder a wire there. It goes to a couple of other places, too. In fact, it looks as if pin No. 2, the "A minus," the "B minus," and ground are all connected together. Does it matter just what wires go where, so long as these four places are all connected together? Well, it matters at v.h.f., but not down here in the AM broadcast band. Let's do it in some reasonably

direct way. A wire from socket pin #2 should go to the frame (ground) side of the tuning capacitor. It can be easily routed around via the terminal on L1. Color should be black for ground, negative, and such things, if we are particular. As the B battery will be sitting alongside the A battery, let's make the wire about six inches longer than necessary. Skin the insulation six inches back from the end and connect that to "A minus"; then skin the end and connect that to "B minus." It is simpler that way.

Now we ought to be finished . . . except for pin No. 7. That goes to the plus side of the A battery, and nowhere else. Better put a clip on the battery end of the wire so we can turn off the unit.

Clip a wire from a water pipe or bed-spring or something onto the "ground" terminal, drape ten feet of old magnet wire from a defunct auto speaker field over (Continued on page 102)

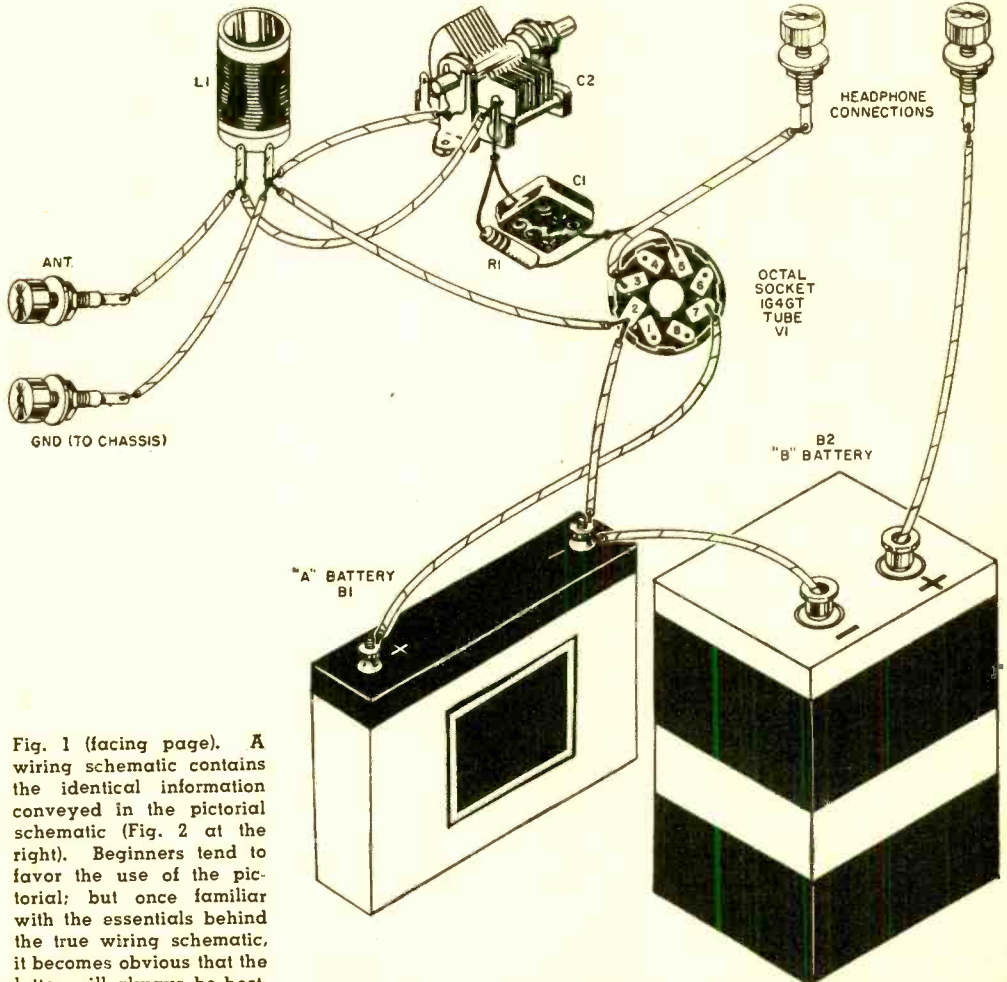
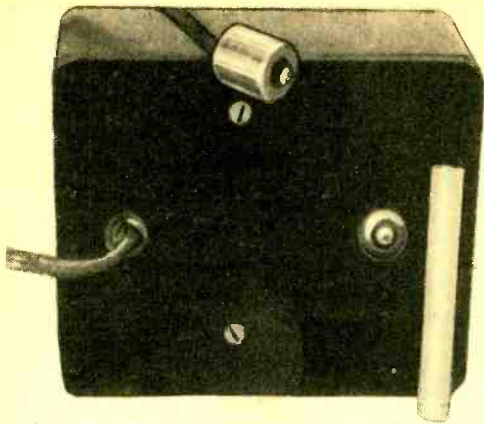

Fig. 1 (facing page). A wiring schematic contains the identical information conveyed in the pictorial schematic (Fig. 2 at the right). Beginners tend to favor the use of the pictorial; but once familiar with the essentials behind the true wiring schematic, it becomes obvious that the latter will always be best.



External view of the tester showing a cigarette on the right for a comparison of size. The neon bulb is mounted in a rubber grommet on the panel near the cigarette.

Positive Flash-Gun Tester

By HARVEY POLLACK

Why waste good film on flash shots when this indicator will test your flash gun's operation

FOR THE CAMERA USER, nothing is so aggravating as a flash bulb which fails to go off when a crucial, never-to-be-repeated scene is being photographed. Although many flash guns are equipped with a "test" position in which the condition of

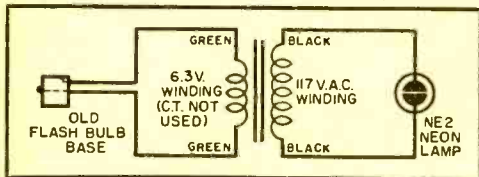

Wiring schematic of the flash-gun tester. Note the simplicity of the circuit which uses a filament transformer and a neon bulb. The plug to the flash-gun bulb socket is made from discarded bulb base.

the cells may be checked by observing the brightness of a flashlight bulb inserted in the socket, inexpensive cameras like the *Hawkeye Flash* and the *Kodak Duoflex I* and *II* cannot be tested this way.

The simple little tester described here can be made up for less than \$1.50. It checks the flash equipment right at the flash-bulb socket, with or without film in the camera. This kind of test reports simultaneously the condition of the dry cells and the cleanliness of all internal contacts.

All that's needed is a spent flash bulb of the right size, an inexpensive filament transformer of the 6.3-volt variety (a *Stancor* P-6134 was used in the author's model), an NE-2 neon lamp, a small box of metal or wood, and two rubber grommets.

The test plug that goes into the flash socket is made from the base of the burned-out flash lamp. Wrap the latter in several layers of cloth and break the glass by rapping it with a hammer. Break away most of the glass shards with a pair of pliers, then soak the metal portion in boiling water for about five minutes to soften the cement. After this, the remaining particles of glass can be removed easily with a screwdriver. Unsolder the old wire leads from the center contact and the brass shell, and then resolder a 2' or 3' length of twin line cord to the base as shown in the illustration. To finish the plug neatly, fill the hollow with molten sealing wax or ordinary paraffin.

Wire the circuit as shown. The NE-2 lamp projects up through the hole in one of the grommets and is firmly supported by friction; the remaining grommet is used as an exit hole for the test lead carrying the plug.

When the flash equipment is ready to be tested, plug the remodeled flash-bulb base into the socket. If there is film in the camera, cover the lens with a piece of cardboard to avoid fogging the film. If the neon tube flashes when the shutter is operated, the batteries and contacts are good; if it fails to do so, the bulbs will not fire!

The principle of operation is so simple that practically nothing can go wrong. As the shutter makes instantaneous flash contact, the cells in the flash gun send a pulse of current through the 6.3-volt winding. This voltage is stepped up by transformer action to a potential sufficiently high to fire the neon lamp. If the cells are weak or the contacts are dirty, the neon lamp will not glow at all.

Build Your Own Applause Meter

By LOUIS E. GARNER, JR.

Add a professional touch to local amateur talent contests and shows with this simple, easily built applause meter

AMATEUR CONTESTS are never complete without an applause meter of some kind. Here is a unit that will add a professional touch to any amateur show—whether at a church benefit, a local high school show, a lodge show, or a civic group's charity performance.

But an applause meter need not be confined to the job of judging contests. Since it is basically a simple sound level meter, it may be used in dozens of other applications—from checking relative noise levels in an industrial plant to determining the efficiency and performance of a p.a. system by checking sound levels in various parts of an auditorium.

Assembling this applause meter can be a lot of fun. Standard, easily available parts are used throughout, and the circuit is simple and foolproof. Little or no difficulty will be encountered even by the beginner in building the unit—one or two evenings or a single weekend will provide adequate time.

Construction

As can be seen from the circuit diagram (Fig. 1), this device is basically a three-stage amplifier fed by a loudspeaker used as a microphone. The output of the amplifier is rectified and passed through a 0-500 microampere meter. Thus, the meter deflection is directly proportional to the intensity of sound striking the speaker microphone.

A standard wall-type loudspeaker baffle



View of applause meter as seen by contest judges. Ordinary clothesline cleat serves as a support for the power cord.

was used as a cabinet for housing the model. Four rubber feet are attached to its "base" and a kitchen cabinet handle to its "top." Almost any type of housing will serve as well—a metal utility box, the cabinet from an old table-model radio receiver, or even a home-made wooden box. The chassis and control panel are of aluminum. A commercial chassis base (ICA No. 29080) was used in the model, but a satisfactory chassis can be bent from sheet stock if preferable. Dimensions are not critical. The panel was cut from an aluminum cookie sheet, but any stiff, durable material may be used, and even plywood or hard board, such as *Masonite*, is satisfactory.

After cutting the panel to size, check its

fit. In the author's model, imperfections in the speaker baffle left several gaps between the panel and the baffle "cabinet." If a snug, tight fit is obtained, a few 1/2" holes should be drilled either in the sides or in the top and bottom of the cabinet. These serve the dual purposes of providing ventilation and keeping the speaker from being "muffled" by a closed air chamber, with a resulting drop in sensitivity. Standard decals are used for labeling the controls. A clothesline cleat is mounted on the panel and serves as a holder for the coiled line cord when the instrument is carried.

A 6" PM loudspeaker is used as a microphone in the model, but any size PM speaker from a 2" midget to a 15" giant will do the

- | | |
|--|---|
| <p>R1—250,000 ohm volume control (audio taper)
 R2—10 megohm, 1/2 w. carbon res.
 R3—270K, 1/2 w. carbon res.
 R4—220K, 1/2 w. carbon res.
 R5—27K, 1/2 w. carbon res.
 R6—47K, 1/2 w. carbon res.
 R7—1 megohm, 1/2 w. carbon res.
 R8—220 ohm, 1 w. carbon res.
 R9—1 megohm, 1/2 w. carbon res.
 R10—10 K, 1/2 w. carbon res.
 R11—1K, 2 w. carbon or wirewound res.
 R12—47 ohm, 1/2 w. carbon or wirewound res.
 C1—.005 μd. disc ceramic capacitor
 C2—.01 μd., 200 volt paper tubular capacitor
 C3, C5—.01 μd. disc ceramic capacitor
 C4—10 μd., 25 v. tubular electrolytic capacitor
 C6—.01 μd., 200 volt metalized paper tubular capacitor
 C7, C8—20-40 μd., 150 volt dual tubular electrolytic capacitor
 C9—.025 μd., 200 volt paper tubular capacitor (optional—see text)
 T1—Speaker output transformer, 5000 ohms pri., 3.5 ohms sec. (Merit Type A-3026)
 T2—Small power transformer; 150 v. @ 25 ma., 6.3 v. @ 0.5 amp. (Merit Type P-3046)</p> | <p>S1—S.p.s.t. toggle switch
 SR1—20 ma. selenium rectifier (Radio Receptor Type 8Y1)
 V1—Type 6AU6 tube
 V2—Type 12AT7 tube
 CR1—Type 1N34 crystal diode
 M1—0-500 microampere, 2 1/2" diam. meter (see text)
 1—6" PM loudspeaker (see text)
 1—7-pin miniature tube socket
 1—9-pin miniature tube socket
 1—line cord and plug
 1—speaker wall baffle
 1—kitchen cabinet pull (handle)
 1—control knob
 1—clothesline cleat
 2—2-terminal tie point
 1—7-terminal tie point
 4—1/2" rubber grommet
 1—3/8" rubber grommet
 1—sheet of aluminum (about 8" x 10") for panel
 4—rubber feet
 1—chassis (ICA #29080, 3" x 6 1/8" x 1 1/4")
 Misc.—ground lugs, machine screws, nuts, wire, solder, etc.</p> |
|--|---|

Total cost of parts, approx. \$28.00

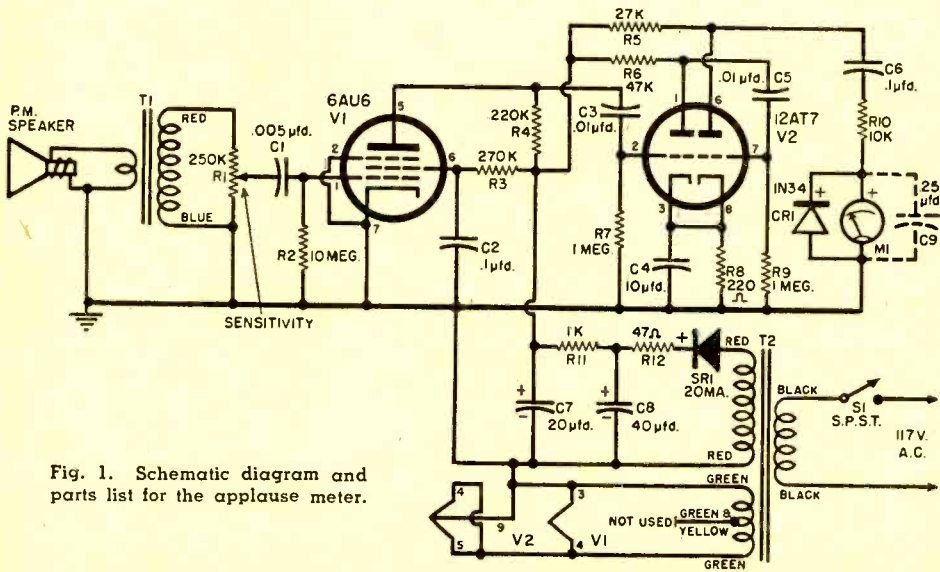
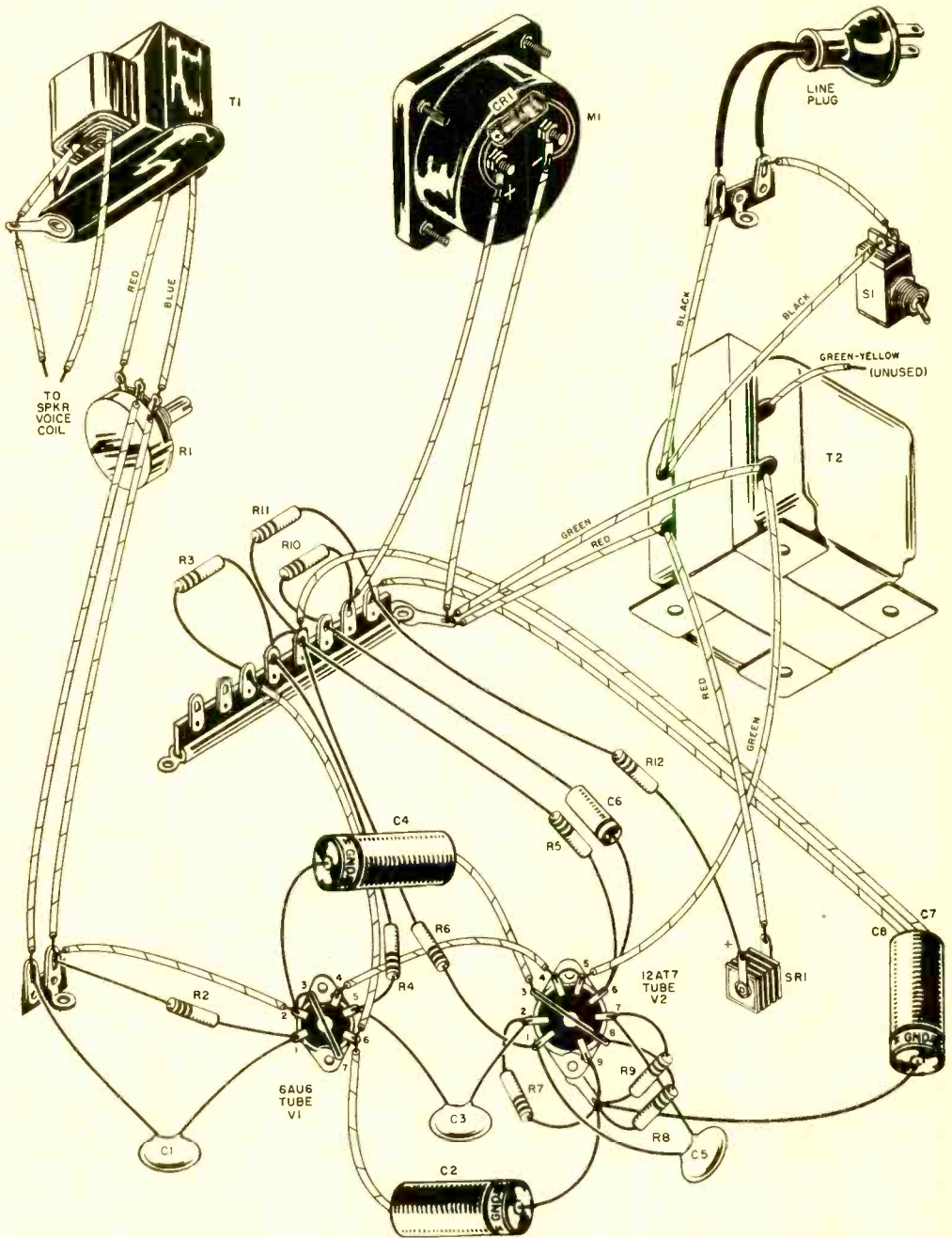

Fig. 1. Schematic diagram and parts list for the applause meter.

job, although the larger speakers may be slightly more sensitive. Use any PM speaker that is available. It may surprise you to learn that a dynamic loudspeaker will operate very satisfactorily as a microphone, provided that it is properly matched to the

amplifier. An output transformer is usually employed for matching. This "microphone" characteristic is utilized in many intercom systems where a single unit serves as both loudspeaker and microphone. A crystal or a high impedance dynamic



Pictorial diagram of the applause meter, indicating the suggested method of wiring the various components. The photographs show location of the components on the chassis.

microphone could be used in place of the loudspeaker. In such a case, the matching transformer, *T1*, would not be needed. Replace *R1* with a 2-megohm control and connect the microphone leads directly across it.

When all chassis machine work has been completed, mount the transformers, tube sockets and other components using small machine screws and hex nuts. Lock washers should be inserted under each nut or, as an alternative, each screw and nut can be painted with fingernail polish. This step will keep the screws from working loose when the instrument is carried about. Use rubber grommets for protection wherever wires pass through the chassis or panel. And take care not to use excessive pressure when mounting the small selenium rectifier *SR1*. Place a fiber washer under the mounting nut and between the rectifier and chassis to serve as a "cushion." To minimize the chances of damage, mount the meter last of all . . . preferably after the wiring is completed.

Wiring Hints: Since the applause meter is basically a three-stage audio amplifier, the same wiring precautions apply as in assembling an amplifier. Lead dress is not too critical, but the input and output lead connections should be kept well separated to avoid oscillation and component leads kept as short and as direct as possible to avoid hum and noise pickup. Use a hot, clean, well-tinned soldering iron and rosin core solder, and complete all connections as quickly as possible to avoid heat damage. Take special pains when soldering the terminals of the selenium rectifier, as excessive heat can damage this component.

It is best to wire as much of the main chassis as possible before attaching it to the panel. Since the instrument will probably

be used on the stage of an auditorium or in other places where a standard outlet may not be close by, install a long line cord—12' to 15' length is not excessive.

Circuit Modifications: There are two circuit modifications which may be incorporated in the instrument . . . (1) a simple "filter" to reduce the sharp peaks caused by someone whistling, and (2) a meter other than the 0-500 microampere unit used in the model and specified in the parts list. To add a simple filter, connect a small paper capacitor across the meter terminals, as shown at *C9*. The exact value is not critical; try sizes from 0.05 μ f. to 0.5 μ f. to see which gives the best results. Voltage rating is unimportant.

A 0-1 ma. meter may be substituted without changes in the circuit, but the instrument's sensitivity will be reduced somewhat. A 0-200 or 0-100 microampere meter will give greater sensitivity than the 0-500 unit, but it may be necessary to increase the size of *R10* slightly to reduce "needle slamming" when the *sensitivity control* is turned up. Determine the best size experimentally.

Installation

With the wiring completed and checked for errors, install the tubes and plug the unit into a wall receptacle. Turn it *on* and allow it to warm up for a minute or so. Turn the sensitivity control all the way up and speak a few words out loud. An up-scale deflection should be obtained on the meter. If a down-scale deflection occurs, reverse the connections to the germanium diode (1N34). Speak in a louder and in a softer voice. The louder the voice, the greater the deflection that should be obtained. Try turning the sensitivity control back. As it is turned back, less deflection should be obtained for the same sound level.

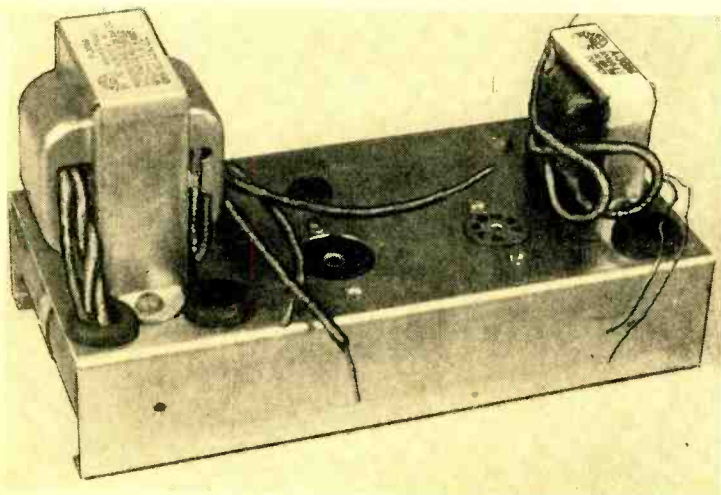

Top view of chassis after the two transformers have been mounted and before any of the wiring has been done. Location of tube sockets and rubber grommets can be readily determined from this photograph.

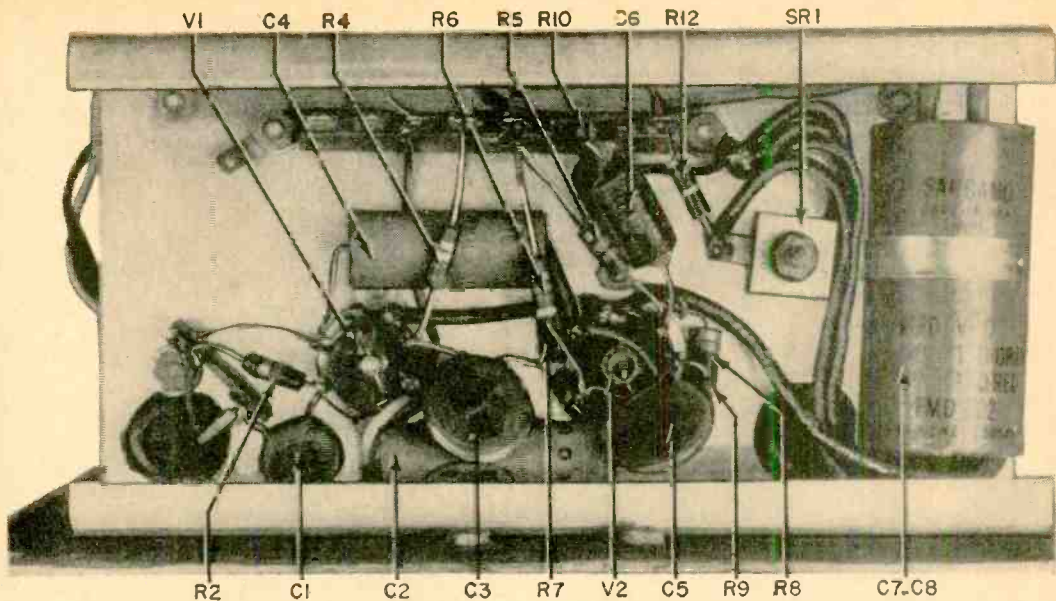

Underchassis view with the major components identified in accordance with Fig. 1.

If a small deflection is obtained even when there are no sounds in the room or when the sensitivity control is turned back, don't worry. There may be some small hum or noise pickup in the circuit, but this will not prevent the instrument's use. If the "no signal" deflection is appreciable, check the circuit wiring carefully. If necessary, shield the input leads.

To use the completed instrument as an

applause meter, set it on a table so that the speaker faces the audience. One or more "judges" may watch it and record the results. Before a performance begins, ask the audience for a good "hand." While they are applauding, set the sensitivity control so that the needle deflects about two-thirds or three-quarters of full scale. Keep the control at this setting throughout the judging.

-30-

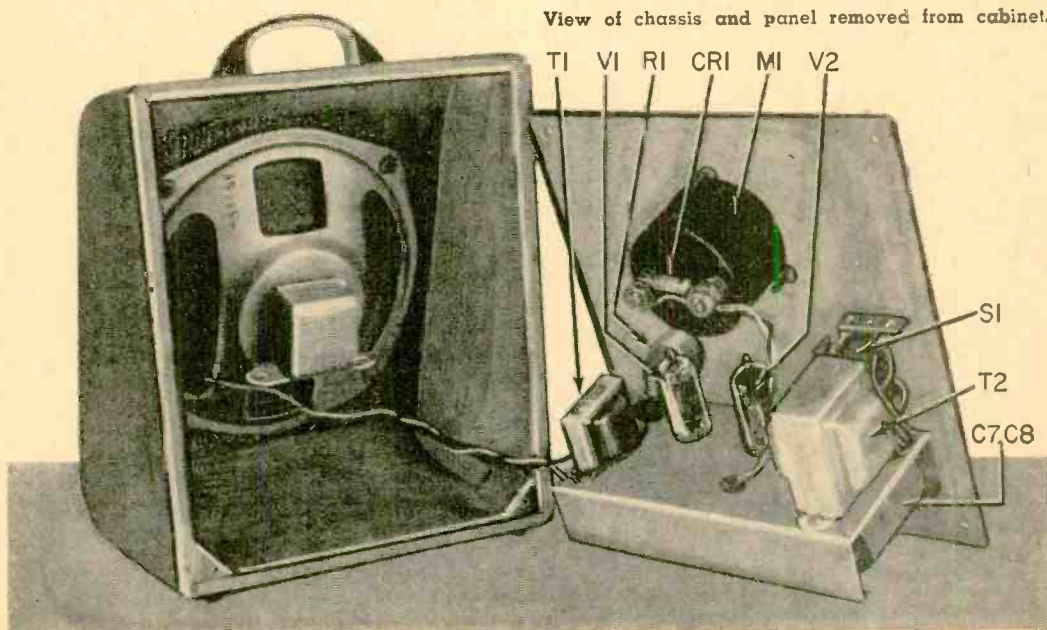

Checking a Typical Clock Radio

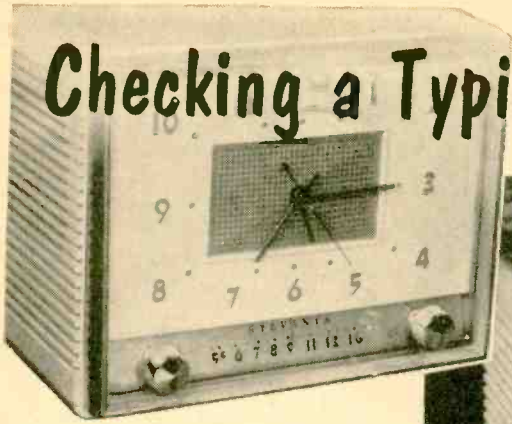

Usually mounted on the back of all clock radios is a tag or sheet describing the operation sequence. Also outlined on the back cover is a diagram of the tube positions, "switched" a.c. outlet, and controls for setting time on the clock.



Disassemble the clock radio in the same way that the ordinary household radio would be disassembled. Before slipping the radio chassis from the plastic case, note that the clock is plugged into the receiver chassis by a small two- or three-prong male plug. Pull this plug out and the receiver chassis will be free.

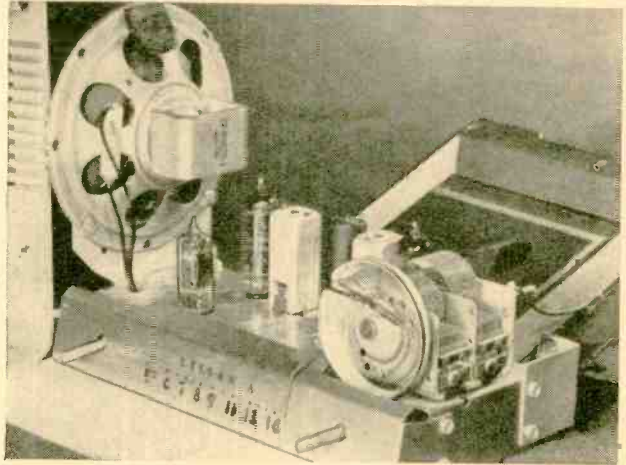

Should it ever become necessary to operate the radio without the clock, the "on-off" switch in the clock mechanism must be shorted. Use an ohmmeter to determine the correct terminals and connect them with a short length of wire.



Clock radios differ from ordinary radio receivers in that they include an electric clock—this is how they may be checked

By H. LEEPER

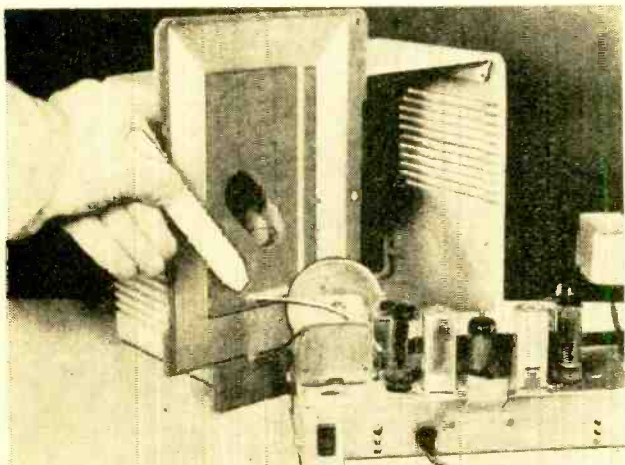

Two spots to be checked for wear and tear are the connections to the loop antenna and the entry of the a.c. line through the chassis wall. If the former is frayed, it may be necessary to replace the wire to insure a good connection. If the a.c. line is cut or scarred, it should be replaced with fairly heavy a.c. cord (capable in some clock radio combinations of handling at least 1000 watts).

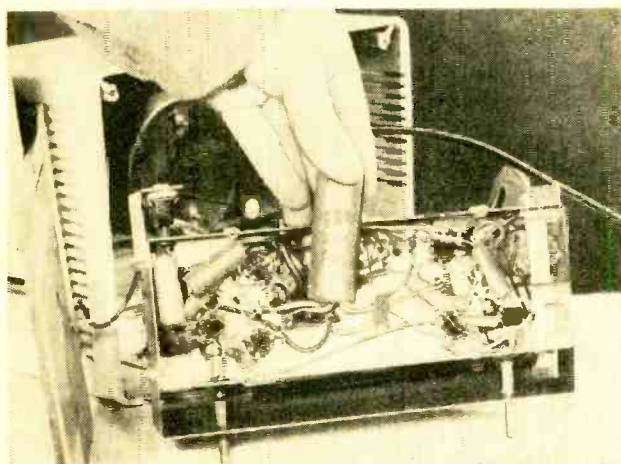

As is usual with most small a.c.-d.c. household radios, excessive hum or distortion is probably due to the filter capacitors. Replace them if they have broken open or are leaking. Use values shown on capacitor cartridge and carefully observe polarity (coloring of wires) when soldering new unit in place.

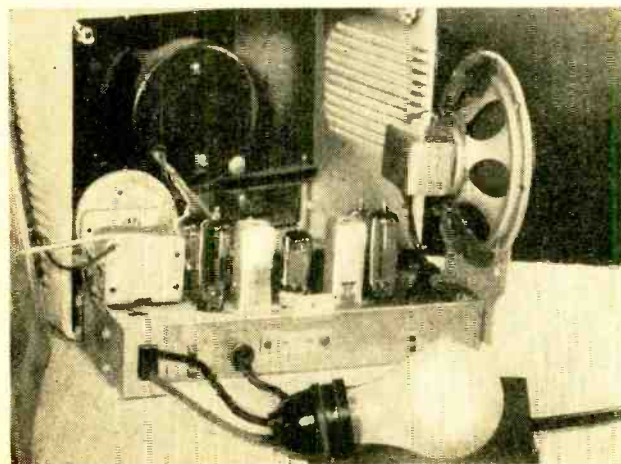

To check the appliance outlet, temporarily plug in a 100-watt lamp bulb. Before plugging in the clock radio, of course, reassemble the connections to the clock motor and switch. Check the time when the appliance switch went into operation. Also note if there is excessive hum in the speaker, which in some cases may be due to the clock motor. If faulty time switching prevails or the hum cannot be corrected, clock may have to be replaced.

Build Your Own Geiger Counter Probe

By CARTER ROBERTSON

Handy method of adding another G-M tube to counters utilizing the CK 1026 in 900-volt circuit to increase flexibility greatly

MOST inexpensive Geiger counters are not supplied with an external probe. Such a probe is very convenient to use in prospecting because it offers better exposure to radioactivity. This article describes an inexpensive method of constructing a sturdy probe which will operate with any Geiger counter using a CK 1026 G-M tube.

Parts required are as follows: a spiral wire holder for a CK 1026 tube, which can be purchased for a few cents from a supplier of parts and kits for Geiger counters or can be shaped from heavy-gauge bare copper wire; a CK 1026 Geiger tube; five feet of double stranded wire cable; two Fahnestock clips; a polarized two-prong plug with an insulated socket; and a s.p.d.t. slide switch.

The probe is made from a metal tube approximately 8" in length and having a 1 1/4" inside diameter. A nickel-plated brass tube of these dimensions can be obtained from a plumbing supply store for about 50 cents. Make a wooden handle of any desired length from a round piece of wood of the proper diameter with a 1/4" hole drilled lengthwise through the center for the wire cable. A cylindrical-shaped wooden plug can then be fashioned to fit snugly into the metal tube, and the Geiger tube holder is mounted on the plug. Drill a small hole lengthwise through the

wooden plug for the wire which attaches to the center electrode of the Geiger tube by means of a Fahnestock clip soldered to the end of the wire. This wire should be covered by polystyrene tubing or spaghetti to prevent leakage of high voltage.

Mount the spiral holder for the Geiger tube in a hole drilled lengthwise through the wooden plug, and bend back the end of the tube holder into another hole drilled about 1/4" into the wooden plug. A Fahnestock clip should then be soldered to the end of the Geiger tube holder where it is bent back, and the solder should be permitted to flow around the end of the tube holder to affix it firmly to the assembly. Solder should also be applied at the other point where the tube holder fits into the wooden plug. Care must be taken so that no metal of the Geiger tube mounting will touch the metal tube when the plug is inserted into it. A clear-

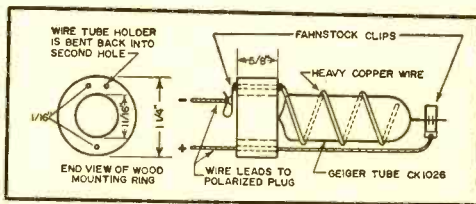

Geiger tube mounting in the probe.

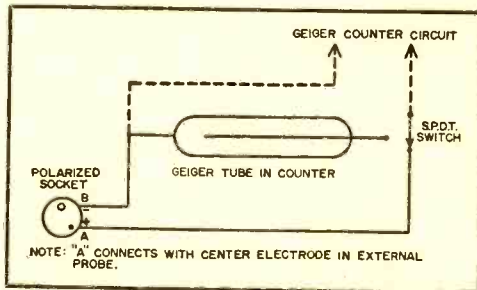

Circuit adaptation for external probe.

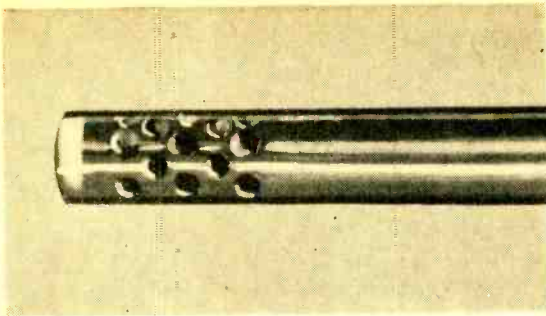

Finished probe assembly ready for attaching to a Geiger counter. The holes permit beta ray entry into the CK1026 tube.

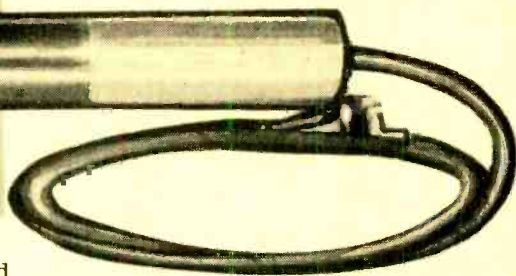

ance of $\frac{1}{16}$ " should separate the soldered connections and Fahnestock clips from the outer metal shell of the probe.

Drill a network of holes into the metal tube for a length of three inches. These should be about $\frac{3}{8}$ " in diameter and evenly spaced so as not to weaken the structure of the tube. The holes permit the passage of beta radiation to the Geiger tube which would not normally pass through the wall of the probe.

Insert the CK 1026 Geiger tube into the spiral holder, making a tight connection. The wire cable is fed through the wood handle and the two wires are connected to the Geiger tube mounting. Electrician's tape or a metal clamp should be placed on the wire cable at the inside end of the handle to take up the strain of pull on the cable. Fix the handle and the wooden plug in place by means of small wood screws through holes drilled in the metal tube. A wooden plug is fitted into the end of the probe to complete the assembly. Solder a two-prong

polarized plug at the end of the wire cable.

The Geiger counter is easily adapted to connect to the external probe. Remember that it is important that the Geiger counter switch be turned off, as there are 900 volts across the Geiger tube. The two terminals of a polarized socket are connected in parallel with the Geiger tube terminals in the counter. Proper polarity of the socket connections is determined from the polarity of the plug attached to the probe. The wire which connects the center (positive) electrode of the Geiger tube in the probe should connect with the center electrode of the tube in the Geiger counter.

Insert a s.p.d.t. slide switch in the circuit as illustrated, connecting either the probe or the original Geiger counter circuit at one time. Holes should be drilled into the Geiger counter's case to accommodate the socket and switch which are mounted in place with small self-tapping screws.

-30-



Filter Eliminates TVI

THE COMPACT HIGH-PASS filter-type TV interference eliminator announced by *Clippard Instrument Laboratory, Inc.*, is intended for use with any video receiver having a 40-mc. i.f. channel. Known as the *Clippard "De Luxe Hi-Pass Filter, Model No. 4125,"* it is said to eliminate or reduce interference and reject or attenuate low frequency signals below 50 mc. The unit

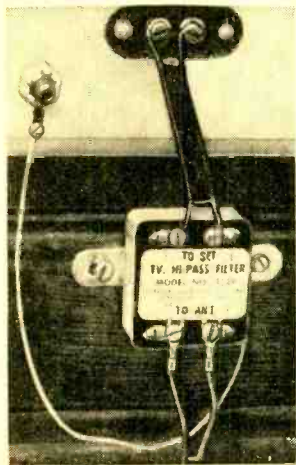

may be used with 300-ohm balanced input systems or 300-ohm twin lead.

For additional details, write to the manufacturer at 7390 Colerain Road, Cincinnati 31, Ohio.

-30-

Unbreakable TV Lamp

SOFT INDIRECT LIGHT is cast by a new lamp which is designed to illuminate the TV viewing area in the home.

A thick felt pad under the base prevents scratching. The entire unit is washable, color-fast and unbreakable. Made by *Peerless Products Industries, 812-16 N. Pulaski Rd., Chicago 51, Ill.*, this TV lamp is listed at \$4.95.



-30-

Plastic Tape Reels

MADE OF TOUGH, glass-reinforced plastic instead of metal, the 10½" magnetic tape reel just introduced by *Minnesota Mining and Manufacturing Company*, Saint Paul 6, Minn., producer of "Scotch" brand mag-

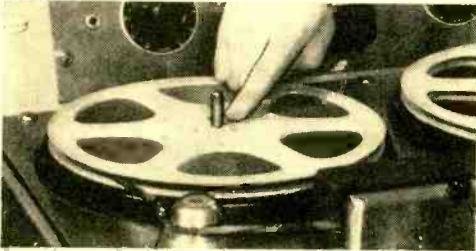

netic tapes, incorporates new structural features. The first of its design to be commercially available, according to the manufacturer, it eliminates many of the prob-

lems encountered with conventional aluminum reels and offers superior tape-handling characteristics.

An important innovation is the tiny center hole, 5/16" in radius, which is said to provide more accurate centering, improved balance, and greater strength than the 3" center hole found in conventional 10½" reels. The reinforced plastic material provides a reel that cannot be bent or permanently distorted, as compared to aluminum reels. Its one-piece precision construction replaces the three pieces of the metal reel normally held together by bolts, and eliminates the possibility of bolts loosening or being lost.

Designed for use with equipment which accommodates 10½" metal reels, the new reel lists for \$4.50. It holds 2400 feet of "Scotch" brand No. 111 or No. 120 "High Output" tape or 3600 feet of "Scotch" brand No. 190 "Extra Play" magnetic tape. —30—

Low-Cost Intercom

"AN ELECTRONIC INTERCOM that everyone can afford" is the description given by

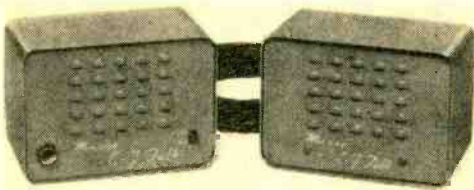

Mark Simpson Mfg. Co., Inc., Long Island City, N. Y., to its new *Masco "E-Z TALK."* Complete with 50 feet of cable, the two-

station system lists at \$19.90. The all-metal cabinets are finished in an attractive ivory enamel and all units are *U.L.*-approved.

The master unit features an "on-off" power switch, volume control, and separate press-to-talk switch, while the remote unit can answer calls from a distance with no switch necessary for operation and is always "open" for baby-sitting or dictation.

This new intercom is said to offer natural voice reproduction, with ample sensitivity and low hum and noise. The system costs less to operate than a 30-watt bulb. Both master and remote units measure 6½" x 3¾" x 4½" high. Shipping weight of each complete system is 6½ pounds. —30—

Short-Wave Hi-Fi Tuner

THE FIRST SHORT-WAVE AM tuner for high fidelity has been announced by *Browning*

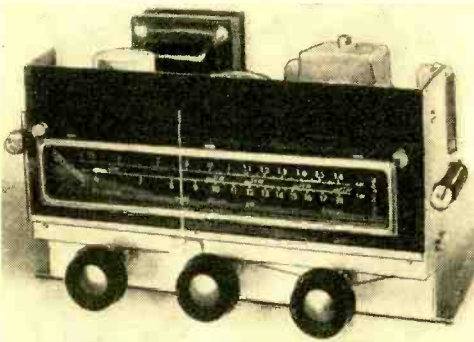

Laboratories, Inc. Entitled the "Brownie" L-500, it is designed as a twin companion

to the "Brownie" L-300, "FM-only" tuner.

As the first tuner to cover short wave, the L-500 enables audiophiles to listen to famous foreign orchestras, music festivals, folk music, special events, and news programs. Outputs connect to amplifier and speaker as well as tape recorder.

The L-500 covers both domestic AM and the international short-wave band—19 to 49 meters. Sensitivity is under 2 microvolts, said to be comparable to the finest communications receivers. Other features are: broad and sharp AM tuning; full frequency response; 10-kc. whistle filter; built-in high-gain ferrite antenna; cathode follower output to permit remote installation; and self-contained power supply.

Now on display at hi-fi dealers, the L-500 is priced at \$87.50 net. Specifications are available at dealers or from manufacturer at 750 Main St., Winchester, Mass. —30—

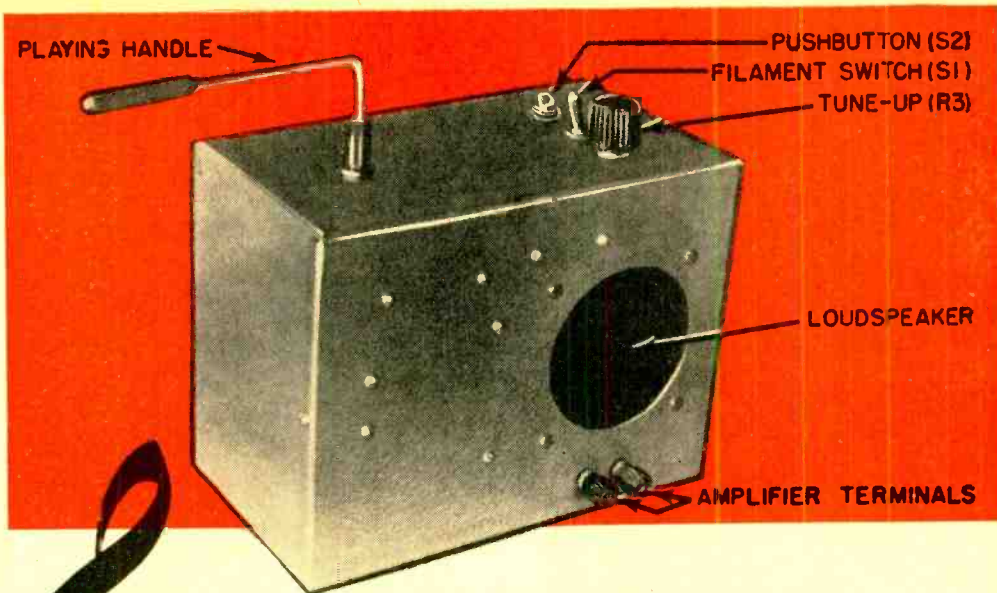

Electronic "Whistler"

By RUFUS P. TURNER

BUILDING an electronic organ is not a task that should be lightly undertaken by a novice. However, there are many little electronic "music-makers" that he can easily put together. Such gadgets are interesting to build and fun to operate.

This article describes a music-maker on which a little over two octaves can be played—a range which will allow the player to strike up many simple tunes. Although far from being a fine musical instrument, the notes obtainable from this gadget have enough overtones to sound good; in fact, it sounds something like a violin. While it is intended primarily as an electronic toy for youngsters, older people will enjoy it also.

The electronic "whistler," so named because of its output characteristics, has its own loudspeaker. But its output is rather low, allowing it to be played without disturbing others. If louder sounds are desired, this music-maker has two binding posts which can be connected to an external amplifier or to the audio stage of a radio. Since it contains its own batteries, it does not have to be connected to the power line, and so is safe even for small children to operate. It can be held in the hand or set on a table while being played.

Enjoy leisure hours building and playing this music-maker—it has tonal quality similar to a violin, covers over two octaves, is easy to operate

Music is achieved by swinging a lever-type handle to locate the notes and pressing a push button to give the sound. No sound comes from the loudspeaker until the button is pressed. The sound continues as long as the button is held. A little practice will show how far the handle should be swung for a certain note. Playing by ear is easy with this instrument.

How It Works

The simple electronic "whistler" consists of a tunable oscillator (which generates the notes) followed by an amplifier and loudspeaker. Two tubes and two batteries are employed in the unit.

Figure 1 shows the complete circuit.

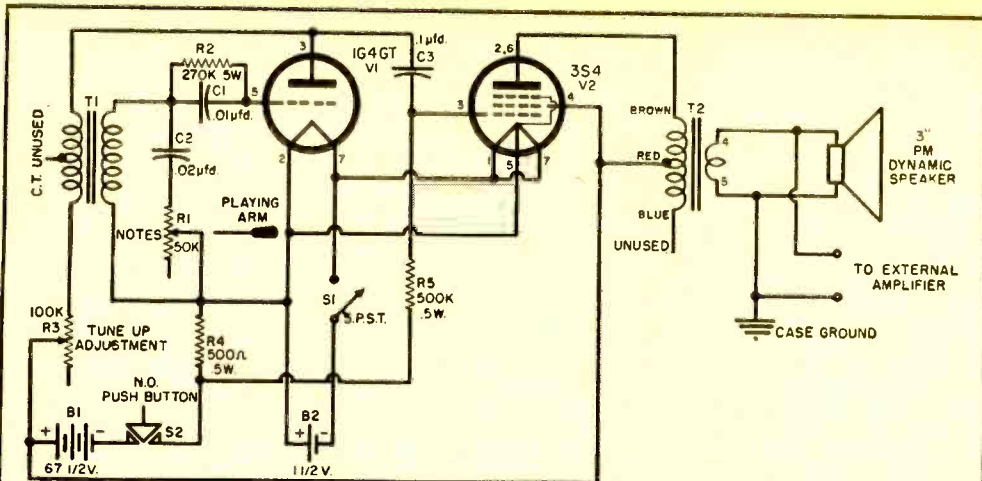

Fig. 1. Schematic diagram and parts list for the electronic music-maker.

- R1—50,000 ohm pot.
- R2—270,000 ohm, 1/2 w. res.
- R3—100,000 ohm pot.
- R4—500 ohm, 1/2 w. res.
- R5—500,000 ohm, 1/2 w. res.
- C1—0.01 µfd. mica capacitor
- C2—0.02 µfd., 200 v. tubular capacitor
- C3—0.1 µfd., 200 v. tubular capacitor
- S1—S.p.s.t. toggle switch
- S2—S.p.s.t. normally open miniature push-button switch (Switchcraft 101-L)
- T1—Audio driver trans. (Triad A-81X)
- T2—Universal output trans. (Stancor A-3823)
- V1—1G4-GT tube
- V2—3S4 tube
- B1—67 1/2 v. battery (Burgess XX45)
- B2—1 1/2 v. battery (Burgess 2FBP)
- 1—Chassis, 8" x 6" x 4 1/2" (L.M.B. No. 146) or 8" x 6" x 3 1/2" (ICA 29444, Bud CU-2109; see text)
- 1—3" PM dynamic speaker
- 1—Octal socket with 3/4" mounting pillars
- 1—7-pin miniature socket
- 3—2-lug insulated terminal strips
- 1—1-lug insulated terminal strip
- 2—Insulated binding posts
- 1—3 1/2" x 3 1/2" piece of speaker grille material
- 1—Alignment tool (ICA Type 6161)
- 1—Metal shaft coupling for 1/4" shaft
- 1—Finger-grip knob for 1/4" shaft

Total cost of parts, approx. \$16.50

Parts having the same mechanical and electrical specifications as those indicated may be used.

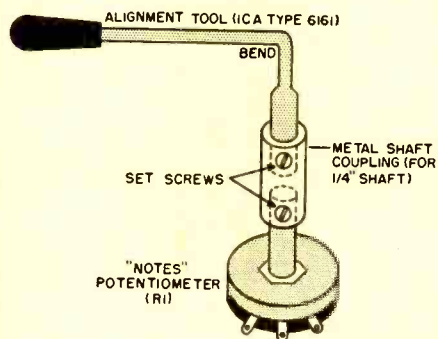

Fig. 2. Details of the playing handle.

The 1G4-GT tube is the oscillator. Notes are selected by adjusting potentiometer *R1*. A second potentiometer, *R3*, allows the music-maker to be tuned up—either by ear or with a piano.

When push button *S2* is pressed, whatever note has been selected by the setting of the "Notes" potentiometer, *R1*, is heard from the speaker. This push button, when it is pressed, places the two tubes into operation by applying plate voltage. The main "on-off" switch, *S1*, controls the filaments of the two tubes.

Tones from the oscillator are amplified by the 3S4 tube and fed through an output transformer to a small 3" speaker. The terminals labeled "To External Amplifier" may be connected to an amplifier or to the audio stage of a radio when more volume is wanted.

The music-maker operates on two small batteries which are mounted inside its case. One of these (*B1*) is a 67 1/2-volt B battery which supplies voltage to the 1G4-GT plate, and to the 3S4 plate and screen. The other (*B2*) is a 1 1/2-volt A battery which lights the filaments of both tubes.

How It Is Built

How the "whistler" is built is shown in the photographs and pictorial diagram. Housing consists of an aluminum chassis box 8" long, 6" wide, and 4 1/2" deep (*Bender* No. 146). If this specific cabinet cannot be obtained, a standard 8" x 6" x 3 1/2" unit (*ICA* 29444, *Bud* CU-2109) may possibly be used by rearranging the parts and perhaps obtaining smaller batteries. A 3"-diameter hole is cut at one end of the front

panel of the box and the speaker mounted behind it. A 3½" square piece of loud-speaker grille material covers the hole.

The lever-type handle, used to locate the notes, is made from a plastic-handled metal alignment tool (ICA Type 6161) and a metal shaft coupling. First, the coupling is fastened to the shaft of potentiometer R1, as shown in Fig. 2. A right-angle bend

then is made in the rod of the alignment tool and the broad round tip on the end of this rod is sandpapered or filed a little to allow it to slide into the coupling freely. Now the setscrews of the coupling are tightened, and the job is finished.

The "External Amplifier" terminals are a pair of insulated binding posts which can be seen mounted near the speaker. One

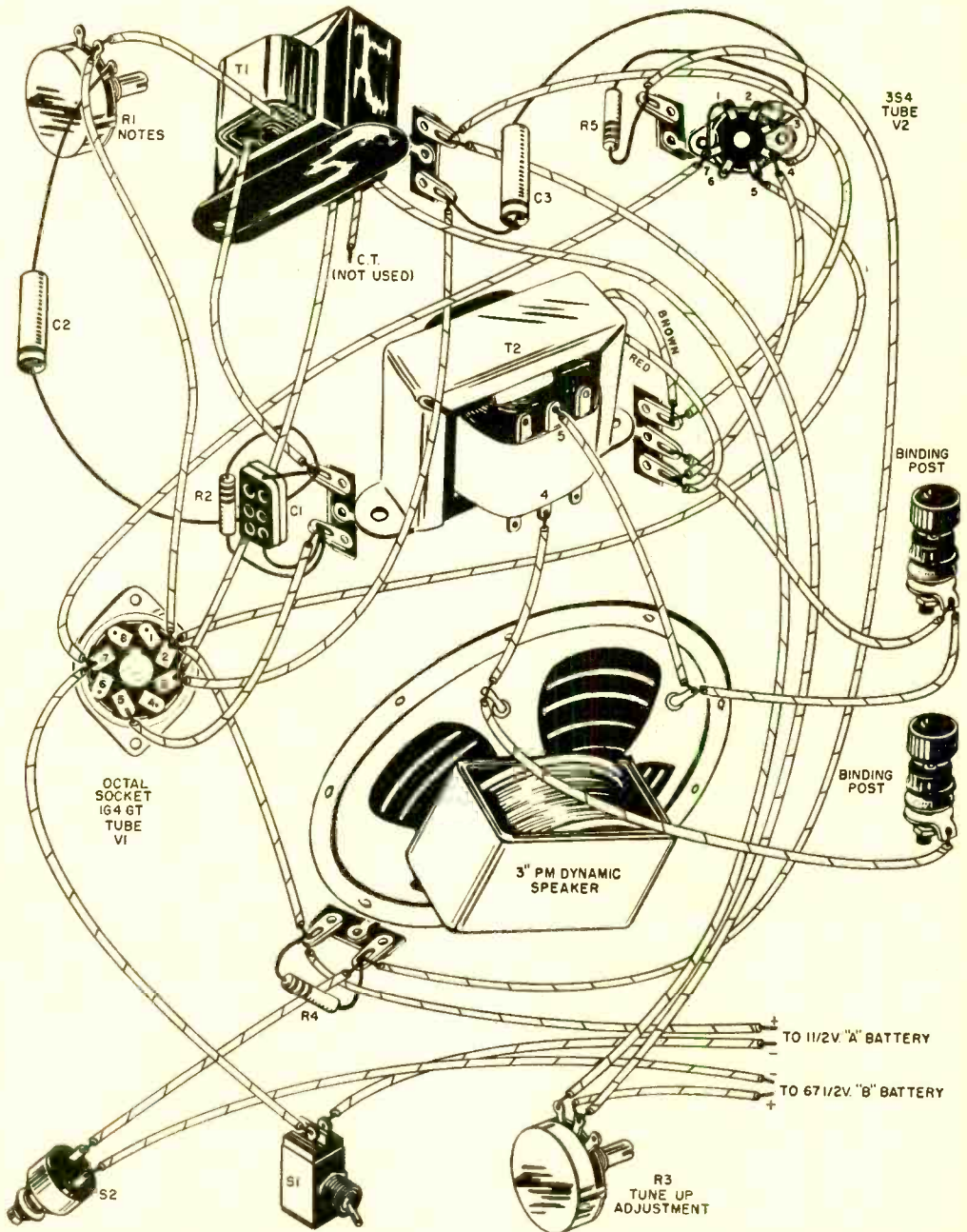

Pictorial diagram of the "whistler" showing all of the components except the batteries B1 and B2.
August, 1955

of these posts is insulated from the metal case with the fiber washers that come with the post, and the other grounded to the metal case. Whenever the music-maker is connected to an amplifier or radio, the grounded post must be connected to ground, or chassis, of the amplifier or radio. To avoid confusion, a black binding post may be used for the grounded terminal and a red post for the other.

Adjustment and Operation

After the wiring has been carefully inspected and any mistakes corrected, insert the tubes into their sockets and connect the batteries.

Turn on switch *S1*. Set potentiometer *R3* to the middle of its range, press push button *S2*, and swing the "Notes" handle from one end to the other. If no sound is heard, transformer *T1* probably is connected backward. This can be corrected by reversing the leads of *either* the primary or the secondary of the transformer, but not *both*. Positive feedback must be present for the oscillator to oscillate.

With sound coming out of the speaker, continue to hold the push button down, and swing the handle to one end where the lowest note is heard. Now, adjust potentiometer *R3*, by ear or by piano, for middle C. Finally, press the button rapidly while swinging the arm through its range. Notes can be played, can't they? A little practice will give the "feel" of knowing where to swing the arm for each note.

If desired, a pointer can be put on the arm and the notes written on the top of the case with crayon! Now, try a little tune—something like "How Dry I Am."

An interesting warble effect can be obtained (to break the monotony of sustained notes) by wiggling the arm rapidly back and forth a short distance on each side of a selected note. A broken-note effect can be obtained by rapidly pumping the push button.

For an unusual variation, try building four of these units and form a quartet. Adjust the tonal ranges for soprano, alto, tenor and bass, and persuade some musically minded friends to "take over." An ideal arrangement would be for the four players to seat themselves around a card table with the units in front of them. If volume is insufficient, an auxiliary amplifier may be used, with a microphone placed at the center of the table. The output of each instrument *could* be fed to one input on a four-channel mixer and then to the amplifier, but such an arrangement could become rather unwieldy. After a little practice, try recording one or two selections on a tape or disc recorder. This is the best way of finding out how the quartet *really* sounds!

There should be many hours of pleasure obtainable with the electronic "whistler." And it might lead the way to building the more complicated musical devices which will be described in future issues of POPULAR ELECTRONICS.

-30-

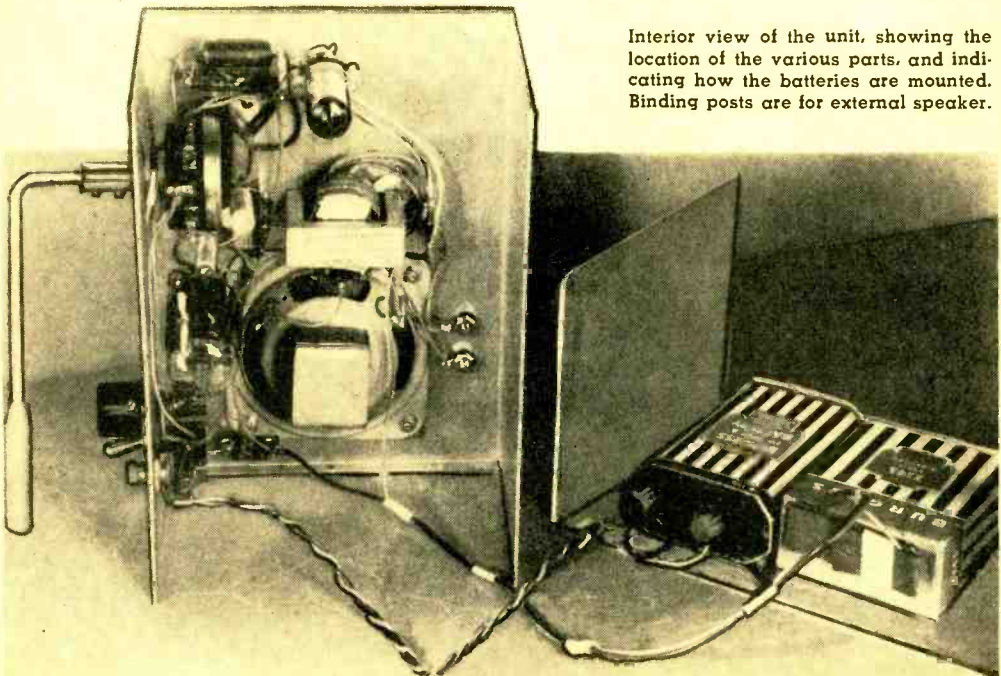

Interior view of the unit, showing the location of the various parts, and indicating how the batteries are mounted. Binding posts are for external speaker.

Electronic Analyzer Diagnoses Car Ailments

QUICK AND ACCURATE DIAGNOSIS of automotive engine ills is possible with an electronic instrument developed in the research laboratories of *Socony-Vacuum Oil Company, Inc.* This instrument has now been made available for general public use. Known as an engine analyzer, it will be manufactured and sold by the *Allen B. Du Mont Laboratories, Inc.*, Clifton, N. J., under a licensing agreement recently concluded between the two companies.

Weighing less than 60 pounds, the engine analyzer "televises" engine performance through a cathode-ray tube on an oscilloscope screen. Connected to an automobile ignition system by two lead wires, it gives simultaneous pictures of the behavior of each cylinder in an operating engine. It can diagnose faults in a car ignition system in less than one minute.

The analyzer detects virtually all ignition system troubles. For example, burned distributor points—one of the chief causes of poor engine performance—are easily identified by the analyzer. In addition, it will diagnose pre-ignition faults as well as troubles caused by noise and vibration or combustion knock. The instrument may also be used to check ignition timing and operation of intake and exhaust valves. In all, picture patterns depicting about 65 different engine ailments have been observed and identified.

Power for the engine analyzer may be supplied by the battery of the car being

tested or from any ordinary 110-volt source. The leads are long enough to

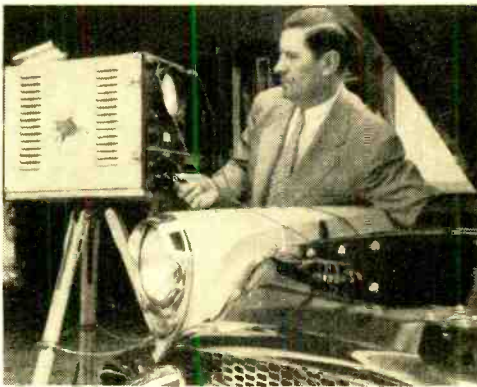

permit road testing with the instrument placed on the floor of the car ahead of the front seat. Its use in road testing makes it possible to detect engine faults that show up only under particular operating conditions.

In a recent experiment, the analyzer proved that only five out of 35 cars chosen at random were in top running condition. In one car, it detected a short circuit that had eluded mechanics for months—caused periodically by the float on a gasoline gauge when it reached a certain fuel level.

The instrument will be listed by *Du Mont* as the "Type 901 Cathode Ray Engine Analyzer." -30-

Indoor Rotating Antenna

DESIGNED FOR METROPOLITAN and suburban area reception, the *Walsco* "Star" indoor antenna contains a built-in electronic rotating and tuning control. Turning the control changes the directivity by automatically selecting the correct combination of elements for a sharp, clear picture on each channel. External interference is reported noticeably reduced or eliminated without moving or twisting to find the best angle.

The three different-size receiving elements on the new *Walsco* "Star" are tuned to pick up v.h.f. or u.h.f. stations in opposite directions and on widely separated channels. Style-wise, the antenna's ceramic base colors of lime, green and sand were chosen for their ability to blend with all furnishings.

Similar in appearance is the economy model without the electronic tuning. This is the "Starlet" model, recommended pri-

marily for strong signal areas. For additional information, write to *Walsco Electronics Corporation*, 3602 Crenshaw Boulevard, Los Angeles 16, Calif. -30-



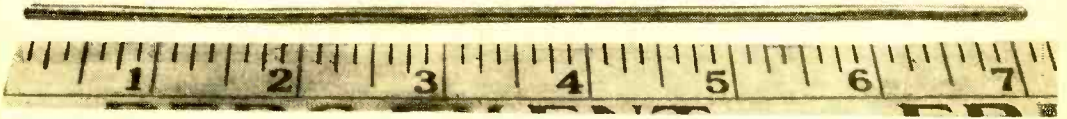
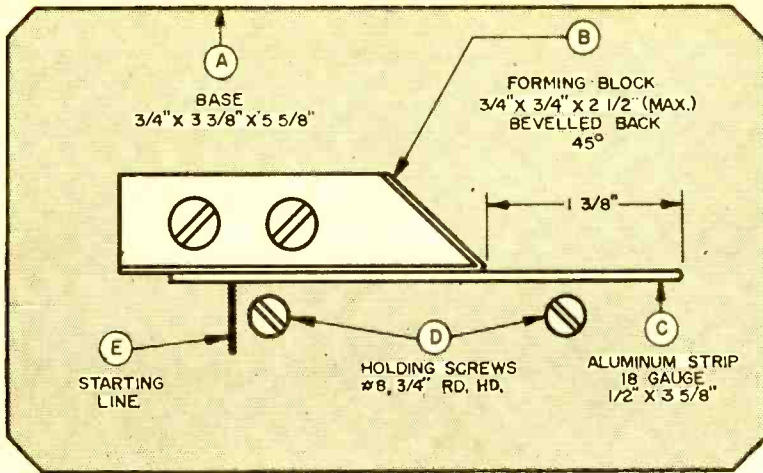

Jig Makes Solder Gun Tips

A SOLDER gun is worth its weight in U-235—that is, if its tip is in good shape and ready to go at all times. Since most solder gun tips soften and corrode after a few hours of use, with wear occurring at the point of solder application, spare tips should always be available at a moment's notice.

Having wearied of buying new tips at the prices asked, the writer designed the home-made tip jig shown here from a few scraps of wood and a small strip of 18-gauge aluminum. The jig fabricates tips of uniform size quickly and without fuss; best of all, one small roll of No. 10 soft-drawn

By HARVEY POLLACK

copper wire will last indefinitely at the rate it is used in the process.

To make the jig, cut the rectangular base (A) preferably from hard wood, like maple or oak; prepare the forming block (B) by cutting it to size and then beveling

Outline and dimensions for jig are shown at top of page. Parts designated by code letters are explained in text. Below: first step in forming new solder gun tip, using jig.

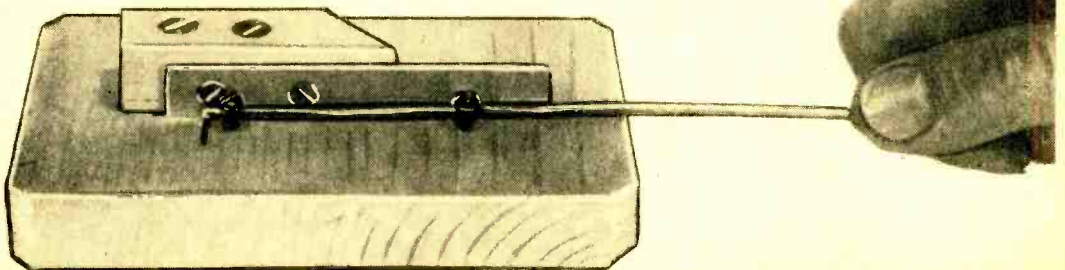

it at an angle of 45°. Hacksaw and file an aluminum strip (C) to size. Drill and countersink it for two ½" No. 6 wood screws, flat-head. Secure the strip (C) to the side of the forming block (B) as shown in the illustrations using these wood screws; in so doing, let the strip project downward toward the base a distance of about ¼" beyond the bottom of the forming block. This projection will fit into a groove chiseled into the base to prevent the strip from bending while the tip is being made. The right end of the strip projects exactly 1⅜" beyond the end of the beveled forming block. Screw the forming block to the base after having chiseled out a recess for the bottom edge of the aluminum strip. By sinking the strip in the base this way, a degree of rigidity is obtained that is of great help in using the jig.

As a final step, screw two round-head wood screws into the base near the aluminum strip, separated from the latter by the diameter of the No. 10 wire to be used. These holding screws (D) are allowed to protrude above the base about ¼".

To use the jig, first cut a length of wire exactly 7¼" long. Slide the end of the wire between the strip and the holding screws to the starting line (E), and bend the wire around the end of the strip. Using a pair of gas pliers or long-nose pliers, squeeze the wire around the bend close to the strip on each side, and then continue to bend it by hand so that it follows the contours of the forming block.

Place the clamping nuts (that come with the gun) on the wire. Make sure the threads face the right way to permit fastening to the gun. Then bend up ¼" of each end of the tip. Insert into the gun's retaining holes, and tighten the clamping nuts. The new solder tip is now correctly mounted. Tin the tip, and the gun is ready for use.

-30-

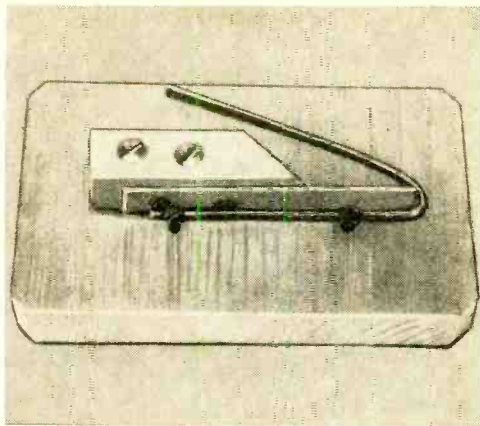

Second step in making a tip for the soldering gun is to bend the 7¼" strip of wire back over the metal forming piece.

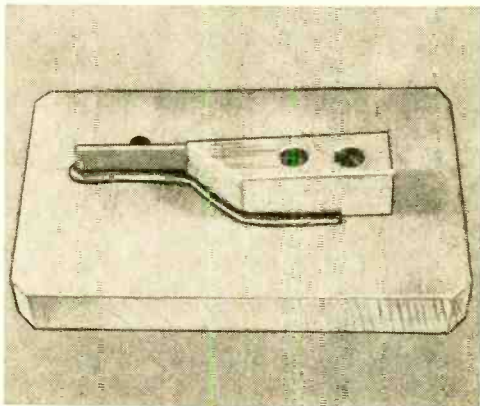

The tip has been shaped. Note how it follows the contours of the forming block.

Below, soldering gun with new tips ready for assembly. End of tips that fit into gun "barrels" must be bent up slightly after the clamping nuts are attached.

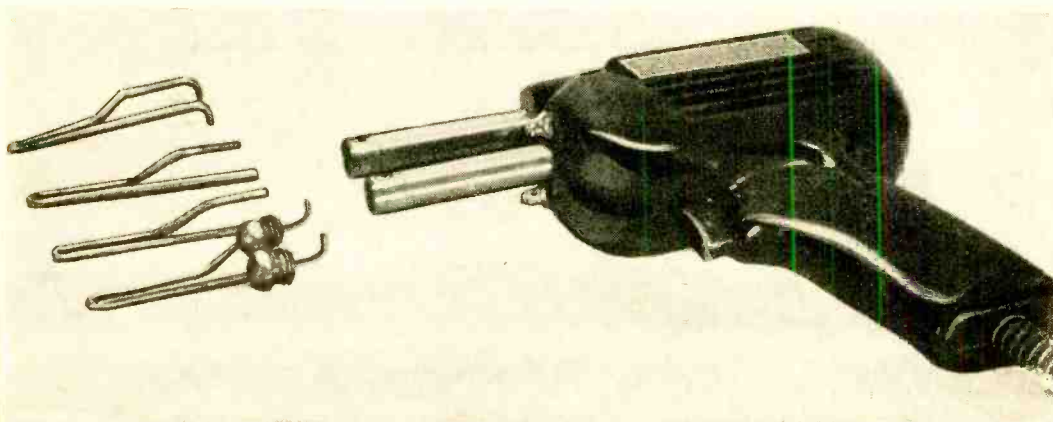

The \$1.60 Signal Generator

By FRANK H. TOOKER

ANYONE with a small piece of wood, a buzzer, a couple of flashlight batteries, and \$1.60 can build a modulated signal generator that can be used to align receivers, test r.f. circuits, and do many other things a modulated signal generator costing 20 to 100 times as much can do.

How this inexpensive little signal source can be made is shown in the photograph and wiring diagram. Only five parts are needed. These are arranged on a piece of $\frac{5}{8}$ "-thick plywood measuring about 4" x 6". Connections to the dry cells are made by driving four brass wood screws into the board until their heads are in contact with the brass cap on one end of the cell and the bottom of the zinc can on the other end. The screws are spaced close enough to permit moderate pressure for good electrical contact. A simple bracket holds the cells in place. Wires soldered to the slots of the screws connect the cells in series and make the connections to the coil and buzzer.

The 0.25- μ fd. fixed capacitor must be connected, as shown, across the buzzer contacts. If this capacitor is connected across the buzzer winding or across the buzzer as a whole, the unit will not operate.

The Miller 20-A r.f. coil is a standard part which has been slightly modified. The original coil has a primary winding consisting of a few turns of very fine wire wound on a short adjustable sleeve. This primary

Undoubtedly the simplest tunable signal generator yet devised for the novice ham and experimenter—build it and see for yourself

will not be used, so clip the fine wires leading to it and remove the cardboard sleeve by slipping it off the end of the coil form. Wind on a new primary consisting of about 10 turns of ordinary No. 20 plastic hookup wire over the bottom end of the tuning coil, and connect the ends to the terminals from which the fine wire primary leads were clipped. Locate the parts on the board (the arrangement isn't at all critical), make the few electrical connections shown in the diagram—and the unit is finished.

How It Works

It is a basic principle in electricity that when a current flowing through a coil of wire—especially one having an iron core such as the buzzer winding—is suddenly

This photo does not show the toggle switch included in the pictorial and wiring schematic. It is obviously required to turn the circuit off after use.

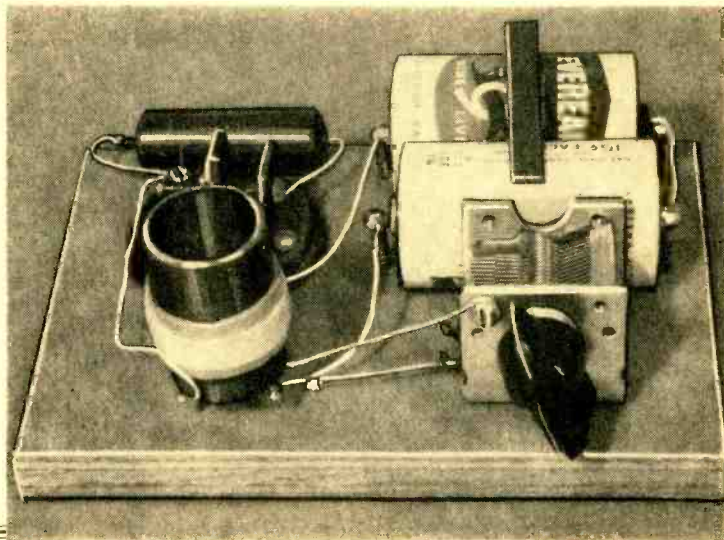

interrupted, a voltage much higher than the battery voltage will appear momentarily across its terminals. This induced voltage is caused by the abrupt collapse of the magnetic field around the coil. Use is made of this principle in the present signal generator.

A rapid succession of inductive voltage kicks is induced across the buzzer winding by the rapid making and breaking of the winding current due to the operation of the buzzer contacts. The current from these voltage kicks flows in sharp, rapid pulses through the primary coil, where it excites the tuned circuit and causes it to oscillate at a frequency determined by the setting of the variable capacitor—in the present setup—at any desired frequency between 540 and 1700 kc., the standard broadcast band.

Oscillations of the tuned circuit are automatically modulated by the buzzer tone, so all that is necessary when touching up the front end of an a.c.-d.c. set, for instance, is to turn on the signal generator and set its variable capacitor somewhere near the high end of the band. Then tune the receiver until the buzzer tone is heard coming from the speaker. Adjust the trimmers on the receiver for loudest output. Generally, no direct connection between the receiver and signal generator is needed. Standing the two fairly close together is sufficient. When tighter coupling is needed, wrap an insulated wire two or three turns around the lead to one side of the tuned circuit, with the other end of the wire lying near or connected to the receiver's loop or antenna terminal.

The buzzer used in the generator shown in the photograph is a 1000-cycle type generally used for code practice, but an ordi-

nary household buzzer may be substituted if necessary. In this case, additional batteries may be needed. Using a different buzzer does not affect the tuned circuit, so the coil and variable capacitor need not be altered. If the sound from the buzzer is too loud for the strength of its tone to be distinguished easily in the speaker, enclosing either the buzzer or the entire generator in a cotton-padded cardboard or wooden box (not metal) will decrease the sound coming directly from the buzzer without disturbing the r.f. output.

If a short antenna is connected to point (A) in the wiring diagram, this little signal generator will make an ideal code practice oscillator, since its signals can be transmitted from one room to another without wires and can be picked up on any broadcast set! The antenna should be no longer than necessary to produce a good tone in the speaker when the receiver's volume control is well turned up. When using the generator in this manner, connect the telegraph key in place of the switch shown in the diagram.

-30-

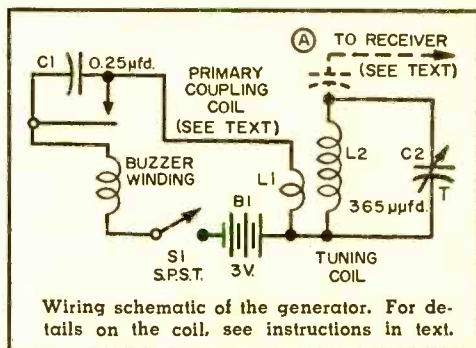

Pictorial wiring drawing of the generator. As mentioned in the caption on the facing page, this drawing includes the toggle switch not shown in photo.

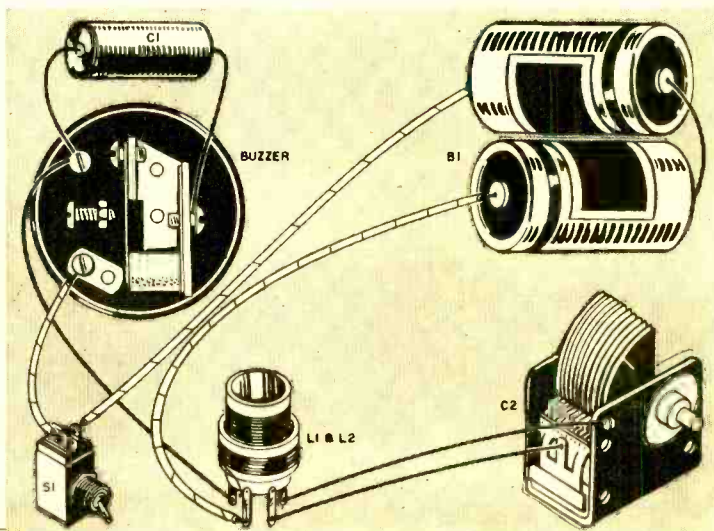

CARL & JERRY

By

JOHN T. FRYE

*The two boys climb a hill, then
talk about kinds of TV antennas and how they work*

THE HOT AUGUST SUN beat down on the two boys climbing up the steep path. Lanky, athletic Carl Anderson scarcely breathed hard as he forged steadily up the hill; but behind him his overly plump chum, Jerry Bishop, puffed like a steam locomotive as he toiled along the steep ascent. In spite of his noisy effort, Jerry kept falling farther and farther behind, and finally he came to a full stop and collapsed in the shade of a huge boulder beside the path.

"How come you're dropping anchor there, Blimp Boy?" Carl called down. "We've still got a quarter of a mile to go to the top."

"I can never make it," Jerry gasped feebly. "Go on without me. Just say my spirit was willing but the flesh was weak. Leave me a dozen sandwiches or so to make my last moments comfortable."

"Not a chance!" Carl interrupted harshly. "I coaxed you on this hike to sweat some of the fat off you, and off it comes—one way or another. We agreed to eat, you will remember, when we got to the top of the hill. Well, if I've got to go on by myself, I'm going to



take the lunch with me and eat it—all of it—up there just as we planned."

"You wouldn't dare!" Jerry cried, with the quick instinctive anger of a hungry dog who sees his bone suddenly snatched from him.

"Oh no?" Carl said tauntingly, as he squatted on his heels and opened the lunch basket he was carrying. Very deliberately,

he removed a thick paper-wrapped sandwich and slowly pulled out the toothpick thrust through it.

With a snarl of mixed hunger and rage, Jerry leaped to his feet and charged up the path toward his tormenter. Carl barely had time to toss the sandwich back into the hamper and scramble upward out of Jerry's clawing reach. The latter was so incensed by the horrifying prospect of Carl's eating all the lunch that he did not slacken his pace and the two boys arrived at the top almost neck and neck.

"You made it!" Carl congratulated, as he flung himself at full length on the thick grass beneath a tree.

For a minute, Jerry stood over him with his face still wearing its menacing scowl, but then as he looked about and realized he had actually reached the summit, his round countenance broke into a pleased grin and he sat down abruptly beside his friend.

"We better cool off a little before we eat," Carl suggested. "It certainly is a wonderful view, isn't it?"

"It sure is," Jerry agreed, with his head buried in the picnic hamper. "Now that we've cooled off for at least a couple of hundred seconds, let's eat. Do you want your tenderloin sandwich with or without mustard?"

There was little conversation for the next few minutes as the boys waded through the assorted sandwiches, hard-boiled eggs, and fresh fruit that Carl's mother had provided. Finally, though, when they were munching their chocolate bar dessert, Carl said lazily:

"Jer, look at all those TV antennas down there. Hardly two of them are alike; yet they're all intended to receive the same stations. How come there are so many different kinds?"

Jerry pillowed his head on his clasped hands and stared up at the fleecy white clouds drifting across the blue sky overhead. "To answer that properly really takes a lot of doing," he said slowly. "You almost have to go into the subject of how TV antennas work."

"So let's go into it," Carl promptly urged. "I've got the time, and you think you've got the information."

"When TV broadcasting first started," Jerry began, "the receivers were invariably close to the transmitter, and the engineers simply adapted the old standby short-wave receiving antenna, the half-wave dipole. This is simply a conductor which is an electrical half-wavelength long at the frequency being received and which is cut in two at the middle so that each half feeds into one part of a two-conductor feedline, such as a twisted pair, coaxial cable, or piece of twin-lead. In radio work, the conductor is usually wire; but since a half wave is only a matter of a few feet on the TV frequencies, the TV antenna was made up of a couple of pieces of aluminum tubing secured to a center block of insulation."

"I don't see anything like that down there," Carl remarked as he raised himself on an elbow and looked down at the rooftop antennas.

"No, that simple antenna didn't last long because it had several serious faults. For one thing, it had a front-to-back ratio of 1 to 1. By that I mean its horizontal reception pattern looked like a figure '8.' While practically no reception was had off either end of the dipole, identical reception lobes extended out from either side. If you called one side the 'front' of the antenna and pointed it at a station, another station at the rear would be equally favored in reception. As more and more stations came on the air, forcing many to share the same channel, this became a serious defect. Secondly, the output impedance of the dipole is about 72 ohms, an inconvenient value for matching to low-cost, low-loss transmission lines."

"I don't dig this impedance-matching business as well as I might," Carl admitted.

"Every piece of equipment that generates, carries, or receives r.f. currents has a certain amount of built-in opposition to the flow of those currents that is called 'impedance,'" Jerry explained, beginning to enjoy his role of lecturer. "In order to transfer the maximum amount of power or signal from one piece of equipment to another, their respective impedances must be equal or 'matched.' If the TV antenna is not matched to the feedline and if the feedline is not matched to the receiver, you not only lose a lot of signal but the mismatch is likely to generate annoying ghosts in the picture. Most TV sets are built with an antenna input impedance of 300 ohms. Low cost and efficient twin-lead designed to match this also has a 'surge' impedance, as it is called, of 300 ohms. But if you have to feed a 72-ohm half-wave dipole antenna into the end of this 300-ohm feedline, you have a 4 to 1 mismatch."

"And I guess a 52-ohm coax line would be worse?"

"It can be done, and some receivers have a 52-ohm input for this line, but it is much more expensive than twin-lead and has a much higher loss than a good grade of dry twin-lead. It was easier to change the dipole so that its impedance would match the inexpensive 300-ohm flat line."

"How did they cut that caper?"

"Just by placing another conductor a half wavelength long three or four inches above the dipole and connecting its ends to the

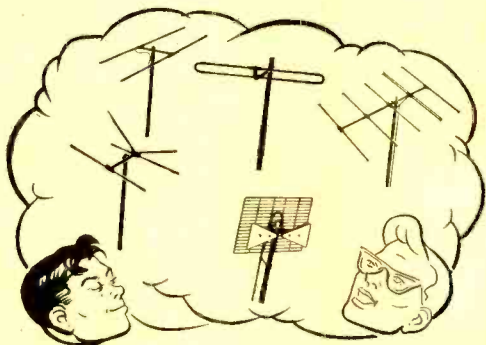

outside ends of the dipole. This changed the simple dipole into a 'folded dipole,' with several important advantages. For one thing, the antenna impedance was quadrupled so that it was almost an exact match for the 300-ohm line. Secondly, the frequency response of the folded dipole is much wider than that of the simple dipole."

"Wait up!" Carl commanded. "What's this jive about widening the frequency response?"

"The dipole delivered maximum received signal strength only on the channel for which it was cut. Signals on adjacent channels excited much less response in the antenna, and signals from channels still farther removed from the antenna's resonant frequency produced still less response. Since the antenna responded only to signals close to its resonant frequency, we say it had a *narrow* bandwidth. The folded dipole responds much more strongly to signals on adjacent channels, so we say it has a *wider* bandwidth. Catch?"

"Roger. With a wide-band antenna, you can receive several channels on the same antenna. With a narrow-band job, you can receive only one channel well."

"I do believe you're getting brighter!" Jerry said sarcastically. "At any rate, the folded dipole still did not have all the answers. Especially, it did not prevent receiving a station just as well off the back as the front. To correct this fault, TV design engineers borrowed the yagi antenna radio

(Continued on page 116)

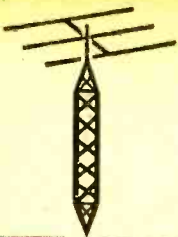

THE TRANSMITTING TOWER

HERB S. BRIER, W9EGQ

It is with considerable personal pleasure that I am able to introduce Herb S. Brier, W9EGQ, to the readers of POPULAR ELECTRONICS. Having worked with Herb for several years, I am aware of his great interest in the novice ham radio ranks. His many articles and columns also attest to his desire to aid and assist newcomers in obtaining radio amateur licenses. The Editors of POPULAR ELECTRONICS believe that Herb's work should be brought to the attention of a wider audience and are pleased to welcome him to our staff. Readers are encouraged to address inquiries and items of ham radio interest to Herb, simply addressing them to his attention % POPULAR ELECTRONICS, 366 Madison Ave., New York 17, N. Y.

o.p.f.

SHAKESPEARE defined Cleopatra's fascination as follows: "Age cannot wither her, nor custom stale her infinite variety." By a similar definition, amateur radio is the Cleopatra of hobbies. It thrills the newest beginner and continues to fascinate men and women who have been radio amateurs for 40 years or more.

Among the more than 130,000 licensed amateurs in the United States are doctors, lawyers, merchants, scientists, prize fighters, nuns, actors and actresses, invalids, coal

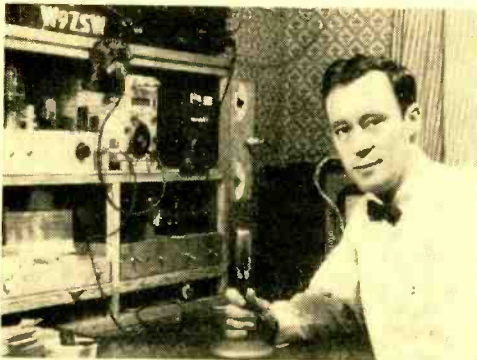

Roger Harned, W9ZSW, Terre Haute, Ind., has a typical low-power ham station built around "war surplus" radio equipment. Roger started out as a novice (36 states) and now has a General Class license. Doctor Harned is well known as the co-discoverer of the new antibiotic, seromycin (cycloserine); this drug has proven effective in fighting deep-seated infections and combating tuberculosis.

miners, artists, college professors, generals, privates, missionaries, school children, milkmen, plumbers, and politicians. From among the 65,000 overseas, you can add kings, princes, and dukes to the list. They engage in two-way communication between themselves via their own radio stations, purely as a personal pursuit, without thought of pecuniary gain of any sort. They operate in special bands of frequencies throughout the radio spectrum that have been set aside for their use by international agreement.

The *Transmitting Tower* will appear monthly in POPULAR ELECTRONICS, and it will be devoted to amateur radio. Of course, many of its readers will already have their licenses, but we are anxious to have the rest of you join us; therefore, this first column will outline how you may obtain your license.

As you will see, you do not have to be an electronic wizard to obtain a license. Even if your electronic knowledge does not extend beyond the ability to tune a television set or an automobile radio, you can quickly qualify for your license. Yet, I repeat, amateur radio is not a hobby you will soon outgrow. In fact, the more you learn about it, the more fascinating it becomes.

The Federal Communications Commission, Washington 25, D.C., issues amateur licenses in five grades—Novice, Technician, Conditional, General, and Extra Class. If you are a citizen of the United States, you are eligible to apply for one of them, regardless of your age, sex, or practically any physical disability. Furthermore, it will not cost you a penny.

Classes of Licenses

Here is a brief description of the various classes of amateur licenses and the privileges that they grant.

The simplest amateur license to obtain is the Novice license. It will be issued to any citizen of the United States who has not previously held an amateur license and can send and receive the radiotelegraph code at a speed of five words per minute and pass a simple written examination. The examination consists of about 20 multiple-

choice questions covering elementary amateur radio theory and Novice regulations. No circuit diagrams are required, and 74 is a passing grade.

This license authorizes code operation in segments of the 3.5-, 7-, and 21-mc. amateur bands and either voice or code in a segment of the 144-mc. band. A crystal-controlled transmitter is required, and its power input must not exceed 75 watts. The latter is not much of a handicap. Few Novices use more than half this power, but they still talk to amateurs all over the United States and make an occasional foreign contact.

In effect, the Novice license is a learner's permit. It is issued for a one-year period and cannot be renewed. Therefore, the licensee must qualify for a higher class amateur license within that time or leave the air. Most qualify for another license within



Bill (W3WRC) and Louise (W3WRE) Moreau, Johnston, Pa., constitute one of the many husband and wife ham teams. Starting out as Novices with a 35-watt transmitter, they are now using a WRL "Globe Scout." Rivalry exists as to who will work the 48 states first with General license.

a few months. All other classes of amateur licenses are issued for five-year periods and are renewable.

The Technician Class license also requires passing a five-word-per-minute code test, but its written examination, which is the "standard" amateur examination, requires a good grasp of amateur theory and regulations, plus the ability to draw schematic diagrams of basic amateur circuits.

Technician Class license holders are granted full amateur privileges on the amateur bands above 50 mc., except on the 144-mc. band. These privileges include the right to use phone, code, teletype, and other forms of emission with a transmitter power up to 1000 watts. The disadvantage to the license is that the normal communication range on these bands is limited. With simple equipment, it is about 50 miles. Unusual conditions, which occur fairly frequently, especially in the warmer months, do extend ranges many times for periods ranging from a few minutes to several hours.

The General Class license grants all amateur privileges on all amateur bands. It is obtained by passing a 13-wpm code test and the standard amateur written examination described above at an FCC examination point. The Conditional Class license grants the same privileges, and it requires passing the same type of examination. However, it is issued by mail under conditions to be described a bit later.

Because two years of licensed amateur experience is one of its prerequisites, the Extra Class license is of no immediate importance to prospective amateurs. Other prerequisites are a 20-wpm code test and a very comprehensive written examination. Obtaining this license is a matter of pride, because it grants no special privileges.

Technically speaking, the amateur operator and station licenses are separate. But they are applied for on the same form and are issued together on a single license card. Furthermore, only a licensed amateur operator will be issued an amateur station license.

In the United States, all amateur call signs, except Novice, consist of the prefix "W" or "K," followed by a number from 1 to 0 and two or three additional letters. Novice calls contain the letter "N" between the prefix and the number. The "N" is removed when the Novice qualifies for a higher class license.

Learning exactly what you must know is

(Continued on page 102)

These members of the Martinsville, Ind., High School Radio Club meet twice a month during school periods. Meetings are held in the science laboratory where the club station W9FXV is installed. Hams shown in this photo include WN9NPS, W9UPJ, WN9NFB, WN9NCK, and W9DUD who is the High School club sponsor.



AMA-TOURING

with Roger Legge



THE 11-YEAR sunspot cycle is of primary importance to DX radio transmission and therefore is of special interest to short-wave listeners. "Sunspots," which appear as black spots on the sun, are believed to be gigantic temporary craters caused by eruptions on the sun. Sunspot numbers, calculated on the basis of the number of observed sunspots and their area, are found to vary from a minimum to a maximum and back again to a minimum over periods averaging 11 years.

During years of low sunspot numbers, the MUF's (maximum usable frequencies) are low and transmission conditions on the higher frequency bands, such as the 28-mc. band, are poor. The hours of usefulness for long-distance transmission of lower bands, such as the 14-mc. band, are considerably reduced. As the sunspot numbers rise, the MUF's also rise, resulting in better transmission conditions on the high frequency bands until, during years of sunspot maximum, DX conditions on the 14-, 21-, and 28-mc. bands are at their peak.

We are now in a period of low sunspot numbers, but having passed the minimum over a year ago, in May, 1954, the sunspots are on the way up, and we can look forward to constantly improving DX conditions during the next five years. The effect

of the rise in MUF's has resulted in improved conditions on the 14-mc. band, and should be particularly noticeable during the coming fall and winter period on both the 14-mc. and 21-mc. bands.

I WOULD APPRECIATE receiving reports on DX heard, particularly on new stations in the less frequently heard countries, with frequency, time heard, and any other information of interest regarding them.

Here are some reports that have been received from readers on DX stations. All times are based on EST, 24-hour clock system.

North and South America

Corn Island—YNØYN, 14.12 mc., was operated for a short time from Corn Island, off the east coast of Nicaragua, by a DX expedition composed of WØEIB, WØAIW and YN4CB. YNØYN was also operated mobile marine from the ship while they were on the way to the island. If you heard this one, reports may be sent to WØEIB, Walter J. Klassen, 110th & Antioch, Lenexa, Kansas. (Tom Gallagher, Fla.; Hugh Clark, Calif.)

Greenland—U. S. personnel stationed in Greenland are now using KG1 calls instead
(Continued on page 122)

AUGUST DX FORECAST FOR 14-MC. BAND

From	In Eastern & Central USA (EST)	In Western USA (PST)
Central and South America	0600-2200 Best 1700-2100	0600-2100
Europe and North Africa	1500-1900	1400-1600
Central and South Africa	1600-1800	1400-1600
Far East	0600-0800	0500-0800 2100-2400
Australia and New Zealand	0000-0300 0600-0800	0500-0800 2200-2400

In these forecasts, based on information obtained from the National Bureau of Standards, the 24-hour clock system has been used. The hours from midnight until noon are shown as 0000 to 1200, while the hours from 1 p.m. to midnight are shown as 1300 to 2400. EST represents Eastern Standard Time; PST is Pacific Standard Time, three hours later than EST.

Tuning the Short-Wave Bands

By HANK BENNETT

THE SUMMER vacationing period is perhaps at the most active stage now and DX'ing, as a rule, is slow. During the summer months, or roughly from June through Labor Day, many DX'ers take time out from the pursuit of their hobby in order to take care of the hundred and one things that must be done around the house and yard. The summer weather, with the lightning disturbances and the outside noise created by power mowers and other power tools, makes listening more of a chore than a pleasure. Then, too, many of the DX'ers do their listening through earphones, and in the warm, humid weather, this does not add to the comfort of listening.

Next month, though, with the advent of cooler weather and the lessening of static, many receivers will again be put into service. New stations on the various s.w. bands will be heard; many others will be noted on new frequencies. Some will have increased their power and others will have made extensive program changes. You, the DX'ers that make our column possible, will resume sending in frequent reports to us and we, in turn, will be able to present our readers with more information. The coming DX season promises to be better than average, judging from the increasing sunspot activity.

For this month, we present an article written by Mr. Ben Adams, of New York City, concerning *Radio Free Europe*. It is our hope that you will enjoy this article, which seems to cover the subject very thoroughly and interestingly.

Radio Free Europe

You've no doubt heard a great deal about *Radio Free Europe* in the past several months because of its fund-raising campaign, which has, appropriately enough, gone to the American radio and television audience for assistance. In the event that you've also wondered about it and felt the need of a little more information or background, please allow me to offer the following:

Radio Free Europe is a division of the National Committee for a Free Europe, August, 1955

which is supported by contributions from the American people through "Crusade for Freedom," its fund-raising arm, and which does just about what its title suggests and implies. *RFE* was organized in December of 1949 to conduct an on-the-spot campaign of psychological warfare against the Communist regimes in Czechoslovakia, Poland, Hungary, Roumania, Bulgaria, and Albania, specifically, all countries that are strategically placed in the battle for men's minds now being waged in Europe.

The station went on the air in July of 1950 with one transmitter located near Frankfort in West Germany, and began broadcasting for a total of 10 hours per week. It has been on the air continuously ever since, and now has 21 short- and medium-wave transmitters located throughout West Germany and Portugal broadcasting 430 hours of programs a week to its six target countries.

RFE's main broadcasting studios are in Munich, in the American Zone of Germany, where exiles from behind the Iron Curtain, Germans, Americans, and personnel from other countries are stationed. Additional programs are tape-recorded from the *Radio Free Europe* studios in New York.

The primary purpose of *RFE*, which grew from a handful of employees in the begin-



George Cox, of New Castle, Delaware.

ning to more than 1000, is to sustain the hope of captive peoples behind the Iron Curtain of regaining their national freedom and their individual liberties, and to encourage the eventual restoration of these peoples to the free world.

In order to carry out a program of such scope, *Radio Free Europe* realized early that a new approach, utilizing new propaganda techniques, had to be adopted for its target areas. In a short time, experimentation proved that *RFE* could most effectively deliver its message—and at the same time promote American ideas, and understanding of the American people—if it spoke with the voice and authority of exiles from behind the Iron Curtain. To do this, *RFE* developed a network of six stations, the *Voices of Free Czechoslovakia, Free Hungary, Free Poland, Free Roumania, Free Bulgaria, and Free Albania*. On each of these stations, freedom-loving exiles from the captive countries of their birth now speak to their people in their own idiom. Chosen on the basis of professional capabilities and devotion to the cause of freedom and democracy, *RFE* exiles write their own scripts, prepare their own programs, broadcast in their own styles.

This is the general policy under which *RFE* operates.

To break it down further, *RFE's* programs cover a range of subjects equal to almost any radio station in this country. The American scene and world news are, of course, included in programs of many types. World news is broadcast around the clock, every hour, since the truth is a precious commodity in the war of words. Special programs are designed for young people, workers, farmers, intellectuals, women, scientists, military men, and even Communists. Religious news and services are broadcast to listeners of all faiths. Culture and comedy, drama and music, satire and quiz shows, forums and interviews are also included in a schedule designed to build the biggest and broadest of audiences.

Of primary importance is *RFE's* practice of telling its listeners what goes on within their own countries. Refugees are interviewed on conditions in their countries. Researchers constantly add new information to their files, piecing it together and analyzing it into the most accurate picture of conditions that is possible. As to the effectiveness of *RFE* in its nearly six years of operation, President Eisenhower recently had this to say:

"Through *Radio Free Europe*, men and women, who might otherwise have succumbed to the philosophy that it is good to be slaves, still keep alive the spark of freedom in their hearts. This work serves

not only the nations we seek to help; it serves the best interests of the United States."

Now FOR THE LATEST from the DX scene; all times shown are Eastern Standard, based on the 24-hour system.

AZORES—Ponta Delgada, 11925 kc., is again heard during the summer months on this frequency at 1400-1500. Evidently the 4867 channel is the winter outlet. (*Legge, Va.*)

BRAZIL—*Radio Brazil Central*, Goiania, Brazil, is testing two new transmitters on 9755 and 11815 kc. Although these stations have not been heard often, they are noted late evenings with American and Latin-American music and announcements in Portuguese and German. (*Parker, N. H., NNRC*). The "Ministerio da Educacao" outlet in Rio de Janeiro is being tuned around 1525 and 1945. (*Ferguson, N.C.*)

CEYLON—Colombo can be heard in English on 11770 and 7190 kc. at 2000-2300 and on 9520 and 6006 kc. at 0600-1200. They present a news relay from the *BBC* at 0930 on 9520 kc. (*Roemer, Ky.*)

CUBA—*COBZ, Radio Salas*, Havana, has moved from 9025 to 9015 kc.

ECUADOR—*HC2RL*, Guayaquil, on 6635 kc., was noted around 2200. This station is believed to operate Tuesdays only at 2100-2300. (*Legge, Va.*) New stations operating include *Radio Ondas Nacionales*, Quito, *HC1GT*, 200 watts, on 5955 and 1380 kc.; "*Radio Universal*, *HC2UM*, Guayaquil, 9550 kc., 250 watts; *Radio Ecos del Agro*, *HC2JJ*, Quevedo, 3960 kc., 200 watts; *Radiodifusora Fatima*, *HC3CD*, Loja, 5975, 400 watts; and *Radio Cultural Religiosa*, *HC6JX*, Banos, 4920 kc., 200 watts. (*World Radio Handbook*)

FINLAND—The newest schedule from Helsinki, Finland, which runs until September 21, includes news in English to North America at 2300-2315, and to Europe and South America at 1430-1445. Both programs are heard on weekdays (no Sundays) on *OIX5*, 17800; *OIX4*, 15190; and *OIX2*, 9550 kc. Effective September 23, 1955, to March 20, 1956, the transmission to Europe and South America will be heard at 0430-0550, to North America at 0600-0755.

GREECE—The latest schedule of *Radio Athens* is as follows: 9607 kc.—0200-0315 daily to Cyprus, 0400-0500 daily except Sunday* to Egypt, 0530-0800 daily to Cyprus, 1100-1200 daily to Cyprus, and 1300-1330 daily to Northwest Europe; 11718 kc.—1030-1045 daily to Russia, 1215-1245 daily to France, England and Mariners; 7142 kc.—0830-1015 daily to the Balkans, 1400-1455 daily to Northwest Europe. (*Buettner, Germany*)

(Continued on page 119)

R/C NOTES

OFTEN, IN THE PAST, we've sounded off on various and sundry subjects apropos radio control. Transistorization, miniaturization, reliability—all have received our scholarly treatment; and more often than not, we've arrived at the conclusion that not enough is being done to adapt the various advances made in the electronics field to the hobbyist.

Well, lest you get the idea that all we do is sound off, we have some projects cooking that should help electronic hobbyists get their feet good and wet in some of these new techniques. This issue, for example, contains a step-by-step construction article on "Printed Circuitry for R/C" starting on page 74, by the well-known R/C'er Paul Runge. His technique for making printed circuits is just one that we would like to advance for your experimentation. Future issues of *POPULAR ELECTRONICS* will contain articles on the etching method as well as a roundup of printed circuit kits available to electronic hobbyists.

So far as transistorization is concerned, we'll soon have an article for you on a transistorized R/C receiver.

SHARKS DO IT, why not yachtsmen? We've all heard about or seen pictures of the little pilot fish that swim around in front of sharks, and now comes a yachtsman who has a radio-controlled model of his motor cruiser which always precedes him into his berth. This we think is a clever and whimsical gesture that some other full-size yachtsman might like to try. We pass it along for what it's worth.

IN RESPONSE to questions by some of our readers, we've queried the Canadian Department of Transport, Telecommunications Division (equivalent to our FCC), on its rules governing the radio control of models, etc. According to the Honorable G. C. W. Browne, Controller of Telecommunications: "The question of licensing such equipment is now under review, and until a decision has been reached no further licenses are being issued. In the interim, however, operation of approved radio-control equipment is being permitted on a temporary basis."

Holders of a Canadian amateur radio

experimental license may operate R/C equipment on all authorized frequencies above 53 mc. Special authority may be obtained to operate R/C equipment in the industrial, scientific, and medical bands (13.554 to 13.566 mc., 26.958 to 27.282 mc., 40.660 to 40.700 mc., 890 to 940 mc., 2400 to 2500 mc., and 5775 to 5925 mc.).

In the past, non-amateurs were permitted to operate R/C equipment on the industrial, scientific, and medical bands if they were British subjects, over 16 years of age, and holders of a private commercial license which cost \$10.00 annually. Whether the new regulations to be evolved will be as lenient as those governing the Citizen's band in this country remains to be seen.

JUST OUT is a de luxe model airplane kit that has been specially designed and engineered for radio-control flying. It is the "Live Wire Champion," built to something called "R/C Scale"—which is a new term invented by the manufacturer, the *deBolt Model Engineering Co.*, of Williamsville, N. Y., the idea being that the model was designed for optimum R/C flying first and then made to look like a full-scale model.

The model is patterned after the *Aeronca "Champion"* and is especially suited to .15-size engines (or a well-throttled .19). The



bare model weighs 30 ounces, leaving over 2 pounds for R/C equipment if you like. Wing span is 56 inches.

THERE ARE LOTS of flying meets scheduled for R/C fans in August. Texas has the *Alamo Regional Contest* in San Antonio on the 6th and 7th; write to C. C. Perkins at 235 W. Drexel, San Antonio 10, Texas, for further information. The *Fifth Annual Metropolitan Championships for R/C* will be held on August 7th at Staten Island, N. Y.; contact Sal Cannizzo of 293 Maryland Ave., Staten Island 5, N. Y., for data on these. *New England R/C Championships* are scheduled for August 14th in Beverly, Mass., with John K. Ross of 23 Lantern Lane, Wellesley Hill, Mass., acting as Contest Director. The *Ninth Annual Mid-Western States Model Airplane Championships* will be held on August 14th at Indianapolis, Ind.; the C. D. is Roland C. Rhein, *Allison Div., General Motors Corp.*, Indianapolis, Ind. Good luck!

Printed Circuitry For R/C



First, on a sheet of paper, make a layout of the proposed printed circuit board, utilizing actual parts to determine final size.



Transfer the paper pattern to the copper side of the laminate. Use a punch to locate the component terminal positions.

WITH THE rapid adoption of printed circuitry in the electronics field, many R/C fans have attempted to devise simple ways of making their own printed cards for their favorite receivers and transmitters, with varying degrees of success.

A number of methods have been used. One that has found a moderate following uses silver conducting ink which is applied with pen or brush on ordinary $\frac{1}{16}$ " linen base material. However, the technique of applying the ink requires more of an artistic touch than many R/C fans will ever develop. Also, this type of printed card must be handled with care so that it is not accidentally scratched and the circuit opened.

In commercial use, the etched card is probably favored most by the manufacturers. It utilizes a sheet of copper foil which is laminated to a phenolic base during manufacture. The circuit is printed on the copper side with a special ink by one of a number of different methods. The printed cards are then placed in a bath of ferric

chloride which etches away the exposed copper and leaves the pattern covered by the ink. Home experimenters who have tried this method prefer it to the silver ink technique.

Stripping Technique

A third method of making printed circuits is known rather simply as the "Stripping Technique." It is obviously not intended for mass production or for very complicated circuitry. However, with a little practice, multitube receivers and transmitters may quite easily be put on small sheets of copper laminate. The stripping technique does not require a lot of extra equipment.

This method consists first of planning the layout on a piece of paper, drawing out the design and employing the actual components to be used to help provide physical dimensions. After the design has been satisfactorily settled on, it is transferred to a piece of $\frac{1}{16}$ " copper laminate by using a center punch or scribe. A sharp model knife cuts the pattern onto the copper and the

Why not make printed R/C circuits this easy way— it's inexpensive, compact, and interchangeable

By PAUL F. RUNGE

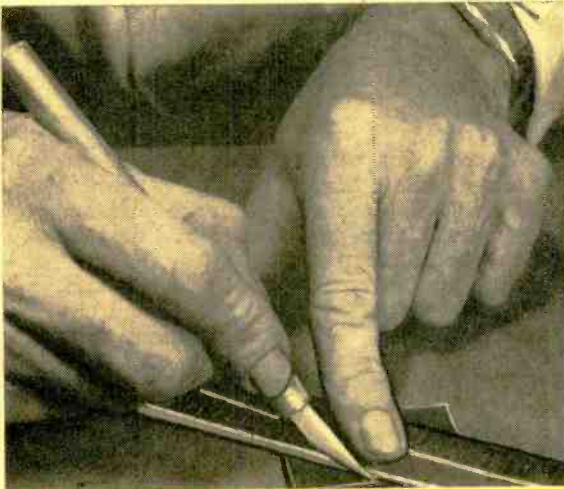

With a sharp model knife, cut the copper just deep enough so that the unwanted portion may be peeled off. Use a metal rule.

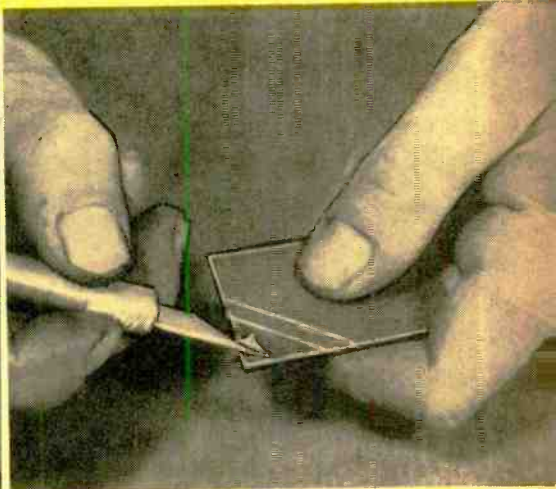

Peel the unwanted copper off the laminate with a sharp knife. Do this slowly so as to avoid tearing the remaining conductors.

unwanted portions of the copper are simply peeled off.

A few general observations may prove helpful before actually laying out the base. In printed circuitry, generally speaking, all components are mounted on one side of the base. This is not a hard and fast rule and may be varied to suit individual needs. The components may be mounted directly in small-size holes drilled into the copper strip, or an "island" may be formed which is slightly wider than the strip, and an eyelet inserted.

Generally, relays are *not* mounted on printed bases; this permits a compact unit and follows the trend of separate mounting which is rapidly developing. Advanced R/C'ers find that it is far better not to mount the relay on a receiver base, since weight may be distributed more easily, and crash damage is considerably minimized. Lightweight soldering irons are a must for printed circuits. They should be about 25 to 37½ watts, and should be used with a fine low-heat solder. A multiple core type,

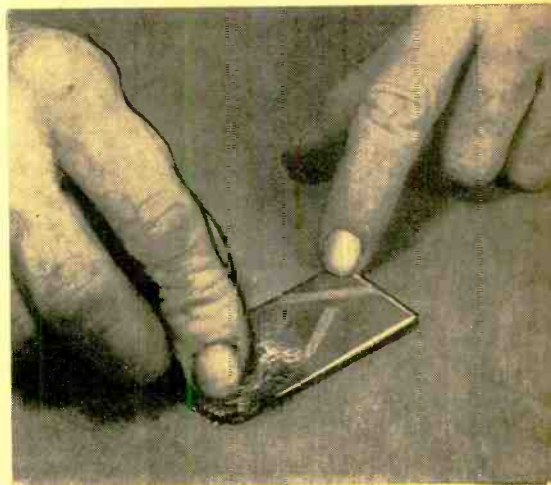

Rub steel wool over the copper conductor side of the printed base to eliminate any rough edges and to prepare for soldering.

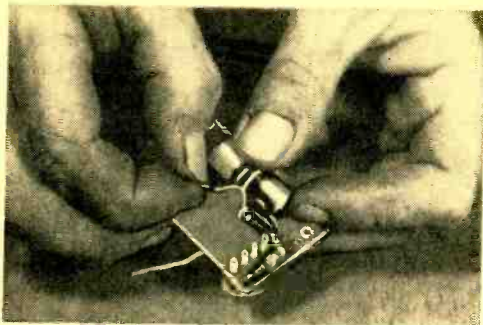

Mount the components on the base as required and then solder the lot after all parts are mounted and connections made.

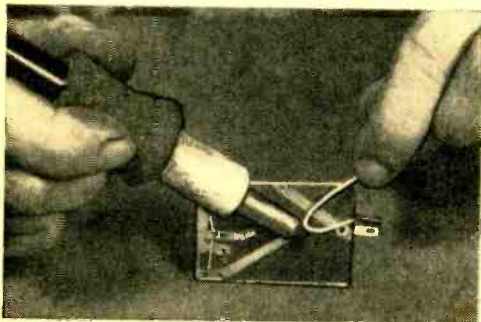

Be sure to use a small soldering iron and a low temperature solder. Snip off all the excess leads; brush off excess solder.

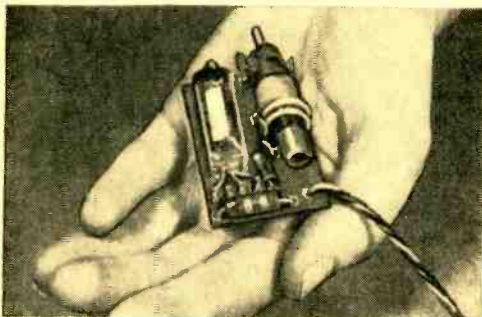

Complete printed circuit version of the "Lorenz 61" R/C receiver made according to the instructions given in the text.

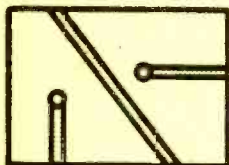

BOTTOM VIEW

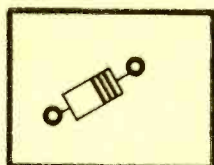

TOP VIEW

If printed circuit layout has two lines which must cross, use a component or jumper.

such as an *Ersin*, has a low melting point, making neater joints. Heavy irons and high temperature solder might cause blisters which would pull the copper laminate away from the phenolic base, and then the troubles would begin.

Almost any circuit may be put on a printed circuit card. One of the easiest as a beginning project, however, would appear to be the "Lorenz 61" receiver, published in *POPULAR ELECTRONICS* in November, 1954. Following is a step-by-step explanation of the making of a printed circuit using the "Lorenz 61" as an example.

Mounting a Circuit

Gather all the components called for in the circuit. Plan on making the copper lines wider than actually necessary— $\frac{3}{32}$ " to $\frac{1}{8}$ " should be ample. Finer lines and extreme miniaturization may be attempted later. The use of flea clips for subminiature tube leads is recommended, so that the tube may be removed. Eyelets may be used if the tube is to be soldered onto the base. Special miniature sockets for printed circuits are available for the miniature tube types, such as the 3A4, etc.

With the parts, paper, pencil, and rule, juggle the components around, using the schematic to determine where to place each part. Many sheets of paper used in this step of the process will result in a much neater unit. This is the most painstaking and time-consuming step. In two- and three-tube circuits, it may sometimes be necessary to place components so that they will bridge copper lines rather than have copper lines cross and short out. Jumper wire may be used for this purpose; however, careful spacing of components will make it unnecessary in many cases.

When the layout is satisfactory, double-check to make sure the "wires" correspond to the schematic. This is the time to correct wiring mistakes, since it will be too late to do so once the printed card is made.

Cut the copper laminate to the size required for the base. (Small sheets of the copper laminate by itself may be had from *Tele-Diagnosis Co.*, 155 West 72nd St., New York 23, N. Y., *Ace Radio Control*, P.O. Box 301, Higginville, Mo., or *Techniques Inc.*, 135 Belmont St., Englewood, N. J.)

Transfer the paper pattern to the copper side of the laminate using a center punch, scribe, or any sharp-pointed tool. Connect the lines and draw a pencil pattern of the strips desired. With a sharp model knife, cut these lines just heavily enough to penetrate the copper. A bit of practice on some scraps will help determine the amount of pressure required.

(Continued on page 101)

POPULAR ELECTRONICS

Audio and Hi-Fi Section

77	Disc and Tape Review.....	<i>Bert Whyte</i>
79	Birth of a Loudspeaker.....	
82	Distortion in Hi-Fi Equipment (Part 3)....	<i>Norman H. Crowhurst</i>
84	What Is an Audio Watt?.....	<i>Eugene F. Coriell, Major, USAF</i>
86	Square-Wave Converter.....	<i>Howard J. Carter</i>

Disc and Tape Review

By BERT WHYTE

AS YOU PROBABLY KNOW, this column has been devoted in the main to a series of record reviews, having as its object the building of a basic classical record library. We have waded through a lot of records in an effort to cull the best recordings of many works. In so doing we have already compiled a sizable library, but you must remember that the repertoire of classical music is a vast subject. Even with the "basic library" as a goal, there is still a long way to go. While this endeavor will continue to occupy a large portion of available space, the expansion of this column will allow us to touch upon other areas of music, such as jazz, "pops" . . . prerecorded tape and other musical interests. Your letters and comments about this new format would be greatly appreciated.

Mendelssohn Symphonies

Felix Mendelssohn must be reckoned in musical history as one of the most versatile of composers. Piano and violin concerti, organ sonatas, symphonies, oratorios, and many other forms of musical composition comprise his vast output. And music must be forever in his debt for resurrecting the works of Bach from dusty oblivion. Indeed, this is a most interesting fellow, and if you ever have the time and opportunity to read the story of his life, you will find it quite a fascinating one.

As might be expected, a great musical talent like Mendelssohn is well served in the matter of recordings of his works. He wrote five symphonies in all, but only the last three have gained a lasting place in today's repertoire.



The *Third Symphony*, subtitled the "*Scotch*" *Symphony*, is a cleverly constructed and most melodious work. Seven versions exist on LP, only three of which can be considered as modern hi-fi recordings.

By far the best of these three is the Mitropoulos, N. Y. Philharmonic reading on *Columbia* ML4864. I consider this recording as one of the finest things Mitropoulos has ever done. The musicianship is of extremely high order. The sound too, is extraordinary. The N. Y. Philharmonic string tone is revealed as something which can stand comparison with the best. Especially notable are the clean sonorities of the cello. Brass, woodwinds, percussion . . . these, too, are heard with smooth, wide-range response, crisply accented where need be and with appropriately wide dynamic range. Add to this picture the almost complete absence of pre- or post-echo and other distortions, and you have an outstanding recording.

Next recording of the "*Scotch*" *Symphony* in matter of choice is the Solti/London Symphony version on *London* LL708. This too, is a fine recording with sound which, if anything, is even better than the *Columbia*. The main point of superiority is the superb transient response and acoustic environment which is most persuasively "live." However, the Solti performance, while a solid, workmanlike job, is not the equal in brilliance and inspiration of the Mitropoulos reading.

The third recording for consideration is the Steinberg/Pittsburgh Symphony effort on *Capitol* S-8192. Steinberg is a most ex-

cellent technician and knows his orchestra, but it is these very qualities which are also his downfall. He puts forth too much effort in having every note in the score "letter perfect," and in so doing loses the essential feeling of the music. Perhaps this is accentuated by the sound, which is wide-range, quite hi-fi and all that . . . but suffers from very dry, cramped acoustics.

If you own any one of these three recordings, you have a modern version of the Mendelssohn *Third Symphony*, but for those of you who have yet to acquire this work . . . put your money on the Mitropoulos disc and you can't go wrong!



The *Fourth Symphony* of Mendelssohn, the "*Italian*" *Symphony*, is his most popular work. This fact can be attested to by the 16 versions of this work in the LP catalog!

Easily the most outstanding disc is the Dorati/Minneapolis Symphony recording on *Mercury* MG50010. This has the great advantage of the fabulous "Olympian" technique single-*Telefunken*-mike sound. The "*Italian*" *Symphony* is a rousing, brilliant work, and particularly benefits from the sharply focused, cleanly articulate string tone, the bright, incisive brass, and the low transient distortion apparent in the percussion. Top this with ultrawide dynamics and good, live acoustics, and you have a most exhilarating sonic experience. Performance-wise, Dorati knows and obviously enjoys the score, and his conducting perfectly reflects his attitude. His tempi are brisk, his phrasing well modeled. He is not slovenly of detail; neither is he fussy to the point of distraction. His balance is always judicious, as are his dynamics. In Dorati's hands, the "*Italian*" sings . . . as it should . . . a bubbling, capricious, joyous outpouring of beautiful music!

Breathing hard on Dorati's neck for second-place honors is the Leinsdorf/Rochester Philharmonic version on (of all things) the low-priced *Columbia Entre* label, RL-3102! Mr. Leinsdorf is another vastly underrated conductor, as is shown by his masterful handling of the score. Save for some tempo-tampering and occasional imbalance with the orchestral choirs, his reading is properly warm and lyrical, and is really quite exemplary. In spite of the fact that this is on a low-priced label, the sound is quite good. If the recording does not have the brilliance and cleanness of the *Mercury* disc, it is nevertheless well recorded with good wide range, excellent dynamics, and nice "live" acoustics. The major fault (and not too serious) is a rather characterless bass which inexplicably crops up at various places in the recording (prob-

(Continued on page 112)

Contest for Hi-Fi Fans!

A FREE "week-end with high fidelity" plus a complete home music system is the first prize in a contest sponsored by ELECTRO-VOICE, INC., of Buchanan, Mich. This first nationwide contest for audiophiles and music lovers consists of completing, in 50 words or less, the statement: "I would like to have an ELECTRO-VOICE matched high fidelity system because . . ."

Nine other prizes include various E-V loudspeakers. To enter the contest, participants must hear E-V equipment at an E-V distributor, from whom they also obtain entry blanks. The contest closes at midnight, September 30, 1955.

-30-

BIRTH OF A LOUDSPEAKER



Behind the scenes at Electro-Voice, Inc., where hi-fi speakers are made and tested

1 Research and experimentation in the laboratory (right) are the first steps in the birth of a loudspeaker. Permanent magnet field strength, suspension, elasticity, and frequency response are but a few of the physical factors that must be carefully analyzed before new speaker can be made.



2 From the laboratory, the basic idea is sent to the model shop (left). Here, skilled craftsmen translate the engineer's dream into tangible form.

3 Alpha Wiggins (right) tests frequency response of prototype in sound chamber from behind audio oscillator and recording setup. New model must prove itself before it can be put into production. When all problems are solved, model is "frozen" and sent to drafting for plans.





4 Performance of speaker in suitable enclosure is checked. In this test, the speaker system is placed in a "free-space" area out-of-doors. Sound output is picked up by microphone and fed into sound-level meters for measurement. Test at left is of speaker in folded horn cabinet.

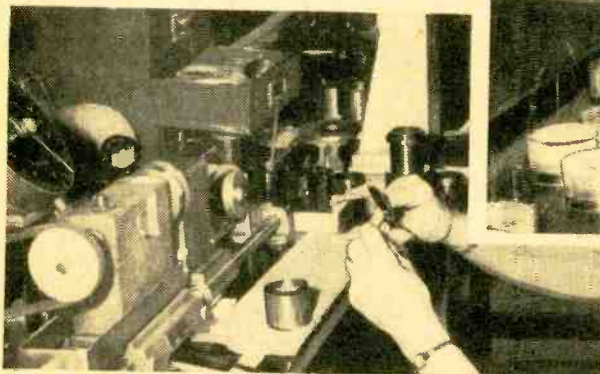

6 After coil is wound and trimmed, it is positioned onto a plastic sleeve (above). This operation requires adherence to close tolerances. Voice coil will receive all electrical impulses that must be reproduced by speaker cone as audible sound waves.

5 Tests over, the speaker goes into production. Voice coils are wound on special machine. Next, voice-coil leads are trimmed to specified length. Edgewise-wound aluminum wire is used since it is light in weight and provides greatest number of turns within given area.

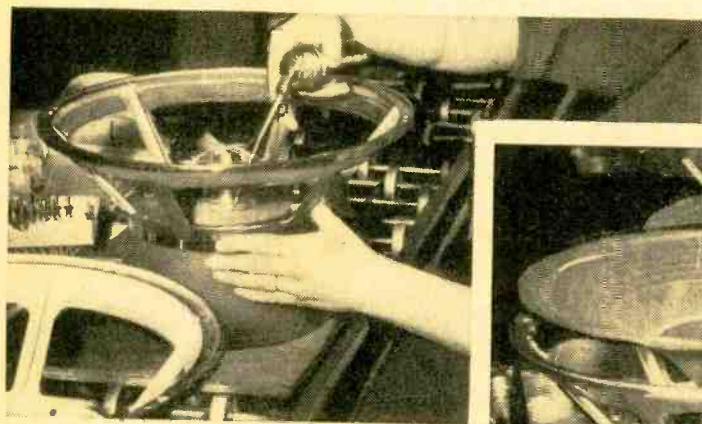

7 Voice coil and spider are combined into one assembly and cemented in place (above). Spider will hold speaker cone. It also acts as dust cover to protect magnet.



8 The cone (right) is made of pressed paper. It is centered and cemented onto the coil-spider assembly. Its outer edge is glued to the outer rim of the metal frame.



9 General view of assembly operations in plant of Electro-Voice, Inc., Buchanan, Mich. Other operations include die-casting the speaker "basket" (frame) as well as varied and extensive machine-shop activities.



10 Weight and strength of magnet determine, to a large degree, the quality of the loudspeaker. Alnico V, a powerful alloy, is used widely. Above, the outer tube of a magnet structure is ground to 1/1000-inch accuracy.



11 In the final stages of assembly, voice-coil leads are brought from spider to speaker cone. They are twisted into pigtails to prevent the damping of the cone as well as lead breakage.



12 Array of testing equipment used in final inspection. Loudspeaker is operated under simulated "living room" conditions to determine performance quality.

DISTORTION

in Hi-Fi equipment

(PART 3)

By NORMAN H. CROWHURST

THE two preceding portions of this discussion have been concerned with frequency response (June issue, page 73) and phasing (July issue, page 70). In this concluding section, a few words will be said with regard to harmonic distortion, noise, and parasitic oscillation.

Many of the more advanced readers will immediately recognize that these are the most prevalent sources of hi-fi and audio equipment distortion. Obnoxious and elusive to trace, these forms of distortion are the most difficult to eradicate. Detection, however, is also an important problem, and is the general theme of this article.

There is a type of meter on the market, known as a distortion meter, which is used with a pure sine-wave input to measure the total spurious components in the output. It does so by filtering out the true frequency and measuring all that is left. This type of meter will not show up the varieties of distortion previously discussed, but only the kinds that will be taken up now.

Harmonic Distortion

The first kind is known as harmonic distortion, because the spurious tones added to the original sound are harmonics or regular multiples of the original tone applied. This kind of distortion can be measured by means of the meter already mentioned or a wave analyzer can be used for more detailed analysis as follows.

A pure tone is injected at the input of the amplifier and the output waveform is measured by means of the wave analyzer to find out what other tones are there besides the original tone put in at the input. Second, third, fourth, etc., harmonics of the original tone are measured, and the distortion value of the output waveform is computed in accordance with certain rules. It might be a good idea at this point to relate the nomenclature of harmonic analysis to the corre-

sponding musical terminology. The second harmonic is the first musical overtone. The third harmonic is the second overtone, and so on. As mathematicians would write it, the n th harmonic is the $(n-1)$ th overtone.

Intermodulation Distortion

The same type of causes in an amplifier that can produce harmonic distortion on a single-frequency sine wave can produce intermodulation distortion when more than one frequency is applied at the input simultaneously. In practice, of course, all music and speech material consists of a whole range of frequencies applied simultaneously. So presence of this form of distortion means that a great many frequencies not present in the original sound will appear in the output.

The basic test for intermodulation distortion consists of putting in just two frequen-

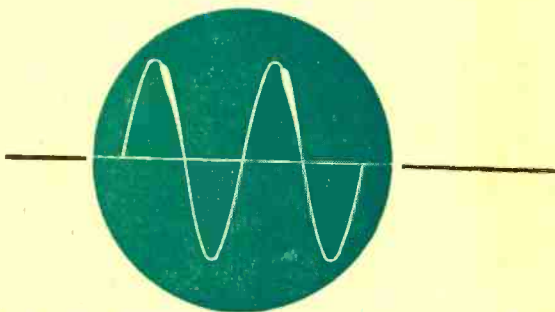

Fig. 1. The trailing edge of this sine wave shows a type of parasitic oscillation that is "triggered" as it passes through an amplifier. This distortion would probably not be audible on a single sine wave, but will become audible when a program of music or speech is fed through the amplifier.

cies and measuring the output for spurious frequencies different from the two put in. If a low frequency and a high frequency are put in simultaneously, the spurious frequencies will be other high frequencies differing from the original one by a number equal to the low frequency.

For example, if 60 cycles and 2000 cycles are the original tones selected for the test, the amplifier will produce spurious frequencies such as 1940 and 2060 cycles if it suffers from intermodulation distortion. The numbers quoted are just sample spurious frequencies. In practice, a whole sequence of frequencies could also be produced in addition to these two, such as 1880, 1820 and 2120, 2180, etc.

If, on the other hand, two frequencies fairly close together are applied to the input of an amplifier, and it suffers from intermodulation distortion, a frequency equal to the difference or sum of the original two frequencies will appear. For example, if 3000 cycles and 3500 cycles are applied to the input simultaneously, a frequency of 500 cycles may appear in the output, although it was not applied at the input. Additionally, a frequency of 6500 cycles may appear, but to the ear the 500-cycle tone is probably the one that could be most annoying in this particular example, because it might well interfere with other lower frequency components and produce notably undesirable effects.

Parasitic Oscillation

Another kind of distortion that does not come conveniently under any of the headings already discussed is caused by spurious or parasitic oscillation at high audio frequencies—or even radio frequencies. This kind of oscillation is usually not audible in itself but will have a distorting effect upon the sound which is audible.

The audible effect may take a form similar to harmonic distortion or perhaps appear more like intermodulation, but it is really a little different from either of these particular forms of distortion. The easiest way to identify it is by means of the oscilloscope. As soon as the waveform is presented on the oscilloscope, it will be observed quite readily, although it is not audible.

There are two kinds of parasitic oscillation, one of which is set off at particular points on a waveform, as shown in Fig. 1. Using only a single sine-wave input signal, this may not even have any audible effect, because the high frequency burst does not move the loudspeaker diaphragm at all; and the fundamental frequency of the sine wave works the loudspeaker in its normal fashion. However, if there are other frequencies

(Continued on page 128)

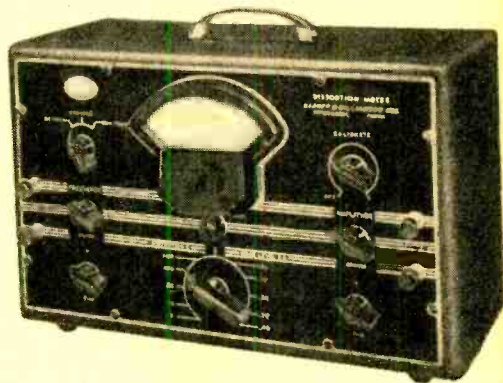

Distortion meters, such as the Barker & Williamson Model 400 shown above, are used extensively to determine the noise and harmonic content in the audio ranges.

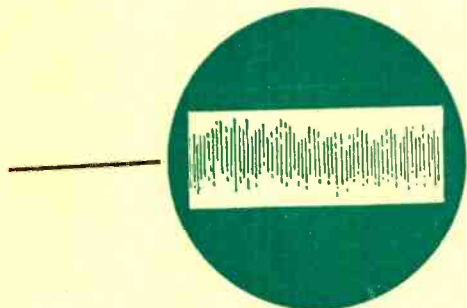

Fig. 2. An oscilloscope would show continuous parasitic oscillation in a form something like this. No music is coming through the amplifier. Usually such amplifiers are surprisingly quiet because the high frequency oscillation effectively "blocks" the hiss and hum normally in the background.

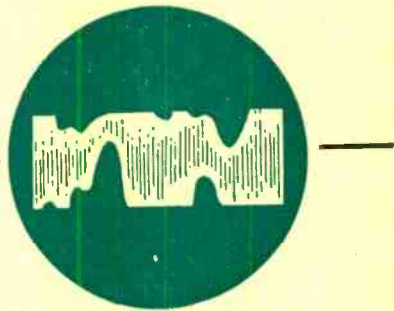

Fig. 3. This is how a waveform will appear when program material is fed through the amplifier at the same time that parasitic oscillation is taking place. The audio would break up the oscillation from time to time and original sounds would suddenly appear in the output for very short periods of time.

By EUGENE F. CORIELL, Major, USAF

A question that puzzles many hi-fi enthusiasts is answered

TO ACCOMPLISH useful work, whether it be moving a car along the highway or moving the cone of a loudspeaker to produce sound, power must be expended. The more power expended, the more work done. Mechanical power is generally expressed in horsepower and electrical power in watts or kilowatts.

The concept of electrical power is important to the audio hobbyist because almost every element of a tape recorder or hi-fi rig generates, transmits, or absorbs power—electrical watts. The end result is the driving of the loudspeaker, and since the air opposes movement of its cone or diaphragm, power must be expended to overcome that opposition. In the case of the loudspeaker, the driving power is furnished by the amplifier which is rated as having an output of 10, 20, or more *audio watts*. It follows that the speaker must also be rated as to the electrical power or

wattage it can absorb. This value should be at least equal to the amplifier rating, and in the case of several speakers, the combined power rating should equal the amplifier rating.

Within the amplifier, the most obvious element important from an audio wattage standpoint is the output transformer. This is the last component in the final stage of the amplifier, and is the component that the loudspeaker "sees." The output transformer is a device which matches output tubes to the speaker voice-coil. If the amplifier is rated at 10-watts output, the transformer must be able to handle this power. If it is too small, distortion or burn-out may occur.

Another element within an amplifier which is important, wattage-wise, is the lowly resistor. There are many of these in the average amplifier, although not all of them handle appreciable power. Resistors are available in many different resistance

These two instruments are typical of the commercially available units for measuring audio watts. At the right is the Heathkit Model AW-1, which utilizes the v.t.v.m. principle to measure a voltage across internal load resistors. On the left is the General Radio Model 583A, a professional laboratory unit. Both of these instruments have provisions for matching the impedance of the amplifier under test.

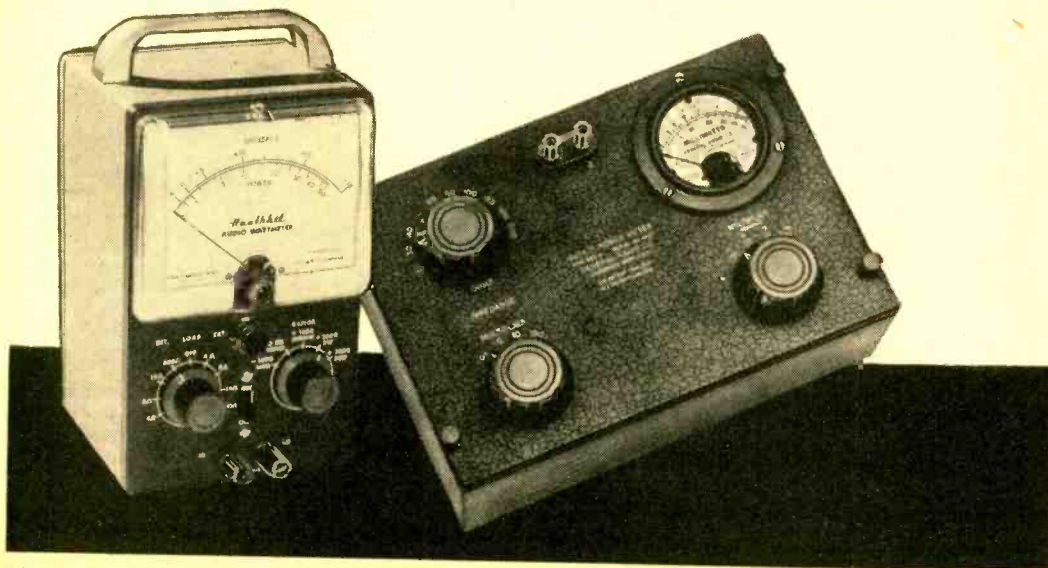

is an Audio Watt?

ratings in ohms, and in various power ratings. In home amplifiers, the resistor power rating may range from one-quarter watt to several watts. The resistor rating is important at some positions in the amplifier circuit since the current forced through the resistor by the applied voltage results in absorption of power by the resistor. This power is dissipated as heat, and a resistor of correct resistance value but with too low a power rating may fail completely or cause noise in the amplifier output.

It might be well here to distinguish between the audio power input and the 115-volt house a.c. input to the amplifier. For 10 watts of audio output, the house system must furnish several times that much power to the amplifier 115-volt a.c. input. On the other hand, the microphone or record player furnishes only an extremely minute amount of program power to the amplifier audio input. This tiny audio input power, ranging from a few microwatts to milliwatts, in effect controls the 115-volt

power that the amplifier draws from the house a.c. system, which is the real source of the power fed to the loudspeaker.

Continuous power of one watt delivered to the speaker will result in an uncomfortably loud program in the average living room. The question then arises: why use amplifiers rated at 10, 20 or more watts? The cone-type speaker has a very low efficiency. This means that only a small fraction of the electrical or audio power fed to the speaker creates useful sound (horn-type speakers are more efficient but are less common in home systems).

Another reason for building considerable power output into amplifiers is the fact that there are many instantaneous peaks of sound in music which are far above the average level; lack of power capacity in the amplifier will result in distortion on these peaks. Still another reason is the need for reserve power when a room full of guests creates a high background noise level—or when the hi-fi fan insists on turning up the volume for better reproduction of the extreme lows and highs. The need for reserve power becomes more apparent when it is realized that doubling the audio output from the amplifier will achieve only a moderate increase in loudness. While most amplifiers will deliver more than their rated output, the distortion percentage will generally rise above the manufacturer's stated value, which is the per cent of harmonic distortion at rated output. A really high-fidelity amplifier will deliver its rated output with 1% distortion or less.

Figure 1 shows a simple setup for measuring amplifier output power. A sine-wave audio oscillator furnishes a steady signal at a particular frequency, perhaps 1000 cycles, to the amplifier input. Amplifier output is loaded by an appropriate resistor in place of the speaker (see speaker impedance rating). A vacuum-tube voltmeter—and an oscilloscope if available—is in parallel with the resistor. Amplifier volume control is set at the point at which the output is to be measured and the oscillator control is adjusted to obtain the amplifier input voltage recommended by the manufacturer. Output of the amplifier in

(Continued on page 120)

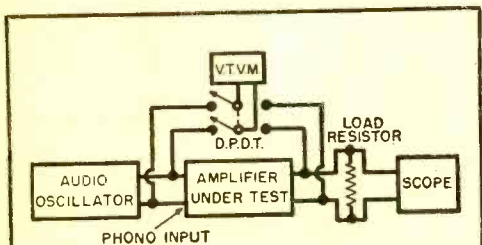
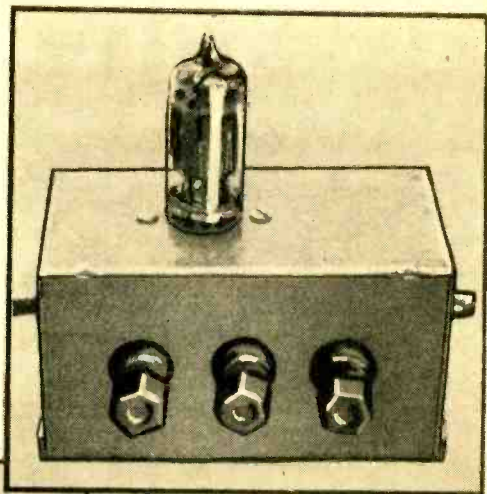

Fig. 1. This is the test arrangement for measuring the power output of a hi-fi amplifier. The vacuum-tube voltmeter must be sensitive enough to read the extremely small voltage input to the amplifier as specified by the manufacturer, which may be only a few millivolts. Output wattage is equal to the square of the voltage as measured by the v.t.v.m. divided by the value of the resistance of the load resistor; this resistor is a substitution for the speaker. The oscilloscope is not required for actual wattage measurements, but enables the sine-wave pattern to be checked for distortion. Power output is measured at various frequencies over the response range of the amplifier. See text for details.

SQUARE- WAVE CONVERTER

By HOWARD J. CARTER



The converter is mounted in a small standard aluminum box. See interior view at left.

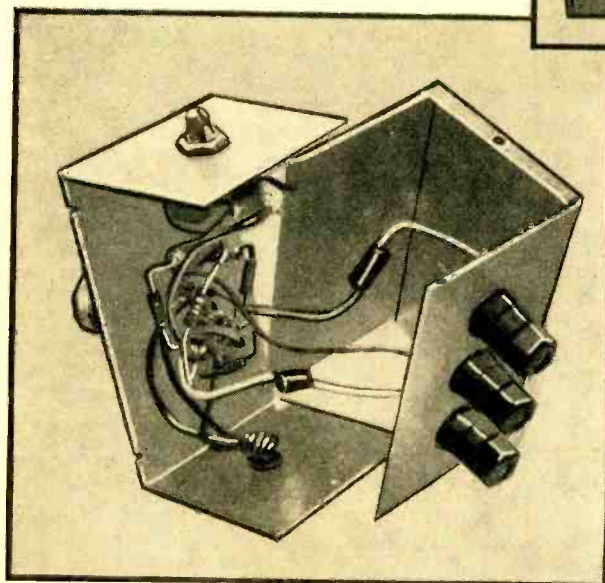

Control R1 is mounted on end plate near tube socket. The three terminals include both "input" and "output" circuits since the ground terminal is common to each.

Useful adaptation of a little known circuit to form clean square waves from sine waves, valuable in testing all types of hi-fi and audio amplifiers

THE interesting presentation by Norman Crowhurst on the use of square waves to test hi-fi equipment (POPULAR ELECTRONICS, July, 1955, p. 70) raised the following question among many readers possessing sine-wave audio generators: "How can I get a square-wave signal source?" This article is the answer to that question. It describes the simple construction of a converter which takes a sine-wave input and makes it into a square wave. Technically speaking, this is a Schmidt discriminator.

Unlike normal hi-fi amplification where the output is identical to the input, only greatly multiplied, this circuit has only two output voltage levels. When the sine-wave input voltage falls below a certain critical value, the output voltage will be quite low.

As the input voltage increases, there will be a certain point at which regeneration within the tube will take place. This causes the output voltage to jump suddenly to a high value. The high value is maintained until—on the downward slope of the sine-wave—the critical "cutoff" point is once again passed and the output returns to the low voltage setting.

This effect has no relationship to the length of time that the input voltage remains at either the high or low value. In other words, the circuit is essentially independent of the frequency of the sine-wave input. The input may then be varied to suit individual circuit requirements with assurance that the output will always be a square wave.

The output waveform will be a sharp-corner square wave up to input frequencies of 10,000 cycles; above this frequency, the input sine-wave amplitude must be increased to maintain fast rising and falling edges. For audio amplifier testing, however, a 10,000-cycle fundamental is quite adequate.

Plate supply voltage may be anywhere from 50 to 250 volts. The output will then be from 6 to 30 volts, and the input peak-to-peak minimum will be from 3 to 12 volts. Although a 12AX7 tube is specified, the same results may be obtained with a 12AT7. Layout of parts is not critical. Twist the heater wires together to reduce hum pickup. A knot should be tied in the power wires inside the box for strain relief. Use spaghetti on the capacitor leads to prevent shorting. Some constructors will find that the circuit is compact enough to be added easily to the chassis of their sine-wave audio generators.

To use the converter, connect the power lead wires to the appropriate points on the amplifier under test. If low-level stages are being tested, the output will have to be attenuated with a compensated voltage divider as shown on the schematic. Set the trimmer *Cx* to the point where the oscilloscope shows the best square wave at the junction of the potentiometer, *Rx*, with the amplifier under test connected.

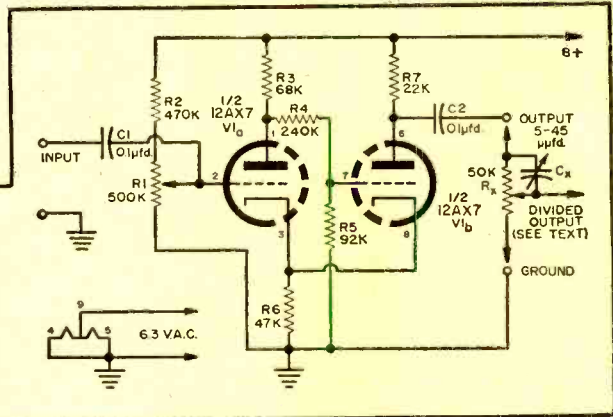
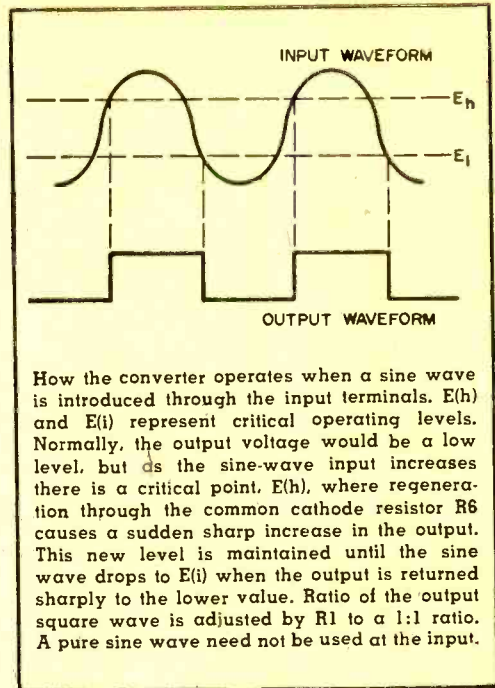

Wiring schematic of the square-wave converter. The potentiometer, *R₁*, is used to set the level or ratio of the output. This adjustment should permit the user to obtain a square wave that appears very similar to (a) of Fig. 3, page 71, July issue. It must be made since the output waveform depends on the input sine wave and plate voltage which is applied to the converter.

- R₁*—500,000 ohm potentiometer
 - R₂*—470,000 ohm, 1/2 w. res.
 - R₃*—68,000 ohm, 1/2 w. res.
 - R₄*—240,000 ohm, 1/2 w. res.
 - R₅*—92,000 ohm, 1/2 w. res.
 - R₆*—47,000 ohm, 1/2 w. res.
 - R₇*—22,000 ohm, 1/2 w. res.
 - C₁*, *C₂*—1 µfd., 200 v. paper capacitor
 - C_x*—4.80 µfd., mica trimmer or padding capacitor
 - R_x*—50,000 ohm potentiometer, linear taper
 - V₁*—12AX7 tube (or see text)
- Also required:
- 1—Aluminum case, 2 1/4" x 2 1/4" x 4"
 - 1—9-pin miniature tube socket
 - 3—Superior 5-way binding post
 - 1—Terminal strip

Total cost of parts, approx. \$5.00

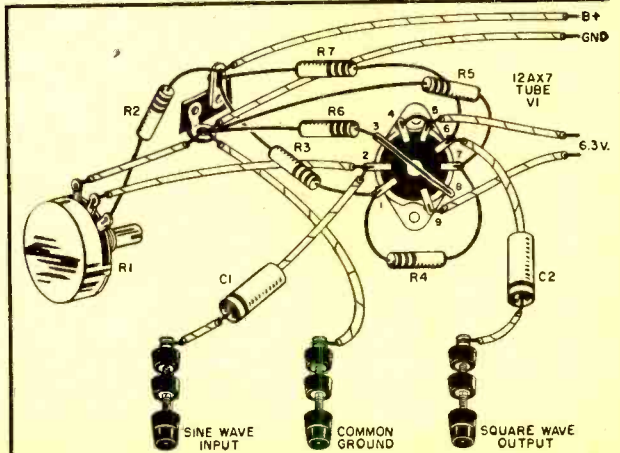

AFTER CLASS

POWER TRANSFORMERS

THE HUM of a transformer is a song of unleashed power held in check by the skill of design and construction engineers. In some transformers it signals lethal voltages lying in wait for the first incautious move; in others it tells of gentle voltages applied to delicate tube filaments. In any case, we can learn to handle this versatile component by becoming familiar with the basic rules that govern its operation.

A power transformer—the simplest kind—consists of two separate coils of insulated wire wound around a common core of

silicon steel or some similar material that concentrates magnetic lines of force. As a fluctuating voltage (E_p in Fig. A) is impressed across the primary (pri.) coil, the pulsating magnetic field that results from the flow of primary current (I_p) cuts through the secondary turns (sec.) inducing a new voltage (E_s) in this winding. If a load that can consume electrical power is connected as shown, then a secondary cur-

rent (I_s) flows through the load. In modern power transformers, practically all of the lines of force produced by the primary current cut through the secondary winding; this is a matter of proper design and materials. When it occurs, the windings are said to be "closely coupled," a condition that results in most efficient operation.

It should be pointed out that transformers operate only on *alternating* current, since the process of inducing a voltage in the secondary winding depends on a *change* in the magnetic lines of force. Don't let anyone talk you into trying to locate a d.c. transformer! Most of the electrical power in this country has a frequency of 60 cycles per second, although some 25-cycle power is still in use in various localities.

The secondary voltage, E_s , may be found by applying this simple formula:

$$E_s = E_p \times \frac{\text{Secondary turns}}{\text{Primary turns}}$$

Suppose we have a transformer whose primary has 500 turns closely coupled to a 2000-turn secondary. What secondary voltage may we anticipate if the input to the primary is 120 volts? Substituting in the formula above:

$$E_s = 120 \times \frac{2000}{500} = 480 \text{ volts}$$

Thus, this is a *step-up* transformer which boosts the input voltage to four times its original value. The fraction 4/1 is called the *S:P turns ratio*. Evidently, from the example given above, the turns ratio is equal to the fraction "Secondary turns/Primary turns" and may be used in place of it in the equation, so that:

$$E_s = E_p \times \text{turns ratio}$$

Take another example: a filament transformer (a *step-down* type) designed to operate on 120-volts primary input has a turns ratio of 1:20 (another way of writing 1/20). What secondary voltage will it produce? Using the second formula:

$$E_s = 120 \times \frac{1}{20} = 6 \text{ volts}$$

By exercising care in the design of the windings and the choice of the core, both

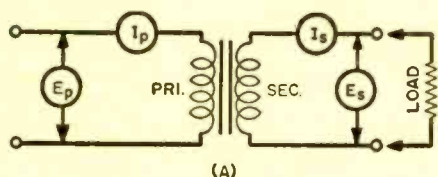

(A)

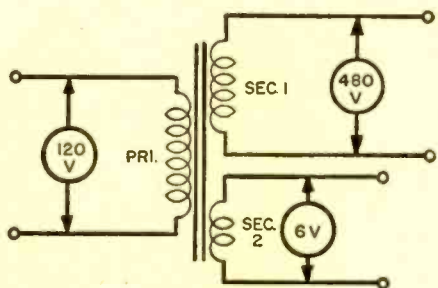

(B)

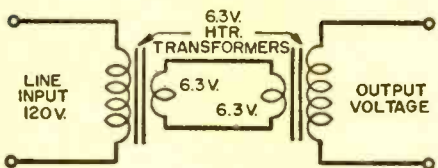

(C)

silicon steel or some similar material that concentrates magnetic lines of force. As a fluctuating voltage (E_p in Fig. A) is impressed across the primary (pri.) coil, the pulsating magnetic field that results from the flow of primary current (I_p) cuts through the secondary turns (sec.) inducing a new voltage (E_s) in this winding. If a load that can consume electrical power is connected as shown, then a secondary cur-

transformers described in the foregoing paragraphs may be combined to form a standard multiple winding type as shown in Fig. B by winding both secondaries on the same frame as the primary.

Contrary to the convictions of many beginners, transformers don't give you something for nothing. Although it is true that a transformer can step up voltage, in the process of so doing it balances the score by taking more current from the lines than it provides to the load. *No transformer can ever supply more power to the load from the secondary winding than is put into its primary winding.* Under ideal conditions of 100% efficiency, the secondary power may equal the primary power, but it can never exceed it. Ignoring power factor (to be discussed in a future issue):

$$E_p \times I_p = \text{primary power}$$

$$E_s \times I_s = \text{secondary power}$$

Thus:

$$E_p \times I_p = E_s \times I_s$$

This last equation can be rewritten as:

$$I_p = I_s \times E_s / E_p$$

and may be used to find the amount of primary current that will be necessary to provide a given secondary current to a load when a given transformer is used. For instance, consider our first example of a transformer having a turns ratio of 4/1. Assume that this device is to operate a radio set which acts as a 100-milliampere load. How much primary current must flow to supply this current at 480 volts in the secondary?

$$I_p = 100 \times 480 / 120$$

$$I_p = 100 \times 4 = 400 \text{ ma.}$$

Therefore, as the transformer quadruples the input voltage by its step-up action to provide an output voltage of 480 volts, the current taken from the lines by its primary winding is *four times greater than that provided for the load's use.* This "balancing" action is completely automatic and is dictated by a natural law of physics called "the conservation of energy." If we could invent a transformer that would provide more secondary power than that consumed by its primary, perpetual motion would be the easy step!

The following quiz is intended as a self check. All of the questions can be answered correctly if the foregoing text has been mastered. Answers are on page 127.

QUIZ

1. Radio sets made in this country and shipped to Great Britain are usually accompanied by transformers to permit the use of the 110-volt radios on 220-volt lines employed in the latter country. What must be the S:P turns ratio of these transformers?
2. A 125Q7 tube heater requires 12.6 volts for proper operation. A step-down transformer

having an S:P turns-ratio of 1:10 yields the right voltage when used on a house line. What must be the line voltage?

3. How much current flows in the primary of the transformer described below? Is this a step-up or step-down transformer?

$$\text{Primary voltage} = 2500 \text{ volts}$$

$$\text{Secondary voltage} = 125 \text{ volts}$$

$$\text{Secondary current} = 100 \text{ amperes}$$

4. Very often, two filament transformers of identical rating are used "back-to-back" as shown in Fig. C. This brings about a favorable condition called "isolation from the line." What final secondary voltage might be expected?
5. A certain step-up power transformer having a turns ratio of 10:1 blows a fuse in its primary circuit when the load on the secondary is made excessive. How can this happen?

ELECTROSTATIC SPEAKERS

Electrostatic speakers are beginning to find their way into modern, medium-priced high-fidelity equipment. It seems a good idea, then, to review the principles of this unique kind of loudspeaker to see how it fits into the hi-fi picture of today.

An electrostatic speaker is nothing more than an elegant capacitor having one flexible and one rigid plate. The principle of its operation is quite simple. Audio voltages applied to the plates of the capacitor set up a varying electric field between them. Since this field contains more or less energy depending upon the amplitude of the potential differences, the flexible plate is caused to move in step with these varying potentials. The air in contact with the moving electrode is then set in motion at an audio rate and sound results.

A typical circuit in which an electrostatic speaker is used in combination with

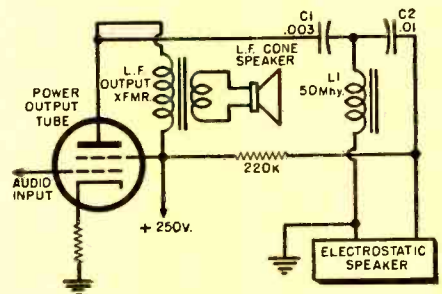

a PM cone speaker to form a "woofer-tweeter" arrangement is given in the figure. Capacitors, C1 and C2, and inductance, L1, form a cross-over network which feeds the high frequency audio to the electrostatic speaker while keeping the low frequency components directed toward the low-frequency cone speaker transformer.

Early models of electrostatic speakers had two big disadvantages: they could not

(Continued on page 98)

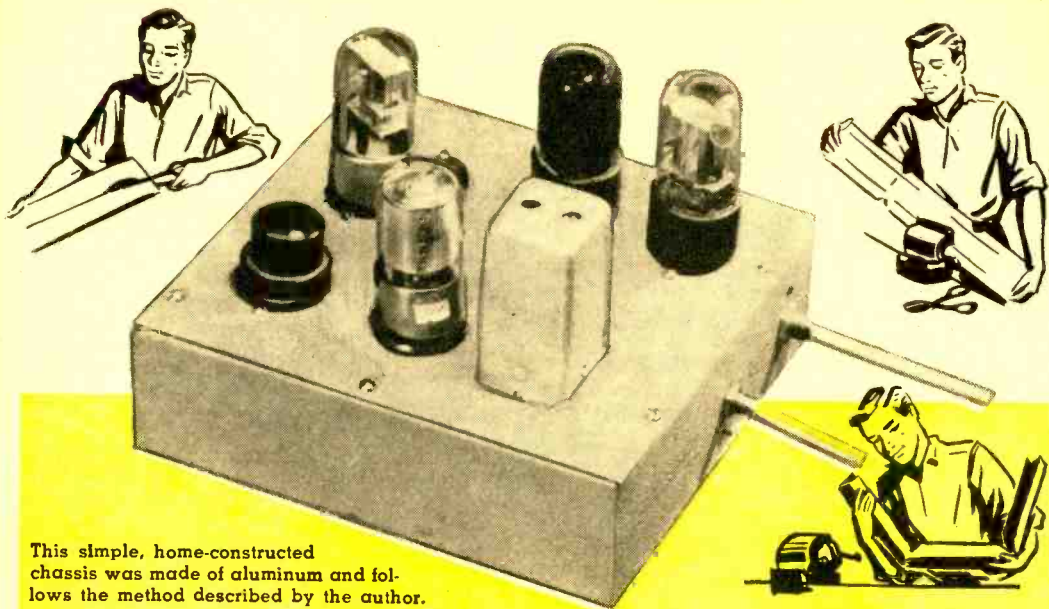

This simple, home-constructed chassis was made of aluminum and follows the method described by the author.

Thin-Skin Chassis Cuts Costs

AMONG the many problems facing the average experimenter is the cost of the chassis which must be used as a foundation for almost every piece of equipment which is constructed.

If one is to make his own chassis, a material that may be easily worked is a practical necessity, particularly if shop facilities are limited. One such material is $\frac{1}{4}$ " wire mesh, which is both cheap and easily worked. However, this material leaves something to be desired as far as eye appeal is concerned. In addition, the shielding offered by the $\frac{1}{4}$ " mesh is inadequate with some circuits, as several units constructed by the author were affected by body capacity.

It was, therefore, decided that the only alternative material was aluminum. The first attempt at a home-constructed chassis resulted in a very serviceable but decidedly "unpretty" aluminum box.

For the next project, a quantity of 18-gauge 24ST aluminum was purchased from a surplus outlet for use as top and/or bottom plates. For the sides some 24-gauge aluminum was secured from a local hardware store. The 24-gauge material is very easily worked and can be bent with only a light hand pressure, as may be seen in the accompanying illustrations.

Use of these materials has turned out particularly well for the author. Once a circuit is operating satisfactorily, the unit may be permanently wired on the same chassis which was used as a breadboard, or if need be, a new top plate may be cut to allow a better parts arrangement.

When the top plate is drilled and punched (including holes for mounting to the base), all major components may be mounted and wiring completed, with the exception of the controls and switches which are to be mounted on the front of the chassis. This produces an almost integral unit on the chassis plate, which materially simplifies construction and any subsequent changes which may be necessary.

In assembling a chassis, the details shown in the photographs will serve as a guide. However, it should be noted that there is a $\frac{1}{2}$ " flap provided for joining the two ends of the base. All bends should be accurately scribed and care exercised in making all cuts so that the finished job will be structurally strong as well as nice-looking. A coat of wrinkle paint will further dress it up and give that elusive professional appearance.

While the completed chassis is not as strong as a commercially built job, it is perfectly adequate for most applications.

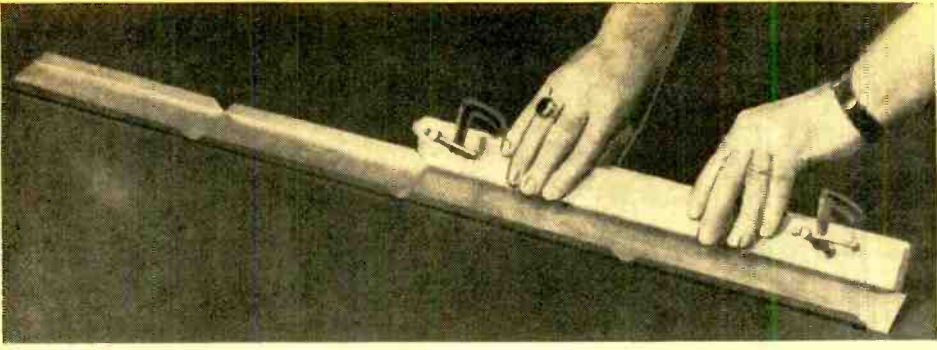

Only light pressure is required to bend the aluminum. The sheet, clamped between two boards, is supported on a flat surface for bending.

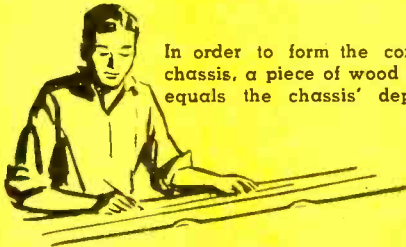

In order to form the corners of the chassis, a piece of wood whose width equals the chassis' depth is used.

By RICHARD C. SAUNDERS

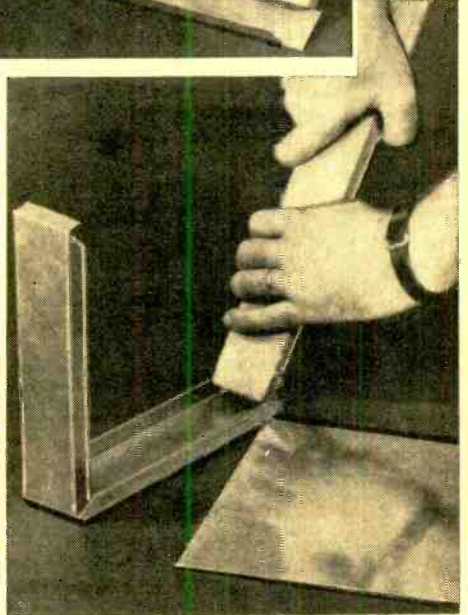

However, the addition of a bottom plate will add considerable strength to the unit, if it is found necessary. This method of construction has the advantage of being relatively cheap, and in addition, no special tools are required. Even if tinsnips and 'C' clamps need to be purchased, the savings on the first few chassis will more than pay the cost of the tools.

-30-

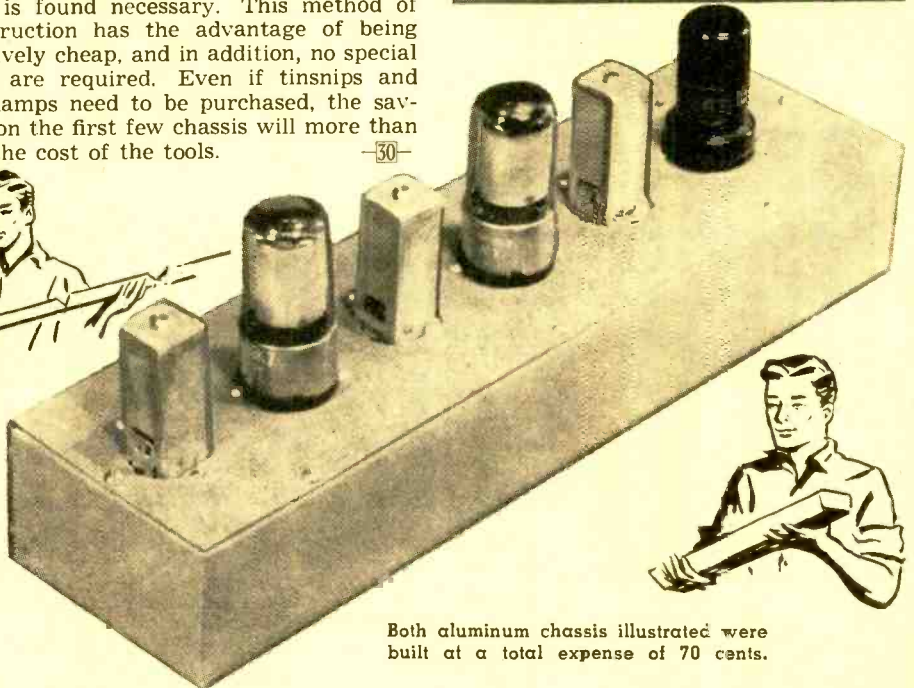

Both aluminum chassis illustrated were built at a total expense of 70 cents.

Build YOUR OWN HEATHKITS

INTERESTING—EDUCATIONAL



work has already been done for you. No cutting, drilling, or painting required. All parts furnished including tubes. Knowledge of electronics, circuits, etc., not required to successfully build Heathkits.

New PRINTED CIRCUIT VACUUM TUBE VOLTMETER KIT

The VTVM is the standard basic voltage measuring instrument for radio and TV servicemen, engineers, laboratory technicians, experimenters, and hobbyists. Because of its extremely high input resistance (11 megohms) the loading effect on the circuit being measured, is virtually negligible. The entire instrument is easy to build from a complete kit, with a detailed step-by-step Construction Manual. Featured in this instrument is an easy-to-wire fool-proof printed circuit board which cuts assembly time in half.

CIRCUIT AND RANGES: Full wave AC input rectifier permits 7 peak-to-peak voltage ranges with upper limits of 4000 volts peak-to-peak. Just the ticket for you TV servicemen. Seven voltage ranges, 1.5, 5, 15, 50, 150, 500 and 1500 volts DC and AC RMS. Peak-to-peak ranges 4, 14, 40, 140, 400, 1400, and 4000 volts. Ohmmeter ranges X1, X10, X100, X1000, X10K, X100K, X1 meg. Additional features are a db scale, center scale zero position, and a polarity reversal switch.

IMPORTANT DESIGN FEATURES: Transformer operated—1% precision resistors—6AL5 and 12AU7 tubes—selenium power rectifier—individual AC and DC calibrations smoother improved zero adjust control action—new panel styling and color—new placement of pilot light—new positive contact battery mounting—new knobs—test leads included. Easily the best buy in kit instruments.

New peak-to-peak meter scale—new color harmony—new control knobs.

New printed circuit board for faster, easier construction—exact duplication of Laboratory development model.

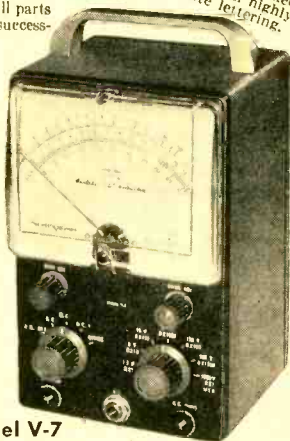

Model V-7

\$24⁵⁰

Shpg. Wt. 7 lbs.

New charcoal gray baked enamel panel with highly readable white lettering.

New easy-to-read open panel layout. Off-on switch incorporated in selector switch.

Heathkit HANDITESTER KIT



MODEL M-1
\$14⁵⁰

Shpg. Wt. 3 lbs.

The Heathkit Model M-1 Handitester readily fulfills all requirements for a compact, portable volt-ohm-milliammeter. Its small size permits the instrument to be tucked into your coat pocket, tool box or glove compartment of your car. Always the "handitester" for those simple repair jobs. Packed with every desirable feature required in an instrument of this type. AC or DC voltage ranges, full scale 10, 30, 300, 1000 and 5000 volts. Ohmmeter ranges 0-3000 ohms and 0-300,000 ohms. DC milliammeter ranges 0-10 milliamperes and 0-100 milliamperes. Use 400 microampere meter—1% precision resistors—hearing aid type ohms adjust control—high quality Bradley rectifier. Test leads are included.

Heathkit MULTIMETER KIT



MODEL MM-1
\$29⁵⁰ Shpg. Wt. 6 lbs.

Here is an instrument packed with every desirable service feature and all of the measurement ranges you need or want. High sensitivity 20,000 ohms per volt DC, 5000 ohms per volt AC. Has the advantage of complete portability through freedom from AC line—provides service ranges of direct current measurements from 150 microamperes up to 15 amperes—can be safely operated in RF fields without impairing accuracy of measurement.

Full scale AC and DC voltage ranges of 1.5, 5, 50, 150, 500, 1500, and 5000 volts. Direct current ranges are 150 microamperes, 15, 150, and 500 milliamperes and 15 amperes. Resistances are measured from .2 ohms to 20 megohms in three ranges and db range from -10 to +65 db. Ohmmeter batteries and necessary test leads are furnished with the kit.

HEATH COMPANY
A SUBSIDIARY OF DAYSTROM, INC.
BENTON HARBOR 10, MICHIGAN

New
PRINTED
CIRCUIT

Heathkit 3" OSCILLOSCOPE KIT



Model
OL-1

\$29.50

Shpg. Wt.
15 lbs.

Ideal for individual home work shop, ham shack, or as extra instrument for outside servicing.

Compact size, light weight, portable — perfect for service work or field operation.

New, modern styling, gray panel with white lettering, light gray knobs and red and black contrasting terminal posts.

New printed circuit for constant performance, rugged component mounting — assembly time cut in half!

Measures only 11 3/4" x 6 3/4" x 19 1/2" and weighs only 11 pounds.

USE: This brand new Utility Scope was designed especially for servicemen and radio amateurs, and is adaptable for use in all general Scope applications. Perfect for modulation monitoring, etc. Use it to tackle alignment or adjustment problems. Equally valuable in breadboard work. A must for ham shack or for outside servicing.

DESCRIPTION: Front panel controls of the Model OL-1 are "bench tested" for ease of operation and convenience. Sharp focusing 3" CRT. Printed circuit for ease of assembly and constant performance. Assembly time cut in half! High quality electronic components used. Sensitive hor. and vert. amplifiers with broad freq. response; cathode follower for isolation. Push-pull hor. and vert. output to deflection plates. Int. .60 cycle, or ext. sync. Sweep freq. range 10-100,000 cycles. Direct connection to deflection plates. Provision for Z axis input. Uses 3GP1 CRT, 4-12AU7 hor. and vert. amplifiers, 1-12AX7 sweep gen., 1-6X4 LV rect., and 1-1V2 HV rect. The Heathkit Model OL-1 is a real standout value at only \$29.50, and is another example of the famous Heathkit combination; quality plus economy.

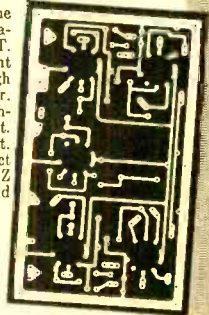

Heathkit

SIGNAL GENERATOR KIT

USE: This instrument is "serviceman engineered" to fill the requirement for a reliable basic service instrument at moderate cost. Frequency coverage extends in five bands from 160 Kc to 110 Mc on fundamentals, and dial is calibrated to 220 Mc for harmonics. Pre-wound and pre-aligned coils make calibration unnecessary for service applications.

DESCRIPTION: The Heathkit Model SG-8 Signal Generator provides a stable modulated or unmodulated RF output of at least 100,000 microvolts which can be controlled by both a continuously variable and a fixed step attenuator. Internal modulation is at 400 cycles, or can be externally modulated. AF output of 2-3 volts is also available for audio testing. Uses dual purpose 12AU7 as Colpitts RF oscillator and cathode follower for stable, isolated, low impedance output, and type 6C4 tube for 400 cycle oscillator. Operation of the SG-8 is well within the frequency limits normally required for service work. Modern styling features high definition white letters on charcoal gray panel with re-designed control knobs. Modern professional appearance and Heathkit engineering know-how combine to place this instrument in the "best buy" category. Only \$19.50 complete.

New, modern panel and knob styling — professional appearance and professional performance.

Broad frequency coverage — fundamentals from 160 KC to 110 MC in 5 bands — up to 220 MC on calibrated harmonics.

Cathode follower output for good isolation — fixed step and continuously variable attenuation.



Output selection — internal modulation, pure r.f., or audio output.

MODEL SG-8 **\$19.50** Shpg. Wt. 3 lbs.

Heathkit ANTENNA IMPEDANCE METER KIT



MODEL
AM-1

\$14.50 Shpg. Wt. 2 lbs.

The Model AM-1 Antenna Impedance Meter makes an ideal companion unit for the GD-1B Grid Dip Meter or a valuable instrument in its own right. Perfect for checking antenna and receiver impedance and match for optimum system operation. Use on transmission lines, halfwave, folded dipole, or beam antennas. Will double as monitor or relative field strength meter. Covers freq. range of 0-150 Mc and impedance range of 0-600 ohms. Uses 100 microampere meter and special calibrated potentiometer. A real buy at only \$14.50 complete.

Heathkit

GRID DIP METER KIT



MODEL
GD-1B

\$19.50 Shpg. Wt. 4 lbs.

Amateurs and servicemen have proven the value of this grid dip meter many times over. Indispensable for locating parasitics, neutralizing, and aligning filters and traps in TV or Radio and for interference problems. The Model GD-1B covers from 2 Mc to 250 Mc with 5 pre-wound coils. Featuring a sensitive 500 microampere meter and phone jack, the GD-1B uses a 6AF4 or 6T4 tube. An essential tool for the ham or serviceman.

ACCESSORIES: Low freq. coverage to 355 KC with two extra coils and calibration curve. Set No. 341A for GD-1B and set No. 341 for GD-1A. Shipping weight 1 lb. Only \$3.00.

HEATH COMPANY

A SUBSIDIARY OF DAYSTROM, INC.

BENTON HARBOR 10, MICHIGAN

New

Heathkit VFO KIT



MODEL VF-1

\$1950

Ship. Wt. 7 lbs.

Here is the new Heathkit VFO you have been waiting for. The perfect companion to the Heathkit Model AT-1 Transmitter. It has sufficient output to drive any multi-stage transmitter of modern design. A terrific combination of outstanding features at a low kit price. Good mechanical

and electrical design insures operating stability. Coils are wound on heavy duty ceramic forms, using Litz or double cellulose wire coated with polystyrene cement. Variable capacitor is of differential type construction, especially designed for maximum bandspread and features ceramic insulation and double bearings.

This kit is furnished with a carefully precalibrated dial which provides well over two feet of calibrated dial scale. Smooth acting vernier reduction drive insures easy tuning and zero beating. Power requirements 6.3 volts AC at .43 amperes and 250 volts DC at 15 mills. Just plug it into the power receptacle provided on the rear of the AT-1 Transmitter Kit. The VFO coaxial output cable terminates in plastic plug to fit standard 1/4" crystal holder. Construction is simple and wiring is easy.

- Smooth acting illuminated and precalibrated dial.
- 6AU6 electron coupled Clapp oscillator and OAZ voltage regulator.
- 7 Band coverage, 160 through 10 meters—10 Volt RF output.
- Copper plated chassis—aluminum cabinet—easy to build—direct keying.

Open layout—easy to build—simplified wiring.

Smooth acting illuminated dial drive.

Clean appearance—rigged construction—accessible calibrating adjustments.

Copper plated chassis—careful shielding.

Ceramic coil forms—differential condenser.

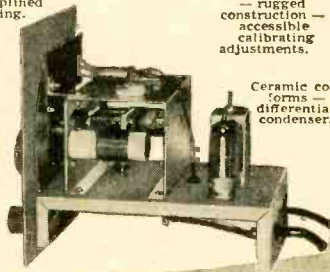

Heathkit AMATEUR TRANSMITTER KIT



MODEL AT-1

\$2950

Ship. Wt. 16 lbs.

Here is a major Heathkit addition to the Ham radio field, the AT-1 Transmitter Kit, incorporating many desirable design features at the lowest possible dollar-per-watt price. Panel mounted crystal socket, stand-by switch, key click filter, A. C. line filtering, good shielding, etc. VFO or crystal excitation—up to 35 watts input. Built-in power supply provides 425 volts at 100 MA. Amazingly low kit price includes all circuit components, tubes, cabinet, punched chassis, and detailed construction manual.

SPECIFICATIONS:

Range 80, 40, 20, 15, 11, 10 meters.
 6AG7 Oscillator-multiplier.
 6L6 Amplifier-doubler
 504G Rectifier.
 105-125 Volt A.C. 50-60 cycles 100 watts. Size: 8 1/8 inch high x 13 1/4 inch wide x 7 inch deep.

Crystal or VFO excitation.

Prewound coils—metered operation.

Rugged, clean construction.

Single knob band switching.

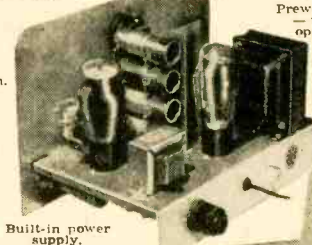

52 ohm coaxial output.

Built-in power supply.

Heathkit COMMUNICATIONS RECEIVER KIT

RF gain control with AVC or M.V.C.

Electrical bandspread and scale.

Stable BFO oscillator circuit.

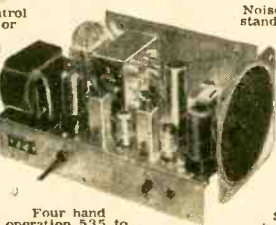

Four hand operation 535 to 35 Mc.

Noise limiter—standby switch.

1/2 inch PM Speaker-Headphone Jack.

Six tube transformer operation.

SPECIFICATIONS:

Range..... 535 Kc to 35 Mc
 12BE6 Mixer-oscillator
 12BA6 I. F. Amplifier
 12AV6 Detector—AVC—audio
 12BA6 B. F. O. oscillator
 12A6 Beam power output
 5Y3GT Rectifier
 105-125 volts A.C. 50-60 cycles, 45 watts.

A new Heathkit AR-2 communications receiver. The ideal companion piece for the AT-1 Transmitter. Electrical bandspread scale for tuning and logging convenience. High gain miniature tubes and IF transformers for high sensitivity and good signal to noise ratio.

Construct your own Communications Receiver at a very substantial saving. Supplied with all tubes, punched and formed sheet metal parts, speaker, circuit components, and detailed step-by-step construction manual.



MODEL AR-2

\$2550

Ship. Wt. 12 lbs.

CABINET:

Froxylin impregnated fabric covered plywood cabinet. Ship. weight 5 lbs. Number 91-10, \$4.50.

HEATH COMPANY
 A SUBSIDIARY OF DAYSTROM, INC.
 BENTON HARBOR 10, MICHIGAN

WHAT'S THE PE ANSWER?

Eliminating Radio Commercials

The other day I saw a gadget that cut out the commercials on FM. Can you tell me how this operates, or better, publish a drawing in one of your future issues.

ADAM F. SCHIMARISKI
Evergreen Park, Ill.

Automatic commercial eliminators for AM or FM usually operate on the principle that voice frequencies have a different energy content than music. Thus, circuits can be arranged to shut off the program when anyone is speaking, and turn it back on again when music is being received. Such a system has several disadvantages; it will not shut off singing commercials, and it will shut off desirable programs such as news reports, commentaries, etc. To the best of our knowledge, there is no true "commercial eliminator" other than a manually operated switch.

Modifying Radio for Short Waves

I have an old Philco Model 20 radio that's in very good condition, and I would like to know if I could modify it so that I can pick up short wave. From the way I look at it, I think I can, but some friends with more experience than I say I would have quite a job on my hands.

STEPHEN DI CLEMENTE
Philadelphia, Pa.

We do not recommend that you attempt to alter your present receiver so that it will receive the short-wave bands. The best answer to your problem is to use a converter that will convert the short-wave signals to a frequency which can be received on your present receiver. We hope to publish details on such a converter in the near future.

25-Cycle Operation

What I would like to know is whether the projects that appear in POPULAR ELECTRONICS operate on 50/60 cycles only. I was wondering if you have or could design an instrument that would change the frequency from 25 to 60 cycles. If not, is there any such instrument available on the market?

GEO. JEACOCK, JR.
Toronto, Ontario

Transformers designed for 50/60 cycle operation will overheat and probably burn up if used on a 25-cycle power line of the same voltage. Equipment of the a.c.-d.c. type does not contain a power transformer and so may be operated at 25 cycles. However, the lower frequency requires more filtering capability to remove the ripple from the rectified output, so it may be necessary to add inductance or capacity or both to the power supply filter.

There is no convenient, cheap method of converting 25-cycle power to 60 cycles. In some cases, it may be possible to obtain a 25-cycle transformer having characteristics similar to the 60-cycle version, particularly in Canada where 25-cycle power is more prevalent than in this country. Check with your local parts jobber.

Meter for Geiger Counter

I have just completed building the Geiger counter described in the January issue. As I have a multimeter, would you print a circuit for using the meter instead of headphones?

RODNEY PETREE
Calistoga, Calif.

We have had a number of requests for information on adding a meter and neon flasher to this Geiger counter. However, the unit was designed to be as simple and cheap as possible, and the additions requested would call for a major redesign, both electrically and mechanically. We suggest that anyone desiring a Geiger counter with a meter and neon flasher study the deluxe unit described in the July issue. We also plan to publish other designs from time to time, to give our readers a variety of instruments from which to choose.

Wireless Record Player

In the March issue of POPULAR ELECTRONICS, you have a diagram for a wireless record player. I was looking it over and it seemed to me that there would have to be an easier and cheaper way to make one. I started to work on it and came up with the one shown below.

JERRY ZALUDEK
Toronto, Canada

Thanks very much for the suggested circuit. It is being reproduced here with the thought that others may wish to try it out. Actually, there

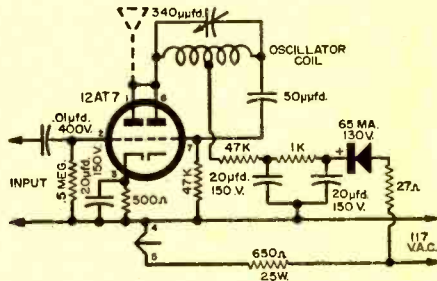

is a wide variety of designs for a wireless record player, and it is difficult to say which is best without building and testing each one. The basic principles are the same, however: an r.f. oscillator of suitable frequency and power output is amplitude-modulated by the desired audio signal—usually the output of a record player. This modulated r.f. is then picked up by a radio receiver and reproduced in the same manner as the signal from a broadcasting station.

One major disadvantage to the circuit shown above is that one side of the power line is connected directly to one side of the pickup—which can lead to a severe shock hazard.



National Schools brings you a new dimension in training for TELEVISION-RADIO-ELECTRONICS

YOU CAN LEARN BY HOME STUDY, IF—

- you are ambitious to increase your earning power.
- you want to broaden your knowledge and skill.
- you choose the school with the most complete training, service and experience.

50 Years of Successful Training

National Schools has been training men for success since 1905. Our graduates are located around the globe, in good-paying jobs in servicing, installation and manufacturing... in public and private industry, or in their own businesses.

What This New Dimension in Home Study Means to You

As a National Schools student, with Shop Method Home Training, you master *all phases* of the industry—TV, Radio, Electronics—theory and practice. You learn *HOW* and *WHY*, in one complete course at one low tuition. Age and education are no barriers.

Because our world headquarters are in Los Angeles—a "Capital City of Electronics"—we are in close touch with industry. Our lessons and manuals keep you up-to-the-minute on latest developments. We show you how to make spare time earnings as you learn, and give you free placement assistance upon graduation. Both our Resident and Home Study courses are approved for G. I. Training. If you are of draft age, your course helps you achieve specialized ratings and pay grades.

Your Course Includes Valuable Units

We send you important equipment, including a commercial, professional Multitester... plus parts to build Receivers, Oscillators, Signal Generator, Continuity Checker, other units, and Short Wave and Standard Broadcast Superhet Receiver.

Mail Coupon for Complete Information

These 2 free books explain our new dimensions in Home Training. Get illustrated fact-book and sample lesson. No obligation, mail coupon now!



NATIONAL SCHOOLS

TECHNICAL TRADE TRAINING SINCE 1905
Los Angeles 37, Calif. • Chicago 323 W. Polk St.
In Canada: 811 W. Hastings St., Vancouver, B.C.

MAIL NOW TO OFFICE NEAREST YOU!

(mail in envelope or paste on postal card)

NATIONAL SCHOOLS, Dept. R2G-85

4000 S. FIGUEROA STREET OR 323 W. POLK STREET
LOS ANGELES 37, CALIF., CHICAGO 7, ILL.

Rush FREE BOOK, "Your Future in Radio-TV-Electronics," and FREE LESSON. No obligation, no salesman will call.

NAME _____ BIRTHDAY _____ 19__

ADDRESS _____

CITY _____ ZONE _____ STATE _____

Check if interested ONLY in Resident Training at Los Angeles.
VETERANS: Give date of discharge _____

After Class

(Continued from page 89)

reproduce the low audio frequencies well and they often suffered voltage breakdowns because of the poor quality of the dielectric materials available at that time. The first problem is avoided by confining operation of the electrostatic speaker to the approximate audio range of 6500 to 15,000 cycles per second. A low frequency speaker is then required, of course, to supplement the capacitor speaker, that is, to provide reproduction over the range of 20 or 30 cycles to 7000 cycles or so. The second problem no longer exists because of the

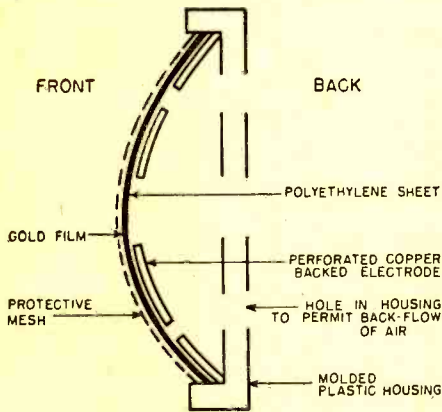

excellence of the new polyvinyls and polyethylenes which can withstand relatively high voltages without puncturing.

The illustration shows the construction of one modern type now being installed in several hi-fi "packages." The perforated copper-backed plate serves as one electrode and the gold film sprayed on the insulating foil serves as the other. The polyethylene dielectric carrying the gold film is the flexible electrode and vibrates in accordance with the applied audio voltages to produce the sound.

ANALOGS AND DIGITALS

These rather formidable titles are applied to the two types of electronic computers now in common use. The older of the two with respect to time of development is the analog type.

Any information device which accepts data in the form of physical quantities, operates upon the physical quantities, and provides an answer in terms of other quantities according to the rules of its construction may be termed an *analog* machine. An electrical wattmeter is a perfect example of an analog computer because it extracts from the electricity passing through it information concerning the magnitudes of current and voltage, takes into

account the power factor of the circuit, and computes the power consumption in the form of a meter reading which serves as a continuous indication of the circuit wattage regardless of the changes that may be taking place. Its accuracy very obviously depends upon the precision of its design and construction and upon the care taken by the operator in reading it. A slide rule is another perfectly respectable information machine of the analog type: the user translates numbers into movements of the "slip-stick" and transformations from one scale to another, while the slide rule, proceeding according to the rules which have been built into it, provides a product, quotient, square, or cube root with high or low accuracy depending upon the quality of the instrument and the caliber of the operator.

A *digital* machine, on the other hand, works only with numbers. The machine processes the numbers in accordance with the rules of arithmetic and formal logic, and expresses the answer in numerical form. A digital computer could calculate the power consumption in an electrical circuit if it were provided with the numbers corresponding to volts, amperes, and phase angle; then, following the rules implicit in this operation, it would yield the answer in watts with as high an accuracy as the original numbers possessed. The wattage reading, in contrast with the analog wattmeter, would hold only for the instant when the original current and voltage appeared. This is the reason why analog machines are said to operate in "real time" (answers given at the instant when they apply). But it should be noted that the same digital computer which just calculated power consumption may now be used to reckon the income tax of a large business firm without changes in its construction. It is simply fed different numbers upon which the machine will operate with the same high degree of accuracy. Picture a wattmeter being used to figure income tax!

Thus, analog computers are built to do a specific, highly specialized job while digital machines can handle any task that can be translated into numbers. Analogs, although having a much lower accuracy potential than digitals, operate in real time and provide continuous answers, even for data that may be constantly in a state of flux. For simple problems, analogs probably never will be replaced by digitals because they are fundamentally simpler in structure and concept, but the digital computer is the machine of the future for solving complex, tedious problems of numerical nature.



Superior's new
Model 670-A

SUPER METER

A COMBINATION VOLT-OHM MILLIAMMETER PLUS
CAPACITY REACTANCE INDUCTANCE AND DECIBEL MEASUREMENTS

SPECIFICATIONS:

D.C. VOLTS: 0 to 7.5/15/75/150/750/1,500/7,500 Volts
A.C. VOLTS: 0 to 15/30/150/300/1,500/3,000 Volts
BUTPUT VOLTS: 0 to 15/30/150/300/1,500/3,000 Volts
D.C. CURRENT: 0 to 1.5/15/150 Ma. 0 to 1.5/15 Amperes
RESISTANCE: 0 to 1,000/100,000 Ohms 0 to 15 Megohms
CAPACITY: .001 to 1 Mfd. 1 to 50 Mfd. (Good-Bad scale for checking quality of electrolytic condensers.)
INDUCTANCE: 50 to 2,500 Ohms 2,500 Ohms to 2.5 Megohms
DECIBELS: .15 to 7 Henries 7 to 7,000 Henries
DECIBELS: -6 to +18 +14 to +38 +34 to +58

ADDED FEATURE:

Built-in ISOLATION TRANSFORMER
reduces possibility of burning out meter through misuse.

The Model 670-A comes housed, in a rugged crackle-finished steel cabinet complete with test leads and operating instructions.

\$2840
NET

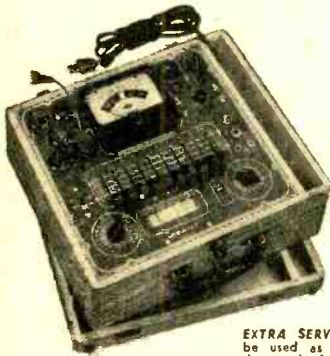

Superior's new
Model TV-11 **TUBE TESTER**

SPECIFICATIONS:

- ★ Tests all tubes including 4, 5, 6, 7, Octal, Lock-In, Peanut, Bantam, Hearing Aid, Thyatron Miniatures, Sub-miniatures, Novals, Sub-minars, Proximity fuse types, etc.
- ★ Uses the new self-cleaning Lever Action Switches for individual element testing. Because all elements are numbered according to pin-number in the RMA base numbering system, the user can instantly identify which element is under test. Tubes having tipped filaments and tubes with filaments terminating in more than one pin are truly tested, with the Model TV-11 as any of the pins may be placed in the neutral position when necessary.
- ★ The Model TV-11 does not use any combination type sockets. Instead individual sockets are used for each type of tube. Thus it is impossible

to damage a tube by inserting it in the wrong socket.

- ★ Free-moving built-in roll chart provides complete data for all tubes.
- ★ Newly designed Line Voltage Control compensates for variation of any Line Voltage between 105 Volts and 130 Volts.
- ★ NOISE TEST: Phone-jack on front panel for plugging in either phones or external amplifier will detect microphonic tubes or noise due to faulty elements and loose internal connections.

The model TV-11 operates on 125-130 Volt 60 Cycles A.C. Comes housed in a beautiful hand-rubbed oak cabinet complete with portable cover.

\$4750
NET

EXTRA SERVICE—The Model TV-11 may be used as an extremely sensitive Condenser Leakage Checker.

A relaxation type oscillator incorporated in this model will detect leakages even when the frequency is one per minute.

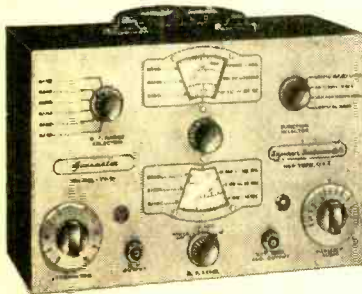

THE NEW MODEL TV-50

GENOMETER

A versatile all-inclusive GENERATOR which provides ALL the outputs for servicing:
A.M. Radio • F.M. Radio • Amplifiers • Black and White TV • Color TV

7 Signal Generators in One!

- ✓ R. F. Signal Generator for A.M.
- ✓ R. F. Signal Generator for F.M.
- ✓ Audio Frequency Generator
- ✓ Bar Generator
- ✓ Cross Hatch Generator
- ✓ Color Dot Pattern Generator
- ✓ Marker Generator

R. F. SIGNAL GENERATOR: The Model TV-50 Genometer provides complete coverage for A.M. and F.M. alignment. Generates Radio Frequencies from 100 Kilocycles to 80 Megacycles on fundamentals and from 60 Megacycles to 180 Megacycles on powerful harmonics.

VARIABLE AUDIO FREQUENCY GENERATOR: In addition to a fixed 400 cycle sine-wave audio, the Model TV-50 Genometer provides a variable 300 cycle to 20,000 cycle peaked wave audio signal.

BAR GENERATOR: The Model TV-50 projects an actual Bar Pattern on any TV Receiver Screen. Pattern will consist of 4 to 16 horizontal bars or 7 to 20 vertical bars.

CROSS HATCH GENERATOR: The Model TV-50 Genometer will project a cross-hatch pattern on any TV picture tube. The pattern will consist of non-sifting, horizontal and vertical lines interlaced to provide a stable cross-hatch effect.

DOT PATTERN GENERATOR (FOR COLOR TV): Although you will be able to use most of your regular standard equipment for servicing Color TV, the one addition which is a "must" is a Dot Pattern Generator. The Dot Pattern projected on any color TV Receiver tube by the Model TV-50 will enable you to adjust for proper color convergence.

MARKER GENERATOR: The Model TV-50 includes all the most frequently needed marker points. The following markers are provided: 189 Kc., 282.5 Kc., 458 Kc., 600 Kc., 1000 Kc., 1400 Kc., 1800 Kc., 2000 Kc., 2500 Kc., 3579 Kc., 4.5 Mc., 5 Mc., 10.7 Mc., 1519 Kc. is the color burst frequency.)

THE MODEL TV-50 comes absolutely complete with shielding leads and operating instructions. Only ...

\$4750
NET

SHIPPED ON APPROVAL NO MONEY WITH ORDER - NO C.O.D.

Try any of the above instruments for 10 days before you buy. If completely satisfied then send down payment and pay balance as indicated on coupon. No interest or Finance Charges Added! If not completely satisfied return unit to us, no explanation necessary.

MOSS ELECTRONIC DISTRIBUTING CO., INC.
Dept D-152 3849 Tenth Ave., New York 34, N. Y.

Please send me the units checked. I agree to pay down payment within 10 days and to pay the monthly balance as shown. It is understood there will be no finance, interest or any other charges, provided I send my monthly payments when due. It is further understood that should I fail to make payment when due, the full unpaid balance shall become immediately due and payable.

Model 670-A. Total Price \$28.40 \$7.40 within 10 days. Balance \$3.50 monthly for 6 months.

Model TV-11. Total Price \$47.50 \$11.50 within 10 days. Balance \$6.00 monthly for 6 months.

Model TV-50 Total Price \$47.50 \$11.50 within 10 days. Balance \$6.00 monthly for 6 months.

Name.....
Address.....
City..... Zone..... State.....

POP'tronics



BOOKSHELF

"BASIC VACUUM TUBES AND THEIR USES" by John F. Rider and Henry Jacobowitz. Published by *John F. Rider Publisher, Inc.*, New York, N. Y. 204 pages. Paper bound. Price, \$3.00.

This book is addressed to the general lay reader and the beginning technician. While covering its avowed subject thoroughly from a technical standpoint, its style and treatment manage to capture something of the "magic" of electronics that has fascinated people for more than 50 years.

The first chapter introduces the vacuum tube and traces its development from the first observations of the "Edison effect" in 1883 to present-day types. Chapter 2 is a lucid explanation of electron behavior and emission in tubes. Chapters 3, 4, and 5 deal with diodes, triodes, and multielectrode tubes respectively. For each general tube type, the authors provide an explanation of how it works.

Graphs, schematics, and animated cartoon-type drawings supplement the text. A subject index at the end of the book adds to its usefulness.



"PAY AS YOU SEE TV" by Ira Kamen. Published by *Howard W. Sams & Co., Inc.*, Indianapolis, Ind. 94 pages. Paper bound. Price, \$1.50.

The subject of subscription television has caused one of the hottest controversies raging in the current world of video. Sponsors, artists, networks, engineers, service technicians, the FCC, and the viewing public at large are all concerned and involved. The general idea behind this development is to get the home audience to pay a fee to see special types of programs, presumably non-sponsored and free of commercials.

"Co-existence" between commercial TV and subscription TV is, of course, a possibility. The audience may choose to tune in a regular channel and see what is available, or spend a small amount to operate a special attachment to a set. This accessory would be a decoding device that would permit the special show being telecast to appear on the screen. The "special shows"

planned are first-run stage hits or new movies, special events, etc.

In this book, Mr. Kamen explains the three systems that have been developed to provide subscription television. Known respectively as "Phonevision," "Subscriber-Vision," and "Telemeter," these systems are discussed and explained both from the technician's as well as the consumer's standpoint. Suitable photographs and block diagrams add to the reader's understanding of the new techniques.

Although the author is frankly in favor of subscription TV, his approach is calm and objective. Certainly, it will take as cogent a work as Mr. Kamen's to refute the case for "pay-as-you-see TV."



"ELECTRICITY" by Eric de Ville. Published by *Penguin Books, Inc.*, Baltimore, Md. 159 pages. Paper bound. Price, 65 cents.

An amazing amount of historical and technical information is presented in this compact volume. The discovery of electricity, landmarks in its development, its uses and modern applications are clearly explained. The author surveys the field from the early experiments performed at the court of Queen Elizabeth I down to the electron microscopes of our day.

More than a simple narrative account, this book actually tells how things happen. Subjects treated include magnetism, power, heat, light, communication, cathode rays, x-rays, radio, television, radar, and atomic power. Numerous line drawings, 16 pages of photos, and an index add to the book's value. Certainly, this is the best 65 cents' worth we've seen in a long time.



"TV REPAIR QUESTIONS AND ANSWERS ON FRONT ENDS" by Sidney Platt. Published by *John F. Rider Publisher, Inc.*, New York, N. Y. 132 pages. Paper bound. Price, \$2.10.

As an aid to practical servicing, *Rider* has brought out this compact volume. Included in it is material on turret-type, switch-type, and continuous-type tuners for television receivers, as well as antennas and transmission lines.

The book is arranged as a series of questions and answers. Questions cover typical problems that arise in the average TV receiver, while the answers provide step-by-step procedures for correcting defects. Many answers are followed by discussions of the problems which contain useful hints.

To help locate the answer to any specific problem, the arrangement of the book's chapters is based on the path taken by a signal entering the TV set. —30—

Printed Circuitry

(Continued from page 76)

When all lines have been scored, use the knife to cut between the copper and the base and slowly peel off the unwanted copper. Take this step slowly, since too hasty a pull may yank loose some of the copper wiring.

When the card is completely stripped, use steel wool to smooth any rough edges on the lines. That's all there is to it. Drill the holes required by the layout, using a sharp drill. Lay the copper side up and drill down for a cleaner hole. Eyelets may now be put in.

Mount the components, using the light-weight soldering iron; snip off the excess leads. Bring hookup cable through the cable hole and solder to the flea clips or eyelets as required. Insert the tube, and the printed circuit is ready for the test. If the layout is correct and all solder joints have been made properly, the set should be ready to go. If it fails to function, check the solder connections for high-resistance rosin joints which cause malfunction.

There are many other uses for printed circuits in R/C and other electronic applications. For the ultimate in receivers and transmitters, learn how to design printed circuit bases. They're simple, durable, and offer many advantages over conventional-type wiring.

-30-

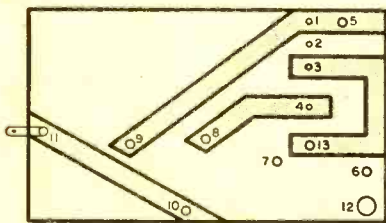

(A)

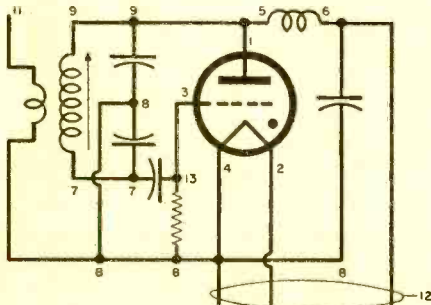

(B)

Shown in (A) is the bottom of the printed base of the "Lorenz 61" R/C receiver shown in (B). Parts are mounted on the top side.



Fix your TV Set YOURSELF!

BUY YOUR TV TUBES
AT WHOLESALE!

100% GUARANTEED! BRANDED! SAME DAY SERVICE!

1A4P	.29	6BD5	.59	7F8	.59
1A7	.49	6BE6	.39	7J7	.59
1B3	.59	6BG6	.99	7K7	.59
1B4P	.79	6BH6	.49	7U5	.49
1C6	.29	6BJ6	.49	7Z4	.39
1C7	.29	6BK7	.69	12A15	.39
1E7GT	.39	6BL7	.69	12AT6	.39
1F5G	.29	6BN6	.99	12AT7	.69
1H5	.49	6BQ6	.79	12AU6	.39
1L4	.49	6BQ7	.79	12AU7	.59
1L6	.59	6BY5G	.59	12AV6	.39
1LA6	.39	6BZ7	.79	12AV7	.69
1LC5	.39	6C4	.39	12AX7	.59
1LC6	.39	6CB6	.49	12BA6	.39
1N5	.49	6CD6	.99	12BA7	.59
1R5	.49	6CU6GT	.99	12BE6	.39
1S5	.39	6F6	.39	12BH7	.59
1T4	.49	6F7	.69	12SA7	.49
1T5GT	.69	6J6	.59	12SK7	.49
1U4	.49	6J8	.79	12SN7	.59
1U5	.39	6K6	.39	12SL7	.59
1X2	.59	6L6	.69	12SQ7	.39
2A3	.29	6N6	.69	14S7	.79
2A7	.29	6S4	.39	19B6	.99
3AGT	.99	6S8	.59	19T8	.69
3Q4	.49	6SA7	.49	25BQ6	.79
3Q5	.59	6SD7	.49	25L6GT	.39
3S4	.49	6SK7	.49	25W4GT	.39
3V4	.49	6SL7	.59	25Z6	.39
5U4	.39	6SN7	.59	35B5	.39
5V4	.49	6SQ7	.39	35C5	.39
5Y3	.29	6SR7	.49	35W4	.29
5Y4	.49	6T8	.69	35Z3	.29
5Z3	.29	6U8	.69	35Z5	.29
6AB4	.39	6V6	.49	35/51	.29
6AG5	.49	6W4GT	.39	36	.29
6AJ5	.69	6X4	.29	37	.29
6AK5	.69	6X5	.29	39/44	.29
6AL5	.39	7A4/XXL	.39	49	.29
6AQ5	.49	7A6	.49	50B5	.49
6AS5	.49	7A7	.49	50C5	.49
6AT6	.39	7A8	.49	50L6	.49
6AU6	.39	7AK7	.79	75	.29
6AV6	.39	7B4	.49	76	.29
6B7	.79	7B5	.49	77	.29
6BA6	.49	7B6	.49	80	.29
6BA7	.59	7B7	.49	117L7GT	.99
6BC5	.49	7F7	.59	117Z3	.29

Minimum Order \$7.00

25% deposit with order. Balance C.O.D. If full remittance is sent, please include postage. Excess money will be refunded. Quantity users—write for special discounts!

FREE!

with every order of \$20 or more—famous "Ox-wall" magnetic screwdriver kit. Includes all sizes—Phillips head, long handles to get in those tight spots, etc. 7 screwdrivers in all. May be purchased outright. List value \$4.89 —\$1.99 each; 3 for \$5.50.

Mail Your Order to

VIDEO

ELECTRIC COMPANY

79 CLINTON PL.

NEWARK, N. J.

Schematic Lingo

(Continued from page 45)

the window frame for an antenna, connect the phones, and presto . . . Grandpa Jones, Peggy Lee, news bulletins, and used-car commercials.

If you should accidentally touch the "A plus" lead to "B plus," the tube filament will go up like a press photographer's flash-bulb at the Miss America contest. This can be annoying, although not as serious as in the old days when tubes cost six dollars apiece.

Why "A" and "B" Batteries?

The terms "A" and "B" for batteries, for the benefit of those youngsters who were not playing with radio in the 1920's, goes back to the time when all home radio sets ran on batteries. Since "filament" and "plate supply" and such expressions did not ring bells in the minds of the general public, the battery people came up with some nice simple names having one letter each. When the family radio started to get laryngitis, you opened up the top of the cabinet (they all had piano hinges) and looked at the filaments. If they looked dim, you hauled the 6-volt storage battery off the shelf under the table and took it out for a recharge. If this didn't fix it, you had to run down to the corner radio store and exchange eight bucks for a pair of 45-volt heavy-duty B batteries.

But suppose we end the history lesson and get back to diagrams. Figure 2 is a pictorial diagram of the same circuit as Fig. 1. Now, honestly, do you still think it's simpler than the schematic?

Actually, one big trouble with pictorials is that the man drawing the diagram has less choice as to where he locates the parts. This makes for more of a tangle in the wiring. Not too bad for simple circuits like this one, it gets rapidly worse with two- and three-tube circuits, and the multiplicity of crossovers makes the wires hard to follow without a flock of colored pencils.

Wiring Schematic Preferred

A schematic, if it is drawn right, will have very few crossovers of leads. Then, there are standard conventions that help, which are followed by almost everyone: (1) stages are laid out in approximately a straight line, with the signal proceeding from left to right; (2) auxiliary circuits go below the tube they affect, e.g., in a superhet the oscillator is drawn below the mixer; (3) power supply circuits are drawn below, near the bottom of the sheet; (4) ground, filament, a.v.c., and such low-volt-

age wiring is drawn along below the tubes, while high-potential or "B plus" wiring may be drawn along above the tubes. It is hardly possible to follow these conventions in a pictorial. Each pictorial is, hence, a one-shot affair so far as learning goes. But every schematic understood, preferably redrawn, and perhaps built, is a step toward a better understanding of electronics. -30-

Transmitting Tower

(Continued from page 69)

the first step in passing any examination. *The Radio Amateur's License Manual*, \$0.50, published by *The American Relay League, Inc.*, West Hartford 7, Conn., is a complete source of this information.

It contains reprints of the FCC-suggested study guides for the three classes of amateur examinations, complete with answers. These are not the same questions that appear in the examinations, but if you can answer and understand them, you will have no trouble with the actual examination questions. Also included in the manual is a complete list of all FCC offices and examination points and the dates and times when amateur class examinations are held. Concluding the booklet is a complete reprint of all regulations governing the operation of amateur stations. The license manual is revised frequently to keep it up to date.

Companion booklets to the license manual are *How To Become A Radio Amateur*, \$0.50, and *Learning The Radiotelegraph Code*, \$0.50. The first contains constructional details for several, low-power amateur stations and much other information for the beginning amateur, including brief instructions for learning the radio code. The second booklet covers the latter more thoroughly.

The license manual is invaluable as a study guide and a source of information about the whole amateur licensing picture, and the other two booklets are quite helpful. All three are available in a small packet, *The Gateway To Amateur Radio*, for \$1.50.

Also available from ARRL is *The Radio Amateur's Handbook*, \$3.00, paper bound. It is a complete, one-volume text on the theoretical and practical sides of amateur radio. *The Radio Handbook*, \$6.00, cloth bound (*Editors and Engineers*) is somewhat similar in its coverage. Both are good, and any ham shack should contain one or the other.

Another valuable amateur study guide is the *Radio Amateur Questions And Answer*

Guide, \$0.50, published by American Electronics Co., 1203½ Bryant Ave., New York 59, N. Y. Based upon the FCC amateur study guides, the questions and answers in this booklet are arranged in the multiple-choice form used in the actual FCC examinations. Two simulated "examinations" are included to help the student decide when he is ready for the actual examination. Most students find this feature decidedly helpful.

AMECO also offers their Complete Radio Theory Course, \$3.95, paper bound, which is a home-study course in amateur radio theory. The course is complete with many tests, so that you can check your progress at frequent intervals.

These books may be ordered directly from the publishers or from the radio supply houses that advertise in POPULAR ELECTRONICS. The catalogs of the latter list other books, which you will probably wish to add to your bookshelf later, but a selection from those listed here will take care of your immediate needs.

Learning The Code

Being able to pass the technical examination is only half the battle in obtaining an amateur license. Even if you plan only to operate a voice (phone) transmitter, you must pass the required code test before you

will get a chance to display your technical knowledge. There are no exceptions to this rule.

Next month, I shall discuss how to learn the code in detail. Here, I will only say that it seldom takes more than a few weeks to master the code and the elementary theory required to qualify for a Novice license. However, the average beginner can pass the Technician/Conditional/General written examination quite a while before he can send and receive the code at a speed of 13 words per minute.

This is why the Novice license is so popular. With one, you can be on the air and making contacts while bringing your code speed up to the 13-wpm level required for a full-fledged amateur license.

Obtaining A License

There are several ways to obtain your first amateur license: (1) you can appear at an FCC examination point* and apply for a General license; (2) you can apply for a Conditional license by mail, if you live over 75 miles from any point where the FCC holds amateur license examinations at least once every three months* or are unable to appear for a General examination as a result of protracted illness or being in

*See list of addresses in the license manual mentioned earlier.

OIL CONDENSERS <table border="1"> <thead> <tr> <th>Mfd.</th> <th>Volt</th> <th>Price</th> </tr> </thead> <tbody> <tr> <td>2</td> <td>600</td> <td>39c</td> </tr> <tr> <td>7</td> <td>600</td> <td>89c</td> </tr> <tr> <td>2</td> <td>1000</td> <td>75c</td> </tr> </tbody> </table>	Mfd.	Volt	Price	2	600	39c	7	600	89c	2	1000	75c	<h2>HERSHEL'S MID-SUMMER SALE</h2>		PHOTO ELECTRIC CELL CE Vacuum Cell used in Ampro Projector—also useful for opening Garage Doors and Alarm Systems, etc.
Mfd.	Volt	Price													
2	600	39c													
7	600	89c													
2	1000	75c													
KIT 1. HARDWARE Over 1,000 pieces. 2½ lbs. of assorted RADIO & TV HARDWARE. 99¢ was \$1.49	KIT 5. RESISTORS 100 ASSORTED TYPES. Range from 1 ohm to 15 meg. ½ to 5 watt. \$175 was \$1.98	KIT 2. CERAMICONS 100 ASSORTED. ED. Range from .75 mmfd. to 6,000 mmfd. \$250 was \$3.80	KIT 6. R.F. CHOKES 25 ASSORTED. Range from .5 mh. to 25 mh. 95¢ was \$1.98												
ALL-PURPOSE FIL. TRANSFORMER For Model Trains, Welding, Transmitters, etc. PRI. 117 v. 60 cyc. sec. \$495 <table border="1"> <tr><td>6.4 v.</td><td>12A</td></tr> <tr><td>6.4 v.</td><td>10A</td></tr> <tr><td>5 v.</td><td>3A</td></tr> <tr><td>5 v.</td><td>3A</td></tr> <tr><td>5 v.</td><td>3A</td></tr> <tr><td>2.5 v.</td><td>1.78A</td></tr> </table>	6.4 v.	12A	6.4 v.	10A	5 v.	3A	5 v.	3A	5 v.	3A	2.5 v.	1.78A	MYSTERY PACKAGE ELECTRONIC PARTS The Surprise of Your Life 20 pounds of BRAND NEW USABLE GOVT. SURPLUS. \$395 Ideal gift for the ham, etc.	Kit 3. Volume Controls 25 ASSORTED. Range from 2 ohm to 3 meg. Some with switch. \$275 was \$4.75	KIT 7. TOGGLE & SLIDE SWITCHES 25 ASSORTED. DPST, DPDT, SPST, etc. \$325 was \$4.98
6.4 v.	12A														
6.4 v.	10A														
5 v.	3A														
5 v.	3A														
5 v.	3A														
2.5 v.	1.78A														
FIND YOUR KIT PARTS HERE															
TRANSFORMER —Pri. 110 V. 60 Cy. Sec. 6.3 V. 4 Amp. 95c TRANSFORMER —Pri. 110 V. 60 Cy. Sec. 400 VCT. 6.3 V. 1 Amp. 5 V. 2 Amp. 20 Ma. \$1.49 SCOPE TRANSFORMER —Pri. 110 V. 60 Cy. Sec. 4000 V. 10 Ma. \$2.95 TRANSFORMER —Pri. 110 V. 60 Cy. Sec. 600 VCT. 6.3 V. 3 Amp. 5 V. 2 Amp. 70 Ma. \$2.45 RELAY D.P.D.T. —110 VAC. 8 Amp. contacts \$1.69 RELAY D.P.D.T. —3 VDC. 11 ohm coil cont. 15 Amp. 110 V. Gold Plated 95c KEY —J38 Telegraph key 95c LIP MIKE —With Head band cord and switch \$1.29 CHOKE —2.5 Mh. 125 Ma. 35c CHOKE —1.5 Mh. 100 Ma. 15c COIL —Plug in type 4, 5, 6. Prong Type 29c OUTPUT TRANSFORMER —5V6 to 3.2 Voice Coil 39c OUTPUT TRANSFORMER —P.P. 6V6 to 3.2 Voice Coil 59c OUTPUT TRANSFORMER —50L6 to 3.2 Voice Coil 35c CHOKE —AC-DC. Type. 8 H. 80 Ma. 49c COIL —Ignition Type. Pri. 3 V. Sec. 16,000 VDC. Ideal for Photo Flash Triggering \$1.29															
HI GAIN DYNAMIC MIKE KIT Uses UTC. Transformer and Western Electric Mike. Ideal for Hams, PA. CAP, Recording, Mobile Equip. —50 DB/80-7500 CPS. \$195 Diagram Furnished.															
HERSHEL RADIO CO. Dept. M Terms: Cash with order or 25% DOWN—Balance will be shipped C.O.D. 5245 Grand River, Detroit 8, Mich. NO ORDER LESS THAN \$2.00—SHIPPED FOB DETROIT															

the service of the United States and being prevented by your official duties from appearing for such an examination—in either of the latter events, your application must be accompanied by an appropriate certification from your doctor or commanding officer; (3) you can apply for a Novice or Technician license by mail only.

To apply for any amateur license by mail, write to the nearest FCC office and request the material for the class of license you are interested in. By return mail, you will receive an application blank (form 610), a sealed envelope containing the written examination, and full instructions.

You then fill out the application blank and have it notarized. Next, a volunteer examiner gives you the code test and states on the application form whether or not you have passed it. If you have not, the examination stops there, and the application form and the unopened envelope of questions must be returned to the FCC office from which they were received.

Assuming that you do pass the code test, someone opens the sealed envelope and hands you the examination papers. After you complete the examination, he states on the application form that you did so without help. Finally, the examination papers and the application form are mailed back

to the FCC office from which they were received in the envelope supplied for the purpose.

In about a month, your new license will arrive through the mail, unless you have failed the written examination. Do not be overly discouraged, if this occurs. You can try again, after 30 days have elapsed, if you fail either part of the examination.

You choose your own code examiner for the "by mail" examination. He must hold an amateur General, Advanced*, or Extra class license, or—within five years of the test—have held a commercial radiotelegraph license issued by the FCC or have been employed in the services of the United States as an operator of a manually operated radio-telegraph station.

Most amateurs are happy to act as code examiners for the tests. Also, many amateur clubs have licensing committees for the purpose. If no other arrangements can be made, the FCC will appoint a code examiner.

The witness to the written examination must be at least 21 years old. If he meets this requirement, the code examiner can act in both capacities.

Going back a bit, you can apply for both

*The Advanced license is no longer issued, but many amateurs still hold valid licenses of this class.

LIFETIME GUARANTEED TUBES

BRAND NEW PICTURE TUBES

• RCA Licensed.			
• One Year Unconditional Guarantee.			
Type	Price	Type	Price
10BP4	\$11.90	17BP4	\$20.83
12LP4	14.38	19AP4	24.81
14BP4	16.85	21AP4	28.79
16RP4	19.38	21EP4	28.79
16LP4	19.38	24AP4	42.50

Picture Tubes shipped F. O. B. Harrison, N.J.

NEW INDOOR ANTENNA

Both UHF and VHF. Brings better reception than most outdoor antennas. Use on top of TV.

List Price \$9.95. \$3.99 each

YOUR PRICE \$3.29 each Lots of 3

FREE BONUS BOX With Every \$25 Order

- 1 RCA Cheater Cord
- 10 Assorted resistors
- 10 Assorted 2 color "blank" tube cartons
- 1 6BQ6GT tube
- 1 6AU6 tube
- 1 6CB6 tube

FREE CLOCK RADIO

With Every \$125 Purchase Within 30 Days Wake-master clock radio with famous Sessions clock movement wakes you to music or alarm. May be purchased outright from MAJOR BRAND for \$17.95. In ivory or rust.

FREE GIFT CERTIFICATE*

worth \$5 toward the purchase of any of our merchandise on future orders will be sent with any order of \$50 or more.

* Free Gift Certificate cannot be used to obtain another certificate unless order is \$65 or more.

WE PAY ALL POSTAGE on orders shipped in USA, Territories and APO's. Send only purchase price of merchandise. Please include approximate postage on foreign shipments. All orders subject to prior sale. Add 25¢ handling on orders under \$5.00. Quantity users write for special discount.

Write For FREE Tube List—Order Blank—and FREE Sample Tube Carton. We want Y-O-U On Our Mailing List!

• We guarantee to replace tubes labeled MAJOR BRAND forever • Each Tube Individually Boxed And Guaranteed For Life • Over A Half Million Tubes Always In Stock • Immediate Shipment • Free Postage On All Orders With Full Remittance.

HERE'S HOW LIFETIME GUARANTEED TUBES

SAVE YOUR MONEY

There are fewer "call backs" • There are no "out of date" tubes • "Peak Performance" testing in our fully equipped Testing Department before shipment guarantees quality.

024	.43	3CB6	.52	6AX5GT	.57	6L7	.42	788	.55	19T8	.68
1A4P	.33	3Q4	.46	6B4G	.52	6N7	.60	7E7	.70	2A4	.39
1A7GT	.43	3Q5GT	.57	6B8	.69	6Q7	.40	7F7	.59	25AV5GT	.78
1B3GT	.55	3S4	.47	6BA6	.47	6S4	.40	7F8	.70	25BQ6GT	.78
1C5GT	.41	3A4	.47	6B7	.58	6A7	.45	7G7	.75	25LQ6GT	.47
1D5GP	.43	4BQ7	.89	6BC5	.47	65C7	.48	7M7	.50	25W4GT	.43
1E7GT	.41	4BZ7	.95	6BC7	.80	65G7	.41	7J7	.75	25Z5	.37
1G6GT	.41	5AW4	.75	6BE6	.45	6S7	.43	7K7	.75	25Z6	.37
1M4G	.43	5J6	.63	6BF5	.40	6J7	.43	7L7	.75	27	.25
1M5GT	.47	5T4	.69	6BF6	.50	65K7	.45	7N7	.50	35A5	.46
1J6GT	.47	5U4G	.43	6B6G	1.15	65L7GT	.55	12AT6	.37	35B5	.50
1L4	.45	5UR	.74	6BH6	.50	65N7GT	.55	12AV7	.66	35C5	.50
1L6	.55	5V4G	.59	6BJ6	.47	65Q7	.39	12AZ7	.63	35L6GT	.47
1LA4	.57	5Y3	.31	6BK5	.68	65R7	.41	12AU6	.53	35W4	.34
1LA6	.47	5Y4G	.36	6BK7	.76	65S7	.41	12AV6	.35	35Z3	.39
1L84	.57	5Z3	.41	6BL7GT	.75	6T4	.95	12AV6	.35	35Z5GT	.34
1LC5	.49	6A7	.57	6BN6	.58	6TR	.68	12AV7	.67	37	.29
1LC6	.47	6AR	.45	6BQ6GT	.63	6U8	.42	12AX7	.58	50A5	.46
1LD5	.57	6AR4	.43	6BQ7	.78	6V3	.80	12AX7	.58	50B5	.50
1LE5	.57	6AC7	.67	6BY5G	.58	6V6GT	.46	12B4	.68	50C5	.50
1LG5	.57	6AF4	.79	6C6	.39	6W4GT	.39	12B6G	.46	50L6GT	.43
1LM4	.64	6AG5	.50	6C4	.37	6W6GT	.53	12BD6	.48	75	.42
1LN5	.57	6AH6	.69	6C5	.35	6X4	.34	12BE6	.46	76	.38
1N5GT	.50	6AH6	.69	6C6	.36	6X6	.73	12BH7	.60	77	.38
1R5	.50	6AJ5	.70	6CD6G	1.15	6X8	.45	12C6	.95	78	.38
1S5	.42	6AK5	.54	6D6	.48	6Y6G	.55	12BZ7	.61	80	.34
1V2	.65	6AL5	.45	6E6	.48	7A8	.45	12C6	.95	84, 6Z4	.44
1U4	.47	6AQ5	.46	6F5	.37	7A5	.53	12C7	.45	117L7GT	1.09
1U5	.42	6AR5	.46	6F6	.38	7A6	.45	12J7	.45	117P7GT	1.09
1V2	.65	6AS5	.46	6G6	.40	7A7	.43	12SK7	.45	117Z3	1.09
1X2	.61	6AS6	1.70	6H6	.39	7A8	.45	12SN7GT	.45	117Z6GT	1.09
2A3	.55	6AS7G	2.19	6J4	1.79	7B5	.39	12SQ7	.37	117Z6GT	1.09
2A5	.55	6AT6	.39	6J5	.39	7B6	.42	12SR7	.45	117Z6GT	1.09
2A7	.55	6AU4GT	.65	6J6	.41	7B7	.45	12SVGT	.45	117Z6GT	1.09
3A4	.51	6AUSG	.59	6J7	.43	7B8	.45	12X4	.37	117Z6GT	1.09
3AL5	.50	6AU6	.42	6J8G	.85	7C4	.39	14A7	.42	117Z6GT	1.09
3AL5	.43	6AU6G	.65	6J8	.85	7C5	.42	14B6	.38	117Z6GT	1.09
3AV6	.46	6AV5GT	.65	6K7	.39	7C6	.43	14B7	.50	117Z6GT	1.09
3AV6	.54	6AV6	.39	6K8	.65	7C7	.45	14Q7	.50	117Z6GT	1.09
3B6G	.70	6AX4GT	.60	6L6	.68	7E5	.45	19B6G	1.15	117Z6GT	1.09

This Ad Is Worth M-O-N-E-Y
Clip out this ad and attach it to your order. Three 65N7GT's will be shipped FREE with any order of \$10 or more.

MAJOR BRAND TUBE CO.

Romano Bldg., ESsex 4-1106 Harrison, N. J.

the Novice and Technician licenses at the same time, or you can first obtain a Novice license and later obtain a Technician license. Carrying the thought a step further, if you hold a Technician license and are eligible for a Conditional license, you can obtain it by passing the 13-wpm code test.

If you are not eligible for a Conditional license, you will not have this latter option. Even if you already possess a Technician license, you still must take the entire examination when applying for a General license. Fortunately, if you can pass the written examination once, you certainly can do it again.

Incidentally, the procedure for taking the General examination is practically the same as that for the "by mail" examinations, except that it is given by FCC examiners in an FCC office.

News And Views

Each month, this part of the *Transmitting Tower* will contain news for and about you. Write and tell us about your amateur experiences. How many states and how much DX have you worked? What kind of equipment do you use? What is your favorite band? What would you like to know about other amateurs?

All letters received will be carefully read and, to the limit of the space available, the more interesting ones will be printed. To permit using more of them, those selected will be condensed where possible.

In addition, the column can use good, sharp pictures of you and your equipment similar to those used this month. Preference will be given to pictures of simple installations; however, an occasional picture of a "de luxe" amateur station will be printed to give those just starting out something to dream about.

In keeping with the theme of this first column, I am including the addresses of two radio clubs that conduct regular classes to help prospective amateurs obtain their licenses. They are the *El Ray Radio Club* and the *Watauga Amateur Radio Club*.

For information on the *El Ray Radio Club* classes, contact Bill Welsh, W1SAD, 1228 Cambridge St., Cambridge 36, Mass.; this club turns out 20 to 30 new amateurs a month. For information on the *Watauga Amateur Radio Club* classes, contact Mark C. Green, KN4ARZ, Secretary, Box 582, Johnson City, Tenn.; new classes start every three months.

Future *Transmitting Towers* will publish the names of other clubs and individuals offering help to prospective amateurs.

I'll be waiting for you on the same corner next month. Until then, 73, Herb, W9EGQ.

-50-



As Much As
50%
SAVINGS
With WRL!
Here's
Just A Few

In our stock of over 600 reconditioned items, protected by our 90 day, **New** guarantee . . . and of special interest to beginners!

Heath AT-1 (CW) Xmtr.	\$24.95
Hallcrafters HT-17 (CW) Xmtr.	29.95
Lettine 240 (Fone and CW) Xmtr.	49.50
Stancor ST203A (Fone and CW) Xmtr.	29.95
Stancor ST202A (CW) Xmtr.	79.00
Hallcrafters S-38, S-38A	27.50
Hallcrafters S-38C	35.00
National SW-54	29.95

Send for our complete recond. equip't. list today!

"It's Easy to do Business with WRL!"

EVERYTHING IN HI-FI EQUIPMENT!

Players ★ Amplifiers ★ Tuners ★ Speakers
Microphones ★ Tape Recorders

"Personalized Engineering Service"

Send for **FREE Hi-Fi Booklet . . . TODAY!**

65 watt
GLOBE SCOUT
Completely
Bandswitching



The ideal transmitter for novice or stand-by Xmtr. Fully bandswitching. 160 thru 10M., 65 watts CW, 50 watts on fone. Metering provided. PI Network antenna tuner. Self-contained power supply. May be used mobile; provisions for dynamotor attachment. 100% modulation of Final. TVI screened cabinet. Compact: 8"x16"x8".

only
\$7.95
per month
Pay \$10.00 Down
Cash: \$99.95

IMMEDIATE DELIVERY



WORLD RADIO LABORATORIES



PE-8

"The World's Most Personalized Radio Supply House"

Please rush me your:

FREE 1955 Catalog
 FREE Hi-Fi Booklet

And full information on:

Globe Scout
 Wall Radio Map (25c)

Reconditioned Equipment List

Address to:

3415 W. Broadway Council Bluffs, Iowa

Name: _____

Address: _____

City and State: _____

TOOLS

& GADGETS

MORE HEAT FROM SOLDERING GUN

The new "Primax" soldering gun reaches soldering heat in less than six seconds. Rated at 60 watts, it is said to provide heat equivalent to 120 watts. Another feature is its unbreakable plastic handle. Weight of the new gun is 1 lb., 11 oz. The alloy tip of the "Primax" requires no filing and is said to last indefinitely in normal

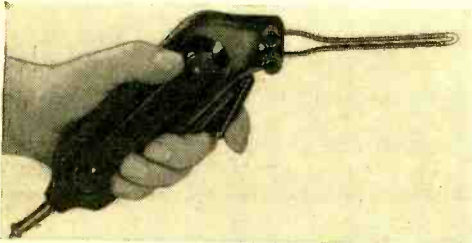

use. Wiping it with a rag or paper restores its tinned luster. Grip and trigger control are balanced to provide for convenient operation. Furnished in a pouch, the gun is available for either 110 volts or 220 volts, a.c. For further information, write to the manufacturer, *Paul C. Roche Co., Inc.*, 11 Park Place, New York 7, N. Y.

INSULATING CONNECTOR

Insulated joints between wires are made quickly and positively with the *Ideal* crimp connector which is furnished with "Wrap-Cap" insulation. It has two parts: a sleeve and an insulating cap. Both parts are listed by *Underwriters' Laboratories, Inc.* for general use in branch circuits and fixture wir-

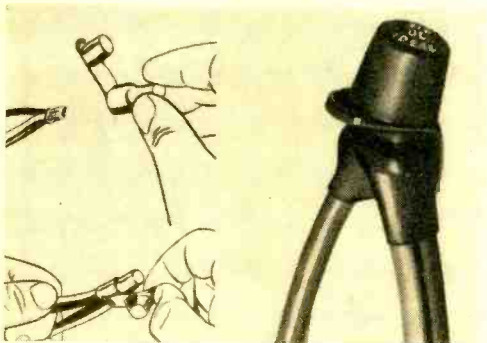

ing. No tape is required. This new connector insulates all around the joint and between the wires. The resulting insulation is said to have a higher dielectric strength

than the insulation on the wires themselves. For further information, write to the manufacturer, *Ideal Industries, Inc.*, Sycamore, Ill.

CIRCULAR SLIDE RULE

A circular slide rule, designed for users with limited mathematical training, has been announced by the *Lithocalculator Co.*, 31 St. Joseph St., Arcadia, Calif. Computations are made by dialing in the numbers with a movable cursor. The answer never runs off the scale, and is always read at the same stop position on the "Answer Dial." Trigonometric scales are included on the back. This unit retails for approximately \$10.00. For further information write to the manufacturer.

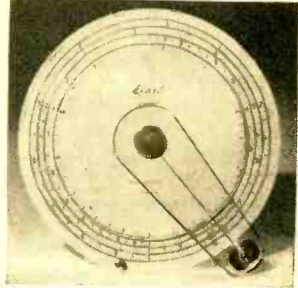

"TWISTUBE" FOR COLOR TRANSMISSION

With the advent of color television, the question of adequate antennas and transmission lines is beginning to take on added importance. Interference and ghost images

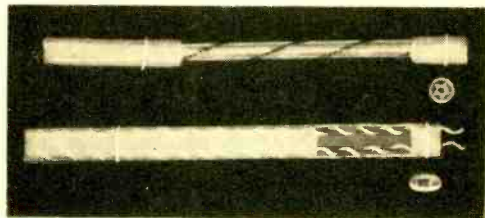

are even more disturbing in color reception than in black and white. "Twistube" is a new type of transmission line especially designed to reduce interference pickup automatically.

"Twistube" is transposed around a star-shaped air-spaced former to equalize the capacity of both conductors. It is said to give perfect reception—whether for color or black and white—in distances ranging up to 105 miles, even under the most difficult fringe area conditions. It features uniform low capacitance and attenuation.

"Twistube" is manufactured by *Fenton Company*, 15 Moore Street, New York 4, N. Y., and is distributed through jobber channels.

SPRING WINDER A HANDY TOOL

A versatile tool is the new "Speedex Spring Winder," developed by *General Cement Mfg. Co.*, 919 Taylor Avenue, Rockford, Ill. Claimed to be very easy to

use to make any desired spring, this novel device should find a growing acceptance by tool rooms, maintenance departments, experimental or engineering groups, and automotive mechanics.

Any type of spring, any number of coils and any pitch desired can be turned out on the spring maker, using any size wire and forming any diameter spring. Also, both compression and extension springs are possible. The winder fastens to any bench, and a simple screw adjustment varies the pitch instantly.

The "Speedex Spring Winder" (Catalogue No. 5209) carries a net price of

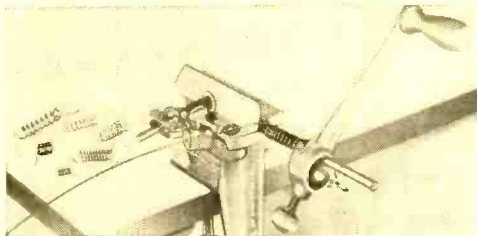

\$14.95, complete with an assortment of spring wire. Additional information is available from the manufacturer.

SNAP-AROUND VOLTAMMETER

The "Amprobe Junior" is a snap-around ammeter that measures current instantly

without shutdowns or ammeter connections. It is also a voltage meter which gives an accurate voltage reading on a full-size 1.8" calibrated scale. Accuracy for both amperage and voltage is within 3% of full scale. The user can choose the model that fits his particular job. Ranges are available up to 100 amperes, a.c. and 250 volts, a.c.



Other features include a 3" d'Arsonval high-torque movement with an Alnico 5 magnet. Probe jaws are completely insulated, and tapered for hard-to-get-at wires. Transformer joints are dove-tailed. The meter is pocket-sized and is shaped and balanced for one-hand trigger operation. To measure current without ammeter connections, the device's jaws are snapped around one conductor (insulated or uninsulated). To measure voltage, the test

TELTRON TUBES

Guaranteed! Lowest Prices Ever!

All tubes individually boxed . . . unconditionally guaranteed for one year.

GIFT OFFER!
One 6BG6G tube will be shipped FREE with any \$10 order accompanying this ad.

FREE!

\$7.20 list value Bonus Box of three 6SN7 tubes and 25 assorted resistors with each order of \$25 or more.

SAME DAY SERVICE
48 hour Postal Delivery to West Coast

SPECIALS!

Till September 1

Type	Reg.	Special
OZ4	.45	.39
1B5GT	.62	.59
1R5	.51	.47
354	.48	.44
5U4G	.43	.39
6AG5	.52	.48
6AL5	.43	.38
6BA6	.56	.45
6BQ6GT	.83	.72
6J6	.61	.42
6K6GT	.39	.35
6SN7GT	.60	.55
6V6GT	.48	.42
6W4GT	.43	.35
12AT7	.75	.66
12AZ7	.61	.54
12SN7GT	.56	.49
25L6GT	.41	.37
35L6GT	.41	.37
50L6GT	.50	.45

NEW LIBERAL

TERMS!

No minimum order. All postage paid on orders over \$10.00 in U.S.A., A.P.O.'s and Territories. 10% deposit on C.O.D.'s to our Canadian and foreign friends. Please send approximate freight, excess will be refunded. Orders subject to prior sale.

WE WANT NEW

ACCOUNTS

If you are rated, your credit is good with us. We are "Eico" distributors. Write us about special deals on test equipment.

FREE BONUS OFFER!



Model 625K

- Illum. gear-driven "Speed Ratchet"
- New lever-action switches for individual testing of every element
- Tests all conventional and TV tubes

This Eico Tube Tester is yours FREE when you buy \$199 worth of tubes or more within 60 days at Teltron. May be bought outright from Teltron for \$34.95.

TYPE	PRICE	TYPE	PRICE	TYPE	PRICE	TYPE	PRICE	TYPE	PRICE
1A7GT	.53	6AT6	.37	6D6	.59	7N7	.52	25W4GT	.43
1H5GT	.51	6AU6GT	.60	6E5	.60	12A7E	.37	25Z5	.55
1L4	.51	6AU6	.43	6F5	.44	12A7U	.58	25Z6GT	.36
1L6	.51	6AV5GT	.60	6F6	.42	12AV6	.42	35A5	.48
1LC6	.49	6AV6	.37	6H6	.50	12AV7	.73	35B5	.48
1N5GT	.51	6AX4GT	.60	6J5	.49	12AX4GT	.60	35C5	.48
1S5	.43	6AX5GT	.60	6K5	.60	12AX7	.61	35W4	.33
1T4	.51	6BA7	.58	6K7	.40	12B4	.72	35Y4	.42
1U4	.51	6BC5	.48	6L6	.78	12B6	.46	35Z3	.41
1U5	.43	6BC7	.75	6Q7	.40	12B7	.58	35Z5GT	.33
1X2	.65	6BE6	.46	6S4	.41	12BE6	.46	37	.59
3A5	.65	6BF5	.48	6S8GT	.65	12BH7	.61	43	.55
3Q4	.53	6BF6	.48	6SA7	.45	12BY7	.65	45	.55
3Q5GT	.61	6BG6G	1.18	6SK7	.45	12H6	.50	50A5	.48
3V4	.48	6BH6	.51	6SJ7	.45	12J5	.40	50B5	.48
5R4	.95	6BK5	.51	6SQ7	.40	12K7	.40	50X6	.53
5V4	.49	6BK6	.75	6T8	.71	12Q7	.48	75	.44
5Y3	.30	6BK7	.78	6U8	.76	12Q7	.45	77	.55
5Y4G	.37	6BL7GT	.78	6V3	.80	12S7	.45	80	.40
6A8	.40	6BN6	.90	6W6GT	.53	12SK7	.45	84	.46
6AB4	.43	6BQ7	.85	6X4	.37	12SL7	.60	117GT	1.20
6AC7	.65	6BY5G	.60	6X5GT	.38	12SQ7	.38	117L7GT	1.20
6AH4GT	.65	6BZ7	.95	6X8	.80	14A7	.43	117N7GT	1.20
6AF4	1.02	6C4	.41	6Y6G	.61	14B6	.36	117P7GT	1.20
6AK5	.96	6C5	.46	7A8	.46	14Q7	.52	117Z3	.33
6AQ5	.48	6CB6	.51	7C5	.44	19B6G	1.48	117Z6GT	.65
6AR5	.48	6CD6G	1.63	7F7	.59	19T8	.71	1629	.39
6A55	.52	6CU6	.95	7F8	.77	25BQ6GT	.82		

We have thousands of tube types too numerous to list here. On ordering types not listed take 75% off current list price for cost of tube.

TELTRON ELECTRIC COMPANY

428 HARRISON AVE.

DEPT. PE-8

Phone HUmboldt 4-9848

HARRISON, N. J.

leads are plugged into the instrument and clipped to the load. For additional information, write to the manufacturer, *Pyramid Instrument Corp.*, 630 Merrick Rd., Lynbrook, L. I., N. Y.

POCKET-SIZE MAGNIFIER

The "Precision-Vision 5-Power Magnifier" consists of: an all-aluminum frame—



2" in diameter and 3/4" in thickness—in a black crinkle finish to eliminate reflections; and two individual optical-ground, polished, 1 1/8" lenses. These lenses are press-locked into ingenious mountings, making them absolutely dustproof and breakage-resistant. The two lenses are separated by an air space, precision-set to bring about powerful magnification.

This magnifier is light in weight and can be easily carried in a pocket. Retailing at \$3.50, it is made by *S. B. Logan & Co.*, Genoa City, Wis. For descriptive literature, or to order, write direct to the manufacturer.

LOW-COST MITER

Announced by the *Dresden Manufacturing Co.*, 2375 Walnut Ave., Long Beach, Calif., the "Tru-cut Magnetic Miter" is said to be both lightweight and accurate. This new miter, designed for the do-it-yourself home handyman and professional carpenter alike, is priced at \$2.95. It embodies many features heretofore found only on more ex-

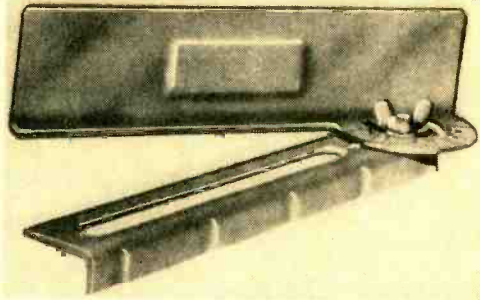

pensive miters. Easily adjustable to any angle, it can be folded to pocket size or left on the saw blade.

SAVE UP TO 90% OFF LIST PRICES ON PARTS and TUBES

For every dollar you spend for parts or tubes you'll receive a coupon redeemable for FREE gifts! These gifts include: Electrical Appliances, etc! Use them in your own home or sell them over the counter! Send for FREE PREMIUM CATALOGUE. But better yet place your order NOW. Start collecting these valuable coupons:

- All tubes individually boxed
- All tubes RTMA guaranteed for one full year
- Same day service

Several or one of these brands will be supplied on your order. Hallicrafters, Admiral, Stewart-Warner, Zenith, Emerson, Philco, Stantron, Crosley, Motorola, Sonora, American, Muntz.

TYPE	PRICE	TYPE	PRICE	TYPE	PRICE	TYPE	PRICE
O2A	.45	6A55	.50	6S07	.43	12SL7GT	.69
183GT	.79	6A56	2.00	6SH7	.45	12SN7GT	.60
1L4	.56	6A57G	2.25	6SJ7GT	.45	12SQ7GT	.44
1L6	.60	6A7G	.40	6SK7	.50	14A5	.59
1L4A	.66	6AU5GT	.70	6SL7GT	.70	14A7	.45
1L8A	.68	6AU6	.48	6SN7GT	.60	14B6	.40
1L6G	.68	6AV5GT	.85	6SQ7GT	.44	14Q7	.52
1L05	.66	6AX5GT	.59	6WG6T	.48	19B6GG	1.18
1L3	.66	6B4G	.90	6WAGT	.60	19J6	.66
1L6S	.66	6B8A	.49	6W6	.60	19T8	.70
1R4	.66	6B8CS	.55	6W6GT	.56	25A7GT	1.50
1LNS	.49	6B8E	.50	6XA	.35	25AV5GT	.80
1NSGT	.55	6B8GG	1.18	6X5	.39	25BQ6	.98
1R5	.67	6B8HG	.81	6K5GT	.65	25BQ6GT	.90
154	.65	6B8J6	.49	6K8	.75	25V5	.45
154	.65	6BK5	.70	6Y6G	.33	25Z5	.38
155	.65	6BK7A	.78	7A4-XXL	.47	25Z6GT	.42
175GT	.65	6B07A	.80	7A5	.55	35A5	.48
1U4	.50	6B17GT	.77	7A6	.47	35B5	.52
1V	.57	6B06GT	.88	7A7	.45	35C5	.51
1X2A	.79	6B07A	.80	7A8	.46	35L6GT	.48
2D21	1.00	6B27	.90	7B5	.41	35W4	.39
2V3G	.80	6B75G	.60	7B7	.43	35Y4	.40
2X2A	1.00	6C4	.39	7B8	.47	35Z3	.41
3D6	.45	6C5	.38	7C4	.40	35Z5GT	.39
3LF4	.80	6C6	.50	7C5	.44	50B5	.52
3Q4	.62	6C86	.55	7C6	.45	50C5	.51
3Q5GT	.63	6D6G	1.18	7F8	.70	50L6	.48
3V4	.65	6D6	.50	7Y4	.35	50L6GT	.45
5T4	.70	6E5	.46	12AT6	.46	50S5	.44
5U4G	.49	6F6	.40	12AT7	.68	77	.39
5V4G	.71	6H6GT	.40	12AU6	.46	77	.39
5Y3GT	.39	6J4	2.00	12AU7	.60	78	.39
5Y4G	.43	6J5GT	.40	12AV6	.46	80	.35
5Z3	.47	6J6	.49	12AX7	.70	80	.35
5Z4	.54	6J7	.45	12AY7	.90	83V	.60
6A7	.59	6K7	.40	12B6	.48	117L7GT	2.00
6B8	.59	6K6GT	.39	12B4	.70	117N7GT	2.00
6A8A	.48	6L7	.44	12B6G	.50	117P7GT	2.00
6A8F	.80	6N7	.61	12BH7	.70	117P7GT	2.00
6A8S	.56	6Q7	.45	12BY7	.68	117Z3	.37
6A8G	.80	6S4	.48	12SA7	.52	117Z6GT	.65
6AK5	.80	6S7G	.47	12SH7	.47		
6AL5	.44	6S7GT	.50	12SJ7GT	.50		
6AL7GT	.70	6S7	.50	12SK7	.50		

PARTS SPECIALS TILL SEPT. 1ST

Picture Tube BRIGHTENER
Lots of 3 \$1.19
\$1.29 ea.

Unconditionally Guaranteed CONDENSERS
\$1.57

Molded Tubulars:
.001 MFD—600 V 10c ea.
Lots of 10, 8c ea.
.01 MFD—600 V 12c ea.
Lots of 10, 10c ea.

4" PM SPEAKER
With Matching Output Transformer. Alnico former. Alnico in 5 magnet. Output transformer matches 50L6, etc.
\$2.99 ea.

RESISTOR KIT
100 asstd. resistors in most wanted ohm's. RMA coded in 1/2, 1 2 watt. List \$12.50! 99c ea. Kit.

70° COSINE YOKES KIT
Popular yoke deflection yoke. New cosine type for anti-astigmatic focusing. Complete with leads. List \$10.30! \$2.99 ea.

CERAMICON KIT
Assortment of 50 ceramic condensers. Popular sizes. List price \$10. Lots of 5, \$1.85 ea. Singly \$1.99

21" TV SET
TABLE MODEL
Reg. \$149.95.
\$115

Tube Specials! Till Aug. 1
175GT
1U4
1V
1X2A
2D21
2V3G
2X2A
3D6
3LF4
3Q4
3Q5GT
3V4
5T4
5U4G
5V4G
5Y3GT
5Y4G
5Z3
5Z4
6A7
6B8
6A8A
6A8F
6A8S
6A8G
6AK5
6AL5
6AL7GT

AC-DC SUPER-HET JEWEL 5-TUBE RADIO
Terrific buy! Special Stanley price! Reg. list price \$22.95!
\$14.95

39c EACH

FREE with each \$25 or more order! S-Pc. Sylvania Repair Kit. Value \$4.95. Includes: flashlight head, Phillips screwdriver, flat head screwdriver, alignment tool and polystyrene case.

FREE with EVERY order regardless of size! Combination kit of resistors, condensers, volume control and line cords—retail value \$2.95.

Special Purpose Transmitting and Cathode Ray TUBES
Send for parts and tube listing.

TERMS: 25% deposit required on all orders, balance COD. Orders under \$5.00, \$1 service charge. Postage paid in USA on all orders accompanied by full remittance. All unused money refunded with order.

OPEN ACCOUNT TO RATED FIRMS

Dept. PE-8

Stanley ELECTRONICS CORP.
935 MAIN AVENUE - PASSAIC, N. J.

GRegory 1-2498

TIPS and TECHNIQUES

NEW USES FOR TV CONNECTORS

Small polystyrene plugs and sockets used for connecting TV transmission lines can be handy aids to the radio builder and experimenter. The photo shows how a pair of them may be stacked and fastened to a breadboard by a thin aluminum strip. Thus mounted, they serve as a receptacle for the power plug, which is another pair held together by cellophane tape. This method of

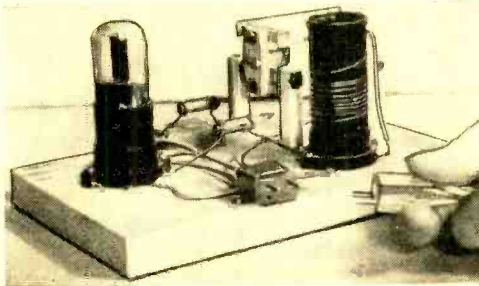

pairing plug and socket provides correct polarization.

Another use for these units is in conjunction with headphones. Frayed ends of headphone cords are often difficult to attach to a plug. The setscrews in these TV plugs will hold the ends neatly, and the other half of a plug can serve as a jack. A third use is for plugging in meters. Cheap and readily available, these plugs provide for quick and easy shifting of leads wherever necessary.

"THIRD HAND" FOR SOLDERING

Small metal components, plugs, adapters and connectors are notoriously hard to solder. They tend to slide all over the workbench with every touch of the soldering iron. If they are clamped in a vise, the heavy mass of metal absorbs too much heat, resulting in weak "cold" soldered joints. An easily assembled "third hand" that will make small parts soldering a cinch is shown in the photograph on page 110.

A 10" x 12" piece of plywood or hardboard is used as a base. Mount a 4" to 6" section of 1 x 2 stock in the center of the baseboard, using either wood screws or nails and glue. Two spring-type wooden



BUILD YOUR OWN GEIGER COUNTER

with ALLIED'S exclusive SUPER-VALUE KIT!

only \$15⁹⁵



it's easy to build this low-cost KNIGHT URANIUM LOCATOR & RADIOACTIVITY DETECTOR

Get started in uranium prospecting now with this extremely sensitive instrument—comparable in quality to costly equipment, yet easy to build at only a fraction of the price. It's simple to operate; just turn it on, flip the high voltage switch and listen to the clicks in the headphone when you hit a radioactive source. Uses low-cost long-life batteries. Kit includes all parts, case with handle and leather shoulder strap, tubes, 22½ and 1½ volt batteries, AEC prospecting booklet, radioactive sample and headphones. Complete instructions. 6¾ x 5¼ x 2¼". Shpg. wt., 2½ lbs. More sensitive than units selling at several times this low price.

83 S 242. Geiger Counter Kit. Only.....\$15.95
80 J 663. Extra Battery Kit. Only.....\$ 1.07

FREE

ALLIED'S BIG-VALUE SUPPLEMENT



Send for our latest Supplement packed with big values and new releases in builders' kits, High Fidelity systems and components, P.A. Systems, recorders, test instruments, TV accessories, electronic parts, tubes and tools. Save money—order from the world's largest stocks of Electronic supplies.

ALLIED RADIO

ALLIED RADIO CORP., Dept. 79-H-5
100 N. Western Ave., Chicago 80, Ill.

- Send FREE ALLIED Supplement No. 148.
- Send Kit No. 83 S 242 \$..... enclosed.

Name _____

Address _____

City _____ Zone _____ State _____

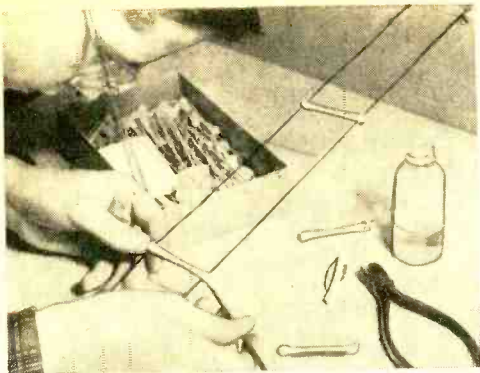

wave kit. No. 18 enameled wire will work for an open line used for reception or low-power transmitting. Its diameter, .040", is just right to slip snugly through the notches in the ends of most curlers of this type. If the hole is obstructed, ream it with a #60 twist drill.

To assemble the line, secure the two wires on nails driven 2" apart, stretch out the desired length, then string on the plastic "spreaders." To hold the spreaders in place, use a dab of polystyrene cement on each end. The "characteristic impedance" of this line will be about 550 ohms; and although this will not match the usual TV antenna or receiver, a great improvement in stormy-weather reception is often real-

ized with open line. If a "high-impedance" antenna, such as a "rhombic" is used, operation should be improved over conventional line performance in all weather, due to better matching.

ALLIGATOR CLIPS ACT AS CLAMPS

Alligator clips may double as clamps on small gluing or cementing jobs. The photo shows four clips holding the cardboard ring

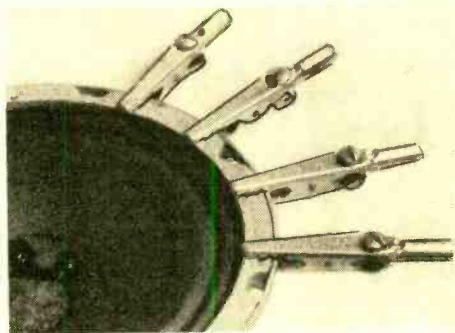

that has been recemented to the speaker frame. These clips may be similarly used on small pieces in model making.

QUICK CONNECTIONS

In experimental work, it is often necessary to connect phone cord tips to wires, lugs, terminal screws, and so on. Quick and secure connections are needed. One way

LAFAYETTE POPULAR ELECTRONICS KITS!

HEADQUARTERS FOR
HARD TO GET PARTS FOR KITS -
WE HAVE THEM!

NEW! LORENZ R/C RECEIVER KIT WITH PRINTED CIRCUIT

The new LORENZ R/C Receiver Kit with PRINTED CIRCUIT BOARD. Complete Kit with Raytheon 6X4 tube, Sigma Relay, Printed Circuit Board; Chassis and all other parts as described in POPULAR ELECTRONICS.

KT-52 17.85

LORENZ R/C TRANSMITTER KIT

Complete parts, tube, crystal and batteries as described in December 1954 POPULAR ELECTRONICS.

KT-54 Net 19.75

TRANSISTOR RADIO KITS

TRANSISTOR RADIO RECEIVER KIT:

1 2-gang Variable Condenser; 1 Crystal Diode 1N64; 1 .02 Mfd Condenser; 1 220K Resistor; 1 G.E. 2N107 Transistor; 1 Loopstick; 1 Dynamic Ear Phone

KT-51 Net 5.22

TWO TRANSISTOR RADIO RECEIVER KIT

1 Loopstick; 1 2-gang Variable Condenser; 2 G.E. 2N107 Transistors; 1 Volume Control with Switch; 1 Transistor Audio Transformer; 1 100K Resistor; 1 10 mfd Condenser; 1 Dynamic Ear Phone.

KT-50 Net 9.74

TRANSISTOR CODE PRACTICE KIT:

1 G.E. 2N107 Transistor; 3 Resistors; 1 Volume Control; 2 .01 mfd Condensers; 1 Telegraph Key; 1 Dynamic Ear Phone; Batteries.

KT-49 Net 5.33

Write For Brochure on TRANSISTOR KITS

700 VOLT GEIGER COUNTER
DESCRIBED IN POPULAR ELECTRONICS

COMPLETE PARTS including AMPREX GEIGER TUBE FOR SIMPLE COUNTER as described in POPULAR ELECTRONICS JULY 1955.

KT-55 Net 27.95

COMPLETE ADDITIONAL PART FOR DELUXE KIT

KT-56 Net 16.25

MAKE YOUR OWN PRINTED CIRCUIT NOTHING ELSE TO BUY!

Our Inexpensive Etched-Wire Kits Contain: Laminated Copper Boards (XXX-P); Printed Circuit Tube Sockets; Copper Etching Material and Instructions; Etch-resistant material for Circuit layouts; Eyelets and drill for connections; Scaled layout sheets for making your own or standard Printed Circuits. All Kits Are Supplied with Plastic Case

5001P—BASIC KIT : 5003P—SERVICEMAN & TECHNICIANS' KIT

- : Contains a complete assortment of materials needed to make a variety of different Printed Circuits. Circuit Diagrams include Multimeter and 1-tube Receiver.
- : Only **3.95**
- : Contains three times the material of Kit 5001P with special Sockets, Connectors and Double-faced Copper Boards.
- : Only **9.75**

5004P—PRODUCT DESIGNERS' KIT

This special Kit enables the Manufacturer and Laboratory to make a pilot run of etched wire Printed Circuits with his own staff and facilities. Contains all the latest information, materials and methods for adapting your product to mass production techniques.

25.00

CDS—PHOTOCELL KIT with PRINTED CIRCUIT BOARD

Complete Kit with PRINTED CIRCUIT BOARD; CDS photocell tube, Sigma Relay, chassis and all parts as listed in POPULAR ELECTRONICS.

KT-53 Net 13.95

Lafayette Radio DEPT. IH Write for FREE Catalog!

BROOKLYN, N.Y. 542 E. Fordham Rd.
NEWARK, N.J. 24 Central Ave.
PLAINFIELD, N.J. 139 West 2nd St.
BOSTON, MASS. 110 Federal St.

100 SIXTH AVE. NEW YORK, N.Y.
Include postage with order.

FIND URANIUM REWARDS EASIER with
The Only COMPLETELY
TRANSISTORIZED
MIRACLE GEIGER COUNTERS*

- Sensitivity: Indicates full scale on background count
- Completely transistorized power supply*
- NO VIBRATORS
- NO TUBES
- NO REPAIRS
- FEATHERWEIGHT
- ALMOST INDESTRUCTIBLE
- WEATHERPROOF



MIRACLE TRANSISTORIZED AUDIO

—available separately at \$15.
 —adapts to ALL geiger counters
 Amplifies detection clicks 10 times.
 Single 15c flashlight cell. 12 ounces.
 Size of cigarette pack cubed. Replaces bulky, irritating earphones.
 No drain on expensive gelger batteries—pays for itself in short time!

Walking Stick #UAC 402: \$99.50

(with scabbard). 40" x 2" overall. Weighs less than 3 lbs. Over 1,000 hours continuous use on 2-15c flashlight cells! Includes Universal's Transistorized Audio* & flashing neon light. Aluminum shield for beta discrimination.

Gun Type #UAC 411: \$149.50

(with holster). Weighs less than 4 lbs. Over 500 hours of continuous use on 2-15c flashlight cells! Includes Universal's Transistorized Audio* built-in, and newly designed full view, free swing ratemeter with 3 ranges. Aluminum shield for beta particle discrimination.

UNCONDITIONALLY GUARANTEED

All instruments sold by UAC are tested and approved by our scientific laboratory. Send your check or money order (we pay shipping) or send 25% (we ship COD, FOB N.Y.C.). Specify single or double Jack if ordering audio separately. Write for free information on uranium prospecting and instruments from \$19.95 to \$4995.

*pat. applied for

UNIVERSAL ATOMICS CORPORATION
 Dept. E 8 19 East 48th St. New York 17, N. Y.

FREE LEARN TV the practical way..
CATALOG of TV KITS
 Assemble a TRANSISTION TV KIT in easy stages. Pay as you wire—only \$15 for Starting Package #1. Learn while building a superb 17" to 27" screen TV Set with latest features. Ideal for Fringe Areas, adaptable to UHF. Easy — no instruments or technical knowledge required. Free Catalog describes 8 great TRANSISTION TV KITS.
 Write today to Educational Dept. at—
TRANSISTION, INC., Dept. PE, NEW ROCHELLE, N. Y.

INVENTORS

When you are satisfied that you have invented a matter of value—write me, without obligation, for full information on what steps you should take to secure a Patent.

PATRICK D. BEAVERS

Registered Patent Attorney

109B Columbian Building Washington 1, D. C.

TRANSISTOR Personal Portable Radio Kit BATTERIES LAST 10,000 HOURS

COMPLETE . . . Nothing else to buy
 SIMPLIFIED . . . A child can assemble it

Screwdriver only tool needed
 TRANSISTOR, diode, earphones, batteries, tuning capacitor, antenna, attractive carrying case, etc., included. Complete instruction.

FREE TRANSISTOR code practice oscillator kit with each TRANSISTOR radio only \$9.95—check or money order 10-day Money-Back Guarantee

TRANS-AIRE ELECTRONICS INC.

149 Broadway Dept. E New York 6, N. Y.

to achieve them is by means of alligator clips as shown in the photo. Using a pair of long-nose pliers, spread the sleeve of a clip so that the phone tip can be pushed into the sleeve securely. If the sleeve has been enlarged correctly, the tip can be

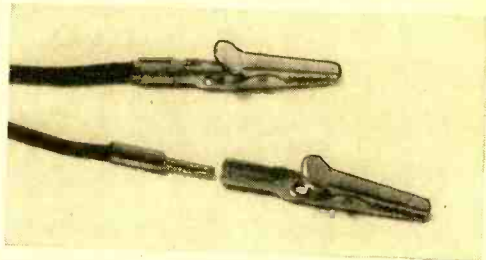

easily pulled out when desired. Removing the screws on the clips may be necessary to prevent interference with the inserted tips.

-30-

Disc and Tape Review

(Continued from page 78)

ably a "boo-boo" in the transfer from tape to disc).

It may surprise many that I place the great Toscanini in the third spot, but that's all I can truthfully say his reading merits. Don't get me wrong! The Maestro *couldn't* do a bad job on this work. But his furious energy seems, in this case, misdirected. There may be many who say they like the breakneck tempo at which the Maestro conducts this work. I, for one, do not feel that this is a wholly accurate representation of the work. And tempo is not the only fault . . . the dynamics are overblown and his handling of the orchestral choirs leaves much to be desired. Soundwise, this is a fair effort, but suffers from the afflictions of poor acoustics and restricted range . . . something the unfortunate Toscanini has had to contend with, almost up to the close of his illustrious career. When one hears some of his very last recordings in which the new "Orthophonic" technique is utilized, one realizes how poorly this great conductor has been served in matters of sound in past years. If you were one of the fortunate who heard the Toscanini of 10, 15, or even 20 years ago, you will realize that his reading of this work then is most closely paralleled today by the Dorati version.

Fourth and fifth place honors are fairly evenly divided between the Krips/London Symphony disc and the Beecham/Columbia recording. Beecham takes a middle-of-the-road approach to the score; and if his reading is not inspired, it is at least competent. Krips indulges in many mannerisms and

departures from the accepted norm, a fact which is surprising considering the good work this conductor has done with the classic repertoire in the past. Krips out-guns Sir Thomas in matters of sound, although the *Columbia* engineers have put their "best foot forward." The *London* sound has cleaner, wider range in frequency and dynamics, and the string tone is less "edgy" than the *Columbia* effort.

Summing up . . . Dorati wins the potted palm, but you need not be ashamed if you own the *Leinsdorf* or *Toscanini* versions.

○ ○ ○

The *Fifth* or "*Reformation*" *Symphony* has been growing in popularity the past few years, but has not enjoyed the universal recognition afforded the *Fourth*. On LP, there are but five recordings of the work, and of these only two can make the grade as hi-fi recordings.

By great good fortune, the best performance is again by *Mitropoulos*, and is on the other side of the *Third Symphony* reviewed previously—making this disc one of the best buys in the entire catalog. To the *Fifth*, *Mitropoulos* brings a stately grandeur, and once again he is blessed with exceptional engineering. French horns are particularly well reproduced on this disc, and string tone is a smooth and edgeless delight.

The *Toscanini* reading is less incandescent in this than in the *Fourth*, but nevertheless is still too much imbued with his nervous energy to qualify as "definitive." However, it must be stated in all fairness that the *Maestro* knows how to delineate a score as few others do, and if it is letter-perfect conducting you want, this disc has it to spare.

○ ○ ○

I see that we have completed the *Mendelssohn* symphony round-up. Next month, we will take up the matter of the *Mendelssohn* violin concerto, as well as some piano works and other compositions.

Hi-Fi Record of the Month

This month a classical record and a "pop" disc share recording honors, even if they are unwilling bedfellows! The classical winner is a 10" LP of that old warhorse, *Liszt's Hungarian Rhapsody #2*, with *Albert Wolff* conducting the *Paris Conservatory Orchestra* on *London LD9171*; and the "pop" winner is a 12" LP entitled *George Wright Plays the Mighty Wurlitzer*.

○ ○ ○

The *Albert Wolff* record is a terrific buy at the low price of \$2.50. I will positively guarantee that this little disc will make even the most modest of hi-fi systems sound big and imposing . . . due to the tremendous sonorities generated by the orchestra



LEKTRON SPECIALTIES ONE BUCK BUYS!

KIT
OF THE
MONTH!

10 PANEL SWITCHES

Selected shop assortment of most popular toggle, bat handle, momentary contact, sensitive switches, 8 types. Rated up to 25 A. Variety contact arrangements. Wt. 1 lb. Reg. \$11.



50 CERAMIC CONDENSERS. Scoop! Tubular, disc, button types. 20 selected values. 2 to 3000 muf. Shop must! Wt. 1 lb. Reg. \$13.

15 SWITCHES. Rotary, push, micro, toggle. Experimenters, note! Wt. 3 lbs. Reg. \$12.

125 CARBON RESISTORS. 40 selected values. 100 ohms to 1 meg.; 1/2, 1 and 2 w. Many 5% too! Top makers—a rare buy! Wt. 1 lb. Reg. \$21.

60 TUBULAR CONDENSERS. .00015 to 1 mf. up to 1000V. 25 types. Wt. 2 lbs. Reg. \$10.

25 OIL CAPACITORS. Bathtub and tubular. 1 and 2 mf. up to 600V. Well-known mfrs. Wt. 4 lbs. Reg. \$17.

10 ELECTROLYTICS. Tubular and EP units. 8 to 1000 mf. up to 450V. Many multi-sections. Wt. 2 lbs. Reg. \$11.

60 RESISTORS. 56 ohms to 20 megs. 1/2, 1 and 2 watts. 35 values. Many 5%. Insulated. Wt. 1 lb. Reg. \$15.

1500 PIECES SPAGHETTI tubing, lengths to 4". Ass'd. sizes. Reg. \$7.

TEN 25-ft. ROLLS WIRE. Plastic and cloth insulated; solid & stranded. 18 to 24 ass'd. colors. Wt. 2 lbs. Reg. \$5.50.

50 RF COILS CHOKES and slug-tuned coils for TV, radio, lab. 20 types. Wt. 1 lb. Reg. \$15.

10 BATHTUB OILS. Long-lasting bathtub capacitors. 0.5 to 2 mf. up to 600VDC. Selected values. Some worth \$3.50 each. Wonderful lab assortment! Wt. 3 lbs. Reg. \$25.

25 TUBE SOCKETS. Up to 9 pin, some w/shield base, some ceramic. 10 types. Handy for shop. Wt. 1 lb. Reg. \$6.50.

200 COIL FORMS. 50 sizes & shapes. Bakelite and ceramic. Experimenters' must! Wt. 2 lbs. Reg. \$14.

TV ACCESSORY KIT. Brand new! 1 each 60 cycle, 70 degree yokes, focus coil. Wt. 8 lbs. Reg. \$10.

10 RADIO CHASSIS. 5, 6 & 7 tube punched chassis. New! Workman must! Wt. 8 lbs. Reg. \$8.50.

60 MICA CAPACITORS. Rare bargain! Postage stamp type. .0001 to .01 mf. Many silver. 5% too! 20 values. Wt. 1 lb. Reg. \$17.

75 KNOBS. TV and radio. Some worth 25¢ ea. 15 types, push-on, set screw. Wt. 2 lbs. Reg. \$8.50.

50 PILOT LITE SOCKETS. Screw and bayonet bases. Wt. 2 lbs. Reg. \$6.

THREE LBS. HARDWARE. Assorted. Over 2000 pieces; screws, nuts, lugs, etc. Reg. \$6.50.

R/C ASSEMBLY. Exclusive! Build on term. strips: 70 moulded, paper and mica capacitors. .0001 to .047 mf., 400V; 45 1/2 watt resistors. Brand new. 2 lbs. Reg. \$15.

20 W.W. RESISTORS. Power, carbon & "dogbone" types. 5 to 10000 ohms. 5 to 50 watts. 15 values. Wt. 2 lbs. Reg. \$11.

15 CONTROL. Up to 1 meg. Some w/switch. 12 selected TV and radio values. Wt. 2 lbs. Reg. \$12.

70 TERM. POSTS & STRIPS. Builders' special! Ass't. binding posts, screw & lug type terminal strips (1 to 10 terms). Wt. 1 lb. Reg. \$4.50.

10 PRECISION WW RESISTORS. 10 different 1 & 2% values. 1HC W.W. 2, 4 & 5. 1/2 & 1 watt. Wt. 1/2 lb. A \$25 value!

25 VARIABLES. Erie & Elmenco mica and ceramic trimmers. Singles and duals from 3-12 to 8-10mf. Wt. 1 lb. Reg. \$16.

50 MOULDED CAPACITORS. All best known makes! .0005 to .05mf up to 600V. Wt. 1/2 lb. Reg. \$13.

SUMMER CLEARANCE BUY-LINES!

- 2 H @ 200ma choke; strap mtd. Reg. \$3.50. 45¢ ea. 3 for \$1
- XFMR. In/115; Out/180V @ 15ma; 8.3 @ 8A 65¢ ea. 2 for \$1
- Pilot lite assembly, enclosed, amber. Reg. 87¢ ea. 8 for \$1
- Erie trimmers. 3-12, 7-45, or 8-50. Reg. 97¢ ea. Any 12 for \$1
- Darkroom or parts tray—9x11x1 1/2. Wt. 5 lbs. Reg. \$3. . . . 69¢
- Sealed relay. 24VDC/300 ohms, DPDT. 2 1/2x1 1/2x1 1/2. . . . \$1.49
- Reg. \$11
- Veeter-Root counter 0-9,999. Reg. \$8.50. . . . \$1
- 25 slug-tuned coils, ass'd. TV-radio. Reg. \$9. . . . \$1
- 0 to 20 min. timer, bell rings end of cycle. Reg. \$4.50. . . . \$1
- 3" sq. meter, measures 0 to 10VDC. Reg. \$8. . . . \$1.88
- Full-wave rect./18 VAV to 12VDC @ 250ma. Reg. \$4. 3 for \$1
- Dual variable. 15 muf per sec. w/2" drum. Reg. \$1. . . . 4 for \$1
- Mobile, slug-tuned assem., broadcast band, push control. 3 for \$1
- Anti-capacity or lever switch CTS). 4P4T. . . . 79¢
- 50 or 60 degree yokes. . . . Any two for \$1
- RCA type 21175 Flyback transformer. Reg. \$5. . . . \$1.25
- 115/160 to 6V @ 6 amps. Reg. \$4. . . . 10 for \$1
- 500mfm @ 10 kV ceramic cartwheel condenser. Reg. \$2.50. . . . 88¢
- 6 or 12 volt bayonet type standard bulbs. Reg. 10¢ ea. 25 for \$1
- Record changer bases. Reg. \$4. . . . \$1

Please send check or M.O. Include postage. C.O.D. orders 25% down payment. Rated accounts NET 30.

Lektron Specialties, Dept. E8
28 Gardiner Street CHelsea 3-6325 Chelsea, Mass.
WRITE FOR OUR LATEST BARGAIN-FILLED BULLETIN

IT'S NEW! IT'S FREE!

1955 Walter Ashe Catalog of Radio, Electronics and TV



The Treasure Chest of Values!

Features all the leading brands of Communication Equipment, Test Instruments, Build-it-Yourself Kits, Hi-fi, Sound and Recording Equipment, Radio, Electronics and TV Parts and Supplies for every conceivable need . . . in stock — ready for immediate delivery. A "must" for experimenters, amateurs, servicemen, engineers, builders and "hi-fiers."

Walter Ashe
RADIO CO.
1125 PINE ST. • ST. LOUIS 1, MO.

Send for your
FREE Copy

MAIL COUPON TODAY!

WALTER ASHE RADIO CO.
1125 Pine St., St. Louis 1, Mo.

PE-8-55

Rush FREE Copy of New 1955 Catalog.

Name _____

Address _____

City _____

Zone _____ State _____

NEW RCA SURPLUS TV CAMERA only \$197.50!



Labs, hobbyists, industries, TV technicians—set up your own telecast system! It's a "mechanical eye" for factories, prisons, swim pools, closed circuit TV—100's other uses! SEND FOR FULL DETAILS TODAY!

FREE CATALOGUE ON REQUEST!

HARJO SALES CO., Dept. PE
503 N. Victory Blvd. Burbank, Calif.

FIND URANIUM!!!

Prospecting made easy with Goldak's new U-238C triple-action geiger counter! Also famous line of metal locators, from \$49.50

Send 25c for radioactive uranium sample! FREE DETAILS. Dealer Inquiries Welcome.



GOLDAK COMPANY 1547 W. Glenoaks Blvd., Glendale, Calif.

WANTED

Write full description and condition to

POPULAR ELECTRONICS
BOX 50
366 Madison Avenue
N. Y. 17, N. Y.

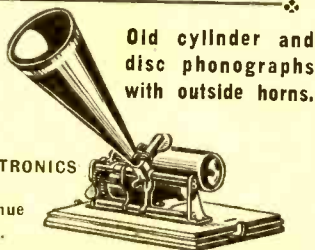

Old cylinder and disc phonographs with outside horns.

in the opening and ensuing passages.

Here is great, "big hall" sound, ultra-natural in its perfect balance. The contrabass here sound out hugely, yet they are not "fuzzy." When the contrabassi and trombone team up with the rest of the usual string complement and a big bass drum in the introduction, the effect is tremendous. The bass drum is stroked rather lightly in this passage and affords an interesting test. Played on a small speaker system, it is almost impossible to hear. Go up a few notches in quality, and it begins to make its presence felt with the rest of the orchestration. Play it on some real heavy-weight systems, like the *Jim Lansing* "Hartsfield," the *Jensen* "Imperial" or an *Electro-Voice* "Georgian," and its 30-odd cycle solid impact lends solid substance to the orchestration which, in turn, has become still more sonorous.

Throughout the work, the sound is very wide-range in frequency and in dynamics, and distortion is virtually non-existent. Performance is slow paced, built on a grandiose scale. Some critics have lambasted it for being "draggy." Let's face it . . . the music is slightly cornball, and if Mr. Wolff chooses to exploit its tonal nuances as an exercise in sonorities, I say . . . good for him! I have heard enough "straight" performances of the work to last me a lifetime. I cannot recommend this disc too highly as a demonstration piece, be your system a weak-lunged 8" or a leather-bellowed exponential horn.

o o o

Much the same might be said about the "pop" winner, although it will be the boys with the "big horns" who will derive the maximum benefit from this disc. *George Wright Plays the Mighty Wurlitzer*, on a new label called "HifiRecord," is a 12" LP tagged at \$4.95, list. You will probably have trouble finding this disc; so if you are interested, drop me a card and I will probably know of a number of sources by the time this column appears in print.

This is one of the most sensational pop organ recordings I have ever heard. George Wright was formerly organist at the New York Paramount theatre, and to put it mildly . . . he really knows his onions! A lot of the pop organ stuff I have heard has been pretty awful, both from the standpoints of sound and performability. This disc is as extraordinary for the wondrous facility and technique of Mr. Wright as it is for the fabulous sound.

In such familiar old standbys as *Jealousy*, *Brazil*, *Stella by Starlight*, *Ebbtide*, etc., Mr. Wright displays amazing virtuosity. His choice of stops makes for interesting arrangements and tonal textures, yet he

does not fall into the pitfall of gaudy over-orchestration as do so many of his contemporaries. The organ used in the recording is one of the biggest of that dying breed, the Wurlitzer theatre type. As such, it has some gargantuan 32- and 64-foot pedals, and the engineers on this disc have captured their full-throated power better than I have ever heard before.

Boy, these will really give you woofers a workout! In *Jealousy*, for instance, Mr. Wright uses the pedals as rhythmic counterpoint, and they give furch in your speaker with a mighty WHUMP! The high end is not neglected either, and what is heard comes through clearly with fine intonation. As played through a 50-watt amplifier and a big exponential horn at a good loud level, the effect is such that neighbors begin to wonder how you managed to cram a theatre organ into your home.

If the engineers and Mr. Wright do as well in their next recording as in this, they'll have to start worrying about their tax bracket. Don't miss this one!

○ ○ ○

BIG BAND BASH

Billy May and his Orchestra
Capitol T-329, 12" LP, RIAA curve, \$3.98

This 12" disc is a must for those of you who like smooth, slickly orchestrated "big

band" jazz. Actually, it is a combining of a previous 10" disc, which was quite successful, with some newer material. Heard are numbers like *Perfidia*, *Tenderly*, *Your Drivin' Me Crazy*, etc.

As an example of a multi-mike jazz mix, this would be hard to beat. The brasses have that close-to, sharp, bright sound . . . the saxes are richly mellow, yet have good transient attack in sections calling for it. Trombones are growly and big-throated. Percussion is ultra sharp, superbly clean. The whole is wrapped in sound of extraordinary wide range in frequency and dynamics, balance is near perfect, acoustics "live" without destroying intimacy. To top it off, the surfaces are dead quiet and the net result of this and the splendid sound is a near approach to the perfection of tape.

○ ○ ○

Speaking of tape, especially prerecorded tape, we don't have anything worthwhile enough for review this month. However, I have just been informed that the *A/V Tape Libraries* are now issuing tapes taken from the masters of that excellent small company, *Vanguard*. I understand both their classical and jazz releases will be available, which should give us some new riches to review. I'll keep you posted and see you next month.

-50-

Get This Valuable Book

FREE



Yes, you get this big, brand new book, "150 Radio-Television Picture Patterns and Diagrams Explained", absolutely FREE! Just off the press! Gives complete wiring circuits and diagrams on the latest Radio and Television Sets. Easy-to-read, large 8½ x 11" pages, with full instructions on how to read and use the diagrams. A "must" in every Radio and Television service-man's repair kit. You get this valuable book as a FREE Gift for asking to see Coyne's great new 6-book set, "Applied Practical Radio-Television"!

Here's "Know-How" That Makes You Worth More!

Coyne's great new 6-volume set gives you all the answers to servicing problems—quickly! For basic "know-how" that is easy to understand, you'll find everything you want in volumes 1 to 5 which contain over 5000 practical facts and data. They cover every step from principles to installing, servicing, trouble-shooting and aligning all types of radio and TV sets. So up-to-date it includes COLOR TV and UHF, adapters and converters. Also covers very latest information on TRANSISTORS.

900-Page Television Cyclopedic Included

And then, for speedy on-the-job use, you get volume 6—the famous COYNE TELEVISION CYCLOPEDIA. It answers today's television problems on servicing, alignment, installation and others. In easy-to-find ABC order, cross indexed. Use this 6 volume TV-RADIO LIBRARY free for 7 days; get the valuable Servicing Book ABSOLUTELY FREE!

Just for Examining COYNE'S New 6-Volume Set

"Applied Practical Radio-Television"

ON 7 DAY
FREE
TRIAL!



SEND NO MONEY! Just mail coupon for 6-volume set on 7 days free trial. We'll include book of 150 TV-Radio Patterns & Diagrams. If you keep the set, pay \$2 in 7 days and \$2 per month until \$22.50 plus postage is paid. (Cash price \$20.95). Or you can return the library at our expense in 7 days and owe nothing. YOU BE THE JUDGE. Either way, the book of TV-Radio Patterns is yours FREE to keep! Offer is limited. Act NOW!

FREE BOOK — FREE TRIAL COUPON!

Coyne Electrical School, Educational Book Publ. Div., Dept. 85-PE
500 S. Paulina St., Chicago 12, Ill.

YES! Send 6-volume "Applied Practical Radio-Television" for 7 days FREE TRIAL per your offer. Include TV-Radio Patterns & Diagram Book FREE.

Name.....Age.....

Address.....

City.....Zone.....State.....

Where Employed.....

Check here if you want library sent COD. You pay postman \$20.95 plus COD postage on delivery. 7-day money-back guarantee.

Perma-Power Radio Controlled Garage Door Opener

Now, the newest, finest Radio-Control Garage Door Opener styled in a modern spun-aluminum fixture that beautifies garage interiors.

Convenience and safety features galore — New automatic shut-off, positive locking of door, FCC authorized radio frequency . . . and many more plus qualities!

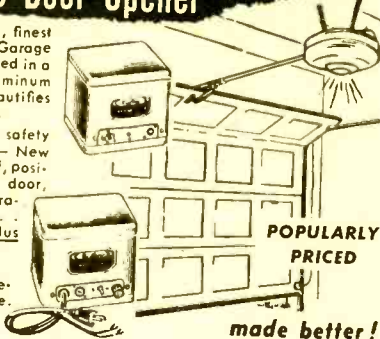

POPULARLY PRICED

made better!

Write today for descriptive literature.

Everyone can afford this modern convenience!

- * It's really simple to install . . . one man can do it easily!
- * Takes just an afternoon with common hand tools; no soldering.
- * Complete instructions assure professional-type installation.

MAIL THIS COUPON FOR COMPLETE FACTS!

Perma-Power COMPANY 4727 N. DAMEN AVE. CHICAGO 25, ILL.

- Please send FREE descriptive literature on your GARAGE DOOR OPENER
- Please advise name of your nearest electronic parts distributor carrying your GARAGE DOOR OPENER

NAME _____

ADDRESS _____

CITY _____

STATE _____

PRINTED CIRCUIT MATERIAL

Copper Laminated Bakelite 1/16" thick, coated on one side. Ideal for making your own PC receivers. Sheet size 4 1/2 x 6. Special offer, limited time only,

2 Sheets, postage paid \$1.00.

Lorenz "61" kit, with conventional base and 3 copper laminated bases to provide practice material. Complete except for tube and relay. \$3.95.

Larger sizes copper laminate 3c per square inch.

ACE RADIO CONTROL

BOX 301

HIGGINSVILLE, MO.

RADIO CONTROLLED

Garage Door Actuator Mechanism

\$24.50

Write for information

P. E. HAWKINS CO.

631 Prospect

Kansas City 24, Mo.

NEW! WRIST RADIO

Amazingly powerful! Plays while you wear it. 400-mile reception using just its own antenna. No connections needed to ground, aerial, lamp, telephone, etc. Tunes entire broadcast band with sharp selectivity. BUILD YOUR OWN—New book has complete instructions. How-to-do-it book \$1.98 postpaid. Also a basic kit consisting of attractive pre-drilled case, "outline" chassis, and all necessary hardware \$2.98 ppd. Combination of book and basic kit, SPECIAL \$3.98 postpaid. C.O.D.'s \$1 deposit. HUCKERT ELECTRONICS, Box 7400-L2, Washington 4, D. C.

Carl & Jerry

(Continued from page 67)

hams had been using on 10 and 20 meters for years. To change a folded dipole into a yagi, you mount the dipole horizontally on a long horizontal boom. On this boom, parallel to the dipole, you mount several other metal rods or tubes called 'parasitic elements' because they have no direct connection to the 'driven element' that is connected to the feedline. Parasitic elements on the front part of the boom are called 'directors,' and they are a trifle shorter than the driven element and must be mounted at certain critical distances ahead of that element. At the rear of the boom, also at a critical distance, is mounted a parasitic element called a 'reflector' that is somewhat longer than the driven element.

"A complete yagi may have all the way from 3 to 12 or more elements. Directors concentrate the received signal on the driven element in much the same way that lenses focus light. The reflector reinforces this action in the same manner that a polished surface will reflect and concentrate light rays on a particular spot. The end result is that the reception of a signal arriving from the front of the antenna is greatly improved and response to a signal arriving from any point of the compass *except* the front is cut way down."

"Sounds like the perfect answer to the TV antenna problem."

"For single-channel reception, it's hard to beat—but there's the rub. In its conventional form, a yagi is a very narrow-band affair good for reception only of the single channel for which it is designed. Lately, however, the engineers have given the old yagi a new look by working it over into what

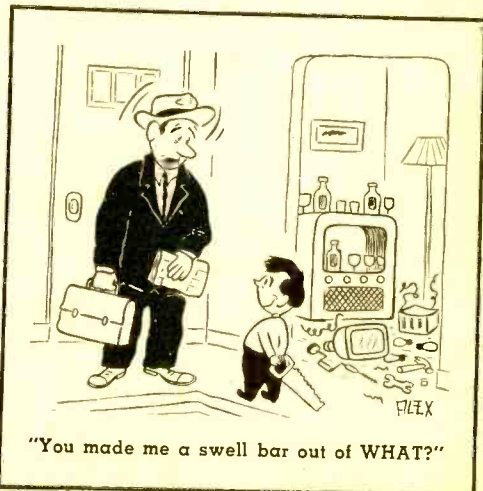

"You made me a swell bar out of WHAT?"

is known as the broadband yagi—capable of yielding good signal strength and excellent front-to-back ratio on all 12 v.h.f. channels. This is done by using more than one driven element and by carefully adjusting the length and spacing of the parasitic elements so that they do double or triple duty, producing effectively the equivalent of several different yagi antennas mounted on a single boom. That antenna over there, next to the church, which is called an 'Interceptor,' is a good example of this design."

"How about those jobs with the elements sticking out every which way? I think they are called *conicals*."

"Well, going back to our original dipole, increasing the physical size of the dipole elements will widen the frequency response. Theoretically, the best way to do this is to use metal cones mounted tip-to-tip for the elements. The cones can be flattened into triangular sheets of metal without much loss of effectiveness, and this is actually done on the u.h.f. channels. The resulting dipoles are called 'bow-ties' because of their appearance, and are usually mounted in front of a reflecting metal grid or inside the jaws of two such grids edge-connected at a 90° angle to form what is known as a 'corner reflector.'

"On the v.h.f. channels, where wavelengths are measured in feet instead of inches, a bow-tie of proper dimensions would be too bulky and expensive and have too much wind resistance. However, metal rods or tubes that preserve the outline of the bow-tie, and that might be considered the skeleton of the original cones, serve almost as well. By inclining the skeleton wings of this 'conical' dipole slightly forward to form a shallow funnel, reception on the higher channels is improved. TV signals are directed in toward the feedline point in much the

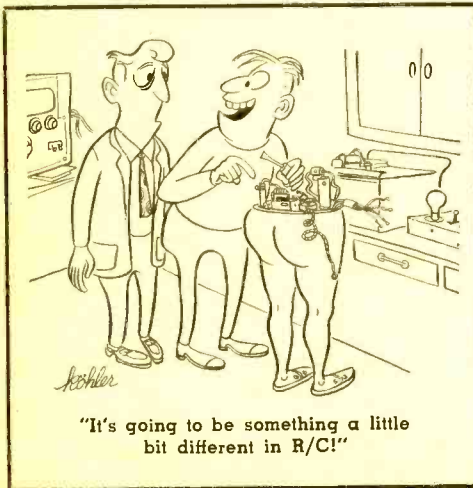

August, 1955

LEARN basic electricity electronics

THE EASY "PICTURE BOOK" WAY!



Just Released: The fabulous
ILLUSTRATED Training Course
now used by the U. S. Navy!

You Learn by Pictures

Over 25,000 Navy trainees have already learned Basic Electricity and Basic Electronics this easy, "Picture Book" way! Now, for the first time, YOU can master the basics of Electricity and Electronics with this same "Learn-by-Pictures" training course! Over 1,700 simple, easy-to-understand drawings explain every section—these "teaching" pictures actually make up more than half the entire course! No other Basic Electricity or Basic Electronics course in America uses this revolutionary illustrative technique! You learn faster and easier than you'd dream possible!

A Complete Idea on Every Page

Here's how this easy, illustrated course works: every page covers one complete idea! There's at least one big illustration on that same page to explain it! What's more, an imaginary Instructor stands figuratively at your elbow, doing "demonstrations" that make it even easier for you to understand. Then, at the end of every section, you'll find review pages that highlight the important topics you've just covered. You build a thorough, step-by-step knowledge at your own pace—as fast as you yourself want to go!

Everyday English—A Course Anyone Can Understand

Sponsored by the Navy to turn out trained technicians in record time, this modern course presents Basic Electricity and Basic Electronics in a simple way that everyone can grasp—regardless of previous education! Every phase is made instantly clear—explained in plain, down to earth English—with hundreds of easy-to-understand illustrations to help you!

10 Complete Volumes

Volumes 1 and 2 of "Basic Electricity" cover DC components and circuits; Volumes 3 and 4 cover AC components and circuits; Volume 5 covers AC and DC motors and machinery.

Volume 1 of "Basic Electronics" covers Diodes & Power Supplies; Vols. 2 and 3 cover Amplifiers & Oscillators; Vols. 4 and 5 cover Transmitters & Receivers.

Home Study Without Correspondence

This course is so different, so complete—there's no need for the usual letter writing, question and answer correspondence! Learn at home—at your own pace!

10 Day Examination—Money Back Guarantee

Send today for these exciting new training courses—you risk nothing! When you receive the volumes, examine them in your own home for 10 full days. If, at the end of that time, you're not completely satisfied, simply return the books to us and we'll gladly refund your full purchase price! Total cost for either 5-volume course is only \$9.00! In Canada, prices approximately 5% higher.

ORDER TODAY!

These books are sold by electronics parts jobbers and book stores. If YOUR dealer doesn't have these books, mail this coupon to us!

JOHN F. RIDER PUBLISHER, INC.
480 Canal Street, N.Y.C.

- I have enclosed \$..... Please send me
 5-vol. Basic Electricity set @ \$9 set
 5-vol. Basic Electronics set @ \$9 set
 Both sets. I understand I may return the books in 10 days, and receive a complete refund of the full purchase price if I am not satisfied.
 Add state or city sales tax where applicable.

Name

Address

City & State..... P-3

ELECTRONIC SUPPLIES

For Experimenters-Service-Industry

Clean Useful Items sold on satisfaction
Guaranteed basis. WHOLESALE OR RETAIL.

PORTABLE VIBRAPACK —Transceivers, Walkie, Talkies, etc. Operates from 12V source—8DC outputs—complete with schematics, plug, spare vibrator, etc. Govt. cost over \$100—Ship wt. 10 lbs. Special \$4.95	Crystal Diode IN34—New—2 \$1.00
MODEL QAV-1 RADAR TRAINING UNIT —115 Volt 60 Cycle—Variable frequency outputs—150-250 MC—Fixed Outputs .1KC, 1KC, 10KC, 100KC. Housed in beautiful grey cabinet. Shipping wt. 70 lbs.—Govt. cost over \$500—Special. Complete with all tubes—instruction book. \$14.95	Miniature xformer—9 povel term '18—diagr on case. 98c
ELECTRONIC Remote Control Chassis —loaded with valuable parts, plate relay xformer, etc. 4 for \$3.00	Headbands for earphones—boxed. 2 for \$1.00
WESTERN ELECTRIC STEPPER SWITCH —6 or 12 VDC—44 steps—Bridging wipers—Gold Plate Contacts—4.4 Ohms—1 make—1 break. NEW \$7.95	Cushions for earphones. 4 for \$1.00
Test Set US/O Nancy Receiver —Housed in Beautiful Oak Chest. Contains 60' 2 conductor Microphone cable—Probes, Plugs, Etc. Govt. cost over \$100. Brand new \$4.95	SM Chassis—contains val parts—800 ohm plate relay. \$1.00
Small Parts & Tube Values Crystal Diode IN29—New—3/\$1.00	Miniature storage ltry—2.2 Volts—2x1/4x1/2—New. Dry charged. 98c
Altitude Calculator —5 Circular slide rule type charts in leather folio 12x12-Bi. New—Govt. Cost \$20 Special \$12.00	Battery tester—King Sol-Foto Flash Fans Save Film. Time—Closeout 98c
2050 Thyratron 1.25 954 acorn 3/1.00 1625B Pentode 3/1.00	Mica window Geiger Muller tube—Type CV—BS-6—\$40 regular price. Special \$7.95
2021 Thyratron 1.00 955 acorn 2/1.00 1626 triode 4/1.00	W.E. Quincey Xformer Ratio 2.5-1 2 for \$1.00
884 Thyratron 1.25 956 acorn .75 1629 magic eye 4/1.00	Sub-miniature hearing aid tubes, unbranded. 5 for \$1.00
VR105 Volt. Reg. .95 957 acorn .75 838 triode 1.50	Micas, Silver Micas Ass'd—Big value. 75 for \$1.00
VR150 Volt. Reg. .95 958A acorn .75	3A5 UHF twin triode. 3/\$1.00
902-2' C. R. Tube 5.00 959 acorn 1.75	Generator 3450 RPM—Output 425VDC—76.5 Watts. . \$5.00
	Paper tubular cond. 50 for \$1.00
	SPST Toggle sw. 4 for \$1.00
	Coax fitting Chassis—SO-239 2/90c
	Coax fitting male—PL-259—removed. \$1.00
	R-1/ARR—1 Recvr—200 MC—New w/tubes \$3.50

Include Postage With Order

REX RADIO SUPPLY

88 CORTLANDT ST., NEW YORK 7, N. Y.

GEIGER COUNTER KIT



STOWERS & SON, Dept. 51, 804 Grand, Kansas City 6, Mo.

You can assemble it yourself in about an hour. All holes drilled and ready for wiring. No special tools required. Full instructions and easy to follow diagram included. Government booklet "Prospecting with a Counter" and radioactive sample provided free with kit. Full price including tubes, headset and batteries only \$17.50 postpd. Satisfaction Guaranteed. Order your kit today.

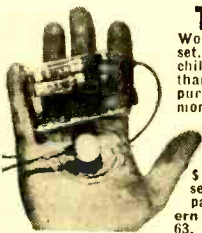

TRANSISTOR RADIO!!!

World's smallest and lowest priced transistor set. Perfect for baseball fans, office workers, children. Polystyrene plastic case smaller than cigarette pack, carry in shirt pocket or purse. Tunes all stations. Operates one month on two pen cells. Plays indoors, outdoors, at beach, on boats. Ideal emergency portable for Civil Defense stations. Assemble quickly. Complete with battery, less earset—\$12.00. Special imported hearing aid earset—\$4.00. Single headphone—\$2.00. Postpaid—Cash, Check or Money Order. Eastern Audio Research, Box 62, Little Neck 63, New York.

Get your FCC LICENSE quickly!

Guaranteed preparation, in a MINIMUM OF TIME, for F.C.C. commercial operator examinations. Our highly specialized training is available by correspondence, or in resident classes in WASHINGTON, D. C. and HOLLYWOOD, CALIF. Write for our free booklet with complete details. Grantham School of Electronics, Dept. 104-P 737 11th Street N.W., Washington 1, D. C.

same way that sound waves are collected by an old-fashioned hearing trumpet. A skeleton bow-tie reflector is usually mounted behind the conical antenna to improve the front-to-back ratio. To get still more strength in fringe areas, it is a common practice to stack two, four, or even more of these conical 'bays,' as they are called, one above the other on the same mast, and connect them to a common feedline. To insure that the signals picked up by the several bays actually reinforce instead of buck each other, it's necessary that bays be mounted the proper distance apart and that they be connected together with special 'stacking harness.'

"Any more TV antennas?" Carl asked drowsily.

"Lots more, but you'd never stay awake to hear about them," Jerry observed tartly. "Some antenna manufacturers depend upon stacking several dipole-and-reflector bays vertically for increased gain. Half-wave elements, properly phased, may be mounted side by side and several such bays stacked to form what is called a 'collinear array.' The appearance of such an antenna, together with a reflecting screen, has given rise to its popular nickname of 'the bedspring antenna.' Other manufacturers combine yagi and conical antennas on a single boom, hoping to get the benefits of both from this marriage."

"What's meant by antenna gain?"

"That's the ratio between the signal voltage delivered by the antenna to the feedline on a certain channel and the voltage delivered by a reference dipole antenna cut to the frequency of that channel and mounted in the same spot. This ratio is expressed in decibels. For example, if the antenna under test delivers twice as much signal voltage as does the dipole on Channel 6, we say it has a 6-db gain on that channel. If it delivers four times the voltage, it has a 12-db gain."

"What characteristics would you say the perfect TV antenna should have?"

"First, it should have high gain; second, it should maintain this gain across all v.h.f. and u.h.f. channels with no peaks or dips; third, it should present a consistent 300-ohm impedance to the feedline on all frequencies; fourth, it should have a single, narrow reception lobe and should present infinite rejection to signals arriving from the side or rear; and finally, it should be cheap, light, and easily mounted, with a low wind resistance and a beautiful appearance."

"Sounds like quite an order."

"It is, especially when you realize that antenna gain, bandwidth, front-to-back ratio, and impedance are all closely interlocked so that you cannot vary one of them without changing all the others. And right there you have your answer as to why there

are so many different kinds of antennas. Each manufacturer tries a different compromise in his approach to this ideal antenna. One may stress high maximum gain or front-to-back ratio; another advertises price and appearance; still another may boast that the response curve of his antenna has no sharp dips and valleys in it—something especially important in an antenna used for color TV reception. Each advertising claim appeals to a certain group of customers who feel that the stressed characteristic is just what they need to solve their reception troubles. If it doesn't, then they are ready to try another new antenna, always hoping they will eventually come across the perfect TV antenna which will insure perfect reception all the time."

"You sound a little cynical about this."

"I'm not really. I know how important it is to have a good antenna, especially in a weak-signal area; but I also know for a fact that the TV antenna can only do so much. It cannot receive a signal that just isn't there; nor can it compensate, beyond a certain point, for a poor receiver. The TV antenna is like the automatic choke on a car; it gets a lot of blame for 'sins' of which it is not guilty."

Carl rose and brushed the grass from the seat of his pants.

"Well, I guess we had better be starting for home, Marconi. Do you think you will be able to totter down the hill or had I better just roll you like a barrel?"

"Don't get smart with me," Jerry said, as he struggled to his feet, trying not to wince at the protest from his sore muscles. "Just don't get in my way, going down as you did coming up."

-30-

Short-Wave Bands

(Continued from page 72)

LIBERIA—ELWA, Monrovia, has moved from 11800 to 15200 kc. This one is being heard daily with a "Back to the Bible" program at 1250-1330. Another religious program starts at 1400. Their address is P.O. Box 192, Monrovia, Liberia, and they ask for reports. (Taylor, N.J.; Kenney, Calif.)

NETHERLANDS NEW GUINEA—The complete schedule from *Radio Omroep Nieuw Guinea*, Hollandia, is as follows: Sundays to Thursdays—1930-2030 on 7126 kc.; daily—0400-0700 on 3345 and 5045 kc.; Friday—2200-0030 on 7126 kc.; and Sunday—1830-2330 on 7126 kc. The transmitter is a 250-watt rig made by Philips, with 200 watts fed into the antenna. All programs are in Dutch except at 0900-0930 (daily except Sunday) when Malay is transmitting. A new transmitter of 5000 watts is expected to be in

HOW TO FIX ANY PART OF ANY CAR

QUICKLY--EASILY--RIGHT!



FREE 7-DAY TRIAL

Whether you're a beginner or an expert mechanic—now you can "breeze through" any "fix-it" job from simple carburetor adjustment to complete overhaul. Just look up job in index of MOTOR'S Brand-New 1955 Auto Repair Manual. Follow simple step-by-step directions. Clear pictures. Presto—the job is done!

No guesswork! MOTOR'S MANUAL takes you from "scratch"—shows WHERE to start, WHAT tools to use. Covers EVERY job on EVERY car built from 1940 thru 1955!

Everything You Need to Know "Boiled Down" from 160 Official Shop Manuals

NEW, REVISED, ENLARGED, 1955 Edition contains the "meat" from over 160 OFFICIAL shop manuals—simplified for YOU. 23,436 essential repair specifications on 737 chassis models. Over 1,000 big pages. More than 2,000 "this-is-how" pictures, 225,000 service and repair facts. Leads beginners every step of the way. Time-saving factory repair procedures for experts. Instructions and pictures so clear you CAN'T go wrong. Used by U. S. Army and Navy.

Try Book FREE 7 Days

SEND NO MONEY! Pay postman nothing.

Make Manual show you what it's got. Unless you agree this is the greatest time and work saver you've ever seen—return book in 7 days and pay nothing. Mail coupon today to: MOTOR'S Book Dept., Desk 328, 250 W. 55th St., New York 19, N. Y.

Same FREE Offer On MOTOR'S Truck and Tractor Manual

Covers EVERY job on EVERY popular make gasoline truck, tractor made from 1946 thru 1954. FREE 7-Day Trial. Check proper box in coupon.



MOTOR'S AUTO REPAIR MANUAL

Covers 737 Models All These Makes

- Buick
- Cadillac
- Chevrolet
- Chrysler
- Crosley
- Dodge
- Ford
- Frazier
- Henry J.
- Hudson
- Kaiser
- Lincoln
- Mercury
- Nash
- Oldsmobile
- Packard
- Plymouth
- Pontiac
- Studebaker
- Willie

2,000,000 Copies Sold!

MAIL COUPON NOW FOR 7-DAY FREE TRIAL

MOTOR BOOK DEPT. Desk 328, 250 W. 55th St., New York 19, N. Y.

Rush to me at once (check box opposite book you want):

MOTOR'S New AUTO REPAIR MANUAL. If O.K., I will remit \$2 in 7 days, \$2 monthly for 2 months and a final payment of \$36 (plus \$5c delivery charges) one month after final. Otherwise I will return the book postpaid in 7 days. (Foreign price, remit \$9 cash with order.)

MOTOR'S New TRUCK & TRACTOR REPAIR MANUAL. If O.K., I will remit \$2 in 7 days, and \$2 monthly for 3 months, plus \$5c delivery charges with final payment. Otherwise I will return book postpaid in 7 days. (Foreign price, remit \$10 cash with order.)

Print Name..... Age.....

Address.....

City..... State.....

Check box and save 35c delivery charge by enclosing WITH coupon entire payment of \$6.95 for Auto Repair Manual (or \$8 for Truck & Tractor Repair Manual.) Same return-refund privilege.

TECHNICIANS WANTED



RADIO TELEVISION AND ELECTRONIC INDUSTRIES NEED WELL TRAINED MEN.

The man who really has the "know-how" will win the best rank and position and the highest pay in the years ahead. Engineering Opportunities shows how you can be thoroughly trained by specialized home study courses. It lists details of over ninety courses in all branches of engineering and academic fields. Get your free copy of "Engineering Opportunities" to-day by mailing the coupon below.

Canadian Institute of Science & Technology Limited, 594 Century Building, 412, 5th Street, N.W., Washington, D.C.
Please forward free of cost or obligation of any kind your 105-page handbook, "ENGINEERING OPPORTUNITIES".

Name.....
Address.....
Course interested in..... Age.....

WALKIE-TALKIE

Build a real wireless portable radiophone for the 2 meter amateur band with the following precision components. Factory wired and tested transceiver chassis complete with special dual tube \$6.50. UTC "ouncer" mike transformer \$.98. High output carbon mike \$1.49. Super Alnico headphone \$1.25. 2" x 5" x 9" aluminum case \$2.00. Wiring diagram \$.50. Uses standard batteries available at your local radio store. Please include 5% for postage. COD's require \$1.00 deposit.

SPRINGFIELD ENTERPRISES

Box 54-E Springfield Gardens 13, N. Y.

When Answering Advertisements Please Be Sure to Mention POPULAR ELECTRONICS

BUILD SOLOTRON ELECTRONIC ORGAN DESIGNED for HOME CRAFTSMEN
EASY TO BUILD 30 KEYS
3 TUBES - 2 WATTS
\$1 PLANS
The SOLOTRON Co. 29641 GILCHRIST AV. DEPT. PE FARMINGTON, MICH.

TV TUNER REPAIRS 48-HOUR SERVICE

Defective tuners rebuilt to factory standards. New tuner guarantee. Ship prepaid.

RADIO PRODUCTS CO.

College Point 56 We carry a full stock of Replacement Tuners for all makes of T.V. New York

operation by October 1 from the Island of Biak; it will, of course, be s.w. (Scheiner, N.J.)

PERU—OAX8C, *Radio Nacional*, Iquitos, has moved to 9335 from 9523 and is being received much better due to less QRM. OAX4Z, *Radio Nacional del Peru*, at Lima, is now using 6082 kc. at 1800-0000. This replaces the old frequency of 9560. (Legge, Va.)

PORTUGAL—Lisbon, on 9776 kc., has moved to 15120 kc., and is being heard at 1230-1530 in the African beam.

SARAWAK—*Radio Sarawak* is audible at times on the West Coast at 1300-1400 with English on the 5050A outlet. (Kenney, Calif.)

TURKEY—TAT, Ankara, on 9515 kc., is noted regularly at 1815-1900 with news and popular American records. Announcements are in English. (Meyers, Ohio; Thomas, Pa.)

LIBERIA (Additional)—The transmitter being used by ELWA is a *Gates*, 10-kw. rig, covering 2 to 22 mc. Temporary antenna is a triangle matched half-wave unit. The permanent antenna will be a three-wire rhombic on a 240' stainless tower. (Finkle, Calif.)

AS WE MENTIONED EARLIER, sunspots affect radio reception; the greater the sunspot activity, the better the s.w. reception will be. The latest sunspot prediction is as follows: for August—18; for September—19, and for October—21. Compare this with an actual average of 11.3 for last April. Short-wave reception should improve considerably before the next DX season rolls around. (Swiss S/W Service via Ferguson, N.C.)

Audio Watt

(Continued from page 85)

watts at this 1000-cycle frequency will be the square of the voltmeter reading divided by the resistance of the resistor. The purpose of the oscilloscope is to observe the output waveform for distortion. When the waveform begins to depart from a smooth sine wave, the amplifier output contains distortion which, as mentioned earlier, must be considered along with the power output.

The method of measuring audio power just described is well within the capability of the audio hobbyist who has an audio oscillator and a vacuum-tube voltmeter sensitive enough to read the minute output of the oscillator as well as the amplifier output voltage. For the hobbyist who desires to make his own wattmeter, a sim-

plified design using a crystal element is shown in the *Sylvania Electric Products Inc.* booklet called "Forty Uses For Germanium Diodes." The *Heath* unit shown in the photograph is sold as a kit for home construction.

-30-

CdS Photocell

(Continued from page 43)

technique was developed for mounting this lens and cell. The cell is wrapped with a few layers of tape so that it fits into the neck of a large rubber attachment plug, and the lens fits in the other end after the prongs have been removed. Both parts fit tightly and will stay without further fastening, but a drop of glue may be added if desired. The assembly is mounted to the chassis by means of a metal electrolytic capacitor mounting plate.

A suitable lens for this device can be obtained from any of a number of surplus optical houses, such as *Edmund Scientific Corp.*, Barrington, N. J. Quality is not important; a cheap lens will perform as satisfactorily as a more expensive one, for its purpose is to concentrate incoming light.

After the unit is assembled and the switch turned on, the relay should close when the lens is illuminated by a bright light, and should open when the light is interrupted. The only adjustment might be to move the photocell back and forth in its mounting to make sure that it is located at the focal point of the lens. This is the point of maximum sensitivity. One precaution: make certain that the load placed on the relay contacts does not exceed the ratings given by the relay manufacturer.

A suitable source of light can be made from a small automobile spotlight powered by a filament transformer, or any other source giving a relatively narrow beam. The relay can be hooked up to operate a light, bell, counter, or whatever the experimenter wishes. By proper choice of relay contacts, the unit can be connected to operate when the light beam is interrupted (normally closed contacts), or to operate when a beam of light strikes it (normally open contacts). In some cases, it might be desirable to shield the lens from stray light by means of a short tube having an inside diameter approximately the same as the lens diameter.

Although somewhat lacking in sensitivity, this device will provide loads of fun for the experimenter. Future issues will describe units incorporating amplifiers for increased sensitivity, and will discuss some other applications of this versatile photocell.

-30-

WHAT SECRET POWER DID THIS MAN POSSESS?



BENJAMIN FRANKLIN
(A Rosicrucian)

WHY was this man great? How does anyone—man or woman—achieve greatness? Is it not by mastery of the powers within ourselves?

Know the mysterious world within you! Attune yourself to the wisdom of the ages! Grasp the inner power of your mind! Learn the secrets of a full and peaceful life!

Benjamin Franklin—like many other learned and great men and women—was a Rosicrucian. The Rosicrucians (NOT a religious organization) first came to America in 1694. Today, headquarters of the Rosicrucians send over seven million pieces of mail annually to all parts of the world. Write for YOUR FREE COPY of "The Mastery of Life"—TODAY. No obligation. No salesmen. A non-profit organization. Address: Scribe N. P. K.

THIS BOOK FREE!



The ROSICRUCIANS

SAN JOSE • (AMORC) • CALIFORNIA

—SEND THIS COUPON—

Scribe N. P. K.
The ROSICRUCIANS (AMORC)
San Jose, California

Please send me the free book, *The Mastery of Life*, which explains how I may learn to use my faculties and powers of mind.

Name _____

Address _____

City _____

Ama-Touring

(Continued from page 70)

of the OX3 calls formerly used. The first one on was KG1AA, heard on 14.20 at 0430 and 0600; he uses 300 watts and a rhombic antenna. (Don Kenny, Calif.)

Europe

Andorra—A beam antenna is en route to PX1YR, Andorra's only amateur, so he should be getting out better.

Liechtenstein—Swiss amateur HB1MX is operating portable in Liechtenstein on weekends. He operates around 14.15 mc.

Rhodes—SVØWU should be on by now from Rhodes, according to a statement made by SVØWM.

Asia and Oceania

Brunei—VS5CT, 14.155 mc., was heard at 1100. He said he would be going to British North Borneo (VS4) soon, and that QSL's should be sent via the VS2 QSL Bureau. (Jim Moore, Calif.)

Caroline Islands—KC6CG, located on the island of Ulithi in the Eastern Carolines, has been noted on 14.24 mc. at 0315. (Moore)

Cook Islands—ZK1BI, Raratonga, was heard on 14.18 mc. at 0320. His transmitter is 50 watts. (Kenny)

Formosa—BV1US has been noted on 14.20 and 14.25 at 0920. C3VA was heard on 14.205 at 0320. The address for BV1US is MAAG, APO 63, c/o P.M., San Francisco, Calif. (Moore)

Midway—KM6AX was logged on 14.21 mc. at 0330. (Kenny)

Netherlands New Guinea—JZØDN was noted on 14.195 mc. at 0325 with weak signals. (Moore)

Okinawa—Okinawa stations are getting through to the East Coast around 0600-



Ham band listening post of Thomas Neal located at Mt. Rainier, Maryland.

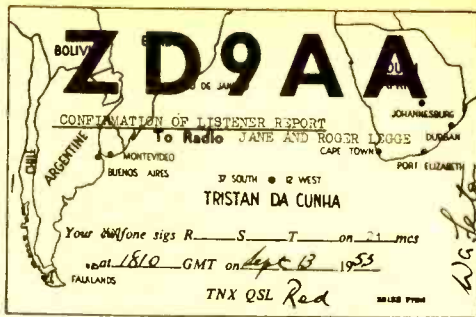

This rare QSL card is from the island in the South Atlantic Ocean called Tristan Da Cunha. To obtain QSL cards like this requires patience and a knowledge of where and when to listen.

0800, including: KR6AF, 14.175; KR6LJ, 14.13; KR600, 14.145; and KR6USA, 14.125. (RL)

Africa

Reunion Island—FR7ZA is being heard on 14.115 at 0930. He uses phone only occasionally, as he generally operates on c.w. He also operates on the 21-mc. band. (Moore)

Seychelles—VQ4NZK plans to make a trip to the Seychelles and operate from there as VQ9NZK, but the date is still unsettled.

The following are other Africans who are active on phone, arranged alphabetically by call letters. Frequencies shown are subject to variation.

- CN2** (Tangier): CN2AD, 14.11
- CN8** (Morocco): CN8GQ, 14.14; CN8MM, 14.17
- CR4** (Cape Verde Islands): CR4AG, 14.15; CR4AL, 14.12
- CR5** (Sao Tome): CR5NC, 14.19
- CR6** (Angola): CR6AG, 14.14; CR6BH, 14.17
- CR7** (Mozambique): CR7AU, 14.19; CR7CF, 14.11
- CT3** (Madeira): CT3AN, 14.15
- EA8** (Canary Islands): EA8AI, 14.18; EA8AP, 14.16
- EA9** (Spanish Morocco): EA9AR, 14.19; EA9BC, 14.15
- EA9** (Rio de Oro): EA9DE, 14.18; EA9DQ, 14.13
- EAØ** (Spanish Guinea): EAØAB, 14.11; EAØAC, 14.19
- EL** (Liberia): EL2X, 14.11; EL9A, 14.19
- ET2** (Eritrea): ET2US, 14.18; ET2ZZ, 14.12
- ET3** (Ethiopia): ET3Q, 14.32; ET3S, 14.17
- FA** (Algeria): FA3GZ, 14.13; FA9WD, 14.19
- FB8** (Madagascar): FB8BC, 14.17; FB8BM, 14.19
- FE8** (French Cameroons): FE8AC, 14.12; FE8AE, 14.15

- FF8 (French West Africa): FF8AH, 14.11; FF8AP, 14.12
 FL8 (French Somaliland): FL8AI, 14.15
 KT1 (Tangier): KT1UX, 14.17; KT1WX, 14.19
 OQ5 (Belgian Congo): OQ5CX, 14.16; OQ5FO, 14.19
 OQØ (Ruanda-Urundi): OQØDZ, 14.19
 ST (Sudan): ST2DB, 14.14; ST2NW, 14.17
 VQ2 (Northern Rhodesia): VQ2DT, 14.14; VQ2FU, 14.18
 VQ3 (Tanganyika): VQ3ES, 14.15; VQ3RJB, 14.12
 VQ4 (Kenya): VQ4AQ, 14.14; VQ4EZ, 14.18
 VQ5 (Uganda): VQ5EK, 14.14; VQ5DES, 14.17
 VQ6 (British Somaliland): VQ6LQ, 14.15
 VQ8 (Mauritius): VQ8AL, 14.11; VQ8AR, 14.16
 VQ8 (Chagos Islands): VQ8CB, 14.10
 ZD2 (Nigeria): ZD2EHW, 14.18; ZD2RWW, 14.19
 ZD3 (Gambia): ZD3BFC, 14.11
 ZD4 (Gold Coast): ZD4BF, 14.17; ZD4BR, 14.12
 ZD6 (Nyasaland): ZD6BX, 14.10
 ZD8 (Ascension Island): ZD8AA, 14.175
 ZD9 (Tristan Da Cunha): ZD9AB, 14.17; ZD9AC, 14.14
 ZE (Southern Rhodesia): ZE2JN, 14.20; ZE6JI, 14.17
 ZS (South Africa): ZS1SW, 14.19; ZS5DE, 14.12
 ZS3 (Southwest Africa): ZS3AH, 14.13; ZS3P, 14.16
 ZS7 (Swaziland): ZS7A, 14.14; ZS7C, 14.17
 ZS8 (Basutoland): ZS8E, 14.15; ZS8I, 14.10
 ZS9 (Bechuanaland): ZS9F, 14.18; ZS9G, 14.16
 3V8 (Tunisia): 3V8AS, 14.195; 3V8BL, 14.13
 5A (Libya): 5A2TZ, 14.19; 5A4TU, 14.12

-30-

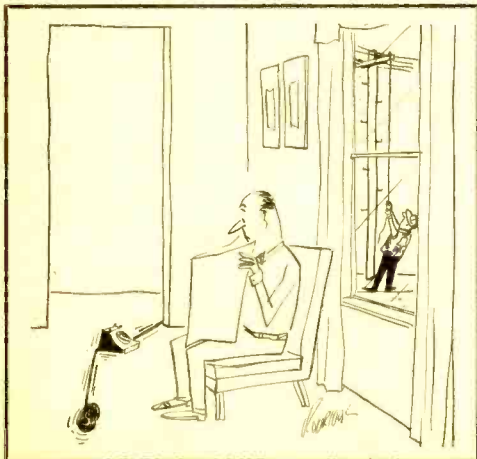

August, 1955

BUILD 15 RADIO CIRCUITS AT HOME

With the New Improved 1955 Progressive Radio "EDU-KIT" NOW INCLUDES RECEIVER, TRANSMITTER, SIGNAL TRACER, CODE OSCILLATOR CIRCUITS

ONLY \$19.95 Complete

- Attractively Gift Packaged
- Free Soldering Iron
- Absolutely No Knowledge of Radio Necessary
- No Additional Parts Needed
- Excellent Background For Television
- 30-day Money-Back Guarantee
- School Inquiries Invited
- Used in 79 Countries
- Learn High Fidelity



WHAT THE PROGRESSIVE RADIO "EDU-KIT" OFFERS YOU

You will learn how to identify Radio Symbols and Diagrams; how to build radios, using regular radio schematics; how to wire and solder in a professional manner. You will learn proper chassis layout. You will learn the basic principles involved in radio reception, transmission and audio amplification. You will learn how to service and trouble-shoot radios. You will learn code. You will receive instructions for F.C.C. Novice license. In brief you will receive a practical basic education in Radio, worth many times the small price you pay.

THE KIT FOR EVERYONE

It is not necessary that you have even the slightest background in science or radio. The "Edu-Kit" is used by young and old; by radio schools and clubs; by Armed Forces personnel and Veterans. No instructor is required. Instructions are complete, simple and clear.

PROGRESSIVE TEACHING METHOD

The "Edu-Kit" uses the principle of "Learn by Doing." Therefore you will build radios, perform jobs, and conduct experiments to illustrate the principles which you learn. You begin by learning the function and theory of each of the radio parts. Then you build a simple radio. Gradually, in a progressive manner, you will find yourself constructing more advanced multi-tube radio sets, and doing work like a professional Radio Technician. The "Edu-Kit" Instruction Books are exceedingly clear in their explanations, illustrations and diagrams. These sets operate on 105-125 V. AC/DC. For use in foreign countries having 210-250 volt source, an adapter for 210-250 V. AC/DC is available.

The Progressive Radio "EDU-KIT" is Complete

You will receive every part necessary to build fifteen different radio circuits. The "Edu-Kit" contains tubes, tube sockets, variable, electrolytic and paper condensers, resistors, tie strips, coils, hardware, tubing, Instruction Manuals, etc. No solder or hook-up wire included. A soldering iron is included, as well as Electrical and Radio Tester. Complete, easy-to-follow instructions are provided. All parts are guaranteed, brand new, carefully selected and matched. In addition, the "Edu-Kit" now contains lessons for servicing with the Progressive Signal Tracer, High Fidelity, F.C.C. Novice instructions, quizzes.

TROUBLE-SHOOTING LESSONS

Trouble-shooting and servicing are included. You will learn how to recognize and repair troubles. You will build and learn to operate a professional Signal Tracer. You will receive an Electrical and Radio Tester, and learn to use it for radio repairs. While you are learning in this practical way, you will be able to do many a repair job for your neighbors and friends and charge fees which will far exceed the cost of the "Edu-Kit."

FREE EXTRAS

- ELECTRICAL & RADIO TESTER • SOLDERING IRON
- HI-FI GUIDE • TV BOOK • QUIZZES
- CONSULTATION SERVICE

PROGRESSIVE "EDU-KITS" INC., 497 Union Av., Brooklyn 11, N.Y.

MAIL TODAY—Order shipped same day received.
 30-Day Money-Back Guarantee. INCLUDE ALL FREE EXTRAS
 "EDU-KIT" Postpaid. I enclose full payment of \$19.95
 "EDU-KIT" COD—I will pay \$19.95 plus postage (USA only)
 Outside USA: Enclose \$20.95. "Edu-Kit" sent postpaid
 Outside USA: 210-250V. AC/DC Adapter. Enclose \$2.50
 More details on "EDU-KIT" Free—No Obligation
 FREE Radio-TV Servicing Literature. No obligation

NAME _____

ADDRESS _____

PROGRESSIVE "EDU-KITS" INC. 497 UNION AVE.
 Room 511D, Progressive Building Brooklyn 11, N. Y.

GLOSSARY OF ELECTRONIC TERMS

For the next several months, we will provide a selected group of definitions of electronic terms, reprinted by permission from a booklet entitled "A Dictionary of Electronic Terms," published by Allied Radio Corp., 100 N. Western Ave., Chicago, Ill. The complete dictionary, containing over 3500 terms, is available from Allied at 25 cents a copy.

A battery—The battery used to supply power for the filaments of electron tubes. Sometimes loosely applied to the filament power supply.

a.c.-d.c.—Term applied to electronic equipment indicating it is capable of operation from either an alternating current or a direct current primary power source.

adapter—Any device used for changing temporarily or permanently the terminal connections of a circuit or part.

aerial—A system of wires or electrical conductors employed for reception or transmission of radio waves. Specifically, a radiator which couples the transmission line or lead-in to space, for transmission or reception of electromagnetic radio waves. Synonym: **antenna**.

air core—Descriptive term for coils or transformers which have no iron in their magnetic circuits, and are used chiefly in radio frequency circuits or for alternating current ammeter multipliers.

align—To adjust or tune one or more circuits so that they operate to predetermined specifications.

alligator clip—A long-nosed metal clip with meshing jaws used on test leads to make temporary connections.

alnico—Alloy of iron with aluminum, nickel and cobalt, used to make permanent magnets for loudspeakers, motors, dynamotors, meters and motor-generators. Has characteristic of holding magnetism indefinitely. Alnico is usually known by an alloy number. Formerly, the alnico was Alnico III; now a more powerful alloy has been created known as Alnico V.

alternating current—Electric current such as is usually supplied by power lines and produced by rotating machines. The ideal form is sinusoidal. Current results from a surging back and forth of electrons in the lines. Current flow from zero constitutes one cycle. An alternation is half a cycle. The number of cycles per second (cps) is the frequency. Power frequencies are of the order of 60 cps; but the term a.c. is used in connection with other frequencies to distinguish varying frequency currents from d.c. components.

ammeter—An instrument to measure current flow in amperes.

ampere—A practical unit of current. It is the current flowing through 1-ohm resistance at 1-volt potential. The movement of 6,280,000,000,000,000 electrons past a given point in a circuit in one second corresponds to a current of one ampere. Abbreviated **amp**.

ampere turn—A unit of magnetomotive force, obtained by multiplying the current in amperes by the number of turns in a coil.

amplification—The process of increasing the strength of a signal, current, voltage or power, and usually produced by vacuum tubes, transformers and feedback circuits.

amplifier—A device of electronic components with or without vacuum tubes used to increase power, voltage or current of a signal.

amplitude—Term used to describe the magnitude of a simple wave or simple part of a complex wave. It is the largest or crest value measured from zero.

amplitude modulation—The common system of radio broadcasting. It consists of modulating a carrier frequency current by varying its amplitude above and below normal value in step with the audio frequency being transmitted. Abbreviated as **AM**.

anode—The radio tube electrode to which the main electron stream flows. It is commonly called the plate, and is usually placed at high positive potential with respect to the cathode. Identified on diagrams by the letter P.

array—A combination of antennas or antenna elements so arranged that each reinforces the performance of the other. Hence, an array is often used when a great amount of directivity and gain is required.

attenuation—Reduction in the strength of an electrical impulse.

audio—Pertaining to currents or frequencies corresponding to normally audible sound waves.

audio transformer—An iron-core transformer used to couple two audio amplifier circuits.

automatic frequency control—An electronic circuit which keeps a superheterodyne receiver, or a transmitter, accurately tuned to a predetermined frequency. Used chiefly in FM receivers. Also used in receivers which are push-button tuned to correct slight inaccuracies in the operation of the tuning system. Abbreviated **a.f.c.**

automatic gain control—Abbreviated **a.g.c.** In a television receiver, a circuit which performs the same function (for video and audio) as the a.v.c. circuit in a radio receiver.

autotransformer—Any transformer of single coil construction where the primary and secondary connections are made to the single coil, and used to change voltage amplitudes.

baffle—A wood, metal or composition horn or flat surface used with a loudspeaker to increase the length of the air path from the front to the back of the loudspeaker diaphragm, thereby reducing interaction between sound waves produced simultaneously by front and back surfaces of the diaphragm. A baffle thus serves to direct the sound produced by a loudspeaker and improve the fidelity.

banana jack—A receptacle that fits a banana plug.

banana plug—A banana-shaped plug. Elongated springs provide a low-resistance compression fit.

band—In radio, frequencies which are within two definite limits and are used for a definite purpose. Thus, the standard broadcast band extends from 550 kc. to 1600 kc.

bandspread—Any method, mechanical or electronic, of increasing space on tuning scale between stations otherwise crowded and difficult to tune.

bandwidth—A section of the frequency spectrum required to transmit the desired information, whether visual, aural or both. The bandwidth of the average television channel is 6 mc.; of a broadcast channel, 10 kc., which is 1/600 that of a television channel.

bass booster, also bass boosting circuit—A group of components connected in a circuit so that bass (low) frequencies are emphasized.

bass compensation—Any means, electrical or acoustical, of offsetting the natural drop in the response of the human ear to low audio frequencies at low volume levels.

bass reflex—A type of speaker enclosure noted for its ability to enhance the bass characteristics of a loudspeaker. Bass reflex enclosures have a volume of up to 10 cubic feet and employ a port opening, the size of which is determined by the volume of the enclosure and the cone resonance of the associated speaker.

bathbub capacitor or condenser—A capacitor enclosed in a metal can with rounded corners like a bathtub.

B battery—The battery used to supply the d.c. voltages required by the plates and screen grids of vacuum tubes.

beam power tube—A vacuum tube constructed with end shields so that the electrons are concentrated by emerging only at the two opposite sides. The two grids have parallel spacings to concentrate further the electrons in beams. The result is a sufficient electron density near the plate to achieve the effect of a suppressor grid which behaves as a virtual cathode. Performance is similar to that of a pentode.

beat frequency—The frequency obtained when signals of two different frequencies are combined and rectified. The beat frequency is equal in numerical value to the difference between the original frequencies.

bel—Unit of relative power, named after Alexander Graham Bell, and used to express differences in power amplitudes. Generally used as 1/10 bel, termed a decibel, and abbreviated **db**.

bell wire—A common term for the cotton-covered B. & S. No. 18 copper wire used for making doorbell and thermostat connections in homes.

bias—The fixed voltage applied between grid and cathode electrodes of a radio tube. Also called **C bias** when speaking specifically of the control grid.

bias resistor—The cathode resistor through which plate and screen grid currents of a vacuum tube flow, developing across this resistor a d.c. voltage used as a **C bias**.

binaural effect—The effect of sound reaching both human ears by which it is possible to locate the sound source.

binding post—A terminal fixed in position and usually consisting of a threaded post to which wires may be attached by means of one or more nuts. Binding posts may be equipped with lugs or jacks.

block diagram—Simplified outline of an electronic system in which circuits or parts are shown as rectangles.

blocking capacitor or condenser—Any capacitor used in a radio circuit to block the flow of direct current while allowing a.c. signals to pass.

body capacity—The capacity existing between the human body and a piece of radio apparatus or ground.

breadboard—Laboratory idiom for an experimental circuit setup exposed on a board for portability and ease of assembly or disassembly.

breakdown voltage—The voltage at which the insulation between two conductors or parts will break down.

broadband—Ability of a circuit or antenna to be useful over a large frequency range and maintain voltage gain or amplification over this range.

B. & S. gauge—Brown and Sharpe wire gauge, the standard gauge used in the United States to specify wire sizes.

buffer amplifier—One or more stages of r.f. amplification used in a transmitter to build up the control crystal frequency to an appropriate level before modulation. This prevents feedback of undesired frequencies to the crystal.

bug—A semi-automatic code transmitting key in which movement of a lever to one side produces a series of dots, and movement to the other side produces a single dash.

bus—Term used to specify an uninsulated conductor (a bar or wire). Usually square or round; may be solid or hollow.

bypass capacitor or condenser—A capacitor used to provide a low-impedance path for radio or audio signals around a resistor or between a circuit terminal and ground.

capacitance—The quantity of electrical charge which can be received by a system of insulated conductors from a potential source of given value. The term **capacity** is often used in this connection. A capacitor does not become filled but will receive more charge with increasing potential until breakdown occurs. Unit of capacitance is the farad. A one-farad capacitor requires one coulomb of charge to raise its potential one volt. A microfarad ($\mu\text{fd.}$) is one one-millionth (10^{-6}) of a farad. A micromicrofarad ($\mu\mu\text{fd.}$) is one one-millionth of a microfarad or (10^{-12}) farads.

capacitor-input filter—A type of power supply filter which changes the pulsating d.c. output of a power supply rectifier to pure d.c. In this type of filter, a capacitor across the output of the rectifier precedes an inductor or a resistor; there may be several such elements. Voltage regulation with this type of filter is not as good as when using the inductor (choke) input filter and ripple may become serious at high currents. However, capacitor input filters offer the advantage of about 55% greater output from a given voltage source than inductor input filters.

capacitive reactance—The reactance which a capacitor offers to a.c. or pulsating d.c. It is measured in ohms, and decreases as frequency and capacity are increased.

















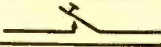
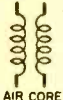
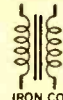
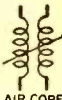



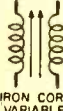











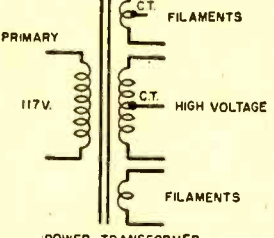

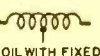
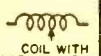



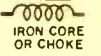

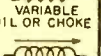

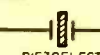
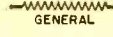
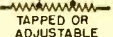
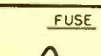
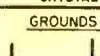

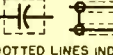



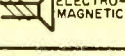

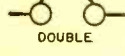

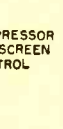
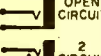
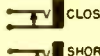

capacitor—A radio part consisting of two conducting surfaces separated from each other by an insulating material such as air, oil, paper, glass, mica or ceramic. A capacitor is capable of storing electrical energy. In radio circuits, capacitors are used to block the flow of direct current while allowing alternating and pulsating currents to pass. The capacitance of a capacitor is specified in microfarads and micromicrofarads. The capacitance of a parallel plate capacitor in air is equal to the area of the dielectric divided by 4 pi times the thickness of the dielectric.

capacity coupling, also capacitive coupling—A type of coupling in which a capacitor provides a path for signal energy between two circuits or stages of an amplifier.

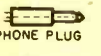
capacity-operated relay—A type of electronic relay circuit which is actuated by very small capacitance changes, such as those caused by bringing a hand near a pickup wire or plate connected to the circuit. Capacity-operated relays have many industrial applications as safety devices.

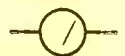
(To be continued next month)

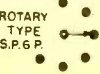
STANDARDIZED WIRING DIAGRAM SYMBOLS

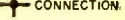
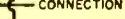
<p style="text-align: center;">ANTENNAS</p> <div style="display: flex; justify-content: space-around;"> <div style="text-align: center;">  GENERAL </div> <div style="text-align: center;">  DIPOLE </div> <div style="text-align: center;">  LOOP </div> <div style="text-align: center;">  FERRITE TYPE </div> </div>	<p style="text-align: center;">MICROPHONE</p> <div style="display: flex; justify-content: space-around;"> <div style="text-align: center;">  SINGLE BUTTON DYNAMIC </div> <div style="text-align: center;">  DOUBLE BUTTON VELOCITY </div> <div style="text-align: center;">  CAPACITOR CRYSTAL </div> </div>	<p style="text-align: center;">TELEGRAPH KEY</p> <div style="text-align: center;">  </div>	<p style="text-align: center;">TRANSFORMERS</p> <div style="display: flex; justify-content: space-around;"> <div style="text-align: center;">  AIR CORE </div> <div style="text-align: center;">  IRON CORE </div> <div style="text-align: center;">  AIR CORE VARIABLE </div> </div>	
<p style="text-align: center;">BATTERIES</p> <div style="display: flex; justify-content: space-around;"> <div style="text-align: center;">  SINGLE-CELL </div> <div style="text-align: center;">  MULTI-CELL </div> </div>	<p style="text-align: center;">NEON BULB</p> <div style="text-align: center;">  </div>	<p style="text-align: center;">PILOT LIGHT</p> <div style="text-align: center;">  </div>	<p style="text-align: center;">IRON CORE VARIABLE</p> <div style="text-align: center;">  IRON CORE VARIABLE </div>	<p style="text-align: center;">AUTO</p> <div style="text-align: center;">  </div>
<p style="text-align: center;">BELL</p> <div style="text-align: center;">  </div>	<p style="text-align: center;">BUZZER</p> <div style="text-align: center;">  </div>	<p style="text-align: center;">PHONO PICKUPS</p> <div style="display: flex; justify-content: space-around;"> <div style="text-align: center;">  CRYSTAL </div> <div style="text-align: center;">  MAGNETIC </div> </div>	<p style="text-align: center;">PLUG OR SOCKET</p> <div style="text-align: center;">  </div>	<p style="text-align: center;">IRON CORE VARIABLE</p> <div style="text-align: center;">  IRON CORE VARIABLE </div>
<p style="text-align: center;">CAPACITORS</p> <div style="display: flex; justify-content: space-around;"> <div style="text-align: center;">  FIXED MICA OR PAPER </div> <div style="text-align: center;">  ELECTROLYTIC </div> <div style="text-align: center;">  VARIABLE CAPACITORS GANGED </div> </div>	<p style="text-align: center;">RECEPTACLE 117V.</p> <div style="text-align: center;">  </div>	<p style="text-align: center;">RECORDING HEAD</p> <div style="text-align: center;">  MAGNETIC </div>	<p style="text-align: center;">POWER TRANSFORMER</p> <div style="text-align: center;">  117V. PRIMARY FILAMENTS C.T. HIGH VOLTAGE FILAMENTS C.T. </div>	<p style="text-align: center;">RECTIFIER</p> <div style="text-align: center;">  SELENIUM TYPE </div>
<p style="text-align: center;">COILS</p> <div style="display: flex; justify-content: space-around;"> <div style="text-align: center;">  FIXED R.F. COIL </div> <div style="text-align: center;">  COIL WITH FIXED TAP </div> <div style="text-align: center;">  COIL WITH VARIABLE TAP </div> </div>	<p style="text-align: center;">RELAYS</p> <div style="display: flex; justify-content: space-around;"> <div style="text-align: center;">  S.P.S.T. NORMALLY OPEN </div> <div style="text-align: center;">  S.P.S.T. NORMALLY CLOSED </div> <div style="text-align: center;">  S.P.D.T. </div> </div>	<p style="text-align: center;">IRON CORE OR CHOKE</p> <div style="text-align: center;">  IRON CORE OR CHOKE </div>	<p style="text-align: center;">BIFILAR</p> <div style="text-align: center;">  </div>	<p style="text-align: center;">VARIABLE COIL OR CHOKE</p> <div style="text-align: center;">  </div>
<p style="text-align: center;">CRYSTALS</p> <div style="display: flex; justify-content: space-around;"> <div style="text-align: center;">  CRYSTAL DETECTOR </div> <div style="text-align: center;">  PIEZOELECTRIC CRYSTAL </div> </div>	<p style="text-align: center;">RESISTORS</p> <div style="display: flex; justify-content: space-around;"> <div style="text-align: center;">  GENERAL </div> <div style="text-align: center;">  TAPPED OR ADJUSTABLE </div> </div>	<p style="text-align: center;">CRISTAL DETECTOR</p> <div style="text-align: center;">  </div>	<p style="text-align: center;">PIEZOELECTRIC CRYSTAL</p> <div style="text-align: center;">  </div>	<p style="text-align: center;">PENTODE</p> <div style="text-align: center;">  SUPPRESSOR SCREEN CONTROL </div>
<p style="text-align: center;">FUSE</p> <div style="text-align: center;">  </div>	<p style="text-align: center;">SHIELDING</p> <div style="text-align: center;">  DOTTED LINES INDI- CATE SHIELDING COULD BE AROUND ANY COMPONENT OR GROUPS </div>	<p style="text-align: center;">GROUND</p> <div style="display: flex; justify-content: space-around;"> <div style="text-align: center;">  WIRING </div> <div style="text-align: center;">  CHASSIS </div> </div>	<p style="text-align: center;">SPEAKERS</p> <div style="display: flex; justify-content: space-around;"> <div style="text-align: center;">  P.M. </div> <div style="text-align: center;">  ELECTRO- MAGNETIC </div> </div>	<p style="text-align: center;">DIODE</p> <div style="text-align: center;">  HEATERS OR FILS. </div>
<p style="text-align: center;">HEADPHONES</p> <div style="display: flex; justify-content: space-around;"> <div style="text-align: center;">  DOUBLE </div> <div style="text-align: center;">  SINGLE </div> </div>	<p style="text-align: center;">SWITCHES</p> <div style="display: flex; justify-content: space-around;"> <div style="text-align: center;">  S.P.S.T. </div> <div style="text-align: center;">  S.P.D.T. </div> <div style="text-align: center;">  PUSH- BUTTON </div> </div>	<p style="text-align: center;">PLATE</p> <div style="text-align: center;">  GRID CATHODE TRIODE </div>	<p style="text-align: center;">TETRODE</p> <div style="text-align: center;">  GRID CAP DIODE PLATE </div>	<p style="text-align: center;">TRIODE</p> <div style="text-align: center;">  GRID CAP DIODE PLATE </div>
<p style="text-align: center;">JACKS</p> <div style="display: flex; justify-content: space-around;"> <div style="text-align: center;">  OPEN CIRCUIT </div> <div style="text-align: center;">  CLOSED CIRCUIT </div> </div>	<p style="text-align: center;">TRANSISTOR (JUNCTION)</p> <div style="text-align: center;">  BASE COLLECTOR EMITTER P-N-P TYPE N-P-N TYPE SAME SYMBOL EXCEPT ARROW IS REVERSED </div>	<p style="text-align: center;">PHONE PLUG</p> <div style="text-align: center;">  </div>	<p style="text-align: center;">PIN PLUG</p> <div style="text-align: center;">  </div>	<p style="text-align: center;">PIN JACK</p> <div style="text-align: center;">  </div>
<p style="text-align: center;">METER</p> <div style="text-align: center;">  </div>	<p style="text-align: center;">MOTOR</p> <div style="text-align: center;">  </div>	<p style="text-align: center;">ROTARY TYPE S.P.G.P.</p> <div style="text-align: center;">  </div>	<p style="text-align: center;">WAFER</p> <div style="text-align: center;">  </div>	<p style="text-align: center;">VIBRATOR</p> <div style="text-align: center;">  </div>
<p style="text-align: center;">CONNECTION</p> <div style="text-align: center;">  </div>	<p style="text-align: center;">NO CONNECTION</p> <div style="text-align: center;">  </div>			

ADVERTISERS' INDEX

ADVERTISER	PAGE NO.
Ace Radio Control	116
Allied Radio Corp.	109
Amacco	110
Ashe Radio Co., Walter	114
Beavers, Patrick D.	112
Cabinart	3rd Cover
Canadian Institute of Science	120
Coyne Electrical School	5, 115
Eastern Audio Research	118
Electronic Instrument Co., Inc. Eico	14
Electronic Measurement Corporation	8
Electro-Voice	15
Goldak Company	114
Grantham School of Electronics	118
Gyro Electronics Co.	110
Hallicrafters	4th Cover
Harjo Sales Co.	114
Hawkins Co., P. E.	116
Heath Company	92, 93, 94, 95
Hershel Radio Co.	103
Huckert Electronics	116
International Correspondence Schools	13
Johnson, E. F.	6
Lafayette Radio	111
Lektron Specialties	113
McGraw-Hill Book Co., Inc.	11
McMorrow, Berman & Davidson	9
Major Brand Tube Co.	104
Mason Shoe Mfg. Co.	127
Miller, Gustave	127
Motor Book Dept.	119
Moss Electronic Distributing Co., Inc.	19, 99
Musical Masterpiece Society	10
National Radio Institute	3, 130
National Schools	97
Perma Power Company	116
Precision Radiation Instrument, Inc.	127
Progressive "Edu-Kits," Inc.	123
Radio Products Co.	120
Radio-Television Training Association	7
Raytheon Manufacturing	17
Rex Radio Supply	118
Rider Publishing Co., Inc., John F.	117
Rosicrucians, The	121
Shure Bros., Inc.	18
Smith & Co., Johnson	127
Solotron Company	120
Sprague Products Co.	20
Springfield Enterprises	110, 120
Stanley Electronics Corp.	108
Stowers & Son	118
Suprex Electronics Corp.	128
Teltron Electric Company	107
Trans-Aire	112
Universal Atomics Corporation	112
Uranium Prospectors Supply Co.	2nd Cover
U. S. Air Force	12
Valparaiso Technical Institute	127
Video Electronics Company	101
World Radio Laboratories	105

POWER TRANSFORMER QUIZ

(Questions on page 89)

1. 1:2. 2. 126 volts. 3. 5 amperes—step-down. 4. 120 volts. 5. Since the voltage step-up is 10:1, the primary current is normally ten times greater than the secondary current; when the load on the secondary increases, the primary current increases 10 times as fast, causing the primary fuse to blow.



**\$35,000
REWARD
FOR
URANIUM**

Here's your chance to "cash in!" Over \$2,500,000 in Government Bonuses have been paid for URANIUM discoveries in the past 2 years. Currently \$150,000 a month is paid to people just like you. Precision Geiger Counters and Scintillators are the finest instruments made for URANIUM prospecting. These highly sensitive instruments are compact, lightweight and ruggedly built for field use. Prices start at \$29.95.

CONTACT YOUR NEAREST DEALER or write direct to factory for FREE 12-PAGE CATALOG, describing URANIUM and Metal detectors.

PROSPECTORS

RELY ON...



PRECISION RADIATION INSTRUMENTS, INC.

4223PT W. Jefferson Boulevard • Los Angeles 16, California
WORLD'S LARGEST MANUFACTURER OF RADIATION INSTRUMENTS

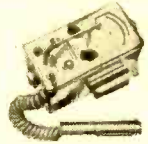

A POSTCARD PUTS YOU IN BUSINESS!

Earn \$84.00 EXTRA a Month on Just 5 Sales a Week!

Go into business without spending a cent! My powerful FREE Sales Kit makes it easy to take orders for Mason's fast-selling line of leather jackets. Your friends, relatives, outdoor workers will grab these from you, paying you Big Profits on each order! Just sell 5 of our popular Fleece-lined Leather jackets a week, to make \$84 extra income a month! Besides jackets of Horsehide, Cape skin leather, Suede, Nylon, Gabardine, Wool... take orders for 174 fine shoe styles for men, women, including popular Air-Cushioned work shoes. People MUST buy from you, because we do not sell through stores! To start at once, rush postcard for your free money-making Sales Kit! MASON SHOE MFG. CO., Dept. MA 758, Chippewa Falls, Wisconsin



FREE KIT!

Catalog of 3000 Novelties 10c

Send 10c for amazing catalog of novelties, live animals, scientific supplies, hobbies, funmakers, planes & boats, looms, magic tricks, joke articles, unusual seeds, gadget timesavers, cameras, optical goods, projectors, movies, lucky jewelry, religious novelties, disguises, musical instruments, stunts, puzzles, fortune tellers, radios, auto & bike accessories, telescopes, magnifiers, compasses, banks, smokers' gadgets, artists' supplies, printing sets, engines, motors, shockers, knives, billfolds, fireworks, guns, rifles, sports, books, games, plants, etc. Send name, address & 10c to

JOHNSON SMITH & CO., Dept. 105, Detroit 7, Michigan

INVENTORS

Send for PATENT INFORMATION REGISTERED PATENT ATTORNEY Book and INVENTOR'S RECORD ASSOCIATE EXAMINER without obligation U.S. PAT. OFF. 1922-1929

GUSTAVE MILLER
85-PE WARNER BUILDING
WASHINGTON 4, D. C.

Patent Attorney & Advisor
U. S. NAVY DEPT. 1930-1947
PATENT LAWYER

GET INTO ELECTRONICS

You can enter this uncrowded, interesting field. Defense expansion, new developments demand trained specialists. Study all phases radio & electronics theory and practice: TV; FM; broadcast; servicing; aviation; marine; police radio. 18-month course. Graduates in demand by major companies. H. S. or equivalent required. Begin Jan., March, June, Sept. Campus life. Write for Catalog.

VALPARAISO TECHNICAL INSTITUTE

Dept. PE

Valparaiso, Indiana

Hi-Fi Distortion

(Continued from page 83)

present at the same time as the fundamental frequency causing the burst of oscillation, these may get "lost" during the oscillation.

Figure 2 shows the effect of the other kind of spurious oscillation. Here the amplifier goes into a continuous state of extremely high-frequency (if not r.f.) oscillation which probably gives full output at its own frequency. However, since the diaphragm of the loudspeaker cannot move at this high frequency, it has no effect in the room. In fact, because the amplifier is completely loaded by the high frequency, it may sound even quieter than usual, i.e., the normal background hiss and hum level may appear to be completely missing, even when the ear is put very close to the loudspeaker. But when a musical program is put into the amplifier, it chops up the spurious inaudible oscillation and manages to break through here and there; while at the quieter passages of the program material, the oscillation takes over completely and swamps out the audio. Figure 3 shows a typical waveform of an amplifier with program material going through when it is suffering from spurious oscillation.

Another kind of distortion that occurs does not originate with the program material injected to the system either. This takes the form of audible noise. It may be tube hiss or other random noise of that kind which, if it is too loud compared to the program material, can seriously mar the program; or it may take the form of a hum due to ripple voltages from the power supply which get mixed up with the program material in the amplifier. Hum may be of 60 cycles or can be of a higher frequency due to the effect of the rectifier in multiplying the frequency of the ripple.

If the hum is relatively low in level compared to the program material, it may be just an annoying background that spoils reproduction because of its presence. If it gets a little stronger, however, it may also tend to break up the reproduction, like some kinds of intermodulation distortion, so that the reproduction sounds choppy. This is due to the fact that the amplification of the program material changes during different parts of the 60-cycle wave. Thus, during one part of the 60-cycle wave, the program material is amplified more than it is during another part of the wave. The alternate increase and decrease in amplification during the 60-cycle wave has the effect of chopping up the program material.

-30-

a real buy!

NEW!

Sensiphone

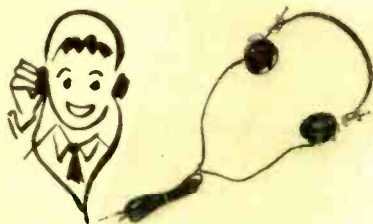

SUPEREX

EARPHONES

It's the greatest thing in ear-phones today! Genuine feather-weight, "Black Beauties" . . . with powerpacked Alnico V magnets and balanced dual coil construction. Top quality, low cost, exceptional sensitivity and tone.

Improves reception from crystal and battery sets, monitoring tape recordings, any equipment requiring ear-phones. COMPARE with any other . . . it's the best!

SEE your neighborhood radio or hobby dealer TODAY . . . or write, DEPT. E-8

Single earphone (1000-OHM) **\$1.98**
Pair earphones
(2000-OHM, as shown) **\$3.49**

Superex ELECTRONICS CORP.

6 Radford Pl., Yonkers, N. Y.

Classified

RATE: 50c per word—minimum 10 words

FOR SALE

PEPPY Pal Solderless Crystal Radio Kits, \$1.50. Code Practice Keys. Radi-Ore Labs., Lynn, Mass.

CRYSTAL Blanks, AT cut, 2-3 megacycles, easily ground to frequency, 243 type, 5 for \$1.00. PP Crystals, 1510 C St. SW., Cedar Rapids, Iowa.

TV, Radio Parts, Tubes, Antennas, Wire, Speakers, Condensers, Selenium Rectifiers, Rotators, Towers, Benches, Shelving, Test Equipment, TV Tables. Make us your leading supplier. Catalog free. Radio Tube Merchandising Company, 508 Clifford Street, Flint 3, Michigan.

DIAGRAMS: Counters, Timers, Intercoms, Organs, etc., \$1.00 each. List free. Parks, 104-A S. E. 57th, Portland 15, Oregon.

BUY Surplus Radio Electronics Parts, Equipment. Hundreds of other items Direct from Government. List \$1.00. Box 169 ZF, East Hartford 8, Conn.

LEARN Code! Minicode practice oscillator, codes, instructions, warranty, \$4.00 postpaid. Details free. Stout 2241 A. E. Broadway, Muskegon, Michigan.

ELECTRIC Guitars, amplifiers, parts, wholesale. Free catalog. Carvin PE287, Covina, Calif.

LACK—space? E-H Vector 80 meter Antenna occupying one foot cube \$15.00. Antenna, 609 Dawes Ave., Utica, N. Y.

SLIDE Rule easy to learn methods. Write for Particulars, L. J. Klersey, 1510 C. Street SW., Cedar Rapids, Iowa.

ETCHED-wire printed circuits. Complete assortment of Materials. Contains XXX-P Copper Board, special Printed Circuit Tube Sockets, Etching materials and instructions, Etch-resistant material for Layouts, Eyelet Connections and Drill, Circuit Diagrams for Multimeter and 1-tube Receiver. Kit No. 35 only \$3.50 complete. Fully guaranteed. Send Check or Money Order. Dept. E, Techniques, Inc., 135 Belmont Street, Englewood, New Jersey.

"ELECTRICAL Money Saving" (33p. booklet), \$1.00 postpaid. James McRoberts, 746 Carroll Street, Brooklyn 15, N. Y.

BUILD Pocket Radios. 5 selected plans 50c. Cook, 422 Shandon, Midland, Texas.

DIAGRAMS for repairing radios \$1.00 Television \$2.00. Give: make, model. Diagram Service, Box 672-PE, Hartford 1, Conn.

SOLAR battery converts light into electrical energy. High output type for operating transistors. Only \$1.99. Springfield Enterprises, Box 54-E8, Springfield Gardens 13, New York.

SUPERSENSITIVE VHF radio receives television, FM broadcast, CAP and amateurs without antenna or ground. Factory wired assembly complete with special tube only \$3.98 postpaid. Thousands in use by experimenters, amateurs, civil defense. Springfield Enterprises, Box 54-E8, Springfield Gardens 13, New York.

WALKIE-Talkie. Build wireless portable radio for less than \$10.00. Plans for variable frequency and crystal control types, only 50c for both. Springfield Enterprises, Box 54E8, Springfield Gardens 13, New York.

TRANSMITTER-receiver for 2 meter band. 110 volt AC operated. 10 to 50 mile range. Only \$59.50. Everything included and ready to operate. Crystal controlled transmitter meets FCC requirements. Springfield Enterprises, Box 54-E8, Springfield Gardens 13, New York.

TRANSISTORIZED code practice oscillator operates forever from solar battery. Requires only 5 candlepower illumination. Complete kit only \$6.95. Alnico headphone \$1.25 extra. Springfield Enterprises, Box 54-E8, Springfield Gardens 13, New York.

FIDELITY Unlimited: Authorized Distributors of High Fidelity Components. Shipments Prepaid and Insured. Specials: New Collaro RC-54 with Mounting Board, 45 Spindle, dual Blank Heads, \$38.75. Accessories: RFX-050, dual sapphires: \$6.50. Diamond and Sapphire Stylus, \$10.75. Write Us Your Hi-Fi Requirements. Free Audio Guide, Complete Stock. Fidelity Unlimited, 63-03 39th Ave., Woodside 77, N. Y. Dept. P.E.

WANTED

CYLINDER and old disc phonographs. Edison Concert, Balmoral, Conqueror, Opera, and Oratorio models. Berliner Gramophones and Zono-o-phones, Columbia disc and cylinder Graphophones, Bettini micro-reproducer. Want old catalogues and literature on early phonos prior to 1919. Will pay cash or trade late hi-fi components. Popular Electronics Box 50.

HELP WANTED

RUN spare-time Greeting Card and Gift Shop at home. Show friends samples of our new 1955 Christmas and All-Occasion Greeting Cards and Gifts. Take their orders and earn to 100% profit. No experience necessary. Costs nothing to try. Write today for samples on approval. Regal Greetings, Dept. 77, Ferndale, Michigan.

AMAZING Tall-Glow, Kodachrome Christmas Cards sell swiftly. Free Samples. \$52.50 profit on 50 boxes easy! Many Cards, Stationery, Novelties. Profits to 100%, Gift Bonuses. Samples on approval. Hurry—get sensational Mail Minder Free. Creative, 4401 Cermak, Dept. 515-B, Chicago 23.

EARN to \$1500 Monthly. Jobs, South America, The Islands, USA, etc. All Trades. Labor Drivers, Clerical, etc. Fare Paid. Application Forms. Free Information. Write Dept. 72E. National Employment Information, 1020 Broad, Newark, N. J.

FOREIGN—U. S. Employment. If interested in Stateside and Foreign projects write. High Pay. Stamped self-addressed env. appreciated. Job Information, Dept. 9G, Waseca, Minn.

INVENTIONS WANTED

INVENTIONS wanted. Patented; unpatented. Global Marketing Service, 1404 Mitchell, Oakland 1, Calif.

BUSINESS OPPORTUNITIES

FREE Booklet "Money-Making Facts" tells mechanically-inclined men how to start spare time business at home. Lee Foley Company, Columbia Heights, Minnesota.

WANT To Make big money at home? \$5 profit in an hour possible with Invisible Reweaving. Make tears, holes disappear from clothing, fabrics. Steady year-round demand from cleaners, laundries, homes. Details Free. Fabricon, 8343-S Prairie, Chicago 19, Ill.

MAKE Extra Money at home, sparetime! Exciting new Booklet shows "How!"—Dozens of proven money-making Plans, Ideas, for entire family! Rush 25c for yours! Mail Products, 82-46c—247th Street, Bellerose 26, New York.

\$500.00 Monthly Possible Mailing post-cards. Instructions \$1.00. Adelle's, 739 Marshall, Rochester 11, N. Y.

\$200 weekly cleaning Venetian Blinds. Free revealing book. Burt. 2434BU, Wichita 13, Kansas.

TAPE RECORDERS

TAPE Recorders, tapes, accessories. Unusual values. Dressner, Box 86E, Peter Stuyvesant Station, N.Y.C. 8.

INSTRUCTIONS

OPPORTUNITY! Complete high school at home in spare time with 58-year-old school. Texts furnished. No classes. Diploma. Information booklet free. American School, Dept. XC56, Drexel at 58th, Chicago 37, Illinois.

HIGH School—No Classes. Study at home. Spare Time. Diploma awarded. Write for Free Catalog HET9. Wayne School, 2527 Sheffield, Chicago 14, Ill.

MINERALS & PROSPECTING

GEIGER Counter and Metal Detector Kits. Inexpensive. Educational. Free Literature. Electronic Applications, Dept. B, 5024 Lee Highway, Arlington 7, Va.

URANIUM Finding Made Easy. Completely Transistorized Geiger Counters now available for the first time. Extra Sensitive. Lightweight. Scientifically engineered. Unconditionally guaranteed. Also a complete line of prospecting instruments priced from \$19.95. Write today for free information. Universal Atomics Corp., Dept. PE8, 19 East 48th Street, New York City.

URANIUM Found Easier with Universal's new Miracle Transistorized Audio. Adapts to all Geiger counters . . . amplifies detection clicks ten times . . . replaces bulky earphones . . . operates 500 hours on 15c flashlight cell. \$15. F.O.B. N.Y.C. Send \$5 for C.O.D. Universal Atomics Corp., Dept. PE 80, 19 East 48th Street, N.Y.C.

GEIGER counter. Only \$13.95. Ready to operate. Superior to \$30.00 models. Springfield Enterprises, Box 54-E8, Springfield Gardens 13, New York.

MISCELLANEOUS

"HEADPHONES." Complete repair handbook 50c. Including "Radiobuilder" Magazine. Laboratories, 328-L Fuller, Redwood City, California.

TUBES—TV, Radio, Transmitting, special purpose types—Bought, Sold, Exchanged. Send details to B. N. Gensler W2LNI, 512 Broadway, New York 12, N. Y.

BUILD super crystal radios, electrotonic crystal, detector, instructions 50c, Electrotonics, Box 98-E, Dixon, Missouri.

POWER. "Like Yoga-hypnotism-telepathy-psychology combined." (Details—10c.) Delmar Wisdom, 833-S8 Sunnyside, Chicago 40.

FREE Condenser & Resistor Code Chart! Get yours now Plus new value-packed catalogue! K. & L. Radio Parts Co., 1406 Venice Blvd., Los Angeles 6, California.

FREE Transistor code practice oscillator kit. Trans-Aire Electronics Inc., 149 Broadway, Dept. E, New York 6, N. Y. See display ad this issue, or write.

Learn to Service TV Sets—any make or model—Quickly

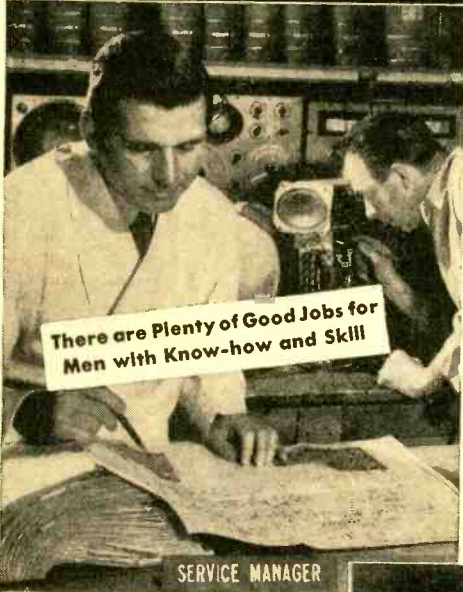

There are Plenty of Good Jobs for Men with Know-how and Skill

SERVICE MANAGER

17" Picture Tube, Components for a TV Receiver, Scope, Signal Generator, HF Probe—all included in introductory price under \$200—Easy Terms

If you want to go places in TV servicing, you will act quickly to find out what you get, what you practice, what you learn and how NRI's new course in Professional Television Servicing will help you advance through better technical knowledge and training. See pictures of equipment supplied, read what you practice in book offered FREE to ambitious men with some knowledge of Radio or TV fundamentals. Find out about this ALL PRACTICE Professional TV servicing Course now.



You Learn By Doing

UHF and COLOR Create Growing Opportunities

To cash in on the present UHF and the coming COLOR TV boom you'll need the kind of knowledge and experience NRI's Course gives. You'll get practice installing front-end channel selector strips in modern UHF-VHF receivers. You learn UHF servicing problems and their solution. Mail the coupon now. Discover how NRI's new course in PROFESSIONAL TELEVISION SERVICING meets the needs of the man who wants to get ahead in TV Servicing.

Not for Beginners

If you have some knowledge of Radio-TV fundamentals, or have had some Radio Shop experience or some Radio school training, this course is FOR YOU. Mail coupon today.

MAIL NOW

COUPON BRINGS IMPORTANT BOOK FREE

Get this book and judge for yourself how this course will further your ambition to reach the top in TV Servicing or help to build a more secure business of your own in TV. Many of tomorrow's top TV Servicemen . . . men who can service any make, any model, UHF, VHF or Color TV . . . will be graduates of this training. Mail the coupon now. There is no obligation.



National Radio Institute,
Dept. 5HD4T,
16th and U Sts., N.W., Washington 9, D.C.

Please send my FREE copy of "How to Reach the Top in TV Servicing." I understand no salesman will call.

Name Age

Address

City Zone State

— for 8" or 12" speakers,

THE

Rebel^{*} 5

A KLIPSCH CORNER FOLDED HORN OF MINUTE PROPORTIONS!

An amazing 20' high, the Rebel 5 design involves a cavity (capacitance); a slot (inertance) and a corner horn to provide back loading for a direct radiator speaker. The middle and extreme high ranges are preferably reproduced with corresponding horns and the resulting 3-way speaker system can be squeezed into the tiny space.

Reduction in size of speaker structure sacrifices one or more of the following: the maximum wavelength the system can produce; the smoothness of response (reduction of size invariably produces peaks in the bass range); introduction of distortion because of extreme diaphragm excursion if the enclosure is too small (this is usually associated with peaked response). All Rebels necessarily violate these principles. The trick in retaining a high level of quality typical of Rebel design is to coordinate the design of the low-pass filter with the short length of horn exterior to the housing and to introduce an effective cut-off of gradual slope such that the output, instead of becoming highly distorted in the extreme bass range, merely attenuates without presenting frequency doubling and resultant intermodulation of high frequencies.

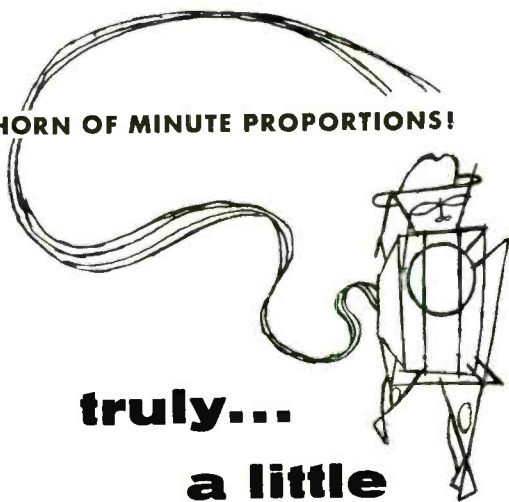

**truly...
a little
monster**

" — the most amazing Klipsch design "

Portability keys the flexibility of the Rebel 5. Used in a corner, on a wall, in the center of a room, the 5 design outperforms larger conventional resonant box systems.

* Trade Mark

MODEL KR-5-U	MODEL KR-5	MODEL KR-5-P
		
Unfinished \$33.00 Net	\$48.00	Leatherette \$48.00

prices slightly higher
west and south

an
exclusive
manufacture



75 North 11th Street, Brooklyn 11, N. Y.



ALERT!

and ready to "scramble".....

America's Armed Forces, alert and on guard, are ready to swiftly defend our country or to strike back at the enemy. Hallicrafters is alert to this emergency which requires dependable electronics equipment. Our facilities are *now* developing, perfecting and producing secret equipment for the Air Force and other branches of the service. The unmatched experience of over twenty years in electronics, plus the lessons gained in producing vital communications during World War II and the Korean conflict, make Hallicrafters a "Primary Producer" for the United States Armed Forces.

*World's leading exclusive manufacturers
of communications radio*

hallicrafters

4401 West Fifth Avenue, Chicago, Illinois

HALLICRAFTERS FACILITIES ARE NOW BEING USED FOR THE DEVELOPMENT AND PRODUCTION OF: GUIDED MISSILE CONTROL EQUIPMENT • COMMUNICATIONS EQUIPMENT • COUNTER-MEASURE EQUIPMENT • COMBAT INFORMATION CENTER • HIGH FREQUENCY ELECTRONIC EQUIPMENT • MOBILE RADIO STATIONS • MOBILE RADIO TELETYPE STATIONS • PORTABLE TWO-WAY COMMUNICATIONS EQUIPMENT • RADAR RECEIVERS AND TRANSMITTERS (ALL FREQUENCIES) • RADAR EQUIPMENT.