

# POPULAR ELECTRONICS

JUNE  
1955

25  
CENTS

In U. S. and Canada

RADIO • TV • R/C • HI-FI • ELECTRONICS

TALKING WITH LIGHT BEAMS  
SENSITIVE METAL LOCATOR  
BUILD YOUR OWN RAIN ALARM  
PICKING YOUR PHONO PICKUP  
MODEL BOATS • SILENT SOUND



# cabinart **KITS**

**cabinart**

## HI-FI speaker-equipment cabinets

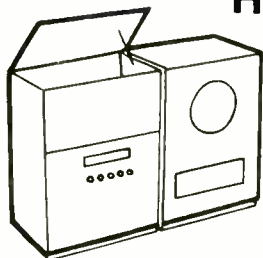

Model 80 has lift lid, removable panels. Bass reflex tuned for 12" or 15" speakers. Overall dimensions: 33½"H, 23"W, 16"D. M80 tuner section, inside: 20"H, 21¾"W, 15½"D. M8112, M8115 baffle volume: 6 cubic feet. ¾" white pine

Model 80 equipment cabinet kit \$27.00  
 Model 8112 12" speaker cabinet kit 18.00  
 Model 8115 15" speaker cabinet kit 18.00

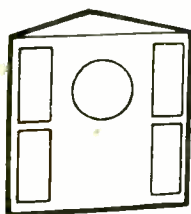

All kits precision-cut to size, baffles pre-cut for 12" or 15" speakers. Kits include Saran plastic acoustic cloth, glue, sandpaper, plastic wood, hardware, assembly instructions and finishing instructions. Write for complete catalogs and nearest Cabinart kit dealer.

### CORNER HORN

Model 61, 12" speaker—\$19.95  
 Model 63, 15" speaker—\$23.95

all prices slightly higher west and south

**ACOUSTICALLY ENGINEERED—ASSEMBLED WITH ONLY A SCREWDRIVER!**

### FEATURING THE KLIPSCH-DESIGNED

**Rebel<sup>\*</sup> 4**

ready-to-finish birch

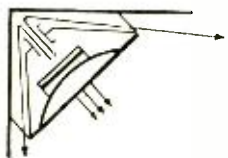

DIRECT RADIATION OF HIGHS  
 BACK RADIATION OF LOWS

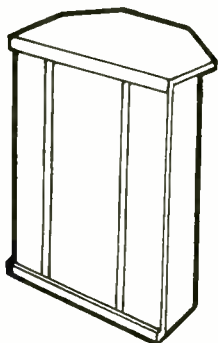

MODEL K-12—\$36.00

MODEL K-15—\$42.00

REBEL enclosure development entails a cavity and slot port, to form a resonant chamber, and a horn coupled to the slot. The slot is loaded by the horn; the proportioning of slot, cavity and horn provide bass response below 100 cycles which corresponds in efficiency to the front-of-cone direct radiator response above this critical 100-cycle point. There are two ways one might consider the function of this horn. One is a bass reflex with a horn acting as a resistive load on the port. System resonances are damped by useful radiation resistance while the horn does not cost anything. It is already formed by the room corner. Again, if a full horn were added below the 100-cycle point bass response would be boomy and unnatural. But, in the Rebel enclosures, the cavity-port combination acts as an acoustic low pass filter. And its design is such that low-end response will compare with response higher in the sound scale.

**cabinart**

KIT FORMS BY



75 North 11th Street  
 Brooklyn, N. Y.

\* Trade Mark

# Good Pay-Security-Promotions for You



**RADIO-TELEVISION BROADCASTING** 3000 Radio Broadcasting stations operating day and night provide interesting jobs with good pay to tens of thousands of operators and technicians. 200 Television stations on the air now, hundreds more under construction and still more authorized, creating job demand and bright future for men who qualify.



**RADIO-TELEVISION SERVICING** 115 million home and auto Radios plus 25 million Television homes (with total growing rapidly) mean increasing opportunities for qualified servicemen. Many NRI students make \$10, \$15 a week extra fixing sets in spare time while training. Many NRI graduates start their own full-time business or take good jobs with dealers.



J. E. SMITH, President  
NATIONAL RADIO INSTITUTE,  
WASHINGTON, D. C.

has trained more men for Radio-Television than anyone else. You benefit from his 40 years' experience training men at home.

## Let Me Show How You Can Qualify for RADIO-TELEVISION <sup>AT HOME</sup> in Spare Time

TRAINING plus OPPORTUNITY is the PERFECT combination for ambitious men. Let me send you a sample lesson from my course to prove you can keep your job while TRAINING at home in your spare time, for better pay and a brighter future. I will also send my 64-page book to show you that Radio-Television is today's field of OPPORTUNITY for properly trained men.

### Television Growth Making More Good Pay Jobs, Prosperity

Radio is bigger than ever and Television is still growing fast. Government, Aviation, Police, Ship, Micro-wave Relay, Two-way Communications Systems for buses, taxis, trucks, railroads are other growing fields providing good job opportunities and bright futures for men properly trained in Radio-Television.

### Start Soon to Make '10, '15 a Week Extra Fixing Sets

You can start to cash in fast. Many men I train fix neighbors' sets, make extra money, starting soon after they enroll. Multitester built with parts I send helps locate and correct set troubles. Read at left how you build actual equipment that gives you practical experience with circuits common to both Radio and Television.

### Mail Coupon - Find Out About Tested Way To Better Pay

Act now to enjoy more good things of life. Take NRI training for as little as \$3 a month. Many NRI graduates (some with only a grammar school education) make more in two weeks than the total cost of my training. Mail coupon today for Actual Lesson and 64-page Book—BOTH FREE. J. E. SMITH, President, National Radio Institute, Dept. 5FD4, Washington 9, D. C. OUR 40TH YEAR.

### I Trained These Men

**Extra Money Spare Time**  
"Four months after enrolling as servicing Radios and averaged \$10 to \$15 a week spare time. Now have full-time Radio and Television business."—WILLIAM WEYDE, Brooklyn, New York.

**Got Laid Off, Good Thing**  
"Got laid off my machine shop job which was the best thing that ever happened to me so I opened a full-time shop. Business has been picking up every week."—E. T. SLATE, Corsicana, Texas.

**Engineer with Station WHPE**  
"Thanks to NRI, I operated a successful radio repair shop. Then I got a job with WPAQ, later with WBOB and now I am an engineer for WHPE."—VAN W. WORKMAN, High Point, North Carolina.

**Owner of Appliance Store**  
"I own a third of the Granville Appliance Co. Inc. in my home town with a branch store in Spencer, West Virginia. Things look very good for the future."—BERNARD SIERS, Grantsville, West Va.

## Practice Broadcasting or Servicing with Kits of Parts I Send You

Nothing takes the place of practical experience. That's why NRI training is based on LEARNING BY DOING. My training includes kits of parts which you use to build equipment and get practical experience on circuits common to both Radio and Television. Shown at the left is the low-power Broadcasting Transmitter you build as part of my Communications Course. It gives you experience putting a station "on the air," learning procedures required of broadcast station operators. Shown below is the modern Radio you build as part of my Servicing Course. You use it to conduct tests, get experience locating and correcting set troubles. My book shows other specially designed equipment you build to get practical experience, to bring to life things you learn from my illustrated lessons. All equipment is yours to keep.

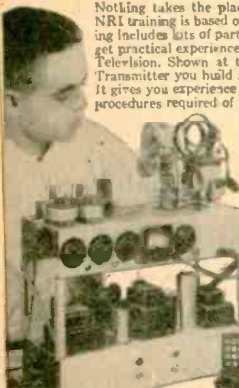

AVAILABLE TO  
**VETERANS**  
UNDER GI BILLS

## Good for Both—FREE

Mr. J. E. SMITH, President, Dept. 5FD4  
National Radio Institute, Washington 9, D. C.  
Mail me Sample Lesson and 64-page Book, FREE. (No salesman will call. Please write plainly.)

NAME.....AGE.....

ADDRESS.....

CITY.....ZONE.....STATE.....

**VETS** WRITE IN DATE OF DISCHARGE.....



POPULAR ELECTRONICS is published monthly by Ziff-Davis Publishing Company, William B. Ziff, Chairman of the Board (1946-1953), at 64 E. Lake St., Chicago 1, Ill. Entered as second class matter August 27, 1954 at the Post Office, Chicago, Illinois. SUBSCRIPTION RATES: One year U.S. and possessions, and Canada \$3.00; Pan-American Union Countries \$3.50; all other foreign countries \$4.00.

# POPULAR ELECTRONICS

Registered U. S. Patent Office

## CONTENTS

Silent Sound.....	Lewis E. Garner, Jr.	17
Tradic—The "Super Computer".....		22
Multicolor Radar.....		24
Heat Without Flame (Part 1).....		26
Geniac.....		30
Middle East Gets Its First Television Station.....		33
Planning To Be An Electronic Engineer?.....	Forrest H. Frantz, Sr.	34
The Muzak Story.....		36
Learn While You Doze.....		39
Talking with Light (Part 1).....	Elbert Robberson	41
Portable Metal Locator.....	Harvey Pollack	47
Thyratron Phototube Relay.....		54
Keep Dry With This Rain Alarm.....	Eugene Richardson	58
A Miniature R/C Transmitter.....	Murray Feigenbaum	64
The Boom in R/C Boats (Part 2).....	William Winter	67
R/C Frankie.....	Carl Kohler	71
Distortion in Hi-Fi Equipment (Part 1).....	Norman H. Crowhurst	73
Picking Your Pickup.....	Hans Fantel	76
Tape Recorders.....	Bert Whyte	80
Disc Review.....	Bert Whyte	81
Simple TV Interference Trap.....	Walter H. Buchsbaum	82
Universal Arm Holds Small Assemblies.....		86
Carl & Jerry.....	John T. Frye	88

## DEPARTMENTS

From the M. Ed. of POP'tronics.....		8
Letters from Our Readers.....		10
R/C Notes.....		63
After Class.....		84
Ama-Touring with Roger Legge.....		91
Tuning the Short-Wave Bands.....	Hank Bennett	94
POP'tronics Bookshelf.....		103
Tips and Techniques.....		108
Tools & Gadgets.....		112
Glossary.....		124
Abbreviations.....		125
Standardized Wiring Diagram Symbols.....		126
Resistor Color Code.....		130
Capacitor Color Code.....		130

(Also see page 6)

JUNE 1955

VOL. 2 - NUMBER 6

EDITOR  
OLIVER READ. WIETI

MANAGING EDITOR  
O. P. Ferrell

TECHNICAL EDITOR  
H. S. Renne

FEATURE EDITOR  
Norman Eisenberg

ASSOCIATE EDITORS  
M. C. Magna  
Charles Tepfer

CONTRIBUTING EDITORS  
J. T. Frye L. E. Garner, Jr.  
H. Bennett R. P. Turner  
R. Legge H. Pollack

ART  
Frank Sayles (Director)  
A. J. Reich M. Whelpley  
J. A. Golanek A. A. Gans

ADVERTISING DEPARTMENT  
New York (MU 7-8080)  
L. L. OSTEN—Adv. Dir.  
WM. G. McROY—T. SUITO

Chicago (AN 3-5200)  
M. B. CROFFORD—J. WEAKLEY

Los Angeles (Mich. 9856)  
JOHN E. PAYNE



Copyright 1955  
(All Rights Reserved)

ZIFF-DAVIS  
PUBLISHING COMPANY

W. B. ZIFF (1898-1953) FOUNDER

Also Publishers of  
RADIO & TELEVISION NEWS

Editorial and Executive Offices  
366 Madison Ave., New York 17, N.Y.

PRESIDENT  
B. G. DAVIS

VICE-PRESIDENTS  
H. J. MORGANROTH M. FROELICH

SECRETARY-TREASURER  
G. E. CARNEY

CIRCULATION MANAGER  
M. MICHAELSON

BRANCH OFFICES  
Chicago (1), 64 E. Lake St.  
Los Angeles (14), Statler Center,  
900 Wilshire Blvd.

### SUBSCRIPTION SERVICE:

All communications concerning subscriptions should be addressed to Circulation Dept., 64 E. Lake St., Chicago 1, Ill. Include your old address as well as new—enclosing if possible an address label from a recent issue of this magazine. Allow at least 4 weeks for change of address.

### CONTRIBUTIONS:

Contributors are advised to retain a copy of their manuscripts and illustrations. Contributions should be mailed to the New York Editorial Office and must be accompanied by return postage. Contributions will be handled with reasonable care, but this magazine assumes no responsibility for their safety. Any copy accepted is subject to whatever adaptations and revisions are necessary to meet the requirements of this publication. Payment covers all author's, contributor's, and contestant's rights, title, and interest in and to the material accepted and will be made at our current rates upon acceptance. All photos and drawings will be considered as part of material purchased.

POPULAR ELECTRONICS



Train for Better  
Jobs in

# ELECTRICITY OR TELEVISION-RADIO

in Great  
Shops of COYNE

## GREAT OPPORTUNITY FIELDS

Conditions are changing. Many "one operation" jobs that have paid well will not last. *Don't be satisfied with a "no future" job.* Whether 17 or up to 45 years of age, train the Coyne way for a better job and a real future in **ELECTRICITY** or **TELEVISION-RADIO**, *fields that offer a world of opportunities.*

## YOU can TRAIN in great CHICAGO SHOPS

Train on real, full-size equipment at COYNE where thousands of successful men have trained for over 55 years—**largest, oldest, best equipped school of its kind**—established in 1899. No advanced education or previous experience needed. **TRAINING APPROVED FOR VETERANS.**

B. W. COOKE, President

**COYNE**  
ELECTRICAL SCHOOL

FOUNDED 1899

A TECHNICAL TRADE INSTITUTE CHARTERED NOT FOR PROFIT  
500 S. PAULINA STREET, CHICAGO, Dept. A5-71H

ELECTRICITY ★ RADIO ★ TELEVISION ★ REFRIGERATION ★ ELECTRONICS

COYNE offers  
LOW COST

# TELEVISION RADIO-ELECTRONICS

Training in  
Spare Time AT HOME

The future is **YOURS** in TV-RADIO!  
A fabulous field—good pay—fascinating work—  
a prosperous future! Good jobs, or independence  
in your own business!

Coyne brings you the first *truly lower cost*, MODERN—QUALITY Television Home Training training designed to meet Coyne standards. Not an old Radio Course with Television "tacked on". Here is MODERN TELEVISION TRAINING including working knowledge of Radio. Includes UHF and **COLOR TV**. No Radio background or previous experience needed. Personal guidance by Coyne Staff. **Practical Job Guides** to show you how to do actual servicing jobs—*make money early in course.* With Coyne Television Home Training you pay only for your training, no costly "put together kits".

B. W. COOKE, President



Coyne—the Institution behind this training... the largest, oldest, best equipped residential school of its kind. Established 1899.

**COYNE**  
ELECTRICAL SCHOOL

500 S. Paulina St., Dept. A5-HT7, Chicago 12  
A TECHNICAL TRADE INSTITUTE OPERATED  
NOT FOR PROFIT

**START NOW—PAY LATER**—Finance Plan and Easy Monthly Payment Plan. Also part-time employment help for students.

## Get FREE Book

Send coupon for 48 page illustrated book "Guide to Careers in Electricity and Television-Radio." No cost; no obligation; no salesman will call. Get vital facts now!



B. W. COOKE, President  
COYNE ELECTRICAL SCHOOL  
500 S. Paulina St., Chicago 12, Ill., Dept. A5-71H

Send **BIG FREE** book and details of your training offer. This does not obligate me and no salesman will call. I am interested in:

Electricity  Television-Radio

Name \_\_\_\_\_

Address \_\_\_\_\_

City \_\_\_\_\_

State \_\_\_\_\_



## SEND COUPON FOR FREE BOOK

and full details, including easy Payment Plan.

**No obligation, no salesman will call.**



COYNE ELECTRICAL SCHOOL

Television Home Training Div.

500 S. Paulina St., Chicago 12, Ill.,  
Dept. A5-1117

Send Free Book and details on Television Home Training. This does not obligate me and no salesman will call.

Name \_\_\_\_\_

Address \_\_\_\_\_

City \_\_\_\_\_

State \_\_\_\_\_

Build this  
**REMOTE CONTROL UNIT**

for model planes, boats, cars

Using a



**TRANSISTOR**

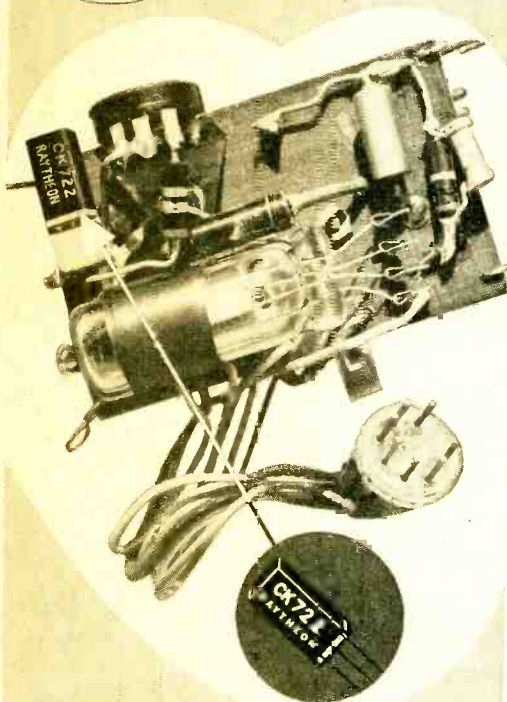

Thanks to the Raytheon CK722 Transistor, you can build a compact, lightweight radio control unit that will give you more hours of performance than ever before possible.

The useful life of the RK61 in control circuits is governed principally by the amount of plate current drawn during operation. Use of a Raytheon CK722 Transistor as a D.C. amplifier following the RK61 circuit permits the thyatron to idle at a lower value of plate current thus increasing tube life.

Free circuit information on this new CK722 Transistor application is yours for the asking. Simply write Department P6.



*Excellence in Electronics*

**RAYTHEON MFG. CO.**

Receiving and Cathode Ray Tube Operations  
 Newton 58, Massachusetts

RELIABLE SUBMINIATURE AND MINIATURE TUBES  
 SEMICONDUCTOR DIODES AND TRANSISTORS  
 NUCLEONIC TUBES

RECEIVING AND PICTURE TUBES • MICROWAVE TUBES

**ITEMS OF INTEREST**

Scatter Propagation Tests.....	38
TV Received in Flight.....	90
Rocket Seeks Radio Data.....	102
Tape-of-the-Month Club.....	102

**NEW PRODUCTS**

Economical Hi-Fi Amplifier.....	40
Wide Range Tape Recorder for Custom Installation.....	40
Hearing Aid Concealed in Head Band.....	90
Low Cost Signal Generator.....	90
Unique Kit for Experimenters.....	93
Kit Builds TV Set.....	93
Kit Builds Electronic Organ.....	100
Hi-Fi FM Antenna.....	100
Compact 3-Way Hi-Fi Speaker.....	101

If you are unable to find these listed products locally, write directly to the manufacturers at the addresses given. Also see the monthly review of new items of interest to the electronics hobbyist in "Tools & Gadgets" appearing on pages 112 to 114 of this issue of POPULAR ELECTRONICS.

**COMING NEXT MONTH  
 POPULAR ELECTRONICS**

*"Uranium Prospecting Issue"*

- The Bakerfield Uranium Strike
- Building a Simple Geiger Counter
- Modifying Geiger Counters for Metering
- Market Survey of Geiger Counters
- Light Beam Transmitter for Voice Communication
- Audio Frequency Meter
- Checking Out Clock Radios
- Easily Built Chassis Rack
- Transistor Pocket Radio Receiver

- High-Fidelity Audio ■ Kits ■ Radio Control
- Short-Wave Listening ■ What's New ■
- How It Works ■ How to Make It ■ How to Use It ■
- Carl & Jerry ■ Tips & Techniques

**IN THIS MONTH'S  
 RADIO & TELEVISION NEWS**

(June)

- A Transistorized Light-Beam Audio Transmitter
- Helicopter Communications on 2 1/2 Meters
- Why the NARTB Curve for Magnetic Tape?
- The "Rebel 5"
- Tone Transmitter for Radio Control

# INVENTORS

Learn how to protect your invention. The U. S. Patent Laws provide that any new and useful art, machine, article of manufacture, or composition of matter, or any new and useful improvement thereof, may be patented if the act of invention is involved. Therefore, every inventor with a valuable invention should take advantage of the Patent Laws and proceed for patent protection in order to safeguard his rights.

A patent gives the inventor the exclusive right to prevent others from making, using, or selling the invention claimed in the patent for a period of seventeen years.

The Patent Laws were enacted for the benefit of the inventor to give him protection for the features of his invention which are patentable. These features must be properly and concisely set forth and claimed in a formal application for patent, in order to comply with the requirements of the Patent Laws. For that reason, unless the inventor is familiar with patent matters, he should engage a competent registered patent attorney or agent to represent him. We are registered to practice before the U. S. Patent Office and are prepared to serve you in the handling of your patent matters.

A specially prepared booklet entitled "Patent Guide for the Inventor", containing detailed information with respect to patent protection and procedure, together with a "Record of Invention" form will be promptly forwarded to you without obligation upon request.

---

## CLARENCE A. O'BRIEN & HARVEY JACOBSON

*Registered Patent Attorneys*

59-F DISTRICT NATIONAL BUILDING

WASHINGTON 5, D. C.

Here's World Radio's

The  
ECONOMY  
CODE  
OSCILLATOR  
KIT

**KIT**  
of the month

Top  
View

Bottom  
View,  
wired

only  
**\$4.95**  
complete

Build this low-cost, code oscillator! Helps you learn code faster; prepare for your novice license. All parts and simplified wiring instructions included. Then plug into any 110 volt AC source, and with accessories shown, you're ready to go.

Stock No. 89A001

SEND FOR COMPLETE  
LIST OF WRL KITS  
TODAY!

**ACCESSORIES**

J-38 Key \$ .99  
Stock No. XA883

Headphones \$2.01  
Stock No. 50A005

Phone Plugs \$ .33  
Stock No. 1A025

Order By Cat-  
alog Number

Completely  
Bandswitching  
**GLOBE SCOUT**

65 Watts CW; 50 Watts Fone  
Transmits on 10-160M  
amateur bands. Metering  
provided. Pi Network  
antenna tuner. Self-con-  
tained power supply. May  
be used mobile; provi-  
sions for dynamotor at-  
tachment. 100% modulation  
of Final. Thoroughly  
TVI-screened cabinet. An  
ideal rig for the novice.  
Cabinet 8"x16"x8".

only  
**\$7.95**  
per month  
Pay Just \$10.00  
Cash Down



cash price: \$99.95

All Prices Subject To Change Without Notice!



WORLD RADIO  
LABORATORIES

3415 W. Broadway — Co. Bluffs, Iowa

Please send me your:

- Code Oscillator Kit (\$4.95)
- Info on Other WRL Kits
- Info on Globe Scout
- Giant Radio Map (25c)
- Recond. Eqpt. List
- J-38 Key (99c)
- Headphones (\$2.01)
- Phone Plugs (33c)
- FREE CATALOG



NAME: \_\_\_\_\_

ADDRESS: \_\_\_\_\_

CITY and STATE: \_\_\_\_\_

FROM THE **M. Ed.**  
OF **POP'tronics**

FOLLOWING THE RELEASE of our April issue which contained a short April Fool article on "Contra-Polar Energy" (page 27), a number of readers wrote in asking if at some future date negative energies and frequencies might be possible. Although the "Contra-Polar Energy" article may have made negative energy appear to be a simple matter, it is actually a reversal of many well-known accepted physical laws. As portrayed in this article, "Contra-Polar Energy" is an impossibility.

As mentioned in this column last month, the July issue will contain, in addition to our many regular articles and features, a section on Geiger counters. We will show detailed plans on building a handy 700-volt Geiger counter with metering, earphones and a neon flasher. And Leo Sands has been assigned the task of writing a story from Bakersfield, Calif., on the uranium prospecting rush in that vicinity.

Considerable effort has gone into the preparation of a market survey of commercially available Geiger counter equipment for the July issue. To our knowledge, this will be the first time that material of this nature and scope will appear in print. If you are in the market for a Geiger counter to take on your camping trips, you will find this particular article of value.

The August issue of "POP'tronics" will introduce a new department catering to the interests of our radio amateur-minded readers. It will be conducted by Herb Brier, W9EGQ, a popular writer on the subject of novice ham radio. Herb will encourage the participation of newcomers in novice radio. His material published in other magazines has done much to further radio amateur activity.

There appears to be some confusion as to the use of the Citizen's Radio bands. In fact, the possibility that a great number of unlicensed transmitters are in operation has been brought to our attention. Next month we will devote space to a clarification of the Federal Communication Commission Rules and Regulations on this subject. Please look for it if you are a model radio-control enthusiast!

o.p.f.

POPULAR ELECTRONICS





VETERANS!

NON-VETERANS!

# MY FREE LESSON

## MAY CHANGE YOUR ENTIRE LIFE

L. C. Lane, B.S., M.A.  
President, Radio-Television  
Training Association,  
Executive Director, Pierce  
School of Radio & Television

### THREE COURSES TO TRAIN YOU FOR THE JOB YOU WANT

#### RADIO-FM-TELEVISION TECHNICIAN COURSE

— No previous experience necessary. You learn by practicing with the professional equipment I send you. Many of my graduates now have good paying technician jobs with such firms as RCA, NBC-TV, Dumont TV and numerous other TV Studios and plants.

**FM-TV TECHNICIAN COURSE** — Previous training or experience in radio required. You can save months of time if you have previous Armed Forces or civilian radio experience! Train at home with kits of parts, plus equipment to build BIG SCREEN TV RECEIVER. ALL FURNISHED AT NO EXTRA COST!

**EXTRA TRAINING IN NEW YORK CITY AT NO ADDITIONAL COST** — After you finish your home study training in either of these two courses, you get two weeks, 50 hours, of intensive Laboratory work on modern electronic equipment at our associate school in New York City, Pierce School of Radio & Television. **THIS EXTRA TRAINING IS YOURS AT NO EXTRA COST WHATSOEVER.** My courses are complete without this extra training, but it gives you added opportunity for review and practice.

**TV CAMERAMAN AND STUDIO TECHNICIAN COURSE** — Advanced training for men with radio or TV training or experience. I train you at home for an exciting high pay job as the man behind the TV camera.

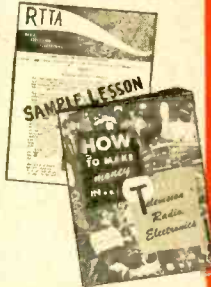

Just by clipping the coupon below and sending it to me today, you can open up a whole new future for yourself in America's fastest-growing field — Radio-Television-Electronics.

The very day I receive your coupon I will send to you Free a Sample Lesson and my New 36-page Book showing you "How to Make Money in Television, Radio, Electronics" by **STUDYING AT HOME IN YOUR SPARE TIME.**

At absolutely no cost or obligation you can see for yourself how you can begin now to prepare yourself for a better-paying career as a TV repairman, studio technician, cameraman or any one of the many promising jobs in the field that is bringing success and security to hundreds of men — many of them with no more than grammar school education and no experience whatsoever.

If you think I was exaggerating when I said, "My Free Lesson May Change Your Entire Life," just see what some of my graduates say about my training —

## VETERANS

My school fully approved to train Veterans under New Korean G.I. Bill. Write discharge date on coupon.

**EARN WHILE YOU LEARN** — Almost from the very start you can earn extra money while learning by repairing Radio-TV sets for friends and neighbors. Many of my students earn up to \$25 a week . . . pay for their entire training from spare time earnings . . . start their own profitable service business.

**FREE FCC COACHING COURSE** — Important for BETTER PAY JOBS requiring FCC license. You get this training AT NO EXTRA COST. Top TV jobs go to FCC-licensed technicians.

**ENOUGH EQUIPMENT TO SET UP YOUR OWN HOME LABORATORY**

With the equipment I send you as part of your course you BUILD and KEEP a professional GIANT SCREEN TV RECEIVER complete with big picture tube (takes any size up to 21-inch) . . . also a Super-Het Radio Receiver, AF-RF Signal Generator, Combination Voltmeter-Ammeter-Ohmmeter, C-W Telephone Transmitter, Public Address System, AC-DC Power Supply. Everything supplied, including all tubes. My practical, easy-to-understand lessons have brought success to hundreds of men. You, too, can train for a better-paying job or set up a business of your own if you act NOW!



# Radio Television Training Association

52 EAST 19th STREET • NEW YORK 3, N. Y.  
Licensed by the State of New York • Approved for Veteran Training

"RTTA training gave me the skill and know-how to do the work I love best and enjoy better things in life."  
Harold Gimlen  
Flint, Michigan

"If it had not been for you, your instructor and the school, I never would have had this opportunity."  
J. A. Iwin  
Radio-TV Repairman  
Coburg, Ont. Canada

"I know I would not have achieved this progress if it weren't for the help and guidance from RTTA."  
Edward Brouitt  
Chief Radar Operator  
National Guard  
Central Falls, R. I.

These letters and many more like them are in my files. The TV Boom that brought good opportunities to these RTTA graduates is still on with no sign of letting up. Don't let opportunity pass you by. Write today for your Sample Lesson, new 36-page book, TV Job Opportunities List, and 43-state list of future TV stations — ALL FREE!

### MAIL THIS COUPON TODAY!

Public Address System

Mr. L. C. Lane, President  
RADIO-TELEVISION TRAINING ASSOCIATION  
Dept. 600, 52 East 19th St. New York 3, N. Y.

Draw Mr. Lane, Mail, my NEW FREE BOOK, FREE SAMPLE LESSON, and FREE kit that will show me how I can make BIG MONEY IN TELEVISION, understanding how order, do business and, as jobless will call!

(PLEASE PRINT PLAINLY)

Name \_\_\_\_\_ Page \_\_\_\_\_

Address \_\_\_\_\_

City \_\_\_\_\_ Zone \_\_\_\_\_ State \_\_\_\_\_

I AM INTERESTED IN:  
 Radio-FM-TV Technician Course  
 FM-TV Technician Course  
 TV Cameraman & Studio Technician Course

**VETERANS!**  
Write discharge date \_\_\_\_\_

**NO SALESMAN WILL CALL!**

# LETTERS

## FROM OUR READERS

### FREQUENCY RESPONSE OF SPEAKERS

■ In "What We Hear" (March issue, page 22), I read: "Unfortunately, no single speaker has yet been designed that covers the complete audio spectrum." I presume that "complete" means 16 to 16,000 cps. If so, that is wrong. I have just been to the University of British Columbia's Open House Day, and in the Physics Department I saw and heard an electronic instrument that produced frequencies from 10 to 30,000 cps through a single speaker. (I heard only 20 to 15,700 cps.) At full volume, around 10 or 15 cycles, it gave me a peculiar feeling in the chest, and at 15,000 cps it nearly shattered my teeth! Have you any idea how this speaker worked? Apparently, the speaker was limited only by the range of the signal generator.

Pete Rugge  
Vancouver, B. C., Canada

*What reader Rugge describes is more of a laboratory experiment than an actual listening situation in which speech and music are heard under normal conditions. Be that as it may, the response of a speaker to pure signal generator tones is not necessarily the last word on how it will*

*respond to music from a sizable ensemble. Other factors must be considered, such as how the speaker handles complex combinations of numerous frequencies at once; hangover effects; transients; degree of balance throughout the audible range; power-handling capacity; resonant frequency; etc. Getting a transducer to vibrate at different separate frequencies is only part of the problem involved in designing loudspeakers that are intended for use in hi-fi music systems. However, we are looking into this matter, and if and when a single speaker that covers adequately the range of 16 to 16,000 cycles is made commercially available, we will be happy to acknowledge it.*

### PHONO STYLI

■ One question: Why don't they make phonograph styli from tungsten carbide, which is almost as hard as diamond?

Mike Rivers  
Arlington, Va.

*Attempts have been made to "shape" such styli but have been largely unsuccessful to date.*

### MATERIAL ON TV

■ Congratulations on a good magazine. I have enjoyed your articles very much and intend to save every issue.

Noted in your "Letters from Our Readers" column one asking for information on TVI and TV boosters. All well and good but I would hate to see this fine little magazine go the way of a few

FREE  
Bonus Offer!

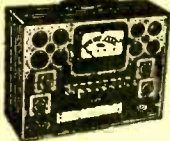

Model 625K

- Illum. gear-driven "Speed Roll-chart"
- New lever-action switches for individual testing of every element
- Tests all conventional and TV tubes

This Eico Tube Tester is yours FREE when you buy \$100 worth of tubes or more within 60 days at Teltron. May be bought outright from Teltron for \$34.95.

#### SPECIALS!

Thru July 1st

TYPE PRICE

1B3GT	.55
1U4	.38
1U5	.38
5U4G	.39
6AG5	.38
6AU6	.37
6BE5	.39
6BQGGT	.74
6C0GG	.74
6S4	.38
6SN7GT	.52
6W4GT	.38
12A77	.65
12A47	.49
12SA7	.39
12SK7	.39
12SQ7	.35
35L6GT	.38
50L6GT	.45

# TELTRON TUBES

Guaranteed! Lowest Prices Ever!

All tubes individually boxed . . . unconditionally guaranteed for one year.

**GIFT OFFER!**  
One 6B6G tube will be shipped FREE with any \$10 order accompanying this ad.

#### TYPE PRICE

1A7GT	.53
1H5GT	.51
1L4	.51
1L6	.51
1L6G	.49
1N5GT	.51
1R5	.51
1T4	.51
1X2	.65
2A3	.35
2A7	.35
3Q4	.53
3Q5GT	.61
3S4	.48
3V4	.48
5V4G	.49
5Y3GT	.30
5Y4G	.40
6A8	.40
6AC7	.65
6AF4	1.02
6AH4GT	.65

#### TYPE PRICE

6AK5	.96
6AL5	.43
6AQ5	.48
6AR5	.48
6AU5GT	.60
6AV6	.37
6AX4GT	.60
6AX5GT	.60
6BAE	.58
6BA7	.58
6BC5	.48
6BF5	.48
6BG6G	1.18
6BH6	.51
6BJ6	.51
6BK5	.75
6BK7	.78
6BM6	.90
6BL7GT	.78
6BQ7	.85
6BY5G	.60
6BZ7	.95

#### TYPE PRICE

6C4	.41
6CB6	.51
6CU6	.95
6F6	.42
6F5GT	.44
6H6	.50
6J5GT	.49
6J6	.61
6K6GT	.39
6K7	.40
6L6	.78
6M7	.40
6S8GT	.65
6SA7	.45
6SK7GT	.45
6SL7GT	.60
6SQ7	.40
6T8	.71
6U8	.76
6V3	.80
6V6GT	.48
6W6GT	.53

#### TYPE PRICE

6X4	.37
6X5GT	.38
6X8	.80
7F8	.49
7N7	.52
12AL5	.43
12AT6	.37
12AU6	.43
12AV7	.73
12AX4GT	.60
12AX7	.61
12AZ7	.65
12B4	.72
12BA6	.46
12BA7	.58
12BE6	.46
12B7H	.61
12BY7	.65
12BZ7	.63
12SL7GT	.60

#### TYPE PRICE

12SN7GT	.56
19T8	.71
25BQ6GT	.82
25CU6	1.09
25L6GT	.41
25Z5	.55
25Z6GT	.36
35B5	.48
35C5	.48
35W4	.33
35Y4	.35
35Z5GT	.33
50A5	.48
50B5	.48
50C5	.48
117L7GT	1.20
117Z3	.33
117Z6GT	.65
80	.40
1629	.39

**SAME DAY SERVICE**  
48 Hour Postal Delivery  
To West Coast

TERMS: Save all freight and postage charges. All orders accompanied by full remittance will be shipped POSTAGE PAID anywhere in the continental U.S.A. 25% deposit required on C.O.D.'s. \$1.00 handling charge on orders under \$10. Open accounts to rated firms only.

**FREE** \$7.20 list value Bonus Box of three 6SN7 tubes and 25 assorted resistors with each order of \$25 or more.

# TELTRON ELECTRIC COMPANY

428 HARRISON AVE.

DEPT. PE-6

Phone HUmboldt 4-9848

HARRISON, N. J.

**ADD HIGH FIDELITY  
TO YOUR HOBBY**

*for all the family  
TO ENJOY*

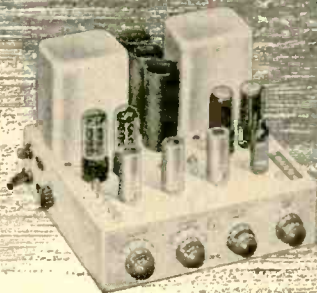
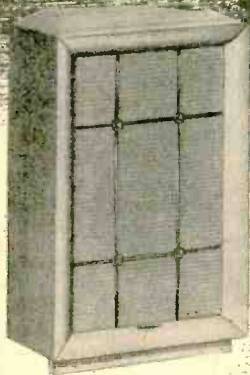

This natural extension of your hobby provides a new source of pleasure for your entire family. And with the "know-how" you already have, it is easy to put together a true high-fidelity system that gives thrilling, lifelike music reproduction. Just as E-V microphones and other equipment are widely used in amateur and commercial communications...so have E-V high-fidelity reproducing components and systems achieved high recognition for their outstanding quality. Shown here are a few typical examples.

**The Aristocrat.** Folded-horn corner enclosure. Designed for E-V or any full-range 12-in. speaker or E-V separate 2-way or 3-way systems. Unusually smooth reproduction down to 35 cps. Selected mahogany veneers. Size: 29-5/8 in. high, 19 in. wide, 16-5/16 in. deep.

Mahogany Net: \$66.00  
Korina Blonde. Net: \$72.00

**Model A20C Circotron Amplifier.** Has all necessary inputs and controls for handling a complete high-fidelity system. Power output 20 watts rated, 40 watts on peaks. Frequency response  $\pm 1$  db 20-20,000 cps at full 20 watts. Size: 10 3/4 in. wide, 11 3/4 in. deep, 7 3/8 in. high.

Net: \$110.00

**Model 12TRXB Triaxial Speaker.** Integrated 3-way speaker system combines E-V T35B Super Sonax, Radax Propagator, and large bass cone with heavy magnet in one compact, concentric assembly. Response 35-15,000 cps in recommended Aristocrat enclosure. With level control for VHF driver. Net: \$59.70

**Model 84 Ultra-Linear Ceramic Cartridge.** Flat response  $\pm 2\frac{1}{2}$  db from 20 to 15,000 cps. No preamplifier required. No inductive hum pick-up. No microphonics. High-level output. For microgroove 33 1/3 and 45 rpm.

**Model 84D.** With Diamond Stylus. Net: \$23.10  
**Model 84S.** With Sapphire Stylus. Net: \$ 9.60

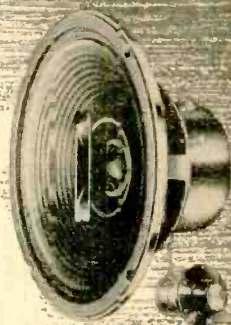

See your E-V Distributor, or write for helpful literature

ELECTRO-VOICE, INC. • BUCHANAN, MICH.

**Electro-Voice**®

HIGH FIDELITY SPEAKER SYSTEMS, AMPLIFIERS, MICROPHONES, PHONO-CARTRIDGES, AND OTHER ELECTRO-ACOUSTIC PRODUCTS

## GET THE WORLD'S LEADING RADIO & TV CATALOG



**free!**

**VALUE-PACKED  
308  
PAGE 1955  
ALLIED  
ELECTRONIC  
BUYING GUIDE**

**Builders and Experimenters:  
Save on Everything in Radio & TV!**

You'll find everything you'll need for building any project in this publication in the 1955 ALLIED Catalog. Select from the world's largest stocks of parts, tubes, tools, kits, books, diagrams—plus Amateur equipment, TV components, Hi-Fi equipment, test instruments, recorders—at lowest, money-saving prices. Write for your FREE ALLIED Catalog today!

### POPULAR ALLIED KITS

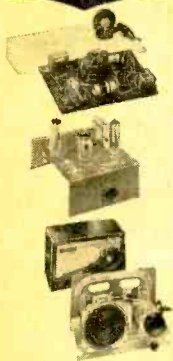

**DOZENS OF  
OTHER KITS  
AVAILABLE**

#### Famous Radio Lab Kit (10 Kits in 1)

Here's the most instructive Experimenter's kit you can buy. With it, you can build a broadcast receiver, phono amplifier, phono oscillator, signal tracer, electronic timer, photo cell relay, home broadcaster, electronic switch, etc. Fascinating, instructive. Complete with all parts, tubes, microphone, 12-page manual. Shpg. wt., 10 lbs.

83 S 265. Radio Lab Kit, only..... \$14.25

#### Wireless Broadcaster Kit

Permits "broadcasting" phonograph or microphone through any standard radio set (up to 50 feet away) without any connection to set. May be used with any phono or crystal mike. Easy to build. Includes all tubes, chassis, parts, instructions. 4½ x 5 x 6". For AC-DC. 3 lbs.

83 S 705. Broadcaster Kit. Only..... \$9.95  
99 S 556. Crystal mike for above... \$3.95

#### Ranger II Superhet (with Cabinet)

Learn radio while you build and enjoy this sensitive AC-DC broadcast receiver. Tunes 540-1680 kc: includes built-in antenna, PM dynamic speaker, automatic volume control, handsome walnut plastic cabinet. Easy to assemble from detailed manual; complete with punched chassis, all parts, tubes and cabinet. Shpg. wt., 8 lbs.

83 S 735. "Ranger II" Kit, only..... \$16.75

## ALLIED RADIO

ALLIED RADIO CORP., Dept. 79-F-5  
100 N. Western Ave., Chicago 80, Ill.

Send for  
FREE  
Catalog

- Send FREE 308-Page Catalog
- Send Kit No. 83 S 265       Send Kit No. 83 S 735
- Send Kit No. 83 S 705      \$ \_\_\_\_\_
- Mike for above 99 S 556      enclosed

Name \_\_\_\_\_

Address \_\_\_\_\_

City \_\_\_\_\_ Zone \_\_\_\_\_ State \_\_\_\_\_

others that I used to purchase. I can remember how we hams and experimenters were slowly eased out of these publications with the advent of TV until they are now almost completely filled with TV service articles. I suggest that people requesting information on TV be referred to these magazines.

Maybe, if this letter were printed, we could get some other comments.

John J. Broadbrook, W1TYS  
Bridgeport, Conn.

*Thank you, W1TYS, and rest assured we will never go the way you fear. See page 102, in our May issue, for a clear statement of our policy on these matters. To the extent, however, that any material on these subjects does not seriously invade the domain of the professional technician and does have interest for our readers, we will run it.*

### WAX HOLDS SCREW FIRMLY

■ In your April issue, you have an article which describes holding a screw with tape on the screw-driver. I find, when working on a TV or radio set, that I keep the screw on by rubbing the head of the screw on a waxed paper capacitor or any waxed article that is in the set. The slot on the screw fills with wax which gives a pretty snug fit.

Cornell Siket  
Fairfield, Conn.

### END-OF-STORY SYMBOLS

■ I am a long-time reader of your "sister-publication" RADIO AND TELEVISION NEWS, and a constant reader of POPULAR ELECTRONICS since the first issue last October. The former uses the symbol ~~—30—~~ at the end of stories instead of the word "end." Somehow I feel this is more appropriate since it not only looks better but is an old radio operator's signal for signing off.

Russell B. Boyce  
San Francisco, Calif.

*Starting with this issue, the symbol ~~—30—~~ will be used to designate the end of a story. Actually, this symbol had its origin in old telegraphy procedure and later was adapted by newspaper writers to indicate to the printer that the end of the manuscript had been reached.*

### BUILDING TAPE RECORDERS

■ I am extremely interested in tape recorders and would like to build one completely myself—mechanically and electronically. Now, in setting up the motor, is speed reduction best accomplished by gears, resistors, or transformers?

Also, where can I find a schematic on the pre-amplifier for such a recorder?

Gary A. Thompson  
Shaw A.F.B., S. C.

*The steps necessary to construct your own tape recorder will be covered in a series of articles planned for our late summer and fall issues.*

### BOUQUET FOR "CARL AND JERRY"

■ I noticed that some readers have complimented you on the fine electrical articles. I also noted that no one has made mention of Mr. Frye's "Carl and Jerry" which I certainly think should be commented on. I hope your readers haven't

POPULAR ELECTRONICS

**NOT 40% . . . NOT 50% . . . NOT 60% but . . .  
SAVE 70%, 80% and 90% OFF LIST PRICES!**

**SAME DAY SERVICE. ALL TUBES RTMA  
GUARANTEED FOR ONE FULL YEAR**

- Hallicrafters
- Emerson
- Motorola
- Admiral
- Philco
- Sonora
- Stewart-Warner
- Stantron
- American
- Zenith
- Crosley
- Muntz

Several or one of these brands will be supplied on your order.

All tubes individually boxed. We also carry a full line of all special purpose tubes. Send us your requirements.

**FREE** with each \$25 or more order. 5-Pc. Sylvania Repair Kit. Value \$4.95. Includes: flashlight head, Philips screwdriver, flat head screwdriver, alignment tool and polystyrene case.



0A2	.70	3A4	.53	6B8	.70	6SA7GT	.48	12A7T	.68	25Z5	.38
0A4G	.60	3B7	.57	6BA6	.49	6SC7	.50	12AU6	.49	25Z6GT	.38
0B2	.70	3D6	.45	6BC5	.43	12AU7	.43	12AU7	.55	27	.23
0C3	.90	3LF4	.66	6BE6	.50	6SH7	.45	12AV6	.37	32L7GT	.60
0D3	.90	3Q4	.48	6BF5	.41	6SJ7GT	.45	12AX7	.60	35A5	.48
0Z4	.45	3Q5GT	.59	6BG6G	1.18	6SK7	.48	12AY7	.90	35B5	.52
1A4P	.38	35A	.48	6BH5	.51	6SL7GT	.57	12B6A	.48	35C5	.51
1A7GT	.45	3V4	.58	6BJ6	.49	6SN7GT	.57	12B6B	.48	35L6GT	.48
1B3GT	.68	3R4GY	.75	6BK5	.70	6S07GT	.43	12B6	.50	35W4	.35
1C5GT	.43	5T4	.70	6BK7A	.78	6SR7GT	.43	12BE6	.50	35W4	.35
1D5GP	.45	5U4G	.44	6BN6	.59	6S57	.43	12BH7	.61	35Y4	.35
1E7GT	.43	5V4	.60	6BL7GT	.77	6T7G	.63	12BT7	.68	35Z3	.41
1G6GT	.43	5X4G	.44	6BQ7A	.80	6V6GT	.48	12J5GT	.40	50L6GT	.45
1H4G	.43	5Y3GT	.32	6BZ7	.30	6W4GT	.40	12K8	.49	45Z5GT	.40
1H5GT	.49	5Y4G	.37	6BY5G	.60	6T7G	.63	12S47	.48	50A5	.48
1I6GT	.49	5Z3	.42	6C4	.39	6W6GT	.56	12S47	.47	50B5	.52
1L4	.43	5Z4	.54	6C5	.36	6X4	.35	12S7GT	.45	50C5	.51
1L6	.59	6A7	.59	6CB6	.51	6X5GT	.35	12S7GT	.45	50C5	.51
1LA4	.59	6A8	.59	6CD6G	1.18	6Y6G	.57	12S7K	.48	50L6GT	.45
1LA6	.49	6A8A	.44	6E5	.46	6X8	.75	12S7GT	.59	70L7GT	.60
1LB4	.59	6A7A	.80	6F5GT	.39	7A4-XXL	.47	12SN7GT	.57	75	.44
1LC6	.49	6AG5	.51	6F6	.40	7A5	.55	12SQ7GT	.40	77	.39
1LD5	.59	6AH6	.70	6GG6	.42	7A6	.47	12Z3	.25	78	.39
1LE3	.59	6A15	.70	6HG6	.40	7A8	.46	14A7	.45	83V	.35
1LG5	.59	6AK5	.55	6J4	2.00	7A7	.45	14A5	.59	80	.60
1LH4	.66	6AL5	.40	6J5GT	.40	7B8	.46	14A7	.45	83V	.35
1LN5	.49	6AL7GT	.70	6J6	.49	7B5	.41	14B6	.40	117L7GT	1.10
1NSGT	.51	6A15	.61	6J7	.47	7B7	.43	14Q7	.52		
1PSGT	.50	6A55	.50	6J8G	.90	7B8	.47	19B6G6.1.18		117N7GT	1.10
1R4	.66	6A56	1.75	6K6GT	.39	7C4	.40	19J6	.66		1.10
1R5	.57	6A57G	2.25	6K7	.40	7C5	.44	19T8	.70	117P7GT	1.10
1S4	.53	6A76	.40	6K8	.67	7C6	.45	2A4	.40		1.10
1S5	.52	6A5GT	.60	6L7	.44	7E5	.35	25A7GT.1.50	117Z3	.37	
1T5GT	.58	6A6G	.43	6N7	.61	7F8	.70	25AV5GT.80	117Z6GT	.65	
1U4	.49	6AV6	.40	6R7	.49	7Y4	.35	25B6GT.80	2050	1.25	
1U5	.50	6AX5GT	.59	6S4	.41	12A6	.40	25L6GT	.48	2051	1.25
1V	.43	6B4G	.54	6S7G	.47	12A76	.42	25Y5	.45	9001	1.50
1X2A	.63										
2A5	.59										
2A7	.23										
2B7	.89										
2D21	1.00										
2V3G	.80										
2X2A	1.00										

**19¢ SPECIALS!**  
For Limited Time Only

1A4P	1H4	24A	1619
1E7GT	7E5	26	39/44
1F4	10Y	27	9004
1G6	12Z3	954	9006

**FREE** with every order . . . regardless of size! Here it is—free to everyone—a combination kit of resistors, condensers, volume control and line cords—retail value \$2.95. (May be purchased separately, if desired.) Send for our parts and tube catalogue. Open Account to rated firms.

TERMS: 25% deposit required on all orders, balance COD. Orders under \$5.00, 50c service charge. Postage paid in USA on all orders accompanied by full remittance. All unused money refunded with order.

Same day service. All tubes RTMA guaranteed for one full year.

**Stanley ELECTRONICS CORP.**  
935 MAIN AVENUE - PASSAIC, N. J.

Dept. PE-6

Gregory 1-2498

**EMC EXCLUSIVE**

**BASIC SERVICE SHOP TEST  
EQUIPMENT for only \$6855\***

**PLUS FREE . . . with this special offer**  
Model CRA (Picture tube adaptor for model 208) \$4.50  
2 Model IS (Instrument stands) 1.96  
Total retail cost if purchased \$6.46

You get ALL three of these precision instruments . . . in this sensational offer!

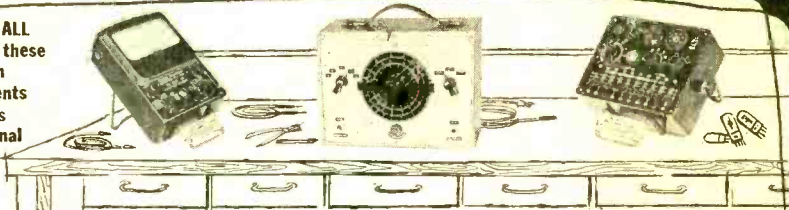

**EMC model 106 VTVM**  
Price of this individual unit  
Model 106 (wired and tested) \$35.90  
Model 106 (in kit form) \$23.90  
Accessory probes available

**EMC model 500 R.F. Signal Generator**  
Price of this individual unit  
Model 500 (wired and tested) \$29.75  
Model 500 (in kit form) \$19.75

**EMC model 208 Tube Tester**  
Price of this individual unit  
Model 208 (wired and tested) \$24.90  
Picture tube adaptor available

**HOW TO GET IN ON THIS SENSATIONAL OFFER!**  
Start your own service shop with professional precision test equipment at solid savings plus the free Picture Tube Adaptor and Instrument Stands given in this special EMC offer.  
Go to your favorite local jobber, purchase the above three instruments (Models 106, 500, 208), mail the three enclosed guarantee cards to EMC and receive by return mail your free \$6.46 worth of valuable accessories. This is a limited offer so act TODAY!

Write Dept. PE-6 for new complete catalog of precision test equipment TODAY!

**EMC** ELECTRONIC MEASUREMENTS CORP.  
280 LAFAYETTE STREET, NEW YORK 12 N. Y.

\*Total price if models 106 and 500 are not purchased in kit form—\$90.55  
Note these instruments can be purchased individually.

**A NEW dimension  
in listening  
pleasure!**



*Music Lovers*  
**CARTRIDGE**

*... for the realism of concert-hall performance in your home*

The "MUSIC LOVERS" Cartridge is a new, 3-speed, dual-needle ceramic cartridge, designed to enhance the quality of all the popular high fidelity equipment in use today. Feeds directly into magnetic or ceramic inputs, allowing the full advantages of compensation circuits.

- Eliminates induced hum
- Eliminates "drag" caused by magnetic attraction to steel turntables
- Increases record and needle life
- Has higher output
- Response not affected by load resistance
- 10-second needle replacement
- Individual needle compliance

**FREE!** Comparative analysis booklet on the "Music Lovers" Cartridge

**SHURE BROTHERS, INC.**

225 W. HURON ST. • CHICAGO 10, ILLINOIS

Please send analysis booklet on your "MUSIC LOVERS" cartridge

NAME.....

ADDRESS.....

CITY.....ZONE.....STATE.....

missed these very entertaining short stories. I also hope Mr. Frye will keep up the good work.

Miles G. Newman  
Blairstown, N. J.

**OOPS!**

■ Noted what I believe is a typographical error in the first column of Bill Winter's article on R/C Reliability (March issue, page 42). The arc suppressor resistor should be a 10-ohm 1/2-watt unit rather than 1/2-ohm, 10 watts as listed.

R. K. Doty  
Kansas City, Mo.

*You are right! A typographical error on our part!*

**REPRINTS AND BACK ISSUES**

■ Is it possible to get either the February issue of POPULAR ELECTRONICS, or a reprint of the article on the c.w. transmitter?

Timmy Smith  
Houston, Texas

*We do not have reprints of the article. However, back issues of our magazine may be obtained by sending 25¢ to our Circulation Department at 64 E. Lake St., Chicago 1, Ill.*

**INFO NEEDED ON HI-FI**

■ I don't care to assemble my own hi-fi system and would appreciate the straight dope on what set is best to buy. I am new at this line.

Gordon L. Burmeister  
Montague, Mich.

*Despite your being new in electronics, you can easily assemble your own system from among the many fine components currently available. Have you read such books as John H. Newitt's "High Fidelity Techniques" (Rinehart) or Weiler's "High Fidelity Simplified" (Rider)? In the coming months, POPULAR ELECTRONICS will publish exhaustive material on every aspect of hi-fi, including information on components, systems, and pre-packaged sets. As a start, check the story on phono pickups in this issue, as well as the items describing various new components.*

**ALUMINUM PARTS FOR THEREMIN**

■ I enjoyed immensely your article entitled "Electronic Music with the Theremin" in the April issue. I would like to know if it would be all right to use sheet aluminum 10" by 10" for the tone and volume antennas instead of having to cut the aluminum into a "T" and "V".

Millard Cohen  
Chicago, Ill.

*Perfectly all right. The important thing is to have enough aluminum sheet to provide a capacitive effect with your moving hand.*

**R/C KITS**

■ Your magazine has interested me in radio control. Could you give me the names of some of the producers of R/C kits, so that I can contact them?

Alan Steinbach  
Minneapolis, Minn.

*Your best guide to these companies are the advertisements in POPULAR ELECTRONICS.* —50—

How's your

# BATTING AVERAGE

with the boss?



Are you still making a hit? Are you up for the job ahead? Here's a sure way to score in any league!

If your boss is like most, he's casting his critical eye on everybody these days. He wants to know how you stack up. Are you making good—or marking time? When the changes come, will you go up—or out?

This is no time for casual resolve. What you plan to do six months from now may be too late. You've got to prove your worth—NOW!

## FOR REAL JOB SECURITY—GET I. C. S. TRAINING

The quickest, surest way to impress your boss is to show him that you're better equipped than the next guy. And here's where I. C. S. can go to bat for you!

I. C. S. training is approved training! Leading companies know it—and use it! At your request, your boss will get regular reports of your progress with I. C. S. More important, he'll notice the immediate improvement in your work.

## LEARN IN YOUR SPARE TIME—SET YOUR OWN PACE

I. C. S. instruction is *personalized* instruction. No interference with other activities. No slow classmates to hold up your progress. You forge ahead as rapidly as your time and ability permit!

I. C. S. Courses are practical, up-to-the-minute. What you learn one night, you apply the next day. You get bedrock facts and theories *plus* everyday know-how. Graduates get the famous I. C. S. diploma—recognized everywhere. "I got a break over more experienced fellows because of my I. C. S. training," says M. A. D., Suncock, N. H.

## QUICK WAY TO TEST YOUR EXECUTIVE ABILITY

Successful men know how to make decisions. Don't put it off! Mail the coupon today!

## 3 FREE BOOKS

Free, illustrated catalog outlining opportunities in the field that interests you. Also 36-page, pocket-size guide to advancement, "How to Succeed," a gold mine of helpful tips. Also, free sample lesson (Math).

For Real Job Security—Get an I. C. S. Diploma! . . . Easy-pay Plan . . . I. C. S., Scranton 9, Penna.

## INTERNATIONAL CORRESPONDENCE SCHOOLS

ICS

BOX 85295E, SCRANTON 9, PENNA.

(Partial list of 277 courses)

Without cost or obligation, send me "HOW TO SUCCEED" and the opportunity booklet about the field BEFORE which I have marked X (plus sample lesson):

### ARCHITECTURE and BUILDING CONSTRUCTION

- Air Conditioning—Refrig.
- Architecture
- Architectural Interior
- Building Contractor
- Building Maintenance
- Carpenter and Mill Work
- Estimating
- Heating
- Painting Contractor
- Plumbing
- Reading Arch. Blueprints

### ART

- Cartooning
- Commercial Art
- Fashion Illustrating
- Magazine Illustrating
- Show Card and Sign Lettering
- Sketching and Painting

### AUTOMOTIVE

- Auto Body Rebuilding
- Auto Elec. Technician
- Auto-Engine Tune Up
- Automobile

### AVIATION

- Aeronautical Engineering Jr.
- Aircraft & Engine Mechanic

### BUSINESS

- Advertising
- Bookkeeping and Accounting
- Business Administration
- Business Correspondence
- Public Accounting
- Creative Salesmanship
- Federal Tax
- Letter-writing Improvement
- Office Management
- Professional Secretary
- Retail Business Management
- Sales Management
- Stenographic-Secretarial
- Traffic Management

### CHEMISTRY

- Analytical Chemistry
- Chemical Engineering
- Chem. Lab. Technician
- General Chemistry
- Natural Gas Prod. & Trans.
- Petroleum Engineering
- Plastics
- Pulp and Paper Making

### CIVIL, STRUCTURAL ENGINEERING

- Civil Engineering
- Construction Engineering
- Highway Engineering
- Reading Struct. Blueprints
- Sanitary Engineering
- Structural Engineering
- Surveying and Mapping

### DRAFTING

- Aircraft Drafting
- Architectural Drafting
- Electrical Drafting
- Mechanical Drafting
- Mine Surveying and Mapping
- Plumbing Drawing and Estimating
- Structural Drafting

### ELECTRICAL

- Electrical Engineering
- Electrical Maintenance
- Electrician  Contracting
- Lineman
- High School
- Commercial  Good English
- High School Subjects
- Mathematics

### LEADERSHIP

- Foremanship
- Industrial Supervision
- Leadership and Organization
- Personnel-Labor Relations

### MECHANICAL AND SHOP

- Gas—Electric Welding
- Heat Treatment  Metallurgy
- Industrial Engineering
- Industrial Instrumentation
- Industrial Supervision
- Internal Combustion Engines
- Machine Design-Drafting
- Machine Shop Inspection
- Machine Shop Practice
- Mechanical Engineering
- Quality Control
- Reading Shop Blueprints
- Refrigeration
- Sheet Metal Worker
- Tool Design  Toolmaking

### RADIO, TELEVISION

- Industrial Electronics
- Practical Radio TV Eng'ing
- Radio and TV Servicing
- Radio Operating

### TELEVISION Technician

- RAILROAD
- Air Brakes  Car Inspector
- Diesel Locomotive
- Locomotive Engineer
- Section Foreman

### STEAM AND DIESEL POWER

- Combustion Engineering
- Diesel—Elec.  Diesel Eng's
- Electric Light and Power
- Stationary Fireman
- Stationary Steam Engineering

### TEXTILE

- Carding and Spinning
- Cotton, Rayon, Woolen Mfg.
- Finishing and Dyeing
- Loom Fix'g  Textile Des'ing
- Textile Eng'g.  Throwing
- Warping and Weaving

### MISCELLANEOUS

- Domestic Refrigeration
- Marine Engineering
- Ocean Navigation
- Professional Engineering
- Short Story Writing
- Telephony

Name \_\_\_\_\_ Age \_\_\_\_\_ Home Address \_\_\_\_\_

City \_\_\_\_\_ Zone \_\_\_\_\_ State \_\_\_\_\_ Working Hours \_\_\_\_\_ A.M. to P.M. \_\_\_\_\_

Occupation \_\_\_\_\_

Canadian residents send coupon to International Correspondence Schools, Canadian, Ltd., Montreal, Canada. . . . Special tuition rates to members of the U. S. Armed Forces.

# NOW

*New*

# SPRAGUE CERAMIKITS

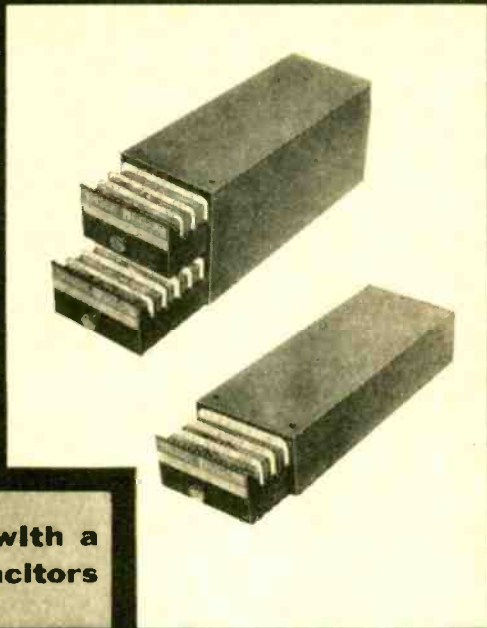

Get these cabinets **FREE** with a basic order of ceramic capacitors

- NOW . . . your own neat and complete cabinet of the ceramic capacitors you use most *at the cost of the capacitors alone!* Sprague has pre-stocked handsome, blue, heavy-gauge steel CERAMIKIT cabinets with its famous Cera-Mite capacitors. Ratings and quantities are based on popularity . . . the frequency with which you are likely to run into them on a job or project.

- Stand-up indexes separate the reusable plastic boxes of capacitors. Catalog numbers and ratings can be seen at a glance. Kits interlock so you can build with Sprague as you buy Ceramikits, using the extra cabinets for handy indexed stocking of all your small parts.

- Whether you use many ceramics or just a few, there's a Ceramikit sized and priced just right for you. Kit CK-2 is a two-drawer model holding 150 different capacitors in 27 different ratings. Kit CK-3 is a single-drawer unit holding 75 capacitors in 12 different ratings.

- See Ceramikits at your nearest electronic parts jobber NOW . . . or get complete information in Sheet M-711 from the Sprague Products Company, 395 Marshall Street, North Adams, Massachusetts.

Sprague Products Co. is the Distributors' Division of the Sprague Electric Co.

### CERAMIKIT CK-3

CONTENTS

3½" x 9¼" x 2"

\$19.25 List

Quan.	Cat. No.	Quan.	Cat. No.
5	5GA-Q1	5	5GA-T47
5	5GA-Q22	5	5GA-T5
5	5GA-Q5	10	5GA-D1
10	5GA-T1	5	5GA-D2
5	5GA-T15	5	5HK-D5
5	5GA-T22	10	5HK-S1

### CERAMIKIT CK-2

CONTENTS

3½" x 9¼" x 4"

\$38.00 List

Quan.	Cat. No.	Quan.	Cat. No.
5	5GA-V5	5	5GA-T27
5	5GA-Q1	5	5GA-T33
5	5GA-Q15	5	5GA-T39
5	5GA-Q22	5	5GA-T47
5	5GA-Q33	5	5GA-T5
5	5GA-Q39	5	5GA-T68
5	5GA-Q47	10	5GA-D1
5	5GA-Q5	5	5GA-D15
5	5GA-Q68	5	5GA-D2
5	5GA-Q82	5	5GA-D33
10	5GA-T1	5	5GA-D4
5	5GA-T12	5	5HK-D5
5	5GA-T15	5	5HK-D5
5	5GA-T22	10	5HK-S1

don't be vague...insist on

# SPRAGUE

**YOU CAN BUILD  
WITH SPRAGUE**



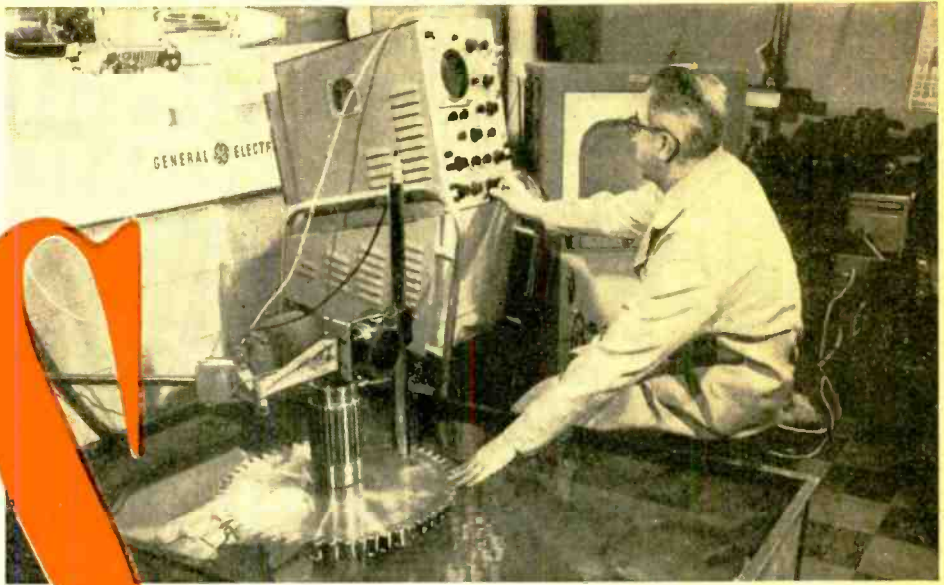

# SILENT SOUND

By LOUIS E. GARNER, Jr.

*Powerful sound waves radiated by mechanical transducers find a multitude of valuable applications in industry.*

ULTRASONIC INSTRUMENTS, industry's newest tools, are used for such varied tasks as measuring the wall thickness of metal tanks, checking forging ingots for flaws, locating defects in railroad tracks, soldering aluminum and other hard-to-solder metals without fluxes, protecting plants and offices against intruders, and for machining metals and other hard materials. Ultrasonic cleaning machines are used for everything from tiny laboratory instruments to aircraft parts, from gears to delicate optical lenses.

*Ultrasonic* refers to those sound frequencies above approximately fifteen thousand cps. The upper limit is very high—into the megacycles (millions of cycles per second). Since ultrasonic signals are not audible, they are frequently called "silent sound."

A *transducer* is a device for changing energy from one form to another. Ear-phones and loudspeakers are transducers, for they serve to change electrical energy

into acoustic energy. Transducers are the important links between the electronic circuits which produce, amplify, and measure ultrasonic signals and the materials which are being processed or tested by the ultrasonic instruments.

Industrial ultrasonic transducers are generally made up either of *piezoelectric* materials or *magnetostrictive* elements. A piezoelectric material is a substance whose physical dimensions change when a voltage is applied to it, producing a mechanical force. The converse is also true in most cases—when mechanical force is applied to the material, an electrical voltage may be generated. The mechanical force may be pressure or a twisting or bending action. Typical piezoelectric materials are quartz crystals, Rochelle salts, barium titanate, and certain other ceramics. Crystal and ceramic microphones and phonograph cartridges are everyday examples of piezoelectric transducers.

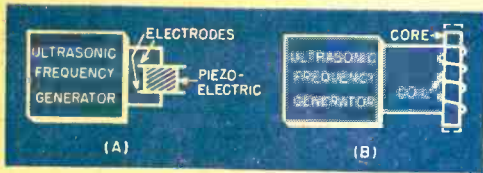
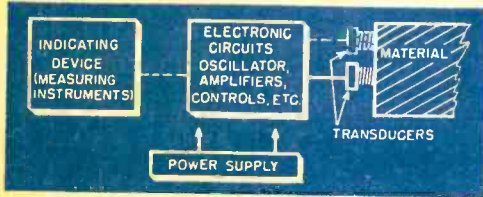

Fig. 1. Two basic transducer designs are shown above. Drawing (A) has a crystal element and drawing (B) a magnetostrictive core. Actual element movement in both cases is extremely small. Fig. 2. (below) shows a simplified block diagram of industrial ultrasonic equipment.



A magnetostrictive element is a core of magnetic material surrounded by an energizing coil. When a piece of material is magnetized, the individual molecules of the substance "line up" in order. This results in a minute change in the material's length. When ultrasonic electrical energy is supplied to the coil, the core is first magnetized in one direction, demagnetized, then magnetized in the opposite direction. Since the core length changes with each magnetization, the result is a change from electrical energy (in the energizing coil) to mechanical movement (lengthening and shortening core). Nickel and its alloys are frequently used as cores for magnetostrictive elements.

A simplified block diagram for industrial

ultrasonic equipment is given in Fig. 2. With modifications, this diagram applies to almost all of the ultrasonic instruments in current use. The "heart and brains" of the equipment are the electronic circuits which generate and control the high frequency electrical signals. In the case of measuring instruments, there may be circuits producing, detecting, and amplifying ultrasonic signals. There will be one or more transducers to convert the high frequency electrical energy into ultrasonic vibrations in the material being tested or processed. Where measurements are involved, there will be an indicating device.

**Cleaning Parts:** One example of the capabilities of ultrasonic instruments is given by the sample plates in Fig. 3. Both of these deeply serrated metal plates were soiled with a black grease pencil. The clean one was given a 2-second rinse in a solvent activated by ultrasonic vibration; the other was given a rinse two and half times as long in the same solvent, but without activation. It required 10 minutes for complete cleaning without ultrasonics—300 times as long as with activation. In some cases, the transducer may be shaped to focus or to concentrate the ultrasonic vibrations. The frequencies used for ultrasonic cleaning range from as low as 15 kc. to 1 mc. and higher.

The efficiency of an ultrasonic cleaner results from two actions: the vibratory motion given to the liquid cleaner by the ultrasonic energy; and the action called cavitation, a "cold-boil" which results when the vibrating liquid is torn into small vacuum pockets. As these pockets form and collapse, they create strong localized pressures, bombarding the parts being

Fig. 3. These plates illustrate the efficiency of ultrasonic cleaning. Both were soiled with a black grease pencil. The clean plate was cleaned in two seconds using a solvent activated by ultrasonics.

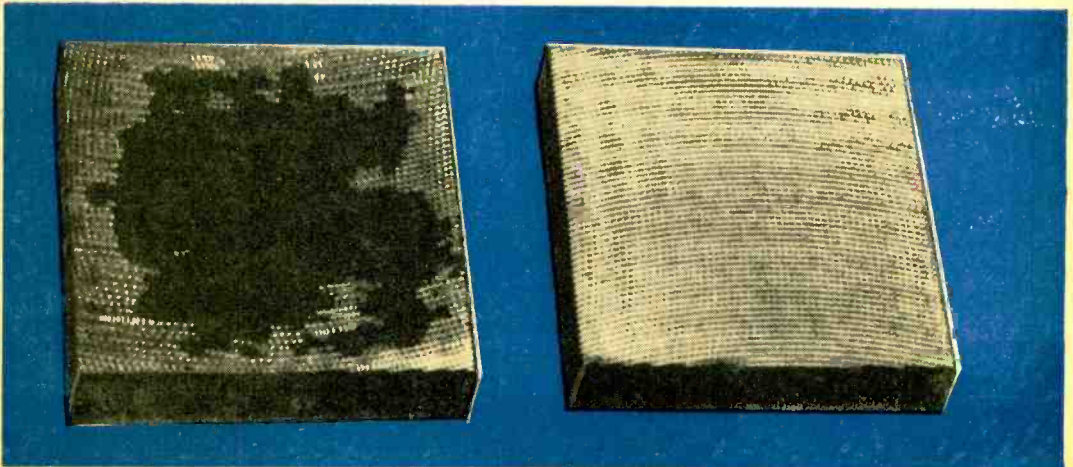

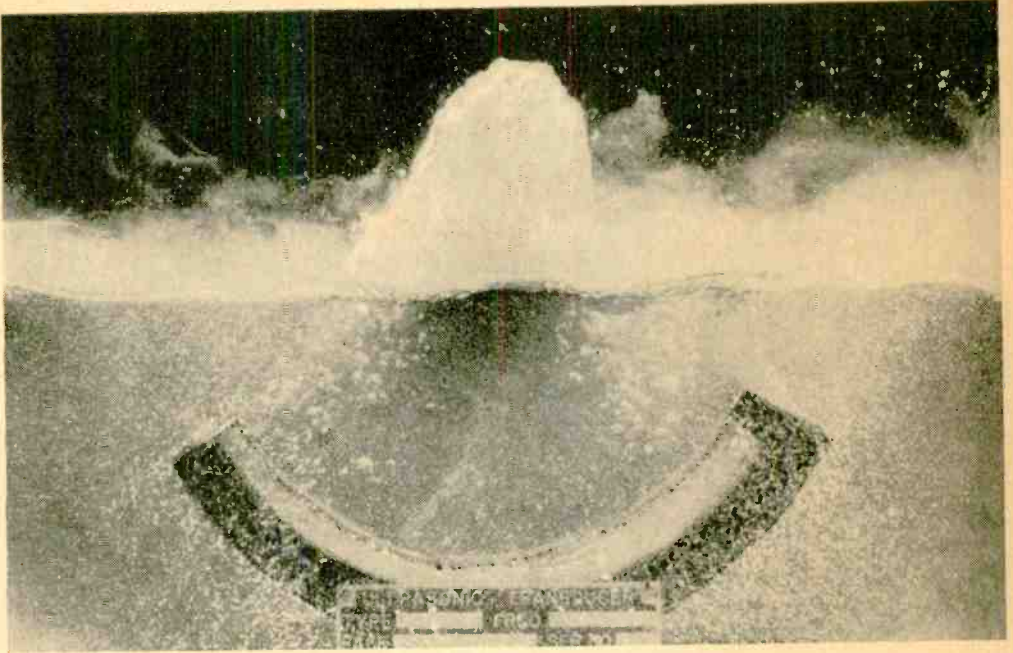

This photo shows the violent agitation of a liquid excited by the curved ultrasonic transducer immersed in the solution.

cleaned from every direction, and blasting off dirt and other foreign matter.

**Thickness Measurement:** To measure the thickness of the metal in a large tank, or in a ship's hull, where only one side can be reached, is not impossible with an ultrasonic thickness gauge.

Several methods may be used but portable instruments frequently employ the principle of resonance. A transducer, driven by an electronic oscillator, is placed in contact with one side of the material to be tested. The ultrasonic wave travels through the material in a narrow beam and is reflected by the opposite surface. At certain frequencies the transmitted wave and the reflected wave will reinforce each other, resulting in an increase in the intensity of the wave in the material. The frequencies at which the reinforcement occurs depend on the thickness of the material and the velocity of sound through it. Since the velocity of sound is constant for a particular material, the determination of the fundamental frequency of resonance (where reinforcement occurs) is a reliable measure of the thickness of the material.

**Inspection and Test:** The "echo" principle is used in industrial test instruments with ultrasonic vibrations taking the place of radio or audible sound waves. The reflectoscope may be used for checking large metal billets for defects, locating flaws in castings and forgings, checking parts for interior defects, evaluating welds, and

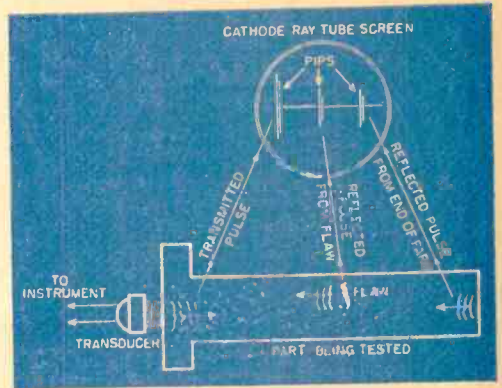
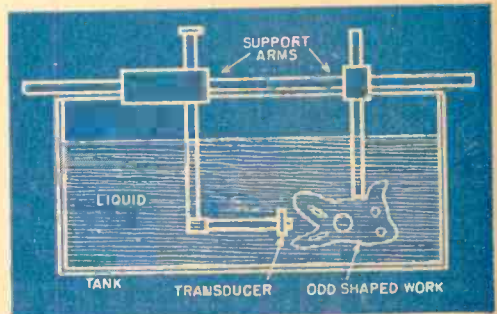

Fig. 4. Pulses of ultrasonic energy are reflected by flaws and displayed on a cathode-ray tube. Fig. 5. (below) Illustration of a method for examining odd-shaped metallic pieces for flaws using ultrasonic waves.





checking the physical dimensions of metal parts where only one end or side may be reached.

In operation, a transducer is placed against one end of the piece to be tested and "beams" pulses of ultrasonic energy through the material (see Fig. 4). These pulses travel to the end of the piece and are reflected back to the transducer, where they are detected. If there are cracks or holes in the piece, these flaws also cause reflections. The transmitted signal and all of the reflected pulses are displayed as "pips" on the screen of a cathode-ray tube. The relative distance between the first pip and succeeding pips on the tube's screen is proportional to the distance between the point where the transducer is placed and the distance to the flaws or to the end of the piece. Thus, the instrument shows both defects and their approximate location. If the piece has an irregular shape, it may be immersed in liquid for testing, as shown in Fig. 5. The

A General Electric ultrasonic generator is shown being used at the Holley Carburetor Co. to clean a jet engine fuel control part.

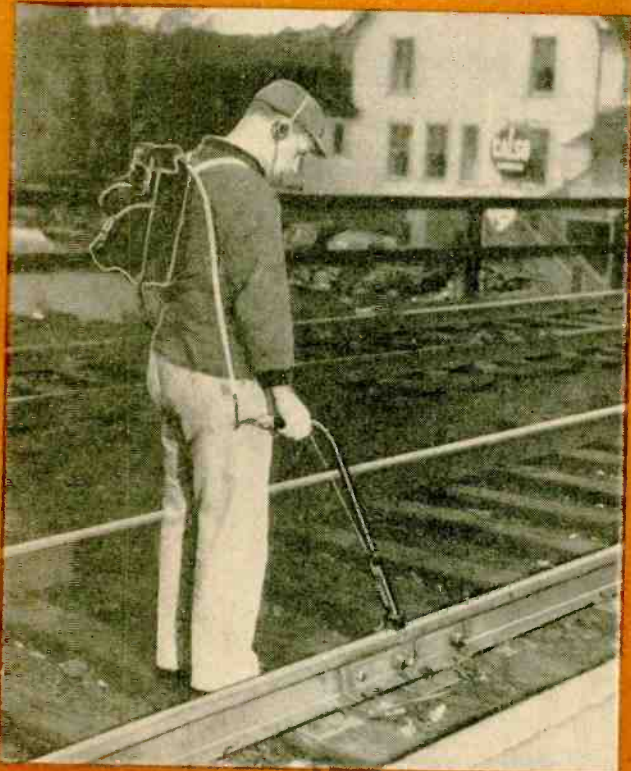

Using a portable ultrasonic flaw detector to check a railroad track rail for defects or cracks.

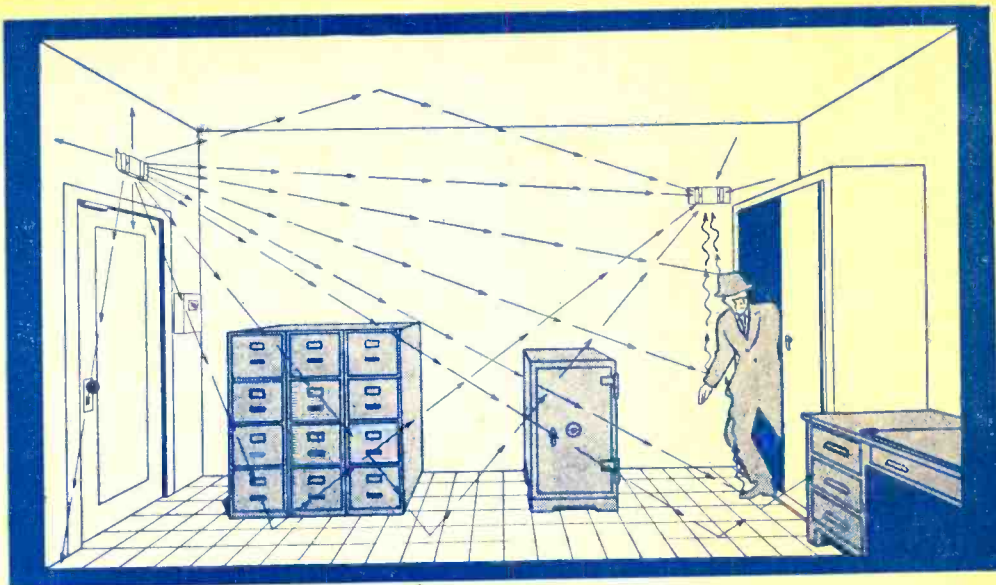

Fig. 6. This sketch illustrates the operation of the ultrasonic alarm system.

liquid transmits the ultrasonic vibrations from the transducer to the piece.

**Ultrasonic Soldering:** Soldering aluminum is difficult because oxide films form so rapidly. Success depends on clean metal surfaces and strong flux. After the soldering is completed, every trace of flux must be removed to prevent corrosion. Ultrasonic soldering instruments, however, have simplified this job. A magnetostrictive transducer, operating at about 20 kc., vibrates the metal and literally rips up oxide films, allowing the solder to form a strong union with the heated metal.

**Plant Protection:** Most modern industrial plants are fairly well protected, either by full time guard staffs or by various electronic burglar alarms, including "electric eye" systems, electronic fences, closed circuit television observation stations, and

similar protective devices. But only ultrasonics can guard against the intruder who hides inside during working hours and works by night.

The operation of an ultrasonic alarm system is illustrated in Fig. 6. High frequency sound waves are "broadcast" by the transmitting transducer, just above the door. These ultrasonic signals bounce off the floor, ceiling, walls and furniture, literally filling the room with silent sound. The signals are picked up by the receiving transducer. As long as the transmitted and received signals are the same frequency, the room is secure and protected. But if anything should move within the room, the frequency of the signal picked up by the receiving transducer changes slightly. Electronic circuits are constantly comparing the frequencies of the transmitted and received signals, and when the small frequency change occurs, an alarm is sounded.

Truly, the surface has barely been scratched as far as potential applications of ultrasonic equipment are concerned. We may expect to see it used in every branch of industry, in the home, in business, and in medicine. Ultrasonic drills have been used in dentistry (see "Dentistry—the Painless Way," POPULAR ELECTRONICS, November, 1954.) Ultrasonic vibrations have been used to accelerate the pollination of plants. Laundry work has been done with ultrasonics. In the future, "smog" may become a thing of the past as ultrasonics is used to coagulate and precipitate smoke and dust.

Future applications will be covered in other issues of POPULAR ELECTRONICS. —30—

A small hand tool is used to make a soldered fillet in a grounded aluminum chassis.

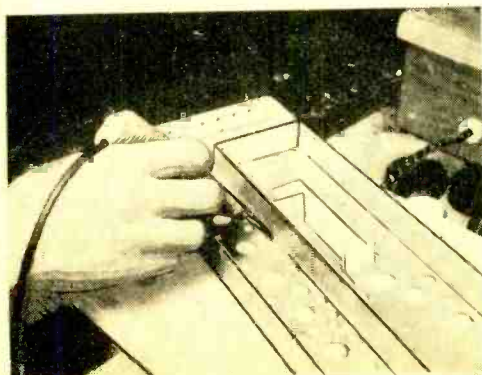

# TRADIC-



A MINIATURE ELECTRONIC "BRAIN" that can operate flawlessly in planes flying at supersonic speed has been developed for the U. S. Air Force by *Bell Telephone Laboratories*.

The "brain" is a digital computer which eliminates vacuum tube failure and heat, jet aircraft's greatest electronic problems, by the use of transistors instead of vacuum tubes. It contains nearly 800 of these tiny, solid devices and is believed to be the first all-transistor computer designed for aircraft. Transistors, developed at *Bell Laboratories*, are completely cold, highly efficient amplifying devices which use very little power.

Known as "TRADIC" (TRansistor-DIGital-Computer), the new computer requires less than 100 watts to operate. This is one-twentieth of the power needed by comparable vacuum-tube computers. Early computers used as many as 18,000 vacuum tubes and frequently required thousands of watts to operate.

The new electronic "brain" contains, in addition to transistors, nearly 11,000 germanium diodes. These serve as the elec-

tronic equivalent of tiny one-way switches. Solid, like transistors, they are capable of operating thousands of times faster than their mechanical counterparts.

When design work has been completed, the computer will probably occupy less than three cubic feet of the critical space in modern military aircraft.

TRADIC can do sixty thousand additions or subtractions, or three thousand multiplications or divisions a second. A typical problem fed into the machine requires it to go through about 250 different steps of computation. It can run through an entire problem of that complexity and provide an answer in about 15 thousandths of a second—much less time than it takes to say "TRADIC." The computer can handle, simultaneously, as many as thirteen 16-digit numbers.

Mathematical instructions are placed into TRADIC by means of a "plug-in" unit resembling a small breadboard. Plug-in units are set up beforehand with interconnecting wires to represent problems at hand. Numbers to be processed are put into the machine by means of simple switches.

The laboratory model of TRADIC provides answers to trigonometric problems with a series of "dots" on an oscilloscope. These dots of light move so rapidly that

# THE "SUPER COMPUTER"

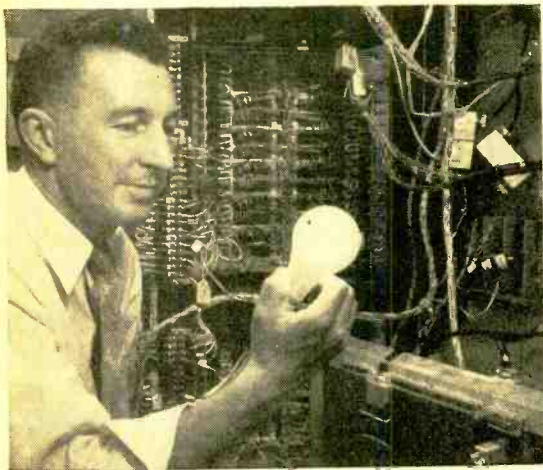

Less power is needed to operate TRADIC than is required to light a 100-watt bulb.

they actually appear to draw geometric diagrams on the scope.

To handle the successive steps of complex computation, a machine, like a human, must have a means of storing information until it is needed. When a man works on an involved mathematical problem, he usually jots down on paper the answer to each section as it is solved, then refers back to this frequently as he proceeds. TRADIC, however, automatically transfers each sub-answer to built-in "memory" packages while continuing to tackle the remaining sections.

There are two main types of computers, digital and analog. A digital computer, like the mileage indicator of a car, is a "counting" machine which clocks off one number after another. Each digit shifts when the number to the right of it passes nine. Digital computers can actually perform only additions or subtractions but they are able to multiply or divide by successive additions or subtractions.

An analog computer might be likened to an automobile speedometer which represents speed in terms of the angle of a pointer on the dial. An analog computer gives results in terms of voltages, resistances or rotations. It is designed for a specific task and cannot be easily adapted for another problem.

TRADIC, fundamentally a digital computer, has the advantage of being able to operate on analog data.

-30-



Answers to trigonometric problems are furnished by series of dots on oscilloscope. Dots move so fast they seem to form lines.

Transistor is inserted into one of TRADIC's "memory" packages. These units store information until entire problem is solved.





Commander C. M. Caldwell, Deputy Director of Electronic Design for the U. S. Navy's Bureau of Ships (left) and Robert Dressler, Director of Research and Development for Chromatic Television Laboratories, Inc., examine screen of first multicolor radar indicator.

### **Special color TV tube is used in solving important National Defense problem by Navy Bureau of Ships.**

MULTICOLOR RADAR, a new data presentation development which has widespread naval, military and commercial applications, was demonstrated recently by *Chromatic Television Laboratories, Inc.*, an affiliate of *Paramount Pictures Corporation*. The demonstration marked the first time it has been possible for different types of radar information—namely, stationary and moving, or friendly and enemy—to be simultaneously displayed in more than one color on a single radar indicator.

Heart of the new color radar device is a single electron-gun color cathode ray picture tube, known as the Chromatron or Lawrence tube. The tube, although redesigned for radar, is virtually the same as

the low cost picture tube which *Chromatic* has developed for commercial color television. This tube is based on the inventions of Dr. Ernest O. Lawrence, Nobel Prize physicist (1939), and others. Dr. Lawrence is Director of the University of California's Radiation Laboratory and a consultant to *Chromatic*. According to Dr. Lawrence, the new device promises to be "an important advantage in military tactical operations and a tremendous safety aid."

The harassed radar operator previously has had only a single color for the interpretation of all data cluttering his screen. Now, with the help of more than one color appearing simultaneously on the same radar screen, he can distinguish be-



# MULTICOLOR RADAR

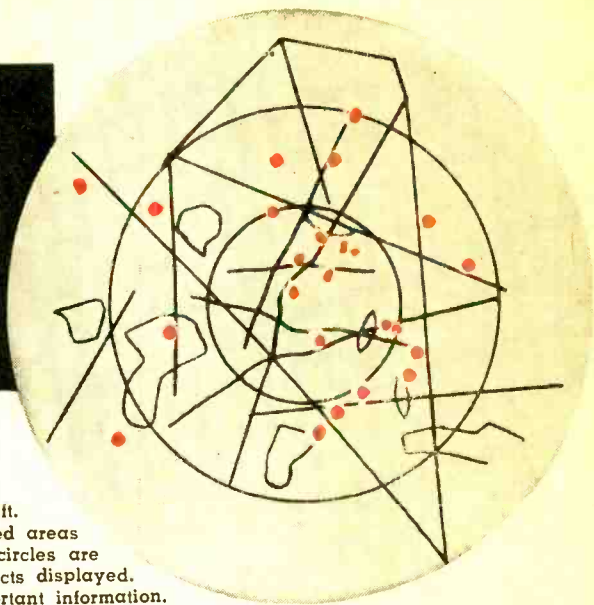

Dots represent moving aircraft. Straight lines show prohibited areas or flight paths. Concentric circles are distances from radar to objects displayed. Color distinguishes the important information. This presentation is called "Plan Position Indicator."

tween incoming signals faster—with greater facility—and for a longer period of time. This is a distinct advantage to the radar operator because it reduces fatigue, an essential safety factor in both military and commercial operations.

The tactical applications of color radar are under further development by several branches of the armed forces.

Dr. Lawrence, inventor of the cyclotron or "atom smasher" and an important figure in the nation's atomic program, has had a continuing interest in developments of importance to the defense program. He was a member of the original committee set up during World War II to carry on radar research.

Dr. Luis W. Alvarez, another *Chromatic* consultant who had served on the wartime radar committee, also helped in the development of multicolor radar. Dr. Alvarez is the inventor and developer of Ground Control Approach, a blind aircraft radar landing system, for which he was awarded one of the nation's highest aviation awards in 1945—the Collier Trophy of the National Aeronautical Association.

Dr. Alvarez also developed the basic design for a long range search radar and an ultra-high resolution airborne bombing radar, and was in charge of aircraft observation and instrument planes for the atomic bomb blasts at Alamogordo, N. M., Hiroshima and Nagasaki.

—30—

Major components of new multicolor radar system are shown in photo below. Block diagram at left is for reference only: (A) color display power supply, (B) tube housing and multiplex circuits, (C), (E) and (F) simulation equipment used in laboratory tests, not during demonstration, (D) standard Navy radar indicator, (G) standard Navy radar indicator power supply. A and G could be integrated as one unit, as could B and D.

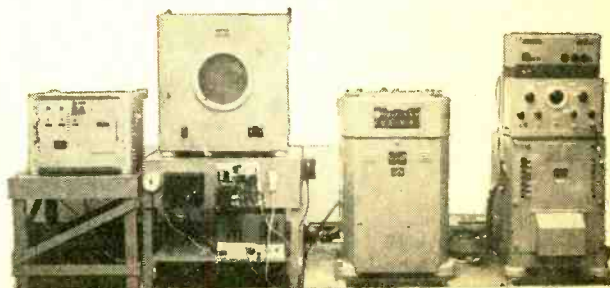
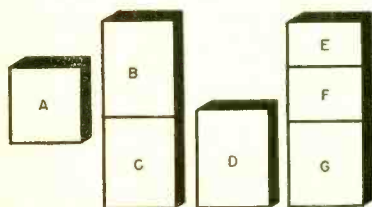

In the first part of this two-part story, the Editors of *POPULAR ELECTRONICS* report on modern advances in the scientific use of induction heaters by industry.

# heat without flame

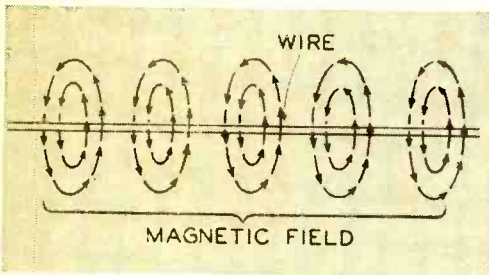

(a)

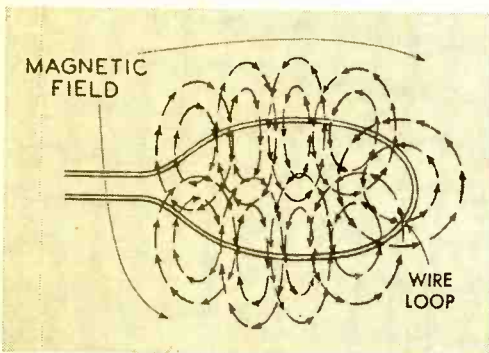

(b)

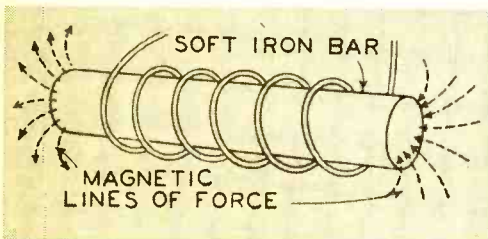

(c)

Current following through a conductor sets up magnetic field (a) which may be concentrated by bending the conductor to form a loop (b), or by providing a core of magnetic material (c).

WITHOUT HEAT, man never could have smelted metals and built the great civilization of today on its foundation of steel, copper, tin, and other metals. For many, many centuries, heat was intimately associated with fire, but in comparatively modern times, the development and use of electrical power has led to heat without fire.

When an electric voltage is applied to a conductor, the conductor offers a resistance to the flow of current and the current, in overcoming this resistance, produces heat. The amount of heat produced depends on both the resistance of the material and the amount of current.

However, even with the development of electric heaters, heat had to be produced before it could be applied. But today in factories and plants all over the world heat is being used without initial generation. Instead, the heat is generated within the material being processed. Two kinds of heaters are in use: induction heaters, used with conductors such as iron and steel; and dielectric heaters, used with insulators, such as wood and plastics. Induction heaters will be discussed now. In a subsequent issue of *POPULAR ELECTRONICS* dielectric heaters will be covered.

## Principles of Induction Heating

When electric current flows through a conductor, heat is produced. In addition, a magnetic field is set up around the conductor. This magnetic field may be concentrated by bending the conductor in loops to form a coil and by providing a core of magnetic material. The intensity of the magnetic field depends on three factors: the amount of current in the conductor; the number of turns in the coil; and the type of core material used.

If an alternating current flows through the conductor, a changing magnetic field will be produced which will build up to maximum intensity, collapse, and build up

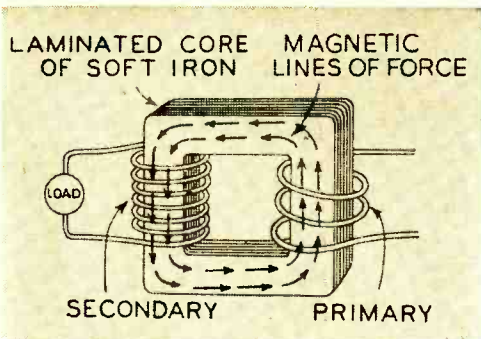

A magnetic field will couple the primary and secondary windings in a transformer.

to maximum intensity again, but with reversed polarity. If this varying magnetic field is brought near a second conductor, a current will be induced in the second conductor. This principle is used in transformers. Two or more coils are placed fairly close together. An alternating current is passed through the first conductor, or *primary* winding, and this current produces a magnetic field which induces currents in the *secondary* windings.

When the primary coil surrounds a relatively solid conducting mass, the induced currents are not channeled as in a transformer, but flow like eddies in many directions. Since the solid mass acts like a short circuit, these eddy currents may be large, causing considerable heat to be generated within the mass. It is on this "transformer" action that induction heating is based.

Where the core is a magnetic material, such as iron or steel, it is rapidly magnetized, demagnetized, and remagnetized in the opposite direction. The individual molecules change position with each magnetization change, resulting in considerable molecular "friction" and producing additional heat. The molecular "friction" which keeps the molecules of the material from changing position easily is known as hysteresis.

In a conventional transformer, the heat produced by eddy currents and hysteresis represents a power loss. Although induction heating equipment is designed to produce such heat in the material being processed, iron core power transformers are designed to keep such heating to a minimum. To accomplish this, the cores of such transformers are made of thin laminations of steel rather than a solid piece. The thin laminations have a comparatively high resistance, keeping eddy current losses at a minimum.

As the frequency of the alternating current is increased, the induced currents tend to flow nearer the surface of the conduc-

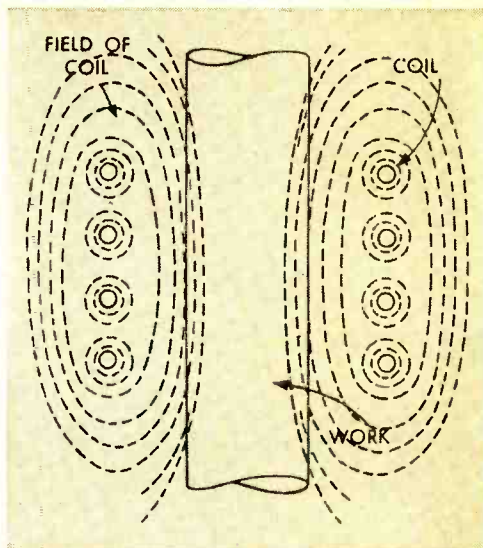

The effect of the electromagnetic field produced by loading the coil is shown above.

tor. At fairly high frequencies, the induced currents may be concentrated in a very thin "skin" right at the surface. This is known as skin effect. Since heating depends to a large extent on these induced currents, induction heating is especially valuable in heating only the surface of a piece of work, such as a bearing or a gear face.

### Types of Induction Heaters

Commercial induction heaters consist of two major components: the alternating current power source or "generator" and the work coil which is coupled to the load and serves to change the alternating current to a varying magnetic field. The frequencies used for induction heating range from 25 cycles per second to several megacycles. Where commercial line frequencies (25-60 cps) are involved, electrical energy may be obtained directly from the power lines. But where higher frequencies are required, there are three basic types of "generators" widely used by modern industry: the motor-generator set; the spark-gap oscillator; and the vacuum-tube oscillator.

*The Motor-Generator Set:* A motor-generator set is an electric motor driving a high frequency generator.

Due to practical limitations on generator size and speed, output frequencies of 1000, 3000, and 10,000 cps are the most popular and the majority of commercial induction heater motor-generators are designed to supply power at one of these frequencies. Power output for a single unit may range from less than 10 kw. to more than 1200 kw. Where higher powers are required, a

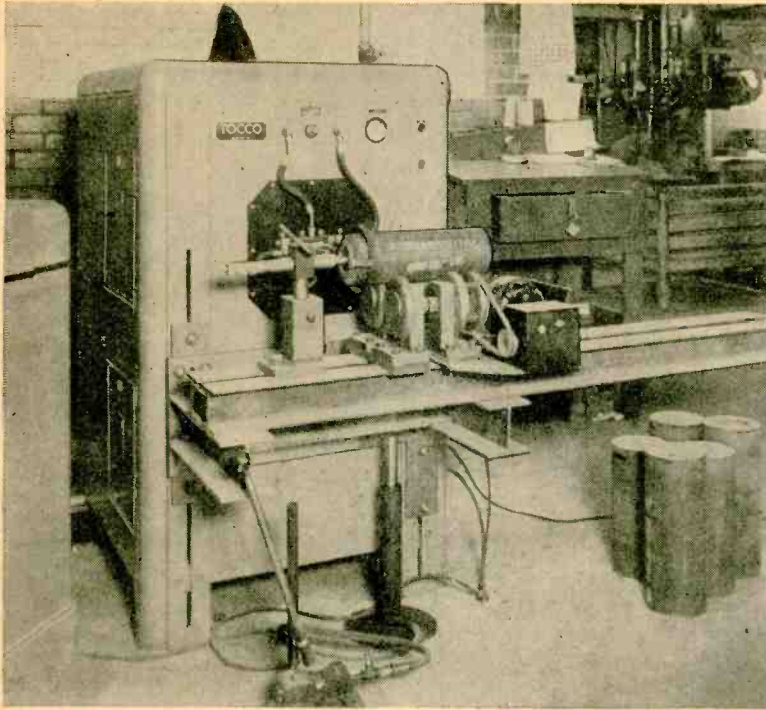

This Tocco heating station with inductor and fixture is used for brazing hydraulic cylinders and cylinder cap assemblies.

"bank" of individual units may be used. Most commercial units have efficiencies running from 60 to 90 per-cent. Motor-generator sets are used where large amounts of relatively low frequency power are required for such applications as forging, melting, and deep hardening.

*The Spark-Gap Oscillator:* The first high frequency generators used for induction heating were spark-gap oscillators. Dr. Edwin F. Northrup, one of the pioneers in the induction heating field, did most of his work in the early 1900's, when spark-gap oscillators were widely used for "wireless"

Epimetheus and Prometheus were assigned the task of providing man and animals with faculties necessary for their preservation. Epimetheus was to do the actual fitting, with Prometheus supervising. Claws were bestowed to one animal, protective armor to another, and wings, fangs, and special coloring to others. But when Epimetheus came to man, he had exhausted his store of gifts and his orders had been to make man superior to all creatures. When Prometheus learned of this, he went to heaven to light his torch at the chariot of the sun and he brought fire to mankind. Zeus was enraged for man was now able to do things which had only been done by gods. And Prometheus was bound to a rocky cliff for all eternity because he dared to bring the power of fire to man.  
—Greek Mythology

communications. Although vacuum tube oscillators have replaced spark-gap units in the communications field, spark-gap oscillators are still extensively used by industry.

In a spark-gap oscillator an inductance coil is connected in series with a spark-gap and both are connected across a large capacitor. A high a.c. voltage is applied to the capacitor. Normally, the spark-gap is non-conducting and acts as an open circuit. The voltage charge of the capacitor builds up to near its peak value, at which point the gap breaks down and effectively closes the connection between coil and capacitor, forming an oscillatory tuned circuit. Very heavy currents surge back and forth between the coil and capacitor, as the capacitor is alternately charged and discharged, at a frequency determined by the inductance and capacity values of the components. With such current surge, the amplitude drops slightly, as energy is dissipated in the circuit and in the load, until there is no longer sufficient energy to maintain the spark. At this point the spark dies out and the gap again acts like an open circuit. The output of a spark-gap oscillator is thus a series of high frequency pulses.

Spark-gap oscillators are generally designed to operate in the frequency range of from 20 to 500 kc. Most manufacturers rate them by power input rather than by

power output. Standard spark-gap oscillators are made with power ratings up to about 40 kw., and down to about 2 kw. With a wide frequency range and low to moderate output powers, spark-gap oscillators are well suited to such applications as melting and forging small to moderate sized pieces.

*The Vacuum-Tube Oscillator:* Except for the power ratings, the oscillator circuits are similar to the circuits used in radio transmitters. But there is a difference between a high-power induction heater and a high-power radio transmitter. Broadcast transmitters generally employ a low to moderate power oscillator, followed by several stages of amplification. Induction heaters, on the other hand, use high power oscillators directly.

The plate (output) and grid (input) circuits of a vacuum-tube amplifier are coupled so that part of the output energy is fed back to the input to overcome circuit losses and to start and sustain oscillation. A tuned circuit is incorporated in either the plate or grid circuits (or both) to establish the operating frequency. The operation of a vacuum-tube oscillator is similar to that of a spark-gap unit, but with a vacuum tube replacing the spark-gap as a source of power pulses. However, the high frequency output is obtained as a continuous wave rather than as a series of pulses with a comparatively low repetition rate.

Feed rolls push barstock through a set of Tocco induction coils which heat the stock to a temperature of about 2350 degrees F.

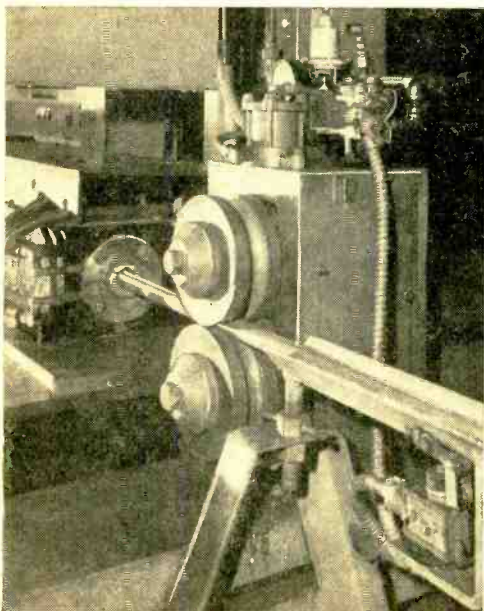

June, 1955

Vacuum-tube power oscillators are used at frequencies of from 150 kc. to one mc. and higher. Commercial units are available with power ratings from a few hundred watts to hundreds of kilowatts.

### Induction Heater Applications

Induction heaters are used in the metal working industries and for soldering the seals of canned foods, hardening machine parts, annealing sheet metal products, brazing fittings, and melting small lots of metals in laboratories developing new alloys. In many cases induction heaters are used to supplement other heating techniques or to do a job faster and more efficiently than older methods. However, induction heating is frequently used in applications where no other heating method has been completely satisfactory.

One example of this type of application is in vacuum heating and melting, where metals are processed in a vacuum. Another example is in the vacuum-tube manufacturing industry. During the evacuation process, the metal elements of vacuum tubes must be heated to high temperatures to drive out gases which might later shorten the service life of the completed tube. Since the tube electrodes are surrounded by a glass envelope, a direct method of heating is not practical, but induction heating may be used when the coil is placed around the outside of the tube's envelope.

*(Continued on page 128)*

This huge Ajax-Northrup heater coil is used for the hot pressing of carbide steels. Portable units are also available for this purpose.

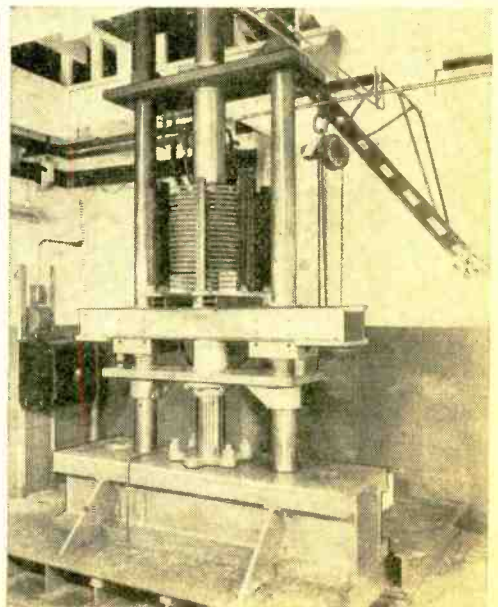

29

# GENIAC

*Interesting kit builds circuits that solve problems and play games.*



Cynthia Scott (Mrs.) and Marlene Saunders (Mrs.)—"two jealous wives"—eye each other with suspicion while awaiting Geniac signal. Circuit warns wife if husband has been unfaithful.

"ELECTRIC BRAINS" THAT WORK in much the same manner as giant computers can now be built quickly and cheaply by the novice using the new Geniac Construction Kit.

One of the most remarkable kits ever introduced to the public, the Geniac kit provides material and instructions for building 33 separate circuits for operating as many "brain machines." Among the devices that may be built are logic machines for comparing and reasoning; cryptographic machines for coding and decoding; games such as tic-tac-toe and nim; arithmetic machines for both decimal and binary computations; puzzles such as "the space ship airlock," "the fox, hen, corn, and hired man;" and miscellaneous devices such as a burglar alarm, an automatic oil furnace circuit, etc.

In addition to a complete assortment of all necessary parts is a carefully prepared instruction manual which explains in detail how to wire each circuit. The 63-page manual also furnishes basic information on the application of symbolic logic to circuits, which is the basis of the Geniac kit.

The kit is completely safe for anyone to

use. No soldering is required, and every circuit operates on one common flashlight battery.

By the use of ingeniously designed parts, such as a new type multiple switch and special circuit jumpers, the kit provides circuits that "act out" or "prove" the truth of verbal statements about certain situations. One of the most popular of these circuits is the machine for the two jealous wives, illustrated here. In this problem, a "brain machine" must be devised that will inform either or both wives of unfaithfulness on the part of their husbands.

Mathematical basis for the Geniac circuits is the application of "Boolean algebra" to circuit design. George Boole, a nineteenth century British mathematician, evolved a system of logic in which symbols represent specific possibilities of things happening one way or another, such as A and B, or, A or B, etc. Certain types of information, when stated verbally, can be analyzed and reduced to simple statements. These statements, or "elements," are, in turn, expressed in symbols. The symbolic statement or "formula" then represents the verbal statement. From the symbols,

it can be determined what circuit components are needed and how, to a large extent, they must be arranged in order to provide a circuit that "acts out" the original statement. The gigantic computers that solve complex problems in the twinkling of an eye are based, in part, on these principles.

A good illustration of how this system works is the problem of the hall light, one of the circuits included in the kit. The problem, stated in normal language, is this: a man wants to turn off or turn on a hall light either from downstairs or from upstairs. A circuit must be devised so that if either switch is turned the light will go off if it was on, and will go on if it was off.

This is a practical problem and involves a kind of wiring that may be familiar to many readers. It implies a switching arrangement in which either of two switches may be "off" or "on" in any position, depending on the relative position of the other switch.

The circuit solution to this problem evolves logically from stating the problem

in Boolean symbols. U represents the upstairs switch in one position, and D represents the downstairs switch in the same relative position. U-D represents the two switches in series and in positions that permit the flow of current to light the bulb. U' and D' represent both switches in their respective opposite positions. Thus, U'-D' also represents a flow of current. U'-D and U-D' both represent the switches in such relative positions as to break the circuit and permit no current to light the bulb.

Stating this in Boolean symbols:  $U-D \vee U'-D'$ . The " $\vee$ " stands for an expression similar to "and/or" and implies a state of parallelism between the two expressions it connects. Thus, the formula tells us that two series switches are needed in parallel with each other. Since each switch must perform one of two possible functions (the "either-or" element), each switch must be a double-throw switch. The diagram and schematic shown here illustrate this reasoning process.

In every application of Boolean logic to

**Oliver Garfield, president of the Toy Development Company, Inc., which developed Geniac, explains its workings to Tim Scully, 9, who assembled a circuit unaided, following kit instructions.**

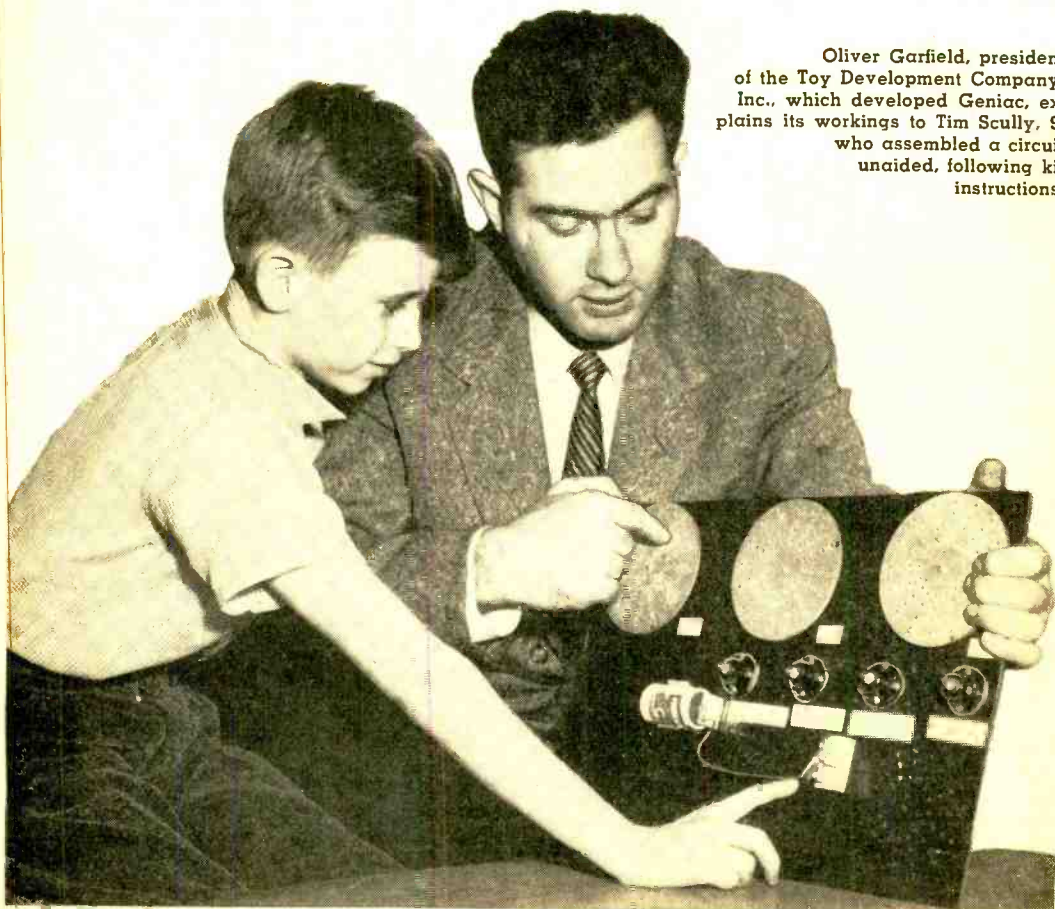

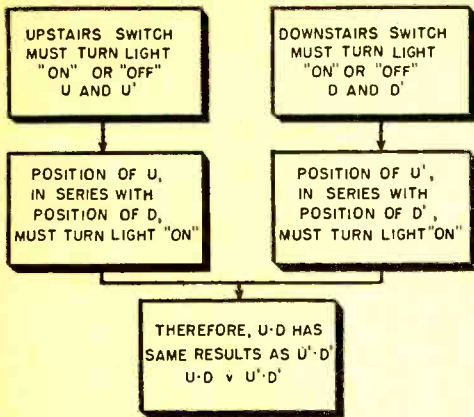

U AND U' INDICATE A SINGLE-POLE, DOUBLE-THROW SWITCH.

D AND D' INDICATE A SINGLE-POLE, DOUBLE-THROW SWITCH.

U-D INDICATES POSITIONS U AND D ARE IN SERIES.

U'D' INDICATES POSITIONS U' AND D' ARE IN SERIES.

v INDICATES THE SETS OF U-D AND U'D' ARE IN PARALLEL IN THE FINAL CIRCUIT.

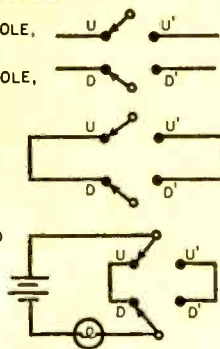

This diagram shows how Geniac solves "the problem of the hall light." Verbal statements are broken down into algebraic symbols which, in turn, indicate the number and type of circuit components required.

The Geniac circuit shown below represents a robot watchman. It warns the farmer when his corn is in danger of being eaten by the hen. It also warns him when the hen is in danger of being devoured by a fox. Circuit takes into account the possibility that the hired man may not be present at all times to prevent trouble. This ingenious circuit also informs the farmer when all is safe.

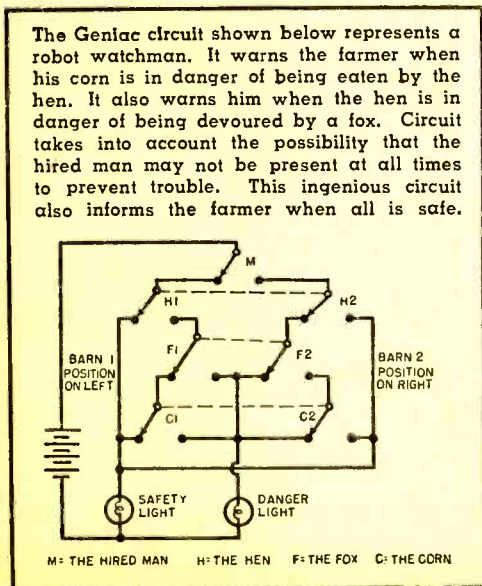

a verbal statement, the circuit must prove the truth of the statement. In this case, the final circuit fulfills the requirements of the man with the upstairs and downstairs halls. In other circuits which can be built with the kit, a similar proof is achieved.

For instance, the kit may be used to construct an electronic version of tic-tac-toe. Now, anyone who has played this game knows that if you make the first move, regardless of what your opponent does, you must either win or draw, provided you make the best possible move following each of your opponent's moves. In other words, the player who goes second cannot win unless the first player commits an error. The Geniac circuit for this situation is a complex one, but once constructed, proves infallible. In a word, you can't beat the machine!

The underlying principles of the Geniac kit have been in development and research for a number of years. One of the best known pioneers in this country in the application of algebraic analysis to the problems of telephone circuitry is Dr. Claude Shannon of *Bell Telephone Laboratories*, whose "magnetic mouse" was described in the May issue of *POPULAR ELECTRONICS*. Another noted mathematician, Edmund C. Berkeley, has contributed largely to the development of the Geniac kit. Mr. Berkeley, an exponent of symbolic logic, is the author of the instruction manual that is furnished with the kit, and the solving of the problems involved in putting it together, is largely the work of the *Toy Development Company*, of which Oliver Garfield, scientist and teacher, is the head.

In addition to its value as a source of amusement and education, the kit exhibits certain technological features that may have widespread implications in other areas. The switches themselves are designed for simplicity and economy. Where the equivalent of several banks is needed, which ordinarily requires a multi-deck or multi-wafer switch built up vertically, the Geniac method uses a single wafer. Contacts on this wafer provide the equivalent—laterally—of what conventionally ganged switches do. This single wafer unit is an exclusive Geniac development, on which patents are pending.

Speaking for the Geniac project, Mr. Garfield is quite optimistic regarding its future. New developments may see an electronic I.Q. tester for professional use, as well as improvements in data analysis machines. For additional information, as well as to order kits, write to *The Geniac Project*, 29 St. Marks Place, New York 3, N. Y.



Building at right houses all TV facilities.

# Middle East

## GETS ITS FIRST TELEVISION STATION

IN AN IDYLIC WOODED GROVE near Baghdad, Iraq, is a modest building resembling a cross between a split-level home and an oversized barn. Its calm, suburban-like appearance belies the feverish activity and "hot" equipment housed within it.

This is the first home of the first television station in the Middle East. Presently located on a site at the Trades Fair, where it was set up by *Pye, Ltd.* of Cambridge, England, as an exhibit, the entire studio and its equipment has been bought by the Iraq government and will be moved soon to an official site belonging to the Iraq broadcasting authorities.

The studio, which was erected and put



on the air only four weeks after the arrival of *Pye* technicians from England, is equipped with all facilities of a modern TV station, including the latest cameras.

During the Trades Fair, *Pye* telecasted many programs which were received on sets in many parts of Baghdad, including the palace of King Feisal. At the outset, however, TV receivers had to be removed from shop windows along the main street because of traffic congestion caused by enthusiastic crowds.

Programs included studio performances by local artists and personal appearances by members of the Iraq government. One of the most likely uses to which the new station will be put is educational. In the Middle East women do not appear in public and so are unable to share the same educational opportunities afforded to those who can attend movies and other public places. The Baghdad authorities hope that television in halls and other places, where women congregate with their children will help to fill the gap in their knowledge of the world about them.

Middle East observers predict that the effect of television in Baghdad will be felt well beyond Iraq. British prestige, and that of her electronics industry, is expected to be enhanced greatly throughout the area.

-30-

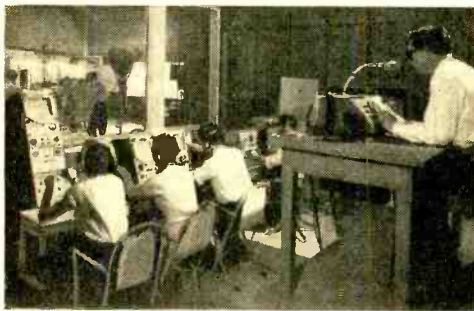

Program producer and team of technicians in control room during Baghdad telecast. Latest equipment and methods are employed.

Young artists pose before *Pye* TV camera. Technicians had to battle sandstorms and thunderstorms in setting up the station.

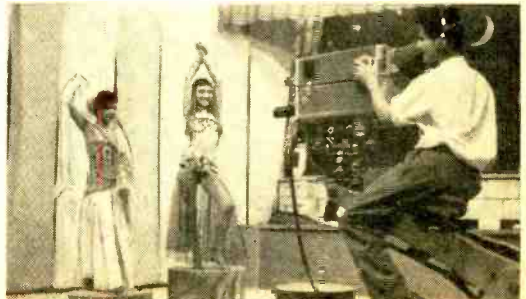



# PLANNING TO BE AN

THE QUANTITY AND VARIETY of careers in electronics are tremendous. Industry is clamoring for men with suitable backgrounds in numerous specialized phases of electronics at various levels of ability and attainment. But the big cry, the big demand, is for men trained at the engineering and scientific level. Specialists are not as much in demand as men with a thorough basic background in mathematics, physics, and engineering.

If you are in high school now, in the armed services for a brief period, or under thirty years of age and able to go to college, consider seriously the possibility of getting into electronic engineering—that is, if your interests and talents tend to be in this direction. A few technicians, after years of experience, earn the status of engineer or scientist in industry, but most engineers enter the profession after securing a degree from an accredited college or university. The same is true of physicists and mathematicians.

To be ready for an engineering or scientific college education, there are several things that you can do now which will make the going easier in college, and enable you to get more out of your college courses. You should:

- 1) Become extremely proficient in mathematics.
- 2) Get a solid background in physics.
- 3) Become familiar with the practical aspects of electronics.
- 4) Learn how to use a slide rule.

This sounds like a big order, and for the most part, it is. However, when you consider that a large number of high school graduates cannot pass college entrance examinations, the need for this "large order" is apparent. Furthermore, anywhere from 30 percent to 60 percent of the students in basic college mathematics

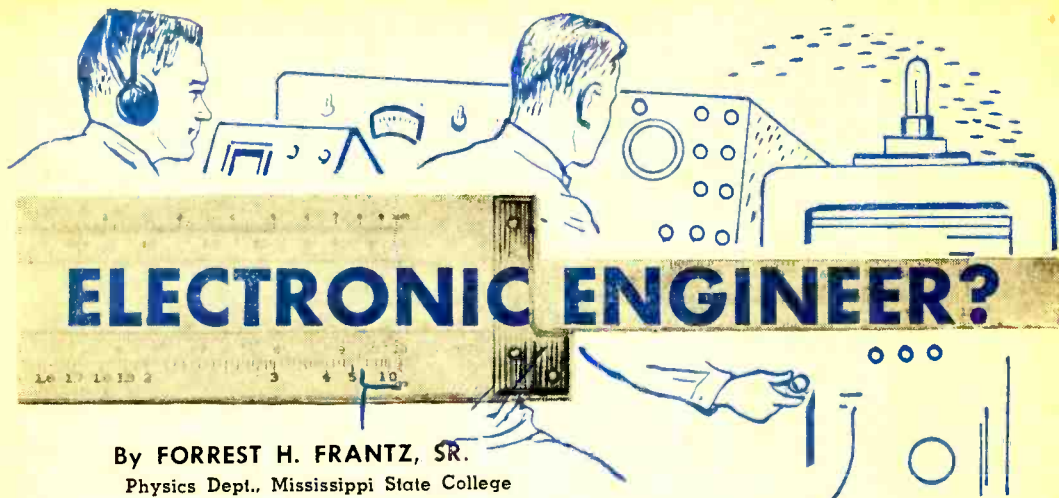

# ELECTRONIC ENGINEER?

By FORREST H. FRANTZ, SR.

Physics Dept., Mississippi State College

and physics courses fail or just barely pass. This indicates that a prospective college student would do well to prepare himself as best he can to meet the standards that have been set. The four points mentioned above are basic for pre-college preparation. Let's examine them more closely and see why they are important.

1) *Become proficient in mathematics:* To do this, you'll have to do more than work a few assigned problems. Work many, many problems. Use your high school trigonometry and algebra texts, and if you can work these problems with ease, try to find texts with slightly harder problems that present a greater challenge. Before you can really get into electronic work on the college level, you will have to complete courses in college algebra, trigonometry, analytic geometry, and calculus. Then you'll be taking courses in differential equations, advanced calculus, and vector analysis along with your electronic courses. If you don't enjoy working with mathematics and can't use it with ease after high school courses, you would be better off not to enter college with electronic courses in mind. It is impossible for the author to find words that adequately describe the importance of mathematics to the engineer. The inability to cope with mathematics is the pitfall for most students who have difficulty with their basic physics courses. A deficiency in mathematical background becomes more serious in advanced science and electronic courses.

2) *Get a solid background in physics.* This is important because every phase of physics comes into play at some time or another in an electronic engineer's career. If you understand basic physics, then you will find it easier to understand your specialized electronic courses. *Electricity* is the basis of electronics; *mechanics* must be

understood to understand fully electrostatics and electromagnetics; *sound* is essential for audio, acoustics, and vibration studies; *light* must be understood to learn the principles of television; and *heat* is important to the study of vacuum tubes, heating devices, and equipment design. Every phase of physics is important to an electronic engineer.

3) *Become familiar with the practical aspects of your field:* You may do this in numerous ways. Read technical periodicals and books on electronics. Build equipment either of the kit form or from construction articles in magazines. Seek the help and advice of persons already engaged in radio, television, and electronics. They'll be glad to help you get started. This is the kind of preparation that keeps your interest in electronics alive and will make your future study an interesting search instead of a tiresome walk in a strange land.

4) *Learn to use the slide rule:* The slide rule is as true, dear, and important to the engineer as the six-gun was to the legendary figures of the "Old West." As a matter of fact, most engineering students carry them fastened to their belts just as the Westerners of past years carried their guns. If you learn to use a slide rule now, you'll become acquainted with a life-long friend. If you can't get one and start to use it before you go to college, put it at the top of your list of things to get when you hit the campus.

As an electronic engineer, you'll receive a good salary, enjoy considerable prestige, and have the satisfying feeling of accomplishment in doing your work. It's a great future, and the future of electronics becomes greater every day. There are many problems to be solved and many new devices to be created. Some of them may be waiting for your particular approach. —30—



Muzak programs are transcribed from master discs onto magnetic tape by these recorders. Reels are then shipped to franchisers.

IMPROVED SERVICE, greater range of selections, wider audiences, higher fidelity, and smoother operation are anticipated from recent changes behind the scenes at *Muzak's* New York headquarters. A remarkable new tape playback unit is the electronic cornerstone of this expansion move by the organization which has been furnishing background music in restaurants and other public places for twenty years.

Designed by *Muzak* engineers, the tape unit is started and stopped automatically by subsonic signals on the tapes containing the musical programs. Desired music for special occasions, such as Christmas carols, may be preselected. In addition, the unit reverses the tape at the end of the 4800-foot reel, changes tracks, automatically rewinds, and shuts itself off and cuts in a companion tape mechanism. Since two of these playback units operating in tandem can play programmed music on tape indefinitely and automatically, *Muzak* maintains that the new system has not only eliminated human error from the operation, but has reduced operating procedures to one visit a day to change the reels in the studio.

The tapes themselves, upon which *Muzak* records its own programs, are mounted on reels that can run a full eight hours, 4

hours in one direction on one track, and then 4 more hours on the other track in the opposite direction.

Tapes and playback units are shipped from *Muzak's* headquarters to its nearly 100 franchised operators. More than 400 communities are now serviced in this manner throughout the United States as well as in Lima, Peru; Vancouver, Toronto, and Montreal in Canada; Mexico City; San Juan, Puerto Rico; and Honolulu. It is estimated that 50 million people hear some portion of a *Muzak* program each day.

### Three Types of Programs

Locations serviced by *Muzak* include restaurants, supermarkets, banks, department stores, business offices, and industrial plants. Three different kinds of programs have been developed to meet the calculated needs of these diverse situations. First, there is the "basic" program, consisting of a wide variety of classical and semi-classical music, show tunes, and popular songs (without vocals). Aimed at public places such as banks, restaurants and stores, this program is divided into 15 minute segments, with 12½ minutes of music and 2½ of silence. The silent period is calculated to prevent the unwelcomed effects of too constant background music.

# STORY



Master disc is played on transcriber turntable as Muzak technician adjusts controls to assure proper feeding of signals into banks of tape recorders.

The second type of program, intended for offices, features a narrower variety of selections which omits classical music. This program is on for 15 minutes and off for 15 minutes, starting on the quarter-hour.

The third, and most recent type, is the industrial program. Planned for factories and plants, this program comprises popular and show tunes exclusively and includes vocal selections. This program is scheduled like the office program—15 minutes on and 15 off—but starts on the hour. Thus the factory schedule dovetails the office schedule, permitting an entire plant to be serviced simultaneously from one tape source.

## Music Played by "Name Bands"

The musical selections themselves are obtained through a unique process. A composition is chosen. A special arrangement is made by staff musicians. The piece is then played for a recording session by one of the many "big-name" bands in the country, although the listener would never recognize the band since its playing is strictly in line with *Muzak's* arrangement and rules regarding tempo, volume, and orchestral effects. The master disc thus recorded is then used to make tape transcriptions. Tapes are recorded on 16-inch reels run-

ning at 3 $\frac{3}{4}$  i.p.s. using dual tracks. Subsonic signals, to be used later for switching on and off the playback units, are also recorded onto the tape.

At one of *Muzak's* franchises, the tape is played back. Signals are fed to local amplifiers and thence, via lines, to the nearest telephone office. From here the signal is fed into lines that carry the music to the individual *Muzak* subscribers in that area. At the subscriber's installation, the signal is fed into a booster amplifier and finally to the loudspeaker.

All the electronic equipment, including amplifiers and speakers, are *Muzak* products. Like the music itself, they are designed and built to *Muzak* specifications.

*Muzak's* 7000 different musical selections make it possible never to program the same number more than once a day; usually it is not necessary to repeat it for an entire week. The unique tonal qualities of this music have occasioned comment by many listeners. *Muzak's* programs are noted for their subdued overtones, lack of stridency, and over-all "mellowness". This quality is not an indication of musical ignorance on the part of the organization, but a deliberate attempt to provide the kind of music that makes good background for various activities. According to *Muzak*, this music ac-

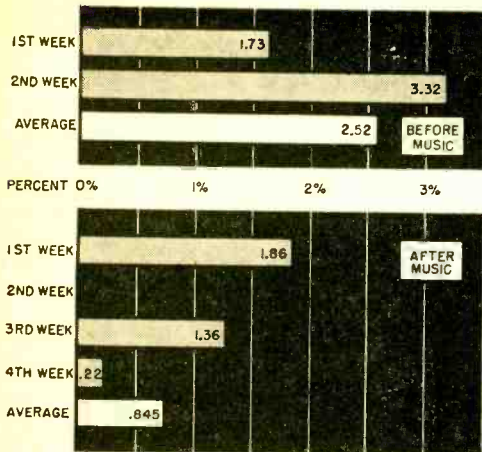

This chart, furnished by Muzak, shows the success of planned music in reducing lost time in one plant. Early departures dropped from 2.52% of man-hours during the two weeks before music was used to only 0.845% during the four weeks after Muzak was installed, representing a decrease of 66%. These measurements were made by the Stevens Institute of Technology. Muzak's conclusions: a cheerful worker is a better worker; the right kind of music helps make, and keep, men happy.

tually helps people work, shop, or dine, and is non-distracting. The philosophy behind *Muzak* is that such music cheers people, boosts morale, increases the positive psychological factors in human behavior, helps increase work output, minimizes fatigue, and makes public places more pleasant so that large numbers of people can function smoothly without running each other down. In line with these points, the programming and timing of the music are based on the "Standard Fatigue Curve" developed by psychologists.

Because the music is designed primarily as background and to blend into the surrounding atmosphere, the over-all response of the system is controlled to permit the transmission of "tones that just penetrate the noise barrier" created by any given set of activities and people. Described by *Muzak* as a "controlled high fidelity that preserves the quality of the original performance, but eliminates all irritating highs," this music is played and reproduced in such a way as not to call attention to itself. It simply serves as a psychological aid to whatever else is going on. Experience, tests, and increasing franchises all seem to indicate that for fulfilling its avowed aims, "music by *Muzak*" is here to stay! -30-

## Scatter Propagation Tests Seek to Extend Communications

A LONG-RANGE TESTING PROGRAM on a new type of communication link was launched at Syracuse University, N. Y., recently when a receiving station built on the summit of a ski hill went into operation.

This new link may play a vital role in military operations. Broadcasts sent over it would be harder to jam, more difficult

to listen in on, and less subject to noise interference than those sent over conventional radio links. The link may also make possible long-distance communication paths, free of relay towers. At present, FM and pulse-type broadcasts cannot be received much beyond the line of sight without such towers.

Daily, signals from an Air Force transmitter at Lexington, Mass., are sent to Syracuse. AM, FM, and pulse-type modulations are being used. The carrier frequency, 915 mc., is scattered beyond the line of sight from the ionosphere or troposphere. These regions are reflecting layers, some 50 to 75 miles above the earth. Dispersion of the signal is called scatter propagation. The scattering causes some of the signal to descend earthward where it can be detected by a receiver.

All signals are received at Syracuse by means of the huge dish-like reflector antenna shown in the photo. Recording instruments indicate with graph lines the nature of the signals. Interpreting the data thus obtained are Drs. Samuel Seely (left) and Stanford Goldman, professors of electrical engineering.

Through these tests, the scientists hope to determine which type of modulation is best suited to this particular link. -30-





# learn while you doze

*Electronic device serves as full-time private tutor.*

THE STUDENT WHO TRADITIONALLY SLEEPS through his classes may be more in line than he realizes if the educational ideas embodied in a new electronic device become widely used.

Basing its operation on the theory that people can learn while in a semi-conscious or completely slumbering state, the "Dormiphone" furnishes oral lessons that are turned on and off by preset controls. The unit can be arranged to drill the lessons loudly while the student is awake, and then to whisper a gentle refresher just before he goes to sleep, during sleep, and upon waking the next morning.

Source of the lessons is a magnetic recorded disc which is played on a phonograph in much the same manner as an ordinary pressed or cut disc. The lesson on the disc may be recorded through the Dormiphone via microphone, using the device as a magnetic disc recorder. Simply changing the cartridge in the phono arm and flicking a switch converts the unit to playback.

Timing control is achieved by a built-in

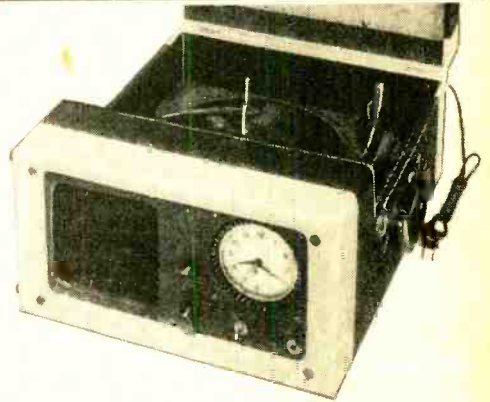

Photo at top of page shows French actress Jeanne Demery as she learns Swedish from language records played on her Dormiphone. Record changer used in unit is the Collaro.

*Telechron* electric clock equipped with a series of switches. These controls can be preset by the user so that any record automatically will start, play, and stop at desired intervals. In effect this is like having a private tutor on hand 24 hours a day.

In addition to its educational function, the Dormiphone may be used as a conven-





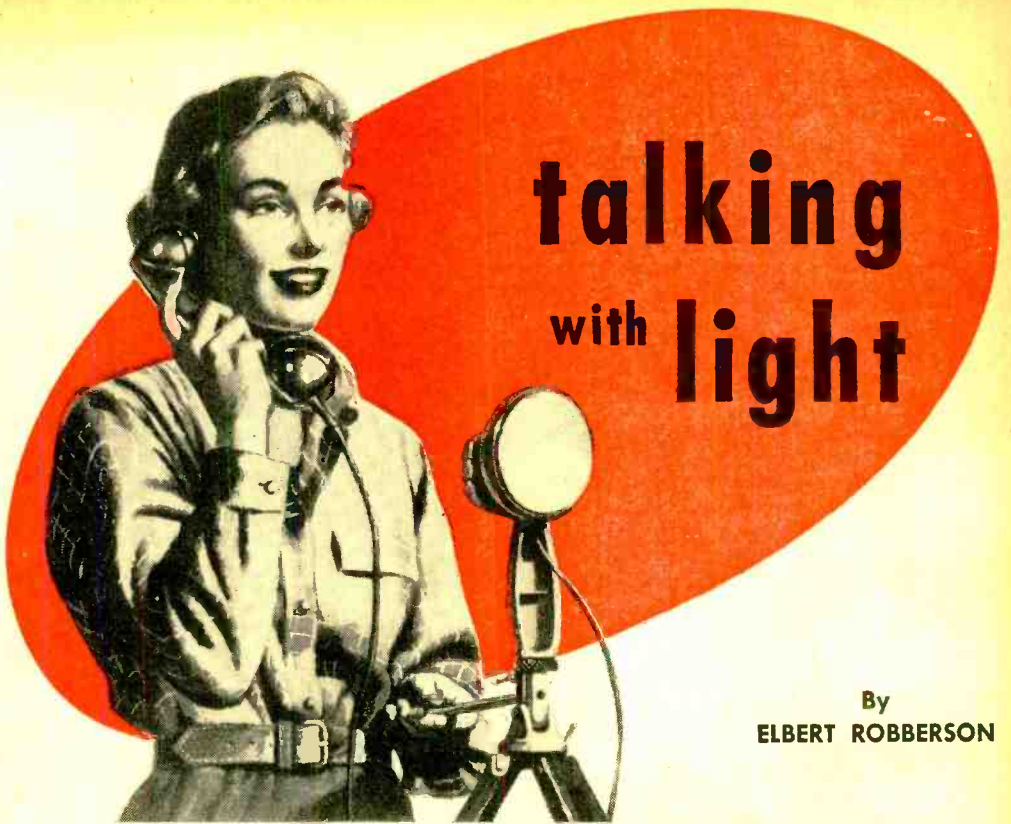

# talking with light

By  
ELBERT ROBBERSON

Cover Photo Story—Painting by Ed Valigursky

*In this first part of a two-part story a simple transmitter is described and the receiver using printed circuits is detailed.*

How would you like to build a light-beam wireless telephone for short-range talking and experimenting? With this unit you can send speech or music over the beam of light, and two people, each one equipped with a "talking-light" (transmitter) and the "light-beam receiver" can carry on conversations over the distance the light beam can be thrown with enough brilliance by which to be read. The best part of experimenting with this kind of "wireless" is that it doesn't require any license. On the "light-beam phone band" there is never any static, and other people can't "tap" the conversations. Furthermore, a complete outfit can be put together in a couple of evenings.

Light-beam communication can be put to practical use. As an example, suppose a member of the household spends hours on the telephone talking to a neighbor. A light-beam circuit will work as well as Mr. Bell's invention, and leave the telephone line free for other calls. Another application would be to have a light-beam hookup with a neighbor, so one family could baby sit for the other, via a microphone in the nursery.

Light-beam signalling is really quite simple. A low-power short-range "transmitter" can be made as shown in Fig. 1 simply by putting an old-fashioned single-button carbon microphone, such as ones used in the old wall or desk-type telephones or the *F-1* button used in modern handsets, in series with a 12-volt battery and a portable 6-volt spotlight. The spotlight illustrated is a unit designed to plug into the cigarette lighter in a car and can be carried in the glove compartment for emergency use. The 12-volt battery may be made of two 6-volt radio A batteries in series. When the lamp, microphone and batteries are connected, the lamp should glow with about normal brilliance. Then when someone speaks strongly into the mike, the light will flicker.

Filaments of the type of lamp used here can change fast enough to hit notes as high as 6000 cycles per second with no strain. This range is more than enough for excellent speech quality.

Send music over the light beam by using an ordinary small radio as shown in Fig. 1. Disconnect the speaker voice coil from the



Light-beam "receiver." Concave shaving mirror gathers light from modulated beam, focuses it on phototube in amplifier unit. Cardboard shield over top shuts out unwanted light from other sources.

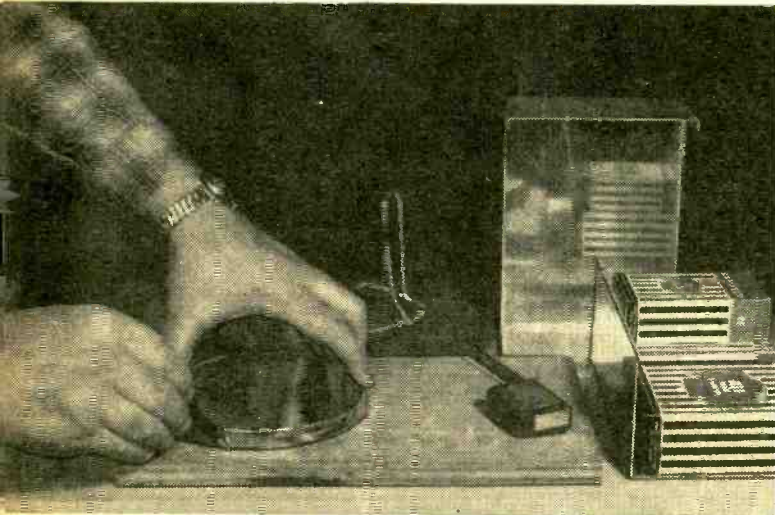

On a piece of  $\frac{3}{4}$ " plywood, trace outline of concave mirror. Keep line very close to rim.

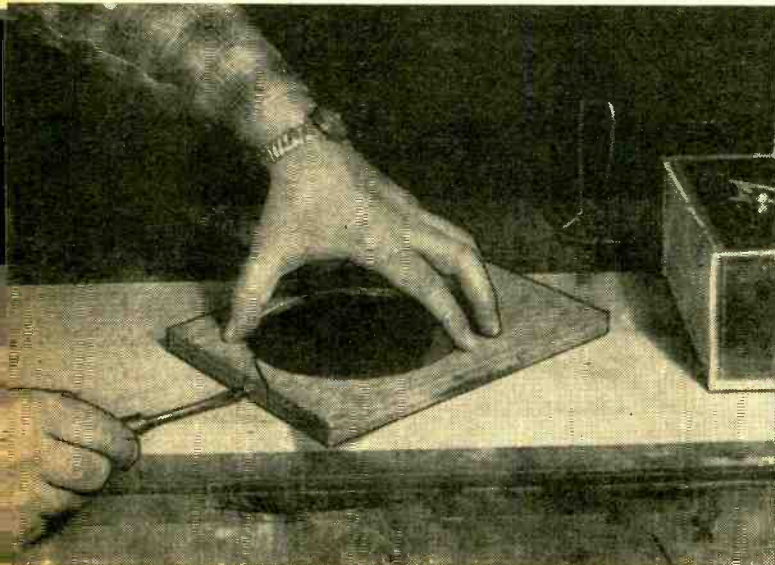

Cut a hole for the mirror with a jig saw. The diagonal cut in from the edge can be squeezed together with a screw to give clamping action in order to hold mirror in place. If mirror is loose in the holder, wrap layers of tape around rim until snug.

secondary of the output transformer. Wire the spotlight and a 6-volt battery in series with the transformer secondary winding. With the station tuned in, turn the volume up "full." The lamp should now burn and flicker with the program modulation.

So much for simple sending outfits. A regular sending unit which will have better performance will be described next month, but first, let's get set up to receive efficiently.

To "listen" to a light beam, just put an "electric eye" in the path of the light rays, and their fluctuations will be turned back to an electrical wave. Add an amplifier and a headset, and the electrical wave will be restored to the original form of a sound wave.

Figure 2 shows the schematic of the light-beam receiver. Using readily available printed circuits for all tube coupling, the number of components was reduced to a mere dozen.

Before wiring it up, some simple carpentry is necessary. As you know, the beam from a spotlight spreads out. The active element of our electric eye has an area of approximately one square inch. The practical effect is that, without some help, only a very small part of the transmitted beam will be intercepted and turned back to sound.

The greater the amount of light beam gathered and focused on the light-sensitive element, the better. A six-inch concave shaving mirror will gather about 28 times more light than the "naked eye." This amounts to a gain of 14 decibels.

Shine a spotlight squarely on the mirror from several feet away, and move a small card away from the mirror center until the point of best focus is reached. This is the "total length" of the mirror, and the platform should be made so the photoelectric tube is exactly the focal-length distance from the mirror. Using the mirror shown in this article, the focal length was 23 inches.

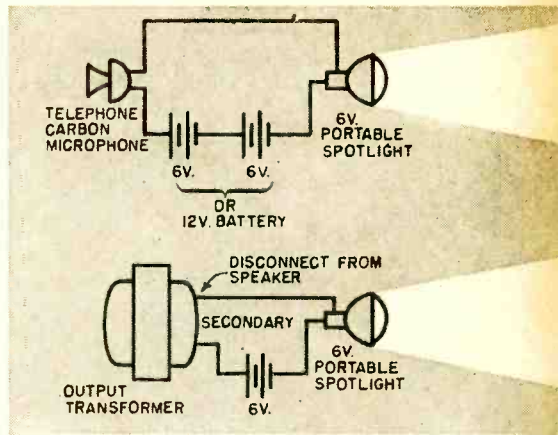

Fig. 1. These two simple transmitters may be used for short-range signaling.

A board 30 inches long was used for the platform, which allows room on the end for the amplifier unit.

The next part is the mirror holder. This can be cut with a jig saw from 3/4-inch plywood, and screwed to the end of the platform. The mirror should be mounted so its center is the same height above the platform as the center of the phototube element.

Fig. 2. Wiring schematic of the light beam receiving unit. The cost is about \$12.

- C1—20  $\mu$ d., 150 v. electrolytic capacitor
- C2—.002  $\mu$ d., 400 v. paper capacitor
- B1—1 1/2 volt battery, Burgess 2F
- B2—Two 45 volt batteries in series, Burgess M-30
- R1—500 ohm, 1/2 w. res.
- V1—930 phototube
- V2—1S5 tube
- V3—1S4 tube
- 1 ea.—Centralab PC-70 "Couplate"
- 1 ea.—Centralab PC-92 "Couplate"
- S1—D.p.s.t. toggle switch
- 1—Socket, octal, Amphenol 78-S8
- 2—Sockets, 7 pin miniature, Amphenol 78-7P
- 1—Phone jack, Mallory A-2

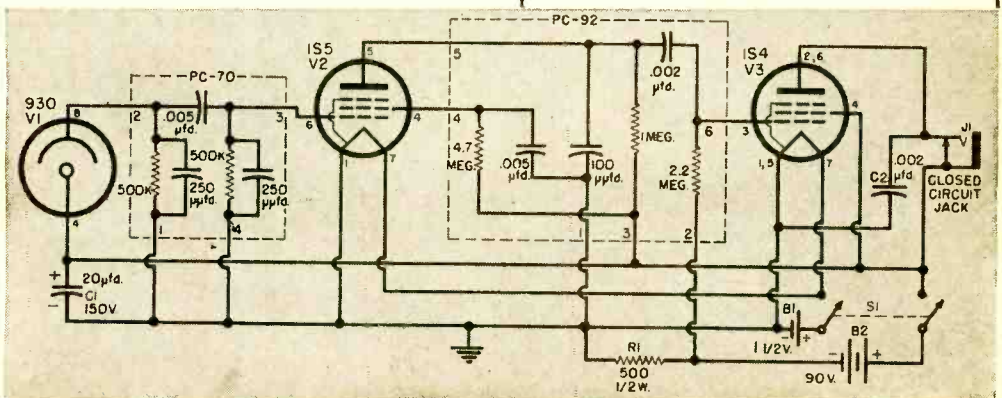

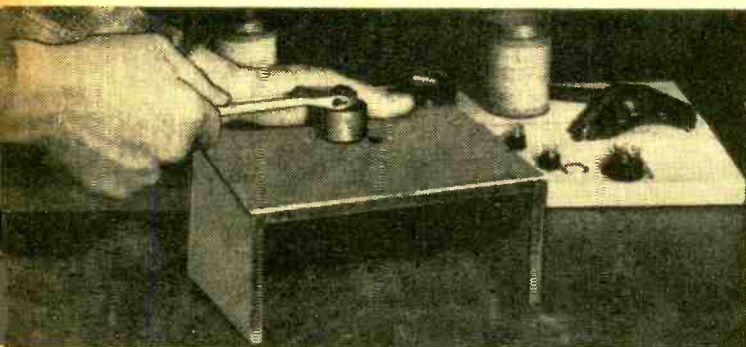

The socket holes are made most easily with chassis punches. Space two  $\frac{5}{8}$ " holes and one  $1\frac{1}{8}$ " hole evenly across center line of utility-box chassis.

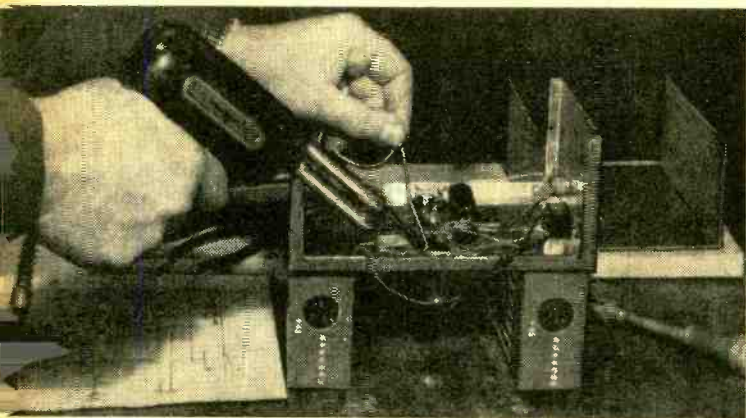

Insert tubes in sockets before wiring, and prop the chassis up on blocks or the batteries. Having the tubes installed prevents distortion of miniature-tube contacts with the strain of attaching and soldering wires.

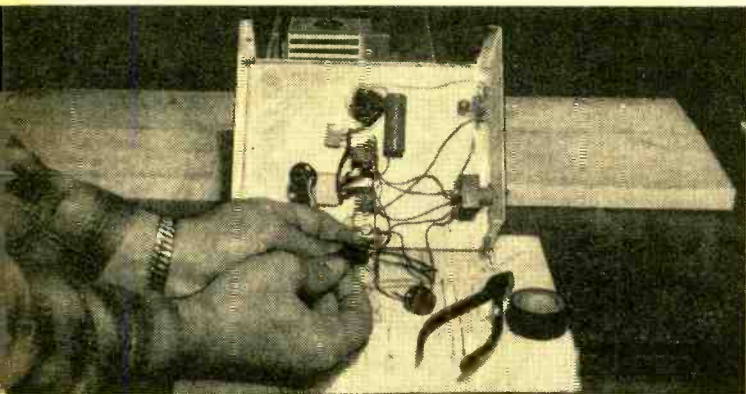

After wiring the battery plugs, cover their backs with plastic tape to prevent short circuits if the plugs should touch the cabinet. Unit is completely wired here—note the grid-bias resistor on the "B"-battery plug.

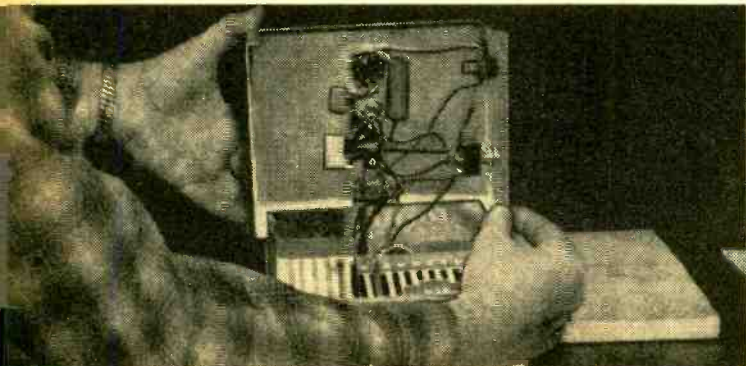

Connect batteries, lay them in the bottom of the case, and slide the chassis in place and secure. Make sure this handling does not move anything so that short circuits can occur.

Now for the receiving unit. Along the center of the top of the utility box, drill pilot holes for tube-socket openings and punch the holes out with chassis punches. On the same center line, drill a #25 hole for the "ground" connection, and on the end of the cabinet make two  $\frac{7}{16}$ -inch holes, one for the "on-off" switch and one for the headphone jack. Install the sockets, jack and switch, and put in a 6-32 machine screw and a couple of lugs for the ground "bus." Orient the tube sockets exactly as shown in the diagram on page 46.

Plug in the tubes, prop the chassis upside down, and commence wiring by running a bare tinned solid copper wire from the ground connection through terminals 1 and 5 of the 1S4 tube socket, then around to pin 1 of the 1S5 tube socket. Connect the tubular center shields to ground also.

Run a wire from the far-center switch terminal to the number 7 terminals of both the 1S4 and the 1S5 tube sockets. Make up the A battery plug with leads about 10 inches long, connect the small pin to the chassis ground, and the large one to the far-end terminal on the switch. The filament circuits are now all wired.

Next, wire the 20  $\mu$ fd. electrolytic capacitor between the 930 tube socket terminal 4 and the ground on terminal 1 of the 1S5 tube socket. Be sure the positive end of the capacitor goes to the 930. Then hook up the jumper between the 930 tube socket terminal 4 and the sleeve and switch contacts of the phone jack.

Run a wire between the tip contact of the jack and terminal 6 of the 1S4 tube socket, and at the same time, connect the .002  $\mu$ fd. capacitor from the 1S4 tube socket terminal 6 to the chassis ground lug.

### Using Printed Circuits

Before installing the "printed-circuit" coupling plates, check their diagrams and the lead numbering against the schematic to make sure they are the same. The hook-up shown here and the numbers on the schematic apply to *Centralab* coupling plates—other manufacturers of equivalent items may use a different code. If there is a difference, either change the numbers on the "couplate" or the wiring diagram to make the connections conform to the schematic.

To install the input circuit, *Centralab PC-70*, connect leads 1 and 4 together, and connect to the ground bus. Use insulating tubing on all leads to prevent accidental short circuits. Lead 2 goes to the 930 tube socket terminal 8; and lead 3 to the 1S5 tube socket terminal 6.

The interstage coupling plate, *Centralab PC-92*, has two more wires than the *PC-70*;

these supply screen voltage to the first tube, but the *PC-92* is no more difficult to wire in than the *PC-70*. Remembering to use spaghetti on all leads, first connect lead 1 to the ground bus. Lead 2 is the connection for negative grid bias for the output tube, and on the schematic this wire is shown running directly to the negative B battery terminal. However, connecting a flexible battery-plug wire to this flimsy lead would be mechanically poor. Since the unused terminal 2 of the 1S5 tube socket is available as a tie-point, connect lead 2 to the 1S5 terminal 2.

*Centralab-PC-92* lead 3 goes to the 1S4 tube socket terminal 4; at the same time, solder a jumper from the 1S4 tube socket terminal 4 to the near-center terminal of the switch. Then, install another jumper from the near-center switch terminal to the sleeve-and-contact terminals of the phone jack.

Connect lead 4 to the 1S5 tube socket terminal 4; and lead 5 to the 1S5 terminal 5. Lead 6 goes to the 1S4 tube socket terminal 3. This completes the chassis wiring.

### Wiring in the Battery

Make up the B battery plugs with about 10-inch leads and connect the 500-ohm resistor between the negative pin and the unused pin on the plug of the battery at the negative end. Here is another instance where an unused terminal is used as a tie-point, giving mechanical security without using any extra hardware. Connect the negative wire to the tie-point terminal 2 on the 1S5 tube socket; and connect the positive lead to the near-end terminal of the switch. Ground the lead from the tie-point terminal on the first battery plug; and the equipment is now completely wired.

It is a good idea to check off the wires on the wiring diagram as each one is put in—then, when finished, double check.

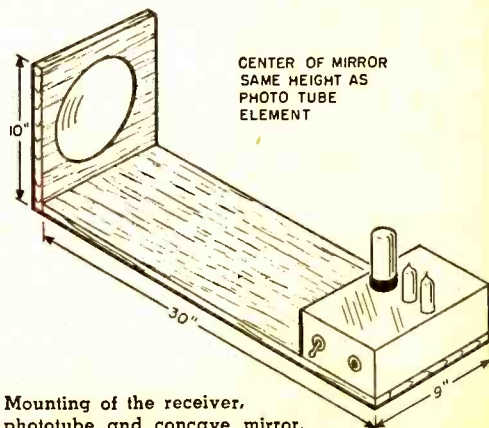

Mounting of the receiver, phototube and concave mirror.

Connect the batteries, plug in the headset, and turn on the switch. A quiet hiss may be heard, and when the tubes are tapped with the finger, a slight ringing should be heard as their elements vibrate. Then touch the finger to terminal 6 of the 1S5 tube—a loud hum should result.

Aim the concave face of the phototube at a burning a.c. lamp or fluorescent tube, and a.c. hum should be heard in the headset. The hum can be interrupted by holding the hand in front of the phototube. This shows that the receiver is light-sensitive.

Place the amplifier on the platform, with the phototube facing the mirror. Directly in line with the mirror and at a distance of several feet, beam in the searchlight. Get back of the mirror, and adjust until the reflected beam is centered on the phototube element. The headphones should now respond to whatever modulation is applied to the beam.

Light, other than that coming from the searchlight, will reduce the sensitivity, so use a shield over the receiver. This shield can be bent up of corrugated cardboard, or light-weight metal, and installed as shown

in the photograph at the top of page 42.

Best range with the light-beam telephone is realized at night. To test the unit, the author put his favorite record program on the light beam, aimed the searchlight out the window, picked up the receiver, and walked down the street. By careful aiming, he was able to pick up the program with surprising fidelity a block away.

As expected, the simple microphone-battery speech transmitter isn't as efficient as a vacuum-tube outfit would be, and too much current through the mike heats the carbon granules, so it has to be tapped occasionally to restore sensitivity. Best performance on speech can be obtained with a light modulator built especially for the job. Next month POPULAR ELECTRONICS will describe such a unit.

In the meantime, get ready by building this receiver and getting acquainted with light-beam communication. It's fun, besides being an introduction to "wireless" which can lead to better things. Many of the basic principles of radio transmission and reception are involved in light beam communication.

-30-

Pictorial wiring diagram of the light-beam receiving unit. Constructors unable to obtain the cheap printed circuit may substitute regular resistors and capacitors with the values shown on page 43.

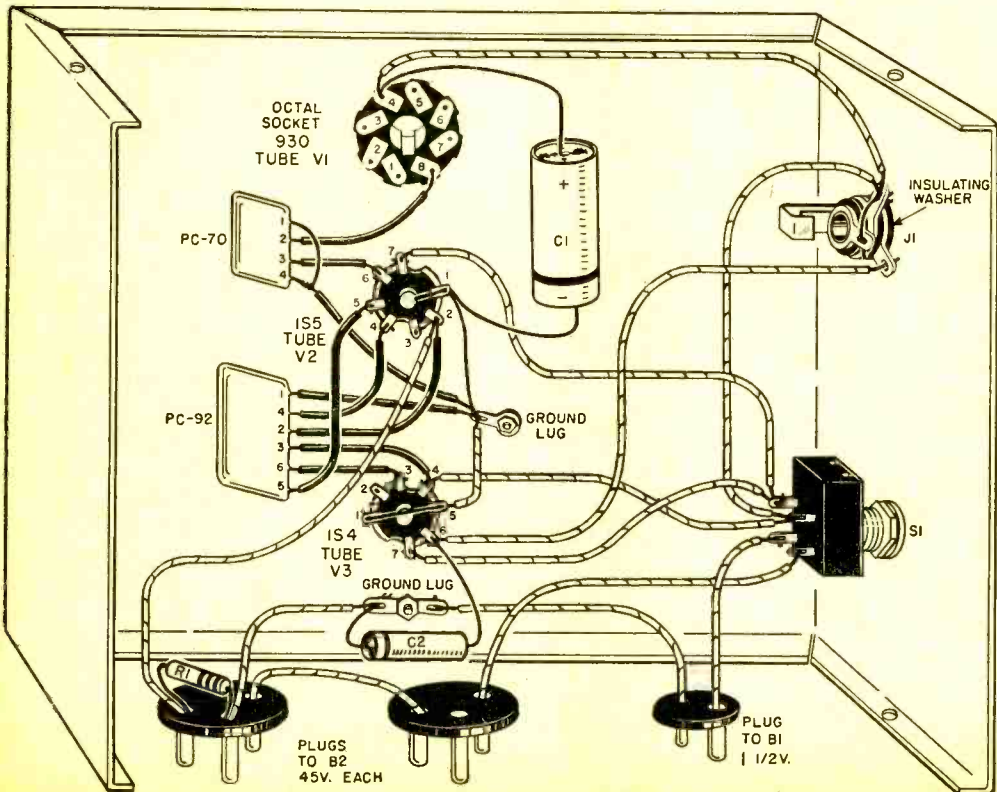

# Portable

## METAL LOCATOR

By HARVEY POLLACK

COMBINING FUN AND PROFIT is something one hears about, but seldom enjoys. The metal locator described in this article, carried in the trunk of the car, can be assembled in minutes and will provide endless hours of fun and excitement with the constant possibility of a rich find. It responds with equal facility to non-ferrous and ferrous metals or ores. It will find underground wires and pipes, metals buried in sand, and electrical conduit lines in brick, plaster, or mortar walls and ceilings. Best of all, it is inexpensive and easy to construct.

The complete outfit consists of two major components: the search coil and its fittings, and the electronic detector. The former is a four-turn coil, 18 inches in diameter wound in, and protected by a plywood "sandwich" 20 inches across. It is carried at the end of a 5-foot length of one-inch round stock when in use. The electronic equipment comprises two distinct battery-operated oscillators. Except for one component, both oscillators are contained within the metal cabinet shown in the illustrations. The exception is the search coil; this forms the tank circuit of one of the oscillators and alters electrical conditions to provide an audible indication when metal is approached.

### Construction of the Search Coil

Any sensitive electronic metal locator demands absolute rigidity of construction to

The metal locator in operation. Any kind of wooden handle may be employed to support the search coil.

avoid wobble and spurious response; in addition, the shielding must be well-nigh perfect if one is to avoid masking of the desired signal by ground capacitance changes. The construction of the search coil should be started first because the work on the electronic portion may be begun while the glued coil frame is drying.



Construct the plywood frame as shown in the drawings, then glue entire assembly together (no nails or screws are used anywhere in the construction of the search coil) using a good resin or casein cement such as *Weldwood* or *Plibond*; for obvious reasons water soluble glues should not be used.

When the coil frame has set, the search coil may be wound in the groove of the "sandwich." Double cotton covered wire, #22 or larger, should be used. Starting near one of the one-inch round projections, wind two full turns and bring out a twisted center-tap. Then wind the remaining two turns, terminating near the same projec-

Schematic diagram, parts list, and pictorial (see opposite page).

DETECTOR UNIT

- R1, R2—100,000 ohms, 1/2 w. res.
- R3—3.3 megohms, 1/2 w. res.
- R4, R5—15,000 ohms, 1/2 w. res.
- C1, C5—100  $\mu$ fd. mica capacitors
- C2—50  $\mu$ fd. mica capacitor
- C3—100  $\mu$ fd. variable capacitor, screwdriver adjustment, capable of being insulated from chassis (National Type W-100 or equivalent)
- C4—.001  $\mu$ fd. paper capacitor
- C6—100  $\mu$ fd. ceramic capacitor
- C7—15  $\mu$ fd. variable capacitor, 1/2" shaft, chassis mounting, double-bearing (Bud Type MC-1850 or equivalent)
- C8—.01  $\mu$ fd. paper capacitor
- C9—.005  $\mu$ fd. paper capacitor
- B1—67 1/2-volt "B" battery, Burgess Type XX45
- B2—1 1/2-volt "A" battery, Eveready Type 720 or RCA Type VSO-69
- I1—Open circuit headphone jack
- L1—Shielded oscillator coil, Meissner Type 14-4243
- RFC1—Radio frequency choke, ceramic cone stand-off, 10 mhy., (National Type R-100U or equivalent)
- S1—D.p.s.t. toggle switch
- V1—1T4 tube
- V2—1R5 tube
- V3—1U4 tube
- 1—Aluminum utility case, Premier Metal Products Type PAC 596
- 1—Aluminum chassis base, 4" x 4 1/8" x 1", ICA Type 29083
- 3—7-pin miniature shielded sockets
- 1—4 ft. strap (An adjustable surplus Army webbing strap was used in this model. The finishing ends were bent from thin sheet tin and pressed flat in a vise. One 8/32 machine screw and nut holds each end of strap to detector case. Do not use sheet metal screws for this purpose.)

- 1—Pair magnetic headphones, high impedance
- 1—4" dial, Bud D-1734 or equivalent
- 1—4-lug terminal strip
- 2—2-lug terminal strips
- 1—Connector strip with leads, for "B" battery
- 1—2-prong plug to fit "A" battery
- SO1—Three-contact chassis receptacle, shielded microphone type, Amphenol Type 91-PC3F or equivalent
- Machine screws and nuts as required (Screws for mounting tube sockets are 4/40, 3/8"; others are 8/32, 3/8".)
- Hookup wire and solder

SEARCH COIL AND CABLE ASSEMBLY

- 1—1/4" plywood panel, 3-ply, approximately 20" x 40", to be cut in half
- 1—6 ft. length of 1" round stock, light-weight wood
- 1—1 ft. length, 3/8" dowel
- 1—3 ft. length of 3/4" x 2" lumber for cross-bar on search coil assembly
- 10 ft. of #22 or larger double cotton-covered copper wire for search coil
- 150 ft. of #22 bare (not enameled) copper wire
- 75 ft. of 1" wide paper masking tape (if 2" cloth or plastic tape is used, reduce by half.)
- 1 pt. of good quality white shellac (Varnish may be used, but drying time is greater.)
- 5 ft. of Twinax (double conductor shielded cable) RG-22/U or equivalent having no more than 17  $\mu$ fd. per foot. Federal Type K-111 shielded twinlead can be used as second choice.
- 1—Small can of Weldwood, Plibond, or similar water-resistant glue
- 1—Jones strip, three terminals
- 1—Three-prong plug, shielded microphone type, Amphenol Type 91-MC3M or equivalent
- Total cost of parts, approximately \$25.00

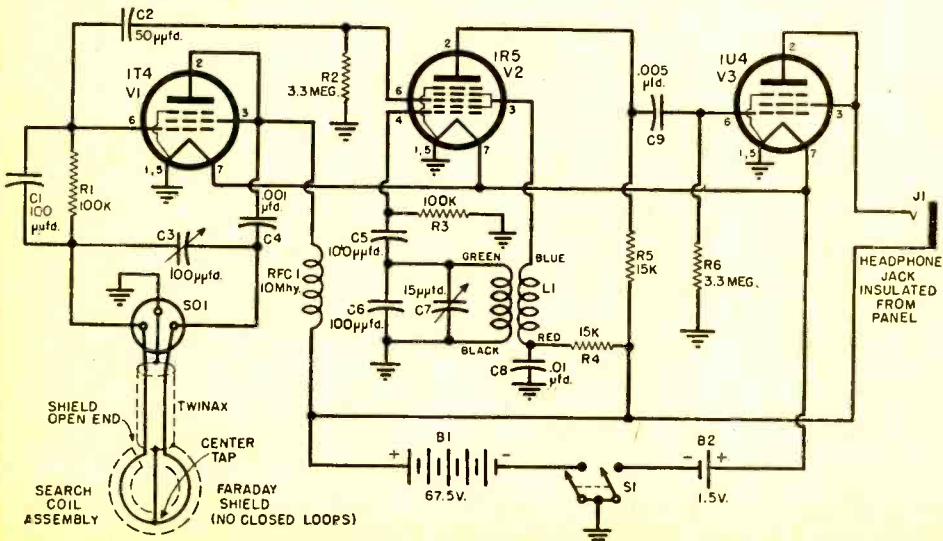



tion. Bring the two ends of the coil and the center-tap out through three fine holes near the inner circumference of the upper ring. Draw fine radial lines on the rim of the frame to aid in layout of the Faraday shield to be wound later. Now give the whole assembly one or two coats of clear shellac or varnish and let it dry thoroughly.

### Construction of the Faraday Shield

The search coil responds to metal by inducing eddy currents in the metal masses by virtue of its magnetic field. Unless protected by adequate and proper shielding, it will also react capacitively to both magnetic and non-magnetic metals. Since this

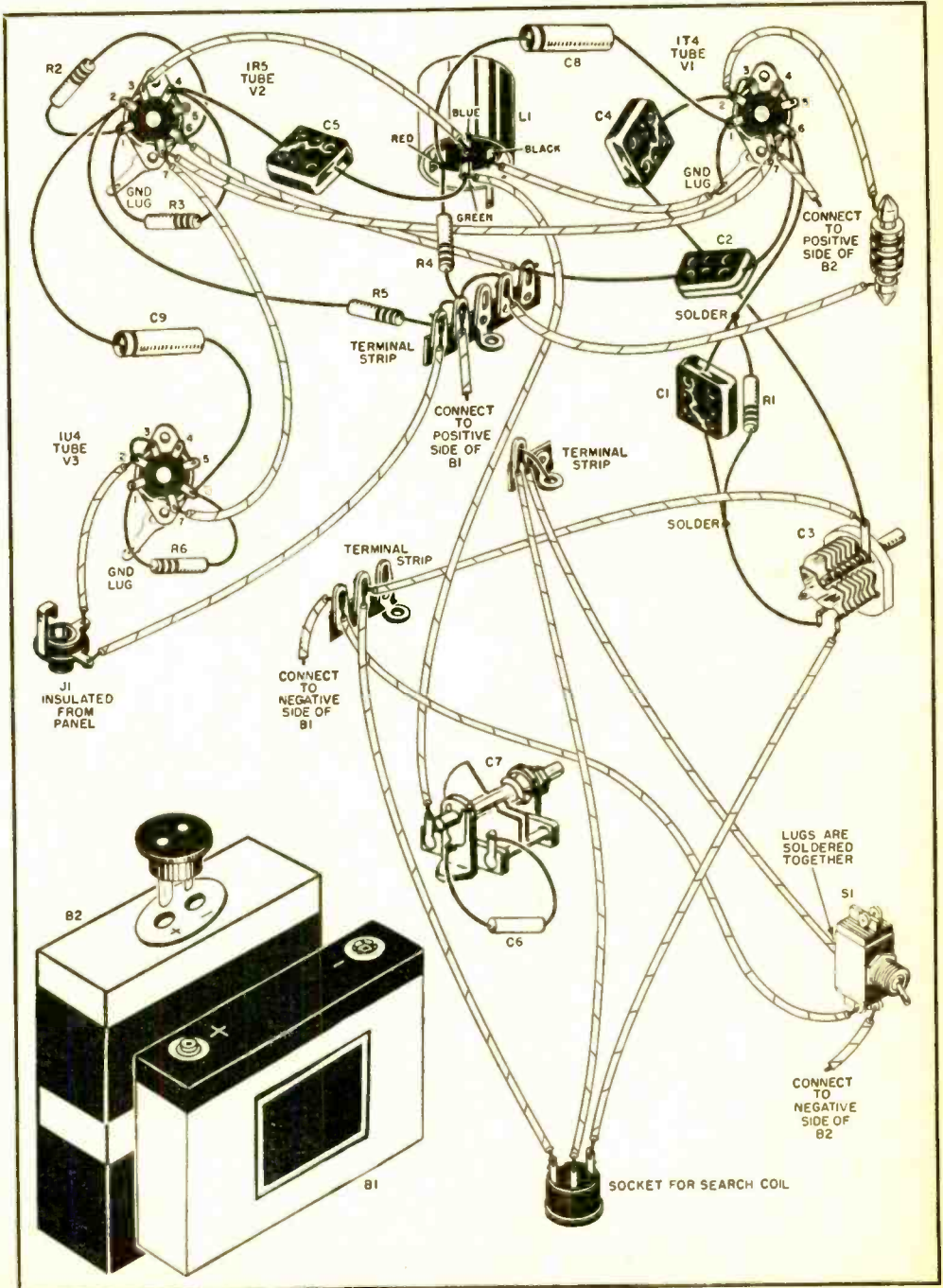

is highly undesirable, a shield must be built which permits the movement of magnetic lines of force without permitting capacitive coupling. Such a shield is called a Faraday shield; it must have no closed loops or current paths in which eddy currents can flow. Neither metal foil nor copper screening is satisfactory because these are full of closed loops which cause serious magnetic field losses, reducing the penetration of the field so that the device becomes insensitive.

To construct the Faraday shield, #22 bare copper wire (not enameled) is wound around and around the rim of the sandwich in toroid fashion, with about 1/8-inch spacing between turns. The radial lines mentioned earlier assist the builder in keeping the winding neat and uniform. The toroid winding starts from one side of the one-inch round stock projection where the search coil wires emerge and continues around, finishing on the other side of the same projection. This leaves a one-inch gap in the large circumference of the toroid, avoiding a closed loop.

A piece of #22 bare wire is now soldered all around the *inside* rim to each turn of the shield; good contact must be established between the shorting bus and *each turn*. Again, the bus leaves a one-inch gap near the same projection. A four- or five-inch length of the same bus wire should be brought up through the center small hole which already carries the center-tap of the search coil.

The entire assembly should now be given at least three coats of shellac or varnish. This coating must prevent water absorption and also hold the turns of the Faraday shield in place when the individual turns are cut open in the next step. Allow the coating to dry thoroughly.

Since there are still closed loops formed by individual toroid turns, a sharp pair of shears or cutters is now used to open each individual turn around the outer rim. As each turn is cut, its ends are pressed inside the sandwich groove to prevent contact between them after the frame is taped. Taping may be accomplished with paper masking tape, which requires a coat of shellac after finishing, or with waterproof cloth or plastic tape, which do not require shellac protection.

Construction details of the loop. Top drawings show top and side views of wooden frame. Center drawing indicates how windings are placed on the frame, and bottom sketches give detailed information on the construction of the Faraday shield.

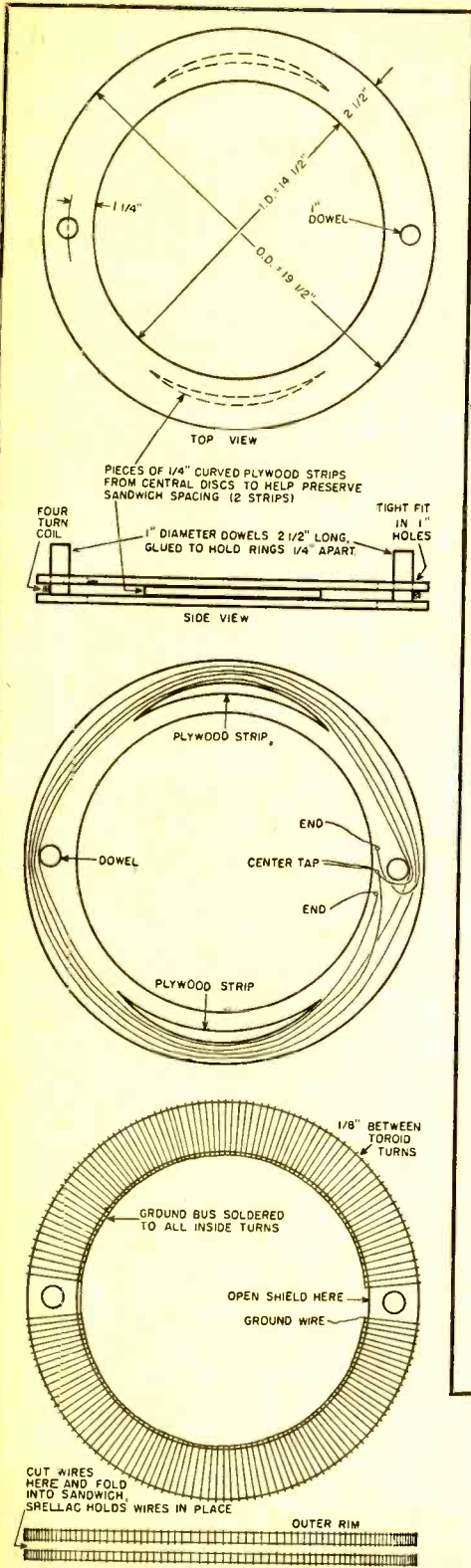

## Completing the Search Coil Frame

The frame is given added rigidity and a socket for the holding pole by means of the  $\frac{3}{4}$ " x 2" x 20" crossbar. The crossbar is pegged in place by wood doweling,  $\frac{3}{8}$ " in diameter, by drilling  $\frac{3}{8}$ " holes downward in the vertical projections to a depth of about one inch and gluing the crossbar in place. A one-inch hole is cut in the center of the crossbar to receive the end of the holding pole. The latter is also pegged in place by means of a  $\frac{3}{8}$ " wood key, which is removable to permit disassembly of the unit for transportation. A three-terminal Jones strip is then screwed to the crossbar; the coil terminals and center-tap are then secured to the Jones strip. The Faraday shield connection goes to the same Jones screw as the center-tap of the search coil.

## Construction of the Electronic Detector

The two oscillators are built as shown in the photos, the schematic diagram, and the pictorial wiring diagram. Although the layout illustrated is good, the builder may make any alterations he pleases, as long as he observes these precautions:

(1) The shielding between oscillators must be excellent. Note that all tubes and the fixed oscillator coil are completely shielded and that the tuning capacitor and oscillator coil of the 1R5 oscillator are above the chassis while the tuning capacitor for the search oscillator is below the chassis. The oscillator coil for the search section is completely outside the box, of course!

(2) All parts must be mounted super-rigidly with short leads used throughout to prevent vibration while the cabinet is being carried. Even the r.f. choke is supported instead of being secured only by its pig-tails. Resistors and capacitors belonging to one oscillator should be kept as far as possible from components of the other oscillator, with their major axes at right angles. The battery leads are not critical but the batteries must be held firmly in place to prevent their motion during transportation. In the author's model, a simple aluminum bracket, bent to fit, is pressed against the batteries on one side and the side-wall of the cabinet on the other. This is shown in the photo with the back cover removed.

(3) Connection between the search coil and the detector cabinet must be made with low-capacity shielded twin-lead or shielded *Twinax*. Unless well-grounded shielded twin-conductor cable is used, body capacitance and stray capacitance acting on the connecting cable will produce instability. Connection between the cable and the detector cabinet is made through

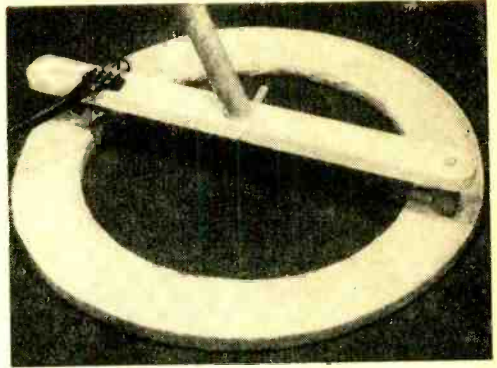

Completely assembled loop, ready for operation. Note terminal strip for connecting the shielded "Twinax" cable, the other end of which connects to a 3-prong plug.

a shielded, three-terminal microphone connector.

A U. S. Army surplus web strap was cut to size and end-finished by means of thin sheet metal bent around the cut end and peened in place. The strap frees both hands for handling the carrying pole, yet keeps the tuning dial within convenient reach of the operator for the occasional readjustments that may be required.

## Testing the Complete Metal Locator

Before connecting the batteries, check the connecting wires for short circuits with an ohmmeter; even a short circuit of brief duration is enough to ruin the batteries—so be careful!

Connect the batteries; set the main tuning capacitor at a little less than full capacitance; turn the switch on and slowly rotate the screwdriver-tuned variable capacitor from full capacitance outward until a loud whistle is heard. While doing this, many whistles of varying intensity will be heard due to various combinations of harmonics of the two oscillators. These are to be disregarded; the beat note between the fundamental frequencies of the two oscillators is three or four times as loud as the others. Leave the semi-variable capacitor at that setting and readjust the main tuning dial for a loud whistle of low frequency. As this adjustment brings the heterodyne closer to zero-beat, the oscillators will lock in with each other and the whistle will disappear. Now bring a relatively large mass of any kind of metal into the vicinity of the search coil; the beat note should immediately reappear, becoming shriller as the metal approaches closer. When the locator follows this pattern, it is ready to be installed permanently in its cabinet.

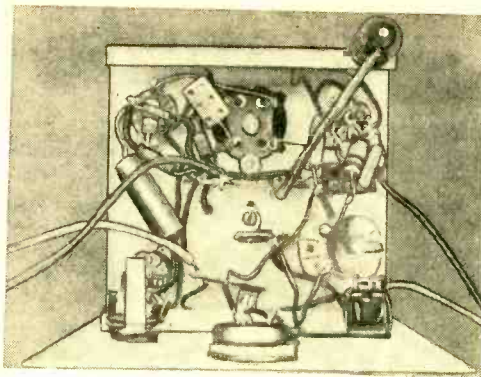
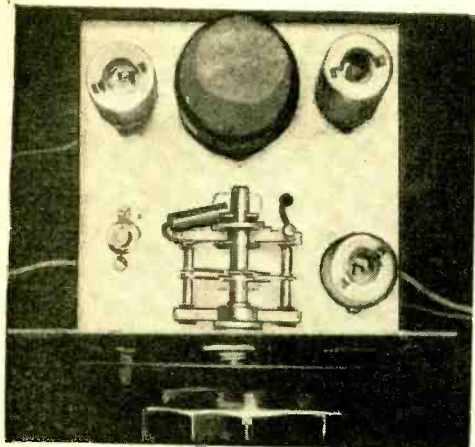

Top (left) and bottom (above) views of chassis, showing location of components.

If beat notes are not heard, the trouble must first be localized to one of the two oscillators or to the audio amplifier. Common trouble spots are weak batteries, incorrect connections, poorly soldered joints, defective components, or components of wrong value. These possibilities should be investigated first.

Oscillators in good working order generate a bias voltage that is easily measurable. Using a vacuum-tube voltmeter or a regular voltmeter having a sensitivity of at least 20,000 ohms per volt, measure the voltage on the grid pins of the 1T4 and the 1R5 with respect to chassis. (Pin #6 on the 1T4, pin #4 on the 1R5.) A negative potential of 3 volts or more indicates proper operation. If the measurement does disclose an inoperative oscillator, check each part and its connection until the trouble is located.

With both oscillators performing as they should, the only other source of possible malfunction is the audio amplifier stage and its associated components. Touching the tip of a screwdriver to the control grid pin of the 1U4 (pin #6) should produce a click or thump in the headphones. If it does not, look for trouble between the plate of the 1R5 and the remainder of the audio circuit up to and including the headphones, using voltage and resistance measurements. Remember that the headphone jack must be insulated from the panel, otherwise the "B" battery will be short-circuited. The B+ to B- check suggested in the first paragraph under "Testing the Complete Metal Locator" would have revealed such a short circuit—if it exists—provided that the circuit has been connected as shown in the pictorial diagram and schematic. The author assured good insulation here by drilling a  $\frac{3}{8}$ " hole for the headphone jack sleeve and using large shoulder washers on each side of the hole.

### Adjusting and Using the Metal Locator

There are two alternative methods of using the locator; one is more sensitive than the other, but is less convenient and requires more careful adjustment.

1. *High Sensitivity Method*—Strap the locator cabinet to your shoulder and connect the headphones and search assembly. The main tuning dial should be within easy reach of your left hand. Hold the search coil a few inches from the ground and adjust the tuning until you hear a low-pitched *fundamental* (loud) beat note, about 30 cycles per second or so. Move forward slowly as you sweep the search coil from side to side parallel to the ground. An approach to metal will be indicated by a sharp rise in pitch of the tone. The disadvantage is that the sound is audible at all times and may become annoying.

2. *Medium Sensitivity Method*—Adjust the tuning very carefully, starting with maximum capacitance of the main variable capacitor, until the oscillators *just barely lock in*. This will be shown by a complete cessation of the beat note. The note will reappear abruptly when metal is approached, so that one may operate in complete silence until the metal mass announces itself.

Sensitivity is somewhat lower for this method than for method 1, because there must be a larger change in inductance of the search coil to produce an audible indication. This is because the two oscillators are "locked" together, and tend to remain locked until an appreciable change in inductance takes place. In method 1, the oscillators are not locked, and any minute change in inductance of the search coil will result in a change in pitch of the audible beat note. The ear is quite sensitive to small changes in pitch, so method 1 results in a detector of high sensitivity.

## Penetration

The depth to which the locator penetrates depends upon three factors: (1) the mass of the metal, (2) the kind of metal—purity, conductivity, etc., and (3) the condition of the soil. To provide the reader with some idea of what might be expected of the instrument, the author performed the following experiments:

(a) Dry soil, galvanized iron trash can cover, buried approximately 3½ feet underground, was easily detected.

(b) Dry soil, same location, an aluminum snow shovel measuring about 15" x 18" was detected at a depth of about 3 feet.

(c) An 8" roll of copper wire, weight about 1½ lb., was located without difficulty at a depth of 3 feet.

(d) Wet soil reduces penetration by about 10% for objects above.

(e) Steel reinforcing rods were easily located in a 12" concrete retaining wall and exact spacing accurately determined.

(f) BX cables in plaster and plaster board walls were located precisely.

(g) A 275-gallon steel oil tank was "located" at a distance of 6 feet through the foundation wall of a building.

(h) A buried sewer "cleanout" cover

was found at once although it was covered by a thick layer of concrete topped by about 5 inches of wet soil.

## How It Works

The two oscillators operate at frequencies around 2 mc. When their frequencies are within 10,000 cycles of each other, a high pitched beat note is heard as a result of the mixing in the 1R5 converter tube; the 1U4 audio amplifier intensifies the beat note so that it is sufficiently loud to be heard even in noisy locations. Assuming that the oscillators are adjusted to produce a beat frequency of 300 to 500 cycles per second, an approach to metal with the search coil causes the induction of eddy currents in the metal mass. According to a well-known electrical law (Lenz's Law), the magnetic field generated by these eddy currents in the metal opposes the field of the search coil. This is reflected back to the search coil as an effect which reduces its inductance. Since the search coil is the tank inductance of one of the oscillators, any change in its inductance causes a proportional change in the frequency of oscillation; this, in turn, changes the pitch of the beat note sharply.

-30-

Over-all view of the complete unit with shoulder carrying strap (below) and rear view with cover removed (right), indicating how batteries are held in place.

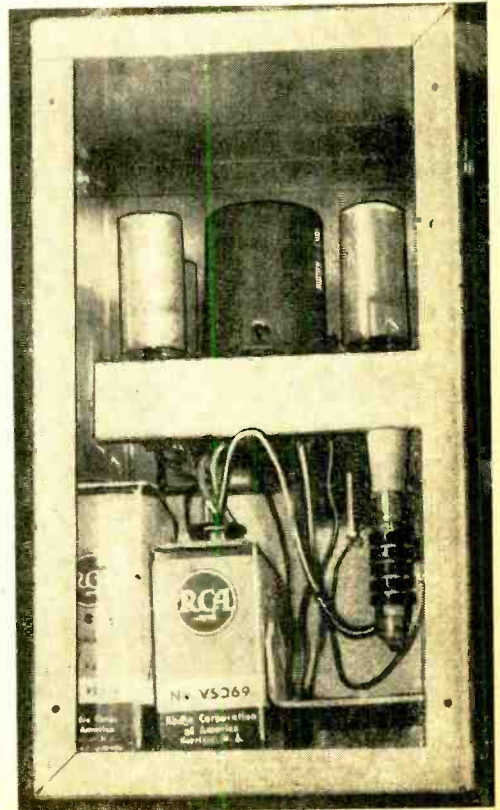

ALUMINUM SUPERSTRUCTURE  
(FLAT BLACK PAINT)

2050 THYRATRON

LENS (10cm. f.l.)

SENSITIVITY CONTROL

ON-OFF TOGGLE SWITCH

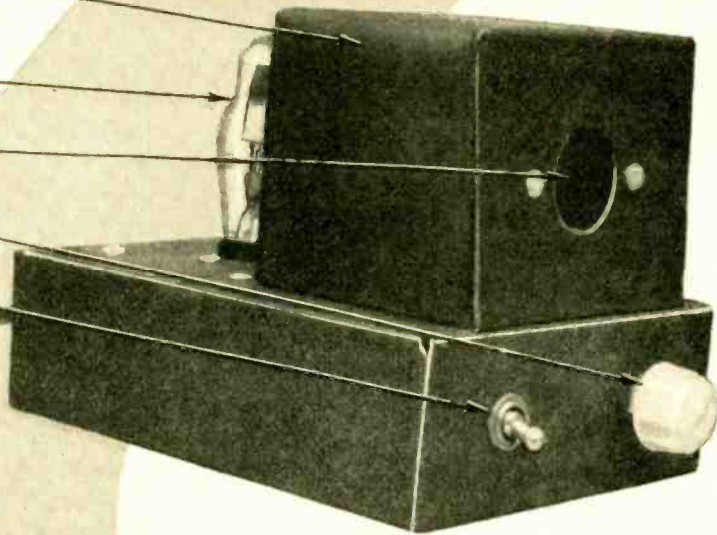

## THYRATRON PHOTOTUBE RELAY

By RECESSING THE TUBE SOCKETS in a standard 5" x 7" chassis and building a small aluminum superstructure to shield the phototube and support the lens, a very pleasing, trim appearance was achieved in this phototube relay without adding to its cost. Incorporated in its design are other features which assure excellent sensitivity to small changes in light, almost complete immunity to excitation from extraneous light sources, insignificant operating power, and so little heat generation that it may be used in tight, unventilated spots.

The circuit is set up to trigger a relay when the light beam is *interrupted*. This kind of response is well suited for use in burglar alarms, doorway annunciators, counter activators, or any other device where a reaction is desired when something or somebody blocks the energizing light beam. The unit is equipped with a built-in a.c. power receptacle to provide 117 volts a.c. when the relay is activated. Thus, any indicator such as a lamp, a bell, or a motor designed for use at the line voltage may be plugged into the receptacle directly for photoelectric control.

A 2050 thyatron is used as the trigger tube. Designed specifically for relay appli-

cation, this inexpensive gas-filled tetrode makes for fast, positive pull-in action. The thyatron draws no current at all through the relay when its control grid voltage is negative enough to prevent ionization; in this state the device is inactive except for the small heater current in the thyatron. But when the light beam is interrupted, the change in phototube current reduces the bias to the point where the thyatron fires. As the firing action is very sudden, the plate current rises from zero to its maximum figure almost instantaneously, resulting in the elimination of relay "chatter." This "all-or-nothing" behavior of the thyatron makes it ideal in photoelectric applications.

The phototube used in this unit is an 868 gas-filled type. Its sensitivity to small changes in light intensity permits the use of less powerful light sources than would be required with a vacuum phototube. Proper precautions have been taken to prevent the application of too much voltage to the phototube elements—precautions especially necessary with gas-filled types.

An inexpensive magnifying lens intensifies the beam falling on the sensitive photo-

Solve your light-operated relay problems with this inexpensive easily constructed unit. Details on a light source are included.

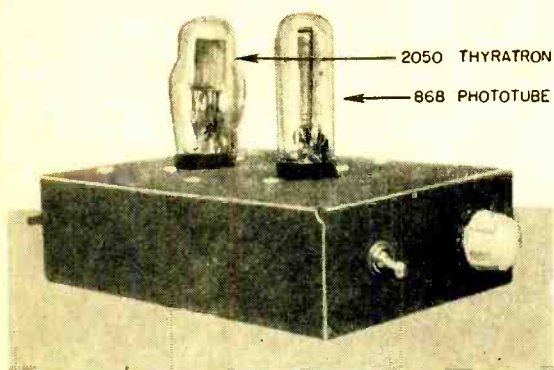

cathode. It helps improve the sensitivity of the relay and assists in the rejection of undesired light from sources other than the energizing one. The lens used in the author's model has a focal length of 10 cm. (approximately 4 inches). The photocathode should be placed so that it is about 75 per cent of the focal length away from the lens—in this case a distance of approximately 3 inches. If a lens of a different focal length is used, plan to mount the phototube so that this relationship still applies. For instance, if the lens has a focal length of, say, 3 inches, the phototube should be placed so that its cathode is approximately  $2\frac{1}{4}$  inches behind the lens ( $.75 \times 3 = 2.25$ ). To find the focal length of an unknown lens, measure the distance between a sheet of white paper and the lens when a sharp image of a distant building is formed on the paper.

#### Construction

Try to follow the layout shown in the photographs as closely as possible. The lengths of the wire connections are not critical, but short leads make for a neater over-all job. Resistors and capacitors should never be made "self-supporting" by

joining their pigtails in mid-air; always plan for terminal strips on which small parts may be mounted to lend rigidity to the assembly. Note that the 8  $\mu$ fd. electrolytic capacitor is held in place by wiring it to the relay solder lugs, while the resistors terminate at terminal strips, active tube pins, or inactive tube pins as the case may be. The practice of using inactive lugs on tube sockets as tie-points—such as lugs #1 and #3 on the phototube socket—is highly recommended.

After the wiring is finished, check it visually by tracing it against the schematic diagram to make sure there are no errors. Leave the lens superstructure off for the moment, and plug the relay into the 117-volt a.c. line with the "on-off" switch in the "off" position. Set a bright light (a 100-watt lamp will do nicely) about four feet from the phototube, rotate the sensitivity control fully counter-clockwise, and move the switch to the "on" position. Allow the unit to heat for about one minute, then rotate the sensitivity control clockwise slowly until the relay click is heard; now back the sensitivity control off in a counter-clockwise direction until the relay clicks once again. The phototube relay is now ready to operate. Interruption of the light beam will cause the relay to operate, and any 117-volt device plugged into the a.c. receptacle at the rear of the chassis will be subject to photoelectric control.

For commercial annunciator or burglar alarm applications, a small light source is necessary to supply a more-or-less parallel beam for energizing the phototube. A suitable arrangement is shown in the accompanying drawing; it involves the use of a 30 candle-power automobile headlight lamp available at any auto supply store, a 6.3-volt step-down transformer having a secondary rated at a minimum of 2 amperes, and a magnifying lens of the same type as used in the phototube superstructure. The only mechanical requirements to be met in building such a light source are that the lens be movable to permit accurate focusing and that sufficient ventilation be provided so that overheating does not occur. The author has constructed several such light sources in which the case is made of plywood and the headlight lamp socket slides between a pair of wooden rails. Once the position of the lamp is adjusted with respect to the lens, it need never be touched again, so elaborate focusing arrangements are unnecessary.

#### Troubleshooting

The straightforward circuit used in this unit has so few parts that it is difficult to imagine anything going wrong with it if it

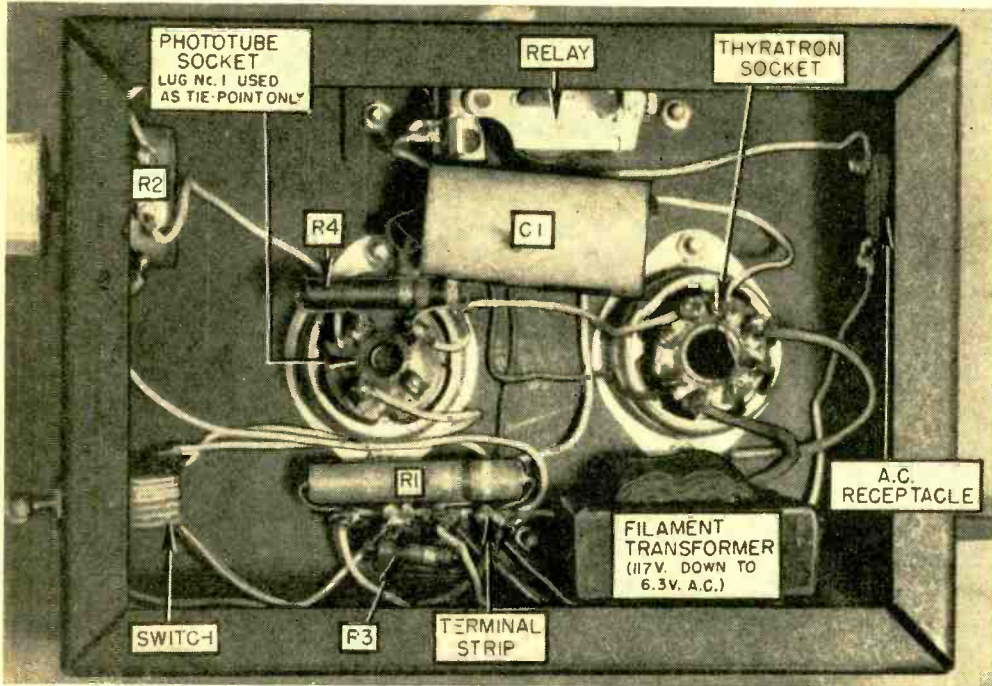

Underchassis view of the control box of the thyatron phototube relay showing the actual placement of parts and wiring details.

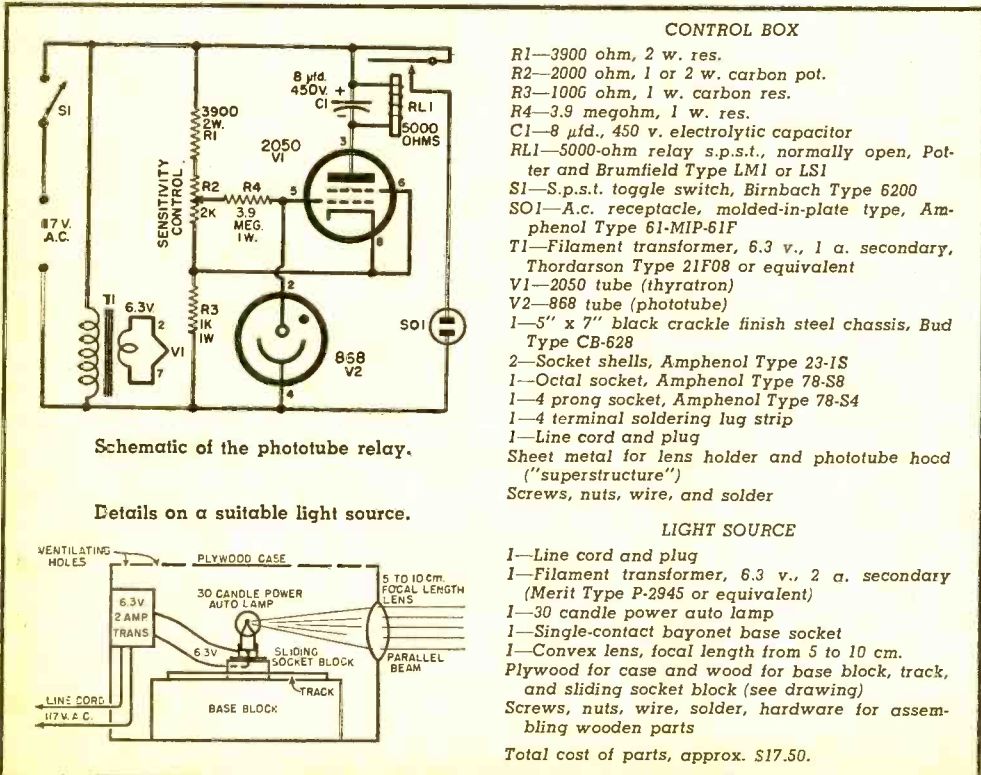

**CONTROL BOX**

- R1—3900 ohm, 2 w. res.
- R2—2000 ohm, 1 or 2 w. carbon pot.
- R3—1000 ohm, 1 w. carbon res.
- R4—3.9 megohm, 1 w. res.
- C1—8  $\mu$ d., 450 v. electrolytic capacitor
- RL1—5000-ohm relay s.p.s.t., normally open, Potter and Brumfield Type LM1 or LS1
- S1—S.p.s.t. toggle switch, Birnbach Type 6200
- SO1—A.c. receptacle, molded-in-plate type, Amphenol Type 61-MIP-61F
- T1—Filament transformer, 6.3 v., 1 a. secondary, Thordarson Type 21F08 or equivalent
- V1—2050 tube (thyatron)
- V2—868 tube (phototube)
- 1—5" x 7" black crackle finish steel chassis, Bud Type CB-628
- 2—Socket shells, Amphenol Type 23-IS
- 1—Octal socket, Amphenol Type 78-S8
- 1—4 prong socket, Amphenol Type 78-S4
- 1—4 terminal soldering lug strip
- 1—Line cord and plug
- Sheet metal for lens holder and phototube hood ("superstructure")
- Screws, nuts, wire, and solder

**LIGHT SOURCE**

- 1—Line cord and plug
- 1—Filament transformer, 6.3 v., 2 a. secondary (Merit Type P-2945 or equivalent)
- 1—30 candle power auto lamp
- 1—Single-contact bayonet base socket
- 1—Convex lens, focal length from 5 to 10 cm.
- Plywood for case and wood for base block, track, and sliding socket block (see drawing)
- Screws, nuts, wire, solder, hardware for assembling wooden parts
- Total cost of parts, approx. \$17.50.



is correctly wired. Assuming that the circuit has been carefully checked after wiring and that all leads terminate at the proper tube pins and tie-points without open or short circuits, certain defects in the components may cause the kinds of troubles listed below. The only instrument required for testing is a vacuum-tube voltmeter having an ohms range or a high-input resistance multitester.

*Relay fails to pull in at any setting of R2*—Make certain the thyatron heater is glowing; remove the phototube from its socket and if the relay clicks down now, it is an indication that too much light is reaching the phototube when it is in place. If the relay still does not operate, look for:

1. A defective thyatron
2. A defective relay
3. R3 open

*Relay fails to open at any setting of R2*—This is generally an indication of insufficient negative bias on the control grid (pin #5) of the thyatron. It may be due to one or more of the following causes:

1. Defective phototube
2. Defective thyatron
3. Insufficient light on the phototube
4. R1 open
5. Cathode of the thyatron shorted to

the lower a.c. leg of the line (as shown on schematic diagram)

*Relay chatters*—This is an indication of:

1. Defective capacitor C1 (open)
2. Capacitor C1 incorrectly polarized (plus and minus connections reversed)

*Relay operates properly but no a.c. is available at receptacle*—This trouble is easily localized. Either the relay contacts are not coming together, because of deformation of armature or fixed contact arm, or the contacts are badly oxidized. Oxidation may be removed by using fine sandpaper (not emery paper or cloth).

*Thyatron heater does not light*—Check the line cord for continuity, then make sure that line voltage appears on the transformer side of the switch S1. If the switch works, the trouble then lies in:

1. Defective thyatron
2. Defective 6.3 volt step-down transformer

One final precaution: Gas-filled phototubes are very sensitive to extremes of light. Be sure to keep direct sunlight away from the phototube and, when artificial light is used, don't use too strong a source. A 100-watt lamp about four feet away is just about the most powerful light that should be used.

-50-

Pictorial diagram of the control box. Relay energizes external circuit when light shining on the phototube is interrupted.

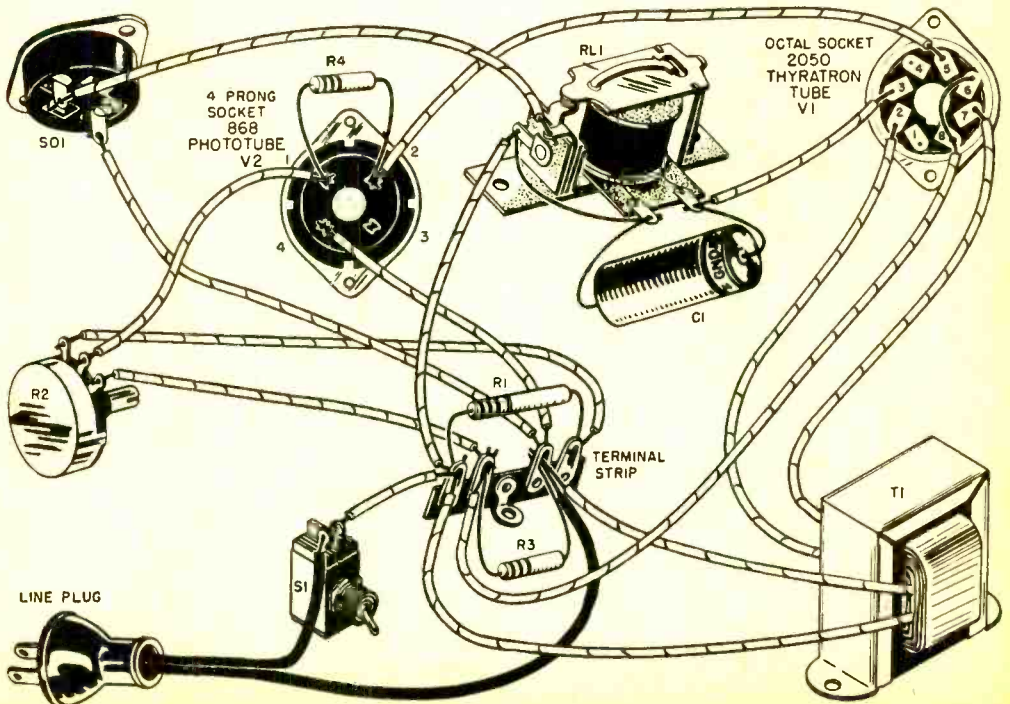

# Keep Dry

with this "RAIN ALARM"

By EUGENE RICHARDSON

DOES THE LADY OF the house have to keep an eye open for clouds whenever she hangs out the laundry? When there's a heavy storm, is it necessary to keep checking the basement for possible water leaks? Has anyone ever turned on the sprinkler to water the lawn, lain down for a short nap, then awakened to find that a storm had come up and water was being wasted on a lawn already soaking from a torrential downpour? Has anyone ever left the top down on a convertible in the evening, had showers during the night, and had to drive to work in a wet car?

If the answer to any of these questions is "yes," or if rain, moisture condensation or water leaks are likely to introduce problems in a personal or business life, then here's a handy little gadget that will help reduce future worries—a novel "rain alarm" so sensitive that the slight moisture condensing from one's breath on its *sensor plate* is enough to operate it.

Yet with all its amazing sensitivity, the rain alarm uses a very simple circuit requiring but a single vacuum tube. It is quite easy to assemble and a cinch to use. An experimenter or home builder of average skill should have no difficulty assembling and wiring his own unit in one or two evenings or on a weekend.

## Assembling the Rain Alarm

Because of the simple circuit employed, relatively few inexpensive, readily available components are required, and these are all specified in the parts list. Chances are all of the parts will not be found at a radio parts distributor, however. It may be necessary to pick up the buzzer, lamp

socket and bulb, and one or two other items at a local hardware store.

The complete rain alarm consists of two independent units — the "Control Box," which includes the electronic circuits as well as the alarm signaling devices, and the "Sensor Plate" which detects the presence of moisture. A length of twin conductor lamp cord is used to connect the two units.

*The Control Box:* The complete electronic circuit shown in the schematic diagram is assembled in the control box. Wiring and layout are not critical and lead dress is not too important. However, a few construction hints should be of help in avoiding errors and in making sure that the unit works the first time it is turned on.

A single piece of sheet metal measuring approximately 3½" x 5¼" is bent to form

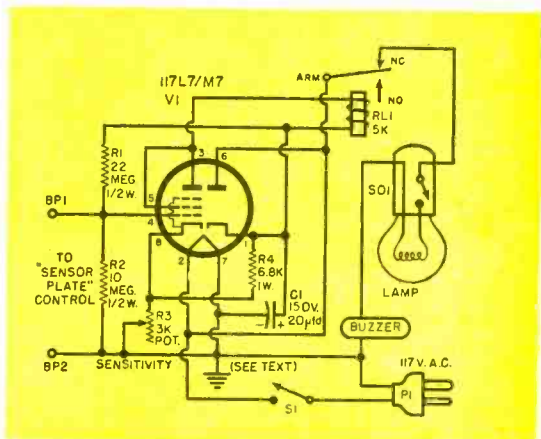

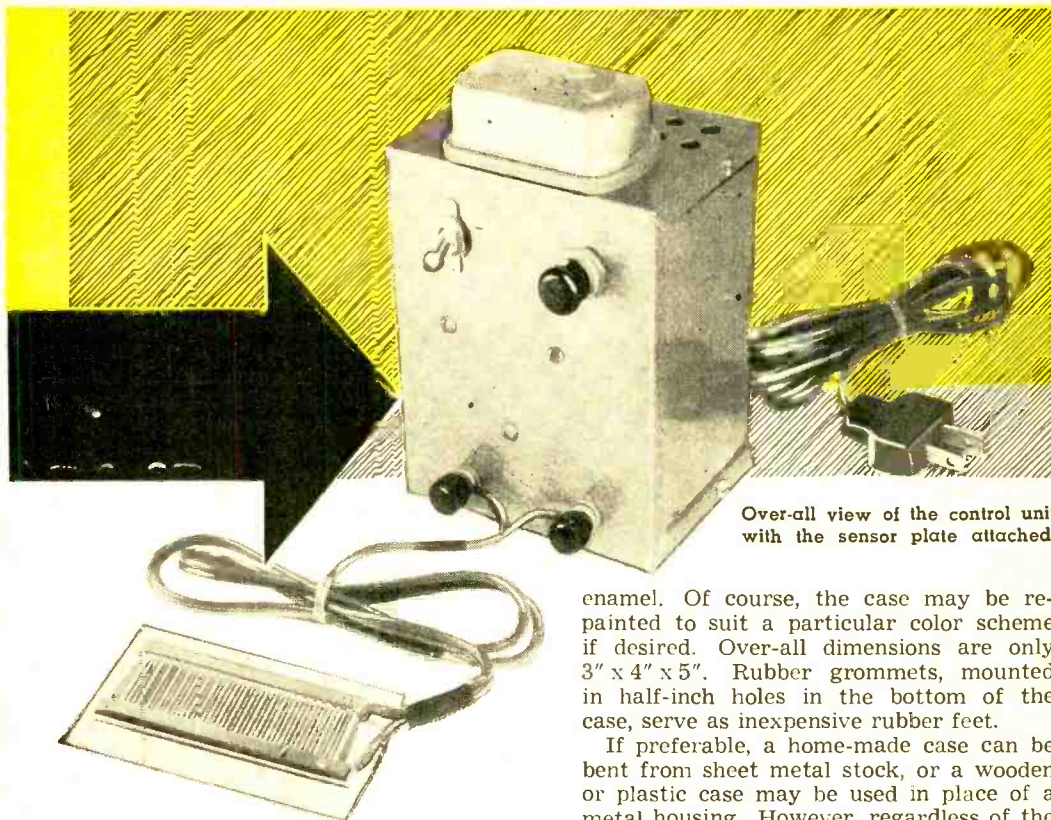

Over-all view of the control unit with the sensor plate attached.

the chassis. Either steel or aluminum may be used, but aluminum is easier to machine and to bend. If steel is used, it will be necessary to give it a protective coating of some sort to prevent rust. Enamel, plastic, or a plating (such as cadmium or copper plating) may be employed.

The model shown is housed in a commercially available aluminum box, finished with an attractive gray hammer-tone

enamel. Of course, the case may be repainted to suit a particular color scheme if desired. Over-all dimensions are only 3" x 4" x 5". Rubber grommets, mounted in half-inch holes in the bottom of the case, serve as inexpensive rubber feet.

If preferable, a home-made case can be bent from sheet metal stock, or a wooden or plastic case may be used in place of a metal housing. However, regardless of the case employed, be sure to allow a reasonable amount of working space, make certain the vacuum tube is not too close to material likely to be damaged by heat, and provide adequate ventilation. In the model, ventilation is provided by a series of  $\frac{3}{8}$ " holes drilled in the back cover, together with a pattern of  $\frac{1}{4}$ " holes in the top. These two sets of vent holes act together to provide a sort of "chimney" effect which gives efficient cooling.

Fig. 1. Schematic diagram and parts list of control unit and sensor plate.

#### CONTROL UNIT

- R1—22 megohms,  $\frac{1}{2}$  w. carbon res.
- R2—10 megohms,  $\frac{1}{2}$  w. carbon res.
- R3—4000 ohm wirewound pot.
- R4—6800 ohm, 1 w. carbon res.
- C1—20  $\mu$ fd., 150 v. tubular elec. capacitor
- BP1, BP2—Binding post terminals
- RL1—S.p.d. plate relay, 5000 ohm coil (Potter and Brumfield Type LB5 or LM5)
- PL1—Polarized line plug (see text)
- S1—S.p.s.t. toggle switch
- SO1—Standard lamp socket, with switch
- V1—117L7/M7GT tube
- BUZZER—6 v. a.c.-d.c. buzzer (Edwards No. 725 "Dixie" Buzzer)
- LAMP—Standard 115 v., 100 w. lamp
- 1—Metal cabinet, 3" x 4" x 5" (Bud "Minibox" CU 2105)

- 1—Sheet of aluminum, approx.  $3\frac{1}{2}$ " x  $5\frac{1}{4}$ " x  $1/16$ " for chassis
- 1—Octal socket
- 1—Line cord
- 1—2-lug terminal strip
- 6— $\frac{1}{2}$ " rubber grommets
- Misc.—Screws, nuts, wire, solder

#### SENSOR PLATE

- 2—Metal pet combs (Obtain from pet shop or hardware store—see text)
- 4—4-36 x  $\frac{1}{4}$ " flat-head machine screws
- 1—piece of Bakelite, fiberboard, or plastic,  $3\frac{1}{2}$ " x  $2\frac{1}{4}$ " x  $\frac{1}{8}$ "
- Misc.—Short length of lamp cord, solder, electrical tape

Total cost of parts, approx. \$17.50

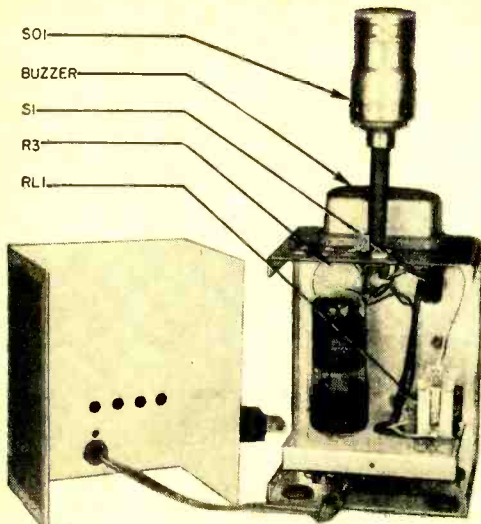

Rear view of control unit with cover removed. Note the subchassis on which the tube and relay are mounted. Holes in back and top are for ventilation.

The lamp socket, *SO1*, and the buzzer are mounted on the top of the case. Be sure to obtain a lamp socket with a built-in switch so that the alarm can be turned "off" when desired.

Wire as much of the chassis as possible before mounting it in the case. The partially wired chassis is shown on page 61 and major components are identified.

**NOTE ON GROUND CONNECTION:** One side of the power line connects to circuit "ground." This ground connection may be to the chassis and case, *provided a polarized line plug is used, so that the chassis is always at ground potential.* As one side of the power line is connected to earth ground in all installations following standard UL code, all standard outlets are "polarized" to receive a special plug in only one way, but they will receive regular plugs in two ways. Where one side of the power line is connected to the chassis of a piece of equipment, and a regular plug is used, it is possible to make the chassis "hot" with full line voltage (with respect to earth ground) if the plug is inserted in a certain way in the wall receptacle. This might result in a severe shock. In a polarized plug, one of which is used in this model, one prong is wider than the other, with the widest prong connected to the "ground" side of the line. It can be inserted in a wall socket in only one way.

If a polarized plug is not available, and cannot be obtained, one can be made out of a standard plug by soldering a small piece of wire around the outer edge of one prong

to increase its width. A paper clip will furnish a preformed wire for this purpose. Remember that the widest prong is the ground connection. Under no circumstances make a power line connection directly to the chassis of the rain alarm (or any other piece of electronic equipment) unless a properly connected polarized line plug is employed. To do otherwise is to invite disaster.

When the wiring is completed and double checked for errors, the tube and the 100 w. lamp bulb can be installed. Turn the lamp switch "off," the power switch "off," and the sensitivity control *R3* to its maximum resistance position. Plug the unit into a wall outlet, then throw the power switch "on" and allow a minute or two for warm-up. Listen for the relay to pull in (there'll be a distinct "click"). If the relay doesn't pull in after a reasonable warm-up period, gradually turn *R3* to a lower resistance position. The relay should pull in before the half-way point of control rotation. The point at which the relay pulls in is the "normal" setting for the sensitivity control. Greater or less sensitivity may be obtained by adjusting to either side of this point.

After setting the sensitivity control, check the operation of the control box by connecting a 1 megohm resistor (any wattage value) across its "control" terminals (binding posts *BP1* and *BP2*, Fig. 1). With the resistor in place, the relay should drop out; when the resistor is removed, the relay should pull in again. If the relay drops out, but doesn't pull in again when the resistor is removed, readjust *R3* to a lower resistance setting.

Finally, with the test resistor removed, and *R3* adjusted so that the relay has pulled in, close the switch on the lamp socket (*SO1*). The lamp should remain dark and the buzzer silent. If the lamp lights and the buzzer sounds, connection has been made to the "NO" terminals instead of the "NC" terminals (Fig. 1). Next, check over-all operation by reconnecting the test resistor across the control terminals . . . immediately, the lamp should light and the buzzer should sound.

**The Sensor Plate:** Two equally good methods may be used for making the sensor plate. The model shown in the photograph was assembled from two pet combs and a small piece of plastic material. In assembling a similar unit, obtain two all-metal pet combs and remove the handles and shafts. Drill and tap two small holes in the back of each comb, then mount the two combs on a piece of Bakelite, fiber, lucite, or similar plastic. The teeth of the two combs should be inter-

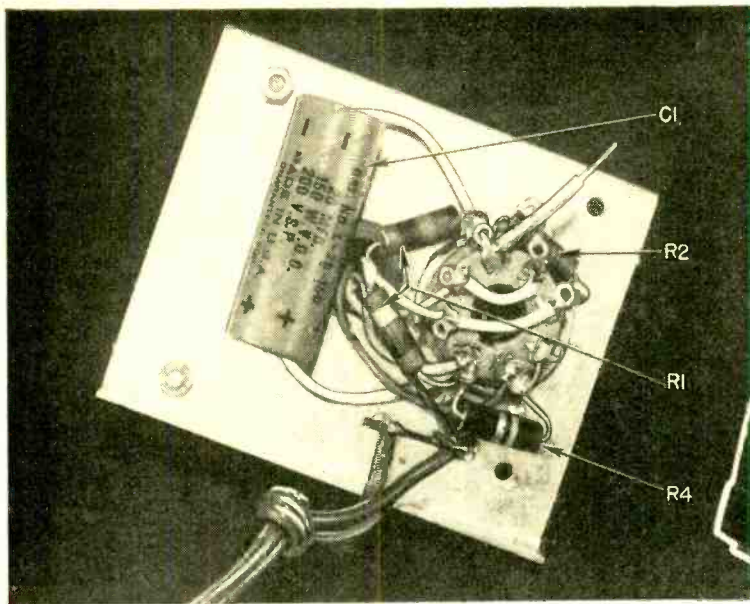

(Left) Subchassis viewed from underneath with the majority of components in place. (Below) Plug with wire soldered to one prong, forming a polarized plug.

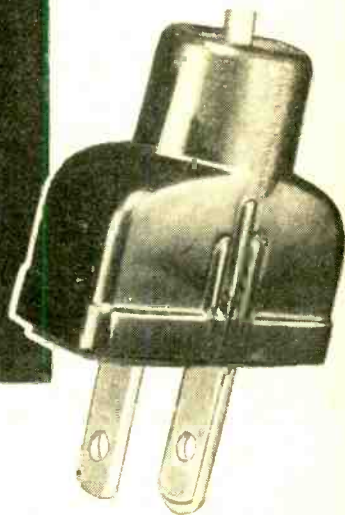

leaved, but not touching. Each comb serves as a separate electrode and is connected to one of the "control" binding posts on the control box. Ordinary twin conductor line cord is satisfactory for connecting the two units together.

A lower cost sensor plate may be made by cementing a piece of aluminum foil to a piece of plastic, then cutting a narrow strip out in such a way that the foil is divided into two electrodes, each of which has a maximum area exposed in close proximity to the other, but without actual contact made at any point.

#### How It Works

The 117L7 tube used in the rain alarm is a multi-purpose tube and is equivalent

to two separate vacuum tubes in a single envelope. One section is a beam power amplifier, the other section a half-wave rectifier. In the rain alarm, the beam power amplifier section is triode-connected (screen grid connected to plate) and is used as a control tube. The rectifier section supplies a d.c. operating voltage for the control section. *C1* serves as a filter capacitor; no filter choke or filter resistor is needed.

In operation, cathode resistor *R3* together with bleeder resistor *R4* develop a

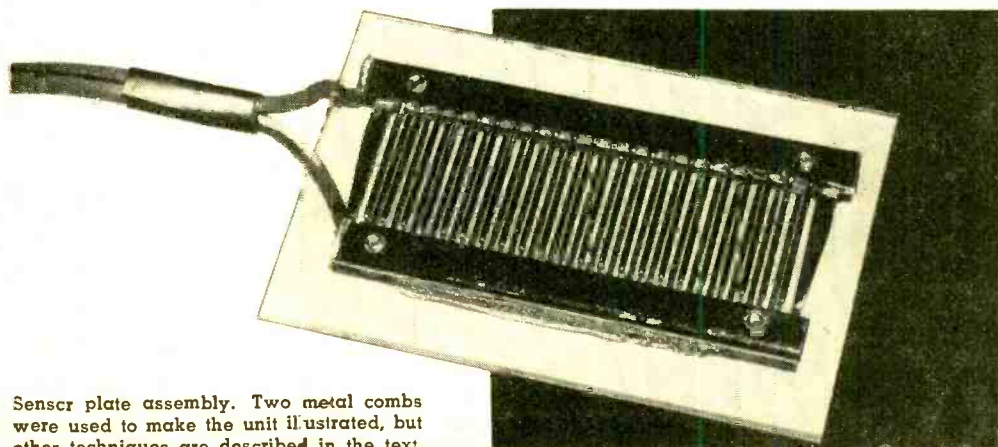

Sensor plate assembly. Two metal combs were used to make the unit illustrated, but other techniques are described in the text.

high bias voltage that would normally prevent the control tube from drawing sufficient plate current to close the relay *RL1*. This high bias is just balanced out by a positive voltage applied to the grid of the tube by voltage divider network *R1-R2*, however, and sufficient plate current flows to close the relay.

But the voltage divider network is made up of very high resistances, and any external resistance connected across grid resistance *R2* will drop the positive grid voltage sufficiently to allow the cathode bias to reassert its effect, reducing plate current and allowing the relay to drop out. Since the sensor plate is connected directly across *R2*, any moisture on the plate which reduces the resistance between the two electrodes acts effectively like an external resistor shunted across *R2*.

The setting of cathode resistor *R3* determines the initial bias and hence the relative sensitivity of the circuit. Sensitivity is such that a resistance of 10 megohms or less connected across its control terminals will initiate operation of the device.

When the relay drops out, voltage is applied to a series circuit consisting of a 100 w. lamp bulb and a six volt buzzer. Both the lamp and buzzer operate. The lamp actually takes the place of a large wattage resistor and acts to drop the line

voltage to the proper value for buzzer operation while, at the same time, providing an "alarm" signal of its own.

*Using the Rain Alarm:* The control box is generally placed in the home at some location where its buzzer may be heard easily or where its light may be seen. The sensor plate is then placed outside where the first drop of rain is likely to strike it. Ordinary line cord is used for connecting the two units. The length to be used will be determined by the quality of the insulation on the line cord. Since this varies so much with different types of cord, it is best to determine maximum length experimentally.

*Circuit Modifications:* The basic circuit, as described and shown, is designed both to sound an audible alarm and to light a visual alarm whenever a drop of moisture accumulates on the sensor plate. Some experimenters may wish to make modifications in the basic circuit to meet their own specialized needs. One modification would be to use the relay contacts to supply power to a motor, closing windows instead of sounding an alarm. Another application might be to replace the sensor plate with a pair of prongs mounted in a tank, using the rain alarm as a "floatless" level control. There is virtually no limit to the possible applications of the basic circuit.

Pictorial diagram of the control unit of the rain alarm.

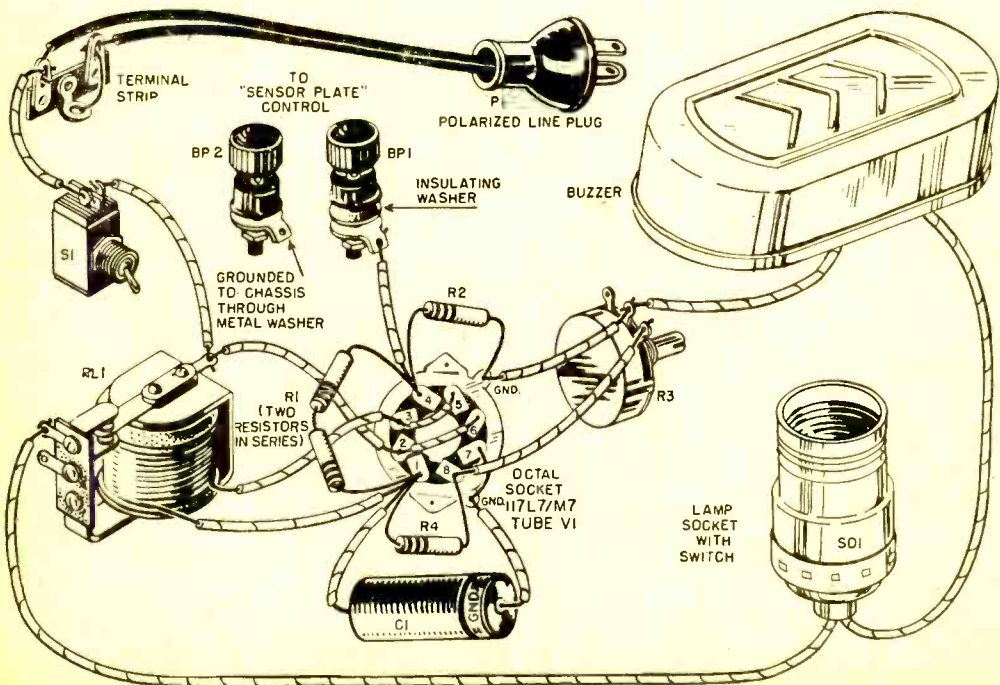

# R/C NOTES

WELL, THE 15TH ANNUAL CONVENTION and Trade Show of the *Model Industry Association* has come and gone (February 18-22, Grand Rapids, Mich.), and frankly, we're disappointed. We're still waiting for someone to come out with a good, reliable line of transistorized R/C equipment for the modeler.

Much as some people in the electronics "know" have been belittling the importance of transistors and emphasizing their limitations, we are impressed with the speed with which they are being applied to more and more uses in various fields. And now, we have received a bulletin from a transistor manufacturer announcing that they are available for as little as \$1.50 each, to manufacturers of electronic equipment. Why haven't R/C equipment manufacturers picked up the ball and produced transistorized equipment? Think of the saving in space and weight that would come with the elimination of the bulky "B" battery for the receiver. And think of the increased reliability that will result when battery voltage is no longer critical!

The increasing use of printed wiring for R/C equipment is an encouraging sign. We're sure that transistors will be along soon also. And you can be sure that we will give you an article on build-it-yourself transistorized equipment as soon as we can.

NOW TO GET OFF OUR transistor soapbox and to show you what can be done to make boat modeling more realistic and colorful, we are reproducing here a photo of a 21-

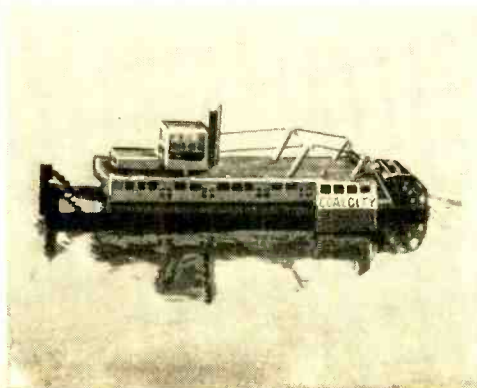

inch scale model of an actual river boat, name and all, built by *Jim Cabbage* of Hampton, Va. In Jim's own words, "The prototype's main duty is pushing coal barges to and from the steel mills at Pittsburgh, Pa." Jim has designed a remarkably flexible pulse control system for the boat giving proportional rudder control as well as high and low speed in forward and reverse. We are going to bring you a complete construction article on this control system in a future issue. It will be suitable for application to any of the commercial boat models.

FOR YOU R/C FLYING FANS out Kansas way, there is a newly organized club—the KC/RCA (*Kansas City Radio Control Association*)—that has about 40 members and will welcome more. The club holds two meetings a month, with one of them either a boating or flying session. Among the members is *Paul Runge* of *Ace Radio Control*, and a couple of other experts who regularly report on things to come in R/C and provide helpful hints on all aspects of the field.

The club welcomes all comers to their flying session—you don't have to be a member to walk off with one of the prizes. The goal of the group is "to get radio control under control, which makes for better flying and better times for all."

Contact *Dan Walters*, President, at 716 Linwood St., Kansas City, Mo., if you're interested.

TALKING ABOUT FLYING MEETS brings us to our monthly roundup of R/C meets scheduled for June. At this writing there are only two, June 4 and 5 at Goodland, Kan., and June 12 at Ft. Wayne, Ind.

The Goodland meet is a Class AA (unrestricted entry) event sponsored by the *Northwest Kansas Gashoppers* and includes R/C. *Kenneth Armstrong* of Goodland, Kan., is Contest Director.

The *Mad Modelers* of Ft. Wayne are sponsoring the Class AA meet on June 12. For additional information, contact *Walter A. Krull* at 414 E. Washington, Ft. Wayne 2, Ind.

PAGING ALL WOULD-BE or would-like-to-be inventors! POPULAR ELECTRONICS would like to have your ideas on what you would like to see operated by radio control around the home. We are preparing some articles now for future publication on radio-controlled gadgets to lighten your work load. If you've long harbored any ideas on this subject that might appeal to our radio-happy gadgeteers, write in to the *R/C Notes Editor* and we'll give them our most serious attention.



# A MINIATURE R/C TRANSMITTER

*An easy-to-build one-tube transmitter  
to actuate our featured R/C receivers.*

WHEN A PERSON WHO is primarily interested in model work decides to enter the radio-control field, he is often overwhelmed by the complexity of the equipment necessary to put his model into operation. Actually, this needn't be so, as the easily carried, rugged transmitter described in this article will prove. This transmitter is used to control the flight of a rather large glider, and gives reliable operation for long periods of time.

The circuit presented here is crystal-controlled and conforms to the requirements of both the FCC and the average model builder. The power output is more than sufficient for line-of-sight operation, while the power input to the amplifier is well under the five-watt limit set by the FCC. This circuit uses a minimum of components.

The transmitter is housed in a wooden hobby chest, simply because it was available, and all of the components fit very snugly. The actual case used for the transmitter is not critical. Just be sure that the box is rigid enough to support the antenna and small enough to be held comfortably in one hand.

Most of the components used in this circuit are mounted on a seven-pin *Vector* socket. This type of three-dimensional circuit building is simple, fast, and easily checked since all connections are in the open. The socket can be mounted on a piece of phenolic or on angle brackets and placed in any position desired.

Probably the best way to build any piece

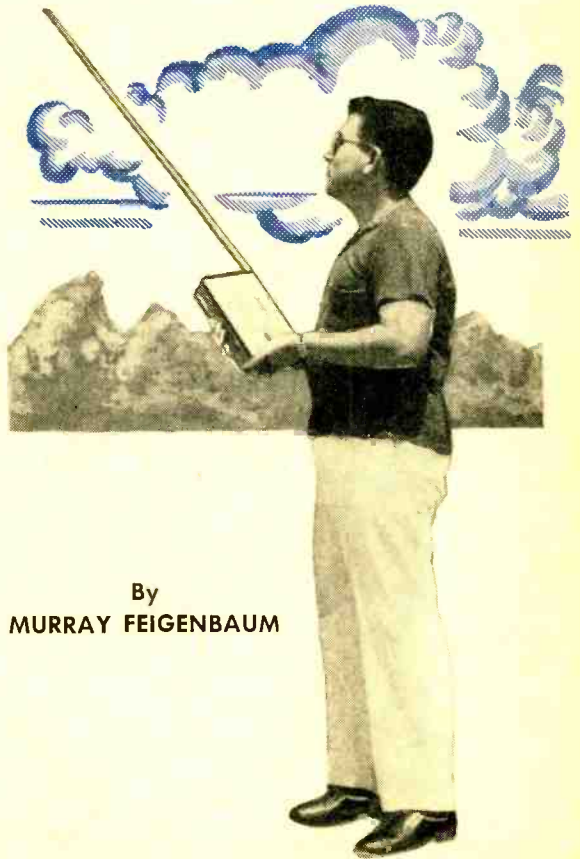

By  
**MURRAY FEIGENBAUM**



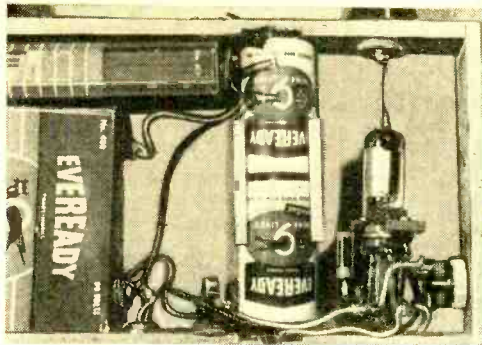

Inside of the transmitter showing the parts layout. The antenna is a side-mounted automobile-type, on the side.

The open-circuit phone jack designated as J1 on the schematic diagram, is shown here being used to hold a button-type keying switch built into a standard phone plug. A milliammeter, also shown attached to a phone plug, can be plugged into the jack to measure the output stage plate current.



of electronic equipment is to have all of the components available before construction is started. This enables the builder to shift parts around before making any permanent connections. Because it is extremely important to keep all of the leads as short as possible, place the components close to the base of the *Vector* socket.

### Construction

The first operation is to solder pin five of the tube socket to the metal mounting ring on the socket. Just bend the pin into position and solder. This establishes the metal ring as ground. For a neat job, use a small, pencil soldering iron for all solder joints.

Study the circuit diagram carefully before continuing. Then, cut the tank coil, L1, to the size given in the parts list. The coil is then mounted between pin two of the tube socket and the bottom pin of the *Vector* socket. A short jumper of number 18 wire from the tap on the coil to pin B of the *Vector* socket completes the mounting and the electrical connections to the coil.

Mount C2, C3, R1, and R2 as shown on the pictorial diagram and solder. The crys-

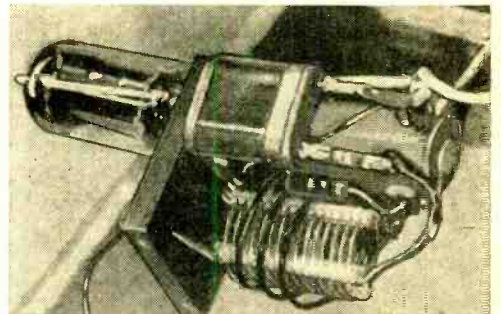

Detailed view of the *Vector* socket, showing the 27.255 mc. crystal holder made from the terminals of a miniature tube socket.

Schematic diagram and parts list for the transmitter. The phone jack shown in the photographs may be eliminated and an ordinary momentary contact type switch may be wired directly into the circuit instead.

- R1—3000 ohm, 1/2 w. res.
- R2—470,000 ohm, 1/2 w. res.
- C1—15  $\mu$ fd., air trimmer capacitor
- C2—12  $\mu$ fd., mica capacitor
- C3—.005  $\mu$ fd., disc ceramic capacitor
- L1—14 t., 1/2" diameter air-wound, B & W Miniductor #3003, tap 4 1/2 t. from grid end
- L2—3 t., #18 enameled wire
- B1—2—67 1/2 v. batteries in series
- B2—2 flashlight batteries in series
- S1—S.p.s.t. toggle switch
- S2—Button-type switch, Grayhill 23-1
- J1—Open-circuit phone jack
- V1—3A4 tube
- Xtal—27.255 mc. crystal
- 7-pin *Vector* socket

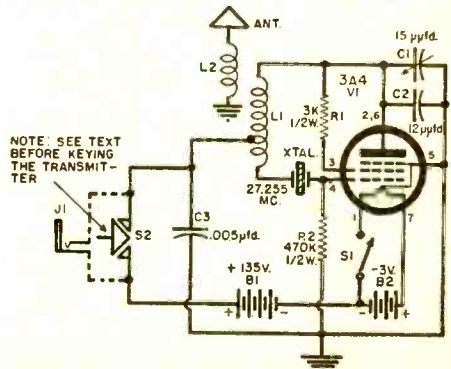

tal is not mounted in a regular crystal socket, since it would require too much space. Instead, break open a miniature socket, and remove two of the pins. Solder these pins to lugs C and D on the *Vector* socket. This makes an excellent crystal holder. Do not attempt to solder directly to the crystal pins. Use short jumper wires to complete the rest of the connections on the socket.

Mount the antenna, the switches, and the tank capacitor, *C1*, onto the case. Keep the end mounting bolt on the antenna as close to the tank capacitor as possible.

For the antenna coil, *L2*, ground one end of a length of number 18 enameled wire. Wrap three turns loosely around the tank coil, *L1*, and then connect the other end directly to the end mounting bolt of the antenna.

Screw the *Vector* socket firmly in place into the case. Place the tube in the socket, and complete all of the wiring in the case.

Now is the time to check carefully all of the solder joints and all wiring connections against the schematic diagram. The builder should not turn the transmitter on until

he has read the rest of the instructions.

A 0-50 milliammeter is necessary for the tuning operation. It is placed temporarily across *S2* while tuning. Use extremely short leads to connect to the meter. A convenient method to use for a quick check on tuning is to replace *S2* with a phone jack. Connect the meter to a phone plug, making sure that the polarity is correct. Connect the button switch to another phone plug. Now, the same connection can be used for keying and for tuning.

Extend the antenna to its full length. Plug in the meter, using just 67½ volts as the plate supply. Turn the transmitter on and tune the tank capacitor, *C1*, until the plate current dips sharply, indicating that the tank circuit is properly tuned. Using both batteries in series to give 135 volts, check the tuning again. The total current at 135 volts should be approximately 18 milliamperes. It is advisable to check the tuning before each day's control work. After tuning, replace the meter with the button switch. It is now ready to operate.

-30-

Pictorial diagram of the miniature transmitter described in this article.

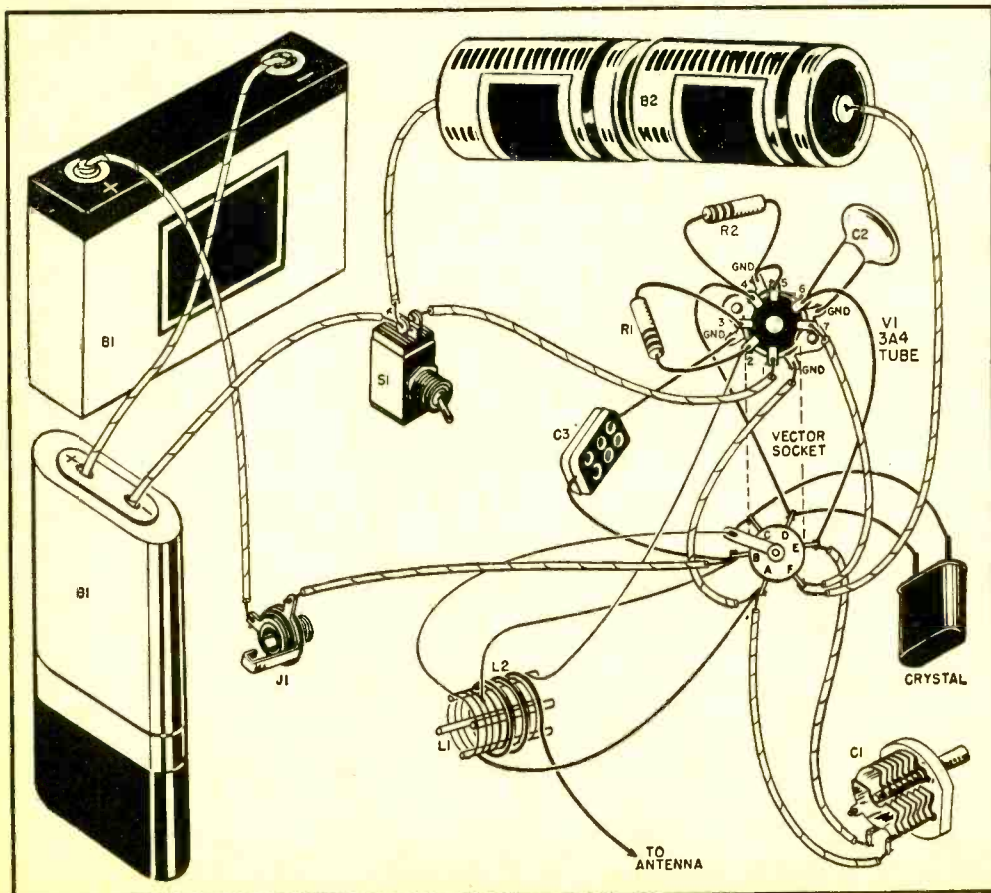



# the boom in R/C boats

## part 2

By **WILLIAM WINTER**  
Editor, "Model Airplane News"

Walter Musciano's Higgins cabin cruiser with radio control.

THERE WAS A TIME when the model boat hobbyist had to hack out his own propeller, shafts, etc., but fortunately times have changed. The *Dumas* "Chris Craft Challenger," for example, has over 40 metal parts. *O & R* has a most complete hardware line. For high speed operation they have cast bronze propellers, made by the dense lost wax method, giving a closely moleculed prop for safe operation at speeds in excess of 15,000 rpm, in sizes from  $\frac{7}{8}$  to 2 inches. *O & R* basic prop shaft sets exist for every size of engine, from Half A up through the *Dooling and McCoy* racing .60's. Shafts are in diameters of  $\frac{1}{8}$ ,  $\frac{3}{16}$ , and  $\frac{5}{32}$  inch.

*A. J. Fisher*, 1002 Etowah Avenue, Royal Oak, Mich., has de luxe unfinished cast bronze propellers in sizes from  $\frac{3}{4}$  to 4 inches, both two- and three-bladed. *Fisher* rudder posts are milled to take soldered-on rudders; their stuffing boxes have packing glands. They make air scoops, anchors, brass steering wheels, rear struts, etc.

*Sterling* has propeller drive sets for Half A, up to .29's and .35's, and for electric drive. *Berkeley* has hardware for Class A and B engines, and for the little Half A's.

### Simple Receivers

The overwhelming majority of boats are equipped with a single channel receiver, mounted on foam rubber to absorb engine vibration. Standard simple receivers now on the market give a current change of as much as three mils, which is more than adequate for good relay operation. Using these simple receivers, the average builder goes in for control by rudder only, as does the plane builder. If he is smart, he'll protect his equipment from water if there is a tendency to ship water while running. The batteries can be coated with paraffin and the receivers tied up in pliofilm bags (used for storing food in refrigerators).

Balanced rudders are desirable. Rudders having the hinge line along their front

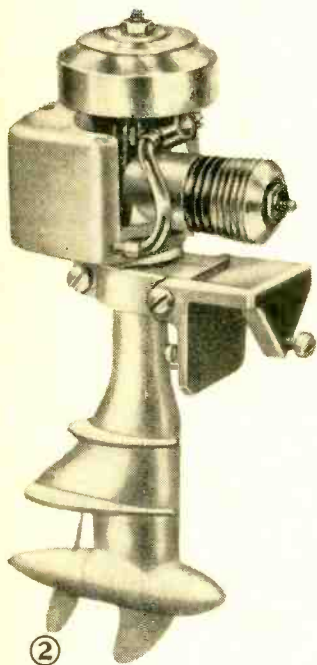
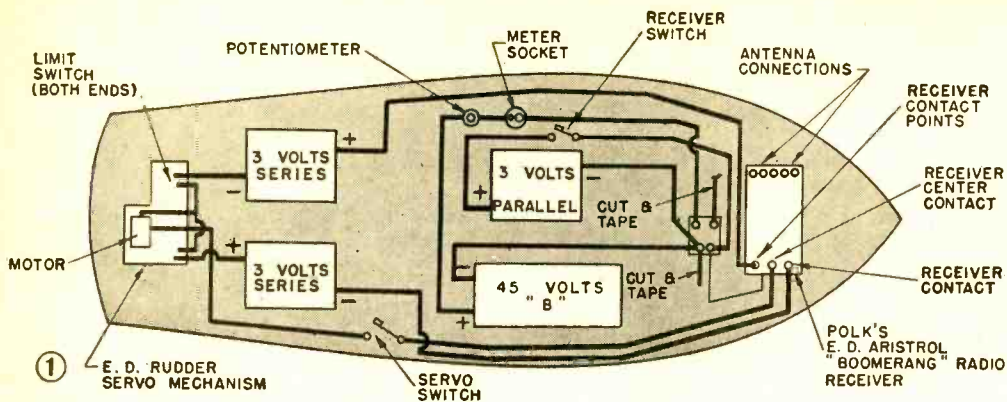

① Block diagram of E.D. radio receiver and rudder servo wiring for typical installation.

② The Atwood .049 outboard motor has all the desirable features of a big engine.

③ Two-cylinder inboard motor for larger models is built and sold by the Allyson Co.

④ The Cameron .09 marine engine is water-cooled but is finned for air cooling as well.

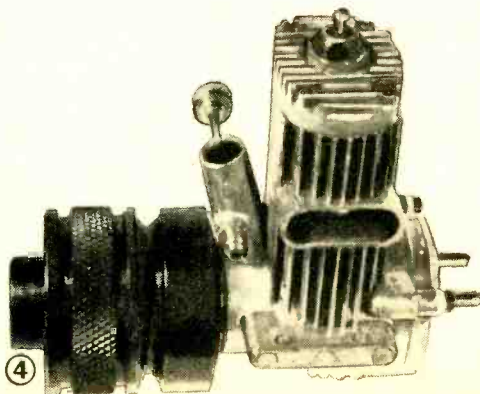
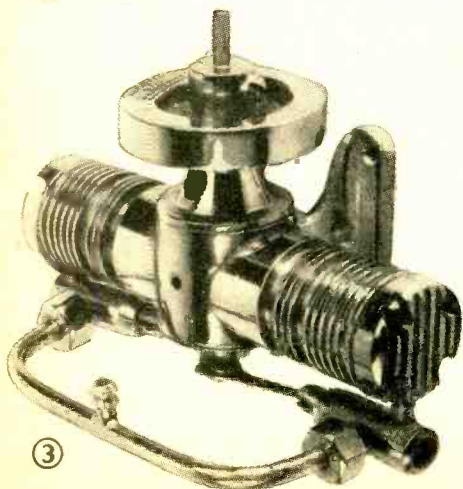

edge, or too close thereto, may be slow to respond and under severe conditions may fail to turn the boat. Part of the area should be placed forward of the hinge line, but not more than 25 per cent of the area.

Most of the airplane escapements often prove inadequate. Water loads on the rudder, transferred through the linkage to the escapement (especially the compound variety), result in sluggish rudder action. In some cases, the rudder may even be forced back to neutral. Extra rubber and higher voltages are half way expedients that introduce other problems, including that of critical spring tension. For best results, boats require special escapements.

### Escapement Mechanisms

One exceptional device is the *E.D.* clockwork escapement, manufactured in England, and imported by *Polks*. Though big and rugged by plane standards, its positive action and powerful clockwork spring make it a natural for boats. The enclosed spring will give 200 movements, the last as powerful as the first. This gives 50 rudder positions on a four-arm wheel, and 100 on a two-arm or self-neutralizing wheel. The unit comes with both; they are readily interchangeable. The four-arm provides a rudder-hold position that requires no current while holding; the two-arm does require current while holding.

*Cameron's* motorboat escapement has a four-arm action. Its ability to take six, or even more, strands of  $\frac{1}{8}$ -inch rubber is extraordinary. Since the four-arm types draw no current with rudder over, this escapement can be used with pen cell batteries, despite the powerful rubber. The power behind this escapement means that even a large boat can be maneuvered quickly.

Some builders alter the well known *Bonner* compound airplane escapement so that it closes contacts in its two positions, instead of using it to move the rudder directly. These contacts can be used for a left-right action of a motor driven servo, such as, again, *Bonner* (this servo is the same as the elevator trim servo that comes with the *Babcock* three-channel radio). The third-control contact could be for the engine or an ordinary self-neutralizing type can be reworked to close contacts in two positions for use with a servo. Servos used in this way give proportionate action but do not center automatically. The field is wide open for home-built actuators; various stepping deals are most popular, although a complicated multi-control system, using telephone dialing ground control, is not exactly quick on the draw.

### Servos

A number of servos exist, notably the Channel Master (*Schmidt*) and the *DMECO's*, which come in four types. The *DMECO's* are designed to replace escapements and provide the same "all or nothing" control movements, as opposed to the trim type of servo, but have far more "muscle" than airplane escapements.

While one of the easiest ways to actuate a two-speed gas motor and shut-off is by means of the electrical contacts of the *Bonner* compound, or of the *DMECO* multiservo, ingenious builders have also adopted the *E* unit from toy trains. This is the gadget that allows the train to stop, start, and reverse. Using this gadget with a compound actuator permits some impressive maneuvering.

The by now familiar pulse systems that have been evolved for airplanes are finding increasing use on boats. In the simplest

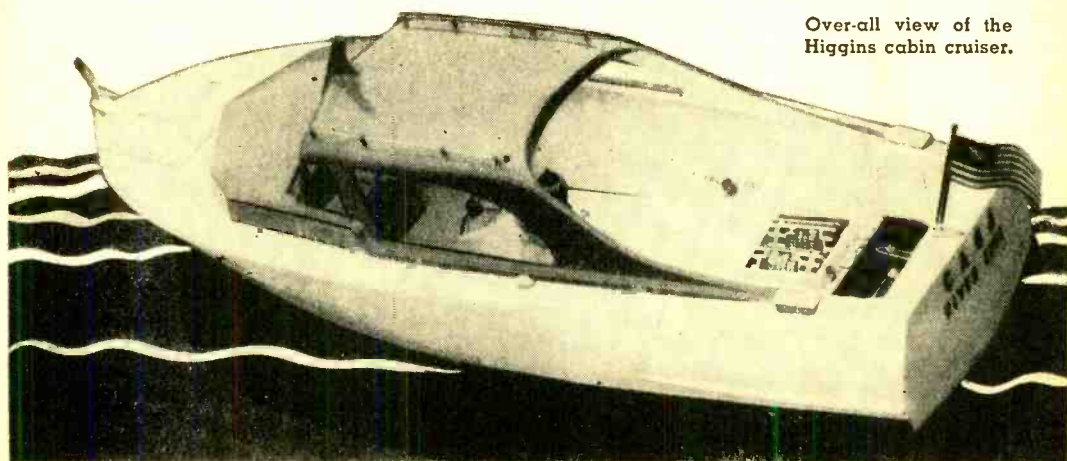

Over-all view of the Higgins cabin cruiser.

form, the pulse system uses a ground control box (attached to the keying lead of the transmitter) which is small enough to hold in the hand. Movements of the control stick in this box vary the pulse length from no signal at one end to steady signal at the other. A magnetic type of actuator slaves to the stick, and displaces the rudder one way or the other in proportion to the movement of the stick. The actuator is connected to both sides of the relay and, as the pulsing armature either slows down or speeds up, it tends to remain for the greater time on either the dropped-out or pulled-in contact, as the case may be. Similarly, the rudder, in following the actuator, governed by the relay, remains for the greater time on one side or the other of the neutral position.

### Proportional Control

In the boat field some wonderful proportionate actuators have been produced. Two notable ones are the Steering Unit, *Ripmax Marine Accessories*, and the *E.D.*, both English imported by *Polks*. They are similar so the description fits either.

A small 3-volt motor is connected by means of gearing or a belt to a threaded screw about 4 inches long. Parallel to the screw is a slotted metal frame. Riding on the threaded screw is a tapped block with a projecting drive pin that extends through, and rides along the slot. To this pin is connected the rudder linkage. The Steering Unit was designed for either multichannel or single channel use; for single channel, a pulse system is needed.

For single channel use, a ground control box, or beep, or pulse box, is essential to vary the pulse lengths. The *Ripmax* control box has two push buttons, a red one (no signal) and a green one (steady signal). In neutral, the pulsing signal does not cause the motor to turn, but with either steady or no signal, the motor turns one way or the other (the polarity is reversed depending on the relay contact in use). Pushing one button causes the boat to turn in one direction. Pushing the other button returns the control to neutral or other desired position, or even to hard over in the other direction. When neither button is depressed, the control will remain at whatever position it was in. This type of steering does require some operational skill in maneuvering the boat because it does not return automatically to neutral. The pilot or captain, if you will, feeds in small heading corrections. Incidentally, the maximum effective rudder movement is  $22\frac{1}{2}$  degrees.

Still another pulse deal is the *Fenners Pike*, which was used to set an airplane

endurance record of approximately 90 minutes. In this compact and ingenious actuator there is a small electric motor which slaves the rudder, without tendency to wiggle as with most pulse systems, to the side-to-side movement of the ground unit control stick. A button on the control box affects a change in pulse rate; the actuator decodes the rate change to work a second control.

One of the cleverest proportionate actuators, the Flyball actuator, mounts on a single-ply chassis, and consists of a Hi-Drive electric motor connected to a governor. As the governor whirls, it expands radially, and therefore has linear contraction. This movement pulls in a rod to move the control in proportion to the movement of the governor. When the motor slows down, the governor reverses the action. A coil spring or rubber band is attached to one side of the rudder, tending to hold it hard over when the governor is relaxed, corresponding to the slow motor condition. When the governor pulls in, it overcomes the pull of the spring to move the rudder toward the opposite side. Here again the actual rudder position depends on the length of the signals being sent, because the receiver's relay favors either a pulled-in or dropped-out contact, as the case may be, with the actuator speed varying accordingly.

### Multichannel Units

For prices ranging from approximately \$150 to \$225, the well-heeled hobbyist can purchase any one of the perhaps half dozen multichannel units now in widespread use or, if he is experienced with electronics, he can dream up his own. But consider that a five-channel receiver makes use of a reed bank; the five relays cost nearly \$40 by themselves. The three-channel receiver ordinarily would operate semi-proportionate type servos for left and right, and some manner of engine control from the third channel. Or, by properly combining a reworked escapement on one channel, that channel can work a rudder servo, leaving two channels free for other uses. Inasmuch as compound escapements or multiservos, or other actuators, can be used with each of the remaining two channels, an almost infinite number of controls can be effected. The possibilities of a five-channel set defy description: on-and-off running lights, raising flags, even lowering a dingy, are a few examples. One chap has music coming out of his river boat!

Kit manufacturers have some sensational ideas up their sleeves. This boat business is much more than a passing fancy. Try it and see!

# R/C Frankie

By CARL KOHLER

"GREAT SAINTS IN THE MORNING!" gasped the wife, her eyes bright with horror. "What is that . . . *that* Thing?"

I smiled a tolerant smile and leaned nonchalantly against my masterpiece. We electronic geniuses have to take the emotional tides of the laity in stride. There are those in my neighborhood who claim that my knowledge of radio could be stuffed in a transistor and still leave room for a ton of silicon; but I prefer to think of myself as a valiant pioneer, slashing new trails in the wilderness of electrical achievement.

"Jazzy, eh!" I chuckled, tapping the just-completed robot with a screwdriver. "You're gazing upon the greatest little gizmo ever to be welded, soldered, and bolted together. Frankie, here, will make us the envy of the . . ."

"Frankie?" her voice teetered on a hysterical note.

"Yes," I simpered modestly, "Frankie—short for Frankenstein. Pretty appropriate, huh?"

She stared at the robot with open distaste.

"B-but what is it?"

"A metal-alloy robot powered by electric motor and operated by radio control," I chanted factually. "Frankie stands exactly five feet tall, moves on three wheels, one of which acts as directional-guider."

"What's that?" she indicated the antenna.

"Pickup aid for Frankie's receiver—which receiver consists of superregenerative detector, two stages of audio amplification, and two relay stages . . . operating on the Citizens Band at 27.255 mc. Signals are sent by a crystal-controlled transmitter unit."

"How's that again?"

"You heard me," I said curtly.

"Why did you paint that awful face on the Thing?"

"Please don't refer to Frankie as 'the Thing,'" I asked with quiet dignity. "He's going to be a very important member of our family. You want to hurt his feelings?"

"It . . . has . . . feelings, *too*?" Disbelief shone across her face. "Who're you kidding, Buster! You talk as though the darn thing was alive!"

I jabbed the *start* button on the control-unit. Frankie rolled toward her on silent rubber wheels. I jabbed *stop*.

"Yeep!" screeched the wife, nimbly leaping atop the workbench. "Did you see it! Did you see it move! It *moved*!"

"Natch," I replied calmly. "That's what Frankie's built to do—move around. Think of all the heavy carrying tasks he'll serve!" Enthusiastically, I patted the rack welded into his body. "Old Frankie here will see to it that we suffer no more tired arms and aching backs from carting trash out to the alley, lugging heavy baskets of wet-wash out to the clothes-lines . . ."

"Hey!" she chirped, climbing off the workbench, "can he push a lawnmower?"

I blushed and lowered my eyes sheepishly.

"What do you think I invented him for?"

Five minutes later we gathered on the backyard lawn for a trial run. I tied the lawnmower securely to Frankie's rack and stepped back. "Ready," I intoned solemnly. A touch on the *start* button, again, and the robot rolled forward smoothly, the mower clattering industriously before it—a nicely cropped wake of lawn behind both. I dropped into a chair and sprawled there comfortably, watching with immense satisfaction.

"He's almost to the edge of the lawn! Watch out he doesn't go through the pe-

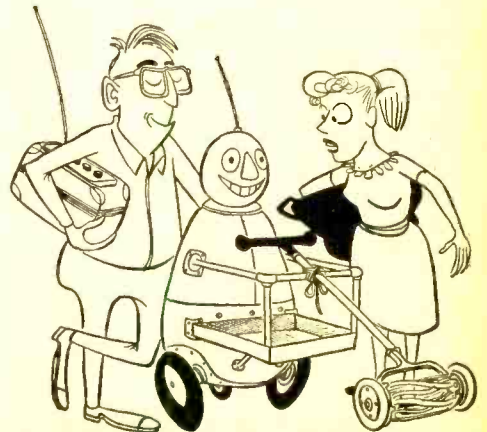

"What is that . . . THING?"



"It's bound to tip over . . ."

tunias" urged the wife nervously. Her eyes followed Frankie's progress anxiously.

"Relax," I advised. Methodically, I jobbed the *left* button. Frankie turned sharply, his motor whirring faintly. When he reached the edge of the lawn again, I simply repeated the control and he obeyed instantly. "See what I mean?" I said, trying to keep the triumph out of my voice. "Simply a matter of getting timing right."

"It's amazing!" she breathed. "But how do you keep him from going over the same ground every time?"

I quickly jabbed the *left* button twice and Frankie moved slightly to the left of his course, straightening out upon the second touch upon the button.

"Terrific!" babbled the wife.

"Complex escapement," I murmured evenly. "Took a lot of thought. I believe in being thorough, you know."

"Yes, I know."

I searched her face for a sign of sarcasm, but found none. Her attention was glued to Frankie, who was shoving the mower accurately around the yard. I showed her how to operate him and lay back with my hands behind my head, giving myself up to analytical thought concerning other possible chores Frankie might take over. Life was definitely going to be a brighter experience.

"Hey! Hey!" cried the wife in alarm, jabbing the buttons on the control-unit case. "Hey, the damn thing's acting crazy!"

I snapped out of my reverie to see Frankie whirling madly.

"Stop punching all those buttons! Here, give me the—"

Without warning Frankie straightened

out and headed for the bottom of the garden. I touched the *stop* button. Frankie picked up speed, his motor buzzing furiously. I bit my lip and calmly forced myself to try the *right* button. Frankie bounced over the brick border and plowed through the tomato plants without altering course.

"Do something!" yelled the wife.

Frantically, I began jabbing all the buttons. Frankie hit a wheelbarrow, ricocheted—lumbered off again, tomato vines flying wildly behind him.

"It must be the receiver!" I decided aloud. "Something's gone wrong with his receiver!"

Frankie crashed through the garden gate in an explosion of splintered wood and disappeared into the yard across the alley. A moment later, a woman's high, prolonged scream ripped through the quiet afternoon.

The wife and I stared at each other in horror.

"Y-you've got to stop that t-thing!"

"Come on!" I shouted, leaping to my feet. "It's bound to tip over or come to a stop soon. We've got to retrieve it before the whole neighborhood—"

To the steady, terrified screams across the alley was now added a yowling cat, the enraged barking of a dog, and the rising voice of a shaken man expressing his fright in colorful, if hardly proper, language.

Frankie's trail was easy to follow. A close-cropped swath of flowers, plants and broken trellis frames led me through the Johnsons' yard. Mr. Johnson burst out of  
(Continued on page 121)



In the center of the pool—sat Frankie draped with vines.



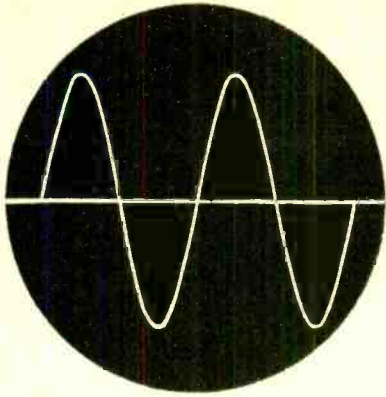

Fig. 1. Waveform of pure sine wave as seen on an oscilloscope screen.

# DISTORTION in Hi-Fi equipment

(PART 1)

By NORMAN H. CROWHURST

SOMETIMES, WHEN LISTENING to a message recorded by a poor dictating machine, the original message is difficult to recognize. This is an indication of very definite distortion, which probably includes every kind of distortion known. There would not be much point in bothering to designate how much of each kind of distortion is present in that example, but in the better kind of modern audio, such as high fidelity equipment, it is necessary to be more specific about the precise nature of the distortion. This is so because the reproduction is much closer to a faithful replica of the original sound, and such information is needed if we are to improve upon high quality systems.

In the broadest sense of the word, distortion can refer to any manner in which the reproduced sound fails to be an exact replica of the original sound.

From the electronic viewpoint we are more concerned with the electrical waveforms than the sound they are responsible for. The sound wave striking the diaphragm of a microphone consists of air pressure fluctuating in accordance with a certain pattern. This produces a corresponding electrical pattern of fluctuation, or wave in the circuit of the microphone, which in turn is amplified and either is reproduced by a loudspeaker as a sound wave, or is recorded on tape or wax for reproduction at some later time. In any event, a copy of the original sound is eventually reproduced by a loudspeaker.

Thus, we are concerned with insuring that the electrical waveform applied to the voice coil of the loudspeaker is an exact replica of the electrical waveform

produced by the original microphone, only very much bigger.

This leads us quite naturally into the question of methods of recognizing distortion. The final criterion, of course, is how the reproduced sound appeals to the ear, so a listening test is always a good method of judging the value of whatever measurements we make. But sometimes it is difficult to know exactly what we are listening for. We can tell, by listening, that there is something different about the sound from what it should be, but we do not know exactly what the difference is. This is where the various kinds of measurement to determine the nature of the distortion prove of great value.

## Equipment

The simplest method of checking waveforms is to view them on an oscilloscope. This is an instrument employing a cathode-ray tube very similar to the picture tube of a TV receiver, except that it is somewhat smaller and uses, as a rule, a color-luminescent screen instead of the white-glowing screen used for TV. The waveform to be viewed is connected to the input terminals of the oscilloscope and, by adjusting what is called the time-base or sweep frequency, it is possible to view successive sections of the waveform on the screen of the oscilloscope.

It is surprising how often a quick look at the pattern displayed on the screen of an oscilloscope can show just what is wrong with the sound which may have been a little puzzling to the ear. But, although the oscilloscope is a very simple and effective method for quick diagnosis of major

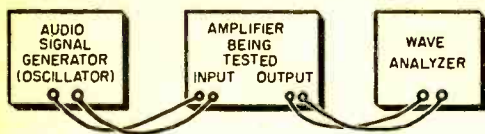

Fig. 2. Setup for using an audio signal generator with a wave analyzer for measuring certain kinds of amplifier distortion.

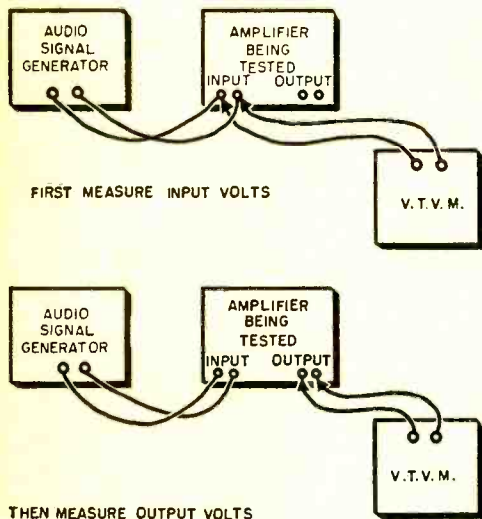
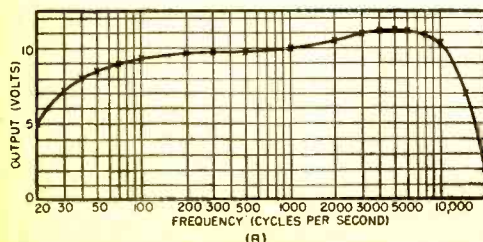
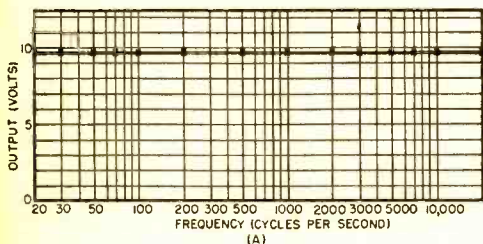

Fig. 3. Method of using an audio signal generator with a vacuum-tube voltmeter to measure amplifier frequency response.

Fig. 4. How to plot the results of frequency response measurement: (A) shows a response where the output at all frequencies is the same for the same input; (B) shows a more common kind of result.



troubles, it is somewhat ineffective in the struggle for perfection. This is so because the ear can be extremely sensitive to minute degrees of distortion, which are insufficient to show up as a variation in the shape of the trace displayed on an oscilloscope screen. So we will also need some various kinds of special test equipment to enable us to track down these more elusive kinds of distortion.

The most useful of these items of equipment is probably the audio signal generator. This is an electronic device that produces a single pure tone of any desired frequency. A single *pure* tone has the characteristic of producing a waveshape that is a pure sine wave, known as sinusoidal. This shape is shown in Fig. 1. The audio signal generator, or oscillator, as it is often called, can be connected to the input of any piece of audio equipment in place of program material. Then, instead of having a whole range of frequencies to be handled at once, the behavior of the equipment can be carefully checked with any one frequency by itself.

Another important item of equipment is an a.c. vacuum-tube voltmeter (v.t.v.m.) which is used to measure the audio voltage at different points in the audio equipment. It can be used for checking, or measuring accurately, the voltage of the test frequency at the input and then at the output of an amplifier. Input frequency and voltage can then be changed, and the voltmeter will help show whether the output is a faithful reproduction of these changes. The v.t.v.m. can also be used for fault-tracing inside the amplifier or other equipment.

A refined type of vacuum-tube voltmeter is called a wave analyzer. This incorporates a filter arrangement that selects any desired frequency for the vacuum-tube voltmeter to measure. When a single pure sinusoidal frequency is applied to the input of an amplifier, the wave analyzer can be connected to the output as shown in Fig. 2. The frequencies coming out of the output can then be checked on the wave analyzer. If the amplifier is free from distortion, the only frequency coming out will be the same as the input frequency. But if the amplifier is causing distortion, there may be other frequencies coming out that were not put in. The wave analyzer will find these other frequencies, even though they may be quite small in comparison with the main frequency, and will measure them separately so that an exact measure of the amount of distortion present can be obtained.

With some idea of the simple forms of equipment that can be used for measuring and locating distortion, we are in a better

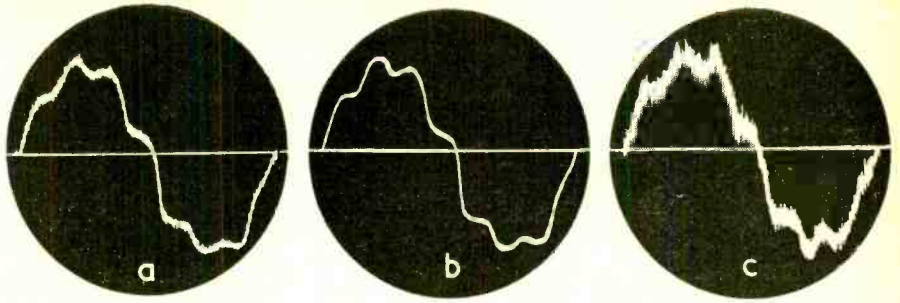
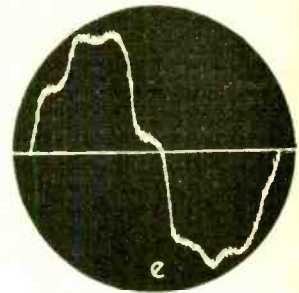
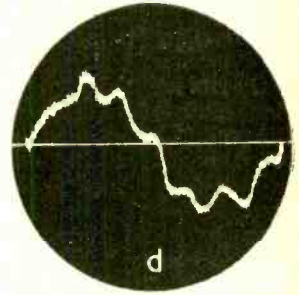

Fig. 5. How frequency response shows up when displaying a sound program on the oscilloscope screen: (a) is the wave presented "flat"; (b) shows high frequency loss; (c) high frequencies over-accentuated; (d) low frequency loss; and (e) low frequencies over-accentuated.



position to differentiate between the different kinds of distortion.

### Frequency Response

The easiest kind of distortion to measure or to observe on the oscilloscope screen and possibly the easiest to recognize by listening is distortion of frequency response. Equipment is said to have a flat frequency response if the same input voltage at all frequencies produces an output which is also equal at all frequencies. However, this ideal is often not achieved. The output at some frequencies may be less or more than the output at other frequencies. This defect is known as frequency response distortion.

The simplest way of measuring this particular property is to connect the oscillator to the input of the equipment using a vacuum-tube voltmeter to check that the waveform applied at the input is always of the same voltage. The vacuum-tube voltmeter is then connected to the output at each frequency and the output voltage is measured. Figure 3 shows the arrangement. If two vacuum-tube voltmeters are available, this will make the procedure much quicker because it will relieve the repeated necessity of transferring the single voltmeter from input to output.

When a series of values of output voltage has been taken at different frequencies, a graph can be plotted, as in Fig. 4, joining up the points taken. If this graph is a straight level line, then the response is said to be flat. Here we can see how the true response gets the name "flat." If the response is not flat, but goes up or down at different points along the line, then there is frequency response distortion.

This kind of distortion can also be detected, particularly if it is serious, by looking at the trace made by program material on an oscilloscope screen, or by listening to

reproduced sound from program material with the aid of a loudspeaker.

Figure 5 shows a series of traces representing the same piece of sound: (a) is the waveform of the original sound without any form of frequency response distortion; (b) shows the effect of reduction of the high frequencies—the wave envelope looks considerably smoother; (c) shows the effect of over-emphasizing the high frequencies—the waveform looks considerably rougher; (d) shows the effect of reducing the low frequency components—the slow fluctuation has been reduced but the smaller parts of the pattern remain similar; (e) similarly shows the result of over-emphasizing lower frequency components.

In listening, the effects of these changes in frequency response are fairly well known: (1) deficiency in high frequencies results in loss of brilliance—the sound seems too woolly and speech loses its definition, "esses" and "tees" particularly seem to be missing; (2) over-emphasis of the high fre-

(Continued on page 128)

# Picking Your Pickup

By HANS FANTEL

*An aid to the selection of the proper cartridge to suit individual hi-fi requirements.*

OF THE BASIC ELEMENTS of a hi-fi installation—pickup, amplifier, and loudspeaker—the pickup is the most generally misunderstood, neglected, and misused. Amplifiers present few, if any, problems in high-fidelity systems. For despite the partisan debates between triode and pentode fanciers and the publicity fanfares at the launching of every new circuit, the fact remains that nearly every modern high-quality amplifier is capable of handling the electric equivalent of practically any musical sound. The transducers, i.e., pickups and loudspeakers, have the more difficult task of translating information from one medium to another—from mechanical to electrical, and vice versa. Largely because of the mechanical factors involved, this translation presents a tricky problem and all existing solutions—though some are amazingly good—are far from perfect. In choosing a loudspeaker, the audio hobbyist receives a fair amount of guidance from the manufacturer's specifications, particularly in terms of frequency response and power-handling capacity. But, as in buying any musical instrument, the best guides—though often contradictory—are the ears and the pocket-book!

## Crystal Pickups

In a crystal pickup, the moving stylus is linked with a crystal (usually of Rochelle salt) whose mechanical deformation sets up an electrical signal proportional to the stylus motion. This is the most common type of pickup found in ordinary commercial phonographs. Its popularity is due partly to its cheapness and partly to the great simplicity of its associated circuits. Since the voltage generated in such a pickup is proportional to the amplitude of the stylus deflection, the wide stylus swings of the bass notes give a stronger signal than the smaller but more rapid swings of the stylus for the treble tones.

The treble response of the pickup generally drops steadily above 5000 cps. Being strong in bass and weak in treble, the

pickup automatically provides just the kind of frequency compensation needed for playing LP records (which are recorded strong in treble and weak in bass). This means that crystal pickups need no complicated equalizer circuits. Since their outputs and impedances are high, they can be connected directly to a first amplifier stage without any preamplifiers or matching transformers. Thus, they are extremely practical for small and simple systems where cost rather than fidelity is the prime consideration.

Crystal pickups vary greatly in design and quality. One factor to note particularly is the mechanical compliance of the stylus, i.e., the ease with which the stylus moves from side to side within the record groove. The force needed to twist the crystal is "work" that must be done by the record. This is an inherent disadvantage of the crystal cartridge. But clever design of the mechanical linkage between the stylus tip and the crystal can reduce the mechanical stress on the groove walls and thus lengthen record and stylus life. A fair idea of stylus compliance may be obtained by moving the stylus *very* gently from side to side with the tip of a finger. It should not feel excessively rigid. Crystal pickups using straight needles and needle chucks with a thumb screw should be avoided, especially for microgroove records. The most compliant styli are shaped somewhat like a crank with the main part of the shaft parallel to the record groove.

## Ceramic Pickups

Within the last two years, ceramic pickups have been widely and successfully used in place of crystal pickups. Ceramic pickups operate exactly like crystal pickups, except that their working elements don't happen to be crystals in the strict physical sense. They have the advantage of an extended and very flat frequency response (20-20,000 cps  $\pm 2$  db). While crystals tend to spoil at temperatures higher than 105° F and in moist climates, the ceramic

---

An example of modern crystal cartridge design is this Astatic "Model 66 Series" pickup cartridge which has an output of 3 volts with a 1-megohm load. The Astatic "68 Series" actually has a higher output of nearly 4.0 volts. Both types are made in single-needle and double-needle models with various diameter tips, and are superb where an extremely high output is required. The crystal element is moisture-proof.

---



---

The Ronette 20-284P crystal phono cartridge is a recent imported unit now being widely distributed in the United States. Recommended load for this cartridge is about 120,000 ohms. Output is claimed by the manufacturer to be 150 millivolts; it has been purposely maintained at a low level to improve high frequency response. Response is approximately equal to the RIAA curve up to 1000 cycles and then 4 db above the curve. The cartridge is also tropicalized.

---



---

Electro-Voice "Ultra-Linear" Model 84 ceramic exemplifies the important features of this type of cartridge. Response is within  $\pm 2.5$  db from 20 through 15,000 cps. Output is of the order of 0.5 volts working into a 3-megohm load. Using this type of cartridge, no preamp is required and hum pickup is virtually eliminated. Diamond or sapphire styli are available.

---



---

Of the ceramic type cartridges, the Sonotone 1P probably has the highest output. It has been reported to have an output of 1.0 volt across a 2.5-megohm load. Frequency response is within  $\pm 3$  db from 30 to 15,000 cycles. Either sapphire or diamond needles are easily snapped into position. Typical of the ceramic cartridges, this model also features very high compliance which enables excellent tracking.

---

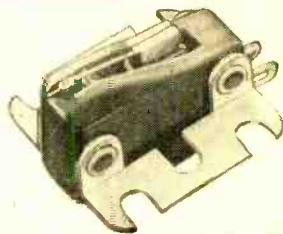

---

The latest ceramic cartridge to appear on the market is the Shure Brothers "Music Lover." The manufacturer claims that this model will introduce a trend in phono cartridges. Essentially it consists of provisions to replace the usual magnetic cartridge with a ceramic pickup and a very small adapter that couples the output into the "magnetic" input of the amplifier. The "Music Lover" plus adapter is said to weigh about the same as a magnetic cartridge. Flopover styli are employed.

---



---

Earliest popular variable reluctance cartridge was the General Electric Model RPX, which introduced to the hi-fi enthusiast the possibility of full frequency coverage from 30 through 15,000 cycles. It remains quite popular and is currently available with either diamond or sapphire styli. Recommended stylus pressure is 6 to 8 grams. Stylus is changed by rotating small knob at top of cartridge.

---

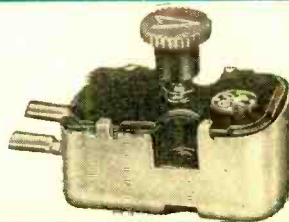

cartridge is unaffected. Ceramic cartridges have a high output and a high terminal impedance; their circuit requirements are as simple as those of crystal pickups. A ceramic cartridge designed for proper stylus compliance gives very good results with great economy of means. It is not surprising, therefore, that ceramic cartridges have steadily grown in popularity during the short time that they have been on the market.

### Magnetic Pickups

The magnetic pickup works by letting the metal shank of the stylus move between two magnetic pole pieces, inducing an electrical signal proportional to the mechanical motion. Others work on the moving coil principle. Unlike the crystal or the ceramic pickup, there is no actual mechanical linkage between the stylus and the electric system of the cartridge. In fact, the total vibrating mass of the magnetic pickup is often negligible. This means that the mechanical compliance of such cartridges is very favorable; the stylus need not work against the mechanical resistance of the linkage levers. It can follow the more rapid oscillations of the record groove with less inertia, thus tracking the high frequencies more faithfully and imposing less wear on the more vulnerable features of the record groove. This mechanical compliance, in part, is responsible for the silky, smooth quality of the higher frequencies as heard through magnetic pickups.

As the output of a magnetic pickup is usually only about one-tenth of the output of crystal or ceramic cartridges, a special preamplifier is required. Nowadays, practically all commercial high-fidelity amplifiers have such a preamplifier built in. The preamplifier circuit also provides the necessary impedance-matching between the low terminal impedance of magnetic pickups and the high impedance of ordinary amplifier inputs.

The magnetic cartridge is a velocity-modulated device. This means that the voltage of the signal depends on the speed of the stylus movement. Since the stylus moves faster at high frequencies than at bass notes, the output of the cartridge is nonlinear (weak in bass) and must be compensated for by a bass boost over and above the bass boost needed for proper record compensation. Such a compensating circuit for boosting frequencies below the 500-700 cps range is incorporated in the preamplifier in all modern high-fidelity amplifiers. With this compensation, magnetic cartridges give exceptionally clean reproduction throughout the entire audible range. The clean reproduction, as well as

the moderate-to-medium price range, has made the magnetic cartridge the most popular type of high-fidelity cartridge.

Such a cartridge has one drawback: it easily picks up hum from stray magnetic fields, most likely from the turntable motor or from a.c. lines. Since the output of the magnetic cartridge has to be so highly amplified, all possible sources of hum must be carefully kept away from the pickup. Only 4-pole turntable motors should be used and the pickup leads must be carefully shielded. When steel turntables are used, it is sometimes advisable to put a foam-rubber mat between the turntable and the record to reduce the magnetic attraction that develops between the magnetic pickup and the turntable. This will reduce the tendency to "pull down" the pickup against the record.

### Special Designs

For those with an eye for beauty, and an ear for excellence, the *Ferranti* ribbon pickup and the *Weathers* FM cartridge should be mentioned.

The *Ferranti* cartridge and arm are small, space-saving, and assure tracking at only 3 grams pressure. A special protective mechanism makes it impossible to damage either the stylus or the record, even if the arm is accidentally dropped on the record. The elegant simplicity of the *Ferranti* pickup and arm, whose entire suspension mechanism is below the turntable, is demonstrated in the photograph on page 79. The *Ferranti* requires a matching transformer (supplied by the company) for connection to standard audio inputs of 100,000 ohms.

The *Weathers* pickup tracks at a pressure of only 1 gram! That can't be beat for gentleness to records. Provided that the records are kept reasonably dust-free, they are bound to last almost indefinitely with this pickup, and not even their most delicate overtones will be scratched from their grooves. Actually, the *Weathers* pickup is more than just a pickup. It is a FM system with several components. An oscillator generates a carrier while the pickup itself is merely a small variable capacitor which modulates the oscillator output with the signal from the record groove. The oscillator takes little space, but naturally it needs power connections. No preamplifier or matching transformers are needed. The pickup can be connected directly to a ½-megohm amplifier input.

Both the *Ferranti* and the *Weathers* are definitely expensive. But if the other parts of the rig, and last but not least, the records are of the same high quality as these pickups, such an investment may be justified.

Fairchild "220 Series" moving coil cartridge has a frequency response from 20 to 17,000 cycles, with a deviation of less than  $\pm 2$  db. Extremely low needle talk and distortion-free playback is claimed, and low impedance output (170 ohms) at about 5.0-mv. A diamond stylus is supplied affixed to stylus arm. This cartridge, like most of the others pictured on these pages, may be easily mounted in standard pickup arms.



The Pickering "Model 260" is a turnover cartridge so arranged that mechanically it consists of two separate cartridges—Series 240 for microgroove records and Series 220 for standard 78-rpm recordings. This magnetic cartridge has special shielding. Relatively high output of 30 mv. (27,000 ohms load) is claimed to mean less amplification and less chance of extraneous hum pickup. Response is flat from 30 to 8000 cycles with a rise of 2 db at 14,000 cycles.

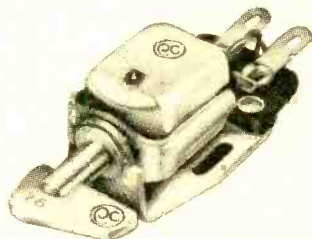

Electro-Sonic cartridges have a frequency range of 20 to 10,000 cycles with a perfectly flat response. The curve then rises gently to about + 1.5 db at 15,000 cycles and 2 db at 20,000 cycles. Output is extremely low, measuring about 1 mv. at an output impedance of 1.5 ohms. The minimum stylus force may be as low as 3 grams. Diamond or sapphire needles are available from the manufacturer.

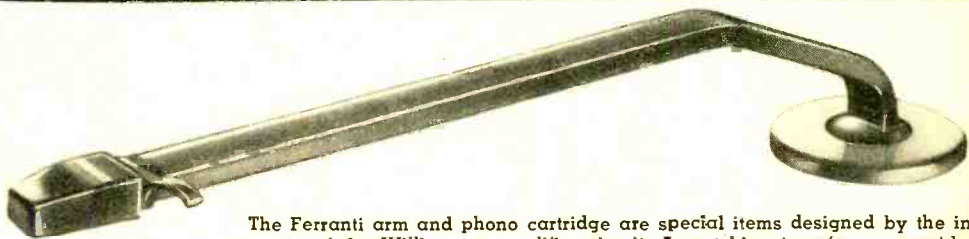
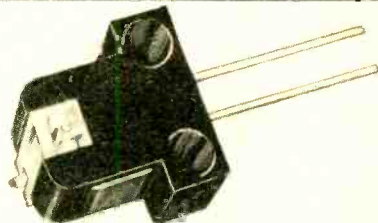

The Ferranti arm and phono cartridge are special items designed by the inventor of the Williamson amplifier circuit. A matching transformer provides about 15-mv. output. Frequency response is within  $\pm 1.0$  db from 20 to 20,000 cycles. Arm and cartridge track at recommended stylus pressure of 3 grams.



For maximum enjoyment of hi-fi recording, regardless of price, the advanced enthusiast can do no better than the Weathers FM pickup system. Compliance is extremely high, and response is essentially flat from 20 through 20,000 cycles. Tone arms, cartridges and complete turntable assemblies are available with either diamond or sapphire needles. The tracking force is 1 gram.

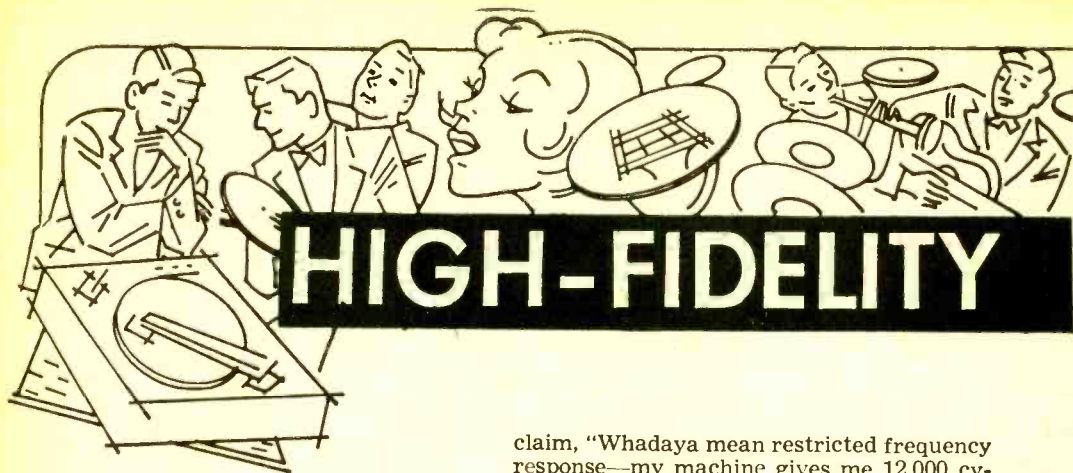

## Tape Recorders

LAST MONTH we began a series of articles on tape machines and tape recording. You may recall that we investigated the "idealized" tape recorder and spent a little time on the techniques of recording with tape machines in the lowest priced category. As promised, this month will be devoted to a discussion of tape machines in the \$80 to \$150 class and the technique of recording music with such equipment.

First of all, let's face a few hard facts of life—even with the top machine in this class, you still will not be able to achieve "professional quality" music recording. No doubt about it—some of these units can produce some pretty decent tapes, but by "professional" standards they are sadly lacking in many respects.

Let's look at some things which are not too readily apparent with units in the price range under discussion. Take the magnetic heads for example. In the less expensive machines, the same head functions as a record and playback unit. It has been pretty thoroughly demonstrated that the gap area which is optimum for a record function is not optimum for a playback function. Hence, all of the professional machines have *three* heads: erase, record, and playback. Of course, the third or playback head is there for other reasons and conveniences, such as monitoring the program which is being recorded.

With this knowledge then, it is not hard to realize that the single record/playback head furnished with the low-priced tape machines is actually a compromise. As such, it has a somewhat restrictive effect on frequency response and signal-to-noise ratio. Right about here there will be more howls! Some outraged tapeworm will loudly pro-

claim, "Whadaya mean restricted frequency response—my machine gives me 12,000 cycles at  $7\frac{1}{2}$ " per second!" Well, this is usually more a case of advertising claims on the part of the manufacturer than anything else, but assuming that the unit actually gets close to the 12,000 cycles, let's see how this figure is achieved.

An extremely small gap area will give improved high frequency response, but remember—there is a compromise head on this unit, so such a minute gap is not feasible. What the manufacturer usually turns to is the equalization circuits. By boosting the treble equalization in the preamp as much as 23 db, the 12,000 cycles become possible. *But* this boosting is not done without incurring a penalty. Harmonic and intermodulation distortion are appreciably increased; there is at least a 5 to 6 db deterioration of the signal-to-noise ratio; and perhaps worst of all, you wind up with a machine which has a non-standard (not NARTB) equalization curve. This latter fact is why many people are unhappy with the results they have heard in the playback of pre-recorded tape. There is much complaining about "thinness" and "stridency", etc. Of course, the tapes sound that way! With the phoned-up equalization, what else can result? In other words, you may be getting 12,000 cycles, but not with professional quality. However, to allow one ray of sunshine into this seemingly gloomy picture—remember that tapes *made on your machine* and *played back on your machine* will get the benefit of the added frequency response and generally will sound pretty normal as far as balance, etc., is concerned.

Looking at the \$80-\$150 class of tape machine from the mechanical viewpoint, we find that here too we have a source of trouble. In order to achieve good recordings, the tape must pass over the record head smoothly and at an extremely uniform rate. In professional machines this uniformity of motion is in the greater measure due to the employment of special synchronous

(Continued on page 115)





# REPRODUCTION

## DISC REVIEW

THIS MONTH WE WILL PAY TRIBUTE to that living legend of music, Jan Sibelius. 1955 will see homage to this great composer as he approaches his 90th year! The music of Sibelius is among the most rewarding in the symphonic repertoire. A man who always had his heart close to nature, he has written some profoundly beautiful works. He has composed seven symphonies up to the present time. There is much speculation that other symphonies have been written, but none has been published and the general feeling is that none will be published except posthumously. The seven symphonies just about reflect the life and philosophies of this composer. The *First* and *Second* are unabashedly romantic, the *Third* is bright and courageous. In the *Fourth* we have the nature lover with brooding overtones, and the *Fifth* and *Sixth* represent massive power combined with almost other-worldly mysticism. The *Seventh* is a return to purer musical forms and is somber and again brooding.

Sibelius is among that unique group of composers like Ralph Vaughn Williams whose total symphonic output has not only been published but recorded within their lifetime. Sibelius has been particularly well served on LP and many recordings have been made of the seven symphonies. So it behooves us to see which are really good hi-fi recordings and which to avoid.

The *First Symphony* is one of the most popular of the seven and has had five LP recordings. Of the five, three can honestly be described as hi-fi in sound, with, however, the other two not the worst sounding records by any means. The Collins reading on *London* LL574 is the best sounding of all with fine clean string tone, nice bright brass, and the important tympani reproduced with startling accuracy. The Collins performance is quite good—solid without

being sensational. Leopold Stokowski's version on *Victor* LM1125 is next in choice for sonic splendor. Not as wide range in frequency response or dynamics as the *London* recording, it does have virtues of its own such as particularly lush strings and woodwinds of great beauty of tone. The brass is cleanly reproduced but not as brilliantly as was *London's*. The tympani are somewhat subdued here, lacking the impact heard on the Collins disc. Stokowski's performance packs a lot of authority. Certainly he gets the most out of the score with his expert handling of dynamics and expression. Sixten Ehrling's recording on *Mercury* 10129 is probably closer to the composer's intent than any of the other versions. He shows respect for the composer's markings for tempi and expression and indulges in few conductorial whims. The sound here is not the splendor of the justly celebrated "Olympian Series," but derives from one of *Mercury's* overseas affiliations. As such, it is good clean sound with particularly good percussion and brass, but with strings that are slightly on the wiry side. Frequency response is somewhat limited but dynamic range holds up well. Summing up, the best sounding disc is definitely the *London* and the best performance is the Ehrling reading.

The Sibelius *Second* is the most popular of all his symphonies and the one which most people associate with his name. Because of this popularity, it has received the most recording and eight versions are in the catalogue. Again, only three can truthfully be termed hi-fi in sound quality. The very latest recording, that by Leopold Stokowski, is the best from both the sound and performance standpoints. The *Second* is the height of musical romanticism and in this kind of repertoire Stokowski is un-

(Continued on page 119)

# Simple TV Interference

By **WALTER H. BUCHSBAUM**

OF THE various types of signals that can interfere with TV reception, perhaps the most prevalent are from strong transmitters located nearby. Such installations as police radio, amateur transmitters, industrial r.f. heating and diathermy machines, may radiate signals which are amplified by the TV set and interfere with the picture. A typical case of diathermy interference is shown in Fig. 1. When interference is present on all TV channels, or at least on channels 2 to 6, it is most likely from one of these sources.

In most instances these interfering signals are picked up by the TV antenna and brought to the tuner where they override the TV channel selecting circuits and pass through the i.f. and video sections to the picture tube. For this reason, the best place to eliminate these interfering signals is right at the antenna terminals of the TV receiver. In extremely stubborn instances the TV receiver chassis may pick up the interference and then other measures are necessary which a TV serviceman is best qualified to handle. For many interference cases, however, the electronically minded layman can build some simple filters to cut out this type of interference.

The television frequencies extend from 54 mc., channel 2, all the way to 890 mc., channel 83, while the intermediate frequencies used in practically all modern TV receivers are either from 21 to 26 mc. or from 41 to 46 mc. Therefore, any signal below 54 mc. can, in some form or other, cause interference.

Two types of filters are described here. One type is called "high-pass" and passes only signals above the 54 mc. limit of channel 2. This filter cuts out all lower frequency signals, regardless of their individual frequency. Figure 2 shows the appearance of a typical "high-pass filter" designed for the 300-ohm balanced twin-lead commonly used as TV transmission line. All the parts are standard items available from any radio distributor. The shield can of an old broadcast i.f. transformer can be used together with almost any kind of terminal. The electrical arrangement of the components is shown in Fig. 3.

All coils are wound on 1-watt carbon resistors. The resistance value is not critical, as long as it is higher than at least 220,000 ohms, since the main purpose of the resistors is to serve as simple, inexpensive coil forms. Any style of capacitor can be used, except the paper tubular type. This type has some inductance at the higher TV channel frequencies.

One advantage of the filter shown in Figs.

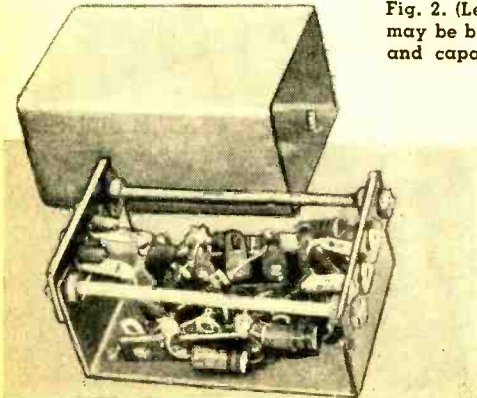
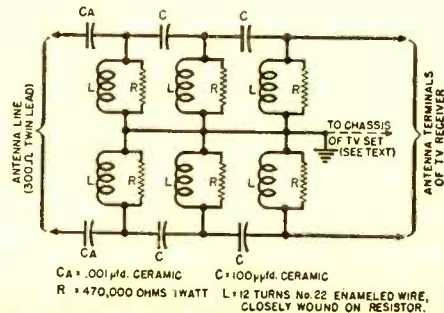

Fig. 2. (Left) The circuit shown in the schematic below (Fig. 3) may be built into an old i.f. transformer can. The resistor chokes and capacitors are mounted on five-point terminal tie strips.



# Trap



Fig. 1. Example of TV interference cured by inserting one of the filters described in this article.

2 and 3 is the fact that no tuning is necessary and none of the components are critical. This type of filter is recommended where the interference is quite severe and its radio frequency is not known. Often in such cases the a.c. power line is also a source of interference and a commercially available power line interference filter may have to be used in addition to the antenna filter.

Figure 4 shows a single frequency, balanced filter, often called a "band rejection" filter. Using two 2-watt carbon resistors as coil forms and a dual trimmer capacitor from an old i.f. transformer assembly, the filter comprises two series resonant circuits. At the frequency to which the filter is tuned, these series circuits present a short circuit bypassing it from the antenna terminals. Carefully assemble the filter as shown in Fig. 5, being sure to wind the two coils as neatly as possible. Then connect it between the transmission line and the TV receiver terminals. When the interference

is present, tune each trimmer capacitor in turn for minimum interference on the screen. Be sure to use a non-metallic screwdriver to avoid hand capacity effects.

Both Figs. 3 and 5 show a dotted line connection to the TV receiver chassis which in some instances will help in the interference elimination. Where the metal chassis is easily accessible from the rear, it is often possible to loosen some screw and slip a solder lug or wire under it for use as a ground for the filter.

It should be kept in mind, however, that there are other sources of interference from signals above the 54 mc. limit of channel 2, which cannot be eliminated by means of an antenna filter such as the one shown here. Typical of these are interference from neighboring TV sets, FM stations, and various aircraft radio systems. A qualified TV serviceman usually is familiar with the types of interference prevalent in his neighborhood and knows just which remedy will work best.

-30-

Fig. 4. (Below right) Filter may be tuned as shown schematically in Fig. 5. The text describes how this may be accomplished and why it is necessary when using certain TV receivers.

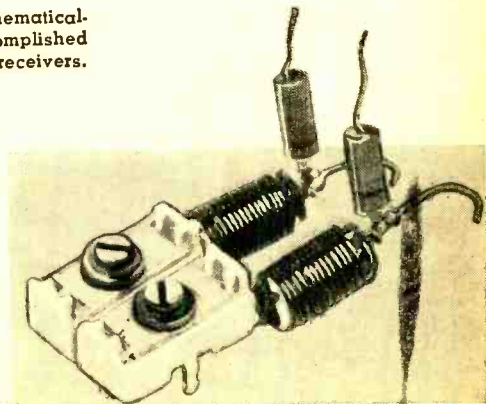
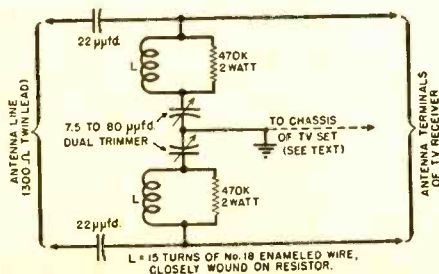

# AFTER CLASS

## RESISTOR AND CAPACITOR COMBINATIONS

RESISTOR-CAPACITOR COMBINATIONS (R-C) are given many bewildering names to distinguish one function from another. Classifications like coupling circuits, filter networks, differentiators, time-delay circuits and so on are just a few samples of these groupings. No wonder the novice often throws up his hands in discouragement at the seeming complexity of electronics. Yet, regardless of function or classification, every R-C combination may be shown to be a simple circuit in which a capacitor charges or discharges through a resistor over a given period of time. This action is merely applied in different ways to achieve various special results.

If a capacitor is connected through a resistor to a source of d.c., as illustrated in Diagram A, it does not reach full charge the instant that the switch is closed. A definite, easily calculated time is required for this process. All that one needs to know is the resistance in megohms and the capacitance in microfarads; these values are then substituted in the simple expression given below and the time required to reach full charge (actually about 99.6% of

100-volt d.c. source. If the voltage across the capacitor is measured after each second elapses from the time of closing the switch, results like these are obtained:

<i>At the end of:</i>		<i>The capacitor voltage is:</i>
0 seconds		0 volts
1 second		63 volts
2 seconds		86 volts
3 seconds		95 volts
4 seconds		98 volts
5 seconds		99.6 volts

Notice how the voltage at first rises very rapidly (63 volts during the first second). As time passes, the voltage changes during successive seconds become smaller and smaller until, during the fifth second, the increase is less than two volts. This is typical of the capacitor charging process.

Should the charging battery now be replaced by a connecting wire (Diagram B), the capacitor behaves like a voltage source and promptly starts sending a current through the resistor. Again, at the end of a five-second interval, the discharging process is practically complete, indicating that time for charge and discharge in a particular circuit is the same.

See how the formula works out with somewhat different values, say, 15,000 ohms of resistance and .01  $\mu$ fd. of capacitance. The time for full charge is:

$$\begin{aligned} T &= 5 \times R(\text{meg.}) \times C(\mu\text{fd.}) \\ &= 5 \times .015 \times .01 = .00075 \text{ second} \\ &= 750 \text{ microseconds} \end{aligned}$$

The microsecond, abbreviated  $\mu$ sec., is often a more convenient unit especially for the expression of very short intervals.

A very important application of these ideas is found in "bleeder" systems used on transmitter power supplies. During operation, the filter capacitors are charged to the full voltage of the power supply, often 1500 volts or more. When the supply is shut down, these capacitors retain a lethal charge unless they are "bled" or drained (Diagram D). The resistance of the bleeder must neither be too low nor too high. Assume that the lowest safe value of the bleeder to avoid excessive current con-

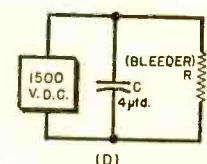
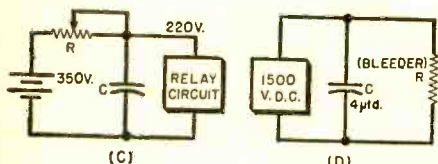
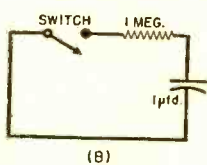
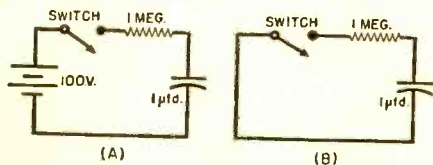

full charge) may be found by simple arithmetic:

$$\begin{aligned} \text{Time for full charge (seconds)} \\ = 5 \times R(\text{meg.}) \times C(\mu\text{fd.}) \end{aligned}$$

Consider a circuit like that of Diagram A in which a 1- $\mu$ fd. capacitor is being charged through a 1-megohm resistor by a

sumption is 25,000 ohms, that the power supply voltage is 1500 volts, and that the capacitance to be drained is 4  $\mu\text{fd}$ . How long will it take to discharge the capacitors fully?

$$\begin{aligned} T (\text{sec.}) &= 5 \times R (\text{meg.}) \times C (\mu\text{fd.}) \\ &= 5 \times .025 \times 4 \\ &= .5 \text{ or } \frac{1}{2} \text{ second} \end{aligned}$$

This time for discharging the capacitors is short enough to remove the hazard of accidental "discharge" shock.

The charge and discharge equations are more often expressed as follows to avoid the use of the number "5" before the  $R \times C$ :

1. Time required to charge a capacitor to 63% of the source voltage (seconds) =  $R (\text{meg.}) \times C (\mu\text{fd.})$
2. Time required to discharge a capacitor to 37% of its original full charge =  $R (\text{meg.}) \times C (\mu\text{fd.})$

For example, suppose a given capacitor is charged to 350 volts. Its capacitance is 1  $\mu\text{fd}$ . and it is to discharge through a 1-megohm resistor. What will be its voltage after discharging for 1 second?

$$\begin{aligned} \text{Time to discharge to 37\% of original} \\ \text{voltage} &= R \times C = 1 \times 1 = 1 \text{ second} \end{aligned}$$

Thus, at the end of 1 second, the capacitor will have discharged to 37% of 350 volts, or approximately 130 volts.

To show how these ideas may be used in building a timer, try this one: a charging capacitor is to trigger a relay circuit when it reaches 220 volts. The source voltage is 350 volts, the time delay desired is 8 seconds, and a capacitor of 2  $\mu\text{fd}$ . is available for use (Diagram C). At what resistance should the variable resistor (potentiometer  $R$ ) be set to trigger the relay? Also, what standard value potentiometer should be purchased?

$$\begin{aligned} T (\text{sec.}) \text{ for 63\% full charge} \\ &= R (\text{meg.}) \times C (\mu\text{fd.}) \\ 8 &= R \times 2 \\ R &= 8/2 = 4 \text{ megohms} \end{aligned}$$

Since  $.63 \times 350 = 220$  volts, the capacitor will charge to this potential—the trigger-

ing potential—with exactly this value of resistance. A 5-megohm commercial potentiometer would do nicely.

The following quiz is intended as a self check. All of the questions can be answered correctly if the foregoing text has been mastered. Answers appear on page 127.

## QUIZ

1. Is it ever possible for any capacitor to charge instantaneously?
2. In using the equation for charge or discharge, what units should  $R$  and  $C$  be expressed in?
3. If a charging resistance is 500,000 ohms, what figure should it be changed to before substituting in the equation for charge time?
4. If a capacitor to be discharged has a value of 2500  $\mu\text{fd}$ ., what value should be used in the equation?
5. How much time in microseconds is required to charge a .001- $\mu\text{fd}$ . capacitor through a 50,000-ohm resistor fully?
6. If the resistance through which a 1000- $\mu\text{fd}$ . capacitor is to discharge is 500 ohms, how long will the discharge process take?
7. If a filter capacitor of 10  $\mu\text{fd}$ . is to discharge fully in  $\frac{1}{2}$  second, what is the maximum size (resistance) of the bleeder?
8. A certain capacitor is to charge to full source voltage in 100 microseconds through a 5000-ohm resistor. What capacitance should it have?
9. A capacitor of 1  $\mu\text{fd}$ . discharges through a resistor of 1,000,000 ohms. If it was originally charged to 1000 volts, what will be its voltage at the end of 1 second?
10. A 10- $\mu\text{fd}$ . capacitor charges through a 10-megohm resistor. How long will it take to charge to 63% of the applied charging voltage? -30-

(Editor's Note: In response to many requests, efforts are being made to enlarge and to "program" the material appearing in this department. Portions of each column will soon be devoted to subjects not usually found in standard radio or electronic textbooks, such as micro-waves, digital computers, black boxes, propagation, etc. This material will be included in addition to the study items now being presented.)

## ATTENTION

- **Hobbyists**      ● **Club Members**      ● **Study Groups**

Subscriptions to POPULAR ELECTRONICS at special bulk rates are available to club members, study groups, employee groups, schools, etc.

**For information, write to:**  
**POPULAR ELECTRONICS**

Dept. 1016

366 Madison Ave.

New York 17, N. Y.

BOTH THE ACTIVE R/C FAN and the occasional dabbler with subminiature construction projects will find the "Universal Arm" assembly shown here a valuable addition to the lab. It may be used to clamp and to hold small chassis, miniature sub-assemblies, selector switches, terminal boards, coils and other components in just the right position for wiring and testing.

Taking but little space on the workbench, the "Universal Arm" is easy to use, easy to make, and, best of all, quite inexpensive. The total cost should not be much

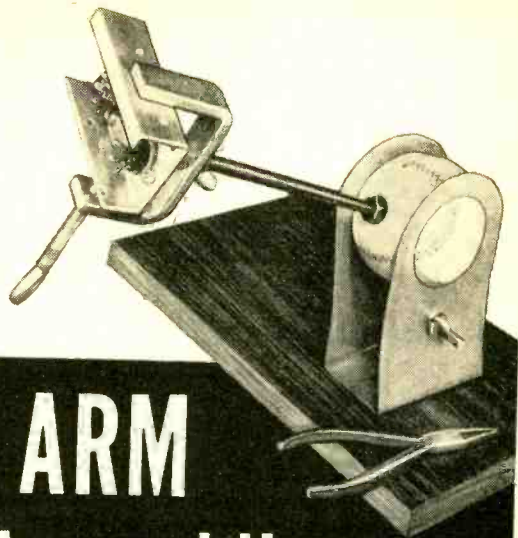

# UNIVERSAL ARM

## Holds Small Assemblies

more than one dollar. Almost all of the parts should be available at the local hardware or dime store.

### Assembling The Arm

The complete unit is made up of two subassemblies—the base and the support arm, which includes the clamp and ball. The base is bent from a single piece of sheet metal measuring approximately 3" x 13". Follow the general layout given in Fig. 1, but vary the size of the large holes to suit the rubber ball used. Either steel or an aluminum alloy may be used for the base piece, but the metal chosen should be reasonably stiff and have a certain amount of springiness. Gauge is not too important, but don't use material so thin that it may be bent with the fingers and lacks strength, nor material so thick that it cracks on bending. Take special pains to insure accuracy when bending the sides, so that the opposing holes line up perfectly. Deburr all holes and round sharp edges with a file.

With the machine work and bending finished, the base is completed by putting a 4" length of  $\frac{1}{4}$ " diameter Redi-Bolt

through the two opposing small holes, then fitting on a pair of flat washers and wing nuts. Do NOT TIGHTEN THE WING NUTS UNLESS THE BALL IS IN PLACE.

Use a solid rubber ball. This is extremely important. Many of the small rubber balls offered for sale are hollow and are filled with gas under pressure. Better check on this point before purchasing the ball.

Bore a  $\frac{1}{4}$ " hole through the ball. Do this with a standard "Cork Borer," but if

Fig. 2. Drill hole for the shaft in the rubber ball. Use a solid ball and "cork borer."

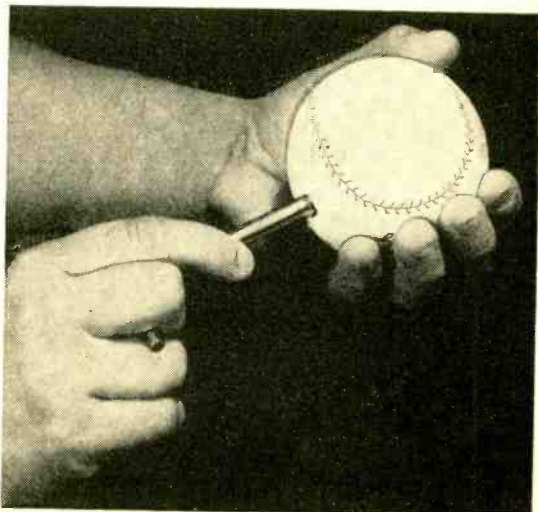

#### BILL OF MATERIALS

- 1—Piece of hard aluminum or steel sheet (see text) measuring approximately 13" x 3".
- 1—Solid rubber ball about 3" in diameter.
- 1—REDI-BOLT,  $\frac{1}{4}$ " x 20, about 12" long.
- 1—"Handy Clamp" made by Stanley (#CD-7097K).
- 3—Hex nuts,  $\frac{1}{4}$ " x 20.
- 3—Wing nuts,  $\frac{1}{4}$ " x 20.
- 5—Flat washers,  $\frac{1}{4}$ " hole.

Fig. 1. Layout of the metal frame. The dimensions may be varied to suit the size of the clamp and solid rubber ball.

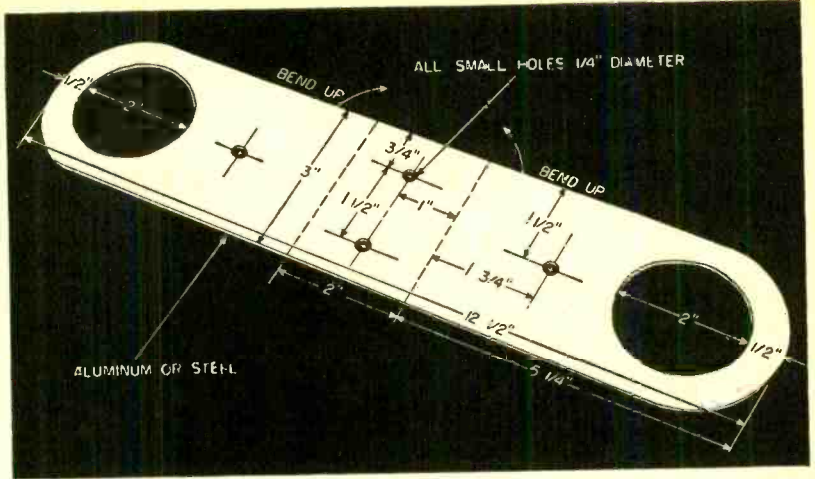

this tube is not available, use a small piece of brass or steel tubing. Sharpen the end of the tubing to give it a tapered end. Then, holding the ball in one hand and the tubing in the other, force the tubing into the ball, using a twisting motion. After the tubing has cut part way into the ball, place the ball on a piece of scrap lumber or hardboard, bearing down with weight to complete the boring job.

An 8" length of 1/4" Redi-Bolt serves as the support arm. Pass one end of the bolt through the hole previously bored in the rubber ball, fastening it with two flat washers and a pair of hex nuts, as shown in Fig. 3. Tighten the nuts enough to insure a secure mounting, but don't use so much pressure that it distorts the ball.

A Stanley "Handy Clamp" is mounted at

the opposite end of the support arm. Prepare the clamp by drilling a 1/4" hole centered on the back strap. Attach it to the support arm using a hex nut, flat washer, and wing nut, as shown in Fig. 4. Lock the hex nut in place with cement. This will permit the clamp to rotate freely when the wing nut is loosened, without danger of the assembly falling apart.

Either mount the metal base permanently on the workbench or attach it to a large baseboard, to be set on the bench when needed. If almost all the builder's work is with subminiature assemblies, he will probably want a permanent mounting. On the other hand, if he works with full-sized chassis on occasion, he will find the temporary mounting handier.

(Continued on page 123)

Fig. 3. Detail view of bolt mounted through the ball. Use flat washers under each nut.

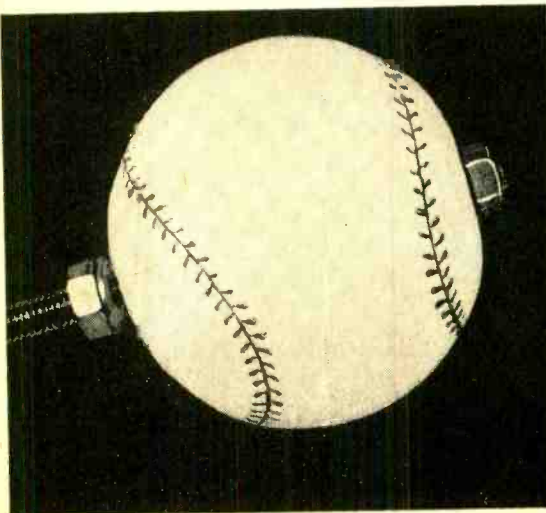
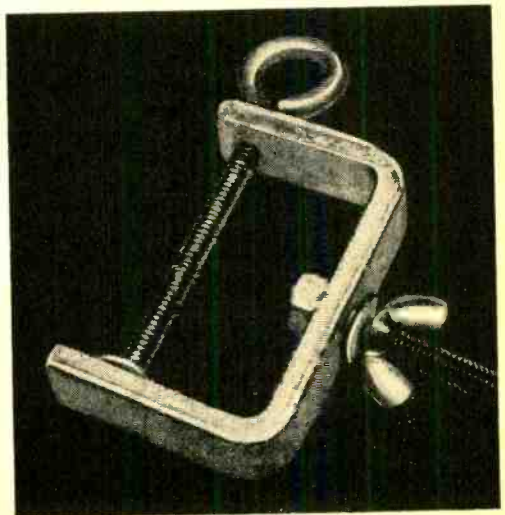

Fig. 4. A winged nut on the threaded shaft permits rotation of the clamp holding arm.



# CARL & JERRY

By

JOHN T. FRYE

*Aided by a garden hose, Jerry explains how a TV picture is made to appear on the screen of a receiver.*

IT WAS HOT, and Jerry certainly was not hurrying at his job of washing the family car. From time to time he looked wistfully across the back yard at the house of his friend, Carl Anderson; but he never presented himself—never, that is, until Jerry had given the gleaming hood a final flick of the chamois and collapsed on the ground to mop his sweating round face.

Then Carl ambled out the back door of his house and slowly strolled over to where Jerry was sprawled on the grass beside the garage. "Rather warm today, isn't it?" he remarked politely as he stifled a bored yawn.

"I wouldn't know," Jerry grunted. "I've been too busy to notice. Of course, if one is too lazy to help one's buddy out, and if all one does is sit around the house like a lounge lizard, I suppose one might think it hot."

"Now don't get your nose hard," Carl said with a disarming grin. "I made up my mind that this was one time you were not going to rope me into helping you. For once," he boasted, tapping his temple with a forefinger, "I used the old bean and stayed in the house until you were finished. Anyway, I was doing some heavy thinking. I was trying to figure out exactly how a TV picture is made to appear on the screen of a receiver."

"Nothing hard about that," Jerry scoffed, as he pulled up a handful of grass and threw it at his chum.

"Okay," Carl challenged; "suppose you fill me in on the subject."

"In the first place," Jerry began, as he picked up the garden hose and opened the nozzle, "you have what is called an *electron-gun* structure at the very back of the picture tube neck. This gun emits a stream of electrons in the same way this hose shoots a stream of water at that garage wall. The electron beam is focused to produce the smallest possible round beam of electrons just as I adjust the nozzle here to produce a small round stream of water.

"When the stream of electrons strikes the

fluorescent material coated on the inside of the picture tube face—the part you call the screen—the material glows and gives off light at the point of impact. Generally speaking, the more electrons in the beam, the brighter is this spot of light on the screen.

"Keep in mind that the electron beam current in a picture tube corresponds to the plate current in an ordinary radio tube. In the picture tube the fluorescent screen takes the place of the radio tube plate. In a vacuum tube you put a fixed negative bias voltage on the grid to make the resting plate current assume a certain value, but in a picture tube you establish a similar bias voltage level with the *brightness control*, so the beam current has a certain static *no picture* value. In a vacuum tube you then apply a signal to the control grid and that causes the plate current to move up and down in accordance with the amplitude and polarity of the signal voltage. In the picture tube, the beam current follows the picture signal voltage applied to the control grid in the same manner. The only difference is that in a radio tube circuit you have to use meters to observe the changes in plate current; but in a picture tube you can observe the variations in beam current as an increase or decrease in fluorescent brightness on the screen."

"I'm still with you," Carl drawled, as he kept his eyes closed behind his horn-rimmed glasses. "But all that does is produce a bright spot. What I want to know is how a picture is made."

"You've got to learn to crawl before you walk," Jerry admonished. "That little spot of light is our paint brush, and we must be able to move the beam producing it to any portion of the screen. What's more, the movement of this beam must be done in a uniform and systematic manner. Suppose this portion of the garage wall I'm marking off with water from the hose is our picture tube screen, and the stream of water represents the electron beam inside the tube. Now I'll start over here in the



upper left-hand corner of our screen and move the beam across to the right. Then I jerk it back very quickly, move the stream down a little, and draw another line below the first. Then I draw another line below that, and so on until I reach the bottom of the screen. Next I go back up and draw another series of lines *between* those already drawn until I again reach the bottom. Because the screen material will continue to glow for a small fraction of a second after the electron beam has moved on and because of the persistence of human vision, the result of this rapid back-and-forth and slower up-and-down deflection of the electron beam results in a *raster* of a number of interlaced parallel horizontal lines on the face of the picture tube."

"How many lines?" Carl wanted to know.

"The first trip down across the face of the tube the beam draws  $262\frac{1}{2}$  lines to complete the first *field* as it is called. Then the beam goes back to the top and draws  $262\frac{1}{2}$  more lines between those already drawn to make the second field. The total number of lines drawn in the two fields that are combined to make a single picture or *frame* as it is called, is 525."

"I'll count 'em sometime and see," Carl said skeptically.

"Well, don't expect to get exactly 525," Jerry warned. "That back and forth motion keeps right on going while the beam is being returned from the bottom of the picture to the top between fields, but you do not see these *retrace* lines because they



... Jerry pulled up a handful of grass and threw it at his chum ...

are blanked out. About twenty-five lines per frame are lost in this manner."

"How is that beam moved back and forth and up and down?" Carl quizzed.

"That's a little complicated to explain in simple terms, but I'll try," Jerry said manfully. "You know that voltmeter I have that has a zero-center scale. When we pass

a current through the meter coil in one direction, the pointer moves in one direction; but if we reverse the direction of the current, the pointer is deflected to the opposite side of the scale. Reversing the direction of the current through the meter coil reversed the polarity of the magnetic field produced by that coil; and this field reacted with the fixed magnetic field of



... at this instant the kinked hose in Carl's hands suddenly gave way ...

the field magnets in the meter to cause the pointer's action.

"A coil called a *deflection yoke* is divided into two parts and these two series-connected coils are arranged opposite one another along the neck of the picture tube at a point along the path of the electron beam on its way to the screen. Now a beam of electrons creates a magnetic field about it just as a stream of electrons, representing a direct current through a wire, creates a field about that wire that can be detected with a compass. You remember we did that experiment in physics class when we were studying the right-hand rule. If we put a current through our series-connected coils, they set up a magnetic field in the portion of the tube neck between them. The magnetic field of the electron beam and the magnetic field produced by these deflection yoke coils react with one another in such a way that the electron beam moves in a direction which will minimize this reaction. The direction and extent of the movement of this weightless, inertia-free electron pointer depends upon the strength and direction of the current through the deflection yoke coils.

"By making the current through the deflection yoke take the form of a saw-tooth—a current pulse that builds up gradually from zero to a certain value and then falls very quickly to zero again—we can make the beam move comparatively slowly from left to right across the tube face and then

(Continued on page 117)



## Hearing Aid Concealed in Head Band

AIMED AT SATISFYING the vanity—as well as the acoustical needs of the hard-of-hearing—is a unique new hearing aid. Developed by *Unex Laboratories* of Hathorne, Mass., the unit consists of a narrow, lightweight head band which houses all parts of the aid, and which may be worn completely concealed by the hair. The band fits the contour of the head comfortably without pressure. Nothing shows below the hair.

This electronic device enables the user to answer the telephone in a normal manner, without the need to hold the receiver against the aid. It also places the pick-up sound source in a more natural position, unrestricted by layers of clothing. Static and clothing rub are thus eliminated.

It is expected that women in particular will be interested in this unit, since it can be worn with any kind of attire. Free literature is available from the manufacturer. —30—

## Low Cost Signal Generator

AVAILABLE IN EITHER KIT or wired form is *Eico's* new Model 324 r.f. signal generator.

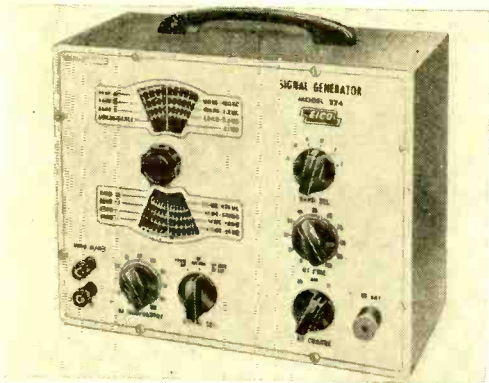

It can be used for i.f.-r.f. alignment; signal tracing; troubleshooting of AM, FM, and TV receivers; as a marker generator for alignment of new high frequency as well as older low frequency TV i.f.'s; and for 400-cycle sine wave audio testing.

Frequency range is 150 kc. to 145 mc. on fundamentals in 6 bands; and 111 mc. to 435 mc. on calibrated harmonics. The unit features a Colpitts r.f. oscillator; turret-mounted, slug-tuned coils; fine and coarse attenuators; variable modulation; and variable gain.

Output on r.f. is 100,000 microvolts; a.f. output is available up to 10 volts. The cost of the kit is \$26.95; wired, the unit is priced at \$39.95. For further details, write to *Electronic Instrument Company, Inc.*, 84 Withers Street, Brooklyn 11, N. Y. —30—

## TV Received in Flight

TELEVISION PROGRAMS have been received successfully over a 21-inch home TV set installed in a stratocruiser on a regularly scheduled flight.

The TV flight test, conducted by *Sylvania Electric Products, Inc.*, and *Pan American World Airways*, proved that qual-



ity images can be transmitted from points as far away as 330 miles and at altitudes ranging from 15,000 to 19,000 feet.

As many as 12 channels from 8 different cities were clearly tuned during the flight from New York's International Airport to Bermuda. The 510YU receiver was placed in the forward section of the clipper's lounge and received power from the aircraft's main alternator having an output of 110 volts at 400 cycles. Approximately 50 feet of RG-59/U antenna transmission line was strung through the cable compartments to the pilot's compartment, and attached to the plane's high frequency receiver and transmitter antenna. The antenna was a 60-foot polyethylene-covered bronze wire running from the nose to the tail of the ship.

Shown in the photo are Charles Mauer (left), *Sylvania* field representative, and *Pan American* Captain S. R. MacLaughlin. —30—

# AMA-TOURING

## with Roger Legge



LISTENING TO AMATEUR RADIO STATIONS in foreign countries is fun, but listening is only part of the hobby of short-wave listener "DX'ing." The other part is obtaining cards from stations heard, confirming your reception.

Most amateurs have attractive cards printed, mainly for sending to other amateur stations to confirm contacts made, but amateur station operators will send a card to confirm listener reports on reception of their transmissions, especially if a detailed report is sent, accompanied by return postage. A reply from all stations to which reports are sent is not to be expected, but use of the best methods of reporting will increase the percentage of replies received.

The first step is to determine the location of the station, as indicated by the prefix of the call letters. A handy means of doing this is by use of the *Electro-Voice* W9IOP "Second Op," a ten-inch wheel with prefixes arranged alphabetically around the edge. Turning the wheel to any prefix will indicate the country, continent and zone, also postage rates, time

differential and great circle bearings from East, Midwest and West U.S.A. The "Second Op" (selling for \$1) is available from many local radio parts jobbers, or directly from the manufacturer at the following address: *Electro-Voice*, Buchanan, Mich.

Addresses are listed in the *Radio Amateur Call Book*, which can be purchased at stores handling amateur radio equipment, or from the publisher at 608 So. Dearborn St., Chicago 5, Ill.

A log book should be used, to keep a record of stations heard, with date, time, stations called or contacted, signal strength, intelligibility and interference. For signal strength, use *S* ratings 1 to 9 as follows: *S*1 — barely audible; *S*2 — very weak; *S*3 — weak; *S*4 — fair; *S*5 — fairly good; *S*6 — good; *S*7 — moderately strong; *S*8 — strong and *S*9 — very strong.

For intelligibility or readability, use *R* ratings 1 to 5 as follows: *R*1 — unreadable; *R*2 — poor; *R*3 — fair; *R*4 — good; and *R*5 — excellent. For interference, note the severity of interference, whether phone or c.w., and if possible, the call letters of the interfering stations. Amateurs also

This table will enable the ham band DX'er to plan his operating periods for maximum activity in certain geographic areas. Predictions are based upon material obtained from the National Bureau of Standards, Washington, D. C.

DX Reception Forecast for June		
14 mc. Band		
FROM	In East & Central U.S.A. E.S.T.	In Western U.S.A. P.S.T.
West Indies, Central America, Northern So. America	0600-2300 Best 1700-2000	0600-2200
Southern South America	1600-2300	1600-2100
Europe	0600-2000 Best 1500-1900	1300-1700
Middle East	0600-0700, 1500-1800	1400-1700
North Africa	0600-0800, 1400-2000	1300-1700
Cent. and So. Africa	1400-1700	1500-1800
Far East	0630-0830	1600-2400
Australia and New Zealand	0700-0900	1500-2400

appreciate a comparison of their signal strength with that of other stations heard at the same time from the same or adjacent countries.

A printed SWL card is a time-saver in sending reports, and I believe is a help in getting replies. Use of a card is not absolutely necessary, as some SWL's have been sending reports by letter for years with satisfactory results. When sending a report, be sure to include the call letters

Radio on	Your phone heard at	on	Mc.
Readability	Strength	Modulation	
Phone QRM	CW QRM		
Fading	Condition of band		
Comparative Report			
<b>U S A</b>			
<b>EXPERIMENTAL RECEIVING STATION</b>			
Phone DX	Country	RECEIVED	Countries Verified
		SK-28	
We would greatly appreciate a QSL card confirming our reception.			
Please specify Phone reception. 73's and Best DX.			
Jane & Roger Legge, 85 Lee Road, Scarsdale, New York, U. S. A.			

of stations called or contacted, so that the amateur can check your report against his log book.

Return postage is a *must* with SWL reports. Some amateurs will reply to listener reports even if return postage is not sent, but I believe that the increased percentage of replies more than compensates for the cost involved in sending return postage. Sending a return-addressed envelope is also a help in making it as easy as possible for an amateur to send you a card. A "Mon-arch" size (4"x7½") envelope is good for this, being large enough to hold most cards.

For stations in the U.S.A. and possessions (except Canal Zone), also at APO and FPO addresses, a return envelope with a 6-cent airmail stamp affixed is recommended. For other countries, send an International Reply Coupon, available for 13 cents at your post office, and exchangeable in foreign countries for stamps to provide postage back to the U.S.

For countries from which a number of stations are heard, it is a good practice to report to the weaker ones, as they are more likely to appreciate listener reports than the higher powered stations. Obtaining at least one card from each country heard makes a fine collection to mount on the wall of your radio room or in albums.

### Stations in North and South America

Canadian Arctic: Some interesting stations at weather stations in the far north have been operating frequently, including VE8ML, 14.325 mc., at Alert Weather Station on the northeast tip of Ellesmere Island, VE3AZG/VE8, 14.197, on Resolution Island, and VE8TK, 14.19.

Cayman Islands: VP5BP on 14.19 mc., operated by VE3CJ while on vacation from Canada, has been providing reception from this rarely heard island group in the West Indies.

Galapagos Islands: HC8GI on 14.175 has been fairly active from these islands off the west coast of South America, best known for their large turtles.

Swan Island: Personnel at the U.S. Weather Station on this tiny island in the Caribbean operate several amateur stations. KS4AW on 14.21 was recently heard at 1500, E.S.T.

Turks & Caicos Islands: VP5AE, heard on 14.15 at 1400, should not be passed over, as he is in the Turks & Caicos Islands, rather than Jamaica, whose much more numerous stations also use VP5 call letters.

Following are listed some of the other 14 mc. phone stations heard recently from countries in the Americas, with the frequency on which they were heard. Since most amateurs now use variable frequency transmitter control, the frequencies are subject to variation, but are included as an indication of the section of the band in which they were heard. The hours to listen for these stations are included in the tabulation of reception times.

CE (Chile)—CE1BN, 14.15; CE3PV, 14.13.  
CO/CM (Cuba)—CO1AH, 14.15; CM9AA, 14.19.  
CP (Bolivia)—CP5AB, 14.11.



CX (Uruguay)—CX2CO, 14.11; CX5AW, 14.15.  
FM7 (Martinique)—FM7WN, 14.135; FM7WQ, 14.155.  
HC (Ecuador)—HC1ES, 14.185; HC1FG, 14.31.  
HH (Haiti)—HH2LR, 14.19.  
HI (Dominican Republic)—HI6EC, 14.18.  
HK (Colombia)—HK3HY, 14.15; HK3PC, 14.13.  
HP (Panama)—HP1LM, 14.16; HP3FL, 14.13.  
HR (Honduras)—HR1CB, 14.19; HR1RC, 14.15.

(Continued on page 114)

# Unique Kit for Experimenters

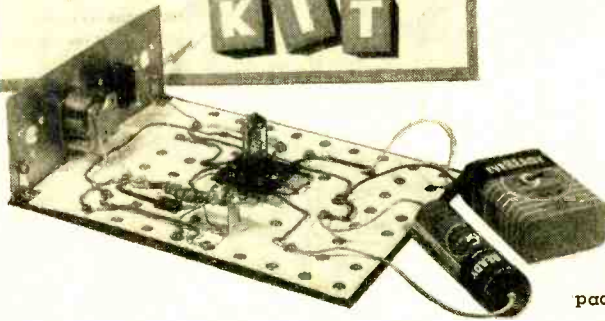
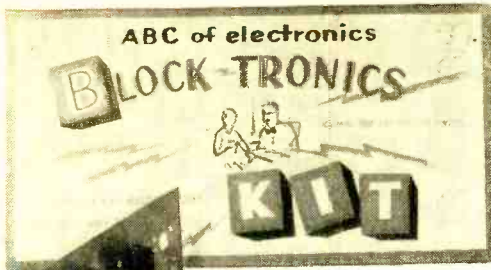

Schematic templates and solderless connections permit fast wiring of many circuits.

No solder was needed to build the one-tube receiver shown at left. Note kit's use of a standard tuning capacitor and simple battery power supply.

AN ENTIRELY NEW METHOD of kit and printed circuit assembly has been announced by *Educational Electronics Co.*, 1023 Waukegan Rd., Glenview, Ill. The manufacturer claims that it will allow the same component to be used repeatedly without the slightest damage. Each resistor, capacitor, coil, etc., is attached to a plastic insulated plate with printed circuit terminals. The plates are then attached to a baseboard with screws, thus eliminating messy soldering and broken pigtail leads.

As an additional feature of the Block-tronics kit, the baseboard is designed so that it may be covered temporarily with a printed paper wiring diagram. The diagram or pictorial schematic slips over the terminals and traces the path of each wire

from terminal to terminal. As a result of this careful system, the novice can lay out his first radio in a matter of only a few minutes—and be sure that it will work.

Advanced technicians will find this unusual kit of value in "breadboarding" new transistor circuits, preamps, etc. The manufacturer will supply the baseboard and plastic mounting strips as separate items.

Included in the basic "Block-tronics" kit, which will sell for \$14.95, are parts and components for wiring such circuits as an interval timer, electronic metronome, code practice oscillator, phono amplifier, regenerative receiver, polarity checker, and many more.

Additional information may be obtained directly from the manufacturer. —30—

## Kit Builds TV Set

A NEW KIT FOR BUILDING a complete television set at home has been designed so that color TV may be added at a later date.

Offered by *Transvision, Inc.*, New Rochelle, N. Y., the kit, Model E-1, includes instructions that permit the novice to assemble the set successfully. Each part of the kit is packaged individually and marked with a number for easy identification. Eight different types of kits are available in 17", 21", 24", and 27" screen sizes. Remote control is an optional feature.

The kit is divided into nine packages, each of which is a complete circuit which the builder can buy separately. The first one sells for approximately \$15.00. Accompanying each kit are photographs, diagrams, and related technical information.

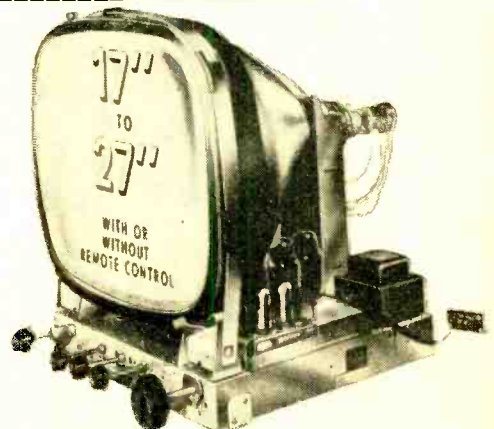

For further details, write to the manufacturer. —30—

# Tuning the Short-Wave Bands

By HANK BENNETT

MANY TIMES DX'ERS will turn their receivers on expecting to receive a certain station that may be presenting a program of interest to the particular listener, or perhaps a special DX program with DX tips and listeners' letters. Many times they will be able to hear the station, but occasionally they will find that because of receiving conditions, the station will not be heard. Active DX'ers, therefore, depend on the WWV advance warning system to tell them what the reception conditions will be for several hours in advance.

WWV operates this forecasting service on frequencies of 2½, 5, 10, 15, 20, 25, 30, and 35 megacycles on an around-the-clock basis. On what frequency you'll receive WWV's signals depends on where you are located. Along the U.S.A. East Coast, 5 mc. is usually good. Those on the West Coast will tune to 10 or 15 mc.

The WWV warning system follows a very definite pattern. The propagation forecasts are prepared four times daily—at 0000, 0630, 1200, and 1800 EST—and each forecast is repeated for about six hours until the next forecast has been prepared. Forecasts are given at 19½ and 49½ minutes past each hour.

The forecasts include a letter indicating present radio reception conditions and a number indicating what the expected quality of future reception will be. Letters used are N, U, and W, signifying "normal," "unsettled," or "disturbed," respectively. The added number (1 to 9) will be the forecast of expected quality of communi-

cations conditions for a period of approximately the next twelve hours.

Forecast	Propagation Conditions	Current
1	Impossible	W
2	Very Poor	W
3	Poor	W
4	Fair to Poor	W
5	Fair	U
6	Fair to Good	N
7	Good	N
8	Very Good	N
9	Excellent	N

A typical forecast might be "N4" meaning that current conditions are normal but that in the next twelve hours they would be only "fair to poor." The forecast is given in Morse code. It is not a hard job to memorize these letters and numbers in code and is definitely to anyone's advantage to know them. There are many worthwhile DX stations operating on short-wave in various commercial services, and some countries can be heard only via the dots and dashes.

The *Hallicrafters* radio people have come out with a dandy little gadget that has already found a definite place in this writer's shack. It is a "Time Selector," with a circular slider that enables a person to determine the time in any part of the world. Printed in green and black on a white background, it contains much useful information on the reverse side. In addition, they are also distributing a booklet entitled "The *Hallicrafters* Short-wave Listeners Guide." If you would like a copy of each, drop a note to *The Hallicrafters Co.*, 4401 West Fifth Avenue, Chicago 24, Illinois. Say you saw it in P. E.

Roger Legge, Virginia, has prepared a Tuning Chart covering the 9-mc. short-wave band showing (on the facing page) the most dependable stations to be logged at night. The chart is based on reception in Eastern U.S.A., but the same situation should apply in general to the central portion of the United States. On the West Coast, some of the Europeans will not be heard and some additional Asiatics will be audible.



Jack Parsons, Tyrone, Pa.

The Venezuelan short-wave stations in the 3-mc. band have shifted considerably, dropping frequencies to about 3400 kc. in order to conform to the revised band allocation of 3200-3400 kc. Also a number of stations appear to be off. Those noted at time of writing include: 3265—YVOC, 3315—YVLI, 3340—YVMU, 3350—YVKT, 3370—YVMI, 3385—YVQI, 3390—YVKX, 3400—YVKP, one unidentified on 3325, and a probable on 3250. These stations are heard best during an ionospheric disturbance, when reception on the higher bands is below normal. In addition, no Latin-American broadcast stations are being heard between 7000 and 9300 kc., except



The SWL receiving station of Charles Sutton, Toledo, Ohio, illustrates a compact arrangement of equipment. The receiver is a Hammarlund HQ-129X with a RME DB-20 preselector. A 20-meter dipole is the antenna.

COBZ on 9025. They have apparently shifted to their assigned broadcast bands or gone off.

A relatively new DX Club has been formed in Oslo, Norway, and bears the name *The Heureka DX Club*. They publish the "Heureka DX Club Bulletin," which is obtainable for 3.50 Norwegian kroner or 8 IRC's per year (airmail \$1.00 or 15 IRC's). The address is The Heureka DX Club, c/o Harald Torgard, Nilserudkleiva 15, U. H., Oslo, Norway.

One of the newer stations being heard nowadays is the "Windward Island Broadcasting Service" on 3395 and 5980. Located in Grenada, British West Indies, the station was officially opened by HRH Princess Margaret Rose on February 7th. The station uses 3395 with 5000 watts for listeners in the four Windward Islands, and 5980 with 250 watts, designed to cover Grenada locally. The apparent schedule is daily (possibly excluding Saturday) at 1700-2000 EST.

Now for a few of the latest items of gen-

### 31 Meter Band Evening Tuning Chart

Kilo-cycles	Station	Kilo-cycles	Station
9500	Mexico (XEW W)	9640	Germany
9505	Brazil (PRB22)	9645	
	Panama (HOLA)	9650	Costa Rica (TIFC)
9510	London		New York (WDSI)
9515	San Francisco (KCBR)	9655	Leopoldville
9520	Denmark	9660	Argentina (LRX)
9525			U.S.S.R.
9530	New York (WCEO)	9665	Switzerland
	Cuba (COCO)		Guatemala (TGNA)
9540	Canada (VE9AI)	9670	Cuba (COCQ)
	Peru	9675	Brazil (PRC22)
9545	Cincinnati Mexico (XEFT)	9680	Mexico (XEQQ)
	U.S.S.R.		Paris
9550	Prague		Panama (HOH7)
9555	Mexico (XETT)	9685	Brazil (PRA6)
9560	Peru (OAX41)		Boston
9565	Brazil (ZYK3)	9690	Argentina (LRA)
9570	Bucharest	9695	
9575	Rome	9700	Cincinnati (WLWO)
9580	London		Brazil (PRH8)
9585			Rome
9590	Netherlands	9705	
9595		9710	
9600	London Chile (CE960)	9715	
9605	Panama (HP5J)	9720	Brazil (PRL7)
9610	Brazil (ZYC8)	9725	
	Norway	9730	
9615	Tangier	9735	Dom. Rep. (HI2T)
9620	Sweden		(I2T)
	Cuba (COJK)	9740	Tangier
9625	Brazzaville Mexico (XEBT)		Cuba (COKG)
9630	Cabada (CKLO)	9745	Quito (HCJB)
9635	Tangier Haiti (4VEH)	9750	Lisbon
		9755	New Delhi
		9760	Argentina (LRY)
		9765	
		9770	Guatemala (TGWA)
			Belgium
			London
		9775	Brazil (PRL4)

eral interest. All times are Eastern Standard, based on the 24-hour clock.

**AUSTRIA:** The "Osterreichischer Rundfunk" (*Austrian Broadcasting System*) is transmitting an experimental short-wave service in preparation for a regular service for foreign listeners. The present test schedule is 1900-2100 on 7245 (OEI22); 2130-2300 on 11935 (OEI36); at 0200-0400 on 5985 (OEI30); 0430-0730 on 7245; 0800-1200 on 5985; 1400-1700 on 9665 (OEI23). Future plans are to erect short-wave transmitters with increased power this year with at least one of the antennas being a directional array beamed on the U.S.A. The service appreciates letters and will reply in English from Singrienergasse 21, Postfach 45, Vienna XII, Austria.

**AUSTRALIA:** The latest noted changes from *Radio Australia* include: to the British Isles and Europe 0100-0215 on 9500 kc.; 0145-0215 (except Saturday) on 7280;

(Continued on page 122)

# Build YOUR OWN HEATHKITS

INTERESTING—EDUCATIONAL

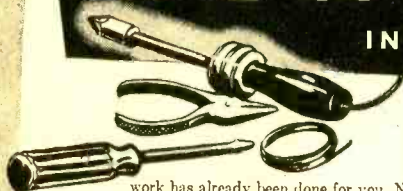

work has already been done for you. No cutting, drilling, or painting required. All parts furnished including tubes. Knowledge of electronics, circuits, etc., not required to successfully build Heathkits.

Heathkits are fun to build with the simplified easy-to-follow Construction Manual furnished with every kit. Only basic tools are required, such as soldering iron, long-nosed pliers, diagonal cutting pliers, and screwdriver. All sheet metal

New charcoal gray baked enamel panel with highly readable white lettering.

## New PRINTED CIRCUIT VACUUM TUBE VOLTMETER KIT

The VTVM is the standard basic voltage measuring instrument for radio and TV servicemen, engineers, laboratory technicians, experimenters, and hobbyists. Because of its extremely high input resistance (11 megohms) the loading effect on the circuit being measured, is virtually negligible. The entire instrument is easy to build from a complete kit, with a detailed step-by-step Construction Manual. Featured in this instrument is an easy-to-wire fool-proof printed circuit board which cuts assembly time in half.

**CIRCUIT AND RANGES:** Full wave AC input rectifier permits 7 peak-to-peak voltage ranges with upper limits of 4000 volts peak-to-peak. Just the ticket for you TV servicemen. Seven voltage ranges, 1.5, 5, 15, 50, 150, 500 and 1500 volts DC and AC RMS. Peak-to-peak ranges 4, 14, 40, 140, 400, 1400, and 4000 volts. Ohmmeter ranges X1, X10, X100, X1000, X10K, X100K, X1 meg. Additional features are a db scale, center scale zero position, and a polarity reversal switch.

**IMPORTANT DESIGN FEATURES:** Transformer operated—1% precision resistors—6AL5 and 12AU7 tubes—selenium power rectifier—individual AC and DC calibrations smoother improved zero adjust control action—new panel styling and color—new placement of pilot light—new positive contact battery mounting—new knobs—test leads included. Easily the best buy in kit instruments.

New peak-to-peak meter scale—new color harmony—new control knobs.

New printed circuit board for faster, easier construction—exact duplication of Laboratory development model.



Model V-7

**\$24.50**

Shpg. Wt. 7 lbs.

New easy-to-read open panel layout. On-on switch incorporated in selector switch

## Heathkit HANDITESTER KIT



MODEL M-1  
**\$14.50**

Shpg. Wt. 3 lbs.

The Heathkit Model M-1 Handitester readily fulfills all requirements for a compact, portable volt-ohm-milliammeter. Its small size permits the instrument to be tucked into your coat pocket, tool box or glove compartment of your car. Always the "handitester" for those simple repair jobs. Packed with every desirable feature required in an instrument of this type. AC or DC voltage ranges, full scale 10, 30, 300, 1000 and 5000 volts. Ohmmeter ranges 0-3000 ohms and 0-300,000 ohms. DC milliammeter ranges 0-10 milliamperes and 0-100 milliamperes. Uses 400 microampere meter—1% precision resistors—hearing aid type ohms adjust control—high quality Bradley rectifier. Test leads are included.

## Heathkit MULTIMETER KIT



MODEL MM-1

**\$29.50** Shpg. Wt. 6 lbs.

Here is an instrument packed with every desirable service feature and all of the measurement ranges you need or want. High sensitivity 20,000 ohms per volt DC, 5000 ohms per volt AC. Has the advantage of complete portability through freedom from AC line—provides service ranges of direct current measurements from 150 microamperes up to 15 amperes—can be safely operated in RF fields without impairing accuracy of measurement.

Full scale AC and DC voltage ranges of 1.5, 5, 50, 150, 500, 1500, and 5000 volts. Direct current ranges are 150 microamperes, 15, 150, and 500 milliamperes and 15 amperes. Resistances are measured from .2 ohms to 20 megohms in three ranges and db range from -10 to +65 db. Ohmmeter batteries and necessary test leads are furnished with the kit.

# HEATH COMPANY

A SUBSIDIARY OF DAYSTROM, INC.  
BENTON HARBOR 10, MICHIGAN





**New**  
PRINTED  
CIRCUIT

## Heathkit 3" OSCILLOSCOPE KIT

Ideal for individual home work shop, ham shack, or as extra instrument for outside servicing.

Compact size, light weight, portable — perfect for service work or field operation.

New, modern styling, gray lettering, light gray knobs and red and black contrasting terminal posts.

New printed circuit for constant circuit performance, rugged component mounting — assembly time cut in half!

Measures only 11 3/4" x 6 3/4" x 19 1/2" and weighs only 11 pounds.

**USE:** This brand new Utility Scope was designed especially for servicemen and radio amateurs, and is adaptable for use in all general Scope applications. Perfect for modulation monitoring, etc. Use it to tackle alignment or adjustment problems. Equally valuable in breadboard work. A must for ham shack or for outside servicing.

**DESCRIPTION:** Front panel controls of the Model OL-1 are "bench tested" for ease of operation and convenience. Sharp focusing 3" CRT. Printed circuit for ease of assembly and constant performance. Assembly time cut in half! High quality electronic components used. Sensitive hor. and vert. amplifiers with broad freq. response; cathode follower for isolation. Push-pull hor. and vert. output to deflection plates. Int. 60 cycle, or ext. sync. Sweep freq. range 10-100,000 cycles. Direct connection to deflection plates. Provision for Z axis input. Uses 3GP1 CRT, 4-12AU7 hor. and vert. amplifiers, 1-12AX7 sweep gen., 1-6X4 LV rect., and 1-1V2 HV rect. The Heathkit Model OL-1 is a real standout value at only \$29.50, and is another example of the famous Heathkit combination; quality plus economy.

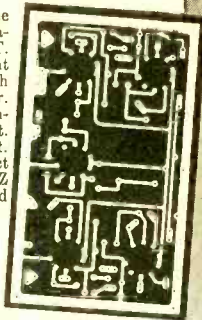

Model  
OL-1

**\$29.50**

Shpg. Wt.  
15 lbs.

## Heathkit SIGNAL GENERATOR KIT

**USE:** This instrument is "serviceman engineered" to fill the requirement for a reliable basic service instrument at moderate cost. Frequency coverage extends in five bands from 160 Kc to 110 Mc on fundamentals, and dial is calibrated to 220 Mc for harmonics. Pre-wound and pre-aligned coils make calibration unnecessary for service applications.

**DESCRIPTION:** The Heathkit Model SG-8 Signal Generator provides a stable modulated or unmodulated RF output of at least 100,000 microvolts which can be controlled by both a continuously variable and a fixed step attenuator. Internal modulation is at 400 cycles, or can be externally modulated. AF output of 2-3 volts is also available for audio testing. Uses dual purpose 12AU7 as Colpitts RF oscillator and cathode follower for stable, isolated, low impedance output, and type 6C4 tube for 400 cycle oscillator. Operation of the SG-8 is well within the frequency limits normally required for service work. Modern styling features high definition white letters on charcoal gray panel with re-designed control knobs. Modern professional appearance and Heathkit engineering know-how combine to place this instrument in the "best buy" category. Only \$19.50 complete.

New, modern panel and knob styling — professional appearance and professional performance.

Broad frequency coverage — fundamentals from 160 KC to 110 MC in 5 bands — up to 220 MC on calibrated harmonics.

Cathode follower output for good isolation — fixed step and continuously variable attenuation.



Output selection — internal modulation, pure r.f., or audio output.

MODEL SG-8 **\$19.50** Shpg. Wt. 8 lbs.



MODEL  
AM-1

**\$14.50** Shpg. Wt. 2 lbs.

## Heathkit ANTENNA IMPEDANCE METER KIT

The Model AM-1 Antenna Impedance Meter makes an ideal companion unit for the GD-1B Grid Dip Meter or a valuable instrument in its own right. Perfect for checking antenna and receiver impedance and match for optimum system operation. Use on transmission lines, halfwave, folded dipole, or beam antennas. Will double as monitor or relative field strength meter. Covers freq. range of 0-150 Mc and impedance range of 0-600 ohms. Uses 100 microampere meter and special calibrated potentiometer. A real buy at only \$14.50 complete.

## Heathkit GRID DIP METER KIT

Amateurs and servicemen have proven the value of this grid dip meter many times over. Indispensable for locating parasitics, neutralizing, and aligning filters and traps in TV or Radio and for interference problems. The Model GD-1B covers from 2 Mc to 250 Mc with 5 pre-wound coils. Featuring a sensitive 500 microampere meter and phone jack, the GD-1B uses a 6AF4 or 6T4 tube. An essential tool for the ham or serviceman.



MODEL  
GD-1B

**\$19.50** Shpg. Wt. 4 lbs.

**ACCESSORIES:** Low freq. coverage to 355 KC with two extra coils and calibration curve. Set No. 341A for GD-1B and set No. 341 for GD-1A. Shipping weight 1 lb. Only \$3.00.

# HEATH COMPANY

A SUBSIDIARY OF DAYSTROM, INC.

BENTON HARBOR 10, MICHIGAN

# New

# Heathkit VFO KIT



MODEL VF-1  
\$1950

Ship. Wt. 7 lbs.

Here is the new Heathkit VFO you have been waiting for. The perfect companion to the Heathkit Model AT-1 Transmitter. It has sufficient output to drive any multi-stage transmitter of modern design. A terrific combination of outstanding features at a low kit price. Good mechanical features at a low kit price. Coils are wound on heavy duty ceramic forms, using Litz or double cellulose wire coated with polystyrene cement. Variable capacitor is of differential type construction, especially designed for maximum bandspread and features ceramic insulation and double bearings.

This kit is furnished with a carefully precalibrated dial which provides well over two feet of calibrated dial scale. Smooth acting vernier reduction drive insures easy tuning and zero beating. Power requirements 6.3 volts AC at .45 amperes and 250 volts DC at 15 milli. Just plug it into the power receptacle provided on the rear of the AT-1 Transmitter Kit. The VFO coaxial output cable terminates in plastic plug to fit standard 1/4" crystal holder. Construction is simple and wiring is easy.

- Smooth acting illuminated and precalibrated dial.
- 6AU6 electron coupled Clapp oscillator and OA2 voltage regulator.
- 7 Band coverage, 160 through 10 meters—10 Volt RF output.
- Copper plated chassis—aluminum cabinet—easy to build—direct keying.

Open layout—easy to build—simplified wiring.

Smooth acting illuminated dial drive.

Clean appearance—rugged construction—accessible calibrating adjustments.

Copper plated chassis—full shielding.

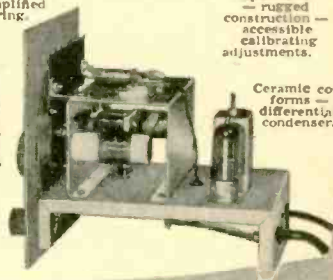

Ceramic coil forms—differential condenser.

# Heathkit AMATEUR TRANSMITTER KIT



MODEL AT-1

\$2950

Ship. Wt. 16 lbs.

Here is a major Heathkit addition to the Ham radio field, the AT-1 Transmitter Kit, incorporating many desirable design features at the lowest possible dollar-per-watt price. Panel mounted crystal socket, stand-by switch, key click filter, A. C. line filtering, good shielding, etc. VFO or crystal excitation—up to 35 watts input. Built-in power supply provides 425 volts at 100 MA. Amazingly low kit price includes all circuit components, tubes, cabinet, punched chassis, and detailed construction manual.

### SPECIFICATIONS:

Range 80, 40, 20, 15, 11, 10 meters.  
6AG6.....Oscillator-multiplier.  
6L6.....Amplifier-doubler.  
5U4G.....Rectifier.  
105-125 Volt A.C. 50-60 cycles 100 watts. Size: 8 1/2 inch high x 13 1/2 inch wide x 7 inch deep.

Crystal or VFO excitation.

Prewound coils—metered operation.

Rugged, clean construction.

Single knob band switching.

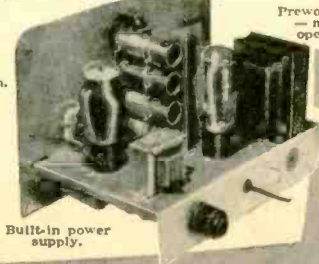

52 ohm coaxial output.

Built-in power supply.

# Heathkit COMMUNICATIONS RECEIVER KIT

RF gain control with AVC or MVC.

Electrical bandspread and scale.

Stable BFO oscillator circuit.

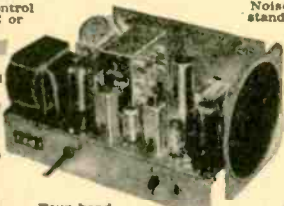

Four band operation 535 to 35 Mc.

Noise limiter—standby switch.

1/2 inch FM Speaker-Headphone Jack.

Six tube transformer operation.

### SPECIFICATIONS:

Range.....535 Ke to 35 Mc  
12BE6.....Mixer-oscillator  
12BA6.....I. F. Amplifier  
12AV6 Detector—AVC—audio  
12BA6.....E. F. O. oscillator  
12A6.....Beam power output  
5Y3G.....Rectifier  
105-125 volts A.C. 50-60 cycles, 45 watts.

A new Heathkit AR-2 communications receiver. The ideal companion piece for the AT-1 Transmitter. Electrical bandspread scale for tuning and logging convenience. High gain miniature tubes and IF transformers for high sensitivity and good signal to noise ratio. Construct your own Communications Receiver at a very substantial saving. Supplied with all tubes, punched and formed sheet metal parts, speaker, circuit components, and detailed step-by-step construction manual.



MODEL AR-2

\$2550

Ship. Wt. 12 lbs.

CABINET:

Proxilin impregnated fabric covered plywood cabinet. Ship. weight 5 lbs. Number 91-10, \$4.50.

**HEATH COMPANY**  
A SUBSIDIARY OF DAYSTROM, INC.  
BENTON HARBOR 10, MICHIGAN



## Edlie for TOP VALUES

**JUST** Newest & Best "Fix-It-Yourself" Aid  
**OUT!** Edlie's E-Z TV REPAIR GUIDE

The only Fix-It-Yourself guide made expressly for YOUR TV set!  
Now you can save costly TV repairs with this new, simplified method which includes all necessary data for just YOUR set. No confusing, unimportant information applicable to hundreds of different makes. Simplifies detection of faulty tubes in your TV receiver quickly, accurately.  
It's a terrific idea—It's a terrific guide! Order today and have your set back in perfect condition at once. Be sure to send us make and model of your TV set when ordering. For most TV sets—new and old.

only  
**50¢**



**5-Tube AC/DC Superhet Radio Kit**  
KIT 5: Includes all top quality components required to construct this latest design, highly sensitive 5-tube, AC/DC superheterodyne broadcast receiver. Complete with black, glistening bakelite cabinet (excludes wire & solder).

Kit of 5 tubes: 12AT6, 12BA6, 12BE6, 35W4 & 50B5 . . . \$3.25  
less tubes . . . . . **\$7.95**

### 6-Tube Radio Kit

KIT 6: A great value in a low-priced radio kit designed for high sensitivity and good tone qualities. Easily constructed circuit. Complete with chassis, all parts, hardware, PM speaker (except wire & solder).

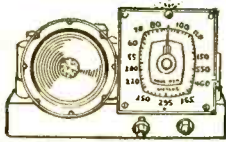

Kit of 6 tubes: 25L6, 25Z6, 65Q7, 6SA7 & CSK7(2) . . . . . **\$3.25**

less tubes . . . . . **\$6.95**

## EDLIE ELECTRONICS

154A Greenwich St. DI. 9-3143 New York 6, N. Y.

*A Fortune Under Your Feet!*

Find It with  
**CONCORD'S PORTABLE URANIUM DETECTOR**

Only **\$29.95** ea. Kit Form

**\$39.95 ea. Wired**  
Lowest Priced Precision Detector in America!



All that you need is Concord's New Sensitive Uranium Detector and you're in the Uranium Prospecting business! This highly sensitive Uranium Detector uses the famous Victororen 1B85 Counter tube. Detects both Beta and Gamma. Uses 3S4 and adjustable spark gap. "A" battery good for 96 hours and "B" battery for about 300 hours. Kit is complete with pictorial diagrams and simple step by step instructions. Can be assembled in about an hour. Earphone included. Less batteries. Batteries for Above . . . . . Only \$ 1.90  
Stock No. PE-M9K . . . Reg. \$52.45 . . . . . Only \$29.50

URANIUM DETECTOR WIRED WITH BATTERIES  
Stock No. PE-M9W . . . Reg. \$67.45 . . . . . Only \$39.50

**Send For Big Free Catalog!**

**Concord Radio**

55 Vesey Street, New York 7, N. Y. Digby 9-1132

## Kit Builds Electronic Organ

A COMPLETE ELECTRONIC ORGAN in the form of a kit has been made available by *The Schober Organ Corporation*. The organ can be built by a novice, yet it is a full concert



instrument with two manuals, 32 pedals, 19 stops, and 6 couplers. Its operation is completely electronic, with no moving parts except the keys and controls. Among its features are 130 printed circuits. Kits for the separate components, such as the tone generators, preamplifiers, stop filters, and so on, may be purchased separately to make budgeting easy. Console, keys, pedals, and bench are designed as furniture, appropriate in appearance at the home. Write the manufacturer at 35A Dail St., New Hyde Park, N. Y., for a booklet containing full details.

## Hi-Fi FM Antenna

HIGH FIDELITY FM RECEPTION demands that the receiver be fed with an adequate signal to reproduce all tones and frequen-

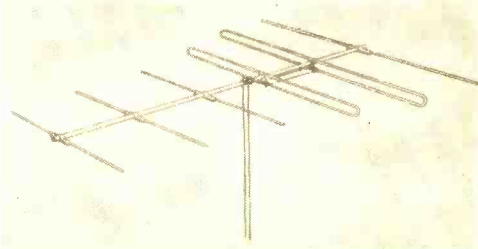

cies broadcast by the FM transmitter. This is known as sufficient signal to give "full limiter action." For this reason, an FM



# LAFAYETTE'S BARGAIN SALE!

**A REAR SEAT AUTO SPEAKER KIT**  
HEAVY DUTY 6"x9" PM KIT



Add another speaker in the rear of your car! You get a 6"x9" PM speaker with a 2.15 Alnico V magnet; a 3 position switch for choosing "rear", "front" or "both"; switch plate and bracket, knob, hardware; your choice of brown, grey or silver plastic grille; wire and instructions.

SK-36—Shpg. Wt. 4 lbs. . . . . Net **4.50**

**DELUXE 6"x9" KIT**  
SK-37, with chrome plated metal grill (Fig. B) . . . . . Net **5.75**

**MINIATURE CRYSTAL MICROPHONE**

A typical Lafayette special for experimenters—students or dealers. Extremely sensitive crystal "mike" used in hearing aids and other small apparatus. Use as lapel "mike"—miniature transmitter mike—"bug"—etc. Brand new! Only 1 3/8" by 5/16"!

MS-108. . . . . Net **1.95**

**CRYSTAL EAR PHONE**

Small, almost weightless, plastic ear phone with crystal element, that features high power and sensitivity. Ideal for all applications where a very high impedance unit is preferred. Fits comfortably in the ear. Complete with 3 ft. plastic covered cord.

**CAN BE USED AS MICROPHONE**

This unit is so powerful and sensitive that it can be used as a close-talking highly directional crystal microphone.

MS-111. . . . . Net **1.95**

**NEW POCKET AC-DC VOM MULTITESTER**  
1,000 ohms per Volt

Ideal portable unit that meets the need for a compact, yet rugged test instrument. Uses full 3/4" rectangular meter with large easy to read scale. Uses 1 1/2% precision resistors, few-jeweled D'Arsonval microsmo meter movement. Ranges: AC-DC and output volts 0-5, 0-25, 0-250, 0-1000V; DC current 0-1, 0-10, 0-100. MA; Resistance 0-10K and 0-100K ohms. Size: 4 3/4" x 3 1/2" x 1 3/8". Supplied complete with test leads and batteries. Shpg. Wt. 2 1/2 lbs. MODEL RW-27C Complete—Singly, ea. 9.95 in lots of 3, ea. 9.45

**OUTSTANDING HI-FI ACHIEVEMENT**

Will outperform any amplifier in its price range—or your money back! Nothing in the HI-FI field to equal it.

LA-54. . . . . Net **64.50**



send for **FREE** RADIO CATALOG

**Lafayette Radio** BRONX, N.Y. 542 E. Fordham Rd  
DEPT. 1F NEWARK, N.J. 24 Central Ave.  
100 SIXTH AVE. PLAINFIELD, N.J. 139 West 2nd St.  
NEW YORK, N.Y. BOSTON, MASS. 110 Federal St.

Include postage with order.

**NOW YOU CAN BUY A PROFESSIONAL TYPE**

**GEIGER COUNTER**  
with transistor-amplified, loud speaker

Not a toy—not a gadget. Vic-Tic is a full size professional Geiger Counter with a transistor-amplified, loud speaker, adjustable in tone pitch. The ideal instrument for uranium exploration. Weighs only 3 pounds and has 4 sensitivity ranges: (1000, 10,000 and 100,000 c/m, plus extra sensitive background range). Furnished with an aluminum wall, counter tube, batteries, shoulder-strap, instruction manual and Radio Active Sample, complete for \$125.00. Additional accessories available include SIX PACK of high sensitivity Bismuth Geiger Tubes (15 times more sensitive than standard tube), hand probe and deep-hole probe can readily be plugged into built-in jack. Vic-Tic was designed by the same staff of engineers who developed the first instrumentation for Atomic Science. Fully Guaranteed. Order now for immediate shipment.

**VICTOREEN INSTRUMENT CO. 5806 HOUGH AVENUE CLEVELAND 3, OHIO**

**THRIFTY SPECIALS**

- 6 FOOT LINE CORD WITH PLUG. . . . . 12¢
- TUNEABLE FERITE LOOP ANTENNA. . . . . 44¢
- U.S. ARMY J38 TELEGRAPH KEY. . . . . 99¢
- 35 WATT SOLDERING IRON. . . . . 89¢

UL approval  
**FREE COLOR CODE WALL CHART WITH EACH ORDER**  
**THRIFTY TV SUPPLY COMPANY**  
13647 Burbank Blvd. Van Nuys, Calif.

## Rocket Seeks Radio Data

ELECTRONIC RESEARCH often takes instruments—if not men—to areas far off the beaten path. The photo shows Navy Viking Rocket No. 12 as it blasts off the floor of the New Mexican desert at White Sands Proving Ground near Las Cruces. Soaring 144 miles upward, the Viking measured the

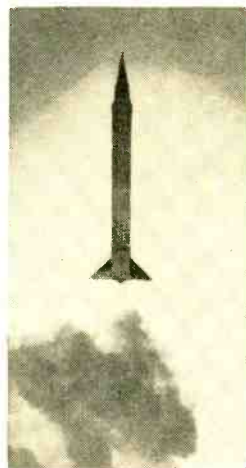

physical characteristics of the ionosphere, gathering information on how radio waves are transmitted. During its trip it took photos and conducted many experiments—with no human being on board. Made by *Martin Aircraft* of Baltimore, Md., this rocket reached a speed of about 4100 miles an hour. It weighs 7 1/2 tons and is 45 feet long.

—30—

## Tape-of-the-Month Club

A MEMBERSHIP PLAN to furnish music and specialty selections on pre-recorded tapes has been launched by the first *Recorded Tape-of-the-Month Club, Inc.* Programs are prepared on 1200-foot tapes on 7-inch reels, the most widely used size for home tape recorders. These reels are sold to members for only \$5.95. Price to non-members is \$8.95.

To become a member for a six-month period, a person pays \$2.00. For this he receives a "Preview" tape every month for six months. On the basis of this tape, which contains "coming attractions" of the next month's selection, the member decides whether he wants to order the forthcoming reel. He agrees to order at least two regular monthly tapes during the six-month period. In any event, he keeps the "Preview" tapes which are, themselves, a source of entertainment easily worth the \$2.00 membership fee. For every three selections he orders, the member may choose an additional free bonus tape.

Selections are usually recorded at 7 1/2 i.p.s. to provide one-half hour of play for a 7-inch reel. Hour-long productions are offered at either 3 3/4 i.p.s., single track, or at 7 1/2 i.p.s., double track. Quality and fidelity are rated fairly high. For further information, write to the Club at P. O. Box 195, Radio City Station, New York, N. Y.

—30—

# POP'tronics



## BOOKSHELF

"BASIC ELECTRONICS" by *Van Valkenburgh, Nooger and Neville, Inc.* Published by *John F. Rider Publisher, Inc.*, New York, N. Y., in five volumes, with a total of 518 pages. Paper bound. Price per vol., \$2.00; for set, \$9.00.

These volumes form the second part of a ten volume set covering basic electricity and electronics, of which the first part was reported on previously (May issue). The present five volumes cover the ground up through basic receiver circuits.

Like its companion set on "Basic Electricity," this one is extremely well prepared and superbly illustrated. The concerted efforts of a skilled group of writers and artists went into the preparation of the books, which were produced originally for use in the U. S. Navy's training program. A complete beginner, having no previous technical training, can readily learn the fundamentals of the subject.

Each page presents a complete "unit" of work, or basic concept in electronics. Sufficient experiments are provided so that theory is adequately balanced with actual practice.

Volume 1 introduces the subject of electronics. Volume 2 covers tubes and simple amplifier circuits, while Volume 3 takes up advanced amplifiers and oscillators, and Volume 4 treats transmitters and modulators. Volume 5 concludes the set with the theory and building of receivers, and furnishes the reader with excellent procedures for troubleshooting.

"LICENSE MANUAL FOR RADIO OPERATORS: A GUIDE TO FCC EXAMINATIONS" by *J. Richard Johnson, W2BDL.* Published by *Rinehart & Co., Inc.*, New York, N. Y. 430 pages. Price \$5.00. Cloth bound.

Here, in one volume, is complete information on how to qualify for a commercial radio license. This book presents questions and full, clear answers to the problems that comprise the eight parts of the FCC examinations. Known as "elements," these eight parts cover basic law, operating practice, basic radiotelephone, advanced radio-

Your  
High Fidelity  
System  
Will  
Sound Better  
with a

**GOODMANS**  
**Loudspeaker**

made in  
england

ROCKBAR CORPORATION Dept. JF-4  
215 East 37th Street, New York 16, N. Y.  
Please send complete description of  
Goodmans High Fidelity loudspeakers.

Name .....

Address .....

City ..... Zone ..... State .....

My Dealer is .....

# ELECTRONIC SUPPLIES

For Experimenters—Service—Industry

Clean Useful items sold on satisfaction Guaranteed basis. WHOLESALE OR RETAIL.

**GEIGER MULLER COUNTER TUBE**—Type USN-CY-B5-6. Mica window high sensitivity, high voltage counter tube. Self Quenching for Beta and Gamma radiation. Geiger voltage threshold 1200–25VDC. Plateau length 400 VDC. This tube is temperature independent (halogen filled) and will not be damaged by excess voltage. Brand New serial no. tubes. regular price \$40.00. SPECIAL while they last... **\$7.95 ea.**

**CONTINUOUS DUTY** low voltage power supply will supply Walkie-Talkies, Transceivers, portable units of many types. Designed to supply plate, screen, and filament power from 12V btry. Electrical Specs.—Input 12VDC-180MA—Outputs: 4.3VDC-50MA; 4.3VDC-50MA; 45VDC-5MA; 45VDC-5MA; 85VDC-5MA; 85VDC-5MA. Brand New #204A—spare vibrator worth \$8.00 inc. Completely self contained—wt. 10 lbs., limited quant... **\$4.95 ea.**

**Lowest previous surplus price.**

**Miniature Storage Battery**—Vitamite—2.2V wet cell—1 3/4" x 1 1/4". New—dry charged... **\$1.00 ea.**

**Resonant Cavity UHF assembly**—with fitting—Brand New Type... **\$1.49 ea.**

**Pocket Battery Tester**—"King Sol" Worth \$8.00 ea. Brand New boxed, instr. sheet. Precision designed ammeter will accept batteries and give actual dynamic indication of condition... **\$1.49 ea.**—4 for **\$5.00**

**Western Electric Stepper Switch**—44 steps—gold plated contacts—6 or 12 VDC coil. Worth over \$30.00... **\$1.00 ea.**

**STANCOR Choke**—61710-7 Henry—150MA—Unused—shelf worth—REG. \$4.45—Special... **\$1.00; 6 for \$5.00**

**Hearing Aid Subminiature Tubes**—unbranded... **\$7.95 ea.**

**RELAY**—Allied—BJ type—24VDC—DPDT—New, boxed... **\$7.95 ea.**

**Buzzer**—type T2—150V 60CY. Removed fr. unused equipment... **3 for \$2.00**

**RF Sig. Gen. type LAE-1**. Input 115V-60cy. freq. 500-1400 mc. cycles w/ally curve. Excellent... **\$1.00**

**SMALL PARTS, TUBE VALUES**

3A5 twin triode UHF	3	\$1.00
1A9 Magic Eye	3	\$1.00
IN22 diode. New	2	\$1.00
IN34 diode. New	2	\$1.00
Phone cushion red/wht trim	6	\$.98
SM Chassis 8-000 Ohm relay	50	\$1.00
Paper tubular Cond.	6	\$1.00
Electrolytic Cond. caps Multiple type. Fresh	2	\$1.00
Infra Red Filter MC-430. 1 1/2" dia.	doz	\$1.00
Asstd. precision resistors 1%	doz	\$1.00
W.E. Ouncer Xformer Ratio 2.5:1	2	\$1.00
Haydon motor 24VAC 1/12HPM Worth \$8.00	NEW	\$1.00
Electrolytic-tubular. IMPD. 50VDC	20	\$1.00
Term'l BD, 12 Turret lugs—Silv. plate 24x1	doz.	\$1.00
Miniature Xformer, 9 porcelain terms, schematic on case, as used with transistors	3	\$.98
Throat Mike, Carbon w/instr. New	6	\$5.00
MICA, 75 asstd.—10W, 4K	20	\$1.00
Resistor, Koolohm—10W, 4K	20	\$1.00

Include Postage with Order

## REX RADIO SUPPLY

88 Cortlandt St. New York 7, N. Y. CO 7-1617

telephone, radiotelegraph operating practice, advanced radiotelegraph, aircraft radiotelegraph, and ship radar.

The answers to the questions are given in the form used when taking the examinations. In addition, the book is indexed to provide a ready reference guide to the hundreds of topics involved in radio.

An important feature is the inclusion of an appendix which provides up-to-date references to the laws governing radiotelephone and radiotelegraph communication, taking into account all recent changes in the law. Another appendix divides the questions into groups corresponding to the subjects of a conventional course in basic radio.

While no substitute for the study, preparation, and basic knowledge essential to passing FCC exams, this book can make such study and preparation far simpler and more valuable to the licensee.

"AN APPROACH TO RADIO" by J. B. Shrewsbury. Published by *Electronic Industries*, Princeton, Ky. 288 pages. Price \$2.95. Cloth bound.

This volume is unique and valuable for its "down-to-earth" handling of the subject of radio. The reader gets electronic theory but in very palatable doses. Referring to familiar things, the text never becomes so involved as to depart from the over-all subject.

Topics covered include the general concepts of radio transmission and reception, audio oscillators and amplifiers, simple receivers and transmitters, and power supplies. Drawings and explanations are painstakingly lucid, enabling the beginner to conduct many experiments and build many basic circuits. Thus, the book may be used as a guide for hours of interesting experiments, or simply as a general information source.

"THE RADIO AMATEUR'S HANDBOOK" by the Headquarters Staff of the *American Radio Relay League*, West Hartford, Conn. 32nd edition. 768 pages. Price \$3.00. Paper bound.

Published continuously since 1926, this handbook has become almost as much of an institution as amateur radio itself. The book is internationally recognized and widely consulted by all segments of the radio world. So many subjects are treated within its covers that it has become one of the leading reference works in the field.

While primarily aimed at the need for theory, equipment know-how, and procedural activities of the amateur, the hand-

Perma-Power

Radio Controlled Garage Door Opener

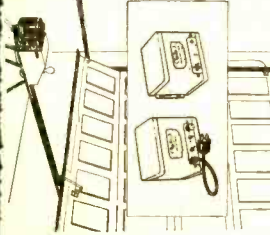

Everyone can afford this modern garage door opener. It's really simple to install. Takes just an afternoon. No soldering. Complete instructions assure professional-type installation.

DOOR... modern garage doors are either one piece tilt-up or sectional roll-up type up to 18' wide. The PERMA-POWER GARAGE DOOR OPENER will operate these doors when equipped with horizontal roller track and a 2 1/2" ceiling clearance is available.

**MOTOR MECHANISM**... Operating force is obtained from an electric motor (1/3 H.P., 117-Volts) coupled to the door through a driving arrangement. Limit switches included to stop door in fully open or fully closed position. In fully closed position, coupling provides self-locking. A quick disconnect device allows for manual door operation in case of power or unit failure. Mechanism includes a light which is on whenever door is open.

**PERMA-POWER REMOTE (PUSH BUTTON) CONTROL**... installed in auto motor compartment is a one tube radio transmitter sending a 27.255 MC signal (authorized by F.C.C.) when push button is actuated. Installed with motor mechanism is two tube receiver which operates the motor. Signal from transmitter opens closed door or closes open door. Door may also be operated with a wall mounted switch.

Available through recognized electronic parts suppliers

Perma-Power

COMPANY

4727 N. DAMEN AVE

CHICAGO 25, ILL

1928

Manufacturers of electronic equipment since 1928



book is full of valuable data that is applicable to many other phases of radio communication. The section on basic radio theory constitutes one of the best treatments of this subject available anywhere. Other subjects covered are the history and operating procedures of amateur radio; basic experimental data; and advanced theory together with practical construction details on transmitters, receivers, transmission lines, antennas, power supplies, etc.

Among the chief revisions of the new edition are those in the vacuum tube tables and base diagrams. Sixty-seven new tube types have been added to the miniature tube section alone. The chapters on v.h.f. theory and equipment have been revised to provide greater clarity as well as information on new techniques.

The book is amply illustrated with over 1300 photographs and diagrams. Included is a catalog section that covers most commercial equipment and parts.

### Free Literature Roundup

A HELPFUL NEW BOOKLET suggesting custom installations for enthusiasts (particularly interesting to hi-fi enthusiasts) has been published by *Conrac, Inc.*, manufacturer of Fleetwood Custom TV sets. Entitled "A Fleeting Glance at Fleetwood Custom Television," the booklet contains photos of installations and brief explanations of each. Both conventionally controlled and remotely tuned sets are featured. A copy may be had by writing to the company at Glendora, Calif.

PUBLICATION OF "CATALOG NO. 41" has been announced by *Servo-Tek*. This 36-page catalog lists many new servo motors, motor tachometers, synchros, etc., as well as a new line of special transformers for use with grid-controlled rectifiers. Nearly all prices have been substantially reduced from those shown in previous editions. For a copy, write to *Servo-Tek Products Co., Inc.*, 1086 Goffle Road, Hawthorne, N. J.

PLASTIC "SEE-THRU" DRAWERS and other workshop equipment are featured in a new catalogue available from *General Industrial Co.*, 5737 N. Elston, Chicago 30, Ill. —50—

**BUILD**  
SOLOTRON  
**ELECTRONIC ORGAN**  
DESIGNED BY HOME CRAFTSMEN  
EASY TO BUILD  
30 KEYS  
3 TUBES - 2 WATTS



**\$1**  
PLANS  
DEPT. PE

*The SOLOTRON Co.*  
29641 GILCHRIST AV.  
FARMINGTON, MICH.

June, 1955

# WHAT'S NEW in Magnetic Recording?

**BIGGEST ADVANCE** in magnetic recording in years! That's what experts are calling new Extra Play Magnetic Tape 190, the revolutionary recording tape developed by "SCOTCH" Brand. Thinner, but made with strength to spare, new Extra Play Tape gives you 50% more recording time. That means you can now record longer broadcasts, concerts, dramatic performances without annoying interruptions for reel change.



**TWO REELS** of new "SCOTCH" Brand Extra Play Tape offer as much recording time as 3 reels of conventional tape . . . plus a generous 3 db. boost in the high frequency range. So, it's easy to understand why Extra Play Tape is already the favorite with high-fidelity fans across the country.

**YOU'LL NOTICE** a crisper tone, more brilliant sound on new Extra Play Tape. It's the result of "SCOTCH" Brand's exclusive oxide dispersion process. By laying fine-grain oxide in a neat, orderly pattern, "SCOTCH" Brand is able to pack in thousands of *additional particles* — to produce a super-sensitive magnetic recording surface. Yet, it's actually 50% thinner than conventional coatings used by other long play tapes. That's important to remember when buying. Because leading engineers are aware that a thinner, more potent oxide coating is essential for improved results with long play tapes.

**SEE THE DIFFERENCE** yourself! Here's an artist's conception of two oxide coatings seen by an electron photo microscope. At left, old-fashioned coating still used by most long play tapes. Compare this jumbled surface with neat pattern at right. "SCOTCH" Brand's unique dispersion method packs in thousands of *additional particles* to give it sound superiority.

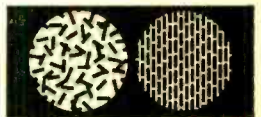

**FREE BOOKLET!** Puzzled by the technical words being used in tape recording circles? Then you'll want to own the fascinating new booklet, "A Glossary of Tape Recording Terms". This 8-page edition clearly explains many of the complicated expressions used by sound experts. Get it absolutely free of charge! Just write to: Box 103 % Popular Electronics, 366 Madison Ave., New York City, giving your name and address. We'd like to hear your comments about this column, too. Would you like to see it continued?



THE TERM "SCOTCH" AND THE PLAID DESIGN ARE REGISTERED TRADEMARKS FOR MAGNETIC TAPE MADE IN U.S.A. BY MINNESOTA MINING AND MFG. CO., ST. PAUL 6, MINN. EXPORT SALES OFFICE: 89 PARK AVENUE, NEW YORK 16, N.Y.

105

Superior's new  
Model 670-A

# SUPER METER

A COMBINATION VOLT-OHM MILLIAMMETER PLUS  
CAPACITY REACTANCE INDUCTANCE AND DECIBEL MEASUREMENTS



**SPECIFICATIONS:**

- D.C. VOLTS:** 0 to 7.5/15/75/150/750/1,500/7,500 Volts
- A.C. VOLTS:** 0 to 15/30/150/300/1,500/3,000 Volts
- OUTPUT VOLTS:** 0 to 15/30/150/300/1,500/3,000 Volts
- D.C. CURRENT:** 0 to 1.5/15/150 Ma. 0 to 1.5/15 Amperes
- RESISTANCE:** 0 to 1,000/100,000 Ohms 0 to 10 Megohms
- CAPACITY:** .001 to 1 Mfd. 1 to 50 Mfd. (Good-Bad scale for checking quality of electrolytic condensers.)
- REACTANCE:** 50 to 2,500 Ohms 2,500 Ohms to 2.5 Megohms
- INDUCTANCE:** .15 to 7 Henrys 7 to 7,000 Henrys
- DECIBELS:** -6 to +18 +14 to +38 +34 to +58

**ADDED FEATURE:**

**Built-in ISOLATION TRANSFORMER** reduces possibility of burning out meter through misuse.

The Model 670-A comes housed, in a rugged crackle-finished steel cabinet complete with test leads and operating instructions.

**\$28<sup>40</sup>**  
NET

Superior's new  
Model TV-50

# GENOMETER

A versatile all-inclusive GENERATOR which provides ALL the outputs for servicing:

A.M. Radio • F.M. Radio • Amplifiers • Black and White TV • Color TV

## 7 Signal Generators in One!

- ✓ R. F. Signal Generator for A.M.
- ✓ R. F. Signal Generator for F.M.
- ✓ Audio Frequency Generator
- ✓ Bar Generator
- ✓ Cross Hatch Generator
- ✓ Color Dot Pattern Generator
- ✓ Marker Generator

**R. F. SIGNAL GENERATOR:** The Model TV-50 Genometer provides complete coverage for A.M. and F.M. alignment. Generates Radio Frequencies from 100 Kilocycles to 60 Megacycles on fundamentals and from 60 Megacycles to 180 Megacycles on powerful harmonics.

**VARIABLE AUDIO FREQUENCY GENERATOR:** In addition to a fixed 400 cycle sine-wave audio, the Model TV-50 Genometer provides a variable 300 cycle to 20,000 cycle peaked wave audio signal.

**BAR GENERATOR:** The Model TV-50 projects an actual Bar Pattern on any TV Receiver Screen. Pattern will consist of 4 to 16 horizontal bars or 7 to 20 vertical bars.

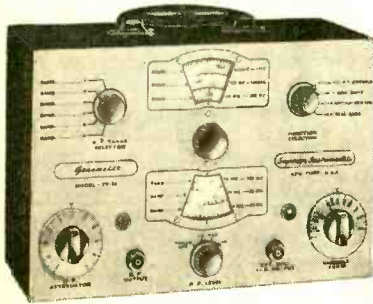

**CROSS HATCH GENERATOR:** The Model TV-50 Genometer will project a cross-hatch pattern on any TV picture tube. The pattern will consist of non-shifting horizontal and vertical lines interlaced to provide a stable cross-hatch effect.

**DOT PATTERN GENERATOR (FOR COLOR TV):** Although you will be able to use most of your regular standard equipment for servicing Color TV, the one addition which is a "must" is a Dot Pattern Generator. The Dot Pattern projected on any color TV Receiver tube by the Model TV-50 will enable you to adjust for proper color convergence.

**MARKER GENERATOR:** The Model TV-50 includes all the most frequently needed marker points. The following markers are provided: 150 Kc., 222.5 Kc., 438 Kc., 600 Kc., 1000 Kc., 1400 Kc., 1600 Kc., 2000 Kc., 2500 Kc., 3579 Kc., 4.5 Mc., 5 Mc., 10.7 Mc., (3579 Kc. is the color burst frequency).

**THE MODEL TV-50** comes absolutely complete with shielded leads and operating instructions.

**\$47<sup>50</sup>**  
NET  
ONLY

# SHIPPED ON APPROVAL NO MONEY WITH ORDER — NO C. O. D.

Try any of the above instruments for 10 days before you buy. If completely satisfied then send down payment and pay balance as indicated on coupon. **No Interest or Finance Charges Added!** If not completely satisfied return unit to us, no explanation necessary.

MOSS ELECTRONIC DISTRIBUTING CO., INC.  
Dept. D-137, 3849 Tenth Ave., New York 34, N. Y.

Please send me the units checked. I agree to pay down payment within 10 days and to pay the monthly balance as shown. It is understood there will be no finance, interest or any other charges. Provided I send my monthly payments when due. It is further understood that should I fail to make payment when due, the full unpaid balance shall become immediately due and payable.

Model 670-A ..... Total Price \$28.40  
\$7.40 within 10 days. Balance \$3.50 monthly for 6 months.

Name .....

Address .....

City ..... Zone ..... State .....

Model TV-50 ..... Total Price \$47.50  
\$11.50 within 10 days. Balance \$6.00 monthly for 6 months.

Superior's new  
Model TV-11

# TUBE TESTER

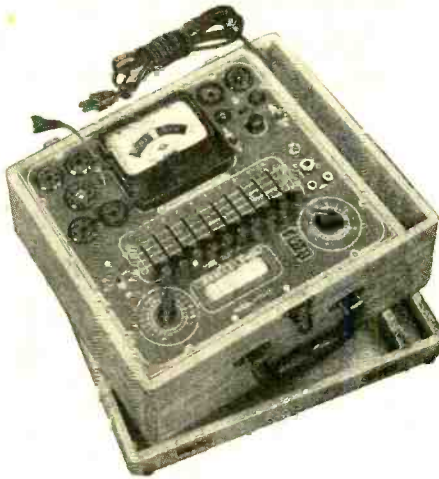

## SPECIFICATIONS:

★ Tests all tubes including 4, 5, 6, 7, Octal, Lock-In, Peanut, Bantam, Hearing Aid, Thyatron Miniatures, Sub-miniatures, Novals, Sub-minars, Proximity fuse types, etc.

★ Uses the new self-cleaning Lever Action Switches for individual element testing. Because all elements are numbered according to pin-number in the RMA base numbering system, the user can instantly identify which element is under test. Tubes having tapped filaments and tubes with filaments terminating in more than one pin are truly tested with the Model TV-11 as any of the pins may be placed in the neutral position when necessary.

★ The Model TV-11 does not use any combination type sockets. Instead individual sockets are used for each type of tube. Thus it is impossible to damage a tube by inserting it in the wrong socket.

★ Free-moving built-in roll chart provides complete data for all tubes.

★ Newly designed Line Voltage Control compensates for variation of any Line Voltage between 105 Volts and 130 Volts.

★ NOISE TEST: Phono-jack on front panel for plugging in either phones or external amplifier will detect microphonic tubes or noise due to faulty elements and loose internal connections.

The model TV-11 operates on 105-130 Volt 60 Cycles A.C. Comes housed in a beautiful hand-rubbed oak cabinet complete with portable cover.

**\$47<sup>50</sup>**  
NET

**EXTRA SERVICE** - The Model TV-11 may be used as an extremely sensitive Condenser Leakage Checker. A relaxa-

tion type oscillator incorporated in this model will detect leakages even when the frequency is one per minute.

The New Model 70 UTILITY TESTER

# FOR REPAIRING ALL ELECTRICAL APPLIANCES MOTORS • AUTOMOBILES • TV TUBES

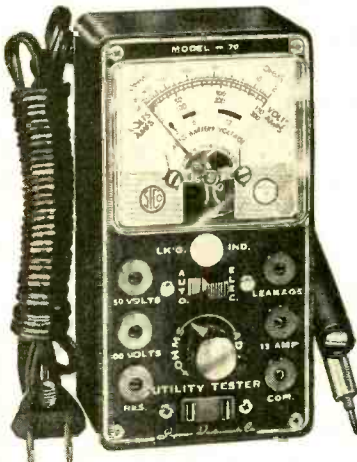

As an electrical trouble shooter the Model 70: As an Automotive Tester the Model 70 will test:

- Measures A.C. and D.C. Voltages, A.C. and D.C. Current, Resistances, Leakages, etc.
- Will measure current consumption while the appliance under test is in operation.
- Incorporates a sensitive direct-reading resistance range which will measure all resistances commonly used in electrical appliances, motors, etc.
- Leakage detecting circuit will indicate continuity from zero ohms to 5 megohms (5,000,000 ohms).
- Will Test Toasters, Irons, Broilers, Heating Pads, Clocks, Fans, Vacuum Cleaners, Refrigerators, Lamps, Fluorescents, Fans, Switches, Thermostats, etc.
- Will test all TV tubes for open filaments, inter-element shorts, burned out tubes, etc.

- Both 6 Volt and 12 Volt Storage Batteries
- Generators • Starters • Distributors
- Ignition Coils • Regulators • Relays
- Circuit Breakers • Cigarette Lighters
- Stop Lights • Condensers • Directional Signal Systems • All Lamps and Bulbs • Fuses • Heating Systems • Horns • Also will locate poor grounds, breaks in wiring, poor connections, etc.

Handsome round-cornered molded bakelite case, 3 1/4" x 5 3/8" x 2 1/4". Complete with all test leads. Also included is a 64 page book giving detailed instructions for testing all electrical appliances, automotive equipment, TV tubes, etc. Only

**\$15<sup>85</sup>**  
NET

## SHIPPED ON APPROVAL NO MONEY WITH ORDER - NO C.O.D.

Try any of the above instruments for 10 days before you buy. If completely satisfied then send down payment and pay balance as indicated on coupon. No Interest or Finance Charges Added! If not completely satisfied return unit to us, no explanation necessary

MOSS ELECTRONIC DISTRIBUTING CO., INC.  
Dept. D-137, 3849 Tenth Ave., New York 34, N. Y.  
Please send me the units checked. I agree to pay down payment within 10 days and to pay the monthly balance as shown. It is understood there will be no finance, interest, or any other charges, provided I send my monthly payments when due. It is further understood that should I fail to make payment when due, the full unpaid balance shall become immediately due and payable.

Model TV-11 ..... Total Price \$47.50  
\$11.50 within 10 days. Balance \$6.00 monthly for 6 months.

Name .....

Address .....

City..... Zone..... State.....

Model 70 ..... Total Price \$15.85  
\$3.85 within 10 days. Balance \$4.00 monthly for 3 months.

# IT'S NEW! IT'S FREE!

## 1955 Walter Ashe Catalog of Radio, Electronics and TV



### The Treasure Chest of Values!

Features all the leading brands of Communication Equipment, Test Instruments, Build-it-Yourself Kits, Hi-Fi, Sound and Recording Equipment, Radio, Electronics and TV Parts and Supplies for every conceivable need . . . in stock — ready for immediate delivery. A "must" for experimenters, amateurs, servicemen, engineers, builders and "hi-fiers."

**Walter Ashe**  
RADIO CO.  
1125 PINE ST. • ST. LOUIS 1, MO.

Send for your  
**FREE Copy**

MAIL COUPON TODAY!

WALTER ASHE RADIO CO. PE-6-55  
1125 Pine St., St. Louis 1, Mo.

Rush FREE Copy of New 1955 Catalog.

Name \_\_\_\_\_

Address \_\_\_\_\_

City \_\_\_\_\_ Zone \_\_\_\_\_ State \_\_\_\_\_

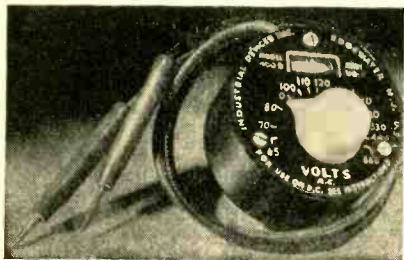

## WORTH ITS WEIGHT IN GOLD!

Hundreds of thousands in use daily! A handy voltage indicator of unlimited use. Takes the place of costly, delicate instruments. Carry it in your pocket, or drop it in your tool box—it's always ready for use!

**RUGGED!** Neon lamp indicator stands over-loads, mechanical shocks, and lasts a lifetime. Practically indestructible!

**ACCURATE!** Measures AC or DC. Indicates 2-3 volt difference at 110 volts. Checks fuses, continuity, shorts, live wires, grounds, voltage drops, etc.



**MODEL 400B** including  
12" insulated leads and  
test prods.

**\$375**  
LIST

Order from your distributor.

Write for free catalog . . .

**INDUSTRIAL DEVICES, INC.**  
Edgewater, N. J.

# TIPS and TECHNIQUES

## PLUG-IN COIL FORMS

THE BAKELITE BASES OF burnt out glass vacuum tubes may be used as inexpensive plug-in coil forms. Octal tubes furnish a source of 8-pin forms while older types, such as the type 80 rectifier and the type 76 triode, furnish 4- and 5-pin bases. To remove the base, first wrap the tube in a cloth to prevent flying glass, then strike

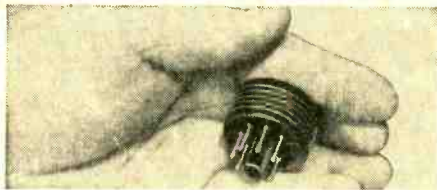

the bulb two or three sharp blows with a hammer. Cut the support leads of tube electrodes with a pair of side cutters. Chip out glass and cement remaining in the base with a pocket knife or small cold chisel. Finally, remove the electrode leads by holding a hot soldering iron against the tip of each pin in turn and pulling out the lead wires with a pair of long-nosed pliers.

## DRILL PRESS SAFETY SWITCH

THIS SAFETY SWITCH for a drill press has two advantages. It prevents unauthorized use of the drill press, and it also makes sure that the chuck wrench has been removed before the power is turned on. Should the wrench be left hanging in

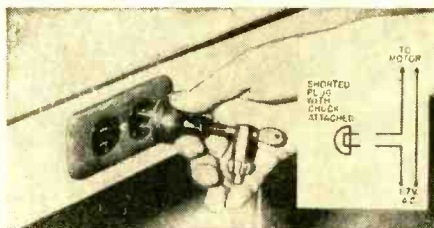

the drill chuck, there's no chance that the motor will be turned on, causing the wrench to be thrown out violently.

Connect an outlet in series with one side of the drill press power line. Then the

POPULAR ELECTRONICS

motor can't be turned on unless this outlet is shorted. The "interlock" is a simple rubber-insulated male plug with the terminals shorted together, taped to the handle of the chuck wrench.

### CIGARETTE CASE HOLDS PARTS

MANY SMALL DRILLS, grinder tips, and brushes which are used with a light hand tool may be kept in place or carried in the

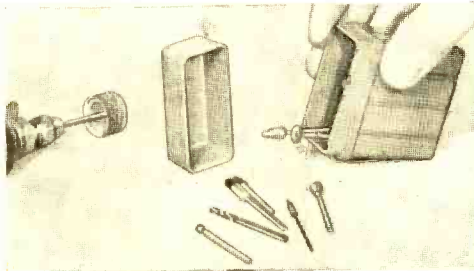

pocket in a plastic cigarette case. Even when hand tool and parts are stored in one larger case, the cigarette container will be convenient. Use as many such containers as are needed. A label, indicating the contents of each container, will speed the work.

### PAPER CLIP AIDS TEST LEAD

A PIECE OF SPRING WIRE, such as a paper clip, bent into the shape shown in the illustration and slipped on the end of a test lead, makes a good device for maintaining contact between the test tip and

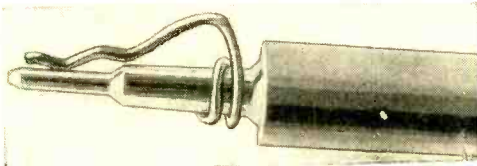

the circuit. The part that is wound around the test prod may be soldered to it, making a permanent installation. The part so used should be wound on a slightly smaller diameter prior to slipping it on the test prod; it may be expanded slightly for a tight fit.

### MULTIPLE OUTLETS FOR WORKBENCH

IF THE ELECTRICAL OUTLET for a workbench is a tangle of cords and double sockets, use a length of "zip" cord with the new slip-on type connectors for a multiple outlet. These molded connectors can be found at most hardware and dime stores. A length of such cord can be strung along the rear of the bench, and as many outlets in-

June, 1955

## LEARN basic electricity electronics

THE EASY "PICTURE BOOK" WAY!



Just Released: The fabulous  
ILLUSTRATED Training Course  
now used by the U. S. Navy!

#### You Learn by Pictures

Over 25,000 Navy trainees have already learned Basic Electricity and Basic Electronics this easy, "Picture Book" way! Now, for the first time, YOU can master the basics of Electricity and Electronics with this same "Learn-by-Pictures" training course! Over 1,700 simple, easy-to-understand drawings explain every section—these "teaching" pictures actually make up more than half the entire course! No other Basic Electricity or Basic Electronics course in America uses this revolutionary illustrative technique! You learn faster and easier than you'd dream possible!

#### A Complete Idea on Every Page

Here's how this easy, illustrated course works: every page covers one complete idea! There's at least one big illustration on that same page to explain it! What's more, an imaginary instructor stands figuratively at your elbow, doing "demonstrations" that make it even easier for you to understand. Then, at the end of every section, you'll find review pages that highlight the important topics you've just covered. You build a thorough, step-by-step knowledge at your own pace—as fast as you yourself want to go!

#### Everyday English—A Course Anyone Can Understand

Sponsored by the Navy to turn out trained technicians in record time, this modern course presents Basic Electricity and Basic Electronics in a simple way that everyone can grasp—regardless of previous education! Every phase is made instantly clear—explained in plain, down to earth English—with hundreds of easy-to-understand illustrations to help you!

#### 10 Complete Volumes

Volumes 1 and 2 of "Basic Electricity" cover DC components and circuits; Volumes 3 and 4 cover AC components and circuits; Volume 5 covers AC and DC motors and machinery.

Volume 1 of "Basic Electronics" covers Diodes & Power Supplies; Vols. 2 and 3 cover Amplifiers & Oscillators; Vols. 4 and 5 cover Transmitters & Receivers.

#### Home Study Without Correspondence

This course is so different, so complete—there's no need for the usual letter writing, question and answer correspondence! Learn at home—at your own pace!

#### 10 Day Examination—Money Back Guarantee

Send today for these exciting new training courses—you risk nothing! When you receive the volumes, examine them in your own home for 10 full days. If, at the end of that time, you're not completely satisfied, simply return the books to us and we'll gladly refund your full purchase price! Total cost for either 5-volume course is only \$9.00! In Canada, prices approximately 5% higher.

#### ORDER TODAY!

These books are sold by electronics parts jobbers and book stores. If YOUR dealer doesn't have these books, mail this coupon to us!

JOHN F. RIDER PUBLISHER, INC.  
480 Canal Street, N.Y.C.

Please RUSH me ..... sets of "Basic Electricity" @ \$9.00 per set, and ..... sets of "Basic Electronics" @ \$9.00 per set. I understand that I may return the books within 10 days and receive a complete refund of my full purchase price.

Name .....

Address .....

City & State .....

P2

# THE NEW DALTON Model D-500 ELECTRIC PORTABLE JIG SAW

**7 SAWS IN ONE!**

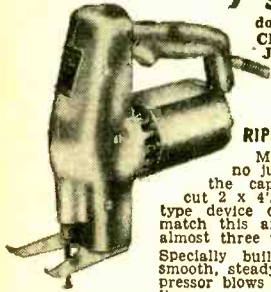

does the work of a RIP...  
CROSS CUT... COPING...  
JIG... SCROLL... BAND  
and KEYHOLE SAW  
CUTS ANY MATERIAL!  
SAWS ANY SHAPE!

RIPS and CROSS CUTS 2x4's

Makes fast, smooth cuts...  
no jumping or chattering. Has  
the capacity to rip and cross  
cut 2 x 4's. The only other similar  
type device on the market that can  
match this amazing performance costs  
almost three times as much!

Specially built Dayton motor assures  
smooth, steady cutting. A built-in  
compressor blows sawdust away from guide  
line.

## SPECIFICATIONS

• 4 to 1 gear reduction. • All gears hardened steel.  
• Motor exposed for cool running. • Oilite bronze bearings.  
• Air is pumped from top down through the center  
section, cooling unit as well as blowing sawdust from line.

IT CUTS wood — plastics — metals —  
composition boards — hard rubber and  
others.

IT SAWS circles — curves — straight  
lines — intricate designs.

Complete with 5  
different blades

**\$48.00**

**SHIPPED ON APPROVAL  
NO MONEY WITH ORDER — NO C. O. D.**

Try it ten days before you buy. If completely satisfied then send \$15.00 and pay balance at rate of \$11.00 per month for 3 months — No Interest or Finance Charges Added. If not completely satisfied, return to us, no explanation necessary.

KAPNER HARDWARE, INC.  
Dept. A-137, 2248 Second Ave., N. Y. 29, N. Y.

Please rush one D-500 Jig Saw. I agree to pay \$15.00 within 10 days after receipt and \$11 per month thereafter.

Name \_\_\_\_\_  
Address \_\_\_\_\_  
City \_\_\_\_\_ Zone \_\_\_\_\_ State \_\_\_\_\_

stalled as there are equipment and electrical tools. Although no one would normally have enough equipment turned on to overload such a line, do make sure that

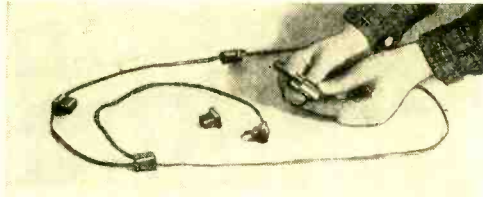

the total of the current drawn at any one time through such a multiple-outlet cord does not exceed 7½ amperes. A close-enough figure for this amperage can be obtained by dividing the power consumption in watts of each unit by the line voltage, usually 117 volts. A total of under 800 watts should be safe. In using such a cord, make sure other appliances connected to the same line elsewhere do not exceed the safe rating for the circuit.

## GRAPH PAPER DIAL

A HANDY ACCURATE DIAL of any diameter can be made from "polar coordinate graph paper" obtainable at all drafting supply stores. Since the sheets are the size of usual letterhead paper, appropriate numbers may be typed on them to denote values or readings.

The paper should be cut to the desired diameter and cemented to the panel with rubber cement. A sharp pointed knob will make an excellent indicator. To dress up the panel the constructor can cover the graph paper with a thin sheet of lucite plastic.

## SPRING CLAMPS HOLD WORK

THOSE WHO HAVE TROUBLE SOLDERING because the work skitters all over the bench should make some of these spring clamps. An old bedspring will make dozens, and

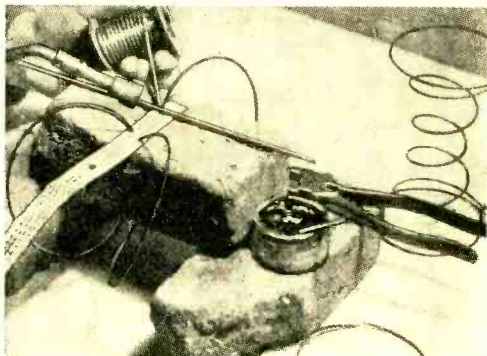

they will be useful for gluing, too. For soldering, they have an advantage over

# REPEAT SALE BY POPULAR DEMAND

WORLD-  
FAMOUS  
HI-FI  
3-SPEED  
AUTOMATIC  
PHONO

3 SPEAKERS

DeLuxe 3-speed automatic record player with speaker cross over network for true high-fidelity. 4 tube amplifier scientifically designed to reproduce from 20 to 20,000 cycles. Automatic shutoff for amplifier when last record has played. Beautiful mahogany cabinet with luxurious woven grill. Dimensions: 17 7/8" x 15 7/8" x 11". Weight 30 lbs.

Nationally  
Advertised  
for \$139.95

CLOSE OUT  
PRICE!

**\$72.50**

Write Dept. PE-6 for FREE catalog.

**STEVE-EL Electronics Corp.**

61 Reade St.

New York 7, N. Y.

conventional iron clamps, since they do not carry away any of the heat. In cutting the circles out of the steel bed springs, use heavy pliers and grip the wire all the way into the jaws. For work on finished material, round the clamp tips with a file, so they won't scratch. Then clamp the work to a firebrick and turn on the heat with torch or soldering iron. The pieces will now stay in place.

### GUARD FOR SOLDERING IRON

TO GUARD SOLDERING IRONS against bent tips and broken "headlight" bulbs, a device



as shown in the photograph may be made quite easily. A cone is cut from stiff cardboard and then rolled into the shape shown. It is next taped to form a "holster" for the soldering gun. This simple expediency may prevent costly damage to the gun.

### INEXPENSIVE SPEAKER GRILLE

PROTECT THE PAPER CONES of loudspeakers against accidental tears and punctures by covering the speaker openings in cabinets with a rigid metal grille. The new "Do-It-Yourself" aluminum is now available in perforated sheets at most hardware stores and is ideal for this purpose. The soft aluminum alloy used may be cut easily with ordinary household scissors. Several patterns are available, and all are decorative enough to be used without finishing in "lab" equipment. For phonographs, TV sets, and other "furniture-type" electronic equipment, loosely woven grille cloth, reinforced with the perforated metal grille, may be used over the speaker opening.

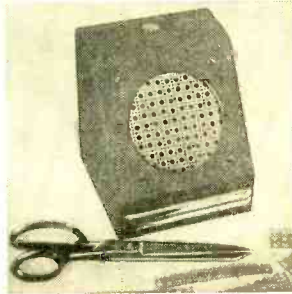

# HUGE \$1 SALE!

## POPULAR ELECTRONIC KITS and TOOLS

**JUNE ONLY BONUS!**

YOUR CHOICE OF ANY ITEM IN THIS AD

**FREE!**

WITH EVERY \$10 ORDER



#### 50 CERAMICON CONDENSERS.

Scoop! Tubular, disc, button types. Over 20 values. \$1  
2 to 4000mf. Shop must! Wt. 1 lb. Reg. \$13.

#### 60 TUBULAR CONDENSERS.

.00035 to 1mf. up to 1000V. 20 types. 1/8" too! \$1  
Wt. 2 lbs. Reg. \$10.

#### 25 OIL CAPACITORS.

Bathub and tubular. .1 to 2mf. up to 600V. 20 selected values. \$1  
Well-known mfrs. Wt. 4 lbs. Reg. \$17.

#### 10 ELECTROLYTICS.

Tubular and FP units. 8 to 1000mf. up to 450V. Many multiple sections. Wt. 2 lbs. Reg. \$11.

#### 50 RF COILS, CHOKES and slug-tuned coils for TV, radio. 1b. 20 types. Wt. 1 lb. Reg. \$15.

#### 60 RESISTORS.

56 ohms to 20 megs. 1/2, 1 and 2 watts. 25 selected values. Many 5% Insulated. Wt. 1/2 lb. Reg. \$12.

#### 50 PILOT LITE SOCKETS.

Builders' special! Screw and bayonet bases. Wt. 2 lbs. Reg. \$9.

#### 1500 PIECES SPAGHETTI tubing.

lengths to 4". 10 sizes. Fiberglass, cambric, plastic. Reg. \$7.

#### 18 W.W. RESISTORS.

Power condohm and "dogbone" types. 5 to 10,000 ohms. 5 to 50 watts. 15 values. Wt. 2 lbs. Reg. \$11.

#### 10 RADIO CHASSIS.

5, 6 & 7 tube punched chassis. New! Workshop must! Wt. 8 lbs. Reg. \$8.50.

#### 75 KNOBS.

Some worth ea. TV and Radio. 15 types, push-on, set screw. Wt. 2 lbs. Reg. \$8.50.

#### THREE LBS. HARDWARE.

Assorted. Over 1200 pieces, screws, nuts, lugs, etc. Reg. \$6.50.

#### 12 CONTROLS.

Up to 1 meg. 12 selected values. Some w/ switch, some duals. For TV, radio. Wt. 2 lbs. Reg. \$12.

#### TEN 25-ft. ROLLS WIRE.

Plastic and cloth insulated, solid & stranded #18 to #24, ass'd. colors. Wt. 2 lbs. Reg. \$5.50.

#### 15 SWITCHES.

Rotary, push, micro, toggle. Export, members' vote! Wt. 3 lbs. Reg. \$12.

#### 25 TUBE SOCKETS.

Moulded, wafer, shield base types. 4 to 9 pin. 10 sizes, some ceramic and mica. Wt. 6 lbs. Reg. \$6.50.

#### 200 COIL FORMS.

50 sizes and shapes. Bakelite and ceramic. Experimenters must! Wt. 2 lbs. Reg. \$14.

#### TV ACCESSORY KIT.

Never before! 1 each 60 & 70 degree yokes, focus coil. Brand new! Wt. 8 lbs. Reg. \$10.

#### R/C ASSEMBLY.

Exclusive! Mtd. on term. strips: 70 moulded, paper and mica capacitors. 0001 to .047 mf up to 600 V; 45 1/2w resistors. Leads 1/2" to 1" long. Brand new. Wt. 2 lbs. Reg. \$15.

#### 60 MICA CAPACITORS.

Rare bargain! Postage stamp type. .0001 to .01 mf. Many silver 5% too! 20 values. Wt. 1 lb. Reg. \$17.

#### MOULDED CAPACITORS.

Outstanding value! 20 selected sizes. .0005 to .05 mf up to 600V. Reg. \$13.

#### 25 VARIABLES.

First time in U.S.! 8 values; mica and ceramic trimmer condensers by Erie and Elmenco; from 3 to 2000 mf. Singles \$1.2 and duals. Wt. 1 lb. Reg. \$16.

#### 10 INDICATORS & HOLDERS.

A. Lektron first! 5 pilot lite and thermal indicators; 5 Littlefuse holders. Wt. 1 lb. Reg. \$8.

#### 70 TERM. POSTS & STRIPS.

Builders' special! Ass't. binding posts, screw and lug type terminal strips (1 to 10 terms.). Wt. 1 lb. Reg. \$4.50.

## SPECIAL!—TOP QUALITY HOT DROP—FORGED STEEL TOOLS

MANUFACTURER'S OVERSTOCK—LIMITED QUANTITY!

only \$1 each!

1. 5" dia. CUTTERS. \$1
2. 6" LONGNOSE PLIERS. \$1
3. 7" GRIPPER-CUTTERS. \$1
4. 6-PIECE SCREWDRIVER KIT. \$1  
Plastic handle, 1/8, 3/16, 1/4, Phillips 1 & 2 interchangeable blades.
5. 7-PIECE NUTDRIVER KIT. \$1  
Long handle, 5/16, 3/4, 5/16, 3/8, 7/16, 1/2" steel socket wrenches in metal box.
6. 9-PIECE TWIST DRILL KIT. \$1  
Long shank, hardened steel, 1/16" thru 3/4" by 6ths. In case.



Please send check or Money Order. Include postage. C.O.D. orders, 25% down payment.

### LEKTRON SPECIALTIES

28 Gardiner Street CHE 3-6325 Chelsea, Mass.

**SAVE UP TO 85% ON GOV'T SURPLUS!**

**GOV'T SURPLUS E.E.B SIGNAL CORPS FIELD TELEPHONE**

A private phone or intercom system. Easy to operate. Use any place that portable, 2-way communication is desired. Gives clear reception up to 15 miles. Operates on two standard batteries. Several phones may be used on the same line. Set contains a ring-generator, leather carrying case and phone. Each set is reconditioned & checked-out.

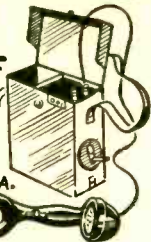

Complete circuit - Set of 2 **1495EA** **2950**

Pay by Money Order or Check. P.O.'s accepted from D&B firms. 50% deposit with C.O.D.'s. Prices F.O.B. Los Angeles.

**WORLD'S MOST AMAZING BARGAIN CATALOG**

**OVER 320 PAGES**

**SAVE UP TO 85% ON WAR SURPLUS**

Packed with SENSATIONAL VALUES in WAR SURPLUS, FACTORY CLOSE-OUTS and GENERAL MERCHANDISE!

Fully Illustrated. Packed with thousands of Bargains in Hand & Power Tools, Radio Speakers, Ear Phones, Electronics, Gadgets, Electric Motors & Blowers, all types of Hydraulic Equipment, Outdoor & Sports Equipn, Cameras, Precision Instruments, Microscopes, plus many, many more.



Send **50c**

To cover the cost of Handling and Mailing. CREDITED to your first order.

**PALLEYSUPPLY CO.**

2263 E. VERNON AVE., DEPT. PL-6  
Los Angeles 58, California

Make your own baby genius computers

**GENIACS**

Scientific—Entertaining—Instructive—Safe new line with our new construction kit including all parts and instructions:

**KT: GENIACS—SMALL ELECTRIC BRAIN MACHINES—AND HOW TO MAKE THEM**

This kit gives simple instructions, construction plans, and a complete set of parts for making over 30 arithmetical, logical, reasoning, computing, puzzle-solving, and game-playing machines (see list below). Each Geniac displays intelligent behavior, runs on one flashlight battery, requires no soldering (all connections with nuts and bolts). This kit is the outcome of five years of design and development work with small robots. This kit is simple enough for intelligent boys; yet instructive to anyone because it demonstrates in easily put-together models the fascinating variety of computing and reasoning circuits. Kit, including instructions and all parts.....\$15.95

Returnable in one week for full refund if not satisfactory. The parts include six multiple switches of a new design; all parts are accurately machined; the parts alone if bought in small quantities would cost over \$25.

Some of the possible GENIACS: Logic Machines: Comparing; Reasoning; Syllogism Machine; Intelligence Test. Game-playing Machines: Tic-Tac-Toe, Nim, Arithmetical Machines (both decimal and binary); Adder, Subtractor, Multiplier, Divider, Arithmetical carrying. Cryptographic Machines: Secret Coder, Secret Decoder, Combination Locks. Simple Machines: Burglar Alarm, Automatic Oil Furnace Circuit, etc., Puzzle-Solving Machines: the Space Ship Airlock; the Fox, Hen, Corn, and Hired Man; Douglas Macdonald's Will; the Uranium Shipment and the Space Pirates.

MAIL THIS COUPON

GENIAC PROJECT

36 W. 11th St., New York 11, N. Y.

Please send me the Geniac kit. Returnable in 7 days for full refund if not satisfactory. I enclose \$15.95 in full payment.

My name and address are attached.

**TOOLS & GADGETS**

**MINIATURIZED ALLIGATOR CLIP**

The smallest alligator clip made has been introduced by *Mueller Electric Company*, 1600V East 31 Street, Cleveland 14, Ohio. Available in steel (cadmium plated) or in solid copper, the clip is half the length of



the standard alligator clip. The photo shows the actual size of these units, which may be fitted with vinyl insulators (right). Sold separately, the insulator sleeve slips over the nose of the clip. The clip weighs only 1/20th of an ounce and will not "lean over." Jaw spread is 3/16-inch. Descriptive literature is available from the manufacturer.

**KIT AIDS CUTTING OF SHAFTS**

*Centralab* has brought together — into one kit — a selection of 6 tools to aid in the adapting of control and switch shafts to individual requirements. A custom-made shaft clamp tool, similar to that used by many tool makers, has been produced specially for this kit. The tool holds a variety of diameters of shafts in a vice without damage for a clean cut.

Also included in the kit are a fine-tooth hacksaw blade and precision half-round

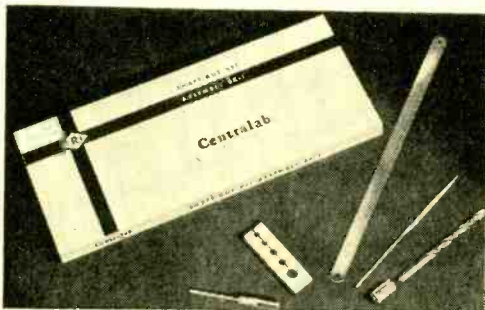

needle file, an "A" size drill and drill stop for drilling out holes in knobs, and a small screwdriver. All tools have been picked for their high quality and usefulness in the radio field.

The "Shaft-Kut Kit" is *CRL* catalogue number SK-1, and can be purchased from any *Centralab* distributor. Complete details are in Bulletin 42-223 available from distributors or by writing directly to *Cen-*



tralab, 900 East Keefe Avenue, Dept. C-97, Milwaukee 1, Wis.

### FLUID CLEANS MOVING PARTS

Specially formulated for the electronic and electro-mechanical industries by *Beaver Laboratories*.

86-81 Palo Alto Street, Hollis 23, N. Y., "Contact" is a new colloidal solution with a hydrocarbon carrier base. The super-capillary action of this product forces it into inaccessible places where it instantly cleans and deposits a coating of "duralube"—a hard-bonded dry lubricant which resists corrosives, heat, and cold.



Non-inflammable and completely harmless to precious metals and all contacts, "Contact" leaves no gummy deposit and has no effect on resistance, capacitance, or inductance.

For complete literature and free sample with dropper applicator, write directly to *Beaver Labs*, Section 1, address above. Enclose 15¢ to cover postage and handling.

### LOW OHM SAFETY METER

Accuracy and simplicity of operation are combined in *Amelco's* new low ohm "Safety Meter." This device will not damage deli-

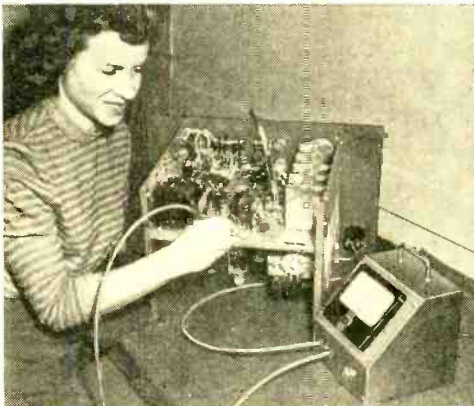

cate components or expensive meters. It differentiates between legs of high current filament circuits and will also indicate sources of troubles in switches, relay con-

June, 1955

# BUILD 15 RADIO CIRCUITS AT HOME ONLY

With the New Improved 1955 Progressive Radio "EDU-KIT"

**\$19.95**  
Complete

NOW INCLUDES  
RECEIVER, TRANSMITTER,  
SIGNAL TRACER, CODE  
OSCILLATOR CIRCUITS

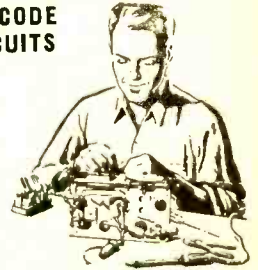

- Attractively Gift Packaged
- Free Soldering Iron
- Absolutely No Knowledge of Radio Necessary
- No Additional Parts Needed
- Excellent Background For Television
- 30-Day Money-Back Guarantee
- School Inquiries Invited
- Used in 79 Countries
- Learn High Fidelity

## WHAT THE PROGRESSIVE RADIO "EDU-KIT" OFFERS YOU

You will learn how to identify Radio Symbols and Diagrams; how to build radios, using regular radio schematics; how to wire and solder in a professional manner. You will learn proper chassis layout. You will learn the basic principles involved in radio reception, transmission and audio amplification. You will learn how to service and trouble-shoot radios. You will learn code. You will receive instructions for F.C.C. Novice license. In brief you will receive a practical basic education in Radio, worth many times the small price you pay.

### THE KIT FOR EVERYONE

It is not necessary that you have even the slightest background in science or radio. The "Edu-Kit" is used by young and old; by radio schools and clubs; by Armed Forces personnel and Veterans. No instructor is required. Instructions are complete, simple and clear.

### PROGRESSIVE TEACHING METHOD

The "Edu-Kit" uses the principle of "Learn by Doing." Therefore you will build radios, perform jobs, and conduct experiments to illustrate the principles which you learn. You begin by learning the function and theory of each of the radio parts. Then you build a simple radio. Gradually, in a progressive manner, you will find yourself constructing more advanced multi-tube radio sets, and doing work like a professional Radio Technician. The "Edu-Kit" Instruction Books are exceedingly clear in their explanations, illustrations and diagrams. These sets operate on 105-125 V. AC/DC. For use in foreign countries having 210-250 volt source, an adapter for 210-250 V. AC/DC available.

### The Progressive Radio "EDU-KIT" is Complete

You will receive every part necessary to build fifteen different radio circuits. The "Edu-Kit" contains tubes, tube sockets, variable, electrolytic and paper condensers, resistors, tie strips, coils, hardware, tubing, Instruction Manuals, etc. No solder or hook-up wire included. A soldering iron is included, as well as are provided. All parts are guaranteed, brand new, carefully selected and matched. In addition, the "Edu-Kit" now contains lessons for servicing with the Progressive Signal Tracer, High Fidelity, F.C.C. Novice Instructions, quizzes.

### TROUBLE-SHOOTING LESSONS

Trouble-shooting and servicing are included. You will learn how to recognize and repair troubles. You will build and learn to operate a professional Signal Tracer. You will receive an Electrical and Radio Tester, and learn to use it for radio repairs. While you are learning in this practical way, you will be able to do many a repair job for your neighbors and friends and charge fees which will far exceed the cost of the "Edu-Kit."

### FREE EXTRAS

- ELECTRICAL & RADIO TESTER • SOLDERING IRON • HI-FI GUIDE • TV BOOK • QUIZZES • CONSULTATION SERVICE

PROGRESSIVE "EDU-KITS" INC., 497 Union Av., Brooklyn 11, N. Y.

MAIL TODAY—Order shipped same day received.

30-Day Money-Back Guarantee. INCLUDE ALL FREE EXTRAS.

- "EDU-KIT" postpaid. I enclose full payment of \$19.95
- "EDU-KIT" COD—I will pay \$19.95 plus postage (USA only)
- Outside USA: Enclose \$20.95. "Edu-Kit" sent postpaid
- Outside USA: 210-250V. AC/DC Adapter. Enclose \$2.50
- More details on "EDU-KIT" Free—No Obligation
- FREE Radio-TV Servicing Literature. No obligation

NAME \_\_\_\_\_

ADDRESS \_\_\_\_\_

PROGRESSIVE "EDU-KITS" INC. 497 UNION AVE.  
Room 509D, Progressive Building Brooklyn 11, N. Y.

## DELUXE POCKET RADIO



Satisfied users report up to 1500 mile range. **ELECTRON TUBE MODEL** uses standard radio parts built to last. No hearing aid parts used. You can assemble this neatly engineered kit in one hour with simple directions. Batteries and parts fit in case. Tube included. **FULLY GUARANTEED.** Batteries \$1.10 per set. Radio headphone \$1.50. Dime-size hearing aid earset, limited supply imported, \$1.85, or use own earphone.

**\$395**  
Post  
Paid

MODEL 3V4, factory-wired (set only) available at \$8.95. If C.O.D. please mail \$1 deposit.

### WESTERN RADIO CO.

Dept. 6 Box 1526 Sacramento 14, Calif.

## THRIFTY SPECIALS

WELLER JUNIOR SOLDER GUN ..... \$5.88  
See April Issue P.E.  
3 TUBE PHONO AMPLIFIER ..... \$2.99  
using 50L6-35Z5-12SQ7 tubes  
all 3 tubes \$1.99  
300 FEET SIX ASSORTED COLOR PLASTIC COVERED  
WIRE, PLUS RACK ..... \$2.95  
ASTATIC CRYSTAL MIKE ..... \$5.25  
excellent for home recording, etc.

### THRIFTY TV SUPPLY COMPANY

13647 Burbank Blvd. Van Nuys, Calif.

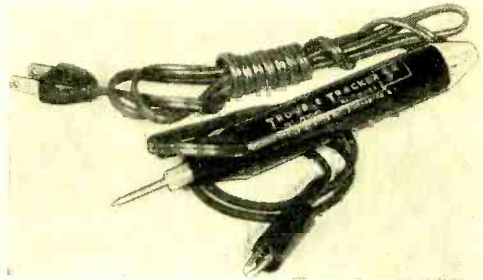

## BE SHARP! SHARP! SHARP!

Hit your friends with a new brain teaser every day! Our 100 thought provokers assure your popularity. These scientific puzzlers sharpen your wits in Electronics, Logic, and Mechanics. They're rough! They're tough! But we give you the answers. Send \$1.00 to

ELECTROFACTS, Box 5027, Bossier City, La.

## NEW R/C SUPPLEMENT

Hundreds of new kits, parts, tubes and relays are listed in our new Supplement 55-2. Keep up to date with the latest in Radio Control. If you are not on our mailing list, send postal and ask for supplement 55-2.

### ACE RADIO CONTROL

Box 301 Higginsville, Mo.

## TRANSISTORS!!!

**EXPERIMENTERS Hurry** • limited quantity, marvels of electronics • build your own audio oscillators, personal radios, hearing aids, etc. • Transistor \$3.00 • Lead Sulphide Photocell in plastic \$1.00 • Cadmium Sulphide Cell \$2.00 • Lead Sulphide Cell in Glass \$1.00 • Learn by doing • Act now.  
**BARGAIN OFFER**—Entire kit, 2 Lead, 1 Cadmium Cells and 1 Transistor ONLY \$5.00 postpaid, including booklet of information and circuits.

**TRANSISTOR-PHOTO PRODUCTS**  
Geneva, Illinois



## TRANSISTOR RADIO!!!

World's smallest and lowest priced transistor set. Perfect for baseball fans, office workers, children. Polystyrene plastic case smaller than cigarette pack, carry in shirt pocket or purse. Tunes all stations. Operates one month on dime store battery. Plays indoors, outdoors, in automobile. Built-in antenna. Assembles quickly, no soldering iron needed. Complete with battery, less earset—\$12.00. Special imported hearing aid earset—\$3.00. Single headphone—\$2.00. Postpaid. Cash, Check or Money Order. Eastern Audio Research, Box 62, Little Neck 63, New York.

tacts, and connectors. The device locates incomplete electrical bonding and detects unsoldered and "cold" soldered connections. It eliminates the possibility of a good continuity indication through a misconnected part. The meter is priced at \$75.00. For further information, write to *Amelco, Inc.*, Dept. 10, 2040 Colorado Avenue, Santa Monica, Cal.

## POCKET SIZE TROUBLESHOOTERS

Two simple and efficient circuit checkers, called "Trouble Trackers" and recommended for use by home and shop electricians, radio and TV repairmen and industrial

engineers, have been announced by *Link Aviation, Inc.*, Binghamton, N. Y.

The pocket-sized units can be used to check all types of heating elements (toasters, flatirons, etc.), motors, generators, windings, relays, switches, filaments of radio and TV tubes, and various hard-to-trace circuits in cars, houses and machines.

The new units are the "Trouble Tracker, Sr.," the more versatile of the two, and "Trouble Tracker, Jr.," which is used to check basic continuity of low-resistance, "power-off" electrical circuits. Both models are simple to use. By attaching the alligator clip to one end of the circuit and touching the probe to the other, a flash of light from a "Trouble Tracker" pinpoints the trouble spot instantly. Additional information may be had by writing to the manufacturer.

—30—

## Ama-Touring

(Continued from page 92)

- KG4 (Guantanamo Bay, Cuba)—KG4AO, 14.22; KG4AU, 14.195.
- KP4 (Puerto Rico)—KP4GI, 14.25; KP4NY, 14.26.
- KV4 (Virgin Islands)—KV4BB, 14.21; KV4BD, 14.26.
- KZ5 (Panama Canal Zone)—KZ5NS, 14.19; KZ5WA, 14.16.
- LU (Argentina)—LU4DMG, 14.19; LU7MAL, 14.15.

OA (Peru)—OA1C, 14.15; OA4CC, 14.12.  
 PJ (Netherlands West Indies)—PJ2AG, 14.17; PJ2CL, 14.14.  
 PY (Brazil)—PY4AEX, 14.16; PY6BN, 14.15.  
 TG (Guatemala)—TG9AI, 14.33; TG9KF, 14.175.  
 TI (Costa Rica)—TI2RMA, 14.15; TI4AC, 14.14.  
 VP1 (British Honduras)—VP1GG, 14.195.  
 VP2 (Leeward Islands)—VP2KM, 14.155, St. Kitts.  
 VP2 (Windward Islands)—VP2DA, 14.15, Dominica.  
 VP3 (British Guiana)—VP3HAG, 14.17; VP3LF, 14.185.  
 VP4 (Trinidad)—VP4LZ, 14.18; VP4TT, 14.12.  
 VP5 (Jamaica)—VP5AK, 14.17; VP5AR, 14.14.  
 VP6 (Barbados)—VP6GP, 14.175; VP6SF, 14.19.  
 VP7 (Bahamas)—VP7NG, 14.155; VP7NW, 14.19.  
 VP9 (Bermuda)—VP9AL, 14.17; VP9BM, 14.19.  
 XE (Mexico)—XE1UM, 14.33; XE2HZ, 14.33.  
 YN (Nicaragua)—YN1RA, 14.15; YN4CB, 14.195.  
 YS (El Salvador)—YS1MS, 14.17.  
 YV (Venezuela)—YV2AM, 14.18; YV5AI, 14.19.

-30-

## Tape Recorders

(Continued from page 80)

motors, along with such amenities as precision-bearing idler capstans, special tensioning devices in the pay-off and take-up reels, and accurate tape guides and gates.

In the lower priced units, the use of synchronous motors is not possible due to their expense, nor are many of the other features of the better units applicable. In fact, one of the really amazing things about the cheap recorders is that, in spite of the lack of these facilities, the tape motion is fairly respectable. However, it would be unwise to delude yourself into thinking that wow and flutter are not present. Just record for a minute or two some sustained piano chords, or flute or violin passages. Unless your ears are far from normal, you will be all too unhappily aware of the unpleasant wavering of the musical tones.

Enough of my carping!! What you want to know is what you can do to correct some of these deficiencies of your tape recorder, especially without spending large sums of money. As mentioned previously, there is not much one can do about the



**Fix your TV Set  
YOURSELF!**  
**BUY YOUR TV TUBES  
AT WHOLESALE!**  
**100% GUARANTEED! BRANDED! SAME DAY SERVICE!**

1A4P	.29	6B5	.59	7F8	.59
1A7	.49	6B6	.39	7J7	.59
1B3	.59	6B6	.99	7K7	.59
1B4P	.79	6BH6	.49	7U5	.49
1C6	.29	6BJ6	.49	7Z4	.39
1C7	.29	6BK7	.69	12A5	.39
1E7GT	.39	6BL7	.69	12AT6	.39
1F5G	.29	6BN6	.99	12AT7	.69
1H5	.49	6BQ6	.79	12AU6	.39
1L4	.49	6BQ7	.79	12AU7	.59
1L6	.59	6BY5G	.59	12AV6	.39
1LA6	.39	6BZ7	.79	12AV7	.69
1LC5	.39	6C4	.39	12AX7	.59
1LC6	.39	6CB6	.49	12BA6	.39
1N5	.49	6CD6	.99	12BA7	.59
1R5	.49	6CU6GT	.99	12BE6	.39
1S5	.39	6F6	.39	12BH7	.59
1T4	.49	6F7	.69	12SA7	.49
1T5GT	.69	6J6	.59	12SK7	.49
1U4	.49	6J8	.79	12SN7	.59
1U5	.39	6K6	.39	12SL7	.59
1X2	.59	6L6	.69	12SQ7	.39
2A3	.29	6N6	.69	14S7	.79
2A7	.29	6S4	.39	19B6	.99
3AGT	.99	6S8	.59	19T8	.69
3Q4	.49	6SA7	.49	25BQ6	.79
3Q5	.59	6SD7	.49	25L6GT	.39
3S4	.49	6SK7	.49	25W4GT	.39
3V4	.49	6SL7	.59	25Z6	.39
5U4	.39	6SN7	.59	35B5	.39
5V4	.49	6SQ7	.39	35C5	.39
5Y3	.29	6SR7	.49	35W4	.29
5Y4	.49	6T8	.69	35Z3	.29
5Z3	.29	6U8	.69	35Z5	.29
6AB4	.39	6V6	.49	35/51	.29
6AG5	.49	6W4GT	.39	36	.29
6AJ5	.69	6X4	.29	37	.29
6AK5	.69	6X5	.29	39/44	.29
6AL5	.39	7A4/XXL	.39	49	.29
6AQ5	.49	7A6	.49	50B5	.49
6AS5	.49	7A7	.49	50C5	.49
6AT6	.39	7A8	.49	50L6	.49
6AU6	.39	7AK7	.79	75	.29
6AV6	.39	7B4	.49	76	.29
6B7	.79	7B5	.49	77	.29
6BA6	.49	7B6	.49	80	.29
6BA7	.59	7B7	.49	117L7GT	.99
6BC5	.49	7F7	.59	117Z3	.29

Minimum Order  
\$7.00

25% deposit with order. Balance C.O.D. If full remittance is sent, please include postage. Excess money will be refunded. Quantity users—write for special discounts!

**FREE!**

with every order of \$20 or more—famous "Ox-wall" magnetic screw-driver kit. Includes all sizes — Phillips head, long handles to get in those tight spots, etc. 7 screwdrivers in all. May be purchased outright. Last value \$4.80 —\$1.99 each; 3 for \$5.50.

Mail Your Order to

**VIDEO**  
 ELECTRIC COMPANY  
 79 CLINTON PL.  
 NEWARK, N. J.

head structure. However, the associated circuitry can be modified to give better results. Much of the poor sound of the low-cost units is due to cheap amplifier design and the use of small cheap speakers. Now, unless you are an experienced serviceman, the next step calls for the services of a qualified radio technician. Have him dig into the electronic innards of your unit (with the aid of a circuit diagram, of course) and install an external jack with a switch, which in one position will allow the normal integral operation and in the other position will feed the output of the head directly to your hi-fi preamplifier and ampli-

fier. Naturally, this process is for the playback function only. With this change accomplished and with your amplifier connected to a reasonably good hi-fi speaker, you'll get some good sound. Equalization of your own and pre-recorded tapes is no longer a problem since you can use the bass and treble controls of your preamp to compensate for balance. Mechanically there is not too much you can do to aid things—one help is to avoid the use of different sized reels, i.e., a 7" reel on the pay-off and a 5" on the take-up or vice versa as this upsets the reel tensioning. Also be sure to use the 7" reel with the new larger diameter hubs.

Like almost everything else in this hi-fi world, this forward step you have taken is also a step backward! You see, now that the circuitry has been modified, you will soon realize that the cheap little crystal microphone that was supplied with your unit is pretty horrible. If you want to do any sort of music recording and expect to get decent results, you would be wise to replace that crystal mike with a good dynamic type such as made by *Electro-Voice*, *Shure*, and others. These range in price from about \$10 to \$70. Most non-professional tape recorders have high impedance mike inputs, so make sure that your microphone is also high impedance. You will probably have to call upon the serviceman again to match the inputs and outputs of microphone and recorder. Incidentally, for the circuitry work previously described and for this mike/recorder matching, a fair charge would be between \$10 and \$12.

If you have followed the procedures outlined in this article, you will have a tape recorder which can be used quite successfully for music recording. If you can afford the cost of still better units in the \$350 and up class, you're equipped to tackle almost anything. Since I see most of my allotted space has been used up, we will have to go into recording techniques next

## BUILD YOUR OWN RADIO OR ELECTRONIC EQUIPMENT *with the* SPEED-CHASSIS

Save time and money...simplify assembly, improve appearance with a SPEED-CHASSIS. This flexible breadboard assembly of modular construction is ideal for testing, designing, modification or permanent equipment. SPEED-CHASSIS is provided with interchangeable socket arrangements; one grounded and four insulated tie point strips; interchangeable plates, with pre-punched holes, are available to meet all needs. Cover and panel make your successful equipment designs both permanent and neat. SPECIFICATIONS: Chassis 5" wide x 5 1/4" deep x 16 7/8" long; 20 gauge cad. plated steel.



CK-200 (Chassis Kit plus ass't plates), **\$9.95**

CK-300 (Chassis Super-Kit: CK-200 plus rack panel and cover), \$18.95

WRITE FOR FREE LITERATURE AND PRICE LIST DESCRIBING CHASSIS, PLATES, DUST COVERS, PANELS, BRACKETS, AND POWER SUPPLIES.

Enclose full amount with order. No C.O.D.'s please.

## SPECIFIC PRODUCTS

14515 Dickens Street • Sherman Oaks 7, California

## TO HELP YOU SELECT THE CORRECT HI-FI ENCLOSURE

**AUTHORITATIVE GUIDE**

*The Karlson Enclosure*

**FREE**

**IDEAS**

**HELPFUL**

**FULL OF FACTS**

**COMPLETE**

**KARLSON**  
ULTRA-FIDELITY  
ENCLOSURES

Send for this free booklet. It contains all the facts you need to select and install the enclosure for the discriminating...the enclosure by which all others are measured.

KARLSON ASSOCIATES, INC.

DEPT. C

1483 Coney Island Ave., Brooklyn 30, N. Y.

Please send copy of your latest book "The Karlson Enclosure" to

Name

Address

City  State



Sun Radio

ONLY  
35c  
A COPY



**DON'T BUY HIGH FIDELITY EQUIPMENT UNTIL YOU HAVE READ THIS BOOK!**  
**SUN'S 1955 HI-FI FACTS**

A complete, comprehensive and authoritative book, fully discussing genuine high-fidelity equipment with illustrations. Includes: How to construct enclosures; evaluate components; how to select a genuine high-fidelity system best for your own needs; complete, simple glossary; and many useful Hi-Fi Facts!

SUN RADIO & ELECTRONICS CO., INC.  
650 6th Ave., New York 11, N. Y.

Send Sun's 1955 HI-FI FACTS for which I enclose 35c.

Name .....

Address .....

City..... Zone..... State.....

## PHONO AMPLIFIER

Add Only \$1.00 with Order and Pay Postman \$5.95 plus Charges or \$6.95 Ppd. 1N34A—Crystals @ 49c each.



5 for \$2.00 ppd.  
Speaker and output transformer \$1.69  
• (Aluminum polished enclosed chassis)  
• With on and off volume control  
• Tone control • Employing 1-50C5—1-12AT6—1-35W4 • RCA Type input socket.

Lower distortion level with a much better than average Tonal Range plus its ability to reproduce accurately makes this compact amplifier the BUY OF THE YEAR—

MacFarlane Industries  
P. O. Box 208, Culver City, Calif.

## EXTREMELY SENSITIVE MICROAMMETER

Weston 301-3 1/2" Rd. Bakelite meter—0 20 micro-amps—condensed scale—Brand New—\$28.00 Value. Never sold in surplus for less than \$10.00. Closeout \$5.95.

GREENWICH SALES CO.

59 Cortlandt St. New York 7, New York

## IS YOUR LIFE WORTH A OF COURSE IT IS!!! \$125??

You need this Westinghouse Hiway Caution Kit which consists of: standard six volt sealbeam, 12 ft. of wire with cigarette lighter plug, plus holding bracket for use as hand spotlight. In addition, kit contains a Scotch Life CAUTION SIGN that glows in the dark.

THRIFTY TV SUPPLY COMPANY

13647 Burbank Blvd. Van Nuys, Calif.

# INVENTORS

When you are satisfied that you have invented a matter of value—write me, without obligation, for full information on what steps you should take to secure a Patent.

**PATRICK D. BEAVERS**

Registered Patent Attorney

1098 Columbian Building Washington 1, D. C.

## GET INTO ELECTRONICS

You can enter this uncrowded, interesting field. Defense expansion, new developments demand trained specialists. Study all phases radio & electronics theory and practice; TV; FM; broadcasting; servicing; aviation, marine, police radio. 18-month course. Graduates in demand by major companies. H. S. or equivalent required. Begin Jan., March, June, Sept. Campus life. Write for Catalog.

**VALPARAISO TECHNICAL INSTITUTE**

Dept. PE Valparaiso, Indiana

"there is a tube in the camera that is a sort of miniature version of the picture tube in the receiver. The image of the scene being photographed is focused on the screen of this tube, and this image is scanned by an electron beam just as we described. What's more, the scanning beam in the camera tube and the one in the receiver picture tube are kept locked exactly in step with even more precision than the movements of the June Taylor Dancers on the Jackie Gleason show."

"Now I'm beginning to get a picture," Carl murmured with his eyes still closed.

"When the scanning beam of the camera tube strikes a light portion of the picture, it causes the amplitude of the transmitter carrier to be reduced; when it moves to a dark picture element, the carrier amplitude increases. How much the carrier decreases or increases depends upon how light or dark that particular picture element is.

"In our TV receiver this increase or decrease of carrier strength is translated into increasing or decreasing negative signal voltage applied to the control grid of the picture tube. Keep in mind that a change in this voltage is immediately apparent as a change in brightness in the line or lines being traced on the screen at the instant the change takes place. Holding all this in mind, let's start scanning our garage-wall picture. First I start at the upper left-hand corner with the stream of water. As I get to about the middle of our screen, I say, 'Cut!'"

Obediently Carl kinked the hose sharply and the water stopped. Jerry moved the nozzle over a bit and commanded, "Open," and Carl released the pressure so that the drawing of the line could be completed. In this manner several interrupted wet lines were drawn across the garage wall inside the rough rectangle Jerry had marked off with the stream. Then the water was cut off while Jerry went back to the top of his "screen" and started drawing another set of interrupted lines between those already drawn. The result was a completely wet rectangle with a rather crude vertical dry stripe up the center. Between directions to Carl, Jerry continued to lecture.

"The directions I'm giving you are the ones given to the transmitter by the pick-up tube in the television camera. These directions are passed on to the TV receiver through its antenna, and inside the receiver are passed right to the electron beam inside the picture tube. That means that when the scanning beam of the camera tube is moving across a light portion of the scene, the TV picture tube is showing a bright line. When the camera tube scan-

ning beam is on a coal-black picture element, the beam of the picture tube is cut off and the screen is allowed to go black. In short, since these two beams are in exact synchronization, whatever is *seen* by the camera tube scanning beam is *shown* on the face of the picture tube by variations in the intensity of its beam. Gray shades are portrayed simply by reducing the intensity of the picture tube beam without actually cutting it off entirely. The nearer the voltage applied to the control grid of the picture tube approaches the cutoff voltage, the dimmer is the line drawn by the beam and the darker is the shade of gray. Well, here goes the last line of our picture. What do you think—?"

He never got to finish his question. At this instant the kinked hose in Carl's hands suddenly gave way and threw a great spray of water over both boys and over the gleaming automobile against which they had been leaning.

"Hey, the modulator's busted!" Carl yelled as he scrambled for the valve to shut off the hose. It was too late. The freshly washed car was splattered all over from the shower it had received.

Jerry surveyed the damage ruefully for a moment and then picked up two pieces of chamois skin and held one out to Carl.

"Be my guest!" he invited.

-50-

## Disc Review

(Continued from page 81)

exceeded. His is a lush, rich musical tapestry with his wonderful facility for expression and dynamics given full rein. Probably there will be many who will criticize this reading as overblown and oversentimentalized. I think the score can stand this treatment and this interpretation combined with the fabulous sound makes it the recording of choice. On *Victor LM1377*, there is an astounding range of dynamics, and woe be to those whose hi-fi systems have hum and noise, which will stand out boldly in the pianissimo passages. Strings are clean and luminous, brass is sparkling and weighty, and the percussion has great impact and solidity. The Collins reading on *London LL822* is a close second to the Stokowski and many will probably prefer his more straightforward performance. Good balance and acoustics are notable in this recording. The Ehrling-*Mercury* disc is in the same vein as the *First Symphony*—good but not spectacular sound, combined with a performance which if not inspirational is at least honest.

The Sibelius *Third* has been recorded but twice, by Collins on *London LL1008* and by

# SALE

## OIL CONDENSERS

Brand New



4 Mfd. 600 Volt.....	\$ 0.95
8 Mfd. 600 Volt.....	1.49
10 Mfd. 600 Volt.....	1.95
.25 Mfd. 2000 Volt.....	.59

5—4 Mfd. 600 V. in One Rectangular Can.....	1.95
801 Tubs—New.....	Ea. .19
5CPI.....	\$2.95 Ea., 4 for 10.00
PC 55 PHONE PLUGS (New).....	.39
0/130 V. AC Meters.....	1.95

## DM40 DYNAMOTORS

14 VOLT

D.C. Input 14 V.

3.4 A.

D.C. Output 172 V.

138 M.A.

BRAND NEW BOXED

**\$1.95**  
Each

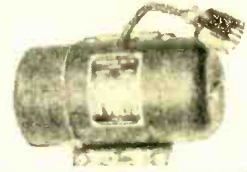

## APN-4 RCVR—SCOPE POWER SUPPLY

4 switch-selected screw-driver tuned RF channels; IF freq. 1050 kc; band-width 45-60 kc; RF freq. 16 2000 kc. Makes fixed tuner for med. freq. police calls or PA system. Has power supply for 5 scope, with 400 cycle trans. Electronic controlled low v. supply; delivers 280 vdc, 150 ma; reg. to .01%. Power supply alone worth more than price.



Less Tubes  
Free with 1st  
200 Orders  
3-6B4G, 1-6H6

ONLY **\$6.95**

## VARIABLE CONDENSERS

14-100 Mmfd.  
Double  
Spaced  
3 1/4" x 3 3/4" x 1 1/2"

**\$1.29**



## PUSHBUTTON ASSEMBLY

FOR  
RECEIVER  
BC-728-C

**59¢**



## THE ATTIC

*universal distributors inc.*

Please send for our latest bulletin  
1729 So. Los Angeles St., Dept. E-6  
LOS ANGELES 15, CALIF.

## MAGIC OF REMOTE RADIO CONTROL

For model airplanes, boats, cars, etc.

### Feb. '55 Preston GARAGE DOOR KIT:

TRANSMITTER KIT: All parts Tube, 6V Dynam. Instr. . . \$16.95  
RECEIVER KIT: All parts, Tube, Relay, Instructions. . . . 14.95  
GEAR BOX: For Garage Door—80/1 Ratio Reduction. . . . 8.95

**GYRO RADIO CONTROL TRANSMITTERS 27.25 Mc.**  
Most POWERFUL 5 Watt TRANSMITTER—LOWEST PRICE. Plans, Tube, G. C. circuit, with GYRO MAGIC TUNING INDICATOR. Completely Tested. Includes: 9 1/2 ft. sect. Antenna, Remote "Clicker" Keying Switch, Meter, Gnd. Plane Booster, Beaut. Cabinet 12x7x6. Available in the following models:



**GYRO X1 TRANSMITTER:** As described with Built-in 2V Storage Battery & Vibrator Supply Battery Charger. GUARANTEED—Complete. . . \$39.50  
**GYRO X2 TRANSMITTER:** As Descri. with Built-in Dynamotor to Oper. from 6 V Auto Battery. \$33.95  
**GYRO X3 TRANSMTR:** 1 tube for dry btry. oper. 23.95

**RADIO CONTROL TRANSMITTER & RECEIVER KIT—27 1/4 mc**  
Band—License Free. All Parts & Diagrams (less tubes & crystal to build Powerful 5 Watt Transmitter Unit & . . . \$9.95

Time 2-Tube Receiver & SIGMA RELAY. . . . 14.15  
LORENZ 2-TUBE RECEIVER KIT with Tubes and Relay. . . 3.95  
SIGMA 4F RELAY: 8,000 ohm. \$4.25; R/C Escapement. . . 6.95  
6 V DYNAM. 250V/65 Ma \$8.95; 2 V Vib. Kit 180V/35 Ma . . 11.75  
Safford's RC Receiver Kit: with tubes & relay. . . . 11.75  
3 TONE MODULATOR KIT—Converts any RC Transmitter to work SAFFORD RECEIVER, with tube & instr. . . . 5.85  
MCENTEE'S "RADIO CONTROL HANDBOOK" . . . . 2.25  
CRYSTALS: 27.25 Mc. Peterson Z9A \$3.95; HOLDER . . . . 1.15  
FLEAWEIGHT HOOKUP WIRE: 25 Feet, 5 Colors. . . . .25  
TUBES: Lowest Prices. XFG1, RK61, 3A4, 3A5, 1A04, 6AQ5 1S4, Clockwork ELECTRIC TIMER: 1/2 min. to 24 min. . . . 1.00  
GENERATOR: 12-24 V DC, 13 amps. Requires 1/8" dia. or larger motor with pulleys, \$6.95; Pencil Soldering Iron. . . 1.95  
12 ft. steel sect. ANTENNA. . . . . 6.95  
Storage BATTERIES: Mini 6V NTB \$2.45; 2V 27 "A" H/L. . . 2.75  
ALL MATERIAL GUARANTEED—FREE CATALOG "ip"  
Save C.O.D. fees, include postage, excess refunded.

## GYRO ELECTRONICS CO.

325 CANAL STREET W., NEW YORK 13, N. Y. Worth 6-1290

## LEARN THE CODE

And Have a Useful Piece of Test Equipment  
with the **JCT AUDIO-CODER**

### CODE PRACTICE OSCILLATOR

ENTIRE CODE PRINTED CLEARLY ON FRONT, CONTINUOUSLY VARIABLE TONE AND VOLUME.

**MODEL SP:** with built in speaker, or use with 'phones. Also use as Audio or RF Signal Source. . . . . Only \$14.00

**MODEL S:** for use with 'phones. \$12.50 Both Models Guaranteed At Leading Jobbers or order (Postpaid) from

**J. C. T. LABORATORY**

880 Bergen Ave. Jersey City, N. J.

## Learn TELEVISION AT HOME

Here is an excellent opportunity to learn complete television servicing at home—from the very beginning, right up to the many complex circuits of modern design.

Offered by one of the leading residential schools in the entire west, Video Specialties, Inc., the course is written in "easy to understand" language and priced so that everyone can afford it.

The course includes a sensational new multi-tester that has been approved by thousands of TV repairmen and experimenters. Complete consultation privileges are open to all students at all times.

The entire cost of the course is **ONLY \$75**

For complete information write today to

**VIDEO SPECIALTIES, INC.** Full price

4570 E. Firestone Blvd. Dept. B, South Gate, California

## VHF AM-FM RADIO

Supersensitive sub-miniature tube set receives television, FM broadcast, C.A.P. and amateurs without antenna or ground. 5 Tubes from 75 mc. to 150 mc. Similar models available in frequency bands from 27 mc. to 225 mc. Pocket size—measures only 2" x 2" x 2". Highest quality components used. Specially battery or AC model. Use with any magnetic headphone or can be connected to audio amplifier for loudspeaker operation. Thousands in use by amateurs, experimenters, and civil defense. Factory wired chassis complete with special tube only \$3.98 postpaid. Postage extra on COD orders

**SPRINGFIELD ENTERPRISES**

Box 54-E Springfield Gardens 13, N. Y.

Ehrling on *Mercury* 10125. The same remarks can be applied to this Ehrling recording as were made for the previously discussed discs. The Collins is a real humdinger in sound with some huge brass sounds especially notable. The performance leaves little to be desired.

The *Fourth Symphony* has been recorded four times, which makes everything come out nice and even. Three of the four are good enough for the hi-fi category and the other is so bad as not to be worth mention. Once again it is Collins on *London* LL1059 who gets the potted palm for best sound and recording. This has a lush string tone, and big-hall acoustics combined with extraordinary dynamics; the reading is knowledgeable without being stuffy and is perhaps the best in this Collins series. The von Karajan performance on *Angel* 135082 is one that will find favor with many people. Save for a few ideas which are von Karajan's and not Sibelius', this is a quiet, well-paced reading with sound which has a great deal of transparency and smoothness, but is somewhat lacking in climactic strength. The third recording once again features Ehrling and as always his is a good reading with more than acceptable sound.

The Sibelius *Fifth* has had five recordings with *Angel* and von Karajan vying with the *London* and *Mercury* discs for top honors. Best of the lot this time is the Ehrling version on *Mercury* 10142. His reading is tremendously powerful and intensely human. Here we find the best of the *Mercury*-Swedish sound. The string tone is huge, brass is nobly proportioned, dynamics are very wide range, and low distortion prevails throughout the disc. The two other recordings have similar virtues in lesser degree.

Ehrling is all alone with the Sibelius *Sixth* since it is the only recording in the catalogue. Happily, in the interests of economy, it can be found on the reverse of *Mercury* 10142 along with the *Fifth Symphony*. The sound and the performance are essentially the same here as they were with the *Fifth*.

The *Seventh* and the least popular of Sibelius symphonies as far as the general public is concerned has had the second greatest number of recordings—a total of seven. Of these only two can qualify as hi-fi and these are Collins and Ehrling on *London* LL1008 and *Mercury* 10125, respectively. The Collins is the better of the two by a hair in sound mainly because of the superior acoustics. Ehrling's performance is most vital and he manages to project the mysticism in this score most effectively. Both recordings are quite wide range in

POPULAR ELECTRONICS



sound and have good dynamics. String tone is better in the *London* and brass is better in the *Mercury* disc.

Next month we will review the symphonies of the great modernist, Shostakovich. —30—



## R/C Frankie

(Continued from page 72)

his garage, a shotgun in his hands. Mrs. Johnson sat on an overturned lawn-swing, crying hysterically. I doubled my gait.

Out on the next avenue, people streamed from their houses and gathered in little knots along the sidewalk. I caught bits of conversation as I streaked past.

"... came rumbling out of Johnson's ..."

"... went down that way ... hit the mailbox ... hurtled across the street ... made that car climb right up ..."

Several fellows, bearing rakes, hoes, and other improvised weapons, passed my lagging trot. The leader carried a thick coil of rope. When they suddenly turned into the next yard, I followed, noting my mower—it's shaft broken—lying beside a concrete post.

In the rear, a sizable crowd was gathering around a small pool. In the center of the pool—draped with vines, part of a clothesline still bearing clothes and surrounded by dead goldfish floating belly up—sat Frankie, his painted face leering innocently into space.

I listened to the comment around me.

"... might be from a flying saucer ..."

"... hasn't moved an inch since it hit the water ..."

*Shorted out*, I decided, looking at the electrocuted fish.

A moment later the police arrived and began questioning various onlookers. Regretfully, I began easing my way out of the excited crowd. Suddenly, the wife appeared beside me.

"You going to claim ownership?"

Mentally, I computed Frankie's intrinsic worth against a dozen probable lawsuits. "Nooooooo," I whispered. "But he makes a dandy pool decoration, doesn't he!" I began guiding her, by the arm, firmly toward home.

"Guess this puts a crimp in that crazy electrical hobby that's been keeping you up nights, eh?" she asked shrewdly.

"Ummmmmm," I murmured, my eyes clouded with thought.

"Now, don't tell me you're planning to start the whole nonsense all over again!" she said, alarmed. "Because if you think for one minute I'm going to put up with—"

"How would you like an entire intercom

# ONCE MORE POPULAR DEMAND ONCE MORE IN JUNE Makes Us Repeat These IN JUNE DISCOUNT PRICES

<b>KIT 1. HARDWARE</b> Over 1,000 pieces. 2 1/2 lbs. of assorted RADIO & TV HARDWARE.	<b>99¢</b> was \$1.49	<b>KIT 5. RESISTORS</b> 100 ASSORTED TYPES. Range from 1 ohm to 15 meg. 1/2 to 5 watt.	<b>\$175</b> was \$1.98
--	--------------------------	---	----------------------------

## MYSTERY PACKAGE ELECTRONIC PARTS

THE SURPRISE OF YOUR LIFE

25 pounds of BRAND NEW USABLE GOVT. SURPLUS. Ideal gift for the ham, etc. Worth \$50. Our Price... **\$495**

<b>KIT 2. CERAMICONS</b> 100 ASSORTED. ED. Range from .75 mmfd. to 6,000 mmfd.	<b>\$250</b> was \$3.80	<b>KIT 6. R.F. CHOKES</b> 25 ASSORTED. Range from .5 mh. to 25 mh.	<b>95¢</b> was \$1.95
---	----------------------------	---	--------------------------

<b>KIT 3. Volume Controls</b> 25 ASSORTED. Range from 2 ohm to 3 meg. Some with switch.	<b>\$275</b> was \$4.78	<b>KIT 7. TOGGLE &amp; SLIDE SWITCHES</b> 25 ASSORTED. DPST, DPDT, 5PST, etc.	<b>\$325</b> was \$4.95
--	----------------------------	--	----------------------------

<b>KIT 4. Rotary Switches</b> 25 ASSORTED TYPES. A Real Buy at only	<b>\$250</b> was \$4.78	<b>KIT 8. PAPER &amp; CAN CONDENSERS</b> 25 ASSORTED. Range from 4 mfd. 150 v. to 80 mfd. 450 v.	<b>\$275</b> was \$3.80
--	----------------------------	---	----------------------------

### HI GAIN DYNAMIC MIKE KIT

Uses UTC Transformer and Western Electric Mike. Ideal for Hams, PA, CAP, Recording, Mobile Equip.—50 DB/80-7500 CPS. Diagram Furnished.

**\$195**

### HERSHEL RADIO CO. Dept. M

5245 Grand River. Detroit 8, Mich.

NO ORDER LESS THAN \$2.00—SHIPPED FOB DETROIT

Terms: Cash with order or 25% DOWN—Balance will be shipped C.O.D.

# URANIUM = \$\$\$

**SEI\* = URANIUM**  
All and Only  
**UNCONDITIONALLY GUARANTEED**  
geiger and scintillation counters



\*SEI—scientifically engineered instruments are necessary to effectively locate commercial (profitable) deposits of uranium

**WRITE TODAY** for free information, catalogs, maps, and newly developed prospecting techniques that put more \$\$\$ in your pocket

**UNIVERSAL ATOMICS CORPORATION**  
Dept E6 527 Lexington Ave New York 17, N Y

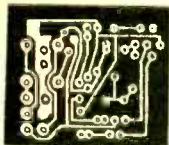

**FREE BOOKLET ON HOW TO  
MAKE YOUR OWN  
PRINTED CIRCUITS**

**Complete Kit \$19.55**  
ppd.

**KIT OF SUPPLIES only \$2.85**

- USE MODERN TECHNIQUES
- MAKE CIRCUIT BOARDS TO YOUR OWN DESIGN
- CONTAINS ALL MATERIALS NEEDED TO MAKE SEVERAL BOARDS.
- COMPLETE, STEP-BY-STEP INSTRUCTIONS
- SIMPLE EASY PROCEDURE FOR DESIGN LAYOUT

Take your newest design idea and layout in printed circuit techniques. Complete, lightweight circuitry with professional appearance and finish. Kit contains complete materials and equipment—nothing else to buy. **MONEY BACK GUARANTEE.**

Send Check or Money Order to Dept. P3

**TELE-DIAGNOSIS CO.**

155 WEST 72 STREET NEW YORK 23, N. Y.

**Get Your F. C. C. LICENSE Quickly!**

Correspondence or residence preparation for F. C. C. examinations. Results guaranteed.

An FCC commercial operator license means greater opportunities and higher pay. We are specialists in preparing you, in a MINIMUM OF TIME, to pass FCC examinations for all classes of licenses. Beginners get 2nd class license in 5 weeks and 1st class in 3 additional weeks. Regularly scheduled resident classes are held in Washington, D. C. and Hollywood, California. Correspondence courses are conducted from Hollywood. Write for our free booklet which contains complete details.

**GRANTHAM School of Electronics**

Dept. 104-K 6064 Hollywood Blvd. Hollywood 28, Calif. **OR** Dept. 204-K 737 11th St. N. W. Washington, D. C.

**LEARN THE CODE NOW**

A 110V AC Code Oscillator that is within reach of every potential amateur at a price they can afford.

**Only \$7.00 net**

Postpaid while they last

**ROBERTS ENGINEERING & MANUFACTURING CO.**  
Post Office Box 75889 Sanford Sta. Los Angeles, Calif.

**NEW RCA SURPLUS  
TV CAMERA  
only \$197.50!**

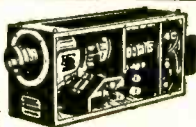

Labs, hobbyists, industries, TV technicians—set up your own telecast system! It's a "mechanical eye" for factories, prisons, swim pools, closed circuit TV—100's other uses! **SEND FOR FULL DETAILS TODAY!**  
FREE CATALOGUE ON REQUEST!  
**SURPLUS EMPORIUM, Dept. PE**  
803 N. Victory Blvd. Burbank, Calif.

**ADDRESS  
POSTCARDS  
AT HOME!!**

write BOX 14, BELMONT, MASS.

system throughout the house?" I suggested. "And photoelectric-controlled doors? And maybe a hi-fi setup distributed through the whole place, so when you break a beam, the music follows you from room to room! Superb idea, eh?"

"No more robots? Promise?"

I turned and had one last look at the milling throng around Frankie. They were calming down.

"Well, not for a while anyway," I agreed.

-30-

**Short-Wave Bands**

(Continued from page 95)

0100-0145 (except Saturday) on 7280 (French). Other noted sessions are in English. The DX program is heard Sunday 0200-0213 on 7280, 9500, 11760, and 15320.

**CANADA:** New schedule to U.S.A. is 2000-2145 on CKLO, 9630 and CHOL, 11720 and excellent to South Pacific daily at 0345-0415 from CKLO and CKNA, 5950. They also have a transmission to Korea at 0330-0345 on CKLO-CKNA. Program to the Northwest Territory is heard from CKLP, 9585 and CKRZ, 6060 at 2200-2230, or later.

**BELGIAN CONGO:** OTM-1, Leopoldville, is being heard on its new 6152 outlet in parallel with 9380 around 0500 at strong level.

**GOLD COAST:** A station rarely noted is ZNT, the Accra Airport on 4742.5 kc. Noted contacting PAA Flight 150 en route to South Africa at 2305-2320.

**SOUTH AFRICA:** Johannesburg, 4895, opens Sunday at 2345 with setting-up exercises in Afrikaan until 0000. BBC news is relayed until 0015.

**FRENCH GUIANA:** Radio Cayenne, 6199, is noted 1730-1830 opening and closing with "La Marseillaise." French news noted 1815-1825.

**MOZAMBIQUE:** Lourenco Marques is noted using this channel (though a bit higher than previous) of 9770 at 2330. Presented usual recordings, commercials, and identities. Asked for report to be sent to "Reception," Box 594, Lourenco Marques, Mozambique. They are particularly interested in receiving reports on this new 31-meter outlet.

**EGYPT:** A seemingly new frequency, widely reported, in Cairo on 11675 at 1655-1700 (and earlier) with news in Arabic.

**PERU:** OBX4Q, 5970, at Lima *Radio El Sol* is testing a new 5-kilowatt transmitter with announcements in Spanish, English, and Italian. They ask for reception reports, promised to QSL at once, and to



# GLOSSARY

- a.f.c.**—Automatic frequency control: (1) control of the frequency of the local oscillator in a superheterodyne to keep the receiver in tune with a desired station; (2) control of the frequency of the horizontal oscillator in a television receiver to keep the horizontal deflection in step with the horizontal deflection at the television studio and thus to keep the picture steady horizontally.
- a.g.c.**—Automatic gain control, control of the amplification of an amplifier so that its output is approximately constant in spite of variations in the input signal; especially such control in television receivers to reduce variations in picture contrast produced by variations in r.f. signal strength.
- a.v.c.**—Automatic volume control (a.g.c. used in radio receivers to reduce variations in sound volume produced by variations in r.f. signal strength).
- choke**—An inductance used especially to present a high impedance to a wide range of frequencies. Filter chokes are used in rectifier-type power supplies to remove from the d.c. output hum components equal to the power line frequency and its harmonics; audio-frequency chokes are used in audio amplifiers and radio-frequency chokes are used in r.f. and i.f. amplifiers, to present a high impedance load to a vacuum tube or to block unwanted signals.
- crystal**—1. Rectifying crystal, one which passes electric current more easily in one direction than in the other and thus can be used to change alternating current to pulsating direct current; made of such materials as germanium, silicon, copper oxide, galena, and carborundum. 2. Piezo-electric crystal, one which transforms mechanical energy to electrical and vice versa. Such crystals, made of Rochelle salt or barium titanate, are used in microphones and phonograph pickups. When cut to a certain size and shape, a piezo-electric crystal, usually made of quartz, can be used as a resonant circuit, to control the frequency of an oscillator or as a frequency-selective filter.
- decibel**—A measure of the ratio between two power levels or of a power level with respect to a designated reference level. Basically, the number of decibels is ten times the logarithm of a power ratio. One decibel is approximately the smallest difference in sound power which can be detected by the average human ear.
- db of feedback**—The number of decibels by which inverse feedback in an amplifier reduces its over-all gain and distortion.
- detector**—A circuit used to recover an audio or video signal from a modulated radio signal.
- electrolytic capacitor**—A type of capacitor in which the dielectric or insulator is a thin film of oxide deposited on one aluminum or tantalum plate and an electrolyte is used between the insulator and the other plate. This type of capacitor provides a larger capacitance in a given volume than any other type. However, except for special a.c. electrolytics, this type can be used only in circuits where voltage of constant polarity is applied to it.
- elevator**—Control surface of an aircraft which regulates its pitch attitude (level, climbing, or diving).
- feedback**—Returning part of the output of an amplifier stage to the input of the same or a previous stage. Negative or inverse (out-of-phase) feedback decreases the gain and distortion of the amplifier; positive (in-phase) feedback increases gain and distortion and may produce oscillation.
- frequency response**—The relative ability of an amplifier, loudspeaker, or other device to respond to different frequencies.
- glow plug**—A type of internal-combustion engine used in models, in which starting is assisted by a filament in the combustion chamber, which is energized by an external battery.
- harmonic distortion**—Distortion consisting of addition to the signal of components whose frequencies are multiples (harmonics) of the original signal frequency. It is produced by an amplifier or other device which is nonlinear (does not give the same ratio of output to input for all input amplitudes).
- heterodyne**—A different frequency (beat) produced by combining two frequencies.
- hole**—Absence of an electron normally present in an atom; a positive charge. The action of some transistors often is explained by referring to movement of holes or positive charges, rather than movement in the opposite direction of electrons or negative charges.
- microammeter**—A meter for the measurement of current flow, which is calibrated in microamperes, or millionths of an ampere.
- milliampere**—One-thousandth of an ampere.
- modulated**—Varied in amplitude, frequency, or some other quality. Radio-frequency signals are modulated in order to carry signals of lower frequency, such as sound or picture signals.
- multitester**—A meter which is a combination of a voltmeter, an ohmmeter, and (often) an ammeter.
- octal**—Designation of one of the standard types of tube base or the socket to fit it. The base has eight equally spaced pins and a centrally located boss, which is made of insulating material and has a key to prevent improper insertion of the tube in the socket. The local tube base is similar, except that its pins are smaller in diameter and the central boss is of metal and has a groove which fits a one-turn spring in the socket, to hold the tube.
- oscillator**—A vacuum-tube or transistor circuit or other device which produces an alternating-current power output without mechanical rotation.
- plate dissipation**—The part of the power applied to the plate circuit of a vacuum tube which does not appear as signal output, but is dissipated as heat in the plate of the tube.
- push-pull**—An arrangement of two vacuum tubes in an amplifier so that the input signal is applied in opposite phases to the two tubes and the signal outputs are combined in phase. This arrangement reduces even-harmonic distortion.

**regeneration**—Positive feedback in detectors and amplifiers. Increases gain and distortion and may produce oscillation.

**saturate**—To reach the maximum possible value of some quantity, such as magnetization in the core of an inductor or electron flow in a vacuum tube from cathode to plate.

**servo-motor**—A special electric, hydraulic, or other type of motor used in control apparatus to convert a small movement into one of greater amplitude or greater force.

**signal generator**—A test instrument providing electrical power substantially similar in amplitude, frequency, and other qualities, to signals found in electronic equipment.

**signal tracer**—A test instrument for detecting the presence of a signal in electronic equipment and, with some signal tracers, measuring its amplitude, frequency, or other qualities.

**superheterodyne**—A receiver in which all incoming radio-frequency signals are mixed with the output of an oscillator to produce a heterodyne or beat frequency. The oscillator frequency is variable so that the beat produced with any desired signal can be adjusted to a certain frequency. The beat-frequency

signal is fed to a fixed-frequency (intermediate-frequency) amplifier, where greater and more uniform gain and selectivity can be obtained than at the original radio frequency.

**superregenerative**—A type of regenerative detector in which the tendency to oscillation is controlled by a quenching voltage of ultrasonic frequency which periodically allows the gain to increase, then reduces it. The quenching voltage can be produced by the detector tube itself or by a separate oscillator. This type of detector has great sensitivity, but poor selectivity.

**tone control**—1. In a radio receiver or an audio amplifier, means provided to change the relative response to audio signals of different frequencies; effects which can be produced are treble boost or attenuation and bass boost or attenuation. 2. In radio control of models, a system wherein the radio signal is modulated by audio tones and control is achieved by keying the modulating tones on and off, instead of keying the r.f. carrier.

**v.t.v.m.**—Vacuum-tube voltmeter, a voltmeter using one or more vacuum tubes to increase the sensitivity of the basic meter movement, so that measurements can be made in a circuit without drawing much current and without disturbing very much the normal operating conditions of the circuit. May also be a combination voltmeter, ohmmeter, and ammeter. —30—

## ABBREVIATIONS

a.c.—alternating current  
a.f.—audio frequency  
a.f.c.—automatic frequency control  
a.g.c.—automatic gain control  
AM—amplitude modulation  
amp.—ampere  
ARRL—American Radio Relay League  
a.v.c.—automatic volume control  
BCI—interference with broadcast reception  
b.f.o.—beat frequency oscillator  
cps—cycles per second  
c.t.—center-tapped  
c.w.—continuous wave  
db—decibel  
dbm—decibels above one milliwatt  
d.c.—direct current  
d.c.c.—double cotton covered (wire)  
d.p.d.t.—double-pole, double-throw  
d.p.s.t.—double-pole, single-throw  
DX—distance  
elec.—electrolytic  
FCC—Federal Communications Commission  
FM—frequency modulation  
freq.—frequency  
GMT—Greenwich Mean Time  
hi fi—high fidelity (of sound reproduction)  
hy.—henry  
i.f.—intermediate frequency  
K—kilo (one thousand)  
kc.—kilocycle  
M—mega (one million)  
ma.—milliampere  
mc.—megacycle  
meg.—megohm  
mike.—microphone, microfarad  
mil—milliampere  
m.o.p.a.—master oscillator, power amplifier  
mu—amplification factor  
 $\mu$ fd.—microfarad

$\mu$ fd.—micromicrofarad  
mw.—milliwatt  
m.w.—medium wave  
PA—power amplifier  
p.a.—public address  
PM—phase modulation, permanent magnet (speaker)  
pos.—position (of a switch)  
pot.—potentiometer  
pri.—primary  
R-C—resistance-coupled  
R/C—radio control  
rect.—rectifier  
res.—resistor  
RETMA—Radio-Electronics-Television Manufacturers Association  
r.f.—radio frequency  
r.m.s.—root mean square  
sec.—secondary  
SN—self-neutralizing (escapement)  
s.p.d.t.—single-pole, double-throw  
spkr.—loudspeaker  
s.p.s.t.—single-pole, single-throw  
s.w.—short-wave  
SWL—short-wave listener  
sync.—synchronization  
t.—turns (of a coil)  
trans.—transformer  
TV—television  
TVI—interference with television reception  
u.h.f.—ultra high frequency  
v.—volt  
v.f.o.—variable frequency oscillator  
v.h.f.—very high frequency  
VR—voltage regulator  
v.t.v.m.—vacuum-tube voltmeter  
vu—volume unit  
w.—watt  
wpm—words per minute  
xmtr.—transmitter

# STANDARDIZED WIRING DIAGRAM SYMBOLS

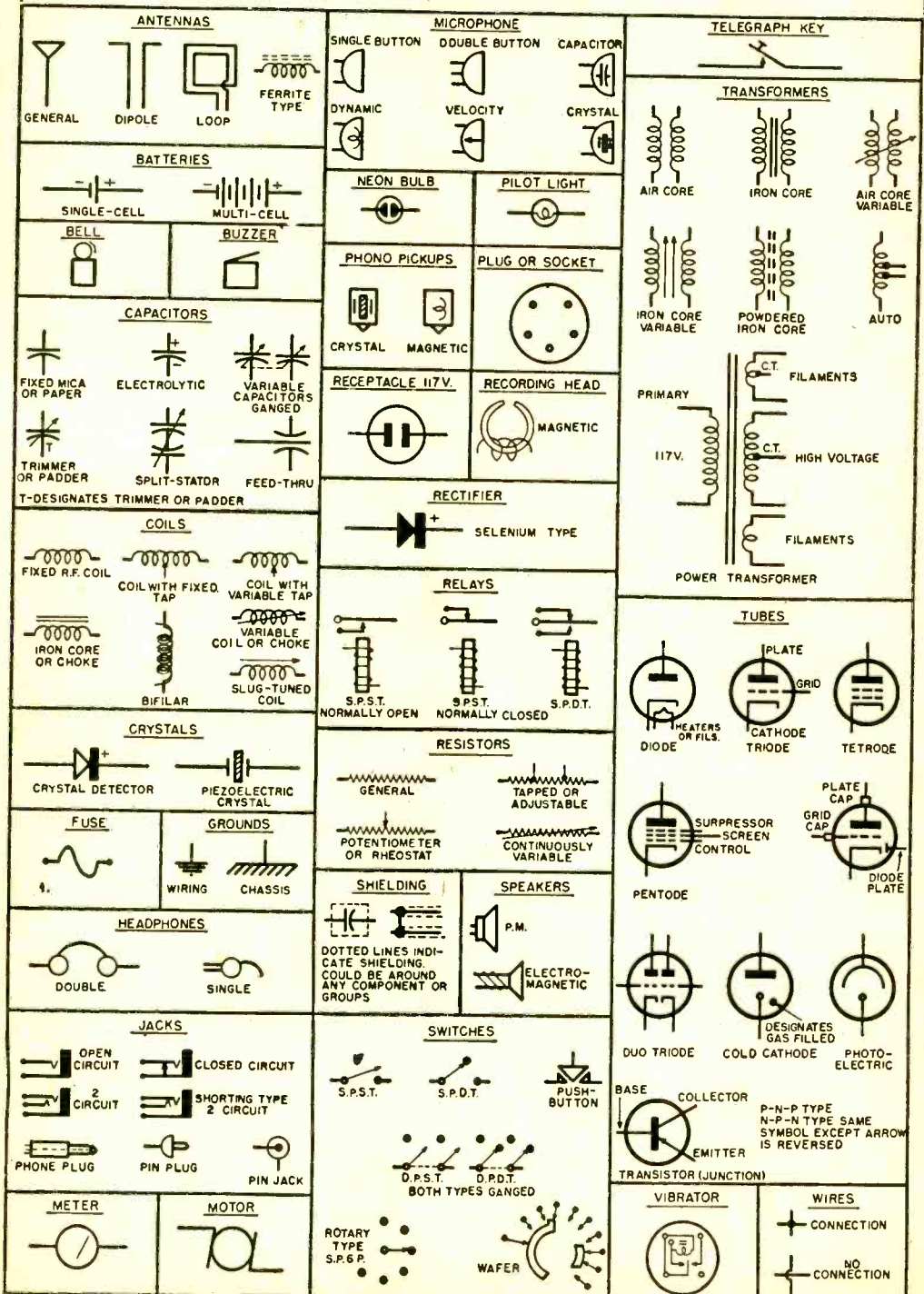

# ADVERTISERS' INDEX

Aaron Electronics	123
Ace Radio Control	114
Allied Radio Corp.	12
Ashe Radio Co., Walter	108
Beavers, Patrick D.	118
Business Information Corp.	122
Cabinart	2nd Cover
Concord Radio	100
Coyne Electrical School	5
Eastern Audio Research	114
Edlie Electronics	100
Electrofacts	114
Electronic Instrument Co., Inc. EICO	101
Electronic Measurements Corporation	13
Electro-Voice	11
Geniac Project	112
Grantham School of Electronics	122
Greenwich Sales Co.	118
Gyro Electronics Co.	120
Hallcrafters	4th Cover
Hawkins Co., P. E.	127
Heath Company	96, 97, 98, 99
Hershel Radio Co.	121
Industrial Devices, Inc.	108
International Correspondence Schools	15
J. C. T. Laboratory	120
Kapner Hardware, Inc.	110
Karlson Associates, Inc.	116
Lafayette Radio	102
Lektron Specialties	111
MacFarlane Industries	118
Miller, Gustave	127
Minnesota Mining & Mfg. Co.	105
Monitor Products	127
Moss Electronic Distributing Co., Inc.	106, 107
National Radio Institute	3
National Schools	3rd Cover
O'Brien, Clarence & H. B. Jacobson	7
Palley Supply Co.	112
Perma Power Company	104
Progressive "Edu-Kits," Inc.	113
Radio-Television Training Association	9
Raytheon Manufacturing	6
Rex Radio Supply	104
Rider Publishing Co., Inc., John F.	109
Roberts Engineering & Mfg.	122
Rockbar Corporation	103, 117
Shure Bros., Inc.	14
Solotron Company	127
Soundtronics Labs.	127
Specific Products	116
Sprague Products Co.	16
Springfield Enterprises	120
Stanley Electronics Corp.	13
Steve-EI Electronics Corp.	110
Stowers & Son	127
Sun Radio & Electronics Co., Inc.	118
Surplus Emporium	122
Tele Diagnosis Co.	10
Teltron Electric Company	10
Thrifty TV Supply Company	102, 114, 118, 127
Transistor-Photo Products	114
Universal Atomics Corporation	121
Universal Distributors, Inc.	119
V. A. Enterprises	128
Valparaiso Technical Institute	118
Victoreen Instrument Co.	102
Video Electronics Company	115
Video Specialties Inc.	120
Western Radio Co.	114
World Radio Labs.	8

## RESISTOR-CAPACITOR QUIZ

(Questions on page 85)

1. No. All lead wires have a certain amount of resistance, even though it may be small, and it takes time to charge a capacitor through a resistance. 2. R in megohms, C in  $\mu$ fd. 3. .5 megohms. 4. .0025  $\mu$ fd. 5. 250 microseconds. 6. 2.5 seconds. 7. 10,000 ohms. 8. .004  $\mu$ fd. 9. 370 volts. 10. 1 minute and 40 seconds.

## FIND URANIUM

with the

### URANIUM DETECTOR GEIGERSCOPE

Easy to use! Scientifically accurate! Fits into your pocket! Durable! Needs no power source! More sensitive to radioactivity in mineral specimens than a geiger counter or scintillator. Indicates radioactive content with sparkles of light. Now in use by scientists in atomic laboratories and universities. Indispensable for prospectors, engineers, experimenters, hobbyists.



**Professional Model \$4.95**

(with eye shield for use in daylight)

**Standard Model \$2.95**

(for use in darkened room)

Each model complete with uranium ore sample, weatherproof holster, full instructions and UNCONDITIONAL GUARANTEE.

**Atomic Prospector's Handbook \$1.00**

Packed with valuable data on radioactive ores, field and lab methods, map showing uranium areas.

No C.O.D.'s Please

**MONITOR PRODUCTS** Suite 1004 • 516 Fifth Ave. New York 36, N. Y.

## METAL LOCATOR KIT \$9.87

As Featured in This Issue  
TINY CRYSTAL KIT

2.5 MH choke	39c
CK 706A diode	5c
Small plastic box	5c
Two jacks & plugs	35c

Order kit complete or parts separately. \$13.34

**THRIFTY TV SUPPLY COMPANY**

13647 Burbank Blvd.

Van Nuys, Calif.

# GIANT CATALOG

## NEW LISTINGS—1955 ELECTRONIC SPECIALS

Listing thousands of surplus electronic and mechanical bargains for experimenters, hobbyists, engineers—10c coin or stamps.

Rectifiers @ 29c ea.	Transformers @ 49c ea.
Controls @ 29c ea.	Bulbs @ 2c ea.
Switches @ 6c ea.	Motors @ 99c ea.
Automatic Steppers @ 95c ea.	

## SOUNDTRONICS LABS

Dept. P-4

632 ARCH STREET

PHILADELPHIA 6, PA.

# INVENTORS

Send for  
**PATENT INFORMATION**  
Book and  
**INVENTOR'S RECORD**  
without obligation

**REGISTERED PATENT ATTORNEY**

ASSOCIATE EXAMINER  
U.S. PAT. OFF. 1922-1929

**GUSTAVE MILLER**  
65-PE WARNER BUILDING  
WASHINGTON 4, D. C.

Patent Attorney & Advisor  
U. S. NAVY DEPT. 1930-1947  
**PATENT LAWYER**

## GEIGER COUNTER KIT

You can assemble it yourself in about an hour. All holes drilled and ready for wiring. No special tools required. Full instructions and easy to follow diagram included. Government booklet "Prospecting with a Counter" and radioactive sample provided free with kit. Full price including tubes, headset and batteries only \$17.50 postpaid. Send check or money order to

**Stowers & Son, 804 Grand, Kansas City, Missouri**

## RADIO CONTROLLED

**Garage Door Actuator Mechanism \$24.50**

Write for Information

**P. E. HAWKINS CO.**

631 Prospect

Kansas City 24, Mo.

## Universal Arm

(Continued from page 123)

base wing nuts, allowing the rubber ball to return to its original dimensions, and permitting the rubber to "rest". To keep the ball clamped in one position for a long period of time may result in a permanent "set" in the rubber.

Above all, don't let these suggested "rules" prohibit the use of the "Universal Arm" in all miniature wiring work. The rules are simple and easy to follow and are designed to help the builder get the most from this gadget.

-30-

## Hi-Fi Distortion

(Continued from page 75)

quencies results in a sharpness of the sound—in speech "esses" and "tees" particularly seem to be over-emphasized; (3) deficiency of low frequencies means in music that the low frequency instruments tend to disappear, string bass, drums, and so on, while over-emphasis makes the reproduction sound boomy; (4) in speech, loss of the low frequencies is not particularly noticeable—in fact, for some purposes it may result in improved intelligibility, but exces-

sive low frequencies in speech reproduction result in a boominess that makes the speech sound unnatural as if the speaker were talking in a large wooden box.

So far we have only introduced one kind of distortion and some ways of measuring. In further articles we will discuss other kinds of distortion and methods of measuring them.

-30-

## Heat Without Flame

(Continued from page 29)

Many present-day applications of induction heaters seem almost like "black magic." A person can place his hand in some types of induction furnaces and, if the furnace were not charged with a load of metal and if he wore no ring, he would feel no heat. Yet this same furnace could melt a piece of steel in minutes.

One problem in melting some types of metals is finding a furnace lining which will not melt itself under the intense temperature. With induction heating it is possible to float a "charge" of metal in mid-air during the heating and melting process, then to release the melted ball at will! This has already been accomplished in laboratory experiments.

-30-

# NOW! TV GLO-TEST KIT. . . Replaces \$279 in TESTING EQUIPMENT



Now, for the first time, this nationally advertised tester is available in a "Do It Yourself" kit! Today the GLO-TEST is enthusiastically used by hundreds of Radio & TV servicemen, hobbyists, Radio amateurs, and experimenters.

Over 50 uses—Measures A.C.-D.C. voltages to 50 KV; Capacity measurements; Resistance continuity to 3 Meg.; Signal Generator and Tracer; Tube Tester etc.

**GLO-TEST KIT**, complete with test leads and instruction book . . . . . only **\$9<sup>95</sup>**

Residents of Calif. include 3% sales tax. Send check or money order to:

V. A. ENTERPRISES, 608 E. Rosecrans Blvd., Compton, Calif.

# Classified

RATE: 50c per word—minimum 10 words

## FOR SALE

**DIAGRAMS** for repairing radios \$1.00, Television \$2.00. Give: make, model. Diagram Service, Box 672-PE, Hartford 1, Conn.

**GEIGER Counter Kit**—Only \$64, assembled \$76. More sensitive than most counters and scintillometers. Counter Diagrams, 50 cents. Uranium, 1.00% U<sub>s</sub> O<sub>s</sub>, \$1.00. Determine ore values with this accurate sample. T. Barrett, 22319 Kathryn Ave., Torrance, Calif.

**ELECTRIC Pencil**: Engraves all Metals, \$1.50. Beyer Mfg., 10511-P Springfield, Chicago 43.

**"PSYCHIC Dominance**. Rule others with your thoughts." \$2. Delmar Wisdom, 833-S8 Sunnyside, Chicago 40.

**HI FI 30 Watt Williamson Type Ultra Linear Output Transformers** with Primary screen Taps for 5881, KT66, 807's. Secondary 4, 8, 16, OHM. Limited Quantity \$14.95 F.O.B. Keltronics, P. O. Box 92, Ventura, Calif.

**15 TESTED** one-tube circuits 50¢, including "Radio-builder," catalog. Laboratories, 328-L Fuller, Redwood City, California.

**HIGH Fidelity**—Complete Schematics \$1.00. HI-FI, 9529 Claremont N. E., Albuquerque, N. M.

**FREE list**, Book bargains, Radio, Electronics, How-to-do. Wilkerson, Box 776, Camarillo, Calif.

**BUY Surplus Radio Electronics Parts, Equipment**. Hundreds of other items Direct from Government. List \$1.00. Box 169 ZF, East Hartford 8, Conn.

**COMPLETE set of parts** to build "Loopstick" Crystal Radio Kit. Finest, most sensitive yet designed. Complete with instructions. \$2.95 postpaid. TV Sales Company, Dept. E, P. O. Box 44, Yonkers 1, New York.

**TV, Radio Parts, Tubes, Antennas, Wire, Speakers, Condensers, Selenium Rectifiers, Rotators, Towers, Benches, Shelving, Test Equipment, TV Tables**. Make us your leading supplier. Catalog free. Radio Tube Merchandising Company, 508 Clifford Street, Flint 3, Michigan.

**DIAGRAMS**: Professional Model Timers, Counters, Intercoms, Organs, etc. \$1.00 each. List free. Parks, 102 S. E. 57th, Portland 15, Oregon.

**URANIUM Detection Instruments**. All newest, finest, scientifically engineered units. Highest sensitivity. Popular priced. Unconditionally guaranteed. Free Prospecting information, maps and techniques. Universal Atomic Corp., Dept. PE6, 527 Lexington Avenue, New York City.



**SUPERSENSITIVE VHF** radio receives television, FM broadcast, CAP and amateurs without antenna or ground. Factory wired assembled complete with special tube only \$3.98 postpaid. Thousands in use by experimenters, amateurs, civil defense. Springfield Enterprises, Box 54-E6, Springfield Gardens 13, New York.

**SOLAR** battery converts light into electrical energy. High output type for operating transistors. Only \$1.99. Springfield Enterprises, Box 54-E6, Springfield Gardens 13, New York.

**WALKIE-Talkie.** Build a real wireless two-way portable radiophone for less than \$10.00. Plans 50c. Springfield Enterprises, Box 54-E6, Springfield Gardens 13, New York.

**PRINTED** Circuit kit. Latest thing in electronics. Replaces conventional wiring. Includes copper laminate, etching salt, etch resistant, drawing pen and instructions. Only \$2.25. Springfield Enterprises, Box 54-E6, Springfield Gardens 13, New York.

**MOTOR** kit, \$1 postpaid. Terrific value; plastic mounting, battery complete; nothing else to buy. Model PB1. Electrons, 1304 Spruce, Asbury Park, N. J.

**NOW** you can make your own Printed Circuits at Low Cost! Complete assortment of materials needed to make Etched-Wire Printed Circuits. Contains XXX-P Copper Board, Etching materials and instructions, Etch-resistant material for Layouts, Eylet Connections and Drill, Circuit Diagrams for Multimeter and 1-tube Receiver. Fully Guaranteed—Send Check or Money Order Kit No. 35 Only \$3.50 Complete. Techniques, Inc., 135 Belmont Street, Englewood, New Jersey.

## WANTED

**EDISON.** Columbia, and other old cylinder phonographs, parts, horns, and accessories; also, early Victrolas, Pathe, etc. Prior to 1915. Trade new Hi-Fi equipment or will buy for cash if reasonable. Write full Particulars to Box 50, c/o Popular ELECTRONICS.

**WANTED:** All types receivers, transmitters, test equipment, power supplies, teletype, cash, or trade for New Hallicrafters, Johnson, Gonset, National, or other. Need ART-13, APR-4, ARC-1. Alltronics, Box 19, Boston 1, Mass. (Richmond 2-0048).

## INVENTIONS WANTED

**INVENTIONS** wanted. Patented; unpatented. Global Marketing Service, 1404 Mitchell, Oakland 1, Calif.

**NEW** Inventor's Handbook contains valuable information never before published on When, Where and How to Sell an Invention. Tells steps that lead to Inventive Success. Send \$1.00 for your copy today. Patent Research Bureau, 309-A Coachman Building, Clearwater, Florida.

## HELP WANTED

**FOREIGN** U. S. Jobs to \$18,000. Many overseas countries. Fare paid. Skilled-unskilled trades, office. Stamped self-addressed env. brings reply. Job Opportunities, Waseca 9-H, Minnesota.

**EARN** Extra Money Selling Advertising Book Matches. Free Sample Kit furnished. Matchcorp, Dept. EZ-1, Chicago 32, Illinois.

**START** Your Own Business Credit. Your own boss. 1135 of our Dealers sold \$5,000 to \$30,000 in 1954. We supply stocks, equipment on credit. 200 home necessities. Sales experience unnecessary. Pleasant profitable business backed by world-wide industry. Write Rawleigh's, Dept. E-U-Pel, Freeport, Ill.

## BUSINESS OPPORTUNITIES

**RECAST** Old batteries into new. Latest achievements. Battery Laboratories, Minneapolis.

**AGENTS,** Bargain Hunters Wanted. Big Discounts on Nationally advertised Merchandise. Wholesale Catalog \$1, refunded with first order. Irving Pollack, 12 Cedar, Akron, New York.

**FREE** Booklet "Money-Making Facts" tells mechanically-inclined men how to start sparetime business at home. Lee Foley Company, Columbia Heights, Minnesota.

**FREE** Folio "Up to \$45,000; Unlimited Vacations." No merchandise, equipment. Unknown! Work home—sparetime! Haylings-PE-2, Carlsbad, Calif.

**\$80.00 WEEKLY.** Operate our selective Mail-Order Business in your area, sparetime. Write: House of Plastics, Paramus 16, N. J.

## INSTRUCTION

**HIGH** School—no Classes. Study at home. Spare time. Diploma awarded. Write for Free Catalog HET-8, Wayne School, 2527 Sheffield, Chicago 14, Ill.

**OPPORTUNITY!** Complete high school at home in spare time with 58-year-old school. Texts furnished. No classes. Diploma. Information booklet free. American School, Dept. XA56, Drexel at 58th, Chicago 37, Illinois.

**567 HOMESTUDY** Courses, textbooks. Sensational bargains! Free illustrated catalog. Nelson Company, 210 S. Clinton. Dept. 9FV-43, Chicago 6.

**PASS** amateur theory exams. Check yourself with sample FCC-type questions & novice & general class examinations. All for only 50¢. American Electronics, 1203 E. Bryant Ave., New York 59, N. Y.

## TAPE RECORDERS

**TAPE** Recorders, tapes, accessories. Unusual values. Dressner, Box 66E, Peter Stuyvesant Station, N.Y.C. 9.

## MISCELLANEOUS

**COLOR** Television from Standard TV using color wheel, simple converter. Details, Colordaptor, 3471 Ramona, Palo Alto, Calif.

**GIANT** book of radio plans 50c. Catalog free. Radio Supply, Fruitland Park, Florida.

**TUBES—TV,** Radio, Transmitting, special purpose types—Bought, Sold, Exchanged. Send details to B. N. Gensler W2LNI, 512 Broadway, New York 12, N. Y.

**BUILD** your own electronic organ, or electronic brain. Jim Kirk, 1552-A Church, San Francisco 14, California.

**"CRYSTAL** Set beginners—Free gifts for stamp." Mailmart, Box 92, Paramus, N. J.

**MATCHBOX** Radio—Amazing! Made for pennies. Guaranteed! Coil form, case, instructions. 50¢. Birchcraft, 5763-A Belmont, Cincinnati 24, Ohio.

**BUILD:** Geigercounter, Crystal Receiver, Tube checker, Capacitor checker, 2 tube pocket-radio etc. Send \$1—for complete set of 10 diagrams with instructions. Vamaline, Box 222, Hawthorne, N. J.

**GEIGER** Counter and Metal Detector Kits. Inexpensive, Educational. Free Literature. Electronic Applications, Dept. B, 5024 Lee Highway, Arlington 7, Va.

**NOTICE:** Inventors and Smaller Industries. Will design and build special electronic test for experimental equipment to your requirements. For information write Box 1191, Dept. B, Minneapolis, Minn.

**QSLs**—\$2.00 per 100, \$5.00 per 300, sample free. W9TFZ, 1419 - 6 Ave., Moline, Ill.

**ENLARGE** those family snaps now! Two 8x10's or three 5x7's, \$1.00 Cash. J. R. Eilken, Box 29-E, Secaucus, N. J.

**LIGHTNING** Calculator. These are printed devices similar to a circular slide rule but giving direct reading answers to problems involving resonance, reactance, frequency, capacity. Price \$1.00 money back guarantee. Lightning Calculator Co., Box 6192, St. Petersburg Beach, Fla.

**RADIO** Television Service forms samples. Jones, 1210 Dudley, Utica, N. Y.

**MAIL** Operators, Agents, new mail order item, a thrilling treasure will create sensation coast to coast. \$2.00 brings sample, Literature. Jay Gee Ell Co., Box 82, Dept. EW, Honolulu 8, Hawaii.

**BOOK** of 300 magic tricks, \$1.00. John C. Chester, 20-E Cromwell Place, Sea Cliff, New York.

**REWEAVING** garments. Reasonable. Cigarette burn \$3.00. Lois Jones, 2432 Berkley Ave., Roanoke, Virginia.

## RESISTOR COLOR CODE

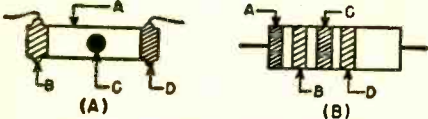

RETMA COLOR CODE CHART

COLOR	VALUE	MULTIPLIER
Black	0	1
Brown	1	10
Red	2	100
Orange	3	1000
Yellow	4	10,000
Green	5	100,000
Blue	6	1,000,000
Violet	7	10,000,000
Grey	8	100,000,000
White	9	1,000,000,000

### TOLERANCE CODE

Gold—±5%	Silver—±10%
No Color—±20%	

The ohmic value of a resistor can be determined by means of the color code. There are two standard methods of indicating this value.

In Fig. A, the body (A) and end (B) indicate the first and second digits of the value while the dot (C) indicates the multiplier to be used. The tolerance of the unit is indicated by the end color (D). For example, if the body (A) is green the number is 5; if the end (B) is grey the second number is 8. If the dot (C) is red the multiplier is 100 or two zeros should be added. The resistor is then a 5800 ohm unit. If the end (D) has no color, the tolerance is ±20%.

In Fig. B, the first two stripes indicate the first two digits; the third stripe the multiplier; the fourth stripe the tolerance. Thus, if stripe (A) is green, (B) is grey, (C) is red, and (D) is silver, the resistor is a 5800 ohm, ±10% unit.

## CAPACITOR COLOR CODE

Color	MOLDED PAPER		MOLDED MICA		CERAMIC	
	Multiplier	Tolerance	Multiplier	Tolerance	Multiplier	Tolerance
Black	1	20%	1	20%	1	20% or 2.0μfd.*
Brown	10		10		10	1%
Red	100		100	2%	100	2%
Orange	1000		1000	3% (RETMA)	1000	2.5% (RETMA)
Yellow	10,000	5%	10,000		10,000	
Green				5% (RETMA)		5% or 0.5μfd.*
Blue					0.01	0.25μfd.*
Violet					0.1	10% or 1.0μfd.*
Gray						
White		10%				
Gold	0.1	5%	0.1	5% (JAN)		
Silver		10%	0.01	10%		
None		20%				*Capacitance less than 10μfd.

Capacitance is given in μfd. Colors have same values as on resistors, except as indicated in tables. Colors (A) and (B) are for first two digits; (C) is for multiplier. (D) is for tolerance. (E) and (F) give voltage rating in hundreds of volts; (E) is used only for ratings less than 1000 volts, (E) and (F) for first two digits of ratings 1000 volts or more. Values of colors for (E) and (F) are same as in resistance values. (G) is class or characteristic of capacitor, (H), (I), and (J) give temperature coefficient. (G), (H), (I), and (J) are not listed in the tables, since this information is seldom needed by the average home builder.

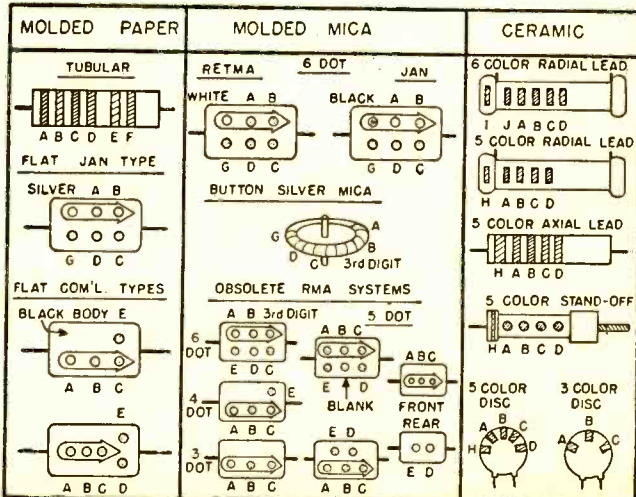



Get more money!  
More security! More out of life!

Learn

# TELEVISION • RADIO • ELECTRONICS

Get the best!

## Get National Schools' SHOP-METHOD HOME TRAINING!

Start now! Why wait around for that raise or promotion that may never come? Get started *now* in high-paying TV-Radio-Electronics! National Schools' SHOP METHOD Home Training prepares you for success in a top-salary job or in your own business. You learn *all three*... Television, Radio, Electronics... in one complete course. Our Shop-Tested lessons and manuals help you master all phases in shortest possible time! Send coupon, find out today!

### WHY NATIONAL SCHOOLS LEADS THE FIELD

Located in the "Television Center" of the world, our staff is in close touch with latest developments and opportunities. We give you personalized job placement assistance. We also give you confidential help with both technical and personal problems relating to your training. We show you how to make Part Time Earnings as you progress. Whether you live 30 miles away, or 3,000, you will always be pleased with our prompt, friendly service!

**DRAFT AGE?** Our home training helps you achieve specialized ratings and higher pay grades if you go in service.

We send you this precision-tested Multitester! Plus parts to build Oscillators, Receivers, Signal Generator, Continuity Checker, Combination Short Wave and Standard

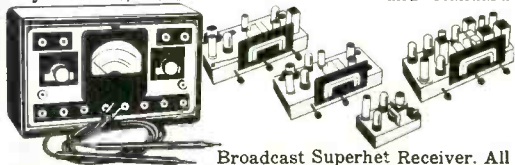

Broadcast Superhet Receiver. All this equipment is part of your National Schools course. **NO EXTRA CHARGES!** Send coupon for free books!

**NATIONAL SCHOOLS**, world-famous technical trade school. Now entering our 50th year!



## NATIONAL SCHOOLS TECHNICAL TRADE TRAINING SINCE 1906

LOS ANGELES 37, CALIFORNIA

In Canada: 811 W. Hastings St., Vancouver, B. C.

- APPROVED FOR G. I. TRAINING
- BOTH HOME STUDY AND RESIDENT COURSES OFFERED

### 30 MILLION TV SETS

need regular repair! Color TV means more sets than ever before. NOW is the golden opportunity to cash in on this multi-billion-dollar industry. Or "write your own ticket" in broadcasting, manufacturing, and other specialized phases!

**YOUR AGE  
IS NO  
OBSTACLE!**

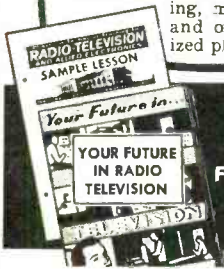

**Send for  
FREE LESSON!**  
FREE BOOK & SAMPLE LESSON  
will convince you!  
**SEND COUPON TODAY!**

### MAIL NOW TO OFFICE NEAREST YOU!

(mail in envelope or paste on postal card)

**NATIONAL SCHOOLS, DEPT. R2G-65**

4000 SOUTH FIGUEROA STREET  
LOS ANGELES 37, CALIFORNIA

OR 323 WEST POLK STREET  
CHICAGO 7, ILLINOIS

Please rush **FREE BOOK**, "My Future in Radio-Television-Electronics," and **FREE LESSON** at once. I understand there is no obligation, and no salesman will call.

NAME \_\_\_\_\_ BIRTHDAY \_\_\_\_\_ 19\_\_

ADDRESS \_\_\_\_\_

CITY \_\_\_\_\_ ZONE \_\_\_\_\_ STATE \_\_\_\_\_

Check if interested **ONLY** in Resident Training at Los Angeles.

VETERANS: Give date of discharge \_\_\_\_\_

## Again, Two New Leaders Bear a Famous Brand\*

We're proud of our name and the twenty years of electronic leadership it represents. Our brand new communications line is in keeping with the high standards we have always maintained. Hallicrafters respects the recognition it has achieved by never compromising quality for price or sacrificing craftsmanship for mass production. These new models are the ultimate in precision-built communications equipment.

W. J. Halligan

Birch Halligan, Jr.

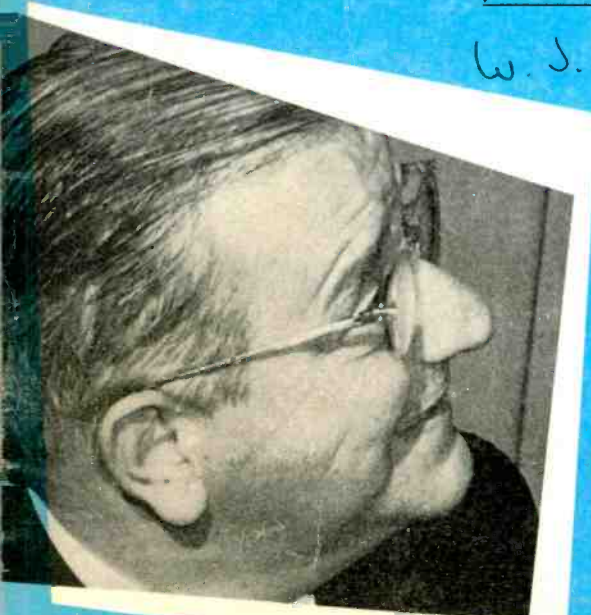

This new receiver reflects the dependable performance of 500,000 Hallicrafters radios with basically this chassis now in the field. Covers Broadcast Band 540-1650 kc plus three short-wave bands from 1650 kc—32 Mc. Electrical bandspread operates over large, easy-to-read dial. Headphone tip jacks on rear and built-in PM speaker. Oscillator for reception of code signals.

Gray steel cabinet with silver frame trim 12 $\frac{3}{8}$ " x 7" x 7 $\frac{1}{4}$ ". Shipping weight 13 lbs. Four tubes plus rectifier. 105/125 V. 50/60 cycle AC/DC \$49.95

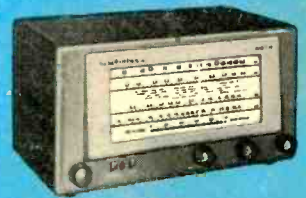

Model S-38D

These two new Civil Patrol receivers replacing the popular S-81 and S-82 are over ten times as sensitive, have greater increased audio power output, and include an extremely reliable *built-in relay squelch system*. This type of squelch system *completely* disables the entire audio system so that not a murmur is heard from the speaker until a signal is received making the unit perfect for monitoring of police, fire, taxi, mobile-telephone, forestry, civil defense. The S-94 covers from 30—50 Mc and the S-95 from 150—173 Mc. Built-in speaker and provisions for headphones. Gray steel cabinet with silver trim panel and red pointer. 12 $\frac{3}{8}$ " x 7" x 7 $\frac{1}{4}$ ". Shipping weight approximately 12 $\frac{1}{2}$  lbs. Eight tubes plus rectifier. 105/125 V. 50/60 cycle AC/DC \$59.95



CHICAGO 24, ILLINOIS



Model S-94 (S-95)



# hallicrafters