

# POPULAR ELECTRONICS

MARCH  
1955

25  
CENTS

In U. S. and Canada

RADIO • TV • R/C • HI-FI • ELECTRONICS



**ELECTRONIC MIRACLES OF THE FUTURE**  
WHAT WE HEAR • R/C RELIABILITY  
RADARANGE • SHORT-WAVE FIREFIGHTING  
CONSTRUCTION DETAILS ON —  
Frequency Meter-Monitor • Moisture Meter  
Wireless Record Player • Automatic Light Switch

# CABINART KITS



**MODEL 80**  
**MODEL 8112**  
**MODEL 8115**

Model 80 has lift lid, removable panels. Bass reflex tuned for 12" or 15" speakers. Overall dimensions: 33 1/2" H, 23" W, 16" D. M80 tuner section, inside: 20" H, 21 3/4" W, 15 1/2" D. M8112, M8115 baffle volume: 6 cubic feet. 5/8" white pine

80	equipment cabinet kit	\$27.00
8112	12" speaker cabinet kit	18.00
8115	15" speaker cabinet kit	18.00

are acoustically engineered. Assembly and finish are up to you! Precision-cut white pine and birch key together perfectly. Assembled by anyone with only a screwdriver.



**Model 61, Model 63**  
corner horn

12" speaker — \$19.95

15" speaker — \$23.95

## Rebel\* 4

KITS

FEATURING KLIPSCH-DESIGNED

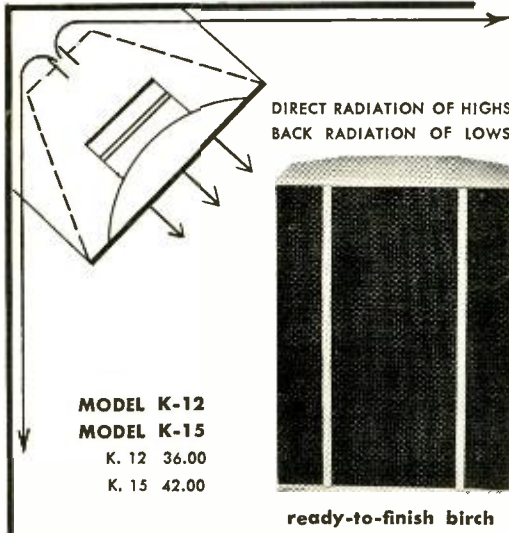

All kits precision-cut to size, baffles pre-cut for 12" or 15" speakers, Kits include Saran plastic acoustic cloth, glue, sandpaper, plastic wood, hardware, assembly instructions and finishing instructions. Write for complete catalogs and nearest Cabinart kit dealer.

all prices slightly higher west and south

\* Trade Mark

REBEL enclosure development entails a cavity and slot port, to form a resonant chamber, and a horn coupled to the slot. The slot is loaded by the horn; the proportioning of slot, cavity and horn provide bass response below 100 cycles which corresponds in efficiency to the front-of-cone direct radiator response above this critical 100-cycle point. There are two ways one might consider the function of this horn. One is a bass reflex with a horn acting as a resistive load on the port. System resonances are damped by useful radiation resistance while the horn does not cost anything. It is already formed by the room corner. Again, if a full horn were added below the 100-cycle point bass response would be boomy and unnatural. But, in the Rebel enclosures, the cavity-port combination acts as an acoustic low pass filter. And its design is such that low-end response will compare with response higher in the sound scale.

CABINETS



BY CABINART

75 North 11th Street  
Brooklyn, N. Y.

## You Practice **SERVICING** with Kits I Send You



Nothing takes the place of PRACTICAL EXPERIENCE. That's why NRI training is based on LEARNING BY DOING. You use parts I send to build many circuits common to Radio and Television. With my Servicing Course you build the modern Radio shown at left. You build a Multitester and use it to help make \$10, \$15 a week fixing sets in spare time while training. All equipment is yours to keep. Coupon below will bring book of important facts. It shows other equipment you build.

## You Practice **BROADCASTING** with Kits I Send You



As part of my Communications Course I send you parts to build low-power Broadcasting Transmitter at left. Use it to get practical experience. You put this station "on the air" . . . perform procedures demanded of broadcasting station operators. An FCC Commercial Operator's License can be your ticket to a bright future. My Communications Course trains you to get your license. Mail coupon. Book shows other equipment you build for practical experience.

# I Will Train You at Home in Spare Time to be a **RADIO-TELEVISION** Technician

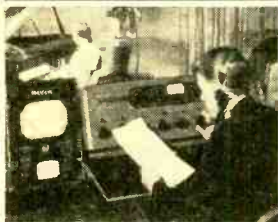

## TELEVISION Making Jobs, Prosperity

25 million homes have Television sets now. Thousands more sold every week. Trained men needed to make, install, service TV sets. About 200 television stations on the air. Hundreds more being built. Good job opportunities here for qualified technicians, operators, etc.



## America's Fast Growing Industry Offers You Good Pay, Success

Training PLUS opportunity is the PERFECT COMBINATION for job security, advancement. When times are good, the trained man makes the BETTER PAY, gets PROMOTED. When jobs are scarce, the trained man enjoys GREATER SECURITY. NRI training can help assure you and your family more of the better things of life. Radio is bigger than ever with over 3,000 broadcasting stations and more than 115 MILLION sets in use, and Television is moving ahead fast.

J. E. SMITH, President  
National Radio Institute  
Washington, D. C.  
Our 40th Year

## N.R.I. Training Leads to Good Jobs Like These

### I TRAINED THESE MEN



"I have progressed very rapidly. My present position is Studio Supervisor with KEDD Television, Wichita."—Elmer Prewaldt, 3026 Stadium, Wichita, Kans.

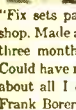

"Fix sets part time in my shop. Made about \$500 first three months of the year. Could have more but this is about all I can handle."—Frank Borer, Lorain, Ohio.



"I've come a long way in Radio and Television since graduating. Have my own business on Main Street."—Joe Travers, Asbury Park, New Jersey.

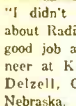

"I didn't know a thing about Radio. Now have a good job as Studio Engineer at KMMJ."—Bill Deltzell, Central City, Nebraska.



BROADCASTING: Chief Technician, Chief Operator, Power Monitor, Recording Operator,

Remote Control Operator. **SERVICING:** Home and Auto Radios, Television Receivers, FM Radios, P.A. Systems. **IN RADIO PLANTS:** Design Assistant, Technician, Tester, Serviceman, Service Manager. **SHIP AND HARBOR RADIO:** Chief Operator, Radio-Telephone Operator. **GOVERNMENT RADIO:** Operator in Army, Navy, Marine Corps, Forestry Service Dispatcher, Airways Radio Operator. **AVIATION RADIO:** Transmitter Technician, Receiver Technician, Airport Transmitter Operator. **TELEVISION:** Pick-up Operator, Television Technician, Remote Control Operator.

## Start Soon to Make \$10, \$15 a Week Extra Fixing Sets

My training is practical, complete; is backed by 40 years of success training men at home. My well-illustrated lessons give you basic principles you need and my skillfully developed kits of parts "bring to life" things you learn from the lessons. I start sending you special booklets that show you how to fix sets the day you enroll. Multitester you build with my parts helps you discover and correct set troubles, helps you make money fixing neighbors' sets in spare time while training. Many make \$10, \$15 a week extra this way.

## Mail Coupon — Find Out What Radio-Television Offer You

Act now to get more of the good things of life. I send actual lesson to prove NRI home training is practical, thorough. My 64-page book "How to be a Success in Radio-Television" shows what your graduates are doing and earning. It gives important facts about your opportunities in Radio-Television. Take NRI training for as little as \$5 a month. Many graduates make more than the total cost of my training in two weeks. Mail coupon now to: J. E. SMITH, President, Dept. 5CD4 National Radio Institute, Washington 9, D. C. Our 40th year.

**AVAILABLE to all qualified VETERANS UNDER G.I. BILLS**

## Good for Both—FREE

MR. J. E. SMITH, President, Dept. 5CD4  
National Radio Institute, Washington 9, D. C.  
Mail me Sample Lesson and 64-page Book, FREE.  
(No salesman will call. Please write plainly.)

Name ..... Age .....

Address .....

City ..... Zone ..... State .....

**VETS** write in date of discharge

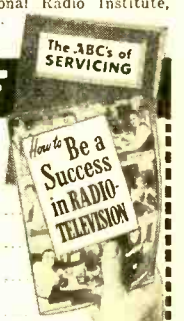

## Mail Today—Tested Way to Better Pay

POPULAR ELECTRONICS is published monthly by Ziff-Davis Publishing Company, William B. Ziff, Chairman of the Board (1948-1953), at 84 E. Lake St., Chicago 1, Ill. Entered as second class matter August 27, 1954 at the Post Office, Chicago, Illinois. SUBSCRIPTION RATES: One Year U.S. and possessions, and Canada \$3.00; Pan-American Union Countries \$3.50; all other foreign countries \$4.00.

# POPULAR ELECTRONICS

MARCH  
1955  
VOL. 2 - NUMBER 3

Registered U. S. Patent Office

**EDITOR**

OLIVER READ, W1ETI

**ASSOCIATE EDITORS**

W. A. STOCKLIN H. S. RENNE  
C. TEPPER J. FRIEBORN  
P. B. HOEFER N. EISENBERG

**ART**

FRANK SAYLES (Director)  
A. J. REICH M. WHELPLEY

**CONTRIBUTING EDITORS**

J. T. FRYE L. E. GARNER, JR.  
K. R. BOORD R. P. TURNER  
R. HERTZBERG H. POLLACK

**DRAFTING**

J. A. GOLANEK A. A. GANS

**ADVERTISING DEPARTMENT**

New York (MU 7-8080)  
L. L. OSTEN - Adv. Dir.  
WM. G. McROY - Sales  
Chicago (AN 3-5200)  
M. B. CROFFORD - Sales  
Los Angeles (Mich. 9856)  
JOHN E. PAYNE - West. Adv. Mgr.



Copyright 1955  
(All Rights Reserved)

**ZIFF-DAVIS  
PUBLISHING COMPANY**

W. B. ZIFF (1898-1953) FOUNDER

Also Publishers of  
RADIO & TELEVISION NEWS  
RADIO-ELECTRONIC ENGINEERING  
Editorial and Executive Offices  
366 Madison Ave., New York 17, N.Y.

**PRESIDENT**

B. G. DAVIS

**VICE-PRESIDENTS**

H. J. MORGANROTH M. FROELICH

**SECRETARY-TREASURER**

G. E. CARNEY

**CIRCULATION MANAGER**

M. MICHAELSON

**BRANCH OFFICES**

Chicago (1), 64 E. Lake St.  
Los Angeles (14), Staller Center  
900 Wilshire Blvd.

**SUBSCRIPTION SERVICE:**

All subscription correspondence should be addressed to Circulation Dept., 64 E. Lake Street, Chicago 1, Ill. Please allow at least 4 weeks for change of address. Include your old address as well as new—enclosing if possible an address label from a recent issue of this magazine.

**CONTRIBUTIONS:**

Contributors are advised to retain a copy of their manuscripts and illustrations. Contributions should be mailed to the New York Editorial Office and must be accompanied by return postage. Contributions will be handled with reasonable care, but this magazine assumes no responsibility for their safety. Any copy accepted is subject to whatever adaptations and revisions are necessary to meet the requirements of this publication. Payment covers all author's, contributor's, and contestant's rights, title, and interest in and to the material accepted and will be made at our current rates upon acceptance. All photos and drawings will be considered as part of material purchased.

## CONTENTS

Electronic Miracles of the Future .....	17
U.S. Air Force's New Radar Height Finder .....	20
What We Hear .....	22
Kits of the Month .....	24
Radarange .....	27
Using the Decibel .....	30
Frequency Meter-Monitor for Ham Stations .....	R. P. Turner 33
Single Layer Coil Design Chart .....	37
This Train Is Radio Equipped .....	38
R/C Reliability .....	W. Winter 41
Splicing 300-Ohm TV Ribbon .....	W. Boyd 45
Moisture Meter Is Novel Use of V.T.V.M. ....	R. C. Saunders 47
A Modern Wireless Record Player .....	49
Neon Blinker-and-Buzzer Code Practice Set .....	A. Trauffer 53
The Walkie-Talkie .....	L. G. Sands 54
Hum .....	B. Whyte 58
Disc Review .....	B. Whyte 59
The C-R Handy Tester .....	C. E. Clark, W1KLS 60
How to Stop Automobile Radio Noise .....	62
So You Want to be a Ham (Part 6) .....	R. Hertzberg, W2DJJ 63
Short-Wave Firefighting .....	67
R/C Ground Control Units .....	E. L. Safford, Jr. 68
Power Supply 1 .....	71
An Automatic Light Switch for the Home .....	L. E. Garner, Jr. 75
The Electronic Husband .....	J. DeGood 79
Carl & Jerry .....	J. T. Frye 80
Ground that TV Antenna .....	B. C. Vaughan, Jr. 82
The World at a Twirl .....	K. R. Boord 88
A Transistor Operated Light Meter .....	93

## DEPARTMENTS

Letters from Our Readers .....	10
R/C Notes .....	66
Tools & Gadgets .....	98
Tricks of the Trade .....	104
After Class .....	109
Standardized Wiring Diagram Symbols .....	125
Glossary of Terms in This Issue .....	126
Abbreviations .....	127
Resistor Color Code .....	130
Capacitor Color Code .....	130

(Also see page 6)



Train for Better  
Jobs in

# ELECTRICITY OR TELEVISION-RADIO

in Great  
Shops of COYNE

## GREAT OPPORTUNITY FIELDS

Conditions are changing. Many "one operation" jobs that have paid well will not last. *Don't be satisfied with a "no future" job.* Whether 17 or up to 45 years of age, train the Coyne way for a better job and a real future in ELECTRICITY or TELEVISION-RADIO, *fields that offer a world of opportunities.*

## YOU can TRAIN in great CHICAGO SHOPS

Train on real, full-size equipment at COYNE where thousands of successful men have trained for over 55 years—largest, oldest, best equipped school of its kind—established in 1899. No advanced education or previous experience needed. TRAINING APPROVED FOR VETERANS.

B. W. COOKE, President

**COYNE**  
ELECTRICAL SCHOOL

FOUNDED 1899

A TECHNICAL TRADE INSTITUTE CHARTERED NOT FOR PROFIT  
500 S. PAULINA STREET, CHICAGO, Dept., 35-71H

ELECTRICITY ★ RADIO ★ TELEVISION ★ REFRIGERATION ★ ELECTRONICS

**START NOW—PAY LATER**—Finance Plan and Easy Monthly Payment Plan. Also part-time employment help for students.

### Get FREE Book

Send coupon for 48 page illustrated book "Guide to Careers in Electricity and Television-Radio." No cost; no obligation; no salesman will call. Get vital facts now!



B. W. COOKE, President  
COYNE ELECTRICAL SCHOOL  
500 S. Paulina St., Chicago 12, Ill., Dept. 35-71H

Send BIG FREE book and details of your training offer. This does not obligate me and no salesman will call. I am interested in:

Electricity  Television-Radio

Name \_\_\_\_\_

Address \_\_\_\_\_

City \_\_\_\_\_ State \_\_\_\_\_

COYNE offers  
LOW COST

# TELEVISION RADIO-ELECTRONICS

Training in  
Spare Time AT HOME



The future is YOURS in TV-RADIO!

A fabulous field—good pay—fascinating work—a prosperous future! Good jobs, or independence in your own business!

Coyne brings you the first *truly lower cost*, MODERN—QUALITY Television Home Training; training designed to meet Coyne standards. Not an old Radio Course with Television "tacked on". Here is MODERN TELEVISION TRAINING including working knowledge of Radio. Includes UHF and COLOR TV. No Radio background or previous experience needed. Personal guidance by Coyne Staff. **Practical Job Guides** to show you how to do actual servicing jobs—*make money early in course.* With Coyne Television Home Training you pay only for your training, no costly "put together kits".

B. W. COOKE, President



Coyne—the Institution behind this training... the largest, oldest, best equipped residential school of its kind. Established 1899.

**COYNE**  
ELECTRICAL SCHOOL

500 S. Paulina St., Dept. 35-HT7, Chicago 12

A TECHNICAL TRADE INSTITUTE OPERATED  
NOT FOR PROFIT

## SEND COUPON FOR FREE BOOK

and full details,  
including easy  
Payment Plan.

No obligation, no  
salesman will call.



COYNE ELECTRICAL SCHOOL  
Television Home Training Div.  
500 S. Paulina St., Chicago 12, Ill.,  
Dept. 35-HT7

Send Free Book and details on Television Home Training. This does not obligate me and no salesman will call.

Name \_\_\_\_\_

Address \_\_\_\_\_

City \_\_\_\_\_ State \_\_\_\_\_

## ITEMS OF INTEREST

This Month's Cover.....	14
World's Smartest Electronic Brain.....	26
"TV Eye" Selects Car Spaces in Parking Lot.....	26
TV Provides Double Vision for Movie Makers.....	32
Radio Network Helps Launch Aircraft Carrier.....	32
"Electronic Heat" for Large Plant.....	32
A Simple Carbon Microphone Speech Amplifier.....	36
Electronics Measures Ocean Waves.....	46
Canadian Wins "Ham" W/VE Contact Contest.....	48
Foolproof Electrical Combination Lock.....	57
Crystal Receiver Built in Soapbox.....	74
Lamp Flasher Made from Surplus Relay.....	74
Unique Crystal Receiver.....	92
New Radar Pinpoints Enemy Fire.....	96
Learn Tube Construction.....	97
Hidden Heater Voltage Trouble.....	103
New Audio Catalogues.....	123
Code Oscillator Used as Signal Generator.....	124

## NEW PRODUCTS

New Small Craft Radar Boasts 16 Mile Range.....	26
(Lavoie Laboratories, Morganville, N. J.)	
Most Powerful Transistor Hearing Aid.....	26
(Sonotone Corp., Elmsford, N. Y.)	
A Novel TV and FM Antenna.....	46
(Plantenna Corp., Silverton, Oregon)	
A Low-Cost "Visual Experimental" Kit.....	70
(Crow Electri-Craft Corp., 1102 Shelby St., Vincennes, Indiana)	
Geiger Counter Kit.....	70
(J. Young Sound Engineering Co., 800 Stockton St., San Francisco, Calif.)	

If you are unable to find these listed products locally, write direct to the manufacturers at the addresses given. Also see the monthly review of new items of interest to the electronic hobbyist in "Tools & Gadgets" appearing on pages 98, 99, 100, 101 and 102 of this issue of POPULAR ELECTRONICS.

## COMING NEXT MONTH POPULAR ELECTRONICS

Electronic Music With The Theremin  
Compact AM Tuner  
Transistor Push-Pull Oscillator  
20 Watt Novice Transmitter  
Simple Power Supply for the Experimenter  
Project Cyclone

### Plus More On

High-Fidelity Audio ■ Kits ■ Radio Control  
■ Short-Wave Listening ■ What's New ■  
How It Works ■ How to Make It ■ How to Use It ■ Carl & Jerry

## IN THIS MONTH'S RADIO & TELEVISION NEWS

(March)

Audio Noise Check List  
TV Stations on the Air  
Loudspeakers—The Weakest Audio Link  
New British Power Amplifier  
Narrow-Band Speech Unit  
The Audio Squelcher  
Light Amplifier

## EMC EXCLUSIVE

# BASIC SERVICE SHOP TEST EQUIPMENT for only \$6855\*

**PLUS FREE...** with this special offer  
Model CRA (Picture tube adaptor for model 208) \$4.50  
2 Model IS (Instrument stands) 1.96  
Total retail cost if purchased \$6.46

You get ALL three of these precision instruments ...in this sensational offer!

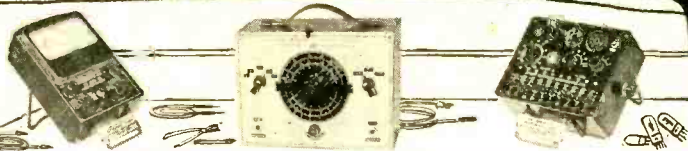

**EMC model 106 VTVM**  
Price of this individual unit  
Model 106 (wired and tested) \$35.90  
Model 106 (in kit form) \$23.90  
Accessory probes available

**EMC model 500 R.F. Signal Generator**  
Price of this individual unit  
Model 500 (wired and tested) \$29.75  
Model 500 (in kit form) \$19.75

**EMC model 208 Tube Tester**  
Price of this individual unit  
Model 208 (wired and tested) \$24.90  
Picture tube adapter available

### HOW TO GET IN ON THIS SENSATIONAL OFFER!

Start your own service shop with professional precision test equipment at solid savings plus the free Picture Tube Adaptor and Instrument Stands given in this special EMC offer.

Go to your favorite local jobber, purchase the above three instruments (Models 106, 500, 208), mail the three enclosed guarantee cards to EMC and receive by return mail your free \$6.46 worth of valuable accessories. This is a limited offer so act TODAY!

Write Dept. PE-3 for new complete catalog of precision test equipment TODAY!

**EMC** ELECTRONIC MEASUREMENTS CORP.  
280 LAFAYETTE STREET, NEW YORK 12, N. Y.

\*Total price if models 106 and 500 are not purchased in kit form — \$90.55

Note these instruments can be purchased individually.

# INVENTORS

**L**earn how to protect your invention. The U. S. Patent Laws provide that any new and useful art, machine, article of manufacture, or composition of matter, or any new and useful improvement thereof, may be patented if the act of invention is involved. Therefore, every inventor with a valuable invention should take advantage of the Patent Laws and proceed for patent protection in order to safeguard his rights.

A patent gives the inventor the exclusive right to prevent others from making, using, or selling the invention claimed in the patent for a period of seventeen years.

The Patent Laws were enacted for the benefit of the inventor to give him protection for the features of his invention which are patentable. These features must be properly and concisely set forth and claimed in a formal application for patent, in order to comply with the requirements of the Patent Laws. For that reason, unless the inventor is familiar with patent matters, he should engage a competent registered patent attorney or agent to represent him. We are registered to practice before the U. S. Patent Office and are prepared to serve you in the handling of your patent matters.

A specially prepared booklet entitled "Patent Guide for the Inventor", containing detailed information with respect to patent protection and procedure, together with a "Record of Invention" form will be promptly forwarded to you without obligation upon request.

---

## CLARENCE A. O'BRIEN & HARVEY JACOBSON

*Registered Patent Attorneys*

59-C DISTRICT NATIONAL BUILDING

WASHINGTON 5, D. C.

VETERANS! — NON-VETERANS!

**WANTED**  
**-200,000 TV**  
**SERVICE MEN!**



**GET IN ON THIS**  
**2 BILLION DOLLAR PLUM!**

200,000 — That's how many service men will be needed to handle radio-television-electronics industry requirements in the next few years. That's the figure given in a recent speech by Harold J. Schulman, director of product service for CBS-Columbia — a man in a position to know.

2.7 billion dollars being spent just for service and installation of TV sets in American homes by 1957!

That's the figure given in another speech recently by one of the top men in the entire industry — Frank M. Folsom, president of the Radio Corporation of America.



L. C. Lane, B.S., M.A.  
President, Radio-Television  
Training Association.  
Executive Director, Pierce  
School of Radio & Television.

**THINK**  
**WHAT THIS CAN**  
**MEAN FOR YOU!**

Here is a field still in its infancy — New jobs with top pay and a secure future are being created everyday — Here is a chance for you to get into an ever-expanding field with unlimited opportunity for advancement — Here is your chance to set up your own business and be your own boss — Here is your opportunity to get in on a 2 billion dollar plum by becoming a Television Technician.

**TRAINED MEN**  
**GET THE**  
**TOP JOBS!**

Top-paying jobs go to the men who prepare themselves. You can prepare yourself without giving up your present job or interfering with your social life. My lessons are especially prepared for you to study at home — even if you have absolutely no experience in this field. All you need is a grammar school education or its equivalent — and the sincere desire to prepare yourself for a better future and a chance to make more money.

**VETERANS!**

My school fully approved to train Veterans under new Korean G.I. Bill. Write discharge date on coupon.

**I CAN DO FOR YOU WHAT I DID FOR THESE MEN:**

**AIRCRAFT INSPECTOR AT GOOD PAY**

"With RTTA training and through repairing radios and televisions for the right people at the right price, I was able to make the right contacts. I am now an Inspector for Douglas Aircraft at about \$125 a week."



Hugh Maddox,  
Los Angeles, Calif.

**MANAGES TWO SHOPS**

"I manage two radio and television shops, one here and one in Pompano Beach. RTTA training increased my knowledge of TV circuits and showed me new, quicker methods of repairing. Lessons as presented are very concise and clear."



William Phillips,  
Fort Lauderdale, Fla.

**\$60 A WEEK IN SPARE TIME**

"I have the skill and know-how to do the work I love best and to enjoy better things in life, thanks to RTTA. I am working at TV servicing and making \$60 a week spare-time."



Harold Gimlen,  
Flint, Michigan

**RADIO-TELEVISION TRAINING ASSOCIATION—52 E. 19th Street, New York 3, N. Y.**



## CHOOSE FROM THREE COMPLETE COURSES

My courses cover all phases of Radio, FM and TV

### 1. Radio, FM and Television Technician Course— No previous experience necessary.

You learn by practicing with the professional equipment I send you. Many of my graduates now hold top-paying technician jobs with such firms as RCA, NBC-TV, CBS-TV, Dumont TV and other TV studios and plants.

### 2. FM-TV Technician Course — previous training or experience in radio required.

You can save months of time if you have previous Armed Forces or civilian radio experience! Train at home with kits of parts, plus equipment to build **BIG SCREEN TV RECEIVER**. ALL FURNISHED AT NO EXTRA COST!

#### EXTRA TRAINING IN N. Y. C. AT NO EXTRA COST!

After you finish your home study training in Course 1 or 2 you get two weeks, 50 hours, of intensive Laboratory work on modern electronic equipment at our associate resident school in New York City, Pierce School of Radio & Television. THIS EXTRA TRAINING IS YOURS AT NO EXTRA COST WHATSOEVER! My courses are complete without this extra training, but it is an added opportunity for review and practice.

### 3. TV Cameraman and Studio Technician Course—advanced training for men with Radio or TV training or experience.

I train you at home for an exciting top pay job as the man behind the TV camera. Work with TV stars in TV studios or "on location" at remote pick-ups!

An optional 30-hour, one week course of practical work on TV studio equipment at Pierce School is offered upon completion of Course 3.

#### FREE FCC COACHING COURSE

Important for BETTER-PAY JOBS requiring FCC License. You get this training AT NO EXTRA COST! Top TV jobs go to FCC-licensed technicians.

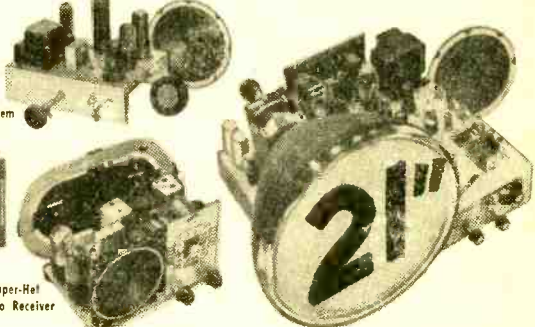
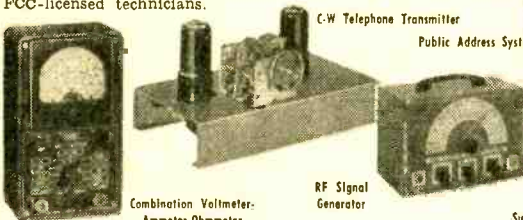

## EARN WHILE YOU LEARN!

Almost from the very start you can earn extra money while learning by repairing Radio-TV sets for friends and neighbors. Many of my students earn up to \$25 a week . . . pay for their entire training from spare time earning . . . start their own profitable service business.

# FREE!

I'LL SEND YOU MY NEW BOOK, "HOW TO MAKE MONEY IN TELEVISION, RADIO, ELECTRONICS," A FREE SAMPLE LESSON, AND OTHER LITERATURE SHOWING HOW AND WHERE YOU CAN GET A BETTER PAY JOB IN TELEVISION.

#### HAS OWN BUSINESS

"I have a shop at home and have been working on radio and TV after working hours of my regular job. I average \$50 a week for this part time job. RTTA training helped me in making extra money and giving me experience in the electronic field."



Richard Hennis,  
Little Rock, Ark.

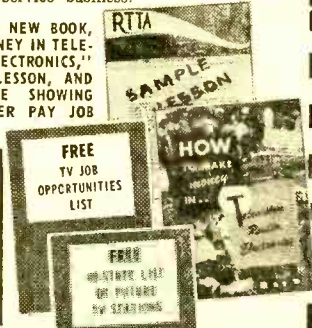

## MAIL THIS COUPON TODAY! NO SALESMAN WILL CALL!

Mr. Leonard C. Lane, President  
RADIO-TELEVISION TRAINING ASSOCIATION

Dept. E-3, 52 East 19th Street, New York 3, New York

Dear Mr. Lane: Mail me your NEW FREE BOOK, FREE SAMPLE LESSON, and FREE aids that will show me how I can make BIG MONEY IN TELEVISION. I understand I am under no obligation and no salesman will call.

(PLEASE PRINT PLAINLY)

Name \_\_\_\_\_ Age \_\_\_\_\_

Address \_\_\_\_\_

City \_\_\_\_\_ Zone \_\_\_\_\_ State \_\_\_\_\_

I AM INTERESTED IN:

- Radio-FM-TV Technician Course
- FM-TV Technician Course
- TV Cameraman & Studio Technician Course

#### VETERANS!

Write discharge date

Licensed by State of New York. Approved for Veteran Training



now...  
you can make  
an accurate,  
highly sensitive

## TRANSISTORIZED VOLTMETER



thanks to

## CK722 TRANSISTORS

The current-amplifying ability of Raytheon CK722 junction transistors makes it possible for you to build a highly sensitive, low cost Voltmeter for many electronic test and service uses. This easy-to-make, rugged, compact (3"x4"x5") Voltmeter is portable. It is powered by a single 1.5 volt flashlight cell so you don't need to rely on AC supply.

For FREE circuitry information on this remarkable Voltmeter simply write Department P-4



*Excellence in Electronics*

### RAYTHEON MFG. CO.

Receiving and Cathode Ray Tube Operations  
Newton 58, Massachusetts

RELIABLE SUBMINIATURE AND MINIATURE TUBES  
SEMICONDUCTOR DIODES AND TRANSISTORS  
NUCLEONIC TUBES

RECEIVING AND PICTURE TUBES • MICROWAVE TUBES

## LETTERS FROM OUR READERS

### PM VS FIELD COIL SPEAKER

I AM no electronics wizard or audio engineer, but I do know that the permanent magnet type loudspeaker is supposed to be an advance over the field coil type, since the field coil requires energizing voltage and the PM type does not.

"Well, the other day, a friend of mine, listening to my table model radio (which has a 5-inch PM speaker), told me I could improve the sound of the set by hooking up a larger speaker to it. So far, so good; this makes sense—except, the speaker he suggested using happens to be an old field coil type. True, it is a 10-inch job and looks pretty husky—but how about its field coil voltage? Where will I get it from? And will it be worth the trouble? My friend says it will, and hinted at a separate power supply for same. Is he nuts, or am I badly informed? Do you people think this is a practical thing to do?"

R. S. Lewis  
Wichita, Kans.

*There is little doubt that the larger speaker will provide better tone, assuming its voice coil impedance is correct with respect to the output transformer of your set. Energizing its field coil is something of a problem, however, and requires a lengthier explanation than can be given in these columns. We suggest you read an article on this very subject entitled "Interchanging Loudspeaker Types" which is to be published soon.*



### TV SOUND ON HI-FI SYSTEM

NICE going on your story 'The High Fidelity Hobby' (Jan. issue, page 13). With reference to the photo diagram on page 17 showing the various components of a hi-fi system, what about this business of feeding TV sound through the hi-fi channels? How come you didn't show this?"

Larry Bernard  
Little Neck, N. Y.

*Reader Bernard is right, of course, in suggesting that the sound portions of TV programs could come through the hi-fi channel afforded by a home music system. The TV sound could enter the system at any of the same points as does the signal from the record changer. In fact, most tuners and amplifiers contain input receptacles specifically designed for TV sound input. We couldn't show all the ramifications of a home sound system. For the same reason we omitted such refinements as the crossover network for the speaker, which may consist of a built-in filter housed within the speaker itself or a comparatively bulky unit that sits outside the speaker. We also omitted the microphone for the tape*

recorder and the antenna for the tuner. No doubt there are some who feel we should have included a stylus pressure gauge and a cloth for wiping records. We had to draw the line somewhere, and for a general wiring layout, we still feel that the diagram does its job.

★ ★ ★

#### WHEN IS B MINUS GROUND?

ON SOME schematics I notice that the ground connection is the same as the negative side of the power line, or B minus. On other diagrams, however, B minus is connected through a capacitor to the chassis. Now, in the second case, is B minus 'ground'? And, why is there this difference? As a matter of fact, how about an article explaining this whole business of 'ground' so that this confusion on my part (and many others I know) will be cleared up once and for all?"

J. H. Rogers  
Yonkers, N. Y.

The idea for an article on this subject is a good one and we'll try to work it up. To answer your specific question however, the capacitor between B minus and the chassis is used only on equipment having a transformerless power supply, or a.c.-d.c. equipment, and is a safety factor. When B minus is connected to the chassis through a capacitor, there is very little impedance between the two for signals of radio frequencies and most audio frequencies. In effect, for such signals, both B minus and the chassis are "ground." However, the capacitor blocks d.c. and has a high impedance to 60-cycle a.c. Hence, one can touch the chassis without contacting one side of the a.c. or d.c. voltage supplies.

★ ★ ★

#### CORRECTION ON VECTORS

THE article 'After Class' (Dec., 1954 issue, page 115) showing phase relations is a very excellent article. I'd like to make one correction on the vectors (Fig. 5). They are shown at 45 degrees instead of 90 degrees. . . ."

Alva Martin  
Findlay, Ohio

Thank you and congratulations! So far you are the only reader who has pointed out this error. Fig. 4 shows phase angles which are 90 degrees and the vector diagram below also should have shown 90 degree angles.

★ ★ ★

#### CITIZENS BAND

I AM interested in the Citizens band that my friend and I could use without a ham license. We would like the construction plan for a receiver and transmitter . . . for use on this band. . . ."

C. I. Strand  
Canton, Ohio

Sorry, but you are out of luck. Even on the Citizens band, the Federal Communications Commission, 1955

# 10 MASTERPIECES

LONG-PLAYING 33 $\frac{1}{3}$  R. P. M. HIGH-FIDELITY

COMPLETE TO THE LAST NOTE!

NO STRINGS ATTACHED!

# FREE

Long  
Playing

NOW YOU can get a real start on a complete record collection. Take ALL TEN of these complete masterpieces—and pay NOTHING but the cost of postage!

#### Why We Make this "Give-Away" Offer

Only by putting our records in your hands can we demonstrate their quality and value. Performed by internationally renowned orchestras and artists. Custom-pressed on purest vinyl plastic. Reproduced with a tone fidelity encompassing the entire range of human hearing. . . . 50 to 15,000 cycles!

#### Mail Coupon Now

As a Trial Member of the Musical Masterpiece Society, you are not obligated to ever buy another record from us. You do have the right to try—free of charge—any of the Society's monthly selections you wish. You receive prior notice of these and pay nothing in advance. Those you want are sent to you for FREE trial. After 5 days, the records you decide to keep are billed you at the low Membership Price of only \$1.65 per disc (average playing time 40 minutes). You save  $\frac{2}{3}$  the usual retail price! Right now, start your collection with these TEN masterpieces absolutely FREE! But membership is limited; once filled, this offer must be withdrawn. Rush coupon with only 25¢ to help cover cost of postage—today!

**MOZART**  
Symphony No. 26  
in E Flat, K. 184  
Netherlands Phil.  
Otto Ackermann, Cond.

**BETHOVEN**  
Piano Sonata No. 24  
in F Sharp, Opus 78  
Grant Johannessen,  
Pianist

**BRAMHS**  
The Academic Festival  
Utrecht Symphony  
Paul Hupperts, Cond.

**BERLIOZ**  
The Roman Carnival  
Netherlands Phil.  
Walter Goehr, Cond.

**VIVALDI**  
Concerto in C for Two  
Trumpets and Orch.  
H. Sevensen and F.  
Hausdoerfer, Soloists;  
Netherlands Phil.  
Otto Ackermann, Cond.

**WAGNER**  
Die Meistersinger,  
Prelude, Act 1  
Zurich Tonhalle Orch.  
Otto Ackermann, Cond.

**BACH**  
Toccatina and Fugue  
in D Minor  
Alexander Schreiner at  
Organ of Tabernacle  
Salt Lake City

**DUKAS**  
Sorcerer's Apprentice  
Utrecht Symphony  
Paul Hupperts, Cond.

**MUSSORGSKY**  
Night on Bald Mountain  
Netherlands Phil.  
Walter Goehr, Cond.

**CHOPIN**  
Fantaisie-Improptu,  
Opus 66  
Robert Goldsand,  
Pianist

Musical Masterpiece Society, Dept. 60-3  
43 West 61st St., New York 23, N. Y.

#### ALL 10 MASTERPIECES—FREE

I enclose 25¢ to cover postage. Please send me ALL 10 of the masterpieces listed above and enroll me as a Trial Member.

I will receive advance descriptions of future monthly selections. I may try any of these—free of charge—without paying a penny in advance. I may reject any recording before or after I receive it, and may cancel my trial membership at any time.

In the future, for each selection I decide to keep, I will pay special Member's Price of only \$1.65 plus a few cents for shipping. . . . saving  $\frac{2}{3}$  off the usual retail price! LIMIT: Only one sample package to a customer.

Name . . . . .

Address . . . . . 60-3

City . . . . . State . . . . .

In Canada, address: 686 Bathurst St., Toronto 4, Ont.

mission has rules that must be observed. The band used for voice frequencies (460-470 mc.) cannot be used except with FCC-approved equipment, and such approval is not granted individual, home-built units. So, while the operator on this band need not have a license, the equipment he uses must be licensed. For all practical purposes, this means using commercially-built units which, unfortunately, range from \$200 up. Your best solution would be to get your amateur radio license and then there will be many bands on which you can operate legally. Such licenses, particularly the Novice class, are not difficult to obtain, so why not work toward getting your "ham ticket."

★ ★ ★

### WRONG PIN CONNECTIONS FOR 3A5

**A**TTEMPTED to build the Three Channel R/C Receiver described in the January issue (pages 73-75). Followed your schematic and pictorial diagram and completed the set but it didn't work. Rechecked the schematic and discovered you indicated wrong pin connections for the 3A5 tube. One grid should be pin 3 and its plate is pin 2; the other grid is pin 5 and its plate is pin 6. Don't like to take raps at what I consider a fine mag, but I thought to let you know about this in case other readers have run into this trouble building the set."

Charlie Linton  
St. Augustine, Fla.

This is one of many comments we've received

on what was a slip-up on our part. See our section on "R/C Notes," this issue, for a detailed explanation.

★ ★ ★

### SAFETY NOTE ON METRONOME

**F**OR safety's sake in constructing the electronic metronome (January issue, page 30), the 'pilot light jewel and bracket' as noted on the parts list should be an assembly which has both leads isolated from the frame, otherwise a short occurring in capacitor C<sub>3</sub> would energize the chassis at line voltage (117 v.a.c.). This could cause bodily injury to an unsuspecting user."

Reeves H. Dengler  
Oreland, Pa.

We agree, and thanks for the suggestion.

★ ★ ★

### MORE TROUBLE WITH THE 3A5

**I**N reference to the '3-Channel Tone R/C Receiver' in your January issue: I looked up the 3A5 tube in the RC-17 RCA Tube Manual but couldn't find it. How come?"

Joel Madison  
Buffalo, N. Y.

The RC-17 tube manual covers only receiving tubes, and RCA doesn't consider the 3A5 as such. You will find this tube type listed in RCA Bulletin CRPS-102; also in Tung-Sol's little booklet entitled "Tubes for Radio and Television" and in the G-E tube manual. END

**FREE  
Bonus Offer!**

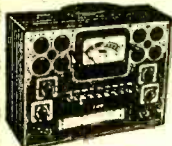

**Model 625K**  
• Illum. gear-driven 'Speed Rollchart'  
• New lever-action switches for individual testing of every element  
• Tests all conventional and TV tubes  
This Eico Tube Tester is yours **FREE** when you buy \$199 worth of tubes or more within 60 days at Teltron. May be bought outright from Teltron for \$34.95.

**SPECIALS!  
Till April 1st**

1B3GT	..	55
1T4	..	47
5Y4G	..	38
6AC7	..	59
6AU6	..	34
6AX4GT	..	54
6BQ6GT	..	73
6CB6	..	47
6K6GT	..	35
6P7	..	35
6U8	..	69
6W4GT	..	35
7A7	..	71
12A7	..	67
12AU7	..	52
25L6GT	..	37
50L6GT	..	44
TYPE 80	..	36

# TELTRON TUBES

**Guaranteed! Lowest Prices Ever!**

All tubes individually boxed . . . unconditionally guaranteed for one year.

**GIFT OFFER!**  
One 6BQ6 tube will be shipped **FREE** with any order accompanying this ad.

TYPE	PRICE	TYPE	PRICE	TYPE	PRICE	TYPE	PRICE	TYPE	PRICE
1A7GT	.. 53	6AF4	.. 1.02	6BL7GT	.. 78	6W6GT	.. 53	12SL7GT	.. 60
1H5GT	.. 51	6AG5	.. 52	6BY5G	.. 60	6X4	.. 37	12SK7	.. 45
1L4	.. 51	6AH4GT	.. 65	6BZ7	.. 95	6X5GT	.. 38	12SQ7	.. 38
1L6	.. 51	6AK5	.. 96	6C4	.. 41	6X8	.. 80	12SN7GT	.. 56
1LC6	.. 49	6AQ5	.. 48	6DC6G	.. 1.63	7F8	.. 49	19T8	.. 71
1N5GT	.. 51	6AR5	.. 48	6CU6	.. 95	12AL5	.. 43	25BQ6GT	.. 82
1R5	.. 51	6AU5GT	.. 60	6F6	.. 42	12AT6	.. 37	25CU6	.. 1.09
1U4	.. 51	6AV5GT	.. 60	6F5GT	.. 44	12AU6	.. 43	25Z5	.. 55
1U5	.. 43	6AV6	.. 37	6H6	.. 50	12AV7	.. 73	25Z6GT	.. 36
1X2	.. 65	6AX5GT	.. 60	6J5GT	.. 49	12AX4GT	.. 60	35B5	.. 48
2A3	.. 35	6BA6	.. 56	6J6	.. 61	12AX7	.. 61	35C5	.. 48
2A7	.. 35	6BA7	.. 58	6L6	.. 78	12AZ7	.. 65	35L6GT	.. 41
304	.. 53	6BE6	.. 46	6S4	.. 41	12B4	.. 72	35W4	.. 33
305GT	.. 61	6BF5	.. 48	6S8GT	.. 65	12B87	.. 61	35Y4	.. 42
354	.. 48	6BG6G	.. 1.18	6SA7GT	.. 45	12BA6	.. 46	35Z5GT	.. 33
3V4	.. 48	6BH6	.. 51	6SK7GT	.. 45	12BA7	.. 58	50A5	.. 49
5V4G	.. 49	6BJ6	.. 51	6SL7GT	.. 60	12BE6	.. 46	50B5	.. 48
5Y3GT	.. 30	6BK5	.. 75	6SN7GT	.. 60	12BH7	.. 61	50C5	.. 48
5Y4G	.. 40	6BK7	.. 78	6T8	.. 71	12BY7	.. 65	117L7GT	.. 1.20
6A8	.. 40	6BN6	.. 90	6V3	.. 80	12BZ7	.. 63	117Z3	.. 33
6AL5	.. 43	6BQ7	.. 85	6V6GT	.. 48	12SA7	.. 45	117Z6GT	.. 65
6K7	.. 40								
6Q7	.. 40								

**SAME DAY SERVICE**  
18 Hour Postal Delivery  
To West Coast

**TERMS:** Save all freight and postage charges. All orders accompanied by full remittance will be shipped **POSTAGE PAID** anywhere in the continental U.S.A. 25% deposit required on C.O.D.'s. Minimum order \$10.00. Open accounts to rated firms only.

**FREE** \$7.20 list value Bonus Box of three 6SN7 tubes and 25 assorted resistors with each order of \$25 or more.

# TELTRON ELECTRIC COMPANY

428 HARRISON AVE. DEPT. PE-3 Phone HUmboldt 4-9848 HARRISON, N. J.

# INTERESTED IN RADIO-TV-ELECTRONICS?

THEN YOU WILL WANT TO KNOW

**WHAT IS  
The FCC?**

**HOW CAN I GET A VALUABLE  
FCC COMMERCIAL OPERATOR'S LICENSE**  
My Passport To Future Security



**CARL E. SMITH, E.E.**  
President

It's amazing what the future holds for you in this modern world of electronics.

Let me send you the entire story—FREE!

- How to pass the FCC Exam.
- A Sample FCC lesson.
- Money making FCC License Information.

**GET THESE FREE**



**These Three Booklets Tell You**

- 1 Where to apply to take FCC Examinations.
- 2 Scope of knowledge required.
- 3 Necessary FCC exam preparation.
- 4 Positive knowledge check.

And additional data of great value.

I can train you to pass the Valuable FCC exam in a minimum of time—if you have any practical radio experience—a fair knowledge of mathematics—and are mechanically inclined.

**JOIN THE LIST OF SUCCESSFUL  
ELECTRONIC TECHNICIANS  
HERE'S PROOF**

	License	Time
✓ Harry G. Frame, Box 429, Charleston, W. Va.	2nd Class	13 weeks
✓ Charles Ellis, Box 449, Charles City, Iowa	1st Class	28 weeks
✓ Omar Bibbs, 1320 E. 27th St., Kansas City, Mo.	1st Class	34 weeks
✓ Kenneth Rue, Dresser, Wisconsin	2nd Class	20 weeks
✓ B. L. Jordan, Seattle, Washington	1st Class	20 weeks

**AND THOUSANDS MORE!**



**NATIONAL HOME  
STUDY COUNCIL**

Approved Member

**THROUGH US—START BUILDING FOR A  
PROFITABLE LIFETIME PROFESSION**

**MAIL COUPON TODAY**

**EMPLOYERS MAKE JOB OFFERS  
EVERY MONTH!**

**YOUR FCC TICKET IS RECOGNIZED  
BY MOST EMPLOYERS IN THE  
ELECTRONICS FIELD AS PROOF OF  
YOUR TECHNICAL ABILITY.**

**PAVE THE WAY FOR YOUR SHARE  
OF THE BETTER THINGS IN LIFE.**

**CLEVELAND INSTITUTE OF RADIO ELECTRONICS**  
4900 EUCLID AVE., DESK **PE-1**  
CLEVELAND 3, OHIO

(ADDRESS TO DESK NO. TO AVOID DELAY)

I want to know the facts, without obligation, how I can get my FCC ticket in a minimum of time. Rush me your FREE booklet "How to Pass FCC License Examinations" (does not cover exams for Amateur License) as well as sample FCC-type exam and the amazing new booklet, "Money-Making FCC License Information."  
**PLEASE PRINT CLEARLY**

NAME .....

ADDRESS .....

CITY..... STATE.....

PASTE ON A 2 CENT POSTCARD OR SEND AIRMAIL  
Special tuition rates to members of the U. S. Armed Forces

**CLEVELAND INSTITUTE OF RADIO ELECTRONICS**  
4900 Euclid Ave. Cleveland 3, Ohio



# Fix your TV Set YOURSELF!

BUY YOUR TV TUBES  
AT WHOLESALE!

100% GUARANTEED! BRANDED! SAME DAY SERVICE!

1A4P	.29	6BD5	.59	7F8	.59
1A7	.49	6BE6	.39	7J7	.59
1B3	.59	6BG6	.99	7K7	.59
1B4P	.79	6BH6	.49	7U5	.49
1C6	.29	6BJ6	.49	7Z4	.39
1C7	.29	6BK7	.69	12AL5	.39
1E7GT	.39	6BL7	.69	12AT6	.39
1F5G	.29	6BN6	.99	12AT7	.69
1H5	.49	6BQ6	.79	12AU6	.39
1L4	.49	6BQ7	.79	12AU7	.59
1L6	.59	6BY5G	.59	12AV6	.39
1LA6	.39	6BZ7	.79	12AV7	.69
1LC5	.39	6C4	.39	12AX7	.59
1LC6	.39	6CB6	.49	12BA6	.39
1N5	.49	6CD6	.99	12BA7	.59
1R5	.49	6CU6GT	.99	12BE6	.39
1S5	.39	6F6	.39	12BH7	.59
1T4	.49	6F7	.69	12SA7	.49
1T5GT	.69	6J6	.59	12SK7	.49
1U4	.49	6J8	.79	12SN7	.59
1U5	.39	6K6	.39	12SL7	.59
1X2	.59	6L6	.69	12SQ7	.39
2A3	.29	6N6	.69	14S7	.79
2A7	.29	6S4	.39	19B6G	.99
3AGT	.99	6S8	.59	19T8	.69
3Q4	.49	6SA7	.49	25BQ6	.79
3Q5	.59	6SD7	.49	25L6GT	.39
3S4	.49	6SK7	.49	25W4GT	.39
3V4	.49	6SL7	.59	25Z6	.39
5U4	.39	6SN7	.59	35B5	.39
5V4	.49	6SQ7	.39	35C5	.39
5Y3	.29	6SR7	.49	35W4	.29
5Y4	.49	6T8	.69	35Z3	.29
5Z3	.29	6U8	.69	35Z5	.29
6AB4	.39	6V6	.49	35/51	.29
6AG5	.49	6W4GT	.39	36	.29
6AJ5	.69	6XA	.29	37	.29
6AK5	.69	6X5	.29	39/44	.29
6AL5	.39	7A4/XXL	.39	49	.29
6AQ5	.49	7A6	.49	50B5	.49
6AS5	.49	7A7	.49	50C5	.49
6AT6	.39	7A8	.49	50L6	.49
6AU6	.39	7AK7	.79	75	.29
6AV6	.39	7B4	.49	76	.29
6B7	.79	7B5	.49	77	.29
6BA6	.49	7B6	.49	80	.29
6BA7	.59	7B7	.49	117LGT	.99
6BC5	.49	7F7	.59	117Z3	.29

Minimum Order  
\$7.00

25% deposit with order. Balance C.O.D. If full remittance is sent, please include postage. Excess money will be refunded. Quantity users—write for special discounts!

**FREE!**

with every order of \$20 or more—famous "Ox-wall" magnetic screw driver kit. Includes all sizes—Phillips head, long handles to get in those tight spots, etc. 7 screwdrivers in all. May be purchased outright. Last value \$4.99—\$1.99 each; 3 for \$5.50.

Mail Your Order To

# VIDEO

ELECTRIC COMPANY

79 CLINTON PL.  
NEWARK, N. J.



## This Month's Cover

THE phenomenal growth of two-way radio, while not as well-known as the "coming of age" of television, is not less spectacular. Two-way radio affects almost everyone's life since it is being used by a widely diversified group of industries ranging from taxi companies to the utility firms responsible for delivering gas and electricity to the home. Bus lines, railroads, airlines, etc. all use two-way radio to insure safe and on-schedule operation.

In this month's issue, three different applications for two-way radio are covered. This month's cover shows the installation in one of the units operated by the Los Angeles Fire Department. For the complete story on "Short-Wave Firefighting," see the article on page 67.

A second interesting application of the technique is described in the article "This Train is Radio Equipped" which appears on page 38.

So many questions regarding the use of "walkie-talkies" have come to us from our readers that we predict the article "The Walkie-Talkie" on page 54 will be a hit. Here are the answers to such questions as, "Do I have to have a license to operate walkie-talkie equipment?", "Can I convert war surplus units to operate on the Citizens band?", etc. **EDITOR**

(Ektachrome by Peter J. Samerjan)

# HIGH-FIDELITY MUSIC-APPRECIATION RECORDS

TO HELP YOU UNDERSTAND MUSIC BETTER AND ENJOY IT MORE



**ON ONE SIDE** there is a full performance of a great musical work, just as on the ordinary records you buy. The records will feature orchestras and soloists of recognized distinction in this country and abroad. You listen to the performance first, or afterward, and then...



**ON THE OTHER SIDE** is an illuminating analysis of the music, with the various themes and other main features of the work played separately with running explanatory comment, so that you can learn *what to listen for* in order to appreciate the work fully.

## A NEW IDEA OF THE BOOK-OF-THE-MONTH CLUB

**A**LL TOO FREQUENTLY, most of us are aware, we do not listen to good music with due understanding and appreciation. Our minds wander, and we realize afterward that we have missed most of the beauties of the work. There is no doubt about the reason: we are not primed about *what to listen for*. MUSIC-APPRECIATION RECORDS meet this need—for a fuller understanding of music—better than any means ever devised. They do it, sensibly, by *auditory* demonstration.

**YOU HEAR MUSIC AS THE GREAT CONDUCTORS HEAR IT...** On the podium they have in mind at every moment the various themes of the work, their interplay and development, and the main architectural features of the composition. This combined aesthetic and intellectual pleasure is what every music-lover can now acquire through MUSIC-APPRECIATION RECORDS. After hearing several of these records, all the music you listen to is transformed, because you learn in general what to listen for.

This enjoyable form of self-education can be as thorough as the Music-Appreciation courses that are given in many universities.

**YOU SUBSCRIBE BUT TAKE ONLY THE RECORDS YOU WANT...** A new MUSIC-APPRECIATION RECORD will be issued—for subscribers only—every month. Ultimately all the great masterpieces of music will be included. The announcement about each forthcoming record will be written by Deems Taylor. After reading this descriptive essay you may take the record or not, as you decide at the time. *You are not obligated as a subscriber to take any specified number of records.* And, of course, you may stop the subscription at your pleasure—at the end of one month, three months, any time!

**TWO TYPES OF RECORDS AT A RELATIVELY LOW COST...** All MUSIC-APPRECIATION RECORDS will be high-fidelity long-playing records of the highest quality—33 $\frac{1}{3}$  R.P.M. on Vinyl-

ite. They will be of two kinds: first, a so-called Standard Record—a *twelve-inch* disc—which will present the performance on one side, the analysis on the other. This will be sold at \$3.60, to subscribers only. The other will be an Analysis-Only Record—a *ten-inch* disc—priced at \$2.40. The latter will be made available each month for any subscriber who may already have a satisfactory long-playing record of the work being presented. (A small charge will be added to the prices above to cover postage and handling.)

**TRY A ONE-MONTH SUBSCRIPTION—NO OBLIGATION TO CONTINUE...** Why not make a simple trial, to see if these records are as pleasurable and as enlightening as you may anticipate? The first record, **BEETHOVEN'S FIFTH SYMPHONY**, will be sent to you at once—at *no charge*. You may end the subscription immediately after hearing this record—and keep it with our compliments—or you may cancel at any time thereafter.

*As a demonstration*  
**WILL YOU ACCEPT  
WITHOUT CHARGE**



## Beethoven's Fifth Symphony

▲ NEW HIGH-FIDELITY RECORDING BY THE LONDON SYMPHONY ORCHESTRA

Norman Del Mar, Conductor  
Analysis by Thomas Scherman

**YOU HAVE HEARD** this great work countless times—what have you heard in it? And what may you have failed to hear? This demonstration will show you what you may have been missing in listening to great music.

PLEASE RETURN ONLY IF YOU HAVE A RECORD PLAYER WHICH CAN PLAY 33 $\frac{1}{3}$  R.P.M. LONG-PLAYING RECORDS

MUSIC-APPRECIATION RECORDS R68-3  
c/o Book-of-the-Month Club, Inc.  
345 Hudson Street, New York 14, N. Y.

Please send me at once the first MUSIC-APPRECIATION RECORD, *Beethoven's Fifth Symphony*, without charge, and enter my name in a Trial Subscription to MUSIC-APPRECIATION RECORDS, under the conditions stated above. It is understood that, as a subscriber, I am not obligated to buy any specified number of records, but may take only those I want. Also, I may cancel this subscription after hearing the first record, or any time thereafter at my pleasure, but the introductory record is free in any case.

Mr. }  
Mrs. }  
Miss } (Please Print)  
Address.....  
City..... Zone..... State..... MAR 1

The data that launched thousands of careers  
and advanced hundreds of amateurs is yours . . .

**FREE**

**REVEALS HOW YOU CAN GAIN QUICKER SUCCESS  
OR TURN YOUR HOBBY INTO A WELL-PAID CAREER  
IN RADIO . . . TELEVISION . . . ELECTRONICS**

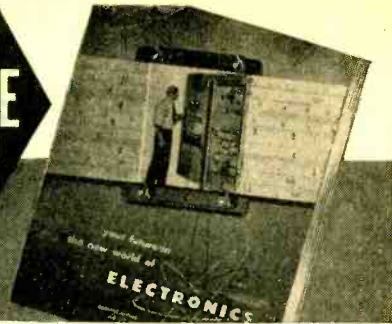

**TURN YOUR HOBBY INTO A HIGH-PAY CAREER!**

Today thousands of electronics hobbyists have an opportunity to turn fun into profits. It's the "Age of Electronics!" Trained men are in crucial demand! You may be "outside" the electronics industries now, working on a job you enjoy far less than experimenting, building, transmitting, receiving; working for less money than is being paid to electronics engineering technicians. But your "true love" is electronics. Why not awaken to your opportunities—now?

**ELECTRONICS IS SCREAMING FOR MEN LIKE YOU!**

Here are just two of the high-level opportunities available from coast to coast:

*"Openings will occur in the GS-10 grade, starting salary \$5,500 per year, for men who can qualify for the servicing of 35mm motion picture sound and projection equipment. Although some previous experience in this field is desirable, it is not essential if the individual has sufficient training in radio . . ."*—Departments of the Army and Air Force.

*"Just about four months have passed since I made my first recruiting trip to CREI. As a result of that visit Messrs. Kohs, Plante and Wenger are now members of the Laboratories and Mr. Kresge soon will be . . . we have some openings now and will have others . . ."*—Bell Telephone Laboratories, Murray Hill, N. J.

*"Two openings in our Field Service . . . aircraft electronics . . . starting salary is \$380 and up . . ."*—North American Aviation, Inc., Columbus, O.

**WHERE WILL YOU BE ONE YEAR FROM TODAY?**

Still plodding along? Getting paltry raises—or none? Facing insecurity?

**ALL YOU NEED IS ADVANCED TECHNICAL TRAINING**

Sure you have some experience. But the fellows with only partial technical knowledge move slowly, or stand still, while you—the man with advanced technical training—plunge ahead in the golden world of electronics opportunities.

**SEND FOR FREE BOOKLET. IT TELLS YOU HOW**

How to gain career success in the tremendous electronics industries. It pinpoints opportunities which exist. By 1960, the electronics industries will do no less than \$10 billion worth of business per year, not counting military orders. Take TV for example: There are about 34,000,000 TV sets and 411 TV stations on the air. Color TV is pushing ahead furiously. There is but one field of maximum opportunity in this electronic age.

**CREI TRAINS YOU IN MINIMUM TIME AT HOME**

Thousands of men before you have benefited quickly from CREI Home Study training. Thousands of CREI graduates are now employed in industry here and abroad. Here is what they say:

*"In this time of less than two years, I have almost doubled my salary and have gone from wireman, to engineering assistant and now to junior engineer. I have CREI to thank."*—Frank A. Eckert, 22 Clover Lane, Levittown, Pa.

*"Shortly after completing the CREI course, I took the Civil Service examination for electronics maintenance technician for the Civil Aeronautics Administration and passed it with very good grades. I was one of the first to be hired by the CAA from the Civil Service Register."*—J. F. Marquez, P. O. 618, Columbus, N. M.

**ACQUIRE NECESSARY TRAINING AT HOME**

Use spare-time hobby hours for CREI Home Study as thousands of successful technicians have since 1927. Get concentrated training in minimum time, then step into a good job and enjoy good pay in the mushrooming electronics industry.

**COUNTLESS POSITIONS MUST BE FILLED**

And only trained men can fill them. You can get your share, if you take time now to gain that indispensable knowledge.

**LEADING COMPANIES ENDORSE CREI TRAINING BY USING IT**

They use CREI courses to train their own personnel. To name a few: United Air Lines, RCA-Victor Division, Radio Corporation of America. There are many others.

**RECEIVE PRACTICAL INSTRUCTION IN PERSONALIZED WAY**

Courses are prepared and administered by recognized authorities in electronics education. They know what industry wants and needs. Instruction is personal and you advance at your own speed. CREI's Placement Bureau is available to help you locate a good job.

**TAKE TWO MINUTES TO FILL OUT THE COUPON BELOW**

Mail it immediately, and get the book that can launch your career as it has for thousands since 1927. Act now!

**VETERAN?** If discharged after June 27, 1950, let new GI Bill of Rights help you get resident instruction. Check coupon for full data.

**CAN YOU COME TO WASHINGTON?**

CREI also offers resident instruction at same high level day or night. Classes start often. Check coupon for Residence School catalog. Qualified residence graduates earn degree: "Associate In Applied Science."

**MAIL THIS COUPON . . . TODAY!**

To help us answer your request intelligently, please give the following information:

EMPLOYED BY .....

TYPE OF PRESENT WORK .....

SCHOOL BACKGROUND .....

ELECTRONICS EXPERIENCE .....

IN WHAT BRANCH OF ELECTRONICS ARE YOU MOST INTERESTED? .....

**CAPITOL RADIO ENGINEERING INSTITUTE**  
Accredited Technical Institute Curricula—Founded in 1927  
3224 16th St., N. W., Dept. 123B, Washington 10, D. C.

Send booklet "Your Future in the New World of Electronics" and course outline.

- CHECK FIELD OF GREATEST INTEREST
- Practical Television Engineering
  - Broadcast Radio Engineering (AM, FM, TV)
  - Practical Radio Engineering
  - TV, FM & Advanced AM servicing
  - Aeronautical Radio Engineering

Name .....

Street .....

City .....

Zone .....

State .....

Check— Residence School  Veteran





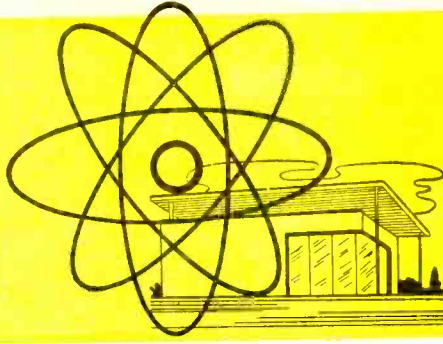

# Electronic Miracles of the Future

**R**ADIO, television, radar, and other everyday electronic marvels were little more than fanciful dreams about fifty years ago. Imagine the miracles that will become commonplace if the progress in the next fifty years is as great as that made in the past five decades. Then multiply that many times over, for progress is not a steady thing; it tends to accelerate and gain momentum like a snowball as time passes. The more man learns about the world and himself, the better able he is to apply that knowledge and learn still more. An imaginary trip to the year 2005 A.D. reveals many possibilities of what we and our children can expect of life in the future.

During our visit to the home of tomorrow, we become aware of a number of changes in architecture. The house is simpler, more functional, and more colorful than today's houses. As we approach the entrance, the housewife's face appears on a screen in the door and her welcome is projected from the kitchen. As the door swings open and we pass over the sill, we experience a very slight tingling sensation. The entire living room ceiling glows pleasantly, bathing the room in soft, shadowless light. When our hostess appears and greets us, we explain our mission and ask her

to tell us what "modern" living is like in the year 2005.

"Certainly," she replies, "I'll be happy to show you around, and to answer any questions you may have."

"Well, as a start, when we came to the front door, we didn't knock, yet you invited us in."

"That's simple," she responded, "as you approached the front door, an electronic sensing device noted your presence and sounded a signal in the kitchen. I simply switched on a two-way television communicator to see and to talk to you. When I invited you in, an electronic coding device released an electric lock and opened the door."

"Then when we came in, the room lights came on automatically. We also noticed a slight tingling sensation as we entered the room."

She smiled. "All our room lights are controlled by another electronic device, similar to the electronic doorbell. It works in conjunction with a light sensitive unit. The lights are turned on automatically when anyone enters a room at night or when there is little outside light. The lights are turned off automatically when the last person leaves the room. And the tingling





sensation you noticed is an ultrasonic screen across the doorway. It keeps out flies and other insects, even when the door is left open."

Looking around the living room, we fail to see the bulky cabinets which represent the radio and television receivers of our day. "Don't you have television?" we ask.

"Of course, this mural on the wall is our television receiver," she answers, pointing to a large picture. "When we are not receiving a program, a mural appears on the screen. The controls are on the frame. Watch!"

As she touches a hidden control, the mural disappears and a television program appears in its place. It is in full color and appears three dimensional. The sound comes on simultaneously and seems to emanate from different parts of the scene.

"You see," she explains, "the television receiver is only a few inches thick, with all the electronic circuits built into the frame. And it has a built-in recorder. If I want to watch a special program, but I'm busy with the children, I turn a switch and record the program for later viewing. The television receiver also serves in place of a newspaper or magazine."

"How do you mean?" we ask.

"Well, take POPULAR ELECTRONICS for example. Since we're subscribers, the magazine is received automatically each month over a special television channel and recorded on a small tape. My husband can look through the issue whenever he wants. He doesn't have to 'read' the magazine. Each article is presented as a short television program. Back issues are filed in an electronic memory bank. Whenever he wants to refer to a past issue of any magazine, he simply speaks the proper code words into a microphone and the issue and article he wishes appears on the screen of the re-

ceiver. Newspapers and books are received and recorded on tapes in a similar fashion."

"What about telephones?"

"They're not as you know them. We have two-way television communicators all over the house. I can watch the children in their playroom, see visitors at the front or back doors, or talk to my husband in his hobby shop no matter what room I'm in. For personal communication we use our small pocket-sized tele-communicators."

She hands us a small object, somewhat larger than a present day cigarette case and about the same shape. On one side is a flat, dull screen. Along one edge is a series of buttons and small controls.

"The tele-communicator you're holding is a combination television receiver, two-way communicator, and a pocket recorder. It's completely self-contained and uses a life-time atomic battery. With it you can communicate with anyone in the world who has a similar unit and who subscribes to the service. You can watch local television programs in color, and you can record conversations. It takes the place of a telephone, portable radio, and notebook."

We return the tele-communicator to our hostess and glance about. "This room seems very pleasant; do you have air conditioning?"

"Yes," she replies, "the entire house is air conditioned, with the temperature and humidity maintained precisely at the best balance by automatic electronic controls. We can change the temperature in any room by setting a dial, regardless of the temperature in other parts of the house. For example, my husband keeps his hobby shop a little cooler than our living room because he does more physical work there. Electronic dust precipitators remove dust and ultraviolet lamps kill germs in the air circulated through the house so that I seldom have to clean. Of course, even with an air conditioned home, we sometimes like to open the windows. These, too, are controlled automatically. Should a heavy wind develop, a drop of rain fall, or the outside temperature drop below a comfortable level, the windows are automatically closed. Automatic shutters adjust to prevent harsh sunlight from coming directly into the house."

"How about your kitchen?" we ask.

"Of course," she answers, "come with me." She leads the way into a room as tastefully and as colorfully decorated as the living room. The customary appliances, however, are not in sight.

"Here is the stove," she says, pointing to a small cabinet. "Food is cooked in the oven by high frequency radio waves. For frying and top of the stove cooking, we

have high frequency induction coils which heat only the pan. Here, let me show you."

With this, she deftly removes a pan from a wall cabinet and places it on the stove. Reaching into another cabinet which is the refrigerator, she removes a small pre-cut slab of butter. She drops the butter into the pan and touches a button on the edge of the stove cabinet. The pan heats rapidly, as we can tell by the sizzling butter.

"But the stove is not the only electronic device in our kitchen," she continues. "We have an ultrasonic dishwasher which removes even the most stubborn grease and food residue. And we have a food sterilizer which I use for home canning. After sealing prepared or fresh food in a plastic container, I sterilize it electronically, and it'll keep almost indefinitely without refrigeration."

"With all of these electrically operated devices, your electric bill must be fantastic."

"Not at all. In fact, we don't buy our electric power like you did in the past. Instead, a large solar battery is mounted on our roof. It converts sunlight into electrical energy which is then stored in special units for later use. Some homes use small atomic energy power plants instead of the solar battery. And many of our electronic devices have built-in atomic batteries which last a lifetime without replacement. We never have to worry about the electricity going off, even during a hurricane."

"Your house seems to be unusually well equipped with electronic devices," we remark. "Is this true of all of your modern world, or is your home an exception?"

"No," she answers, "you might call ours an electronic world. We use electronics extensively in our homes, in our work, in our schools, and even in our recreation. For example, if your hobby is photography, you'd like our electronic cameras. They're small enough to slip in a coat pocket and record full color sound pictures on tape. No developing is necessary. The pictures are ready to be shown as soon as you take them. And the camera itself can be used as a projector. Or you can remove the tape and play it through the living room television receiver. We even use electronics in our transportation. If you wanted to visit my husband's office, you would travel

in an electronically controlled auto-copter."

"Auto-copter! What's that?"

"The auto-copter is our principal means of transportation. It is sort of a cross between the automobile and helicopter of your day. For most trips, it is electronically controlled. For example, when my husband wants to go to his office, he gets in his auto-copter and presses a button. The automatic electronic controls of the auto-copter take over. He doesn't have to drive. He can watch a television program or simply relax during the trip. A pre-recorded tape knows the shortest and best possible route to his office and automatically guides the auto-copter to its destination. Small radar controls prevent accidental collisions and automatic signal devices insure that the speed limit is not exceeded, that the auto-copter stays in the proper traffic lane, and that all turns are properly made. The auto-copter can't break any traffic laws so there's no worry about policemen or tickets. On arriving at the office, the auto-copter automatically parks itself in its assigned niche."

"You must be perpetually astounded by the miracles of your world!"

"No. You didn't consider the automobile, the airplane, or television to be miracles. They were ordinary, everyday things. In the same way, automatic electronic devices are commonplace to us."

Glancing at our wrist watch, we see it's quite late. "You'll have to excuse us," we say, "but we must return to our own time."

"I understand," she smiles, leading us to the front door. "But do come again. You'd like to visit my husband's office, and perhaps our factories and schools. There's lots more to see."

Returning to our own time, we reflect, for a moment, on what we've seen. Wondrous miracles, to be sure, but we can see the seeds of all the devices in our present day. We have pocket radio receivers and pocket recorders. Experiments have been carried out with solar batteries as well as atomic batteries. Television programs have been recorded on tape. Giant computers perform miracles of calculation, far beyond human ability. And food has been cooked by radar. Perhaps we didn't go as far into the future as we thought! END

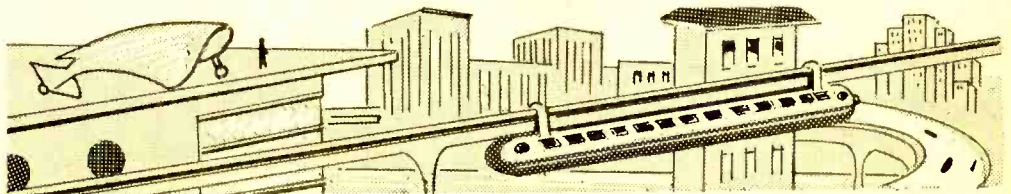

# U.S. AIR FORCE'S NEW

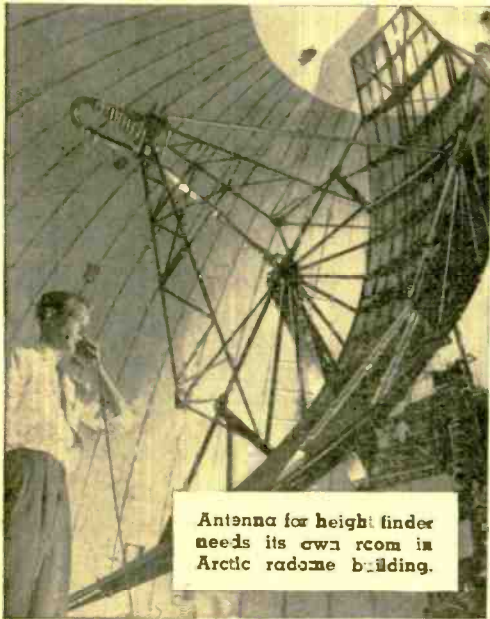

Antenna for height finder needs its own room in Arctic radome building.

**D**EFENSE networks of the United States and its allies are being strengthened by a powerful new radar height-finder.

Made by *General Electric* of Syracuse, N.Y., the new radar set furnishes high-frequency energy which is concentrated in a narrow beam like that of a searchlight. This beam detects planes three times as far as previous units of this type. Its exact range is classified information.

An interesting sidelight is that the energy radiated is so powerful, it can light fluorescent lamps over a hundred feet away, and can ignite flashbulbs tossed in the air in front of the antenna (see photo).

The radar height-finder is being used in conjunction with search radar to detect high flying aircraft and to provide information on distance, altitude, and flight direction.

The new radar is being made in mobile as well as fixed versions. A large quantity has already been supplied for use in strengthening the "radar fences" that guard the North American continent, and for defense posts in countries receiving aid from

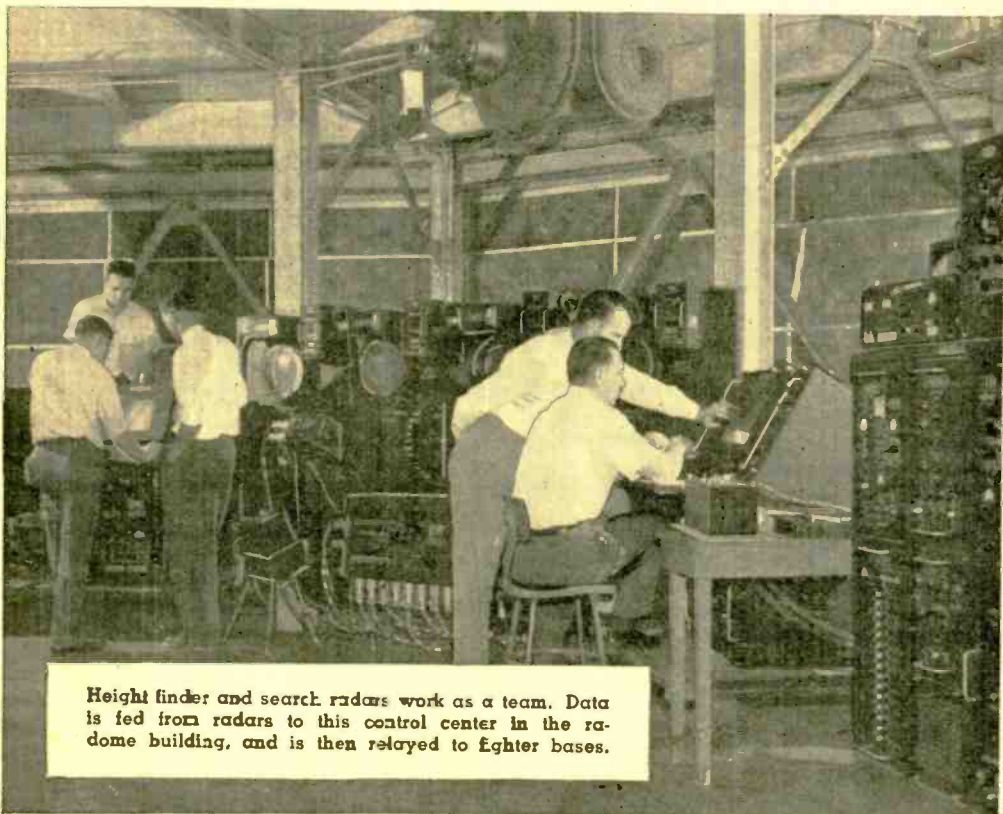

Height finder and search radars work as a team. Data is fed from radars to this control center in the radome building, and is then relayed to fighter bases.

# RADAR HEIGHT FINDER

the United States under the Mutual Defense Assistance Pact. Additional units are being produced for similar use.

As shown in the photos, the complete installation is a complex one, requiring the combined efforts of several trained technical personnel for successful operation. In this set-up, the height-finder and the search radars work as a team. The type of data supplied by search radar (see article in *POPULAR ELECTRONICS*, November 1954) is combined with the data available from the height-finder. The information thus obtained is fed to a central control room, where it is evaluated and interpreted. Then, in turn, it is relayed to fighter bases, from which points necessary action can be taken.

In Arctic climates the radar is housed in a dome-shaped circular structure (see photo) with a balloon-like radome made of woven glass fabric impregnated with a rubber compound. The radome is supported by air pressure, about a half pound per square inch, and can withstand winds up to 125 miles per hour. The radome protects the radar antenna from Arctic weather. **END**



Flashbulb tossed in air is ignited by energy from powerful new radar set.

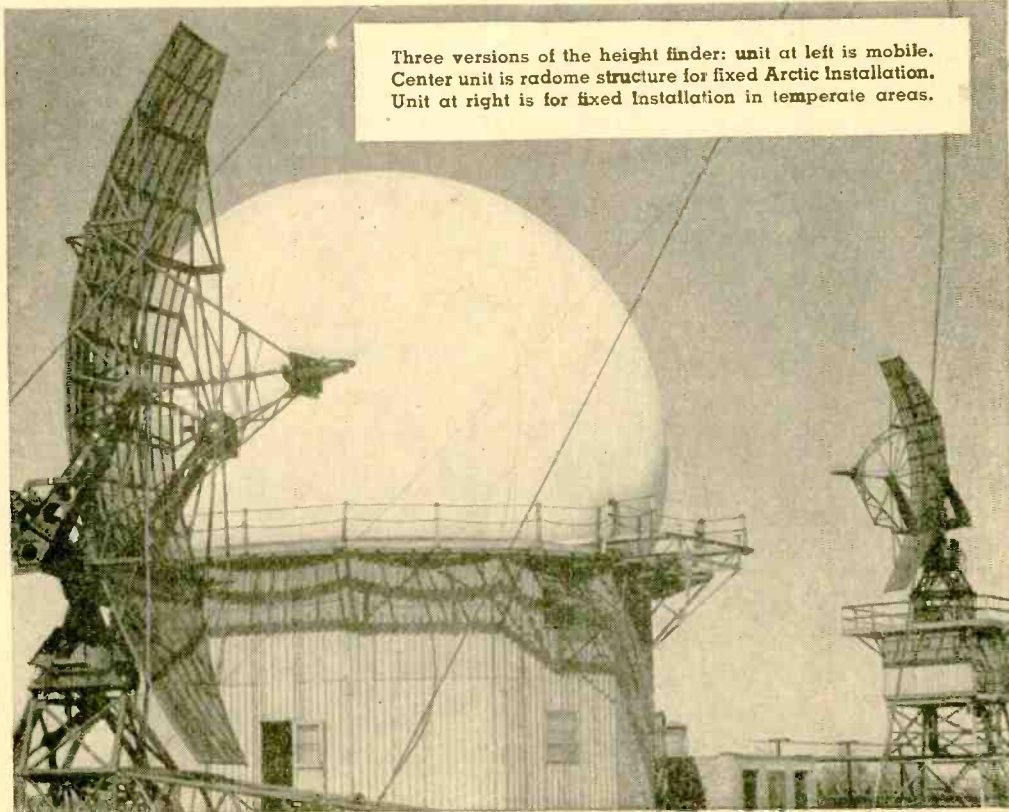

Three versions of the height finder: unit at left is mobile. Center unit is radome structure for fixed Arctic installation. Unit at right is for fixed installation in temperate areas.

# WHAT WE HEAR



## *The audio frequency spectrum and its importance in hi-fi.*

**A** GOOD approach to high fidelity is to determine what it is that hi-fi enables us to hear. This analysis serves not only to explain the nature of sound, but may well act as a yardstick for evaluating a hi-fi system.

All areas within the audio spectrum are important for satisfactory reproduction of sound, particularly music. Even those very high regions above 10,000 cycles contribute to listening pleasure, as this discussion and the chart opposite show.

Most of us begin responding to frequencies as low as 16 cps. This is more of a "feeling" point than an actual hearing level. Music does not go down that far. The lowest note on the piano keyboard is 27.5 cycles. The lowest fundamental tones of large organs may go down to 20 cycles, and the little known octa-contra bass clarinet is reputed to hit that low. You can get an idea of the kind of deep, overwhelming power suggested by these "sub-basement" lows if you recall the lowest rumble of thunder you've ever heard.

Most music, however, occurs above 32 cycles. The second and third octaves (32 to 128 cycles) are the regions of most bass notes, the all-important rhythm section.

The fourth and fifth octaves (128 to 512 cycles) include the relatively higher bass tones such as those produced by tympani and the higher strings of the bass viol. The fundamental tones of most horns, as well as of the male voice, appear in this area.

The sixth and seventh octave region, while above "middle C" on the piano, and musically in the treble range, is often termed "mid-range" from the point of view of its coverage by reproducing equipment. This is the frequency area easiest to reproduce. It includes the minimum range needed for voice communication, but without the bass notes below and the overtones above it, a "pinched" quality—like that of a voice on telephone—results. The trumpet's tones extend into this range, as well as those of the female voice. At the upper reaches of this range are the notes of the flute. The fundamental tones of most musical instruments are to be found

between the fourth and seventh octaves.

The brilliance of clashing cymbals and the piping of the piccolo bring us into the region above 2000 cycles. Violin notes can be heard in this area to well over 3000 cps. The highest piano note, or top of the 8th octave, reaches 4186 cps. Certain speech and musical sounds, of a labial and fricative nature, reach into the 9th octave. Many important overtones, or harmonics generated by fundamental tones originating in lower octaves, are sounded in the 9th. Our ability to hear these overtones helps us, to a large degree, to distinguish between different instruments. It also creates the illusion of "presence" or reality in music reproduction.

These harmonics, or overtones, continue up to 16,000 cycles and beyond. To hear them is to perceive the final touch in tonal brilliance and the subtle shadings of instrumental timbre that characterize live performances of music and the best hi-fi reproducing systems. To some extent, this region of frequencies is an audio "no man's land" because of the controversy regarding its importance in reproducing systems. Some observers claim that we can fully enjoy music without the need to catch anything above 12,000 cycles. Others point to the limitations of present-day program sources, such as records and pickups which do not go up to 16,000 cycles.

By far, the biggest single problem in assembling a hi-fi system, as regards reproducing the full audio spectrum, is the choice of a suitable loudspeaker and enclosure. Unfortunately, no single speaker has yet been designed that covers the complete audio spectrum. As shown on our chart, the "fi" can become truly "hi" only with a speaker *system* which uses separate speaker units and correct frequency dividing facilities. When you consider the number and variety of sizes and shapes of instruments that produced the original sounds, you can begin to appreciate why a greater variety of speakers will reproduce them better than a single speaker. And, in any case, no decent bass reproduction is possible without a suitable enclosure for the low frequency speaker. **END**

**FREQUENCIES**  
(cycles per second)

**IMPORTANT  
AUDIO RANGES**

**SPEAKER  
RANGES**

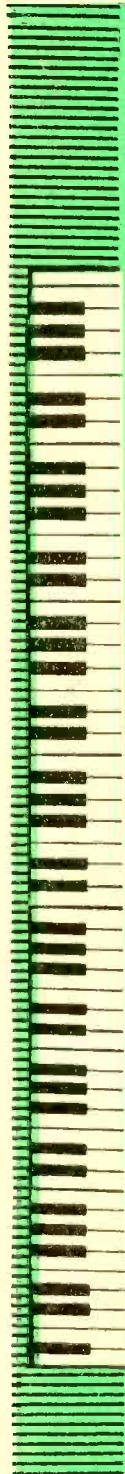

10  
192  
to  
16,000

Highest harmonics add sense of realism, tonal richness. Hearing limits are 16,000 cycles for young people; 12,000 for old.

9  
4096  
to  
8192

Many important harmonics. High fundamental tones of pipe organ, piccolo, and other instruments.

8  
2048  
to  
4096

7  
1024  
to  
2048

Minimum needed for voice, but without overtones and bass tones voice has "telephone" quality. Many instruments in this range.

6  
512  
to  
1024

5  
256  
to  
512

Upper bass for rhythm as well as fullness of tone. Fundamental tones of human voice and many instruments. Middle C is 256 cycles.

4  
128  
to  
256

3  
64  
to  
128

Lower bass region for rhythm and "power" in music. Lowest fundamental tones of such instruments as bass viol, tuba, and clarinet.

2  
32  
to  
64

1  
16  
to  
32

Wind, thunder. Fundamentals of large organs. Low A is 27.8 cycles. Sense of "feeling" at 16 cycles; hearing limit a bit higher.

TREBLE

BASS

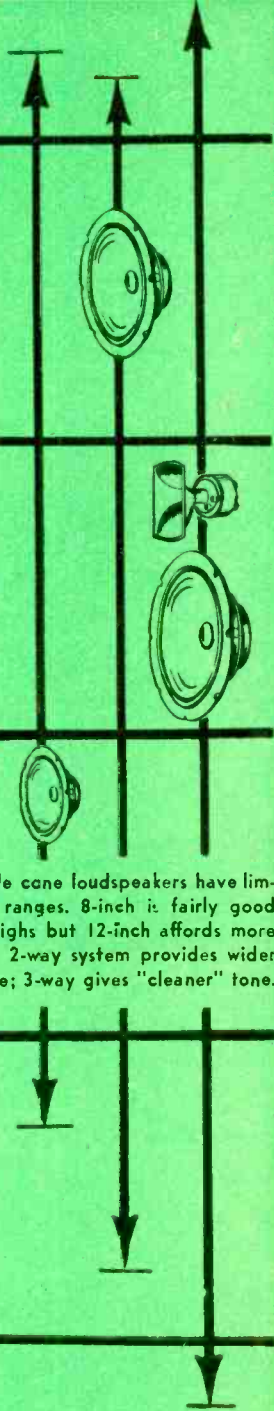

Single cone loudspeakers have limited ranges. 8-inch is fairly good on highs but 12-inch affords more bass. 2-way system provides wider range; 3-way gives "cleaner" tone.

# Kits

Left, the three-tube a.c.-operated "Ocean Hopper." Right, the two-tube "Battery DX-er." The respective schematics are just below the photographs.

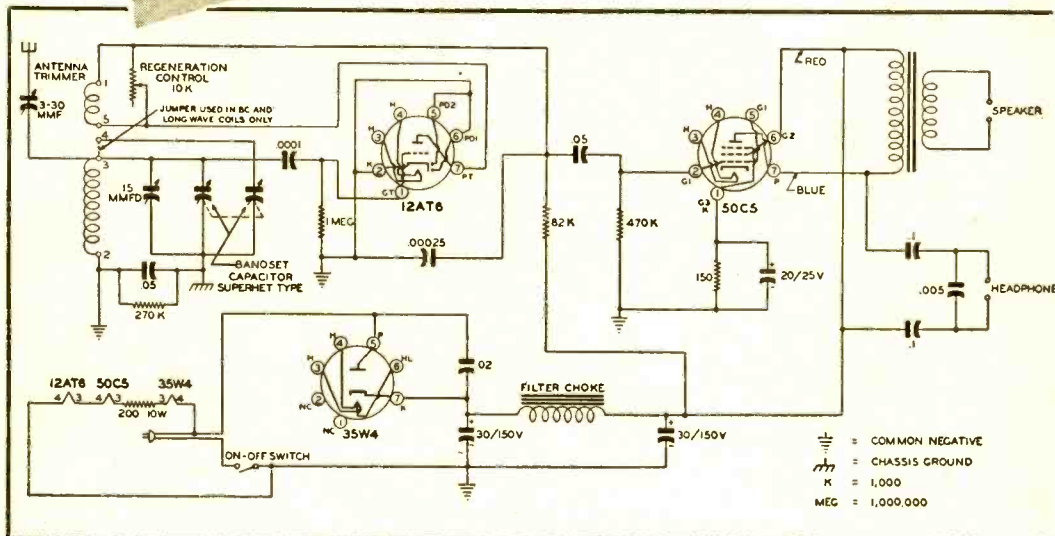
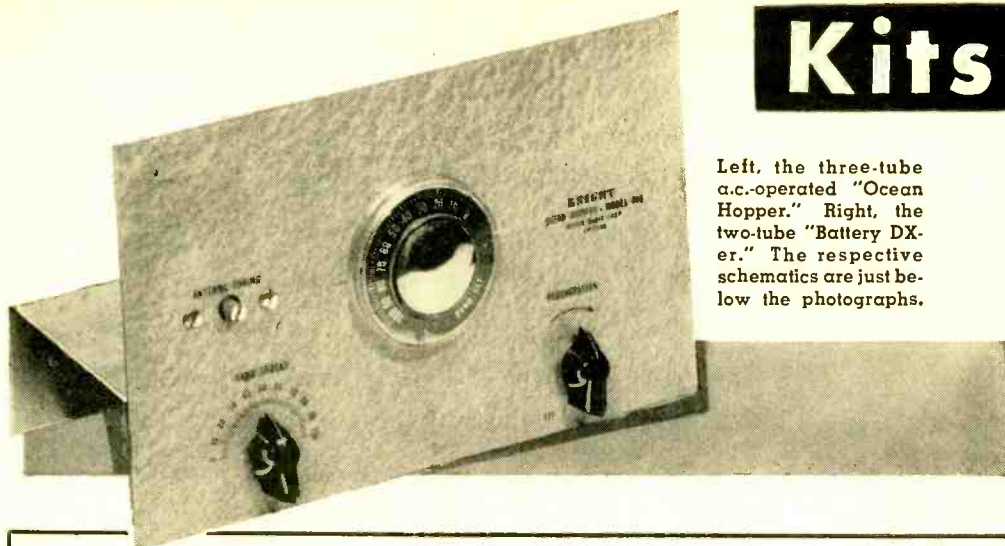

HOW many people have sometimes thought that they might be interested in short-wave listening, yet have hesitated to invest in a regular communications receiver because of doubt that the short-waves offer enough to justify the investment? It is possible to get a low-cost sample and at the same time learn more about electronics. Just build a short-wave kit!

Two simple, inexpensive all-wave receiver kits available for the novice are the *Knight Model 740 "Ocean Hopper"* Kit and the *Knight 2 Tube Battery "DX-er."* Both are marketed by the *Allied Radio Corporation.* The "Ocean Hopper" operates from 117 volts a.c. or d.c., uses three tubes, including a rectifier, and will operate a loudspeaker. The "DX-er" is a battery-operated receiver intended for headphone listening only, using two low-drain tubes.

Both of these receivers use plug-in coils to cover six wave bands. Both receivers cover the regular AM broadcast band as well as short-waves, and the "Ocean Hopper" also covers one long-wave (low-frequency) band. The actual frequency range of the "Ocean Hopper" is from 155 kc. to 35 mc. The "DX-er" covers from 550 kc. to 31.5 mc.

Each receiver has three controls, a bandset or main tuning control, a bandspread or fine tuning control, and a regeneration control. An antenna trimmer also is provided on each set; this adjustment does not have to be changed every time a different station is tuned in, but maximum efficiency will be obtained from the antenna used if the antenna trimmer is reset whenever the operating frequency of the receiver is changed by a large amount.



# of the Month

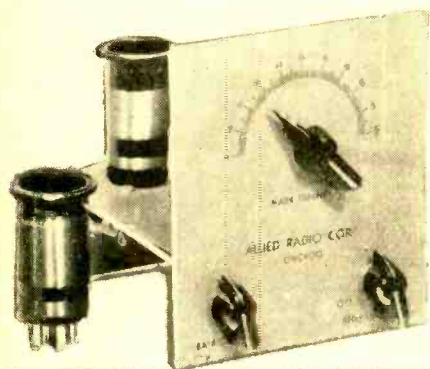

Here are two simple and inexpensive receiver kits which cover most amateur bands and the short-wave and regular broadcast bands.

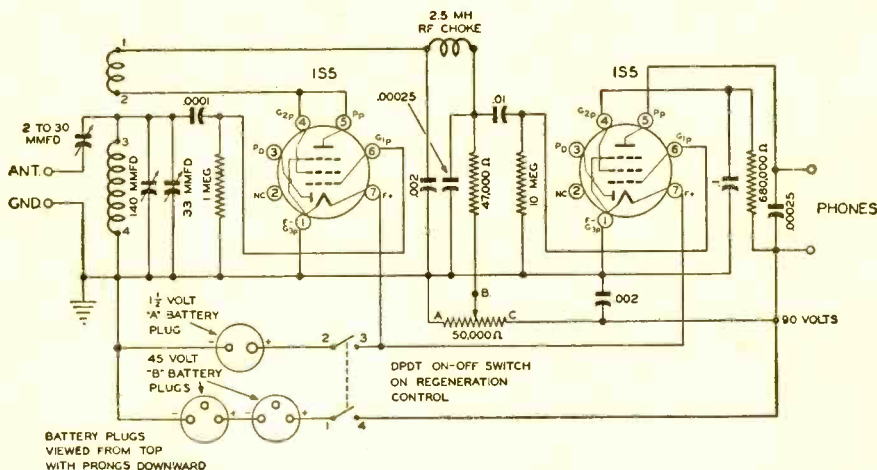

Each kit includes schematic and pictorial wiring diagrams, assembly instructions, and all parts and material required, except hookup wire and solder. The coils used are factory-wound, which not only saves the builder the time and trouble of winding his own coils, but assures him that they will function as intended without any "cutting and trying." The only tools needed are a soldering iron, a pair of longnosed pliers, a diagonal cutter, and one or two screwdrivers. Even a beginner should have little difficulty in putting either receiver together so that it will work properly.

These receivers are not intended to compete with expensive, multi-tube communications sets. They are relatively inexpensive in that each complete receiver costs twenty dollars or less. Naturally, they

lack some of the features of more elaborate receivers; they are less sensitive and less selective. Tuning them is somewhat more difficult since they use regenerative detectors and the regeneration controls affect both tuning and volume.

Dials are not calibrated directly in frequency, but have a single 0-100 scale for all bands. The dial reading for any station will vary somewhat between receivers, because of variations in coils, tubes, and the placement of wiring by the builder.

Those who become seriously interested in short-wave listening will want a receiver with conveniences which these kits lack. However, either of the kits is a good buy for anyone who wants to find out, without investing too much money, just what the short-waves have to offer that might be of interest to him. END

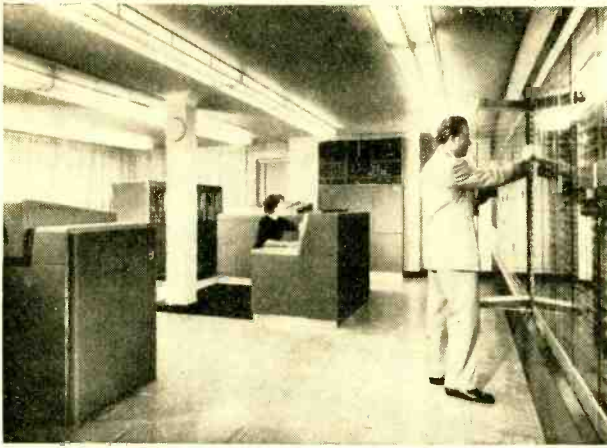

## WORLD'S SMARTEST ELECTRONIC BRAIN

ALL the equipment in this large room is part of "NORC," a gigantic computer built by *International Business Machines Corp.*, N. Y. Standing for "Naval Ordnance Research Calculator," NORC is said to be the "smartest electronic 'brain' ever built," and unmatched by any other computer in existence for speed and productivity. NORC can carry out 15,000 arithmetic calculations a second.

## NEW SMALL CRAFT RADAR BOASTS 16 MILE RANGE

OF INTEREST to owners of small craft is "The Bat," a new small-boat radar system developed by *Lavoie Laboratories*, Morganville, N. J. Said to be an entirely new departure in electronics, the new system has a minimum range of 40 yards and a maximum of 16 miles. Total weight, including the antenna, receiver-transmitter, and indicator, is approximately 130 pounds. It uses standard tubes and is priced at about the cost of a good automobile. Its TV-type radar screen shows up all other craft or obstructions as spots on the screen with great clarity. The system is so designed that its components may be placed anywhere on a boat without affecting its operation. "The Bat" has been tested through 1400 hours of all weather conditions, including four hurricanes. It has withstood winds of over 100 m.p.h.

Originally developed for military use, the new radar is now ready for civilians.

## 'TV EYE' SELECTS CAR SPACES IN PARKING LOT

SPACE-spotting by television to speed car parking service is the latest achievement of the "TV Eye" developed by the *Radio Corporation of America* as a means of extending human sight.

The closed-circuit spotter has gone into service at Oakland, Calif., where it is being used by the *Downtown Merchants Parking Association*. The "TV Eye" camera is mounted atop a light standard overlooking the lot and is connected to a 21-inch TV receiver installed in the entrance booth. A special pan and tilt mechanism enables the camera automatically and continuously to scan the parking area and project what it "sees" to the receiver in the booth. Control switches in the booth also enable the attendant to operate the camera manually. When a motorist drives into the lot, the attendant, without leaving his booth, need only glance at the TV screen to locate a vacant parking space.

## MOST POWERFUL TRANSISTOR HEARING AID

USING four transistors (shown below) in a new electronic circuit, *Sonotone Corporation*, N. Y., has developed what is said to be "the world's most powerful small-size hearing aid." It can be operated for as little as two cents a week with a single battery. Features of the new unit are: provision for 12 combinations of amplified power, depending on the wearer's needs; automatic regulation of the power drained from the battery; switch to cut off outside noises; "bifocal" control to help understand speech in noisy places; recessed microphone grille; and a newly designed magnetic microphone with good low frequency response, important for bone conduction users.

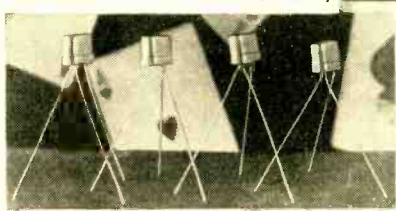



# RADARANGE

Only the food gets hot in the new "Radarange". Cooking utensils and interior of oven remain cool since these materials do not absorb the microwaves that cook the food.

**F**OOD can be cooked in a fraction of the time it usually requires, by the new "Radarange" which utilizes microwave energy to heat nothing but the food itself. Made by the *Raytheon Manufacturing Company* of Waltham, Mass., the new oven can prepare an 18-pound roast of beef in 40 minutes. At a recent demonstration, a chicken was roasted in 9 minutes; an apple pie baked in 6 minutes; and steaks done in 1 minute. The walls of the oven, as well as the utensils holding the food, remained cold and could be touched with bare hands.

Designed for primary cooking, defrosting, and reheating, the "Radarange" heats food by microwave energy generated at 2450 megacycles, produced by QK-390 continuous wave, air-cooled magnetrons. In model 1161, two magnetrons produce a maximum of 1600 watts; in smaller model 1170, one magnetron produces a maximum of 800 watts. In both cases the microwave energy is directly coupled to the oven cavity, where it is confined by the metal

walls and a door designed with appropriate chokes. Thus, instead of the food being cooked by the conventional method of applying heat to its surface and then waiting for the heat to be conducted through the food, the food in the "Radarange" oven is penetrated by the microwaves to a depth of about 2½ inches. As it penetrates, the microwave energy sets up molecular friction deep within the food which in turn creates the heat that cooks it. This process is the key to the tremendous reduction in time needed for cooking the food.

No physical change takes place in the food, except the normal changes caused by the heat. And the only heat present is within the food itself. Since the stainless steel of the oven, and the material of which cooking utensils and plates are made resist microwave penetration, they do not get hot.

The "Radarange" oven's tremendous speed helps reduce food wastage. For example, in estimating a restaurant's daily needs for roasts, only enough meat for the



Model 1170, above, is smaller of two models of "Radarrange" now commercially available.

Speed of "Radarrange" is shown by cooking times required for various dishes.

smallest expected amount of business is cooked by conventional methods. Should extra business develop later in the day, extra roasts may be prepared in the "Radarrange" oven in ample time to meet the orders. In most establishments, this procedure may be used repeatedly, keeping just "one roast ahead" of business.

Except for the magnetrons, all the electrical equipment in the "Radarrange" runs at power frequencies and consists of power supply and control equipment. The only tubes besides the magnetrons are the rectifier tubes in the power supply, which furnishes 320 ma. at 5000 volts to each magnetron.

Magnetrons are essentially constant voltage devices like gas voltage regulator tubes and will draw widely fluctuating amounts of current with very small changes in voltage. Therefore, some means of current control is required. This control is accomplished very simply with a saturable reactor circuit in series with the primary of the high-voltage transformer. Using this reactor, the magnetron circuit, and thus the cooking speed, is held virtually constant for changes in line voltage of plus 10 or minus 5 per-cent from the design voltage. The reactor is also used to provide lower oven heats by reducing the magnetron current. This method is a particularly convenient way to control heats, as all switching can be done in the low current control circuit rather than in the power circuit.

Power is provided for exhausting steam from the oven and cooling magnetrons and other components. Considerable care has been taken to insure long life by running the electrical components cool. The air in commercial kitchens is usually hot, grease laden, and frequently full of lint. The electronic components in the range operate at relatively high power and must be kept cool if long and trouble-free operation is to be achieved. Cooling air, therefore, is drawn in at the front, where the air is most apt to be cool and free of grease when the range is placed in a row of other cooking equipment. The air is then filtered and forced over the electrical components and out through openings in the back of the cabinet.

The microwave ovens are designed to operate on 208 to 230 volts, single phase, 60 cycles. The neutral wire carries no current and can be used for grounding. The conversion from 208 to 230 volts is made by changing a transformer tap within the range. The large model consumes about 1.02 kw. on standby and about 5.3 kw. on high heat. The power demand for the small model is half of that of the large range.

The efficiency of the magnetron itself is about 50 per-cent; that is, about half of the power supplied to the magnetron is fed into the oven as microwave power. Over 90 per-cent of this power is converted to heat in the food. The remaining 10 per-cent is dissipated in random heating.

END



Shown at left, new model 1161 has completed two years of field tests to prove its worth. This unit uses two magnetrons to generate the microwave cooking energy.

Maintenance of new unit has been simplified. Parts are readily accessible. Note air-cooling unit at left.

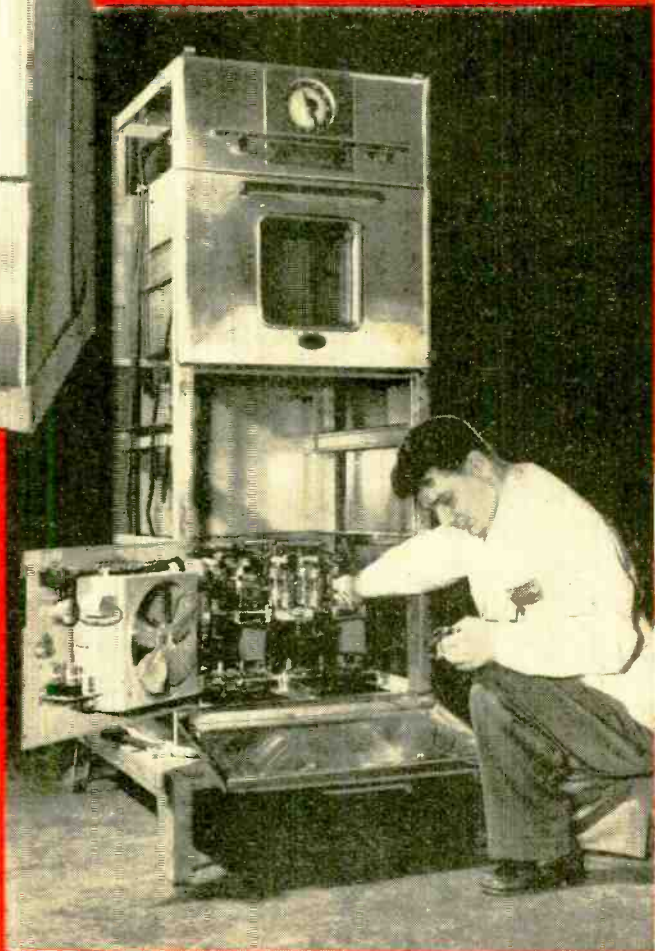

# USING THE DECIBEL

IN ANY listening situation, the smallest increase in the volume of any sound that can be detected by the human ear is one-fourth, or 25 per-cent, over a previous sound. In other words, if any two sounds have a power ratio of at least 1.25 to 1, we will detect that the former is louder.

This ratio holds true for a wide range of power regardless of the absolute power of a particular sound. If we hear two sounds whose powers are respectively 12.5 and 10 watts, we would still hear the same difference in their loudness as we heard between the sounds at 1.25 and 1 watt, since the ratio is still the same (1.25).

This is because we hear approximately in proportion to the logarithm of the intensity, rather than in direct linear response to it. The decibel has been developed as a convenient unit for expressing and measuring intensity logarithmically. Mathematically, "1 decibel" is approximately 10 multiplied by the common logarithm of the ratio, 1.25 to 1.

The factor of 10 enters the picture because the original unit used was the "bel" (named for Alexander Graham Bell), which is the logarithm of 10 to the base 10. The decibel is actually one-tenth of a "bel" and is used in preference to the bel inasmuch as a change of sound intensity of 1 decibel approximates very closely the ratio of 1.25 to 1, which is the minimum change in sound intensity human ears can detect.

The decibel is used widely in audio work because it represents accurately the response of the ear to different intensities and because it can be used over a wide range of intensities. Decibels are used for expressing power ratios, voltage ratios, current ratios, amplifier gain, hum level, loss due to negative feedback, network loss, and loss in attenuator circuits and in transmission lines.

Gain is expressed as plus db; loss as minus db. Ratios between currents and voltages across the same or equal resistors are also expressed in decibels. In the case of voltages or currents, the logarithm of the ratio must be multiplied by 20. This is because the decibel is basically an expression of power (wattage) which is always a function of the square of either current or voltage. To square a number, you double its logarithm. Thus, in the case of values already expressed as powers

(wattage), we multiplied the logarithms of the ratio by 10. But in the case of values not yet expressed as powers, such as voltage or current, we multiply the logarithm of their ratio by 10 doubled, or 20.

We now can state all the above in terms of these simple formulas:

$$\text{Db} = 10 \log \frac{P_2}{P_1} \text{ when } P \text{ is known in watts,}$$

$$\text{Db} = 20 \log \frac{E_1}{E_2} \text{ when } E \text{ is known in volts.}$$

$$\text{Db} = 20 \log \frac{I_1}{I_2} \text{ when } I \text{ is known in amp.}$$

The value of the "common logarithm" (sometimes written as  $\log_{10}$ ) is easily obtained from standard tables that are included in most mathematics and technical textbooks. From then on it's a case of simple arithmetic.

The table on the opposite page is a shortcut aid in determining db gain or loss. It has, in effect, already computed the logarithms of the power (and voltage and current) ratios for you. Notice that the right-hand side (4th and 5th columns) expresses ratios in which there is a gain (1 or higher). The left-hand side (1st and 2nd columns) expresses ratios in which there is a loss (1 or lower). The center column gives you the number of decibels of either gain or loss for a given ratio.

Let us now work a few problems using both the formulas and the table.

*Example:* What will be the gain in db of an amplifier whose output power rises to 5 times its input?

The formula tells us that for power (in wattage),

$$\text{Db} = 10 \log_{10} \frac{P_2}{P_1}$$

In this case,  $P_2$  over  $P_1$  is given; it is known to be 5. (In other words, the input might be 2, the output 10, resulting in a ratio of 5 to 1). The log of 5 is approximately 0.7. Multiplying this by 10, we get 7, which is the solution. In other words, this amplifier has a gain of 7 decibels. In practical terms this means that

(Continued on page 113)



# DECIBEL TABLE

Voltage or Current Ratio (Equal Impedance)	Power Ratio	$\leftarrow$ — db + $\rightarrow$	Voltage or Current Ratio (Equal Impedance)	Power Ratio
1.000	1.000	0	1.000	1.000
0.989	0.977	0.1	1.012	1.023
0.977	0.955	0.2	1.023	1.047
0.966	0.933	0.3	1.035	1.072
0.955	0.912	0.4	1.047	1.096
0.944	0.891	0.5	1.059	1.122
0.933	0.871	0.6	1.072	1.148
0.923	0.851	0.7	1.084	1.175
0.912	0.832	0.8	1.096	1.202
0.902	0.813	0.9	1.109	1.230
0.891	0.794	1.0	1.122	1.259
0.841	0.708	1.5	1.189	1.413
0.794	0.631	2.0	1.259	1.585
0.750	0.562	2.5	1.334	1.778
0.708	0.501	3.0	1.413	1.995
0.668	0.447	3.5	1.496	2.239
0.631	0.398	4.0	1.585	2.512
0.596	0.355	4.5	1.679	2.818
0.562	0.316	5.0	1.778	3.162
0.531	0.282	5.5	1.884	3.548
0.501	0.251	6.0	1.995	3.981
0.473	0.224	6.5	2.113	4.467
0.447	0.200	7.0	2.239	5.012
0.422	0.178	7.5	2.371	5.623
0.398	0.159	8.0	2.512	6.310
0.376	0.141	8.5	2.661	7.079
0.355	0.126	9.0	2.818	7.943
0.335	0.112	9.5	2.985	8.913
0.316	0.100	10	3.162	10.00
0.282	0.0794	11	3.55	12.6
0.251	0.0631	12	3.98	15.9
0.224	0.0501	13	4.47	20.0
0.200	0.0398	14	5.01	25.1
0.178	0.0316	15	5.62	31.6
0.159	0.0251	16	6.31	39.8
0.141	0.0200	17	7.08	50.1
0.126	0.0159	18	7.94	63.1
0.112	0.0126	19	8.91	79.4
0.100	0.0100	20	10.00	100.0
$3.16 \times 10^{-2}$	$10^{-3}$	30	$3.16 \times 10$	$10^3$
$10^{-2}$	$10^{-4}$	40	$10^2$	$10^4$
$3.16 \times 10^{-3}$	$10^{-5}$	50	$3.16 \times 10^2$	$10^5$
$10^{-3}$	$10^{-6}$	60	$10^3$	$10^6$
$3.16 \times 10^{-4}$	$10^{-7}$	70	$3.16 \times 10^3$	$10^7$
$10^{-4}$	$10^{-8}$	80	$10^4$	$10^8$
$3.16 \times 10^{-5}$	$10^{-9}$	90	$3.16 \times 10^4$	$10^9$
$10^{-5}$	$10^{-10}$	100	$10^5$	$10^{10}$
$3.16 \times 10^{-5}$	$10^{-11}$	110	$3.16 \times 10^5$	$10^{11}$
$10^{-6}$	$10^{-12}$	120	$10^6$	$10^{12}$

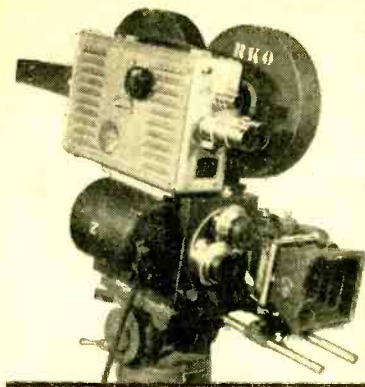

Mounted atop a 35 mm. movie camera, the new "Tel-Eye" provides director with same view recorded by camera.



## TV Provides Double Vision for Movie Makers

A NEW movie film technique by which a miniature *Du Mont* "Tel-Eye" television camera, mounted on a movie camera, gives film directors and their crews instantaneous duplicate TV pictures of what the film camera "sees" has been developed by *Allen B. Du Mont Laboratories, Inc.*, and *RKO-Pathé*. Still in the experimental stage, the method is expected to save money, time, and film footage because directors will not have to wait for film to be developed and "rushes" screened before knowing how much film is usable.

Under present movie making methods, only the cameraman has an instantaneous camera-eye view of the scene being shot once the cameras start to roll. Under the

new method, the director and his staff can have a large screen TV picture of what the camera sees so that they are in complete control of the shooting at all times.

The "Tel-Eye" TV camera to be used is about the size of a shoe box. The photo shows it mounted on a *Mitchell* 35 mm. movie camera.

Other uses for the "Tel-Eye", distinct from movie production, are in cases where a highly portable TV pickup device is desired. It can be used for monitoring remotely the operation of machinery, for guarding banks and plants, for traffic control, in places and where temperature, pressure or other factors create hazards to personnel. END

### "ELECTRONIC HEAT" FOR INDUSTRIAL PLANT

ELECTRONIC heat—the kind obtained from a radio or TV set after it's been on a while—has gone to work at the *General Electric* plant at Syracuse, N. Y.

The 200,000 square-foot building meets about half its heating needs with heat from sixty-four 8 x 8 x 4-foot test sets. The sets, installed by the Army Signal Corps to test huge thyatron tubes, give off enough total heat to warm 130 six-room houses.

Air, blown into the sets to cool their tubes and other units, comes out at about 100 degrees. Then, if needed, it is ducted right into the building's regular air-conditioning system.

The sixty-four test sets give off a total of 10 million BTU (British Thermal Units) of heat per hour. The average TV set gives off 750 BTU per hour.

### RADIO NETWORK HELPS LAUNCH AIRCRAFT CARRIER

A COMMUNICATIONS problem involved in the recent launching of the world's largest warship—the aircraft carrier U.S.S. *Forrestal*—was solved by the Radio division of *Bendix Aviation Corporation*, who set up a miniature radio network to help prevent damaging the ship or the dock.

Previous communications methods such as hand signals, loudspeakers, and field telephones were inadequate because of the tremendous size and dimensions of the ship.

Radio packets were operated at three strategic control points, one on the ship's "island" superstructure, another on deck, and a third on the dock. They were tuned to the same frequency as transmitter-receiver units on a dozen tugs, in a tightly knit communications network to help assure a precise operation.



# FREQUENCY METER-MONITOR

With this handy tool you can check the frequency and hear the quality of your signals.

## FOR HAM STATIONS

By RUFUS P. TURNER



**A**FTER the transmitter and receiver, the next most important piece of equipment for the new amateur station is a combined frequency meter and monitor.

As its name indicates, this instrument serves two purposes. As a frequency meter, it is used to check the transmitter frequency. As a monitor, it is used to listen to one's own c.w. signals to monitor them for cleanness and to watch the keying.

The frequency meter-monitor must be shielded and completely self-contained. This prevents its picking up signals except *directly* from the transmitter. The best way to keep the instrument self-contained is to operate it from internal batteries. Thus, no troublesome power-line cords are needed. By using only low-drain tubes, the batteries will give long life.

The instrument consists of a tuned r.f. oscillator, a detector, and an audio amplifier. The oscillator is calibrated and thus is a type of signal generator. In using the frequency meter, the unknown r.f. signal is fed into the detector through an external

antenna or pickup wire. Headphones are plugged into the output of the audio amplifier. The oscillator also is connected to the detector internally. As the oscillator is tuned over its range, its signal will set up a "beat note" whistle with the unknown signal when the two signals are close to the same frequency. The whistle grows lower in pitch as the oscillator is tuned closer and closer to the frequency of the unknown signal. When the two signals are of exactly the same frequency, the whistle which has grown quite low in pitch disappears completely—the condition known as "zero beat."

Thus, the unknown frequency is determined by adjusting the oscillator of the frequency meter-monitor to zero beat with the incoming signal, and reading the frequency from the dial calibration of the oscillator. An interesting and useful fact is that zero beat is obtained also when the unknown signal is a harmonic of the oscillator frequency (two times, three times, four times, etc. the oscillator frequency). The unknown frequency then is determined by multiplying the oscillator frequency by 2, 3, 4, or whatever number signifies the harmonic involved.

Here is an illustration: The oscillator in the instrument shown here tunes from 1725 to 2000 kc. Unknown signals in this range can be read directly, by the zero beat method, from the oscillator calibration. But suppose you know your transmitter is operating somewhere between 3500 and 4000 kc.

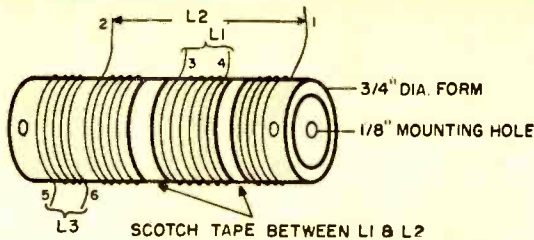
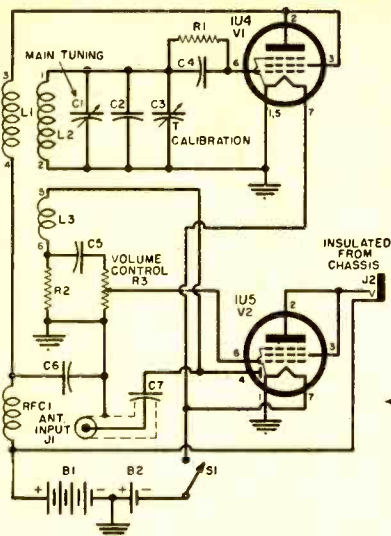

All coils are wound in same direction and connected as shown in the diagrams. Note that  $L_1$  is wound over center section of  $L_2$ .

← The schematic diagram shows that the frequency meter monitor circuit is relatively simple.

The pictorial wiring diagram will help you in wiring the instrument. Note particularly the connections of the coil windings,  $L_1$ ,  $L_2$ ,  $L_3$ . →

- $R_1$ —100,000 ohm,  $\frac{1}{2}$  w. carbon res.
- $R_2$ —50,000 ohm,  $\frac{1}{2}$  w. carbon res.
- $R_3$ —500,000 ohm pot.
- $C_1$ —50  $\mu$ fd. midget, straight-line-frequency variable capacitor (National SE-50)
- $C_2$ —100  $\mu$ fd. midget silvered mica capacitor (Aerovox 1469)
- $C_3$ —140  $\mu$ fd. midget trimmer-type variable capacitor (Hammarlund APC-140)
- $C_4$ —250  $\mu$ fd. midget silvered mica capacitor (Aerovox 1469)
- $C_5$ —0.1  $\mu$ fd. 200-volt tubular capacitor
- $C_6$ —0.002  $\mu$ fd. postage stamp mica capacitor
- $C_7$ —0.002  $\mu$ fd. postage stamp mica capacitor
- $B_1$ —45-volt "B" battery—Burgess W30
- $B_2$ —1½-volt "A" battery—Burgess 2FBP
- $J_1$ —Shielded pin jack (I. C. A. No. 2385), with matching I. C. A. No. 2383 pin plug
- $J_2$ —Midget open-circuit phone jack
- $L_1$ —Plate coil: 26 turns No. 26 enamelled wire

- closewound on top of  $L_2$  from which it is insulated
- $L_2$ —Grid coil: 58 turns No. 26 enamelled wire closewound on  $\frac{3}{4}$ "-diameter form
- $L_3$ —Coupling coil: 25 turns No. 26 enamelled wire closewound on same form as  $L_2$ , and spaced  $\frac{1}{8}$ " from ground end of  $L_2$
- RFC—2½-millihenry r.f. choke (National R100)
- $S_1$ —S.p.s.t. toggle switch
- 1—7-pin miniature ceramic socket with shield, for 1U4 tube (Amphenol 147-501 socket and 5-402 shield)
- 1—7-pin miniature socket without shield, for 1U5 tube
- 1—4-inch dial graduated for 270° or 325° rotation (I. C. A. 2170 or equivalent)
- 1—Metal subchassis: See text
- 1—8" x 6" x 4½" metal radio utility box (Bender No. 146)
- 1—2¾" length  $\frac{3}{4}$ " diameter Polystyrene tubing, (Amphenol)

(80-meter ham band) and you get zero beat at an oscillator dial setting corresponding to 1760 kc. Then your true frequency is 1760 multiplied by 2, or 3520 kc. We multiply by 2 because the 3500-to-4000-kc. range is twice the oscillator tuning range.

This instrument can be used in the same way to check frequencies all the way to 30,000 kc. (top of the 10-meter ham band). When using the device as a c.w. monitor, the transmitter signal is tuned in on one side of zero beat so as to give a tone pleasing to the ear. With the signal thus tuned in, you can listen to your own keying.

### Circuit Details

The schematic diagram shows the circuit. The oscillator tube ( $V_1$ ) is the 1U4. A pickup coil ( $L_3$ ) transmits the oscillator signal to the detector which is the diode section of the 1U5 tube ( $V_2$ ). The audio amplifier is the pentode section of the 1U5. Headphones are driven by the 1U5. Potentiometer  $R_3$  serves as a volume control.

Both the 1U4 and the pentode section of the 1U5 are operated as triodes by connecting their plates and screens together.

The antenna signal is picked up by means of a short rod or wire inserted into jack  $J_1$  and is delivered to the 1U5 diode along with the signal from the oscillator.

One 45-volt "B" battery ( $B_1$ ) and one 1½-volt dry cell "A" battery ( $B_2$ ) furnish operating power.

### Construction

The instrument is built in an aluminum box 8" high, 6" wide, and 4½" deep (Bender No. 146). The carrying handle is a drawer pull from the ten-cent store. You will also need a shelf-type subchassis 5⅞" long and 4¼" wide with ⅝" folds on the short ends. You can make this from a piece of 1/16"-thick aluminum by forming it in a vise, or you can have your local sheet metal shop do the job. Tube sockets are mounted in ⅝"-

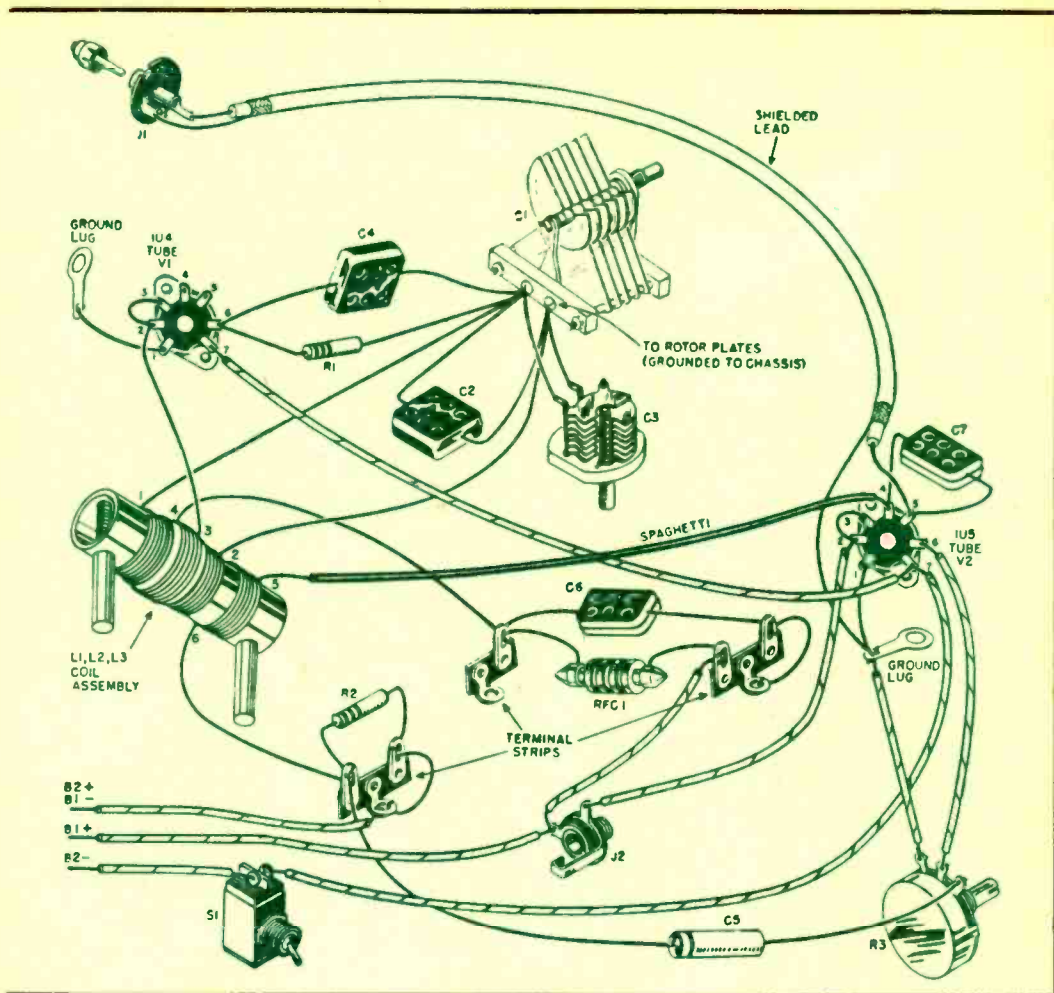

diameter holes drilled in this chassis. The 1U4 socket is a shielded, ceramic type. The tuning capacitors and coil also are mounted on the chassis.

Wind the coil as shown in the drawing. First, close-wind 58 turns of No. 26 enameled wire ( $L_1$ ) on a  $\frac{3}{4}$ "-diameter,  $2\frac{3}{4}$ " length of Polystyrene tubing. Then,  $\frac{1}{8}$  inch from  $L_2$ , wind  $L_3$  which consists of 25 turns of No. 26 enameled wire closewound. Finally, wind a single layer of Scotch tape over  $L_2$  for insulation, and on top of this wind  $L_1$ , 26 turns of No. 26 enameled wire closewound. Mount the coil on the chassis solidly on long screws and metal or ceramic pillars.

The main tuning capacitor,  $C_1$ , must have heavy, widely-spaced plates. This component is bolted solidly to the chassis. Mount the trimmer capacitor,  $C_3$ , directly behind  $C_1$  upside down, with its adjustment (tuning) screw extending through and below the chassis. It is adjusted from underneath.

From jack  $J_1$  run a length of shielded lead to capacitor  $C_7$  at the  $V_2$  socket. Various leads pass from the top of the chassis to the compartment below through a small hole lined with a rubber grommet.

The chassis is held in place by means of four 6-32 screws and nuts,  $3\frac{1}{2}$  inches below the top of the case.

It is essential that all parts be firmly mounted, and that the case be tightly closed. This gives stable operation.

### Calibration

After the instrument has been assembled, it must be calibrated. For this purpose, you must borrow a good unmodulated r.f. test oscillator or signal generator. (1) With the instrument temporarily outside of its case, switch on, and allow a 15-minute warmup period. (2) Turn the plates of  $C_1$  all the way in. (3) Connect the test oscillator output to jack  $J_1$  and the frequency meter case (ground). (4) Set the test oscillator to 1725

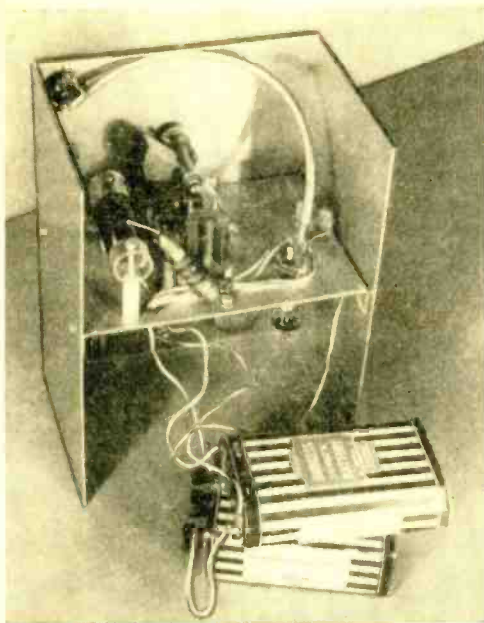

Inside of the frequency meter monitor case, from above, showing placement of major parts. Note how the coil is mounted on standoffs.

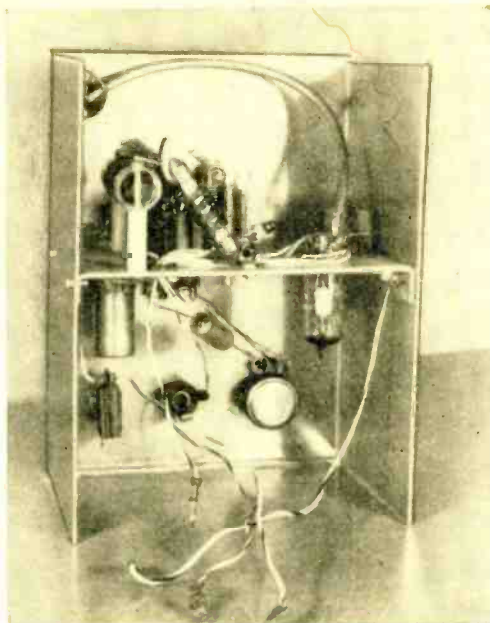

Rear view of the instrument without its batteries, showing the parts below the shelf. Note that the tubes are mounted upside down.

kc. (5) Plug the headphones into jack  $J_2$ . (6) Using an insulated screwdriver, adjust trimmer  $C_3$  for zero beat with the test oscillator signal. (7) Increase volume control setting, if necessary. (8) Record main dial reading. (9) Fasten cover of instrument. (10) Retune test oscillator to 1750 kc. (11) Tune instrument to zero beat with main dial and record dial reading. (12) Repeat at as many points as possible until 2000 kc. is reached. (13) The dial readings now may be recorded with the corresponding frequencies on a chart, or the frequencies

may be marked or scratched on the dial.

### Operation

Use of the frequency meter-monitor is simple. Connect a 1- or 2-foot length of wire or a stiff metal rod to jack  $J_1$ . Switch on the instrument, connect the headphones, and tune in the transmitter signal to zero beat. Read the frequency from the dial or the calibration chart and multiply by the proper factor if the transmitter is known to be operating on a harmonic of the frequency of the meter. **END**

## A SIMPLE CARBON MICROPHONE SPEECH AMPLIFIER

**T**HE conventional circuit for a carbon microphone voltage amplifier requires a high ratio step-up transformer to obtain a reasonable driving voltage from the inherently low impedance microphone, and a current source for excitation. A simple substitute is shown here which obviates these two requirements. This new circuit uses a grounded grid amplifier in which the microphone acts as the cathode bias resistor of a conventional triode. Voltage outputs of the order of 35 volts peak (suitable for 20 db speech clipping into two selenium rectifiers back to back) are obtained from a 6C4 triode, conventional 200-ohm microphone, 15 K load resistor, and a 300-volt plate supply. Maximum output occurs when the plate load resistor is somewhat greater numerically than the

value of the plate resistance of the tube.  
LT. JOHN J. DOUGHERTY, USN

Schematic of the simple speech amplifier that eliminates the need for transformer.

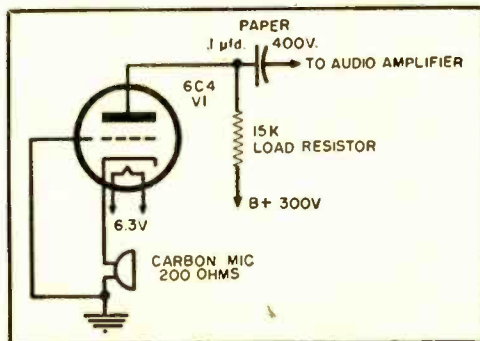

# SINGLE LAYER COIL DESIGN CHART

**T**HIS chart can be used to find inductance of a coil when dimensions and number of turns are known, or to find specifications to give a desired inductance. Draw a line between either T and L or d and 1/d, whichever are both known. Draw a second line between remaining known quantity and point of intersection of first line and unmarked vertical line. Extend second line to scale for unknown quantity and read answer.

**EXAMPLE A:** We have a coil 5" in diameter, 19 turns, 37 turns per inch, and wish to find the inductance.  $l = 19/37 = .52$ ";  $1/d = .52/5 = .104$ .

Draw a line between  $d=5$  and  $1/d=.104$ . Draw a second line from  $T=37$  through the intersection point to the L scale. Read the answer, 100 microhenrys.

**EXAMPLE B:** We require the number of turns of a coil 5" in diameter, wound 37 turns per inch, to give 100 microhenrys. Draw a line between  $T=37$  and  $L=100$ . Draw a second line from  $d=5$ , through the intersection point, to the 1/d scale, and read  $1/d=.104$ . Then  $l = 5 \times .104 = .52$  inches. The number of turns is  $.52 \times 37 = 19$ , approximately. **END**

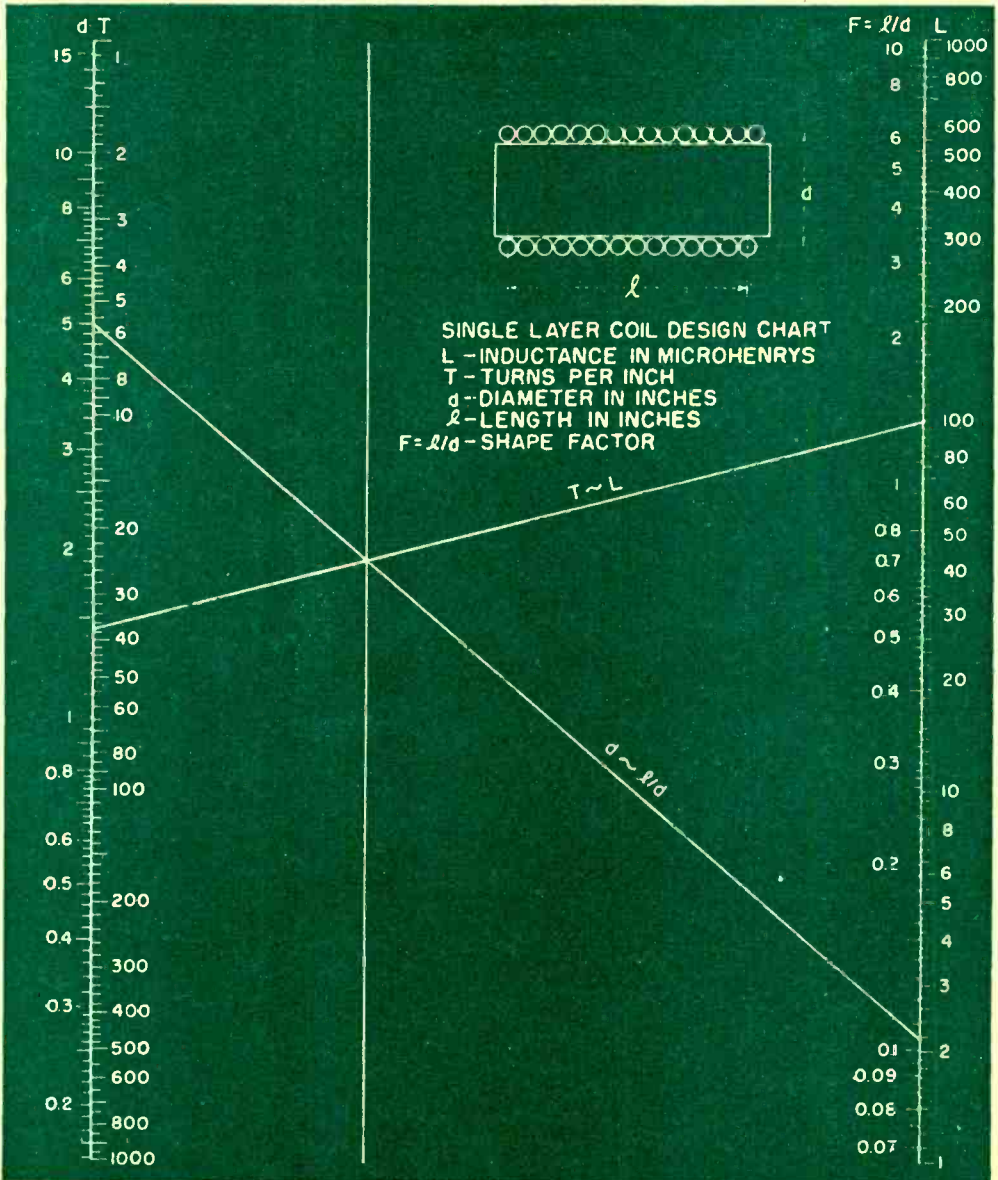

# This Train



In the caboose of this train, a Motorola walkie-talkie is used in lieu of a regular, high-powered mobile communication set.

In this diesel switching locomotive, the train's radio equipment is shown mounted near the center of the engine's windshield.



*More and more railroads are adopting radio as a means of speeding service and providing better and safer operation.*

"**W**E'VE cleared the slow track, Joe. Let's 'high ball,'" cried the crisp voice coming from the loudspeaker horn in the cab of the giant diesel-electric locomotive. It was the voice of the conductor in his caboose a mile away at the tail-end of the long freight. The train had just passed over a section of track where the speed was restricted during maintenance operations.

Before radio, the engineer had to guess when his train had cleared the slow track. Now, with radio, he could resume speed as soon as the conductor gave the word.

Although the train crews objected when they first heard that radio was to be installed on the trains, they quickly found that radio didn't abolish their jobs, but instead, made life on a freight train infinitely better. Most of the railroaders who have used train radio wouldn't want to do without it. Of course, once in a while as in any industry, a sorehead may refuse to admit that he's sold. However, let him walk a mile in a heavy rain from the caboose to the engine because he has no radio or because the radio equipment failed. It's a cinch he will prefer radio to walking.

When hot boxes develop, the train crews have found radio a wonderful time saver.

They can maneuver the train more readily and the defective car can be dropped off at a siding in a fraction of the time it used to take before radio.

Sometimes the flagman takes a walkie-talkie with him when he walks back along the track to protect his train from possible on-coming trains. When the engineer is ready to go, he blows a whistle signal for the flagman to get back on the train. He can also tell him by radio to come on back. When the flagman is fairly close to the train, he can radio the engineer to high-ball. If the flagman doesn't want to carry the eight-pound walkie-talkie with him, he might get left behind. It has happened often.

Most of the radio communication on the train is between the caboose and engine. However, crews of passing trains often call attention to dragging equipment, hot boxes, and other hazards. The amount that radio has saved the railroads by preventing accidents and property damage is difficult to calculate in dollars. Nevertheless, it is staggering.

When the crew wants more information than they have in their written train orders, they can use two-way radio to call the nearest wayside operator. If he isn't on

# Is Radio Equipped

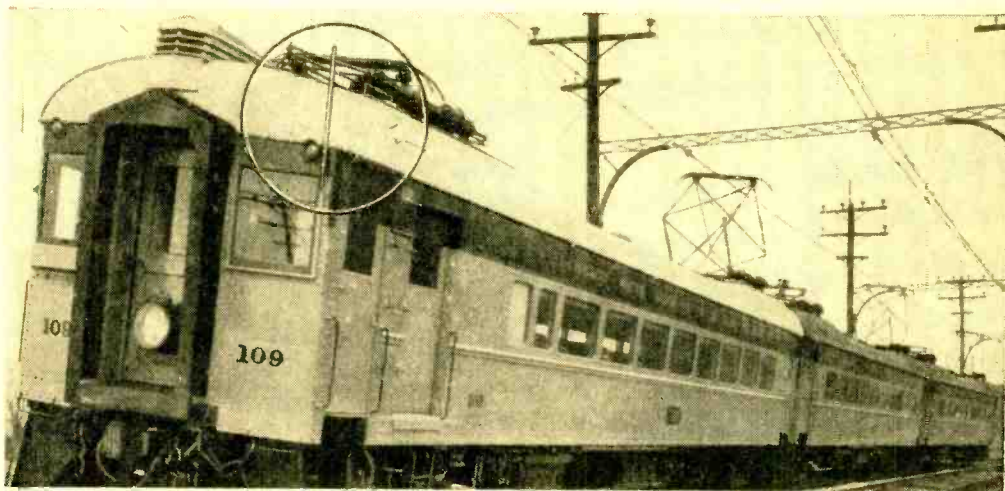

This air-conditioned commuter train is equipped with two-way radio. Note antenna.

duty, they get through automatically to the dispatcher by means of a telephone line which interconnects wayside stations and the dispatcher's office.

The v.h.f. radio transmitter-receiver unit is generally located in the nose of the diesel locomotive. Up in the cab, the control box and a telephone handset are found in a spot convenient for use by either the fireman or the engineer. A horn-type loud-speaker which is located above their heads puts out enough sound to be heard above the roar of the engines.

Railroad radio systems operate in the 152 to 162 megacycle band. Both transmitters and receivers are crystal-controlled and fixed tuned to a specifically assigned frequency. Sometimes dual-and triple-channel equipment is used so that crews may switch the radio unit to different frequencies for train and end-to-end, train-to-wayside station, and train-to-yard office communication.

One railroad has four-unit locomotives, with a cab at each end. One cab is used at a time, but both are radio-equipped, so radio facilities will be available with either end of the locomotive facing forward. When the railroad first installed radio, they equipped only one cab and installed auxiliary remote control equipment in the other cab. This didn't work out. When the locomotive units were separated for maintenance, the interconnecting cable connectors were often damaged. Sometimes the

four-unit locomotive was divided into separate two-unit locomotives, and then only one had radio.

Putting radio in the caboose presented more problems than in the case of the locomotive. The caboose originally had no electric lights or power source. Since the radio equipment requires electrical power for operation, power had to be provided.

The locomotive had already been equipped with radio so, as a stop-gap measure, the railroad furnished a walkie-talkie for the caboose. To increase range, a v.h.f. antenna of the same type as used on the locomotive was installed atop the cupola of the caboose. Since the caboose was made of wood, a sheet of metal was tacked on the roof under the antenna to serve as a ground plane. This was unnecessary on the locomotive because it had a metal roof.

Although the fractional watt output walkie-talkie was adequate for communicating with the engine crew, it had several shortcomings in this application. It did not have a loudspeaker, which made monitoring of calls from the engine, other trains, and waystations impractical. Used for extended periods, the self-contained batteries ran down. When the flagman took the walkie-talkie with him to inspect the train, the caboose was without communication. Sometimes it was necessary to relay messages to waystations via the locomotive.

When standard 15-watt railroad radio equipment was installed in the caboose,



From the cupola the caboose crew can see ahead and, since radio has been installed, can talk to both the engine crew and the wayside operators.



The operating position in a diesel. Note how the handset for the two-way radio is mounted so that engineer can reach it from his chair.

the walkie-talkie became a very useful tool for the flagman and the brakeman and served as a standby radio.

To provide power for radio and for electric lights, a 12-volt truck battery was installed under the caboose. An alternator installed under the caboose is driven through a step-up V-belt drive assembly by the caboose axle. The three-phase a.c. output of the alternator is converted to d.c. by a heavy-duty selenium rectifier which is fed to the battery. A plug-in type voltage regulator prevents overcharging and excessively high voltage.

The FM radio equipment in the caboose is identical to the locomotive radio unit except that it is operable from 12 volts d.c. instead of 117 volts a.c. and it operates in the 152-162 megacycle band. The control box and handset were installed overhead where they could be reached from the cupola or the main floor of the caboose. The loudspeaker is a re-entrant type horn of high efficiency so it will provide enough sound to override the high noise level when the train is running down grade at high speed.

Wayside stations about 30 miles apart have also been equipped with two-way radio. The waystation operator can be reached by train crews within radio range. When it is necessary to talk to the dispatcher, the local operator connects his radio station to the dispatcher's telephone line. Then the train crew can communicate with the dispatcher even if they are 100 miles apart.

During hours when some wayside stations are unattended, the dispatcher can still contact the crews of radio-equipped trains. The dispatcher's office is equipped with an electrical selector system which permits him to ring any one of the many telephones connected across his train dispatching telephone line. He can also select any one or all of the wayside radio stations

and talk and listen through the one he selects. It is just as simple as all that.

Formal train orders are not yet being transmitted by radio direct to trains. However, radio is being used for conveying much valuable supplemental information. It is possible that the taboo on direct transmission of train orders to trains will be lifted when suitable facsimile or telegraph printing equipment becomes available. Then both the conductor and engineer will be able to receive identical orders in written or printed form.

Railroaders like to recall an incident which occurred several years ago when train radio was new. A railroad vice-president was asleep on the sofa in the parlor of his private car which was hooked on the end of a long freight train. As the train started and the slack in the couplers was taken up, the private car made a sudden and severe lurch forward, hurling the veep to the floor.

The conductor quickly picked up the handset of the veep's train radio and called the engineer to advise that the big boss had been thrown from his sofa. Through the loudspeaker came the engineer's jolly voice, "Tell him to lie where he is, I'll roll him back in." END

The control-head mounting in train's caboose.

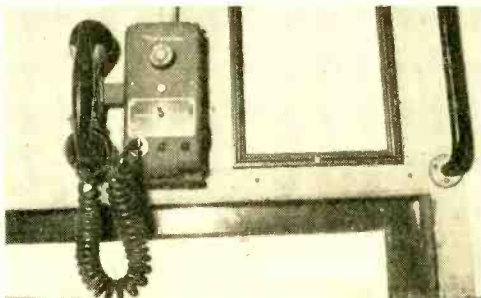



# R/C

## RELIABILITY

By **WILLIAM WINTER**  
Editor, "Model Airplane News"

*Radio control of your model airplane gives you greater realism and maneuverability in your flights but—you're inviting loss of control if you don't have reliability.*

**R**ADIO control is simple. Connect the wires, turn on the switch and, presto, you're in business. Start the motor, launch the model, turn it left, right, glide in for a landing. Wow, this is a cinch! (Famous last words!)

Heresy? Not at all. Everybody who has flown radio-controlled models knows that the tenth flight is harder to achieve than the first, that one deserves a medal for making 50 hops without a slip, and 100? Well, sir, the century mark accomplished without a crack-up or a chase of an errant plane is a test of man and equipment. Mainly, it is a test of man.

Can he remember to check battery voltages? Clean a relay? Keep the transmitter tuned? Watch for vibration-fatigued wires? Anyone, even the duffer, can make a few flights, but we are talking about reliability. Good flight after good flight, not just a "new car" type of reliability!

It goes without saying that there can be no reliability without a good, properly

tuned transmitter and a sufficiently sensitive receiver which also is properly tuned and adjusted. If it is impossible to get very close to the maximum receiver current drop or rise (as the case may be) upon signal, when the receiver is tuned to the transmitter at an absolute minimum of 600 feet on the ground, it is a gamble every time the plane is put into the air. Any lapse, even a single skip of the rudder which cannot be clearly accounted for, should ground the plane that day. Yet at every flying session at least one person takes such a risk.

### Relays

Relay dependability is primarily a matter of the amount of current change available, shock mounting, and proper adjustment. If large current change is available, permitting a pull-in and drop-out adjustment at a high current reading on the meter, the result is good contact pressure and positive armature action. The higher

the power of the engine and the flying speed of the airplane, the more critical these adjustments become because of the increased effects of vibration.

For example, one of the author's models has a wing span of 5½ feet, a gross weight exceeding 6½ pounds, and a .29 cubic inch displacement engine. The single hard-tube *Miller* receiver idles at 2.8 mils, drops to one mil with signal at a distance; the relay (*Kurman* 5,000 ohm) is adjusted to pull in at 2.2 mils (leaving a margin of .6 mil if the idling current decreases) and drops out at 1.7 mils (leaving a margin of .7 mil to allow for weaker signals at extreme range in the air). The spread between pull-in and drop-out is .5 mil. In this particular airplane, a smaller gap or difference between pull-in and drop-out is dangerous. At a .2 mil difference, vibration causes the relay to actuate the escapement without a signal being given. Of course, this is an extreme example. A difference of .2 mil is considered the reliable minimum for average installations.

A current change of 1.5 mils is desirable for reliability (allowing for variations in plane and power), although receivers can be operated with a current change of approximately one mil with good results. Small current change, low operational currents, and low spring tension will make contact opening and closing unreliable. Thus, the relay may skip in the presence of vibration, as when spiraling the model down, where a miss could mean a cartwheel contact with the earth. Arcing (the sparking at the relay contacts when the flow of current to the actuator is broken) must be suppressed. Otherwise, over a period of time, the contacts may become pitted and dirty, producing sticking of the armature (spin to earth), or lack of electrical contact (ship flies off). A .02  $\mu$ fd. disc ceramic capacitor and a ½ ohm, 10 watt resistor in series across the relay contacts (from armature contact to live contact) will suppress this arcing.

Probably the lowest relay operational values in general use are found with the single gas-tube receivers and the 465 mc. hard-tube jobs. In the gas-tube *Aerotrol*, for instance, the tube normally would idle at 1.3-1.5 mils, dropping at a distance with signal to perhaps .3 mil. The relay should not be set with too great a difference between pull-in and drop-out, otherwise the available margin above and below this range would not be adequate for safety. Also, relay armature action would be fluttering and unreliable.

Indeed, most gas-tube receivers operate a relay with a .2 mil change between drop-out and pull-in, for example: 1.1 mils pull-

in if the idle current is 1.3 mils, with a .9 mil drop-out. Two tenths mil idle above pull-in is regarded as minimum. The greater margin between drop-out and signal-on current is to allow for diminishing signal as the airplane flies out. If drop-out was, say, .6 mil and, at 1,500 feet distance, the signal-on current drop reached only .61 mil, no contact could be made and the plane would be on its own, unless it circled closer to the transmitter. At the other end, any drop in idle current (such as might result from weakening batteries) might wash out the margin of idling current above the relay pull-in. In the case where the idle current is 1.3 mils and the pull-in value is 1.1 mils, a fall in idling current to less than 1.1 mils, would not permit the relay to pull in once dropped out, and the ship inevitably would pile in.

It is interesting to note that one of the practical results of lower currents and contact pressures is the effect on the receiver and/or relay suspension. Such receivers have to be mounted relatively loosely in the airplane to avoid vibration effects, whereas receivers having higher operating values and current changes can be more firmly tied down. With either the single gas-tube receiver or the 465 mc. job, a 5½-foot plane, such as the *Live Wire Sr.*, should not be powered by more than a .19 engine for trouble-free operation by the average modeler. In a small plane like an .09 powered *Live Wire Trainer*, vibration would not be a problem.

Some hard-tube receivers idle at 3, 4, or even 4½ mils. It is to be realized, however, that higher idling currents are rough on batteries, so much so, that hearing aid "B" batteries cannot be used reliably with such receivers—unless it is convenient to swap batteries after every flying session.

One drawback of the one-tube receivers commonly used is that the single tube must perform both detection and amplification. This problem can be avoided by the use of a multi-tube receiver. In the *Babcock* single-channel tone receiver, the third or final tube (the relay tube) comes through with a fantastic wallop of some 6 mils current change.

In the *Lorenz* type of two-tube receiver, the first tube may be idled at anywhere from .4 to .7 mil (depending on the particular receiver), dropping to a fraction of a tenth of a mil at a distance. This drop is accompanied by a current rise of as much as three mils in the second or relay tube, depending on the batteries, relay resistance, and values of limiting resistors and potentiometer. Since the second tube is idling at virtually nothing before signal, the current change through the relay is

A Citizen-Ship radio control receiver operating on the 465 mc. Citizen's band. Note the special shock mounting for the tube and the use of a Sigma 4F relay.

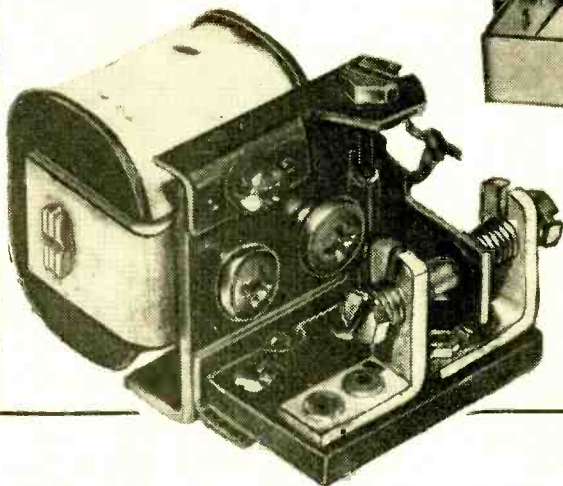
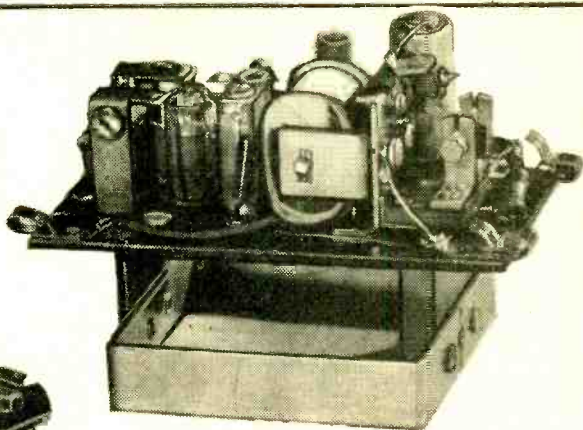

Sigma 4F relay for radio-control receivers. This is and has been one of the most popular of relays for radio control model work. A new relay, the Sigma 26F has been especially designed for R/C fans.

practically three mils. The relay can be adjusted for say, a one mil change between pull-in and drop-out. The slamming action of the armature is audible outside the airplane and the contact pressure is excellent, holding on through the roughest vibration. In small airplanes, many builders fasten the relays down without shock-mounting, although, for reliability, the author favors shock-mounting everything. Not only relays, but tubes also can have their wits addled by a rough engine.

A relay that closes the actuator circuit upon pull-in is more reliable than one that functions on drop-out because the contact pressure is higher. On pull-in the magnet maintains armature pressure against the contact, but on drop-out only spring tension maintains contact.

This is not a relay article, and the adjustment of various types of relays is not our business here, but a few tips may help. Do not allow the armature of the relay to come into contact with the core piece or magnet; otherwise, residual magnetism may build up in the armature and cause it to stick on making contact. Put a piece of cigarette Cellophane over the core piece, pressed flatly in place with the ends neatly cemented down. Since a very slight air gap normally is left between the armature (in the pulled-in position) and core piece, this

Cellophane automatically insures that gap and prevents physical contact between armature and core piece. Now, and this is important, be sure, in the case of receivers which operate on pull-in, that the armature strikes the live or upper contact before it touches the Cellophane or core piece. If it does not, no contact will result, or the contact may be so weak that vibration will cause the armature to flutter, making and breaking contact and wiggling the rudder.

In the *Sigma 4F* type of relay, always check the relay carefully after any crack-up, inasmuch as the coil mounting bracket may bend or shift, or the armature may be bent, permitting a corner to touch the core piece unobserved. Also, the frame may be so sprung that the delicately pivoted armature will have a binding action. On the old model *Kurman* relay, solder a stiff wire re-enforcement along the contact arms to prevent their shaking in resonance to vibration.

Always be sure that the contact screws in any relay do not turn easily, for vibration will alter the relay adjustment. Clean relay contacts before every flying session. Slide a dollar bill between the armature and live contact, place slight pressure on the armature, and lightly polish the contacts. Some people recommend a soft brush

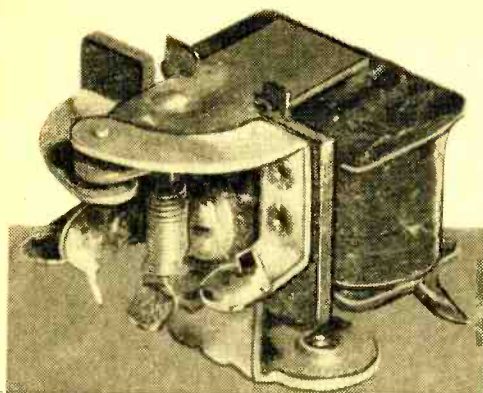

The Kurman relay shown here has been used in thousands of R/C jobs. The new Kurman relay has adjustable screw contact points.

and carbon tetrachloride. The writer's experience has been that this method may leave a film which prevents contact. Check the adjustment of the relay before every flying session, after every five flights in one day, or after a rough landing is made. A potentiometer in the plane, or mounted on the meter, allows quick variations in current to check the pull-in and drop-out current values. Unexplained variations in relay operational values (on some relays) may be explained by the stiffness of the wire that connects to the moving armature, or to the shifting of the coil tension spring where it loops over a hook on the armature or relay frame. Carefully solder the end of such a spring to prevent such movement. Do not clean contacts with any abrasive material because pitting will result.

Rated a close second to the relay as a trouble source is the escapement. Probably the biggest trouble with escapements is the tendency to consider them completely and indefinitely reliable, and then bury them in some inaccessible place in the plane. Actually, the tension of a spring may change with long and repeated use, or gaps and overlaps may be altered from the slamming action of the claw upon the pawl, many thousands of times repeated. Burrs may develop on the mating surface of the claw and the pawl, shaft holes may become elongated, dirt may get between the armature and magnet, or glow fuel exhaust may build up an oily deposit in the same place. The escapement should be regarded as a kind of relay for it too has a proper pull-in and drop-out adjustment.

A thorough once-a-month check of the escapement is in order if the flier operates every weekend. To permit such a check, the escapement must be mounted in a readily accessible location, as on the front of the bulkhead that forms the rear of the

cabin. A large door in the floor, immediately beneath the escapement, will allow access of fingers and tools from beneath. By far the best arrangement is to install the escapement on a section of 1/8-inch plywood, that slides down into place between runners of 1/4-inch balsa. By disconnecting the linkage, the escapement can be lifted, on its mount, out into the free space of the cabin, where it can be worked upon easily, and examined with a magnifying glass. Once a burr is seen through the glass, inspection pays off!

Opinion is divided as to whether it is better to tape batteries together into packs or to install them individually in battery boxes. While there is little to choose between the pack and a good, new box, it becomes increasingly important with use to be sure that the box maintains firm contact pressure. Sometimes, a finger placed on the batteries in a box while the engine is running will give a stinging sensation, showing the fantastic amount of shaking that takes place in an insecurely boxed battery. On sensitive tone receivers, or even the typical hard-tube jobs, the noise due to poor contacts can result in poor control. If boxes must be used, use only those that are made expressly for radio control work.

Continuing this discussion of reliability, the author will show next month how to check and adjust an escapement and evaluate batteries and their installation for reliability. END

For ease of inspection and maintenance of the escapement, mount it on a slide that can be taken out of the plane, as shown here. A drop of cement will hold the slide in its grooves in the plane during flights.

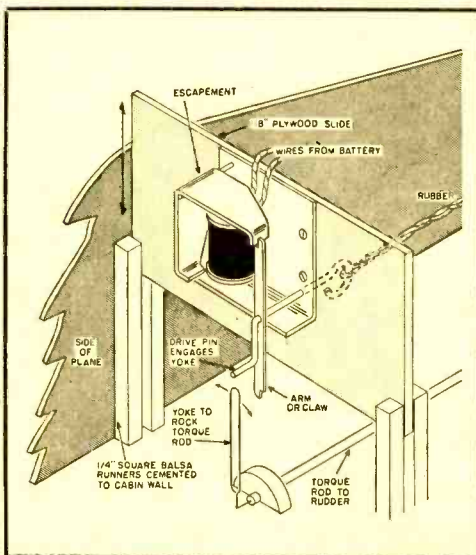

# SPLICING 300-OHM TV RIBBON

By W. BOYD

**Q**UITE often there is a need to extend the available length of the television lead-in wire. Sometimes it's when the good wife decides to move the furniture across the room, only to find that the TV antenna wire was cut exactly for the set when it was near the window. Another instance occurs when the antenna is moved for some reason. When splicing is necessary, don't just twist the two wires together—they'll break every time, probably right in the middle of the family's favorite program.

There is a simple, effective method of splicing plastic TV lead-in ribbon so that it will be mechanically strong, electrically almost perfect, and also weatherproof.

Square off the ends to be spliced with a pair of "dikes," or electrician's wire cutters. Carefully run a sharp knife just inside each wire, cutting into the plastic ribbon and leaving a tongue of plastic about one inch long. Nick the plastic around both wires, but don't mark the wire itself. Slip the plastic covering from the wires, exposing a length equal to the tongue. Prepare each end for splicing in the same way.

Bring the ends together, overlapping the plastic tongues until the bared wires butt up against each other. Neatly twist the wires together on each side, and touch the twist with a hot iron and just enough solder to flow a perfect joint. Remember, too much heat will melt the plastic and ruin the splice; too little heat will result in a cold-solder joint that will cause the TV picture to flicker annoyingly.

Nip off all but about three-eighths of an inch of the twisted wire, and lay the neat pigtail alongside the tongue, on either side. Now, using *Scotch* black plastic tape, begin just below one tongue and wrap a tight spiral neatly across the splice to a point just beyond the tongue on the reverse side of the ribbon, and the splice is finished.

This connection will hold in any weather and be almost perfect electrically. It will also withstand any mechanical strain that the ribbon itself can stand.

END

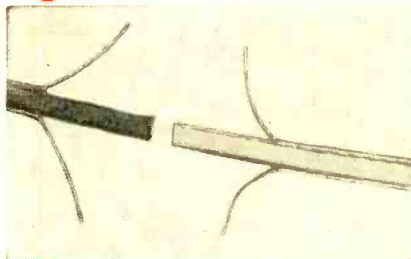

Bare ends of wire for about an inch and leave a tongue of plastic to be used for overlapping. This strengthens the splice and protects wires.

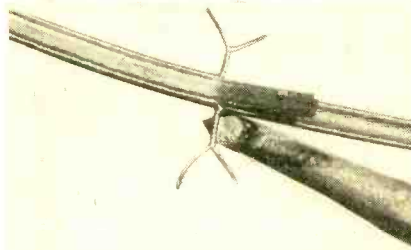

Bring the two ends together, overlapping the tongues as far as the length of bared wires allows. Then twist the wires tightly and solder them.

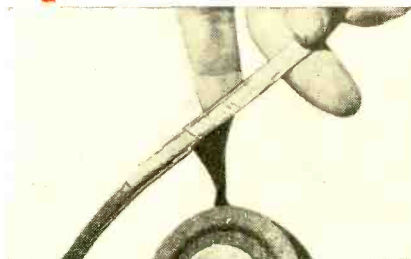

Use black *Scotch* plastic tape to wrap a snug spiral over both tongues for the splice's full length. Ordinary type friction tape is not to be used.

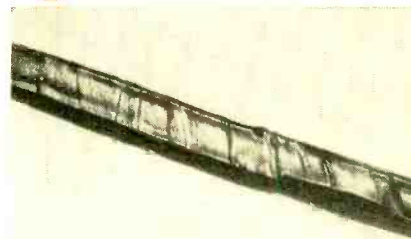

This completed splice has strength and good electrical characteristics. If spliced properly, a few shorter pieces make a useful length of wire.

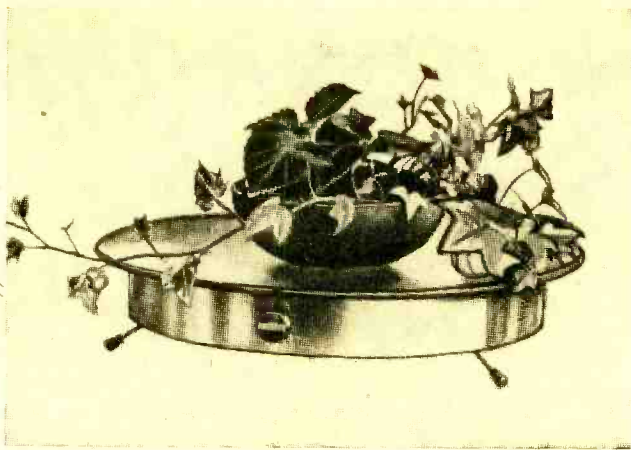
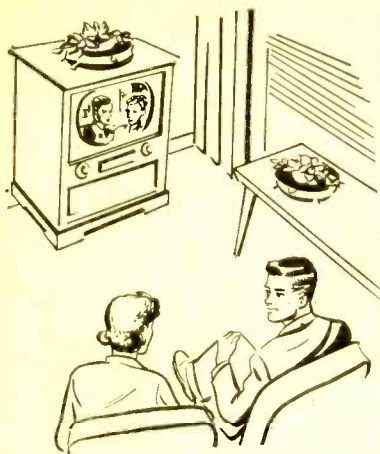

## A NOVEL TV AND FM ANTENNA

**E**FFICIENT performance is combined with unique design in the new "Plantenna," illustrated above. Housed in the circular base is an indoor antenna for use on FM as well as v.h.f. television. It is suitable for use in primary areas or wherever "rabbit-ear" antennas have proved satisfactory, but it is not recommended for fringe area reception. A simple finger-tip adjustment of the "213" tuner incorporated in the antenna enables the user to adjust to channels for best reception. The antenna, a folded dipole type, is essentially non-direc-

tional, and is polarized horizontally to reduce interference. Its location with respect to the set is not critical, and installation is quite simple.

The planter unit may be removed for plant care, or to facilitate other uses for the tray, such as to hold confections, floral arrangements, etc. The unit has an attractive brushed-brass finish, and measures 13 inches in diameter, and 4 inches in height. It weighs 2 pounds. Further information is available from the manufacturer, *Plantenna Corp.*, Silverton, Oregon. **END**

## Electronics Measures Ocean Waves



as erosion, harbor protection, effects on ships, etc. Dr. Sheldon S. Chang (upper photo), co-inventor with Dr. Willard J. Peterson, Jr., points out that the new device does, in 5 to 10 minutes, the computations that previously took two weeks.

The photo below shows N.Y.U. researcher Peter W. Johnson playing back a tape. The analyzer unit at the right demodulates the record of wave impulses for study.

**A**N ELECTRONIC instrument that accurately measures the energy and frequency of ocean waves has been developed by the Research Division of New York University's College of Engineering under contract with the U. S. Beach Erosion Service.

Consisting of a tape recorder, playback unit, and wave analyzer, the new device records ocean waves by means of a flux gauge set under the sea's surface. Results are then used in studying such problems



# MOISTURE METER IS NOVEL USE OF V.T.V.M.

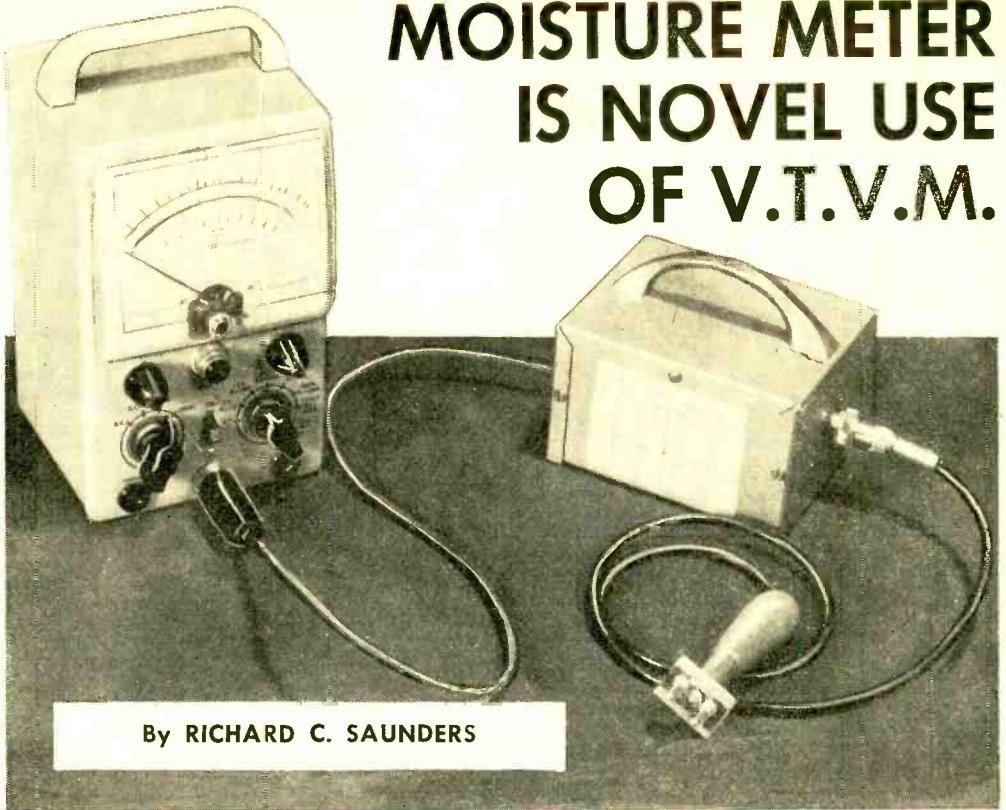

By RICHARD C. SAUNDERS

A cable is used for both probe and meter connections to minimize number of leads.

**A** SIMPLE electronic instrument, which is merely a variation of the well-known megohmmeter, is the moisture meter, which is intended primarily for measuring the moisture content of wood.

The unit described was constructed because the paint on the outside of the author's home was peeling and blistering and such a condition may be caused by an excess of moisture in the wood at the time paint is applied. Consequently, some simple means of measuring the moisture content of wood was desired.

Although portability is definitely an asset in such an instrument, a vacuum-tube volt-

meter and 117 volt extension cord were used by the author in the interest of economy. This was a small sacrifice, especially since the instrument was intended for occasional use only.

As can be seen in the schematic diagram, the instrument consists of a high voltage d.c. power supply connected in series with a high resistance and a voltmeter. In this particular application, the high resistance is wood, the resistance of which varies with moisture content.

Using such an arrangement, the resistance may be computed by the formula  $R_x = R_m [(E_1 - E_2) / E_2]$ , where:  $R_x$  is the un-

Schematic diagram of "accessory" unit to convert v.t.v.m. to a "moisture meter".

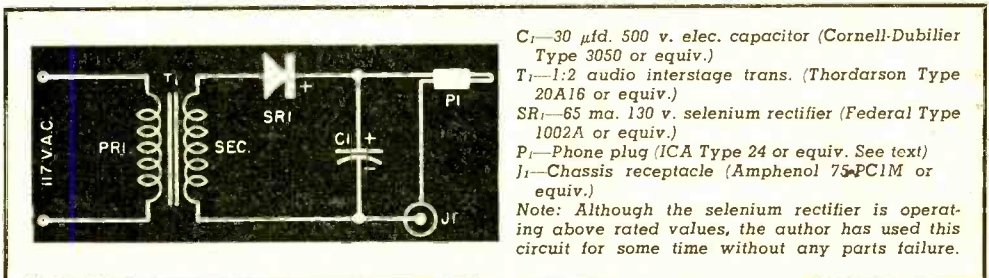

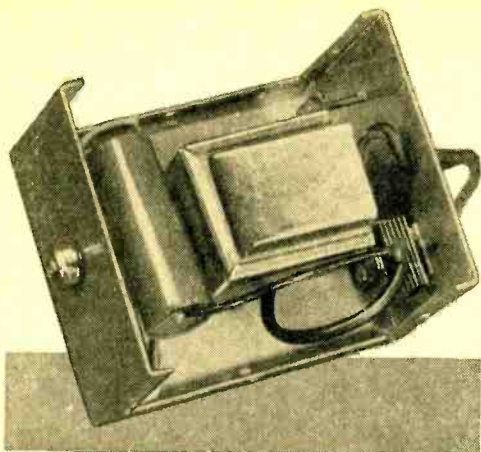

Parts arrangement used by the author. Any small power transformer can be used in construction.

known resistance  $R_m$  is the internal resistance of the indicating meter,  $E_1$  is the applied high voltage, and  $E_2$  is the voltage indicated by the meter.

Table 1 shows the correlation between the indicated voltage (on a *Heathkit* v.t.v.m.), moisture content and resistance. In the event that a different voltmeter or power supply is to be used, the proper voltage-moisture relationship may be computed by making the necessary substitutions in the formula.

When the various moisture percentages and their associated voltages are known, a table may be compiled showing this relationship, and attached to the 3" x 4" x 5" aluminum utility box which houses the unit.

Although the builder has a wide latitude

VOLTAGE	MOISTURE (Per-cent)	RESISTANCE (Megohms)
.3	7	6656.7
.5	8	3990.0
1.5	9	1323.3
2.0	10	990.0
10.0	12	190.0
55.0	16	26.4
130.0	20	5.4
200.0	25	0

Table 1. Correlation between voltages indicated on v.t.v.m., moisture content, resistance.

in the selection and arrangement of parts, care should be taken to duplicate the probe as exactly as possible, otherwise individual calibration will be necessary, a rather exacting process if one does not have a commercial moisture meter on hand to use as a standard.

The probe tips are re-worked phone tips which are filed to a sharp point 5/32" long. The tip bodies are tapped with a 6-32 thread, and mounted 19/32" apart on a 1/2" x 3/4" x 1 1/4" Lucite block. A small file handle completes the assembly. To use the instrument, simply insert the points of the probe in the wood, read the voltage, and make the necessary conversion to moisture percentage from the table.

Experience has shown that a dry exterior surface will have a moisture content of approximately 7 per-cent. A 12 per-cent moisture content seems to be the maximum safe limit for the application of paint, although paint has been applied to some surfaces showing 14% moisture, with no apparent ill effects. However, surfaces that give readings of 16 per-cent or more will almost invariably either peel or blister. END

## CANADIAN WINS "HAM" W/VE CONTACT CONTEST

FOR the first time in the history of the event, a Canadian amateur radio operator has won the W/VE contest. This is an international goodwill competition among radio "hams" in the United States and Canada designed to promote increased radio communication between amateurs. It has been conducted annually for many years and has been most successful in its aims.

Russ Wilson, owner and operator of amateur station VE6VK, Calgary, was the 1954 winner with a grand total of 37,725 points. These are awarded for each contact between an American station and a Canadian one.

A new cup, known as the "Emerson W/VE Trophy," was presented by *Emerson Radio of Canada* to the Montreal Amateur Radio Club, sponsors of the event. A miniature trophy will be presented to Russ.

The previous cup was won permanently by Carl Evans, WIBFT of Concord, N. H.,

who was a winner for three consecutive years—retiring the cup. END

Alex Reid, Canadian general manager of the ARRL (left) and Carl Lockhart of Emerson Radio of Canada (right) watch as Rupert K. Grant, sales manager of the firm, presents trophy to Harold Ward, president of Montreal Amateur Club.





# A Modern Wireless Record Player

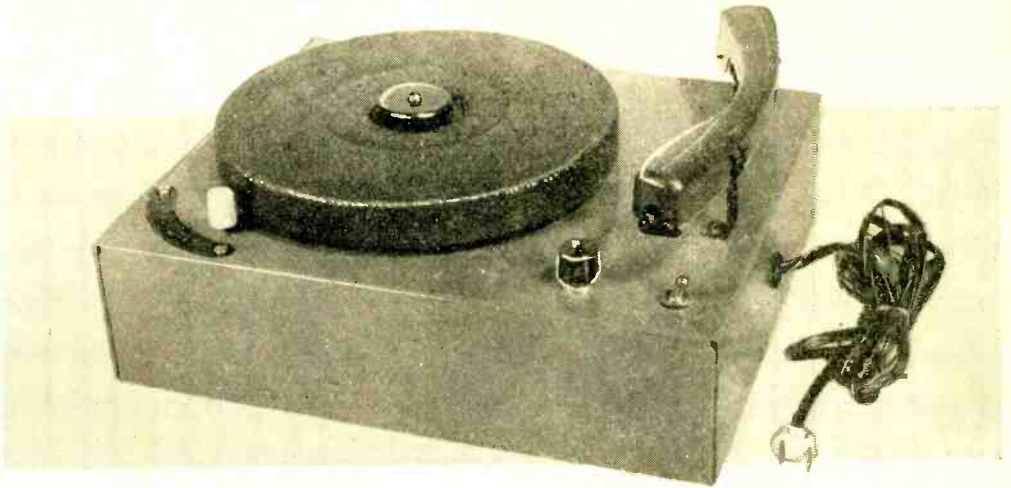

*You can build this broadcasting phonograph and use all of the AM radios in your house to pick up the sound.*

**E**VERY AM receiver in your home becomes an extension speaker if you have a "wireless" record player like the unit shown. And direct connections to the individual receivers are not necessary. The record player acts as a miniature broadcast station and will play records through any receiver in the home, whether in the attic den, in the kitchen, or in the basement playroom.

Strictly modern, the record player will handle either standard 78 rpm,  $33\frac{1}{3}$  rpm long playing records, or the small 45 rpm discs. It features a straight a.c. circuit, so you won't have to worry about electric shocks such as you may have received in the past from a.c.-d.c. equipment. The quality of record reproduction is as good as the best quality sound you can obtain from your AM receivers.

The cost of the unit, although not very high, may be reduced considerably if you are able to obtain a reasonable number of components from your "junk-box" or from your lab stock. You may be able to salvage a motor and turntable from a discarded phonograph.

A wooden record player base is preferred for housing the unit, but many radio supply houses no longer stock such items. Of course, you can assemble your own base if

you have access to a woodworking shop and are handy with carpentry tools.

However, a standard 10" x 12" x 3" aluminum chassis base is satisfactory and was used for the model. Dimensions for mounting holes are not given as these will vary with the particular motor assembly and pickup arm you use. Locate the mounting hole for the pickup arm by using the template furnished by the manufacturer.

After completing machine work on the base, you'll probably want to enamel it. Don't mount parts until you've completed this job and the enamel has had a chance to dry thoroughly.

The turntable is removed for mounting the motor assembly. Other parts mounted on the record player base are the pickup arm and its holder, the "on-off" power switch,  $S_1$ , the motor switch,  $S_2$ , and the "Gain" control,  $R_1$ . All other electrical parts are mounted on a small subchassis.

The subchassis measures  $2\frac{7}{8}$ " x 4" x 1" over-all and is made by cutting down a standard chassis measuring  $3\frac{1}{8}$ " x 4" x 1". This is necessary if the chassis is to fit into the 3" deep base.

Mount the power transformer,  $T_1$ , the dual electrolytic capacitor,  $C_6$ - $C_7$ , and the two 7-pin miniature tube sockets on the subchassis. Use small machine screws and

- R<sub>1</sub>—1 megohm carbon pot, audio taper
- R<sub>2</sub>—270 ohm, 1 w. carbon res.
- R<sub>3</sub>—100,000 ohm, 1/2 w. carbon res.
- R<sub>4</sub>—22,000 ohm, 1/2 w. carbon res.
- R<sub>5</sub>—10 megohm, 1/2 w. carbon res.
- R<sub>6</sub>—1500 ohm, 2 w. carbon res.
- R<sub>7</sub>—27 ohm, 1/2 w. carbon res.
- C<sub>1</sub>—10  $\mu$ fd., 25 v. elec. capacitor
- C<sub>2</sub>—.005  $\mu$ fd., 200 v. tubular paper capacitor
- C<sub>3</sub>—50  $\mu$ fd. tubular ceramic capacitor
- C<sub>4</sub>—100  $\mu$ fd. tubular ceramic capacitor
- C<sub>5</sub>—340  $\mu$ fd. mica padder capacitor (Arco Type 303)
- C<sub>6</sub>, C<sub>7</sub>—40/20  $\mu$ fd., 150 v. dual elec. capacitor
- L<sub>1</sub>—Local oscillator coil for broadcast band (Meisner Type 14-1033)
- RFC<sub>1</sub>—2.5 mhy. r.f. choke
- S<sub>1</sub>—S.p.s.t. toggle switch ("Power")
- S<sub>2</sub>—S.p.s.t. rotary switch ("Motor")
- SR<sub>1</sub>—20 ma. selenium rectifier (Radio Receptor Type 8Y1)
- T<sub>1</sub>—Power transformer, 125 v. @ 15 ma., 6.3 v. @ 0.6 amp. (Stancor Type PS 8415)
- V<sub>1</sub>—6AB4 tube
- V<sub>2</sub>—6BE6 tube
- Phonograph turntable and motor (General Industries Type DSS, SS or TR, or Alliance Model JPTS)
- Phonograph pickup cartridge (Astatic Type P-29 or Shure 92-U)
- Record player base or 10" x 12" x 3" chassis and bottom plate (Bud Type AC-413 chassis and Type BP-675 bottom plate)
- Small aluminum chassis (ICA #29082, 4" x 3 1/8" x

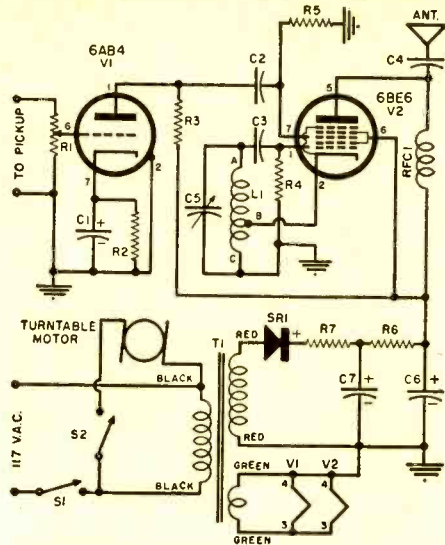

1"); two 7-pin miniature tube sockets; 4-terminal tie-point strip; 2-terminal tie-point strip; two ground lugs; knob for rotary switch; rubber grommets; wire; solder; machine screws and nuts; sheet metal screws; line cord and plug; etc.

Although the phonograph uses standard parts in a simple circuit, it has plenty of power.

hex nuts. Note, too, the small "L" bracket mounted alongside the power transformer.

Wire as much of the sub-chassis assembly as you can before mounting it in the base. Follow the schematic and pictorial wiring diagrams. Layout and lead dress are not too critical, but you'll find it worthwhile to follow the layout shown.

After you've wired the sub-chassis and checked for errors, mount it on the base, making the final electrical connections to R<sub>1</sub> and to the power switch and line cord.

The sub-chassis is held in place by the mounting stud of C<sub>5</sub>, by two small sheet metal screws, and by a small "L" bracket mounted alongside the power transformer, T<sub>1</sub>, which fastens to the base.

The antenna consists of a short piece of flexible insulated wire. Use a piece about 5 or 6 feet long to start. Later, you can cut the antenna wire to a shorter length. The antenna wire can be wrapped around the power cord.

A bottom plate may be added to com-

This view of the subchassis shows mounting of the tube sockets, electrolytic capacitor, and oscillator coil and capacitor.

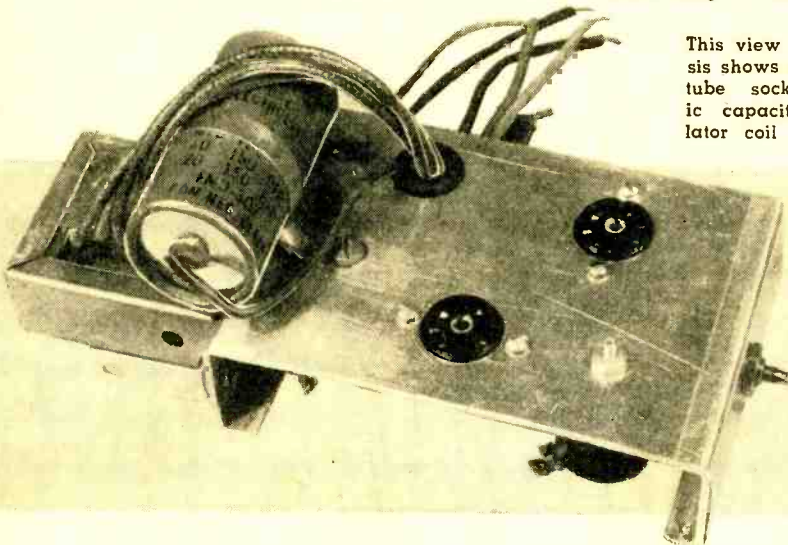

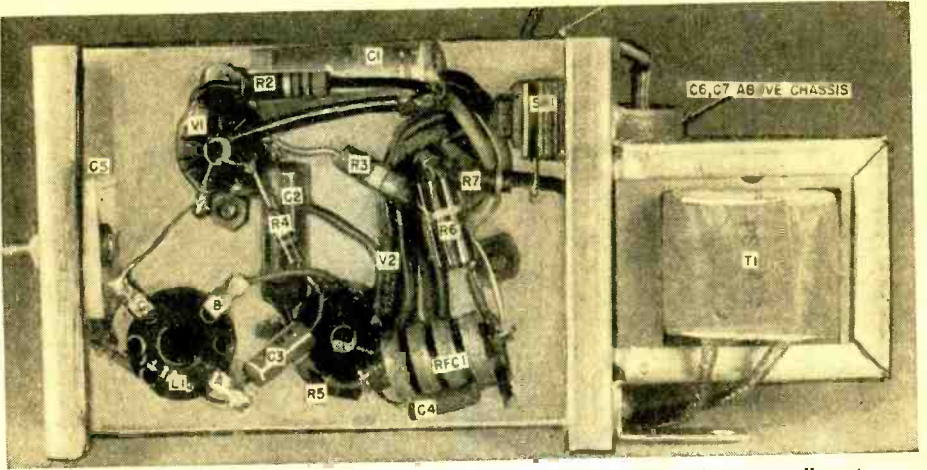

This bottom view of the chassis shows the positioning and wiring of most small parts.

Pictorial wiring diagram shows connections of parts, but not actual relative positions.

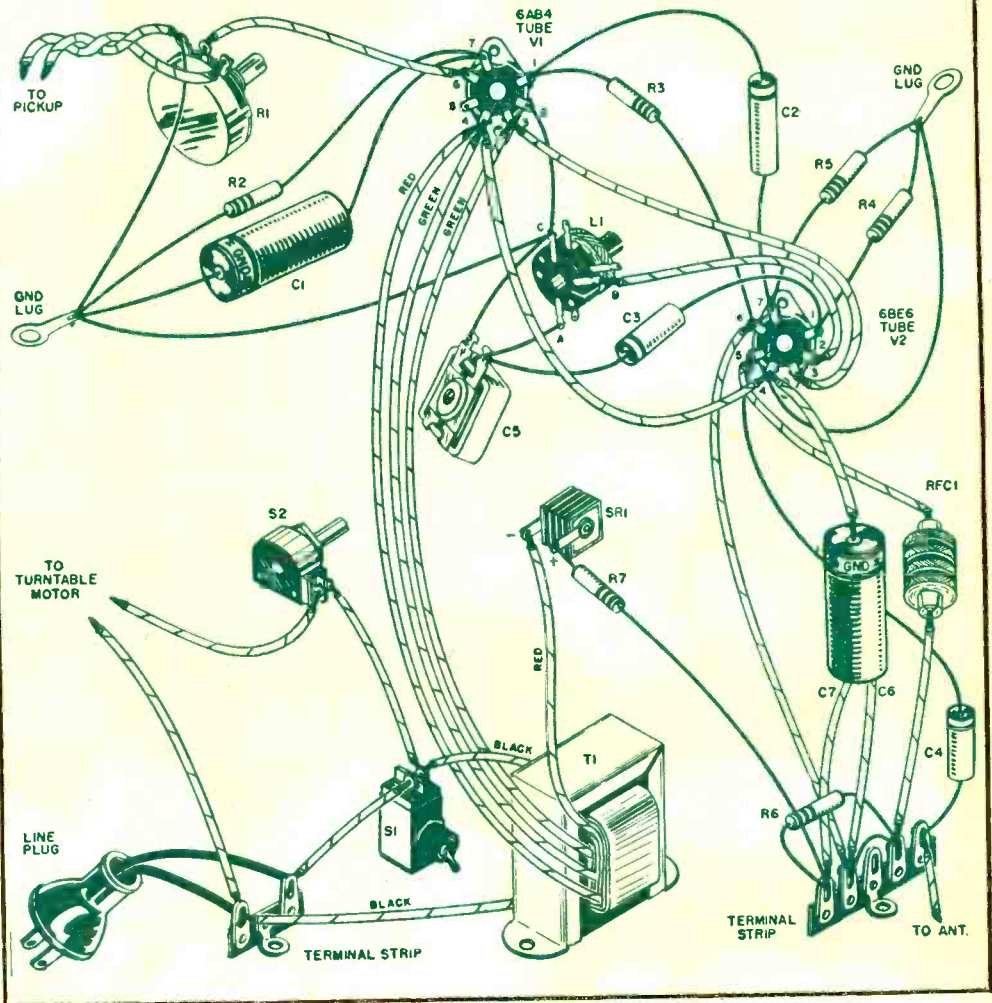

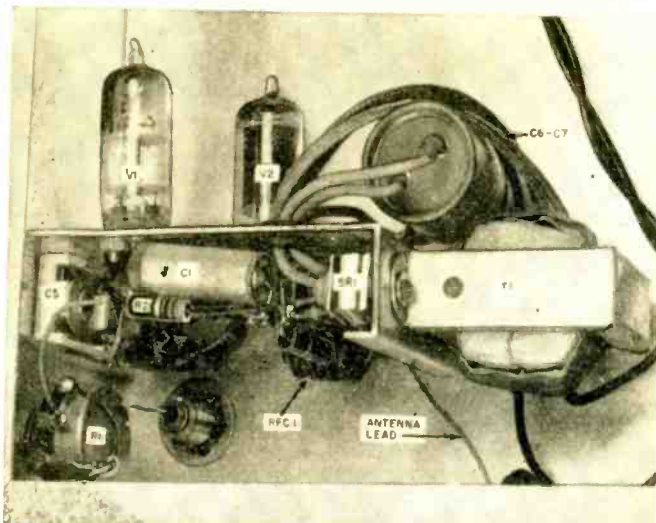

Detail view of the subchassis. Note that a single mounting screw is used for the selenium rectifier and one end of the transformer, and that all of the leads of the electrolytic capacitor and of the transformer secondaries pass through the grommet.



Over-all view of the bottom of the finished phonograph. At lower left are the leads from the phono cartridge, coming through the mounting hole for the arm. The toggle type main power switch and the rotary type motor switch are at lower right.

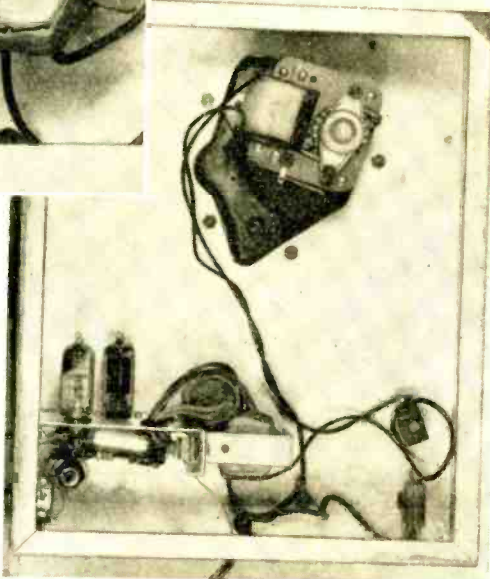

plete the assembly of the record player. However, it is best to check out the operation of the player and to adjust the "Gain,"  $R_1$ , and "Tuning,"  $C_5$ , controls before adding the bottom plate.

First, plug the record player into a wall receptacle and turn the power switch on. Allow one or two minutes' warm-up.

While waiting for the record player to warm up, place an AM radio from 6 to 15 feet away and turn it on. Tune the radio to a "dead" spot near the middle of the broadcast band and turn the volume control full up.

Turn the "Gain" control on the record player full up. With a record on the turntable, turn the motor on and place the pickup stylus on the record. Next, adjust the "Tuning" control,  $C_5$ , with a screwdriver until the record can be heard over the nearby radio receiver. Adjust the volume control of the receiver to a comfortable level. The sound probably will be badly distorted at this point.

Next, readjust the "Gain" control of the record player until the sound is clear and undistorted, even during loud passages.

Finally, cut the antenna down as much as possible without appreciably weakening the sound heard over the nearby receiver. Use as short an antenna as you can. In some cases, a slight readjustment of the tuning control may be necessary when you shorten the antenna lead.

**Caution:** The circuit used in the record player will deliver a fairly strong signal. The Federal Communications Commission has strict regulations covering the operation of unlicensed broadcast equipment. Therefore, don't try to extend the range of the record player by using a long antenna!

Once the "Gain" and tuning controls of the record player have been properly adjusted, they may be left fixed in position. In the future, when you want to use the record player, simply tune one (or more) of your AM receivers to the proper point on the dial to pick up the record player signal. The easiest way to do this is to start playing a record and to tune the radio until the record can be heard—just as you would tune in a regular broadcast station.

END

# Neon Blinker-and-Buzzer Code Practice Set

By ARTHUR TRAUFFER

**E**ACH time you press the key on this simple code practice outfit, the neon lamp lights up and you hear an a.c. hum in the 'phones. It is about as close as one can get to something for nothing. It requires no batteries. It plugs into your house lighting circuit, but draws little or no current. Chances are, you already have a *Robolite* neon night light or a *Ne-O-Lite* or *Amerline* electrical circuit tester, which you can borrow when you want to practice the code. There is no danger of shock, because the 'phones and key are isolated from the house wiring by means of two blocking capacitors, and all the parts and wires that are "hot" are well insulated.

The photo shows clearly how the parts are mounted and wired on a 6" x 4" x 3/4" hardwood base. The dime store wall-mounting receptacle fastens to the wood base by means of the long wood screw that comes with it. The POSJ zip-cord is fastened to

the wood base with one or two insulated staples. Note that the wire leads on the "hot" side of the two .01  $\mu$ fd., 600 v., fixed capacitors are covered with spaghetti tubing, if desired, as an extra safety measure. The two Fahnestock clips in the lower left hand corner are fastened to the wood by one wood screw. This does away with the need for a wire lead connecting the two clips. It makes no difference to which pair of clips the 'phones and key are connected, as they are connected in series in either case. **END**

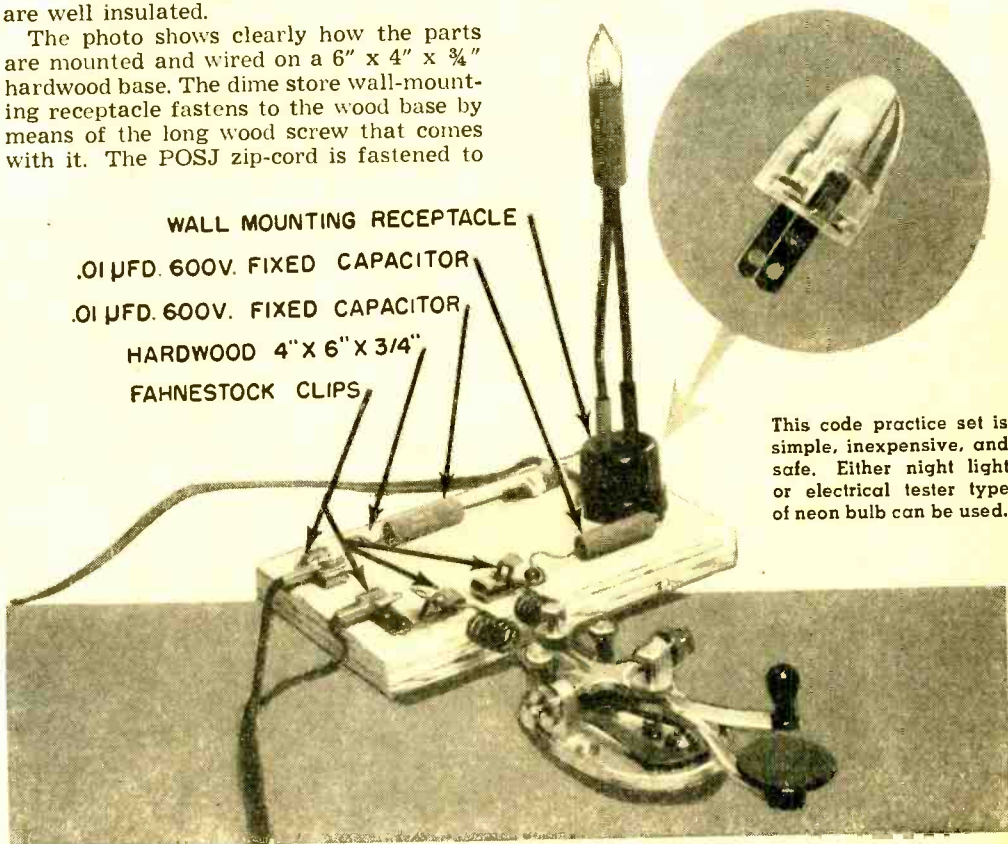

This code practice set is simple, inexpensive, and safe. Either night light or electrical tester type of neon bulb can be used.

Bendix's MRT-9 portable two-way radio unit for the 152-174 mc. band.



The Bendix MRT-9 packset in its shoulder-strap protective case.

# THE WALKIE-TALKIE

Motorola packset with a monitoring speaker on top of case.



The Motorola "Handie-Talkie" for 152-174 mc. band. Case is available to protect set from weather.

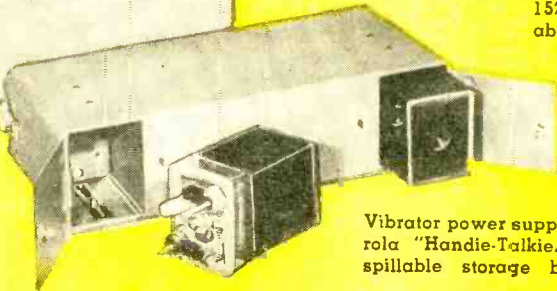

Vibrator power supply section of Motorola "Handie-Talkie." Note the non-spillable storage batteries in unit.

By LEO G. SANDS



(Left) RCA's lightweight walkie-talkie for the 25-50 mc. band. It uses a Western Electric type 500 handset. (Below) Interior view of typical unit using miniature and subminiature tubes.

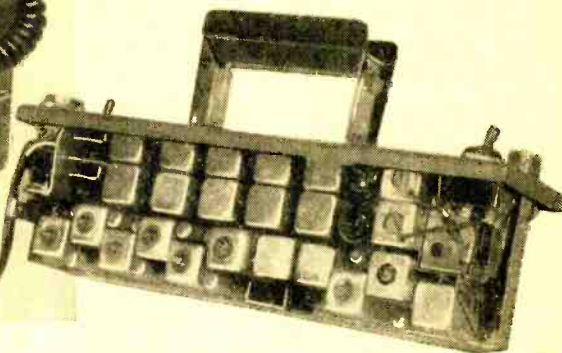

*Two-way radio has captured the imagination of the public—  
here is the story on available units and operating rules.*

THE portable two-way radio has been brought vividly to the attention of the public by "Dick Tracy." His is the two-way radio which would sell like the proverbial hot cakes if it really existed. Many are trying to develop a "Dick Tracy" radio and no doubt someone will succeed.

Today, crime fighters must content themselves with somewhat heavier and bulkier portable two-way radio sets. Several excellent portable units are on the market and they do a commendable job, even if they fall short of the performance of "Dick Tracy's" wrist radio.

Depending upon their size and form factor, they have been called, among other things, a walkie-talkie, "Handie-Talkie" (a tradename), pack set, "Port-A-Fone" (also a tradename), and a breakie-backie.

If you buy a pair of walkie-talkies, there is no assurance you can use them. *All radio transmitters, even flea-powered, hand-carried portables, must be licensed by the Federal Communications Commission (FCC).* Different kinds of walkie-talkies are designed for licensed operation in different categories of radio services as defined by the FCC. Equipment for use in the industrial, land transportation, and public safety radio services must generally meet more rigid technical standards than equipment to be used in the Citizens or amateur radio services.

Unless you operate a business which is eligible for licensing in the land transpor-

tation or industrial radio services or unless you are an amateur radio operator, you as an individual can only operate walkie-talkies in the Citizens radio band. The Citizens band is open to all citizens whether for private personal use or in connection with a legal commercial enterprise.

For use only in the Citizens radio service on 465 megacycles are such low-priced, hand-carried two-way radio units as the *Stewart-Warner* "Port-A-Fone." Here, the range is limited from a few hundred feet to a mile or more, depending upon local conditions. This type of unit uses a super-regenerative receiver which is converted into a self-excited AM transmitter.

The more widely used and more expensive portable two-way radio units are designed for operation in either the 25 to 50 megacycle or 152 to 174 megacycle v.h.f. (very-high-frequency) bands which are reserved exclusively for eligible commercial enterprises and government agencies.

To meet FCC requirements, these commercial pack sets employ crystal-controlled transmitters operable on one or two specifically assigned fixed frequencies within the band for which the equipment was designed. Fixed tuned superheterodyne receivers, which are also crystal controlled, are used. Transmitter and receiver are packaged in the same enclosure along with either wet or dry batteries.

When wet batteries are used, they are of the non-spillable type and are used to

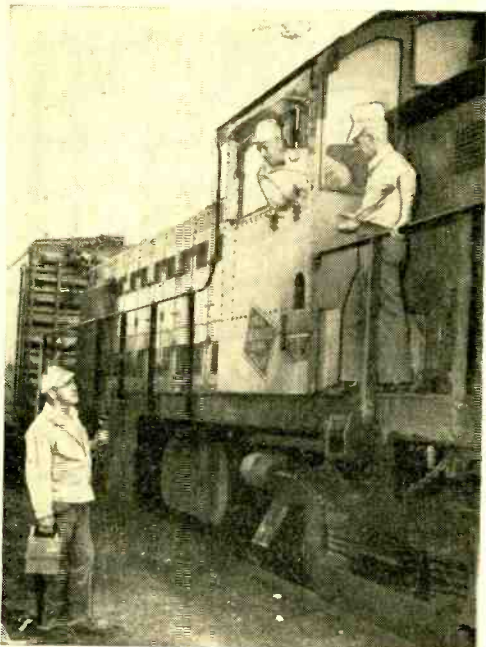

Pack sets are used by many railroads to extend communications to the man on foot. The unit shown here is manufactured by Hallicrafters.

supply filament power and to drive a vibrator power supply for plate power for the tubes in the transmitter and receiver. Generally, when dry batteries are used, plate power is derived directly from "B" batteries instead of a vibrator power supply.

Both subminiature and miniature type tubes are used in commercially available walkie-talkies. The transistorized walkie-

talkie has not yet made its debut and is not expected to do so, at competitive prices at least, for quite some time.

The antenna used with nearly all of the commercially available walkie-talkies is either a vertical flexible quarter-wave whip or a telescoping antenna similar to those used in automobiles. An external antenna may be used in fixed or mobile applications by removing the antenna and plugging in a coaxial cable leading to the antenna.

The range obtainable with walkie-talkies is sometimes amazing, especially when operating in the 25 to 50 megacycle band. A range of 8 or 10 miles between a walkie-talkie and a higher powered base station is often reported. However, much depends upon terrain conditions.

Operating in the 152 to 174 megacycle band, the range is generally considerably less. However, communication between a walkie-talkie on this band and a higher powered base station up to 8 or 10 miles has been achieved but not as regularly as when operating in the 25 to 50 megacycle band.

The range between a pair of walkie-talkies is generally quite limited because of the power output of the transmitters and because of the low effective antenna elevation. Of course, the range can be several miles if one walkie-talkie is operated on a hill top and the other one is within line-of-sight or at a point where signals are easily reflected.

In railroad yards, for example, many have been disappointed to find the range attainable between a pair of pack sets is so short as to be unsatisfactory. This is particularly true when one or both walkie-

Three versions of the Hallicrafters "Littlefone." (Left) The standard model with handset. (Center) Unit adapted for under-the-dash mounting in a car. It is powered by car battery. (Right) "Littlefone" with a 4" speaker mounted on case.





talkies are carried by personnel standing or walking between freight cars. This would also apply in congested areas as in city streets lined by tall buildings or many trees.

The cure in such cases is to employ a relay station if permitted by FCC regulations in the service in which the equipment is to be operated. When using a relay station, two different radio frequencies are required, one for transmitting and one for receiving.

*Motorola* and *General Railway Signal Company* have developed novel portable transmitters for one-way radio communication. They are not much larger than a flashlight and are primarily used in railroad yards where personnel on foot talk out over a portable transmitter and receive calls and replies over a public address system. A typical walkie-talkie like the MRT-8 manufactured by *Bendix* weighs only eight pounds and is available for hand carrying or for mounting on personnel with suitable straps. *Hallicrafters* manufactures portable two-way radio units which can be adapted for installation in motor vehicles. Power is derived from the vehicle's electrical system.

Surplus walkie-talkies offered at bargain prices are seldom licenseable without extensive modification. Very few, if any,

military surplus portable radio telephones can be readily modified for use in the 25 to 50 mc., 152 to 174 mc., or the 450 to 470 mc. bands. Some, however, can be modified for operation in one or more of the amateur bands. However, to be eligible to operate walkie-talkies in the amateur bands, it is necessary to possess an amateur operator's license which requires taking a code test and passing a written examination on radio theory and FCC regulations.

In the land transportation, industrial, and public safety radio services, persons using mobile and portable stations do not need operator's licenses although the operator of an associated base station must possess a restricted radio telephone operator's permit. Although a station license is required for Citizens band walkie-talkies, an operator's license is not needed.

It is possible to build your own walkie-talkies for use in the Citizens band or in one of the commercial radio services. However, to build such equipment so that it will comply with FCC regulations requires considerable skill, a vast amount of precision test equipment, a good deal of time, and ample funds. It is generally cheaper to buy factory-made equipment. Commercially available walkie-talkies cost from \$200 to \$500 each. END

## FOOLPROOF ELECTRICAL COMBINATION LOCK

**A**N ELECTRICAL combination lock may come in very handy for a frequently used door such as one on a garage or workshop. A number of single-pole, single-throw switches can be connected in series (Fig. A) in such a way as to activate a magnetic door release when the switches are thrown in a preset pattern. This circuit may not always prove satisfactory since a large number of switches must be used to eliminate the possibility of the lock's being opened by the trial and error method. It is, therefore, desirable that the

switches not only have to be thrown in a set pattern, but also in the proper sequence. In Fig. B, the double-pole, double-throw switches are connected in such a manner that switches 1, 2, 3, 4, and 5 must be thrown in exactly that order to open the lock. If they are not thrown in that sequence, or if dummy switches 6 and 7 are thrown at all, an alarm goes off.

Any number of switches can be used in this circuit. The relay and re-set button are not completely necessary but they add to the security of the lock. J. STURMAN

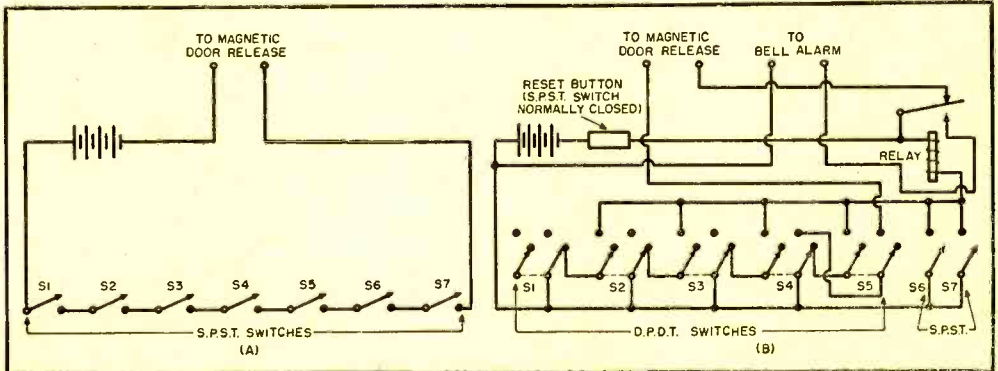



# HUM

**H**UM is a problem which most hi-fi fans have encountered at one time or another.

It is most vexing to hear this unpleasant noise superimposed on your music. Hum is a subject about which books could and have been written. It is not our purpose here to write a compendium on hum, but to discuss some of the most common causes of hum and measures which can be taken towards its elimination.

A pickup cartridge of the magnetic reluctance or moving coil type can be a major source of hum. Most of this is inductive hum which is caused by the pickup coming into conjunction with the field of a changer or turntable motor. If you own a changer, there is not much to be done to eliminate hum which the changer manufacturer already hasn't or should have done. A turntable allows more flexibility because it does not have a pickup arm as an integral part of its structure. Therefore, you can place the arm on the motorboard in such a manner that, at the maximum of its arc across the disc, it will be as far away from the motor as possible. Foam rubber turntable mats have been introduced recently and it is a wise practice to use one on the changer and turntable. This not only will help to eliminate some hum and rumble, but it will also help to prolong the life of your recordings. There is a cushioning effect that will offset the downward pull caused by attraction between magnetic cartridges and steel turntables. This pull is usually not observed in stylus pressure measurements. You think that you are playing your records at a nice, safe 5-6 grams, when actually there may be considerably more stylus

force on the grooves because of this pull. Many arms now come equipped with three-wire pickup leads. One lead is an extra ground which can be soldered to the case of the cartridge at one end, and the input jack of your preamp at the other end. This has proved quite successful in reducing hum, especially in such cartridges as the *Fairchild* and *Pickering*.

Turntable and changer motors are in themselves a source of hum. The problem here seems to be one of expense. The cheapest type, which is the two-pole motor, is the worst offender. The four-pole motor, which is the type used most commonly in the average hi-fi system, is considerably better than the two-pole, and the deluxe hysteresis synchronous motors have little inherent hum. In all three types of motor, some improvement can be made by grounding the case of the motor to the input jack of the preamp.

The leads between pickup and preamp can cause hum trouble, and this fact is overlooked by many otherwise careful audiophiles. The lead should be well shielded by the use of tinned copper braid, and of low capacity. Absolutely clean ground connections are a "must" on these leads. No "cold joints" or "resin joints" should be tolerated. The length of the lead from pickup to preamp should never exceed from six to eight feet and the smaller the better. Be very careful not to parallel the audio lead with the a.c. power line, as this can also cause hum.

Most of the modern preamps and power amplifiers have hum levels of at least 70 db below the full rated power output. For most purposes this is practically inaudible. For those who do not want to hear hum even when they stick their heads inside their speakers, amplifiers are available which have hum levels as low as 96 db below full rated output. However, there are times when the hum level of a preamp or power amplifier seems to be at variance with the specifications. Most manufacturers of high grade amplifiers are pretty reliable,

*(Continued on page 124)*



By BERT WHYTE

# REPRODUCTION

## DISC REVIEW

THE recordings described and recommended to you in previous issues of *POPULAR ELECTRONICS* have been wholly orchestral in nature, and have been musical works of the standard repertoire. This format has been followed intentionally in order to acquaint you with the "basic symphonic library." Of course, there are many other forms of classical music, like chamber music, opera, concertos, and the special literature of religion. In this article and in others to follow, we will also venture into some of these other musical forms.

Sooner or later, every hi-fi fan discovers the "king of instruments"—the pipe organ. Discovery is usually accompanied by vast enthusiasm for the wonderful sounds an organ can make and a most intemperate buying spree ensues. In no other form of recorded music is the old dictum, *caveat emptor*—"let the buyer beware"—so applicable. The organ has the greatest tonal range of any instrument, reaching from the rumbling, sub-bass depths of 16 cycles (which is more nearly "felt" than heard) to a stratospheric 16,000 cycles. The dynamic range is tremendous, going from the tiniest whisper to the mighty thunder of 32 and 64 foot pipes. Because of these tonal and dynamic characteristics, the organ is the most difficult of all instruments to record. Since most organs are in churches or other large auditoriums, the usually over-reverberant acoustics are a major trouble factor in recording. Thus it behooves one to be most careful in purchasing organ LP's. The number of *really good*, wide range, low distortion recordings is quite small.

When it comes to a question of repertoire for the organ, while the literature is fairly voluminous, most of the recording efforts have been centered around the music of that doughty old champion of the organ, Johann Sebastian Bach. If one's acquaintance with Bach has been only a nodding one, and it has been concluded that his music is a little too "dry" for one's taste, one will probably find his organ works to be an entirely different matter. It would be a most unresponsive person who would be unmoved by the dazzle and excitement of the *Tocatta and Fugue in D* or the stately splendor of the *Passacaglia and Fugue*.

The *Tocatta and Fugue in D* is probably the most popular of all Bach organ works. *Tocatta* means literally "to touch lightly" and most works

in this form are really display pieces for organ virtuosi. It is odd that this *Tocatta* is one of the most mathematically "precise" works that Bach ever wrote, and yet the work which is considered the "easiest" to assimilate.

There are five recordings of this work, and of the five, only two can be considered as having modern hi-fi sound. E. Power Biggs is the organist on *Columbia* ML4500 and Reginald Foort, the artist on *Cook* 1054. Some critics have called Mr. Biggs' performance "insensitive," and although there is some stolidity to his playing, his is certainly the most capable and honest performance thus far. Mr. Foort tends to over-romanticize his performance and seems less sure of his ground. In the matter of sound we are faced with a most unusual circumstance. *Both* of these recordings were made with the new Aeolian Skinner organ in Boston's Symphony Hall. Because of this, we have a nearly perfect example of how different recording techniques can make the same music on the same instrument sound entirely different. The sound of the *Cook* record is notable for extremely wide frequency response, and purportedly, reaches all the way down to 16 cycles. The word "purportedly" is used because of the fact that the reproduction of this frequency is well-nigh impossible, even with *good* hi-fi systems.

It might be wise here to point out a few facts about ultra-low frequency reproduction. One of the main reasons organ recordings are so popular with audiophiles is that they constitute a readily available source of low frequencies which will show off the "low end" capabilities of their systems. The low end sound of the organ is thrilling, but I'm afraid that most hi-fi fans have been deluding themselves in thinking that they hear 16 or 32 or even 40 cycles! Few hi-fi fans realize just how low 100 or 75 cycles is; they forget that the organ has great *power* at those and all the lower frequencies. Most modern high quality amplifiers will give satisfactory reproduction of 16 cycles, but let's take a look at the speaker situation. The well equipped hi-fi fan usually has a 15-inch coaxial or two or three-way system in a bass reflex or "infinite" enclosure. Assuming that the reflex part is perfectly "tuned" (which is usually not the case), good response will occur as low as 50-55

(Continued on page 122)

# THE C-R HANDY TESTER

By CLINTON E. CLARK, W1KLS

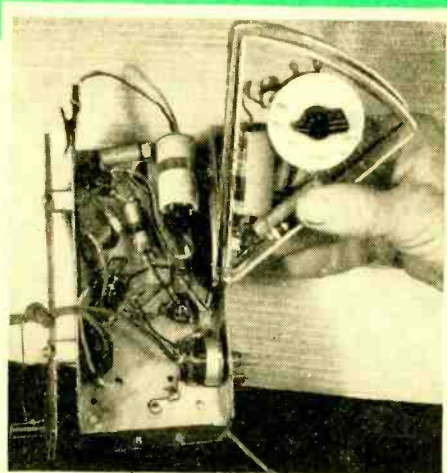
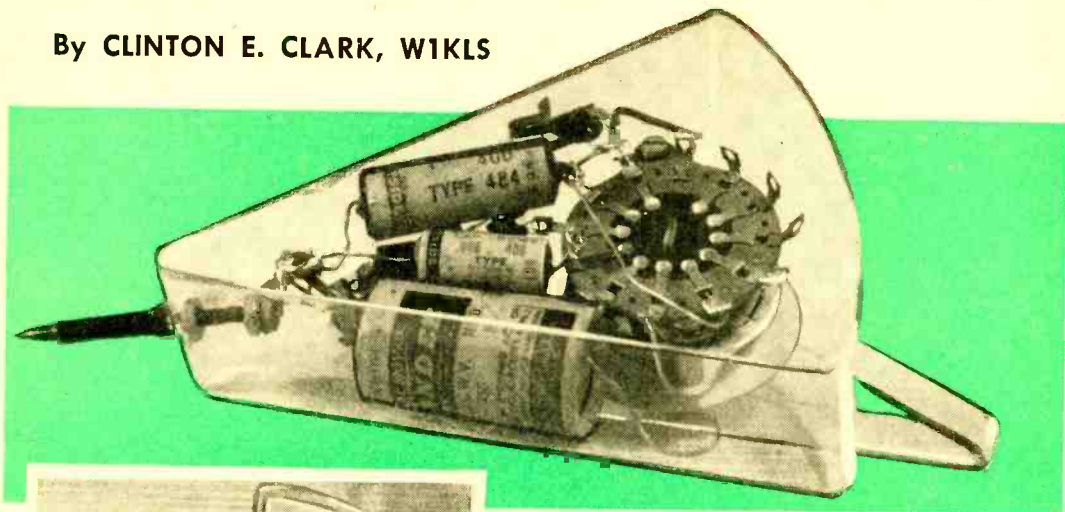

With the alligator clip connected to the chassis, the probe can be used to connect parts into equipment which is being checked.

Capacitors or resistors which are suspected of being defective can be checked with this unit.

**T**O FIND out whether a suspected part actually is defective, many technicians and experimenters simply substitute a part which is known to be good, then recheck the over-all performance of the equipment involved. Substitution testing has important limitations, but generally it is simple and quick, and it does not require any expensive testing equipment. The capacitance and resistance substitution tester shown in the photos and diagram is unusually simple to make and use. It contains several typical values of capacitance and resistance, with a convenient common terminal and an insulated probe to get at hard-to-reach points.

Parts required for the C-R Tester are described in the parts list. The wedge-shaped plastic case shown in the photos was designed to hold a piece of pie and is obtainable in many five-and-ten stores. A different container could be used if the pie case is not available. If a metal case is used, all of the wiring and all of the terminals of the components should be insulated from the case.

All of the components should be as small as can be obtained readily for ease in wir-

- R<sub>1</sub>*—250 ohm, 5 w., wire-wound res.
- R<sub>2</sub>*—30,000 ohm, 5 w., wire-wound res.
- R<sub>3</sub>*—250,000 ohm, 1 w., carbon res.
- C<sub>1</sub>*—.005  $\mu$ fd., 600 v., mica capacitor
- C<sub>2</sub>*—.1  $\mu$ fd., 600 v., tubular capacitor
- C<sub>3</sub>*—8  $\mu$ fd., 450 v., elec. capacitor
- B<sub>1</sub>*—penlight cell
- PL<sub>1</sub>*—flashlight lamp, single penlight cell type (GE Type 112)
- S<sub>1</sub>*—miniature rotary tap switch, single-pole, seven or more positions (Centralab Type PA-1001)
- I*—wedge-shaped plastic pie case
- k*—knob for switch
- d*—dial plate for switch
- f*—Fahnestock clip
- a*—alligator clip
- Machine screws, nuts, wire, solder, and electrical tape

ing within the limited space. The switch required is one with a single pole and as many positions as there are circuits to be switched. The switch shown in the photograph was used simply because it happened to be available. Smaller rotary switches can be obtained and one should be used if the continuity tester ( $B_1$  and  $PL_1$ ) shown in the schematic is to be incorporated in the tester. The continuity checking circuit was omitted from the tester shown in the photographs because the bulk of the switch leaves little room for the penlight cell and flashlight lamp.

The test prod which forms a common terminal point for all of the circuits was made from a two-inch 6/32 bolt. One end was ground to a point and insulated with a wrapping of electrical tape. The other terminal of the tester is a Fahnestock clip. Since most of the circuits which would be tested have a common return to a metal chassis, it will be convenient to insert a flexible wire in the clip, terminated in an alligator clip.

The plastic case has a tendency to crack if holes are drilled in it. The best way to make the holes for mounting the switch, prod, and clip is by heating an ice pick over a flame and burning the holes in.

To complete the tester, a paper dial can be made with the values inked in the proper positions.

The three capacitors specified have values which can be used as substitutes for testing purposes for most of the capacitors in radio and audio equipment. The .005  $\mu$ fd. capacitor will substitute in the low capacitance range for values between .002 and .01  $\mu$ fd. These values are found in radio frequency circuits and, often, in coupling capacitors between tubes. The .1  $\mu$ fd. capacitor will substitute for values between .02 and .5  $\mu$ fd. Look for these in cathode, screen, and plate bypass circuits. The 8  $\mu$ fd. capacitor will take care of most power supply filters and audio cathode bypass capacitors from 4 to 20  $\mu$ fd.

The three resistor values listed in the parts list will cover most of the required substitutions. The 250-ohm value can be used for cathode bias resistors in the range from 150 to 1000 ohms. For most voltage dropping resistors, the 30,000-ohm size will do. Plate and grid resistors between 100,000 ohms and 1 megohm can be replaced by the 250,000-ohm value.

To check a component suspected of being shorted, one terminal must be disconnected before the substitute is inserted in the circuit. If a component is open, the substitution can be made simply by connecting the test part in parallel with the original.

Substitution testing must be performed

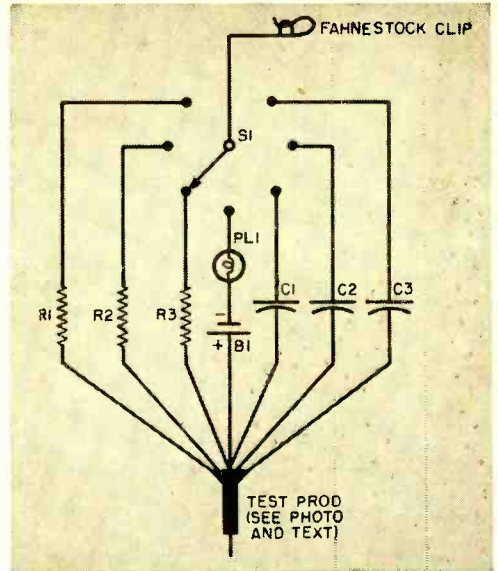

The C-R Tester consists of only a few parts, described in the parts list. See text for discussion of continuity tester ( $PL_1$  and  $B_1$ ).

with caution. First, there is a danger of damaging the substitute part if conditions which damaged the original still exist. If symptoms indicate that a resistor was burned out or a capacitor was shorted, be careful. Second, the results of the test may not be conclusive. If the equipment is restored to operating condition by the substitution, it is likely that its previous non-operating condition was due to a faulty part. On the other hand, if substitution does not restore proper operation, it should not be concluded immediately that the original part was OK. More than one part may be faulty and replacing one will not restore operation.

The continuity testing circuit can be used to determine whether or not there is "continuity" (a path of relatively low resistance) between two points. It is, in effect, a rough type of resistance checker. When it is connected between two points, lighting of the lamp indicates that there is a direct connection or, at least, a path of low resistance between the points. If the lamp does not light, there is an open circuit or, at least, only a path of relatively high resistance.

Continuity testing can be used: to verify that there actually is a connection between two points which are supposed to be connected; to show the presence of unwanted shorts between wires, or unintended grounds (connections to the chassis); to show whether or not the heater or filament of a tube is open; or to determine whether or not capacitors are shorted. END

# How To Stop Automobile Radio Noise

IT IS not at all unusual to buy a new car, drive it a year or so, and have the radio that had played so well when the car was new, develop one or more noises that are peculiar to auto radios.

Practically all of the noises that develop can be traced to your automobile. There is no suppressor which can be put on a radio that will keep it from picking up interference generated by the various electrical (and in some cases mechanical) components in the car. However, there are suppressors available to use on the offending parts. These can be bought at any radio parts store. The first step in stopping auto radio noise to locate the source of the trouble.

The most important single item for good, quiet radio reception is the aerial. The lead-in especially should be given a visual check to find whether the shield is making a proper ground on each end. Be sure the lead is pushed tightly into the aerial jack on the radio. A car radio can be no better than its aerial. If it is badly bent and the connections are loose, it is advisable to replace the complete aerial.

Most garages install a generator capacitor at the time the radio is installed. These capacitors occasionally open up after several years use. Generator trouble is found by starting the motor, tuning the radio to a point where the noise is loudest, and then turning off the ignition. If the noise stops immediately when the key is turned off, it is probably due to the spark plugs and not the generator. If the generator is at fault, the noise will fade out as the motor and generator slow down. For this test, have the motor turning over rather rapidly. If the generator does not have a capacitor on it and you wish to install one, merely ground the shell of the capacitor and connect the pig tail lead to the battery wire.

Voltage regulator trouble is usually easy to find. Start the motor and listen for the noise to start in the radio as the speed of the motor is increased gradually. This noise generally starts as soon as the generator begins charging. Watch the ammeter and listen for the noise. If it is the regulator, you will notice that as soon as the needle swings to the charge side the noise starts. Cleaning the contact points carefully with emery paper is usually a cure for a noisy regulator. However, in extreme cases the unit may need to be replaced.



If there is no noise when the car is not in motion although the motor is running, then the disturbance is being generated by the wheels or parts associated with them. Both front wheels should have suppressors in them. A wheel static suppressor is a coil spring that fits in the inner hub cap. These can be bought at any radio shop. If this does not stop wheel static, the trouble may be in the brake linings dragging the brake drums. This can be determined by applying the brakes gently while driving at a good rate of speed and seeing if the noise stops. As soon as the linings are firmly against the drums, the noise will stop. The only remedy for brake noise is to have the brakes adjusted at a reliable garage.

Sometimes such small accessories as an electric clock or turn signals will cause interference. The only check for these is to take a capacitor and try it on each item until the guilty one is located. These capacitors will be connected to the hot wire and grounded to the metal of the car.

Spark plugs are the worst offenders as far as noise is concerned. Spark plug noise will stop the instant the ignition key is turned off and it is also easy to spot by sound. When the motor is turning over very slowly you can hear the plugs as they fire. A distributor suppressor is usually enough to quiet this noise. If this fails, you can get suppressors for each plug.

Car radio noise is really not as hard to find as it may sound; all you need is a little time and a lot of patience. **END**



## So You Want to be a Ham

By

ROBERT HERTZBERG

W2DJJ

Edwin J. Becker, W7LJO, Salem, Oregon, shows how he tunes the Morrow 5BRF short-wave converter, to right of which is the Morrow fixed-tuned receiver. Note how the units hang from dash without cutting leg room.

## GOING MOBILE

*Part 6. A whole world of excitement and fun can be yours when you operate from the "mobile station" in your car.*

**M**ORTON B. KAHN, of Great Neck, Long Island, has a short-wave receiver and a low-powered transmitter in his car. One day recently, while fighting his way through mid-town New York traffic, he thought he'd check the functioning of a new tube that he'd put into the transmitter the night before. He flipped the switches, and as he watched the meters on the panel, he spoke just to activate the circuits. "Hello CQ, hello CQ, CQ, this is W2KR mobile, William 2 King Roger mobile, in New York City. Is this thing working, I wonder?"

Half a second after he released the microphone button, the loud speaker on the dashboard came to life.

"Hello W2KR mobile, calling William 2 King Roger mobile, this is DL4HA, Dog Love 4 How Able, in Germany. You're putting in a swell signal over here, old man. How do you read me? W2KR mobile, this is DL4HA, over."

Thrilling? Enough to make your scalp tingle! Unusual? Not altogether. When conditions are right you can work all around the world with flea power and a buggy whip antenna. Conditions must

The mobile gear in Henry Y. Satterlee's (W6VAA) car. Left to right the equipment includes Gonset "Super-Six" converter, Gonset 50-watt "Commander" transmitter, variable frequency oscillator, and Gonset "Super-Ceiver"—a fixed-tuned i.f. unit.

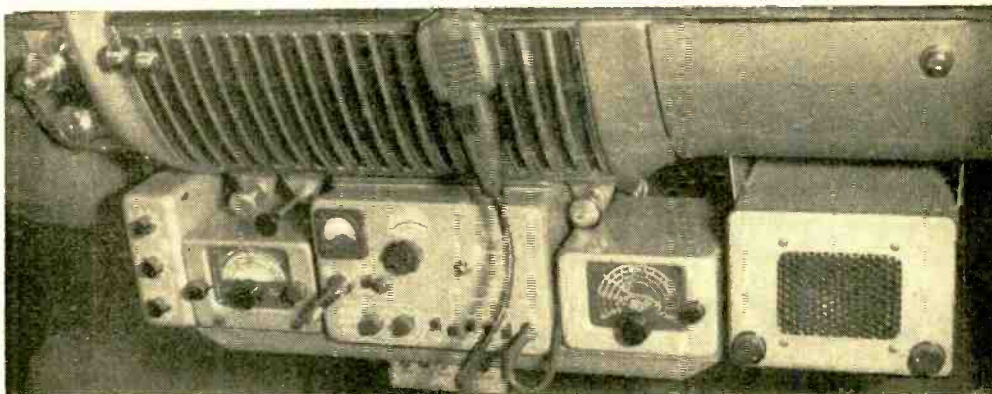



All Thorton Lyford (WOQIK) has to do is press the mike button and his mobile transmitter is on the air. His car is equipped with Johnson's "Viking Mobile," a compact 8-tube, 60 w. unit.



Morton B. Kahn, W2KR, designed and built his own mobile station. Complete receiver and transmitter are contained in a drawer-like chassis that pulls out from under dash for inspection.

have been good that day, because Mort repeated the performance in reverse when he retraced his route through Manhattan a few hours later. The ignition systems of passing trucks were creating a shower of noise in the receiver, but out of the uproar came a fairly good signal.

"Hello CQ, hello CQ, CQ, CQ. Calling Stateside. This is CN8EY, CN8EY, Charlie Nan 8 Easy Yoke, in French Morocco, Africa. What say someone, please?"

French Morocco! Mort glanced at the walls of the canyon formed by the surrounding skyscrapers. "What can I lose?" he mused to himself as he reached for the mike. "Hello CN8EY, CN8EY, calling Charlie Nan 8 Easy Yoke in French Morocco, this is W2KR mobile, William 2 King Roger mobile, William 2 King Roger mobile. How are we doing there, feller? Over."

He learned soon enough how he was doing.

"Hello W2KR mobile, this is CN8EY. Thanks for the call Mort. I've heard you on the air often, and I'm glad to work you . . ."

Fifteen minutes later Mort had to cut the QSO because he'd reached his destination. Neither station had missed a word.

Mobile radio is so exciting and so full of challenges that many hams have turned their cars into veritable stations on wheels. Once you obtain your general class license, you too can "go mobile" and engage in unlimited phone operation on the popular frequency bands. Every drive you take then becomes a new adventure.

From the equipment standpoint, mobile is relatively simple. For receiving purposes several arrangements are possible. The most popular one, because it's inexpensive and effective, makes use of the regular

broadcast receiver in the car and its accompanying whip antenna. This receiver is adjusted to a quiet spot at the top of the band, usually around 1400 kc., and it acts as a fixed-tuned intermediate-frequency (i.f.) amplifier in combination with a small short-wave converter which is connected between it and the antenna. On the converter is a changeover switch that permits you to cut over for broadcast reception at any time without disturbing the new antenna connection. Various styles of converters cover from two to six frequency bands. They use only a few tubes, which draw their filament power from the car's storage battery and their plate power from the vibrator in the broadcast receiver. It's a minor job to tap into the latter for the necessary connections.

Auto radio receivers, as a class, have excellent amplification and selectivity. The combination of such a receiver and a separate converter forms a double-conversion superheterodyne that really drags in the signals.

If your car presently has no receiver in it at all, you can install either an entirely separate, self-contained, bandswitching short-wave receiver of compact design, or the combination of the described converter and a matching fixed-tuned i.f. amplifier strip. In most cases the loudspeaker and the plate power supply are separate items of equipment. A converter alone costs about \$50; a complete receiver about \$165.

The average converter is only about half the size of a cigar box. You can mount it readily on the steering column, where you can reach it without shifting your normal driving position. Some of the newer complete receivers are also very compact. One 10-tube job measures only 8½ x 6 x 4½ inches over-all, minus power pack and



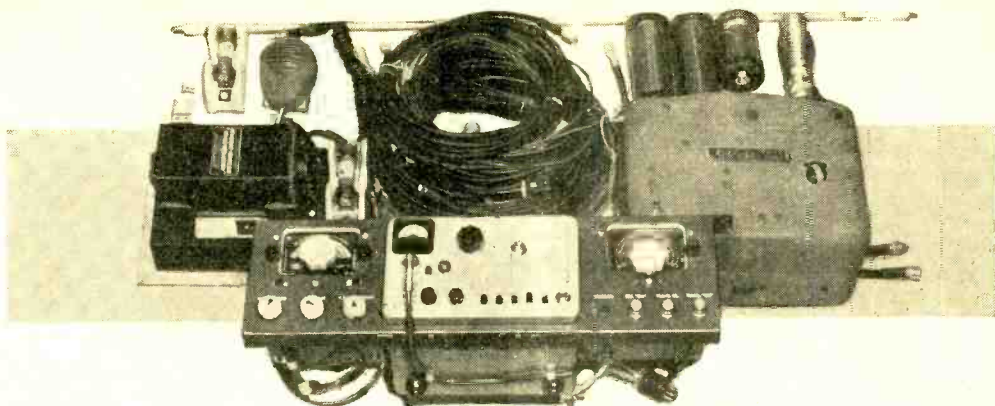

A complete amateur mobile "package" as supplied by the Amateur Sales Department of Motorola Inc. This includes (rear) whip antenna and loading coils, dynamotor, fuses, all necessary cables, control relays, and (front) Gonset "Super-Six" converter and Gonset "Super-Ceiver," Gonset "Commander" transmitter, and Gonset variable frequency oscillator. This deluxe combination's transmitter is rated at a nominal 50 watts.

speaker. The two latter units are easily disposed of under or behind the dashboard.

A mobile receiving unit adds very little to the normal electrical load on the engine-driven generator of a car. However, even a small transmitter puts a very considerable drain on it. Many a ham rushes into mobile operation without realizing this, and then finds himself in real trouble with a burned-out electrical system the first time he hits the road with a new rig.

The size of the storage battery is relatively unimportant. What is important is the rating of the charging generator, expressed by the number of amperes of current it can deliver safely and continuously. The battery is needed mainly for starting purposes. Once the engine is running, it merely "floats" across the generator line. In fact, you can disconnect it entirely and the engine will continue to run if you keep it revved up a little beyond nor-

mal idle speed. You don't think so? Try it and see.

In late model cars using standard three-cell batteries, generators are usually of the 30 or 35-ampere size. This sounds like a lot of juice until you add up the current requirements of headlights, tail and instrument panel lights, heater fan, ignition system, and broadcast receiver, all of which are likely to be on during a winter drive at night and which easily can total 25 amperes. This load doesn't strain a 30 or 35-ampere generator, but suppose you add a transmitter that takes 20, 25, 30 or 40 amperes *all by itself*? Obviously, you're inviting disaster. You might get by during daylight, but even then you'd be stretching your luck.

From the practical standpoint, you can't use much more than about a 50-watt transmitter for mobile purposes in a standard

*(Continued on page 120)*

Center-loaded whip antenna on Mort Kahn's car is mounted on rear and is pulled down and tied to rain molding when car is garaged. Base spring gives flexibility.



# R/C NOTES

**R**ELLEASE of the new long-life *Raytheon* RK-61 tubes has caused a reversal (temporarily, at least) of the trend to hard tubes. The two-tube jobs, using the gas-filled type of tubes, are quite popular due to simplicity, reliability, good sensitivity, and solid relay action. The drawback is the relatively short life of the gas tube.

When substituting the new tube into the first stage of a two-tube receiver like the *Lorenz* or *North American*, the result may be a decrease in sensitivity. To get the tube up to full sensitivity, idle the tube in for 15 minute periods at 1.5 ma.

**W**E recently received a notice from the *Academy of Model Aeronautics* relative to some rule changes affecting radio-control model competition at *AMA* sanctioned meets. These new rules are to go into effect in the 1955 meets. We quote the rule change:

"There will be two classes of radio-control models: rudder control and multi-control. Entry will be permitted in only one of these classes at a contest.

"There will be a new pattern combining the old precision and stunt patterns with the suggestion that part of the pattern (mostly precision) be used for local meets and that the entire pattern be used for large meets.

"It will be up to the R/C event director to decide and announce the number of flights to be permitted at each contest. This is done before official flying begins.

"Power-on spot landings will be permitted providing the flyer calls the approach and makes a single landing attempt."

**R**ADIO-CONTROL modelers in Indiana may be interested in joining up with a new club formed on October 22nd in Indianapolis. The club is called *The Indianapolis Radio-Control Modelers* and has, as its first order of business, the obtaining of a flying field. They already have a donation to cover the insurance on such a field.

If you are interested in this new group, contact *Harold L. Stofer*, 1832 Singleton St., Indianapolis, Indiana.

**A** VERY clever idea that any model aircraft club can try to help its mem-

bers increase their ability and knowledge of pulse radio control is the one submitted to us by the *Southeast Virginia Radio Control Group*. They have constructed a club model airplane which is used as a demonstrator and trainer for the newcomers to the club. A newcomer can get checked out on this model before flying his own creation, and thus avoid crackups due to inexperienced handling.

The design used is a "Bootstraps," with 2-wheel gear, *Cub* .09 engine, *Controlaire* receiver with pulse rudder control. The ship flies very smoothly and slowly.

**T**HE article "3-Channel R/C Receiver," by *E. L. Safford, Jr.*, on page 73 of our January issue contained an error which we would like to correct as quickly as possible. The 3A5 tube ( $V_s$ ) pin numbers on the circuit and pictorial diagrams on page 75 were interchanged. The plates should be numbered 6 and 2; the corresponding grids are 5 and 3 respectively. Consequently, all connections shown at pin 6 should go to pin 5 and vice versa. The same applies to pins 2 and 3.

**W**E can't recommend strongly enough that you read the article on "R/C Reliability" on page 41 of this issue. This and future articles on this subject are straight from the flying fields by an author who is well known among model aircraft flyers. Just in case you have bumped into *Bill Winter* and didn't know it, we are reproducing herewith a photo of Bill shown among some of his aircraft. Can it be that the quizzical expression on his face is due to some lack of reliability in his R/C equipment?

As you may know, *Bill Winter* is Editor of *Model Airplane News* and author of quite a few widely read books on model airplane construction and flying. You will find his authoritative articles in every issue of *POPULAR ELECTRONICS*. END



POPULAR ELECTRONICS



# SHORT-WAVE FIREFIGHTING

By LOS ANGELES FIRE DEPARTMENT

**Y**OU are about to step off the curb at a busy Los Angeles intersection when a police whistle and the wail of approaching sirens brings you to a quick stop. Heavy fire equipment appears with red lights flashing warning to motorists and pedestrians. Then, just as suddenly, the lights go out, the sirens cease, and the lead apparatus slowly turns up a side street. What happened? Wrong address? Did they lose the way? Not a chance! You have just witnessed the saving of many tax dollars because short-wave radio units installed in the responding apparatus tipped the boys off that they were heading for a false alarm.

It costs taxpayers about \$450 to have the fire department respond to an alarm in a big city. Thus, when the first arriving officer finds a false alarm or a minor fire and turns back the major portion of a full assignment of men and equipment, he saves the city money.

Approximately 300 fire companies, including scores of special units and chiefs' cars are equipped with short-wave radio and an additional frequency is provided as a command channel for administrative use. The transmitter-receiver arrangement allows two-way conversation from mobile unit to dispatching office, or from mobile unit to mobile unit. Firefighting equipment, irrespective of location or direction of travel, can be "talked in" to the proper strategic position for efficient operation on a big fire. Units scattered over brush fire areas can be directed in a matter of minutes to a single location in order to join forces to stop a fast

moving "head" of sweeping flame. Special equipment so sorely needed for rescue, explosion, suffocation, and other emergencies can be called instantly to the scene by the first officer to arrive and determine the requirements of the situation.

As soon as the final radio unit was installed in 1952, the Los Angeles Fire Department was able to launch its greatest fire prevention effort in history—a continual house-to-house fire protection campaign which utilized the efforts of every one of the 2500 men on its payroll. This program would not have been possible except for the installation of two-way radios on all fire trucks. Now firefighters carrying out their fire prevention work can be reached by any one of four dispatching offices and sent directly to a fire in a minimum of time. The entire program, to date, has succeeded in knocking three thousand fires off the annual record of alarms!

The installation of two-way radio has meant a stepped-up program of effective fire control that no other single element could have accomplished. Radio is being used to the very best advantage over the vast 454 square mile area that comprises the city of Los Angeles. Waterfront, mountain, heavy industrial, and business fires constantly tax the efforts of firemen, not to mention the 400,000 homes which account for 60% of L. A.'s fires.

Chief Curtis Hart, in charge of the system, states that now the department is fully radio-equipped, maximum utilization of men and equipment can be achieved. END



# R/C GROUND CONTROL UNITS

By E. L. SAFFORD, JR.



Fig. 1. Rotary ground control switch added to a Babcock transmitter. The regular control button of the transmitter serves as the sync button.

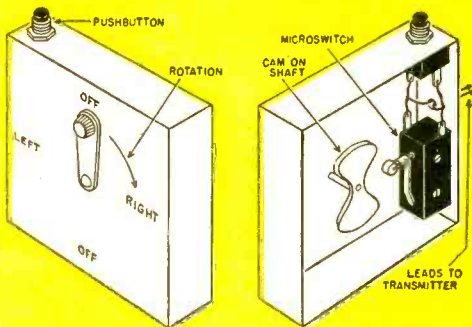

Fig. 2. Front and rear views of a simple ground control unit using a cam in conjunction with a Microswitch to key the transmitter on and off.

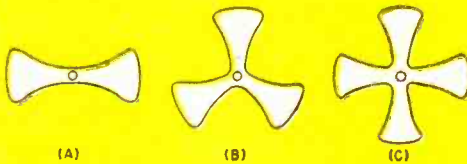

Fig. 3. Three different cams which can be used in the simple ground control unit of Fig. 2. The cam in (A) is for a two-finger escapement code sequence, (B) is for a three-finger escapement, and (C) is for a four-finger escapement.

You've built the transmitter and receiver for your radio-controlled boat or plane—  
fine, how do you maintain control? Here are a couple of units that will do the job

THE receiver in a radio-controlled model airplane or boat responds to the signals sent out from a transmitter. The operator transmits a different set of signals for the specific maneuver desired. Each set of signals is called a sequence; each control operation has its own sequence. Radio control *via* different audio frequencies or tones does not use signal sequences and is, therefore, an exception. Signal sequences are formed by a particular switch arrangement, which may consist simply of a push-button switch or of a more complicated device, depending on the type signal sequences to be transmitted. This switching arrangement is the ground control unit.

The first of two ground control units which will send forth escapement sequences and which will be described in this article, is simple to construct. It will cause the sequence to be transmitted as the operator rotates a small hand crank (see Figs. 1 and 2). The type of sequence is determined by the shape of a cam, mounted inside the box and attached to the crankshaft, which operates a Microswitch. Fig. 3 shows three different cams to use for three different sequences.

The only requirement in using this type of ground control unit is that the crank always be turned in the same direction. If it is turned forward to a control position and then back to neutral, the sequence is lost until the escapement is brought back into step. Because there is always the possibility that this will occur and also to be certain that the escapement is in the correct starting position for control operations, the push-button synchronization switch is mounted on the box and wired across the Microswitch leads. To synchronize, turn the crank handle to a known control position. If the control surface does not move to the proper position, rotate the handle to the starting neutral position. Now, using the push-button, the signals are transmitted slowly and the control surfaces are observed. When the last deflected position before starting neutral is reached (in Fig. 2 this would be "left"), the button is released and the controller is ready for operation.

#### Motor Driven Switch

The second ground control is based on an original idea thought up by Dr. Walter Good. Its principal advantage is that

the direction of rotation of the steering wheel on the control box is not important. The operator merely turns it to the function desired as often as necessary.

A second advantage is that the rate at which the sequences are transmitted is always the same. This allows the speed of sequence transmission to be set for the most reliable operation.

This unit consists of a drum which has solid pins set into its surface and a set of tabs at one end which will activate a Microswitch as the drum rotates. (See Fig. 4.) The shaft through the drum is driven either by a small electric motor, which is geared down to about one revolution every three or four seconds, or a small spring-wound motor and gear section of the type used in certain toys. The type of motor used necessitates a slight difference in the mechanical construction.

When using a spring-wound motor, the drum should be attached rigidly to the shaft and soldered if it is a metal drum. When an electric motor is used, the drum should be loose on the shaft so that the shaft can continue to rotate when the drum is stopped by means of the slide finger and pins. This prevents a stalled motor and subsequent high current drain, which causes short battery life.

Fig. 4. Motor driven ground control unit which transmits a uniform speed control sequence that is not subject to the excitement of the operator.

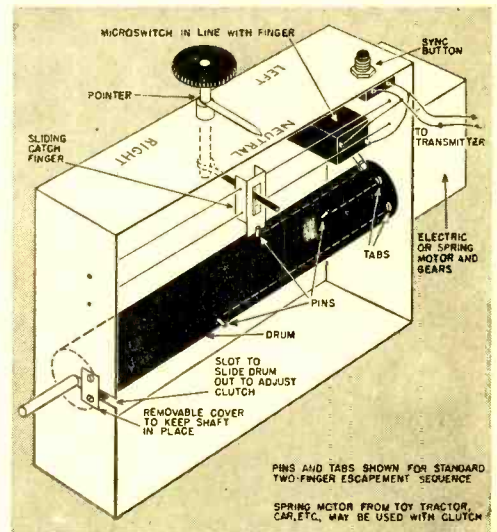

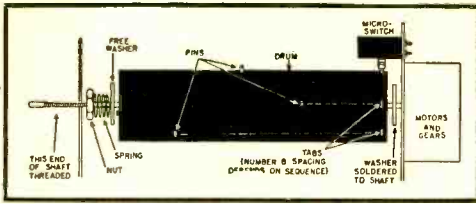

Fig. 5. Detailed drawing of the clutch mechanism used in the ground controller of Fig. 4.

When the slide finger is moved, the drum should rotate with the shaft and have enough power to move the tabs against the Microswitch to activate it. This is accomplished by means of a small friction clutch which can be attached to one end of the shaft as illustrated in Fig. 5. Note how the drum is mounted between a fixed washer soldered to the shaft on one side, and a free washer made of some friction material like hard rubber on the other side. The free washer is tightened up against the drum by a nut and small compression spring.

Above the drum and across the box are placed two small metal rods shown in Fig. 4. A small U-shaped catch finger is drilled and mounted on the rods so that it can slide back and forth as the steering wheel is rotated from left to right. The Microswitch is located at the tab end of the drum so that it can be activated by the tabs.

The pins on the surface of the drum are positioned in such a manner with respect to the tabs so that the drum may be stopped after any particular number of on and off signal combinations correspond-

ing to a particular command. The simplest case would be a sequence for a standard escapement where the code is *off* for neutral, *on* for left, *off* for neutral, and *on* for right. This would require two tabs and three pins. The center pin (neutral position of the steering wheel) would not have a tab on line with it. "Left" would have a pin on line with a tab. After a space, there would be another tab with a pin on line with it for "Right."

Any sequence may be set up by locating the proper number of stopping pins on the left or right half of the drum to correspond to left or right steering positions. An example of a drum set up for a complicated signal sequence is shown in cross-section in Fig. 6.

A word about the steering wheel and pointer: The pointer arm should have a small spring-loaded pin set into it in such a manner that it will click into small indentations on the box surface as the various command positions are reached. This allows accurate positioning of the slider, and also allows steering by "feel." END

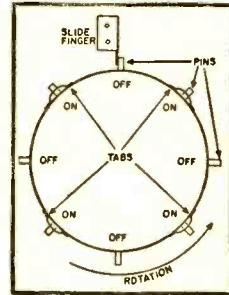

Fig. 6. End view of the roller of the unit in Fig. 4 showing the alignment of pins and tabs for an eight part code sequence.

## A LOW-COST "VISUAL EXPERIMENTAL" KIT



A LOW-COST kit, which contains 82 components to perform 60 experiments in electronic fundamentals is now being offered by *Crow Electric Corp.* as its Model 50-A. A folder describing this new educational aid is available from the company at 1102 Shelby St., Vincennes, Indiana.

## GEIGER COUNTER KIT

A "BUILD-IT-YOUR-SELF" kit for constructing a Geiger counter has recently made its appearance as the Model K-2.

Developed by *J. Young Sound Engineering Co.*, the kit comes with complete instructions. Free literature is available.

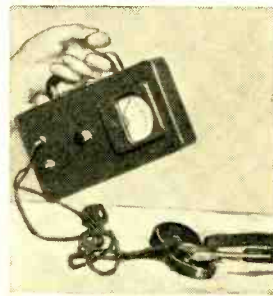

# POWER SUPPLY

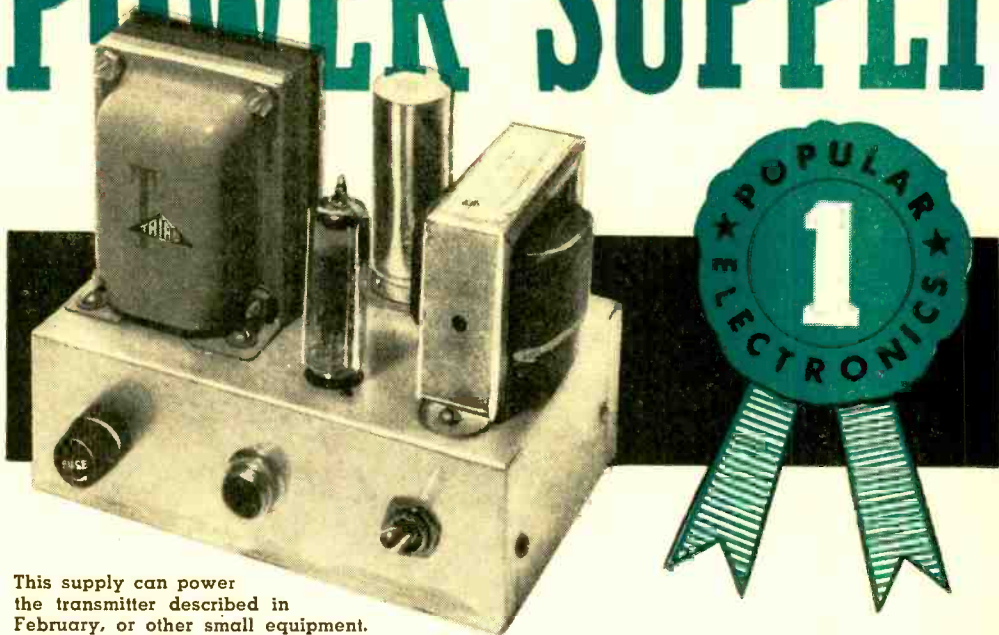

This supply can power the transmitter described in February, or other small equipment.

**T**HIS particular power supply has been designed specifically for use with the c.w. transmitter described in last month's issue. As was pointed out in the article, the transmitter could have been operated from batteries or from any power supply that provides the required voltage and current. For those who do not have such a unit, this power supply is being presented.

In going over the schematic diagram and parts list you will note that there are many components specified that are not quite the ultimate in design for this particular unit. Basically, the 6X4 tube is designed for a maximum of 70 ma. Therefore, the power transformer, filter chokes, etc. should have been selected with this value in mind. This certainly would have been possible if all the components were specially designed, as they are in commercial units. Since all of the components for this construction had to be readily available from parts distributors, some compromises were necessary. For example, the power transformer,  $T_1$ , could have been designed for 70 ma. However, the 65 ma. unit was the closest standard unit available. Similarly, filter choke  $CH_1$  could have been 70 ma. instead of the 85 ma. unit used.  $CH_2$  could also have been 70 ma. instead of 130 ma. A 5-watt bleeder resistor for  $R_1$  would have been large enough but the 20-watt unit was more readily available, so it was specified.

These points are brought out solely for the benefit of those who might like to design their own units. Needless to say, the parts chosen for the construction were selected on the basis of their availability as well as their suitability. This is just one of the necessary compromises that must be made in home-constructed projects.

Since the power transformer is designed for a maximum current of 65 ma. this value determines the maximum output current available from this supply. Do not under any condition operate it at a current drain higher than this value.

Note that a 35,000 ohm bleeder resistor,  $R_1$ , has been added across the output terminals. This is used solely to improve regulation. However, since the current drain through  $R_1$  is about 6 ma. at 210 volts it does restrict the usable current from this unit to about 59 ma.

It is suggested that when this power sup-

*Editor's Note: This is the first of a group of articles describing equipment that has been designed and built by our staff with a particular purpose in mind. In addition to its use with the c.w. transmitter described last month, we will, from time to time, cover other equipment with which this power supply can be used. Instead of publishing details on this power supply with each construction article to which it applies, we will simply make reference to this article. Reprints will be made available for readers who miss this particular construction article.*

Bottom view of the power supply, showing placement and wiring of parts. Note particularly choke  $CH_2$  and the bleeder resistor  $R_1$ .

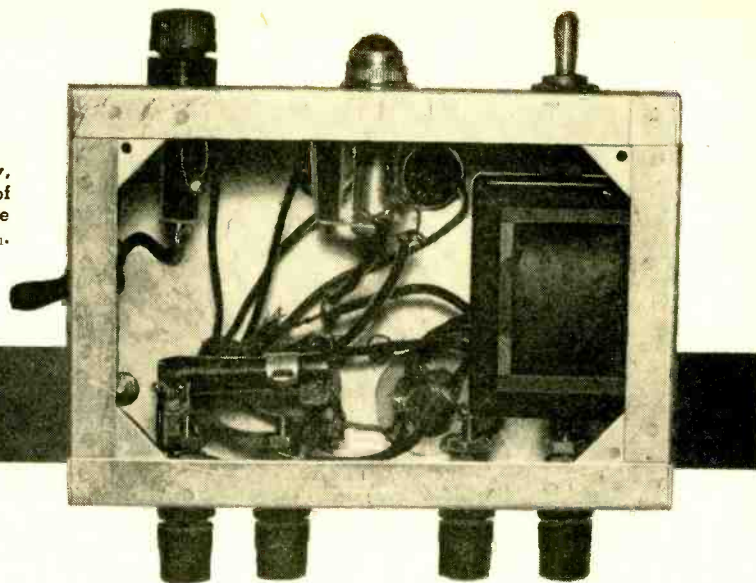

ply is used with the c.w. transmitter this bleeder resistor be omitted. Should you have a 0-100 ma. d.c. meter available you may check the current drain of the equipment that is to be operated. If it is less than 59 ma. it is advisable to put the bleeder in the circuit.

The 6.3 volt filament supply has been brought out to two terminals in the rear. The actual current drain of the 6X4 tube and the pilot light totals .75 ampere. Since the power transformer filament winding is designed for a maximum of 2.7 amperes, this allows 1.95 ma. at 6.3 volts that may be used for the operation of external equipment. Again, do not exceed this value. For those who are not able to check either or both voltages and currents it is suggested that your power supply be used without the bleeder resistor  $R_1$  to operate the c.w. transmitter described in last month's issue.

Construction of this unit is relatively simple. If you follow the schematic and pictorial diagrams you should encounter very little difficulty. There are a few points, however, which should be mentioned. The particular power transformer that was used has a 6.3 volt winding that has two strands of wires coming out for each lead. When hooking up these leads it is necessary to remove *all* of the enamel and twist the leads together securely before soldering. This is particularly true of the center-tap lead. Although it is not used, it is important that all of its wires are soldered together securely.

The second filter choke,  $CH_2$ , was placed under the chassis in the interests of compactness. It is a very tight fit and every precaution should be taken to make sure

that none of the other components or leads touch this unit. It is not a simple task to mount it in the chosen position, however, it will fit. The most difficult part, of course, is installing the necessary bolts and nuts for mounting purposes. With a little patience it can be done.

### How It Works

When transformer  $T_1$  is connected to 117 volts a.c., the 6.3 volt output is supplied by the low voltage secondary winding.

Production of the d.c. voltage is a bit more complicated. The voltage with which we start is approximately 117 volts a.c., alternating in polarity and varying in amplitude as shown by the waveform on the schematic diagram. To obtain 200 to 300 volts d.c. (of constant polarity and amplitude), we must go through three steps: increasing the voltage; changing the alternating polarity to a constant polarity; and changing the varying amplitude to a nearly constant amplitude.

The first step is performed by the transformer. Its high voltage secondary produces approximately 300 volts a.c. between the center-tap (ground) and each end of the winding.

The high a.c. voltage is applied between each plate of the rectifier tube,  $V_1$ , and ground in such a way that during each half of the a.c. cycle one plate is positive with respect to ground and the other is negative. Electrons can flow through a diode only from cathode to plate and only when the plate is positive with respect to the cathode. Electrons can flow through one section of tube  $V_1$  on one half-cycle and through the other section on the other half-



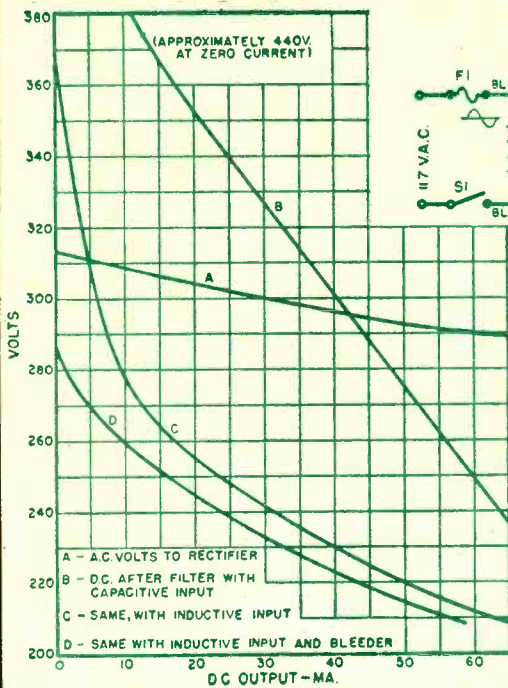

Regulation chart of the power supply. These curves show effect of current drain on a.c. voltage at rectifier tube plates and on d.c. output voltage for capacitor input filter and for choke input, with and without a bleeder.

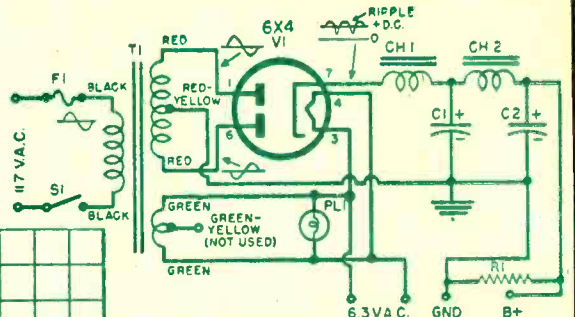

- R<sub>1</sub>—35,000 ohm, 20 w., wirewound res.
  - C<sub>1</sub>, C<sub>2</sub>—20/20  $\mu$ d., 450 v. elec. capacitor (Cornell-Dubilier 2245 in single can)
  - CH<sub>1</sub>—Filter choke, 8 hy., 85 ma., 250 ohms d.c. res. (Stancor C-1709)
  - CH<sub>2</sub>—Filter choke, 2.5 hy., 130 ma., 100 ohms d.c. res. (Stancor C-2303)
  - F<sub>1</sub>—3 amp. fuse and fuse mount (Buss Type AGC3 and Type HKP)
  - PL<sub>1</sub>—#47 pilot light and socket (Dialco Type 810B)
  - S<sub>1</sub>—S.p.s.t. toggle switch
  - T<sub>1</sub>—Power trans. 300-0-300 v. @ 65 ma.; 6.3 v. c.t. @ 2.7 amps. (Triad Type R-5A)
  - V<sub>1</sub>—6X4 tube
  - 1—4-point terminal strip
  - 1—7-pin miniature tube socket (Cinch Type 7EB)
  - 1—Line cord and plug
  - 4—Binding posts (Superior Type 30—two each of red and black)
  - 2—Rubber grommets
  - 1—Chassis, 6" long, 4" wide, 2" deep (Premier Metal Products ACH 431)
  - 2—4-40 screws and nuts for tube socket
  - other screws, nuts, wire, solder
- Approximate cost of all parts: \$18.00

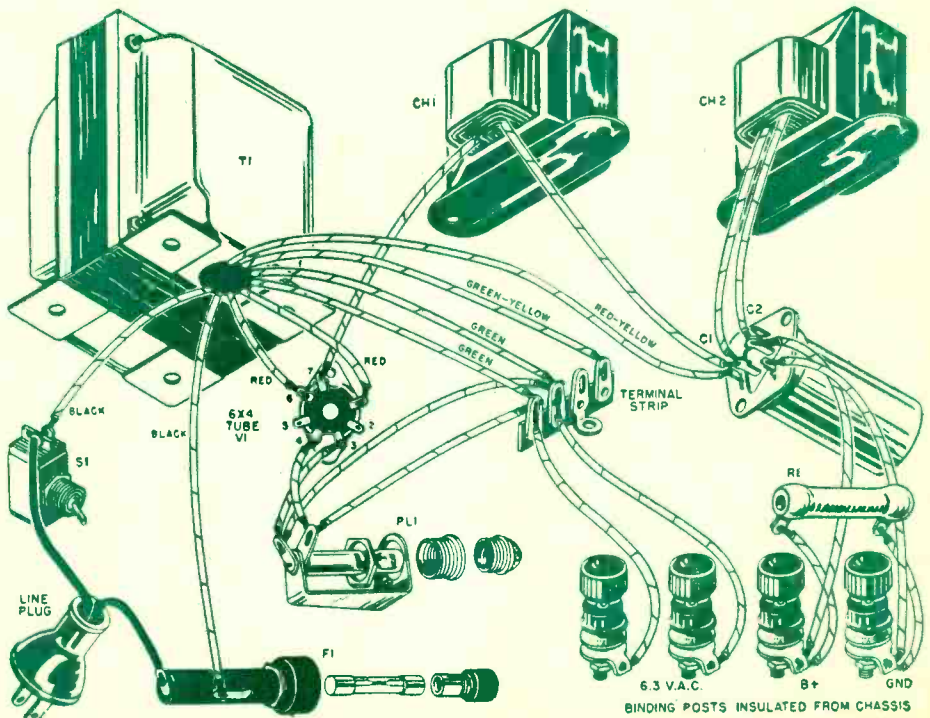

cycle. Therefore, electrons can flow at any time through  $R_1$  and/or the power supply load from ground to "B+", through  $CH_2$  and  $CH_1$  to the cathode of  $V_1$ , then to the positive plate of the tube. Since electrons cannot flow through the tube in the opposite direction, they cannot flow in the opposite direction through  $R_1$  and the load, so the output voltage has a constant polarity. However, without the filter ( $CH_1$ ,  $CH_2$ ,  $C_1$ , and  $C_2$ ) the amplitude would vary as indicated by the waveform at the cathode of  $V_1$ .

Capacitors tend to keep the voltage across their terminals constant and inductors oppose changes in current flowing through them. Therefore, when filter inductors ("chokes") are connected in series with a line and capacitors are connected across the line, they combine to reduce variations ("ripple" or "hum") in the output voltage.

A rectifier-type d.c. supply, like a battery,

delivers less voltage when more current is drawn from it. Increased current causes increased voltage drops in the transformer, rectifier, and filter chokes. The output voltage obtained and its variation with current drain also depend upon the filter arrangement used. A capacitor input filter (with a capacitor between rectifier cathode and ground) would give the result shown by Curve B on the regulation chart. Here, the output voltage is high, but it drops sharply with increased current drain. Such a large variation in voltage with load current is called poor regulation. With the filter as shown in the diagram, but without  $R_1$ , Curve C results. With choke input, the regulation is poorer than for capacitor input at low currents, but considerably better at high currents. With  $R_1$  in the circuit, even if the load draws very little current,  $R_1$  draws enough to give the improved regulation shown in Curve D. END

## CRYSTAL RECEIVER BUILT IN SOAPBOX

THIS crystal receiver (see schematic below) is built in an ordinary aluminum soapbox that measures  $3\frac{1}{2}'' \times 2\frac{1}{2}'' \times 2''$ . The headphone is mounted on the case so that the whole set may be held with the hand against the ear. The wire for antenna and ground can be coiled neatly and stored in

the box when the receiver is not in use.

Different stations are tuned in by adjusting the slug in the antenna coil. The coil can be peaked on the strongest station and left at this setting. Station interference can be eliminated by shortening the length of the antenna wire.

In some cases, a stronger signal will be heard if a .01  $\mu$ fd. capacitor is connected across the headphone terminals.

This diminutive receiver requires no power supply, is completely portable, and amazingly simple to build. The aluminum soapbox presents no problems in mounting the headphone, since a sharp knife will cut the box quite readily.

N. SCHEIN, K2ECD

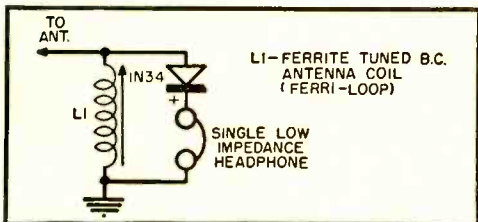

## LAMP FLASHER MADE FROM SURPLUS RELAY

SURPLUS relays can be wired up to turn themselves on and off periodically. This makes a good lamp flasher as well as an interesting experiment. Parts needed are a high-resistance relay, a selenium rectifier (to get the d.c. power required), a variable resistance, and a large electrolytic capacitor. The parts values given in the diagram give an oscillation frequency of about 1 cycle-per-second. Relay coil resistance is not critical, but it should be about 2000 ohms. The lower the coil resistance, the faster the oscillation. A larger capacitor gives a lower frequency.

Action is somewhat like that of a buzzer, but is also analogous to a neon tube relaxation oscillator (POPULAR ELECTRONICS, November 1954, p. 90). Current charges up capacitor  $C_1$  until there is enough voltage to pull the relay down. This breaks the circuit, but the charge stored in ca-

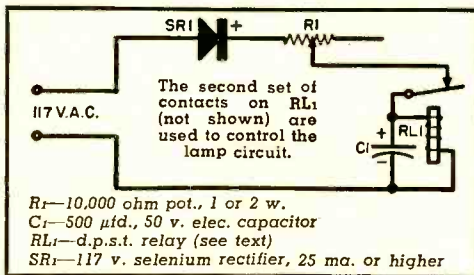

pacitor  $C_1$  holds it down for a moment, because the current required to keep the armature down is less than that needed to pull it down. Finally the armature drops back, and the cycle is repeated.

Any handy power pack of up to 300 volts d.c. can be used instead of the rectifier  $SR_1$ . For higher voltages, increase the resistance of  $R_1$  proportionately. L. F.

# An Automatic Light Switch for the Home



By LOUIS E. GARNER JR.

YOU won't have to worry about coming home to a dark house at night if you build an automatic light switch like the one described here. When a table or floor lamp is plugged into its receptacle, it will automatically turn the lamp on at night and off during the day.

The light switch is useful for discouraging prowlers and housebreakers, too. If you plan to be away from home on a vacation for a few days, you can plug a lamp into the light switch. Every night the light will go on and every day it will go off . . . just as if someone were in the house.

Compact, inexpensive, and easy to build, the light switch is an ideal "rainy day" project for the electronics hobbyist. Only two tubes are used, a type 921 phototube and a type 117L7 amplifier-rectifier.

The components you'll need to build your own light switch are given in the parts list. All the parts are standard and should be available at your nearest radio parts distributor. However, if you are unable to locate the parts locally, you can order them from one of the large mail order supply houses, such as the *Allied Radio Corpora-*

*tion*, 100 N. Western Avenue, Chicago 80, Illinois, or the *Radio Shack Corporation*, 167 Washington Street, Boston 8, Massachusetts.

## Construction

A small commercial aluminum chassis (*Bud* type CB-1617) measuring 4" x 3½" x 1" may be cut down and drilled and punched as shown. If you prefer, you can make up a chassis "from scratch" using sheet stock. Except for the phototube, the parts layout and hole locations are not critical. Simply place the relay and tube sockets on the small chassis to locate the mounting holes, arranging the phototube socket so the phototube will be close to the front of the case.

If you want to duplicate the model exactly, you can use a standard *Bud* "Minibox" measuring 3" x 4" x 5" for housing your unit. Locate the ¾" x 1½" rectangular hole directly in front of the phototube. Other hole locations are not critical.

Although finished in an attractive gray hammerloid enamel, the "Minibox" may be repainted to suit the color scheme in your



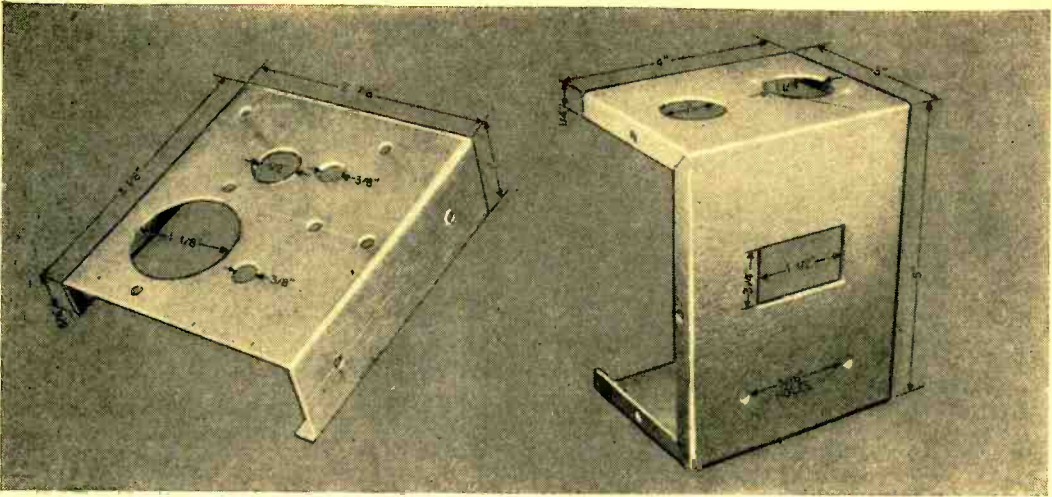

Subchassis for the Photoelectric Light Switch.

Case front. See text for "window" position.

home. Mount small rubber feet on the bottom of the case to prevent scratches on your tables.

On the other hand, if you don't want a metal case, you can assemble your own light switch in some other type of housing. Either a wooden cabinet or a plastic case is satisfactory. An ingenious builder might combine a table lamp and the automatic light switch in a single attractive unit.

However, regardless of the type of housing you use, be sure to provide adequate ventilation for the 117L7 tube and make sure that outside light can strike the phototube. In the model, ventilation is provided by a rectangular "pattern" of eight- $\frac{1}{8}$ " diameter holes drilled in the back and by a 1" "vent plug" in the top of the case.

Except for the connection to the line receptacle (mounted on the top of the case), all components and wiring are on the small chassis. Do all the chassis wiring first, following the schematic and pictorial wiring diagrams. Small machine screws and hex nuts are used for mounting the tube sockets and the relay. Use only *rosin core* solder when wiring the unit.

Lead "dress" is not critical. However, you should protect any bare leads with spaghetti tubing to avoid accidental shorts. Use rubber grommets for protection wherever leads pass through holes in the chassis or case.

Use temporary "lap" joints when installing  $R_3$ . The final value of this resistor will have to be determined experimentally after the unit is wired.

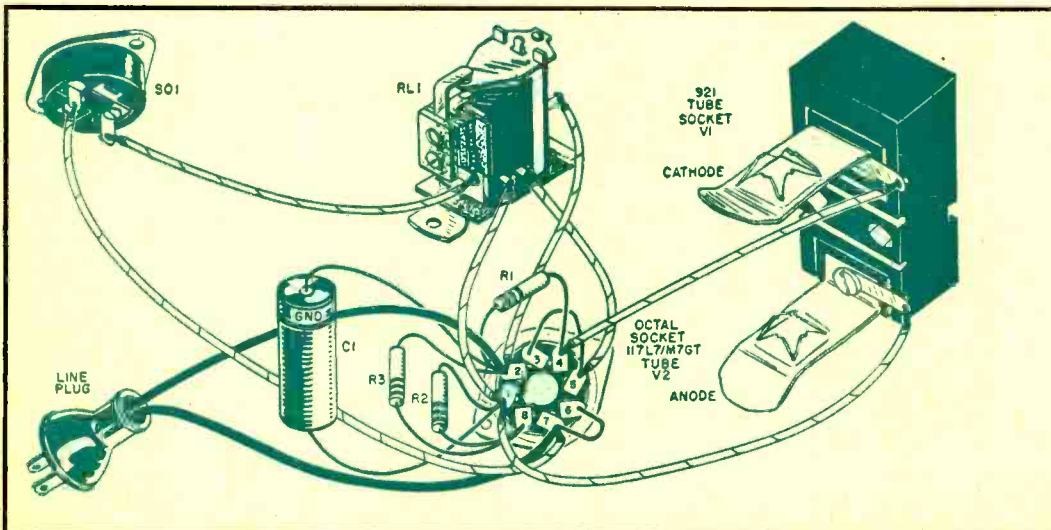

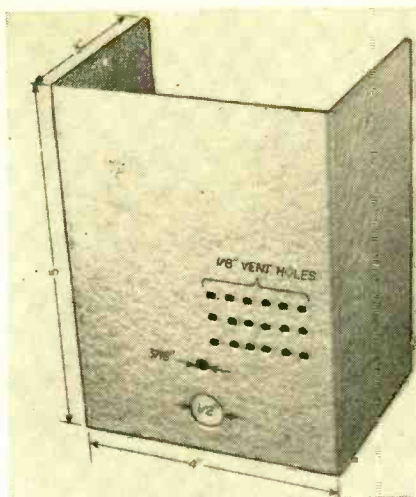

Rear of case for Photoelectric Light Switch.

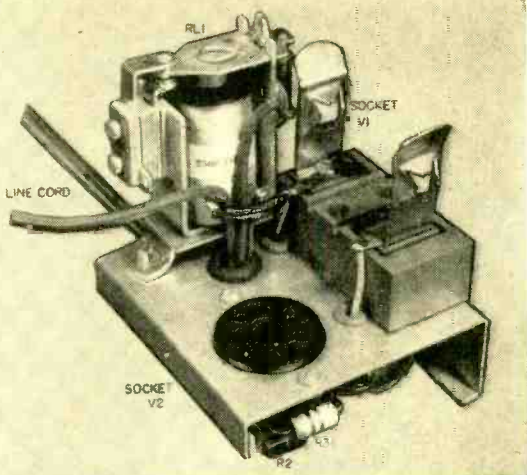

The subchassis, with parts mounted and wired.

When you've completed the chassis wiring and double-checked for errors, tape the leads to the line receptacle (making sure they don't accidentally short together). Plug the unit into a wall socket and allow several minutes warm-up. **CAUTION:** If a blue glow develops in the phototube when you plug the light switch in for the first time, pull the plug out immediately. The phototube has been installed backwards. Reverse the connections to the phototube.

Check the operation of the light switch by placing it where normal daylight (not direct sunlight) falls on the phototube. The relay should close. Darken the phototube

by placing a cardboard box over the unit; the relay should open.

If this action is not obtained, there is either an error in wiring, a defective component, or the value of  $R_3$  needs to be changed. Assuming the wiring to be right and all parts to be in good condition, you can determine the proper value for  $R_3$  very quickly.

Connect either a resistance substitution box or a 5000-ohm rheostat in place of  $R_3$ . Checking the unit for operation by alternately lighting and darkening the phototube, adjust the resistance until proper operation is obtained. The correct value for  $R_3$  will generally fall between 2700 and 4700 ohms. Once the proper value has been determined, install a fixed resistor.

If you prefer a control on sensitivity, you

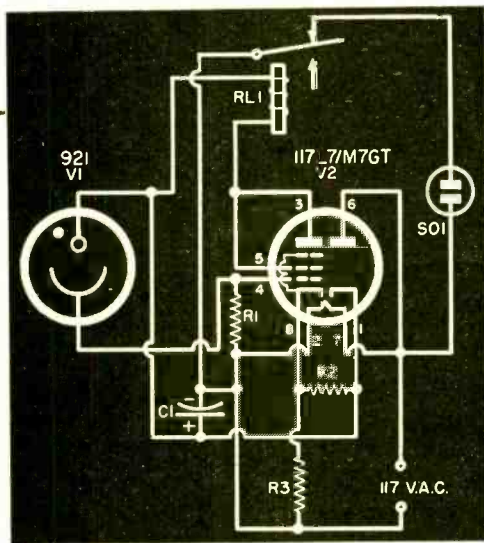

In wiring the switch, use the schematic with the pictorial wiring diagram. Note that none of the components are connected to chassis.

- $R_1$ —10 megohm,  $\frac{1}{2}$  w. carbon res.
- $R_2$ —10,000 ohm, 2 w. carbon res.
- $R_3$ —3900 ohm, 2 w. carbon res. (see text)
- $C_1$ —20  $\mu$ d., 150 v. tubular elec. capacitor
- $RL_1$ —2500 ohm coil plate relay, s.p.d.t. contacts (Potter & Brumfield type LB-5)
- $V_1$ —921 phototube
- $V_2$ —117L7/M7GT tube

Misc.—one octal socket; one phototube socket (Amphenol type 146-121); one a.c. line plug receptacle (Amphenol type 61-MIP-61F); line cord and plug; 1" vent plug; four rubber feet and mounting screws; small aluminum chassis (Bud #CB-1617); 3" x 4" x 5" metal box (Bud #CU-2105); one pkg. assorted rubber grommets; one pkg. assorted sheet metal screws; one pkg. assorted machine screws and nuts; wire, solder, spaghetti tubing, etc.

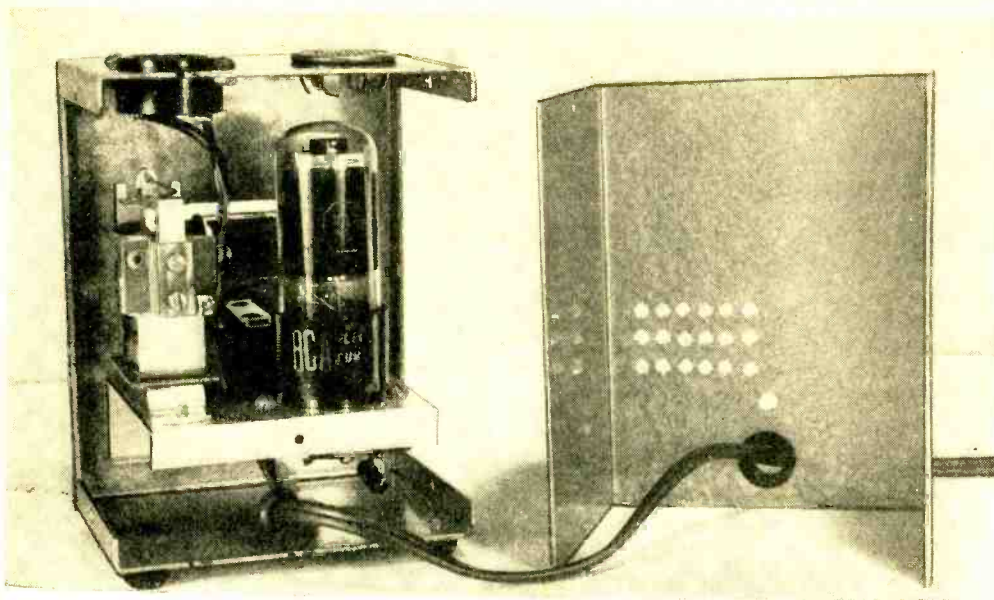

Automatic Light Switch after wiring, but before front and rear sections of cabinet are assembled.

can install a 5000-ohm rheostat in place of  $R_3$  as a permanent part of the circuit.

After the final value of  $R_3$  has been determined and this resistor permanently installed, the light switch chassis may be mounted in its case. Use either self-tapping or sheet metal screws for mounting the chassis. Lockwashers are not generally necessary.

### Applications

Once you've completed the assembly of your automatic light switch, you'll find many applications for it in addition to controlling a lamp in the home. Here are a few possibilities:

*Photo Darkroom:* Plug the safelight into the light switch. When the normal lights are turned out, the safelight comes on automatically.

*Store Windows:* Connected to control display lights, the unit will turn them on automatically at night or on cloudy days.

*"Morning Alarm":* Connected to a buzzer or bell and placed so the morning sun strikes the phototube, the light switch will wake you at "the crack of dawn." Of course, it may not sound the alarm till late on cloudy days, but most people like to sleep late on such days, anyhow. END



The Light Switch in use. The lamp is controlled by light passing through the window in the box.

# The Electronic Husband

By JEANNE DeGOOD

WHEN a man becomes interested in electronics, he becomes so tied down to his work that his wife can't pull him away from his workbench. Such wives could use the lessons learned in electronics to good advantage.

The simplest form of electric circuit is a man with work to be done, and resistance connected to his terminals (see Fig. 1).

This circuit is broken or opened when a connection is removed at any point. The connection to be broken is usually at a point between the husband and his workbench, and the wife who desires her husband to work needs only to break this connection.

A switch is a device that may be used to break such a connection. Its use is restricted largely to little boys, however, and it is seldom advisable in the case of husbands. It is therefore necessary to find a substitute for a switch, and in finding this substitute, wives may use Ohm's Law to good advantage:

$$I (\text{me}) = \frac{E (\text{he})}{R (\text{resistance})}$$

This can be stated as follows: The work that  $I$  (me) want done is directly proportional to what  $E$  (he) wants to do, and inversely proportional to his  $R$  (resistance) to the work.

At this point, it is necessary to find units of measurement. Thus:

$I$  = go to the grocery for me?

$E$  = no!

$R$  = ?

Therefore:

$$R (\text{resistance}) = \frac{E (\text{no!})}{I (\text{go?})}$$

In order to find the value of the "no!" as it applies to the resistance, the equation may be transposed:

$$E (\text{no!}) = I (\text{go?}) R (\text{resistance})$$

The simplest method of completing the equation at this point would be to remove the  $R$  (resistance). This may be done easily when the resistance happens to be a solder-

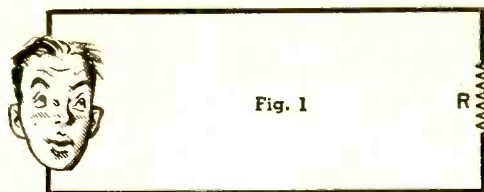
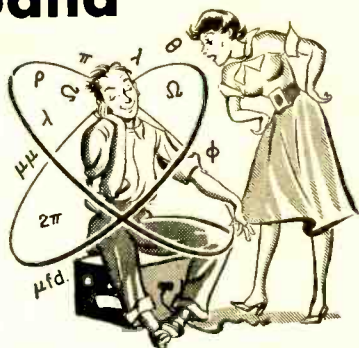

Fig. 1



ing gun, a tube tester, or a voltmeter. However, since the resistance in this case happens to be a workbench, removing the resistance might be a bit difficult for a 110-pound housewife.

It is obvious, therefore, that power and energy are the needed elements, and that another equation is now needed:

$$P = EI$$

This can be stated:  $P$  (power)—the rate of doing work—is equal to  $E$  (amount of energy required for the job) multiplied by  $I$  (the amount of interest in the job).

In this equation, *power* is measured in muscles, *energy* in vitamins, and *interest* in facial expressions. And since facial expressions indicate no interest in going to the grocery store, the equation may now read:

$$P (\text{power}) = E (\text{energy}) I (\text{interest}) \\ = E (\text{energy}) \times 0$$

It is now necessary to find the efficiency of the husband's  $E$  (energy):

$$\text{Eff.} = \frac{P_o}{P_i}$$

where:  $\text{Eff.}$  = amount of husband's useful energy

$P_o$  = power outside

$P_i$  = power inside

A quick glance shows us that  $P_o$  (power outside) may also be measured in muscles.  $P_i$  (power inside) must be measured in vitamins.

A quick glance shows that more  $P_i$  (power inside) must be supplied, so it is advisable at this point to add a piece of apple pie and a cup of coffee to the  $P_i$ . Thus:

$$\text{Eff.} = \frac{P_o}{P_i + P (\text{pie}) + C (\text{coffee})}$$

We have now arrived at the final equation:

$W$  (work—getting it done) =  $P$  (patience)  $\times$   $T$  (time), for the husband has now finished the work he was doing and is now ready to go to the grocery willingly. END

By JOHN T. FRYE



## GOING UP, UP, UP

IT WAS one of those unseasonably warm days that March often borrows from May and then pays back with a chilly day of its own during the latter month. Jerry Bishop was a victim of this nice weather. Instead of lolling comfortably on the leather-covered couch in his basement laboratory while his nimble mind toyed with some fascinating electronic problem, he found himself standing in the middle of a vast expanse of winter-littered front yard with a rake firmly grasped in his plump hands. Recalling the dark threats his father had made about what would happen if he came home that evening and discovered a single unraked square foot of that yard, the boy plied the rake vigorously.

As he engaged in this unaccustomed and—to his mind—unseemly exercise, Jerry reflected bitterly that any other time his pal and neighbor, Carl Anderson, would be around to provide Jerry with at least a fifty-fifty chance of inveigling his friend into helping; but Carl had not shown up all day. Like most jobs, though, once started it was not so bad. He had the yard more than half finished an hour later when Carl came dashing around the house with his dog, Bosco, in playful pursuit. Around and around the yard the boy and dog romped while Jerry leaned on his rake handle and looked at this reckless waste of energy with mild disapproval. Finally Carl threw himself on his back at full length in front of Jerry and let Bosco tug and worry at his pants leg while he looked up with a grin and said, "Well, Blubber Boy, how do you like doing a little physical labor for a change? I've been sitting up there with old Mr. Gruber in his room for the past hour watching you. It was an interesting study in slow motion."

"What were you talking to him about?" Jerry asked, ignoring the other remarks.

"I was *trying* to get him to tell me about his experiences with the Rough Riders. I always thought old people enjoyed talk-

ing about the past. Well, someone ought to explain this to Mr. Gruber. All he wants to talk about is flying saucers!"

"What about flying saucers?"

"He's read everything about 'em he can get hold of, and he has a stack of science-fiction magazines this high," Carl said as he suddenly elevated one powerful, lanky leg straight up in the air to show the height of the magazine stack, with Bosco, his eyes tightly shut, still clinging doggedly to the pants cuff. "Mr. Gruber's convinced the saucers contain people from Mars who are trying to raid the earth, and he keeps a loaded double-barrelled shotgun right by his bed to repel an invasion by day or night."

As Carl talked, Jerry walked slowly over to a silvered-ball lawn ornament and stared at it fixedly as he walked around it.

"Crystal gazing will get you nowhere," Carl jeered unsympathetically. "You may as well make with the rake, Jake."

"I was just noticing I could see you and Bosco reflected in this globe, no matter where you were playing with him," Jerry said with a thoughtful look on his round face.

"A fascinating bit of useless information," Carl remarked as he sat up and vigorously wiped his horn-rimmed glasses with a questionable-looking handkerchief.

"No information is useless," Jerry declared reprovingly. "This gives me an idea. TV signals move in straight lines much the same way light does. If we had a silvered ball like this mounted away up in the air where it would be in the direct line-of-sight of signals arriving from the station on Channel 6, sixty-five miles away, those signals would strike different points on the ball and be reflected down into every location in town, where TV antennas pointed right at the ball should provide excellent reception. A balloon with a metallic painted surface doubtless would serve just as well as the silvered ball. Even if such a spherical balloon moved around,



there would always be some point on its surface that would serve to reflect the signals down to a given antenna, just as there was always a point on this ball that reflected the light waves from you and Bosco to my eye."

"Well, since we don't have a balloon—" Carl suddenly stopped short and clapped a hand over his mouth.

"Hey! You know where there is a balloon!" Jerry accused excitedly.

"Me and my big mouth!" Carl exclaimed in disgust. "I just remembered that I have a rubber balloon six feet in diameter and a cylinder of compressed helium to inflate it. Dad picked them up at a war surplus store some time ago. I'm saving the balloon for amateur Field Day. Then I'm going to see how our portable club station transmitter can get out with a long wire vertical antenna."

"Aw, Carl, you don't want to wait until then to try out your balloon," Jerry wheedled. "Maybe that cylinder has enough helium in it to fill the balloon several times. Let's spray it with a coat of aluminum paint and see how my idea works tonight."

"We-l-l-l, I dunno," Carl said slowly, obviously weakening. "How high would it have to go, and what would we use to hold it? I was going to use wire out in the country, of course."

"Using wire on a balloon in town, around all the wires carrying high voltage electricity, would be about as healthy as rubbing noses with a cobra," Jerry observed. "I've got a roll of binder twine in the basement that will be just the stuff. As to how high we've got to go, let's see now . . ." He pulled a battered slide rule from his hip pocket and began working with it as he talked.

"I remember the formula for determining how far out you can see on the earth's surface from a high point, allowing only for the normal curvature of the earth.  $D = 1.23 \sqrt{H_t}$ , where  $D$  is the distance you can see in miles and  $H_t$  is the height of the viewing position—in this case the top of the transmitting antenna—in feet. Channel 6's tower is just about 1,000 feet; so we take the square root of that, which looks like 31.6, and multiply it by 1.23, and we get very, very close to 39 miles.

"Now we know the station is 65 miles away, and 39 from 65 leaves 26 miles as the distance our balloon must be able to 'see' if it is to establish what hams call 'eyeball contact' with the transmitting antenna. Substituting this in our formula gives us  $26 = 1.23 \sqrt{H_b}$ , where  $H_b$  is the needed height of the balloon in feet. Dividing both sides of the equation by 1.23 gives us about  $21.1 = \sqrt{H_b}$ . Squaring both sides

of this yields  $445 = H_b$ . In other words, our balloon should be around 450 feet in the air for line-of-sight reception. In actual practice, the height worked out by this formula can be decreased by a factor of from 1.25 to 1.35 to allow for the refraction that TV signals experience in the earth's atmosphere that ordinarily increase the 'virtual line-of-sight' distances beyond the true line-of-sight figures. Just to be safe, though, I think we'll stick to the figure worked out."

"Well, let's get going," Carl said as he sprang to his feet and vigorously brushed off the seat of his trousers.

"I'd like to," Jerry said wistfully, "but I've got to finish this yard first. Of course, if you were to get your rake and help. . . ."

"All right, all right!" Carl shouted over his shoulder as he hurdled the fence between his yard and Jerry's. "I might have known I'd be suckered into something if I came around while you had work to do, but maybe this will teach me a lesson. I'll be right back with the rake."

He was as good as his word, and the remainder of the yard was quickly finished. Carl's explosive energy made short work of the leaves and twigs—and even of some of the grass roots! As soon as the yard was done, both boys tossed their rakes aside and made a bee-line for Carl's garage. There Carl fished a long box out of an old trunk and opened it to reveal the limp carcass of a large yellow rubber balloon and a small metal cylinder of gas. It took only minutes to attach the two and open the valve. There was a great hissing sound, and the wrinkled envelope swelled and smoothed out into a beautiful golden sphere. Apparently the man who filled the cylinder calculated very nicely, for just as the balloon reached a diameter of rough-

(Continued on page 118)



# Ground that TV Antenna

By BRUCE C. VAUGHAN, JR.

Proper method of grounding a TV antenna tower. Note that clamps are used on both the ground rod and on the leg of tower itself.



*Protect your home from fire and your TV set from damage by taking the few simple precautions outlined by author.*

**A**NYTOWN U.S.A.: Early this morning the local Fire Department answered a call to the home of Mr. T.V. Watcher whose home suffered extensive damage from fire and smoke. A preliminary investigation as to the cause of the fire revealed an ungrounded TV antenna and it is believed that lightning hit the TV antenna, setting fire to the roof."

While this particular news item is purely fictitious, reports similar to this one appear all too often during the course of the year.

With plenty of stormy weather ahead as Spring rolls around, take time out now to check, or have checked, your television antenna system so that all hazards can be eliminated before it is too late.

A properly grounded and lightning protected antenna is essentially a form of lightning rod, but an ungrounded aerial is a definite fire hazard. Yet with a little time and effort, both home and television set can be protected from the dangers of lightning.

The ideas below indicate proper protection.

## Grounding Tower Type Antennas

There are more towers being installed now than ever before, and a survey of them reveals that many are not adequately grounded. This is due, in part, to the false assumption that if the tower is mounted on the ground instead of the roof, there is no danger from lightning. Actually, since most towers are set as close to the house as possible in order to keep the lead-in short, lightning can very likely damage a home if it hits an ungrounded tower. Even though a tower is set directly on the ground instead of the usual concrete base, a ground is still necessary.

The local hardware store or radio supply house can determine the length ground rod required in a specific locality. Drive the rod into the ground as near to the base of the tower as possible. Connect to the tower with number 6 or heavier wire. Be sure to use a ground clamp on one leg of the tower

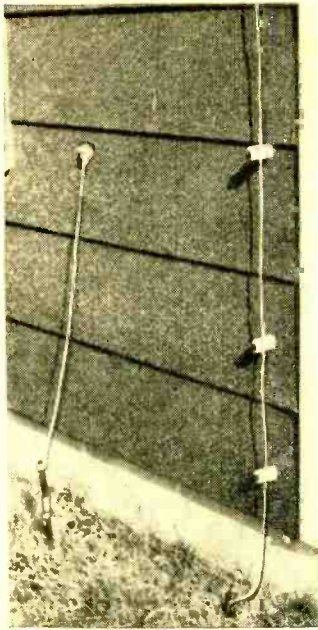

Ground coming down side of house from roof-mounted antenna. Ground wire at left goes to a radio receiver.

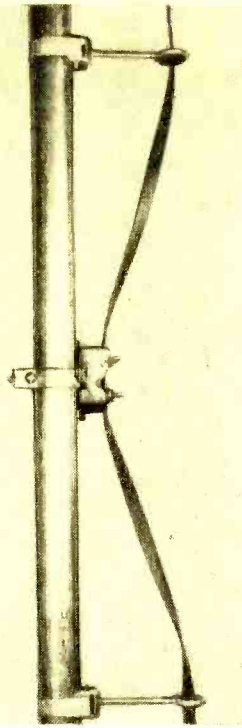

A mast-type lightning arrester. A stand-off insulator is placed above and below to keep lead intact.

Right (bottom) and wrong (top) method of tying the ground wire to ground rod. Always use clamp, as shown, on lower part of rod, never just a wrapped wire.

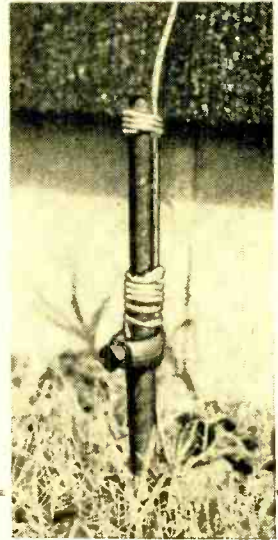

to obtain a good, firm electrical connection.

### Grounding Roof Mounted Antennas

In grounding a roof mounted antenna, either a ground rod of recommended length or, if available, a water pipe may be used. It is not wise to depend upon a wire wrapped around a pipe or ground rod for a good connection. A heavy ground clamp is made for this purpose and provides a cheap form of fire insurance. Number 6 aluminum wire is ideal for grounding roof mounted antennas. Secure the ground wire to the base of the mast with a clamp and make sure of good connections. The wire should be run along the roof and down the side of the house to ground. The wire may be attached to the side of the house with staples or, if you prefer, split knob type insulators.

### Lightning Arresters

Even though an antenna is properly grounded, a lightning arrester should be used to protect the television set from damage. Although lightning may not strike your antenna, it is possible to have a static discharge burn out the antenna coil in the set.

Two kinds of arresters are ordinarily used: the mast mounted type and the wall

mounted type. Either affords a good degree of protection.

Place the mast type arrester near bottom of the mast. Then place a stand-off insulator immediately above and below the arrester to keep the lead-in from being snapped by the wind where the teeth of the lightning arrester clamp the wire.

The wall mounted arrester is attached to the outside wall at the point where the lead-in makes its entrance into the house. Ground this arrester to a ground rod or water pipe and again take all precautions for a good connection.

### Damage Through The Power Lines

To be sure of protection, a television set should be unplugged from the wall outlet during thunderstorms or when no one will be at home for some time. If lightning should hit a power line near a specific home, it is going to be hunting a path to ground. A perfect route to ground is through that family's TV, up the lead-in, and down the ground wire. During the past five years, the author has installed over 400 TV antennas and there has not been one single case of lightning damage through the antenna.

END

# Build YOUR OWN HEATHKITS

INTERESTING—EDUCATIONAL



work has already been done for you. No cutting, drilling, or painting required. All parts furnished including tubes. Knowledge of electronics, circuits, etc., not required to successfully build Heathkits.

Heathkits are fun to build with the simplified easy-to-follow Construction Manual furnished with every kit. Only basic tools are required, such as soldering iron, long-nosed pliers, diagonal cutting pliers, and screwdriver. All sheet metal

New charcoal gray baked enamel panel with highly readable white lettering.

## New PRINTED CIRCUIT VACUUM TUBE VOLTMETER KIT

The VTVM is the standard basic voltage measuring instrument for radio and TV servicemen, engineers, laboratory technicians, experimenters, and hobbyists. Because of its extremely high input resistance (11 megohms) the loading effect on the circuit being measured, is virtually negligible. The entire instrument is easy to build from a complete kit, with a detailed step-by-step Construction Manual. Featured in this instrument is an easy-to-wire fool-proof printed circuit board which cuts assembly time in half.

**CIRCUIT AND RANGES:** Full wave AC input rectifier permits 7 peak-to-peak voltage ranges with upper limits of 4000 volts peak-to-peak. Just the ticket for you TV servicemen. Seven voltage ranges, 1.5, 5, 15, 50, 150, 500 and 1500 volts DC and AC RMS. Peak-to-peak ranges 4, 14, 40, 140, 400, 1400, and 4000 volts. Ohmmeter ranges X1, X10, X100, X1000, X10K, X100K, X1 meg. Additional features are a db scale, center scale zero position, and a polarity reversal switch.

**IMPORTANT DESIGN FEATURES:** Transformer operated—1% precision resistors—6AL5 and 12AU7 tubes—selenium power rectifier—individual AC and DC calibrations smoother improved zero adjust control action—new panel styling and color—new placement of pilot light—new positive contact battery mounting—new knobs—test leads included. Easily the best buy in kit instruments.

New peak-to-peak meter scale—new color harmony—new control knobs.

New printed circuit board for faster, easier construction—exact duplication of Laboratory development model.



Model V-7

**\$24<sup>50</sup>**

Shpg. Wt. 7 lbs.

New easy-to-read open panel layout. On-on switch incorporated in selector switch.

## Heathkit HANDITESTER KIT



MODEL M-1  
**\$14<sup>50</sup>**

Shpg. Wt. 3 lbs.

The Heathkit Model M-1 Handitester readily fulfills all requirements for a compact, portable volt-ohm-milliammeter. Its small size permits the instrument to be tucked into your coat pocket, tool box or glove compartment of your car. Always the "handitester" for those simple repair jobs. Packed with every desirable feature required in an instrument of this type. AC or DC voltage ranges, full scale 10, 30, 300, 1000 and 5000 volts. Ohmmeter ranges 0-3000 ohms and 0-300,000 ohms. DC milliammeter ranges 0-10 milliamperes and 0-100 milliamperes. Uses 400 microampere meter—1% precision resistors—hearing aid type ohms adjust control—high quality Bradley rectifier. Test leads are included.

## Heathkit MULTIMETER KIT



MODEL MM-1  
**\$26<sup>50</sup>** Shpg. Wt. 6 lbs.

Here is an instrument packed with every desirable service feature and all of the measurement ranges you need or want. High sensitivity 20,000 ohms per volt DC, 5000 ohms per volt AC. Has the advantage of complete portability through freedom from AC line—provides service ranges of direct current measurements from 150 microamperes up to 15 amperes—can be safely operated in RF fields without impairing accuracy of measurement.

Full scale AC and DC voltage ranges of 1.5, 5, 50, 150, 500, 1500, and 5000 volts. Direct current ranges are 150 microamperes, 15, 150, and 500 milliamperes and 15 amperes. Resistances are measured from .2 ohms to 20 megohms in three ranges and db range from -10 to +65 db. Ohmmeter batteries and necessary test leads are furnished with the kit.

**HEATH COMPANY**  
BENTON HARBOR 10, MICHIGAN

*New*

PRINTED  
CIRCUIT

# Heathkit 3" OSCILLOSCOPE KIT



Model  
OL-1

**\$29.50**

Shpg. Wt.  
15 lbs.

Ideal for individual home work or as extra instrument for outside servicing.

Compact size, light weight, portable — perfect for service work or field operation.

New, modern styling, gray panel with white lettering, light gray knobs and red — contrasting terminal blocks.

New printed circuit for constant performance, rugged component mounting — assembly time cut in half!

Measures only 11 3/4" x 6 3/4" x 10 1/2" and weighs only 11 pounds.

**USE:** This brand new Utility Scope was designed especially for servicemen and radio amateurs, and is adaptable for use in all general Scope applications. Perfect for modulation monitoring, etc. Use it to tackle alignment or adjustment problems. Equally valuable in breadboard work. A must for ham shack or for outside servicing.

**DESCRIPTION:** Front panel controls of the Model OL-1 are "bench tested" for ease of operation and convenience. Sharp focusing 3" CRT Printed circuit for ease of assembly and constant performance. Assembly time cut in half! High quality electronic components used. Sensitive hor and vert. amplifiers with broad freq. response; cathode follower for isolation. Push-pull hor. and vert. output to deflection plates. Int. 60 cycle, or ext. sync. Sweep freq. range 10-100,000 cycles. Direct connection to deflection plates. Provision for Z axis input. Uses 3GP1 CRT, 4-12AU7 hor. and vert. amplifiers, 1-12AX7 sweep gen., 1-6X4 LV rect., and 1-1V2 HV rect. The Heathkit Model OL-1 is a real standout value at only \$29.50, and is another example of the famous Heathkit combination: quality plus economy.

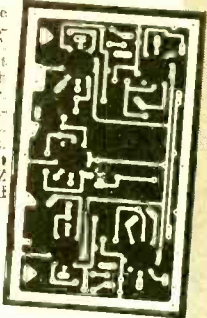

# Heathkit SIGNAL GENERATOR KIT

**USE:** This instrument is "serviceman engineered" to fill the requirement for a reliable basic service instrument at moderate cost. Frequency coverage extends in five bands from 100 Kc to 110 Mc on fundamentals, and dial is calibrated to 220 Mc for harmonics. Pre-wound and pre-aligned coils make calibration unnecessary for service applications.

**DESCRIPTION:** The Heathkit Model SG-8 Signal Generator provides a stable modulated or unmodulated RF output of at least 100,000 microvolts which can be controlled by both a continuously variable and a fixed step attenuator. Internal modulation is at 400 cycles, or can be externally modulated. AF output of 2-3 volts is also available for audio testing. Uses dual purpose 12AU7 as Colpitts RF oscillator and cathode follower for stable, isolated, low impedance output, and type 6C4 tube for 400 cycle oscillator. Operation of the SG-8 is well within the frequency limits normally required for service work. Modern styling features high definition white letters on charcoal gray panel with re-designed control knobs. Modern professional appearance and Heathkit engineering know-how combine to place this instrument in the "best buy" category. Only \$19.50 complete.

New, modern panel and knob styling — professional appearance and professional performance.

Broad frequency coverage — fundamentals from 100 KC to 110 MC in 5 bands — up to 220 MC on calibrated harmonics.

Cathode follower output for good isolation — fixed step and continuously variable attenuation.



Output selection — internal modulation, pure r.f., or audio output.

MODEL SG-8 **\$19.50** Shpg. Wt. 8 lbs.

# Heathkit ANTENNA IMPEDANCE METER KIT



MODEL  
AM-1

**\$14.50** Shpg. Wt. 2 lbs.

The Model AM-1 Antenna Impedance Meter makes an ideal companion unit for the GD-1B Grid Dip Meter or a valuable instrument in its own right. Perfect for checking antenna and receiver impedance and match for optimum system operation. Use on transmission lines, halfwave, folded dipole, or beam antennas. Will double as monitor or relative field strength meter. Covers freq. range of 0-150 Mc and impedance range of 0-600 ohms. Uses 100 microampere meter and special calibrated potentiometer. A real buy at only \$14.50 complete.

# Heathkit GRID DIP METER KIT



MODEL  
GD-1B

**\$19.50** Shpg. Wt. 4 lbs.

Amateurs and servicemen have proven the value of this grid dip meter many times over. Indispensable for locating parasitics, neutralizing, and aligning filters and traps in TV or Radio and for interference problems. The Model GD-1B covers from 2 Mc to 250 Mc with 5 pre-wound coils. Featuring a sensitive 500 microampere meter and phone jack, the GD-1B uses a 6AF4 or 6T4 tube. An essential tool for the ham or serviceman.

**ACCESSORIES:** Low freq. coverage to 355 KC with two extra coils and calibration curve. Set No. 341A for GD-1B and set No. 341 for GD-1A. Shipping weight 1 lb. Only \$3.00.

**HEATH COMPANY**  
BENTON HARBOR 10, MICHIGAN

# New

# Heathkit VFO KIT



MODEL VF-1

**\$1950**

Ship. Wt. 7 lbs.

- Smooth acting illuminated and precalibrated dial.
- 6AU6 electron coupled Clapp oscillator and OAZ voltage regulator.
- 7 Band coverage, 160 through 10 meters—10 Volt RF output.
- Copper plated chassis—aluminum cabinet—easy to build—direct keying.

Here is the new Heathkit VFO you have been waiting for. The perfect companion to the Heathkit Model AT-1 Transmitter. It has sufficient output to drive any multi-stage transmitter of modern design. A terrific combination of outstanding features at a low kit price. Good mechanical

and electrical design insures operating stability. Coils are wound on heavy duty ceramic forms, using Litz or double cellulose wire coated with polystyrene cement. Variable capacitor is of differential type construction, especially designed for maximum bandspread and features ceramic insulation and double bearings.

This kit is furnished with a carefully precalibrated dial which provides well over two feet of calibrated dial scale. Smooth acting vernier reduction drive insures easy tuning and zero beating. Power requirements 6.3 volts AC at .45 amperes and 250 volts DC at 15 mills. Just plug it into the power receptacle provided on the rear of the AT-1 Transmitter Kit. The VFO coaxial output cable terminates in plastic plug to fit standard 1/4" crystal holder. Construction is simple and wiring is easy.

Open layout — easy to build — simplified wiring.

Smooth acting illuminated dial drive.

Clean appearance — rugged construction — accessible calibrating adjustments.

Copper plated chassis—concrete slushings.

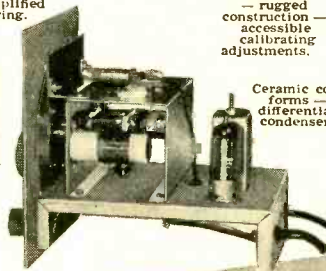

Ceramic coil forms — differential condenser.

# Heathkit AMATEUR TRANSMITTER KIT



MODEL AT-1

**\$2950**

Ship. Wt. 16 lbs.

### SPECIFICATIONS:

Range 80, 40, 20, 15, 11, 10 meters.  
 6AG7 ..... Oscillator-multiplier.  
 6L6 ..... Amplifier-doubler  
 6X4G ..... Rectifier.  
 105-125 Volt A.C. 50-60 cycles 100 watts. Size: 8 1/8 inch high x 13 1/8 inch wide x 7 inch deep.

Crystal or VFO excitation.

Here is a major Heathkit addition to the Ham radio field, the AT-1 Transmitter Kit, incorporating many desirable design features at the lowest possible dollar-per-watts price. Panel mounted crystal socket, stand-by switch, key click filter, A. C. line filtering, good shielding, etc. VFO or crystal excitation—up to 35 watts input. Built-in power supply provides 425 volts at 100 MA. Amazingly low kit price includes all circuit components, tubes, cabinet, punched chassis, and detailed construction manual.

Rugged, clean construction.

Single knob band switching.

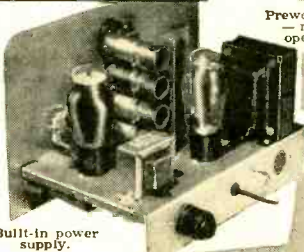

Prewound coils metered operation.

52 ohm coaxial output.

Built-in power supply.

# Heathkit COMMUNICATIONS RECEIVER KIT

RF Gain control with AVC or MVC.

Electrical bandspread and scale.

Stable BFO oscillator circuit.

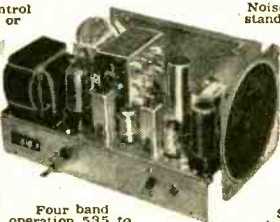

Four band operation 535 to 35 Mc.

Noise limiter—standby switch.

1/2 Inch PM Speaker-Headphone Jack.

Six tube transformer operation.

### SPECIFICATIONS:

Range.....535 Kc to 35 Mc  
 12BE6 ..... Mixer-oscillator  
 12AV6 ..... I. F. Amplifier  
 12BA6 ..... Detector—AVC—audio  
 12BA6 ..... B. F. O. oscillator  
 12A6 ..... Beam power output  
 6Y3GT ..... Rectifier  
 105-125 volts A.C. 50-60 cycles, 45 watts.

A new Heathkit AR-2 communications receiver. The ideal companion piece for the AT-1 Transmitter. Electrical bandspread scale for tuning and logging convenience. High gain miniature tubes and IF transformers for high sensitivity and good signal to noise ratio.

Construct your own Communications Receiver at a very substantial saving. Supplied with all tubes, punched and formed sheet metal parts, speaker, circuit components, and detailed step-by-step construction manual.



MODEL AR-2

**\$2550**

Ship. Wt. 12 lbs.

CABINET:

Proxylon impregnated fabric covered plywood cabinet. Shipp. weight 5 lbs. Number 91-10, \$4.50.

**HEATH COMPANY**  
 BENTON HARBOR 10, MICHIGAN





# THE WORLD AT A TWIRL

By K. R. BOORD

**I**N sending reception reports to short-wave stations for verification purposes, you'll find that airmail is much faster than ordinary mail—but it costs more. Have your letter weighed by the stamp clerk at your post office. He will then tell you the proper amount of airmail postage to affix to the envelope.

If you are positive that the station to which you are reporting does not require an International Reply Coupon (IRC) for return postage, you may wish to send your report on an airletter form (which costs only 10 cents at your post office and which is good via first-class airmail to any point in the world)—but you can not enclose anything.

Reports on postal cards are "definitely out" for verification requests to international short-wave broadcasters—simply because you can not give sufficient details on a card. However, a card might be used for later reports in which you do not ask for confirmation, especially if such further checks have been requested by the station.

"Form" reports are convenient but should be prepared carefully, and it is much better also to send along a friendly letter.

How long will it be before you receive a QSL? That is always the \$64 question! It may take weeks, months—or even years. A few stations have been known to QSL after two or three years. Normally, a reasonable time to wait for a reply is four to eight months. If no reply has been received at the end of that period, it would be a good idea to send a new report, if possible, and refer to the old one to advise the station that no answer was received.

Don't hesitate to send a fresh report at intervals. Some stations seem to have a habit of answering for a time, and then

stopping. This is especially true of Latin American broadcasters. Also, the station may be under new management and may have adopted a different policy.

Short-wave broadcasters fail to verify generally for one of two reasons: a poor report on the part of the SWL, or poor management on the part of the station. Some stations lack time, personnel, or funds for this purpose. Many will reply when they first take to the air, or when they have made a change of frequency or power, but then stop QSL'ing because they know how their station is being received and reports are no longer of much value to them. Others have their own monitors located in various parts of the world. Then, too, certain stations literally get "flooded under" with reports. And there are a few broadcasters which *have a definite policy of not verifying*. By and large, however—according to a survey I made not long ago—SWL's report that they receive approximately 75 per-cent verification from stations on the short-wave broadcast bands. Collecting verifications takes time and a little money—but it's great fun!

For information on what stations do or do not verify and for QRA's (addresses) of broadcasters, your best source would be the 1955 Edition of *World Radio Handbook*, compiled by O. Lund Johansen, Copenhagen, Denmark. The *English* version should be available now for \$2, postpaid, directly from the American agent, Gilfer Associates, Box 239, Grand Central Station, New York 17, New York.

For next month, I've asked certain monitors for POPULAR ELECTRONICS throughout the country to compile a list of "Best Bets" for the various geographical areas of the United States. In the meantime, here are this month's listening tips.

(NOTE: Unless otherwise stated, all time herein is expressed in Greenwich Mean Time—GMT—subtract 5 hours for EST, 6 for CST, 7 for MST, 8 for PST. This is on a 24-hour clock basis in which midnight is 2400 (or 0000). 3 a.m. is 0300, 10 a.m. is 1000, and noon is 1200, for example; instead of starting again at 1 p.m., as the 12-hour system does, the 24-hour system continues to increase the number of each hour until 2359 (11:59 p.m.) is reached, thus 1 p.m. is 1300, 5 p.m. is 1700, 10 p.m. is 2200.)

With regards to the terms "wavelength" and "frequency", wavelength is measured in meters. For every wavelength there is a corresponding frequency which

is the number of complete waves, or cycles, sent out by a transmitter every second. A "kilocycle" is 1000 cycles, a "megacycle" is 1000 kilocycles or 1,000,000 cycles. As a SWL you will be concerned primarily with megacycles (mc.). To convert megacycles to meters (m.) divide the frequency in megacycles into 300. For example, 6 mc. divided into 300 gives you 50 m. (wavelength) and, conversely, 50 m. (wavelength) divided into 300 gives you 6 mc (frequency).

The letters "A" and "V" which sometimes appear after the frequencies mean "approximate" and "varying." A station that "varies" may operate above or below the frequency listed.



## For Beginners

**Angola**—Radio Angola, 11.862A, Luanda, plays interval signal of steady native drum beats, clock striking sequence, and "A Portuguesa" preceding actual sign-on at 1830; runs to 2230 closedown.

**Australia**—VLA11, 11.760, is now used by Radio Australia to western North America 0255-0415, while VLB9 is now on 9.540, replacing 9.615, for the eastern North American beam 1200-1345. DX sessions are Sundays at 0400 over 11.760 and 1330 over 9.540. The DX sessions offer many valuable current tips for the SWL.

**Canada**—Eastern listeners will find a good signal from CJCX, 6.010, Sydney, Nova Scotia, at 1130 in a summary of the overnight news, beginning with a weather forecast for Cape Breton. The Latin American Service of CBC at 2350-0400, with English at 0230-0300, is scheduled over CHOL, 11.720, and CKLO, 9.630.

**Ceylon**—In West Virginia, the Commercial Service of Radio Ceylon, 9.520, Colombo, is at good level, with a little QRM from U. S. "powerhouse" on the low-frequency side at 1245 when English news is presented. It has good music and many commercials. Try for this one!

**China**—English periods from Radio Peking are heard in California as follows: at 0300-0330 on 15.060, 15.100, 11.650, 11.330, 11.960, 9.663; at 0900-0930 on 9.663, 11.330, 11.650, 15.100, 15.060; and at 1430-1500 over 15.060, 11.330, 11.650, 9.663, 9.080. East Coast listeners should try for Radio Peking

on 11.330, parallel 11.650 (this one usually is almost buried in CW QRM) around 2200-0130 and again around 1200-1500.

**Egypt**—Radio Cairo, 9.475, now opens 1800 (instead of former 1820).

**El Salvador**—YSS, 9.555, San Salvador, closes 0410A; all-Spanish.

**England**—When this was compiled, the BBC was radiating its North American Service to Canada-USA at 1500-1715, 15.360; 1800-1915, 11.930 (Monday-Friday); 1915-2045, 9.825 (Monday-Friday); 2045-2215, 9.825; 2115-2215, 6.110. The General Overseas Service was beamed on Canada, USA, Mexico at 2215-0030, 9.825; 2215-0030, 9.560; 2215-0300, 6.110, and 0430-0615, 6.110.

**Germany**—The Voice of Germany, Cologne, has good signal on West Coast at 1530 on 9.640 when presents news in English—parallel with 11.795.

**Guatemala**—TGWA, 9.760, opens around 1228 with anthem, identification is given in Spanish; strong level in West Virginia.

**Haiti**—Radio Haiti has been logged on measured 6.216 around 2300. On Thursdays it should have an English session—"Musical Caravan"—from around 0300 or 0315 to 0345A closedown. At other times it uses mostly French.

**Holland**—For English from Radio Nederland, tune 11.730 around 2145-2230; and at 0230-0310 try 6.025.

**India**—Easterners should tune 9.840 at 1330-1445 for All India Radio's beam in English (news 1335) to Asia. Good level  
(Continued on page 116)

QSL cards are displayed to advantage in an inexpensive album by the use of art corners. This enables them to be removed safely. Note "Verified All Continents" page at left.



The Model  
TV-50

# GENOMETER

A versatile all-inclusive GENERATOR which provides ALL the outputs for servicing:

**A. M. Radio    F. M. Radio    Amplifiers    Black and White TV    Color TV**

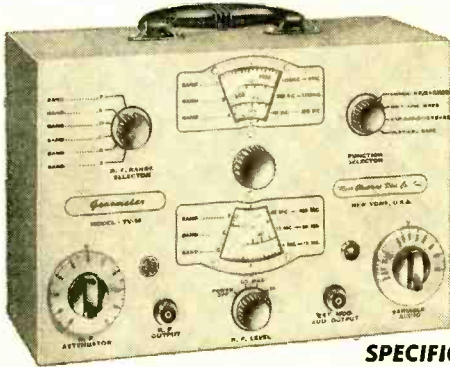

## 7 Signal Generators in One!

- ✓ R. F. Signal Generator for A.M.
- ✓ R. F. Signal Generator for F.M.
- ✓ Audio Frequency Generator
- ✓ Bar Generator
- ✓ Cross Hatch Generator
- ✓ Color Dot Pattern Generator
- ✓ Marker Generator

### SPECIFICATIONS:

#### R. F. SIGNAL GENERATOR:

The Model TV-50 Genometer provides complete coverage for A.M. and F.M. alignment. Generates Radio Frequencies from 100 Kilocycles to 60 Megacycles on fundamentals and from 60 Megacycles to 180 Megacycles on powerful harmonics. Accuracy and stability are assured by use of permeability trimmed Hi-Q coils. R.F. is available separately, modulated by the fixed 400 cycle sine-wave audio or modulated by the variable 300 cycle to 20,000 cycle variable audio. Provision has also been made for injection of any external modulating source.

#### VARIABLE AUDIO FREQUENCY GENERATOR:

In addition to a fixed 400 cycle sine-wave audio, the Model TV-50 Genometer provides a variable 300 cycle to 20,000 cycle peaked wave audio signal. This service is used for checking distortion in amplifiers, measuring amplifier gain, trouble shooting hearing aids, etc.

#### BAR GENERATOR:

This feature of the Model TV-50 Genometer will permit you to throw an actual Bar Pattern on any TV Receiver Screen. Pattern will consist of 4 to 16 horizontal bars or 7 to 20 vertical bars. A Bar Generator is acknowledged to provide the quickest and most efficient way of adjusting TV linearity controls. The Model TV-50 employs a recently improved Bar Generator circuit which assures stable never-shifting vertical and horizontal bars.

#### CROSS HATCH GENERATOR:

The Model TV-50 Genometer will project a cross-hatch pattern on any TV picture tube. The pattern will consist of non-shifting, horizontal and vertical lines interlaced to provide a stable cross-hatch effect. This service is used primarily for correct ion trap positioning and for adjustment of linearity.

#### DOT PATTERN GENERATOR (For Color TV)

Although you will be able to use most of your regular standard equipment for servicing Color TV, the one addition which is a "must" is a Dot Pattern Generator. The Dot Pattern projected on any color TV Receiver tube by the Model TV-50 will enable you to adjust for proper color convergence. When all controls and circuits are in proper alignment, the resulting pattern will consist of a sharp white dot pattern on a black background. One or more circuit or control deviations will result in a dot pattern out of convergence, with the blue, red and green dots in overlapping dot patterns.

#### MARKER GENERATOR:

The Model TV-50 includes all the most frequently needed marker points. Because of the ever-changing and ever-increasing number of such points required, we decided against using crystal holders. We instead adjust each marker point against precise laboratory standards. The following markers are provided: 189 Kc., 262.5 Kc., 456 Kc., 600 Kc., 1000 Kc., 1400 Kc., 1600 Kc., 2000 Kc., 2500 Kc., 3579 Kc., 4.5 Mc., 5 Mc., 10.7 Mc. (3579 Kc. is the color burst frequency.)

The Model TV-50 comes absolutely complete with shielded leads and operating instructions. Only

**\$47<sup>50</sup>**  
NET

# SHIPPED ON APPROVAL NO MONEY WITH ORDER — NO C. O. D.

Try it for 10 days before you buy. If completely satisfied then send \$11.50 and pay balance at rate of \$6.00 per month for 6 months. **No Interest or Finance Charges Added!** If not completely satisfied return unit to us, no explanation necessary.

MOSS ELECTRONIC DISTRIBUTING CO., INC.

Dept. D-103 3849 Tenth Ave., New York 34, N.Y.

Name.....

Address.....

City.....Zone....State.....

Please rush one Model TV-50. I agree to pay \$11.50 within 10 days and to pay \$6.00 per month thereafter. It is understood there will be no finance, interest or any other charges, provided I send my monthly payments when due. It is further understood that should I fail to make payment when due, the full unpaid balance shall become immediately due and payable.



Superior's new  
Model 670-A

# SUPER METER

A COMBINATION VOLT-OHM MILLIAMMETER PLUS  
CAPACITY REACTANCE INDUCTANCE AND DECIBEL MEASUREMENTS

**SPECIFICATIONS:**

**D.C. VOLTS:** 0 to 7.5/15/75/150/750/1,500/7,500 Volts  
**A.C. VOLTS:** 0 to 15/30/150/300/1,500/3,000 Volts  
**OUTPUT VOLTS:** 0 to 15/30/150/300/1,500/3,000 Volts  
**D.C. CURRENT:** 0 to 1.5/15/150 Ma. 0 to 1.5/15 Amperes  
**RESISTANCE:** 0 to 1,000/100,000 Ohms 0 to 10 Megohms  
**CAPACITY:** .001 to 1 Mfd. 1 to 50 Mfd. (Good-Bad scale for checking quality of electrolytic condensers.)  
**REACTANCE:** 50 to 2,500 Ohms 2,500 Ohms to 2.5 Megohms  
**INDUCTANCE:** .15 to 7 Henries 7 to 7,000 Henries  
**DECIBELS:** -6 to +18 +14 to +38 +34 to +58

**ADDED FEATURE:**

**Built-in ISOLATION TRANSFORMER**  
reduces possibility of burning out meter through misuse.

The Model 670-A comes housed, in a rugged crackle-finished steel cabinet complete with test leads and operating instructions.

**\$2840**  
NET



Superior's new  
Model TV-11

# TUBE TESTER

**SPECIFICATIONS:**

- ★ Tests all tubes including 4, 5, 6, 7, Octal, Lock-In, Peanut, Bantam, Hearing Aid, Thyatron Miniatures, Sub-miniatures, Novals, Sub-minars, Proximity fuse types, etc.
- ★ Uses the new self-cleaning Lever Action Switches for individual element testing. Because all elements are numbered according to pin-number in the RMA base numbering system, the user can instantly identify which element is under test. Tubes having tapered filaments and tubes with filaments terminating in more than one pin are truly tested, with the Model TV-11 as any of the pins may be placed in the neutral position when necessary.
- ★ The Model TV-11 does not use any combination type sockets. Instead individual sockets are used for each type of tube. Thus it is impossible

to damage a tube by inserting it in the wrong socket.

- ★ Free-moving built-in roll chart provides complete data for all tubes.
- ★ Newly designed Line Voltage Control compensates for variation of any Line Voltage between 105 Volts and 130 Volts.
- ★ **NOISE TEST:** Phone-jack on front panel for plugging in either phones or external amplifier will detect microphonic tubes or noise due to faulty elements and loose internal connections.

The Model TV-11 operates on 105-130 Volt 60 Cycle A.C. Comes housed in a beautiful hand-pubbed oak cabinet complete with portable cover

**EXTRA SERVICE**—The Model TV-11 may be used as an extremely sensitive Condenser Leakage Checker. A relaxation type oscillator incorporated in this model will detect leakages, even when the frequency is one per minute.

**\$4750**  
NET



SUPERIOR'S NEW MODEL TV-40

# C.R.T. TUBE TESTER

- ★ A complete picture tube tester for little more than the price of a "make-shift" adapter!!

- ★ Tests all magnetically deflected tubes . . . in the set . . . out of the set . . . in the carton!!

The Model TV-40 is absolutely complete! Self-contained, including built-in power supply, it tests picture tubes in the only practical way so efficiently test such tubes; that is by the use of a separate instrument which is designed exclusively to test the ever increasing number of picture tubes!

**EASY TO USE:**

Simply insert line cord into any 110 volt A.C. outlet, then attach tester socket to tube base (Ion Trap Need Not Be on Tube). Throw switch up for quality test . . . read direct on Good-Bad scale. Throw switch down for all leakage tests.

- Tests ALL magnetically deflected picture tubes from 7 inch to 30 inch types.
- Tests for quality by the well established emission method. All readings on "Good-Bad" scale.
- Tests for inter-element shorts and leakages up to 5 megohms.
- Tests for open elements.

Model TV-40 G.R.T. Tube Tester comes absolutely complete—nothing else to buy. Housed in round cornered, molded bakelite case. Only

**\$1585**  
NET

**SHIPPED ON APPROVAL  
NO MONEY WITH ORDER—NO C.O.D.**

Try any of the above instruments for 10 days before you buy. If completely satisfied then send down payment and pay balance as indicated on coupon. No Interest or Finance Charges Added! If not completely satisfied return unit to us, no explanation necessary.

**MOSS ELECTRONIC DISTRIBUTING CO., INC.**  
Dept. D-103, 3849 Tenth Ave., New York 34, N. Y.

Please send me the units checked. I agree to pay down payment within 10 days and to pay the monthly balance as shown. It is understood there will be no finance, interest or any other charges, provided I send my monthly payments when due. It is further understood that should I fail to make payment when due, the full unpaid balance shall become immediately due and payable.

Model 670-A.....Total Price \$28.40  
\$2.40 within 10 days. Balance \$3.50 monthly for 6 months.      Model TV-11.....Total Price \$47.50  
\$1.50 within 10 days. Balance \$6.00 monthly for 6 months.      Model TV-40.....Total Price \$15.85  
\$3.85 within 10 days. Balance \$4.00 monthly for 6 months.

Name.....  
Address.....  
City..... Zone... State.....

# HERSHEL'S "KIT" SPECIALS

**ALL-PURPOSE FIL. TRANSFORMER**  
For Model Trains, Welding, Transmitters, etc.  
PRI. 117 v. 60 cyc. sec.  
6.4 v. .... 12A  
6.4 v. .... 10A  
5 v. .... 3A  
5 v. .... 3A  
5 v. .... 3A  
2.5 v. .... 1.75A

**\$495**

## MYSTERY PACKAGE ELECTRONIC PARTS

The Surprise of Your Life  
25 pounds of Worth \$50.  
BRAND NEW Our Price  
USABLE GOVT. **\$495**  
S U R P L U S .  
Ideal gift for the ham, etc.

### KIT 1. HARDWARE

Over 1,000 pieces. 2½ lbs. of assorted RADIO & TV HARDWARE.

**\$149**

### KIT 5. RESISTORS

100 ASSORTED TYPES. Range from 1 ohm to 15 meg. ½ to 5 watt.

**\$198**

### KIT 2. CERAMICONS

100 ASSORTED. ED. Range from .75 mmfd. to 6,000 mmfd.

**\$350**

### KIT 6. R.F. CHOKES

25 ASSORTED. Range from .5 mh. to 25 mh.

**\$195**

### Kit 3. Volume Controls

25 ASSORTED Range from 2 ohm to 3 meg. Some with switch.

**\$475**

### KIT 7. TOGGLE & SLIDE SWITCHES

25 ASSORTED. DPST, DPDT, SPST, etc.

**\$495**

### Kit 4. Rotary Switches

25 ASSORTED TYPES. A Real Buy at only...

**\$475**

### KIT 8. PAPER & CAN CONDENSERS

25 ASSORTED. Range from 4 mfd. 150 v. to 80 mfd. 450 v.

**\$350**

## FIND YOUR KIT PARTS HERE FOR POPULAR ELECTRONICS KITS

- TRANSFORMER—Pri. 110 V. 60 Cy. Sec. 6.3 V. 1 Amp. 95c
- TRANSFORMER—Pri. 110 V. 60 Cy. Sec. 400 VCT. 6.3 V. 1 Amp. 5 V. 2 Amp. 20 Ma. \$1.49
- SCOPE TRANSFORMER—Pri. 110 V. 60 Cy. Sec. 4000 V. 10 Ma. \$2.95
- TRANSFORMER—Pri. 110 V. 60 Cy. Sec. 600 VCT. 6.3 V. 3 Amp. 5 V. 2 Amp. 70 Ma. \$2.45
- RELAY D.P.D.T.—110 VAC. 8 Amp. contacts \$1.69
- RELAY D.P.D.T.—3 VDC. 11 ohm coil cont. 1.5 Amp. 110 V. Gold Plated 95c
- KEY—J38 Telegraph key 95c
- LIP MIKE—With Head band cord and switch \$1.29
- CHOKE—2.5 Mh. 125 Ma. 35c
- CHOKE—1.5 Mh. 100 Ma. 15c
- COIL—Plug in type 4, 5, 6, Prong Type 29c
- OUTPUT TRANSFORMER—6V6 to 3.2 Voice Coil 39c
- OUTPUT TRANSFORMER—P.P. 6V6 to 3.2 Voice Coil 59c
- OUTPUT TRANSFORMER—50L6 to 3.2 Voice Coil 35c
- CHOKE—AC-DC. Type. 8 H. 80 Ma. 49c
- COIL—Ignition Type. Pri. 3 V. Sec. 15,000 VDC. Ideal for Photo Flash Triggering \$1.29
- GLOW-LITE—2½ Watt Argon Lite 110 VAC. 29c
- MOTOR—From Gun Camera 24 VDC. Will Run on 110 VAC. 95c
- CABINET—RCA Speaker Cabinet. Plastic for 8 inch Round Speaker \$1.95
- RHEOSTAT—30 ohm 50 Watt 95c

## HI GAIN DYNAMIC MIKE KIT

Uses UTC. Transformer and Western Electric Mike. Ideal for Hams, PA. CAP, Recording, Mobile Equip.

—50 DB/80-7500 CPS.  
Diagram Furnished

**\$195**

## HERSHEL RADIO CO.

5245 Grand River, Detroit 8, Mich.

ALL ITEMS SHIPPED F.O.B. DETROIT

Terms: Cash with order or 25% DOWN—Balance will be shipped C.O.D.

## UNIQUE CRYSTAL RECEIVER

**M**OST crystal sets have a high impedance output, but this one will operate with headphones that may vary from as low as 200 ohms and up with little difference in volume. The author has operated a 3-inch PM speaker using a doorbell transformer as a matching transformer, with the primary connected in place of the headphones.

$L_2$  consists of 15 turns of almost any small size wire wound over the top of  $L_1$ , a Ferri-Loopstick antenna coil. Less than 15 turns will provide more selectivity but less volume. Any antenna trimmer with a suitable range may be used, such as *El Menco* type 465 which has a range from 50 to 380  $\mu$ fd.

Experimenters can substitute the following detector in place of the crystal.

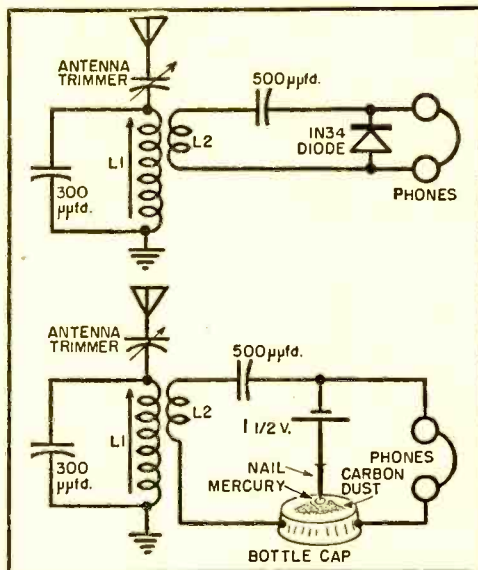

Schematic and modifications possible in set. See text for explanation of parts.

Scrape the paint from the top of a bottle cap (steel). Remove the carbon from a used flashlight battery cell and scrape a small pile of it on top of the bottle cap. In the center of the carbon dust, place a small drop of mercury. Make contact to the mercury with a common pin or small nail. A flashlight battery (1½ volts) is connected as shown. Polarity is not important. Current drain is small. A rusty nail will provide an extra and undesirable rectifying surface, between the rust (iron oxide) and the nail itself, so use a clean nail.

The carbon microphone used in telephone handsets will also work as a detector in series with a 1½-volt battery. This detector will not work well in high impedance circuits.

MAYNARD KERNAHAN

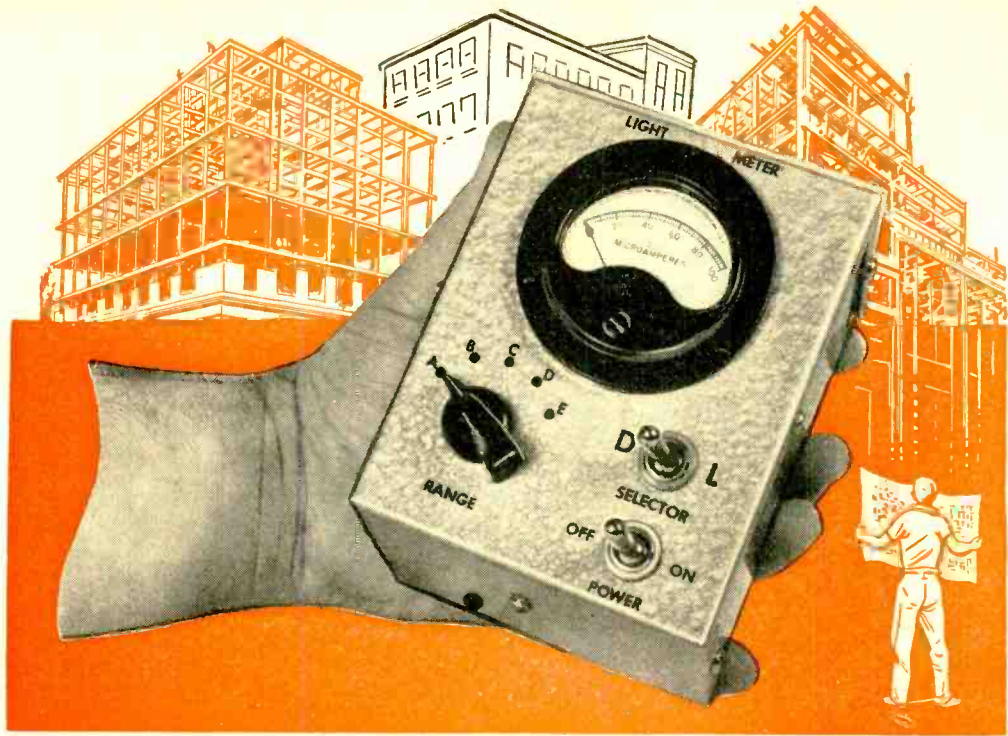

## A Transistor Operated Light Meter

*Its basic application is as an illumination meter—it has greater sensitivity than a conventional exposure meter.*

**L**IGHT METERS are widely used by architects, electrical engineers, industrial engineers, and similar groups for determining illumination levels in buildings, to assist in selecting lighting fixtures and their locations, and in choosing ceiling and wall finishes and paints. Similar instruments, but with different calibrations, are used by both amateur and professional photographers as *exposure meters*.

The basic light meter consists of a self-generating (barrier type) selenium photocell directly coupled to a sensitive microammeter. Since meter deflection depends solely on the current generated by light falling on the photocell, the sensitivity of such instruments is fairly limited. Many of the instruments give very little or no indication where low light levels are encountered, and are of limited value in comparing small changes in light intensity.

However, it is possible for the average electronic experimenter or technician to construct a light meter having several

times the sensitivity of most commercial units.

The increased sensitivity of the instrument shown is attributable to the use of a junction transistor as a direct-current amplifier between the selenium photocell and the microammeter.

Referring to the schematic diagram, consider that the "Dark-Light" selector switch,  $S_1$ , is in the "Light" position and that the "Power" switch,  $S_2$ , is closed.

With no light falling on the photocell, little or no base-emitter current flows, and the collector current is low. The collector current divides between the meter and the "meter shunt" resistor selected by "Range" switch,  $S_3$ —"open",  $R_2$ ,  $R_3$ ,  $R_4$  and  $R_5$ . Thus, the meter reading depends both on the amplitude of the collector current and upon which of the shunt resistors is selected.

The "no light" collector current may vary widely, depending on the individual characteristics of the selenium photocell and the transistor used. With the "Range" switch

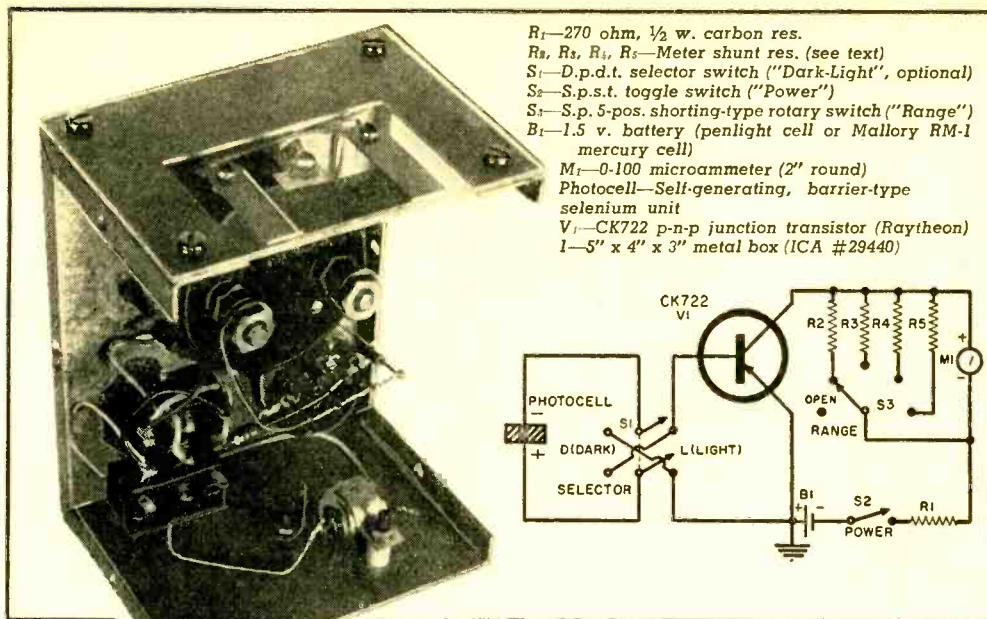

- $R_1$ —270 ohm,  $\frac{1}{2}$  w. carbon res.
- $R_2, R_3, R_4, R_5$ —Meter shunt res. (see text)
- $S_1$ —D.p.d.t. selector switch ("Dark-Light", optional)
- $S_2$ —S.p.s.t. toggle switch ("Power")
- $S_3$ —S.p. 5-pos. shorting-type rotary switch ("Range")
- $B_1$ —1.5 v. battery (penlight cell or Mallory RM-1 mercury cell)
- $M_1$ —0-100 microammeter (2" round)
- Photocell—Self-generating, barrier-type selenium unit
- $V_1$ —CK722 p-n-p junction transistor (Raytheon)
- $I$ —5" x 4" x 3" metal box (ICA #29440)

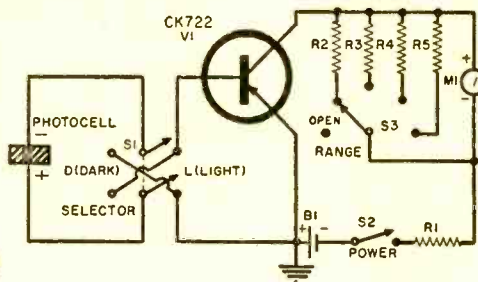

Schematic diagram and parts list covering the transistorized light meter, and an interior view of the completed unit. It may be made more compact, if desired, by using smaller parts. See text.

in the "open" position, the meter reading may be close to zero or as high as half scale.

However, regardless of the meter reading with the photocell dark, an up-scale reading will be obtained as more and more light falls on the photocell. With increasing light on the photocell, the base-emitter current increases, and the collector current increases correspondingly, but the collector current will be several times greater than the base current, thus giving the instrument unusual sensitivity.

Under some conditions, depending on the individual transistor and photocell, a current amplification as high as ten or twelve may be obtained.

As greater amounts of light are allowed to fall on the photocell, the meter reading will soon reach full scale, and the "meter shunt" resistors may be switched into the circuit to reduce meter sensitivity (by means of  $S_3$ , which thus serves as a sensitivity "Range" switch).

Power is supplied by a single cell battery,  $B_1$ . A Mallory type RM-1 mercury cell is used in the author's model, but a penlight cell may be used instead. It will not give as long life in service as the mercury cell, however.

Resistor,  $R_1$ , is provided in series to limit collector current to 5 milliamperes (maximum for the CK722 transistor). The "Dark-Light" selector switch,  $S_1$ , is optional and can be provided if a reasonable up-scale

meter reading is obtained under "no-light" conditions with  $S_3$  in the "open" position.

As mentioned previously, the "no-light" meter reading may vary from zero to better than half full-scale, depending on the individual characteristics of the transistor and selenium cell used. Where the "no-light" meter reading is at least one-third full-scale, a d.p.d.t. switch may be used to reverse the polarity of the photocell connections to the base-emitter circuit. This switch serves as the "Dark-Light" selector,  $S_1$ .

In operation, throwing  $S_1$  to the "Dark" position permits a *reverse bias* to be applied to the base-emitter circuit of the transistor. Where this reverse bias current is small, as when no light is allowed to fall on the photocell, the collector current approaches the "no-light" value previously discussed. Thus, an up-scale meter reading is obtained.

As light is allowed to fall on the photocell, the reverse bias increases, *rapidly reducing the collector current to zero*. Thus, the meter reading increases as the light level is reduced, with the maximum reading obtained under conditions of "no light"! This permits easier measurements under some conditions of extremely low light levels.

The operation of the instrument may be summarized as follows: (a) with the "Dark-Light" switch in the "Light" position, an up-scale meter reading is obtained with increasing light levels; and (b) with the "Dark-Light" switch in the "Dark" posi-

tion, an up-scale meter reading is obtained with increasing darkness (reduced light levels).

### Construction Hints

The entire instrument has been assembled in a standard 3"x4"x5" metal utility box. For an extremely compact unit, smaller switches may be used (miniature slide switches in place of the toggle switches used in the model) and a 1½" or 1" meter may be substituted for the 2" meter used by the author.

When the builder solders the transistor in place, special care should be exercised to avoid damaging this part. Leave the transistor leads as long as is practicable, and solder the connections as quickly as possible, using a hot, well-tinned iron.

Except for the selenium photocell, all components used in the construction of the instrument are standard and should be available through regular supply houses. The selenium cell, although not normally considered a "stock" radio-electronic item, is often available through the larger mail order supply firms.

Electrical connections to the photocell should be made by means of pressure contacts. *Do not attempt to solder leads to this component unless special soldering lugs are already provided on the unit.* In most commercial units the back of the cell serves as the positive terminal, while the negative terminal consists of one or more narrow metallic strips on the sensitized face of the cell.

Mount the photocell so that the sensitized face is exposed to light. In the model this has been accomplished by mounting the cell directly behind a sheet of clear plastic.

Shunt resistors, selected by "Range" switch  $S_3$ , are used to reduce the sensitivity of the instrument. These resistors,  $R_2$ ,  $R_3$ ,  $R_4$ , and  $R_5$ , may be selected in one of several ways.

First, the resistors may be chosen to increase the full-range reading of the meter by definite multiples, from 100 microamperes to 200, 300, 500, or 600 microamperes, or even to a milliampere or more. The exact resistor sizes chosen will depend on the internal resistance of the meter.

Another way to choose these resistors is to select values to give a definite full-scale reading to each range in terms of light intensities—full-scale readings of 10, 20, 30, 40, or 50 footcandles might well be chosen.

If this method is chosen, a standard light meter may be used for comparative tests. Place the standard light meter and the transistorized instrument at a fixed distance from a light source and connect a decade resistance box across the meter,  $M_1$ .

Adjust either the light source or the position of the two instruments until the desired full-scale reading (in footcandles) is obtained on the standard. Then adjust the shunt resistance value until a full-scale reading is obtained on the meter. Finally, substitute a fixed resistor of this value for the corresponding range of  $S_3$ .

Repeat this step for each of the desired ranges.

Finally, if the transistorized light meter is not to be used for actual light measurements, but only for comparative tests, the resistors may be given arbitrary values. This was the method used in the author's model. The values chosen were as follows:  $R_2=10,000$  ohms;  $R_3=200$  ohms;  $R_4=100$  ohms; and  $R_5=20$  ohms.

Where the completed light meter is to be used only for comparative tests, as is the author's model, there is no real need to calibrate the instrument in terms of actual light intensity levels.

On the other hand, if the builder wishes to use the completed instrument for obtaining actual measurements, some form of calibration will be necessary.

To calibrate the instrument, a standard light meter should be employed. A diffused light source is also helpful.

Arrange the standard meter and the transistorized unit so that the same amount of light falls on both instruments. Note the readings on both units.

Vary the illumination level, either by moving the instruments further from the light source or by partial shading. Record

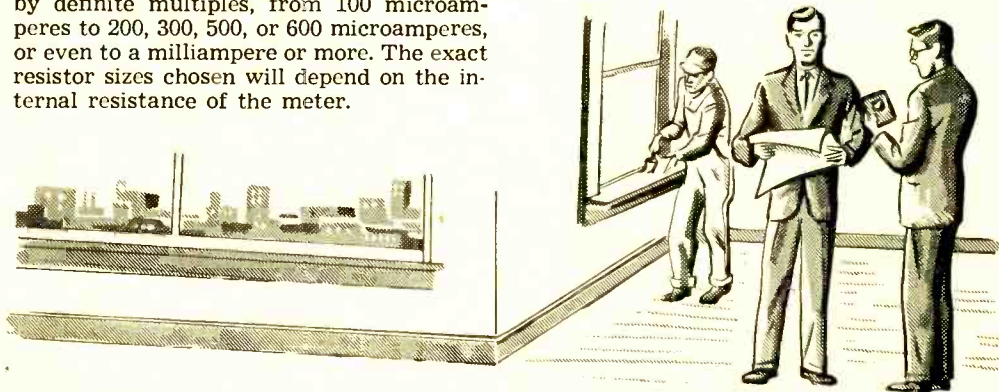

the new readings obtained. Continue these steps until a complete set of readings has been obtained for each range of the instrument.

Once a complete set of readings is obtained, indicating actual light or illumination levels in terms of meter readings, a calibration curve or chart may be prepared. As an alternative, a new meter scale may be drawn so that direct readings can be obtained.

If the light levels to be measured exceed 60 to 70 footcandles (depending on the individual photocell), provision should be made for reducing externally the amount of light striking the cell.

This can be accomplished by providing one or more opaque shields to fit over the photocell's sensitized surface. Small holes or slots are provided in the shield to admit a fixed percentage of the total light. Such shields serve as "coarse" range controls where high light intensities are to be measured.

If desired, additional calibration charts or curves may be prepared for each of the shields provided.

The transistorized light meter may be used in many of the applications where or-

dinary light meters are employed, except that its increased sensitivity makes it possible to conduct many tests and measurements which are not practical with less sensitive units.

For example, the instrument may be used to check the relative reflective qualities of different types of materials or finishes. The author found it quite easy to distinguish between the light reflection of white, "creamy-white", "yellow-white", and "gray-white" papers.

By providing appropriate color filters ahead of the photocell, the same technique may be used for checking the "color brightness" of paints, textiles, papers, and similar materials. All tests of this nature should be conducted for the purpose of comparing samples of the same basic color. Efforts to compare different colors (red and blue, for example) may lead to erroneous results, brought about by differences in transmission qualities of differently colored filters, and because the photocell itself is not absolutely "flat" in its response to different colors.

Other applications will become apparent as the user becomes familiar with the instrument. END

---

## NEW RADAR PINPOINTS ENEMY FIRE

**T**HE new radar "eye" pictured here acts as sentry, warns of enemy movements, and pinpoints enemy mortar locations. With the help of this electronic detector, front line forces can detect and "lock on" the path of enemy mortar shells, automatically track their trajectory, and obtain computer range data which reveals the enemy position. Known as the AN/MPQ-10, the equipment is compact and mobile. The radar antenna is mounted on a portable tracker, shown at the right. The remote control console is shown below. The tracker can be tilted up or down and rotated in any direction for continuous search. Already in use, the new radar is said to have literally saved the lives of hundreds of GI's. The device was developed jointly by the U. S. Army Signal Corps and the *Sperry Gyroscope Co.*, N. Y.





## LEARN TUBE CONSTRUCTION

**A**DVANCED experimenters as well as beginners can learn a good deal about vacuum tube construction by carefully disassembling old tubes. Technical schools frequently include such projects as part of their practical training.

As a start, you'll find it best to work with full-sized tubes instead of miniatures and subminiatures (GT,G, and metal types are best). The first step is to remove the envelope.

On a glass tube, use a three-cornered file to scratch a mark around the glass envelope close to the base. Wrap the tube in a piece of cloth and, holding the tube in one hand, strike the base lightly with a rubber mallet. As an alternative, you can wrap a piece of resistance wire around the tube against the filed mark. Pass current through the wire to heat it. When hot enough, the glass will crack cleanly along the mark.

The envelope of a metal tube may be removed by using a hacksaw. Wrap the upper part of the tube with a cloth and clamp it lightly in a vise. Don't apply too much pressure or you may crush the tube. Using a hacksaw, cut a slot in the envelope close to the base. Then rotate the tube slightly, continuing to lengthen the slot until the envelope is loose.

With the envelope removed, the tube electrodes may be taken off with negligible bending and distortion by cutting their support wires close to the base. Use a sharp pair of diagonal cutters for this operation.

When the disassembly is completed, each tube electrode may be studied. A small magnifying glass is handy for this. The tube shown disassembled in the photograph below is a type 1B3GT, a high-voltage rectifier from a TV receiver, but any tube will do just as well for this practical lesson in tube construction. **END**

Disassemble an old tube, as described, to permit a careful study of the various components.

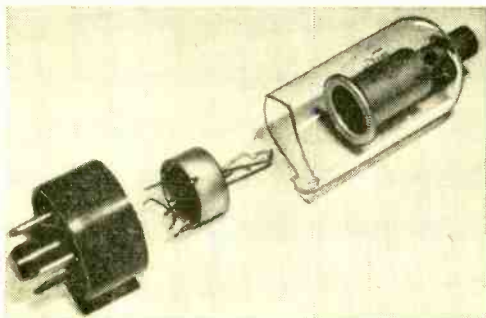

March, 1955

## Get New FREE PUBLIC ADDRESS HANDBOOK



### Valuable Facts Help You Install Better PA Systems

- Shows how to make sound surveys and recommendations for factories, arenas, etc. Gives typical examples and results.
- Discusses public address requirements in relation to characteristics of auditoriums, stadiums, large rooms, etc.
- Explains operational factors of importance in public address speaker systems for all types of applications, indoors and outdoors.
- Tells what the CDP Compound Diffraction Projector is—what it does—and how it provides a PA speaker system of much greater range, efficiency and dispersion.
- Includes illustrations, diagrams, charts, formulas, engineering data, technical and architectural specifications.

Send for your **FREE** copy now

## Electro-Voice®

ELECTRO-VOICE, INC., BUCHANAN, MICHIGAN  
Without obligation, send **FREE** copy of the CDP  
Public Address Handbook.

NAME \_\_\_\_\_

ADDRESS \_\_\_\_\_

CITY \_\_\_\_\_ ZONE \_\_\_\_\_ STATE \_\_\_\_\_

**Crystal Clear  
Pictures** like  
**MAJIC**  
with amazing  
**CLEAR-PIX  
FILTERS**



**HIGH REJECTION EFFICIENCY**

- Scientifically designed with proven HI-Q circuits
- Low Cost
- Easy to install

Most of the 26 million TV sets now in use suffer from some type of interference. Now you can enjoy TV entertainment to the fullest . . . save your family and yourself discomfort and eyestrain. GRAYBURNE CLEAR-PIX filters are effective . . . can be installed quickly, easily. There's one for each type of major interference.



Model #	Interference
CPF	FM
CPD	Diathermy
CPI	Ignition
CPH	Amateur (21 mc.)

**1.98** list **ORDER TODAY** from your local dealer

successor to  
Grayburne  
Corp.

**Superelex** ELECTRONICS CORP.

23 Atherton St., Yonkers, N. Y.

for everything in Electronics!



**1440 page MASTER**

- Detailed specs • 8,500 illus.
- 85,000 items • Fully indexed
- Full descriptions • Wgt. 6 lbs.

List \$6.50-As low as \$1.95 at distributors  
**UNITED CATALOG PUBLISHERS, INC.,**  
110 Lafayette St., N. Y. C. 13

**EASY TO LEARN CODE**

Learn or increase speed with an Instructograph—the Radio-Telegraph Code Teacher that takes the place of an operator-instructor and enables anyone to master code without further assistance. Available tapes from beginners alphabet to typical messages on all subjects. Speed range 5 to 40 WPM. Always ready—no QRM. Thousands have “acquired the code” with the Instructograph System. Write today for convenient rental and purchase plans.



**INSTRUCTOGRAPH COMPANY**  
4713-P Sheridan Road, Chicago 40, Illinois

**ADDRESS  
POSTCARDS  
AT HOME!!**

write BOX 14, BELMONT, MASS.

**TOOLS  
& GADGETS**

**NEW CHASSIS PUNCH**

A new “D” shaped radio chassis punch has been added to the “Pioneer” chassis punch line by the Chase Mfg. Co. It is used to punch holes for miniature tube sockets having a flat on their shanks. Sockets so mounted will not twist in the chassis. Useful also for holes for microphone connectors, it is screw operated and eliminates the need for hand filing. It is made from high grade tool steel, and is available in the 1/2-inch size at a list price of \$3.70 each, complete with punch, die, drive screw and nut. For additional information, write the manufacturer at 5008 West Jefferson Blvd., Los Angeles 16, California.

**OIL IMMERSED COIL**

The new “Oilcoil” is an ignition transformer, oil insulated and cooled and said to perform with outstanding efficiency. Unusually high voltage output as well as long life are claimed by the manufacturer, *Ranbaken Electrical Products*, Manchester, England. When used on cars or trucks, the coil is said to provide better starting, greater acceleration, improved “tick-over,” and pulling under load. It is also recommended for use on stationary combustion engines. “Oilcoils” are distributed in the U.S.A. by the *Paul D. Rosenthal Co.*, 320 South Swall Drive, Los Angeles 48. Retail price is \$19.95. For further information, write to the U.S. distributor.

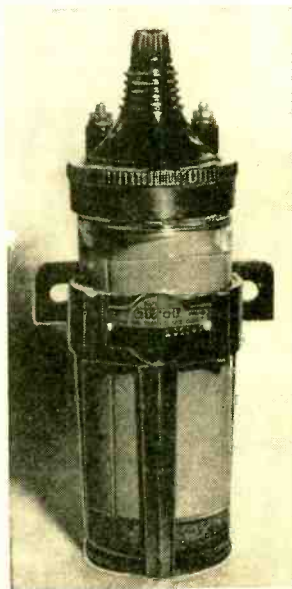

**NEW HOLLOW WALL SCREW ANCHOR**

To reduce installation time, cut labor costs, and help produce a more finished installation, *Rocket Devices Corp.*, 142 Lib-

POPULAR ELECTRONICS

erty Street, New York 6, N. Y., has created the "Wallgrip." This is a new and improved screw anchor for hollow walls of plaster, wallboard, cinder block, marble, wood, or tile. It makes easier than ever the fastening of loudspeaker enclosures,



heating panels, brackets, and other components to walls and doors. The new device has ribbed locking wings which provide a positive stop to assure permanent installations. To install a "Wallgrip" it is only necessary to drill a hole of the required size, insert the "Wallgrip," tighten it, remove the screw, and install the fixture with the same screw.

#### HAND TYPE WIRE STRIPPER

A new, inexpensive, hand-type wire stripper for the hobbyist and home craftsman is manufactured by *Crown Industrial Products Company*, 1331 Amsterdam Street, Woodstock, Ill.

Fabricated of hardened steel construction throughout, the stripper has interchangeable, precision-milled stripping blades carefully matched to strip insulation clean without damaging the wire. It strips both stranded and solid wire. A patented lock-open feature holds the jaws open automatically, so that the wire can be removed after stripping, without crushing. Net price is \$4.75 with one set of blades. A catalogue sheet is available from the manufacturer.

#### NEW STURDY FLASHLIGHT

A new "Eveready" Flashlight, designed for users who want an extra-sturdy light at a moderate price, has been announced by *National Carbon Company*, a division of *Union Carbide and Carbon Corporation*. The new light is designated the "Eveready" Heavy-Duty Flashlight, and is available in both a two-cell model (No. 1251A) for \$2.50 and three-cell model (No. 1351A) for \$2.75.



The flashlight has a special lens-guard made of tough polyethylene which protects the lens and throws a powerful red safety-warning light. Another feature of the light is its hand-replaceable, self-lubricating

March, 1955

## GET THE WORLD'S LEADING RADIO & TV CATALOG

free!

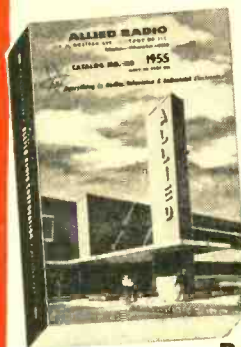

VALUE-PACKED

308 PAGE 1955

**ALLIED  
ELECTRONIC  
BUYING GUIDE**

**Builders and Experimenters:  
Save on Everything in Radio & TV!**

You'll find everything you'll need for building any project in this publication in the 1955 ALLIED Catalog. Select from the world's largest stocks of parts, tubes, tools, kits, books, diagrams—plus Amateur equipment, TV components, Hi-Fi equipment, test instruments, recorders—at lowest, money-saving prices. Write for your FREE ALLIED Catalog today!

#### POPULAR ALLIED KITS

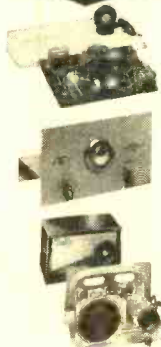

DOZENS OF  
OTHER KITS  
AVAILABLE

#### Famous Radio Lab Kit (10 Kits in 1)

Here's the most instructive Experimenter's kit you can buy. With it, you can build a broadcast receiver, phono amplifier, phono oscillator, signal tracer, electronic timer, photo cell relay, home broadcaster, electronic switch, etc. Fascinating, instructive. Complete with all parts, tubes, microphone. 12-page manual. Shpg. wt., 10 lbs.

83 S 265. Radio Lab Kit, only..... \$14.25

#### Popular "Ocean Hopper" (Amazing DX)

A remarkable Short-Wave receiver. Covers 155 to 35.0 mc with plug-in coils (below). Features bandspread; for headphone or speaker use. Easy to build. Complete with all parts, tubes, broadcast coil, hardware, full instructions. For AC-DC. Wt., 5 lbs.

83 S 740. "Ocean Hopper" Kit, only..... \$12.75

59 J 110. 2000 ohm heads..... \$1.67

Five coils (155 kc to 35 mc)..... \$3.82

#### Ranger II Superhet (with Cabinet)

Learn radio while you build and enjoy this sensitive AC-DC broadcast receiver. Tunes 540-1680 kc; includes built-in antenna. FM dynamic speaker, automatic volume control, handsome walnut plastic cabinet. Easy to assemble from detailed manual; complete with punched chassis, all parts, tubes and cabinet. Shpg. wt., 8 lbs.

83 S 735. "Ranger II" Kit, only..... \$16.75

## INSTANTLY ISOLATE TV TROUBLE

Save Time And Money with

### THE NEW TV DYNATRACER!

- No Additional Equipment Needed.
- Swiftly Traces Signals Voltages.
- Pinpoints Defective Components.
- Amazingly Simple to Operate.

YES, a low cost test instrument that locates TV troubles without extra equipment. Tracks TV signals in Video, AFC, Sound, Sync, Horizontal or Vertical sweep circuits. TROUBLE PINPOINTED IN STAGE OR COMPONENT. TV DYNATRACER also traces voltages (50/500 V AC/DC)—detects leaky, open or shorted condensers, resistors, coils, transformers,

• Technician-Amateur-Home Hobbyist. The new TV DYNATRACER is a budget priced necessity. Take advantage of our 10 day MONEY BACK GUARANTEE now!  
Prompt orders receive a TV HIGH VOLTAGE INDICATOR — helpful accessory to all test work.

4.98  
PPD.

FREE

**Century ELECTRONICS CO.**

Dept. 60 211-04 99th Ave., Queens Village 29, N. Y.

## HERE IS AN UNBEATABLE 5 WATT AC AMPLIFIER VALUE!

Complete,  
ready to  
play

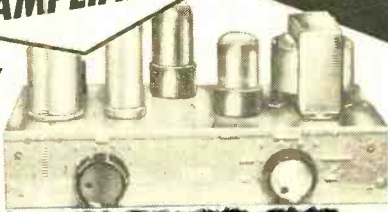

slide switch which provides thousands of trouble-free operations. A company spokesman has pointed out that this is the first time a flashlight of this type has been made available through regular distribution channels to the general public. The two-cell model is shown in the illustration.

### MINIATURIZED FEEDTHROUGH CAPACITOR

A new miniaturized feedthrough capacitor (Bulletin 5420) has been developed by *Allen-Bradley Co.*, Milwaukee, Wis. This small discoidal capacitor prevents high fre-



quency stray currents from passing from shielded areas over the power supply circuits, by providing a low resistance path through the shield for power currents and a low impedance coupling to the shield for diverting undesirable, high frequency currents.

### PRECISION PRESSURE GAUGE

A new precision dynamometer for determining the force required to actuate delicate mechanisms has been announced by *George Scherr Co., Inc.*, 200 Lafayette St., N. Y. 12, N. Y. Gauges are available with different ranges in grams. The unit with the range 0-15 is recommended for use as a stylus-pressure gauge on high quality phonograph equipment. Other uses of the gauges are to measure, calibrate, and standardize the pressure or power required to operate such devices as relays, clocks, business machines, micro motors, windshield wipers, and time switches. Highly accurate, the gauge is priced at \$9.85.



### NESTING TOTE-BOXES

Newly redesigned *Trojan* "Handipan" Tote Boxes, constructed of 18-gauge steel, have, according to the manufacturer, several time- and space-saving features. Sturdy one-piece die-stamped ends provide handles and label holders on each side, plus a recessed edge for easy tiering. Designed to prevent sticking or jamming when nested, a special stacking feature separates each pan by about 1/4 inches, giving complete visibility to the contents of each container and making the contents readily accessible. Pans measure 16" x 11" x 5" and

POPULAR ELECTRONICS

weigh 8 pounds each. Address inquiries to Trojan, Auto Sheet Metal Works, 735 E. Gage Avenue, Los Angeles 1, Calif.

**LOW PRICED V.T.V.M.**

Shasta Model 201 a.c.-d.c. vacuum tube voltmeter is said to be the first available low-priced unit of its type. It features an improved circuit that eliminates the need for preselecting diodes for replacement purposes. Provision is made for operating the Shasta Model 952 "Illuma-Probe." Model 201 covers the d.c. voltages in 7 full scale ranges of 1.5 to 1500 volts.

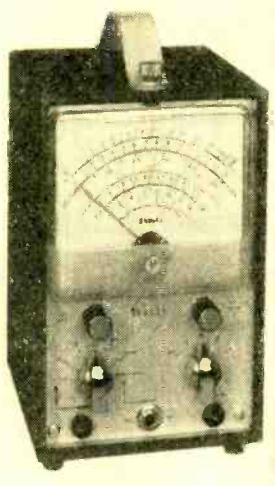

A.C. ranges are calibrated both in r.m.s. values of sine waves and in peak-to-peak values. Resistance values from 1000 ohms to 1000 megohms are covered in 7 ranges. The new meter is made by Shasta Division, Beckman Instruments, Inc., 1432 Nevin Ave., Richmond, Calif. Priced at \$68.00 f.o.b. Richmond, Calif., immediate delivery from stock is assured.

**NEW FOUR-INCH METER**

A new four-inch panel meter has been added to the line of four-inch meters now being manufactured by the Triplett Electrical Instrument Company of Bluffton, Ohio. The new panel meter, Model 420-P1, combines a transparent plastic case with a molded base. The case front projects over the rim of the instrument giving longer scale length and permitting clearer legibility. It mounts on studs inserted through the panel and is available in two basic types: d.c. permanent magnet moving coil and a.c. iron vane.

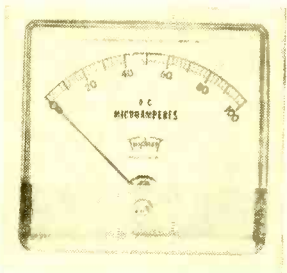

**A.C. OUTLET FOR MULTIPLE WIRING**

A new miniature outlet designed to simplify multiple outlet installation and

March, 1955

Here's Your Coupon for bigger values... at lower prices!

FROM THE WORLD'S LARGEST DISTRIBUTOR OF AMATEUR RADIO EQUIPMENT

JUST CHECK THE ITEMS BELOW THAT YOU'RE INTERESTED IN! CLIP AND MAIL! WE'LL RUSH INFORMATION!

- LATE RECONDITIONED EQPT. LIST
- BANDSWITCHING GLOBE SCOUT
- AMATEUR RADIO KITS!  FREE 1955 CATALOG!
- GIANT RADIO MAP (25c)
- TEN DAY FREE TRIAL PLAN

Build your own transmitter and receiver and tune on the air with this simple kit and simple instructions. Complete kit only \$14.70. Single wire antenna. Power supply included. May be purchased separately. Write for full details.



**RECEIVER**  
\$14.70 Complete



**TRANSMITTER**  
\$29.40 Complete

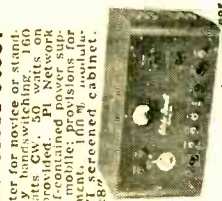

**ONLY \$795 per mo.**  
**\$10.00 DOWN**  
**or \$99.95 CASH**

Send information to:

Name \_\_\_\_\_  
Address \_\_\_\_\_  
City and State \_\_\_\_\_

ALL PRICES SUBJECT TO CHANGE WITHOUT NOTICE.



Leo Z. Hyman  
W6FQ

PE-3  
WORLD'S MOST PERSONALIZED RADIO SUPPLY HOUSE  
**World Radio LABORATORIES**  
ELECTRONIC LABORATORIES  
3415 W. BROADWAY, CO. BLUFFS, IA. Phone 2-0277

IT'S BIGGER AND BETTER THAN EVER!

B-A's NEW 1955

**FREE CATALOG!**

**164  
PAGES**

LOADED WITH  
SAVINGS AND  
NEW ITEMS  
IN RADIO,  
TV AND  
ELECTRONICS!

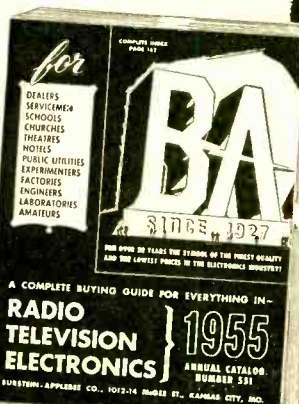

**SEND  
FOR IT  
TODAY!**

**BURSTEIN-APPLEBEE CO.**

Dept. PE, 1012-14 McGee St., Kansas City 6, Mo.

Send Free B-A Catalog No. 551.

Name.....

Address.....

City.....

State.....

**SPECIAL PURCHASE!**

**Brand NEW RCA  
TV CAMERAS**

Just Received! **\$197.50**



100's of Used Models Sold at \$225 up! Rig up your own TV watchdog for swim pools and other uses—plus training, etc. 1846 Iconoscope, 6-stage video amplifier and clipper. Write for complete tech. data.

TN-65/APQ-15 for a 2-METER XMTR. With 6J6, 2-6C4's, less 832. With schematics and conversion sheet. **\$7.95**

MICRO SWITCH BZ-7RDT—New.....5 for \$2 postpaid

51.5 OHM COAX. CABLE **\$4.50**

100' roll

RG34U 71 OHM COAX. .625 dia. 5 KW rating. 85' roll with pl-173 plug at one end. New..... **\$6.95**

**MINIATURE LINE MATCHING TRANSFORMER.** \$1 plus 25¢ postage. For blocking oscillators on TV Recvs. & camera input circuits, tone oscillator transformer for electric organ, digital computer systems. 1000's other uses.

**24 V TRANSFORMER & RECTIFIER COMB.** a basic 24 V. DC power supply of 110 V AC primary. 24 V secondary and Rectox Rectifier. Operates intermittently up to **\$2.95** 3 or 4 amps.

**APS 13 MAKES A 420 MC**



**RADIOPHONE** when converted. Range in most cases equal to 2 meters. Complete with RF sections, conversion booklet and 30 MC I.F. strip, less tubes, dynamotor and minor parts not needed for conversion. Shpg. wt. **\$3.95**  
13 lbs. .... \$19.95  
New APS 13..... \$19.95

Send check with order (no COD's, please.) Prices FOB Whse.

**Harjo Sales Co.**

Dept. PEH, 4109 BURBANK BLVD., BURBANK, CALIF.  
Phone Victoria 9-2411—Get FREE CATALOG!

wiring has just been added to the Alden "mini-spACe" outlet line. Furnished pre-wired with two leads on each contact, mul-

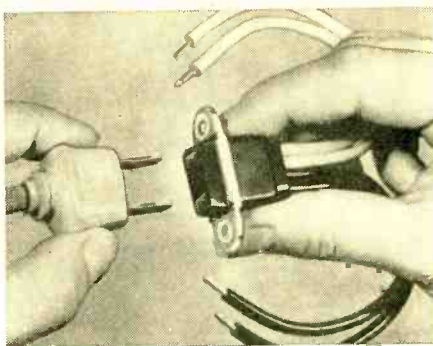

iple outlets can now be installed simply by riveting or eyeleting the outlets onto a panel—matching the black and the white coded leads to those of the adjacent outlets and interwiring rapidly by wire nuts. The new outlet can serve as a low cost, multiple outlet installation.

**POWDER RUST REMOVER**

A new and unusually effective non-toxic rust remover, in powder form, is being produced by the *By-Buk Company*, Los Angeles 19, Calif. It will meet any derusting or corrosion removal requirement for ferrous or non-ferrous metals. It is non-toxic, non-obnoxious, non-inflammable, leaves no alkalies and requires no neutralizer. It leaves the derusted surfaces metallically clean with a thin rust-resistant coat, ready—with no other treatment—to form a perfect bond for paints, nickel, or chromium plating, galvanizing, and other protective coatings.

**DOUBLE-ENDED WRENCH**

A new double-ended wrench, specially designed for volume control and toggle switch nuts, is offset at both ends to facilitate the speedy tightening of nuts in the rear of chassis. There are two wrench sizes, 1/2 inch and 9/16 inch, on one wrench, made of case hardened steel, cadmium

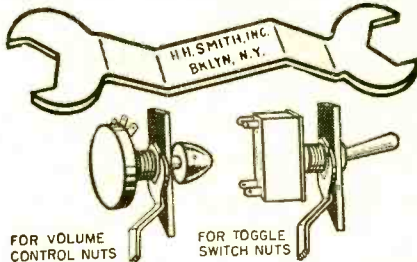

FOR VOLUME CONTROL NUTS

FOR TOGGLE SWITCH NUTS

plated. A new catalogue, #55A, may be obtained from the manufacturer, *Herman H. Smith Inc.*, 2326 Nostrand Avenue, Brooklyn 10, N. Y. **END**

## HIDDEN HEATER VOLTAGE TROUBLE

By Lawrence Fleming

IF THE tube heater load on a power transformer is much less than the transformer winding's rating, the heater or filament voltage will be too high—quite often high enough to shorten seriously the life of the tubes. A meter, which will measure 6.3 volts a.c., and a handful of 1 or 2 ohm, ½ watt resistors are important items for the builder of amateur and experimental equipment to have on hand.

Suppose we are building a two-tube amplifier using 6AU6 tubes which draw .3 amp. each at 6.3 volts. Suppose the power transformer is a radio replacement type with a 6.3-volt winding rated at 2.5 amps. Our actual load is .6 amp. and the actual voltage with this load will generally be around 6.8 or 7 volts. This is high enough to make a big difference in tube life. It also increases the hum. To make the voltage right, insert a little resistance in series with the heater supply. In this case, we want to get rid of about .6 volt. By Ohm's law, the right resistance is 1 ohm. The wattage dissipated is .36 watt, so a ½ watt resistor will do. Odd values of resistance can be made up by combining low-value resistors in series or, more usually, in parallel.

Surplus and "bargain" transformers are more prone to deliver too much heater voltage than standard units, and the voltage should be checked under load.

Tubes operated at low plate current can be run at low heater voltage and will generally have very long life when operated this way. Commercial v.t.v.m.'s often use 5.8 volts on tubes drawing about .5 ma. plate current. Life is almost indefinite. A good schedule for maximum life is given in Table 1 below.

In the gay 1920's when receiving tubes cost \$6.00 each, there was a rheostat on every filament and many radio sets had Weston voltmeters on the front panel. Nowadays the problem isn't cost, but reliability. We use so many tubes that excessive failures become a real nuisance and repairs take more time in modern equipment. Thus, filament voltage is about the most important detail of all. END

Table 1.

PLATE CURRENT	HEATER VOLTAGE
1 ma. or less	5.7-5.9 volts
1 ma. to 5 ma.	5.9-6.1 volts
Over 5 ma.	6.3 volts

March, 1955

Become an

## Electrical Engineer



### Major in Electronics or Power BS Degree in 36 months

Prepare now for a career as an electrical engineer or engineering technician—and take advantage of the many opportunities in these expanding fields.

You can save a year by optional year 'round study. At MSOE previous military, academic, or practical training may be evaluated for advanced credit.

### Enter Radio and Television — courses 12 to 18 months

You can be a radio technician in 12 months. In an additional 6-months you can become a radio-television technician with Associate in Applied Science degree. Color television instruction is included in this program.

These technician courses may form the first third of the program leading to a degree in Electrical Engineering. Twenty-one subjects in electronics, electronic engineering and electronic design are included in these courses.

Courses also offered: radio-television service (12 mos.); electrical service (6 mos.); general preparatory (3 mos.).

### Terms — April, July, Sept., January

Faculty of specialists. 50,000 former students —annual enrollment from 48 states, 23 foreign countries. Non-profit institution. 52nd year. Courses approved for veterans. Residence courses only.

MS-6B



## MILWAUKEE SCHOOL OF ENGINEERING

MILWAUKEE SCHOOL OF ENGINEERING  
Dent. PE-355, 1025 N. Milwaukee Street  
Milwaukee 1, Wisconsin

Send FREE illustrated booklets

- Career in Electrical Engineering.  
 Career in Radio-Television.

I am interested in..... (name of course)

Name..... Age.....

Address.....

City..... Zone..... State.....

If veteran, indicate date of discharge.....



## AUDEL'S T.V. RADIO SERVICE LIBRARY

2 VOLS. \$6 COMPLETE \$1 A MO. PAY ONLY

HERE IS LATE INFORMATION IN A HANDY FORM FOR RADIO & TELEVISION REPAIRMEN, SERVICEMEN AND STUDENTS  
**IT PAYS TO KNOW!**

AUDEL'S T.V. RADIO SERVICE LIBRARY presents the important subjects of Modern Radio, Television, Industrial Electronics, P.M. Public Address Systems, Auto, Marine & Aircraft Radio, Phonograph Pick-Ups, etc. Covers Basic Principles—Construction—Installation—Operation—Repairs—Trouble Shooting. Shows How to get Sharp, Clear T.V. Pictures, Install Aerials—How to Test, Explains Color Systems & Methods of Conversion. 1001 Facts—Over 1200 Pages—25 Illustrations of Parts & Diagrams—Valuable for Quick Ready Reference & Home Study. Tells How to Solve T.V. & Radio Troubles—Answers T.V. & Radio Questions.

Get this information for Yourself,  
**7 DAY TEST—ASK TO SEE IT!**

-----MAIL ORDER-----

AUDEL, Publishers, 49 W. 23rd St., New York 10, N.Y.  
Mail AUDEL'S T.V. RADIO SERVICE LIBRARY 2 Vols. \$6 on 7 days free trial. If O.K. I will remit \$1 in 7 days and \$1 monthly until \$6 is paid. Otherwise I will return them.

Name \_\_\_\_\_

Address \_\_\_\_\_

Occupation \_\_\_\_\_

Employed by \_\_\_\_\_

## MAKE BIG MONEY—EASY!



**\$210.00 and MORE YOURS!**  
**\$210.00 IN A WEEK!**

**Amazing D-FROST-O-MATIC Actually Sells Itself on Dramatic FREE TRIAL!**

30,000,000 women need, want to end messy hand defrosting. Sell out of 10 automatically with sure-fire D-Frost-O-Matic FREE TRIAL. Leave sensational D-Frost-O-Matic in home day or two, come back and pocket your big

profit without effort. Make \$15.00, \$20.00 and more in an hour full or spare time—up to \$210.00 and more in a week!

**FREE!** Rush name, address on a postcard for exciting big-profit facts and proof, with details of dramatic FREE TRIAL PLAN that sells 8 out of 10 automatically. Everything FREE, no obligation. Write TODAY. D-FROST-O-MATIC, 173 W. Madison, Dept. F-54 Chicago 2, Ill.

## THAT PROFESSIONAL LOOK!

### PERFORATED AND FINISHED CHASSIS

• Give that "Build Your Own" electronic project eye appeal! We can furnish perforated and finished chassis and cabinets for projects featured in all issues of Popular Electronics. Write today for what you need.

### HOUSEHOLD HANDIES

2307 Main Street

Santa Monica, Calif.

## TRANSISTORS!!!

EXPERIMENTERS Hurry • limited quantity, marvels of electronics • build your own audio oscillators, personal radios, hearing aids etc. • Price only \$3.00 each postpaid • SAVE by buying set of 3 photocells and 1 transistor • Bargain price \$4.95 per set • Learn by doing; Be the first. Don't pay high prices • Act now • ELECTRONIC'S greatest development • Marvels of Science.

TRANSISTOR-PHOTO PRODUCTS  
Geneva, Illinois

# TRICKS of the TRADE

## CLEANING CHASSIS

A DUST accumulation in a piece of electronic equipment may cause several types of improper operation. In a radio receiver, dust accumulating between the

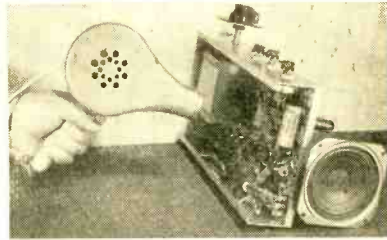

plates of the tuning capacitor will cause severe noise as different stations are tuned in. In a television receiver, a dust accumulation in the high voltage circuit may build up to the point where arcing and other discharges can occur, introducing streaks in the picture and noise in the sound. And in test equipment, accumulated dust may provide leakage paths, changing the resistance of some circuits and thus changing the calibration of the equipment.

The best way to remove dust from electronic gear is by *blowing* it away. A small hair dryer may be used for this purpose, as shown in the photo. A vacuum cleaner, used as a *blower*, is also good and will generally deliver a heavier stream of air than a hair dryer.

\* \* \*

## IMPROVE YOUR PHONO PLUGS

THOSE tight-fitting phono pin-plugs are so small that it is hard to get a good grip on them when you want to pull them out of the jacks. A handy suggestion is to solder ring type electrical fixtures onto the pin-plugs to act as handles. These fixtures

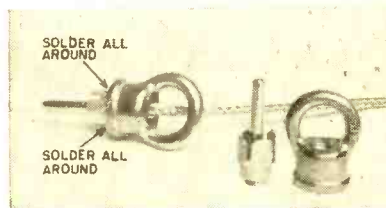

consist of a brass ring with a shank which is threaded internally with 1/8" pipe threads, and they are used by electricians for hanging chains from ceiling bowls on ceiling lamp fixtures. Electricians call them "chain hangers" and they sell for a dime each.



Slip this unit over the phono cable and onto the pin-jack. The two parts are soldered together securely by running solder all around the joint. If the chain hanger fits the plug a little too loosely, pinch the hole in the chain hanger to a slightly oval shape with a pair of pliers before soldering.

\* \* \*

### ADD PILOT LAMP EASILY

**B**ATTERY eliminators of the type illustrated have provisions for "A" and "B" voltages. To install a pilot lamp in the "A"

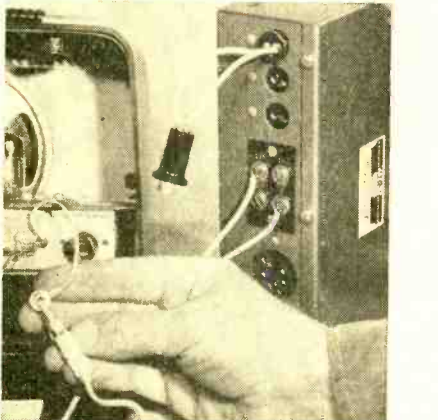

a socket to the proper plug-in terminal and use a dial lamp of the correct voltage. A 2½-volt lamp is shown in the photo. When substituting the "B" voltage of the eliminator for test purposes on a portable or automobile radio, the pilot lamp serves two purposes. It indicates that the eliminator is operating, and—with practice—it enables you to observe its brightness as an indication of excessive drain in the plate circuits of the receiver.

\* \* \*

### CONNECTING PHONE TIPS

**W**HEN connecting phone tips to binding posts with removable tops, it's hard to

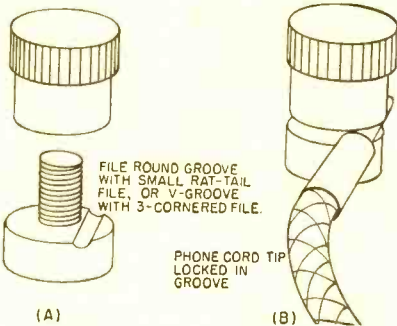

FILE ROUND GROOVE WITH SMALL RAT-TAIL FILE, OR V-GROOVE WITH 3-CORNERED FILE.

PHONE CORD TIP LOCKED IN GROOVE

voltage plug-in, it is only necessary to wire

make the tips stay put. A little sideways tug on the cord is all you need to pull the

## LAFAYETTE'S BARGAIN SALE!

### WESTERN ELECTRIC HEARING AID

Brand new, in original Western Electric's jeweler's case. Supplied with receiver, cord, battery cord and plug (less batteries). Money back guarantee. Act now while they last. Uses Burgess XX00 or 88 batteries at \$1.55 per set.



Reg. Price **\$85.00** Our Price **14.95**

### PRECISION GEIGER COUNTER

**29.95**



Geiger counter featuring high sensitivity to radioactive substances and extremely compact design. Detects uranium ore, cosmic rays, radium and X-rays by instantly producing a loud series of clicks in earphone. Uses a miniature amplifier tube, one 22½" hearing aid battery and one flashlight battery. Strong plastic case 1½" x 3" x 5". Supplied complete with headset, 3" x 5" batteries, radio-active sample and instructions. Shpg. Wt. 3 lbs.

Model 108 ..... **29.95**

### WELLER SOLDERING KIT

Kit includes 250 watt instant heat — dual spotlight Weller gun — ample supply of Kester solder — soldering tip — smoothing tip — tip interchange wrench — two instruction booklets — sturdy metal case for convenient storage. Sht. Wt. 5 lbs. Weller 8250-AK Net 10.99



### PRECISION DRAFTING SET



11 Pieces — Fitted Fit-Lined Case. Made in Germany. Of heavy brass, nickel plated and polished. Instruments include 5¼" Compass with pencil and pen points, and lengthening bar. 5¼" Divider, three 3¼" sideheel bow dividers with needle point, pen point and pencil point. 3" Ruling pen, extra handle for pen or pencil, capsule with extra leads. Your money back — if this price is not worth twice our price!

**2.75**

F-13 ..... NET 2.75

### TIMER-SWITCH SALE 3.95

Automatically turns on radio, television sets, toasters, coffee-makers, etc. — at any pre-set time within 12 hour period; also tells time. Requires 3½" diameter round hole, depth behind dial face 2¼". Shpg. wt. 1½ lbs. MS-62, for 110V/60 Cy AC



### NEW POCKET AC-DC VOM MULTITESTER

1,000 ohms per Volt



AC-DC MULTITESTER. An ideal portable unit that meets the need for a compact, yet rugged test instrument. Uses full 3" rectangular meter with large easy to read scale. Uses 1% precision resistors, jeweled D'Arsonval microamp meter movement. Ranges: AC-DC and output volts 0-5, 0-25, 0-250, 0-1000V. DC current 0-1, 0-10, 0-100, MA; Resistance 0-10K and 0-100K ohms. Size: 4¾" x 3¼" x 1¾". Supplied complete with test leads and batteries. Shpg. Wt. 2½ lbs. MODEL RW-27C Complete —

Singly, ea. 9.95 In lots of 3, ea. 9.45

### 3 LENS TURRET MICROSCOPE

100X-200X-300X 6.75

Precision built for accuracy and long lasting service. Triple position turret holds 3 achromatic color-corrected objectives for magnification of 100X, 200X and 300X power! Dual knob focusing. High-grade micro-optics used throughout. Complete with fitted wood carrying case and slides. Shpg. Wt. 4½ lbs. F-10 ..... NET 6.75



### 30 POWER TELESCOPE

● All metal — Chrome trimmed! Precision machined body. Hand ground, hard coated, achromatic lenses. Sharp, clear, brilliant images. In the same manner as fine binoculars. Brings objects 30 times closer! Smooth, easy sliding focusing. Collapses to 7" — extends to 14½". Always yours must be satisfied or return for immediate refund. Shpg. Wt. 1 lb. F-59 ..... NET 7.50



### EXPERIMENTERS MULTI-PURPOSE KIT

**13.95**

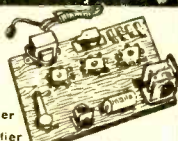

#### 10 Kits in One

1. Broadcaster Receiver
2. Phonograph or Microphone Amplifier
3. Phono Oscillator
4. Home Broadcast Station
5. Code Practice Oscillator
6. Capacity Operated Relay
7. Signal Tracer
8. Electronic Timer
9. Electronic Switch
10. Photo Cell Relay

You can play your phonograph through your radio, broadcast your voice through your radio, etc. Kit is complete with breadboard, microphone, 3 tubes and all necessary parts for construction, with 12 page manual of instructions and schematic and pictorial diagrams. Less headphones, photo cell and socket, wire and solder. Shpg. Wt. 10 lbs.

KT-36 ..... Net 13.95

Photo Electric Cell type 868 ..... Net 2.50  
Amphenol 77MP4 Socket for above ..... Net 7¢

### BINOCULARS NEVER BEFORE AT THIS PRICE

Imported Direct  
Fluor-Coated Lenses  
with order, Add 10% Fed. Tax

- All-Metal Construction
- Individual Focus
- Complete with Leather Case & Straps



F-105, 8 x 30 with case... NET 19.95  
F-15, 7 x 35 with case... NET 22.50  
F-103, 7 x 50 with case... NET 24.95  
F-104, 12 x 50 with case... NET 32.50

Lafayette Radio DEPT. PE2 Write for FREE Catalog  
BRONX, N.Y. 542 E. Fordham Rd.  
NEWARK, N.J. 24 Central Ave.  
PLAINFIELD 139 West 2nd St.  
BOSTON, MASS. 110 Federal St.  
100 SIXTH AVE. NEW YORK, N.Y.  
Include postage with order.

## RADIO CONTROL for GARAGE DOOR

FROM YOUR CAR—NO FCC LICENSE REQUIRED

**TRANSMITTER KIT:** incl. 6 V. Dynamo, 27 1/4 Mc Crystal, Tube, Cab., Wound Coil, Switch, Resistors, Condensers, Instructions. \$16.95; with 12 V. Dynamo add ..... **\$2.00**

**RECEIVER KIT:** 27 1/4 Mc. incl. Transistor, Sens. Relay, Wound Coils, Resistors, Condensers, Instructions. . . . **\$10.95**



### MULTITESTER—Measures 3 1/2" x 4 1/4" x 1 1/4"

AC: 0-15, 150, 750, 3000 volts.  
DC: 0-15, 75, 300, 750, 3000, volts.  
DC MA: 0-15, 150, 75ma  
Resistance: 0-10,000, 100,000 ohms.  
Complete with battery, test leads. Brand New. . . . . **\$9.95**

**PARTS AVAILABLE for all Radio Control Equipment described in Popular Electronics**  
Clockwork **ELECTRIC TIMER;** 1/2 to 24 min. . . . . **\$1.00**

**TRANSMITTER & RECEIVER KIT:** 27 1/4 Mc band License Free. All Parts & Diagrams (less tubes & crystal) to build Powerful 5 Watt Transmitter Unit & 2-Tube Supersensitive lightweight Receiver, including SIGMA 10,000 ohm Relay. . . . . **\$9.95**

**GENERATOR:** 12-24V DC, 13 amps. Requires 1/6 h.p. or larger motor with pulleys. . . . . \$5.25  
**RECTIFIERS:** 18V 1A \$1.40; 2A \$2.10; 4A . . . . . 4.95  
**TOY TRAIN TRANSF:** 18V 2A \$1.65; 4A . . . . . 3.75  
**SIGMA 4F RELAY:** 8,000 ohm, 1 Ma. \$4.95; 3,000 ohm 5.95  
**SIGMA 26 F CDS RELAY:** 8000 Ohm. . . . . 8.50  
**1 1/2 V. Tiny Atom MOTOR** with Variable Speed Gearbox. 3.95  
**Storage BATTERIES:** 2 Volt 3"x4"x5 1/2", 27 Amp. Hr. . . . . 2.75  
**MINI. 6 V. BATTERY:** Willard NT6-21/2"x1 1/4"x3 1/2". 2.45  
**G. E. RELAY CONTROL:** with sens. 10,000 ohm relay. . . . . 1.25  
**2 V. VIBRATOR SUPPLY KIT:** 180 V./35 Ma. . . . . 6.95  
**2 V. BATTERY CHARGER KIT:** \$4.95; wired. . . . . 6.95  
ALL MATERIAL GUARANTEED—FREE CATALOG "P"

**GYRO ELECTRONICS, 325 Canal Street**  
WORTH 6-1290 NEW YORK 13, NEW YORK

## Beginners ELECTRONIC KIT

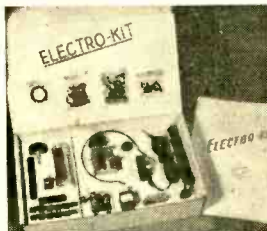

For young and old  
**35 EXPERIMENTS**

Complete, no extras to buy. Build 5 radios, audio amplifier and oscillator, electronic organ, 2 power supplies plus many others. Kit has duo-purpose tube, selenium rectifier, headphone, crystal, all necessary resistors, condensers, hardware, etc.

Only \$1 with order, pay postman \$8.95 plus charges or \$9.95 prepaid.

### ELECTRO KIT

Box 3468 Dept. PE-4 Maplewood 17, Mo.

## WANTED: TUNING UNITS

FOR RECEIVER AN/APR-4, and AN/APR-9

### ENGINEERING ASSOCIATES

434 Patterson Road Dayton 9, Ohio

## Catalog of 3000 Novelties 10c

Send 10c for amazing catalog of novelties, live animals, scientific supplies, hobbies, funmakers, planes & boats, looms, magic tricks, joke articles, unusual seeds, gadget timesavers, cameras, optical goods, projectors, movies, lucky jewelry, religious novelties, disguises, musical instruments, stamps, coins, puzzles, fortune tellers, radios, auto & bike accessories, telescopes, magnifiers, compasses, banks, smokers' gadgets, artists' supplies, printing sets, engines, motors, shakers, knives, billfolds, fireworks, guns, rifles, sports, books, games, plants, etc. Send name, address & 10c to:

**JOHNSON SMITH & CO., Dept. 863, Detroit 7, Michigan**

**FREE!**

REQUEST PORTFOLIO 950

**TO EVERY TV SERVICEMAN**

GET IT TODAY!

TV accessories and parts catalog, literature, data sheets, etc. Yours for the asking!

**Vidaire**

**ELECTRONICS MFG. CORP**

676 WEST MERRICK ROAD LYMBROOK, N.Y.

tips out again. To solve this problem, file a groove across the top face of the bottom part of the post, as shown in "A". When the tip is locked in the groove as shown in "B", it's impossible to pull it out unless you unscrew the top of the post. A round groove can be made with a small rat-tail file, or you can make a V-groove with a three-cornered file. If you make two grooves, one on each side of the screw, the post will hold two phone tips securely.

\* \* \*

## INSULATED SCREWDRIVER

ONCE in a while the need arises for a screwdriver with an insulated blade, especially when working around automo-



tive equipment where the body serves as ground. The shaft of any screwdriver may be insulated quickly and easily by wrapping it with thin, plastic electrical tape (Scotch #33). The insulation is very effective; yet the tape is so thin that the blade is not bulky. This tape also works very well on the handles of pliers and other tools.

\* \* \*

## LINE-CORD KINK

HERE'S a good way to insulate and anchor the line-cord at the place where it enters the chassis. As shown in the photo, mount two small rubber grommets close together, split the line cord, and then pass one wire through each

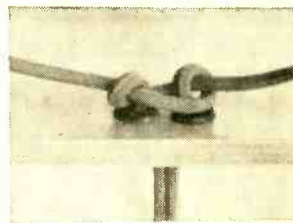

grommet into the chassis. Now, make a small loop in the right-hand wire close to the grommet and bring the wire to the left. Now loop the left-hand wire around the first wire and pass the end through the right-hand loop. Pull the two leads tight while pressing the two loops close to the grommets.

\* \* \*

## SOLDERING AID

WHEN connecting or tinning leads on small parts, one frequently wishes for a third hand. In lieu of this, a good idea is to wrap a small length of solder around the index finger of one hand. Pull down a sufficient length of solder to reach the work, which may be held by the thumb and

remaining fingers. The soldering gun may be handled with the other hand. Some ex-

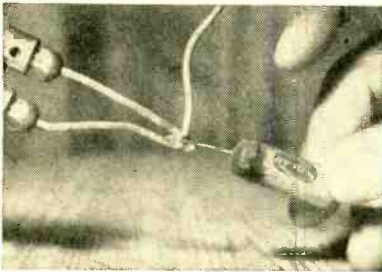

perimenters find this much faster than using a vise or trying to prop up a pair of pliers holding the work.

\* \* \*

### HOLDS GUY WIRES TIGHT

**T**O ANCHOR antenna guy wires securely after you've pulled them tight, a handy clamp made from a bolt is very useful. With a hacksaw, make a slot lengthwise through the threads into which the wire will lay. Then after the wires have been

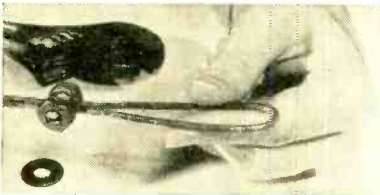

adjusted, slip the bolt over them, add a washer and nut, and tighten with two wrenches to avoid kinking the wire.

\* \* \*

### TOOL HOLDER FROM I.F. CAN

**A** CONVENIENT and inexpensive holder for alignment tools can be made from an old i.f. or r.f. metal shield can. Holes drilled into the top of the can will accommodate the assortment of tools shown in the photo.

The can may then be mounted permanently on the service bench, or moved around as desired.

Bench mounting is facilitated by using the can's original mounting terminals.

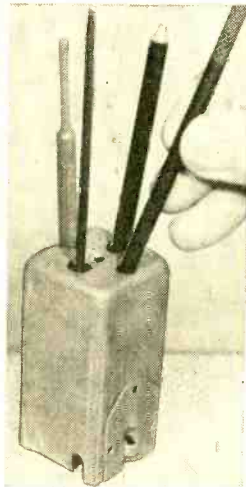

\* \* \*

### USE RUBBER GROMMETS

**R**UBBER grommets are available which may be forced over the chassis edges

March, 1955

## Build These WRL Kits

Described in This Issue of Popular Electronics!  
(Nationally Known, New Parts — No Surplus!)

### WRL C-R HANDY TESTER KIT

Here is a handy tester in kit form that will save many hours when searching for those hard-to-find defective parts. See picture and article elsewhere in this magazine. Complete with plastic case, all necessary parts and hardware, and instructions for easy assembly. Include 30c for Post. and Ins.

Only  
**\$5.09**  
Complete

### WRL WIRELESS RECORD PLAYER KIT

Three speed record player in kit form that you can play through all AM radios in your house. Complete with turntable, wired phono oscillator, tubes, and all necessary parts. Simplified assembly plans included. Add 75c for Post. and Ins.

Only  
**\$22.50**  
Complete

### WRL FREQUENCY METER-MONITOR KIT

This kit is a must for every ham station. Can be used for monitoring your signals and as a frequency meter. See picture and description in this issue. Comes complete with all tubes, parts, pre-wound coil, hardware and wire. Simplified assembly instructions with kit. Include 40c for Post. and Ins.

Only  
**\$19.95**  
Complete

### WRL ECONOMY POWER SUPPLY KIT

This power supply has an average output of 250 V. at 65 M. A.; is fully described in this mag. Many uses for the experimenter; —small transmitters, receivers, bias supplies, modulators and audio amplifiers. Here it is in kit form, complete with tube, punched chassis and easy-to-follow instructions. Add 50c for Post. and Ins.

Only  
**\$14.95**  
Complete

### WRL LIGHT METER KIT (Transistor-Type)

Handy light meter in kit form! Can be used by architects, engineers and photographers; for determining illumination levels or as an exposure meter. Complete with meter, photo cell, all necessary parts and punched chassis. Simplified instructions included. Add 40c for Post. and Ins.

Only  
**\$20.95**  
Complete

**Use this Handy Order Coupon today!**



WORLD RADIO  
LABORATORIES

3415 W. Broadway — Co. Bluffs, Iowa

Please rush me the WRL Kits and information I have marked below! My check (or money order) is enclosed.

- C-R Handy Tester Kit ..... \$ 5.09
  - Wireless Record Player Kit ..... 22.50
  - Frequency Meter-Monitor Kit ..... 19.95
  - Economy Power Supply Kit ..... 14.95
  - Light Meter (Transistor-Type) Kit ..... 20.95
- Plus Indicated Postage

Send Complete FREE Information on:

- WRL All-Band Antenna Kit ..... \$ 6.95
- WRL Handy Tool Kit ..... 1.98
- WRL Ccde Oscillator Kit ..... 4.95

NAME: \_\_\_\_\_

ADDRESS: \_\_\_\_\_

CITY and STATE: \_\_\_\_\_

## HUGE SAVINGS ON POPULAR COMPONENTS!

**SCOOP! 10 mil METER**  
Reg. \$8 only . . . . . **\$1.88**



Marion Type 53S rect. Basic movement 10 ma. scale now 0 to 5. BRAND NEW!

**G-E SELENIUM FULL-WAVE BRIDGE**  
In: 18VAC Out: 12VDC @ 250 ma. Reg. \$4.00. Sale . . . . . **69¢**

**100 PAPER CONDENSERS**  
.00035 to .25mf up to 1600V, popular mfrs. and sizes. Reg. \$12. . . . . **\$1.69**

**100 RESISTORS**  
½w-70, 1w-20 and 2w., insulated, top mfrs. Reg. \$15.30 . . . . . **\$1.69**

**50 POPULAR KNOBS**  
Some worth 25¢. Reg. \$3.50. Sale price only . . . . . **79¢**

**2 LBS ASSTD HARDWARE**  
Over 1000 pieces! Reg. \$2.50 value. Only . . . . . **88¢**

**10 VOLUME CONTROLS**  
Radio and TV. Some with switch. Reg. \$8. Only . . . . . **69¢**

**50 SOLDER LUG STRIPS**  
1 to 10 terminals. Reg. \$3.00, now only . . . . . **69¢**

Please send check or M.O., include estimated postage. C.O.D. orders, 25% down payment.

**50 RF COILS, CHOKES & slug-tuned coils.** \$100 Reg. \$15.00. Only . . . . .

**50 THREADED IRON SLUGS**  
Asstd. for slug-tuned coils. Reg. \$2.50. Only. . . . . **79¢**

**25 ASSTD. AIR TRIMMERS**  
Singles. duals. Reg. \$7 . . . . . **69¢**

**10 25 FT. ROLLS WIRE**  
Plastic & cloth insulated, solid and stranded #18 to 24. Asstd. colors. Only . . . . . **\$1.00**

**15 SWITCHES**  
Rotary, push, micro. Experimenters' model Reg. \$7. Only . . . . . **95¢**

**25 TUBE SOCKETS**  
4, 5, 6, 7, 8, 9 pin, some w/shield base, some Isolantite. Only . . . . . **89¢**

**ERIE CERAMIC TRIMMERS**  
3-12, 8-50mmf. Reg. \$1.15 . . . . . **10¢**

## LEKTRON SPECIALTIES

28 Gardiner St. Chelsea, Mass.

## MOVING?

Please advise our CIRCULATION DEPT.

64 E. LAKE ST., CHICAGO 1, ILL.

Include your old address as well as new—enclosing if possible an address label from a recent issue of this magazine. Allow at least 4 weeks for change of address.

## Inventors

Send today for our instructive booklet, "Patent Protection for Inventors" outlining preliminary steps to take toward patent protection, also for convenient "Evidence of Invention" form.

VICTOR J. EVANS & CO.

139-C MERLIN BUILDING, WASHINGTON 6, D. C.

## NORDIC CUSTOM RADIOS FOR 1952 TO 55 FORDS

SUPERHETERODYNE • BIG 6 x 9 INCH SPEAKER • LOW BATTERY DRAIN • EASY INSTALLATION PERMEABILITY TUNER

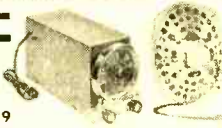

\$38.90

WRITE FOR LITERATURE

NORDIC RADIO COMPANY • BOX 582 • EVANSTON, ILL.

and then straightened out to form an insulator, at openings from ¼ to ⅝ inches in diameter. The installation of such grommets provides safe insulators for line cords or other cables brought out from experimental or permanent chassis.

\* \* \*

## ENLARGING CHASSIS HOLES

**YOU** can easily enlarge a punched hole, or even a small drilled hole, to the exact size you want. Use a burring reamer in a brace (or large electric drill) as shown. When you have obtained the proper size hole, touch up the sharp edges with a round file.



\* \* \*

## QUICK CONNECTIONS

**E**xperimenters and others who make a great many temporary connections will find that they can save considerable time by utilizing small coil springs for making electrical contacts. Leads to be connected are merely pushed between coils of the spring where they are held securely as long as the connection is needed. An ordinary unpainted door spring can be bought at nominal cost at a hardware store. When cut into ¼ or 1-inch lengths



it will supply a sufficient quantity of these "lightning" connectors to take care of almost any "breadboard" layout.

\* \* \*

## INSULATED TEST CLIPS

**T**hese insulated test clips will save you from getting "bit" when working on a live wire yet they are very easy to fix. Cut a piece of ¼" or ⅜" spaghetti so that it

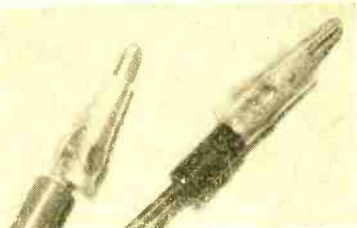

is about ⅜" shorter than the metal portion of the clip and slip it over the alligator clip as shown. **END**

POPULAR ELECTRONICS

# AFTER CLASS

## SERIES—PARALLEL RESISTANCE CIRCUITS

IN THE October issue we discussed methods of finding the total resistance of two or more resistors in series or in parallel. Often, three or more resistors are found in a circuit which combines series and parallel connections. The total resistance in such cases can be found by combining the methods previously described.

For example, in diagram (A),  $R_1$  and  $R_2$  are in series with each other, and the combination is in parallel with  $R_3$ . The resistance of  $R_1$  and  $R_2$  combined,

$$R_{1,2} = R_1 + R_2 = 2 + 3 = 5 \text{ ohms.}$$

The total resistance of the combination of 5 ohms and 4 ohms in parallel,

$$R_{1,2,3} = \frac{5 \times 4}{5 + 4} = \frac{20}{9} = 2\frac{2}{9} \text{ ohms.}$$

To take another example, diagram (B),  $R_5$  and  $R_6$  are in parallel and the combina-

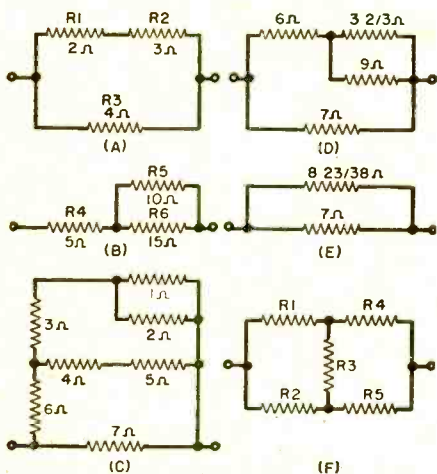

tion is in series with  $R_4$ . The total resistance of 10 ohms and 15 ohms in parallel,

$$R_{5,6} = \frac{10 \times 15}{10 + 15} = \frac{150}{25} = 6 \text{ ohms.}$$

The total resistance of  $R_4$ ,  $R_5$ , and  $R_6$ ,

$$R_{4,5,6} = 5 + 6 = 11 \text{ ohms.}$$

More complicated combinations can be calculated by repeating similar steps. Take the circuit in diagram (C), for example. The 1 ohm, 2 ohm, and 3 ohm resistors are in a circuit like that of diagram (B) and

their total resistance is  $3\frac{2}{3}$  ohms. The 4 ohm and 5 ohm resistors are simply in series and their total resistance is 9 ohms. Therefore the total resistance in diagram (C) is the same as the circuit in diagram (D), where  $3\frac{2}{3}$  ohm and 9 ohm resistors have been substituted for the combinations which have those values. Now, in diagram (D), the 6 ohm,  $3\frac{2}{3}$  ohm, and 9 ohm resistors in series-parallel combination are equivalent to one resistor of  $8\frac{23}{38}$  ohms, so the original circuit can be redrawn again as in diagram (E). Finally, we have the parallel combination of two resistors of 7 ohms and  $8\frac{23}{38}$  ohms. The total resistance is  $3\text{-}510/593$  or approximately 3.856 ohms.

Now let's take a combination which looks a bit simpler, since it has only five resistors, but which has its resistors connected in a slightly different way, diagram (F). This one cannot be solved by the methods which have been used in the previous circuits. It may seem at first sight that  $R_1$  and  $R_2$  are in series, but the rule for the total resistance of two resistors in series is based on the assumption that the resistors are connected so that all of the current which flows through one of the resistors flows through the other one also. This rule can be applied to two resistors only when one end of the first resistor is connected to one end of the other resistor and nothing else is connected at that junction. The same amount of current does not necessarily flow through  $R_1$  and  $R_2$ , because of the connection of  $R_3$  at their junction. Either some of the current through  $R_1$  may flow through  $R_3$  instead of  $R_2$ , or some of the current through  $R_2$  may flow through  $R_3$  instead of  $R_1$ .

It may seem at first that  $R_1$  and  $R_2$  are connected in parallel, but the rule for the total resistance of resistors in parallel is based on the assumption that they are connected so that the same voltage appears across both resistors. In diagram (F), some of the voltage across  $R_1$  or  $R_2$  may be across  $R_3$ .

Similarly,  $R_2$  and  $R_5$  may appear to be in series and  $R_4$  and  $R_5$  may appear to be in parallel, if we overlook  $R_3$ . Actually no two of the five resistors are either in series or in parallel. We cannot eliminate  $R_3$  by

combining it in a series or parallel combination with any of the other resistors.

There is, of course, a way to find the total resistance of circuits such as that in figure (F). It will be discussed in a future issue.

The following quiz is intended as a self check. You should be able to answer all of the questions correctly if you have mastered the foregoing text. The answers appear on page 128.

### QUIZ

1. What would be the total resistance in Fig. (D) with four 2 ohm resistors?  
(a) 1.2 ohms; (b) 0.8 ohms; (c) 2.67 ohms.
2. What would be the total resistance in Fig. (C) with a 2 ohm resistor substituted for the 1 ohm resistor and all other values as shown in the diagram?  
(a) 29 ohms; (b) 3.89 ohms; (c) 3.67 ohms.
3. What would be the total resistance in Fig. (C) with zero ohms substituted for the 1 ohm resistor and all other values as shown in the diagram?  
(a) 3.78 ohms; (b) 4.47 ohms; (c) 4.77 ohms.
4. What would be the total resistance in Fig. (C) with zero ohms substituted for the 7 ohm resistor and all other values as shown in the diagram?  
(a) 8.61 ohms; (b) 0 ohms; (c) 6.81 ohms.
5. What would be the total resistance in Fig. (F) if each of the five resistors had a value of 1 ohm?  
(a) 1-1/3 ohms; (b) 1-1/6 ohms; (c) 1 ohm.

## PUSH-PUSH FREQUENCY MULTIPLICATION

**N**O, IT'S not a printer's error; it really is intended to read "push-push."

Although push-pull amplifiers are familiar circuits in both r.f. and a.f. systems, push-push arrangements are strange to many electronics fans.

The usual frequency doubler found in amateur and commercial transmitters employs a single tube operating in Class C (very high negative grid bias). Its grid circuit is tuned to the fundamental frequency produced by the previous stage, while its plate circuit is set to resonate at double this frequency, or the second harmonic. The use of very high negative bias introduces intentional distortion in the radio wave, making it very rich in harmonics, including the second harmonic, so that the plate circuit of the doubler has something to which it can resonate to yield frequency-doubled output. This type of doubler is relatively inefficient, however.

The usual push-pull circuit cancels out even-harmonic distortion, if the two tubes are matched. If two tubes are arranged as shown in the figure, the fundamental frequency components of the signal and the odd-harmonic distortion are canceled out,

but the even-harmonic components produced by the two tubes are added. The grids of the tubes are connected in push-pull and are tuned to the fundamental frequency; the plates are joined together, the common lead going to the top of the output tank circuit. Assume that the input signal coupled to the grids is 3500 kc.; on each positive

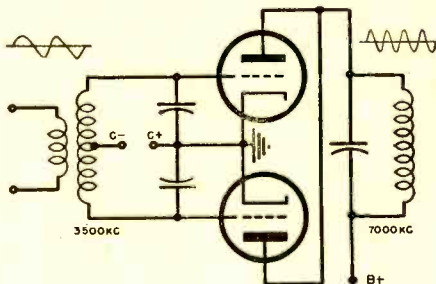

half-cycle, the grid of tube A is driven into conduction and on each negative half-cycle the same thing happens to tube B just as it does in a push-pull arrangement. But, due to the parallel connection of the plates, the output tank circuit receives an excitation pulse of the same polarity each time either of the two tubes conducts. Hence, for the whole cycle of input there are two pulses of excitation fed to the output tank circuit. Since the latter is tuned to the harmonic frequency, its output will be double the input frequency by virtue of the paired-pulse excitation.

The uniqueness of the push-push circuit lies in its ability to operate almost as efficiently as a straight amplifier, because, unlike other frequency multipliers, it produces a pulse of plate current for each cycle of the output signal. An additional advantage is that this circuit can be operated as a straight amplifier simply by removing filament or heater voltage from one tube and retuning the output. The grid-to-plate capacitance of the cold tube, being similar to that of the operating tube, provides just the amount of neutralization required.

## BEATING DEGENERATION

**I**N ANY normal single-tube audio amplifier, omitting the bypass capacitor across the cathode bias resistor gives rise to degeneration, an effect which causes a significant loss of gain. The proper operation of an amplifier tube requires that the cathode potential be held constant while the signal is permitted to swing the grid. Ordinarily, the cathode bypass capacitor charges to some d.c. voltage and maintains the same potential across the bias resistor even though the audio signal is varying the plate

current. Omission of this capacitor causes the cathode to swing in step with the signal voltage on the grid of the tube, reducing the effective input signal, so that the over-all gain is reduced.

The push-pull audio amplifier circuit shown in the figure "beats" degeneration in the sense that this loss of gain does not occur even though the bypass capacitor is not used. To prove this point, all we have to do is show that the current flowing

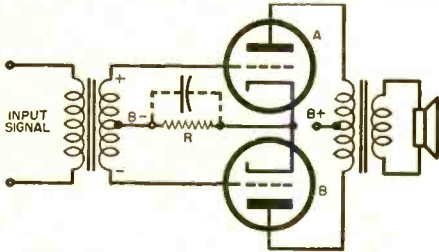

through *R* does not vary *even when full signal currents are flowing* through the circuit.

Here is the way it works: The total current flowing through *R* is the sum, at any instant, of the plate currents of the two tubes, *A* and *B*. If we assume that the grid of tube *A* is positive-going, then the grid of tube *B* must be negative-going because the two ends of a transformer are always out-

of-phase by 180 degrees. This means that the plate current of tube *A* is rising when the plate current of tube *B* is falling. If the two tubes are matched and are operated on the straight portions of their grid voltage—plate current characteristics, the sum of the two plate currents always equals a constant value. Thus, even with no capacitor connected across *R*, the cathode is maintained at a constant potential while the grid swings with the input signal and degeneration does not appear.

### INTEGRATING COUNTERS

IN MANY military, industrial, and medical applications, high speed counting of successive events is an essential operation. The repetition rate in such cases usually goes far beyond the capabilities of slow mechanical counters. For example, the measurements of machine gun rate-of-fire, the counting of rapid neurological impulses, the evaluation of radioactivity by Geiger counters, and the counting of the passage of small objects on a high speed conveyor belt all involve recurrence rates which exceed the response of electromagnetic counters.

An integrating counter is a relatively simple device which "scales down" the rate of recurrence to some smaller figure which may then operate a mechanical counter sat-

### R/C MODELS for BEGINNER AND EXPERT

#### FOR BEGINNERS:

48" SPAN



#### LIVE WIRE "TRAINER" WORLD'S MOST POPULAR R/C MODEL

A quickly built model of medium size, stable, rugged and simple to fly. Features a removable R/C unit. PRE-FAB. KIT \$6.95

### MULTI-SERVOS

POWERFUL-DEPENDABLE

#### MOTOR DRIVEN R/C ACTUATORS

Ample power to move any model control. 4 great models, one for every purpose. 2 oz. CAP.



#### Positive-Flow FUEL TANK

Gives perfect fuel flow, under all flight attitudes, upright or inverted. The tank with the internal swivel.

DESCRIPTIVE LITERATURE FREE SERVO INFO BOOKLET . . . . . 75c



\$11.95 TO \$14.95 \$1.29

### FOR ADVANCED FLYING:

65" SPAN



#### LIVE WIRE "CRUISER" FOR THE ULTIMATE IN R/C FLYING

A big, high performance, realistic model capable of carrying the heaviest of equipment with ease. Has elevators and a re-movable R/C unit. PRE-FAB. KIT \$14.95

deBOLT MODEL ENGINEERING CO. BOX 73 WILLIAMSVILLE, N. Y.

## EASY! BUILD your own Professional Electronic Instruments with EICO KITS! SAVE 50%

• Complete easy-to-follow instructions

• Fully guaranteed

#### 5" PUSH-PULL OSCILLOSCOPE



KIT \$44.95 WIRED \$79.95

#### VACUUM TUBE VOLTMETER



KIT \$25.95 WIRED \$39.95

#### 1,000 Ohms/Volt MULTIMETER



KIT \$12.90 WIRED \$14.90

#### 6V & 12V BATTERY ELIMINATOR & CHARGER



KIT \$29.95 WIRED \$38.95

Write now for FREE Catalog PE-3 describing 38 EICO KITS.



ELECTRONIC INSTRUMENT CO., INC. 84 Withers St., Brooklyn 11, N. Y.

© 54

isfactorily. An example will simplify this.

Neurological impulses occur in the form of potential "spikes" at the rate of several hundred per-second. An electronic circuit may be set up in which 100 nerve pulses must occur before the mechanical counter is triggered once. Such a circuit is said to have a scale of 100:1. Thus, if the mechanical counter displays five counts per-second, it is then known that the nerve spikes must have a repetition rate of 500 per second. The integrating counter is a kind of electronic divider which keeps track of received impulses, triggers a counter after a certain number have been received, and then resets itself so that it may handle the next train of spikes.

Small thyratrons like the 2051 and the 2050 are favored as trigger tubes in integrating counters. Many circuit arrangements are possible with refinements and modifications to suit the needs of the individual process. The basic circuit shown here is used for explanatory purposes only.

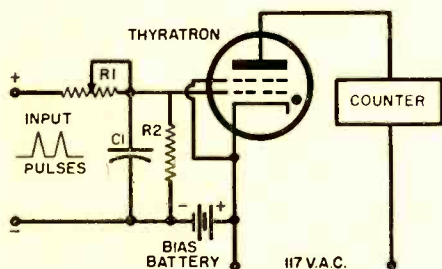

The thyratron is prevented from firing at the start by the bias battery which applies a negative voltage to the grid through  $R_2$ , a resistor of very high value. The incoming pulses are positive so that each one adds a definite amount of charge to capacitor  $C_1$ , gradually bringing its voltage up to the point where it cancels the battery voltage and permits the thyratron to fire and actuate the counter. The number of pulses needed to charge  $C_1$  to the "critical voltage" or firing point may be chosen by adjusting the value of  $R_1$ . The smaller the resistance of  $R_1$ , the fewer the pulses required to elevate the potential of  $C_1$  to the point where it will permit the thyratron to ignite. The counter may be equipped with a pair of contact points (not shown) which discharge  $C_1$  after every counter step, thus making it ready to accept the next train of pulses.

## VACUUM CAPACITORS

**C**APACITORS handle a great many jobs in electrical and electronic circuits. In many of these functions the requirements are not critical and low or medium grade

capacitors are perfectly satisfactory. If one remembers that a perfect capacitor (of which there aren't any) would offer infinite resistance to the flow of direct current, would have absolutely no leakage, and would suffer no other losses, it is easy to see as the circuit under consideration begins to involve higher standards, one's capacitor must begin to approach perfection.

Demands for near perfection are made of capacitors used in transmitter tank circuits and in diathermy and electronic heating equipment where very high voltage, very low leakage capacitors are essential. Vacuum capacitors approach perfection more closely than any other type.

These capacitors are available in values ranging from 6  $\mu\text{fd.}$  to 100  $\mu\text{fd.}$  with voltage ratings from 7500 volts to 16,000 volts in small size units. As compared with equivalent paper or mica-dielectric units, vacuum capacitors have these important features: they are completely self-healing even if subjected to over-voltages which cause arcing between plates; they have practically zero leakage; and they are designed to slip into standard fuse clips.

The design and construction of vacuum capacitors are minor triumphs of modern engineering. The accompanying illustration shows the constructional details of a typical 7500-volt vacuum capacitor.

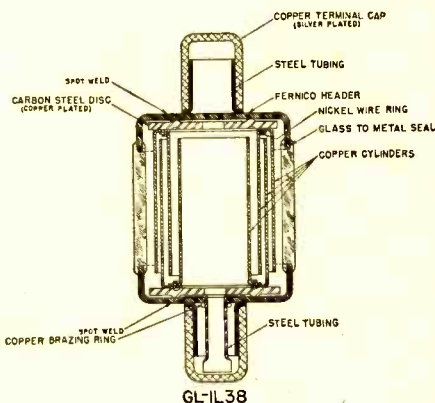

One of the interesting features is the manner in which the glass-to-metal seal is handled. Fernico, an iron-nickel alloy having the same coefficient of thermal expansion as glass, is used in "cup" form at the top and bottom of the unit. Both Fernico cups are imbedded in the glass so that the latter adheres permanently to the inside and outside of the cup. Vacuum capacitors of this type can withstand vibrations up to 20G without any signs of deterioration of the seals or internal bonds.

The dielectric is, of course, a dry vacuum in which leakage currents cannot flow. **END**



## Using the Decibel

(Continued from page 30)

the difference in sound intensity between the input to the amplifier and the output from it would be heard by the ear as seven times the minimum change in loudness that we could detect.

Now, let us use the table to work this problem. Since there is a gain involved, we refer to the right-hand portion of the table. Since the values are in terms of power (watts), we use the 5th column. The nearest figure in this column to our power ratio of 5 happens to be 5.012. This corresponds to plus 7 in the db column. Again, our answer is plus 7 db.

Let us work a problem using voltages.

**Example:** What will be the gain in db of an amplifier whose output voltage rises to 9 times its input (across equal resistances)?

Here we must multiply the logarithm of the ratio by 20, since we are dealing with a voltage value rather than a wattage value.

The common log of 9 is 0.95. Multiplying this by 20 we get 19 db.

Again, the same answer could be obtained directly from our table. Since a gain is involved we again confine ourselves to the right-hand side of the table. Since our ratio is expressed in voltage, we check down the 4th column. We find that the number of decibels that corresponds most closely to a voltage ratio of about 9 happens also to be 19 db.

As long as this table is available, there is no need for the formulas or for logarithmic values of the ratios. If the table is not handy, though, the formulas and a table of common logarithms will solve any problem.

Let us now take a situation in which there is a decibel loss to be calculated. For example, an amplifier has a negative voltage feedback loop which is intended to reduce distortion at the output. This feedback voltage also reduces the over-all gain of the amplifier. But by how much? Assume that we measure 1.2 volts at the output of the amplifier with its feedback loop in operation. Then we disconnect the feedback loop and find the output measures 12 volts.

Our ratio in this case is 1.2 over 12, or 0.1. We now consult the left-hand side of our table for decibel loss. Since these are voltages we check down the column so headed. We discover that a voltage ratio of 0.1 indicates a 20 db loss. Thus we express the feedback value in this amplifier as minus 20 db.

Conversely, if an amplifier's specifica-

# DON'T THROW OLD RADIOS AWAY!



This giant book shows exactly how to fix them . . . without a lot of previous experience!

There's a "secret" to repairing old radios fast and profitably . . . and this big **RADIO TROUBLESHOOTER'S HANDBOOK** is it!

Just look up the old make and model you want to fix. This manual-size, 3 1/4 pound 744-page Ghirardi handbook tells what the trouble is likely to be . . . **AND SHOWS YOU EXACTLY HOW TO FIX IT.** No useless testing! No wasted time! Even beginners can handle jobs "slick as a whistle" *The only guide of its kind . . . cuts repair time in half!*

Included are common trouble symptoms and remedies for over 4,800 models of home and auto radios and record changers. Actual case histories cover practically every model made by 202 manufacturers between 1925 and 1942—Airline, Apex, Arvin, Atwater Kent, Belmont, Bosch, Brunswick, Clarion, Crosley, Emerson, Fada, G.E., Kolster, Majestic, Motorola, Philco, Pilot, RCA, Silvertone, Sparton, Stromberg and DOZENS MORE. Gives how-to-do-it data on SPECIFIC jobs—NOT general theory. Includes hundreds of pages of invaluable tube and component data, service short cuts, etc. Price \$6.50. 10-day free trial.

## HERE'S HOW TO GET YOUR START

IN RADIO-TV-ELECTRONICS

Here's basic training you can really understand . . . training that can help fit you for a good paying radio-television-electronic career! No matter what part of the work you want to do, this is the kind of training you need **FIRST!**

Ghirardi's **RADIO PHYSICS COURSE** is the oldest book of its kind . . . and still a best seller **BECAUSE IT IS SO AMAZINGLY CLEAR AND COMPLETE.** Thousands now in electronics got their start from this great book—**AND THEY'LL RECOMMEND IT TO YOU TODAY!**

Starts with Basic Electricity (over 300 pages) then takes you step by step through the entire radio-electronics field. Covers principles, theories and practices that are basic to even the most modern equipment. 972 pages; 508 pictures; 856 helpful self-review test questions. Price only \$6.50.

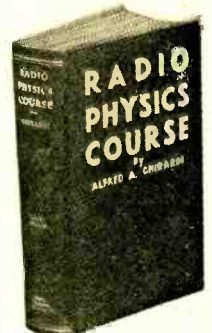

More experts got their basic training from this big book than any other of its type!

36 courses in one!

----- 10 DAYS FREE TRIAL -----

Dept. PE-35, RINEHART & CO., INC.  
232 Madison Ave., New York 16, N. Y.

Send book(s) checked for free examination. In 10 days, I will either send price shown (plus postage) or return books postpaid and owe nothing.

Ghirardi's RADIO TROUBLESHOOTER'S HANDBOOK, \$6.50.     Ghirardi's RADIO PHYSICS COURSE, \$6.50.

Name .....

Address .....

City, Zone, State .....

(OUTSIDE U.S.A.—\$7.25 each, cash only. Money back if books are returned in 10 days.)

## Edlie for TOP VALUES

**JUST** Newest & Best "Fix-It-Yourself" Aid  
**OUT!** Edlie's E-Z TV REPAIR GUIDE

The only Fix-It-Yourself guide made expressly for YOUR TV set! Now you can save costly TV repairs with this new, simplified method which includes all necessary data for just YOUR set. No confusing, unimportant information applicable to hundreds of different makes. Simplifies detection of faulty tubes in your TV receiver quickly, accurately. It's a terrific idea—It's a terrific guide! Order today and have your set back in perfect condition at once. Be sure to send us make and model of your TV set when ordering.

only  
**50¢**



### 5-Tube AC/DC Superhet Radio Kit

KIT: Includes all top quality components required to construct this latest design, highly sensitive, 5-tube, AC/DC superheterodyne broadcast receiver. Complete with black, glistening bakelite cabinet (excludes wire & solder).

Kit of 5 tubes: 12AT6, 12BA6, 12BE6, 35W4 & 50B5... \$3.25 less tubes... **\$7.95**

### 6-Tube Radio Kit

KIT: A great value in a low-priced radio kit designed for high sensitivity and good tone qualities. Easily constructed circuit. Complete with chassis, all parts, hardware, PM speaker (except wire & solder).

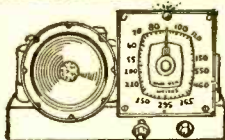

Kit of 6 tubes: 25L6, 25Z6, 6SQ7, 6SA7 & 6SK7 (2)... **\$3.25** less tubes... **\$6.95**

Write today for FREE Catalog. All mds. shipped F.O.B. New York City, prices subject to change without notice. Include 20% deposit with C.O.D.'s.

### EDLIE ELECTRONICS

154 Greenwich St. Dl. 9-3143 New York 6, N. Y.

## VEST POCKET RADIO

### PACKS AMAZING POWER!

Owners report COAST-TO-COAST reception on this tiny, hearing aid tube radio. Truly, a gem of electronic magic, this little set must delight you or your money back. Fully finished PRE-FAB kit includes attractive plastic case, fibre chassis with battery clips and soldering terminals, high-gain ferrite tuner, low drain hearing-aid tubes, switch, miniature resistors and condensers and many other finished parts. Anyone can assemble in 30 minutes, no radio experience needed. Clear picture plan shows every connection. Batteries and hearing-aid earset extra at \$1.10 for batteries and \$3.90 for dime-sized hearing-aid earset. Regular size headphone can be used if desired.

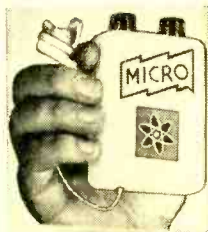

**\$2.99** POST-PAID

SEND ONLY \$1.00 WITH ORDER . . .

BALANCE C.O.D.

TRANSI-MITE RADIO LAB Manteo, No. Car.

tions claim that the circuit incorporates a minus 20 db feedback loop (or "negative feedback, 20 db"), this means that the output of the amplifier should measure one-tenth the voltage with the loop that it does without the loop.

*Another example of decibel loss:* Assume that an amplifier has a rated output of 20 watts. We want to determine what its hum level is because in order not to hear the objectionable hum, its level should be very low—maybe 50 db below the rated output of 20 watts. Here's how this is done: We apply a signal to the input of the amplifier and connect a voltmeter across its output terminals, say the 8-ohm terminals. Next we turn up the gain of the amplifier to the point necessary to produce its rated 20 watts output. Since we are using a voltmeter at the output terminals, we must translate watts into volts. From Ohm's Law we know that power in watts is equal to the square of the voltage divided by the resistance. ( $P = \frac{E^2}{R}$ ). There-

fore,  $E$  equals the square root of  $P \times R$ .  $P$  is 20 and  $R$  is 8. Thus  $E$  equals the square root of 160 which is approximately 12.7 volts.

Consequently, when our voltmeter—connected across the 8-ohm output terminals—reads 12.7 volts, we have reached the amplifier's rated output of 20 watts. We now disconnect the input signal and short the input. Naturally, the voltage to be expected with no input signal should be quite small. But whatever is present will be noise and hum within the amplifier circuit itself. Again, consulting our voltmeter (still connected at the 8-ohm terminals) we discover that it reads 3 millivolts (0.003 volts).

To determine the number of "minus decibels" the hum level is with respect to the 20 watts output, we must first get our voltage ratio, which is 0.003 over 12.7. This comes to approximately 0.00024. Since we are dealing with a loss in voltage, we consult the 1st column of our table, and we find there is no figure like our 0.00024!

Therefore, we must interpolate. The nearest significant figure to our ratio of 0.00024 happens to be 0.251. This gives us minus 12 db. But our ratio is about one-thousandth, or  $10^{-3}$ , of 0.251. We, therefore, consult the  $10^{-3}$  value in the same column and discover we must add another minus 60 db to the minus 12 we already have. Thus our final answer is minus 72 db. This means the hum level of the amplifier is 72 decibels below its rated output, which puts it well below the level at which it could be heard.

Conversely, this means that if an amplifier is rated at 20 watts output with a hum level of minus 72 db, the actual voltage measured across its 8-ohm output terminals with no signal input should not exceed 0.003 volts.

Three main types of meters are used for measuring db directly, without the need for calculating values by the use of logarithms or the table. The simplest and possibly the most familiar type is the "output meter" or the decibel scale found on many multi-meters. This is actually an a.c. voltmeter calibrated to read the number of db that expresses a ratio between the power being fed into the meter and some fixed reference level, usually 6 milliwatts. The meter calibration assumes that the voltage is measured across 500 ohms resistance. This type of meter is used in determining the relative outputs of various audio circuits and is also used in receiver alignment.

The "VU meter" is similar to the output meter, except the reference level is 1 milliwatt in 600 ohms resistance. In addition, the VU meter has time-constant characteristics which determine its response to voltage peaks, such as "sound bursts" or other short time interval peaks. It is widely used in broadcasting and recording studios to monitor the output levels of programs.

A third type of decibel meter is the

sound level indicator. This is actually an assembly of a microphone, an amplifier, and an a.c. voltmeter calibrated to provide a db reading which corresponds to human hearing levels. On this meter, zero db represents the threshold of hearing. This meter is used by acoustics technicians to determine hearing conditions in auditoriums and theaters.

In summary, the decibel is used to express any ratio of power, voltage, current, acoustic energy, etc. whether it be a gain relationship or a loss. It can be used to express the range of a symphony orchestra and then to determine how much amplification is needed to carry the music across lines of certain distance in order to fill a hall of a certain size or cut a particular recording. Any type of gain or loss in any circuit may be expressed in decibels which provide a quick and accurate key to the operating conditions of the circuit. The advantage of using decibels is that it permits the simple addition of ratios to obtain complete gain and loss data whereas using *E*, *I*, or *P* ratios would involve multiplication and division. For example, it is easier to add 25 db and 36 db than it is to multiply the corresponding gain figures of 316.2 and 4000, to get the total gain of two amplifiers in cascade. END

## BUILD YOUR OWN PHONO

### HERE'S WHAT YOU GET

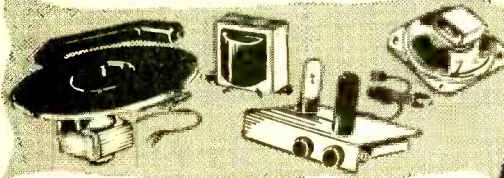

- An excellent rim drive motor with velvet finish turntable
- 2-Tube AC-DC Amplifier with tone control
- 5" PM speaker with matching output transformer

Deluxe crystal pickup arm with all-purpose needle  
Everything you need for a complete record player (except cabinet). High quality parts throughout. 5" spkr. Crystal pickup. AC-DC. Incl. tubes.

Stock No. FKT-10 (single speed 78 RPM) Net \$9.95

Stock No. FKT-11 (three speed) . . . . .Net \$12.95

Motor alone—Single Speed \$3.99 Three Speed \$4.95

## WIRELESS MICROVOX MICROPHONE

This convenient mike plays through your radio with no wires necessary. Battery powered to operate up to 75 feet from set. Broadcasts from 1000 to 1700 kc. Tune radio to non-interfering point to pick up mike. Plastic unit incl. battery.

Stock No. F-MV1 . . . . .Net \$6.50



## Another Concord Value



### CANNON HEARING AID FOR RADIO-TV

This new headphone device brings new enjoyment to persons who find it difficult to hear radio programs properly. Also very useful for private listening without disturbing others. Quickly and easily attached to any radio in a few minutes. Supplied with switch permitting speaker only, phones only or both. Low resistance phones match loudspeaker impedance and provide excellent tone fidelity. Shpg. Wt. 2 lbs.

- Stock No. FC2 . . . . .Net \$4.12
- FC-1—Same, but with single phone . . . . .Net \$3.37
- FK-4—3-way switch adapter only . . . . .Net \$1.65

### CONCORD RADIO

Dept.

55 Vesey St., N. Y. 7

E 3

MINIMUM ORDER \$5.00 20% deposit with C.O.D.

Please send NEW 1955 CONCORD Catalog!

NAME \_\_\_\_\_

ADDRESS \_\_\_\_\_

CITY \_\_\_\_\_ ZONE \_\_\_\_\_ STATE \_\_\_\_\_

CONCORD RADIO 55 Vesey Street, New York 7, N. Y.  
Olghy 9-1132

## The World at a Twirl

(Continued from page 89)

in West Virginia although at times it seems jammed. Westerners may find a better signal over the 11.620 outlet, in parallel.

**Japan—Far East Network, AFRS, 11.750, Tokyo, opens now 2100; carries English news 2200; is audible on West Coast often ZL3, 11.780; 0615-closedown, ZL7, 6.080, with English news. This channel usually runs to 2000 closedown.**

**New Zealand—Latest revised schedules for Radio New Zealand read to Australia 2000-0600, ZL19, 11.830; 0615-closedown, ZL18, 9.520. To Pacific Islands 1700-0600, ZL3, 11.780; 0615-closedown, L7, 6.080. Closedown times are 1045 weekdays, 1120 Saturday, 1000 Sunday.**

**Norway—On Sunday at 1700-1720A sign-off, eastern and midwestern SWL's should get a good signal from Radio Norway's LLM, 15.175, when it has English sessions called "Norway This Week."**

**Panama—Colon's HOLA, 9.505, has been heard in Indiana on a Sunday at 2130 with religious program in English.**

**Portugal—While Lisbon's 9.746A outlet is scheduled with all-Portuguese session to North America 0000-0200, occasionally it has some English (regarding the Port Goa-India affair).**

**Sweden—Eastern DX'ers should get a good signal from Radio Sweden, 11.705, with English news 1200-1215; western DX'ers at 1600-1615 on 9.535.**

**USSR—Radio Moscow is reported to North America in English 2300A-0600A on many channels including 6.070, 6.240, 7.130, 7.150, 7.160, 7.170, 7.200, 7.230, 7.240, 7.250, 7.270, 7.290, 7.350, 9.570, 9.660, 9.700, 9.830, 15.110. Obviously some of these outlets are actually satellite relays from countries within the Soviet orbit.**

### For Experienced DX'ers

**Albania—ZAA, measured 7.848, Tirana, now has English 2030-2100.**

**Angola—Eastern and midwestern DX'ers should try for Radio Angola on 9.050A, parallel with 11.862 (best bet) around 2200-2230 closedown.**

**Bolivia—CP38, measured 9.436, La Paz, has news in Spanish 0030; runs to 0230A; all-Spanish programs.**

**British Somaliland—A real "toughy," VQ6MI, 7.125, Hargeisa, has been logged on West Coast weakly around 1330-1430 closedown; is best the last 15 minutes of transmission.**

**Burma—XYZ, 4.777A, Rangoon, is heard in California at 1400 with native music.**

**China—West Coast SWL's report Radio**

**Peking opening 2200 and running to 0130 closedown on 15.060, 15.100, 11.650, 11.330, 9.663 (no English). It changes programs every half hour and re-opens with chimes and "Red" March. Not all are in parallel; outlets peak after 2300; all use Asian languages.**

**Cyprus—Sharq-al-Adna, 11.720A, Limassol, has been heard at fair level 1630-1700 by California DX'ers. It uses Arabic and has also been heard in Delaware.**

**Fr. Camerouns—Although when this was compiled, it had not been reported as "heard" in North America, Radio Douala, according to European sources, has settled down on 6.115 daily 1730-2000 and Sunday also 1000-1300.**

**Fr. West Africa—Radio Dakar, 4.890A, 4.950, 9.560A, all parallel, has been noted on West Coast with news in French 0730. The 11.896A channel has been heard 0800-0830 sign-off.**

**Hong-Kong—For a real DX "catch," try 9.525 for ZBW3, Victoria, at 1100 when it has weather report, BBC news relay in English and then music.**

**India—Eastern listeners should tune 11.850 for All India Radio which opens 2330 to the West Indies. It should have English news 0030.**

**Indonesia (USI)—YDQ2, 9.550, Makassar, Celebes, has been heard in California with Indonesian language session at dictation speed 0730-0815, fair level.**

**Iraq—For another real DX "catch," tune 11.702A for Radio Baghdad around 1600; uses Arabic and has been heard on both East and West Coasts. If you're truly "lucky," you might get this one when it has English, 1915-2000 closedown.**

**Malaya—The British Far Eastern Broadcasting Service, Singapore, has been logged by a West Coaster on 17.755 at good level 1530 in English.**

**Pakistan—Radio Pakistan, Karachi, now uses 6.235 and 7.010, parallel, for English news 1445-1500; heard in California.**

**Philippines—Don C. Smith, Transmitter Supervisor, Far East Broadcasting Co., Inc., Box 2041, Manila, P. I., would appreciate reception reports on the new 10 kw. transmitter which now operates on 9.730 at 0900-1700, 2100-0100. Printed report forms will be sent to anyone interested in reporting reception to FEBC regularly. The new transmitter, a Collins Model 21M, replaced an older transmitter of about 1.8 kw. A good time to try for this one is 1000 when there is news in English.**

**Tahiti—Radio Tahiti, 6.135, Papeete, should be audible at least some days around 0400-0600 in French.**

**Thailand—After months of vain monitoring, a California SWL has picked up Radio**

Thailand, HSK9, 11.670, Bangkok, during the North American transmission 0415-0515; peaked around 0435 when *English* news was in progress.

#### Last-Minute Flashes

*Radio France-Asie*, Saigon, Indo-China, has replaced 11.790 with 6.115 for *English* to Europe at 1600, good signal on West Coast. This transmission opens in French 1535 and closes down 1630; 6.115 is also used 1030-1530 with French news 1515. It has QRM, however, from Moscow until 1500.

COBZ, *Radio Salas*, Havana, Cuba, has been heard on West Coast on 17.810 at 1515 with classical music. Although not reported to me as heard yet in North America, the "Forces Broadcasting Service, North Africa," at Benghazi, Libya, is noted in *English* from around 1630 to 2100 closedown on 3.305; opens daily at 0400 on 7.220

*Radio Sarawak*, Kuching, Sarawak, 4.870, heard on West Coast, closes 1330A but final *English* announcement is at 1314A. It carries news in *English* 1300. *Radio Ankara*, Turkey, uses TAS, 7.285, and TAP, 9.465, parallel, with *English* for Western Europe 2100-2145 closedown. *English* sessions from HVJ, Vatican City, are currently scheduled *daily* at 1500 over 7.280, 9.646, 11.685; at 1815-1830, 7.280, 9.646, 11.685, 15.120; on *Tue.* at 1600-1615, 11.685, 21.740.

4VEH, Haiti, has been noted on measured 6.242 testing around 2250 when announced in *English* and asked for reports. According to the International Short Wave Club, London, the Technical Staff of Radio Nederland has published a new booklet, "Improvement of Short-Wave Reception," available from Radio Nederland, Postbus 137, Hilversum, Holland. Radio Montserrat, 3.255, 40 watts, using a center-fed doublet, operates Sunday 1630-1700, 2000-2030, and Wednesday 1815-1830, 1900-1930. If you pick up this one, QRA for reports is Radio Montserrat, Box 201, Plymouth, Montserrat, B.W.I.

Since August 1953, KGEI, Box 47, San Francisco, Calif., has been broadcasting exclusively to Latin America under the non-commercial sponsorship of *General Electric Co.* It is scheduled on 9.550 at 2300-0230 and is always glad to receive reception reports from listeners in this country. Each correct report is answered with a verification card.

Beginning in April, many stations will make seasonal changes. Some will go on "summer time" (one hour earlier than listed herein), and some will go on "summer" frequencies. In the meantime, good DX, fellows, as you "twirl to tune the world!"

(Continued next month)

March, 1955

## Electronic "Road Map" helps build the fastest-assembled radio in the world



This "road map" or guide used with Jiffy Connectors and electronic components makes it possible to assemble a complete radio set in *four minutes*. All these parts are contained in the Science Electronics Jiffy Kit, together with complete instructions. You can't possibly go wrong, for the placement of each numbered part is clearly indicated on the guide by a corresponding number.

Fourteen receiving and transmitting sets (and a code practice oscillator for "hams") can all be built rapidly and safely without tools or soldering and with no danger of shock. Everyone from 6 to 60 can follow these crystal-clear instructions — and have barrels of fun doing it.

The Jiffy Kit is used by over 440 schools and universities to teach electronics. You can use it as an expandable electronics laboratory. With the addition of inexpensive parts you can build electric-eye devices, short wave, radio control and amateur equipment. A receiver made from the Jiffy Kit can be your reserve battery-operated radio in the event of an emergency.

Send today for your Jiffy Kit — \$14.95 C.O.D. with a complete money-back guarantee, or send for literature and a free Jiffy Connector and terminal post.

SCIENCE ELECTRONICS, INC.

485 Main Street • Cambridge, Massachusetts

## Carl & Jerry

(Continued from page 81)

ly six feet, the hissing noise stopped and the rubber sphere ceased to grow.

"Maybe the cylinder has enough helium in it to fill the balloon several times," he says," Carl quoted bitterly.

"So I was wrong," Jerry cheerfully admitted as he closed the valve in the neck of the balloon. "Wups!" he exclaimed as the neck slipped from his fingers and the balloon soared up and bumped along the rafters of the tall barn that had been converted into a garage. "It's a good thing we didn't fill it out of doors. You get a ladder and recapture the slippery thing while I get our spray gun and put some aluminum paint in it."

Neither operation took long. Carl held the captive balloon and turned it about while Jerry stood on a stepladder and sprayed the surface with metallic paint. Jerry directed the paint spray with more enthusiasm than accuracy, and by the time the job was finished, Carl's face had a metallic sheen that matched the silvery sphere he was holding.

"I'll bet my face cracks six ways the next time I smile," he muttered through stiff lips. "Now I know how the man in the iron mask must have felt. Say, wait a minute!" he exclaimed as he picked up a piece of black tissue paper and began whacking away at it with the tin snips. In a couple of minutes he climbed up on the ladder and pressed the bits of paper against the sticky surface of the balloon. Those bits of paper (serving as eyes, mouth, and nose), transformed the silvery bubble into the bald head of a menacing, snaggle-toothed ogre.

"Holy cow!" Jerry exclaimed, "I'd hate to meet that guy in the dark."

"When I was in the third grade, I won a prize for carving the meanest-looking Hallowe'en pumpkin," Carl modestly admitted.

The boys spent the remaining daylight hours rigging up an old yagi Channel 6 antenna the Bishops had taken down when they put up their new all-channel antenna and rotor. The yagi was mounted on a broomhandle thrust through the rungs of a stepladder so it could be rotated on a horizontal axis.

"By keeping the side of the yagi pointed at the station while the front of it points up in the sky, we can make sure all the reception we get is reflected from the balloon," Jerry explained. "A yagi picks up practically nothing off the side."

Carl's folks had gone out of town for the weekend; so the two boys had the

run of the Anderson home. It was thought best to keep the balloon raising point, the yagi antenna, and the TV receiver all as close together as possible so that information could be easily relayed back and forth between the balloon-and-antenna operator and the TV set observer. To this end a short length of twin lead was run from the TV receiver out through a window to the yagi set up on a short ladder between the Anderson house and the Gruber home next door. The binder twine was measured off and a knot tied every fifty feet so the height of the balloon could be known. When everything was ready, both boys went over to Jerry's house for supper, leaving the balloon safely hidden inside the closed garage. They did not want to send it up until after dark to avoid attracting attention.

By eight o'clock it was quite dark except for the light of a bright moon just coming over the housetops. Carl and Jerry, armed with flashlights, stealthily conveyed the balloon, tugging and bobbing in the gusty breeze, out of the garage and into the narrow space between the houses.

"Sh-h-h, don't make any noise," Carl whispered as he pointed to the lighted window above their heads on the second floor of the Gruber house. "Grandpa Gruber must be catching up on his science fiction reading, and in spite of his eighty years, he's got plenty good ears."

"Okay; let her go up," Jerry commanded.

"Aye, aye, sir; releasing ballast," Carl whispered as he let the coarse binder twine slide through his fingers.

The released balloon soared aloft like a live thing for about twenty feet, and then it stopped with a jerk.

"What's the matter?" Jerry whispered hoarsely.

"Darned twine is tangled," Carl muttered as he fumbled with knots in the darkness. Above their heads the balloon was caught by a gust of wind and lurched over and bumped against the lighted window pane with a soft whumping sound.

"Holy cow! Let it go, tangle and all," came Jerry's agonized plea.

Carl obeyed, and the balloon started up again; but it was too late. From the lighted room there came a sound that was half a scream of fright and half a Rebel yell.

"Boots and saddles! Prepare to mount! Charge!" came the muffled shouts of Grandpa Gruber. Then his window was thrown open and a long black tube thrust outside. A moment later an orange tongue of flame licked out of the tube toward the balloon, only to be followed a second later by a second jet of flame. Three reports rang out almost as a single clap of sound,

and the balloon evaporated from sight. The binder twine dropped back to earth in a tangle over the heads of both boys.

"I got him! I got the varmint!" Grandpa Gruber cackled at the open window, as doors were thrown open and people came running from all directions. "Look for his carcass down there, but keep an eye peeled for some more of them Martians that may be hanging around. He was thirty feet tall with a head as bald as an egg and as big as a barn door and the skinniest body you ever did see. I got a real good gander at him while he was peering in my window, and I'll swear I never saw such a mean-looking countenance outside of a nightmare. Hain't you found his carcass yet? Old Betsy here put two loads of chilled shot right between his nasty eyes; and there ain't a thing on this earth or any of the rest of the planets that can live after a dose like that."

"All right, folks, stand back; what's going on here?" demanded a policeman as he shouldered his way through the crowd.

"Mr. Gruber up there saw somebody—or some thing—peeping into his window and shot at it," a woman explained.

"Peeping into a second story window!" the policeman scoffed. "Grandpa, you'd better close that window and go on back to bed before you catch a cold. You've been having a nightmare."

"Nightmare my eye, young know-it-all!" Mr. Gruber said tartly. "I tell you I saw a man from Mars, and I let moonlight through his pumpkin head with Old Betsy here. If you can't find the body, like as not his companions have lugged it off in one of their saucer ships. But there's no use trying to explain anything to stupid people who read nothing but the comics."

Saying this, Grandpa Gruber slammed down the window, and a few minutes later the light in his room went out.

Jerry and Carl had very quietly and unobtrusively slipped into the Anderson house as soon as the policeman arrived, but they had not escaped his notice. As he got back into the squad car he said reflectively to his fellow officer, "You know, every time there's some excitement, that tall tow-headed kid with the glasses and the short fat one are right on the spot. I wonder how come."

Inside the Anderson home, Carl and Jerry sat on a couch and grinned at each other rather sheepishly.

"That's the end of my Field Day balloon and your experiment," Carl said slowly, "but I guess neither of us minds too much. It was worth it just to let Grandpa Gruber get a good look at one of his saucer folks. I just hope I've got half his zip and fire when I'm that old." END

March, 1955

T  
E  
C  
H  
M  
A  
S  
T  
E  
R  
C  
U  
S  
T  
O  
M  
B  
U  
I  
L  
T  
K  
I  
T  
S

**DELUXE  
630-TYPE  
TV KIT**

World's  
Finest  
TV Receiver:

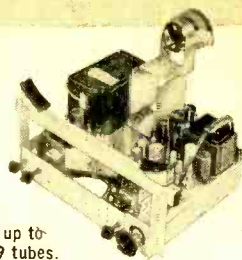

for picture tubes up to  
24" (70° defl.). 29 tubes.  
All principal components mounted

**Model 630D24:** Complete with all components, tubes, brackets, and quality speaker. (Less kine, wire and solder).....Net **\$159.50**

**AC/DC TV KIT**

High Quality TV  
at Low Cost:

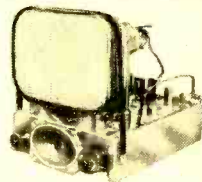

for 14" and 17"  
rectangular tubes.

**Model 5116:** Complete with tubes, hardware and mounting brackets. (Less kine, wire and solder).....Net **\$99.95**

**WILLIAMSON-TYPE  
20-WATT  
AMPLIFIER  
KIT**

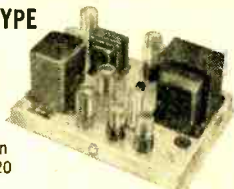

Famous Williamson  
circuit with full 20  
watt output.

Specially-wound, quality output transformer.

**Model TM-15A,** complete with tubes...Net **\$49.95**

**4-CHANNEL,  
PRE-AMPLIFIER-  
EQUALIZER KIT**



With cathode follower output.

Inputs for FM tuner, phono, tape recorder and other signal sources.

**Model TM-15P (with Cabinet)**.....Net **\$19.95**

**AC/DC SUPERHET  
RADIO KIT:**



Receives all  
standard AM  
broadcasts, 550-  
1720 KC. 5 tubes  
including rect.  
Super-sensitive  
high gain cir-  
cuit with built-in loop antenna.

**Model 3B5-K:** Complete with all tubes, and handsome bakelite cabinet.....Net **\$19.95**

Write for latest catalog  
of complete Tech-Master line



**TECH-MASTER CORPORATION**

Television — Radio — Audio

75 Front Street, Brooklyn 1, N. Y.

## ELECTRONIC SUPPLIES

For Experimenters—Service—Industry

Clean useful items sold on satisfaction  
Guaranteed basis. **WHOLESALE OR RETAIL**

Miniature Hearing Aid Crystal  
Microphone (postage stamp  
size) extremely sensitive. Thou-  
sands of applications. Famous  
Make Worth over \$8.00. Guar-  
anteed \$1.49 ea.

### ELECTRONIC REMOTE CON- TROL UNIT

Contains tube sockets, conden-  
sers, resistors, tube sockets,  
panel lamp, 3,000 Ohm SEN-  
SITIVE PLATE RELAY (worth  
over \$4.00) Transformer. We  
include schematic instruction  
sheet. TO CLOSE OUT RE-  
MAINING QUANTITY.

79¢ ea.; 4 for \$3.00

### Brand New Meter Specials

3" Round Westinghouse 75-

0-75 Mils D.C. \$2.95

2" Sq. ELECT. 0-10 Amp.

D.C. Iron Vane. . . . .98¢

2" Rd. G.E. 0-1 AMP. D.C.

Iron Vane. . . . .98¢

Miniature 0-500 Microamps

(worth over \$7). . . . .\$3.39

Miniature 0-1 Mill. D.C. \$3.95

WESTON 506 0-200 Micro-

amps (not surplus). . . . .\$7.00

### RETRACTABLE PHONE CORD

—worth over \$4.00 ea. Over

6' long. Brand New.

\$1.50 ea.; 4 for \$4.00

### HEADSETS (EARPHONES)

GOVT/SURPLUS. Excellent

condition 2000 Ohms or bet-

ter. \$1.95

### TELEGRAPH KEYS—U. S. Signal

Corps TYPE J-4; Original

Overseas wrapped 89¢ ea.; 4

for \$3.00. We'll include sim-

plified Code Training course

with \$4.00 order.

### SELENIUM RECTIFIERS. Full

Wave Bridge Types. Input

from 0-18 Volts A.C.

2 Amps. . . . . \$2.10 ea.

4 Amps. . . . . 3.75 ea.

6 Amps. . . . . 4.50 ea.

Factory guaranteed for one

year. Applications: Model RR,

Electroplating, Battery charger,

etc. We'll quote on any size

Include Postage with Order

## REX RADIO SUPPLY

88 CORTLANDT STREET, NEW YORK 7, N. Y., CO 7-1617

or quantity on request.

### TUBE VALUES

1629—Magic Eye Tube.

7 for \$1.00

6H6—Dual Diode 4 for \$1.00

3A5 Min. pentode used in

Model Airplane Remote Con-

trol. RCA. . . . .3 for \$1.00

807 JA N. . . . .2 for \$2.50

1625 . . . . .3 for 1.00

1626 . . . . .4 for 1.00

6A K5 . . . . .89¢

6Y6 . . . . .70¢

6L6 . . . . .70¢

Hearing Aid Miniature

tubes Unbranded. New.

5 for \$1.00

Toggle Switches Bakelite body.

SPST 3A 125V AC.

4 for \$1.00

DPDT 3A 125V AC.

3 for \$2.00

DPDT Center Off. 10 Amps.

\$1.00 ea.

### SMALL PARTS VALUES

BELL WIRE Stranded 3-50'

Hanks . . . . . \$1.00

**SOUND POWER**—Head &

Chest set used—Operat-

ing

Mica condensers, worth

40¢ ea. . . . . 6 for \$1.00

Brand New Telephone Hand-

sets . . . . . \$5.95 ea.

1/4" Panel Lamp Indicators

Red or Amber. . . . . 6 for \$1.00

Carbon Chest Mike. \$2.95

Chassis w/8000 Ohm rel.

\$1.00 ea.

Coaxial 59/100' . . . . . 4 for \$2.00

450VDC Worth \$2.

FP electrolytics Multiple can

types Fresh. . . . . 6 for \$1.00

10MFD. 400VDC (dual 5)

Oil Lect. Cond. NEW. \$1.00

7 pr. Min. Sealrite Sockets.

Worth 25¢ ea. Doz. \$1.00

Western Electric Stepping

Switch 2 circuit 46 steps

6 or 12 VDC Coil Worth

\$30. Special. . . . . \$7.95 ea.

## So You Want to Be a Ham

(Continued from page 65)

automobile for daytime driving. Some actual figures will tell you why. A typical commercially-made transmitter rated at 50 watts, which means input to the final amplifier stage, actually requires 6.3 volts at 4 amperes or 25.2 watts for the filaments and 500 volts at 225 milliamperes or 112.5 watts for the plate circuits, a total of 137.7 watts. A standard vibrator type high-voltage power unit for the plate supply takes 35 amperes at 6.3 volts or 220.5 watts. The difference between 220.5 and 137.7 watts represents unavoidable conversion loss. The aggregate current drain from the car's generator for the transmitter alone is 35 plus 4 or 39 amperes. Add to this about seven amperes already being taken for the ignition and the receiver and you come up with the staggering figure of 46 amperes! This is one reason why smart hams keep the nominal power input of their mobile transmitters down to about 25 watts. At this level the primary current is reasonably within the safe capacity of a standard 35-ampere generator.

A quick question is probably forming in your mind. "What's to prevent me from installing a larger generator in my car?"

Nothing, chum, nothing except money. Let's consider what such a change entails in a common *Ford*. The standard 35-ampere generator in it costs about \$16.00 from an authorized dealer, the accompanying regulator about \$5.00. The next larger size generator, rated at 60 amperes, costs \$85, the necessary 60-ampere regulator \$50! Also, you need new and heavier wiring to carry the increased current. If you let the dealer do the whole revamping job, it will cost about \$225. If you can afford it, good for you. A surprisingly large number of hams do install these bigger units because it means they can operate mobile day or night, winter or summer, with full confidence in their rigs. And here's a tip—perfectly good oversize generators and regulators, salvaged from wrecked taxis, police cars, etc., can often be picked up at bargain prices at "junkies," that is, automobile "graveyards."

Regardless of your electrical system, you will find it advisable to transmit only with the engine running. If you expect to remain stationary for a while, speed up the engine (by means of the hand throttle or the choke) so that the ammeter or tell-tale light shows a slight charge, or at least no discharge, when the transmitter is on full. Save the battery. It has to put out between 200 and 300 amperes when you press the starter switch, and it won't if



## ITALIAN ACCORDIONS

### AT LOWEST WHOLESALE PRICES

**5-DAY FREE TRIAL**

**"PAY AS YOU PLAY"**  
Small Down Payment  
As Little As  
**\$10** per month

**DIRECT from Importer to You!**

SATISFACTION GUARANTEED, or your money back! NOW you can save up to 50% by direct purchase from America's leading distributor of famous genuine ITALIAN ACCORDIONS. Trade-Ins Accepted.

Send for FREE Illustrated Catalog!

**ACCORDION MANUFACTURERS & WHOLESALE OUTLET**  
2003 West Chicago Ave. Dept. PE-35, Chicago 22, Ill.

## Get Your F. C. C. LICENSE Quickly!

Correspondence or residence preparation for F.C.C. examinations. Results guaranteed.

An FCC commercial operator license means greater opportunities and higher pay. We are specialists in preparing you, in a MINIMUM OF TIME, to pass FCC examinations for all classes of licenses. Beginners get 2nd class license in 5 weeks and 1st class in 3 additional weeks. Write for free booklet.

### GRANTHAM School of Electronics

Dept. 104F, 6064 Hollywood Blvd., Hollywood 28, Calif.  
Phone: Hollywood 2-1411



you've run it down even partially with a 40-ampere load for an hour or so.

The usual location for the transmitter is under the dash, over the center line of the floor. Here it does not restrict the leg room of either the driver or a passenger in the front seat, and it is also accessible for tuning. Some rigs are found stowed away in the trunk, but this limits operation to a single frequency unless an elaborate remote-control system is used. The high-voltage vibrator or dynamotor power supply is invariably mounted in the engine compartment to keep the heavy primary wires at minimum length. A starting relay is always used in the primary circuit, exactly as it is for the starting motor of the engine.

For the popular 10-meter band, the mobile antenna is usually a flexible whip about eight feet long, with a heavy mounting base fitted with a connector for coaxial cable. Because of the danger of hitting trolley wires, tree limbs, and other low-hanging obstructions, the antenna is best located on the lowest part of the car, the rear bumper. At that, you have to bend the whip forward and hook it somewhere along the rain molding at the front left edge of the body, to enable you to clear garage entrances and similar obstacles.

For 20-, 40-, and 80-meter operation, the antenna should really be much longer than eight feet, but the structural problems become too difficult. The standard practice is to use eight-foot whips with "loading coils" inserted either in the center or at the base. These have proved very successful.

In some cars, interference created by the electrical systems can be annoying. Eliminating it is a matter of probing around with bypass capacitors and filters, and bonding all parts of the chassis together to assure continuity of the "ground" connection. Sometimes the trouble comes from a seemingly innocent accessory, like the fuel gauge. Late model cars are astonishingly "clean" of interference because the bonding operation is carried out during assembly and is quite thorough. For instance, you'll find heavy copper braid between the engine block and the fire wall, and a wiping contact arm where the hood closes against the body.

Hams with mobile rigs in their cars have performed valuable services in establishing vital communications during periods of public emergency. In recognition of this work, many states issue special license plates bearing the hams' call letters. These plates are highly distinctive and, of course, very desirable. Check with the licensing authority in your state to see if you're eligible.

(To be continued)

# BUILD 15 RADIOS AT HOME ONLY

With the New Improved 1955 Progressive Radio "EDU-KIT" **\$19.95**  
NOW INCLUDES

**HIGH FIDELITY, SIGNAL TRACER, CODE OSCILLATOR**



- Attractively Gift Packed
- Free Soldering Iron
- Absolutely No Knowledge of Radio Necessary
- No Additional Parts Needed
- Excellent Background For Television
- 10-Day Money-Back Guarantee
- School Inquiries Invited
- Sold in 79 Countries

## WHAT THE PROGRESSIVE RADIO "EDU-KIT" OFFERS YOU

The "Edu-Kit" offers you a Home Radio Technician Course at a rock-bottom price. You will learn how to identify Radio Symbols and Diagrams; how to build radios, using regular radio schematics; how to wire and solder in a professional manner. You will learn how to operate Receivers, Transmitters, and Audio Amplifiers. You will learn how to service and trouble-shoot radios. You will learn code. You will receive training for F.C.C. license. In brief, you will receive a practical basic education in Radio, worth many times the small price you pay.

### THE KIT FOR EVERYONE

It is not necessary that you have even the slightest background in science or radio. The "Edu-Kit" is used by young and old; by radio schools and clubs; by Armed Forces personnel and Veterans for training and rehabilitation. No instructor is required. Instructions are complete, simple and clear. You cannot make a mistake.

### PROGRESSIVE TEACHING METHOD

The "Edu-Kit" uses the principle of "Learn by Doing". Therefore you will build radios, perform jobs, and conduct experiments to illustrate the principles which you learn. You begin by learning the function and theory of each of the radio parts. Then you build a simple radio. Gradually, in a progressive manner, you will find yourself constructing more advanced multi-tube radio sets, and doing work like a professional Radio Technician. The "Edu-Kit" Instruction Books are exceedingly clear in their explanations, illustrations and diagrams. These sets operate on 105-125 V. AC/DC. Adapter for 210-250 V. AC/DC available.

### The Progressive Radio "EDU-KIT" is Complete

You will receive every part necessary to build fifteen different radio sets. Our kits contain tubes, tube sockets, chassis, variable condensers, electrolytic condensers, mica condensers, paper condensers, resistors, line cords, selenium rectifiers, tie strips, coils, hardware, tubing, Instruction Manuals, etc. A soldering iron is included, as well as an Electrical and Radio Tester. Complete, easy-to-follow instructions are provided. All parts are guaranteed, brand new, carefully selected and matched. In addition, the "Edu-Kit" now contains lessons for servicing with the Progressive Signal Tracer, High Fidelity, F.C.C. instructions, quizzes. The "Edu-Kit" is a complete radio course down to the smallest detail.

### TROUBLE-SHOOTING LESSONS

Trouble-shooting and servicing are included. You will be taught to recognize and repair troubles. You will build and learn to operate a professional Signal Tracer. You receive an Electrical and Radio Tester, and learn to use it for radio repairs. While you are learning in this practical way, you will be able to do many a repair job for your neighbors and friends, and charge fees which will far exceed the cost of the "Edu-Kit." Our Consultation Service will help you with any technical problems which you may have.

### FREE EXTRAS

- Electric-Radio Tester • Soldering Iron • TV Book
  - Radio Trouble-Shooting Guide • Consultation Service
  - Quizzes • F.C.C. Training.
- PROGRESSIVE "EDU-KITS" INC., 497 Union Av., Brooklyn 11, N.Y.**  
10-Day Money-Back Guarantee. **INCLUDE ALL FREE EXTRAS.**

RUSH ME the Following—Include all Free Extras:  
 "EDU-KIT" Postpaid. I enclose full payment of \$19.95  
 "EDU-KIT" C.O.D. I will pay \$19.95 plus postage  
 Outside USA: Enclose \$20.95. "Edu-Kit" sent postpaid.  
 Outside USA: 210-250V. AC/DC Adapter. Enclose \$2.50  
 More details on "EDU-KIT" Free—No Obligation  
 FREE Radio-TV Servicing Literature. No Obligation

NAME \_\_\_\_\_  
ADDRESS \_\_\_\_\_

PROGRESSIVE "EDU-KITS" INC. 497 Union Ave.  
Room 506D, Progressive Bldg. Brooklyn 11, N. Y.

# IT'S NEW! IT'S FREE!

## 1955 Walter Ashe Catalog of Radio, Electronics and TV

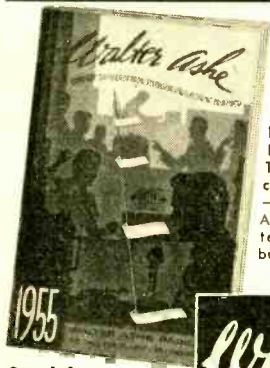

### The Treasure Chest of Values!

Features all the leading brands of Communication Equipment, Test Instruments, Build-it-Yourself Kits, Hi-fi, Sound and Recording Equipment, Radio, Electronics and TV Parts and Supplies for every conceivable need... in stock—ready for immediate delivery. A "must" for experimenters, amateurs, servicemen, engineers, builders and "hi-fiers."

**Walter Ashe**  
RADIO CO.  
1125 PINE ST. • ST. LOUIS 1, MO.

Send for your  
**FREE Copy**

MAIL COUPON TODAY!

WALTER ASHE RADIO CO.  
1125 Pine St., St. Louis 1, Mo.

PE-3-55

Rush FREE Copy of New 1955 Catalog.

Name \_\_\_\_\_

Address \_\_\_\_\_

City \_\_\_\_\_ Zone \_\_\_\_\_ State \_\_\_\_\_

## Secrets of VENTRILOQUISM Now Revealed!



Easy to learn in 60 to 90 days with our Home Study Course. **RESULTS GUARANTEED.** Make Money! Be Popular! Have Fun! Big Opportunity! Radio, Television, Stage Appearances! For FREE Information regarding price and terms, WRITE. You must state your age. Dummy Catalog 25c.  
**FRED MAHER SCHOOL OF VENTRILOQUISM**  
Box 36, Studio PE-3 Kensington Station  
Detroit 24, Michigan

## INVENTORS

Send for  
**PATENT INFORMATION**  
Book and  
**INVENTOR'S RECORD**  
without obligation

**GUSTAVE MILLER**  
35-PE WARNER BUILDING  
WASHINGTON 4, D. C.

**REGISTERED PATENT ATTORNEY**

ASSOCIATE EXAMINER  
U.S. PAT. OFF. 1922-1929

Patent Attorney & Advisor  
U. S. NAVY DEPT. 1930-1947  
**PATENT LAWYER**

## TEST TV—RADIO TUBES



Yourselves with UNATEST 51. Own your own tube tester for less than the cost of one service call. Buy your tubes at discount! SAVES MONEY the first time it's used. Mahogany Case—110 volt AC Tests all popular size tubes. Simple to operate—Fully guaranteed. **ORDER TODAY!** ONLY \$5.00—Post Paid. Send Cash, Check or M.O. Dept. PE-53

**BAUMBACH ENG. CO.** 10147 Halbrant  
San Fernando, Calif.

## GET INTO ELECTRONICS

You can enter this uncrowded, interesting field. Defense expansion, new developments demand trained specialists. Study all phases radio & electronics theory and practice: TV; FM; broadcasting; servicing; aviation, marine, police radio. 18-month course. Graduates in demand by major companies. H. S. or equivalent required. Begin Jan., March, June, Sept. Campus life. Write for Catalog.

**VALPARAISO TECHNICAL INSTITUTE**

Dept. PE Valparaiso, Ind.

## Disc Review

(Continued from page 59)

cycles. Below that, a reflex enclosure is a dead pigeon. Some of the more affluent fans have back or front-loaded horn systems which, with all components perfectly matched, get down to 40 cycles and might touch 35 cycles. A small percentage of fortunate audiophiles have mammoth exponential horn enclosures of the *Klipsch* type which will take you down another notch to about 30-35 cycles. An infinitesimal percentage have gone "whole hog" and possess such impractical things as tremendous "straight" or curled exponential horns made of concrete, whose mouth area is sometimes that of the entire wall of a room! These elephantine horns are just about the only thing that will give an honest 16 cycle fundamental tone. However, it must be pointed out that even these huge horns will not reproduce 30 cycles and below, if the phono pickup cartridge which is used "cuts off" above these frequencies.

Cartridges are still another "Achilles heel" in the reproduction of ultra-low frequencies. The average magnetic reluctance or moving coil type of cartridge is fairly "flat" down to 30 cycles and then starts to "roll-off" very quickly. Another imposition of low organ frequencies is that their amplitude or lateral "swing" on the disc is so great that it takes a cartridge with an extremely compliant stylus to track them properly. Only the most expensive moving coil types of cartridge will respond as low as 20 cycles with good tracking, and about the only thing you can use to get a true 16 cycles is the expensive frequency modulation pickup. There are many other variables involved in low frequency reproduction, such as cone resonance and even room size, but I believe that it is obvious that low frequency reproduction is a difficult and expensive task.

Although you just *know* you can hear 20 cycles the chances are more than likely you are hearing the *harmonics* of ultra low stuff. In other words, instead of 20 you hear 40 cycles, and instead of 30, you are hearing 60 cycles. The power of the organ is so great at low frequencies that your ear "kids" you into thinking that you are actually hearing the McCoy!

As noted, the *Cook* disc is very wide range and has better low frequency reproduction than the *Columbia* record. However, the *Columbia* disc has the better over-all sound. The *Cook* has a tendency to be thin in the middle registers, and dynamics (mostly the fault of the organist) are too extreme. The *Columbia* effort has a fuller, richer, more balanced sound, with excellent revelation of inner detail. It adds up like this: If you are looking for a super "test" type of recording for ultra-low frequencies, the *Cook* gets the laurel. If the most musical and best balanced sound is desired, then the choice is the *Columbia* disc. Incidentally, the *Columbia* disc also has the *Passacaglia and Fugue* and other Bach works as an added virtue. The *Cook* may be more attractive to some by virtue of a lower price.

After our exploration in the realm of the organ, let's return to the symphonic repertoire. The modern work for this month's column is the *Third Symphony* by the well known American composer, Aaron Copland. We will not have any difficulty deciding which is the best recording of this

work, since there is only *one* in the LP catalogue. Happily, this recording is one of the finest examples of hi-fi sound available. The work is played by the Minneapolis Symphony orchestra conducted by Antal Dorati and is on the Mercury label MG50018. Don't brush off this work by listening to the first few minutes and then deciding that you don't like what you heard. Stick with it and you will be rewarded with some of the most fabulous scoring and awesome sound you've ever encountered! There is a section in the symphony known as the "Fanfare" which, for sheer power, is hard to beat. You will hear the super-clean, bright blare of massed trumpets playing in a high register, the explosive articulation of tympani, and tremendous blasts of bass drum. Top all this with the shattering impact of a great Chinese gong, and you've heard sound which best epitomizes the expression "high fidelity."

Throughout the work, the sound is ultra wide range and distortion free and has some truly incredible dynamics. You will have to watch the gain on your system most carefully if you live where loud sound may be objectionable. Acoustic perspective is always an important factor in how "live" a recording sounds. In this disc you can realize the work is being played in a typical "symphony" hall because just the right amount of hall reverberation is recorded to aid the elusive quality called "presence," without obscuring the important inner detail. All in all, it is one of the best recordings of the age of LP, a wonderful score, stunningly recorded and splendidly performed by Mr. Dorati and his superb orchestra.

Next month we will investigate some large scale choral works as well as the usual "standards." END

## NEW AUDIO CATALOGUES

IN KEEPING with the quality and beauty of music reproduction associated with high fidelity, most audio equipment catalogues are attractive and well-prepared booklets that not only list hi-fi components, but offer valuable information on the nature of hi-fi, advice on selecting units, and how to assemble your own system.

Two of the newest 1955 catalogues are no exception to this happy rule. *Leonard Radio, Inc.*, 69 Cortlandt St., New York 7, N. Y., has issued its "1955 Audio Reference Guide" containing 160 pages describing most hi-fi components made by a wide variety of manufacturers. In addition, it features a section devoted to speaker enclosures, including construction data.

The *Sightmaster Corporation*, New Rochelle, N. Y., has issued its 1955 catalogue. While limited to descriptions of *Sightmaster's* own units, the booklet covers every type of component used in the home, including TV sets that may be integrated into a hi-fi system. Valuable notes on audio reproduction are included.

Both catalogues are amply illustrated and contain prices and purchasing information. Both may be had free by writing to the respective organizations. END

March, 1955

**SAVE UP TO 85% ON GOV'T SURPLUS!**

**GOV'T SURPLUS E.E.B SIGNAL CORPS FIELD TELEPHONE**

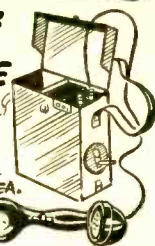

A private phone or intercom system. Easy to operate. Use any place that portable, 2-way communication is desired. Gives clear reception up to 15 miles. Operates on two standard batteries. Several phones may be used on the same line. Set contains a ringing generator, leather carrying case and phone. Each set is reconditioned & checked-out.

1495 EA.  
2950

Complete circuit - Set of 2

Pay by Money Order or Check. P.O.'s accepted from D&B firms. 50% deposit with C.O.D.'s. Prices F.O.B. Los Angeles.

## WORLD'S MOST AMAZING BARGAIN CATALOG

OVER 320 PAGES

SAVE UP TO 85% ON WAR SURPLUS

Packed with SENSATIONAL VALUES in WAR SURPLUS, FACTORY CLOSE-OUTS and GENERAL MERCHANDISE!

Fully Illustrated. Packed with thousands of Bargains in Hand & Power Tools, Radio Speakers, Ear Phones, Electronics, Gadgets, Electric Motors & Blowers, all types of Hydraulic Equipment, Outdoor & Sports Equip., Cameras, Precision Instruments, Microscopes, plus many, many more.



Send 50c To cover the cost of Handling and Mailing. CREDITED to your first order.

**PALLEY SUPPLY CO.**

2263 E. VERNON AVE., DEPT. PL-3  
Los Angeles 58, California

## Sensational Device Tests Eyes

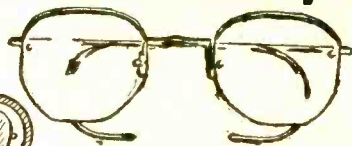

SAVE up to \$15.00 on Glasses! Big news to the millions of Spectacle Wearers and Prospects. Means Freedom from Outrageous Prices. Sold on Money-back Guarantee.

MAKE BIG MONEY QUICK—FREE SAMPLE KIT! Show it to friends and others. Let them use it Free and watch their amazement over this Self Testing system. Here is a great new opportunity in a tremendous new field of unlimited possibilities. Spare or full time. No experience needed. Write for Free sample kit.

C. G. Optical Co., Dept. A-276 20 E. Delaware Pl., Chicago 11, Ill.

## UNLIMITED OPPORTUNITIES IN ENGINEERING

BACH. SC. DEGREE IN 27 MONTHS in Elect., Radio (TV), Mech., Civil, Chem., Aero., Adm. Engineering; Bus. Adm., Acct. Visit campus, see well-equipped labs. Heavy demand for graduates. Placement service. Prep. courses. Approved for Korean Vets. Enter March, June, Sept., Jan. Low cost. Write Jean McCarthy for Catalog, View Book, "Your Career" Book.

3635 College Ave.  
TRI-STATE COLLEGE Angola, Indiana

## "SNOOPER" GEIGER COUNTER



Super-sensitive! Only 1 1/4 lbs.! Fits pocket—uses flashlight battery. Find a fortune in uranium. Order Now! Send \$5.00, balance C.O.D. MONEY BACK GUARANTEE. FREE CATALOG—scintillator and larger uranium and metal detectors. DEALERS WANTED.

2995 COMPLETE

PRECISION RADIATION INSTRUMENTS  
2235PT S. La Brea, Los Angeles 16, Cal.

## Hum

(Continued from page 58)

but the one thing over which they can't have perfect control is tube quality. The input tube in the first stage of an amplifier and especially in preamps, is very critical. The manufacturer usually puts in the best quality low-noise tube that is practical in cost and availability. However, tubes being what they are, things happen and you might be getting a lot of hum from a noisy first stage tube. The preamp is more usually the culprit and the tubes in most common use in the input stage are 12AX7 and 12AU7. Try replacing these tubes with new ones and there may be a drastic reduction of the hum with this little maneuver. There are also certain extra-cost, "premium type" tubes which can be used to replace a 12AX7. These are the 12AY7 and the very fancy "five star" tube, the 6072. These tubes are supposed to be very low-noise, and they may turn the trick for you. A number of the fancier preamps have a d.c. supply for the tube heaters and this practically guarantees no hum. It is possible to convert your preamp so that the tube heaters are d.c. operated, but it is a *very tough job*. If you insist on it, you can find information on selenium bridge rectifier circuits in free literature published by most rectifier manufacturers. Or you can go to the expense of batteries or the "battery eliminator" type of power supply. This is expensive tinkering as you may have guessed, and it is fortunate that such drastic measures are rarely needed.

You may own the most hum-free amplifier ever constructed, but it is wasted money if this sterling unit is incorrectly installed in a cabinet. A cabinet with changer, preamp, amplifier, and speaker all installed together may be nice and compact, but you are really asking for trouble. Placing your amplifier too near the changer motor can result in induction hum; placing changer and amplifier too near the speaker can cause a terrific howl called "acoustic feedback." Some people think they can get away with these all-in-one installations by liberal padding and isolation with rubber and fibreglas. You may think you have succeeded until you want to play something at a pretty loud level. This can disillusion people!

When your preamp is installed, you will have a lot of audio leads coming from your amplifier, tuner, pickup, tape recorder, etc. which will terminate in the rear of the preamp. Instead of letting them dangle in wild abandon, "parcel" them together with string or pressure tape and keep them separated from the various a.c. lines. A little

thing like that can sometimes cut hum considerably.

As a last resort, you can try changing the polarity of the main a.c. line by reversing the plug in the socket until you determine which position gives a minimum of hum. Then drive an unpainted metal stake into the earth and ground your amplifier to it with a flexible wire.

By following these suggestions, most of your hum problems can be eliminated. If in spite of careful adherence to these practices, you still get hum, you may have serious trouble such as open windings in coils or transformers, or capacitor problems. Take heed! It's time to consult the manufacturer! END

## CODE OSCILLATOR USED AS SIGNAL GENERATOR

**T**HIS oscillator is simple and economical to build, and useful as a code oscillator or as an audio signal generator for checking receivers and amplifiers. Wiring is not critical, so almost any layout may be used.

To use the unit as a code practice oscillator, simply connect headphones or amplifier to the output terminals. Be sure to observe polarity when connecting to an amplifier (minus side goes to ground).

To use as a signal generator, connect the minus side to the chassis or B minus of the set to be checked. Apply the signal from the positive side to successive stages of the set under scrutiny, starting with the output and working back. Try first the

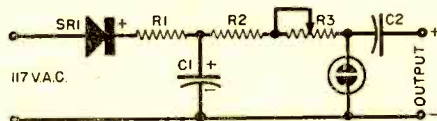

Schematic and parts list for the oscillator.

R<sub>1</sub>—300 ohm, 1 w. res.

R<sub>2</sub>—500,000 ohm ½ w. res.

R<sub>3</sub>—500,000 ohm vol. contr. pot.

C<sub>1</sub>—16 µfd., 150 v. elec. capacitor

C<sub>2</sub>—001 µfd. mica capacitor

SR1—75 ma. selenium rectifier

One—Type NE-2 neon glow lamp

Use a 1:1 ratio isolating transformer across input to eliminate shock hazard.

speaker voice coil, then the output transformer, then the plate and grid of the output tube, etc., until a point is reached which provides no signal output in the speaker. The trouble is then localized between this point and the last point checked that did provide a signal output.

To use the oscillator as a warning siren, connect it to an amplifier and vary its pitch slowly with the volume control. The pitch may also be changed by using different values for C<sub>2</sub>. JIM BROOKS

# STANDARDIZED WIRING DIAGRAM SYMBOLS

<p style="text-align: center;"><b>ANTENNAS</b></p> <div style="display: flex; justify-content: space-around;"> </div> <p style="font-size: small; text-align: center;">GENERAL    DIPOLE    LOOP    FERRITE TYPE</p>	<p style="text-align: center;"><b>MICROPHONE</b></p> <div style="display: flex; justify-content: space-around;"> </div> <p style="font-size: small; text-align: center;">SINGLE BUTTON    DOUBLE BUTTON    CAPACITOR DYNAMIC    VELOCITY    CRYSTAL</p>	<p style="text-align: center;"><b>TELEGRAPH KEY</b></p>
<p style="text-align: center;"><b>BATTERIES</b></p> <div style="display: flex; justify-content: space-around;"> </div> <p style="font-size: small; text-align: center;">SINGLE-CELL    MULTI-CELL</p>	<p style="text-align: center;"><b>NEON BULB</b></p> <p style="text-align: center;"><b>PILOT LIGHT</b></p>	<p style="text-align: center;"><b>TRANSFORMERS</b></p> <div style="display: flex; justify-content: space-around;"> </div> <p style="font-size: small; text-align: center;">AIR CORE    IRON CORE    AIR CORE VARIABLE</p>
<p style="text-align: center;"><b>BELL</b></p> <p style="text-align: center;"><b>BUZZER</b></p>	<p style="text-align: center;"><b>PHONO PICKUPS</b></p> <div style="display: flex; justify-content: space-around;"> </div> <p style="font-size: small; text-align: center;">CRYSTAL    MAGNETIC</p> <p style="text-align: center;"><b>PLUG OR SOCKET</b></p>	<div style="display: flex; justify-content: space-around;"> </div> <p style="font-size: small; text-align: center;">IRON CORE VARIABLE    POWDERED IRON CORE    AUTO</p>
<p style="text-align: center;"><b>CAPACITORS</b></p> <div style="display: flex; justify-content: space-around;"> </div> <p style="font-size: small; text-align: center;">FIXED MICA OR PAPER    ELECTROLYTIC    VARIABLE CAPACITORS GANGED</p> <div style="display: flex; justify-content: space-around;"> </div> <p style="font-size: small; text-align: center;">TRIMMER OR PADDER    SPLIT-STATOR    FEED-THRU T-DESIGNATES TRIMMER OR PADDER</p>	<p style="text-align: center;"><b>RECEPTACLE 117 V.</b></p> <p style="text-align: center;"><b>RECORDING HEAD</b></p> <p style="font-size: small; text-align: center;">MAGNETIC</p>	<div style="display: flex; justify-content: space-around;"> </div> <p style="font-size: small; text-align: center;">PRIMARY    FILAMENTS</p> <p style="font-size: small; text-align: center;">117V.    HIGH VOLTAGE    FILAMENTS</p> <p style="text-align: center;"><b>POWER TRANSFORMER</b></p>
<p style="text-align: center;"><b>COILS</b></p> <div style="display: flex; justify-content: space-around;"> </div> <p style="font-size: small; text-align: center;">FIXED R.F. COIL    COIL WITH FIXED TAP    COIL WITH VARIABLE TAP</p> <div style="display: flex; justify-content: space-around;"> </div> <p style="font-size: small; text-align: center;">IRON CORE OR CHOKE    BIFILAR    VARIABLE COIL OR CHOKE</p> <div style="display: flex; justify-content: space-around;"> </div> <p style="font-size: small; text-align: center;">SLUG-TUNED COIL</p>	<p style="text-align: center;"><b>RECTIFIER</b></p> <p style="font-size: small; text-align: center;">SELENIUM TYPE</p>	<p style="text-align: center;"><b>RELAYS</b></p> <div style="display: flex; justify-content: space-around;"> </div> <p style="font-size: small; text-align: center;">S.P.S.T. NORMALLY OPEN    S.P.S.T. NORMALLY CLOSED    S.P.D.T.</p>
<p style="text-align: center;"><b>CRYSTALS</b></p> <div style="display: flex; justify-content: space-around;"> </div> <p style="font-size: small; text-align: center;">CRYSTAL DETECTOR    PIEZOELECTRIC CRYSTAL</p>	<p style="text-align: center;"><b>RESISTORS</b></p> <div style="display: flex; justify-content: space-around;"> </div> <p style="font-size: small; text-align: center;">GENERAL    TAPPED OR ADJUSTABLE</p> <div style="display: flex; justify-content: space-around;"> </div> <p style="font-size: small; text-align: center;">POTENTIOMETER OR RHEOSTAT    CONTINUOUSLY VARIABLE</p>	<p style="text-align: center;"><b>TUBES</b></p> <div style="display: flex; justify-content: space-around;"> </div> <p style="font-size: small; text-align: center;">DIODE    HEATERS OR FILS.    CATHODE    GRID    PLATE    TETRODE</p> <div style="display: flex; justify-content: space-around;"> </div> <p style="font-size: small; text-align: center;">PENTODE    SURPRESSOR SCREEN CONTROL    PLATE CAP    GRID CAP    DIODE PLATE</p>
<p style="text-align: center;"><b>FUSE</b></p> <p style="text-align: center;"><b>GROUNDS</b></p> <div style="display: flex; justify-content: space-around;"> </div> <p style="font-size: small; text-align: center;">WIRING    CHASSIS</p>	<p style="text-align: center;"><b>SHIELDING</b></p> <p style="font-size: small; text-align: center;">DOTTED LINES INDICATE SHIELDING COULD BE AROUND ANY COMPONENT OR GROUPS</p> <p style="text-align: center;"><b>SPEAKERS</b></p> <div style="display: flex; justify-content: space-around;"> </div> <p style="font-size: small; text-align: center;">P.M.    ELECTRO-MAGNETIC</p>	<div style="display: flex; justify-content: space-around;"> </div> <p style="font-size: small; text-align: center;">DESIGNATES GAS FILLED    COLD CATHODE    PHOTO-ELECTRIC</p>
<p style="text-align: center;"><b>HEADPHONES</b></p> <div style="display: flex; justify-content: space-around;"> </div> <p style="font-size: small; text-align: center;">DOUBLE    SINGLE</p>	<p style="text-align: center;"><b>SWITCHES</b></p> <div style="display: flex; justify-content: space-around;"> </div> <p style="font-size: small; text-align: center;">S.P.S.T.    S.P.D.T.    PUSH-BUTTON</p> <div style="display: flex; justify-content: space-around;"> </div> <p style="font-size: small; text-align: center;">D.P.S.T.    D.P.D.T.    BOTH TYPES GANGED</p>	<div style="display: flex; justify-content: space-around;"> </div> <p style="font-size: small; text-align: center;">DUO TRIODE    COLD CATHODE    PHOTO-ELECTRIC</p>
<p style="text-align: center;"><b>JACKS</b></p> <div style="display: flex; justify-content: space-around;"> </div> <p style="font-size: small; text-align: center;">OPEN CIRCUIT    CLOSED CIRCUIT</p> <div style="display: flex; justify-content: space-around;"> </div> <p style="font-size: small; text-align: center;">2 CIRCUIT    SHORTING TYPE 2 CIRCUIT</p> <div style="display: flex; justify-content: space-around;"> </div> <p style="font-size: small; text-align: center;">PHONE PLUG    PIN PLUG    PIN JACK</p>	<p style="text-align: center;"><b>TRANSISTOR (JUNCTION)</b></p> <p style="font-size: small; text-align: center;">BASE    COLLECTOR    EMITTER</p> <p style="font-size: x-small; text-align: center;">P-N-P TYPE N-P-N TYPE SAME SYMBOL EXCEPT ARROW IS REVERSED</p>	<p style="text-align: center;"><b>VIBRATOR</b></p> <p style="text-align: center;"><b>WIRES</b></p> <div style="display: flex; justify-content: space-around;"> </div> <p style="font-size: x-small; text-align: center;">CONNECTION    NO CONNECTION</p>
<p style="text-align: center;"><b>METER</b></p> <p style="text-align: center;"><b>MOTOR</b></p>	<p style="text-align: center;"><b>ROTARY TYPE S.P.G.P.</b></p> <p style="text-align: center;"><b>WAFER</b></p>	<p style="text-align: center;"><b>ROTARY TYPE S.P.G.P.</b></p> <p style="text-align: center;"><b>WAFER</b></p>

# GLOSSARY

**a.f.c.**—Automatic frequency control: (1) control of the frequency of the local oscillator in a superheterodyne to keep the receiver in tune with a desired station; (2) control of the frequency of the horizontal oscillator in a television receiver to keep the horizontal deflection in step with the horizontal deflection at the television studio and thus to keep the picture steady horizontally.

**a.g.c.**—Automatic gain control, control of the amplification of an amplifier so that its output is approximately constant in spite of variations in the input signal; especially such control in television receivers to reduce variations in picture contrast produced by variations in r.f. signal strength.

**a.v.c.**—Automatic volume control (a.g.c. used in radio receivers to reduce variations in sound volume produced by variations in r.f. signal strength).

**choke**—An inductance used especially to present a high impedance to a wide range of frequencies. Filter chokes are used in rectifier-type power supplies to remove from the d.c. output hum components equal to the power line frequency and its harmonics; audio-frequency chokes are used in audio amplifiers and radio-frequency chokes are used in r.f. and i.f. amplifiers, to present a high impedance load to a vacuum tube or to block unwanted signals.

**crystal**—1. Rectifying crystal, one which passes electric current more easily in one direction than in the other and thus can be used to change alternating current to pulsating direct current; made of such materials as germanium, silicon, copper oxide, galena, and carborundum. 2. Piezo-electric crystal, one which transforms mechanical energy to electrical and vice versa. Such crystals, made of Rochelle salt or barium titanate, are used in microphones and phonograph pickups. When cut to a certain size and shape, a piezo-electric crystal, usually made of quartz, can be used as a resonant circuit, to control the frequency of an oscillator or as a frequency-selective filter.

**decibel**—A measure of the ratio between two power levels or of a power level with respect to a designated reference level. Basically, the number of decibels is ten times the logarithm of a power ratio. One decibel is approximately the smallest difference in sound power which can be detected by the average human ear.

**db of feedback**—The number of decibels by which inverse feedback in an amplifier reduces its over-all gain and distortion.

**detector**—A circuit used to recover an audio or video signal from a modulated radio signal.

**electrolytic capacitor**—A type of capacitor in which the dielectric or insulator is a thin film of oxide deposited on one aluminum or tantalum plate and an electrolyte is used between the insulator and the other plate. This type of capacitor provides a larger capacitance in a given volume than any other type. However, except for special a.c. electrolytics, this type can be used only in circuits where voltage of constant polarity is applied to it.

**elevator**—Control surface of an aircraft which regulates its pitch attitude (level, climbing, or diving)

**feedback**—Returning part of the output of an amplifier stage to the input of the same or a previous stage. Negative or inverse (out-of-phase) feedback decreases the gain and distortion of the amplifier; positive (in-phase) feedback increases gain and distortion and may produce oscillation.

**frequency response**—The relative ability of an amplifier, loudspeaker, or other device to respond to different frequencies.

**glow plug**—A type of internal-combustion engine used in models, in which starting is assisted by a filament in the combustion chamber, which is energized by an external battery.

**harmonic distortion**—Distortion consisting of addition to the signal of components whose frequencies are multiples (harmonics) of the original signal frequency. It is produced by an amplifier or other device which is nonlinear (does not give the same ratio of output to input for all input amplitudes).

**heterodyne**—A different frequency (beat) produced by combining two frequencies.

**hole**—Absence of an electron normally present in an atom; a positive charge. The action of some transistors often is explained by referring to movement of holes or positive charges, rather than movement in the opposite direction of electrons or negative charges.

**microammeter**—A meter for the measurement of current flow, which is calibrated in microamperes, or millionths of an ampere.

**milliampere**—One-thousandth of an ampere.

**modulated**—Varied in amplitude, frequency, or some other quality. Radio-frequency signals are modulated in order to carry signals of lower frequency, such as sound or picture signals.

**multitester**—A meter which is a combination of a voltmeter, an ohmmeter, and (often) an ammeter.

**octal**—Designation of one of the standard types of tube base or the socket to fit it. The base has eight equally spaced pins and a centrally located boss, which is made of insulating material and has a key to prevent improper insertion of the tube in the socket. The loctal tube base is similar, except that its pins are smaller in diameter and the central boss is of metal and has a groove which fits a one-turn spring in the socket, to hold the tube.

**oscillator**—A vacuum-tube or transistor circuit or other device which produces an alternating-current power output without mechanical rotation.

**plate dissipation**—The part of the power applied to the plate circuit of a vacuum tube which does not appear as signal output, but is dissipated as heat in the plate of the tube.

**push-pull**—An arrangement of two vacuum tubes in an amplifier so that the input signal is applied in opposite phases to the two tubes and the signal outputs are combined in phase. This arrangement reduces even-harmonic distortion.

**regeneration**—Positive feedback in detectors and amplifiers. Increases gain and distortion and may produce oscillation.

**saturate**—To reach the maximum possible value of some quantity, such as magnetization in the core of an inductor or electron flow in a vacuum tube from cathode to plate.

**servo-motor**—A special electric, hydraulic, or other type of motor used in control apparatus to convert a small movement into one of greater amplitude or greater force.

**signal generator**—A test instrument providing electrical power substantially similar in amplitude, frequency, and other qualities, to signals found in electronic equipment.

**signal tracer**—A test instrument for detecting the presence of a signal in electronic equipment and, with some signal tracers, measuring its amplitude, frequency, or other qualities.

**superheterodyne**—A receiver in which all incoming radio-frequency signals are mixed with the output of an oscillator to produce a heterodyne or beat frequency. The oscillator frequency is variable so that the beat produced with any desired signal can be adjusted to a certain frequency. The beat-frequency

signal is fed to a fixed-frequency (intermediate-frequency) amplifier, where greater and more uniform gain and selectivity can be obtained than at the original radio frequency.

**superregenerative**—A type of regenerative detector in which the tendency to oscillation is controlled by a quenching voltage of ultrasonic frequency which periodically allows the gain to increase, then reduces it. The quenching voltage can be produced by the detector tube itself or by a separate oscillator. This type of detector has great sensitivity, but poor selectivity.

**tone control**—1. In a radio receiver or an audio amplifier, means provided to change the relative response to audio signals of different frequencies; effects which can be produced are treble boost or attenuation and bass boost or attenuation. 2. In radio control of models, a system wherein the radio signal is modulated by audio tones and control is achieved by keying the modulating tones on and off, instead of keying the r.f. carrier.

**v.t.v.m.**—Vacuum-tube voltmeter, a voltmeter using one or more vacuum tubes to increase the sensitivity of the basic meter movement, so that measurements can be made in a circuit without drawing much current and without disturbing very much the normal operating conditions of the circuit. May also be a combination voltmeter, ohmmeter, and ammeter. END

## ABBREVIATIONS

a.c.—alternating current  
a.f.—audio frequency  
a.f.c.—automatic frequency control  
a.g.c.—automatic gain control  
AM—amplitude modulation  
amp.—ampere  
ARRL—American Radio Relay League  
a.v.c.—automatic volume control  
BCI—interference with broadcast reception  
b.f.o.—beat frequency oscillator  
cps—cycles per second  
c.t.—center-tapped  
c.w.—continuous wave  
db—decibel  
dbm—decibels above one milliwatt  
d.c.—direct current  
d.c.c.—double cotton covered (wire)  
d.p.d.t.—double-pole, double-throw  
d.p.s.t.—double-pole, single-throw  
DX—distance  
elec.—electrolytic  
FCC—Federal Communications Commission  
FM—frequency modulation  
freq.—frequency  
GMT—Greenwich Mean Time  
hi fi—high fidelity (of sound reproduction)  
hy.—henry  
i.f.—intermediate frequency  
K—kilo (one thousand)  
kc.—kilocycle  
M—mega (one million)  
ma.—milliamperes  
mc.—megacycle  
meg.—megohm  
mike—microphone, microfarad  
mil—milliamperes  
m.o.p.a.—master oscillator, power amplifier  
mu—amplification factor  
 $\mu$ fd.—microfarad

$\mu$ fd.—micromicrofarad  
mw.—milliwatt  
m.w.—medium wave  
PA—power amplifier  
p.a.—public address  
PM—phase modulation, permanent magnet (speaker)  
pos.—position (of a switch)  
pot.—potentiometer  
pri.—primary  
R-C—resistance-coupled  
R/C—radio control  
rect.—rectifier  
res.—resistor  
RETMA—Radio-Electronics-Television Manufacturers Association  
r.f.—radio frequency  
r.m.s.—root mean square  
sec.—secondary  
SN—self-neutralizing (escapement)  
s.p.d.t.—single-pole, double-throw  
spkr.—loudspeaker  
s.p.s.t.—single-pole, single-throw  
s.w.—short-wave  
SWL—short-wave listener  
sync.—synchronization  
t.—turns (of a coil)  
trans.—transformer  
TV—television  
TVI—interference with television reception  
u.h.f.—ultra high frequency  
v.—volt  
v.f.o.—variable frequency oscillator  
v.h.f.—very high frequency  
VR—voltage regulator  
v.t.v.m.—vacuum-tube voltmeter  
vu—volume unit  
w.—watt  
wpm—words per minute  
xmtr.—transmitter

## PHOTO CREDITS

Page	Credit
20, 21	General Electric Co.
24, 25	Allied Radio Corp.
26	Top Left, International Business Machines Corp. Bottom Right, Sonotone Corp.
27, 28, 29	Raytheon Manufacturing Co.
32	Allen B. DuMont Laboratories, Inc.
38	Motorola Inc.
39	Chicago South Shore & South Bend Railroad
40	Top Left, Great Northern Railway Top and Bottom Right, Motorola Inc.
46	Top Right, Plantenna Corp. Bottom Left and Right, New York University
48	Bottom Right, Emerson Radio of Canada
54	Top Right and Left, Bendix Radio Bottom Right and Left, Motorola Inc.
55	Left, Radio Corporation of America Right, Western Electric
56	The Hallicrafters Company
70	Left, Crow Electric-Craft Corp. Right, J. Young Sound Engineering Corp.
96	Sperry Gyroscope Company



## HANDS TIED?

—because you lack a  
**HIGH SCHOOL DIPLOMA**

• You can qualify for an American School Diploma in *spare time at home!* If you have left school, write or mail coupon for FREE booklet that tells how. No obligation of any kind.

### OUR 58TH YEAR

**AMERICAN SCHOOL, Dept. V356**  
Drexel at 58th, Chicago 37, Illinois

Please send FREE High School booklet.

Name .....

Address .....

City & State .....

Canadian Residents: Complete Canadian Course Available.  
Write American School, 1610 Sherbrooke St. West, Montreal.

## ABOVE TAKE THE ADVICE OF EXPERTS ALL ESSCO R/C PRODUCTS The Standard of Comparison

**LORENZ 61 RECEIVER KIT.** A complete Kit of high quality parts to build this superior receiver, features high sensitivity, long range and tube life, wound coils, drilled base, tube & special Sigma 26F relay. \$14.95  
Parts Kit less relay. 6.95

**LORENZ RC TRANSMITTER KIT.** A complete Kit of all parts to build the companion set for the above receiver. Includes drilled RF subassembly, tube, crystal, lum. case and 60 in. telescopic antenna. \$14.95  
Orders for both these units. Will receive as free Bonus, McEure's R/C Handbook (\$6.95 for \$2.25).

For Beginners and experienced modelers, alike, ESSCO highly recommends the ESSCO Deluxe Lorenz, dual tube receiver and transmitters, features hi power, reliable long range model control, easy to build, easy to adjust, tuning controls require no readjustments for months. Complete Receiver Kit with sensitive Sigma relay. \$9.95  
Complete trans. Kit includes tube, crystal, cabinet and antenna. \$19.95

Are you planning to build the Safford Tone Receiver? Featured in Jan. Pop. Elect. A 3 tube receiver that gives you as many as 5 controls for your model. The Deluxe ESSCO Kits include all components, tubes, drilled aluminum chassis, complete, easy to build instructions. \$9.95  
With New Sigma 4F relays. 21.95  
With New Lightweight Price relays. 19.95  
The ESSCO Audio Tone XMTK. The ideal Multitone Transmitter for use with the Safford Receiver. Complete Parts Kit. \$29.95

### THE WORLD'S LEADING R/C SUPPLIER

**MONEY BACK GUARANTEE ON ALL ITEMS.** Send for free catalog. FOR FAST, INTELLIGENT, FRIENDLY SERVICE ON YOUR R/C ORDERS "CALL ON ESSCO!"

Serving The West  
**ESSCO-WEST COAST**  
670 Bell Street,  
Palo Alto, Calif.

Serving The Entire R/C Field  
**ESSCO-NEW YORK**  
58 Walker St.,  
New York City 13, N. Y.

## INDEX OF ADVERTISERS

Advertiser	Page
Accordion Mfrs. & Wholesalers Outlet	120
Allied Radio Corp.	99
American School	128
Ashe Radio Co., Walter	122
Audel Publishers	104
Baumbach Eng. Co.	122
Book of the Month Club, Inc.	15
Burstein-Applebee Co.	102
Business Information Corp.	98
Capitol Radio Engineering Institute	16
Century Electronics Co.	100
C. G. Optical Co.	123
Cleveland Institute of Radio Electronics	13
Concord Radio	115
Coyne Electrical School	5
de Bolt Model Engineering Co.	111
D-Frost-O-Matic	104
Edlie Electronics	114
Electro Kit	106
Electro-Voice	97
Electronic Instrument Co., Inc. (EICO)	111
Electronic Measurements Corporation	6
Electronic Specialty Supply Co.	128
Engineering Associates	106
Evans, Victor J.	108
G & H Wood Products Co.	2nd Cover
Grantham School of Electronics	120
Gyro Electronics	106
Hallicrafters	4th Cover
Harjo Sales Co.	102
Heath Company	84, 85, 86, 87
Hershel Radio Co.	92
Household Handies	104
Instructograph Co.	98
Johnson, E. F.	129
Lafayette Radio	105
Lektron Specialties	108
Maher School of Ventriloquism, Fred	122
Miller, Gustave	122
Milwaukee School of Engineering	103
Moss Electronic Dist. Co.	90, 91
Musical Masterpiece Society	11
National Radio Institute	3
National Schools	3rd Cover
Nordic Radio Co.	108
O'Brien, Clarence & H. B. Jacobson	7
Palley Supply Co.	123
Precision Radiation Instruments	123
Progressive "Edu-Kits," Inc.	121
Radio-Television Training Association	8, 9
Raytheon Manufacturing Co.	10
Rex Radio Supply	120
Rinehart & Co., Inc.	113
Science Electronics	117
Smith & Co., Johnson	106
Steve-El Electronics Corp.	100
Superelex Electronics Corp.	98
Tech-Master Corporation	119
Teltron Electric Company	12
Transi-Mite Radio Lab.	114
Transistor Photo Products	104
Tri State College	123
United Catalog Publishers, Inc.	98
Valparaiso Technical Institute	122
Vidaire Electronics Mfg. Corp.	106
Video Electric Company	14
World Radio Laboratories	101, 107

### SERIES-PARALLEL RESISTANCE QUIZ

(Answers to quiz on page 110)

1. a 2. b 3. a 4. b 5. c

(In Question 5, with all resistors equal, no current flows through R3 and it can be omitted.)



# Classified

RATE: 50c per word—minimum 10 words

## FOR SALE

**DIAGRAMS:** Professional Model Timers, Counters, Intercoms, Organs, etc. \$1.00 each. List free. Parks, 103 S. E. 57th, Portland 15, Oregon.

**RADIO** Diagrams \$1.00; Television \$2.00. Give make, model. Diagram Service, 672-PE, Hartford 1, Conn.

**TRANSMITTERS:** Top performance. Sensible prices. 75 watt CW kit, bandswitching 160-10, \$49.95. 25 watts, \$19.95. Hart Industries, 467 Parke, Birmingham, Michigan.

**CODE** Practice Oscillators. Electronic Audio-Visual Trainer, codes, instructions, year warranty \$4.00 Postpaid. Details Free. Stout, 2241A E. Broadway, Muskegon, Michigan.

**RESISTORS,** condensers, micas, electrolytics, tubulars, thousands of new latest types, each piece new, usable, some short leads. 10 lbs., \$9.50. Prepaid, Cagan Sales, Box 1152, Rochester, New York.

**WHOLESALE** Speaker Reconing. Send for dealer price list. Prompt service. C. Bernard Smith, 920 So. Euclid Ave., Pasadena 5, Calif.

**SIMPLE,** inexpensive device automatically controls model trains at crossings, switches. Prevents collisions. Guaranteed. Plans and instructions \$1. R & K, 5316 Clark, Cleveland 2, Ohio.

**PRINTED** circuit kit. Newest thing in electronics. Replaces conventional wiring. Fascinating educational kit complete with laminate, chemicals, etc. Only \$2.00 postpaid. Springfield Enterprises, Box 54-E3, Springfield Gardens 13, New York.

**INCREDIBLE!** One tube radio receives television, FM broadcast, CAP, and amateurs without antenna or ground. Diagram with special tube only \$2.00. Wired and tested chassis \$2.00. Thousands in use by amateurs, civil defense, experimenters. Springfield Enterprises, Box 54-E3, Springfield Gardens 13, New York.

**SOLAR** battery converts light into electrical energy. Lasts indefinitely. Excellent for powering transistors. 5,000 microamps output! Springfield Enterprises, Box 54-E3, Springfield Gardens 13, New York.

**WALKIE-Talkie.** Build a real wireless two-way portable radiophone for less than \$10.00. Plans 50c. Springfield Enterprises, Box 54-E3, Springfield Gardens 13, New York.

## INVENTIONS WANTED

INVENTIONS wanted. Patented; unpatented. Global Marketing Service, 1404 Mitchell, Oakland 1, Calif.

## INSTRUCTION

**HIGH School**—no Classes. Study at home. Spare time. Diploma awarded. Write for Free Catalog HET-5, Wayne School, 2527 Sheffield, Chicago 14, Ill.

**LEARN** Auto Body fender repair at home, spare time. Big money trade. Includes welding, spray painting metal work. Write for free facts. Autocrafts Training, Dept. XBK-1, 2523 Sheffield, Chicago 14, Illinois.

**PREVIOUS** Studies in Science, Engineering, may qualify you for college degree through extension work. Other educational opportunities. Aureak, 156 West 73rd Street, New York City.

## BUSINESS OPPORTUNITIES

**TELEVISION** Jobs—Names and addresses of companies to contact. \$1.00. Fitzgerald, Dept. A-22, 815 Countryside Drive, Wheaton, Illinois.

## MISCELLANEOUS

**FREE** Condenser and Resistor Code Charts. Largest stock of parts and tubes in West. We can save you money. K & L Radio Parts Co., 1406 Venice Blvd., Los Angeles 6, Calif.

**TUBES**—TV, Radio, Transmitting, special purpose types—Bought, Sold, Exchanged. Send details to B. N. Gensler W2LNI, 136 Liberty St., New York 6, N. Y.

**DETECTIVES**—Experience unnecessary. Detective Particulars free. Write, Wargner, 125 W. 86th, N. Y.

**TV HOME** Repair Manual Straight Forward Instructions only \$1.00. P. O. Box 1344, Milwaukee, Wis.

**BECOME** A Radio Amateur. Free information on how to pass Code and Theory FCC examinations. American Electronics, 1205½ Bryant Ave., New York 59, N. Y.

**GEIGER** Counter and Metal Detector Kits. Inexpensive, Educational. Free Literature. Electronic Applications, Dept. B, 5024 Lee Highway, Arlington 7, Va.

**BECOME** Master hypnotist. (Send stamp.) Hypnomaster, Box 1061-H8, Escondido, Calif.

**MODEL** and Builder vs the atmosphere; money prizes; free manual, Marotti Model Company, Box 655, Fontana, California.

**TROUBLESHOOTING** and repair of any project from "Popular Electronics." Only \$1.00 plus return postage. 48 hour service. Springfield Enterprises, Box 54-E3, Springfield Gardens 13, New York.

**BUILD** your own electronic organ, or electronic brain. Jim Kirk, 1522-A Church, San Francisco 14, California.

**WRIST**—Radio! 400 mile reception while wearing, own antenna. Build-it-yourself book \$1.98. Money back guarantee. Huckert Electronics, Box 7400-L, Washington 4, D. C.

**50 ASSORTED** New Resistors \$1.00 Postpaid. Test Equipment Repair-Kits constructed and rebuilt. Free list. Bigelow Electronics, Beulah, Mich.

**"CRYSTAL** Set beginners—Free gifts for stamp." Mallmart Box 92, Paramus, N. J.

## BUILD YOUR OWN AMATEUR TRANSMITTER

... FROM THIS EASY-TO-ASSEMBLE KIT!



- ✓ **PACKED WITH FEATURES**
- ✓ **PROFESSIONAL APPEARANCE**
- ✓ **EASY TO BUILD**
- ✓ **TVI SUPPRESSED** to prevent television interference

Start your hobby off right with this professional CW transmitter kit. The Viking "Adventurer" operates 50 watts input on the 80, 40, 20, 15 and 11-10 meter amateur bands, and with a simple antenna packs enough power for world-wide radio contacts. No antenna tuner needed—crystal controlled oscillator—powerful 807 transmitting type output tube. Easy to build and safe to operate—kit furnished complete with built-in power supply, tubes, cabinet, wiring instructions and antenna suggestions. Cat. No. 240-181-1 Viking "Adventurer" Kit, less crystal and key

**\$54.95**  
Amateur Net

For more information on the Viking "Adventurer" or Johnson's complete line of keys and practice sets see your favorite distributor or write to:



**E. F. JOHNSON COMPANY • 301 2ND STREET • WASECA, MINNESOTA**

## RESISTOR COLOR CODE

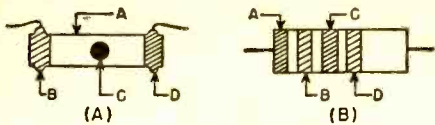

The ohmic value of a resistor can be determined by means of the color code. There are two standard methods of indicating this value.

In Fig. A, the body (A) and end (B) indicate the first and second digits of the value while the dot (C) indicates the multiplier to be used. The tolerance of the unit is indicated by the end color (D). For example, if the body (A) is green the number is 5; if the end (B) is grey the second number is 8. If the dot (C) is red the multiplier is 100 or two zeros should be added. The resistor is then a 5800 ohm unit. If the end (D) has no color, the tolerance is  $\pm 20\%$ .

In Fig. B, the first two stripes indicate the first two digits; the third stripe the multiplier; the fourth stripe the tolerance. Thus, if stripe (A) is green, (B) is grey, (C) is red, and (D) is silver, the resistor is a 5800 ohm,  $\pm 10\%$  unit.

### RETMA COLOR CODE CHART

COLOR	VALUE	MULTIPLIER
Black	0	1
Brown	1	10
Red	2	100
Orange	3	1000
Yellow	4	10,000
Green	5	100,000
Blue	6	1,000,000
Violet	7	10,000,000
Grey	8	100,000,000
White	9	1,000,000,000

### TOLERANCE CODE

Gold— $\pm 5\%$	Silver— $\pm 10\%$
No Color— $\pm 20\%$	

## CAPACITOR COLOR CODE

Color	MOLDED PAPER		MOLDED MICA		CERAMIC	
	Multiplier	Tolerance	Multiplier	Tolerance	Multiplier	Tolerance
Black	1	20%	1	20%	1	20% or 2.0 $\mu$ fd.*
Brown	10		10		10	1%
Red	100		100	2%	100	2%
Orange	1000		1000	3% (RETMA)	1000	2.5% (RETMA)
Yellow	10,000	5%	10,000		10,000	5% or 0.5 $\mu$ fd.*
Green				5% (RETMA)		
Blue						
Violet						
Gray					0.01	0.25 $\mu$ fd.*
White		100%			0.1	10% or 1.0 $\mu$ fd.*
Gold	0.1	5%	0.1	5% (JAN)		
Silver		10%	0.01	10%		
None		20%				

\*Capacitance less than 10 $\mu$ fd.

Capacitance is given in  $\mu$ fd. Colors have same values as on resistors, except as indicated in tables. Colors (A) and (B) are for first two digits; (C) is for multiplier. (D) is for tolerance. (E) and (F) give voltage rating in hundreds of volts; (E) is used only for ratings less than 1000 volts, (E) and (F) for first two digits of ratings 1000 volts or more. Values of colors for (E) and (F) are same as in resistance values. (G) is class or characteristic of capacitor, (H), (I), and (J) give temperature coefficient. (G), (H), (I), and (J) are not listed in the tables, since this information is seldom needed by the average home builder.

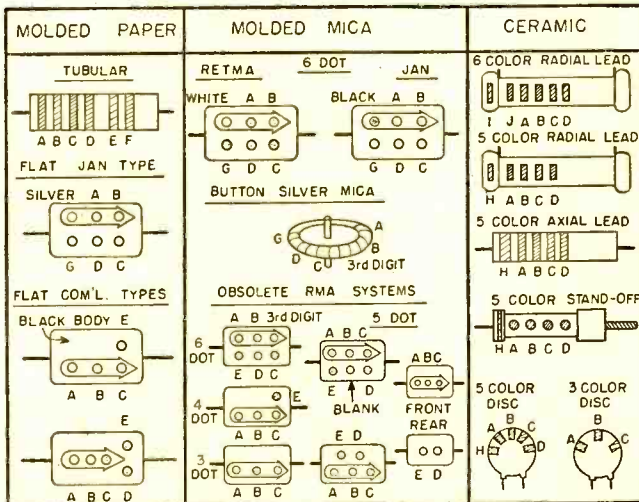



Get more money!  
More security! More out of life!

Learn

# TELEVISION • RADIO • ELECTRONICS

Get the best!

## Get National Schools' SHOP-METHOD HOME TRAINING!

Start now! Why wait around for that raise or promotion that may never come? Get started *now* in high-paying TV-Radio-Electronics! National Schools' SHOP METHOD Home Training prepares you for success in a top-salary job or in your own business. You learn *all three*... Television, Radio, Electronics... in one complete course. Our Shop-Tested lessons and manuals help you master all phases in shortest possible time! Send coupon, find out today!

### WHY NATIONAL SCHOOLS LEADS THE FIELD

Located in the "Television Center" of the world, our staff is in close touch with latest developments and opportunities. We give you personalized job placement assistance. We also give you confidential help with both technical and personal problems relating to your training. We show you how to make Part Time Earnings as you progress. Whether you live 30 miles away, or 3,000, you will always be pleased with our prompt, friendly service!

**DRAFT AGE?** Our home training helps you achieve specialized ratings and higher pay grades if you go in service.

We send you this precision-tested Multitester! Plus parts to build Oscillators, Receivers, Signal Generator, Continuity Checker, Combination Short Wave and Standard

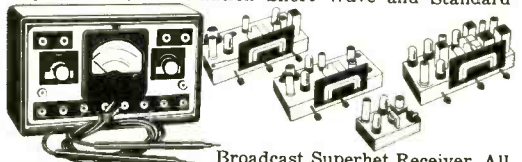

Broadcast Superhet Receiver. All this equipment is part of your National Schools course. **NO EXTRA CHARGES!** Send coupon for free books!

**NATIONAL SCHOOLS**, world-famous technical trade school. Now entering our 50th year!



## NATIONAL SCHOOLS

TECHNICAL TRADE TRAINING SINCE 1905

LOS ANGELES 37, CALIFORNIA

In Canada: 811 W. Hastings St., Vancouver, B. C.

• APPROVED FOR G. I. TRAINING

• BOTH HOME STUDY AND RESIDENT COURSES OFFERED

### 30 MILLION TV SETS

need regular repair! Color TV means more sets than ever before. NOW is the golden opportunity to cash in on this multi-billion-dollar industry. Or "write your own ticket" in broadcasting, manufacturing, and other specialized phases!

**YOUR AGE  
IS NO  
OBSTACLE!**

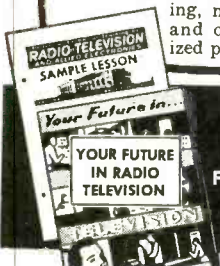

Send for  
**FREE LESSON!**  
FREE BOOK & SAMPLE LESSON  
will convince you!  
**SEND COUPON TODAY!**

### MAIL NOW TO OFFICE NEAREST YOU!

(mail in envelope or paste on postal card)

**NATIONAL SCHOOLS, DEPT. R2G-35**

4000 SOUTH FIGUEROA STREET  
LOS ANGELES 37, CALIFORNIA

OR 323 WEST POLK STREET  
CHICAGO 7, ILLINOIS

Please rush **FREE BOOK**, "My Future in Radio-Television-Electronics," and **FREE LESSON** at once. I understand there is no obligation, and no salesman will call.

NAME \_\_\_\_\_ BIRTHDAY \_\_\_\_\_ 19\_\_

ADDRESS \_\_\_\_\_

CITY \_\_\_\_\_ ZONE \_\_\_\_\_ STATE \_\_\_\_\_

Check if interested **ONLY** in Resident Training at Los Angeles.

VETERANS: Give date of discharge \_\_\_\_\_

only



S-53A The finest small communications receiver built and ideal where maximum performance is required in small space. Several steps better than the S-38C, but not quite up to larger S-40B. Covers Broadcast Band 540-1630 kc plus four short-wave bands covering 2.5-31 and 48-54.5 Mc.

Electrical bandspread for easy tuning. Two i-f stages. Switches for automatic noise limiter, code reception and high-low tone. Phono jack for records. Headphone tip jacks on rear and built-in PM speaker. Temp. compensated to reduce fading due to frequency shift. For 105/125 V. 50/60 cycle AC.

hallicrafters



Brand New and very much wanted—Model HT-30 Single Sideband AM and CW Transmitter/Exciter.

- Highly stable VFO with full 100:1 ratio gear drive system built-in, calibrated in kc.
- Stability comparable to most crystals .009%. Full band switching.
- Ample gain for 55 db microphone. Hum and noise 40 db down.

- Full 50 watt peak power output.
- Complete built-in metering.
- Unwanted sideband at least 40 db down. AM—CW—SSB.
- Undesired beat frequency down 60 db or more. T. V. I. suppressed.
- Stable 50 kc filter system.
- Provisions for coaxial output fitting.
- Built-in voice control circuit with bias switching for final amplifier.

has



Model SX-96 Selectable Sideband Receiver

- Covers Broadcast 538-1580 kc plus three S/W 1720 kc-34 Mc.
- Double conversion with selectable crystal controlled second oscillators.
- Selectable sideband reception of both sup-

pressed carrier and full carrier transmissions. Highly selective 50 kc I. F. system.

- CW operation with AVC on. Delayed AVC.
- Calibrated bandspread—"S" meter—double superhet. Precision gear drive dial system.
- 10 tubes, 1 rectifier and voltage regulator.

COMPLETE



S-94 (S-95) These two new Civic Patrol receivers are over 10 times as sensitive as previous models, greater increased audio power output and built-in relay squelch system. Perfect for monitoring, police, fire, taxicab, telephone-mobile, forestry, Civil Defense. The S-94 covers 30-50 Mc and the S-95 150-173 Mc. Built-in speaker and provisions for headphones. Eight tubes plus rectifier. 105/125 V. 50/60 cycle AC/DC.

HAM



S-38D Low cost unit with high priced performance over Broadcast Band 540-1650 kc plus three short-wave bands from 1650 kc-32 Mc. Electrical bandspread operates over large easy-to-read dial. Headphone tip jacks on rear and powerful built-in PM speaker. Oscillator for reception of cpde signals. Four tubes plus rectifier. 105/125 V. 50/60 cycle AC/DC.

LINE

Write for complete specifications.

hallicrafters

Chicago 24, Illinois

In Canada:

The HALLICRAFTERS COMPANY

Don Mills Road • Box 27, Station R • Toronto 17, Ontario