

POPULAR ELECTRONICS

FEBRUARY
1955
25
CENTS

In U.S. and Canada

RADIO • TV • R/C • HI-FI • ELECTRONICS

A SIMPLE RADIO-CONTROLLED GARAGE DOOR
BUILD THIS NOVICE CW TRANSMITTER
A TWO-TUBE BROADCAST BAND RECEIVER
HOW MAGNETIC TAPE IS MADE
ARCHIVAL STORAGE OF MAGNETIC RECORDINGS

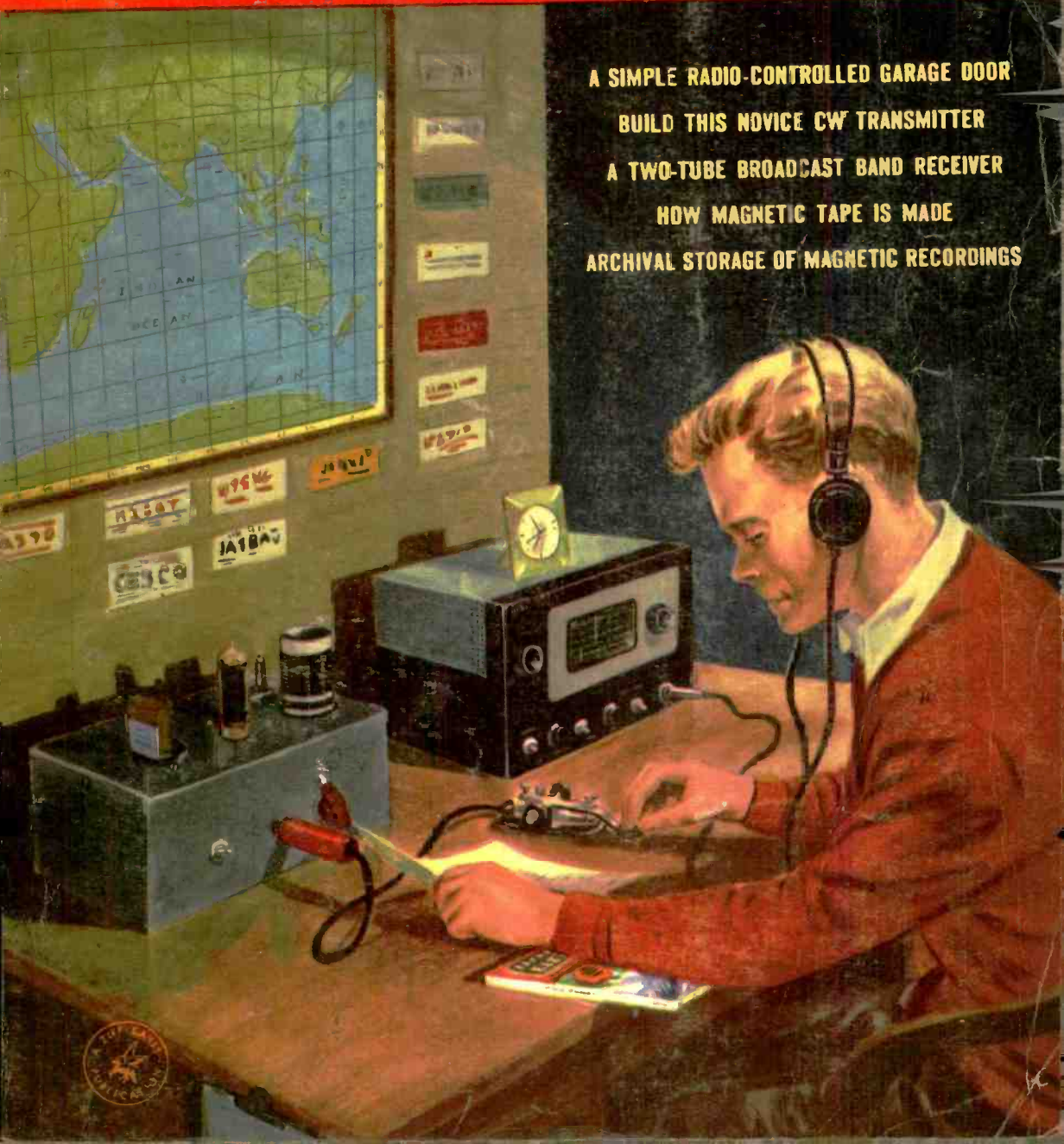

FOR THREE-WAY PERFORMANCE

3 TRIAXIALS

BY

University



IT'S **2**ND TO NONE—

THE MODEL 312 TRIAXIAL

BY

University

A new advance by University in the 12" field. Full range response from 40 cycles to inaudibility. Employs the "Diffusicone" principle for full-bodied mid-range and the HF-206 Super Tweeter for clean, brilliant highs. Built-in L/C network and "balance" control permit you to adjust tonal quality to your own listening tastes. All-Alnico-5 exclusive University "W" magnet and duraluminum voice coil suspension in woofer section results in deep and highly efficient bass response. 8 ohms impedance, 25 watts power capacity.

THE **1** AND ONLY

8" TRIAXIAL SPEAKER—
MODEL 308

BY

University



No other speaker like it! An 8" 3-way speaker—ideal for hi-fi installations where space is at a premium and quality is not to be compromised. Response down to better than 50 cycles, provided by voice coil and diaphragm operated with the exclusive University Alnico-5 "W" magnet. Rich, full-bodied mid-range is achieved through the use of the patented "Diffusicone" section of the unit, crossing over at 1,000 cycles. The high frequency reproducer, a compression driver unit wide angle tweeter which extends to 15,000 cycles, crosses over electrically at 5,000 cycles. Impedance 8 ohms, power capacity 25 watts

IT'S A **3**-WAY WONDER—

MODEL 315 TRIAXIAL

BY

University



Reproduces the entire range, from 30 cycles to inaudibility with such amazing clarity and presence that the superiority of this unit is readily obvious. Built around the sensational C15W woofer assembly, mid-range is provided by the patented "Diffusicone" device, while the clean and brilliant highs are reproduced by a compression driver unit with wide angle horn through an L/C electrical network crossing over at 5,000 cycles. Impedance 8 ohms, power capacity 50 watts.

Custom Design For *University* Speaker Systems

Fine Speaker Enclosures Engineered To Acoustically Enhance The Performance Of University Speakers... Tastefully Styled To Complement The Decor Of Your Home Rather Than Dominate It



EN-15

The best features of rear horn loading, phase inversion, and direct radiation are integrated to result in a highly efficient, extended range enclosure capable of unusual power handling capacity and excellent transient response. Ideally suited for the Model 312 or Model 315 Triaxial speakers, or any of the other fine 12" or 15" University speakers. Available in cherry or blond mahogany at no extra cost, or unfinished.

The EN-15 comes equipped with adapter boards for mounting 2 or 3-way combinations of University woofers and tweeters.

EN-8

Utilizes a combination of rear horn loading for unexcelled power handling and distortion control, and tuned horn mouth for phase inverter action for increased bass efficiency. The perfect enclosure for the Model 308 Triaxial speaker or Diffusicone-8. Available in cherry or blond mahogany at no extra cost, or in unfinished mahogany.

The EN-8 has cut-out for University tweeters for use with 8" woofer or other cones.



University

Engineering Superiority...

Proven by Years of Acceptance



Model 6200 Extended Range Speaker

Full bodied response to beyond 10,000 cycles makes it ideal for radio, TV and phono applications. Excellent basic unit. Eight ohms impedance, 25 watts power capacity.



Diffusicone—8" and 12" Coaxial Speakers

Exclusive patented "Diffusicone" design with 1000-cycle mechanical crossover results in full fidelity anywhere in the room... full undistorted response without loss of highs at listening points progressively off speaker axis. Eight ohms impedance, 25 watts power capacity.

Model 6201 Dual Range System

Acknowledged as the industry's finest value in a high quality 12" loudspeaker. Complete with coaxial tweeter driver and wide angle horn, it is one of the few true dual range systems in its price class. Built-in L/C network and balance control. Eight ohms impedance, 25 watts power capacity.



For complete information on the entire University high fidelity line, write Desk 50

University Loudspeakers

80 SOUTH KENSICO AVENUE,

WHITE PLAINS, NEW YORK

INC.



BE A RADIO-TELEVISION TECHNICIAN

America's Fast Growing Industry Offers You a Bright Future



J. E. SMITH, President,
National Radio Institute,
has trained more men for
Radio-Television than any
other man. Our 40th Year.

I Will Train You at Home in Spare Time for Good Paying Jobs in RADIO-TELEVISION

I Trained These Men

Extra Money in Spare Time
"Four months after enrolling ... averaged \$10 to \$15 a week servicing sets in spare time. Now have full-time business."—William Weyde, Brooklyn, New York.

Chief Technician with Large Shop
"In a year I opened my full-time radio shop. NRI training qualified me as Instructor during war. Now Chief Radio and TV Serviceman."—P. G. Brogan, Louisville, Ky.

Quit Job to Start Own Business
"I decided to quit my job and do television work full time. I love my work and am doing all right. I'm not just punching a time clock."—Wm. F. Kline, Cincinnati, Ohio.

Video Control Engineer
"My position with WNBT is video control engineer on the RCA color project. I owe a lot of my success to your textbooks."—Warren Deem, Malverne, N. Y.



TELEVISION is Making Good Jobs, Prosperity

Radio, even without Television is bigger than ever. 11 1/2 million home and auto radios and 3000 Radio Broadcasting Stations give interesting jobs to service technicians, operators, engineers. NOW ADD TELEVISION. 25 million TV homes and the total growing rapidly. 200 Television stations on the air, hundreds more under construction. Color Television soon to be a reality. All this adds up to good pay now, a bright future for men who qualify.

America's Fast Growing Industry Offers You GOOD PAY - BRIGHT FUTURE - SECURITY

Training PLUS opportunity is the PERFECT COMBINATION for job security, advancement. When times are good, the trained man makes the BETTER PAY, gets PROMOTED. When jobs are scarce, the trained man enjoys GREATER SECURITY. NRI training can help assure you and your family more of the better things of life.

Start Soon to Make \$10, \$15 a Week Extra Fixing Sets

An important benefit of my Radio-Television training is that you can start to cash in fast. I start sending you special booklets that show you how to fix sets the day you enroll. Multitester you build with parts I send helps you discover and correct troubles, helps you make money fixing neighbors' sets in spare time while training. Many NRI students make \$10, \$15 a week extra this way. My training is practical, complete. You benefit by my 40 years' experience training men at home. My well-

illustrated lessons give you basic principles you need, and my skillfully developed kits of parts "bring to life" things you learn from the lessons.

Find Out About This Tested Way to Better Pay — Mail Coupon

Without obligating you in any way, I'll send an Actual Lesson to prove that my training is practical, thorough. My 64-page book, "How to be a Success in Radio-Television" shows what my graduates are doing, earning. It gives important facts about your opportunities in Radio-Television, tells about kits I furnish for practical experience. You don't have to leave home or give up your job to take NRI course. You learn at home in your spare time on terms as low as \$5 a month. Many of my graduates make more than the total cost of my training in just two weeks. Mail coupon below now to J. E. SMITH, President, National Radio Institute, Dept. 88D4, Washington 9, D. C. Our 40th Year.

You Practice Broadcasting-Servicing with Kits of Parts I Send



Nothing takes the place of practical experience. That's why NRI training is based on learning by DOING. My training includes specially developed kits of parts you use to build equipment and get practical experience on circuits common to both Radio and Television. Shown at left is the low power Broadcasting Transmitter you build as part of my Communications Course. Also shown is modern Radio you build as part of my Servicing Course. My free book tells about other equipment you build. Mail coupon. All equipment is yours to keep.

**AVAILABLE TO
VETERANS
UNDER GI BILLS**

"APPROVED MEMBER, NATIONAL HOME STUDY COUNCIL"

Good for Both - FREE

MR. J. E. SMITH, President, Dept. 88D4
National Radio Institute, Washington 9, D. C.
Mail me Sample Lesson and 64-page Book, FREE.
(No salesman will call. Please write plainly.)

Name _____ Age _____
Address _____
City _____ Zone _____ State _____

VETS Write in date of discharge _____



POPULAR ELECTRONICS is published monthly by Ziff-Davis Publishing Company, William B. Ziff, Chairman of the Board (1946-1953), at 64 E. Lake St., Chicago 1, Ill. Entered as second class matter August 27, 1954 at the Post Office, Chicago, Illinois. SUBSCRIPTION RATES: One Year U.S. and possessions, and Canada \$3.00; Pan-American Union Countries \$3.50; all other foreign countries \$4.00.

POPULAR ELECTRONICS

FEBRUARY
1955
VOL. 2 - NUMBER 2

Registered U. S. Patent Office

EDITOR

OLIVER READ, W1ETI

ASSOCIATE EDITORS

W. A. STOCKLIN H. S. RENNE
C. TEPPER J. FRIEBORN
P. B. HOEFER N. EISENBERG

ART

FRANK SAYLES (Director)
A. J. REICH M. WHELPLEY

CONTRIBUTING EDITORS

J. T. FRYE L. E. GARNER, JR.
K. R. BOORD R. P. TURNER
R. HERTZBERG H. POLLACK

DRAFTING

J. A. GOLANEK A. A. GANS

ADVERTISING DEPARTMENT

New York (MU 7-8080)
L. L. OSTEN - Adv. Dir.
WM. G. McCROY - Sales
Chicago (AN 3-5200)
M. B. CROFFORD - Sales
Los Angeles (Mich. 9856)
JOHN E. PAYNE - West. Adv. Mgr.



Copyright 1955
All Rights Reserved

ZIFF-DAVIS PUBLISHING COMPANY

W. B. ZIFF (1898-1953) FOUNDER

Also Publishers of
RADIO & TELEVISION NEWS
RADIO-ELECTRONIC ENGINEERING
Editorial and Executive Offices
366 Madison Ave., New York 17, N.Y.

PRESIDENT

B. G. DAVIS

VICE-PRESIDENTS

H. J. MORGANROTH M. FROELICH

SECRETARY-TREASURER

G. E. CARNEY

CIRCULATION MANAGER

M. MICHAELSON

BRANCH OFFICES

Chicago (1), 64 E. Lake St.
Los Angeles (14), Statler Center,
900 Wilshire Blvd.

SUBSCRIPTION SERVICE:

All communications concerning subscriptions should be addressed to Circulation Dept., 64 E. Lake St., Chicago 1, Ill. Subscribers should allow at least four weeks for any change of address.

CONTRIBUTIONS:

Contributors are advised to retain a copy of their manuscripts and illustrations. Contributions should be mailed to the New York Editorial Office and must be accompanied by return postage. Contributions will be handled with reasonable care, but this magazine assumes no responsibility for their safety. Any copy accepted is subject to whatever adaptations and revisions are necessary to meet the requirements of this publication. Payment covers all author's, contributor's, and contestant's rights, title, and interest in and to the material accepted and will be made at our current rates upon acceptance. All photos and drawings will be considered as part of material purchased.

CONTENTS

A Simple Radio-Controlled Garage Door.....	V. Preston	17
Hi-Fi-Music or Noise.....	L. E. Johnston	22
How Magnetic Tape is Made.....		24
Build This Novice CW Transmitter.....	R. P. Turner	26
Records Are Better Than Ever.....	D. Hoefler	30
A Two-Tube Broadcast Band Receiver.....		33
Mobile Telemetry Unit.....		37
How the Cathode-Ray Tube Works.....		38
Radio Control Installations.....	W. Winter	42
A Solderless Broadcast Crystal Receiver.....		48
Sensitive Low-Cost Photo Relay.....	H. Pollock	49
So You Want to be a Ham (Part 5).....	R. Hertzberg, W2DJJ	53
New Electronics Experimenters Kit.....		56
Electronics Shapes Home of the Future.....		57
Archival Storage of Magnetic Recordings.....	J. A. McRoberts	58
Record Noise.....	B. Whyte	60
Disc Review.....	B. Whyte	61
R/C Compound Escapements & Servos.....	E. L. Safford, Jr.	62
Carl & Jerry.....	J. T. Frye	66
Make Use of Jobbers Catalogues.....		69
"Robot" Speeds TV Production.....		70
The World at a Twirl.....	K. R. Boord	72
Build This Photocell Annunciator.....	L. E. Garner, Jr.	74
Electronic Yardmaster Guides Freight Cars.....		82
Return of the Prodigal Ham.....	C. L. Meistroff, W4TFA	88
Identifying Power Transformer Leads.....		91
What Value Resistance for Best Results.....		98
On the Air.....		102

DEPARTMENTS

Letters from Our Readers.....	10
Tools & Gadgets.....	93
Book Reviews.....	95
R/C Notes.....	96
Tricks of the Trade.....	106
After Class.....	114
Standardized Wiring Diagram Symbols.....	125
Glossary of Terms in This Issue.....	126
Abbreviations.....	127
Resistor Color Code.....	130
Capacitor Color Code.....	130

(Also see page 6)

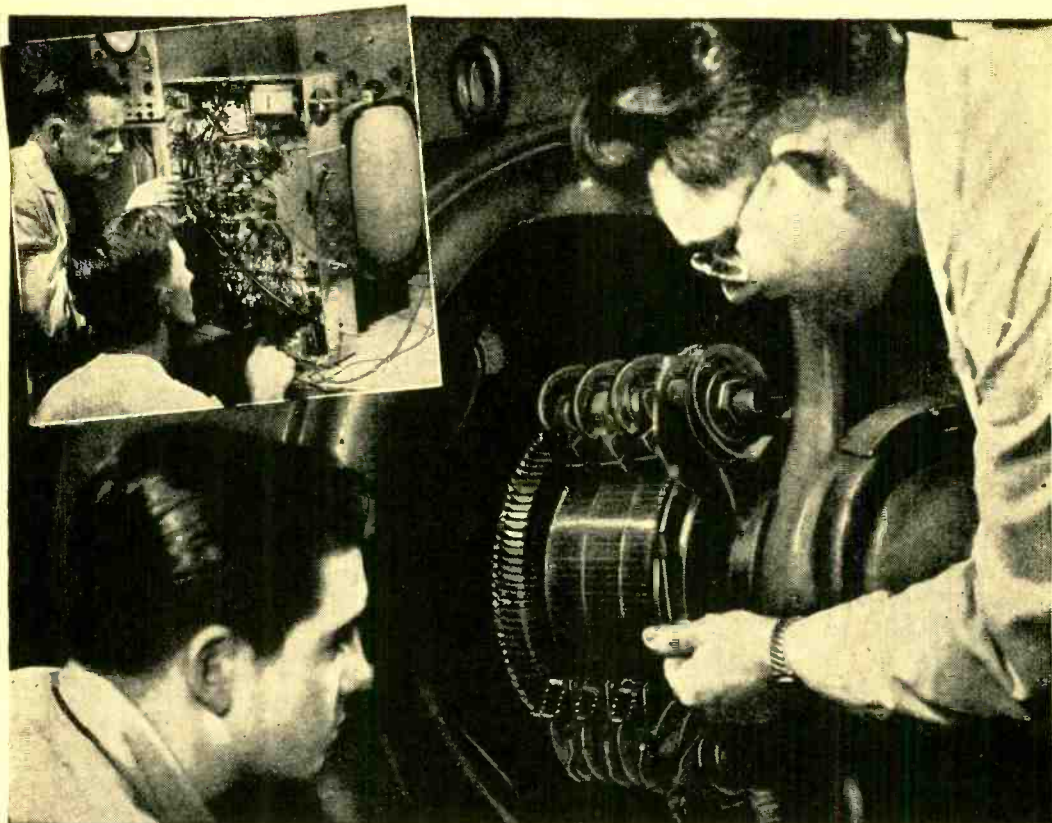

TRAIN FOR A FUTURE IN Electricity or Television-Radio

IT'S THE ACTUAL SHOP TRAINING AT
COYNE THAT MAKES THE DIFFERENCE!

Prepare quickly at Coyne for a career with a future!

Trained men are vitally needed now whether 17 or up to 45. Get a better rating, if drafted—an essential job in industry, if not in A FIELD THAT OFFERS A REAL FUTURE.

WE TRAIN YOU IN CHICAGO

Learn the easier, practical way at Coyne, on real, full size equipment. No advanced education or previous experience needed. You learn *better* the Coyne way.

Train in the shops of Coyne—where thousands of successful men have trained for over 55 years—Coyne is the largest, oldest, best equipped school of its kind—established in Chicago in 1899.

FINANCE PLAN Enroll now. You may pay most of tuition later. We have a *special plan for men of draft age*.

CLIP COUPON NOW for big new illustrated Coyne book. No obligation; no salesman will call. Get vital facts now!

APPROVED
FOR
VETERANS

Mail Coupon
Today for
**BIG FREE
BOOK**



Check whether interested in
ELECTRICITY or TELEVISION-
RADIO or both.

B. W. COOKE, President
COYNE ELECTRICAL SCHOOL
500 S. Paulina St., Chicago 12, Ill., Dept. 25-71-H

Send **BIG FREE** book and details of your training offer. This does not obligate me and no salesman will call. I am interested in:

ELECTRICITY TELEVISION-RADIO

Name.....

Address.....

City..... State.....

B. W. COOKE President **COYNE** FOUNDED 1899
ELECTRICAL SCHOOL

A TECHNICAL TRADE INSTITUTE CHARTERED NOT FOR PROFIT
500 S. PAULINA, CHICAGO, Dept. 25-71-H
ELECTRICITY ★ RADIO ★ TELEVISION ★ REFRIGERATION ★ ELECTRONICS

ITEMS OF INTEREST

This Month's Cover	8
Antenna from Steel Tape	36
New Low Cost TV Towers Made of Aluminum	47
Solar Energy Operates Midget Transmitter	47
Clothespins Provide Pair of "Extra Hands"	48
Aluminum Jaws Protect Work in Vise	68
Simple Filter Blocks Interference to TV	79
R/C Carts Speed Loading in Warehouse	80
Radio and TV Pioneers Meet	80
An Amazing Receiver	90
First Transistorized 20-Watt Audio Amplifier	92
The Why of Hi-Fi	100
Hints on Buying U. S. Equipment Abroad	111
Easily Made TV Lamp	113

NEW PRODUCTS

New Theremin Makes Music Electronically (R. A. Moog Co., 51-09 Parsons Blvd., Flushing 55, N. Y.)	36
Economical Kit Builds Hi-Fi AM Tuner (Approved Electronic Instrument Corp., 928 Broadway, New York 10, N. Y.)	47
Portable Radio for Loudspeaker or Headphone (Distributed by R. I. Mendels, Inc., 41 E. 42nd St., New York, N. Y.)	47
A New Receiver for Radio Control (American Telasco Ltd., Huntington, N. Y.)	65
A Portable Geiger Counter (Technical Associates, 140 W. Providencia Ave., Burbank, Calif.)	65

If you are unable to find these listed products locally, write direct to the manufacturers at the addresses given. Also see the monthly review of new items of interest to the electronic hobbyist in "Tools & Gadgets" appearing on pages 93 and 94 of this issue of POPULAR ELECTRONICS.

COMING NEXT MONTH POPULAR ELECTRONICS

An Automatic Light Switch for the Home
A Frequency Meter Monitor for Ham Stations

Power Supply
What We Hear

How to Add Extension Speaker
Plus More On

High-Fidelity Audio • Kits • Radio Control • Short-Wave Listening • What's New • How It Works • How to Make It • How to Use It • Carl & Jerry

IN THIS MONTH'S

RADIO & TELEVISION NEWS

(February)

A Preselector for the SWL
"Mobile Meter" of Many Uses
A 60-watt "Ultra-Linear" Amplifier
Radio Licensing and the FCC
A "Universal" Counter
Intermodulation Distortion Tester

EMC EXCLUSIVE

BASIC SERVICE SHOP TEST EQUIPMENT for only \$68.55*

You get ALL three of these precision instruments ... in this sensational offer!

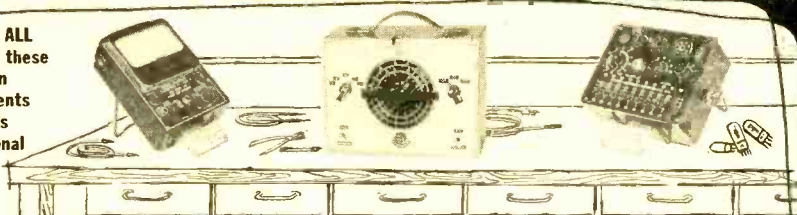

EMC model 106 VTVM

Price of this individual unit
Model 106 (wired and tested) \$35.90
Model 106 (in kit form) \$23.90
Accessory probes available

EMC model 500 R.F. Signal Generator

Price of this individual unit
Model 500 (wired and tested) \$29.75
Model 500 (in kit form) \$19.75

EMC model 208 Tube Tester

Price of this individual unit
Model 208 (wired and tested) \$24.90
Picture tube adaptor available

HOW TO GET IN ON THIS SENSATIONAL OFFER!

Start your own service shop with professional precision test equipment at solid savings plus the free Picture Tube Adaptor and Instrument Stands given in this special EMC offer.

Go to your favorite local jobber, purchase the above three instruments (Models 106, 500, 208), mail the three enclosed guarantee cards to EMC and receive by return mail your free \$6.46 worth of valuable accessories. This is a limited offer so act TODAY!

PLUS FREE ... with this special offer
Model CRA (Picture tube adaptor for model 208) \$4.50
2 Model IS (Instrument stands) 1.96
Total retail cost if purchased \$6.46



Write Dept. PE-2 for new complete catalog of precision test equipment TODAY!

EMC ELECTRONIC MEASUREMENTS CORP.
280 LAFAYETTE STREET, NEW YORK 12, N. Y.

*Total price if models 106 and 500 are not purchased in kit form — \$90.55

Note these instruments can be purchased individually.



INVENTORS

Learn how to protect your invention. The U. S. Patent Laws provide that any new and useful art, machine, article of manufacture, or composition of matter, or any new and useful improvement thereof, may be patented if the act of invention is involved. Therefore, every inventor with a valuable invention should take advantage of the Patent Laws and proceed for patent protection in order to safeguard his rights.

A patent gives the inventor the exclusive right to prevent others from making, using, or selling the invention claimed in the patent for a period of seventeen years.

The Patent Laws were enacted for the benefit of the inventor to give him protection for the features of his invention which are patentable. These features must be properly and concisely set forth and claimed in a formal application for patent, in order to comply with the requirements of the Patent Laws. For that reason, unless the inventor is familiar with patent matters, he should engage a competent registered patent attorney or agent to represent him. We are registered to practice before the U. S. Patent Office and are prepared to serve you in the handling of your patent matters.

A specially prepared booklet entitled "Patent Guide for the Inventor", containing detailed information with respect to patent protection and procedure, together with a "Record of Invention" form will be promptly forwarded to you without obligation upon request.

CLARENCE A. O'BRIEN & HARVEY JACOBSON

Registered Patent Attorneys

59-B DISTRICT NATIONAL BUILDING

WASHINGTON 5, D. C.

LONG-PLAYING 33 1/2 R. P. M. HIGH-FIDELITY

8 MASTERPIECES

COMPLETE TO THE LAST NOTE! **\$1.00**
NOT \$1 EACH, BUT \$1 FOR ALL 8!



NOW you can get a real start on a complete record collection. Yes, you get ALL EIGHT of these great masterpieces — complete to the last note — for only \$1.00!

Why We Make this Amazing Offer

We were FORCED to make this "give-away" offer — for only by putting our records in your hands can we demonstrate their wonderful quality and extreme value. Performed by internationally renowned orchestras and artists. Custom-pressed on purest vinyl plastic. Reproduced with a tone fidelity encompassing the entire range of human hearing... 50 to 15,000 cycles!

Mail Coupon Now

As a Trial Member of the Musical Masterpiece Society, you are not obligated to ever buy another record from us. You do have the right to try — free of charge — any of the Society's monthly selections you wish. You receive prior notice of these and pay nothing in advance. Those you want are sent to you for FREE trial. After 5 days, the records you decide to keep are billed you at the low Membership Price of only \$1.50 per disc (average playing time 40 minutes). You save 2/3 the usual retail price! And, on this sensational demonstration offer, you start your collection with these EIGHT masterpieces for only \$1. But production capacity limits our membership rolls; when they are filled this offer must be withdrawn. Avoid disappointment. Rush coupon with a dollar today!

- SCHUBERT**
Symphony No. 8
("Unfinished")
*Zurich Tonhalle Orch.
Otto Ackermann, Cond.*
- BEETHOVEN**
The Ruins of Athens
(March and Choir)
*Netherlands Phil.
Walter Goehr, Cond.*
- BRAHMS**
Academic Festival
Overture
*Utrecht Symphony
Paul Hupperts, Cond.*
- MOZART**
Piano Concerto in E Flat
*Artur Balsam, piano
Winterthur Symphony
Otto Ackermann, Cond.*
- BACH**
Tocatta and Fugue in
D Minor
*A. Schreiner, Organ of
the Tabernacle,
Salt Lake City*
- WAGNER**
Die Meistersinger,
Prelude, Act 1
*Zurich Tonhalle Orch.
Otto Ackermann, Cond.*
- DUKAS**
Sorcerer's Apprentice
*Utrecht Symphony
Paul Hupperts, Cond.*
- MUSSORGSKY**
Night on Bald Mountain
*Netherlands Phil.
Walter Goehr, Cond.*



This Month's Cover

ONE of the world's most fascinating and worthwhile hobbies is amateur radio. Proof of that statement lies in the fact that "hamming" has captured the imagination of such a diversified group of people throughout the world.

The amateur roll-call includes all age groups from 7-year-old first graders to the real "old timers" in both age and radio experience. Clergymen, doctors, lawyers, showfolk, engineers, students, Boy Scouts and Girl Scouts, housewives, businessmen, and lots of folks like you and me are proud holders of coveted FCC "ham" licenses.

With the recently adopted Novice ticket available, almost anyone can qualify for his ham license. No matter how limited the space for a "ham" shack, you can get on the air.

This month's issue carries several articles of particular interest to the ham or would-be ham, including a nostalgic piece "Return of the Prodigal Ham" (page 88), construction details on a compact unit, "Build this CW Transmitter" (page 26) which is suitable as a "first transmitter", and "Going on the Air" which is Part 5 of the current "So You Want to Be a Ham" series (page 53).

The amateur radio hobby can be as elaborate or as simple as you wish, you can operate with powers of less than a watt or can pour hundreds of watts into the ether; your equipment can cost thousands of dollars or can be built for less than 10 bucks! EDITOR

(Cover painting by Leo R. Summers)

Musical Masterpiece Society, Dept. 602
43 West 61st St., New York 23, N. Y.

ALL 8 MASTERPIECES—\$1.00

I enclose \$1.00 as complete payment. Please send me ALL 8 of the masterpieces listed above and enroll me as a Trial Member.

I will receive advance descriptions of future monthly selections. I may try any of these — free of charge — without paying a penny in advance. I may reject any recording before or after I receive it, and may cancel my trial membership at any time.

In the future, for each selection I decide to keep, I will pay special Member's Price of only \$1.50 plus a few cents for shipping... saving 2/3 off the usual retail price!

Name

Address 701

City State

In Canada, address: 686 Bathurst St., Toronto 4, Ont.

GET IN ON THE



L. C. Lane, B.S., M.A.
President, Radio-Television Training Association. Executive Director, Pierce School of Radio & Television.

BOOM!

TRAIN FOR A HIGH PAYING JOB AS A TELEVISION TECHNICIAN NO PREVIOUS EXPERIENCE NEEDED — study AT HOME in your SPARE TIME

Next to the atom and hydrogen bombs, the biggest noise being made today is by the booming radio-television-electronics industry.

Now, while the boom is on in full force, is the time for you to think about how you can share in the high pay and good job security that this ever-expanding field offers to trained technicians.

Just figure it out for yourself. There are more than 400 television broadcasting stations operating right now

and hundreds more to be built; more than 30 million sets in the country and sales increasing daily. By 1955 moderately priced color television sets will be on the market and the color stampede will be on.

All these facts mean that good jobs will be looking for good men. You can be one of those men if you take advantage of my training now — the same training that has already prepared hundreds of men for successful careers in the radio-television-electronics field.

No experience necessary! You learn by practicing with professional equipment I send you. Many of my graduates who now hold down good paying technician jobs started with only grammar school training.

**RADIO-FM-TV
TECHNICIAN
TRAINING**

If you have previous Armed Forces or civilian radio experience you can finish your training several months earlier by taking my FM-TV Technician Course. Train at home with kits of parts, plus equipment to build BIG SCREEN TV RECEIVER. ALL FURNISHED AT NO EXTRA COST!

**FM-TV
TECHNICIAN
TRAINING**

After you finish your home study training in the Radio-FM-TV Technician Course or the FM-TV Technician Course you get two weeks, 50 hours, of intensive Laboratory work on modern electronic equipment at our associate school in New York City, Pierce School of Radio & Television.

**EXTRA
LABORATORY
TRAINING IN
NEW YORK
CITY
AT NO EXTRA
COST!**

THIS EXTRA TRAINING IS YOURS AT NO EXTRA COST WHATSOEVER. My courses are complete without this extra training, however. It is just an added opportunity for review and practice.



VETERANS!

My School fully approved to train veterans under new Korean G.I. Bill. Write discharge date on coupon.

YOU GET THESE FOUR

free!



MAIL THIS COUPON TODAY!
no salesman will call!

LEARN BY DOING As part of your training, I give you enough equipment to set up your own home laboratory and prepare for a BETTER PAY TV job. You build and keep a professional GIANT SCREEN TV RECEIVER complete with big picture tube (designed and engineered to take any size up to 21-inch) . . . also a Super-Met Radio Receiver, RF Signal Generator, Combination Voltmeter-Ammeter-Ohmmeter, C-W Telephone Transmitter, Public Address System, AC-DC Power Supply. Everything supplied, including all tubes.

EARN WHILE YOU LEARN Almost from the very start you can earn extra money while learning by repairing radio-TV sets for friends and neighbors. Many of my students earn up to \$25 a week . . . pay for their entire training from spare time earnings . . . start their own profitable service business.

FREE FCC COACHING COURSE Qualifies you for Higher Pay! Given to all my students AT NO EXTRA COST. Helps you qualify for the TOP JOBS in Radio-TV that demand an FCC license! Full training and preparation at home for your FCC license.

Mr. Leonard C. Lane, President
RADIO-TELEVISION TRAINING ASSOCIATION
52 East 19th Street, New York 3, N. Y.

Dept. E-2

Dear Mr. Lane: Mail me your NEW FREE BOOK, FREE SAMPLE LESSON, and FREE aids that will show me how I can make BIG MONEY IN TELEVISION. I understand I am under no obligation and no salesman will call.

(PLEASE PRINT PLAINLY)

Name _____ Age _____
Address _____
City _____ Zone _____ State _____

I AM INTERESTED IN:

- Radio-FM-TV Technician Course
- FM-TV Technician Course
- TV Cameraman & Studio Technician Course

VETERANS!
Write discharge date

Radio **T**elevision **T**raining **A**ssociation
52 EAST 19th STREET • NEW YORK 3, N. Y.

Licensed by the State of New York • Approved for Veteran Training

you can

build

LETTERS FROM OUR READERS

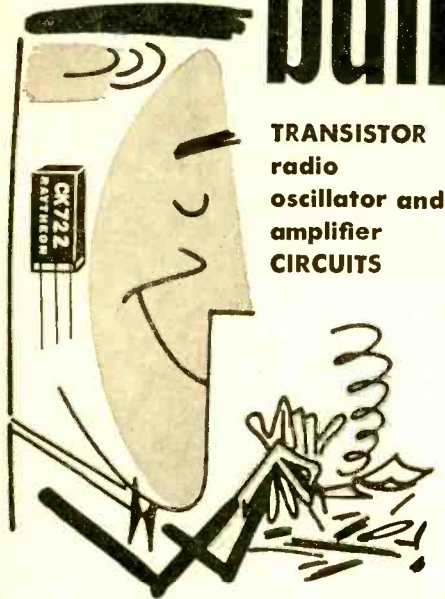

**TRANSISTOR
radio
oscillator and
amplifier
CIRCUITS**

with



CK722

TRANSISTORS

How'd you like to experiment with a circuit that gets its power from the illumination in a room or from the application of wet paper to a dime? Or try experiments with radio, amplifier or oscillator circuits?

You can, using a low cost Raytheon CK722 Transistor and a few standard parts probably available from your own "junk" box. Information on how to build these circuits is yours for the asking. Simply write Department P3. Buy low cost Raytheon CK722 Transistors from your local Raytheon Tube Supplier.



Excellence in Electronics

RAYTHEON MFG. CO.

Receiving and Cathode Ray Tube Operations
Newton 58, Massachusetts

RELIABLE SUBMINIATURE AND MINIATURE TUBES
SEMICONDUCTOR DIODES AND TRANSISTORS
NUCLEONIC TUBES

RECEIVING AND PICTURE TUBES • MICROWAVE TUBES

THANK YOU KINDLY, SIR!
"I WANT to say your system of printing the pictorial diagram opposite the schematic has taught me more during the two months of reading POPULAR ELECTRONICS than all the books I have scoured. It is my hope you will continue this practice. . . ."

Morgan P. Daniels, Jr.
Burlingame, Calif.

We sure will!

"I DISCOVERED your new publication while perusing through the supply of assorted periodicals at one of the corner newsstands. I found that about a nine-second flick through its pages was more than a sufficient warranty for purchase at the very unusual meagerness of twenty-five cents. . . ."

A. M. Heosein
Yeaton, Pa.

Thank you, A.M.H.! Letters like this are still pouring into our offices. Welcome to the ever-growing family of readers of POPULAR ELECTRONICS!

★ ★ ★

TV INFO REQUESTED

"HOW about some information on wave traps for TV interference and how to make TV boosters for both u.h.f. and v.h.f. . . . ?"

Roger J. Pike
Montreal, Quebec

Thanks for the suggestions. We always want to know what our readers would like to see in POPULAR ELECTRONICS. One of our writers has been assigned to work on this very subject, and material on it should be forthcoming in the very near future.

★ ★ ★

A.C. BUZZERS

"IS THERE any buzzer that operates on 115 volts a.c.? I have tried getting one but can't seem to locate it."

Hal Ronstard,
Evanston, Ill.

We've received several queries from readers on this same point. Actually, we never did recommend the use of a 115 volt a.c. buzzer. We have suggested bells which are generally easier to come by. But for the record, there is the Edwards

POPULAR ELECTRONICS

3/40A buzzer which is rated at 120 volts, 5 amps, 6 watts and lists for \$19.00. On the other hand, there is the Edwards 720 buzzer designed for only 6 volts a.c. and listing for \$1.00. Another point: these items are generally found in greater abundance in electrical supply houses rather than at radio parts jobbers. And, of course, items rated at 120 volts can be used on a.c. lines that supply 110, 115, or 117 volts.

★ ★ ★

CHANGE IN RELAY SERIES

"I WENT around to a local jobber the other day to pick up a Potter & Brumfield plate circuit relay, 5000 ohms LS series. The jobber told me that this company's LS series had been changed to the LB series. I have no reason to doubt the jobber but I thought I'd check with you people on this. Have you heard anything about it?"

Len Stammer
Boston, Mass.

The jobber was right! Potter & Brumfield's LS series has been replaced by their LB series. Readers who are building any units that call for such a relay in the LS series are advised simply to revise LS to read LB.

★ ★ ★

CORRECTION ON TUBE TYPE

"STARTED out to build the pie-case radio described in your December issue (pages 50-51), but ran into trouble with the tube you have down there. Your parts list calls for a type 1S5, and the article itself mentions a type 1S5. But according to the 'RCA Manual,' the 1S5 doesn't resemble the tube shown in your schematic. I'd say the tube you show looks more like a 1T4. Now, should it be a 1S5, and if so, what are the connections for it? Or, can another tube be used?"

Victor Kingsbury
Edmonton, Alberta

We "goofed" on this one, and many alert readers have called the mistake to our attention. Reader Victor Kingsbury is quite correct: the tube used in the actual set described in our article was a type 1T4, and the pin connections shown on our schematic are for the 1T4 and not for the 1S5. The simplest thing to do in building this set would be to substitute "1T4" for "1S5" wherever mention is made of the tube used. Of course, other tube types could also be used, with proper connections. If you have a 1S5, you can use it simply by changing the connections shown in the schematic as follows: pin 3 becomes pin 4; and pin 2 becomes pin 5.

Other tube types that could be used, with

you can
buy



CK722

TRANSISTORS

for only \$3⁵⁰ each
through your
RAYTHEON TUBE SUPPLIER

Only \$3.50 opens up the world of transistor circuitry for you. With the inexpensive Raytheon CK722

Transistor there are dozens of circuits you can build — learning about transistors while you do it.

See your Raytheon Tube Supplier about Raytheon CK722 Transistors.

He carries them in stock and you'll find him very helpful in planning transistor experiments.



Excellence in Electronics
RAYTHEON MFG. CO.
Receiving and Cathode Ray Tube Operations
Newton 58, Massachusetts
RELIABLE SUBMINIATURE AND MINIATURE TUBES
SEMICONDUCTOR DIODES AND TRANSISTORS
NUCLEONIC TUBES
RECEIVING AND PICTURE TUBES • MICROWAVE TUBES

FREE 1955 ALLIED TV & RADIO CATALOG

THE COMPLETE ELECTRONIC SUPPLY GUIDE

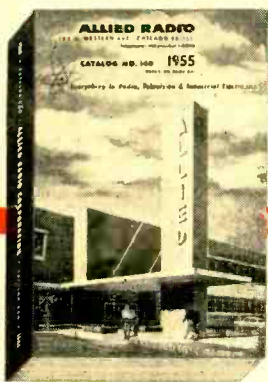

**308
VALUE-
PACKED
PAGES**

**Save on
Everything
in
Electronics**

**WORLD'S
LARGEST
STOCKS**

**Everything for Experimenters,
Builders, Amateurs,
Servicemen, Engineers and
Hi-Fi Specialists**

Send for ALLIED's big 308-page value-packed buying guide to everything in TV, Radio and Electronics! Largest selections of custom TV chassis, antennas and accessories; FM and AM tuners; High Fidelity systems and components; recorders and phono equipment; Amateur supplies; test instruments; builders' kits; industrial electronic supplies—plus the world's largest stocks of electronic parts, tubes, tools and books. Save on everything in Electronics—send today for your FREE 1955 ALLIED Catalog.

Ultra-modern facilities to SERVE YOU BEST



**Send for
FREE
Catalog**

ALLIED RADIO

ALLIED RADIO CORP., Dept. 79-B-5
100 N. Western Ave., Chicago 80, Ill.

Rush FREE 1955 ALLIED 308-Page Catalog

Name _____

Address _____

City _____ Zone _____ State _____

the connections shown in the diagram are the $1T_4$ and the $1U_4$. Finally, a type $1U_5$ could be used, also following the connections shown on the schematic, and ignoring the diode plate element (pin 4) included in the $1U_5$.

★ ★ ★

RESISTOR VS CHOKE IN FILTER

IN THE schematic for the phonograph on page 39 of your December issue, the filter in the power supply uses resistors R_1 , R_2 , and R_3 in series in the high d.c. line. I always thought a choke coil should go in this place. Are resistors used because of the selenium rectifier, or what?"

Al Sanford
Seattle, Wash.

R_2 is the only resistor which might be replaced by a choke coil, but in this case the current drain is low enough so that very little voltage drop will occur even if a fairly high resistance is used. A resistance of sufficiently high value will give just as much reduction in the a.c. ripple as a choke coil—and the resistor is cheaper. R_1 is a current limiting resistor to protect the rectifier. R_3 is a voltage dropping resistor to lower the voltage to the value required by the tube filaments.

★ ★ ★

MAGNETIC PHONO PICKUPS

I HAVE heard a lot about magnetic phono cartridges and how they require pre-amplification and record equalization in order to sound good. Well, I'm not from Missouri, but I still like to be shown, so I replaced the crystal pickup in my record changer with a magnetic one. I made no other changes. I have my record changer plugged into the 'phono' input on my TV set which is the way I've been playing records up to now. With the magnetic cartridge, the sound is much lower than with the crystal—but by turning up the volume control, I can still hear my records, and somehow, they sound 'cleaner.' Now, does this prove anything about magnetic pickups? I mean, if the volume output of the TV set were stronger, wouldn't the magnetic pickup work without this involvement in pre-amplifiers, etc?"

Ralph Miller
New London, Conn.

Sorry, but the magnetic pickup does require preamplification and equalization before the ordinary amplifier stage in order to operate correctly. The output of a magnetic pickup is so weak that it takes a lot more than "increasing the volume output" of your TV set to hear it properly. The reason you hear anything at all without using

H I F I  **CABINART** **CABINET**

KITS

are acoustically engineered. Assembly and finish are up to you! Precision-cut white pine and birch key together perfectly. Assembled by anyone with only a screwdriver.

MODEL 80

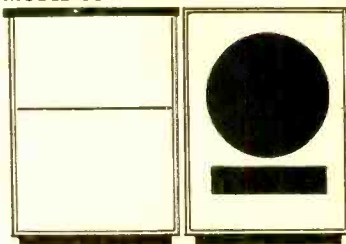

Model 80 has lift lid, removable panels. Bass reflex tuned for 12" or 15" speakers. Overall dimensions: 33 1/2" H, 23" W, 16" D. M80 tuner section, inside: 20" H, 21 3/4" W, 15 1/2" D. M8112, M8115 baffle volume: 6 cubic feet.

M80 equipment cabinet kit \$27.00
 M8112 12" speaker cabinet kit 18.00
 M8115 15" speaker cabinet kit 18.00



MODEL 61

corner folded horn

19.95

..... **FEATURING:**

A KLIPSCH

Rebel *

KIT

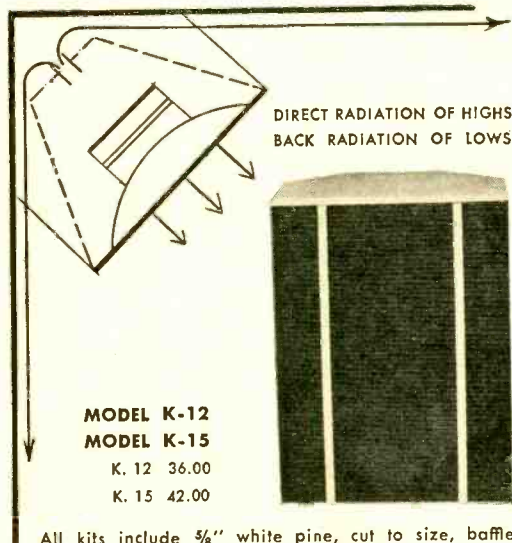

MODEL K-12
MODEL K-15
 K. 12 36.00
 K. 15 42.00

All kits include 5/8" white pine, cut to size, baffle pre-cut for 12" or 15" speaker, Saran plastic acoustict cloth, Kimsul acoustic insulation, assembly and finishing instructions, hardware, plastic wood, sandpaper and glue. Write for complete catalogs and nearest Cabinart kit dealer.

all prices slightly higher west and south

* Trade Mark

REBEL enclosure development entails a cavity and slot port, to form a resonant chamber, and a horn coupled to the slot. The slot is loaded by the horn; the proportioning of slot, cavity and horn provide bass response below 100 cycles which corresponds in efficiency to the front-of-cone direct radiator response above this critical 100-cycle point. There are two ways one might consider the function of this horn. One is a bass reflex with a horn acting as a resistive load on the port. System resonances are damped by useful radiation resistance while the horn does not cost anything. It is already formed by the room corner. Again, if a full horn were added below the 100-cycle point bass response would be boomy and unnatural. But, in the Rebel enclosures, the cavity-port combination acts as an acoustic low pass filter. And its design is such that low-end response will compare with response higher in the sound scale.

CABINETS



BY CABINART

75 North 11th Street
 Brooklyn, N. Y.

a preamplifier is that your volume is probably turned all the way up.

We have fooled around with set-ups like this ourselves to determine just what would happen. The "clean" response you seem to be getting is actually due to the fact that it is so limited a response. In the first place, the output of any pickup unit tends to fall off at the high and low ends of the frequency band; in other words, it is strongest or "loudest" in the mid-range of the audio spectrum. A properly equalized preamplifier compensates for this and tends to provide a somewhat uniform response over the entire audio band. Secondly, the amplifier section of your TV set is probably limiting the frequency response of whatever does get to it. The net result is that you won't hear any surface noise or rumble, etc., but you actually aren't hearing much music either, probably no more than a few octaves around the middle of the audio band—and straining your ears at that. So, if you can obtain the proper type preamplifier for your magnetic pickup, the resultant output will be worth the added cost.

★ ★ ★

ARMS FOR RECORD PLAYER

"COULD you supply some details about the tone-arm to be used on the phonograph described in the article 'Build Your Own Record Player' on pages 37 through 39 of the December issue?"

Charles Linz
New Paltz, N. Y.

Sorry we neglected to include these details in the original article, but thanks for calling our attention to it. There are several usable arms on the market, and if you are not near a parts jobber, a glance through a jobber's catalogue will bring you up to date on this point. Some arms come equipped with a crystal pickup, such as the Shure Model 92H, designed for 78 rpm records. Others come without any cartridge but will accept many standard pickups, such as the Electro-Voice Model 2300. The Astatic Model 8D arm includes a dual-needle cartridge for playing either 78 rpm

records or microgroove (45 and 33 rpm) records.

★ ★ ★

SOLDERING PHONO LEADS

"THE other evening I dropped in on a friend who was soldering the tiny leads in the tone arm of his phono record player that connect to the pickup cartridge. He was doing this with the cartridge connected to the sleeves that were being soldered to the leads—in other words, applying heat directly to the cartridge. I nearly flipped when I saw this but he calmly ignored my protests, saying that the heat would not affect the cartridge since it was a magnetic, not a crystal, pickup. I argued the point but he laughed at my concern. Now, who was right?"

H. T.
Brooklyn, N. Y.

This is a case of both being partly right and both being partly wrong. Actually, without knowing more details on how your friend was going about his task, it would be impossible to say whether his laughter was justified or whether the laugh was unfortunately on him. Generally speaking, the heat from a soldering iron should not affect a magnetic pickup, as it would a crystal unit. However, it is always best to play safe, particularly with units as sensitive and delicate as magnetic pickups. In this case, a good soldering procedure would be: first, remove the slip-on clips from the pickup unit; and second, solder them to the leads using a small soldering iron. If you don't want to bother removing the clips first, it is probably safe to solder with them connected to the magnetic pickup, provided you hold the clip with a long-nose pliers inserted between the soldering point and the pickup unit. The metal of the pliers will then tend to dissipate the soldering heat and prevent any possible damage to the pickup. Again, a small soldering iron should be used rather than a heavy one or a gun. And in the case of crystal units, the slip-on clips must be removed prior to soldering, as described on page 67 of the November 1954 issue of POPULAR ELECTRONICS. END

ATTENTION

- Hobbyists
- Club Members
- Study Groups

Subscriptions to POPULAR ELECTRONICS at special bulk rates are available to club members, study groups, employee groups, schools, etc.

For information, write to:

POPULAR ELECTRONICS

Dept. 1016

366 Madison Ave.

New York 17, N. Y.

The data that launched thousands of careers and advanced hundreds of amateurs is yours . . . **FREE**

REVEALS HOW YOU CAN GAIN QUICKER SUCCESS OR TURN YOUR HOBBY INTO A WELL-PAID CAREER IN RADIO . . . TELEVISION . . . ELECTRONICS

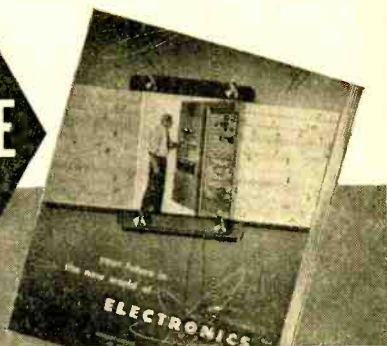

INTERESTED IN GREATER CAREER SUCCESS?

You may plod along for years, get a paltry increase occasionally, feel insecure, find your work dull. Then—something happens. Earnings rise. Self-confidence returns. Your job becomes exciting. "Luck" or "Contacts," some may say. But you will know the answer: **TRAINING!** And it all can start happening for you the moment you fill out the coupon requesting your copy of the free booklet, "Your Future in the New World of Electronics." It reveals how you can gain career success in the booming electronics field. It helps you determine just how you fit in, how you can cash in.

The electronics industries are pleading for well-trained men. The industry is expanding tremendously. Technicians are needed in city after city, coast to coast. And no wonder. By 1960 the electronics industries will do no less than \$10,000,000,000 per year, *not counting* military orders. Today electronics plays a vital role in countless industries and businesses. Think of the opportunities in television, for example, in the manufacturing, broadcasting and servicing fields alone. There are 33,312,714 TV sets; 411 TV stations in operation; color TV means virtual replacement of or extensive additions to existing sending and receiving facilities. Countless positions need filling—with **TRAINED** men—with electronics engineering technicians who at some point took time to gain new knowledge to improve their skills. This need is felt all along the long line of businesses in which electronics plays so important a part.

CREI has been one of the country's leading technical institutes since 1927. Over the years, thousands of CREI graduates have been employed in industry here and abroad. During World War II, CREI trained additional thousands for the Armed Forces. Today, many leading firms enroll employees with CREI for company-paid group training. Among them: United Air Lines, Canadian Broadcasting Corporation, Bendix Products Division, All-American Cables and Radio, Inc. Thou-

WANT TO CHANGE YOUR HOBBY FOR A CAREER?

Today, thousands of electronics hobbyists have a chance to turn fun into profits. Many are now employed in jobs outside of the electronics industries, doing something they enjoy far less than experimenting, building, transmitting, receiving. They often are working for wages far lower than those received by well-paid electronics engineering technicians. They face job futures not nearly so bright. And many of these men can turn the experience they've gained in hobbies into the job qualifications demanded in the electronics industry. Most need additional training, true. Many have turned to CREI for that training. They have acquired the knowledge needed to qualify as well-paid engineering technicians through CREI home study in their spare time (the same hours once used to hobby for fun), without giving up their old jobs until ready for the new. So, without loss of income, by studying electronics which may already be your "true love," at home and at the pace you set, you too can turn a hobby into a well-paid career with a bright future. You start to accomplish this by filling out the coupon below.

sands of individual students are now enrolled. CREI home study courses are prepared and administered by recognized authorities in electronics education. You receive personal supervision, study when convenient. There is no finer, more practical way to earn success in the electronics field. Decide *now* that *you* want that success. Fill out the coupon below and mail immediately. Your free booklet will be in the return mail, revealing "Your Future in the New World of Electronics."

MAIL THIS COUPON . . . TODAY!

CAPITOL RADIO ENGINEERING INSTITUTE

Accredited Technical Institute Curricula • Founded in 1927
3224 16th STREET, N.W. DEPT. 122 B, WASHINGTON 10, D. C.

Please send me your course outline and FREE Illustrated Booklet "Your Future in the New World of Electronics" . . . describing opportunities and CREI home study courses in Practical Electronics Engineering.

- | | | |
|----------|---|---|
| CHECK | } | <input type="checkbox"/> Practical Radio Engineering |
| FIELD OF | | <input type="checkbox"/> Broadcast Radio Engineering (AM, FM, TV) |
| GREATEST | | <input type="checkbox"/> Practical Television Engineering |
| INTEREST | | <input type="checkbox"/> Aeronautical Electronics Engineering |
| | | <input type="checkbox"/> TV, FM & Advanced AM Servicing |

NAME _____
 STREET _____
 CITY _____ Zone _____ State _____
 CHECK: Residence School Veteran



IF YOU CAN COME TO WASHINGTON . . .

CREI also offers resident instruction at the same high technical level, day or night, in Washington, D. C. Classes start frequently. If this type of instruction meets your requirements, check the coupon for Residence School catalogue. Qualified residence graduates earn the degree, Associate in Applied Science.

INFORMATION FOR VETERANS

If you were discharged after June 27, 1950, let the new GI Bill of Rights help you obtain resident instruction. Check coupon for full information.

How a Capacitor Works

(Continued from December Issue)

Now let's take the case of coupling capacitors or "blocking" capacitors. Here we have two electric circuits which are usually at different d-c potentials, and we must pass an a-c voltage from one circuit to the other through the capacitor. It is important that there be no passage of d-c through the capacitor as, for example, from the plate circuit of one tube to the grid circuit of another tube, lest the transfer of voltage cause the lower potential circuit to malfunction or become inoperative. This is the case in an audio amplifier when a leaky coupling capacitor causes a positive voltage to appear on the control grid with resultant "mushiness" and distortion.

Going back to the crock in our analogy—if the crock were filled and the spigot shut off, but continued to drip water, we would have the same condition as a "leaky" capacitor. In the case of an electrostatic capacitor, such as a paper, mica, or ceramic, this leakage current is usually a few microamperes. This current varies greatly with temperature in the dielectric material as we will show later in this series. It is not too greatly affected by the voltage applied.

In the case of electrolytic capacitors, the leakage current is of a relatively larger order of magnitude and may be several milliamperes. Here, too, the leakage current varies with temperature. Moreover, it is much more affected by the voltage applied to the capacitor.

Returning to our tea crock, this would mean that the higher the water level, and thus the pressure on the leaky spigot, the greater the leakage.

Once the rated voltage of an electrolytic capacitor is exceeded, the leakage current rises very rapidly causing internal heating. By over-volting an electrolytic capacitor it is possible to create a runaway condition, in which the self-heating causes the leakage current to increase to such a point that the very thin dielectric will rupture. In terms of our analogy, this would be the case if the vessel cracked permitting water to run out as fast as it runs in. This corresponds, of course, to a short circuit in the capacitor.

—To be continued—

This informative message is No. 3 of a Series contributed by Sprague, the world's largest manufacturer of capacitors. Write Sprague Products Co., N. Adams, Mass., for complete Sprague catalog.

A Simple Radio-Controlled Garage Door



By VERN PRESTON

Open and close your garage door from your auto with the easy-to-build equipment described in this article.

ALMOST every home-built garage door opener seen by the author has been a mass of cables, pulleys, levers, and special expensive motors. In the unit described in this article, any motor from 1/5 to 1 horsepower can be used with a gear box. A large crank is attached to the gear box and this crank travels in a complete circle. Now, if one end of a long rod is hooked to the top of the garage door, and the other end to the crank on the gear box and the motor is started, the crank will turn and the rod attached to the top of the door will either pull up the door or push it closed. The motor does not have to reverse to close the garage door.

The gear box is no problem because any gear reduction of about 80 to 1 will do a

fine job. The author used an army surplus job which was obtained for about \$5.00. If you cannot obtain such a gear box inexpensively, you can of course devise a usable system employing pulleys such as are found in hoist systems. The receiver and transmitter described here can of course also be used with commercial electric garage door openers.

Keep in mind that the door should open and close at a moderate speed. After selecting a gear box, have a 7" piece of 3/4" pipe (no smaller) welded into the gear box. Thread the other end and attach a 3/4" "L"; screw a 4-foot length of 3/4" pipe into the "L." This is the crank mentioned previously.

After the gear box and arm are assem-

The 80 to 1 gear reduction box used by the author. Cutting along the line indicated exposes 1/4" shaft for the large belt-driven wheel.

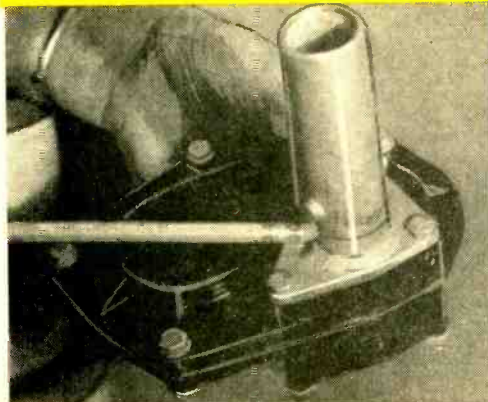

A short piece of pipe is welded onto the bottom or output shaft of the gear box and becomes part of the revolving crank as shown.

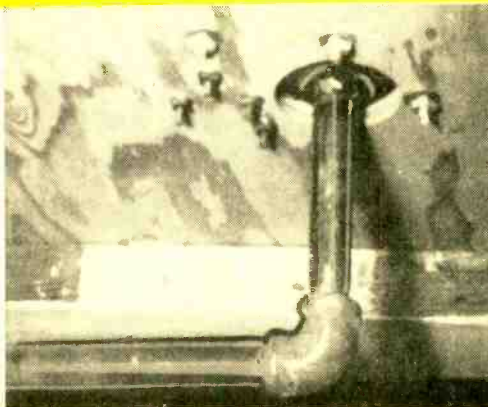

Bottom view of the motor and gear box mounting showing the crank and pipe to the garage door in the closed position. Note microswitches.

Motor and gear box mounting showing the loose belt recommended for the drive wheel.

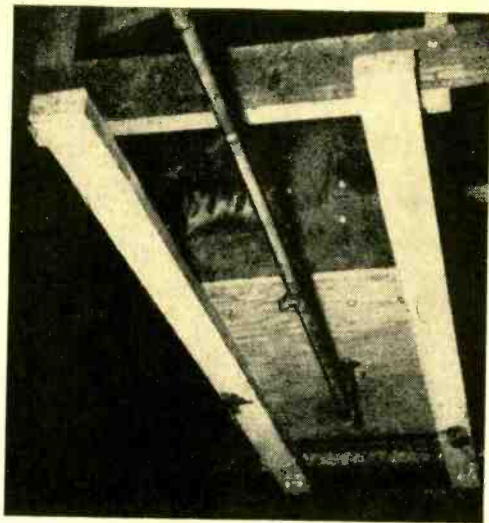
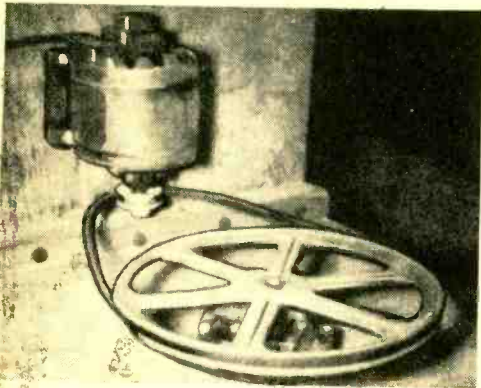

bled, mount the gear box on a piece of 5-ply plywood, 28 inches wide and 36 inches long. Cut a hole in the center of the plywood and bolt the gear box into position. Bolt a 2 x 4 along one end of the plywood, and add another piece of plywood in an upright position to the 2 x 4. This is the base for the motor.

Mount a small pulley (about 1½" diameter) on the motor and about a 10" pulley on the gear-box shaft. Run a loose belt from one pulley to the other, not so loose that it will come off, but loose enough that it can slip if anything should get in the way of the door's travel.

If the belt slips after it is assembled and the door has to be rebalanced, *be sure that you never remove the balance springs with the door open.*

If the garage has stringers or rafters, mount a couple of 2 x 4's between two of them to support the gear box and the motor. Don't bolt the unit into position until you cut the long 1" pipe that connects to the top center of the garage-door frame to open and close the door.

To get the approximate length of this rod, turn the gear-box arm to the open position, *i.e.*, pointing away from the garage door, open the door, hold the rod between the door top and the end of the crank, and mark the rod with a pencil. Then close the door and turn the crank to the closed position; again mark the rod. Do this several times until you are sure that the length is correct.

Next, measure the travel of the door in inches. To do this, close the door and mark on the door jamb the position of the top left-hand corner of the door. Now open the door and measure the distance from the door jamb to the same top corner of the door. This is the travel of the door.

One-half of this distance, measured from the center of the crank, is the place where the push rod is bolted onto the crank.

Drill a ¼" hole in both the push rod and the gear-box crank. Mount the two together using washers and lock nuts. These rods should move freely. The opposite end of the push rod is connected to the top center of the door frame using two bolt-on type screw eyes interlocked to act as a universal.

You are now ready to mount the gear-box assembly and motor. First, close the door and move the crank to the closed position. Next, connect the push rod to the door and to the gear-box crank. Temporarily, nail the gear box and motor assembly in position. Then, operate the large pulley wheel by hand to open and close the door. Do this until all adjustments are made. Finally, bolt down the gear-box and motor.

Now, the unit may be plugged into the outlet and the door will open and close, but you will have to stop the motor; that is, unless you want a flat-top car. To stop the motor automatically, a normally closed "Microswitch" is used. On the regular arm

View of the crank when the garage door is open.

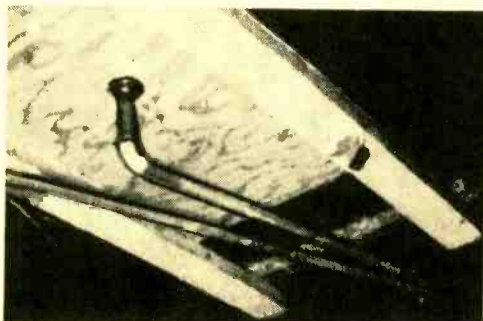

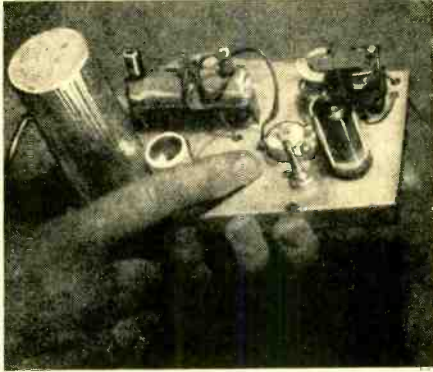

Top view of the receiver showing the arrangement of the parts and the two tuning controls.

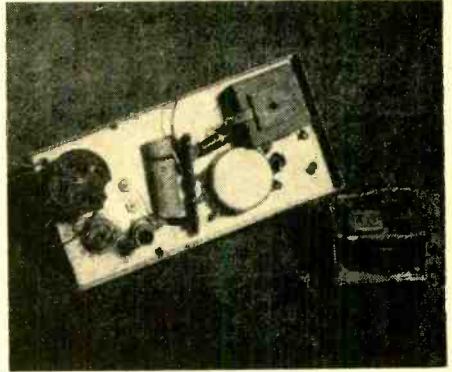

Bottom view of the receiver chassis shown partially wired to emphasize the parts layout.

- R*₁—3 megohm, ¼ w. res.
*R*₂—10 ohm, 2 w. res.
*R*₃—3500 ohm, 25 w. adjustable res.
*R*₄—25,000 ohm 2 w. wirewound pot
*C*₁—3 to 30 μfd. trimmer capacitor
*C*₂—0.02 μfd. 400 v. capacitor
*C*₃—100 μfd. 400 v. capacitor
*C*₄—0.03 μfd., 400 v. capacitor
*C*₅—0.1 μfd. 600 v. capacitor
*C*₆—100 μfd. 300 v. elec. capacitor
*C*₇—10 μfd., 25 v. elec. capacitor
*L*₁—17 t. #24 en., tapped 7 t. from the bottom; wound on ½", slug-tuned coil form (National #380 or equiv.)
*T*₁—National OSR oscillator coil or equiv.
*RFC*₁—150 mc. r.f. choke (#22 en. closewound on full length of 1 megohm, ¼ w. res.)
*RL*₁—S.p.d.t. 8000 to 15,000 ohm relay (Sigma 4F or equiv.)
*SR*₁—Selenium rectifier, 150 ma.
*V*₁—1S4 tube

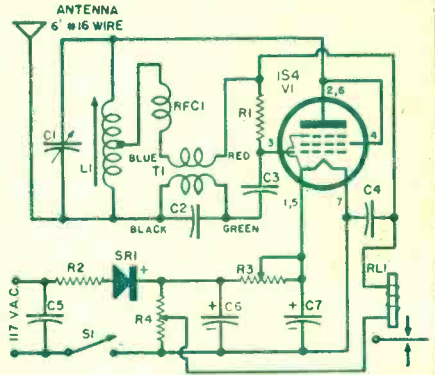

Receiver schematic and pictorial diagrams with complete list of parts required.

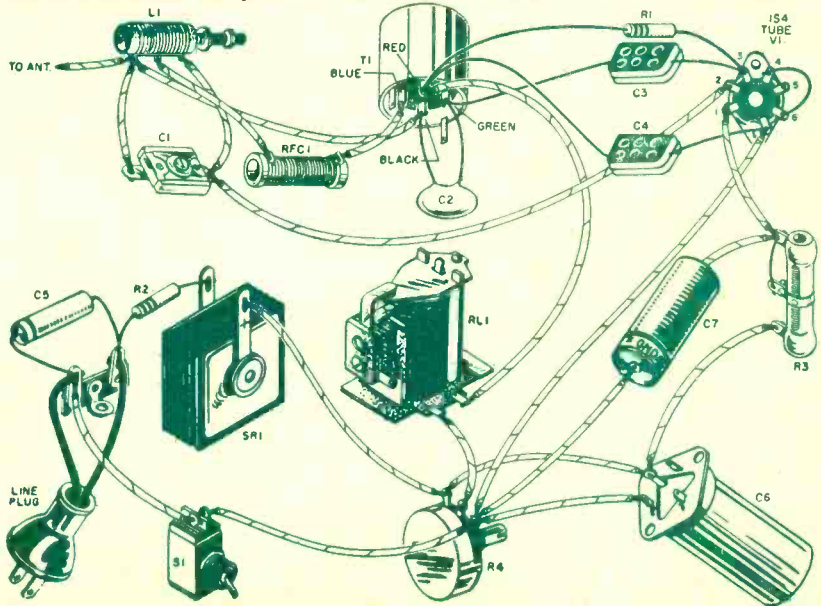

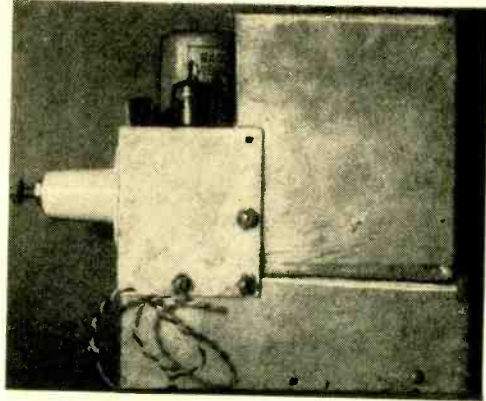
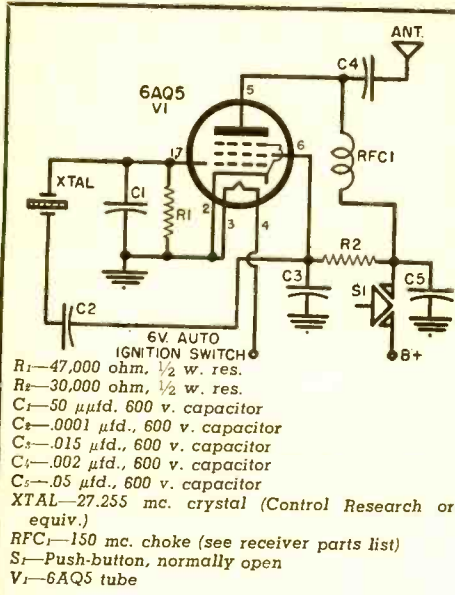

On the left is the schematic diagram of the transmitter and its parts list. Above is a view of the transmitter constructed by the author and added onto his regular auto radio power supply chassis; note the subchassis.

of the switch, solder an extension arm made of brass or tin. The rotating crank of the gear-box strikes this arm and opens the circuit, shutting off the motor.

To find the proper place to mount the "Microswitch," start the motor so that it begins to open the garage door. Shut it off just before the door has fully opened. The door will coast open. Mount the switch where the crank will hit it and stop the motor so that the door will coast completely open. Do the same for the door-closing "Microswitch." Wire up the "Microswitch" circuit as shown in the diagram.

As an added feature, you can turn the lights off in the garage by adding an interlock switch on the door jamb. Add a small lever to the top corner of the door which will strike the switch as the door is closed.

Radio Equipment

A hard-tube receiver is used because it yields longer life. The life of a gas tube is about 300 hours; that is, if it is not overloaded.

To build the receiver, first lay out and mount the parts on a 3" x 5" chassis. Try to keep the power-supply parts on one end of the chassis and the actual receiver circuit on the other end. Check all wiring at least twice before any voltage is applied.

After the receiver is wired, place a voltmeter across pins 1 and 7 of the 1S4 tube socket. Adjust R_2 to 1 volt. If you don't have a meter that will check 1 volt, temporarily connect a 1.5-volt flashlight bulb across tube socket pins 1 and 7. Adjust R_2 so the bulb just lights and that's all. Disconnect the bulb before you place the

tube in the socket. Turn R_2 counter-clockwise (minimum). Place the tube in the socket and readjust R_2 to 1.5 volts.

With the tube in the socket, adjust R_1 until you hear the plate relay pull in. (It will click.) Then turn the control counter-clockwise just past the point where the relay opens. The receiver is now ready to operate.

C_1 and L_1 will be adjusted after you complete the transmitter. These receivers are quite stable and, after they are once ad-

Wiring diagram for the motor, microswitch, and 6-volt relay circuit. Its function is to stop the motor automatically before the garage door is completely opened or closed.

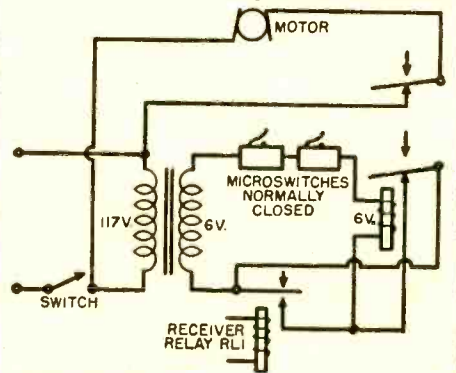

- 1—6 volt d.p.d.t. relay
- 1—6 volt transformer (Stancor PS-8416 or equiv.)
- 1—toggle switch
- 1—line plug, line cord
- 1—1/5th to 1 horsepower motor
- 1—gear box with an 80 to 1 reduction ratio
- 2—snap-action switches ("Microswitches")
- Miscellaneous lengths of $\frac{3}{4}$ " pipe

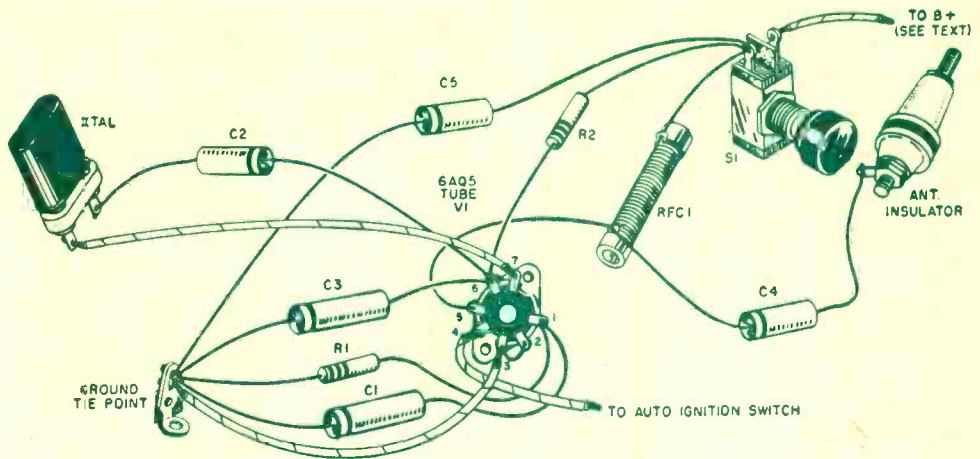

Pictorial diagram of the radio-controlled garage door transmitter.

justed, they will probably need no other adjustments.

Note that although the transmitter is crystal controlled, it uses no tank coil. This is designed to keep the signal at a minimum. It will still operate the receiver at a distance of about 100 feet or more on the 27.255-mc. Citizens band.

The "B+" voltage needed to operate the transmitter is obtained from the car radio. The easiest way to do this is to remove the audio tube of the car radio from its socket. On older sets this will probably be a 6K6; most newer sets use a 6AQ5 or a 12AQ5. If your set uses a 6K6, insert the lead from the push-button on the transmitter into hole 4 on the socket, counting counterclockwise from the key on the top of the socket. Remove only about 1/4 inch of insulation from the end of the wire before inserting it. Then replace the tube. If the set uses a 6AQ5 or 12AQ5, you will have to use a small lug which will fit onto pin 6 of the tube. You can make such a lug by drilling a small hole for the tube pin in a small rectangular piece of brass or copper. Affix the "B+" lead of the transmitter to this lug. Be certain to use insulating tape on the lug to keep it from shorting to the chassis. Slip the lug on to pin 6 and re-insert the tube into its socket.

The heater of the transmitter tube is on all the time that the key is turned on in the car, since the heater voltage is obtained from the ignition switch. The "B+" is keyed through a push-button on the dash of the car.

To use this transmitter, you will have to write to the Federal Communications

Commission, Washington 25, D. C., and ask for Form #505. Fill it out and return it to them. No test is required.

Any auto-radio antenna will do. Be sure that it is well insulated from the frame or body of the car.

Don't install the transmitter in the car until you try it first on the bench with the receiver. Place the units about 6 or 8 feet away from each other, then turn on the receiver and wait for about 30 seconds. Turn on the transmitter and the relay should close. If it does not, rotate C1 and the slug in L1 in the receiver until you can close the relay every time you key the "B+" voltage on the transmitter. Now move the transmitter farther away and retune the receiver so that it will operate reliably at a normal car-to-garage distance. That's all there is to it. END

Motor-gear mechanism and rotating arm. Note the extension on the "Microswitch."



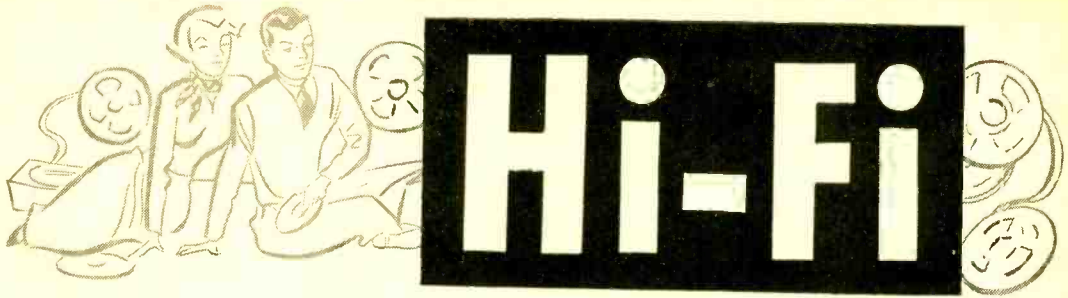

By L. E. JOHNSTON

There are many interesting side issues when it comes to high fidelity—do not let your neighbor confuse you.

THE other evening, the wife and I dropped over to a friend's house to see the Hi-Fi rig he'd been bragging about for several weeks. And what an outfit it turned out to be; the amplifier was a beauty, the turntable was a dream of precision, and the loudspeaker system darned near took up one whole corner of the room. It looked like a million bucks.

"But wait'll you hear it," my chum said, as he started to fish through a stack of records. "Ah, here's the one I want." And with a flourish, he put it on the machine, gently lowered the tone arm into position, twirled a few dials, and turned to us with a look of pure rapture.

Well, I never heard the likes of it! From reading the label afterward, it seems that this particular disc was first taped on the banks of the Hudson River as The New York Central's Twentieth Century Limited went by on the main line. And talk about fidelity; I almost dove under the sofa, it sounded so real!

As the evening wore on, we heard others too: one of a rusty hinge with a truly superb squeak; another of the call of a bull moose, complete with treble and bass, at Glacier National Park; and finally, some excellent music over pie and coffee. All in all, it was very interesting.

But on the way home, I found out that my good spouse thought differently. "The music was fine," she said, "but those noises were terrible. What in the world was he trying to prove? Sarah's husband, Sam, is the same way; he keeps playing the first few bars of Stravinsky's *Firebird Suite* over and over again, just to hear the sound of the chime. If that's what Hi-Fi means, you screwbirds can have it, but keep it out of the living room!"

Well, I didn't think much more about it until the next day when some of the boys

at the office took up the same chorus. Their ideas about Hi-Fi were equally confused; one thought he had it in his new \$19.95 table radio because the instruction book said so, and another agreed with my wife almost verbatim. None of that racket for him.

I did find a soulmate, though, in the new man from across town. "You know," he said, "I've become interested in this thing too. I like music and would like to know more about Hi-Fi, but I'm so confused by guys like your friend, and all the ads in the magazines, that I'm not even sure what it means."

He had a point too, and at the expense of my bread and butter, I kicked the whole problem around in my mind for most of that day. I mentally examined Hi-Fi from all the angles I could think of—the technician's idea of it, the advertising man's approach to it, the salesman's pitch, the artist's view, the stand taken by the record companies, and finally the interest of the buying public. Once this was done, the pieces of the puzzle seemed to fall into place—and the picture made sense.

When you think about it, the interests don't really conflict; they supplement each other. Sound technicians, for example, are basically interested in reproduction as a science. Perhaps they like music or perhaps they don't, but either way, it's a sure bet that they are interested in developing machines that will reproduce it as it was originally played. Their ultimate goal is to bring all of the rich tones and the full depth of a symphonic performance into your living room without change or distortion. It's their job.

The odd noises you hear played in the labs and on experimental sets, the deep rumbles and the high frequency squeaks, are intended to be used for testing only.

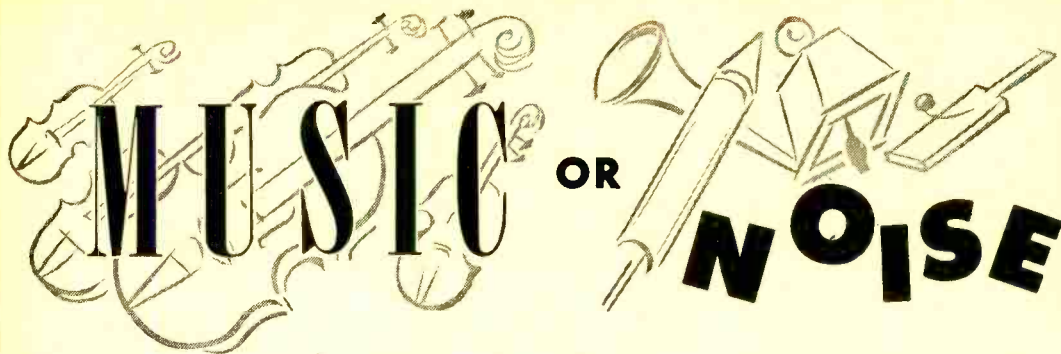

MUSIC OR NOISE

The engineer or the home experimenter figures that if he can design a system which will accurately reproduce both of these extremes of tone, then chances are that it will do the job asked of it on the music too. These people aren't "sound-happy"; they're just using the tools of their trade.

However, most of us would rather hear music, and consequently prefer to judge Hi-Fi for the music-handling ability alone. This is our standard: "Fie on the hoots and hollers, we want to play Brahms or Benny Goodman." And that's OK too! In fact, most sound engineers who have given the public's confusion about Hi-Fi any thought at all, wish we'd forget about everything else but the music. They're the ones who will play Tchaikovsky for you—even in the lab—and they're the first to tell you to forget the experimental activities and enjoy your favorite records. There should be more of this kind!

The record companies have a pretty mature approach to the problem, but even they tend to add some confusion to the issue. For example, not long ago I wandered into my favorite record shop and the girl behind the counter almost broke her neck waving me over to the Hi-Fi booth in the back. With great to-do, she said, "I've been waiting all week to play this record for you; with your interest in Hi-Fi, you should go for it in a big way." The record, for all this enthusiasm, wasn't the music you'd expect, but the words, *Especially Recommended for Hi-Fi Fans*, appeared under the title on the record jacket.

As it turned out, I didn't buy the record, but I did give it some thought later. Those words could communicate at least two ideas to the reader. They could say: "Here's a record with some music on it, but more important, just wait till you hear the way it's put there. Come all you Hi-Fi fans, crank up the gain and give a listen to this one."

Or, to give the author and the record company the benefit of the doubt, it could be taken to say: *Here's a record of some*

excellent music—played and recorded in such a way that you folks with Hi-Fi outfits will appreciate it. In fact, that's probably the way it was intended, but, nevertheless, the first confusing impression was too easy to get. Let's hope that this statement gets reworded.

Then, last but not least, come the hucksters—the people who write ads and compose sales talks. To some few of them, and thank God there are only a few, all of this honest confusion is a golden opportunity. It means that they can use the public's acceptance of the Hi-Fi idea and apply it to any old piece of junk that makes noise. These are the characters who label the \$19.95 AM table radio a *high fidelity model* in hopes that the magic words will sell a few of them to an unsuspecting public. These are the confusion mongers who make the most of a good name at the expense of everyone else.

Phooey!

But in the final analysis, all of this boils down to one thought: Hi-Fi should be judged only as it affects the individual judging it. If you are a scientist, you'll probably want to hear the creaks and groans. If your interest is in music, you'll want to hear a good record and compare it to the same performance "in the flesh" or on the old console. Or if you have dual interests, perhaps you'll want to hear both. But in any case, don't let the other fellow's point of view and interests confuse you. Take it as you will use it, and forget the rest.

Hi-Fi is wonderful anyway, regardless of your tastes—mechanics or music. Once you've heard it, you're a goner for sure, and it's only a matter of time until electronics catalogues will take their place on the living room table along with the funny papers.

If you don't believe it, just ask me! I can be found most any time down in the local record store, or down in my basement wiring up the new amplifier kit that just arrived—while listening to the old one at the same time. END

How Magnetic Tape is Made

THE public's enthusiastic and ready acceptance of tape recording has rather overshadowed the "miraculous" quality of this new medium. We all, more or less, take our tape machines and recording tape for granted.

A lot of time, money, research, and engineering ingenuity goes into each reel of tape you so casually purchase over the counter. As an example of the painstaking care lavished on this product, the manufacturing operation of *ORRadio Industries Inc.* is pictured on these pages. This firm, which makes the "Irish" brand magnetic tape line, is primarily a tape maker so its operation will be described.

Research and development play an important part in the operations of most electronic firms and the tape industry is no exception. Continuing efforts are made to improve the product and one such operation is the experimental formulation for dispersion in a laboratory scale grinding mill.

When the laboratory has OKed a new formula or procedure, the technique is incorporated in the manufacturing process. Mass production of the magnetic coating lacquer is accomplished by huge grinding mills which are capable of delivering 500 gallons of coating. A slow and continuous grinding results in a uniform dispersion of the iron oxide particles in the lacquer type

Huge batches of the magnetic coating lacquer are mixed in 500 gallon mills like this one.



A laboratory technician prepares an experimental formulation in a laboratory grinding mill.

base. Special wetting agents and highly effective lubricants are incorporated during the grinding process.

The precision coating of the magnetic lacquer on the plastic film is the most delicate operation in the manufacture of magnetic tape. The coating machinery required for this operation is manufactured to watchmaker tolerances. The company's tape is coated to a tolerance of a half of 1/10,000 of an inch since a variation of less than 1/10,000 of an inch in thickness may vary the amplitude of the audio output as much as one decibel.

The next step in the operation is the production of 1/4" tapes from coated rolls. This is done by the slitter operator who cuts the 12" coated rolls into 1/4" tapes and winds it on 1200 foot reels, the standard 7" reel of the industry.

After the tape is wound on the reels, it is subjected to a thorough audio analysis. Professional recording and test equipment is used for this operation. The tape is tested for frequency response, amplitude variation, signal output, and noise level.

The final step in the manufacturing process before shipment to distributors is the careful visual inspection of the tape. This inspection is made under fluorescent lighting with the operator checking for inconsistencies in the winding and slitting of the tape and for fractures and molding imperfections in the reel.

The next time you casually pop a reel of tape on your recorder, stop just a second and consider the "little miracle" you hold in your hand. END

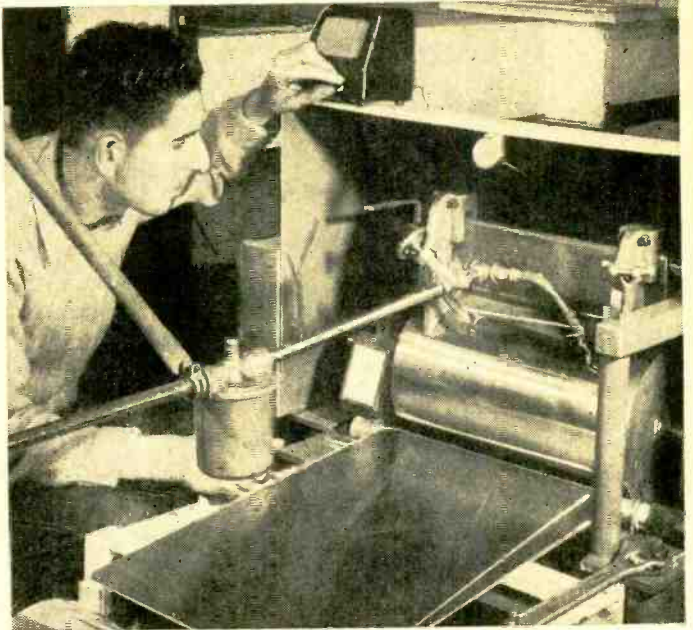
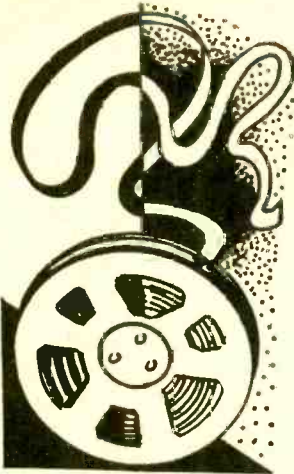

The tape coating operation is extremely critical. It is performed on precision machines.



Producing $\frac{1}{4}$ " tapes from the large coated rolls is a responsibility of slitter operator.

A thorough audio analysis is made on each production run of the tape made by factory.

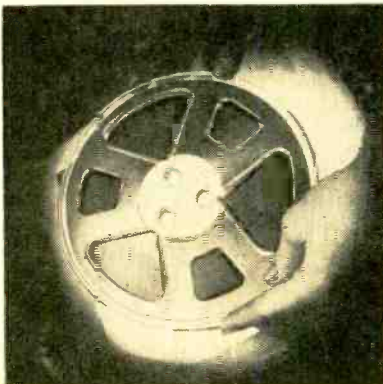

The final visual inspection of the tape is made by skilled operators who use fluorescent lighting boxes.

The novice cw transmitter with the crystal and coil for 80 meters plugged in. It is ready to go when the antenna is connected.

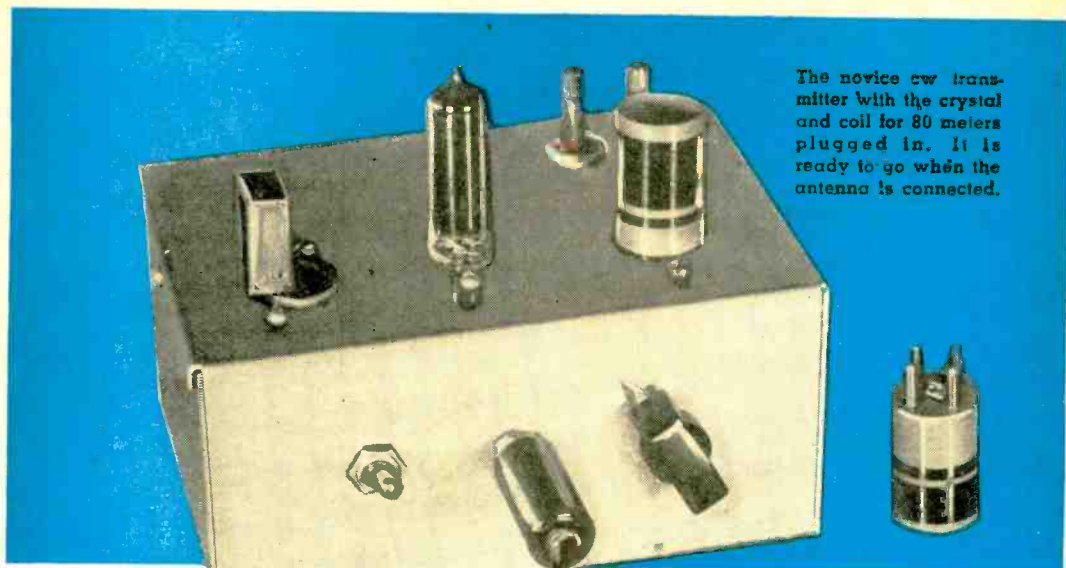

Build



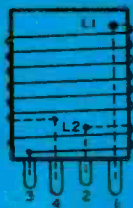

BOTTOM VIEW OF
COIL FORM

COIL TABLE

- 80 meters: L_1 —28 turns No. 22 enameled wire close-wound on 1-inch diameter 4-pin form
 L_2 —5 turns No. 22 enameled wire closewound $\frac{1}{8}$ inch from ground end of L_1
 40 meters: L_1 —15 turns No. 22 enameled wire close-wound on 1-inch diameter 4-pin form
 L_2 —4 turns No. 22 enameled wire closewound $\frac{3}{16}$ inch from ground end of L_1

Use any conventional 4-pin, 1" dia. form. Winding spacing is measured between lower edge of L_1 and upper edge of L_2 .

Before winding the coils, drill holes through form to pass ends of windings. Space holes to allow for width of each winding and distance between windings.

Remove enamel for about half an inch from end of wire. Pass wire through proper hole in side of form and corresponding base

pin. Solder wire to pin. Wind required number of turns around form, keeping wire taut and leaving no space between turns. Cut off wire, leaving a few inches to work with. Pass end through proper hole in form. Remove enamel from end of wire and pass it through pin in base. Carefully pull wire taut, then solder end of wire to pin. Use coil cement over windings to prevent loosening.

Note that two different coils must be built to cover both the 40 and 80 meter bands.

this Novice CW Transmitter

By RUFUS P. TURNER

THE beginner in ham radio with a novice license should become active as quickly as possible with a low-powered telegraph (cw) transmitter. Operating this rig as often as he can will give valuable on-the-air experience in handling the code and in correct operating procedure. The best way to learn is by doing.

A novice's first transmitter should be both simple and inexpensive. A good idea is to use the lower frequency bands. There, the new operator usually will find more "rag-chewers" and local contacts than on the higher frequency long-distance bands. In the 80-meter band, novice cw operation is permitted between 3700 and 3750 kc. In the 40-meter band, the novice's territory is 7175 to 7200 kc. Crystal control *must* be used.

The transmitter shown here was made especially for beginners. While it is low-powered, it will give a good account of itself when operated with a good antenna. It does not take up much room, since it is built on an aluminum radio chassis box (Bender Type 145) 7" long, 5" wide, and 3" high.

To reduce expense and to keep hum-producing power equipment off the trans-

mitter chassis, no power supply is built into the transmitter. This allows the experimenter to use any external unit supplying 250 volts d.c. at 50 to 65 ma. and 6.3 volts a.c. or d.c. at 1 ampere. Most experimenters keep a small power supply of this type on hand for general use. Such units also can be bought cheaply in surplus. The necessary a.c. and d.c. voltages often can be drawn from the receiver used with the transmitter. For portable use, a 6-volt storage battery can be used in conjunction with 180 to 225 volts of "B" batteries or a vibrator-type 250-volt supply.

Transmitter Circuit

The schematic diagram shows the circuit of the transmitter. A 6AQ5 tube (V_1) is used in a crystal oscillator circuit. This particular circuit keys quite well.

A shunt-fed plate circuit is employed. That is, the output (tank) circuit, consisting of coil L_1 and tuning capacitor C_1 , is isolated from the d.c. plate voltage of the tube by capacitor C_2 . This arrangement keeps d.c. voltage off the coil and protects the operator from electric shock. Nevertheless, switch S_1 should be thrown to its "off" position before changing coils, since

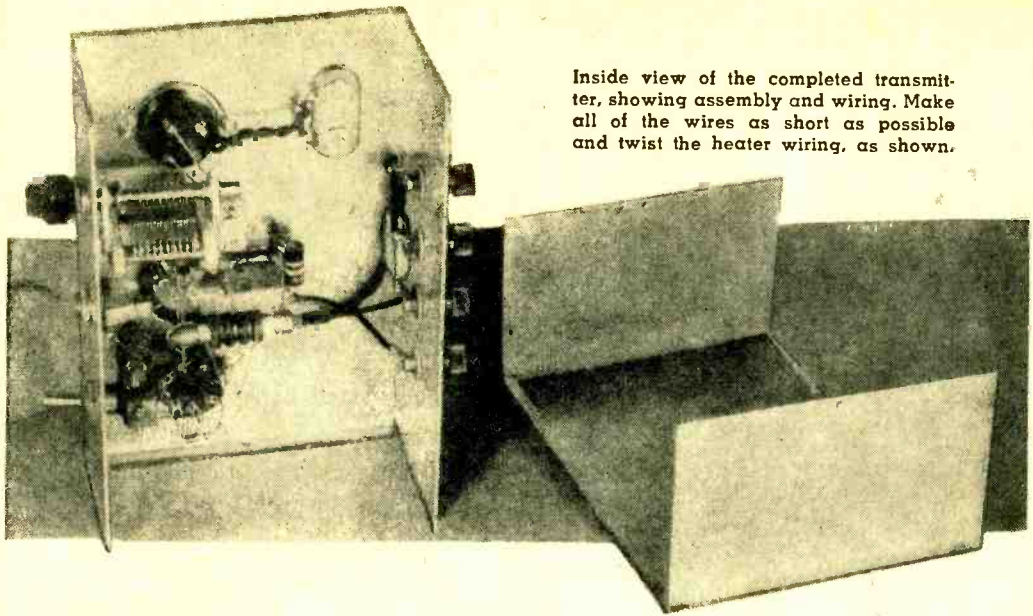

Inside view of the completed transmitter, showing assembly and wiring. Make all of the wires as short as possible and twist the heater wiring, as shown.

the r.f. voltage may burn the fingers quite painfully just the same.

The key is plugged into jack J_1 . The two "Antenna" binding post terminals are connected to the antenna.

Construction

An 8-pin octal tube socket is mounted on the left end of the chassis to hold the crystal. Socket pins 1 and 4 receive the pins of the crystal holder, while other pins of this socket are used as tie points for resistor R_1 , capacitors C_1 and C_2 , and leads. A $1\frac{1}{8}$ " hole is needed for the crystal socket.

A 7-pin miniature tube socket for V_1 is mounted in a $\frac{5}{8}$ "-diameter hole near the center. At the right-hand end of the chassis, a 4-pin tube socket is mounted in a $1\frac{1}{8}$ " hole to hold the plug-in coil.

Directly behind this coil socket is the insulated 2-terminal binding post block for antenna connections. This block assembly is a *National* Type FWH. The insulating blocks fit into $\frac{1}{2}$ "-diameter holes drilled $\frac{3}{4}$ " apart on centers.

Switch S_1 , jack J_1 , and tuning capacitor C_7 are mounted, from left to right, without insulation, along the front lip of the chassis. The jack and tuning capacitor require $\frac{3}{8}$ " mounting holes. The toggle switch (S_1) requires a $\frac{1}{2}$ " hole. Four insulated binding posts are mounted along the rear lip of the chassis for connections to 6.3 volts and 250 volts.

The two coils are wound on conventional 1"-diameter, 4-pin, phenolic plug-in forms. The accompanying coil table gives instructions for winding these coils. Each

consists of a main coil L_1 and a coupling coil L_2 . The ends of L_1 are fed into the two large pins of the form and soldered. The ends of L_2 are fed into the two small pins and soldered.

For adjusting the transmitter, make a test lamp by forming a $1\frac{1}{4}$ "-diameter loop of insulated hookup wire and soldering its two ends to the terminals of a 6-volt pilot lamp.

Obtain an 80-meter crystal on any frequency between 3700 and 3750 kc. and a 40-meter crystal on any frequency between 7175 and 7200 kc. Several crystals in each frequency range will allow movement "around the band" when interference sets in.

The simplest antenna to use with this transmitter is the center-fed type (cut for 40 or 80 meters) with coaxial or low-impedance ribbon feeder. Antenna dimensions and building instructions may be found in any amateur handbook. Other types of antennas may require a coupling coil and tuning capacitor external to the transmitter.

Operating Instructions

To place the transmitter into operation: (a) Plug in an 80-meter crystal. (b) Plug in the 80-meter coil. (c) Connect the 6.3 v. and 250 v. power supply. (d) Throw the switch S_1 to "on." (e) When the tube has heated, plug the key into jack J_1 . (f) Hold the loop of the test lamp over the top of the coil. (g) Depress the key; while holding it, adjust tuning capacitor C_7 until the lamp lights. Back away with the lamp if it is burning too brightly. (h) Tune capaci-

R₁—100,000 ohm, 1/2 w. carbon res.
R₂—33,000 ohm, 2 w. carbon res.
C₁—10 μ fd. mica capacitor
C₂—150 μ fd. mica capacitor
C₃, C₄, C₅—0.05 μ fd. mica capacitor
C₆—100 μ fd. mica capacitor
C₇—140 μ fd. midget variable capacitor (Hammarlund MC-140-S)
J₁—Midget open-circuit phone jack
L₁, L₂—Plug-in coil unit (See Coil Table)
RFC₁, RFC₂—2 1/2-mhy. r.f. choke (National R100)
S₁—S.p.s.t. toggle switch
Xtal—Quartz crystal, 3700-3750 kc. or 7175-7200 kc.
V₁—6AQ5 tube

Other parts you will need: One aluminum chassis, 7" x 5" x 3" (Bender Type 145); one knob with pointer; one 8-pin octal socket; one 7-pin miniature socket; one 4-pin socket; two 4-pin plug-in coil forms; four binding posts; one double binding post assembly; screws, nuts, wire, and solder

Note: One side of the tube heater and B- are connected together. To avoid bypassing S₁ or shorting the heater supply, use a power supply which does not have B- connected to the heater circuit.

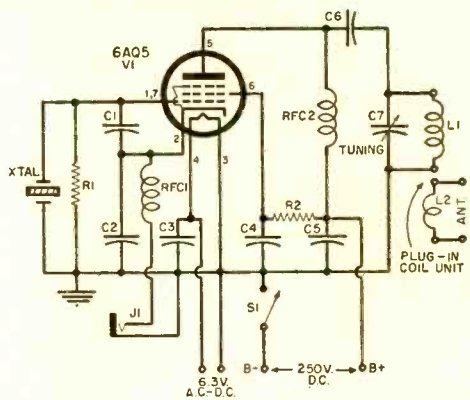

When wiring the transmitter follow both schematic and pictorial diagrams closely.

tor C₇ for brightest lamp response. (i) Taking care that the key is in its up or "off" position, connect the antenna leads to the "Antenna" binding posts. (j) Again, close the key, hold the lamp loop near the coil, and retune capacitor C₇ for brightest lamp response.

The transmitter now is tuned-up on 80 meters, and is ready to go. The signal may be monitored for smoothness by listen-

ing to it with a receiver (minus antenna) or on a c w monitor.

To tune up on 40 meters, repeat the entire process with a 40-meter crystal and the 40-meter coil plugged in.

If you do not have any of the power sources mentioned in the early part of this article, you can use this transmitter with a power supply to be described in the next issue of POPULAR ELECTRONICS. **END**

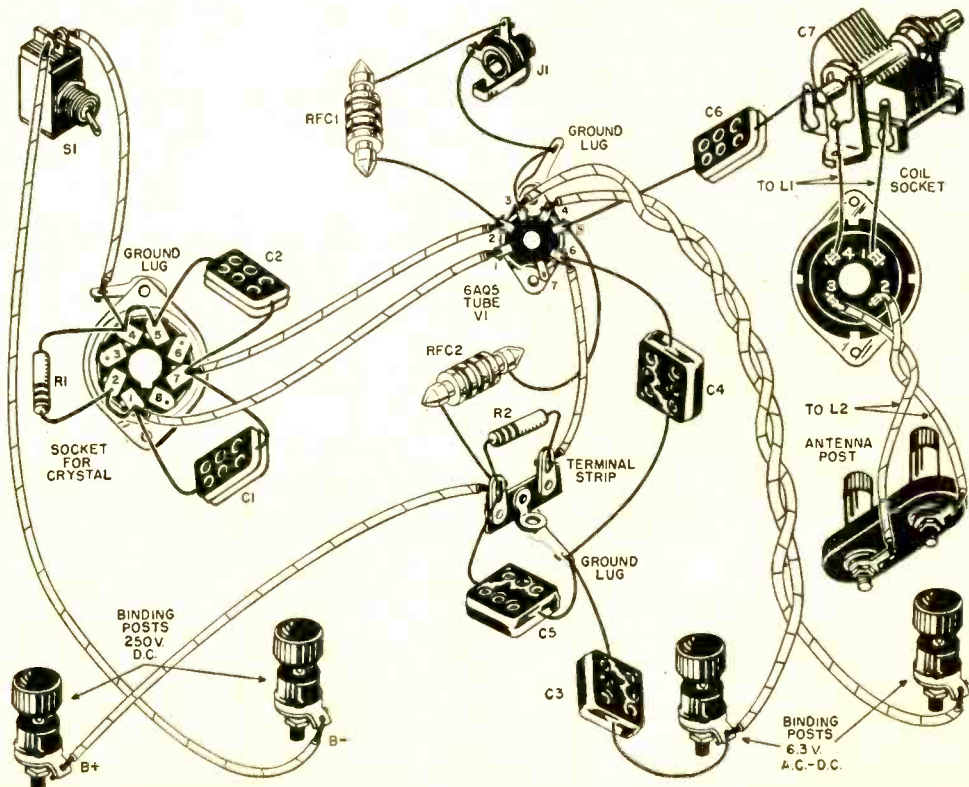

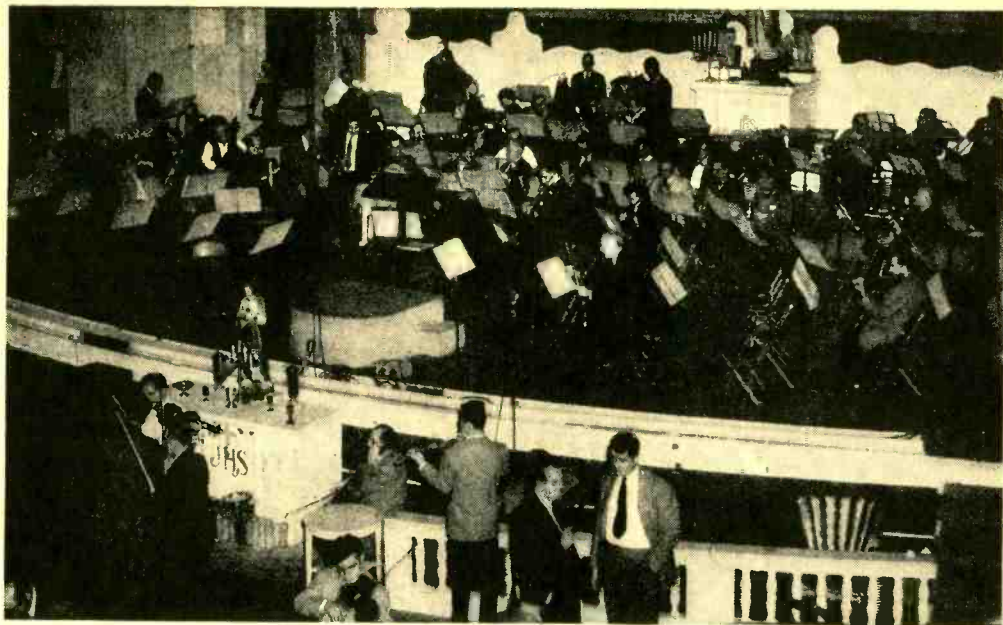

1 Absence of sound-absorbing materials on stage during this Mercury Records recording session helps achieve richer, more spacious sound on final records.



2 Magnetic tape is used for the original recording. Improvement in the original is possible, when necessary, by editing and corrective re-recording. Photo shows Ampex machines being used in session directed by Columbia's Mitch Miller.

3 Conductor Dimitri Mitropoulos listens critically to playback of his last "take." Playback speaker system is Altec-Lansing's "Voice of the Theatre." Mistakes detected by conductor will be corrected before tape is approved for use in making records.

RECORDS

By D. Hoefler

WHEN the current interest in high fidelity began a few years ago, the record industry seemed indifferent. This was not the first time the hi-fi idea had cropped up, and there seemed little reason to suppose it would outlive previous, similar fads.

(Continued on page 32)

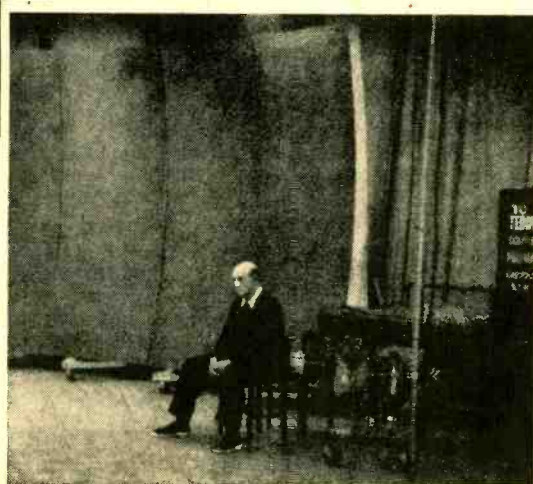

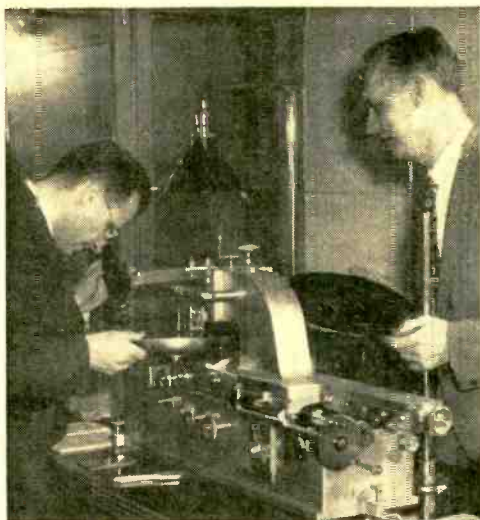

4 Finally approved, the tape original is re-recorded onto a lacquer disc, here undergoing inspection by Dr. Peter Goldmark and William S. Bachman. These men are responsible for the development of Columbia's microgroove long-playing record.

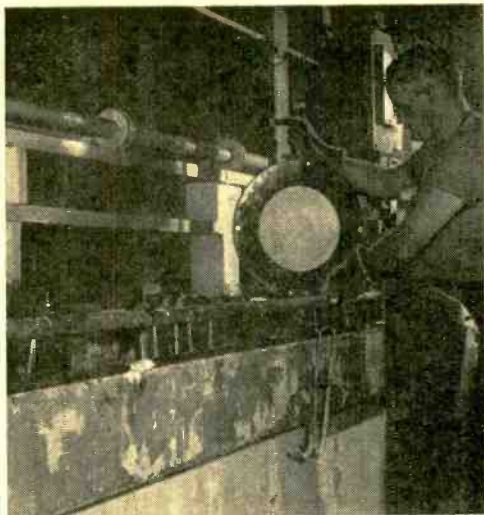

5 After visual and aural tests, the lacquer master disc is placed in an electroplating tank whose contents are controlled by chemical analysis. Not too many years ago, the bath was tested by dipping a finger into it and tasting it!

ARE BETTER THAN EVER



6 The lacquer master disc is separated from its plated metallic coating, which is a perfect negative impression of the record grooves. This coating, known as a "metal master," may be reinforced and used to stamp records, or it may be plated again to provide a positive metal mold known as a "mother." The "mother," in turn, is electroplated to form a "stamper" which is used to make the actual records we hear.

7 Meanwhile the plastic record material is prepared from a precise combination of ingredients in large heated mixers. It then goes to the rollers shown below which produce "biscuits" of uniform thickness and correct size for records.

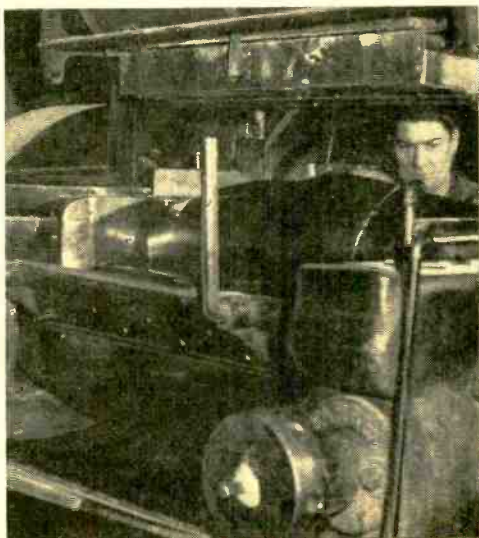



8 Printing of labels, jackets, etc. undergoes careful editorial scrutiny. Copy must be grammatically and factually accurate. Color registration must be perfect. Labels are printed on large sheets and then cut to size on this machine.

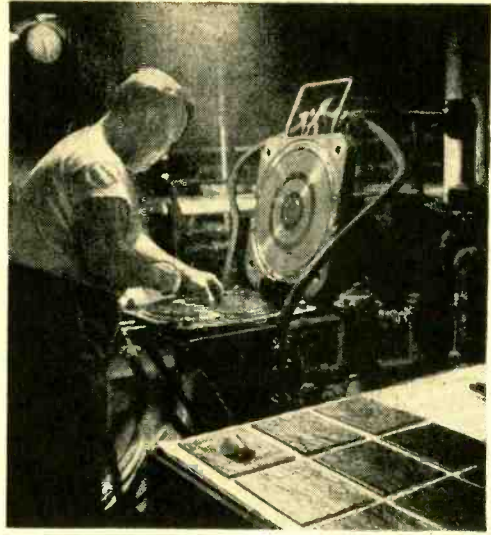

9 The metal stampers, labels, and heated "biscuits" come together in the record press, which resembles a huge waffle iron. Hot steam, followed by cold water, is forced through the press to assure correct formation of the plastic discs.

In fact, the evidence indicated that the public really preferred *low* fidelity. Record-makers and broadcasters had learned this lesson through years of sad experience.

But when public interest and demand made it apparent that high fidelity was here to stay—and grow—the industry responded with an alacrity and vigor that it had not shown in years. The hi-fi "revolution" is now in full swing. New techniques

and quality controls are still being introduced at every stage of record manufacture.

As a result of this stepped-up activity on the part of record manufacturers, the phonograph record of today is a vast improvement over the noisy, fragile, short-playing model of yesteryear. Some of the reasons for this are shown in the accompanying photographs. **END**

10 Excess plastic after pressing is trimmed off by white-gloved operator. She then stacks discs for final inspection and packing. Spacers are placed on the spindle between the discs so that recorded surfaces will not touch each other.

11 Thousands of dollars' worth of skills have been applied to creating the hi-fi record held here by TV actress Pat Percy. She shows her appreciation of this fact by holding the disc at its edge, never touching the recorded surfaces.



In the "reflex" circuit of this receiver, one tube does the work of two and good loudspeaker volume is produced with two tubes.

A TWO-TUBE BROADCAST BAND RECEIVER

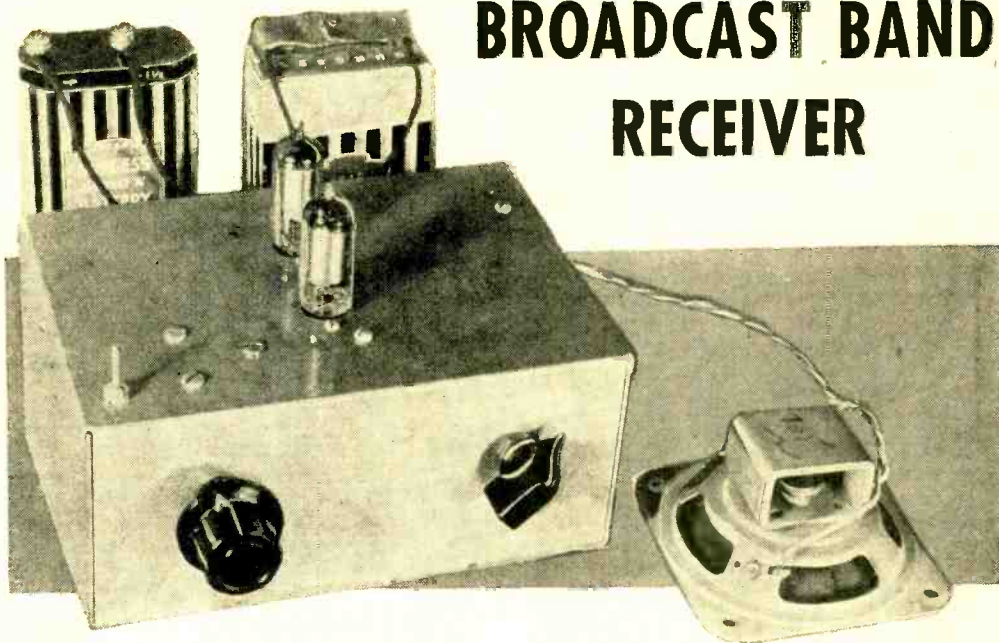

OLD-TIMERS remember the reflex circuit fondly. Newcomers probably never heard of it. The reflex receiver was very popular when radio was young and tubes were high-priced, because it allowed one tube to do the work of two.

We get this unusual action by feeding the signal through the tube twice. The first time around, for example, the tube acts as an r.f. amplifier. We can then detect the amplified signal with a crystal and feed the crystal output back around through the same tube which now acts as an audio amplifier. That is exactly what happens in the little set described in this article.

You can hook up this receiver and have fun observing how the reflex circuit works. Aside from its educational value, this set makes a handy little battery-operated tuned r.f. portable. It tunes fairly sharply over the entire broadcast band and will give good volume on all local stations. When using an outside antenna and a good ground, stations 100 miles away have been received well.

Explanation of the Circuit

Refer to the schematic diagram, which gives the complete circuit of the reflex receiver.

Two tubes (one 1U4 and one 3S4) and

one 1N34 crystal diode detector are used. The 1U4 serves as both r.f. and 1st audio amplifiers. The 3S4 is the audio output amplifier. A 1½-volt "A" battery and a 67½-volt "B" battery supply all power required by the tubes.

The signal coming in from the antenna and ground is tuned in by means of variable capacitor C_1 (which is one half of the dual ganged capacitor C_1-C_7) and the antenna coil, L_1 . The signal then is fed to the 1U4 control grid. R.f. amplification of the signal takes place in the 1U4. The amplified signal appears at the secondary coil of the r.f. transformer, T_1 , which is tuned by the second half, C_7 , of the ganged tuning capacitor.

This amplified signal then is applied to the 1N34 diode detector, CR_1 , through the blocking capacitor, C_6 . The detector delivers an audio signal which, after it passes through the filter (R_1 , R_2 and C_5), is fed to the 1U4 control grid.

Now, this time the 1U4 acts as an audio amplifier and builds up the audio signal coming out of the detector. The amplified audio signal is taken from the 1U4 through coupling capacitor C_8 and the volume control potentiometer, R_3 . It then is fed to the control grid of the 3S4 output amplifier tube which drives the loudspeaker.

Readers who have studied receiver cir-

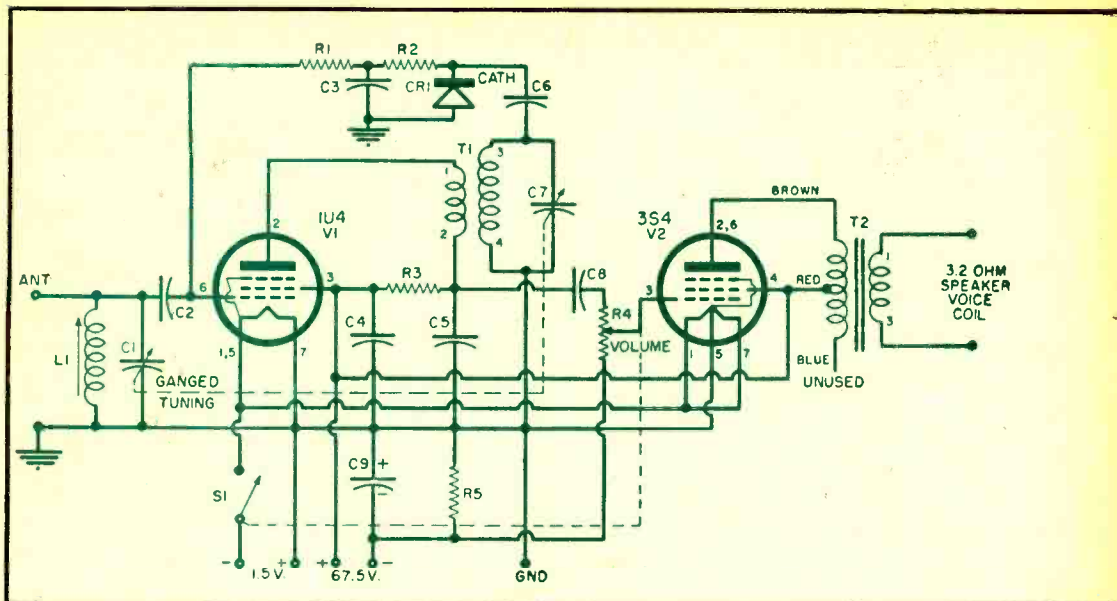

In the circuit shown in the schematic diagram above, V₁ acts as both radio-frequency and audio-frequency amplifier. See the text for an explanation of how this is accomplished.

cuits may be puzzled as to how the first stage of this set can operate simultaneously as an r.f. and audio amplifier. The following points should clarify this. The r.f. signal applied to the 1U4 control grid is prevented from going back into the detector stage by the R_1 - R_2 - C_3 filter. The small capacitor, C_4 , in the 1U4 output bypasses the circuit for r.f. but not for audio. The primary of T_1 thus is grounded for r.f. Resistor R_3 serves as the plate load resistance when the 1U4 is acting as an audio amplifier. At this time, the bottom of the T_1 primary is "high" (because capacitor C_4 has a high impedance at audio frequencies) and audio output can be taken from the junction of R_3 and C_4 .

Editor's Note: The reason reflex receivers are not used as much as they once were is that interaction in the reflex stage, between the r.f. and audio signals, produces undesirable effects. Strong signals may be distorted. Minimum volume may not occur with the volume control at its minimum setting, and may also be accompanied by distortion.

Control grid bias for the 3S4 tube is obtained from resistor R_5 , which is bypassed by the electrolytic capacitor, C_8 . The author used a 4-inch PM dynamic speaker with a 3.2-ohm voice coil. The Stancor A-3823 universal output transformer, T_2 , is connected to supply this particular voice coil. That is, the brown pigtail is connected to the 3S4 plate, red pigtail to screen and "B-plus," blue pigtail unused, and the speaker connected to taps 1 and 3. The

reader can use any other speaker he may have on hand. The A-3823 transformer has sufficient taps (and a complete chart of instructions for connecting) to enable matching a particular speaker to the 3S4 tube.

The "on-off" switch, S_1 , is in the "A-minus" lead. The "B" battery does not have to be switched. The switch is combined with the volume control potentiometer, R_4 .

Construction

The author built his set in an aluminum chassis box, 7" long, 5" wide, and 3" high (*Bender 145*). This chassis later is slipped into a wooden case along with the loudspeaker and batteries. But you do not have to follow this type of construction. You can build your set directly into a radio cabinet, cigar box, or any other type of enclosure that appeals to you. You can even assemble the parts on a wooden breadboard if you wish.

On top of the chassis, the 1U4 tube is to the front, the 3S4 to the rear. In the left front corner is the adjustment screw of the ferrite-adjusted antenna coil, L_1 . The left knob controls the tuning capacitor, and the right knob the combination volume control and "on-off" switch. A card marked off in kilocycles in the broadcast band is placed over the tuning knob when the set is installed in its case.

The under-chassis view shows construction and wiring. The various components can be identified by comparing with the

R₁, R₂—500,000 ohm, 1/2 w. carbon res.
 R₃—100,000 ohm, 1/2 w. carbon res.
 R₄—500,000 ohm pot, audio taper, with switch S₁
 R₅—820 ohm, 1 w. carbon res.
 C₁, C₇—Dual 365 μfd.-per-section, midget tuning capacitor (Miller 2112)
 C₂, C₃—25 μfd. mica or ceramic capacitor
 C₄—.01 μfd. mica capacitor
 C₅—470 μfd. mica or ceramic capacitor
 C₆—100 μfd. mica or ceramic capacitor
 C₈—.1 μfd., 200 v. tubular capacitor
 C₉—10 μfd., 50 v. midget tubular elec. capacitor
 CR₁—Type 1N34 germanium crystal diode
 L₁—Adjustable ferrite antenna coil (Miller 6300)
 S₁—S.p.s.t. switch on R₄
 T₁—Tuned r.f. 540-1750 kc. coil (Miller 20-RF)

T₂—Universal audio output trans., single or push-pull plates, 4000-14,000 ohms to voice coil (Stancor A-3823)
 V₁—1U4 tube
 V₂—3S4 tube
 1—"A" battery, 1.5 V. (Burgess 2FBP)
 1—"B" battery, 67.5 V. (Burgess XX45 or Eveready 467)
 1—4-inch, 3.2-ohm PM speaker

Other parts you will need: one aluminum chassis, 7" x 5" x 3"; two knobs with pointers; two 7-pin miniature sockets; one 5-lug screw-type terminal strip; two 2-lug screw-type terminal strips; one 5-lug tie-point strip; one 1-lug tie-point strip; five ground lugs; screws, nuts, wire, solder.

You can follow this pictorial diagram in wiring the reflex receiver. Be particularly careful about the connections of the tubes, capacitor C₆, r.f. coil T₁, and transformer T₂.

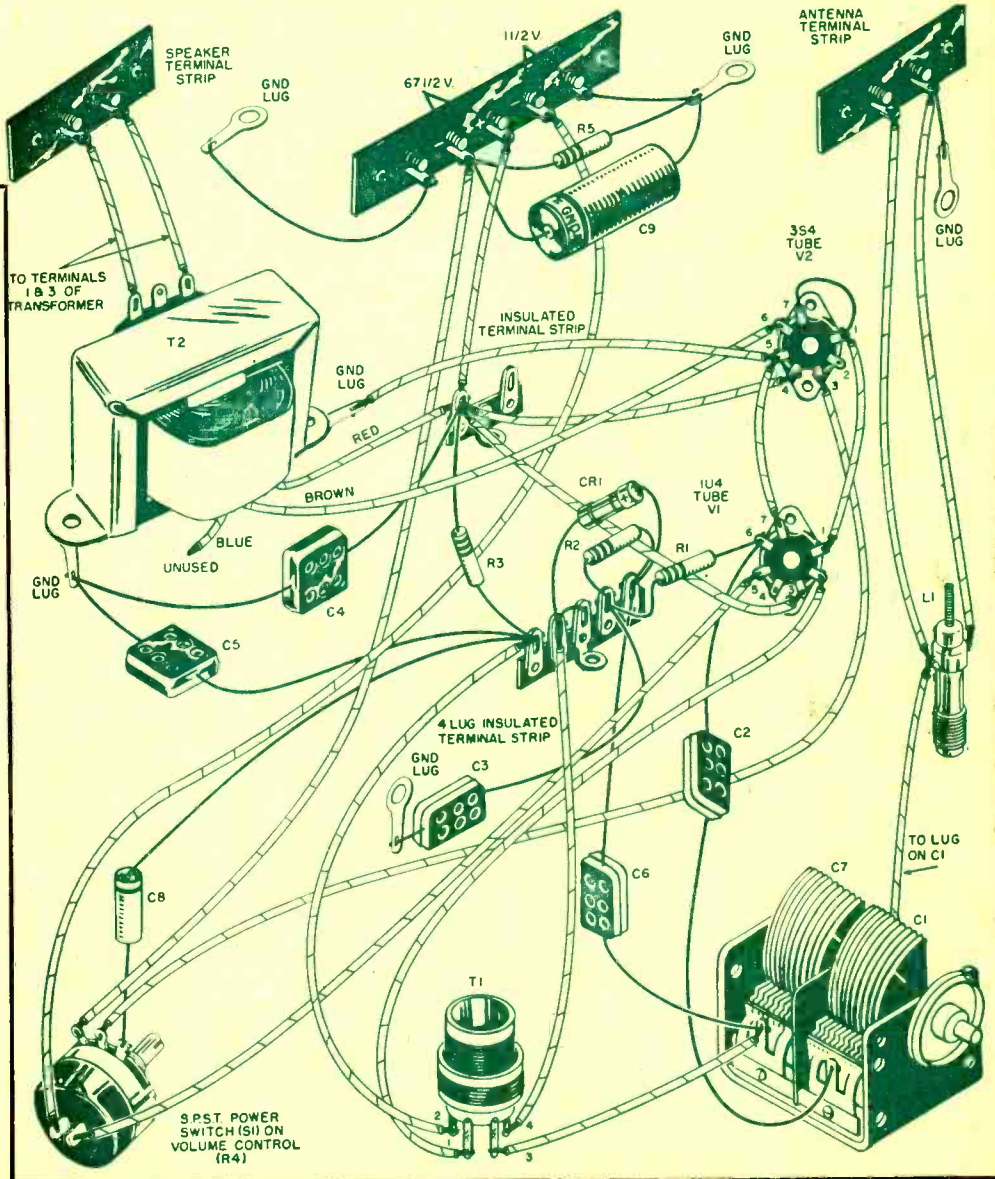

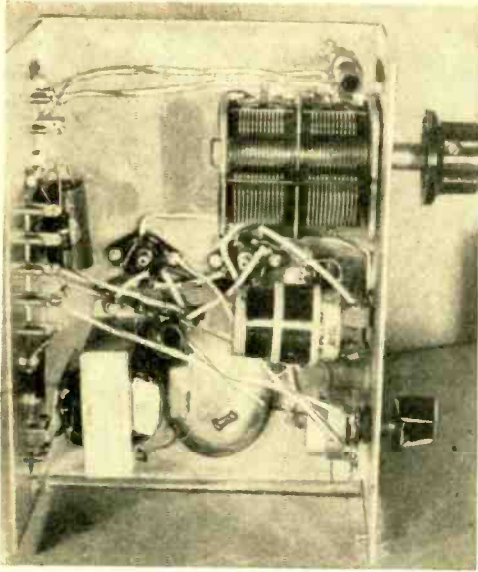

This bottom view of the reflex receiver shows the author's arrangement of the parts. It should be used with the pictorial and schematic wiring diagrams in constructing the set.

pictorial wiring diagram. Note the screw-terminal strips for connection of antenna, ground, batteries, and speaker. A ground screw is provided on the battery terminal strip. This is for convenience in grounding the metal frame of the speaker when this is needed to prevent whistling. Whistling is not experienced in every case, but sometimes it does occur when the speaker must be mounted close to the 1U4 tube.

After the wiring has been checked as correct, connect the batteries and loud-speaker, and switch the receiver on. Turn the volume control all the way up. If you have a modulated signal generator, set it to 1700 kc. and connect it to the antenna and ground terminals of the receiver. Set the receiver tuning capacitor about $\frac{1}{2}$ from completely open and adjust the tuning screw in antenna coil L_1 for loudest sound from the speaker. Adjust the trimmer capacitor on the frame of C_7 for further increase in loudness. Use the lowest generator output that you can still hear, since the low signal allows more accurate adjustment.

If you don't have a signal generator, use a broadcast station instead. Do this by connecting an antenna and ground to the receiver. Set the tuning capacitor and volume control as just explained, and adjust the screw of coil L_1 to tune in a station operating on some frequency at the extreme high end of the broadcast band (somewhere between 1500 and 1700 kc.).

After the initial adjustment, the set is operated simply by adjusting the tuning and volume control knobs. Best pickup is afforded by an outside antenna and a good ground (a cold water pipe usually is very good). But the set will operate also with a 5- to 10-foot length of wire inside the house or "on location." The hank of wire commonly called an *a.c.-d.c. antenna* will suffice.

The batteries shown with the receiver are one *Burgess Type 2FBP* ($1\frac{1}{2}$ v.) and one *Burgess Type XX45* ($67\frac{1}{2}$ v.). END

NEW THEREMIN MAKES MUSIC ELECTRONICALLY



MOVING her hands around the antenna, the young lady at the left is playing music on the Theremin, an electronic musical instrument. The volume and pitch are controlled by hand movements; the performer never touches any buttons or keys. Top unit contains oscillator and control circuits; lower unit is amplifier and loudspeaker. This model is made by the *R. A. Moog Company*.

ANTENNA FROM STEEL TAPE

A FLEXIBLE steel tape makes a fine adjustable antenna, as shown in the photo at the right. One screw through the center eyelet mounts it. Insulated washers where the screw enters the cabinet will prevent shorts. For high frequency uses, mount the tape with a stand-off insulator.



POPULAR ELECTRONICS

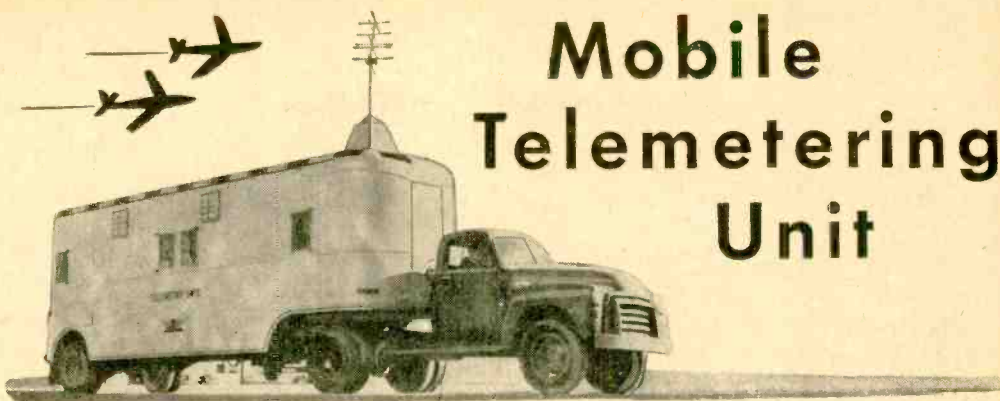

Mobile Telemetering Unit

Housed in a truck trailer, this equipment measures and records performance of test plane 100 miles away.

AERODYNAMISTS can now be furnished with an accurate picture of the vital functions of an airplane under test 100 miles away by means of an electronic telemetry unit housed in a *Fruehauf* truck trailer.

Now in use at *A. V. Roe Canada Limited*, manufacturers of jet planes, the new equipment enables ground technicians to observe and record 67 separate items of data while a test flight is in progress.

From the aircraft, the variables to be measured are converted into electrical signals by a special transducer. These signals are transmitted to the ground unit.

Among the data thus sent are air and liquid pressures, accelerations, rotary and linear motions, temperatures, and various applied forces.

These signals are received in the trailer by an elaborate FM unit and recorded on high speed recorders. The receiver is actually a pre-tuned 67-channel set. Each channel is fed independently to one of 67 discriminator circuits which will handle only its predetermined signal, ignoring all the others. The output of each discriminator varies with the frequency of the particular signal fed into it, similar to the action in a home FM radio set. **END**

Interior of trailer showing telemetry equipment used for checking performance of airplane in flight.

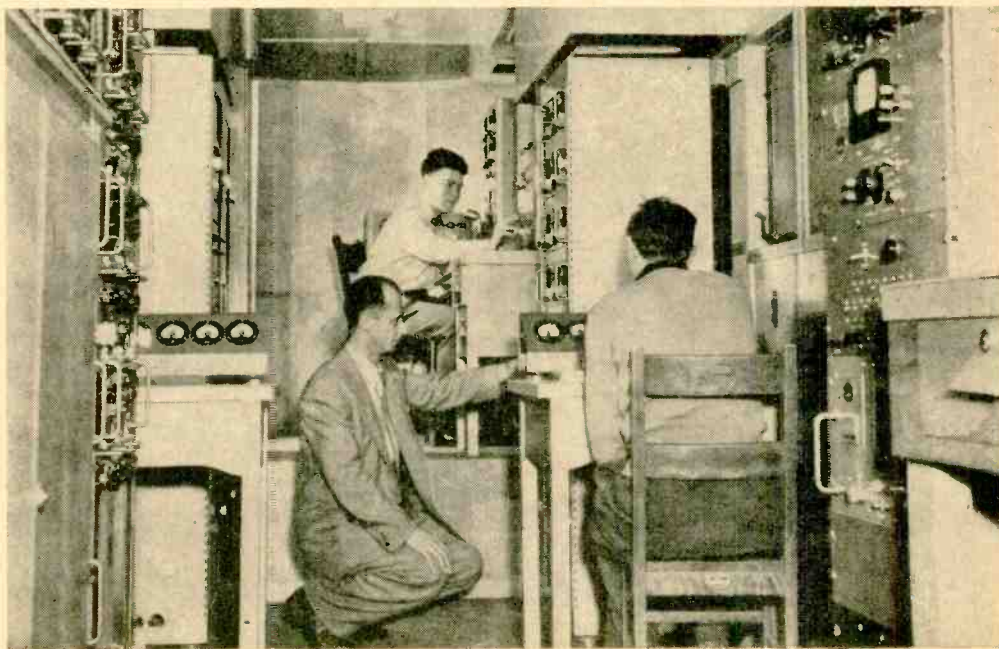
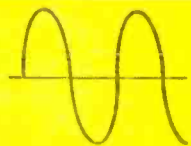
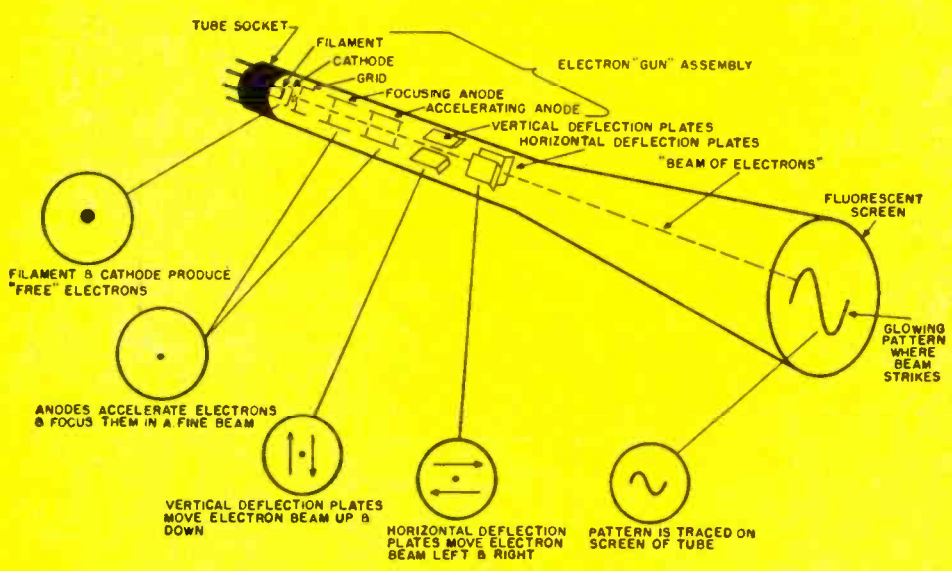

Fig. 1. The larger of these electrostatic cathode-ray tubes is made of glass and measures 5 inches. The smaller is a 1 inch metal tube.



How the Cathode-Ray Tube Works

Fig. 2. Construction details of an electrostatic type cathode-ray tube.





This analysis of both electrostatic and magnetic type tubes provides better understanding of TV picture tube operation

TO MANY, the cathode-ray tube is symbolic of the entire television industry. There is little question that if it were not for this tube, the industrial giant of modern television could never have come into being. However, while it is true that a cathode-ray tube is used in every TV receiver and that thousands of others are used in TV broadcast stations, its use is not limited to this field alone. These tubes are used in radar, in medical electronic apparatus, in test equipment, in atomic research, in industrial electronic equipment, in fact, in all phases of present-day industry and science. To understand the operation of the cathode-ray tube, then, is to be in a better position to understand the entire field of modern industrial technology.

Fundamentally, the cathode-ray tube (or CRT) is nothing more than a special type of indicating device. Just as a loudspeaker converts electrical signals into sound vibrations, and a meter changes electrical energy into the mechanical movement of a needle pointer, the CRT is an instrument used to change electrical signals into patterns of light.

Cathode-ray tubes are made in numerous sizes and shapes and for many special purposes. However, most cathode-ray tubes can generally be divided into two broad classes—"electrostatic" tubes and "electromagnetic" tubes. This classification is based on the means used for deflecting (moving) the electron beam which "paints" the light pattern on a fluorescent screen. Each class of tube has certain advantages as well as certain limitations, and these advantages and limitations have resulted in each type of tube being used in specific applications.

Electrostatic tubes use an electrostatic field for controlling the electron beam. This field is built up between a pair of electrodes called "deflection plates" by the application of moderate a.c. and d.c. voltages. Electrostatic tubes are generally made in small sizes, with screens from one

inch to about ten inches in diameter. They have a good frequency response and are widely used in cathode-ray oscilloscopes, medical electronic equipment, industrial equipment, and in some types of radar work.

Electromagnetic tubes use a magnetic field for controlling the stream of electrons. Two pairs of coils are used for building up this magnetic field. The coils are external to the tube proper and are generally mounted in a single assembly called a "deflection yoke." Electromagnetic tubes are made with screen sizes from five inches to thirty inches in diameter. Although they have a comparatively narrow frequency response, these tubes do permit the formation of large size, sharply focused, bright images and are used in tremendous quantities in television receivers and as indicators in radar systems. Virtually all

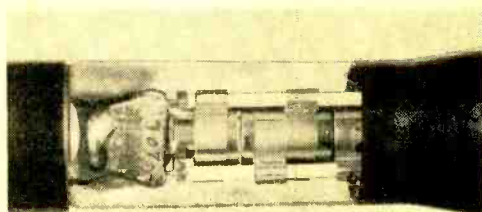
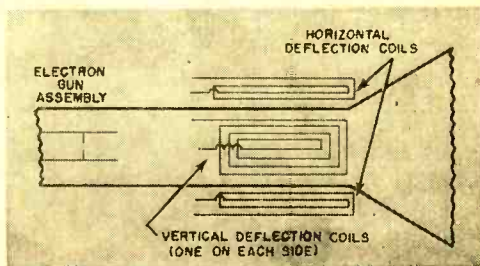
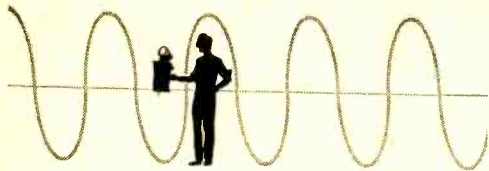

Fig. 3. Photographic illustration of the electron gun assembly of cathode-ray tube.

Fig. 4. In an electromagnetic type of tube, deflection coils are placed on the outside.





modern TV receivers employ electromagnetic tubes.

Since most people find it easier to understand the operation of the electrostatic cathode-ray tube, we shall discuss this type first. Once a clear understanding of the electrostatic tube has been acquired, the electromagnetic tube is easy to master. The basic construction of an electrostatic CRT is shown in simplified form in Fig. 2.

An a.c. voltage is applied to the *filament* of the tube, heating it to a bright glowing red. The filament, in turn, heats the *cathode* which is placed close to it. The cathode is covered with materials which "boil out" electrons when heated, and these electrons gather in a cloud close to the cathode.

A high positive voltage is placed on the *accelerator anode* and this voltage attracts the negatively charged electrons, causing them to move in a stream toward the front of the tube. The electron stream passes through a narrow hole in a cylindrical shaped electrode called the *grid*. Although not shaped like a conventional grid, it is given this name after the grid in an amplifier type vacuum tube because it serves the same function . . . it controls the number of electrons which can pass through.

The electron stream next passes through a group of two or three cylindrical electrodes which have different d.c. voltages applied to them. The *accelerating anode* may be one of this group. The d.c. voltages applied as well as the shape and size of these electrodes set up an electrostatic field which narrows the electron stream and focuses it into a sharp beam. Because of this action, one of the electrodes may be termed the *focusing anode*.

Next, the sharply focused electron beam passes through a pair of flat electrodes arranged in a horizontal plane with respect to the tube. If a d.c. voltage is applied to these plates, the electron beam will be attracted toward the more positive plate and repelled from the negative plate, bending either up or down, depending on how the d.c. voltage is applied. If an a.c. voltage is applied, the beam will move up and down alternately. Since the beam moves in a vertical direction, these electrodes are called the *vertical deflection plates*. The *horizontal deflection plates* are a similar pair of electrodes, but arranged at right angles to the vertical plates, and



Fig. 5. The photograph shows a typical deflection yoke of a modern TV receiver.

serve to move the beam either to the left or right.

After passing through the deflection plates, the electron beam goes on to strike the front of the tube, which has been covered with chemicals which glow when struck by the electrons. This action is termed "fluorescence" and, therefore, the film of chemicals on the face of the CRT is called a *fluorescent screen*. The choice of chemicals used in making the fluorescent screen determines the color of the glow and how long the glow continues after the electron beam strikes the screen. This latter characteristic is called the *persistence* of the screen.

Most of the cathode-ray tubes used in oscilloscopes have a *medium persistence green* screen. Zinc orthosilicate is frequently used for such screens. Television receivers generally employ a *medium persistence white* screen. Various mixtures may be used to produce a white screen, including a combination of zinc sulphide and zinc beryllium silicate. For high speed photography, a CRT using a *short persistence blue* screen is desirable. Such screens may be made from calcium tungstate.

Since the purpose of a cathode-ray tube is to obtain a pattern of light on a screen, the fluorescent screen is often considered one of the most important parts of the tube. This is shown by the fact that a tube's size is given in terms of its screen diameter. A "seven inch tube" has a screen with a diameter of approximately seven inches.

In a cathode-ray tube, the assembly of electrodes which produces the stream of electrons, not including the deflection plates, is called the "electron gun." The electron gun of a typical CRT is shown in Fig. 3.

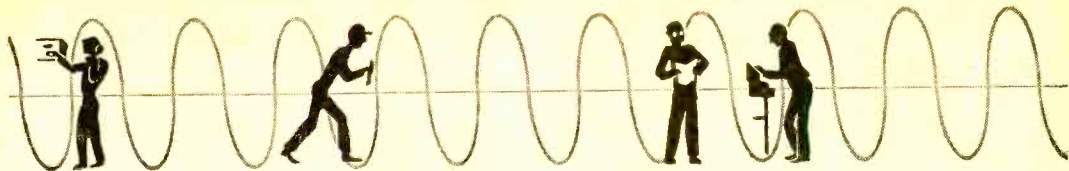

An electromagnetic CRT is somewhat simpler in construction than an electrostatic tube since it does not have deflection plates. However, it still has an electron gun assembly, although the focusing anodes may be missing. The beam of electrons sent out by the electron gun is deflected by a magnetic field set up, in turn, by two pairs of curved coils mounted around the neck of the tube close to the bulge of the "funnel." See Fig. 4. The coil assembly, or *deflection yoke*, of a typical television receiver is shown in Fig. 5. Note how the two sets of coils are mounted at right angles to each other.

Electromagnetic cathode-ray tubes which do not have focusing electrodes in their electron gun assembly employ an external magnet to produce a magnetic focusing field. Such magnets may be either electromagnets or permanent magnets, or a combination of both. Thus, electromagnetic tubes may be subdivided into two smaller classes; those employing electrostatic focusing and magnetic deflection and those employing both magnetic focusing and magnetic deflection.

The shape of the light pattern formed on the screen of a CRT depends on the type of electrical signals applied to the deflection elements (whether coils or electrostatic plates). If steady d.c. voltages are applied, a dot will appear on the screen, with its exact position determined by the relative sizes of the applied deflec-

tion voltages. If a.c. signals are applied, a line or pattern will be formed, with its shape and size determined by the electrical waveforms and amplitudes of the a.c. signals. In a television receiver, the light pattern forms a *raster* made up of a series of horizontal lines.

Varying the voltage applied to the *grid* electrode in the electron gun assembly will change the number of electrons that can pass through and strike the screen and hence the instantaneous brightness of the glow. In a television receiver, the *video* signal is applied to the grid-cathode circuit of the CRT and changes the evenly glowing raster into a pattern of light and dark segments which, in turn, makes up the picture.

The vast majority of present day cathode-ray tubes employ a single electron gun assembly and a single set of deflection elements. However, tubes have been made with a number of electron guns, including some of the tubes designed for color television. Cathode-ray tubes have also been made with several complete electron guns *plus* deflection elements. Such tubes are virtually several independent cathode-ray tubes with a single screen. One such tube is shown in Fig. 6.

Special purpose cathode-ray tubes, color television picture tubes, TV camera tubes, and other types of cathode-ray tubes will be discussed in other issues of **POPULAR ELECTRONICS**. END

Fig. 6. This industrial multi-gun cathode-ray tube has five electron gun and deflection assemblies.

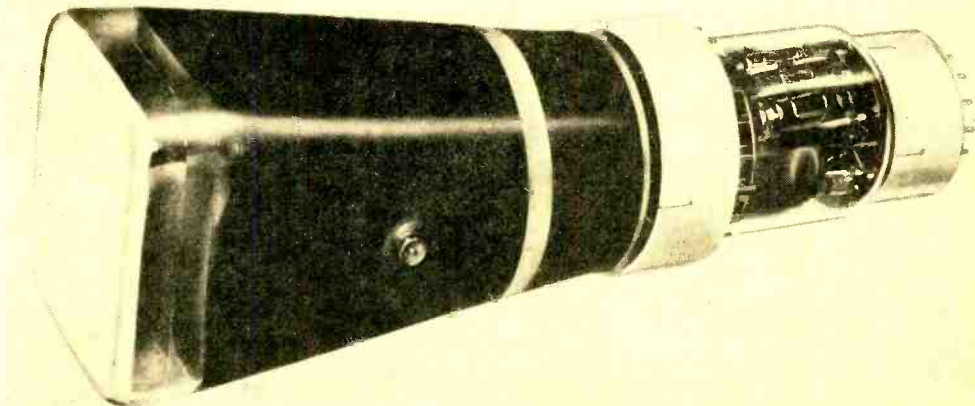



ONE of the oddities of the radio control hobby is the persistent underestimation, even by some manufacturers, of the problems of installing the airborne equipment. Most directions stop with a wiring diagram and the "dope" on tuning. It is no wonder then that the beginner's first R/C installation is a rat's nest of wires, or that the radioman's first model often is torn up by loose batteries and catapulting equipment on the first really hard landing.

A shipshape installation is accessible, removable, facilitates proper functioning of the radio, protects the equipment, and, just as important, protects the airplane from the equipment in a crack-up. If these requirements are not met, the best radio in the world is rendered unreliable.

If this sounds like making a mountain out of a molehill, consider the unnecessary damage that happens to a relay when the receiver bangs around inside a cabin. The heavy coil may deform the frame, causing delicate pivots to bind. This will result in skipping and sticking, eventually causing a bad crack-up or a fly-away. This is just one of the ways a poor installation endangers the equipment.

Let's take the requirements in the order

given. First is accessibility. This, like Sergeant Friday, covers a lot of territory. Just because the frequency trimmer can be reached with a tuning wand doesn't mean that the receiver is accessible. A slug tuner which requires tightening of a lock nut so that vibration will not cause detuning, isn't accessible when the lock nut is under the receiver chassis! Or, you may want to reach the relay to clean a contact, or to adjust spring tension, or reset a contact. Battery voltages often must be read on the field, or batteries may have to be replaced, or the escapement or servo checked. Anything that requires observation or adjustment should be readily accessible.

Equipment should be removable. Maintenance alone requires that all principal parts of the radio system be removable, that is, battery packs, receiver, and actuator. Exhaust smoke from the engine and dust on the field penetrate cabins, eventually causing leakages of capacitors, etc. It certainly is worthwhile to keep the receiver chassis clean. Soldered joints need regular inspection—components may have been pushed out of place, perhaps to the point of shorting out. Tubes may be loose,

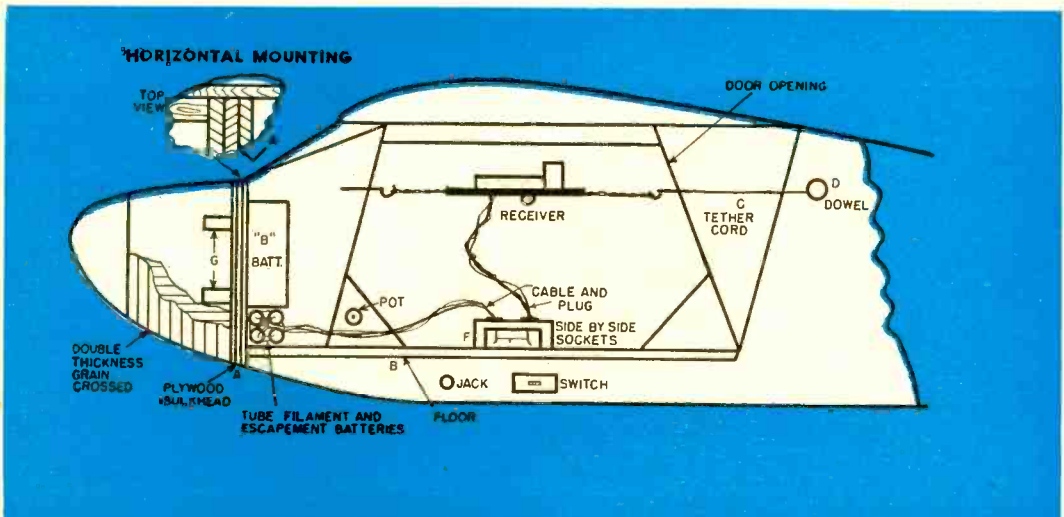

INSTALLATIONS

By **WILLIAM WINTER**
 Editor, *Model Airplane News*

a burr might have developed on the revolving arm of the escapement, or the armature of a servo motor may require cleaning. The radio model is, after all, a real aircraft and, like a real aircraft, requires periodic checks. It is not uncommon for an active hobbyist to log a hundred or more flights a year. If the equipment is not inspected regularly, the model will become a casualty before that many flights can be racked up.

How well the receiver does its job depends on the neatness of the installation and the provision included against the ill effects of engine vibration upon the relay. The beginner tends to place batteries, receiver, and escapement wherever convenient, then to run wires, like as not through space, point to point. Wires can be grouped or cabled. Those wires that connect the switch, potentiometer, jack, sockets, and other stationary components that remain in the plane, regardless of the removability of the receiver, batteries, or actuators, should be fastened to the structure, led along the corners between walls and floor, or by bulkheads (crosswise partitions) and walls.

The stationary wiring can be constricted

into a very small area by a compact arrangement of the permanently installed fixtures. By using miniature socket-type plugs, the receiver can be provided with a plug-in cable, and the battery pack with another. Either or both can be removed by slipping out the plug. Standardize your receiver cable connections to make receivers interchangeable between ships. One big advantage of this practice is that friends can cooperate by sharing receivers when necessary, provided the hook-ups are standard. On the five-pin plug the following connections are suggested: pin 1, "A+"; pin 2, "B+"; pin 3, common minus; pins 4 and 5, relay.

Damping of vibration is accomplished by a variety of shock mounting systems, the two most common ones being a rubber-band suspension of the receiver in a horizontal position, or the placement of the receiver upon a block of foam rubber, either vertically or horizontally. If vertically mounted, the receiver has an infinitely greater immunity to crack-up damage. Indeed, it is possible to destroy the airplane without detuning the receiver or even knocking the relay out of adjustment, when vertical mounting is used. Heavier and

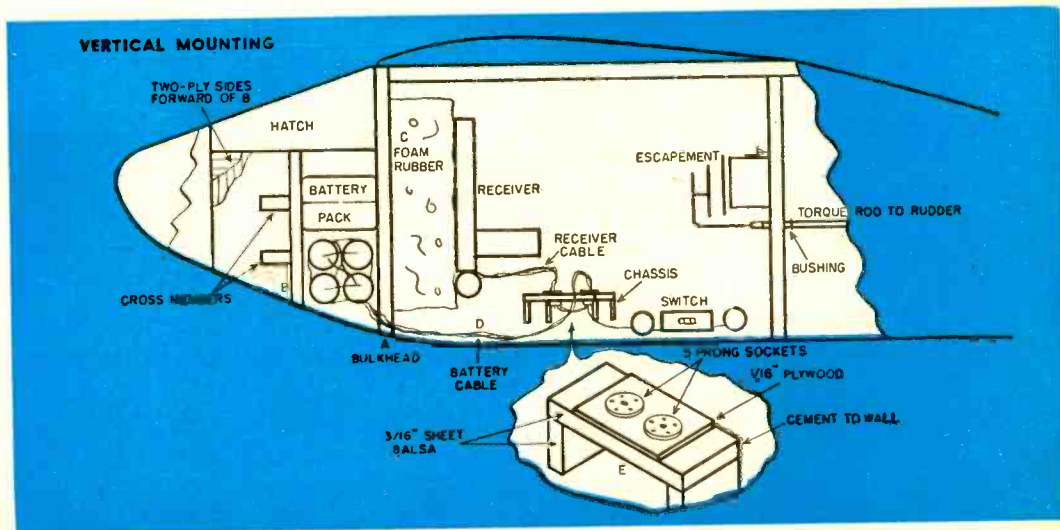

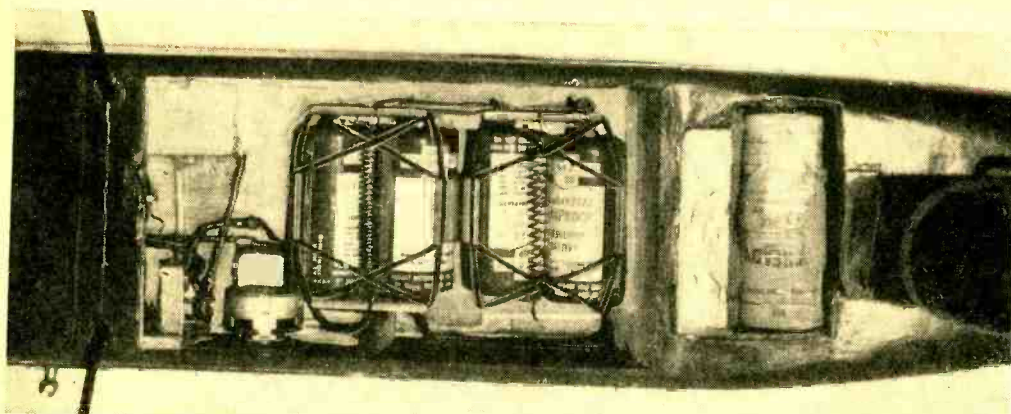

Example of battery installation in the belly of an airplane under the hardwood floor. The forward box contains a hearing-aid "B" battery, the rear compartment contains the batteries for the receiver filaments (1½ volts) and the escapement requiring 3 volts.

larger receivers sometimes rest upon two blocks of sponge, one at either end, or at either side, as the case may be. The rubber is faced with 1/16-inch thick plywood (using rubber cement) and the chassis ends or mounting lugs are attached to the plywood with small wood screws.

Good shock absorption is essential to good relay operation. The writer has seen cases where a 10,000-ohm sensitive relay considered shock proof would not pull in when mounted firmly on wood with a powerful engine shaking the airplane. Contact pressures may not be sufficient to hold a rudder in one position as the plane shudders out of a dive. Probably the manufacturers themselves don't know what happens to a relay armature during repeated signaling in the presence of a severe harmonic vibration, as only modelers seem to create it. If a good installation is able to employ the means of damping vibration to provide crash protection as well, you are ahead of the game.

Last, but not least, is the protection of the airplane from loose equipment. This means that all heavy objects, notably the batteries and the receiver, should not be permitted to gather momentum before coming to rest against a bulkhead. Batteries should always rest snugly against a bulkhead. This bulkhead should be strengthened across the grain with cross members or plywood to prevent splitting. Its ends, or joints with the floor or walls, should be butted against forward movement that would tear out the joints. Batteries should not be fastened down upon flooring, and never held loosely in place. A vertically-mounted receiver that rests against a firm bulkhead, with appropriate strengthening against splitting and movement, causes little or no structural damage and is itself unhurt by hard knocks.

Horizontally-mounted receivers which depend on rubber-bands from the four corners of the chassis may, on a short stop, penetrate a ply bulkhead with well imagined results to electronic equipment. A tether cord attached to the chassis and anchored behind the chassis to some strong point, prevents the receiver from traveling too far, although the back travel, like recoil of a gun, should be similarly damped for safety. Even though the horizontal mounting may hold in a crash, it is likely that the *Sigma* 4F-type relay will be deformed. Tubes will pop out, and everything that isn't tied down, like chokes, quench coils, and capacitors, will move out of position.

Escapements and pushrods take special handling to prevent crash damage. Escapements that simply are cemented against a balsa partition will tumble into the cabin when the plane bangs onto its nose. A pushrod may take off like a javelin, pulling loose the linkage assembly and the rudder.

With such considerations in mind we can tackle the four typical installations given in the illustrations. First is the old fashioned rubber-band mounted receiver, accessible in this case by means of two large access doors in the sides of the ship. A is the plywood bulkhead; B is a thick sheet-balsa floor or a thin plywood floor. The batteries are stacked against the bulkhead or laid flat on the floor with their front edges flush against the bulkhead. The switches, potentiometer, jack, etc., line up along the lower edge of the cabin on the left side, facing a right handed launcher. (This is more or less standard, so the arrangement of accessories, switches, etc., will not be detailed in subsequent examples.)

The receiver is suspended by rubber-

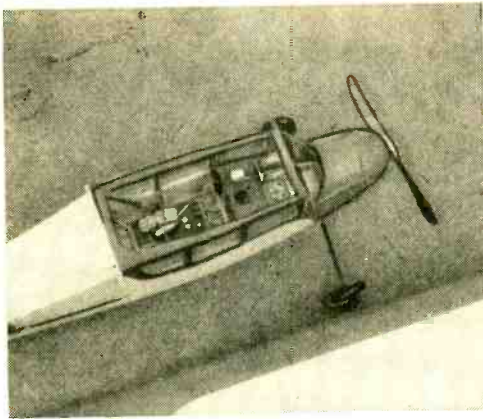

One method for mounting a receiver horizontally is shown here. Batteries and the socket for receiver cable are well forward.

R/C model plane with the receiver mounted horizontally. The batteries are in the nose, mounted on a piece of plywood and inserted through the floor for easy accessibility.

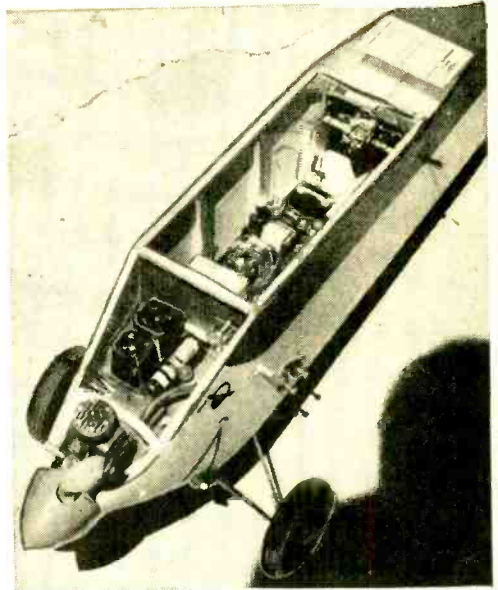

bands (two light bands to each corner stretched to about one-third their limit). *C* is a tether cord attached to the rear wing hold-down dowel, *D*. *F* is a small chassis mounting two sockets, one to accept the battery cable lead, the other the receiver cable. Note the structural cross members, *G*, that reinforce bulkhead *A*. The section forward of this reinforcement is double skinned on each side, with the inner, thicker skin— $3/16$ or $1/4$ -inch thick sheet balsa, butting against bulkhead *A*.

A popular mounting method is to have both receiver and batteries vertical. This provides excellent accessibility to the radio from the open top of the cabin, and to the battery pack from the removable top of the nose section. *A* is a $1/4$ -inch sheet-balsa bulkhead; *B* is either a $1/8$ -inch plywood or a $1/4$ -inch sheet-balsa bulkhead, whose grain runs across ship. Note that the im-

part of the batteries is against this bulkhead; that of the receiver, partly snubbed by foam rubber, is transmitted through *A*. The impact of the snug fitting batteries is transmitted to the key bulkhead *B*. Switches, potentiometer, and jack line up as before, well out of the way should the receiver swing from side to side. *C* is a foam rubber block, against which the receiver is anchored by small rubber bands. The tension of the bands is just enough to prevent the receiver from hanging loosely or swinging back and forth on landing. The battery cable *D* comes through bulkhead *A*, and plugs into a socket on chassis *E*. The receiver cable plugs into a similar socket. Note that the escapement is fully accessible.

The beauty of the torque rod linkage to the rudder is that the linkage cannot damage the escapement in a crack-up, where-

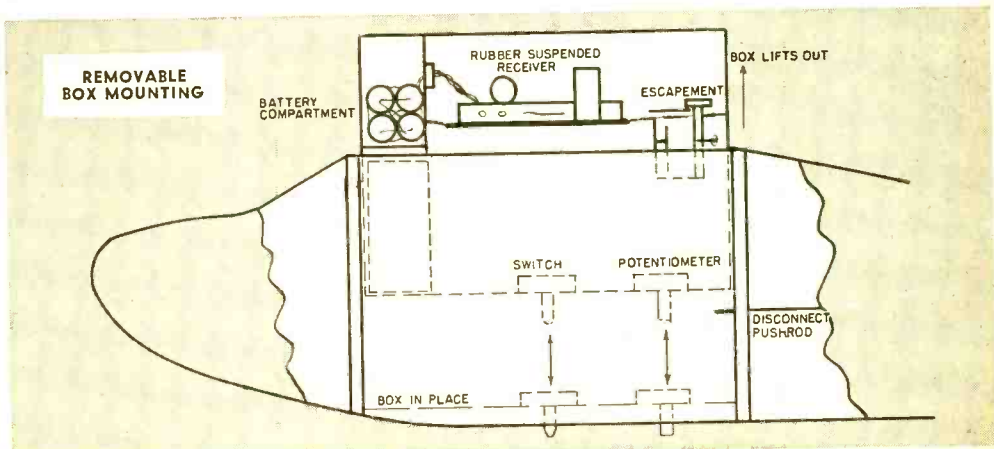

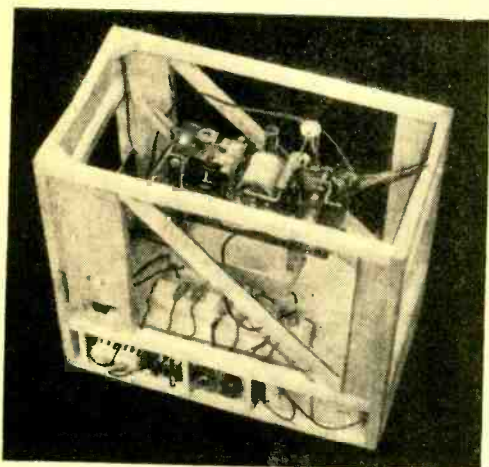

Removable box containing batteries, receiver, and actuator. This allows for easy removal from a plane and interchange between planes.

as the pushrod type transmits a blow to the escapement assembly. Pushrods and bellcranks also put a dead weight on the escapement, which can be a handicap when the nose is down. Pushrods usually require heavier rubber drive for safety and this in turn makes escapement and performance more critical.

A variation of the vertical-type mounting is also shown. Here, a plywood floor *A* extends between bulkheads *C* and *D*. Observe that the floor continues forward of bulkhead *B*, so that the battery weight can be carried far enough toward the nose for correct balancing. Battery boxes bolt directly to the floor, and are accessible by means of a large bottom hatch. The *Acme Products Company* makes sturdy battery boxes for all popular battery combinations including hearing aid "B" batteries. If desired, a large "B" battery may be dropped into place between bulkheads *B* and *D*, with *D* then requiring the usual forward

structural support. Escapements, switches, etc., are mounted as before. The large plywood floor is ideal for anchoring the heavier motor-driven servo-type actuators.

Still another arrangement having very special advantages is the removable box method. This box contains the batteries, receiver, and even the servo or escapement. By detaching the linkage from the actuator, the box can be lifted from the plane without disconnecting a wire. Moreover, it can be dropped into another plane. It is unnecessary to have an actuator in every plane with this set-up. The batteries are packed in a forward compartment in the box; the actuator is mounted at the rear, but in such a manner that it does not snag the adjacent bulkhead when the box is lifted out. Switches, potentiometer, jack, etc., have to be on the bottom of the box, and are reached through holes in the bottom of the ship when the box is in place. In fact, the toggle switch handle extends from the bottom. Usually more confined than a wide open cabin, the box requires that some receivers be beam mounted, that is, placed upon two blocks of foam rubber at either end, or along the sides.

It is not intended that these examples be followed to the exclusion of the reader's own ideas. Rather, it is hoped that this resume of a few of the better kinds of installations will assist the newcomer in the successful operation of his new plane.

It would be well to draw upon these comments in sketching in any installation upon the plan that comes with your airplane kit—before cementing a piece of wood. Few kits detail installations, merely saying, put the batteries here, etc. Nor are they always wise in the location of some items such as an escapement. The average modeler is a great individualist, especially in radio control. So don't be afraid to "gild the lily." END

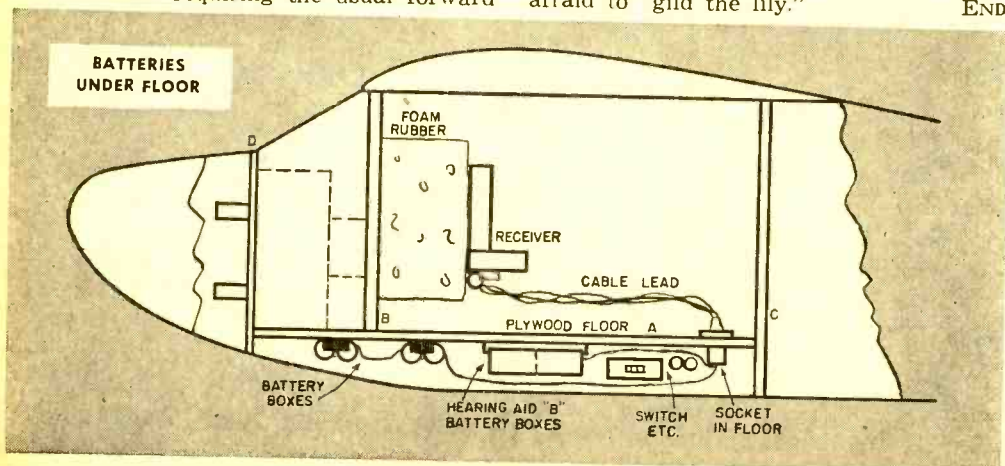

ECONOMICAL KIT BUILDS HI-FI AM TUNER

RECOMMENDED as one of the initial units for a binaural or hi-fi installation is the new V-5 AM tuner being sold in kit form directly from the manufacturer, *Approved Electronic Instrument Corporation*, 928 Broadway, N. Y. 10, N. Y.

Features of the unit are: self-contained a.c. power supply; tuning range, 530-1650 kc.; sensitivity, 5 microvolts; iron core tuned coils; tuned r.f. stage; and 3 section variable capacitor. Dimensions are 9 $\frac{3}{4}$ " x 5" x 5 $\frac{5}{8}$ ".

The complete kit of parts including tubes and pictorial and schematic diagrams is priced at \$24.50.

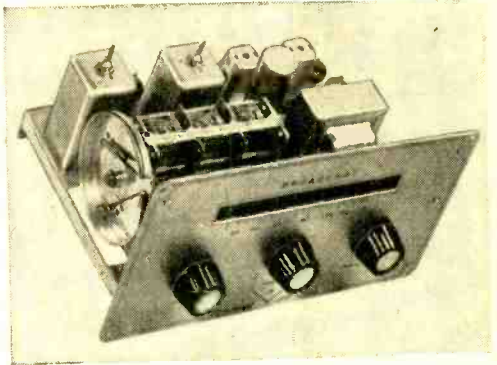

NEW LOW COST TV TOWERS MADE OF ALUMINUM

NEW economies in cost per unit as well as building costs are being realized with the new aluminum TV antenna tower being

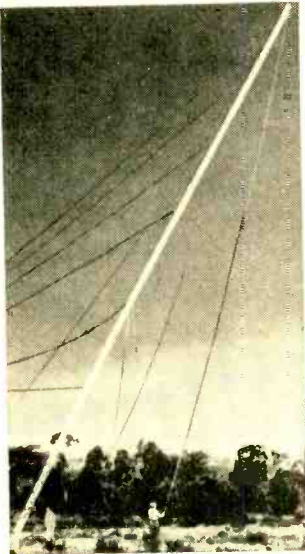

erected in the photo. Made by *Alprodco, Inc.*, Mineral Wells, Texas, the light weight tower is assembled from six-foot sections and raised with another section of aluminum tower acting as a boom. Five men did the job in one day. Similar towers have been installed in many areas.

SOLAR ENERGY OPERATES MIDGET TRANSMITTER

SOLAR energy is used to power this midget experimental transmitter built by Edward Keonjian, *General Electric* engineer at Syracuse, N. Y.

Self-powered and about the size of a package of cigarettes, the unit uses transistors instead of vacuum tubes, and selenium solar energy converters instead of batteries. When light rays strike the selenium, enough electrical energy is delivered to the transistors to operate the midget experimental transmitter.

The transmitter currently has a range of about 100 feet which could be improved, Keonjian says, by adding more selenium units, or by using germanium or silicon instead.

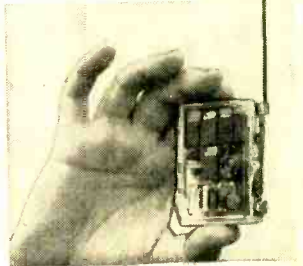

PORTABLE RADIO FOR LOUDSPEAKER OR HEADPHONE

NOVEL feature of the new *Rimenco 415A* portable radio, shown at the left, is a single earphone which plugs into a socket and cuts out the loudspeaker when operating on batteries. Reversing the plug permits earphone and loudspeaker to be used



simultaneously. In a.c./d.c. operation, the loudspeaker operates regardless of the phone plug position. The set is extremely compact, weighing

only 3 lbs., 11 oz. The *Rimenco 420A*, shown at the right, is an all battery portable smaller than the 415A. It features a unique switching arrangement which permits the set to operate at reduced power drain while the batteries are new.

As they age, a flick of the switch increases the set's gain. Distributed by *R. I. Mendels, Inc.*, of N. Y., they are made by *Matsushita*, Japan.

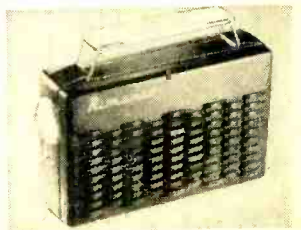

A Solderless B.C. Crystal Receiver

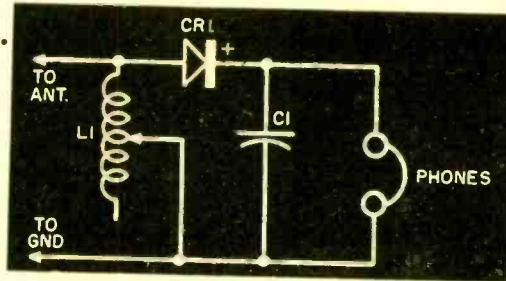

- C1*— $.001 \mu\text{fd.}$ tubular ceramic capacitor
- L1*—250 t. closewound #32 en. wire on $3/4"$ dia. wooden form
- CR1*—Steel galena crystal assembly (see text)
- 1—Pair high-impedance headphones
- 4—Fahnestock clips
- 5—#6 wood screws
- 1—Wooden base
- 1—Slider and contact (made from thin conductive metal strips)

THIS crystal broadcast receiver, although available in kit form, can be built from readily-available parts in virtually less time than it takes to read about it. Its most outstanding features are, of course, its simplicity and low cost. Its selectivity and sensitivity are obviously not as good as in other more elaborate crystal-type receivers.

The tuning coil mounts on the wooden base by means of two nails, driven from the underside of the base, and some airplane glue. The base should be grooved out to conform to the contour of the coil.

After winding the coil, as specified in the parts list, it will be necessary to remove the enamel over that portion of the wire on which the slider rests. A simple method of doing this would be to move the slider back and forth across the coil to wear a path through the enamel insulation.

As can be seen in the illustrations, the crystal supplied with the kit is a "cat-whisker" type. This is available from the company as a separate item. You can, however, use a standard 1N34 crystal diode in its place.

Connect the various components as shown in the schematic diagram. After completion, simply connect an antenna, ground, and a pair of earphones—and the set is ready for operation. The antenna and ground should be the best available in order to provide maximum sensitivity. The headphones should be of the high-impedance type, preferably 2000 ohms or higher.

Tuning is accomplished by moving the slider across the coil.

For those who prefer to work from a kit of parts, the receiver is available as the "Peppy Pal" from *Radi-Ore Labs*, 38 Oneida St., Lynn, Mass. The kit, which retails for \$1.50, contains all necessary components (earphones not included) and instructions. A photograph and diagram, if required, are available for an additional 30 cents. All prices apply to continental U.S. END

CLOTHESPINS PROVIDE PAIR OF "EXTRA HANDS"

THE couple of "extra hands" so often needed to hold a critical piece of work can be approximated by a couple of pairs of clothespins bolted back-to-back, as shown in the photograph. They can be made rigid, or be devised to bend in any direction. Any slender upright rod—wood or metal—can act as a support. Here, a wooden dowel has been inserted into a flat base. Further rigidity could be obtained by screwing the base itself onto the workbench. Note how the improvised "fingers" hold the delicate work while the technician's two hands are occupied. E.R.

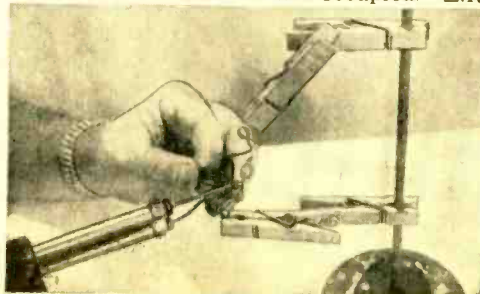



Sensitive Low-Cost Photo Relay

By HARVEY POLLACK



THE brief flare of an ordinary kitchen match at a distance of five feet triggers this sensitive little light-operated relay with startling decisiveness. Its response to small changes in light intensity, coupled with versatility, compactness, and low cost, is attained by a rather novel circuit design.

The arrangement has quite a few attractive features: (a) No transformers or high wattage resistors are needed. Hence a tiny $3\frac{1}{4}'' \times 4\frac{1}{2}'' \times 2''$ chassis may be used. (b) Besides the phototube, only one vacuum tube is required—a 117L7GT, operating directly from the a.c. lines. (c) Either a gas-filled or a vacuum type of phototube may be utilized. Direct interchangeability without alteration of circuit wiring or pin connections is made possible by incorporating a voltage divider which permits only half the line voltage to be applied to the electrodes of the phototube. This adaptability for phototube substitution provides a wide range of sensitivities to varying light values. (d) Either positive action (increased

light actuates controlled device) or negative action (decreased light actuates controlled device) is obtainable by moving a single external wire from one binding post to another at the rear of the chassis.

Positive action is desirable for garage door operators, floodlight actuators, automatic house lighting controls, etc. Burglar alarms, door annunciators, safety devices on machines and other similar applications are best handled by negative action which occurs when a beam of light is interrupted.

Construction

After the chassis has been drilled and punched, mount the octal sockets so that the keyways are facing *toward each other*. The sensitivity control, R_2 , and the binding posts or rear terminal block should be secured to the chassis next. If binding posts like those on the model are used, their mounting holes should be drilled at least $\frac{1}{4}$ inch in diameter, to make it easy to insulate them from the chassis.

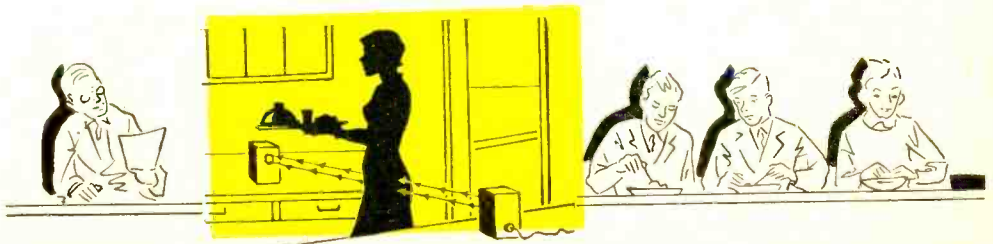

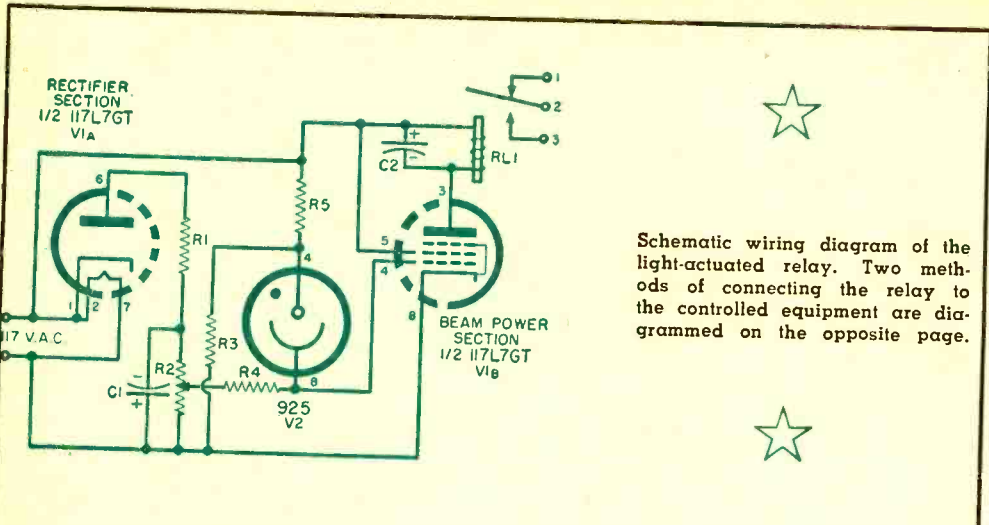

Schematic wiring diagram of the light-actuated relay. Two methods of connecting the relay to the controlled equipment are diagrammed on the opposite page.

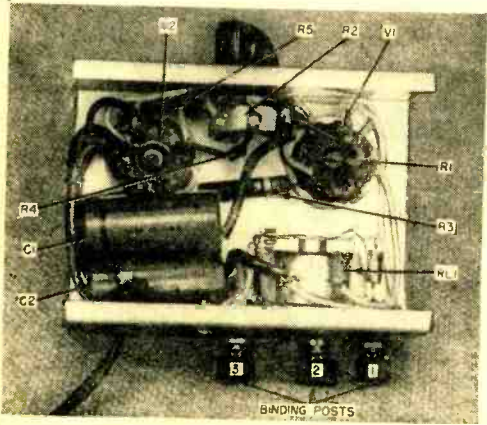

Bottom view of chassis showing placement of major parts.

- R₁—50,000 ohm, 1/2 w. res.
 - R₂—100,000 ohm pot, linear taper
 - R₃—250,000 ohm, 1/2 w. res.
 - R₄—1 megohm, 1/2 w. res.
 - R₅—250,000 ohm, 1/2 w. res.
 - C₁, C₂—8 μfd., 450 v. elec. capacitors (not dual capacitor with common terminal)
 - RL₁—5000 ohm plate circuit relay, s.p.d.t. (Potter and Brumfield Type LB5)
 - V₁—117L7 tube
 - V₂—Either 925 vacuum type or 1P40 gas-filled type phototube, depending on sensitivity requirements
- Miscellaneous parts: One aluminum chassis, 3 1/4" x 4 1/2" x 2", ICA Type 29077; two octal tube sockets; one knob with pointer; three binding posts, supplied with shoulder washers to permit positive insulation from chassis; line cord and plug; machine screws and nuts, wire, and solder.

Pictorial wiring diagram. Some terminals on the V2 socket are used as wiring tie-points.

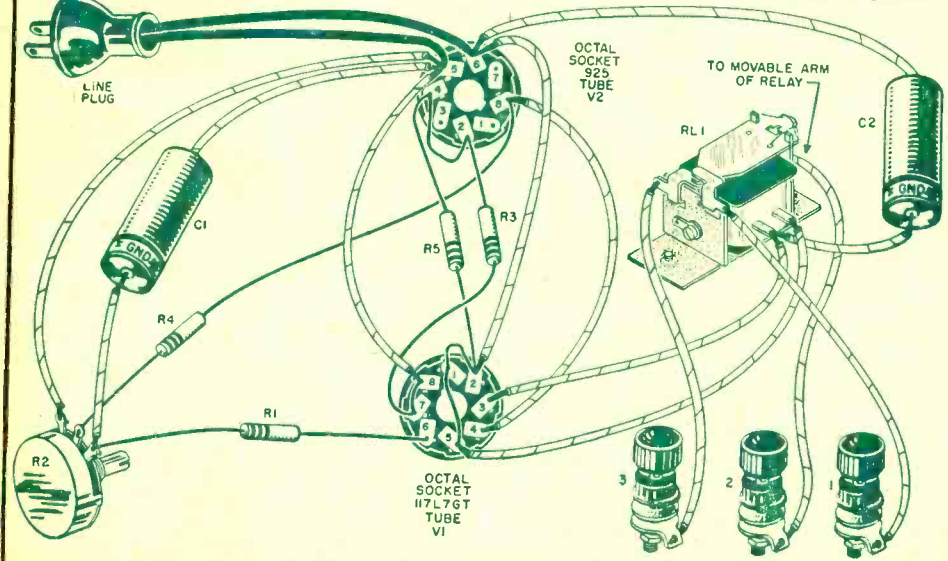

Begin the wiring by joining pins #1, #2, and #5 of the 117L7GT tube socket (right-hand socket in the photograph showing the bottom view of the chassis) by means of short lengths of uninsulated wire. Next, connect pin #7 to pin #8 of the same socket with bare wire. The remainder of the wiring may be handled as the builder sees fit, provided that he bears two precautions in mind: uninsulated leads are not to touch the chassis; and the polarities of the two electrolytic capacitors are to be carefully observed. Mention is also made of fact that lugs #2, #5, and #6 on the phototube socket are used as tie-points.

After the construction is complete, check your work visually to spot obvious errors or short circuits, if any. Using an ohmmeter or other continuity checker, make certain that all three binding posts are completely insulated from the chassis and that no short circuit exists between the prongs of the a.c. line cord.

Choice of Phototube

If you don't have a stock of phototubes—and how many people do?—you will want to purchase either a 925 or a 1P40. The one you buy depends upon the intensity of light to be used for control purposes and the light *differential* anticipated during the control cycle.

The 925 is a vacuum type; it is octal based and light sensitive on the concave side of the big cathode. (See drawing). The 1P40 is identical in all respects save one: it is filled with an inert gas which adds measurably to its sensitivity.

Use the 925 when you expect to have an intense source of light available. The 925 is a safe tube as it is not affected by short exposures to even very bright light.

If a low-intensity source is to be used, however, the 1P40 can be counted upon to provide the additional sensitivity necessary for reliable relay operation. It does have a weakness, though, which makes it somewhat more precarious to use. Exposure to intense light—even for a brief period of time—may deactivate its sensitive cathode surface or seriously change its characteristics.

Testing and Adjustment

Insert the 117L7GT in the proper socket, but leave out the phototube temporarily. Rotate the sensitivity control fully *clockwise*, then apply power. Allow about 30 seconds for warm-up.

Now, as the sensitivity control is slowly backed off in a counter-clockwise direction, a point should be found where the relay clicks in. Moving the control back and forth past this point should cause the relay to pull in and drop out with positive action.

With this condition established, darken the room or cover the phototube with a small cardboard carton and insert it into the remaining octal socket. Adjust the sensitivity control to the point where the relay

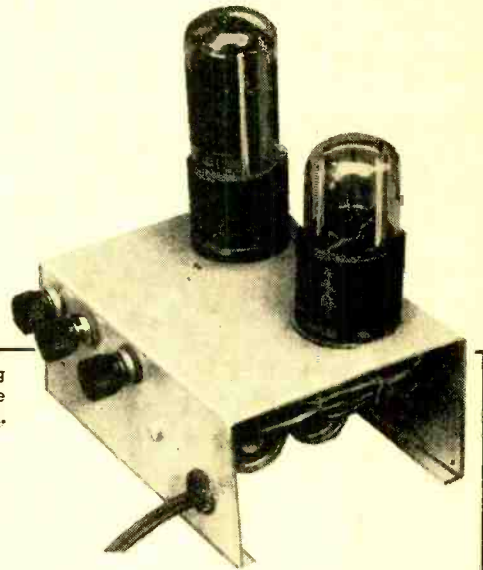

The completed photo relay; binding posts shown are connected to the circuit which is to be controlled.

Binding post connections to open a circuit (A) and to complete one (B), when light increases.

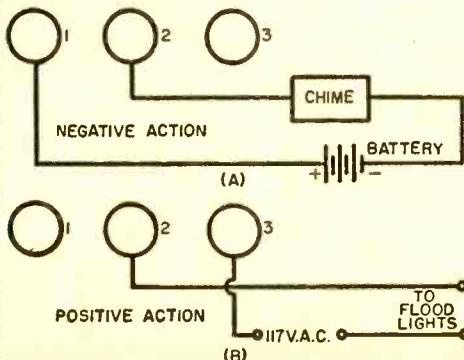

Proper orientation of phototube is with concave side of its cathode toward light source.

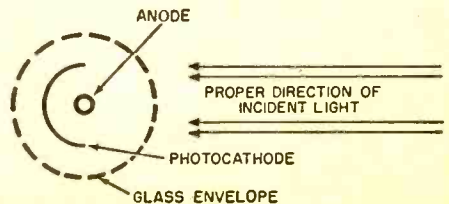

just fails to pull in. This is the setting for maximum sensitivity. Incidence and interruption of light falling on the sensitive cathode surface should now cause relay operation.

Trouble-shooting

Assuming that the wiring is correct and that the values of the components are not in error, there is very little else that can go wrong.

If the relay fails to pull in at all, with or without the phototube in its socket, measure the voltage between the plate and cathode (pins #3 and #8) of the 117L7GT with an a.c. voltmeter when the sensitivity control is fully clockwise. A reading of 75 volts or higher indicates that the relay is all right; in this case, the tube (beam power section) is probably defective. Should relay operation be normal for movements of the sensitivity control but inoperative for changes of light intensity, the phototube should be suspected if an a.c. voltmeter reading shows from 40 to 50 volts between pins #4 and #8.

Another type of trouble that may develop, especially with the gas-filled phototube, is positive latch-in of the relay with any light intensity or no light at all, and at any setting of the sensitivity control. If this occurs, the trouble lies in the phototube; it may be improperly "gassed," a defect which sometimes occurs in manufacture and which causes high gas currents even under dark conditions.

Look for extraneous light reaching the photo-cathode if operation is erratic. In some applications it will be necessary to provide the phototube with a little light-proof box having a window about one inch square directly in line with the cathode. It will be found that such a light shade improves sensitivity as well as stability.

Positive or Negative Action

The model was wired so that the center binding post, #2, was connected to the armature contact of the relay. This binding post is the "common" one on which the control wire remains for either positive or negative action.

When the photo relay is to be used as an

annunciator, for example, an interruption of the light beam across the doorway should cause a chime or bell to operate. This is negative action involving the use of binding posts #1 and #2 as shown in the sketch.

An application in which positive action is required as, for instance, where the headlights of your car activate the photo relay as you drive into your doorway to turn on floodlights, binding posts #2 and #3 are used. This is also shown in the sketch.

Principle of Operation

The rectifier section of the 117L7GT is used in "backward" connection; that is, it is hooked up in a manner such as to provide *negative* voltages across the sensitivity control. This is used as bias potential, adjustable by means of R_2 .

The first adjustment sets the bias just below the pull-in plate current. When light impinges upon the photo-cathode, a tiny current flows up through part of R_2 , through R_4 , and to the upper leg of the a.c. line through the phototube and R_5 . The voltage drop across R_1 is applied as a *positive* voltage to the control grid of the 117L7GT, cancelling enough of the bias to increase the plate current beyond the pull-in current of the relay.

Resistors R_3 and R_5 comprise a "50-50" voltage divider that never permits more than half the line voltage to appear across the phototube, keeping the potentials well within the rating of the gas filled 1P40. C_1 maintains the bias constant during the half-cycles of the a.c. line voltage when the rectifier section is non-conducting, while C_2 prevents relay chatter.

The use of the rectifier to provide bias has two very important advantages, both of which contribute to improved sensitivity and stability: (a) Line voltage fluctuations do not tend to trigger the relay because *both* plate voltage and screen voltage rise in a positive direction while the bias voltage goes in a negative direction and vice-versa. (b) Since there is no cathode resistor used for bias, degeneration is completely eliminated making much better sensitivity possible with the same circuit components. END

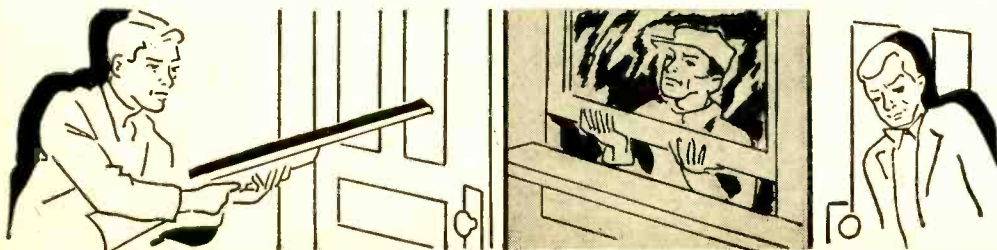



Typical transmitters for "ham" use are shown here. Check all the models you can and choose one that meets your needs.

So You Want To Be A Ham

GOING ON THE AIR

By ROBERT HERTZBERG, W2DJJ

Part 5. Choosing your transmitting equipment—both kits and assembled units can be had in a wide range of prices.

AFTER you've taken the ham license examination, and while you're waiting for your ticket to come through the mail from Washington, you will start to think seriously for the first time about a short-wave transmitter. "Seriously" is the right word because the price range of sending equipment is quite wide.

You can easily find something to suit your pocketbook and your tastes. Some transmitters are sold only in kit form, some only as factory-assembled jobs, and others in both forms. If you decide on a kit, you will have a lot of fun putting the components together, you will learn something about transmitter design and construction, and you will save as much as \$80. In the way of tools you need only a pair of pliers, a screwdriver, a couple of socket wrenches, a soldering iron, and about a yard of rosin-core solder. You can assemble and wire a small transmitter in about three evenings. One of the larger kits may keep you quite busy for a week.

"Isn't a transmitter rather complicated

for a beginner?" Every new ham seems to ask this question. The answer definitely is "No." The diagrams and instructions included with the kits are clear and explicit, and if you follow them step by step, you can hardly go wrong. Transmitters are much easier than receivers, not only to assemble but also to put into operating order. With an inexpensive little crystal plugged into the oscillator stage, you can tune up all the succeeding stages of even a big transmitter in a few minutes. To line up



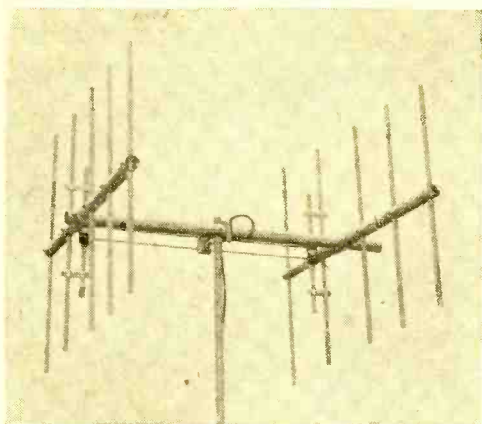

Telrex two-meter beam antenna is representative of a type used by many "hams."

the numerous circuits of a receiver, you need service-type test equipment that can cost as much as the receiver itself and for which you will have no further need after you've done the job.

Ready-made transmitters are, of course, a great convenience. Many hams prefer them because of their impressive appearance and because they are ready to go on the air as soon as connections to them are made for power, antenna, and key or microphone. It's a real thrill to unpack a new transmitter at 2:00 some afternoon and work your first station at 2:30!

The regulations of the Federal Communications Commission limit ham stations to a maximum of 1,000 watts input to the plate circuit of the final amplifier stage. A full one-kilowatt rig makes a very, very large signal on the amateur bands. Relatively few hams are able to take advantage of this generous allowance, simply because the power wiring in ordinary homes is not nearly heavy enough to feed the *complete* transmitter. As a general rule, a transmitter draws about four times as much power from the a.c. line as the nominal power rating of the final amplifier stage alone. On a common 115-volt line, a power demand of four kilowatts, at a reasonable power factor, means a line current of about 50 amperes. Individual circuits in a home are usually fused for 15 amperes and the main fuse is rarely more than 30 amperes. To operate a "full gallon," as hams often refer to a one-kilowatt transmitter, you need a special power circuit, preferably at 230 volts to minimize the line current and hence the size of the required service wires.

Transmitters rated at 400 to 500 watts are about as big as you can run safely in a home or apartment without burning up the place. A typical unit rated by the

manufacturer at 435 watts input draws $12\frac{1}{2}$ amperes at 115 volts from the line. This is about as much of a load as is taken by a standard electric iron. Although 500 watts is only half of the FCC allowance, it is still considered "high power" in ham circles. The majority of hams run much less—10 to 25 watts at first, and 100 to 150 watts after they acquire some operating experience.

As you might expect, the price of a transmitter is pretty much in proportion to its power. To give an idea as to what can be bought for specific sums of money, the following is a review of representative transmitters of the popular and generally available makes:

Heathkit Model AT-1: A kit job, with all parts down to the last nut and washer included, this transmitter is ideal for the new ham. It is intended primarily for c.w. work and does not include modulation equipment for voice transmission. However, a separate modulator can be added any time, a connector plug being provided for the purpose. The power rating is 25 to 30 watts. Plug-in crystals or a separate variable frequency oscillator can be used for frequency setting. Bandswitching is provided, and the user has the choice of the popular 10, 11, 15, 20, 40 and 80 meter bands. Three tubes are used: a 6AG7 oscillator-multiplier; a 6L6 amplifier-doubler; and a 5U4G rectifier. Grid and plate circuits are metered. The finished transmitter is housed in an attractive metal cabinet measuring $8 \times 13 \times 7$ inches. Kit price, \$29.50, tubes included.

Heathkit Variable Frequency Oscillator VF-1: This is an accessory for the Model AT-1 transmitter, and like it, is sold only in kit form. It uses a 6AU6 oscillator tube and an OA2 voltage regulator, and obtains its heater and plate power from a take-off socket on the AT-1. It can readily be adapted to drive any low-power transmitter that now uses crystal control. Kit price, \$19.50, tubes included.

Viking "Ranger" Transmitter-Exciter: Used by itself, the *Ranger* is a self-contained 75 watt c.w. or 65 watt phone transmitter, with 100% AM modulation and pi-network antenna load matching from 50 to 500 ohms. With suitable antennas, it operates in the 10, 11, 15, 20, 40, 80 and 160 meter bands, with either crystal control or from its built-in variable frequency oscillator. Complete shielding and filtering eliminate any tendency to cause interference in nearby television receivers. All controls and adjustments are conveniently located on the front panel. Bandswitching, frequency shifting, and all other circuit tuning can be accomplished in minutes.

If the owner of a *Ranger* gets bitten by the high-power bug, he can use the unit as an exciter for a full one-kilowatt amplifier stage.

The *Ranger* is available in kit form at \$179.50, less tubes, crystal, key and mike, and completely assembled and wired at \$258.50. The kit is designed for easy assembly. Wiring harness, punched chassis, all parts and hardware, step-by-step instructions, pictorial diagrams and operating instructions are included. The completed transmitter is very compact, measuring only 15 x 11 x 9 inches.

Globe Scout Model 40A: This is a general-purpose 50 watt c.w., 40 watt phone bandswitching transmitter, working on 10 through 160 meters. It is intended to fill the need for a compact unit in the low-power field for either fixed station or mobile use. The unit contains six tubes, including rectifier. It is crystal controlled, or can be driven by any external variable frequency oscillator (v.f.o.). Built-in antenna tuner permits use of any standard type antenna. For mobile use, a suitable dynamotor or vibrator power supply is connected through an auxiliary socket. Dimensions are 8 x 16 x 8 inches. In kit form, \$89.95; factory wired, \$99.95.

Globe Champion: This is a compact two-unit 150 watt transmitter for c.w. and voice which stands only 19½ inches high in a strong steel cabinet. It uses 17 tubes and two meters and operates in bands from 10 to 80 meters. In kit form, \$329.50; factory wired, \$349.50. The two units are also sold individually, so you can start with the r.f. section, work on c.w., and then add the modulator later when you have the money. C.w. transmitter only, kit form, \$165; factory wired, \$175. Modulator only, kit form, \$159; wired, \$169.

Globe King: This is classified as a "me-

dium high power" transmitter, being rated at 435 watts. It consists of three sections in a 28¼ inch TVI shielded steel cabinet. From top to bottom, they are the r.f. unit, the speech modulator with power supply, and the dual power supply for the r.f. section. A total of 18 tubes is employed. A special wooden crate is used for shipping purposes. The complete transmitter in kit form is \$495; assembled, \$515. The individual units are available as follows: r.f. section, kit, \$189.50; wired, \$199.50; power supply, kit, \$119; wired, \$129; speech modulator, kit, \$189.50; wired, \$199.50.

Barker & Williamson Model 5100: One of the newest transmitters on the market, the Model 5100 is of striking appearance. In spite of its compactness—it measures only 22 x 11 x 14¼ inches—it is rated at 150 watts for c.w. and 135 watts for phone. It features full bandswitching through six bands, v.f.o. or crystal operation, pi-network output, TVI suppression and built-in low pass filter. The unit uses 18 tubes. Factory-assembled only, this is a high-grade instrument and sells for \$442.50.

Hallicrafters HT-20: Designed in modernistic style to match the well-known Hallicrafters receivers, the HT-20 is a 100-watt table type c.w.-phone transmitter of rugged construction. The cabinet size is 20 x 12¼ x 17¼ inches. Twelve tubes are used. Sockets are provided for 10 crystals. An external v.f.o. can be employed if desired, a power take-off socket being included on the rear of the chassis. A single meter indicates current values in eight different parts of the circuit. Tight shielding and extensive filtering make the unit TVI-proof. Factory-assembled only, at \$449.50.

Collins 32V-3: Although this compact table-top transmitter sells for \$775 without accessories, it is probably the most sought-after instrument of its kind in the ham game. This admittedly high price for a rig rated at 160 watts c.w. and 140 watts phone pays for the following features: extreme accuracy and stability of the variable frequency oscillator; double shielding of the r.f. section; very thorough filtering and shielding to eliminate TVI; flexibility of operation; full bandswitching; and generally rugged construction. Overall dimensions are 21 x 12 x 14 inches. The weight is 113 pounds, which gives some idea as to the quantity and quality of components contained inside. Factory assembled only.

Antennas: Ham antennas assume weird and devious shapes. To get on the air quickly, easily, and cheaply, the best bet is probably a simple "half-wave" dipole made of flat 300-ohm transmission line. You can use common TV lead-in, but this is usually

(Continued on page 119)

Flat 300-ohm transmission line shown below can be fashioned into a simple, "half-wave" dipole antenna that will get you on the air.



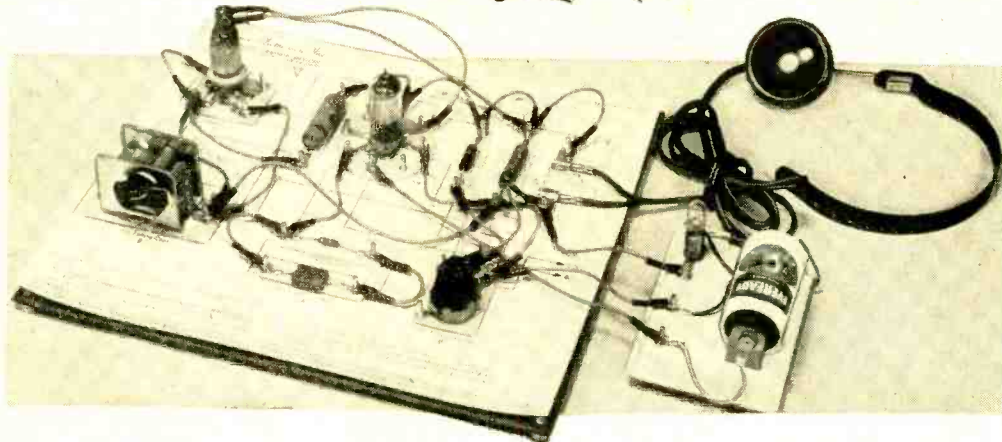

New Electronics Experimenters Kit

Without using solder or tools, your youngster can build fourteen real circuits with this Kit.

A NEW and different approach to learning electronics is embodied in the unique kit shown above. While it will serve for any beginner regardless of age, it is especially recommended for your son or other beginner who is interested in learning this subject.

Without the need for soldering or the use of any tools, and with the aid of special templates, a child can construct fourteen different circuits, from a simple crystal receiver to a one-tube radio receiver. Of special interest is a code practice transmitter that can be built. This unit sends signals that can actually be picked up, if desired, by any nearby receiver, such as the one in your living room.

Complete in every respect, the kit contains all necessary parts including the batteries that are used as power, a vacuum tube, crystal, headset, antenna and ground wires, connecting leads, and even a code sending key and base.

All connections are made by patented "Jiffy" clips which are simple, easy, and foolproof in operation and eliminate the need for soldering or using any tool. The "Jiffy" method of circuit hook-up is used in electronics courses in many high schools and colleges and has been found to be

practical and simple for circuit building.

The templates are especially valuable to youngsters for their educational function. For each circuit that the kit can build there is a separate template showing the point to point connections between components. This not only facilitates the actual construction, but teaches the builder something of the electronic theory behind the circuit. After he has built a circuit with the aid of the template, the youngster can then try to construct the circuit without the template, following only a conventional schematic. The instruction sheets that are included in the kit show the symbol, picture, part number, and name of each part in the kit.

This is not a "dead-end" kit that becomes useless when all its fourteen circuits have been built. Rather, additional parts may be added to expand the kit's usefulness so that it will function in ever widening areas of electronics. The kit is designated as Model T-100 and may be purchased for \$14.95 direct from the manufacturer, *Science Electronics, Inc.*, 485 Main St., Cambridge, Mass. A free sample "Jiffy" connector as well as descriptive literature are available on request to the manufacturer. END

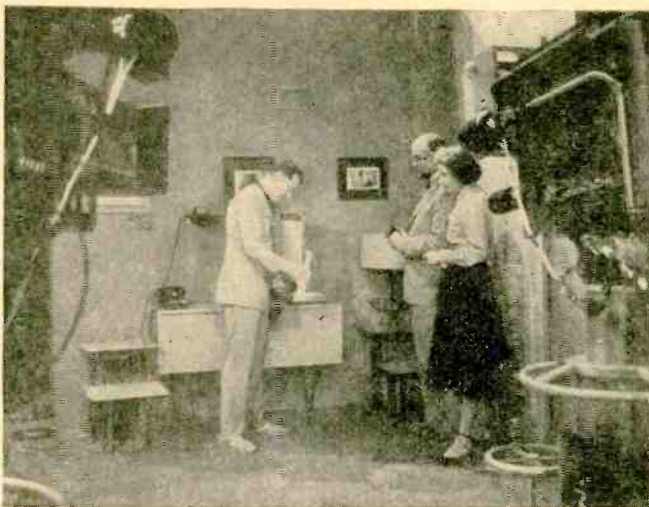

Hugh Downs shows actress Arlene Francis and artist Jack Coggins a mock-up of a new compact television set being developed by General Electric. The screen is light enough in weight to be hung on the wall. The set eliminates the bulk of the picture tube and its electronic gun. Transistors will replace conventional tubes. Color sets designed along these lines will probably be available in ten years.



Being marketed now is the pocket radio held by Mr. Coggins. Made by RCA, it utilizes transistors.

Electronics Shapes Home of the Future

THE increasingly important role played by electronics in our daily lives is indicated by the household items shown here. Presented by the *Natioaal Broadcasting Company* during its "World of the Future" telecast of the Home Show, these electronic devices are not science-fiction fantasies, but actual possibilities, which are now or will be marketed to the public. END

"Chef Phillip" demonstrates Raytheon's new "Radarange." It roasts a turkey in an hour, broils steaks in three and a half minutes, cooks corn and bakes potatoes in a few seconds. Home models are expected early this spring.



Microphone and loudspeaker connected to the base of this telephone enable you to answer it from a distance without lifting the receiver. Developed by Bell Telephone Laboratories, it is the first remote telephone on the market.

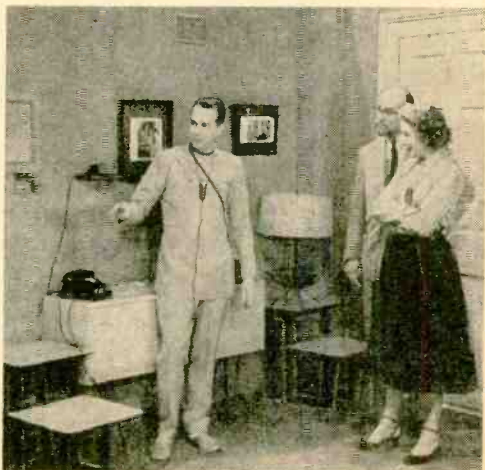

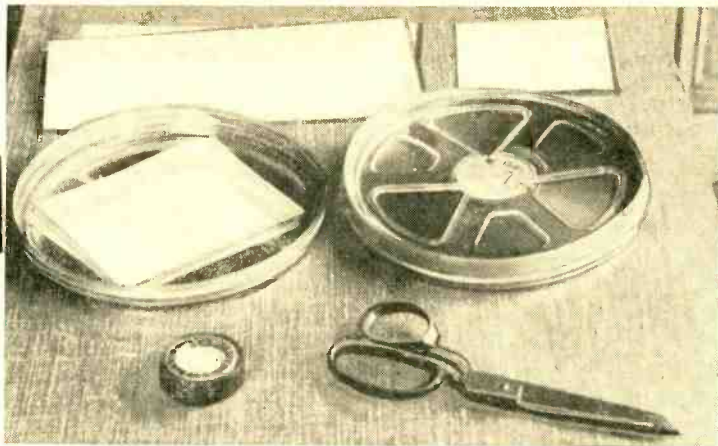

For proper archival storage of tape in can, dried blotting paper must be cut to fit inside the can on top and bottom.

LONG TERM archival storage of magnetic records should differ from temporary storage of the same medium. In addition to the physical conditions of storage, archival recordings should be recorded somewhat differently from those intended for short period storage. Engineering data, legal matters, and Junior's first immortal words (to *his* parents) might be the subject matter of long term storage—over a year from our point of view. Dictation to be transcribed within a few days, capers at a party for the absent guest, and radio or TV sound programs for the husband who was working at the time are examples of short term or temporary storage.

Before considering the physical conditions of storage such as humidity, temperature, and exposure to magnetic fields, the echo effect common to both tape and wire records should be discussed.

Perhaps you have rubbed a screwdriver against a magnet and have learned that it too becomes a magnet. Or perhaps you put the screwdriver in a leather tool pouch with a TV ion trap against the pouch and found a few days later that the screwdriver had become magnetized. Actual contact is not required for one magnet to magnetize another. The amount of magnetism induced in the screwdriver depends on several primary factors such as: *Magnetic intensity*, the magnetomotive force in the ion trap in this example; *Distance*, where the path is broken by an air or other nonmagnetic gap; and *Time*, time in proximity to the source of magnetomotive force.

A magnetic record behaves similarly to the simple example of the screwdriver and the ion trap. First, the process of recording produces a magnetic field on the record. This magnetic field varies with the sound which is recorded. Second, each individual

turn on a reel of recorded tape is near other turns. Its predecessor and the turn following it are separated by the thickness of the plastic base—a small distance. Furthermore, turns of tape several thicknesses away are still near magnetically speaking. The tape will remain wound on the reel for a period of time which is relatively long in archival storage.

A strong magnetic impression on the tape or wire may cause other unwanted magnetizations of nearby turns with the passage of time. Such "secondary" magnetizations are called "echo effects." As many as seven distinct echoes have been noted from a strong initial magnetization in a year.

Several things can be done to minimize echo effects. Firstly, we can record at a lower level to reduce the magnetic intensity of the recording—the lower the level the better. A simple procedure is to set up the recorder with the tape stopped, bring the microphone near the source of sound to be recorded until the peaks enter the overload range of the meter or indicator, and then move the microphone back—away—to three times the distance. By so doing, the playback volume will have to be advanced, but far less echo effect will be observed. Now, rewind the tape or wire loosely. If possible, rewind by hand on another reel. This increases the separation between adjacent turns of the tape and greatly reduces the magnetic effect of one turn upon its preceding and succeeding neighbors. In this rewinding procedure, a separator may be used, such as a blank tape or leader tape. Rewinding the tape each year will also reduce the echo effect.

Effects of Temperature and Humidity

Both high temperature and high humidity have their adverse effects on long term



Archival Storage

By J. A. McROBERTS

of Magnetic Recordings

tape recordings and wire records. It is easy to see how these agents cause corrosion of wire. Older wire made of iron can rust, although most recording wire is stainless or plated to be rust resistant. Tape base may be a good place for fungus growths to settle down and reproduce themselves, thereby damaging the plastic base of the tape and loosening the magnetic coating. Moisture may also cause the adjacent turns of the tape to stick together so firmly that the tape will break. At temperatures over about 85° F. the tape may lose its limpness—it has a special lubricant which helps it keep limp to conform to the contour of the heads. It will become somewhat brittle, adding to the possibility both of breaking and flaking off of the magnetic coating. About 50 per-cent relative humidity is the best moisture content in air at a maximum of 60 to 65 degrees Fahrenheit. Even lower temperatures and humidities are satisfactory.

Storage Containers

Archival records should be stored in cans similar to those used for motion picture film. The diameter of the tape with its reel will fit snugly in such a can, but will leave space in the depth (photo). This space can be used for some form of desiccating agent such as ordinary blotting paper cut in half. Several of these blotting sheets should be dried out in a vented oven to permit water vapor to escape and have been allowed to cool in the oven. These cool sheets are cut in half and placed on top of the reel of tape. While silica gel is a better desiccant, it has the bad feature of shaking out of the bags and making some parts of the tape too dry, thereby impairing its limpness. Blotting paper or any other unfinished paper stock will do as well. The cover is put on as soon as the paper is placed over the tape on its reel and is sealed with surgical adhesive tape or black electrician's tape.

Storage in such containers minimizes the possibility of exposure of the record to stray magnetic fields. The metal container acts

as a shield. Nevertheless, the tins should not be stored on or near electric power lines or other wiring which might generate a relatively powerful magnetic field. Even a weak magnetic field may cause deleterious effects over a long time interval such as several years. Some film storage companies will provide storage facilities for such containers. Most safe deposit companies will store them in their vaults at a fee which is less than the charges for a safe deposit box. Such space is called "silver storage" in some banks. Most safe deposit vaults are cool with low relative humidity. However, the container should not come into contact with a power line or even an extension cord.

Recapitulation

1. Record at the minimum level consistent with a desired reproduction of the weakest sound passages. Loud passages will become partially demagnetized with time, but very little change will occur in the weaker intensities of the record. The playback may be made on a machine equipped with an expansion control in order to correct the relatively greater loss of high intensities, and a tone control for some minor pitch changes with time.

2. Store in reels which have been re-wound by hand, preferably with a blank spacer tape in between.

3. Dry the container and the film with paper—dry paper—as the desiccating agent. The metal cans may be dried in an oven also if necessary. Cool the paper (cans too) prior to placing the tape and its reel in the container. If the tape is moist, seal up as described for a couple of days, open, remove paper, reinsert dry paper and reseal the can. If very wet, the process may be repeated as often as required until the tape is perfectly dry.

4. Seal the lid to the can proper with a good grade of relatively waterproof tape.

5. Store at 50 to 75 degrees Fahrenheit, away from magnetic fields. Rewind every year or two if possible.

END



HIGH-FIDELITY

RECORD NOISE

WHEN a person attends a "live" concert, music is heard at its purest and best. Outside of the occasional cough or sneeze or the rustling of a program there is no background noise which distracts attention from the music. When one is listening to the "concert-hall-at-home"—a good Hi-Fi system, one is all too unhappily aware of any number of noises which intrude upon the music. These include rumble and hum from the system itself and noise generated by the recording. While most Hi-Fi fans eventually get rid of the hum and rumble problem, it does take time—and usually money. Your musical enjoyment can be greatly enhanced at little expense by the elimination of record noises. This can best be accomplished by careful selection of the records you buy, how you play your records, and how you care for and store the records.

There are two main causes of noise on the modern long play record. One is the accumulation of static charges which are heard as "popping" and "crackling" sounds superimposed on the music. The other is a cyclic "scratch" and "hiss" and other noises caused by physical deformities of the record. The very first corrective measure you can apply to these problems is in the selection of the records you purchase. Examine the records most carefully for nicks and scratches. Vinylite is such a soft material that it is almost impossible to get a record which is *entirely* free of all blemishes. Fortunately, unless the nick or scratch is deep enough to cause a "furrow," it will not be heard. Test the suspected scratch by gently running the tip of one of your fingernails *across* the scratch in the

direction of record travel. If you can "feel" the scratch with your nail, it will surely cause a big "click" or "pop." Look particularly for what appear to be tiny humps or bubbles in the record surface. Even with the light 5-6 grams pressure of your pick-up, the stylus will eventually break through these bubbles and cause a huge "pop." Do not accept records which are full of fingermarks. They may not mean a thing, but chances are more than likely that the record was demonstrated a number of times, in the listening booth of the store. The styli in the playback equipment of the average store are usually osmium or at best, sapphire—both of which are usually worn to a chisel edge, and which will literally gouge the music from the record groove. If it is at all possible, *do not* listen to the recording you select at the record store. Most good record stores will allow you to take the record home with you to be played on your own system and return for credit or exchange if you find it defective.

Check the record for warpage and for an eccentric or off-center spindle hole. These off-center records will cause any sustained tones, such as are found in piano, organ and violin music, to "wow" or waver in pitch. The off-center record is a really big problem today and you must be constantly on guard for it.

Observe your pick-up arm on the record while it is being played. A "swinger," as they are called in the trade, will cause your arm to waver to and fro in a lateral motion across the disc. Hiss and static charges can best be taken care of by the use of anti-static preparations and devices now on the market. Most commonly used are liquids which are wiped or sprayed on the disc. Most of these work fairly well, but be careful to use the material sparingly and wipe off any excess. Too much of these liquids applied too often can result in the grooves of the disc becoming "gummy" with subsequent reduction of the high frequency response. There is a concentrated liquid known as "K-33," which is a very efficient record cleaner and anti-static agent. The

(Continued on page 112)



REPRODUCTION

DISC REVIEW

THIS month we will continue with the survey of high fidelity recordings of works that should be in everyone's basic library. You will recall that the records are chosen on the basis of *sound quality*. I do not mean to patronize anyone when I say that an appreciation of *performance* can only come with musical maturity. If the recording I list is concomitantly a good or a "best" performance, I will so state. After all, not everyone can have the discrimination of the musically trained person, but nearly everyone can tell the difference between a good or bad *sounding* recording. As with the previous column, works will be chosen from three major musical eras—the classical, the romantic and the modern.

Perhaps the most cheerful and melodic of all Beethoven symphonies is the Sixth, the *Pastorale*. It is also one of the few Beethoven works to which a "program" has been ascribed. If you have been fortunate enough to have seen Walt Disney's *Fantasia*, you may recall the almost perfect graphic example of Greek mythological figures cavorting in the fields and forests of the lush countryside and scurrying for cover when the storm breaks. When the storm is over the unicorns, winged horses, and other fabulous creatures reappear, and all is peaceful and serene again. There are currently sixteen recorded versions of this symphony. Of this number, six can truthfully be described as Hi-Fi in quality. Erich Kleiber's reading on *London* LL916 is, in my opinion, the best sounding of the six. Exceptionally smooth strings, very "live, breathy" woodwinds, and clean percussion are combined with just the right amount of hall reverberance for maximum "presence." Mr. Kleiber's performance is also first rate. Between Steinberg on *Capitol* P8159, Beecham on *Columbia* ML4828, Scherchen on *Westminster* 5108, and Von Karajan on *Angel* 35080, there is little to choose. All are good sounding recordings, with Steinberg's a shade better than the others in sound and with Von Karajan giving the best performance. Lastly we have the redoubtable Toscanini on *Victor* LM1755. While this recording barely qualifies as Hi-Fi, it is by all odds the best performance. Of course the final judge is *your* ear. Listen to all six of these recordings if you can. You can purchase any of them and feel certain that you are getting a modern, good-sounding recording.

One of the best known of all symphonic works

is Tchaikovsky's *Nutcracker Suite*. This too, was depicted in Disney's *Fantasia*, making the work familiar to countless thousands of people. Hardly a day goes by that this suite is not played somewhere in the world. And no wonder, for this is music with a universal appeal. Full of gay lilting melodies and brightly orchestrated dances, the various sections like the "Waltz of the Flowers" and "Dance of the Sugar-plum Fairies," are as well known to most people as the "pop" ballads of the day. Because of its wide audience, the work has been the subject of many recordings. No less than twenty-three versions exist, some of which are real "clunkers"! Five of the twenty-three can be considered Hi-Fi recordings. The best sound and incidentally the best performance is Stokowski's version on *Victor* LM46. There are a great many tricky little effects in the *Nutcracker Suite*, which are important to the over-all quality of the sound. Absolute clarity must be obtained from the triangles and celeste, from the high flute and piccolo passages, and the *pizzicato* of the strings. Stokowski has demanded and received this kind of recording from his engineers. Throughout, this recording is very clean and free of "fuzziness" in the strings which mars several otherwise good recordings. The other recordings, while all good enough to be Hi-Fi, have faults here and there which keep them out of the top spot. In order of quality they are: Fistoulari on *London* LD9130; Ormandy on *Columbia* ML4729; Von Karajan on *Angel* 35004; and Desormiere on *Capitol* P8140. One other recording should be mentioned. You may have noted that this work is listed as the *Nutcracker Suite*. This is because the music is actually taken from a complete *ballet* called the *Nutcracker*. This ballet contains all of the music in the suite and much more that is interesting and very colorful. Dorati and the Minneapolis Symphony have recorded the complete ballet on *Mercury* OL-2-101. This is a fabulous recording with the sections of the suite sounding even better than the Stokowski. Super wide frequency response and dynamic range in this recording, with tremendous bass drum and tympani sounds, combining with stunning cymbal clashes. Really Super-Fi, this one, and if you can afford the 2-12" LP's the work occupies, this is *it*. A superb "show-off" recording, that will tax the capacities of any system.

(Continued on page 124)

R/C

COMPOUND

ESCAPEMENTS

& SERVOS

By E. L. SAFFORD, JR.

THE more advanced the radio-control hobbyist becomes, the more functions he seeks to control on his model airplane, boat, or racing car. To effect multiple control operations, complicated escapements have been designed. Some of these will be explained in this article.

The escapement illustrated in Fig. 1 was created in order to obtain direct control over two physical functions using a single-channel type receiver. In model aircraft, for example, it is used to control both rudder and elevator. One particular advantage of this unit is that it only deflects the control surfaces in the "on" signal positions and returns both to neutral in the "off" signal positions. This is a safety feature of considerable merit.

Notice that this escapement consists of two two-finger escapement arms and catch-

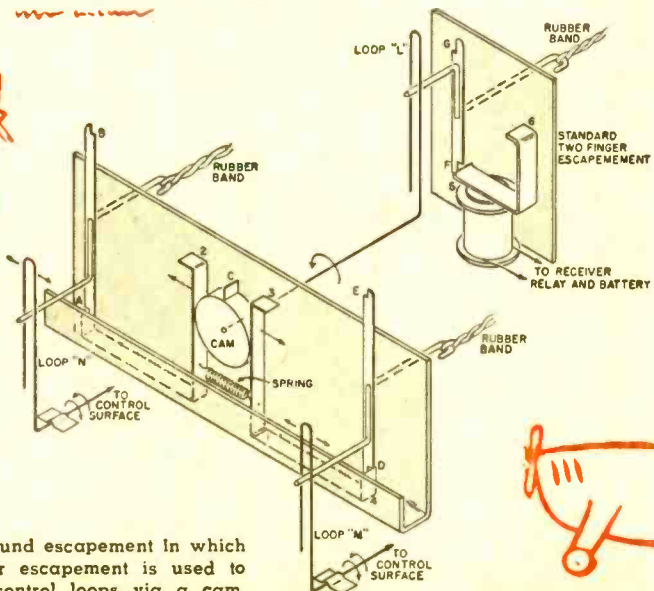
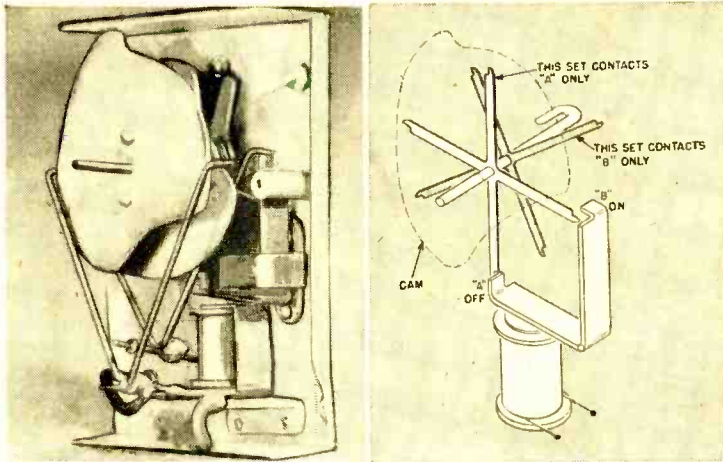

Fig. 1. A type 2 compound escapement in which one standard two-finger escapement is used to actuate two separate control loops via a cam.



Far left, Fig. 2. Back view of an ECCO compound escapement which uses two four-finger units and two cam wheels to actuate two "Y" yokes, each with its own shaft. This allows two control functions. Left, Fig. 3. Simplified drawing of the ECCO compound escapement showing how the four-finger units operate separately with a single solenoid.

points located on a single plate with a cam mounted between them. The cam has a small pin extension *C*. In the drawing, a small spring is shown holding catchpoints 2 and 3 firmly against the cam wheel causing 1 and 4 to rise up and intercept fingers *A* and *D*. This is the starting neutral position.

If now, a signal is sent causing the standard two-finger escapement to move finger *F* to position 6, the cam is caused to rotate 90 degrees counterclockwise pushing catchpoint 2 forward causing catchpoint 1 to move down, releasing *A*. As *A* rotates clockwise, finger *B* is intercepted by catchpoint 2 and held. Loop *N* is deflected to the left.

Now assume that the signal ceases. The arm on the standard escapement rotates another 90 degrees until *G* is intercepted by 5. Through loop *L*, the cam is rotated another 90 degrees, allowing catchpoint 2 to be pulled back by the spring and forcing *I* up to intercept *B*. Loop *N* is again at neutral.

Another "on" signal causes the cam to push catchpoint 3 forward to intercept *E*, deflecting loop *M* to the right. An "off" signal sends the cam back to the starting point, leaving *E* held firmly by 4 and loop *M* again at neutral.

Tracing the action through a second revolution of the cam will show that first loop *N* is deflected to the right, then brought to neutral, then loop *M* is deflected to the left, and brought back to neutral. It has taken two complete revolutions of the cam to go through the complete cycle of operation for both loops.

Although it is necessary to go through the complete cycle in order to effect any one desired control and return to the original starting position, this is not necessarily a disadvantage if the operation is done fast enough. Other surfaces may

move, but will not be held in a deflected position long enough to affect the steering.

Another multiple escapement, this one sold by *ECCO*, is illustrated in Fig. 2. The back cover has been removed in order to reveal the special working parts. It, too, allows control over two physical functions. It is a single, self-contained unit requiring but a single rubber band for power.

The movement of the two output shafts is obtained through the use of the two specially shaped cams, the two "Y" yokes, and two sets of "four-fingers" which engage the armature catchpoints. The two catchpoints are offset from each other so that only one set of fingers contacts the "on" catchpoint, the second set contacting the "off." This is illustrated in Fig. 3.

If the outer cam of Fig. 2 were to rotate 90 degrees clockwise because of rotation of the fingers, the protrusion of the cam would force the left half of the "Y" yoke to the left. At the same time the indented portion of the cam is moved opposite the right half of the yoke, allowing motion to the left. Another quarter revolution returns the "Y" to neutral. The third quarter revolution moves the "Y" right, and the final 90 degrees returns the "Y" to neutral and the cam to its original starting position. This action has taken place in four steps.

Since there are two sets of "four-fingers," mounted as illustrated in Fig. 3, there are actually eight catch positions instead of just four. Thus, with the proper placement of the two cams, the signal sequence is as shown in Table 1.

Notice that the deflection of the yokes occur only in the "on" signal positions. This again is a fail-safe feature.

Servos

First, to remove any mystery that might be connected with the word servo, this

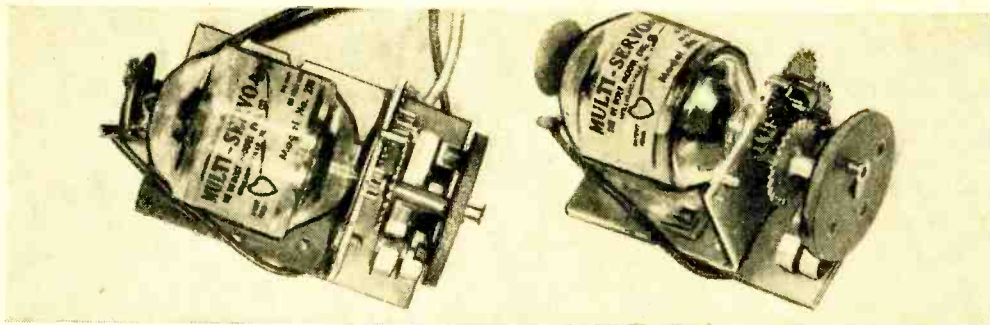

Fig. 4. Top and side views of a typical servo unit for radio control. Motor is about 1" wide.

word comes from the Latin and means slave. Since slaves were once used to do the hard physical work, the word in modern electronic parlance has come to mean the unit which furnishes physical power in a control system; in particular, motors.

The De Bolt 2PN "Multi-Servo" shown in Fig. 4 is an electric motor with associated reduction gears, switches, and anti-coast device. It can be used in the same manner that the standard two-finger escapement is used to move control surfaces. The designation 2PN indicates its operation. This stands for "two positions—one neutral."

Examination of Fig. 4 will reveal the small brass terminal on the face of the fiber disc to which the linkage to the control surface is fastened. Notice also the two brass switches mounted below and behind the output disc, and the small fiber pins on the inside of the fiber disc which open the switches at the proper time.

Comparing this unit to escapements highlights the following:

1. No rubber bands are required.
2. Servos are small and lightweight (2 ounces).
3. They have fast response and are reliable.
4. They require conservative battery

power (2 pen cells or their equivalent).

5. They are failure-safe in case of receiver failure.

6. They consume no power in any control or neutral position.

7. They are rugged and compact.

8. They have a simple and definite control sequence. The sequence is easy to remember and transmit using a standard pushbutton, it is "off" for neutral; "on" for left; and "on-off-on" for right.

Fig. 5 shows a typical wiring setup for a servo. Notice the fiber disc and the fiber shafts labeled *N*, *R*, and *L*. In the position shown, neutral, shaft *N* is depressing switch 2, opening its connection to *D*. The shaft does not open switch 1 since this switch is located lower than switch 2 and shaft *N* is placed nearer the center of the disc than *L* or *R*.

Let's trace through a signal sequence to see the operation. First an "on" signal is transmitted. The armature of the receiver relay *F* is pulled down to make contact with *G*. This lets power flow from the battery through the relay to *B* of switch 1. *B* is making contact with *A*, so the power goes through this switch to one side of the motor. The second motor lead is permanently fastened to the battery, so the motor runs, turning the fiber disc in a

Fig. 5. Physical drawing indicating how a servo may be used in a radio-control model airplane for proportional control of the elevator. It can be used also for the rudder.

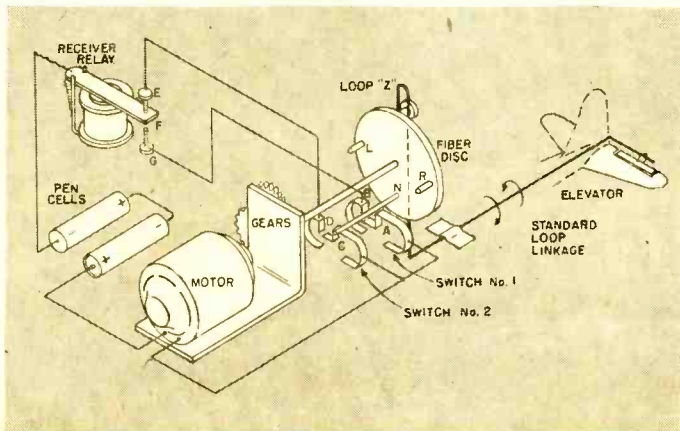

clockwise direction until shaft *R* opens switch *L*, breaking the circuit and causing the motor to stop. As the fiber disc rotates, it moves loop *Z* to the right, giving down elevator. As long as the signal is sent, the loop will remain deflected, but since the circuit to the motor is open, the servo consumes no power.

Now the signal ceases. The receiver relay armature moves from *G* to *E*. Power now flows through switch *2* to the motor, causing it to run again. It runs until shaft *N* opens switch *2*, opening the circuit. Loop *Z* is back to neutral.

To get up elevator, the sequence is "on-off-on," holding the second "on" as long as this control position is desired. It is important that the sequence be sent at a medium rate and not too fast. The first "on" causes the motor to run as before, but instead of stopping, the "off" signal comes and routes power through switch *2* while

TABLE I		
SIGNAL	CAM #1	CAM #2
"ON"	"Y" Left	"Y" Neutral
"OFF"	"Y" Neutral	"Y" Neutral
"ON"	"Y" Neutral	"Y" Left
"OFF"	"Y" Neutral	"Y" Neutral
"ON"	"Y" Right	"Y" Neutral
"OFF"	"Y" Neutral	"Y" Neutral
"ON"	"Y" Neutral	"Y" Right
"OFF"	"Y" Neutral	"Y" Neutral

switch *1* is being opened up by the shaft *R*. The second "on" comes as *L* approaches switch *1*, and since this signal is held, the motor stops running when *L* opens switch *1*. The loop *Z* will now be right, giving up elevator. When the signal stops, the motor again returns the loop to neutral. While the illustrated action has concerned the elevator, it should be mentioned that it works as well for rudders or steering wheels. END



A PORTABLE GEIGER COUNTER

DESIGNED for uranium prospecting is this new portable, battery-operated Geiger counter. It features rugged construction, two sensitivity ranges, built-in loudspeaker, supersensitive lightweight probe, and a large count meter that can be read at arm's length. The unit measures 10" x 4 1/2" x 5 1/2". Known as Model F-6, it is made by *Technical Associates*, 140 West Providence Avenue, Burbank, California and retails for \$159.50.

A NEW RECEIVER FOR RADIO CONTROL

NAMED the "Telecommander 951B," this new subminiature R/C receiver utilizes a 3Q4 tube in a permeability tuned circuit. The built-in 6-pin plug accommodates all external connections. A 6-pin socket is supplied. This set uses the same circuit as Model 951A, but includes the P-100 relay. The set is ready to install and operate and is fully guaranteed by the manufacturer. It weighs 3 oz. Priced at \$21.95, it is available from hobby dealers or from *American Telasco Ltd.*, Huntington, N. Y., the American distributor for the manufacturer, *ECC (Telecommander) Ltd.*

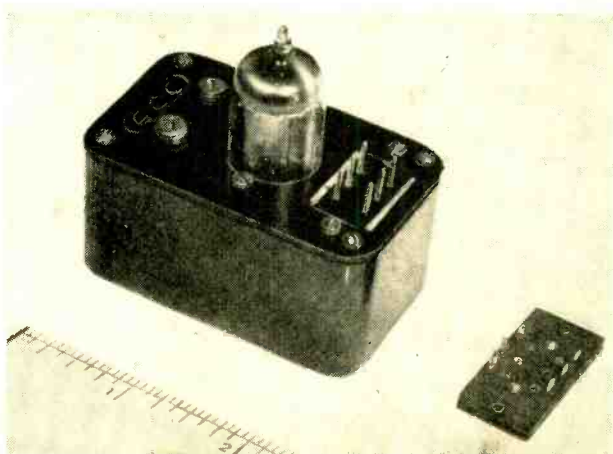

By JOHN T. FRYE



TWO DETECTORS

AT JERRY'S INVITATION, Carl had accompanied him to Carter's Feed Store on their way home from school. Not until they were inside the store did the long and rangy Carl learn that his chubby companion had a reason behind his invitation: he wanted help in carrying home some of his recording equipment that was at the store. Jerry thanked Mr. Carter profusely for something—Carl could not make out exactly for what—and the two boys started home. By some chance Carl found himself carrying the tape recorder that weighed a good thirty pounds, while Jerry padded along carrying a timer clock whose weight could be measured in ounces.

"You know," Carl ruminated aloud, "I used to wonder why you didn't take up with a good strong packhorse for a chum instead of me; but then I realized you would have to feed a horse!"

"Let's not be bitter!" Jerry said as he delicately steadied the clock on top of his flat-top crewcut with the right forefinger while, with his left hand on his hip, he minced along with the exaggerated prance of a baton twirler beside the trudging Carl. "You are a victim of what might be called *muscle oblige*, which is French for, 'Them as has muscles have gotta use 'em.'"

"That's so nice to know," Carl observed sarcastically. "Why did you have this recording junk down at the feedstore, anyway?"

"I wanted to make a recording of rats squealing, and that store has got the rats. I nailed a piece of meat to the floor just under the microphone and set this timer clock to cut the recorder on for fifteen minutes around midnight. I figured that by that time the rats would be having a real ball and I ought to get some dandy squealing."

"And why," Carl patiently pursued, "did you want a recording of rats squealing?"

"For the new party game tape I'm

working out called *Horror Story Sound Effects*. On this tape will be several sound effect strips, each one representing the sounds that might have been heard in an important scene from a well-known horror story. At a party this tape will be played in the darkness and the guests will try to guess the title of the story represented by each sound effect. As an example, I rasp a mason's trowel across a brick a few times, rattle a chain, and give a muffled crazy laugh with the microphone shut up in my clothes closet. That represents the scene where Fortunato is being walled up in *The Cask of Amontillado*, by Poe."

"Hey, that's keen," Carl applauded.

"For *The Pit and the Pendulum*, I want to use the sound effect for the story's climax where the swinging crescent of sharp steel is just about to cut into the victim while the rats are squealing and fighting as they gnaw at his food-smearred bonds. Swishing a wood lath back and forth in front of the microphone takes care of the sound of the swinging knife, but nothing sounds like a rat squealing but a rat himself."

"Well," Carl observed as they reached the basement entrance of Jerry's laboratory, "We'll soon know what we've got on the tape."

In a few minutes the recorder was set up and the boys were listening intently to the faint rustling sounds coming from the speaker. At first, these were the only sounds heard, but after a few minutes the rats apparently became accustomed to the slight noise made by the running recorder and returned to their feast. As they did so, their fighting and squealing rose to a crescendo which was all Jerry could want. He reached over to switch off the recorder, but just as he did so a sound came from the speaker that stopped his hand in mid-air. It was a man's gruff voice, faint and muffled, but clearly understandable:

"You're late. How come?"

"The job took longer than I expected," a younger man's voice replied. "She took an awful lot of choking before she finally died and I had to drag her into the garage."

"No one saw or heard you, did they? Those Hollywood types get a lot of attention."

"I'm sure they didn't. Now I've got another problem. The boss says I've got to get rid of the body right away. How about your helping me dump it tomorrow night?"

"Okay. Do you think we ought to cut it up first to make identification impossible?"

"That won't be necessary. We can just throw the body on your flatbed truck and spread a canvas over it and then drive to that old abandoned stone quarry west of town. Once it's at the bottom of that, no one is ever going to find it."

"All right, I'll be over at your place with the truck about twelve-thirty tomorrow night; then we can—"

At this point the slapping of a freed end announced that the short tape had passed through the machine.

"Holy cow!" Carl breathed softly, "What a time to run out of tape! We've been listening to a couple of murderers."

"And the victim must have been a pretty Hollywood starlet," Jerry said, his staring round eyes matching his round face. "That microphone was hanging just below a window that opens out into an alley. Those killers must have been standing just outside that window."

"Well, what are we waiting on?" Carl demanded as he jumped to his feet. "Let's take this recording down to the police."

"Hold on," Jerry admonished. "Don't forget that since the police found we were behind that startling-scaring business, we are not exactly the fair-haired boys with them. If we take this down there now, they will think we cooked the whole thing up ourselves."

"Surely you're not going to just sit there and let those crooks get away with choking that pretty little starlet to death, are you?" Carl demanded as he paced impatiently up and down the laboratory.

"No, but we've got to go at this calmly," Jerry announced as he assumed his favorite position on the couch with his head pillowed on his clasped hands. "After all, the crime has already been committed, so we can't stop it from happening. What we want to do is make sure the murderers are punished, right?"

"I guess so."

"We know they are going to try and dispose of the body tonight shortly after midnight; and we are both familiar with

the quarry where this is to take place. All we have to do is let them try to carry out their plan and then arrange for the police to catch them right in the act."

"And just how, if I may be so bold as to ask, are we going to manage this little thing?"

"Suppose tonight we ride our bicycles out to the west edge of town and take along a couple of those two-meter walkie-talkies our radio club built up for Civilian Defense work. One of us can station himself at the stone quarry, and the other can stay close to that all-night drugstore at the edge of town. That means we'll only be about a mile apart and can communicate with each other easily. Then when you—I mean when the person at the quarry sees the truck turning into the quarry gate he can flash the word to the fellow at the drugstore. This fellow can then telephone the police to send a squad car to the stone quarry. After the squad car has arrived and caught the cold-blooded killers right in the act of disposing of the body, we can come forward and modestly admit we were the detectors—I mean the detectives—who engineered the whole clever affair. Any questions?"

"Just one," Carl said slowly as he glowered suspiciously down at the reclining figure of his chum. "Who stands watch at the quarry?"

"Why, Carl," Jerry said with round-eyed elaborate carelessness, "I hadn't even thought about that, but I'd better take the job. Of course, since I'm short-legged and a little inclined to be pleasingly plump, I couldn't run very fast if something went wrong, and the men would be sure to catch me and send me down to the bottom of the quarry too, but that's all the more reason why I wouldn't want my best friend to take any chances, even though he is the fastest sprinter our high school has ever had. After all—"

"All right, all right!" Carl interrupted. "I'll go to the quarry; but don't think you suckered me into it. It's just that I'd as soon be scared to death as talked



to death. I'll get the gear together and see you back in the alley about eleven o'clock."

But Carl did not get out of the house at eleven. His folks were watching the late TV show, and it was impossible for him to get out of the house without their noticing until almost a quarter to twelve. The two boys rode their bicycles swiftly to the edge of town and there they parted. Jerry took up his vigil in a dark shadow beside the drugstore, while Carl bravely rode off into the darkness along the road leading past the quarry.

It seemed a long time before Jerry suddenly heard Carl's welcome voice in the earphone of the walkie-talkie pressed close against his ear: "W9CFI, this is W9EGV calling. How do you copy?"

"Five by nine," Jerry said softly with his lips almost touching the mike of the transceiver. "Where are you?"

"Under the bridge that leads off the road into the quarry," Carl reported. "This ditch is dry and deep enough for me and my bike both to get under here. What time is it?"

Jerry cautiously peered around the corner of the building at the clock hanging in the front window before he announced, "Twelve forty-five. See anything of the murderers yet?"

"Don't use that word!" Carl said hoarsely. "I hope this doesn't take long. It's not exactly cosy under this bridge."

"I believe that," Jerry said, "because I can hear your teeth chattering."

"Hey, I see a pair of lights coming down the road," Carl announced excitedly. "I'm

going to duck back under the bridge, and if you hear the truck pass over, get ready to make that phone call *my pronto*. It's getting closer; now it's slowing down—" his voice trailed off at this point, but he kept the transmit switch held down, and Jerry could distinctly hear the hollow rumble as a heavy vehicle passed over the wooden bridge.

"It's them," Carl said in a hoarse whisper with a reckless disregard for his English. "Make that call and ride out here as fast as your fat little legs will carry you. I may need help."

Waiting to hear no more, Jerry tossed the transceiver into the basket of his bicycle and slipped into the phone booth of the drugstore. He dialed the already-memorized police number and tucked his chin down so as to make his voice come from his chest, rendering it—he hoped—deeper and more mature. As soon as a man's voice answered, he carefully intoned: "Listen carefully. Two murderers are disposing of the body of a victim at this very moment at the old stone quarry a mile west of town. If you send a squad car immediately, you can catch them in the act."

Then, without waiting for an answer, he quietly hung up the receiver and slid out of the drugstore. Now, ordinarily Jerry had an almost pathological aversion to exercise in any form, but let it be said to his credit that this once he did not spare the horse power as he pedaled swiftly down the road toward his friend in danger. The night was dark, and he kept his

(Continued on page 122)

Aluminum Jaws Protect Work in Vise

SMALL metal brackets and other parts may get nicked and scratched when clamped in a vise. Avoid such damage by borrowing a trick from professional machinists and provide a set of smooth-face, soft metal jaws for the vise. You can make them in a few minutes, using the new "Do-It-Yourself" aluminum available at hard-

ware stores. Get an extruded angle 1" x 1" x $\frac{1}{16}$ ". Cut and bend it as shown in the sketch. Make up two pieces and slip them over the vise as shown in the photograph. Small and relatively delicate parts may now be held in the vise without fear of damage.

L. E. G.

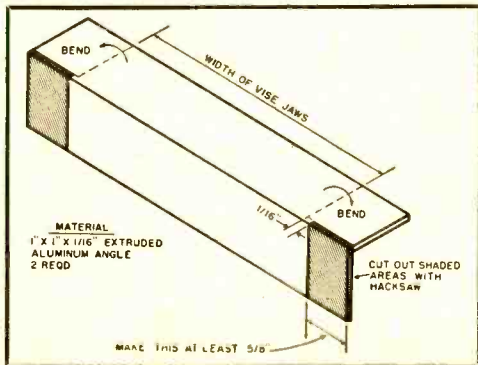
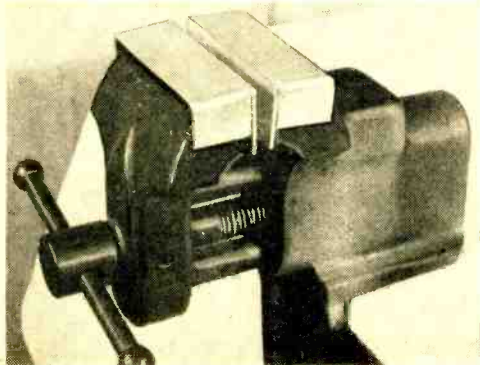



Make Use of Jobbers Catalogues

ANYONE who has ever yearned for a piece of electronic equipment that is more technically advanced than, say, an ordinary lamp cord socket, knows that such items as switches, resistors, relays, and often tubes cannot be found at local hardware stores or at the neighborhood service shop. The source for parts and components—such as you would need to build many of the devices described in this magazine—is generally a large supplier who sells to the amateur and professional technician alike. This supplier is known in the industry as a "parts jobber." The link between manufacturers and the public, a jobber may carry everything from a \$1000 sound system to round-head screws.

Knowing what the jobber has means knowing what you can get. For this reason, the jobber's catalogue is of tremendous service to anyone seriously contemplating the purchase of parts, whether it be to stock his own repair shop or to build a device for his own amusement.

A brief run-down on what is contained in a typical catalogue, published by one of the larger jobbers, will give you an idea of how you can benefit by owning and consulting it.

The catalogue contains many pages that list parts, components, tools, instruments, kits, and even technical books available for purchase. Descriptions of these items include both general and technical specifications as well as illustrations. In addition, many include recommendations for specific use and special applications. Simply thumbing through the catalogue is an education, since it provides you with technical and commercial insight into these items, gives you a broad picture of the parts field, and helps you plan toward your own needs.

In addition, the catalogue contains mail

order instructions and provides forms for convenient ordering through the mail. This is of particular value to those living in rural areas which may be inconveniently located when it comes to direct, over-the-counter purchase of parts. The catalogue also describes the special services that a jobber will provide on request, such as advice on particular problems. Finally, the catalogue contains two indexes—one on the products and one on the manufacturers.

These catalogues are revised and reissued every year. Getting them successively enables you to compare new models with previous models, check up on changes and improvements in various parts, compare prices and other trends that affect the radio-TV industry as a whole and that, to an extent, reflect the overall state of the nation's economy. Moreover, once you are on a jobber's mailing list to receive his catalogue, the chances are you will receive all subsequent "mailers" he may send out—many of which contain valuable up-to-the-minute information.

Some jobbers are specialists in one field of electronics. Their catalogues, in addition to all the material just described, generally include additional information on the subjects related to the special parts they sell. This is especially true of audio and hi-fi equipment houses which usually furnish a brief "course" on hi-fi in such catalogues.

Perhaps the sweetest thing about it is that these catalogues are usually free. They are mailed, with no questions asked, to anyone requesting them. For a listing of parts jobbers who offer such catalogues, may we suggest consulting the various advertisements in this and other issues of POPULAR ELECTRONICS. **END**

"Robot"



This printed circuit section represents approximately 50 per-cent of the complete chassis and is produced by automatic machines. Result is lower cost TV set.

Large drawing of circuit layout is photographed with huge camera that reduces it to actual size negative. "Picture" is then printed on aluminized plastic sheet.

Printed circuits are inspected and retouched wherever needed. Large boards are then cut and punched with holes to receive parts and wiring.



Speeds TV Production



REVOLUTIONARY high speed robot machines that automatically assemble printed circuits for almost half of a television chassis in a matter of seconds are now used by the *Admiral Corporation* of Chicago. *Admiral* predicts that the highly mechanized TV production line eventually will have the same effect on the electronics industry that Henry Ford's moving chassis assembly line methods had on the automotive industry over 40 years ago.

The printed "Robot" chassis assembled by automation has made possible for the first time a TV set utilizing a giant aluminized 21-inch, 90-degree tube with a 270-square inch picture and a full 18-tube vertical chassis for only \$149.95. **END**

Printed circuit boards receive electrical components from automatic assembly machine shown below. Affectionately named "Robot I," equipment is 30 feet long.

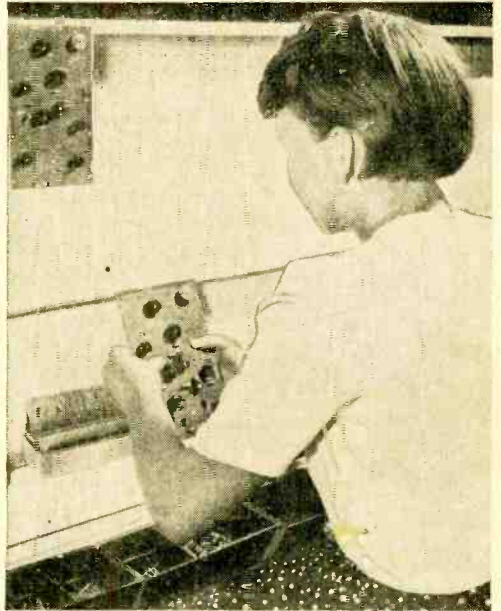

Final assembly on printed circuit layout is done by hand. Increased output has enabled firm to hire additional employees.



When all components have been mounted on printed circuit board, the underside is dipped in molten lead solder as in photo at right. This connects crimped ends of leads to copper pattern of printed circuit.





THE WORLD AT A TWIRL

By K. R. BOORD

MANY short-wave listeners (SWL's) believe in the old saying, "The proof of the pudding is in the eating!" Hence, they collect verifications. Why? Some SWL's have a desire to feel that they have a small, active part in the general business of short-wave broadcasting. Some listeners try for verifications from different countries regardless of distance. To verify all continents (VAC) is a common goal. Others attempt to verify all zones which is quite an achievement! Still others go after a high percentage of extremely distant stations. And some DX-ers try to verify only low-powered transmitters.

Sending reception reports to stations heard and obtaining *verification (QSL)* cards from them to confirm their reception are considered by many SWL's as the most interesting parts of the DX hobby.

Some stations confirm by QSL card, others by QSL letter. A few organizations such as the British Broadcasting Corporation (BBC), which has its own monitoring service throughout the world, do not verify at all.

In reporting to short-wave stations, it is well to remember that the broadcasters want to know how well their transmissions are received in your locality, under what conditions, and what effect they have on you—the listener. Therefore, make every report complete, clear, yet concise. Use a personal, friendly touch! Cover at least 15 minutes of any broadcast—preferably more—for each frequency you wish verified. Reception details over a period of several days—that is, five or six 15 minute periods on different days rather than an hour or so at one time—are of greatest value to a broadcaster because this proves whether or not it was "freak" reception.

Give the date and report in *Greenwich Mean Time (GMT)* on a 24-hour clock basis (see footnote on use of GMT). List the frequency on which the station was heard, give the signal strength, state the interference (*QRM* and/or *CWQRM*—that is, *code QRM*)—from other stations and the source if you know it, *QRN* (*static*, giving the type), *QSB* (*fading*, if any), and give local weather conditions at the time.

This reporting system is generally used for signal strength and intelligibility; *Signal Strength*—S1—barely audible; S2—very weak; S3—weak; S4—fair; S5—fairly good; S6—good; S7—moderately strong; S8—strong; S9—very strong. *Intelligibility* (or *Readability*)—R1—unreadable; R2—poor; R3—fair; R4—good; R5—excellent.

You may wish to describe briefly the equipment used to hear the signal—whether it was "home" or communications receiver, the type of circuit, the number of tubes, trade name and model number, and other equipment used such as a preselector, antenna, and ground system. Another good idea followed by many SWL's is to add a brief comparative reception report on some other station in the area of the broadcaster to which you are reporting.

Uppermost, give data that will be of use to the station and its engineers, which will "prove" when checked against the station's log that you actually heard the station. Tell whether you hear the station regularly or if this was a "one-time" catch. Then definitely but politely (never demandingly), ask that the accuracy of your report be checked, and if found correct, that it be confirmed by a "verification of reception." Some stations which are "long" on "acknowledging" reports are extremely "short" on "verifying" them.

* For further detailed tips, consult the International Short-Wave Department of RADIO & TELEVISION NEWS—K. R. B.

(NOTE: Unless otherwise stated, all time herein is expressed in Greenwich Mean Time—GMT—subtract 5 hours for EST, 6 for CST, 7 for MST, 8 for PST. This is on a 24-hour clock basis in which midnight is 2400 (or 0000), 3 a.m. is 0300, 10 a.m. is 1000, and noon is 1200, for example; instead of starting again at 1 p.m., as the 12-hour system does, the 24-hour system continues to increase the number of each hour until 2359 (11:59 p.m.) is reached, thus

1 p.m. is 1300, 5 p.m. is 1700, 10 p.m. is 2200.)

With regards to the terms "wavelength" and "frequency", wavelength is measured in meters. For every wavelength there is a corresponding frequency which is the number of complete waves, or cycles, sent out by a transmitter every second. A "kilocycle" is 1000 cycles, a "megacycle" is 1,000,000 cycles. As a SWL you will be concerned primarily with megacycles (mc.). To convert megacycles to meters (m.) divide the frequency in megacycles into 300. For example, 6 mc. divided into 300 gives you 50 m. (wavelength) and, conversely, 50 m. (wavelength) divided into 300 gives you 6 mc. (frequency).

Write legibly (use a typewriter if you have one) in the "working" language of the station if you can do a good job. Otherwise, use English which is rapidly becoming the universal language. If possible, reports to Latin American countries should be in Spanish.

Never "fake" a report!

You can get QRA's (addresses) of stations from *World Radio Handbook*, radio magazines, club bulletins, through correspondence, by listening to DX sessions from radio stations which carry them, and over-the-air. Many stations ask for reports and give their QRA's during regular transmissions. The 1955 edition of *World Radio Handbook* should now be available for \$2, postpaid, directly from Gilfer Associates, Box 239, Grand Central Station, New York 17, New York. Often, you can "make up" a satisfactory QRA from the call letters, name of station, slogan or motto, city, state or province (if any), country, and continent. I have had good results in "making up" station QRA's in this fashion—but only as a last resort.

Many stations which are government-operated will verify without return postage being sent to them. It is the best policy, however, to send along an International Reply Coupon (IRC) unless you are certain the station does not require one. An IRC costs 13 cents at your post office and is "good" for one unit of return first-class surface postage from any country which is a member of the Universal Postal Union. Your post office stamp clerk can tell you what countries do or do not accept IRC's. Do not send U.S. stamps.

Write the station's address and your return address carefully (better *print* these) on both your report and the envelope. Usually, it's a good idea to send the letter in care of the Chief Engineer of the station. Be sure to use the correct postage which

You too can collect QSL cards from all parts of the world to "paper" the walls of your radio shack. This is part of the colorful collection of verifications belonging to SWL Rex G. Gillett, South Australia, who is one of the leading SWL's "Down Under."

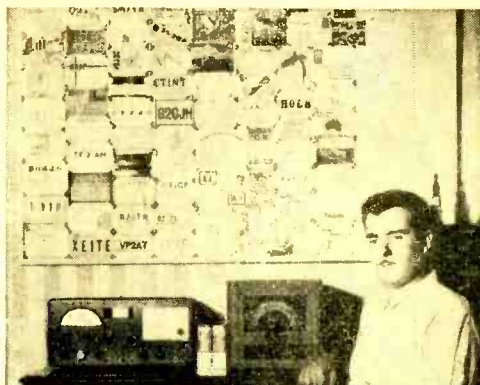
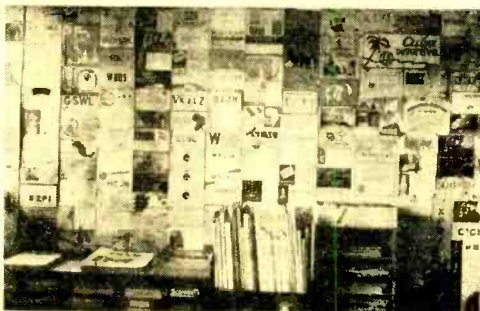

This attractive bulletin board of SWL Galen Balfe, Massachusetts, displays to advantage QSL cards from both international short-wave broadcasters and amateur stations from all over the world. A neat effect is achieved through the use of art corners which hold the cards in place and make them easy to remove without damaging the cards or wall.

you can learn from your post office stamp clerk.

Next month I'll have some more information for you on this matter of collecting verifications—such as giving the station ample time to reply before you send a "tracer" or second report. Now, for this month's tips (*GMT*).

* * *

For Beginners

Australia—For VLI6, 6.090, Sydney, N.S.W., try around 1100 when should have *English* news. West Coast listeners will find 11.810 has replaced 15.200 for the 0155-0415 session beamed to that area by *Radio Australia*.

Azores—Ponta Delgada, 4.865, now runs 2000-2100, 2115-0000; all-Portuguese.

Belgium—Try 6.085 now for ORU in *English* to North America 0100-0300 close-down; is relayed by OTC, 9.655, Leopoldville, Belgium Congo.

Bulgaria—*Radio Sofia* lists *English* for North America now as 0030-0130 (Sunday 0100-0130) over 6.070, 9.700, and 0400-0430 over 6.070 *only*; *English* for Europe (heard in the U.S.) at 2030-2100, 2145-2215 on 7.271A.

Chile—Santiago has been noted with its Spanish sessions on measured 12.152 around 0300 and later.

Czechoslovakia—Prague now uses 7.255-AV for *English* to North America 0030-0100.

England—BBC is scheduled to North America (Canada, USA) 1140-1300, 15.360 (Tuesday only); 1145-1300, 11.930 (Tuesday only); 1500-1715, 15.360; 1800-1915, 11.930 (Monday to Friday); 1915-2045, 9.825 (Monday to Friday); 2045-2215, 9.825; 2115-2215, 6.110. (*Continued on page 120*)



This photoelectric butler can be built at home for fifteen or twenty dollars and will announce visitors automatically.

By
LOUIS E. GARNER, JR.

Build this Photocell



A PHOTOCELL annunciator is used in a doorway or other opening to signal whenever an individual enters or leaves. As a person passes through the doorway, his body interrupts a beam of light. This, in turn, actuates a relay, closing an electrical circuit and sounding a bell, buzzer, or chimes.

Comparatively few parts are needed for the assembly of the photocell annunciator. All the components are standard and should be available at your local electronic parts supply house.

You will have little or no difficulty in duplicating the assembly shown. Not only should you enjoy building the device, but you may be able to pick up spare time work installing similar units in offices and stores.

Construction Hints

The complete instrument consists of three separate assemblies—the photocell control box containing the phototube and its associated electronic circuitry, the light source, and a signaling device. You need only assemble the control box and the light source.

Only two tubes are employed in the control box circuit, a type 921 phototube and a



An installation partially completed. The wire from the control box to the light source must still be run up over the door.

This method of installation requires less wire between control box and light source, yet covers the entrance more fully.

Annunciator

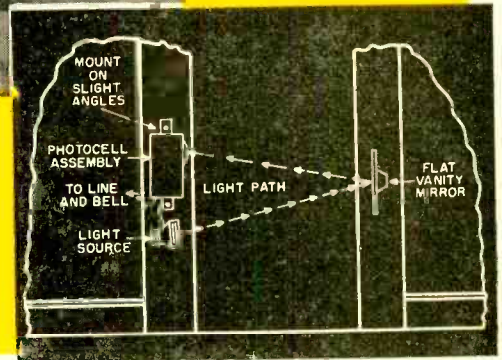

type 2D21 thyratron. Only one adjustment is provided, and this is non-critical.

Assembling the Control Box: Refer to the schematic and pictorial wiring diagrams and the above and below chassis photos. Since layout is not critical, you need not follow exactly the arrangement shown. However, you will find it advisable to keep the circuit as compact as is practicable.

The small aluminum chassis may be bent from a piece of scrap sheet metal or cut down from a larger commercial chassis. Use small machine screws and hex nuts for mounting the parts. In order to conserve space in the model, the chassis was made quite narrow and one lip of the filament transformer was bent down and fastened to the side of the chassis.

Use the schematic and pictorial wiring diagrams as guides when wiring your chassis. Be sure to observe the polarity of the connections to the electrolytic capacitor, C_2 .

After the chassis wiring has been completed and checked for accuracy, the tubes may be installed and the unit mounted in its case. A standard 3" x 4" x 5" "Minibox" is used for the housing.

The relay connections are brought out to a 5-position screw-type terminal strip, mounted on the case with small "L" brackets. Leads from the filament transformer, T_1 , are also brought to this strip, so that 6.3 volts will be easily available for operating the light source and the signaling device.

If the instrument is to be used only at a distance of six to eight feet from the light source, no special lens is required in front of the phototube. Simply punch a 1" diameter hole at the proper point in the case to permit light to strike the phototube easily.

On the other hand, if the separation between the light source and the control box is as much as twelve to fifteen feet, install a small "bull's-eye" lens over the opening in the case to concentrate light on the phototube. The lens can be obtained from an old flashlight and may be attached to the case with a small metal ring and sheet metal screws.

Assembling the Light Source: Continuous duty commercial light sources are available. However, these are fairly expensive. You can assemble a light source suitable for home and limited commercial use as shown.

Two methods of connecting the signaling device to the control box: (A) for 6.3 v.a.c. operation, (B) using a separate power source.

The schematic wiring diagram for the phototube control box shows that the circuit is relatively simple. See the parts list below.

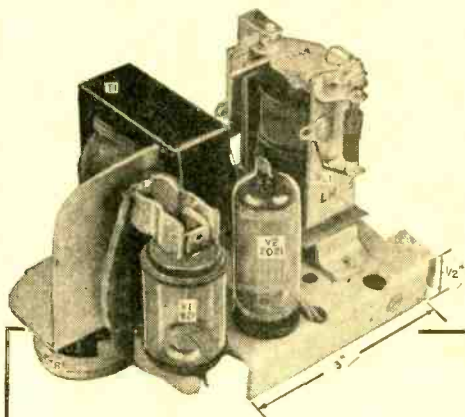
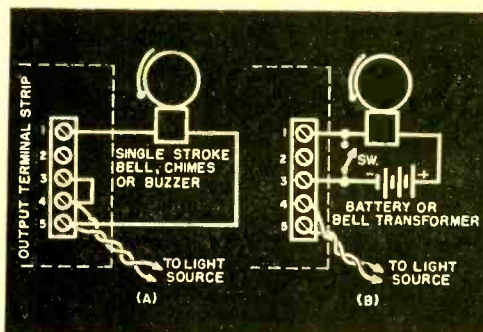
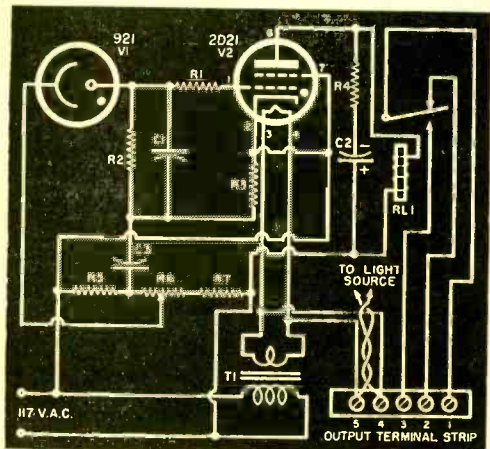

Using a hacksaw, cut the front reflector section from an inexpensive flashlight. Solder the flashlight's rear cap to the back of the cut-off reflector section to make a closed housing. Replace the flashlight bulb with one of similar construction, but having a 6-volt filament.

A small aluminum bracket is made up for the assembly. This mounting bracket should be designed so the light source may be moved slightly in either direction, to permit centering the light beam on the phototube after installation.

Installation

In general, the light source will be mounted on one side of a doorway and the phototube control box assembly will be mounted on the opposite side. A flat metal strip may be used as a mounting bracket for the control box.

The mounting height is not too critical, and, for most purposes, a height of from 18 to 30 inches is satisfactory. If the assembly is mounted too low, however, a person may easily step over the beam of light and enter the door unannounced. If mounted too high, a child may miss the light beam, or a short person may duck under it.

Use a rule to measure the mounting height of both the control box and the light source, to insure that the light beam will be approximately centered on the phototube.

The lead between the control box and the light source can be run around the door frame and fastened in place with insulated staples to complete the installation.

- R_1 —2.2 megohm, $\frac{1}{2}$ w. carbon res.
- R_2 —4.7 megohm, $\frac{1}{2}$ w. carbon res.
- R_3 —7500 ohm, $\frac{1}{2}$ w. carbon res.
- R_4 —1500 ohm, 1 w. carbon res.
- R_5 —150 ohm, 5 w. wirewound res.
- R_6 —2000 ohm wirewound pot.
- R_7 —1000 ohm, 5 w. wirewound res.
- C_1 —.002 μ d., 400 v. paper tubular capacitor
- C_2 —4 μ d., 150 v. tubular elec. capacitor
- C_3 —.02 μ d., 400 v. paper capacitor
- RL_1 —5000 ohm, s.p.d.t. plate relay (Potter & Brumfield Type LM5)
- T_1 —Filament transformer 6.3 v. @ 1 to 3 amps (Stancor Types P-6134, P-5014; Merit Types P-2944, P-2945, P-2946)
- V_1 —921 phototube
- V_2 —2D21 tube

Other parts for the control box: one 7-pin miniature tube socket; one phototube socket; small aluminum chassis (approx. $4\frac{1}{4}$ " x $\frac{1}{2}$ " x 3"); 3" x 4" x 5" "Minibox" (Bud Type CU-2105); 5-position screw-type terminal strip; "bull's-eye" lens (salvage from a discarded flashlight); strip of 1/16" aluminum about 1" x 7" (for the mounting bracket); 2-position tie-point strip; line cord and plug; rubber grommet; screws, nuts, wire, and solder

For the light source: a small flashlight; 6-volt bulb; small aluminum bracket (made from a 1" wide strip of 1/16" thick aluminum); wing nut; grommet; machine screw, nut, and lockwasher

For the signaling device: a set of chimes, a single-stroke bell, buzzer, or similar device and sufficient intercom wire to install the completed assembly. A standard 50' roll of twisted-pair intercom wire should be more than ample for most installations.

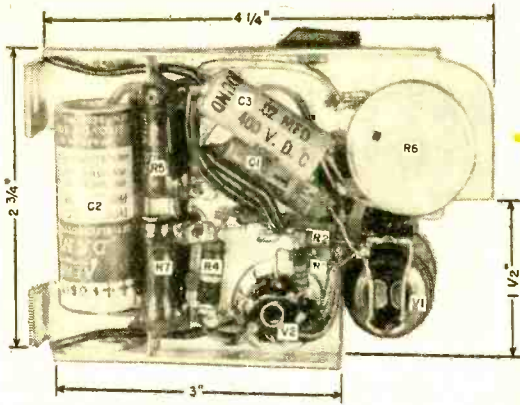

完成后的控制盒

Examine these photos carefully for hints on placing parts and arranging wiring in the control box. Most major components are shown in the view at left. Above is the other side of the chassis, with most of the small parts. The completed control box is at the right.



Pictorial wiring diagram of the annunciator. Note particularly polarities of V1 and C2.

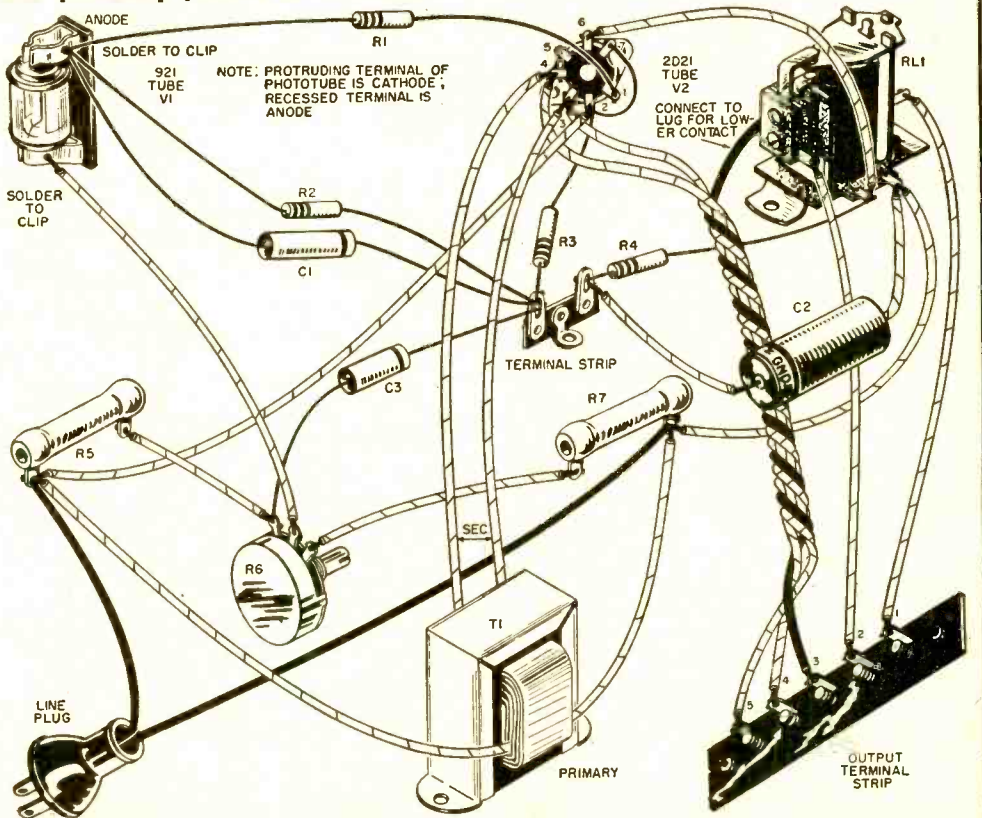

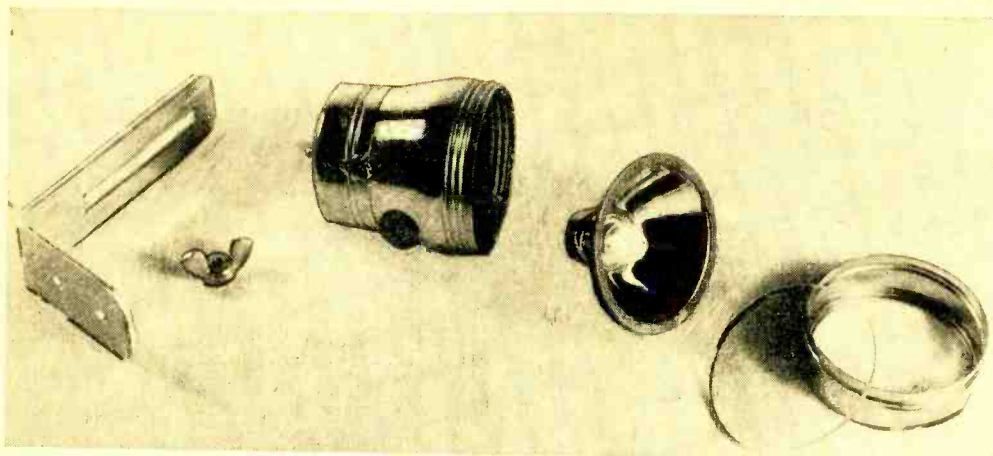

The light source for the annunciator is made from the parts of an ordinary flashlight.

If the location at which the unit is installed has a high average light level, a small hood should be placed over the control box to prevent the operation of the instrument on extraneous light.

In operation, the relay remains open as long as light strikes the phototube. When the light is interrupted by a person breaking the light beam, the relay closes, supplying power to the signaling device.

As long as the power requirement of the bell, chimes, or other signaling device used is not too high, the circuit arrangement shown in diagram (A) may be employed. Power for the signaling device is obtained from the filament transformer.

If preferred, an external power source, such as batteries or a "bell transformer," may be used. In this case, the relay is used as a simple switch and the connections are as shown in diagram (B). A s.p.s.t. push-button switch may be connected in parallel with the relay contacts, if desired, and the bell or chimes may then be operated either by pushing a button or by breaking the beam of light. The connections to this switch are shown dotted in diagram (B).

You may encounter installations where it is desirable to have both the control box and the light source on the same side of the door frame. In such a case, the arrangement shown on page 75 may be employed. The two units are mounted at a slight angle and a small flat mirror mounted across from them in such a position that the light beam is reflected back to the phototube.

This scheme offers some advantages over the "straight across" installation. If the two units are mounted a reasonable distance apart vertically, the light beam will enclose a fair area of the doorway, reducing the possibility of someone getting through the door without breaking the beam.

Adjustment: There is only one adjustment in the phototube circuit, R_0 . This control is adjusted after installation. The setting is not critical.

Simply set the control about midway in its rotation. Next, passing your hand between the control box and the light source to break the beam, adjust R_0 for best operation.

Applications

The photocell annunciator may be used in a professional office to announce the entry of a client. It may be used at the entrance to a "one-man" store or shop to announce the entry of customers.

Another commercial application is to count the number of persons entering or leaving a specific area. This may be accomplished by connecting an electromagnetic counter (such as the Mercury Type MEA-N5-6A) in place of the bell or chimes.

In addition to its commercial uses, the instrument may be used in the home. For example, it may be used at the entry to a recreation room to flash lights or to start a record player. For continuous action, the standard relay used in the model and specified in the parts list should be replaced by a "latching" type relay.

The assembly may be used as an "electric eye" burglar alarm. An intruder who breaks the beam of light will sound an alarm. A latching type relay should be used so the alarm bell will sound continuously once energized.

Equipment can be turned off when the light beam is broken, by using terminals 1 and 2 of the output terminal strip.

How It Works

A detailed explanation of the functioning of the control box circuit will now be given. To follow it, refer to the diagram.

With light on the phototube, V_1 , during one half of each a.c. cycle, when the upper side of the line is positive, electrons will flow from the lower side of the line, through R_7 , part of R_6 , V_1 , R_2 , and R_3 , to the upper side of the line. At the same time, C_1 will be charged, with the terminal nearest to the anode of V_1 and the grid of V_2 being negative. During the other half of the cycle, C_1 will discharge through R_2 , but since the time constant, RC , of this circuit is almost .01 second, C_1 will not discharge completely. The voltage across C_1 will act as negative grid bias for V_2 . During the same half of each a.c. cycle, the a.c. voltage, applied through the coil of RL_1 , will make the plate of V_2 negative, so no plate current will flow.

During the other half of each cycle, when the lower side of the line is positive, electrons will flow from the upper side of

the a.c. line through R_5 , R_6 , and R_7 , to the other side of the line. The voltage across R_5 will be applied almost instantaneously through C_3 to R_3 . The voltage across R_3 will be opposite in polarity to that across C_1 , reducing the negative bias on V_2 . At the same time, voltage applied to the plate circuit of V_2 through the coil of RL_1 will make the plate of V_2 positive with respect to the cathode. However, R_6 normally will be adjusted so that the negative bias produced by electron flow through the phototube will be sufficient to keep V_2 cut off during both halves of the cycle.

Now, if the light is removed from V_1 , C_1 will discharge, removing the negative bias from V_2 . Electrons will flow through V_2 and through the coil of RL_1 on one half of each cycle, energizing RL_1 and connecting terminals 1 and 3 of the output terminal strip. **END**

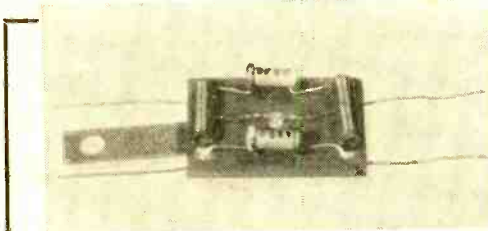

Schematic of high-pass filter for TV interference. Input and output terminals may be reversed since unit is symmetrically made.

L_1, L_2 —34 turns of #28 enamel covered wire, closewound on phenolic or paper forms, $\frac{1}{2}$ " long x $\frac{1}{8}$ " diameter. Center-tapped.
 C_1, C_2 —12 $\mu\text{fd.}$, 20%, ceramic capacitors.
 Ground point—Ground strap $1\frac{1}{8}$ " long, connected to chassis of set.
 Mounting board—Phenolic block with 5 eyelet terminals spaced as shown.

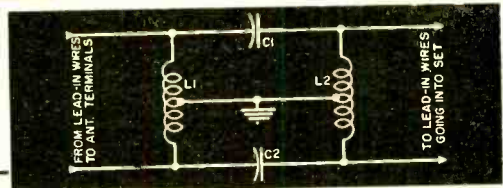

Simple Filter Blocks Interference to TV

INTERFERENCE to television receivers from such sources as nearby transmitters, diathermy machines, industrial equipment, etc. can be reduced with the aid of a simple and inexpensive high-pass filter designed by *American Electronics Company*, N. Y. 59, N. Y.

Since these noises occur below 45 megacycles, the filter is designed to prevent passage of signals below that frequency but to pass readily signals above that frequency. All of the television channels are on frequencies above 45 megacycles, the lowest one, Channel 2, being from 54 to 60 megacycles.

Named the "Ameco High Pass Filter, Model HP-45" the device can be purchased, or built from parts that are easily obtained

from the manufacturer or elsewhere. The schematic and parts list are shown here. The parts are so few and light in weight that merely soldering them through the eyelets on the phenolic board will hold them in place.

To use, bend down the metal ground strap so that it is perpendicular to the phenolic mounting board. Then connect it directly to the chassis of the TV set either by soldering or by a self-tapping screw. Next, break the twin lead-in wire from the antenna into the set. Make this break as close to the TV chassis as possible. Connect one pair of filter leads to the antenna side of the lead-ins. Connect the other pair of filter leads to the other side of the lead-ins going into the set. **END**

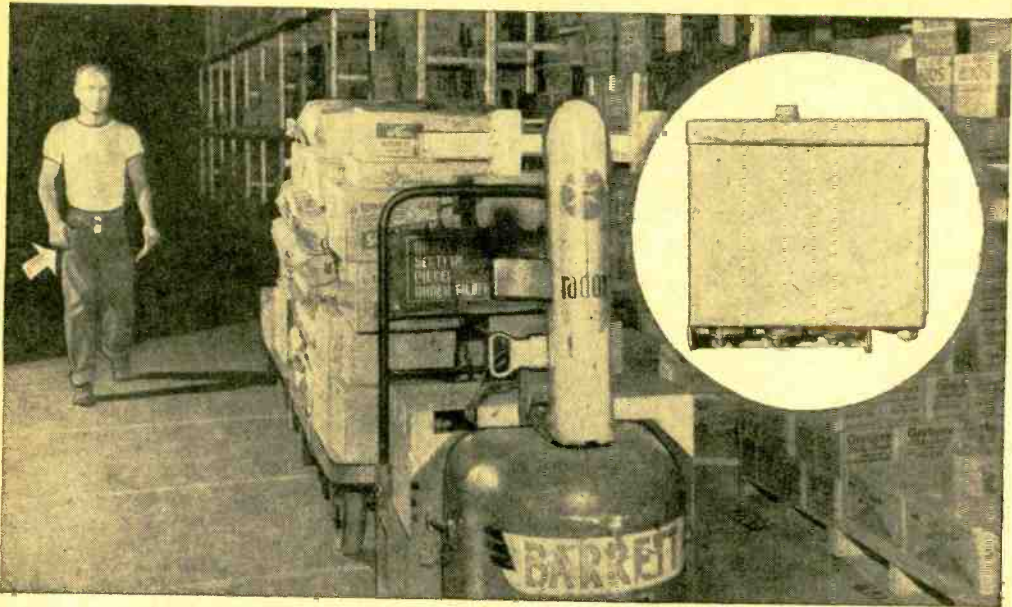

R/C CARTS SPEED LOADING IN WAREHOUSE

ORDER FILLING time is being reduced substantially by use of remote radio-controlled tow trucks at the wholesale grocery warehouse of *Super Valu Stores, Inc.*, in Minneapolis, Minnesota.

Order fillers carry on their belts a ten ounce radio transmitter no larger than a tobacco tin. Signals from the transmitter activate a receiver in the truck and electric power from batteries is then supplied to the truck's drive motor. Each truck pulls a train of merchandise carts.

Called "Radox," the unit is made by the *Barret-Cravens Company* of Chicago. Each

transmitter has a different operating frequency so that it will activate only the truck to which it belongs. The transmitter's range is about 50 feet.

Previously, an order filler loaded the cart, walked forward to the tow truck, mounted it, drove to the next rack, dismounted, walked back, loaded up, and then repeated the entire operation. With the new radio-control unit, he simply loads and presses a button on the transmitter hooked to his belt. The truck will then move forward, to the left, or to the right, as required. . . . HENRY C. SUTER

RADIO AND TV PIONEERS MEET

RADIO and television scientists, members of the "De Forest Pioneers," gathered recently at historic Fraunces Tavern in New York City to honor Dr. Lee De Forest (left) for his development of the radio vacuum tube. Dr. De Forest's invention, in 1905, of the triode tube brought radio out of its infancy. His introduction of the third element (control grid) into the vacuum tube made possible for the first time the use of the tube as an amplifier. Oscillators and other applications followed.

With Dr. De Forest is Dr. Allen B. Du Mont who pioneered the development of the cathode-ray picture tube and its use in television. Dr. Du Mont, who worked with Dr. De Forest 25 years ago, surprised the radio inventor by showing him one of the first audion tubes made by Dr. De Forest, a tube which was thought to have been lost many years ago.



HOT as the new **veeDxer**

THE ALL CHANNEL (vhf) ANTENNA THAT **BEATS 'EM ALL**

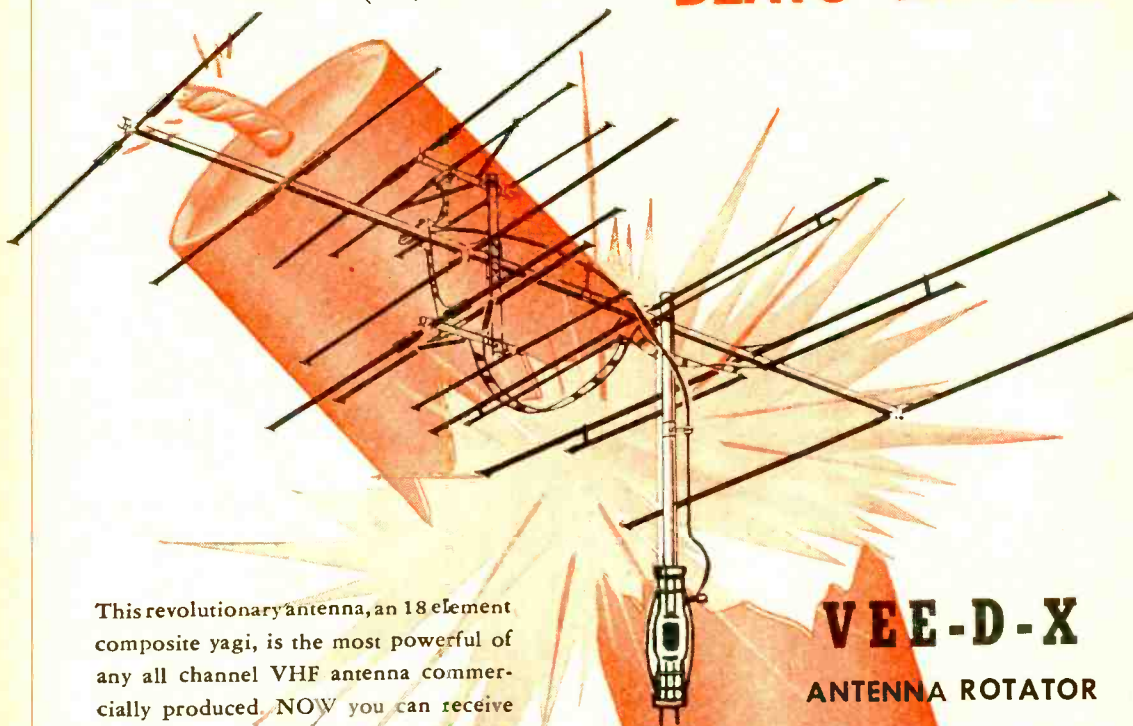

This revolutionary antenna, an 18 element composite yagi, is the most powerful of any all channel VHF antenna commercially produced. NOW you can receive picture perfect reception on all VHF channels comparable to a single channel 10 element yagi. When all others have failed, install a super power VEE-D-Xer for the finest reception.

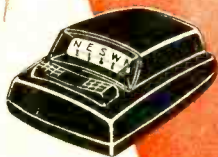

VEE-D-X

ANTENNA ROTATOR

Team together the new VEE-D-X Rotator with the new VEE-D-Xer antenna for matchless reception of ALL VHF channels on the air, in all directions NOW and in the future.

HIGHEST GAIN

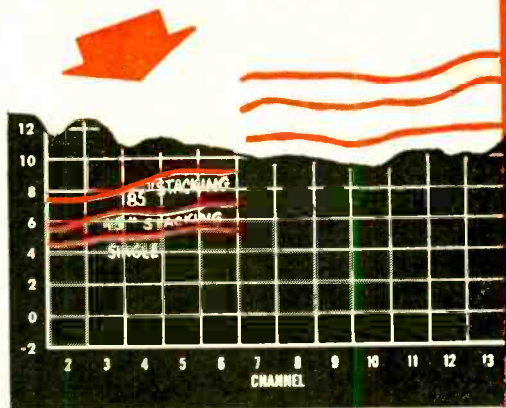

WRITE TODAY for information on the VEE-D-Xer and the new VEE-D-X Rotator.

La Pointe ELECTRONICS INC.
ROCKVILLE, CONN. PE-1

Please send me specification sheets on:

Vee-D-Xer Rotator

NAME

ADDRESS

CITY ZONE STATE

ELECTRONIC YARDMASTER GUIDES FREIGHT



Automatic switching and speed control provided by electronic brain will reduce freight losses.

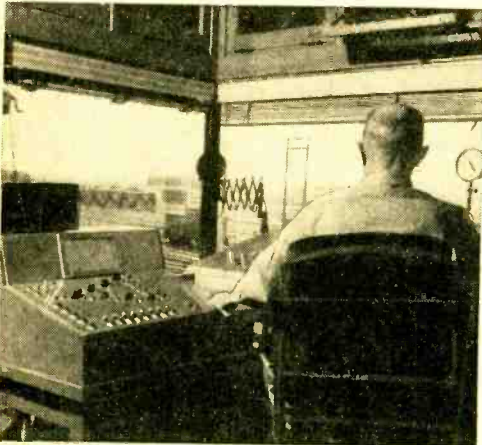

At left is control console for "electronic yardmaster." In front of operator are conventional retarder and switching controls.

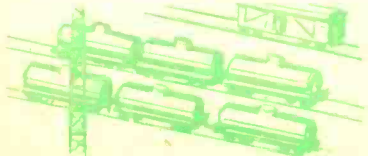

THE first full-time application of automatic switching and car retarding in any railroad freight classification yard has been demonstrated by the *Union Pacific Railroad* at its retarder yard in North Platte, Nebraska.

Called the "electronic yardmaster," the system is expected virtually to eliminate impact damage to boxcar lading resulting from human error. Last year, American railroads paid over \$110,000,000 in freight loss and damage claims, much of which resulted from existing practices in train make-up yards. The new system is expected to reduce substantially this figure, with corresponding savings and better service resulting for industry and the public.

A long string of freight cars is pushed over the hump of the huge classification yard. As a car is uncoupled and starts its descent along the incline to one of the many classification tracks in the yard, its rolling characteristics are electrically determined and transmitted to an electronic brain. The distance the car has to roll to couple with another car standing on the classification track is also computed and fed to the brain by an electronic device similar to the range-

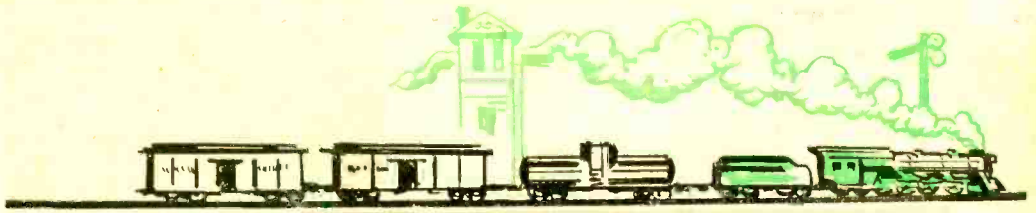

CARS



Car rolls down incline; speed is checked by radar in box at right. Automatic braking will hold speed to safe limit for train coupling.



finding equipment used on big guns during World War II.

The entrance speed of the car into the retainer yard, and its speed through the retarding zone, are measured by a radar speed meter, similar to the mechanism used by police departments to apprehend speeding motorists.

Furnished with this information, the system determines at what speed the rolling car must be retarded and released to reach its coupling point at a safe switching speed. The system then automatically controls the car's speed by means of electro-pneumatic braking devices located on the tracks.

As the classification tracks fill up with coupled cars, the system "remembers" and calculates the shortened distance each newly arrived car must travel. The system's "memory" can retain instructions for as many as 120 cars.

The control tower operator simply pushes buttons to select the proper classification tracks for the cars prior to their entrance into the yard.

The system was developed jointly by the railroad and *Reeves Instrument Corp.*, a subsidiary of *Claude Neon, Inc.*, N. Y. END

February, 1955

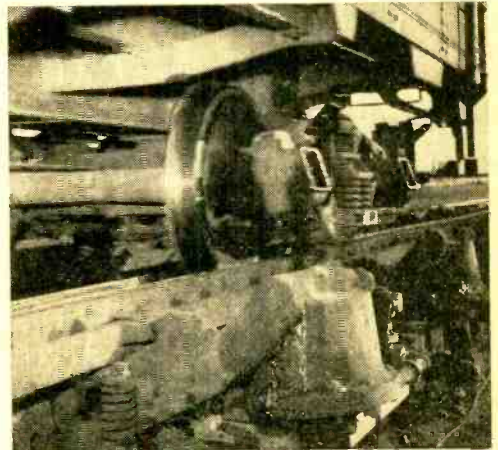

Air-operated pistons apply pressure to steel bars that grip the car's wheels. This slows the car to required speed.

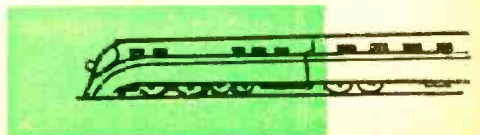

Build YOUR OWN HEATHKITS

INTERESTING—EDUCATIONAL



work has already been done for you. No cutting, drilling, or painting required. All parts furnished including tubes. Knowledge of electronics, circuits, etc., not required to successfully build Heathkits.

Heathkits are fun to build with the simplified easy-to-follow Construction Manual furnished with every kit. Only basic tools are required, such as soldering iron, long-nosed pliers, diagonal cutting pliers, and screwdriver. All sheet metal

New charcoal gray baked enamel panel with highly readable white lettering.

New PRINTED CIRCUIT VACUUM TUBE VOLTMETER KIT

The VTVM is the standard basic voltage measuring instrument for radio and TV servicemen, engineers, laboratory technicians, experimenters, and hobbyists. Because of its extremely high input resistance (11 megohms) the loading effect on the circuit being measured, is virtually negligible. The entire instrument is easy to build from a complete kit, with a detailed step-by-step Construction Manual. Featured in this instrument is an easy-to-wire fool-proof printed circuit board which cuts assembly time in half.

CIRCUIT AND RANGES: Full wave AC input rectifier permits 7 peak-to-peak voltage ranges with upper limits of 4000 volts peak-to-peak. Just the ticket for you TV servicemen. Seven voltage ranges, 1.5, 5, 15, 50, 150, 500 and 1500 volts DC and AC RMS. Peak-to-peak ranges 4, 14, 40, 140, 400, 1400, and 4000 volts. Ohmmeter ranges X1, X10, X100, X1000, X10K, X100K, X1 meg. Additional features are a db scale, center scale zero position, and a polarity reversal switch.

IMPORTANT DESIGN FEATURES: Transformer operated—1% precision resistors—6AL5 and 12AU7 tubes—selenium power rectifier—individual AC and DC calibrations smoother improved zero adjust control action—new panel styling and color—new placement of pilot light—new positive contact battery mounting—new knobs—test leads included. Easily the best buy in kit instruments.

New peak-to-peak meter scale—new color bar chart—new control knobs.

New printed circuit board for faster, easier construction—exact duplication of Laboratory development model.

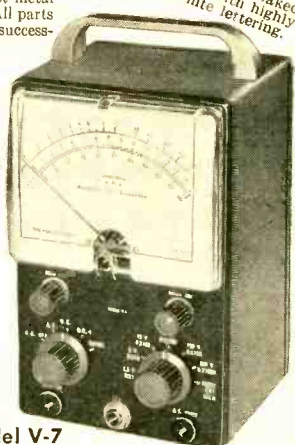

Model V-7

\$24.50

Shpg. Wt. 7 lbs.

New easy-to-read open panel layout. Off-on switch incorporated in selector switch.

Heathkit HANDITESTER KIT



MODEL M-1
\$14.50

Shpg. Wt. 3 lbs.

The Heathkit Model M-1 Handitester readily fulfills all requirements for a compact, portable volt-ohm-milliammeter. Its small size permits the instrument to be tucked into your coat pocket, tool box or glove compartment of your car. Always the "handitester" for those simple repair jobs. Packed with every desirable feature required in an instrument of this type. AC or DC voltage ranges, full scale 10, 30, 300, 1000 and 5000 volts. Ohmmeter ranges 0-3000 ohms and 0-300,000 ohms. DC milliammeter ranges 0-10 milliamperes and 0-100 milliamperes. Uses 400 microampere meter—1% precision resistors—hearing aid type ohms adjust control—high quality Bradley rectifier. Test leads are included.

Heathkit MULTIMETER KIT



MODEL MM-1
\$26.50 Shpg. Wt. 6 lbs.

Here is an instrument packed with every desirable service feature and all of the measurement ranges you need or want. High sensitivity 20,000 ohms per volt DC, 5000 ohms per volt AC. Has the advantage of complete portability through freedom from AC line—provides service ranges of direct current measurements from 150 microamperes up to 15 amperes—can be safely operated in RF fields without impairing accuracy of measurement.

Full scale AC and DC voltage ranges of 1.5, 5, 50, 150, 500, 1500, and 5000 volts. Direct current ranges are 150 microamperes, 15, 150, and 500 milliamperes and 15 amperes. Resistances are measured from .2 ohms to 20 megohms in three ranges and db range from -10 to +65 db. Ohmmeter batteries and necessary test leads are furnished with the kit.

HEATH COMPANY
BENTON HARBOR 10, MICHIGAN



New

PRINTED
CIRCUIT

Heathkit 3" OSCILLOSCOPE KIT

Ideal for individual home work shop, ham shack, or as extra instrument for outside servicing.

Compact size, light weight, portable — perfect for service work or field operation.

New, modern styling, panel lettering with white and gray knobs and case — contrasting red and black terminal posts.

New printed circuit for constant performance, rugged component mounting — assembly time cut in half!

Measures only 11 3/4" x 6 3/4" x 1 1/2" and weighs only 11 pounds.

USE: This brand new Utility Scope was designed especially for servicemen and radio amateurs, and is adaptable for use in all general Scope applications. Perfect for modulation monitoring, etc. Use it to tackle alignment or adjustment problems. Equally valuable in breadboard work. A must for ham shack or for outside servicing.

DESCRIPTION: Front panel controls of the Model OL-1 are "bench tested" for ease of operation and convenience. Sharp focusing 3" CRT. Printed circuit for ease of assembly and constant performance. Assembly time cut in half! High quality electronic components used. Sensitive hor. and vert. amplifiers with broad freq. response; cathode follower for isolation. Push-pull hor. and vert. output to deflection plates. Int. 60 cycle, or ext. sync. Sweep freq. range 10-100,000 cycles. Direct connection to deflection plates. Provision for $\frac{1}{2}$ axis input. Uses 3GP1 CRT, 4-12AU7 hor. and vert. amplifiers, 1-12AX7 sweep gen., 1-6X4 1V rect., and 1-1V2 HV rect. The Heathkit Model OL-1 is a real standout value at only \$29.50, and is another example of the famous Heathkit combination; quality plus economy.

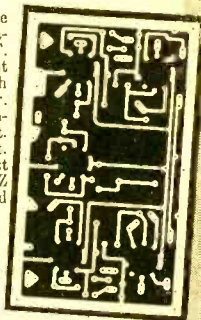

Model
OL-1

\$29.50

Shpg. Wt.
15 lbs.

Heathkit

SIGNAL GENERATOR KIT

USE: This instrument is "serviceman engineered" to fill the requirement for a reliable basic service instrument at moderate cost. Frequency coverage extends in five bands from 160 Kc to 110 Mc on fundamentals, and dial is calibrated to 220 Mc for harmonics. Pre-wound and pre-aligned coils make calibration unnecessary for service applications.

DESCRIPTION: The Heathkit Model SG-8 Signal Generator provides a stable modulated or unmodulated RF output of at least 100,000 microvolts which can be controlled by both a continuously variable and a fixed step attenuator. Internal modulation is at 400 cycles, or can be externally modulated. AF output of 2-3 volts is also available for audio testing. Uses dual purpose 12AU7 as Colpitts RF oscillator and cathode follower for stable, isolated, low impedance output, and type 6C4 tube for 400 cycle oscillator. Operation of the SG-8 is well within the frequency limits normally required for service work. Modern styling features high definition white letters on charcoal gray panel with re-designed control knobs. Modern professional appearance and Heathkit engineering know-how combine to place this instrument in the "best buy" category. Only \$19.50 complete.

New, modern panel and knob styling — professional appearance and professional performance.

Broad frequency coverage — fundamentals from 160 KC to 110 MC in 5 bands — up to 220 MC on calibrated harmonics.

Cathode follower output for good isolation — fixed step and continuously variable attenuation.



Output selection — internal modulation, pure r.f., or audio output.

MODEL SG-8 **\$19.50** Shpg. Wt. 8 lbs.



MODEL
AM-1

\$14.50 Shpg. Wt. 2 lbs.

Heathkit ANTENNA IMPEDANCE METER KIT

The Model AM-1 Antenna Impedance Meter makes an ideal companion unit for the GD-B Grid Dip Meter or a valuable instrument in its own right. Perfect for checking antenna and receiver impedance and match for optimum system operation. Use on transmission lines, halfwave, folded dipole, or beam antennas. Will double as monitor or relative field strength meter. Covers Freq. range of 0-150 Mc and impedance range of 0-600 ohms. Uses 100 microampere meter and special calibrated potentiometer. A real buy at only \$14.50 complete.

Heathkit GRID DIP METER KIT

Amateurs and servicemen have proven the value of this grid dip meter many times over. Indispensable for locating parasitics, neutralizing, and aligning filters and traps in TV or Radio and for interference problems. The Model GD-1B covers from 2 Mc to 250 Mc with 5 pre-wound coils. Featuring a sensitive 500 microampere meter and phone jack, the GD-1B uses a 6AF4 or 6T4 tube. An essential tool for the ham or serviceman.

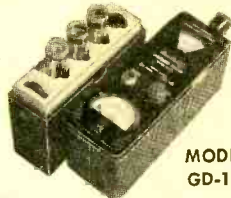

MODEL
GD-1B

\$19.50 Shpg. Wt. 4 lbs.

ACCESSORIES: Low freq. coverage to 355 KC with two extra coils and calibration curve. Set No. 341A for GD-1B and set No. 341 for GD-1A. Shipping weight 1 lb. Only \$3.00.

HEATH COMPANY
BENTON HARBOR 10, MICHIGAN

New

Heathkit VFO KIT



MODEL VF-1

\$1950

Ship. Wt. 7 lbs.

- Smooth acting illuminated and precalibrated dial.
- 6AU6 electron coupled Clapp oscillator and OA2 voltage regulator.
- 7 Band coverage, 160 through 10 meters—10 Volt RF output.
- Copper plated chassis—aluminum cabinet—easy to build—direct keying.

Here is the new Heathkit VFO you have been waiting for. The perfect companion to the Heathkit Model AT-1 Transmitter. It has sufficient output to drive any multi-stage transmitter of modern design. A terrific combination of outstanding features at a low kit price. Good mechanical

and electrical design insures operating stability. Coils are wound on heavy duty ceramic forms, using Litz or double cellulose wire coated with polystyrene cement. Variable capacitor is of differential type construction especially designed for maximum bandspread and features ceramic insulation and double bearings.

This kit is furnished with a carefully precalibrated dial which provides well over two feet of calibrated dial scale. Smooth acting vernier reduction drive insures easy tuning and zero beating. Power requirements 6.3 volts AC at .45 amperes and 250 volts DC at 15 mills. Just plug it into the power receptacle provided on the rear of the AT-1 Transmitter Kit. The VFO coaxial output cable terminates in plastic plug to fit standard 1/2" crystal holder. Construction is simple and wiring is easy.

Open layout — easy to build — simplified wiring

Smooth acting illuminated dial drive.

Clean appearance — rugged construction — accessible calibrating adjustments.

Copper plated chassis—careful shielding.

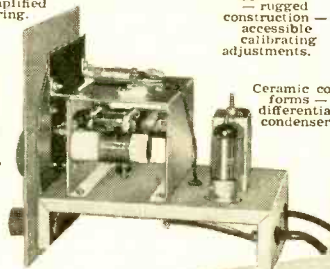

Ceramic coil forms — differential condenser.

Heathkit AMATEUR TRANSMITTER KIT



MODEL AT-1

\$2950

Ship. Wt. 16 lbs.

SPECIFICATIONS:

Range 80, 40, 20, 15, 11, 10 meters.
 6AG7 Oscillator-multiplier.
 6L6 Amplifier-doubler
 5Y4G Rectifier.
 105-125 Volt A.C. 50-60 cycles 100 watts. Size: 8 1/8 inch high x 13 1/8 inch wide x 7 inch deep.

Crystal or VFO excitation.

Prewound coils — metered operation.

Rugged, clean construction.

Single knob hand switching.

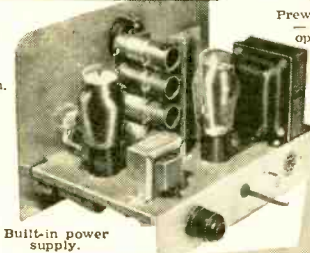

Built-in power supply.

52 ohm coaxial output.

Here is a major Heathkit addition to the Ham radio field, the AT-1 Transmitter Kit, incorporating many desirable design features at the lowest possible dollar-per-watts price. Panel mounted crystal socket, stand-by switch, key click filter, A. C. line filtering, good shielding, etc. VFO or crystal excitation—up to 35 watts input. Built-in power supply provides 425 volts at 100 M.A. Amazingly low kit price includes all circuit components, tubes, cabinet, punched chassis, and detailed construction manual.

Heathkit COMMUNICATIONS RECEIVER KIT

RF gain control with AVC or MVC.

Electrical bandspread and scale.

Stable BFO oscillator circuit.

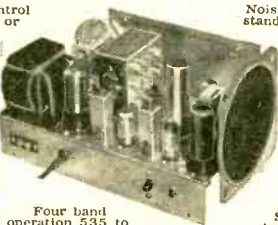

Four band operation 535 to 35 Mc.

Noise limiter—standby switch.

3/8 inch PM Speaker-Headphone Jack.

Six tube transformer operation.

SPECIFICATIONS:

Range.....535 Kc to 35 Mc
 12BE6 Mixer-oscillator
 12BA6 I. F. Amplifier
 12AV6 Detector—AVC—audio
 12BA6 B. F. O. oscillator
 12A6 Beam power output
 5Y3GT Rectifier
 105-125 volts A.C. 50-60 cycles, 45 watts.

A new Heathkit AR-2 communications receiver. The ideal companion piece for the AT-1 Transmitter. Electrical bandspread scale for tuning and logging convenience. High gain miniature tubes and IF transformers for high sensitivity and good signal to noise ratio. Construct your own Communications Receiver at a very substantial saving. Supplied with all tubes, punched and formed sheet metal parts, speaker, circuit components, and detailed step-by-step construction manual.



MODEL AR-2

\$2550

Ship. Wt. 12 lbs.

CABINET:

Proxylon impregnated fabric covered plywood cabinet. Shipg. weight 5 lbs. Number 91-10, \$4.50.

HEATH COMPANY
 BENTON HARBOR 10, MICHIGAN



RETURN OF THE

By CHARLES L. MEISTROFF, W4TFA

An amateur who left the field some time ago tells of the early days and of his recent return to hamming.

YEAH, the old bug bit again, and this time it did a right good job; got me unexpectedly and really stuck. I doubt if even penicillin would have been of any use. Being away from ham radio for over twenty-six years and then coming back was really an experience. I had nothing to do that cool September afternoon except to enjoy the beginning of Indian summer and get some of that fresh ozone . . . to escape from the four walls of that nice hotel room.

I had just turned the corner near the hotel . . . the newsstand seemed to spring out of the ground and wave a profusion of multi-colored magazines at me . . . what I saw gave me a jolt . . . I mean a kw. jolt. "CQ," "QST," RADIO & TELEVISION NEWS, good gosh, were they still being published? Where have I been for all these past years? Then it happened as fast as lightning; I don't even remember doing it . . . out came some change, those radio gazettes were under my arm.

That night before turning in early, so I thought, I would give these old friends a once over. What a revelation that was! Man alive . . . what a new world! I thought I was reading something from Mars; ARC-5's, RG8-U, BC-223's, GP-7, radar, pulsations, p.a. jammers; the names of some of the tubes sounded and ran like chemical formulas, some of the tubes looked like spark-plugs for a space ship. I was lost. It was like having a Model T *Ford* twenty-five years ago and not having a car in the meantime, then going out to buy one of the modern-day streamliners. One would think you had to have a course in jet-training to get your driver's license. I know now how Rip van Winkle felt after that twenty-year sleep in the Catskills. And what had happened to two hundred meters? I was really con-

fused. I was in a new world, old faces done over and more attractive with a new look and better working qualities. Everything seemed to be loaded with electronic vitamins. I almost expected the rosin core solder to have sulfa in it. Nothing fly-by-night, according to the ads—one had a very good choice of anything—better than the old days when you either had to make your own or else!

Gosh, I had quit dabbling in ham radio, or what might have been called that, about 1922. World War I put a temporary stop altogether to tinkering which began about 1912; much had been discovered, enlightenment followed experimentation and brought to use in the intervening years a new and shiny aspect of the old ether-wave theory, and to its primitive equipment, a brand new brilliance that was a Buck Rogers glow!

The war surplus in the aftermath of World War I was full of good bargains, if you could get your hands on them. The *Western Electric* VT 1 and VT 2, the J and E tubes of those early days were prized detector and amplifier or transmitter tubes. One article that I still remember was the old Crocker-Wheeler wind-driven motor generator, looking like a five-inch shell and fastened under the wings of the flying crates of those days. It was driven by an eight- or ten-inch propeller and gave three sets of voltages. I think one was 300 volts for plate, another, 6-12 for filaments, and another, 25 volts grid bias. A two-element tube acted as ballast tube or automatic rheostat, as it was called then, to keep the voltages to specifications. These were usually mounted on a 1x8 board and coupled with rubber hose to about a one-third or half horsepower motor and the whole usually suspended from the cellar beams. Re-



PRODIGAL HAM

sults were excellent as long as the hose coupling lasted!

I had a flashback to the old days—rotary and stationary spark gaps, zinc electrode tips, the old saw-tooth type too, and the one with the rotating single disc, what an improvement that was! Poulsen arcs, over-size keys with dime-sized contacts that on the break would spark enough to knock the cold out of your nose and shake the nails out of your shoes. No one thought there was anything better than tuning through dead-end losses, pencil mark grid-leaks, eraser end verniers! No one bothered to figure out how capacitors measured in capacity, just so they had plates and came in varied sizes and shapes. Sometimes they used castor or mineral oil as a dielectric and were then put in a hard rubber case—remember the beauties that *Murdock* used to turn out? Remember the nice three-one *Acme* audio amplifier transformers? Those beautiful honeycomb coil mountings that *deForest* gave us? The double-filament audion tubes that were mounted on the outside of the panel until *Moorhead* gave us the socket base? And mounting anything on a metal panel—man, you were called *crazy*. You grounded everything by doing that; that was nonsense. More came when *Armstrong* appeared on the scene with his tickler-feedback circuit. And then they started putting in more than four elements in the tubes—what next?

The receivers of those days were something to behold. That catalogue (*The Electro-Importing Company*) was a connoisseur's bible. Listed and shown in the collection were the masterpieces of the day. I raved and revelled in the *Nauen* receiver. How I wished I could afford one—all I could manage was an open primary with three sliders and small tap-off secondary pulled by hand. The usual deluxe receiver of those days was a squarish looking box with a side panel housing the so-called primary varied by means of a set of switches and taps from the coil, that ran single and

multiple turns. The secondary was tube-winding with a similar single switch of multiple taps and slid on a set of rods inside the primary to provide tight or loose-couplings. When the variocouplers came out—what an improvement—no donkey engine was needed to couple or uncouple. The more switches and taps the better, we thought, since all tuning was done on a dead end loss anyway, and not by inductance being cut in or out. Who cared about the capacitive effects between turns? That was a negligible factor anyway and all guesswork to begin with. It was still experimental and probing into the mysteries of a.c. and its effects. Impedance, reactance, reluctance—these things were still items that had to be transposed into something—they had to be brought out into the open, pondered over, comprehended, and then transformed to what would make common sense and basic formulas. Guesswork was gradually eliminated, and a mathematical basis for the common laws and their applications was gradually evolved. The most part was hit or miss, then try again. Who ever heard of antennas cut to frequency? But it did not take long once the first obstacles were hurdled and the road opened for others to follow—success of resonant radiators were shown to be productive of results that not even the most skeptical ham or researcher could disregard. Remember that the greater part of all this was done by hams and carried on without personal compensation although a few companies were doing their own research. They departed little by little from the generally accepted idea of stringing up some wire and letting it go at that—once they overthrew that old theory, then things really began to happen. Don't think so? Look at your TV antennas today, not to mention the ten-, twenty-, and now they are coming with a forty-meter compensated beam—a new kind of a shorty, so the rumors say.

Even the old ether-wave theory had been
(Continued on page 104)

An Amazing Receiver

By
Edmund H. Marriner

ONE of the most remarkable radio receiving sets constructed during World War II was made by Lt. Herb Dixon, ZL2BO, while a prisoner of war at Shampshupo, Argyle Street prison camp, Hong Kong. He wanted to build a short-wave receiver to pick up BBC broadcasts. To accomplish this almost impossible Herculean task, Herb started collecting parts. The first real supply came from an old Austin car which provided wire, bolts, nuts, and metal parts.

As the receiver progressed it was kept hidden in a false garden bed of mint. Filter capacitors were made painstakingly from tinfoil taken from cigarette packages, cut to shape, impregnated with candle grease and sealed in small kerosene cans. The supply of cigarettes being limited, it took seven months of combined effort of the camp to fill the filter requirements.

The headphones took shape from cheese and sugar cans. These, together with the power transformer and filter choke, were finished in four months and were hidden away to await the rest of the parts. Construction of the radio was finally started

on a copper sterilizing tank for the chassis. The resistors required were made from pencil leads of various lengths. The tuning capacitor was made from sheet metal slipped on a four inch nail and fastened to a dial made from mechanical auto horn parts. In all this time, no one had been able to get any vacuum tubes. There were some tubes in the prison hospital, but how to obtain them was a problem. As a last resort, one of the prisoners went to the hospital and demanded to have his appendix removed. On the day he was released from the hospital he managed to hide the tubes under the bandages.

Toward the end of 1943 the receiver was completed. The men sealed it in a kerosene can which had a false top tray containing cooked rice.

For about three months BBC came in loud and clear on 9.5 megacycles. To keep the receiver dried out it was placed on top of the bake ovens in a flour bin for some hours. The Japs discovered it when a guard accidentally knocked over the bin.

The receiver was kept by the Japanese as a museum piece and no one knows just whatever became of it. The boys down under hope some day a clue will turn up which will give a finale for this remarkable receiver—constructed from junk in a Japanese Prison Camp. END

LAFAYETTE'S

WESTERN ELECTRIC HEARING AID

Brand new, in original Western Electric's leather case. Supplied with receiver, receiver cord, battery cord and plug (less batteries). Money back guarantee. Act now while these are available. Burgess XX502 and 8B batteries at \$1.55 per set.

Reg. Price 185.00 Our Price 14.95



TIMER-SWITCH SALE 3.95

Automatically turns on radio, television sets, toasters, coffee makers, etc. — at any pre-set time within 12 hour period, also tells time. Requires 3/4" diameter round hole. Depth, behind dial face 2 1/4". Shpg. wt. 1 1/2 lbs. MS-66 for 110V/60 Cy AC



TWIN LENS, IMPORTED-CAMERAS

2 1/4" x 2 1/4" Negatives With F3.5 Coated Lens A 69.50 VALUE! Only at Lafayette 29.95

- * Shpg. Wt. 7 lbs.
- * Built-in Flash Synchronization
- * Focusing Focusing
- * Sportsfinder
- * 8 Speed Shutter, 1 to 1/200 Sec.
- * Double Exposure Prevention
- * Matched Coated Lenses are Coupled in Helical Mount
- * Accepts 120 Roll Film

Stock No. F-32 29.95



PRECISION GEIGER COUNTER

29.95

Geiger counter featuring high sensitivity to radioactive substances and extremely compact design. Detects uranium ore, cosmic rays, radium and other rays by instantly producing a loud series of clicks in earphone. Uses a miniature amplifier tube, one 221V2 hearing aid battery and one dash light battery. Strong plastic case 1 1/2" x 3 3/4" x 7". Supplied with earphone, batteries, radio-active sample and instructions. Shpg. Wt. 3 lbs.

Model 108 29.95



NEW POCKET AC-DC VOM MULTITESTER

1,000 ohms per Volt

AC-DC MULTITESTER. An ideal portable unit that meets the need for a compact yet rugged test instrument. Uses full 3" rectangular meter with large easy-to-read scale. Uses 1% precision resistors, jeweled D'Arsonval microamp meter movement. Ranges: AC-DC and output volts 0.5, 0.25, 0.250, 0.100V, DC current 0.1, 0.10, 0.100, MA. Resistance 0-10k and 0-100k ohms. Size 4 1/4" x 3 1/4" x 1 3/4". Supplied complete with test leads and batteries. Shpg. wt. 2 1/2 lbs.

MODEL RW-27C Complete

Singly, ea. 19.95 In lots of 3, ea. 9.45



30 POWER TELESCOPE

● All metal — Chrome trimmed!

Precision machined body. Hand ground, hard coated, achromatic lenses. Sharp, clear, brilliant images. In the same manner as binoculars. Brings objects 30 times closer! Smooth, easy sliding focus. Collapses to 7" extends to 13 1/2". As always you must be satisfied — or return for immediate refund. Shpg. Wt. 1 lb.

F-59 NET 7.50



WELLER SOLDERING KIT

Kit includes 250 watt instant heat — dual spotlite Weller gun — ample supply of kester solder — soldering tip — smoothing tip — interchange wrench — two instruction booklets — sturdy metal case for convenient storage. Shpg. Wt. 5 lbs.

Weller 8250-AK Net 10.99



100X-200X-300X 6.75

Precision built for accuracy and long lasting service. Triple position turret holds 3 achromatic color-coated objectives for magnification of 100X, 200X and 300X. Novel dual knob focusing. High-grade micro-optics used throughout. Complete with fitted wood carrying case and sides. Shpg. Wt. 4 1/2 lbs.

F-10 NET 6.75



BINOCULARS NEVER BEFORE AT THIS PRICE

Imported Direct
Prism-Coated Lenses

with order, Add 10% Fed. Tax

- All-Metal Construction
- Individual Focus
- Complete with Leather Case & Straps

F-105, 8 x 30 with case... NET 19.95
F-15, 7 x 35 with case... NET 22.50
F-103, 7 x 50 with case... NET 24.95
F-104, 12 x 50 with case... NET 32.50



PRECISION DRAFTING SET

11 Pieces — Fitted Felt-Lined Case. Made in Germany, of heavy brass, nickel plated and polished. Instruments include 5 1/2" Compass with pencil and pen points and locking bar, 5 1/4" Divider, three 3 1/2" sideview bow dividers with needle point, pen point and pencil point, 5" Ruling with extra handle for pen or pencil, 2 spools with extra leads. Your money back — if this set is not worth twice over price!

F-13 NET 2.75



BAROMETER

Produced in Germany by expert craftsmen — unquestionable quality. Calibrated in 1/100", 1/10", and inches from 26" to 32". Ivory porcelainized metal scale with black and red lettering reading: Stormy Rain or Change Fair — Very Dry. Richly polished mahogany stained hardwood case, 3 1/2" in diameter by 1 1/2" deep. Tells weather 12 to 24 hours in advance.

F-11 NET 3.95



Lafayette Radio

DEPT. PE Write for FREE Catalog!

BRONX, N.Y. 542 E. Fordham Rd.
NEWARK, N.J. 24 Central Ave.
PLAINFIELD, N.J. 139 West 2nd St.
BOSTON, MASS. 110 Federal St.

100 SIXTH AVE. NEW YORK, N.Y.

Include postage with order.



Fig. 1. The correct way to use an ohmmeter to identify transformer terminal connections.

Identifying Power Transformer Leads

Don't discard usable transformers just because you have lost the specification sheet. Identify the terminals this easy way.

THE average home electronics lab has at least one and often several power transformers with unknown connections and characteristics. If the transformer is provided with leads, you'll find that the following color code generally applies: primary (black leads); high-voltage secondary (red leads); high-voltage center-tap (red-yellow lead); rectifier filament winding (yellow leads); amplifier tubes filament winding (green leads). But if only numbered terminals are provided, you'll need another technique to identify the connections.

Here's a method you can use with any small power transformer designed for normal line operation.

First, identify the terminals to each winding and note the resistance reading obtained. Use an ohmmeter for this job, as shown in Fig. 1. Connect one lead of the ohmmeter to one terminal and use the other lead to touch the remaining terminals until a reading is obtained. These terminals are for one winding.

Ignoring the terminals that have been identified, repeat this test with the remaining terminals until all windings are identified and resistance values marked down.

The high voltage secondary winding will

Fig. 2. (A) The general relationship between d.c. resistance and transformer winding. (B) A basic test circuit for checking transformer terminals.

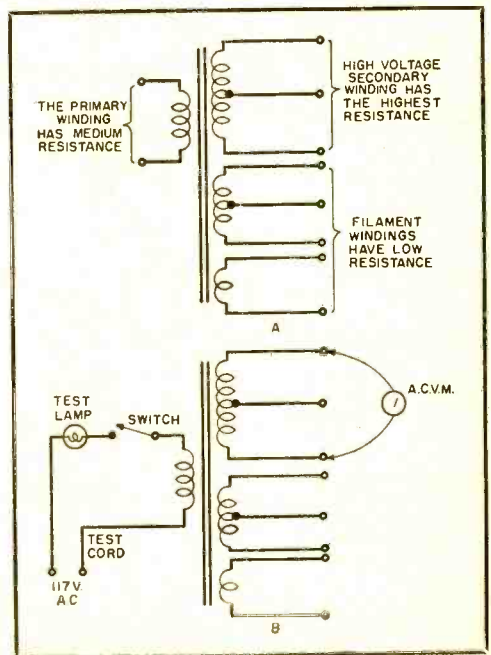

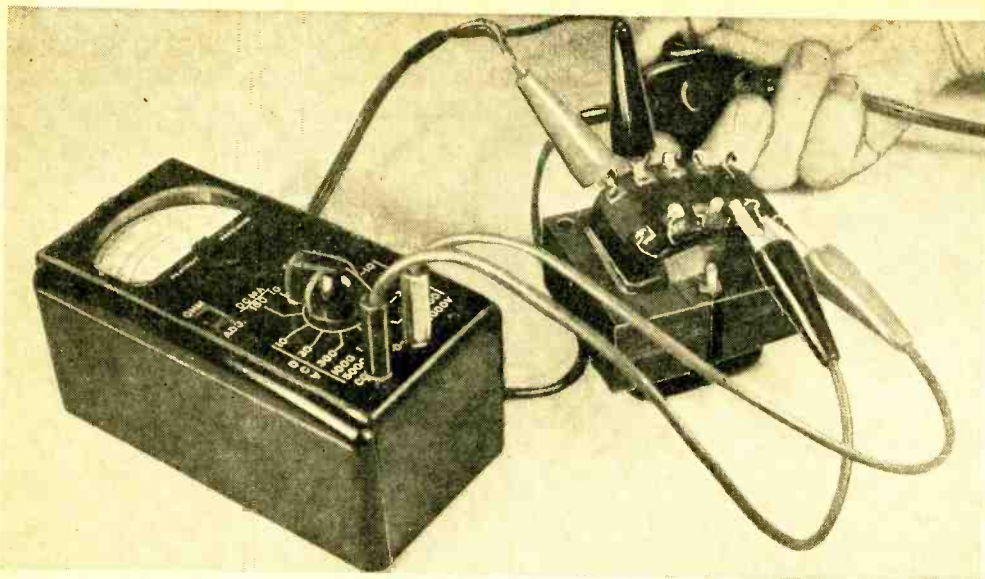

Fig. 3. How an a.c. voltmeter is used for final identification of transformer windings.

have the highest resistance, as shown in Fig. 2A. This value may be as high as several hundred ohms in some cases. The primary winding will have an intermediate value of resistance, generally between 5 and 25 ohms. The filament windings will have low resistance, frequently less than one ohm.

Next, connect a 100 watt or 200 watt lamp bulb in series with a switch and the "primary" winding of the transformer. Using a test cord, connect to the power line as shown in Fig. 2B.

If you have chosen the right pair of terminals as the "primary," and the transformer is in good condition, the lamp will light, but with less than full brilliancy. If the lamp lights to full brilliancy, the wrong pair of terminals has been chosen or the

transformer itself has a shorted winding.

Using an a.c. voltmeter, make preliminary voltage tests across each winding, including the primary. The ratio of these readings will give you a further clue as to the windings. The high-voltage secondary winding should give a higher voltage reading than the primary, while the filament terminals should give a very low voltage reading.

Finally, connect the test cord directly to the primary terminals and use the a.c. voltmeter to check each secondary winding, as shown in Fig. 3. This last test will positively identify the windings and also indicate their approximate voltage ratings. Actual voltage ratings, under load, will be somewhat less than the "no load" readings taken in the last step. END

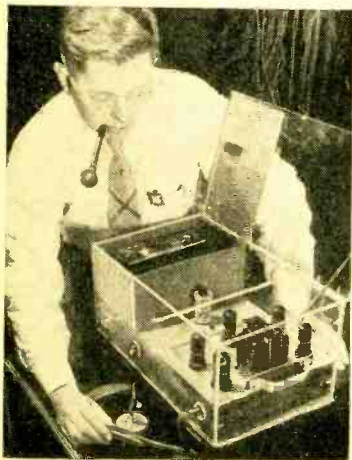

THE FIRST TRANSISTORIZED 20-WATT AUDIO AMPLIFIER

PICTURED at the left is the first transistorized 20-watt linear audio amplifier, as developed experimentally by engineers at *General Electric's* Electronics Laboratory in Syracuse. The amplifier, operating from dry cell batteries, was demonstrated with a record playing system and a 25-watt speaker to prove its linearity over the entire power range.

The power transistors used in the circuit are plug-in units. The amplifier includes two 6 watt, three 2 watt, and four 1/10th watt experimental transistors. One 45 volt, one 1½ volt, and one 7½ volt batteries are used to power the unit. The preamplifier for the *G-E* variable reluctance cartridge in the record player was also completely transistorized. END

TOOLS & GADGETS

R/C SERVO ACTUATORS

In addition to their model 2PN servo for single control models, *The de Bolt Model Engineering Co.* of Williamsville, N. Y. has announced two new models for multi-control actuator use. Model 3P is a three position actuator without an automatic neutral; model 3PN has two posi-

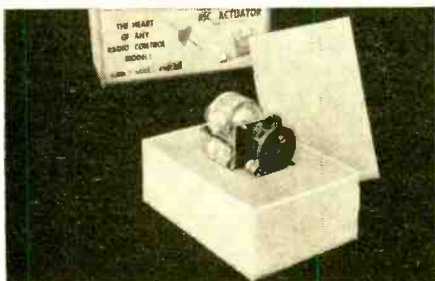

tions with an automatic neutral, plus a second servo circuit added. With a combination of the two models, the R/C enthusiast can enjoy the power to actuate his controls as well as the advantage of a second control such as for three engine speeds. The radio required may be the same he has been using for single control operation with no changes needed to use it for multi-control operation. Model 3P is priced at \$19.95; model 3PN at \$14.95. Additional information is available from the manufacturer.

FOOLPROOF TAPE THREADER

The task of threading a recording tape on a blank reel is greatly simplified by the use of a new simple tape threader, manufactured by *The Flahan Company*, 7517 Pelham Drive, Cleveland 29, Ohio. This



sturdy metal device holds the tape to the reel for the first few turns to get the winding started. Then, it can either be slipped off or left in position to serve as a reel

PAY ONLY 10% DOWN

ON THESE ITEMS

from

WRL

LARGEST DISTRIBUTOR OF AMATEUR RADIO EQUIPMENT - THE WORLD'S

65 Watt Globe Scout Completely Bandswitching

Ideal Xmtr. for beginner. Fully bandswitching, 160-10M., 65 watts CW., 50 watts on fone. Metering provided. Self-contained power supply. 100% modulation of Final. Completely screened for TVI. Housed in 8"x16"x8", grey cabinet.



KIT
\$89.95
CASH

WIRED
\$99.95
CASH

ONLY \$795 Per Mo.

Save Up to 50% ON TOP-VALUE RECONDITIONED EQUIPMENT

We have hundreds of Xmitters., recvrs., speakers, test eqpt., antennas, ham and experimental radio gear of all sorts in factory-new condition, carrying our positive 90-day guaranteed! Here, indeed is a bargain for the novice and professional, alike!

Send for Our Complete, Up-to-Date List Today!

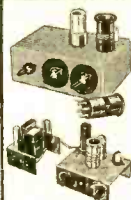

TRANSMITTER RECEIVER
\$29.40 Complete \$14.70 Complete

Build your own transmitter and receiver and go on the air with this complete kit and simple instructions. Complete kit only \$43.22. Designed for single wire antenna. Power supply included with transmitter. Units may be purchased separately. Write for full details.



Plus many, many, more
as shown in our
FREE 1955 CATALOG
Send for Your Copy Now!

ALL PRICES SUBJECT TO CHANGE WITHOUT NOTICE.

WORLD'S MOST PERSONALIZED RADIO SUPPLY HOUSE



3415 W. BROADWAY, CO. BLUFFS, IA., Phone 2-0277

Please Quote Your Top Trade-in Value PE-2
of My _____

(Make, Model Eqpt. I Now Own)

On Your _____
(New WRL Eqpt. Desired)

Send Me:
 Free Catalog 3'x4' Radio Map (25c)
Full Info. On: Globe Scout Receiver
and Xmtr. Kits Reconditioned Equip. List.

Name: _____

Address: _____

City and State: _____

crank. It can be used on any size reel up to 7" and fits all makes and models of recorders which employ standard reel spindles. The new gadget can also be used on standard 8 mm. movie reels. A patent is pending. The tape threader retails at 98 cents.

VERSATILE HAND TOOL

The usefulness of the already versatile "8-in-1 *Buck Nycapper*" has been increased

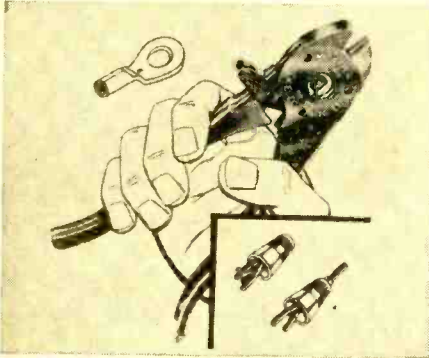

by a recent design change which now enables it to install solderless terminals. In addition, it still performs its original functions as an all-purpose tool for the cutting, stripping and twisting of solid or stranded wire and the installing of the nylon-insulated *Buck "Nycaps"* on pigtail splices.

The new design change enables the tool's 3-way crimping action to be used on wire terminations to make for easy, positive terminal installations of very high mechanical and electrical strength. Controlled de-

formation of the wire, without reduction of the cross-sectional area, is uniformly achieved. The improved "Nycapper" is available through electrical distributors throughout the U.S.A. and Canada. For more information write to Mr. Charles F. Walker, *Buck Electrical Manufacturing Co.*, P.O. Box 147-220, Roselle, N. J.

NEW TAPERED REAMER

A new, "super-hard" tapered reamer has been placed on the market by *Vaco Products Co.*, 317 E. Ontario St., Chicago 11. Useful for metal, wood, plastic, or any hard or semi-hard material, the new tool will enlarge undersize holes from 1/8" up to a maximum of 3/8" diameter. In radio and TV work it is especially recommended for aligning or enlarging off-center holes, protecting drills, etc. It can also deburr, sawed or cut pipe ends. It is available with handle attached for \$2.50. The reamer only, priced at \$1.75, is also sold for use with the many *Vaco* screw driver, nut

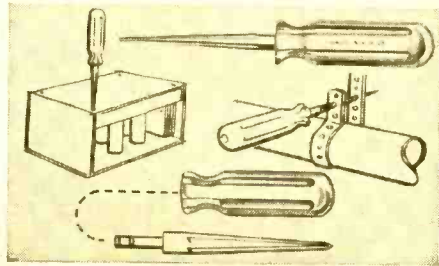

driver, Allen, or other interchangeable kits. For further information, write to the manufacturer. END



TEST TV—RADIO TUBES

Yourselves with UNATEST 51. Own your own tube tester for less than the cost of one service call. Buy your tubes at discount! SAVES MONEY the first time it's used. Mahogany Case—110 volt AC Tests all popular size tubes. Simple to operate—Fully guaranteed. ORDER TODAY! ONLY \$5.00—Post Paid. Send Cash, Check or M.O. Dept. PE-52

BAUMBACH ENG. CO. 10147 Halbreth San Fernando, Calif.

\$5.00

— THAT PROFESSIONAL LOOK! —

PERFORATED AND PAINTED CHASSIS

• Give that "Build Your Own" electronic project eye appeal! We can furnish perforated and painted chassis and cabinets for projects featured in all issues of *Popular Electronics*. Write today for what you need.

HOUSEHOLD HANDIES

2307 Main Street

Santa Monica, Calif.

BUILD YOUR OWN AMATEUR TRANSMITTER

... FROM THIS EASY-TO-ASSEMBLE KIT!

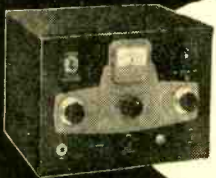

- ✓ PACKED WITH FEATURES
- ✓ PROFESSIONAL APPEARANCE
- ✓ EASY TO BUILD
- ✓ TVI SUPPRESSED to prevent television interference

Start your hobby off right with this professional CW transmitter kit. The Viking "Adventurer" operates 50 watts input on the 80, 40, 20, 15 and 11-10 meter amateur bands, and with a simple antenna packs enough power for world-wide radio contacts. No antenna tuner needed—crystal controlled oscillator—powerful 807 transmitting type output tube. Easy to build and safe to operate—kit furnished complete with built-in power supply, tubes, cabinet, wiring instructions and antenna suggestions. Cal. No. 240-181-1 Viking "Adventurer" Kit, less crystal and key

\$54.95

Amateur Net

For more information on the Viking "Adventurer" or Johnson's complete line of keys and practice sets see your favorite distributor or write to:



E. F. JOHNSON COMPANY • 301 2ND STREET • WASECA, MINNESOTA

BOOK REVIEWS

"ELECTRICAL APPLIANCE SERVICE MANUAL" by William L. Gabbert. Published by Rinehart & Co., Inc., N. Y. 372 pages. Price \$5.00.

This book opens with a discussion of basic electrical principles and continues with a section on testing instruments. Included are instructions for building a simple series test lamp. Another portion deals with tools and wiring.

Appliances are divided into two main groups: those which operate on the heating element principle, such as toasters, and irons, hotplates; and those which operate from an electrically powered motor such as vacuum cleaners, mixers, washing machines, electric clocks, and razors.

Included is a discussion of the fluorescent lamp which the author considers more of an electronic device, introducing new terms to describe the movement of electrons through a gaseous rather than a metallic conductor. The book concludes with a section on the refinishing of surfaces.

"THE BOYS' FIRST BOOK OF RADIO AND ELECTRONICS" by Alfred Morgan. Published by Charles Scribner's Sons, N. Y. 229 pages. Price, \$2.75.

While making an excellent gift to some deserving and interested youngster, this book is actually a very worthy discussion of radio and electronics that could be read by people of all ages who do not have a technical background or engineering training, but who do want to learn.

In view of the modern world's increasing dependence on, and interest in, things electronic, a book such as this should appeal to all. Even for a non-technical person simply to enjoy good music in his home these days, a minimum understanding is essential of at least such things as the difference between a.c. and d.c. or the functions of an amplifier and a loudspeaker. These, and many more topics, are discussed clearly in layman's language.

The actual building of the small sets described in the book is by no means beyond the scope of a youngster, but then, neither should it be beneath the interest of the adult hobbyist. This factor, plus the amount of solid theory included in the book, should make this volume much like the proverbial electric train set: you buy it ostensibly for your children, but wind up enjoying it yourself. **END**

**COYNE offers
LOW COST**

**TELEVISION
RADIO-ELECTRONICS**
Training in
Spare Time **AT HOME**



The future is **YOURS** in TV-RADIO!

A fabulous field—good pay—fascinating work—a prosperous future! Good jobs, or independence in your own business!

Coyne brings you the first *truly lower cost*, MODERN—QUALITY Television Home Training; training designed to meet Coyne standards. Not an old Radio course with Television "tacked on". Here is MODERN TELEVISION TRAINING including working knowledge of Radio. Includes **UHF and Color TV**. No Radio background or previous experience needed. Personal guidance by Coyne Staff. **Practical Job Guides** to show you how to do actual servicing jobs—**make money early in course**. With Coyne Television Home Training you pay only for your training, **no costly "put together kits"**.

B. W. COOKE, President



Coyne—the Institution behind this training... the largest, oldest, best equipped residential school of its kind. Established 1899. Send coupon for details.

**COYNE
ELECTRICAL SCHOOL**

A TECHNICAL TRADE INSTITUTE OPERATED
NOT FOR PROFIT
500 S. Paulina St., Dept. 25-TR7, Chicago 12

**MAIL COUPON FOR
FREE DETAILS**

including information about easy
Payment Plan.

**No obligation, no
salesman will call.**



COYNE ELECTRICAL SCHOOL
Television Home Training Div.
500 S. Paulina St., Chicago 12, Ill.,
Dept. 25-TR7

Send Free Picture Folder and details on Television Home Training. This does not obligate me and no salesman will call.

Name _____

Address _____

City _____ State _____

Check here if interested in Resident School Training in Chicago.

INSTANTLY ISOLATE TV TROUBLE

Save Time And Money with

THE NEW TV DYNATRACER!

- No Additional Equipment Needed.
- Swiftly Traces Signals Voltages.
- Pinpoints Defective Components.
- Amazingly Simple to Operate.

YES, a low cost test instrument that locates TV troubles without extra equipment. Tracks TV signals in Video, AFC, Sound, Sync, Horizontal or Vertical sweep circuits. TROUBLE PINPOINTED IN STAGE OR COMPONENT. TV DYNATRACER also traces voltages (50/500 V AC/DC)—detects leaky, open or shorted condensers, resistors, coils, transformers,

• Technician-Amateur-Home Hobbyist. The new TV DYNATRACER is a budget priced necessity. Take advantage of our 10 day MONEY BACK GUARANTEE now!

Prompt orders receive a TV HIGH VOLTAGE INDICATOR — helpful accessory to all test work.

4.98

FREE

Century ELECTRONICS CO.

Dept. 604 211-04 99th Ave., Queens Village 29, N. Y.

REPEAT SALE BY POPULAR DEMAND

WORLD-
FAMOUS
HI-FI
3-SPEED
AUTOMATIC
PHONO
3 SPEAKERS

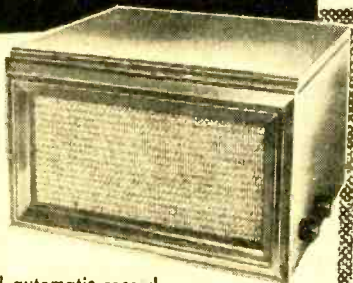

DeLuxe 3-speed automatic record player with speaker cross over network for true high-fidelity. 4 tube amplifier scientifically designed to reproduce from 20 to 20,000 cycles. Automatic shutoff for amplifier when last record has played. Beautiful mahogany cabinet with luxurious woven grill. Dimensions: 17 $\frac{7}{8}$ " x 15 $\frac{3}{8}$ " x 11". Weight 30 lbs.

Nationally
Advertised
for \$139.95

CLOSE OUT
PRICE!

\$72.50

Write Dept. PE-2 for FREE catalog.

STEVE-EL Electronics Corp.

61 Reade St.

New York 7, N. Y.

R/C



NOTES

RADIO-CONTROL model aircraft enthusiasts in the Southwest will have the opportunity on February 20th of competing in an Academy of Model Aeronautics (AMA) sanctioned regional meet in Phoenix, Arizona. This is a Class AAA event, including radio control. For further information, contact *Quentin T. Webster, C.D.*, 521 E. Camelback Road, Phoenix, Arizona.

MODELERS in the Monrovia-Pomona area in California are being paged for the formation of a model aircraft club—R/C or otherwise. If interested, contact *Bruce Staller*, at 2533 Kimball Avenue, Pomona, California, or *Tom Hume*, at the Model Mart in Pomona.

WE WOULD like to pass on to our readers some of the very interesting and important information we obtained recently in talking to *Mr. Gil Rose*, radio-control specialist of *Polk's Model Craft Hobbies*, the large New York City hobby center. In a general discussion of trends on the Northeast coast, *Gil* mentioned that single-channel equipment seemed to be the most popular; multi-channel jobs are rising steadily, but their price seems to be their major deterrent. Multiple control is most often obtained by the use of *DeBolt* actuators or *Bonner* escapements used with the single-channel radio gear. (Have you seen the *Safford* articles on these escapements in this and last month's issues?)

Servos are on the steady increase according to *Gil*—the most popular being the *Fenner* type which yields 2 control operations from one servo *via* proportional control.

An interesting general observation is that of all of the R/C gear in use, 75 percent goes into model aircraft. Of the rest, R/C boats are fast catching on. The price range for typical factory assembled equipment varies from \$50.00 to \$206.00. This is for radio gear alone, including the actuator. According to *Gil*, proportional control can be added to any single-channel existing equipment for \$25.00, without in any way altering the basic equipment.

As to the items which seem to have the greatest sale and popularity in the Northeast, *Gil* was quick to mention the *E. D. Aristol* single-channel transmitter and gas-

tube superregenerative receiver which, complete with a one-arm self-neutralizing escapement, sells for \$57.50, less batteries and ready for installation. Other popular items are *Babcock* multi-channel equipment and *McNabb*.

From his vantage point, *Mr. Rose* was quick to point out that the use of printed circuitry was advancing. *E.D.* was the first to use such circuitry in their *Aristol* transmitter, but it has caught on widely. Its advantages, of course, are more trouble-free operation and easier serviceability. *Gil* thinks the R/C hobbyist is in for quite a few surprises in the way of new equipment ideas very shortly. All advances, he emphasized, are made with the view toward bringing down the price and increasing the reliability. In this connection, he mentioned the great strides made in the application of miniaturization to R/C receivers. "It is interesting to note," he said, "how the development of R/C equipment for the hobbyist parallels the progress made by the field of electronics in general as applied to industrial equipment." Can this be one of the reasons why the R/C hobby is so popular with electronic engineers who see the chance of applying the latest techniques in electronics for their own recreation and enjoyment?

Gil finished with a very sincere warning to beginners and novices in radio control. He put it this way—"You get just exactly what you pay for when you buy radio-controlled gear." Surplus kits in general are not assembled with the attention to quality control that is one of the principal stocks in trade of the reliable finished-product manufacturer. After you have put in a lot of time building a plane, it's a disheartening experience to have it crack up because of unreliable radio equipment.

One of the toughest jobs faced by the hobby-shop operator who sells R/C equipment is the discouraging of beginners and novices who want to start with multi-channel jobs before they are ready for it. In every case, *Gil* tries to start a man off with simple single-channel equipment so that he can obtain enough practice in radio control to graduate to more complicated stuff. He also emphasized the importance of bench-testing the equipment before installing it in the model craft. (This is something we have been emphasizing in most of our R/C articles. Hope you have been taking it to heart.)

An excellent hint from *Gil* was his suggestion that for bench testing you do not use the lightweight, compact batteries you plan to use in the craft. Use the largest batteries available giving the voltages you require. They are more economical and last longer for bench testing. **END**

Perfect
TV Pictures-
ON ALL CHANNELS

150

Miles or more
from TV Stations
UHF and VHF

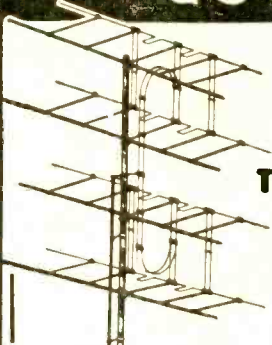

FINCO
MODEL 400A
TV ANTENNA

Only

\$32³⁴

Perfect Pictures- ALL CHANNELS, UHF-VHF, COLOR

Perfect Pictures- ONE TRANSMISSION LINE,
NO SWITCHING!

Perfect Pictures- TESTED AND PROVED RIGHT HERE
IN TOWN — IT'S THE BEST!

Perfect Pictures- ALL YEAR 'ROUND — WEATHERPROOF,
ALUMINUM CONSTRUCTION!

This truly amazing double colateral UHF-VHF antenna has been widely acclaimed as the most outstanding "signal-getter" on the market. Features 32 driven elements that provide remarkably high gain, directivity and superior signal-to-noise ratio. Will give superb fringe area reception on all UHF and VHF channels. Dependable for use where exceptionally long distances must be covered. Will provide excellent VHF reception at distances of 150 miles or more under average receiving conditions. Lightweight pre-assembled construction simplifies installation on masts or towers. Built to withstand the elements. Uses regular 300 ohm line. Requires 10 foot mast. Supplied less mast and wire. Shpg. wt. 14 lbs.

Stock No. H-400A . . . List \$55.00 . . . Net \$32.34



**2 TUBE
AC-DC
RADIO KIT**

- EASILY BUILT
- USES SPEAKER
- TWO BANDS

\$11⁷⁶

This more advanced kit is perfect for the beginner in radio. Offers an excellent opportunity to learn radio fundamentals and at the same time to build a high quality radio superior in tone and selectivity to many manufactured sets. Receives broadcast and shortwave (6-18mc). Complete with spkr. Less tubes. Shpg. Wt. 4 lbs.

Stock No. H7001C Net \$11.76

Please send NEW 1955 CONCORD Catalog!

CONCORD RADIO 55 Vesey St., N. Y. 7 Dept E2A
20% deposit with C.O.D. MINIMUM ORDER \$5.00

NAME _____

ADDRESS _____

CITY _____ ZONE _____ STATE _____

CONCORD RADIO • 55 VESEY ST.
NEW YORK 7, N. Y. • DIgby 9 1132

97

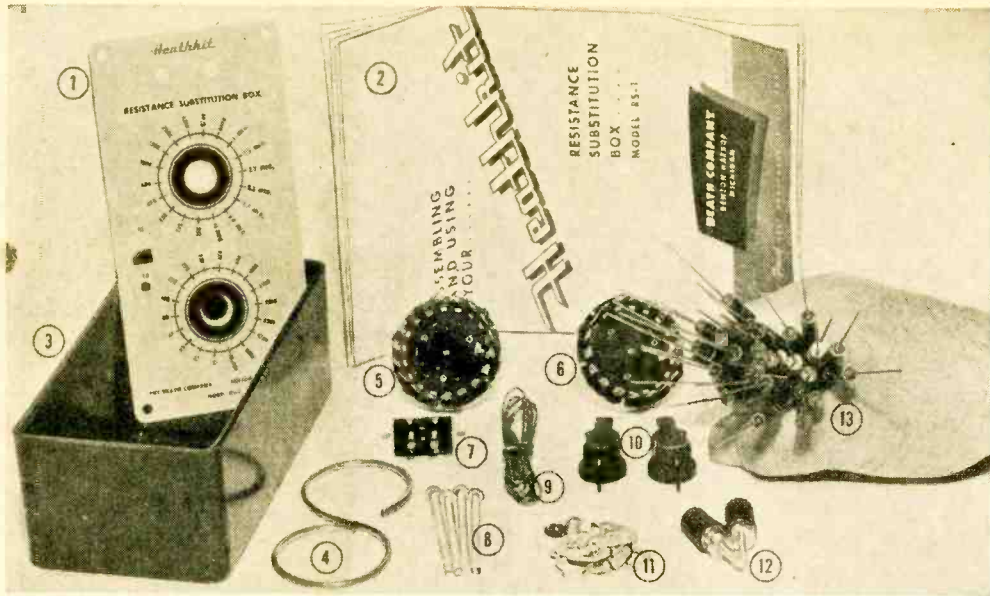

Components comprising the Heath resistance substitution box kit. The stack of 36 resistors is the "heart" of the instrument. (1) Front panel, (2) instruction booklet, (3) case, (4) "S" ring to hold ends of resistors, (5 & 6) rotary switches, (7) slide switch, (8) panel screws, (9) wire, (10) switch knobs, (11) mounting hardware, (12) binding posts, (13) resistors. See article for details.

What Value Resistance for Best Results

YOU'RE experimenting with a small transmitter or an amplifier or some other piece of electronic equipment, and you want to determine the value of a grid resistor, let us say, for best possible results. You can solder in and unsolder half a dozen different resistors, which is the usual method, but if you do you'll probably say to yourself, "This is a nuisance."

You are repairing a receiver with a burned-out resistor. The original is so badly charred that you can't tell what value it was and you don't have the service data. There is nothing to do but use "trial and error," together with your knowledge of electronics. Again, after trying several loose resistors, one after another, you'll probably be talking to yourself, asking: "Isn't there a better way to do this?" There is.

What you should have is a resistance substitution box like the one pictured here. It will take you about an hour and a half to assemble it, and it will save you five times that amount of time the first week you use it. It's such a great convenience in experimental work of all kinds that many people build two, three, and even more units, so that they can adjust the resistance values in several portions of a circuit all at the same time.

The "box" itself is a neat little molded plastic case measuring 6 x 3 x 2 inches, with an aluminum cover panel. The latter holds two rotary switches, one slide switch, and two binding posts. Inside, soldered directly to the terminals of the rotary switches, are 36 separate 1-watt, 10% rating resistors, in the standard values from 15 ohms through 10 megohms. The "low" series runs as follows: 15, 22, 33, 47, 68, 100, 150, 220, 330, 470, 680, 1000, 1500, 2200, 3300, 4700, 6800, and 10,000. The "high" series: 15,000, 22,000, 33,000, 47,000, 68,000, 100,000, 150,000, 220,000, 330,000, 470,000, 680,000, 1 megohm, 1.5 megohms, 2.2 megohms, 3.3 megohms, 4.7 megohms, 6.8 megohms, and 10 megohms. Either group is quickly connected to the binding posts by the center slide switch.

Assembly and wiring of the parts from the *Heathkit* are extremely simple. The main part of the job is identifying the resistors from their color markings and lining them up in order on the switch lugs. This is an excellent project for a beginner because it can readily be completed in one sitting and is ready for immediate use.

Caution: don't use it where the 1-watt power rating would be exceeded or in high-frequency circuits where the wiring capacity would affect operation. **END**



Resistor leads are cut short and soldered directly to switch lugs. Upper leads are left at original length at this stage. Binding posts, slide switch, and one nest of resistors on its switch are mounted on panel in background.

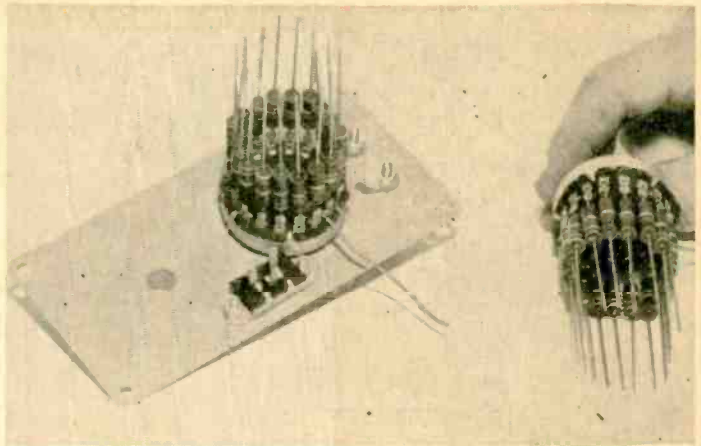

Inside of completed unit. Upper leads of resistors have been bent short around edge of "S" ring and soldered into place. See article for details.

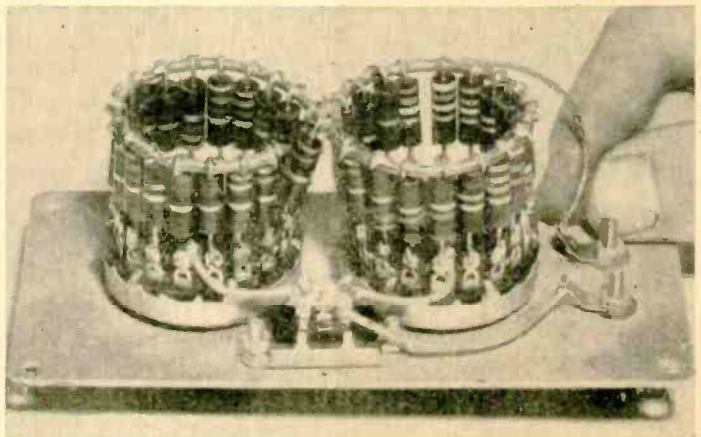

Completed substitution box in actual use to determine the best value for a replacement resistor in a receiver. Slide switch is down in the "Lo" position. The lower switch knob is being turned to put different resistors into circuit.

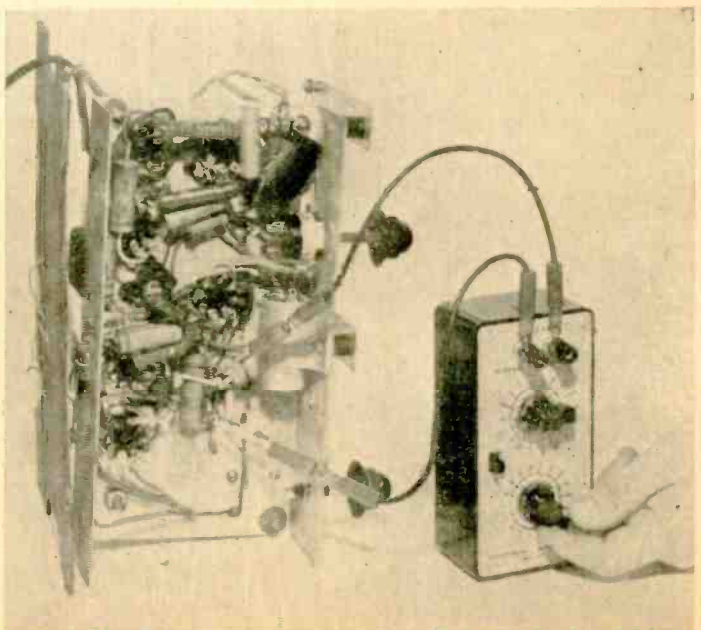



HERE IT IS!

COMPLETE PARTS KIT for building

NOVICE CW TRANSMITTER

AS DESCRIBED IN THE ARTICLE IN THIS MAGAZINE
(If you missed this article, see table of contents)



EVERYTHING YOU NEED!
\$12.88
JUST PUT IT TOGETHER,
IT'S READY TO OPERATE

TOP-QUALITY PARTS THROUGHOUT!

Here is the complete parts kit for the easy-to-build Novice CW Transmitter as described in the article by Rufus P. Turner. Consists of top quality components throughout for the best possible performance. Includes the 6AQ5 tube, crystal, the very popular J38 sending key, an original \$5.00 value, plus all other necessary parts. Easy to follow wiring diagrams both schematic and pictorial are presented in the article itself. Please specify 40 or 80 meter crystal.

No. 22B65; Complete Kit..... **\$12.88**
(Add 50c to cover postage and handling)

POWER SUPPLY KIT

Especially designed by B-A engineers for use with the above CW Transmitter. Complete with all parts including the 5U4G tube and complete wiring diagram. A Terrific Value at the price offered.

No. 22B66; Complete Kit..... **\$5.88**
(Add 25c to cover postage and handling)

FREE! BIG CATALOG!

A COMPLETE GUIDE FOR EVERYTHING IN RADIO, TV AND ELECTRONICS AT LOWEST PRICES ANYWHERE



BURSTEIN-APPLEBEE CO.

Dept. PE, 1012-14 McGee St., Kansas City 6, Mo.

- Send me..... No. 22B65. \$..... Enclosed.
- Send me..... No. 22B66. \$..... Enclosed.
- If you haven't received the 1955 B-A catalog, check here.

Name.....

Address.....

City..... State.....

THE WHY OF HI-FI

By L. E. Johnston

IT'S A rare man these days who hasn't heard of Hi-Fi! The press is full of it; magazine ads claim that most things electronic that make noise have it; and now even the man on the street is kicking it around.

You can find the requirements of a good Hi-Fi system at almost every turn, and there are suggestions galore on any newsstand for assembling an outfit of your own. Ideas vary, of course, and so do prices of components—from a few bucks for kits to several hundred for ready-built rigs for the carriage trade. It can be very confusing at times.

And far be it from me to get involved in this somewhat over-crowded field of reporting; the technical aspects of the subject have had coverage enough without my two cents worth. But there are still a great many people who, after reading all the other articles and pamphlets, are wondering just why in the name of Pete the Hi-Fi bug waited this long to bite. They are curious to know if it could be possible that we had *tin ears* until a few years ago. They wonder why the old console sounded so good for so long, when the experts say now that it should be stripped for parts.

Well, there's an answer and it's fairly obvious, too, after a little study. Think back for a minute and trace the history of music from the days of primitive man till now. Immediately, one curious fact comes to light: *all* musical performances in history up to this very century were done "in the flesh." Salome danced to music played in the same tent, and Ulysses, tied to the mast, heard the song of the Sirens as his ship swept near their rocks. In *all* cases, an audience listening to a performance had to be within hearing distance to get in on the act at all.

Then, all of a sudden with the twentieth century, Alexander Graham Bell, Lee DeForest, and Tom Edison put words and music on wax and out over the air. The reproduction and transmission of sound was accomplished. The immediate effect on the public was awe and wonder, and also the unconscious formation of two standards—one for judging sound quality in the flesh and one for judging it over the wire or off the record. People still insisted that music heard in the concert hall be flawless, but the same performance coming over the old battery radio or from the old wind-up Victrola was OK—all because they were still somewhat impressed with the mechanics of the thing.

And as time passed, most of us continued to accept these two standards as normal without even realizing it. Quality improved, of course, right under our very noses, until by the beginning of World War II, radio and recorded music bore a reasonable resemblance to the original performance. At least it was still acceptable to most of us under the dual standard by which we continued to judge it. The record and equipment people naturally tailored their products to our tastes, and who can blame them.

But there's always a "breed of cats" who hang around development laboratories and in ham shacks who aren't satisfied with just anything; they always want something better. These early electronics engineers knew of the two standards too, and set about to correct the situation by improving the "fidelity," or "faith to the original" of sound as it came from the loudspeaker of the day. And in this process, they named their goal "high fidelity" or Hi-Fi as we know it today.

The war interrupted this work, but also helped it along in some respects. FM radio was extensively used as wartime VHF by the armed forces. In fact, many of the techniques and much of the know-how that led to Hi-Fi came from research done on military projects.

Then after the war, it seemed that all at once we had the microgroove record, the magnetic pickup, the Williamson amplifier circuit, and a variety of high fidelity loudspeakers. For the first time in history, everything needed to assemble an inexpensive radio and record player that reproduced sound almost as it was played was available to the experimenter. This was the beginning of Hi-Fi as we see it today, and the craze-like acceptance it is currently enjoying.

One listen convinced most of us of our past folly. Five minutes of music on a Hi-Fi outfit melted our two standards into one, and we knew that nothing else would ever do. We saw for the first time the quality and realism we had been missing without even being aware of it. We hadn't been kidding ourselves; we were just ignorant of the facts; we were the blind who saw light for the first time.

And now this wonderful realism is available to all. You can assemble a system yourself from a selection which is so large it almost makes you dizzy to look through a catalog. Your ultimate choice of equipment will probably depend on your pocket-book and advice of friends, but no matter which units you choose, it's a sure bet that you'll enjoy music as you never have before. And you will find that you won't be alone, either.

END

A GIFT . . . to Hi-Fi Enthusiasts

LIMITED, DE LUXE EDITION

The Hi-Fi Library, Volume 1, is now available to you as a gift from MUSIC at HOME Magazine. This is a very limited edition, and when the present supply is gone, the wealth of information on records, tape, FM, and hi-fi equipment and installations which it contains *will not be available from any other source.*

YOUR GIFT: A \$12 VALUE

This veritable hi-fi encyclopedia is equivalent to 4 ordinary books of 200 pages, selling at \$3.00 each! But no books on hi-fi are so elaborately illustrated, so beautifully printed, or are written by such an array of authorities on music and equipment! *Yet it is available to you as a GIFT!* Here are the details:

The Hi-Fi Library, Vol. 1, a handsome addition to your book shelves, is comprised of the first six issues of MUSIC at HOME, shipped to you in a dust-proof, *double* case, lettered and decorated in gold. It measures 9 by 12 by 1½ ins. On the outer case is a complete index of articles and authors, enabling you to locate information on any subject instantly!

This idea, originated by Milton Sleeper, is far superior to any binder, because the sturdy double case is more attractive in appearance, keeps the contents in perfect condition, excludes dust and dampness.

HOW TO GET THIS GIFT

Next year, you'll be lucky if you can buy a copy of Vol. 1 for \$10.00. Right now, if you enter a 3-year subscription to MUSIC at HOME, costing only \$6.00, you will receive a copy of the Hi-Fi Library, Volume 1, *as a gift, sent to you prepaid!*

But you must send your order while Volume 1 is still available. Don't wait, because *this offer will expire* when the present limited supply is gone.

MAIL THIS COUPON TODAY!

MILTON B. SLEEPER, Publisher

207-F East 37th Street, New York 16, N. Y.
Enclosed is my remittance for \$6.00. Please send me: 1. Gift copy of the Hi-Fi Library, Vol. 1, de luxe edition. 2. MUSIC at HOME Magazine for 3 years (18 issues). If I am not completely satisfied you will refund my money.

Name

Address

.....
Add \$3.00 for foreign delivery

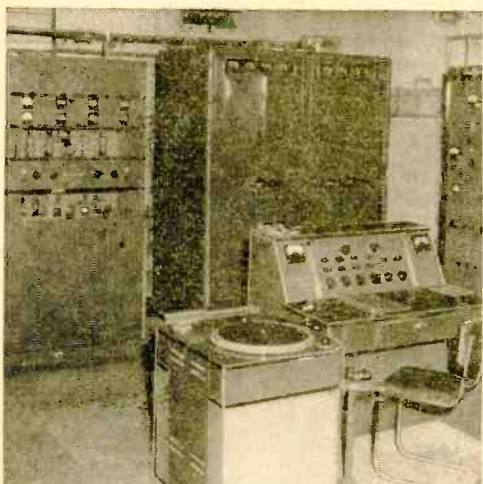

Transmitting plant houses AM (at left) and FM units. Racks at right hold meters, switching devices, receivers, control and measuring equipment. Building also contains studio for emergency use. Annual electric bill is \$2100, about 21 times that paid for average home.



Operating practices of the 250-watter differ from those used by large network outfits.

Antenna tower is 260 feet high; handles AM power of 250 watts at 1100 kc. FM array near top transmits 1000 watts at 98.3 mc. Array at very top is antenna for local police radio.

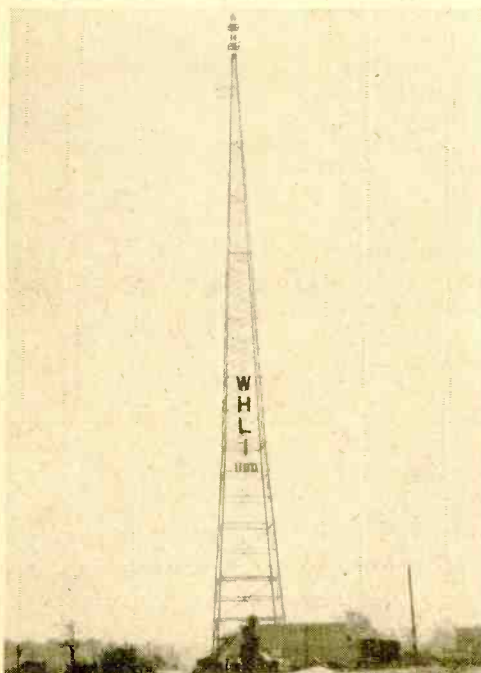

THE continued success of a 250-watt station with no network affiliation may seem paradoxical in these days of nationwide networks and broadcasters who command powers up to 50,000 watts, particularly when the small station is virtually in the backyard of several of its giant neighbors. Yet there are hundreds of such small outfits throughout the U.S.A., who not only hold their audiences but are making good money doing it.

Managing and operating procedures are unique with these stations. In the case of WHLI, Hempstead, Long Island, for example, station heads cannot depend too heavily on national advertising for a source of income. This limitation, however, is turned to advantage, for it forces the station to explore the needs and utilize the resources of its own community. Both listeners and advertisers in the area benefit from a kind of immediacy of service and programming which they could not possibly enjoy at the hands of the more powerful, but more removed, large stations.

One of the things WHLI does is to share its antenna tower with the local police transmitting antenna. In addition, the police transmitter is housed in the station's own transmitter shack. Thus the two most prominent broadcasting systems in the region work side by side and the chance of



Control technician stands by for cue from studio announcer. Programs are monitored in control room. Tape consoles (not shown) can record programs as well as furnish program material. Stylus in tone arm on turntable is changed after 5000 plays (about once a month).



WHLI newsmen prepare one of the station's eighteen newscasts broadcast daily. Portable tape recorders are often used for on-the-spot coverage. Station vice-president and chief engineer Frank Knaack drives around with one in his car, always ready for news to happen.

any problem of interference is minimized. The antenna tower itself was erected on the edge of a large, unused tract of flat land, far enough removed from bodies of water to avoid signal dissipation. The station has established cordial relations with local "ham" operators and practically no interference problems ever arise from that source.

The station uses only trained specialists for specific jobs—no technician ever does any announcing. Similarly, announcers are regarded strictly as "air-voices." They do not even select music for broadcasting; this task is in the hands of a musical director. This policy makes for very professional sounding programs.

Coverage of local news and of conditions especially important to local residents is a prominent item on this station's agenda. National events are reported and when possible, from the standpoint of the station's community. In addition to United Press teletype service, the station has its own news staff and a battery of tape recorders to be rushed to any scene for on-the-spot coverage. A music library of over 50,000 transcriptions caters to the tastes of every type of listener. And since many Long Islanders are vitally concerned about railroad, weather, flying, sailing, and fishing information for their livelihoods, the station provides them with this material regularly.

Realizing its importance to the local community, the station has provisions for staying on the air through almost any situ-

ation with an emergency studio and power generator at the transmitter site. During the recent hurricanes, this 25 kilowatt gasoline-driven generator kept the station on the air. In normal operation, programs originate in the regular studios located in station headquarters about a mile from the transmitters.

Small but effective, these stations are a vital part of the American scene, since apparently those who live in out-of-the-way places depend more on their local radio than the big city dwellers depend on their stations. END

Its more than 50,000 records and transcriptions make WHLI's music library one of the largest in the East. Here, music director Roger Wayne selects an album for broadcast.



SUPER POCKET RADIO

Smaller than many hearing aids. Powerful, portable and can be assembled by anyone in one hour. Uses two inexpensive cells that fit within case. Owners report 1,500 mile reception. No antenna or ground required for local use. Complete kit of hearing-aid parts only \$3.99. Batteries extra at \$1.45. Use any regular headphone with Micro or tiny hearing-aid earset, shown in photo, available from us at low cost. Micro is guaranteed to please or return in 10 days for full refund.



\$3.99 POST-PAID

SEND ONLY \$1.00
BALANCE C.O.D.

TRANSI-MITE RADIO LAB

MANTEO (3) NO. CAR.

IT'S NEW! IT'S FREE! 1955 Walter Ashe Catalog of Radio, Electronics and TV

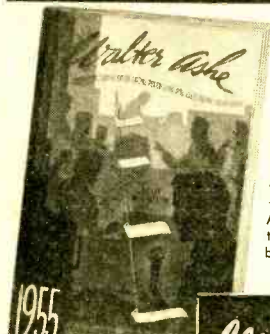

The Treasure Chest of Values!

Features all the leading brands of Communication Equipment, Test Instruments, Build-it-Yourself Kits, Hi-fi, Sound and Recording Equipment, Radio, Electronics and TV Parts and Supplies for every conceivable need . . . in stock—ready for immediate delivery. A "must" for experimenters, amateurs, servicemen, engineers, builders and "hi-fiers."

Walter Ashe
RADIO CO.

1125 PINE ST., • ST. LOUIS 17, MO.

Send for your
FREE Copy

MAIL COUPON TODAY!

WALTER ASHE RADIO CO.
1125 Pine St., St. Louis 17, Mo.

PE-2-55

Rush FREE Copy of New 1955 Catalog.

Name _____

Address _____

City _____ Zone _____ State _____

Prodigal Ham

(Continued from page 89)

exploded and with it all the old holdback basics were overthrown and discarded—with all ties to this cumbersome past severed and the background of old wives tales that stood for radio perceptions done away with, nothing could hold back the men who created the forward sweeping tide of advance and who could do more than just see to the limit of the horizon.

All this flashed across a newly opened mind that had been dormant to everything except the immediate daily needs and left the grand old hobby in mothballs. I grabbed at the newest surplus and started in again. The conversion was a good training sequence—it did not matter to me whether the darned thing would work or not—familiarity with old materials, tools, and handicrafts laid aside years ago had to be revived—old ham gear, secondhand commercial stuff, home-brew oddities, all helped to get back in stride again. It did not take long before the code difficulties were really manifest in a mind that had to cope with daily bread and butter, and the routine passing aggravations in living to contend with left one quite worn at the end of the day and in no condition to bang his head against the wall with code practice. The ice could not be broken that easily. W1AW, however, provided what first friendly help could not donate or make available to me. The exams were taken, but that code—the examiners were the swellest bunch, the most sympathetic fellows one could ever hope to meet and know—but passing that exam was up to me. You could feel their disappointment, as well as my own, in not passing. That 13 wpm was a personal problem and only I could get it. Then the door opened in a most unexpected manner—the Novice Class was made available and passing that and the Technician Class gave me what I had always needed, actual practice on the air in code to build up speed and get the actual feel of hamming. The most painful thing was not failing to pass the code test, but to read in the papers of little Joe Glutz Jr., seven-and-half-years-old, of Crotch Hollow, passing his General Class and then, when asked what he thought of the exam, saying with a toothless smile, "Aw, it was nuttin—it was easy."

It made me feel like a . . . Finally, the constant plugging on the air got me my General Class ticket. Some men take to liquor, some to other men's wives, some to the hounds, and others to the parimutuels, but the ham—he is in a world by himself. He did not take to radio—it took him. It is not a vice in which money is thrown

down a rathole as in the old days—a money spending time-killer that took your dough on a load of junk to give you a tinkering hobby—all that has changed. I found instead that it had grown to a deadly serious business—the business of national welfare, defense, and big business.

Ham activities of today not only present a field for radio investors or a dump into which to throw and dispose of old electrical odds and ends, but provide the entire country with a tremendous reservoir of trained communication maintenance men, operators, radar technicians, and electronic seedlings that could be grown into scientific signal and intelligence fighters for the country. It takes time to train men to 15 wpm c. w., or as high-speed troubleshooters on equipment. Here was a backlog of readily-available reserves who could spring to attack or defense, either civilian or military; the same voluntary scientific leaders who in their younger days had given the world the basic principles of TV, the whip antenna, radar, v.h.f. and u.h.f. They were spread all over the country in a network that was alert to respond to any emergency; local, statewide, or national, through all efforts, combined, net or groups, and individual. The integration of ham activity in the MARS system is proof of this cooperation. CD is another bit of evidence. The voluntary ex-

perimentation for constant improvement and betterment of equipment and efficiency—the insatiable curiosity of the ham with the only compensation being personal satisfaction (in many cases the basic ideas were never patented but left to public domain), showing the self-sacrificing attitude of the ham—have not changed in these times.

Let us consider those who pioneered the trouble-shooting for TVI and the curbing of interference. That is something which cannot be forgotten and the never-ending strive for perfection is still being carried on by the ham. It is he who makes the first step in that direction—no one else.

It is the only hobby in which there is no knifing in the back of the other fellow for personal aggrandizement and gain; no exploitation or profit goals. It brings to a common stratum all walks of life, all human endeavor and the various professions and callings that earn a ham his daily bread—all are attracted by the one interest—ham radio. I am glad that I made it after such a long self-imposed exile, providing myself with a mental port in the daily storm, a retreat from the tensions of the day and above all a medium in which to meet and hold new friends in a common bond for mutual communion, not only nationally but universally. Let's hope, with God's help, to keep it that way. **END**

Get This Valuable Book

FREE



Just for Examining COYNE'S New 6-Volume Set

"Applied Practical Radio-Television"

**ON 7 DAY
FREE
TRIAL!**



Yes, you get this big, brand new book, "150 Radio-Television Picture Patterns and Diagrams Explained", absolutely FREE! Just off the press! Gives complete wiring circuits and diagrams on the latest Radio and Television Sets. Easy-to-read, large 8½ x 11" pages, with full instructions on how to read and use the diagrams. A "must" in every Radio and Television service-man's repair kit. You get this valuable book as a FREE Gift for asking to see Coyne's great new 6-book set, "Applied Practical Radio-Television"!

Here's "Know-How" That Makes You Worth More!

Coyne's great new 6-volume set gives you all the answers to servicing problems—quickly! For basic "know-how" that is easy to understand, you'll find everything you want, in volumes 1 to 5 which contain over 5000 practical facts and data. They cover every step from principles to installing, servicing, trouble-shooting and aligning all types of radio and TV sets. So up-to-date it includes COLOR TV and UHF, adapters and converters. Also covers very latest information on **TRANSISTORS**.

802-Page Television Cyclopedic Included

And then, for speedy on-the-job use, you get volume 6—the famous **COYNE TELEVISION CYCLOPEDIA**. It answers today's television problems on servicing, alignment, installation and others. In easy-to-find ABC order, cross indexed. Use this 6 volume TV-RADIO LIBRARY free for 7 days; get the valuable Servicing Book **ABSOLUTELY FREE!**

Educational Book Publishing Division

COYNE ELECTRICAL SCHOOL
500 S. Paulina St., Dept. 25-PE Chicago 12, Ill.

SEND NO MONEY! Just mail coupon for 6-volume set on 7 days free trial. We'll include book of 150 TV-Radio Patterns & Diagrams. If you keep the set, pay \$2 in 7 days and \$2 per month until \$22.50 plus postage is paid. (Cash price \$20.95). Or you can return the library at our expense in 7 days and owe nothing. **YOU BE THE JUDGE.** Either way, the book of TV-Radio Patterns is yours **FREE** to keep! Offer is limited. Act NOW!

FREE BOOK—FREE TRIAL COUPON!

Coyne Electrical School, Educational Book Publ. Div., Dept. 25-PE
500 S. Paulina St., Chicago 12, Ill.

YES! Send 6-volume "Applied Practical Radio-Television" for 7 days FREE TRIAL per your offer. Include TV-Radio Patterns & Diagram Book FREE.

Name.....Age.....

Address.....

City.....Zone.....State.....

Where Employed.....
() Check here if you want library sent COD. You pay postman \$20.95 plus COD postage on delivery. 7-day money-back guarantee.

TRICKS of the TRADE

DRILL CUSHION

SO THAT you won't mar your work while drilling by letting the drill chuck hit the surface, slip a rubber grommet over the

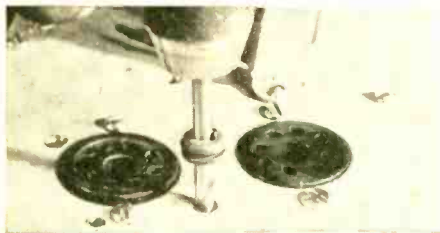

drill bit before you start. Then if the hole breaks through suddenly, the edges will not be scratched by the rapidly descending chuck.

* * *

ADAPTER INSULATES MICROPHONE

HERE is a simple adapter (costing less than 50 cents to make) which will isolate a microphone from a metal floor stand or table stand, thus reducing danger of shock. It is possible to receive shocks by touching two metal mike stands at the same time which are at different "ground" potentials or by touching a grounded mike stand while working around "hot" circuits.

As shown in the photo, simply remove the cable-protecting springs from a female cable connector and a male cable con-

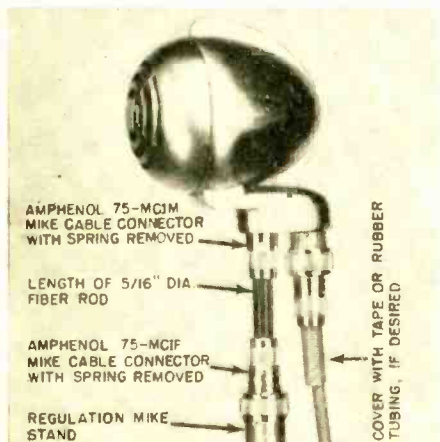

necter, and slip a 2½" length of 5/16" diameter fiber rod into the connectors and tighten the set-screws. The female connector fits the top of the stand, and the male con-

necter fits into the socket on the bottom of the mike. If you are afraid that the spring on the mike's cable connector might make contact with the stand when the cable is moved around, you can cover the spring with rubber tape or tubing, or else use a longer length of fiber rod in the adapter so the spring can't reach the stand.

* * *

CHEAP STAND-OFF INSULATORS

THOSE empty cellulastic pill containers make good low-loss stand-off insulators for indoor use. These insulators fasten to the wall with one screw, and the wire can be attached or removed by simply removing the cap on the container.

The photo shows a pill container holding a 300-ohm ribbon twin-lead to an inside wall.

Remove the cap of the container and saw off about ¼" from the open end of the con-

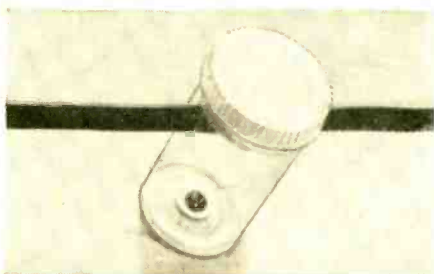

tainer. This removes most of the reduced-diameter end of the container so the cap will fit tightly. Now saw or file two slots (opposite each other) in the end of the container for the wire to slip into. The insulator is completed by drilling a 1/8" or 5/32" mounting hole in the center of the bottom of the container. As shown in the photo, mount the container using a ½"-long wood screw with washer, then slip the wire into the slots on the end of the container, and push the cap on tight. Don't use these outdoors as the rain will seep in the slots. Use a fine-toothed narrow blade hacksaw for cutting the slots.

* * *

CHECK TV LEAD-IN FOR BREAKS

WHEN a TV receiver seems weak and sound does not come in as usual, it is a good idea to check the antenna lead-in which goes from the terminals on the back of the set to the front end tuner.

Where clamps are used along the side of

the chassis to hold the twin lead, be suspicious of breaks and try removing lead-in

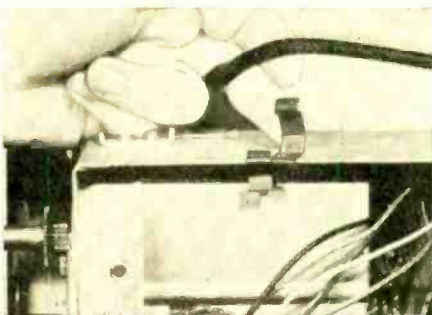

from clamp and twisting to make temporary contact.

In the case shown there was a complete open in one wire of the lead-in under the clamp.

AIDS FOR SMALL RADIOS

SMALL table radios are easier to carry if you fasten a plastic drawer pull to the top of the cabinet, as shown in the photo. These plastic drawer pulls are available in various colors, and are sold in dime and hardware stores. When mounting the handle, shorten the two mounting screws by sawing them off to a length of about $\frac{1}{2}$ " because the plastic radio cabinet is considerably thinner than the wood on the drawers for which the handles were intended.

Small table radios which use only one i.f. transformer, and no loop antenna, are always equipped with a length of antenna wire which must be stretched out to pull in out-of-town stations. It's a pleasure to reel, and unreel, the antenna wire if you mount two pan lid knobs onto the back panel of the radio, as shown in the photo. These



plastic pan lid handles are also available in various colors and cost a few cents each. You may want to saw off part of the shank on the knobs so they won't stand out so far, but don't saw off too much or there won't be any hole and threads left for the mounting screw. Of course, you can always drill an undersize hole in the knob and use a

BUILD 15 RADIOS

AT HOME ONLY

With the New Improved 1955 Progressive Radio "EDU-KIT" **\$19.95**

NOW INCLUDES

HIGH FIDELITY, SIGNAL TRACER, CODE OSCILLATOR

Complete

- Attractively Gift Packed
- Free Soldering Iron
- Absolutely No Knowledge of Radio Necessary
- No Additional Parts Needed
- Excellent Background For Television
- 10-Day Money-Back Guarantee
- School Inquiries Invited
- Sold in 79 Countries



WHAT THE PROGRESSIVE RADIO "EDU-KIT" OFFERS YOU

The "Edu-Kit" offers you a Home Radio Technician Course at a rock-bottom price. You will learn how to identify Radio Symbols and Diagrams; how to build radios, using regular radio schematics; how to wire and solder in a professional manner. You will learn how to operate Receivers, Transmitters, and Audio Amplifiers. You will learn how to service and trouble-shoot radios. You will learn code. You will receive training for F.C.C. license. In brief, you will receive a practical basic education in Radio, worth many times the small price you pay.

THE KIT FOR EVERYONE

It is not necessary that you have even the slightest background in science or radio. The "Edu-Kit" is used by young and old; by radio schools and clubs; by Armed Forces personnel and Veterans for training and rehabilitation. No instructor is required. Instructions are complete, simple and clear. You cannot make a mistake.

PROGRESSIVE TEACHING METHOD

The "Edu-Kit" uses the principle of "Learn by Doing". Therefore you will build radios, perform jobs, and conduct experiments to illustrate the principles which you learn. You begin by learning the function and theory of each of the radio parts. Then you build a simple radio. Gradually, in a progressive manner, you will find yourself constructing more advanced multi-tube radio sets, and doing work like a professional Radio Technician. The "Edu-Kit" Instruction Books are exceedingly clear in their explanations, illustrations and diagrams. These sets operate on 105-125 V. AC/DC. Adapter for 210-250 V. AC/DC available.

The Progressive Radio "EDU-KIT" is Complete

You will receive every part necessary to build fifteen different radio sets. Our kits contain tubes, tube sockets, chassis, variable condensers, electrolytic condensers, mica condensers, paper condensers, resistors, line cords, selenium rectifiers, tie strips, coils, hardware, tubing, Instruction Manuals, etc. A soldering iron is included, as well as an Electrical and Radio Tester. Complete, easy-to-follow instructions are provided. All parts are guaranteed, brand new, carefully selected and matched. In addition, the "Edu-Kit" now contains lessons for servicing with the Progressive Signal Tracer, High Fidelity, F.C.C. instructions, quizzes. The "Edu-Kit" is a complete radio course down to the smallest detail.

TROUBLE-SHOOTING LESSONS

Trouble-shooting and servicing are included. You will be taught to recognize and repair troubles. You will build and learn to operate a professional Signal Tracer. You receive an Electrical and Radio Tester, and learn to use it for radio repairs. While you are learning in this practical way, you will be able to do many a repair job for your neighbors and friends and charge fees which will far exceed the cost of the "Edu-Kit." Our Consultation Service will help you with any technical problems which you may have.

FREE EXTRAS

• Electric-Radio Tester • Soldering Iron • TV Book • Radio Trouble-Shooting Guide • Consultation Service • Quizzes • F.C.C. Training

PROGRESSIVE "EDU-KITS" INC., 497 Union Av., Brooklyn 11, N.Y., MAIL TODAY—Order shipped same day received.

10-Day Money-Back Guarantee. INCLUDE ALL FREE EXTRAS.

- RUSH ME the following—include all Free Extras:
- "EDU-KIT" Postpaid. I enclose full payment of \$19.95
 - "EDU-KIT" COD—I will pay \$19.95 plus postage
 - Outside USA: Enclose \$20.95. "Edu-Kit" sent postpaid.
 - Outside USA: 210-250V. AC/DC Adapter. Enclose \$2.50
 - More details on "EDU-KIT" Free—No Obligation
 - FREE Radio-TV Servicing Literature. No Obligation

NAME _____

ADDRESS _____

PROGRESSIVE "EDU-KITS" INC.

497 Union Ave. Dept. PE-5081 Brooklyn 11, N. Y.

ELECTRONIC SUPPLIES

For Experimenters - Service - Industry

Clean Useful items sold on satisfaction
Guaranteed basis. **WHOLESALE OR RETAIL**
Simplified Code Training course
with \$4.00 order.
TUBES Values
1629—Magic Eye Tube. 7 for \$1.00
6H6—Dual Diode. 4 for \$1.00
6A5—Min. Pentode used in
Model Aeracraft Remote Control
RCA. 2 for \$1.00
Toggle Switches Bakelite Body
SPST 3A. 125VAC. 3 for \$1.00
DPDT 3A. 125VAC. 3 for \$2.00
DPDT Center Off. \$1.00 ea
Amps.
Filament Transformers
6.3 Volt, 1 Amp. \$1.00
12.6 Volt, 1.5 Amp. 1.00
6.3 Volt, 3 Amp. 2.49
Her. Seal
SMALL PARTS VALUES
BELL WIRE—Stranded 3x50/
HANKS. \$1.00
SOUND POWER—Head & Chest
SET Used—Operating. . . \$2.95
Mica Condensers, worth 40c
ea. 6 for \$1.00
Brand new Telephone Hand-
sets. \$5.95 ea.
1/2" Panel Lamp Indicators—
Red or Amber. 6 for \$1.00
Hearing Aid Subminiature
tubes. Unbranded. New.
Carbon Chest Mike w/Brosat
Plate, Sw. \$2.95
Small Chassis containing Al-
lied or Sigma 8000 Ohm Plate
Relay. \$1.00 ea.
Coaxial Cable RG 59/U 100'
lengths. \$2.95
Electrolytic 20x20 Mfd. 450
VDC. Worth \$2.4 for \$2.00
EP Electronics Multiple Can
Types. Fresh. 6 for \$1.00
10 MFD. 400 VDC (dual 5)
Oil Rect. Cond. NEW. \$1.00
7 Pr. Min. Stentite Sockets.
Worth 25c ea. Doz \$1.00
Western Electric Stepping
Switch. 2 Circuit 48 Steps 6
or 12 VDC Coil. Worth \$30.
Special \$7.95 ea.

REX RADIO SUPPLY

88 CORTLANDT STREET, NEW YORK 7, N. Y., CO 7-1617

SAVE ON TELEVISION PARTS

HEAVY DUTY 1 1/4 IN. O.D. TOWERS

VINYL ALUMINUM FINISH

SELF SUPPORTING TO 50 FT.

10 ft. section. \$11.95
Top section (10 ft.) 11.95
Adjustable house brace. 4.95
10 ft. heavy top pipe. 3.98

All Hardware Included

SPECIAL PRICES ON T.V. ANTENNAS

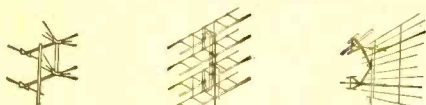

Dbl. Lazy X \$5.95
UHF-VHF Skymaster \$19.95
Dbl. I.S2 \$18.95

300 ohm lead-in—100 ft. \$2.98

ROTORS { U83—Alliance \$20.95
TR4—Radiart 32.50

Write for Finco Antenna Prices

Heavy 1 1/4 in. O.D. self-fitted mast \$3—10 ft.

All Prices F.O.B. Order from This Ad.
C.O.D. Orders—25% Deposit

RICHVILLE T.V. SUPPLY

5666 Navarre Rd. S.W. R.D. 1, Canton, Ohio

self-tapping tinner's screw, or you can drill all the way through the knob and use a machine screw and nut.

TUBE CENTERING ADAPTERS

SMALL centering adapters for seven and nine pin miniature tubes are available at radio and TV stores. The adapter consists of a metal centering pin mounted in a thin insulated plastic or bakelite wafer with the proper number of holes. When slipped on the miniature tube, it is an easy matter to insert the pin in the socket opening and rotate the entire assembly of the adapter and tube until it lines up with the proper socket openings. The adapters re-

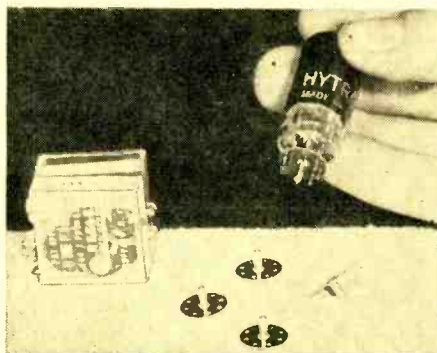

main on the tubes but are economical to replace.

INEXPENSIVE PANEL BUSHINGS

INEXPENSIVE panel bushings for switch and volume control extension shafts may be obtained by breaking up defective potentiometers and old rotary switches.

A pair of diagonal side cutters may be used to bend back the mounting lugs for removing the cover plate. The bakelite or fiber body of the control may be broken by applying pressure in a vise.

LEADS TO PHONE-TIP-JACKS

IN EXPERIMENTAL and test work, it is often necessary to connect wire leads to phone-tip-jacks. These wire leads with phone-tips on their ends may not be readily available. To make it easy to connect any wire lead to any phone-tip-jack, make up several "tip-posts" as shown in the illustration. Using these tip-posts, you can quickly connect any wire lead to the binding post, and then plug the tip-post into the phone-tip-jack, as shown.



To make these tip-posts, solder the threaded shanks on binding posts into the sleeves of phone-tips. Binding posts with non-removable tops (left post in photo)

have the threaded shanks permanently attached, so all you have to do is push the threaded shank into the phone-tip and solder the two together securely. The older type binding posts (right post in photo) use removable machine screws, so you will have to clip off the heads of the screws before you can insert the screws into the phone-tips. Or you can enlarge the hole in the bottom of the post and solder the sleeve of the phone-tip into the enlarged hole, as in the right post in the photo.

* * *

DIAGRAM AIDS CHECKING TUBES

MINIATURE tubes have their prongs so close, and positions are so varied that it is next to impossible, particularly for the

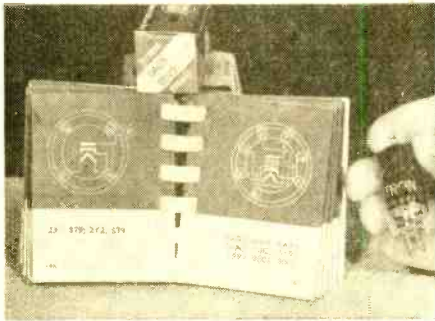

man working only part time on receivers, to remember all types.

A small tube guide as shown takes but little space but will save you considerable time and trouble.

* * *

CABLE SPEEDS EXPERIMENTS

COLOR coded cables with from three to nine conductors enclosed in a plastic covering speed up temporary connections when making various hook-ups.

(Continued on page 110)

SAVE HOURS OF WORK

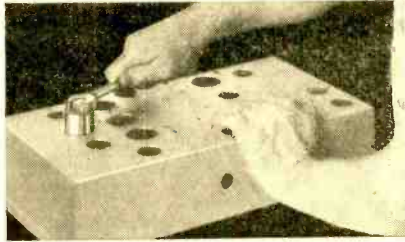

quickly make round, square, key and "D" openings with Greenlee Radio Chassis Punches

In 1½ minutes or less you can make a smooth, accurate hole in metal, bakelite or hard rubber with a GREENLEE Punch. Easy to operate . . . simply turn with an ordinary wrench. Wide range of sizes. Write for details. Greenlee Tool Co., 2382 Columbia Ave., Rockford, Ill.

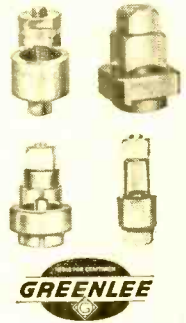

OWN a Business

If employed, start part time. Alert dealers can gross \$5 hourly profit on own service plus \$3 on EACH serviceman. Clean, revive, moth-proof rugs & upholstery on location. No shop needed. Services nationally advertised. Repeat customers. Easy to learn. We locally train and assist you. Quickly established. Easy terms. Send today for FREE booklet. No obligation.

DURACLEAN CO., 5-232 Duraclean Bldg., Deerfield, Ill.

Get info. **PLASTIC LAMINATING AT HOME!**

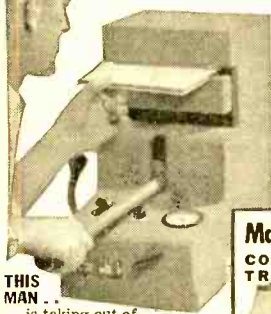

THIS MAN . . . is taking out of the machine a Plastic Sealing Job—ordered by mail—only 11c in material cost brings back \$2.58 in cash by mail. Capacity of machine: \$25.00 profit per hour of operation.

Get **ORDERS** and **CASH** from your mailman—do work in **SPARE TIME** at home—**or expand into FULL TIME** business. Send coupon for Free facts about the newest and most fascinating of all home operated businesses. For the first time a simplified machine brings the fabulous profits of **Plastic Sealing and Plastic Laminating** within the reach of the small operator. Any one can learn to operate the machine with a few minutes practice—then with our **Magic Mail Plan** can get mail orders pouring in daily with cash in every envelope. **No canvassing—no selling.** We even

**Make \$20 to \$30 a Day by..
MAGIC MAIL PLAN!**

supply the circulars you mail to bring back cash and orders. Don't waste a minute. Rush your name. We'll send you **FREE** and postpaid, pictures, prices, details, and all the facts you need to start. Mail coupon or send name on postcard. No charge. **Warner Electric Co., 1512 Jarvis Av., Dept. L-16-B Chicago 26, Ill.**

Make Thousands of Beautiful Art Creations

**COSTUME JEWELRY • CIGARETTE BOXES
TRAYS • CANDLESTICKS • COASTERS
LAMP BASES • BOOK ENDS...ALL IN
SPARKLING COLORED PLASTIC**



**WARNER ELECTRIC CO., 1512 Jarvis Av
Dept. L-16-B, Chicago 26, Ill.**

At no cost to me, please rush complete details postage prepaid. I am under no obligation.

Name _____
Address _____
City _____ Zone _____ State _____

Edlie for TOP VALUES

JUST Newest & Best "Fix-It-Yourself" Aid
OUT! Edlie's E-Z TV REPAIR GUIDE

The only Fix-It-Yourself guide made expressly for YOUR TV set! Now you can save costly TV repairs with this new, simplified method which includes all necessary data for just YOUR set. No confusing, unimportant information applicable to hundreds of different makes. Simplifies detection of faulty tubes in your TV receiver quickly, accurately. It's a terrific idea—it's a terrific guide! Order today and have your set back in perfect condition at once. Be sure to send us make and model of your TV set when ordering.

only
50¢



Kit of 5 tubes: 12AT6, 12BA6, 12BE6, 35W4 & 5085... \$3.25

5-Tube AC/DC Superhet Radio Kit

KIT: Includes all top quality components required to construct this latest design, highly sensitive 5-tube, AC/DC superheterodyne broadcast receiver. Complete with black, glistening bakelite cabinet (excludes wire & solder).

less tubes... **\$7.95**

6-Tube Radio Kit

KIT: A great value in a low-priced radio kit designed for high sensitivity and good tone qualities. Easily constructed circuit. Complete with chassis, all parts, hardware, 8" speaker (except wire & solder).

Kit of 6 tubes: 25L6, 25Z6, 6SQ7, 6SA7 & 6SK7 (2)... **\$3.25**

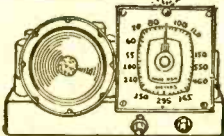

less tubes... **\$6.95**

Write today for FREE Catalog. All mdse. shipped F.O.B. New York City, prices subject to change without notice. Include 20% deposit with C.O.D.'s.

EDLIE ELECTRONICS

154 Greenwich St. DI. 9-3143 New York 6, N. Y.

DELUXE POCKET RADIO



Owners report up to 1500 miles reception. New 1955 electron tube model covers 540-1600 KC. No antenna required for local reception. Assemble kit easily in 1 hour. Batteries, all parts, fit in case. Low price of kit includes tube. (Set, factory wired, \$8.95). Long life batteries \$1.15 per set. Radio headphone \$1.69. High imp. hearing aid earset \$4.95 or use your headphone. All parts FULLY GUARANTEED. Send check or money order for full amount. save C.O.D. fees. If C.O.D., \$1 deposit required.

\$3.95
Post
Paid

WESTERN RADIO CO., Box 1526, Sacramento 14, Calif.

Inventors

Send today for our instructive booklet, "Patent Protection for Inventors" outlining preliminary steps to take toward patent protection, also for convenient "Evidence of Invention" form.

VICTOR J. EVANS & CO.
139-B MERLIN BUILDING, WASHINGTON 6, D. C.

EYE GLASSES by MAIL As low as \$19.50

WRITE for FREE CATALOG with 14 LENS SAMPLE CARD

Thousands of Customers



QUALITY READING-MAGNIFYING OR BIFOCAL GLASSES FOR FAR AND NEAR
ADVANCE SPECTACLE COMPANY, Inc.
537 S. Dearborn St., Dept. PE-1 Chicago 5, Illinois

The cable shown has open end terminals attached which will fit under screws, but a cable may be used with bare wire ends.

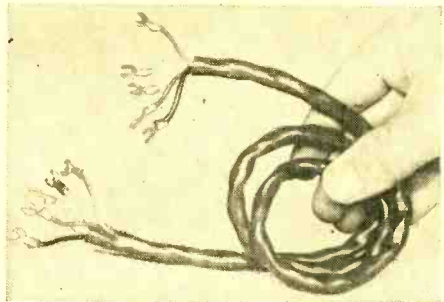

Cable of this type is listed in catalogues for speaker and telephone wiring and is usually number 18 or 22 gauge.

TV CHASSIS CLEANER

A FLEXIBLE brush, having mop strands on a fairly long handle, works well in removing dust from a TV chassis.

Make sure the line plug to the receiver

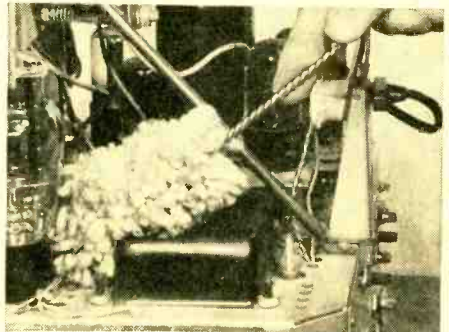

has been pulled for some time before dusting and go easy around the tubes—particularly the picture tube.

Such a brush works best when chassis has been pulled for repairs.

FILE LOOSENS SCREWS

THE three sided handle end, or shaft, of a small file, which is designed to be driven into a wood handle, may be used in an

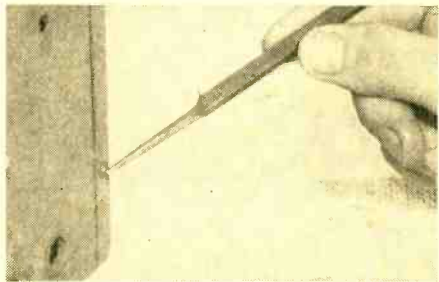

emergency to loosen Phillips type screws if the proper screw driver is not available.

Do not exert too much torque on this emergency tool.

END

HINTS ON BUYING U.S. EQUIPMENT ABROAD

EXPERIMENTERS and builders abroad can purchase parts and components from U. S. suppliers with comparative ease, according to Mr. George Zarrin of the *Harvey Radio Co., Inc.*, N. Y.

Canadian customers can be shipped material by Railway Express or by parcel post. Those choosing Railway Express can have their packages sent collect for express charges. Otherwise, the cost of postage should be determined beforehand by the purchaser and sent together with the purchase order and net price.

Packages to Central America and the Caribbean area can be sent by mail or by air express directly from the U. S. supplier. Certain large or bulky items are best sent by ocean freight, in which case the supplier turns over the shipment to a local forwarding agent. The cost of overseas packing and the agent's fee are then met by the customer.

Countries in these areas present no problems regarding the usual customs declaration and various documents, etc. These and similar problems may come up on shipments to countries further away from the U. S., such as some South American coun-

tries and those not in the Western hemisphere.

Requirements vary from nation to nation, and the overseas purchaser should check his own government's regulations. For instance, in some countries, if the shipment exceeds a specified amount of dollars, or if the items are semi-strategic, such as radio receivers or transmitters, licenses are required of both buyer and seller. The buyer applies for an import license at his own governmental agency. This license is sent with the purchase order. The U. S. supplier, in turn, must get his own export license before he can make shipment. Getting the licenses, while a matter of form, may take as long as three weeks. Aside from this time delay, however, they are readily available.

When shipping overseas, the American supplier will not, as a rule, determine beforehand the shipping charges. Most likely, he will send the item f.o.b. If export packing is required, it usually involves an additional charge of about five percent. Naturally whatever costs the shipment incurs beyond the f.o.b. point must be paid by the purchaser when claiming his package.

Beyond this, states Mr. Zarrin, it is impossible to generalize. Each nation has its own rules, some of them filling volumes. When in doubt, check with your government. END

Perfect
TV Pictures—
ON ALL CHANNELS

150

Miles or more
from TV Stations
UHF and VHF

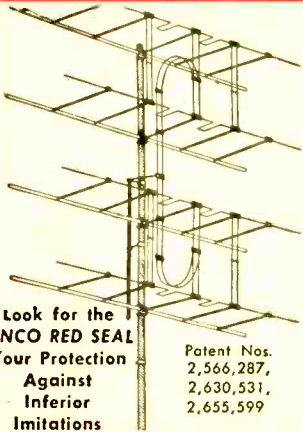

Look for the
FINCO RED SEAL
Your Protection
Against
Inferior
Imitations

Patent Nos.
2,566,287,
2,630,531,
2,655,599

**WRITE TODAY FOR
Interesting Free
LITERATURE.**

FINCO® 400-A
Double CO-Lateral
TV ANTENNA

- Perfect Pictures— ALL CHANNELS, UHF-VHF, COLOR
- Perfect Pictures— TESTED AND PROVED RIGHT HERE
IN TOWN — IT'S THE BEST!
- Perfect Pictures— ONE TRANSMISSION LINE,
NO SWITCHING!
- Perfect Pictures— ALL YEAR 'ROUND — WEATHERPROOF,
ALUMINUM CONSTRUCTION!

THE FINNEY COMPANY Dept. PE-25 • 4612 St. Clair Ave. • Cleveland 3, Ohio

HERE
IT IS

Novice CW Transmitter Kit

(As described in
this issue.)

Available at **NEWARK** only **14.44**

Here is the economical way for the novice to start his "ham practice". All of the components described in the article are included in the Kit, less wire, solder and hardware.

62F990 80 Meter Band.....Net each \$14.44

62F991 40 Meter Band.....Net each \$14.44

A613 J38 Key, sold only with above.....Net 79c

See Newark's New Catalog for individual components in above kit.

SEE THE LATEST IN Electronics EQUIPMENT



FREE

Send for

Newark's 1955 Catalog

Select the fast, easy, dependable way from the New Electronics Reference Book — full of the latest releases and largest selections of High Fidelity, Radio, TV, Amateur and Electronics equipment.

NEWARK
ELECTRIC COMPANY

Dept. P-2, 223 W. Madison, Chicago 6, Ill.

LEARN ELECTRICAL APPLIANCE

START YOUR OWN BUSINESS **Repairing & Installation**
Revolutionary NEW TRAINING METHOD, trains you AT HOME... in just a few short weeks!

You receive big "ON-THE-JOB" home training kits, test equipment, audio instructions and practical service training lessons. You learn how to Service, Repair and Install all types of ELECTRICAL Appliances and Equipment. How to build and operate your own business, etc.

You EARN As You Learn

You charge on basis of \$3.00 to \$5.00 per hour for spare time work! Write now for your Free Book, full details about this amazing opportunity for you in modern Electric Servicing.

**Big Book
FREE!**

ADVANCE TRAINING 5944 NORTH NEWARK AVENUE
Dept. 752, CHICAGO 31, ILL.

RECORD NOISE

(Continued from page 60)

use of this material will add greatly to the quiet operation and life of your recordings. A solution is made from the concentrate and placed in a pan big enough to accommodate a 12" LP. The record to be cleaned is *totally* immersed in the solution and the pan rocked from side to side for a few seconds to "swish" the liquid over the record surface. This is done on both sides of the record and then it is drained and wiped free of excess with a soft viscose sponge which has been wrung-out in the solution. Unfortunately the labels of some record companies do not have color-fast dyes, and they run rather badly. Painting the label with a thin clear nail polish and allowing it to dry will effectively waterproof your discs. This is a somewhat cumbersome process, but I have found that the record grooves are almost microscopically clean and it is well worth the bother.

There are various record brushes on the market, designed to clean the record continually while the disc is revolving. Except for the very expensive units which use sable hairs, I would caution that these brushes may do more harm than good. A much more effective way of continuous anti-static protection is in the use of radioactive materials. One such device, a very tiny affair, clips to the end of your pick-up arm. As the record revolves the air above the record surface is "ionized," thus discharging the accumulated static.

There are some records that will have a high hiss level, no matter how you try to correct them. I think you will find this to be true, in most cases, with the cheaper records on the market. A pure vinylite disc has a very low inherent hiss level. To save money, the manufacturers of the cheaper discs add various "filler" compounds to the vinylite and it is these "fillers" that cause the higher hiss. This is of course, not universally true, but a persistently high hiss in a disc is due nine times out of ten to the use of "filler."

There are a few other things, seemingly quite trivial, which help to keep your records quiet. After playing a record, don't leave it on the changer or turntable. Dust settling on the surface can undo all your work of cleaning. Always replace the disc in its jacket. When doing this, compress the record jacket so that it "bulges" wide open. This will avoid the possibility of sharp cardboard edges' scratching the record surfaces. It is also good practice to examine the interior of the record jacket. If you find it dusty (and many are), blow

out the dust as well as you can. I know one conscientious soul, who uses a tire pump for this task! In handling records, do so only by the edges—fingerprints are greasy and will pick up dust and grit. When storing records, *never* lay them flat because they will surely warp. Instead, store upright in an appropriate cabinet.

One final note—you are wasting your time with all the foregoing procedures, if you are playing your records with anything other than a diamond stylus. It is the poorest of economy to use substitute materials. Osmium or other "precious metal" styli will show appreciable wear in as little as *nine hours* use. The best sapphire will be dangerous to use after *25-30 hours*. Contrast this with a good diamond stylus, which in a well designed arm is good up to *1000 hours!* Remember this above all—there jest ain't no sech animule as a "permanent" stylus. Even diamonds wear out and it is a prudent person who examines his diamond every 100 hours for signs of deterioration. Any variance, such as a "flat" worn on the normally *smooth round* point, should be cause for rejection. **END**

EASILY MADE TV LAMP

A SCRAP of wood, a piece of wallpaper left over from the last time you papered the room, and a quart-size glass fruit jar are all you need to build this TV lamp.

Use a good grade of heatproof glue to attach the paper to the jar. Do not use a bulb larger than 25 watts as the heat may be excessive. Besides, a 25-watt bulb will furnish enough light to serve the lamp's purpose.

To make the base, cut three discs of 1" thick wood in diameters of 4½", 6", and 7½" each. Cut a 3" hole in the center of the two smaller discs for mounting the lamp socket. The base may then be finished to match the other woods in the room.

Variations on the base design are, of course, possible, but remember to drill that hole for the lamp cord! **B.C.V**

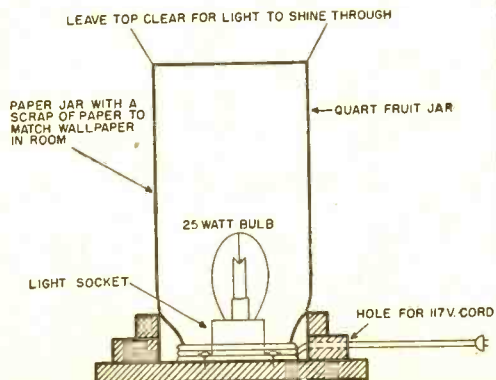

February, 1955

Get more out of electronics this easy way--

Whether electronics is your hobby or career, the **Gernsback Library** of low-cost, easy-to-read technical books will help you understand it better, get more out of it. Order the books you need today.

NEW—Just off the press!

Radio-Control Handbook—No. 53.

By Howard G. McEntee. W2SL. **\$2.25**

A practical how-to-do-it book that tells how to build and maintain radio-control systems that work. No theory—just facts on radio and mechanical components.



Model Control By Radio—No. 43.

By **Popular Electronics** writer E. L. Safford, Jr. Covers theory and practice. **\$1.00**

High-Fidelity—Design, Construction, Measurements—No. 48. \$1.50

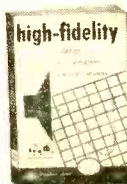

New 3-way approach to getting top performance from hi-fi systems. 21 top audio men helped write this book.

High-Fidelity Techniques—No. 42. James R. Langham's easy-reading, fact-packed hi-fi classic. **\$1.00.**

Basic Radio Course—No. 44. Cloth bound. \$2.25

Popular Electronics writer John T. Frye teaches you fundamentals from Ohm's Law to advanced techniques in easy, enjoyable steps.

Radio-Tube Fundamentals—No. 45.

You must know tubes to know electronics. This book explains them clearly. **\$1.00.**



From the publishers of **RADIO-ELECTRONICS Magazine.**

Mail this coupon today

Gernsback Publications, Inc. PE-25

25 West Broadway, New York 7, N. Y.

My remittance of \$..... is enclosed.

Please send me the following books postpaid.

53 43 48 42 44 45

Name..... (Please print)

Street.....

City..... Zone..... State.....

Camera Owners!

10¢

BRINGS YOU A DIGEST OF Successful Color Photography

the new \$4.95 book by
Andreas Feininger

Here is the authoritative, yet easy-to-follow work on color photography you've been waiting for. Written by Andreas Feininger—one of the world's foremost photographers—it's the simplest, yet most complete discussion of color photography ever to appear.

This book digest from the pages of Popular PHOTOGRAPHY Magazine is going to save you time, money and temper . . . and improve your pictures in the bargain. And—while the supply lasts—it's yours for only 10¢.

But don't delay. Fill out the coupon below and mail it today!

Popular PHOTOGRAPHY, Box PE
366 Madison Avenue, New York 17, New York
Here's my 10¢. Please send me a copy of SUCCESSFUL COLOR PHOTOGRAPHY, a digest of the \$4.95 book by Andreas Feininger.

Name _____

Address _____

City _____ Zone _____ State _____



NOW...
Pick up broadcasts
2,000 miles away!

WITH NEW
**SUPERKIT
CRYSTAL
RADIO**

only \$2.95

(completely wired in
plastic case... \$3.95)

Finest crystal set yet designed. The Superkit Crystal Radio is the ONLY crystal set featuring the world-famous powerful LOOPSTICK for loud volume, long distance reception . . . and the only one with all these: professional metal chassis . . . slide rule dial for precision tuning . . . radar type fixed crystal . . . simple illustrated step-by-step instructions . . . full guarantee. No electricity, no batteries. Only a screwdriver is needed for assembly.

SEE your neighborhood electronic parts supplier or hobby shop dealer TODAY . . . or order direct, Dept. PE.

SupereX CORP.
ELECTRONICS

23 Atherton Street, Yonkers, N. Y.

1 tube Superkit radio, finest, most sensitive
of its type . . . fully guaranteed . . . only \$3.95

communications systems, another type of multivibrator plays an extremely important role: the *bistable type*. In this arrangement, the usual plate-to-grid feedback capacitors are replaced by resistors. When the component values are carefully chosen, this circuit becomes stable with one triode conducting and the other cut off. Upon the arrival of a triggering pulse, an almost instantaneous reversal of circuit conditions occurs: the triode which was conducting before the advent of the pulse suddenly drops to cut off while the tube that was formerly non-conducting begins to conduct. This new state is just as stable as the first. A second pulse may then be applied to restore the circuit to its original stable condition. The bistable multivibrator is also called a *binary frequency divider*, an *Eccles-Jordan trigger circuit*, and a *locking circuit*.

Another variant is the *mono-stable multivibrator* or *flip-flop circuit*. In this arrangement, there is only one stable state in which one of the two triodes conducts and the other is cut off. A triggering pulse of the correct magnitude and polarity can produce a circuit reversal, but this new condition is not stable and, after the pulse has passed, the tubes revert to their original state of their own accord. This variation is found in certain multiplex communications transmitters where the mono-stable action is essential. A bistable multivibrator may be converted into the mono-stable type by substituting a capacitor of the proper value for one of the feedback resistors and applying a fixed bias to one of the grids. "One-Shot" Multivibrator is another name for the mono-stable multivibrator.

TECHNICAL QUIZ

RESISTORS R_1 , R_2 , and R_3 are connected as shown in the diagram. Each resistor has a value of 3 ohms. If the battery

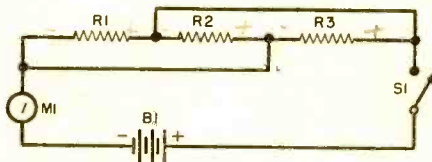

voltage is 3 volts, what will be the total current drain, as indicated by the ammeter, when switch S_1 is closed? The answer is given on page 128.

ULTRASONICS AND SUPERSONICS

ALTHOUGH these words were at one time synonymous, they are now clearly differentiated in scientific literature.

Supersonics is applied only to velocities. That is, it is a term which relates to the speeds of planes (or flying saucers!) when the speed is above that of sound waves. Since the speed of sound is, at sea level, approximately 765 miles per hour, any object which moves at a velocity higher than this is moving at a supersonic speed.

Ultrasonics, on the other hand, is the science which deals with sound waves having frequencies far above those that are audible to the human ear. Modern ultrasonic generators are based upon electronic circuits in which oscillators produce extremely rapid vibrations in quartz crystals, special types of metal plates, or formed ceramic materials. These frequencies range from about 24,000 cycles per second as used in "echo sounding" on ships to 100,000,000 cycles per second (100 mc) or more in modern metal cleaning arrangements.

Both of the above "sonics" are still wide open fields and great things may be looked for in the coming years in supersonic aviation and ultrasonic industrial and medical applications.

EPUT METERS

JUST as RADAR signifies Radio Detection And Ranging, the abbreviation EPUT stands for Events Per Unit Time. An EPUT meter is a versatile and ac-

curate instrument for counting the number of events or occurrences which take place in a given length of time provided that these events can be translated into electrical pulses.

One important application of an EPUT meter lies in the measurement of the average frequency of an oscillator which is required by the nature of the circuit in which it appears to vary over a period of time. In this case, the "events" being measured are the recurring voltage cycles of oscillation.

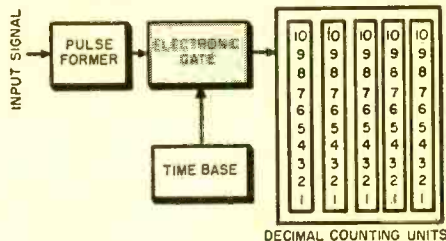

The accompanying figure is a block diagram of one particular EPUT meter. Pulses corresponding to the events, occurring at an unknown rate, are amplified and properly shaped by the input circuit. These pulses are then passed through the electronic gate to the bank of five deci-

FREE Bonus Offer!

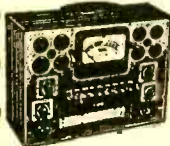

- Model 625K**
- Illum. gear-driven "Speed Rollchart"
 - New lever-action switches for individual testing of every element
 - Tests all conventional and TV tubes

This Elec Tube Tester is yours FREE when you buy \$199 worth of tubes or more within 60 days at Teltron.

May be bought outright from Teltron for \$34.95.

SPECIALS! Till March 1st.

1B3GT	..58
1U4	..42
1X2	..58
6AL5	..32
6AU6	..35
6BQ6GT	..75
6C6	..52
6SN7GT	..48
6U8	..69
6W4GT	..35
12AU7	..50
12BA6	..39
12BE6	..39
12BH7	..55
12SA7	..40
12SK7	..40
12SQ7	..35
35L6GT	..38

TELTRON TUBES

Guaranteed! Lowest Prices Ever!

All tubes individually boxed . . . unconditionally guaranteed for one year.

GIFT OFFER! One 6BQ6G tube will be shipped FREE with any order accompanying this ad.

TYPE	PRICE	TYPE	PRICE	TYPE	PRICE	TYPE	PRICE	TYPE	PRICE
1A7GT	..53	6AF4	..1.02	6BY5G	..60	6X5GT	..38	12SN7GT	..56
1H5GT	..51	6AG5	..52	6BZ7	..95	6X8	..80	19T8	..71
1L4	..51	6AH4GT	..65	6C4	..41	7F8	..49	25BQ6GT	..82
1L6	..51	6AK5	..96	6CB6	..51	7N7	..49	25CU6	..1.09
1LC6	..49	6AQ5	..48	6DC6G	..1.63	12AL5	..43	25L6GT	..41
1N5GT	..51	6AR5	..48	6CU6	..95	12AT6	..37	25Z5	..55
1R5	..51	6AV5GT	..60	6F6	..42	12AT7	..71	25Z6GT	..36
1T4	..51	6AU5GT	..60	6F5GT	..44	12AU6	..43	35B5	..48
1U5	..43	6AV6	..37	6H6	..50	12AU7	..58	35C5	..48
2A3	..35	6AX4GT	..60	6J5GT	..49	12AV7	..73	35L6GT	..41
2A7	..35	6AX5GT	..60	6K6GT	..39	12AX4GT	..60	35W4	..33
304	..53	6BA6	..56	6L6	..78	12AX7	..61	35Y4	..42
305GT	..61	6BA7	..58	6S4	..41	12AZ7	..65	35Z5GT	..33
3S4	..48	6BE6	..46	6S8GT	..65	12B4	..72	50A5	..49
3V4	..48	6BF5	..48	6SA7GT	..45	12B87	..61	50B5	..48
5U4G	..43	6BG6G	..1.18	6SK7GT	..45	12BA6	..46	50C5	..48
5V4G	..49	6BH6	..51	6SL7GT	..60	12B7A	..58	50L6GT	..50
5Y3GT	..30	6BJ6	..51	6SQ7GT	..38	12BE6	..46	TYPE 80	..40
5Y4G	..40	6BK5	..75	6T8	..71	12B7B	..65	117L7GT	..1.20
6A8	..40	6BK7	..78	6V3	..80	12BZ7	..63	117Z3	..33
6AC7	..65	6BN6	..90	6V6GT	..48	12SL7GT	..60	117Z6GT	..65
6K7	..40	6BQ7	..85	6W6GT	..53				
6Q7	..40	6BL7GT	..78	6X4	..37				

SAME DAY SERVICE
48 Hour Postal Delivery
To West Coast

TERMS: Save all freight and postage charges. All orders accompanied by full remittance will be shipped POSTAGE PAID anywhere in the continental U.S.A. 25% deposit required on C.O.D.'s. Minimum order \$10.00. Open accounts to rated firms only.

FREE \$7.20 list value Bonus Box of three 6SN7 tubes and 25 assorted resistors with each order of \$25 or more.

TELTRON ELECTRIC COMPANY

428 HARRISON AVE.

DEPT. PE-2

Phone HUmboldt 4-9848

HARRISON, N. J.

HERSHEL'S "KIT" SPECIALS

ALL-PURPOSE FIL. TRANSFORMER

For Model Trains, Welding, Transmitters, etc.
PRI. 117 v. 60 cyc. sec.

6.4 v.	12A	\$495
6.4 v.	10A	
v.	3A	
v.	3A	
2.5 v.	1.75A	

MYSTERY PACKAGE ELECTRONIC PARTS

The Surprise of Your Life
25 pounds of Worth \$50.
BRAND NEW
USABLE GOVT.
S U R P L U S .
Ideal gift for
the ham, etc.

\$495

KIT 1. HARDWARE

Over 1,000
pieces, 2 1/2 lbs.
of assorted
RADIO & TV
HARDWARE.

\$149

KITS, RESISTORS

100 ASSORTED
TYPES. Range
from 1 ohm to
15 meg. 1/2 to
5 watt.

\$198

KIT 2. CERAMICONS

100 ASSORT-
ED. Range from
.75 mmfd. to
6,000 mmfd.

\$350

KIT 6. R.F. CHOKES

25 ASSORTED.
Range from
.5 mh. to 25
mh.

\$195

Kit 3. Volume Controls

25 ASSORTED
Range from 2
ohm to 3 meg.
Some with
switch.

\$475

KIT 7. TOGGLE & SLIDE SWITCHES

25 ASSORTED.
DPST, DPDT,
SPST, etc.

\$495

Kit 4. Rotary Switches

25 ASSORTED
TYPES. A Real
Buy at only...

\$475

KIT 8. PAPER & CAN CONDENSERS

25 ASSORTED.
Range from 4
mfd. 150 v. to
80 mfd. 450 v.

\$350

HERSHEL RADIO CO.

5245 Grand River, Detroit 8, Mich.

Terms: Cash with order
or 25% DOWN—Balance
will be mailed
C.O.D.

All Prices F.O.B. Detroit

SPECIAL PURCHASE!

Brand New RCA TV CAMERAS

Just Received! **\$19750**

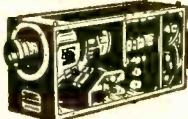

100's of Used Models Sold at \$225 up! Rig up your own TV watchdog for swim pools and other uses—plus training, etc. 1846 Iconoscope, 6-stage video amplifier and clipper. Write for complete tech. data.

TN-65/APQ-15 for a 2-METER XMITT. With 6J6, 2-6C4's, less 832. With schematics and conversion sheet. **\$7.95**

MICRO SWITCH BZ-7RDT—New..... 5 for \$2 postpaid

51.5 OHM COAX. CABLE..... **\$4.50**

100' roll

RG34U 71 OHM COAX. .025 dia. 5 KW ratings. 85' roll with pl-173 plug at one end. New..... **\$7.95**

MINIATURE LINE MATCHING TRANSFORMER. \$1 plus 25¢ postage. For blocking oscillators on TV Recvrs. & camera input circuits, tone oscillator transformer for electric organ, digital computer systems. 1000's other uses.

24 V TRANSFORMER & RECTIFIER COMB. a basic 24 V. DC power supply of 110 V AC primary. 24 V secondary and Rectox Rectifier. Operates intermittently up to **\$2.95** 3 or 4 amps.

APS 13 MAKES A 420 MC

RADIOPHONE when converted. Range in most cases equal to 2 meters. Complete with RF sections, conversion booklet and 30 Mc I.F. strip, less tubes, dynamotor and minor parts not needed for conversion. Shpg. wt. **\$3.95**
13 lbs. New Aps 13..... **\$19.95**

Send check with order (no COD's, pls.) Prices FOB Whse.

Harjo Sales Co.

Dept. PEG, 4109 BURBANK BLVD., BURBANK, CALIF.
Phone Victoria 9-2411—Get FREE CATALOG!

mal counting units. The gate is opened by a signal from the time base and remains open for an accurately controlled interval of time and is closed by a second signal from the time base. The number of events that has occurred during that time interval is displayed on the illuminated panels of the electronic counting units.

For instance, suppose that the instrument is equipped with a time base that permits the electronic gate to remain open for 10 seconds, and that the accuracy of a 3500 cycle per second audio oscillator is to be checked. The signal from the audio oscillator is fed into the EPUT meter, the activating button on the meter is operated, and the 10-second timing interval begins. The panels of the decimal counters flash rapidly and, at the end of the interval, the gate closes, thus halting the operation abruptly. The illuminated panel would then show the answer, for example, a final reading of 36189. Since 36189 events occurred in 10 seconds, the frequency of occurrence is therefore 3618.9. This is the *actual* frequency of the oscillator being checked.

After adjusting the constants of the circuit so that the oscillator is "right on the button," the EPUT panel will, of course, read 35,000 events in 10 seconds, indicating a frequency of 3500 cycles per second.

CATHODE FOLLOWERS

IS IT true that the gain of a cathode follower stage is always less than one? If so, why is a cathode follower so often used in the vertical amplifier of an oscilloscope?

Yes; in this circuit (which has the output taken from the cathode rather than from the plate), the ratio between the output and input signal voltages (the voltage gain) always is less than one. However, the ratios between output and input signal currents and between output and input signal powers usually are very high. A cathode follower may operate on a very low power input signal and deliver a high power signal output. Consequently, the input impedance is said to be very high and the output impedance, very low.

It is for this reason that the cathode follower often is used as the first stage of the vertical amplifier in an oscilloscope. Because of its high input impedance, it draws practically no current from the circuit under test (the circuit to which the oscilloscope probe is connected) and therefore does not distort the waveform. This feature is of such importance that it more than compensates for the voltage gain of less than one.

END

Going on the Air

(Continued from page 55)

made of thin, soft copper wires and won't stand much stretching or swinging. A better deal is the *Amphenol* twin-lead, made of strong No. 16 copper-clad steel wire. This is put up in handy kit form, along with a 75-foot length of regular twin-lead for the lead-in and a special T-shaped insulator for the center connection. Four kits are available, with the antenna sections precut to the right lengths for the 10, 20, 40 and 80 meter bands, respectively. Prices are from about \$5.35 to \$11.25. With a transmitter running between 25 and 100 watts, working into one of these antennas, you can communicate all around the world on c.w. without much difficulty.

If your roof situation permits a little construction work, you will find it advantageous, eventually, to erect some sort of "beam antenna" with a motor rotator. A beam acts like an electronic searchlight and directs most of the radiated signal energy in one particular direction instead of scattering it all around the horizon. This concentration is equivalent to increasing the power of the transmitter. Generally speaking, the more elements or rods in such an antenna, the sharper the beaming

effect and the greater the increase in effective radiated power. Beam antennas are mechanical rather than electrical problems and require rigid, well-supported masts or towers. One picture shows a ten-element 2-meter beam, consisting of two five-element sections.

Trade name list: For your guidance in obtaining further information about amateur transmitting equipment, the following is a list of the manufacturers' names and addresses:

Heathkit: The Heath Company, Benton Harbor, Mich.

Viking: E. F. Johnson Co., Waseca, Minn.

Globe: World Radio Laboratories, Council Bluffs, Iowa.

Barker & Williamson: Barker & Williamson, Inc., Upper Darby, Pa.

Hallicrafters: Hallicrafters Company, Chicago 24, Ill.

Collins: Collins Radio Co., Cedar Rapids, Iowa.

Millen: James Millen, 150 Exchange St., Malden, Mass.

Gonset: Gonset Co., 801 S. Main St., Burbank, Calif.

Most of the transmitters mentioned in this article, as well as others, probably can be obtained from your local radio distributor. If there is no distributor in your vicinity, write to any one of the mail order houses. END

R/C MODELS for BEGINNER AND EXPERT

FOR BEGINNERS:

48" SPAN



LIVE WIRE "TRAINER"

WORLDS MOST POPULAR R/C MODEL

A quickly built model of medium size, stable, rugged and simple to fly. Features a removable R/C unit. **PRE-FAB. KIT \$6.95**

MULTI-SERVOS

POWERFUL-DEPENDABLE

MOTOR DRIVEN R/C ACTUATORS

Ample power to move any model control. 4 great models, one for every purpose.



Positive-Flow FUEL TANK

Gives perfect fuel flow under all flight altitudes, upright or inverted. The tank with the internal swivel.

DESCRIPTIVE LITERATURE FREE
SERVO INFO BOOKLET 75c



\$11.95

TO

\$14.95

\$1.29

FOR ADVANCED FLYING:

65" SPAN



LIVE WIRE "CRUISER"

FOR THE ULTIMATE IN R/C FLYING

A big, high performance, realistic model capable of carrying the heaviest of equipment with ease. Has elevators and a re-movable R/C unit. **PRE-FAB. KIT \$14.95**

deBOLT MODEL ENGINEERING CO.
BOX 73
WILLIAMSVILLE, N. Y.

EASY! BUILD your own Professional Electronic Instruments with EICO KITS! SAVE 50%

• Complete easy-to-follow instructions

• Fully guaranteed

3" PUSH-PULL OSCILLOSCOPE

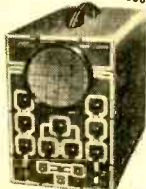

KIT \$44.95 WIRE \$79.95

VACUUM TUBE VOLTMETER



KIT \$25.95 WIRE \$39.95

1,000 Ohms/Volt MULTIMETER



KIT \$12.90 WIRE \$14.90

6V & 12V BATTERY ELIMINATOR & CHARGER



KIT \$29.95 WIRE \$38.95

Write now for FREE Catalog PE-2 describing 38 EICO KITS.

EICO

ELECTRONIC INSTRUMENT CO., INC.
84 Withers St., Brooklyn 11, N. Y.

© 54



HANDS TIED?

—because you lack a
HIGH SCHOOL DIPLOMA

• You can qualify for an American School Diploma in spare time at home! If you have left school, write or mail coupon for FREE booklet that tells how. No obligation of any kind.

----- OUR 58TH YEAR -----

AMERICAN SCHOOL, Dept. V-256
Drexel at 58th, Chicago 37, Illinois

Please send FREE High School booklet.

Name.....

Address.....

City & State.....

Canadian Residents: Complete Canadian Course Available.
Write American School, 1810 Sherbrooke, St. West, Montreal.

RADIO CONTROL for GARAGE DOOR

FROM YOUR CAR—NO FCC LICENSE REQUIRED

TRANSMITTER KIT: incl. 6 V. Dynamotor, 27 1/4 Mc. Crystal, Tube, Cab., Wound Coil, Switch, Resistors, Condensers, Instructions \$16.95

RECEIVER KIT: 27 1/4 Mc., 110 V., AC DC, incl. sens. Relay, Tubes, Wound Coils, Drilled Chassis, Resistors, Condensers, Instructions 10.95

PARTS AVAILABLE for all Radio Control Equipment described in Popular Electronics

Clockwork ELECTRIC TIMER: 1/2 to 24 min. \$1.00

TRANSMITTER & RECEIVER KIT: 27.255 Mc band License Free. All Parts & Diagrams (less tubes & crystal) to build 5 Watt Transmitter Unit & 2-Tube lightweight Receiver, including SIGMA 10,000 ohm Relay 9.95

GENERATOR: 12-24V DC, 13 amps. Requires 1/6 h.p. or larger motor with pulleys \$5.25

TOY TRAIN TRANSF: 18V 2A \$1.65; 4A 4.95

RECTIFIERS: 18V 1A \$1.40; 2A \$2.10; 4A 3.75

SIGMA 4F RELAY: 8,000 ohm, 1 Ma. \$4.95; 3,000 ohm 5.95

Storage BATTERIES: 2 Volt 3"x4"x5 1/2", 27 Amp. Hr. 2.75

MINI. 6 V. BATTERY: Willard NT6-21/2", X13/4"x3 1/2" 2.45

G. E. RELAY CONTROL: with sens. 10,000 ohm relay 1.25

2 V. VIBRATOR SUPPLY KIT: 180 V./35 Ma. 6.95

2 V. BATTERY CHARGER KIT: \$4.95; wired 6.95

ALL MATERIAL GUARANTEED—FREE CATALOG "P"

GYRO ELECTRONICS, 325 Canal Street

WORTH 6-1290

NEW YORK 13, NEW YORK



for everything in Electronics!

1440 page MASTER

- Detailed specs • 8,500 illus.
- 85,000 items • Fully indexed
- Full descriptions • Wgt. 6 lbs.

List \$6.50—As low as \$1.95 at distributors
UNITED CATALOG PUBLISHERS, INC.,
110 Lafayette St., N. Y. C. 13

GIANT CATALOG

ELECTRONIC SPECIALS FOR EXPERIMENTERS

Send 10c for giant 16 page catalog listing hundreds of surplus bargains for experimenters.

Rectifiers @ 29c ea. Transformers @ \$1.50 ea.
Controls... @ 29c ea. Bulbs..... @ 2c ea.
Switches @ 6c ea. Motors..... @ 1.79 ea.
Automatic Steppers @ \$1.75 ea.

SOUNDTRONICS LABS

632 ARCH STREET

Dept. P-2

PHILADELPHIA 6, PA.

Catalog of 3000 Novelties 10c

Send 10c for amazing catalog of novelties, live animals, scientific supplies, hobbies, funmakers, planes & boats, toms, magic tricks, luke articles, unusual seeds, gad. get timers, cameras, optical goods, projectors, movies, lucky jewelry, religious novelties, disguises, musical instruments, stamps, coins, puzzles, fortune tellers, radios, auto & bike accessories, telescopes, magnifiers, compasses, banks, smokers' gadgets, artists' supplies, printing sets, engines, motors, shockers, knives, billfolds, fireworks, guns, rifles, sports, books, games, plants, etc. Send name, address & 10c to:

JOHNSON SMITH & CO., Dept. 862, Detroit 7, Michigan

The World at a Twirl

(Continued from page 73)

Fr. West Africa—Radio Dakar, 11.896A, should now be using a new 25 kw. transmitter; should be good level in French around 2100-2300 closedown.

Haiti—"Glimpses of Haiti" is the title of the English session on Sunday only from 4VC, Radio Commerce, 9.485, Port-au-Prince, at 2200-2230; announces the 49-m. outlet (6.091A) as in parallel.

Hungary—Radio Budapest currently has English for North America 0030-0100 and 0400-0430 on 6.248, 7.220, 9.833.

India—Try for All India Radio on 11.620 in English 1330-1445 (news 1335).

Italy—Rome now announces 9.570 parallel 6.010 for English to North America starting 0015.

Ivory Coast—By careful tuning, you may be able to pick up Radio Abidjan, 4.945, in French around 2100-2130 when closes with "La Marsaillaise."

New Caledonia—Radio Noumea, 6.035, opens in French 0700, is good level on West Coast; is also heard in eastern U.S., probably best around 0800-0930.

Spain—Madrid's "wandering" transmitter is now back near 9.369, with English 2015-2045, 2300-2345A, and 0300A-0350A.

Roumania—Bucharest now uses 6.210A for English to North America 0300-0330, 0430-0500.

Surinam—Tune measured 5.758 around 2300-2400 for PZH5, Paramaribo, in Dutch.

Sweden—West Coasters should find Radio Sweden, 9.535, at good level at 1600 with English news.

* * *

For Experienced SWL'S

Angola—Radio Angola, 11.862, Luanda, has interval signal of steady native drum beats, clock striking sequence, and "A Portuguesa" preceding actual sign-on at 1830. Heard in Indiana; runs to 2130 or later.

Canary Islands—EA8AB, 7.510A, Tenerife, has been heard at weak level in Delaware around 2020 with Spanish musical program; has CWQRM.

Ceylon—Radio Ceylon, 9.520, is heard in western U.S. to 1730 closedown.

China—Radio Peking is heard on West Coast on 15.060AV, 15.100, 11.330, 11.650, and 9.665 (best) with fair to good signals in Asiatic languages around 2230-0130; usually reaches peak by 0000. Is again using 11.960 for English news 0300.

Cyprus—Tune 11.720 around 1645 for ZJM7, Limassol, in Arabic.

Dutch New Guinea—Radio Hollandia is

now using 3.390, opens around 0930 or 1000, according to New Zealand's SWL's.

Ethiopia—Radio Addis Ababa, 15.342A, is reported heard in both eastern and western U.S. irregularly around 1700 to 1930 closedown; some *English*.

Indo-China—Radio France-Asie, Saigon, is noted on West Coast on 9.755A with *English* newscast 1400-1415, fair signal.

Indonesia (USI)—Try YDF2, 11.875, Djakarta, for *English* news (then beamed on Europe) at 1900; heard in eastern U. S.

Lebanon—When this was compiled, Radio Beirut, 8.036A, had been logged in Delaware around 2015 to 2130 closedown (with anthem).

Liberia—ELBC, 6.025A, Monrovia, has been heard in eastern U. S. around 2245 in *English* to closedown with anthem at 2346A; at times has QRM from Hilversum, Holland, and from Radio Moscow.

North Borneo—Radio Sabah, Jesselton, is scheduled on 7.237, 250 watts, around 0400-0530; a new 5-7.5 kw. transmitter will be installed in March or April with tests scheduled to begin in June or July; frequencies allocated besides the present one include 5.980, 6.090, 7.180, 7.240, 9.660, 9.740.

Pakistan—Try 7.010 for Radio Pakistan, Karachi, at 2015 when has *English* news.

Philippines—DZH8, 11.955, may be heard some days on West Coast with *English* news 2300.

Sao Tome—CR5SC, 4.807, is heard in eastern U.S. around 2000 to sign-off with "A Portuguesa" at 2058A.

South Korea—HIKB, 7.935, Seoul, is heard on West Coast around 1200 in Korean language.

Last-Minute Flashes

Radio Sweden has discontinued its weekly DX session "for budget reasons." 4VEH measured 6.242, Cap Haitien, Haiti, has been noted testing in *English* around 2250; asked for reports. A new station in Honduras has been heard testing in *English* on 6.085 (announced 6.090) around 0700 and again around 1200; requested reports to HRNQ, Box 393, Tegucigalpa, Honduras.

"Voice of America" verifies reception of all VOA transmitters (either in continental U.S. or at overseas relay points) from new QRA of United States Information Agency, IBS/FN, 330 Independence Ave., S.W., Washington 24, D.C. The Tokyo commercial transmitters, JOZ2, 6.055, and JOZ, 3.925, now have an "Economic Program" in *English* 0750-0800; heard on West Coast.*

May much seasonal DX be yours as you "twirl to tune the world!"

(Continued next month)



**Fix your TV Set
YOURSELF!**
BUY YOUR TV TUBES
AT WHOLESALE!
100% GUARANTEED! BRANDED! SAME DAY SERVICE!

1A4P	.29	6BD5	.59	7F8	.59
1A7	.49	6BE6	.39	7J7	.59
1B3	.59	6BG6	.99	7K7	.59
1B4P	.79	6BH6	.49	7U5	.49
1C6	.29	6BJ6	.49	7Z4	.39
1C7	.29	6BK7	.69	12A15	.39
1E7GT	.39	6BL7	.69	12A76	.39
1F5G	.29	6BN6	.99	12A77	.69
1H5	.49	6BQ6	.79	12A06	.39
1L4	.49	6BQ7	.79	12A07	.59
1L6	.59	6BY5G	.59	12AV6	.39
1LA6	.39	6BZ7	.79	12AV7	.69
1LC5	.39	6C4	.39	12AX7	.59
1LC6	.39	6CB6	.49	12BA6	.39
1N5	.49	6CD6	.99	12BA7	.59
1R5	.49	6CU6GT	.99	12BE6	.39
1S5	.39	6F6	.39	12BH7	.59
1T4	.49	6F7	.69	12SA7	.49
1T5GT	.69	6J6	.59	12SK7	.49
1U4	.49	6J8	.79	12SN7	.59
1U5	.39	6K6	.39	12SL7	.59
1X2	.59	6L6	.69	12SQ7	.39
2A3	.29	6N6	.69	14S7	.79
2A7	.29	6S4	.39	19B6	.99
3AGT	.99	6S8	.59	19T8	.69
3Q4	.49	6SA7	.49	25BQ6	.79
3Q5	.59	6SD7	.49	25L6GT	.39
3S4	.49	6SK7	.49	25W4GT	.39
3V4	.49	6SL7	.59	25Z6	.39
5U4	.39	6SN7	.59	35B5	.39
5V4	.49	6SQ7	.39	35C5	.39
5Y3	.29	6SR7	.49	35W4	.29
5Y4	.49	6T8	.69	35Z3	.29
5Z3	.29	6U8	.69	35Z5	.29
6AB4	.39	6V6	.49	35/51	.29
6AG5	.49	6W4GT	.39	36	.29
6AJ5	.69	6X4	.29	37	.29
6AK5	.69	6X5	.29	39/44	.29
6AL5	.39	7A4/XXL	.39	49	.29
6AQ5	.49	7A6	.49	50B5	.49
6AS5	.49	7A7	.49	50C5	.49
6AT6	.39	7A8	.49	50L6	.49
6AU6	.39	7AK7	.79	75	.29
6AV6	.39	7B4	.49	76	.29
6B7	.79	7B5	.49	77	.29
6BA6	.49	7B6	.49	80	.29
6BA7	.59	7B7	.49	117L7GT	.99
6BC5	.49	7F7	.59	117Z3	.29

Minimum Order \$7.00

25% deposit with order. Balance C.O.D. If full remittance is sent, please include postage. Excess money will be refunded. Quantity users—write for special discounts!

FREE!

with every order of \$20 or more—famous "Ox-wall" magnetic screw driver kit. Includes all sizes—Philips head, long handles to get in those tight spots, etc. 7 screwdrivers in all. May be purchased outright. List value \$4.89—\$1.99 each; 3 for \$5.50.

Mail Your Order To

VIDEO

ELECTRIC COMPANY

79 CLINTON PL.

NEWARK, N. J.

START YOUR HI-FI RIGHT!

Karlson Handyman KIT

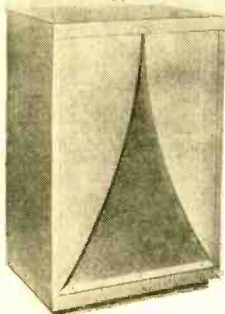

WITH
KARLSON
ULTRA-FIDELITY
ENCLOSURES

The performance of a speaker, like a violin, largely depends upon the cabinet.

The Ultra-Fidelity Karlson is completely NEW and has amazed thousands at every audio show. "A new standard of performance,"... "unsurpassed"... HI-FI Manual. Send today for information on this exciting new scientific discovery.

Available in kit or finished form from \$45 to \$117.60

If not yet available from your Hi-Fi dealer, order direct

Immediate Delivery
only \$45.00

51 Intricately cut pieces
... 3/4" plywood ...
34 1/2" x 22 1/2" x 18" overall.

Send for
Complete Literature

KARLSON ASSOCIATES, INC.

DEPT. H

1483 Coney Island Ave., Brooklyn 30, N. Y.

SAVE MONEY! SAVE SERVICE CALLS!
CHECK ALL TV, RADIO & PICTURE TUBES
with this **VISULITE TV TUBE CHECKER**



Only **\$3.95**
Complete

NO TECHNICAL KNOWLEDGE REQUIRED
Simple Instructions Furnished
SAFE — QUICK — FOOLPROOF

Most Radio set failures are due to burned out tubes. Just plug tube into socket provided and Neon Lamp indicates this condition instantly. Operates on 110 Volt AC or DC.

PERFORMS 1001 ELECTRICAL CHECKS!

Checks continuity of resistors, appliances, motors or any Electrical device. Sturdily built for long life of trouble shooting. Test Leads included—Nothing else to buy. **SOLD ON 10 DAY MONEY BACK GUARANTEE.** See it at your distributor today. If he can't supply, order direct from factory. \$3.95 Postpaid anywhere in the U. S.

VISULITE CO., Dept. PE-2 423 Broome St., New York 17, N.Y.

PRESTON GARAGE DOOR OPENER RECEIVER & TRANSMITTER KIT

Basic Receiver, all resistors, condensers, OSR and coils, less tube and relay **\$8.50**

Basic Transmitter, all resistors, condensers, etc. less tube and xtal **\$2.50**

Xtal 4.95 **6AQ5 1.25 154 1.25 BK7 relay 3.50**

Write for Free Illustrated Catalog

ACE RADIO CONTROL

Box 301

Higginsville, Mo.



FINISH HIGH SCHOOL AT HOME!

No classes to attend. Easy spare-time training covers big choice of subjects. Friendly instructors; standard texts. Full credit for previous schooling. Diploma awarded. Write now for FREE catalog!

WAYNE SCHOOL Catalog HET-3
2527 Sheffield Ave., Chicago 14, Illinois

Carl & Jerry

(Continued from page 68)

bicycle light turned off. This made it very difficult to tell exactly where he was, especially since his eyes were still not completely accustomed to the darkness. Just as he was thinking that he must be nearing the quarry, there was a sudden pinging sound. His bicycle rose beneath him like a bucking bronco, and he sailed over the handlebars to make a perfect three-point landing on his knees and nose in the frozen gravel of the roadway.

Before he could gather his scattered senses, Carl was dragging him by an elbow toward the deep ditch at the side of the road and hissing into his ear, "Get down here in the ditch before they see us. I crawled up a few yards to wait for you, but you came along so fast I didn't have time to flag you down. I was afraid to call out, so I just grabbed up a stick and ran it through your front spokes. That stopped you!"

"Oh fine!" Jerry muttered as he tenderly felt his scraped nose. "Here I am rushing to help you, and you try to murder me."

"Quit griping," Carl hissed. "With all that natural padding you've got, a little bump isn't going to do any damage. Let's get back under the bridge until the squad car comes."

They had barely reached this sanctuary before they heard the wailing of a siren, and a few seconds later the flashing red light of a squad car rapidly approached down the road. With a great screeching of brakes and showering of gravel the car slowed down and turned abruptly across the bridge. The boys immediately popped out of their hiding place to see a truck and two men standing in the glare of the squad-car spotlights.

"All right, you two; don't move!" one of the officers commanded as he stepped from the car with a drawn gun. "What are you up to?"

"Why we were just getting ready to dump a body—" one of the men began.

"Ha! So you admit it," the officer said menacingly. "Mack, you cover me while I examine the body."

With his gun still drawn, the policeman stepped forward cautiously, taking care not to come between the gun of his fellow officer and the two men, and jerked the canvas from the object on the truck. The two boys had stolen out of the ditch and were standing right at the rear fender of the squad car. The simultaneous gasp they gave as the canvas slipped to the ground so unnerved the policeman standing beside

the car that he tried to point his gun in all four directions at the same time and came very close to shooting a hole in the squad car itself.

"It's a car body!" the boys said in chorus.

"And what did you think it was?" demanded one of the men in the spotlight.

"Hey, where did you kids come from? Did one of you call us?" the officer near the car demanded.

"Ye-yes, I did," Jerry quavered. Then he told the whole story of the tape recording. Before he finished the two men with the truck were slapping each other on the back and laughing so hard they could scarcely stand up. Finally the younger one wiped his eyes and started to explain:

"I do some dirt track racing. Jack here, who works at a machine shop from 4 p.m. until midnight, helps me fix up my cars. I often talk with him after he eats a midnight snack at the restaurant right across the alley from the feedstore. Last night I was telling him about a beat-up racecar I had bought in a neighboring town and had managed to drive home. The heap was in such sad shape that I had to keep choking the motor to make it run. It finally died completely right in front of the house and I had to tow it into my garage. We weren't going to use the old body and my wife said I had to get rid of it. I call my wife 'The Boss'—just kidding, of course."

"We're both married; we understand," one of the policemen said.

"In this race business, every driver likes to keep the other drivers guessing about a new rod he intends to use. That's why we didn't want anyone to see the car we were rebuilding. Leaving the old body lying around would be a giveaway, so we were going to drop it into the quarry."

"What was that about 'the Hollywood type attracting a lot of attention,'" Carl asked.

"The jalop had a Hollywood muffler on it that made a lot of noise when you gunned the motor," Jack explained promptly.

The older policeman studied the dejected faces of the two boys for a few seconds and then said kindly, "Don't take it so hard, fellows. Even without hearing that tape, I can imagine how convincing it must have sounded. And if it *had* been a serious affair, you did a good job of detecting."

Jerry looked up with a sudden expression of resolution. "From now on," he announced, "'detection' is going to be just a radio term as far as I am concerned."

"I'm with you," Carl said fervently as he started toward his bicycle. END

HERE'S HOW TO GET YOUR START

IN RADIO-TV-ELECTRONICS

Here's basic training you can really understand . . . training that can help fit you for a good paying radio-television-electronic career! No matter what part of the work you want to do, this is the kind of training you need **FIRST!**

Ghirardi's RADIO PHYSICS COURSE is the oldest book of its kind . . . and still a best seller **BECAUSE IT IS SO AMAZINGLY CLEAR AND COMPLETE.** Thousands now in electronics got their start from this great book—**AND THEY'LL RECOMMEND IT TO YOU TODAY!**

Starts with Basic Electricity (over 300 pages) then takes you step by step through the entire radio-electronics field. Covers principles, theories and practices that are basic to even the most modern equipment. 972 pages; 508 pictures; 856 helpful self-review test questions. Price only \$6.50.

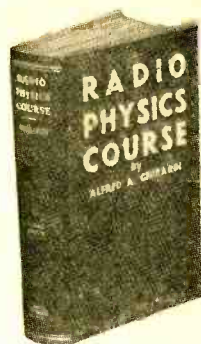

More experts got their basic training from this big book than any other of its type!

36 courses in one!

DON'T THROW OLD RADIOS AWAY!



This giant book shows exactly how to fix them . . . without a lot of previous experience!

There's a "secret" to repairing old radios fast and profitably . . . and this big **RADIO TROUBLESHOOTER'S HANDBOOK** is it!

Just look up the old make and model you want to fix. This manual-size, 3½ pound 744-page Ghirardi handbook tells what the trouble is likely to be . . . **AND SHOWS YOU EXACTLY HOW TO FIX IT.** No useless testing! No wasted time! Even beginners can handle jobs "slick as a whistle." **The only guide of its kind . . . cuts repair time in half!**

Includes are common trouble symptoms and remedies for over 4,800 models of home and auto radios and record changers. Actual case histories cover practically every model made by 202 manufacturers between 1925 and 1942—Air-line, Apex, Arvin, Atwater Kent, Belmont, Bosch, Brunswick, Clarion, Crosley, Emerson, Fada, G-E, Kolster, Majestic, Motorola, Philco, Pilot, RCA, Silvertone, Sparton, Stromberg **AND DOZENS MORE.** Gives how-to-do-it data on **SPECIFIC jobs**—NOT general theory. Includes hundreds of pages of invaluable tube and component data, service short cuts, etc. Price \$6.50. 10-day free trial.

--- 10 DAYS FREE TRIAL ---

Dept. PE-25, RINEHART & CO., INC.
232 Madison Ave., New York 16, N. Y.

Send book(s) checked for free examination. In 10 days, I will either send price shown (plus postage) or return books postpaid and owe nothing.

Ghirardi's RADIO TROUBLE-SHOOTER'S HANDBOOK. \$6.50. Ghirardi's RADIO PHYSICS COURSE. \$6.50.

Name

Address

City, Zone, State

(OUTSIDE U.S.A.—\$7.25 each, cash only. Money back if books are returned in 10 days.)

Beginners ELECTRONIC KIT

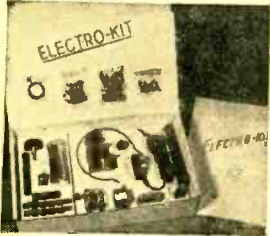

For young and old
35 EXPERIMENTS

Complete, no extras to buy. Build 5 radios, audio amplifier and oscillator, electronic organ, 2 power supplies plus many others. Kit has duo-purpose tube, selenium rectifier, headphone, crystal, all necessary resistors, condensers, hardware, etc.

Only \$1 with order, pay postman \$8.95 plus charges or \$9.95 prepaid.

ELECTRO KIT

Box 3468 Dept. PE-3 Maplewood 17, Mo.

Get Your F. C. C. LICENSE Quickly!

Correspondence or residence preparation for F.C.C. examinations. Results guaranteed.

An FCC commercial operator license means greater opportunities and higher pay. We are specialists in preparing you, in a MINIMUM OF TIME, to pass FCC examinations for all classes of licenses. Beginners get 2nd class license in 5 weeks and 1st class in 3 additional weeks. Write for free booklet.

GRANTHAM School of Electronics

Dept. 104E, 6064 Hollywood Blvd., Hollywood 28, Calif.
Phone: Hollywood 2-1411

INVENTORS

Send for
PATENT INFORMATION
Book and
INVENTOR'S RECORD
without obligation

GUSTAVE MILLER
25-PE WARNER BUILDING
WASHINGTON 4, D. C.

REGISTERED PATENT ATTORNEY

ASSOCIATE EXAMINER
U. S. PAT. OFF. 1922-1929

Patent Attorney & Advisor
U. S. NAVY DEPT. 1930-1947
PATENT LAWYER

EASY TO LEARN CODE

Learn or increase speed with an Instructograph—the Radio-Telegraph Code Teacher that takes the place of an operator-instructor and enables anyone to master code without further assistance. Available tapes from beginners alphabet to typical messages on all subjects. Speed range 5 to 40 WPM. Always ready—no QRM. Thousands have "acquired the code" with the Instructograph System. Write today for convenient rental and purchase plans.



INSTRUCTOGRAPH COMPANY

4713-P Sheridan Road, Chicago 40, Illinois

GET INTO ELECTRONICS

You can enter this uncrowded, interesting field. Defense expansion, new developments demand trained specialists. Study all phases radio & electronics theory and practice: TV; FM; broadcasting; servicing; aviation, marine, Police radio. 18-month course. Graduates in demand by major companies. H. S. or equivalent required. Begin Jan., March, June, Sept. Campus life. Write for Catalog.

VALPARAISO TECHNICAL INSTITUTE

Dept. PE Valparaiso, Ind.

ADDRESS POSTCARDS AT HOME!!

write BOX 14, BELMONT, MASS.

Disc Review





















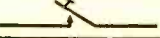























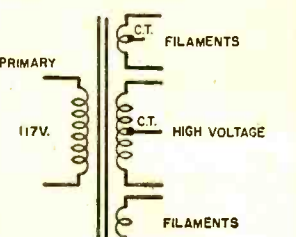



























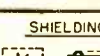







(Continued from page 61)

Rachmaninoff's *Piano Concerto No. 2* is one of the most popular piano works ever written. Even Tin Pan Alley knows this and you may have heard one of the themes from the work as the pop ballad, "Full Moon and Empty Arms." That the work has survived this assault is high tribute to its intrinsic worth. As might be expected, there are more than a few recordings of this concerto. In all there are twelve, five of which are worthy of being called Hi-Fi. One of the newest recordings, that of Geza Anda on *Angel* 35093, sounds the best and Mr. Anda's performance is just about tops, too. In any piano recording, you must listen for such things as "wow" or wavering of pitch. The piano is a fixed pitch instrument so any speed variation in the tape recorder that made the master, the recording or cutting lathe that made the disc, or your turntable will show up very quickly. In a good piano recording, the tone must not be harsh or ring, but be smooth and liquid. Hammer action of the keys should not be heard. A poor recording will exhibit distortion in high level chordal passages. The piano, along with the organ is the most difficult of all instruments to record, and it is a tribute to the *Angel* disc, that the sound of Mr. Anda's piano has been so faithfully captured. Some of the other recordings are more *spectacularly* Hi-Fi than the *Angel* disc, but carry with them some of the penalties mentioned previously. In order of choice we have Katchen on *London* LL384, Farnadi on *Westminster* 5193, Kapell on *Victor* LM1097, and DeGroot on *Epic* 3009. Kapell gives the best performance among these and *Westminster* the best sound. It would be unkind not to mention the fact that you can hear Rachmaninoff himself on *Victor* LCT 1014. If you can appreciate performance, there is none better, but be forewarned. This sound is typical of the period in which it was recorded—restricted range, tubby bass, dull, dead-sounding. *Victor* has tried to help matters a little by adding some reverb, but you know instantly you are listening to an old recording. One more word about piano recordings. By their nature they have differing effects on certain pickup cartridges. If with the cartridge you are using, the sound seems distorted, or is subject to a peculiar "ringing" overtone, try changing to another cartridge. The amazing thing is that sometimes the *cheaper* cartridges sound better than more expensive units, although generally speaking the better quality units are very reliable. If you can afford it, buy the cartridge with the greatest compliance in the stylus. Since piano music is largely transients, it will sound best through such a unit. Next month . . . organ and violin concertos, among other forms of music will be reviewed. END

AUDIO FANS!

Keep up with the latest record releases on all labels by reading Bert Whyte's monthly "Certified Record Revue" in our sister publication, **RADIO & TELEVISION NEWS**. Available at all newsstands!

STANDARDIZED WIRING DIAGRAM SYMBOLS

<p style="text-align: center;">ANTENNAS</p> <div style="display: flex; justify-content: space-around;">     </div> <p style="text-align: center;">GENERAL DIPOLE LOOP FERRITE TYPE</p>	<p style="text-align: center;">MICROPHONE</p> <div style="display: flex; justify-content: space-around;">    </div> <p style="text-align: center;">SINGLE BUTTON DOUBLE BUTTON CAPACITOR</p> <div style="display: flex; justify-content: space-around;">    </div> <p style="text-align: center;">DYNAMIC VELOCITY CRYSTAL</p>	<p style="text-align: center;">TELEGRAPH KEY</p> 
<p style="text-align: center;">BATTERIES</p> <div style="display: flex; justify-content: space-around;">   </div> <p style="text-align: center;">SINGLE-CELL MULTI-CELL</p>	<p style="text-align: center;">NEON BULB</p>  <p style="text-align: center;">PILOT LIGHT</p> 	<p style="text-align: center;">TRANSFORMERS</p> <div style="display: flex; justify-content: space-around;">    </div> <p style="text-align: center;">AIR CORE IRON CORE AIR CORE VARIABLE</p>
<p style="text-align: center;">BELL</p>  <p style="text-align: center;">BUZZER</p> 	<p style="text-align: center;">PHONO PICKUPS</p> <div style="display: flex; justify-content: space-around;">   </div> <p style="text-align: center;">CRYSTAL MAGNETIC</p> <p style="text-align: center;">PLUG OR SOCKET</p> 	<p style="text-align: center;">IRON CORE VARIABLE</p>  <p style="text-align: center;">POWDERED IRON CORE</p>  <p style="text-align: center;">AUTO</p> 
<p style="text-align: center;">CAPACITORS</p> <div style="display: flex; justify-content: space-around;">    </div> <p style="text-align: center;">FIXED MICA OR PAPER ELECTROLYTIC VARIABLE CAPACITORS GANGED</p> <div style="display: flex; justify-content: space-around;">    </div> <p style="text-align: center;">TRIMMER OR PADDER SPLIT-STATOR FEED-THRU</p> <p style="text-align: center;">T-DESIGNATES TRIMMER OR PADDER</p>	<p style="text-align: center;">RECEPTACLE 117 V.</p>  <p style="text-align: center;">RECORDING HEAD</p>  <p style="text-align: center;">MAGNETIC</p>	<p style="text-align: center;">POWER TRANSFORMER</p>  <p style="text-align: center;">PRIMARY 117V. C.T. FILAMENTS HIGH VOLTAGE FILAMENTS</p>
<p style="text-align: center;">COILS</p> <div style="display: flex; justify-content: space-around;">    </div> <p style="text-align: center;">FIXED R.F. COIL COIL WITH FIXED TAP COIL WITH VARIABLE TAP</p> <div style="display: flex; justify-content: space-around;">    </div> <p style="text-align: center;">IRON CORE OR CHOKE BIFILAR VARIABLE COIL OR CHOKE</p> <div style="display: flex; justify-content: space-around;">  </div> <p style="text-align: center;">SLUG-TUNED COIL</p>	<p style="text-align: center;">RECTIFIER</p>  <p style="text-align: center;">SELENIUM TYPE</p>	<p style="text-align: center;">RELAYS</p> <div style="display: flex; justify-content: space-around;">    </div> <p style="text-align: center;">S.P.S.T. NORMALLY OPEN S.P.S.T. NORMALLY CLOSED S.P.D.T.</p>
<p style="text-align: center;">CRYSTALS</p> <div style="display: flex; justify-content: space-around;">   </div> <p style="text-align: center;">CRYSTAL DETECTOR PIEZOELECTRIC CRYSTAL</p>	<p style="text-align: center;">RESISTORS</p> <div style="display: flex; justify-content: space-around;">   </div> <p style="text-align: center;">GENERAL TAPPED OR ADJUSTABLE</p> <div style="display: flex; justify-content: space-around;">   </div> <p style="text-align: center;">POTENTIOMETER OR RHEOSTAT CONTINUOUSLY VARIABLE</p>	<p style="text-align: center;">TUBES</p> <div style="display: flex; justify-content: space-around;">    </div> <p style="text-align: center;">DIODE HEATERS OR FILS. CATHODE TRIODE TETRODE</p> <div style="display: flex; justify-content: space-around;">   </div> <p style="text-align: center;">PENTODE SURPRESSOR SCREEN CONTROL PLATE CAP. GRID CAP. DIODE PLATE</p> <div style="display: flex; justify-content: space-around;">    </div> <p style="text-align: center;">DUO TRIODE COLD CATHODE PHOTO-ELECTRIC</p>
<p style="text-align: center;">FUSE</p>  <p style="text-align: center;">GROUND</p> <div style="display: flex; justify-content: space-around;">   </div> <p style="text-align: center;">WIRING CHASSIS</p>	<p style="text-align: center;">SHIELDING</p>  <p style="text-align: center;">SPEAKERS</p> <div style="display: flex; justify-content: space-around;">   </div> <p style="text-align: center;">P.M. ELECTRO-MAGNETIC</p> <p style="font-size: small;">DOTTED LINES INDICATE SHIELDING. COULD BE AROUND ANY COMPONENT OR GROUPS</p>	<p style="text-align: center;">TRANSISTOR (JUNCTION)</p>  <p style="text-align: center;">BASE COLLECTOR EMITTER</p> <p style="font-size: small;">P-N-P TYPE N-P-N TYPE SAME SYMBOL EXCEPT ARROW IS REVERSED</p>
<p style="text-align: center;">HEADPHONES</p> <div style="display: flex; justify-content: space-around;">   </div> <p style="text-align: center;">DOUBLE SINGLE</p>	<p style="text-align: center;">SWITCHES</p> <div style="display: flex; justify-content: space-around;">    </div> <p style="text-align: center;">S.P.S.T. S.P.D.T. PUSH-BUTTON</p> <div style="display: flex; justify-content: space-around;">   </div> <p style="text-align: center;">D.P.S.T. D.P.D.T. BOTH TYPES GANGED</p> <div style="display: flex; justify-content: space-around;">   </div> <p style="text-align: center;">ROTARY TYPE S.P.S.P. WAFER</p>	<p style="text-align: center;">VIBRATOR</p>  <p style="text-align: center;">WIRES</p> <div style="display: flex; justify-content: space-around;">   </div> <p style="text-align: center;">CONNECTION NO CONNECTION</p>
<p style="text-align: center;">METER</p>  <p style="text-align: center;">MOTOR</p> 		

GLOSSARY

a.f.c.—Automatic frequency control: (1) control of the frequency of the local oscillator in a superheterodyne to keep the receiver in tune with a desired station; (2) control of the frequency of the horizontal oscillator in a television receiver to keep the horizontal deflection in step with the horizontal deflection at the television studio and thus to keep the picture steady horizontally.

a.g.c.—Automatic gain control, control of the amplification of an amplifier so that its output is approximately constant in spite of variations in the input signal; especially such control in television receivers to reduce variations in picture contrast produced by variations in r.f. signal strength.

a.v.c.—Automatic volume control (a.g.c. used in radio receivers to reduce variations in sound volume produced by variations in r.f. signal strength).

choke—An inductance used especially to present a high impedance to a wide range of frequencies. Filter chokes are used in rectifier-type power supplies to remove from the d.c. output hum components equal to the power line frequency and its harmonics; audio-frequency chokes are used in audio amplifiers and radio-frequency chokes are used in r.f. and i.f. amplifiers, to present a high impedance load to a vacuum tube or to block unwanted signals.

crystal—1. Rectifying crystal, one which passes electric current more easily in one direction than in the other and thus can be used to change alternating current to pulsating direct current; made of such materials as germanium, silicon, copper oxide, galena, and carborundum. 2. Piezo-electric crystal, one which transforms mechanical energy to electrical and vice versa. Such crystals, made of Rochelle salt or barium titanate, are used in microphones and phonograph pickups. When cut to a certain size and shape, a piezo-electric crystal, usually made of quartz, can be used as a resonant circuit, to control the frequency of an oscillator or as a frequency-selective filter.

decibel—A measure of the ratio between two power levels or of a power level with respect to a designated reference level. Basically, the number of decibels is ten times the logarithm of a power ratio. One decibel is approximately the smallest difference in sound power which can be detected by the average human ear.

db of feedback—The number of decibels by which inverse feedback in an amplifier reduces its over-all gain and distortion.

detector—A circuit used to recover an audio or video signal from a modulated radio signal.

electrolytic capacitor—A type of capacitor in which the dielectric or insulator is a thin film of oxide deposited on one aluminum or tantalum plate and an electrolyte is used between the insulator and the other plate. This type of capacitor provides a larger capacitance in a given volume than any other type. However, except for special a.c. electrolytics, this type can be used only in circuits where voltage of constant polarity is applied to it.

elevator—Control surface of an aircraft which regulates its pitch attitude (level, climbing, or diving).

feedback—Returning part of the output of an amplifier stage to the input of the same or a previous stage. Negative or inverse (out-of-phase) feedback decreases the gain and distortion of the amplifier; positive (in-phase) feedback increases gain and distortion and may produce oscillation.

frequency response—The relative ability of an amplifier, loudspeaker, or other device to respond to different frequencies.

glow plug—A type of internal-combustion engine used in models, in which starting is assisted by a filament in the combustion chamber, which is energized by an external battery.

harmonic distortion—Distortion consisting of addition to the signal of components whose frequencies are multiples (harmonics) of the original signal frequency. It is produced by an amplifier or other device which is nonlinear (does not give the same ratio of output to input for all input amplitudes).

heterodyne—A different frequency (beat) produced by combining two frequencies.

hole—Absence of an electron normally present in an atom; a positive charge. The action of some transistors often is explained by referring to movement of holes or positive charges, rather than movement in the opposite direction of electrons or negative charges.

microammeter—A meter for the measurement of current flow, which is calibrated in microamperes, or millionths of an ampere.

milliampere—One-thousandth of an ampere.

modulated—Varied in amplitude, frequency, or some other quality. Radio-frequency signals are modulated in order to carry signals of lower frequency, such as sound or picture signals.

multimeter—A meter which is a combination of a voltmeter, an ohmmeter, and (often) an ammeter.

octal—Designation of one of the standard types of tube base or the socket to fit it. The base has eight equally spaced pins and a centrally located boss, which is made of insulating material and has a key to prevent improper insertion of the tube in the socket. The loctal tube base is similar, except that its pins are smaller in diameter and the central boss is of metal and has a groove which fits a one-turn spring in the socket, to hold the tube.

oscillator—A vacuum-tube or transistor circuit or other device which produces an alternating-current power output without mechanical rotation.

plate dissipation—The part of the power applied to the plate circuit of a vacuum tube which does not appear as signal output, but is dissipated as heat in the plate of the tube.

push-pull—An arrangement of two vacuum tubes in an amplifier so that the input signal is applied in opposite phases to the two tubes and the signal outputs are combined in phase. This arrangement reduces even-harmonic distortion.

regeneration—Positive feedback in detectors and amplifiers. Increases gain and distortion and may produce oscillation.

saturate—To reach the maximum possible value of some quantity, such as magnetization in the core of an inductor or electron flow in a vacuum tube from cathode to plate.

servo-motor—A special electric, hydraulic, or other type of motor used in control apparatus to convert a small movement into one of greater amplitude or greater force.

signal generator—A test instrument providing electrical power substantially similar in amplitude, frequency, and other qualities, to signals found in electronic equipment.

signal tracer—A test instrument for detecting the presence of a signal in electronic equipment and, with some signal tracers, measuring its amplitude, frequency, or other qualities.

superheterodyne—A receiver in which all incoming radio-frequency signals are mixed with the output of an oscillator to produce a heterodyne or beat frequency. The oscillator frequency is variable so that the beat produced with any desired signal can be adjusted to a certain frequency. The beat-frequency

signal is fed to a fixed-frequency (intermediate-frequency) amplifier, where greater and more uniform gain and selectivity can be obtained than at the original radio frequency.

superregenerative—A type of regenerative detector in which the tendency to oscillation is controlled by a quenching voltage of ultrasonic frequency which periodically allows the gain to increase, then reduces it. The quenching voltage can be produced by the detector tube itself or by a separate oscillator. This type of detector has great sensitivity, but poor selectivity.

tone control—1. In a radio receiver or an audio amplifier, means provided to change the relative response to audio signals of different frequencies; effects which can be produced are treble boost or attenuation and bass boost or attenuation. 2. In radio control of models, a system wherein the radio signal is modulated by audio tones and control is achieved by keying the modulating tones on and off, instead of keying the r.f. carrier.

v.t.v.m.—Vacuum-tube voltmeter, a voltmeter using one or more vacuum tubes to increase the sensitivity of the basic meter movement, so that measurements can be made in a circuit without drawing much current and without disturbing very much the normal operating conditions of the circuit. May also be a combination voltmeter, ohmmeter, and ammeter. END

ABBREVIATIONS

a.c.—alternating current
a.f.—audio frequency
a.f.c.—automatic frequency control
a.g.c.—automatic gain control
AM—amplitude modulation
amp.—ampere
ARRL—American Radio Relay League
a.v.c.—automatic volume control
BCI—interference with broadcast reception
b.f.o.—beat frequency oscillator
cps—cycles per second
c.t.—center-tapped
c.w.—continuous wave
db—decibel
dbm—decibels above one milliwatt
d.c.—direct current
d.c.c.—double cotton covered (wire)
d.p.d.t.—double-pole, double-throw
d.p.s.t.—double-pole, single-throw
DX—distance
elec.—electrolytic
FCC—Federal Communications Commission
FM—frequency modulation
freq.—frequency
GMT—Greenwich Mean Time
hi fi—high fidelity (of sound reproduction)
hy.—henry
i.f.—intermediate frequency
K—kilo (one thousand)
kc.—kilocycle
M—mega (one million)
ma.—milliamperes
mc.—megacycle
meg.—megohm
mike—microphone, microfarad
mil—milliamperes
m.o.p.a.—master oscillator, power amplifier
mu—amplification factor
 μ fd.—microfarad

μ fd.—micromicrofarad
mw.—milliwatt
m.w.—medium wave
PA—power amplifier
p.a.—public address
PM—phase modulation, permanent magnet (speaker)
pos.—position (of a switch)
pot.—potentiometer
pri.—primary
R-C—resistance-coupled
R/C—radio control
rect.—rectifier
res.—resistor
RETMA—Radio-Electronics-Television Manufacturers Association
r.f.—radio frequency
r.m.s.—root mean square
sec.—secondary
SN—self-neutralizing (escapement)
s.p.d.t.—single-pole, double-throw
spkr.—loudspeaker
s.p.s.t.—single-pole, single-throw
s.w.—short-wave
SWL—short-wave listener
sync.—synchronization
t.—turns (of a coil)
trans.—transformer
TV—television
TVI—interference with television reception
u.h.f.—ultra high frequency
v.—volt
v.f.o.—variable frequency oscillator
v.h.f.—very high frequency
VR—voltage regulator
v.t.v.m.—vacuum-tube voltmeter
vu—volume unit
w.—watt
wpm—words per minute
xmtr.—transmitter

The New Model 70 UTILITY TESTER FOR REPAIRING ALL ELECTRICAL APPLIANCES MOTORS • AUTOMOBILES • TV TUBES

As an electrical trouble shooter the Model 70:

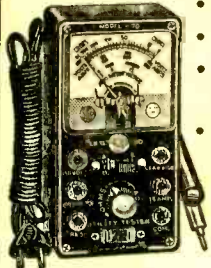

- Measures A.C. and D.C. Voltages, A.C. and D.C. Current, Resistances, Leakage, etc.
- Will measure current consumption *while the appliance under test is in operation.*
- Incorporates a sensitive direct-reading resistance range which will measure all resistances commonly used in electrical appliances, motors, etc.
- Leakage detecting circuit will indicate continuity from zero ohms to 5 megohms (5,000,000 ohms).
- Will test toasters, toasters, Broilers, Heating Pads, Clocks, Fans, Vacuum Cleaners, Refrigerators, Lamps, Fluorescents, Fans, Switches, Thermostats, etc.
- Will test all TV tubes for open filaments, inter-element shorts, burned out tubes, etc.

As an Automotive Tester the Model 70 will test:

- Both 6 Volt and 12 Volt Storage Batteries • Generators • Starters • Distributors • Ignition Coils • Regulators • Relays • Circuit Breakers • Cigarette Lighters • Stop Lights • Condensers • Directional Signal Systems • All Lamps and Bulbs • Fuses • Heating Systems • Horns • Also will locate poor grounds, breaks in wiring, poor connections, etc.

Handsome round-cornered molded bakelite case, 3 1/2" x 5 7/8" x 2 1/4". Complete with all test leads. Also included is a 64 page **BOOK**, giving detailed instructions for testing all electrical appliances, automotive equipment, TV tubes, etc. Only **\$15.85**

**SHIPPED ON APPROVAL
NO MONEY WITH ORDER - NO C. O. D.**

Try it for 10 days before you buy. If completely satisfied then send \$3.85 and pay balance at rate of \$4.00 per month for 3 months — No Interest or Finance Charges Added! If not completely satisfied, return to us, no explanation necessary.

MOSS ELECTRONIC DIST. CO., Dept. D-95
3849 Tenth Ave., New York 34, N. Y.

Please rush 1 Model 70. I agree to pay \$3.85 within 10 days after receipt and \$4.00 per month thereafter.

Name _____
Address _____
City _____ Zone _____ State _____

INDEX OF ADVERTISERS

ADVERTISER	PAGE NO.
Ace Radio	122
Advance Spectacle Co.	110
Advance Training	112
Allied Radio Corp.	12
American School	120
Ashe Radio Co., Walter	104
Baurbach Eng. Co.	94
Burstein-Applebee Co.	96
Business Information Corp.	124
Cabinart	13
Capital Radio Engineering Institute	15
Century Electronics Co.	100
Clarence A. O'Brien & Harvey Jacobson	7
Concord Radio	97
Corona Radio & TV Co.	128
Coyne Electrical School	5, 95, 105
de Bolt Model Engineering Co.	119
Desco Mfg. Co.	129
Duraclean Co.	109
Edlie Electronics	110
Electro Kit	124
Electronic Instrument Co., Inc., EICO	119
Electronic Measurement Corporation	6
Evans, Victor J.	110
Finney Company, The	111
Gernsbach Publications	113
Grantham School of Electronics	124
Greenlee Tool Co.	109
Gyro Electronics	120
Hallcrafters	4th COVER
Harjo Sales Co.	118
Heath Company	84, 85, 86, 87
Hershel Radio Co.	118
Household Handies	94
Instructograph Co.	124
Johnson, E. F.	94
Karlson Associates, Inc.	122
Kleer Vision Sales Co.	115
Lafayette Radio	90
LaPointe Electronics, Inc.	81
McGraw Hill Book Co., Inc.	115
Miller Gustave	124
Moss Electronic Distributing Co., Inc.	128
Musical Masterpiece Society	8
National Radio Institute	3
National Schools	3rd COVER
Newark Electric Co.	112
Progressive "Edu-Kits," Inc.	107
Radio-Television Training Association	9
Raytheon Manufacturing Co.	10, 11
Rex Radio Supply	108
Richville TV Supply	108
Rinehart & Co., Inc.	123
Sleeper, Milton B., Publisher	101
Smith, Johnson & Co.	120
Soundtronics Labs	120
Sprague Products Co.	16
Steve-El Electronics Corp.	100
Superelex Electronics Corp.	116
Teltron Electric Company	117
Transi-Mite Radio Lab.	104
United Catalog Publishers, Inc.	120
University Loudspeakers	2nd COVER
Utilities Engineering Institutes	128
Valparaiso Technical Institute	124
Video Electronics Co.	121
Visulite Co.	122
Warner Electric	109
Wayne School, Inc.	122
Western Radio Co.	110
World Radio Laboratories	93

CORONA RADIO KITS

EASY TO BUILD • EDUCATIONAL • EXCELLENT RECEPTION

**BROADCAST
SUPERHET
KIT**

\$14.75

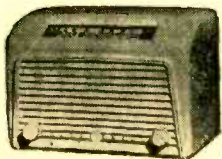

ROCKET 115K - Latest Single Band superhet circuit for ultimate in sensitive reception and tonal quality. Kit includes all necessary parts, punched chassis, attractive bakelite mahogany cabinet, built-in loop antenna, iron core IF's, big Alnico V sprk. tubes: 12SK7, 12SA7, 12SQ7, 50L6, 35Z5. Automatic vol. control, beam power output. Tunes 540 to 1700 kc. Simple step-by-step instructions included.

Plaza 812K 2-Band AC-DC Super Kit.....net 520.75
Globemaster 814K 3-Band Super Kit.....net 524.75
All kits supplied less wire and solder. Please include 25% deposit with C.O.D. orders. Dept. P-7

CORONA RADIO & TV CO.
370 Broadway New York 13, N.Y.

Success Requires Training! **LEARN**



**AIR CONDITIONING
and REFRIGERATION**

This great, modern industry is alive with opportunities for trained men. Installation, maintenance and servicing of home and industrial equipment is a well-established, paying trade and business. Now mechanically inclined men can get practical instruction in spare time at home, plus quick shop practice at U. E. I. (founded 1927).

Important Facts FREE - Write today

Find out all about these interesting opportunities without obligation. Send a postcard or short note right now, **UTILITIES ENGINEERING INSTITUTE, Dept. BK-1, 2528 SHEFFIELD AVENUE • CHICAGO 14, ILLINOIS**

ELECTRICAL POWER QUIZ

(Answers to quiz on page 115)

1. b 2. a 3. c 4. c 5. a

TECHNICAL QUIZ

(Answer to quiz on page 116)

The resistors are actually connected in parallel. This can be easily noted by re-drawing the diagram in a more conventional manner. The current drain with switch S1 closed will be 3 amperes.

Classified

RATE: 35c per word—minimum 10 words

FOR SALE

RADIO Diagrams \$1.00; Television \$2.00. Give make, model. Diagram Service, 672-PE, Hartford 1, Conn.

15 TESTED One-tube circuits 25c, including "Radio-builder," catalog. Laboratories, 328-L Fuller, Redwood City, California.

DEMAGNETIZER for small tools and watches. Can also be used to magnetize. Any 110V. a.c. socket. Rush \$3.95. Norman, 168-74 - 92nd Rd., Jamaica, N. Y.

BARGAIN, Small Electric Motors 110V, a.c. Rush \$1.00 each full price. Norman, 168-74 - 92nd Rd., Jamaica, N. Y.

ULTRAVIOLET light. A Must for experimenters, students of chemistry, photography, amateur detectives, antique and stamp collectors. Amazing! Rush \$1.98. Norman, 168-74 - 92nd Rd., Jamaica, N. Y.

FIFTEEN assorted—Resistors, Condensers, Knobs, 30c. Trowbridge, 312 West 75th, Chicago 21.

SOUND-Off! Build fully automatic electronic brain. The Musicon cuts out commercials. Lets any radio, TV play only music! Priceless possession for home, business, office. Simple, low-cost construction. 2-tubes. Handsome booklet, schematic, full instructions Plus special component, \$3.50 with order. Free literature. Norman Electronics Company, P. O. Box 733, Brooklyn 1, N. Y.

GEIGER Counter kits—Save dollars, buy them in kit form. Include radioactive sample. Send for free literature. Geiger Counters, Station A, Box 111, Dept. EP, Hartford 6, Conn.

SOLAR battery converts light into electrical energy. Lasts indefinitely. Excellent for operating transistors. 5000 microamps maximum output. Only \$2.00. Springfield Enterprises, Box 54-E2, Springfield Gardens 13, New York.

WALKIE-Talkie. Build a real wireless two-way portable radio-telephone for less than \$10.00. Plans 50c. Springfield Enterprises, Box 54-E2, Springfield Gardens 13, New York.

INCREDIBLE! One tube radio receives television, FM broadcast, CAP and amateurs. Special tube and diagram only \$2.00. Wired assembly \$2.00. Springfield Enterprises, Box 54-E2, Springfield Gardens 13, New York.

TESTER \$1.79, Tests R-TV Tubes, Electrical Appliances, Etc. DMJ Products, Box 1196, Arlington 13, Virginia.

DIAGRAMS: Professional Model Timers, Counters, Intercoms, Organs, etc. \$1.00 each. List free. Parks, 106 S. E. 57th, Portland 15, Oregon.

INSTRUCTION

HIGH School—no Classes. Study at home. Spare time. Diploma awarded. Write for Free Catalog HET-4. Wayne School, 2527 Sheffield, Chicago 14, Ill.

LEARN code more easily. Free information. Don Rogers, Ivyland, Pa.

1955 U. S. GOVT Jobs! Men-Women, 18-55. Start high as \$86.00 week. Qualify Now! 23,000 jobs open. Experience often unnecessary. Get Free 36-page book showing jobs, salaries, requirements, sample tests. Write: Franklin Institute, Dept. Z-23, Rochester, N. Y.

BUSINESS OPPORTUNITIES

PROFITABLE Home Business. Make Fast-Seller. Chenille Monkey Trees, Holiday Flower, Novelties, Literature Free. Velva, Bohemia 24, N. Y.

PICTURESQUE Overseas Postcards. Liberal Discount. Write: Goodall, 136 Joost, San Francisco 12.

TELEVISION Jobs—Names and addresses of companies to contact. \$1.00. Fitzgerald, Dept. A-22, 3038 West Wellington Avenue, Chicago 18, Illinois.

INVENTIONS WANTED

INVENTIONS wanted. Patented; unpatented. Global Marketing Service, 1404 Mitchell, Oakland 1, Calif.

MISCELLANEOUS

DETECTIVES—Experience unnecessary. Detective Particulars free. Write, Wagner, 125 W. 86th, N. Y.

BUILD, and play your own electronic organ. Jim Kirk, W6DEG, 1552 Church Street, San Francisco 14, Calif.

TEST Equipment Repair—Kits Constructed and Rebuilt. Free information. Bigelow Electronics, Dept. PE, Beulah, Michigan.

RADIO Television Service Forms Samples. Jones, 1210 Dudley, Utica, N. Y.

VIGOROUS Health. Amazing method. Inquire. Solar Health System, Box 1061-S8, Escondido, Calif.

LEARN Code—Complete electronic equipment and instructions—\$2.99. Deluxe set two units—\$4.99. Mailmart-C, Box 92, Paramus, N. J.

"HOW to build crystal sets" and crystal set—\$1.00. Mailmart-PE Box 92, Paramus, New Jersey.

FREE Condenser and Resistor Code Charts. Largest stock of parts and tubes in West. We can save you money. K & L Radio Parts Co., 1406 Venice Blvd., Los Angeles 6, Calif.

TUBES—TV, Radio, Transmitting, special purpose types—Bought, Sold, Exchanged. Send details to B. N. Gensler W2LNI, 136 Liberty St., New York 6, N. Y.

TOP Dollar Paid for Art-13's, dynamotors, parts racks and all other component parts. Write: Harjo Sales Co., 4109 Burbank Blvd., Burbank, Calif.

PHOTO CREDITS

Page	Credit
24, 25	ORRadio Industries, Inc.
37	Fruehauf
47	Top Left, Alprodo, Inc., Middle Right, General Electric Co.
53	Left, Top to Bottom, World Radio Labs, Inc., The Hallicrafters Co., Barker & Williamson, Inc. Right, The Heath Co. Bottom Right, E. F. Johnson Co.
57	National Broadcasting Company
70, 71	Admiral Corp.
79	American Electronics Co.
80	Bottom, Allen E. Dr. Mont Labs, Inc.
82, 83	Union Pacific Railroad Co. & Reeves Instrument Corp.
92	Bottom, General Electric Co.

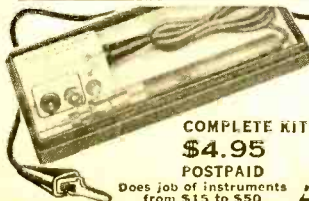

TESTS LIVE OR DEAD CIRCUITS UP TO 600 VOLTS!

NEW Desco CIRCUITRACER—thousands in use—by Auto-Lite, Bendix, General Electric, electricians, servicemen. For all electrical, Hi-Fi, radio-TV, automotive, aircraft, marine. Locates grounds, opens shorts. Tests tube filaments; plates, screens; vibrators, output voltages. Ind. AC or DC. Ind. through 20 megohms res. Tests your wiring before you apply power. Kit includes incand. signal light, neon lamp, batteries, 12-pr. book "Tracer Tips." Rugged lifetime constr. Ironclad money-back guarantee.

COMPLETE KIT
\$4.95
POSTPAID

Does job of instruments from \$15 to \$50



Circuitracer
DESCO MFG. CO.

ORDER BY MAIL—
FOR C.O.D. ENCLOSE DEPOSIT OF \$1.00
601 E. WALNUT, PASADENA 1, CALIF.



RESISTOR COLOR CODE

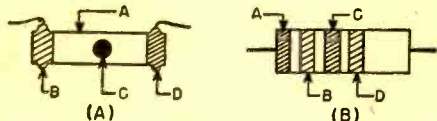

RETMA COLOR CODE CHART

COLOR	VALUE	MULTIPLIER
Black	0	1
Brown	1	10
Red	2	100
Orange	3	1000
Yellow	4	10,000
Green	5	100,000
Blue	6	1,000,000
Violet	7	10,000,000
Grey	8	100,000,000
White	9	1,000,000,000

TOLERANCE CODE

Gold—±5%	Silver—±10%
No Color—±20%	

The ohmic value of a resistor can be determined by means of the color code. There are two standard methods of indicating this value.

In Fig. A, the body (A) and end (B) indicate the first and second digits of the value while the dot (C) indicates the multiplier to be used. The tolerance of the unit is indicated by the end color (D). For example, if the body (A) is green the number is 5; if the end (B) is grey the second number is 8. If the dot (C) is red the multiplier is 100 or two zeros should be added. The resistor is then a 5800 ohm unit. If the end (D) has no color, the tolerance is ±20%.

In Fig. B, the first two stripes indicate the first two digits; the third stripe the multiplier; the fourth stripe the tolerance. Thus, if stripe (A) is green, (B) is grey, (C) is red, and (D) is silver, the resistor is a 5800 ohm, ±10% unit.

CAPACITOR COLOR CODE

MOLDED PAPER			MOLDED MICA		CERAMIC	
Color	Multiplier	Tolerance	Multiplier	Tolerance	Multiplier	Tolerance
Black	1	20%	1	20%	1	20% or 2.0μfd.*
Brown	10		10		10	1%
Red	100		100	2%	100	2%
Orange	1000		1000	3% (RETMA)	1000	2.5% (RETMA)
Yellow	10,000	5%	10,000		10,000	
Green				5% (RETMA)		5% or 0.5μfd.*
Blue						
Violet						
Gray					0.01	0.25μfd.*
White		10%			0.1	10% or 1.0μfd.*
Gold	0.1	5%	0.1	5% (JAN)		
Silver		10%	0.01	10%		
None		20%				

*Capacitance less than 10μfd.

Capacitance is given in μfd. Colors have same values as on resistors, except as indicated in tables. Colors (A) and (B) are for first two digits; (C) is for multiplier. (D) is for tolerance. (E) and (F) give voltage rating in hundreds of volts; (E) is used only for ratings less than 1000 volts, (E) and (F) for first two digits of ratings 1000 volts or more. Values of colors for (E) and (F) are same as in resistance values. (G) is class or characteristic of capacitor, (H), (I), and (J) give temperature coefficient. (G), (H), (I), and (J) are not listed in the tables, since this information is seldom needed by the average home builder.

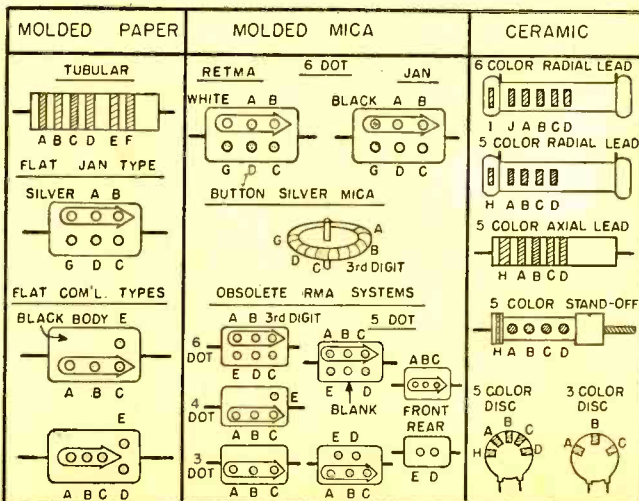

ADVANCE! Raise your earning power—learn RADIO-TELEVISION-ELECTRONICS by SHOP-METHOD HOME TRAINING

GOOD JOBS AWAIT THE TRAINED RADIO-TV TECHNICIAN

There is a place for you in the great Radio-Television-Electronics industry when you are trained as National Schools will train you at home!

Trained technicians are in growing demand at good pay—in manufacturing, broadcasting, television, communications, radar, research laboratories, home Radio-TV service, and other branches of the field. National Schools Master Shop-Method Home Training, with newly added lessons and equipment, trains you in your spare time, right in your own home, for these fascinating opportunities. **OUR METHOD IS PROVED BY THE SUCCESS OF NATIONAL SCHOOLS TRAINED MEN, ALL OVER THE WORLD, SINCE 1905.**

EARN WHILE YOU LEARN

Many National students pay for all or part of their training with spare time earnings. We'll show you how you can do the same! Early in your training, you receive "Spare-time Work" Lessons which will enable you to earn extra money servicing neighbors' and friends' Radio and Television receivers, appliances, etc.

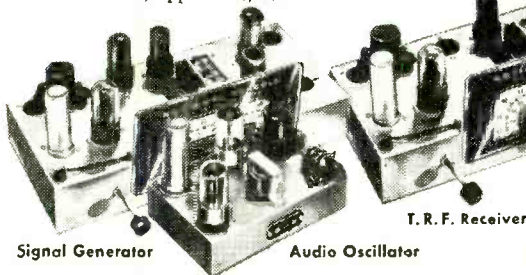

Signal Generator

Audio Oscillator

T. R. F. Receiver

National Schools Training is All-Embracing

National Schools prepares you for your choice of many job opportunities. Thousands of home, portable, and auto radios are being sold daily—more than ever before. Television is sweeping the country, too. Co-axial cables are now bringing Television to more cities, towns, and farms every day! National Schools' complete training program qualifies you in all fields. Read this partial list of opportunities for trained technicians:

Business of Your Own • Broadcasting
Radio Manufacturing, Sales, Service • Telecasting
Television Manufacturing, Sales, Service
Laboratories: Installation, Maintenance of Electronic Equipment
Electrolysis, Call Systems
Garages: Auto Radio Sales, Service
Sound Systems and Telephone Companies, Engineering Firms
Theatre Sound Systems, Police Radio
And scores of other good jobs in many related fields.

TELEVISION TRAINING

You get a complete series of up-to-the-minute lessons covering all phases of repairing, servicing and construction. The same lesson texts used by resident students in our modern and complete Television broadcast studios, laboratories and classrooms!



MASTER ALL PHASES!

Get Master Shop-Method Home Training from an Established Practical Resident School with its own Training — almost 50 Years of Successful Experience in Training Ambitious Men.



Shops, Laboratories, Studios —

We Bring National Schools To You!



You also receive this Multitester

Superheterodyne Receiver

LEARN BY DOING

You receive and keep all the modern equipment shown above, including tubes and valuable, professional quality Multitester. *No extra charges.*

FREE! RADIO-TV BOOK AND SAMPLE LESSON!

Send today for National Schools' new, illustrated Book of Opportunity in Radio-Television-Electronics, and an actual Sample Lesson. No cost—no obligation. Use the coupon now—we'll answer by return airmail.

APPROVED FOR
VETERANS
AND
NON-VETERANS
Check coupon below

Both
Resident and
Home Study
Courses Offered!



NATIONAL SCHOOLS

LOS ANGELES 37, CALIFORNIA • ESTABLISHED 1905
IN CANADA: 811 W. HASTINGS STREET, VANCOUVER, B.C.

GET FACTS FASTEST! MAIL TO OFFICE NEAREST YOU!

(mail in envelope or paste on postal card)

NATIONAL SCHOOLS, Dept. R2G-25
4000 S. Figueroa Street or 323 West Polk Street
Los Angeles 37, Calif. Chicago 7, Ill.

Send FREE Radio-TV Electronics book and FREE sample lesson. No obligation, no salesman will call.

NAME _____ BIRTHDAY _____ 19 _____

ADDRESS _____

CITY _____ ZONE _____ STATE _____

Check here if interested in Resident School Training of Los Angeles.
VETERANS: Give Date of Discharge

Again, Two New Leaders Bear a Famous Brand*

We're proud of our name and the twenty years of electronic leadership it represents. Our brand new communications line is in keeping with the high standards we have always maintained. Hallicrafters respects the recognition it has achieved by never compromising quality for price or sacrificing craftsmanship for mass production. These new models are the ultimate in precision-built communications equipment.

W. J. Hallicrafters Bielhallicrafters, Jr.



This new receiver reflects the dependable performance of 500,000 Hallicrafters radios with basically this chassis now in the field. Covers Broadcast Band 540-1650 kc plus three short-wave bands from 1650 kc—32 Mc. Electrical bandspread operates over large, easy-to-read dial. Headphone tip jacks on rear and built-in PM speaker. Oscillator for reception of code signals.

Gray steel cabinet with silver frame trim 12 $\frac{1}{8}$ " x 7" x 7 $\frac{1}{4}$ ". Shipping weight 13 lbs. Four tubes plus rectifier. 105/125 V. 50/60 cycle AC/DC \$49.95



Model S-38D

These two new Civil Patrol receivers replacing the popular S-81 and S-82 are over ten times as sensitive, have greater increased audio power output, and include an extremely reliable *built-in relay squelch system*. This type of squelch system *completely* disables the entire audio system so that not a murmur is heard from the speaker until a signal is received making the unit perfect for monitoring of police, fire, taxi, mobile-telephone, forestry, civil defense. The S-94 covers from 30—50 Mc and the S-95 from 150—173 Mc. Built-in speaker and provisions for headphones. Gray steel cabinet with silver trim panel and red pointer. 12 $\frac{1}{8}$ " x 7" x 7 $\frac{1}{4}$ ". Shipping weight approximately 12 $\frac{1}{2}$ lbs. Eight tubes plus rectifier. 105/125 V. 50/60 cycle AC/DC \$59.95



CHICAGO 24, ILLINOIS



Model S-94 (S-95)



hallicrafters