

# POPULAR ELECTRONICS

JANUARY

1955

25

CENTS

In U.S. and Canada

RADIO • TV • R/C • HI-FI • ELECTRONICS

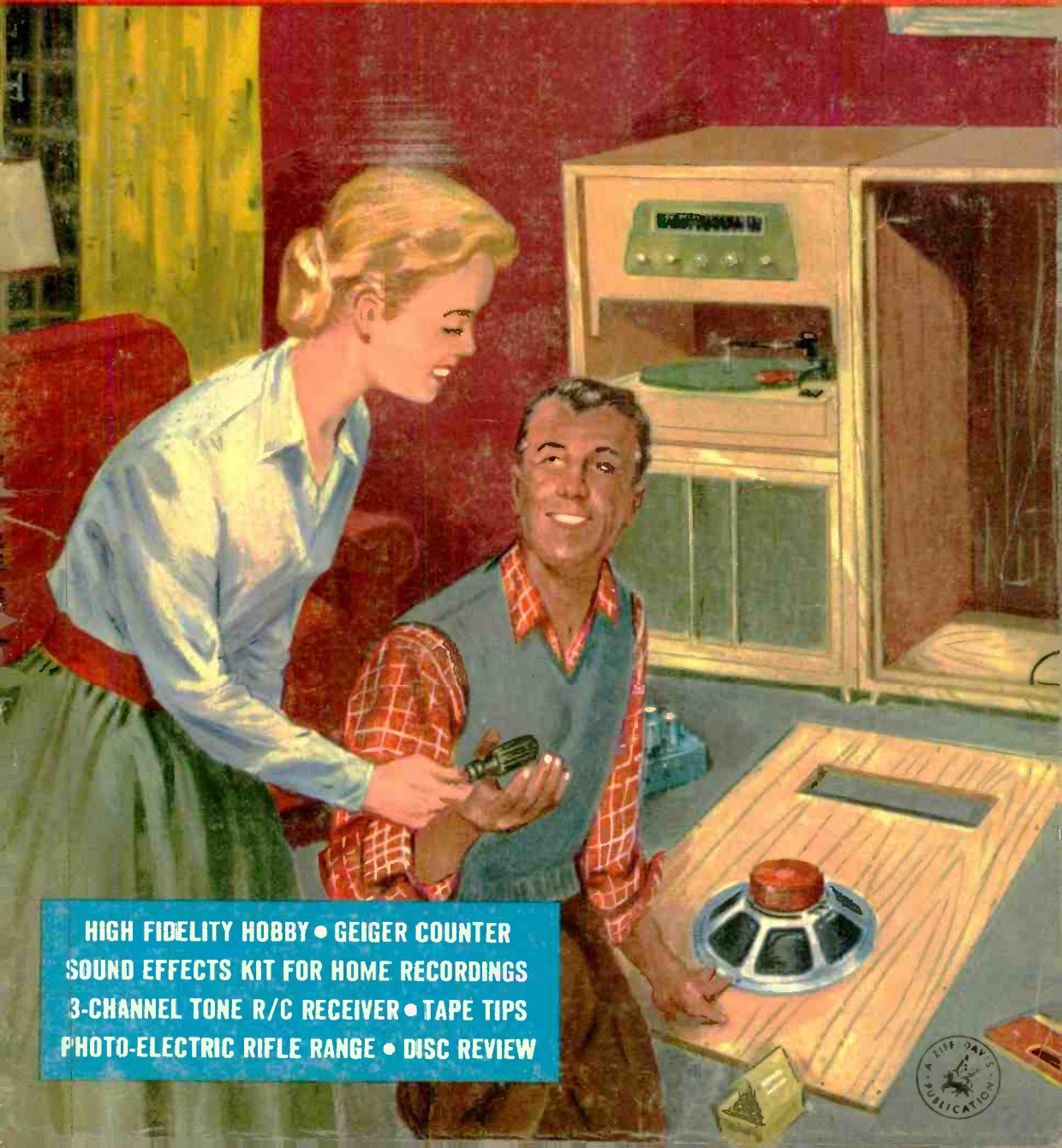

HIGH FIDELITY HOBBY • GEIGER COUNTER  
SOUND EFFECTS KIT FOR HOME RECORDINGS  
3-CHANNEL TONE R/C RECEIVER • TAPE TIPS  
PHOTO-ELECTRIC RIFLE RANGE • DISC REVIEW



# BUILD YOUR OWN HIGH FIDELITY CABINETS AND ENCLOSURES

by **Cabinart**

*With a cabinet kit by CABINART you get exactly the style that you want. The finish is up to you. You get top-quality white pine or birch—perfect for any finish that you select. And so easy to put together . . . all you need is a screwdriver.*

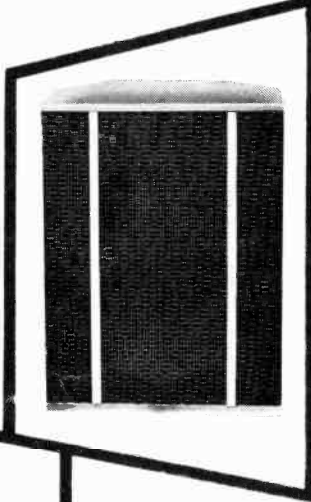

## Paul Klipsch-designed Rebel IV

You can now build your own corner horn speaker enclosure . . . designed by Paul Klipsch. Identical in acoustic design to assembled units and easily put together with a minimum of tools. Priced for the home-builder in unfinished birch.

12" model . . . **\$36.00** net\*  
15" model . . . **\$42.00** net\*

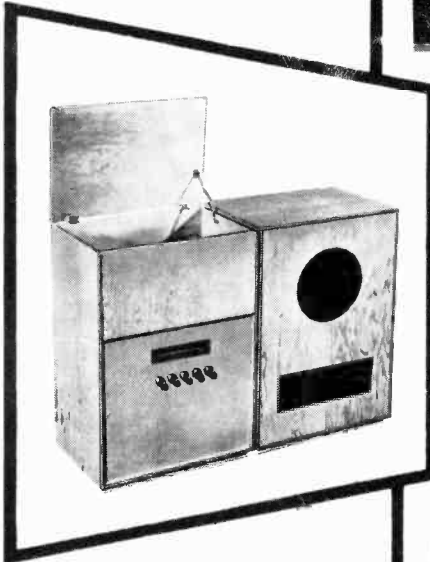

## Bass Reflex and Equipment Cabinets

The ideal housing for high fidelity components . . . removable panels make future changes easier. Loudspeaker cabinet acoustically designed for either 12" or 15" speaker. Overall dimensions: 33½" H., 23" W., 16" D. Tuner compartment: 20" H., 21¼" W. (inside dimensions), 15¼" D. Baffle volume: 6 cu. ft.

**Model 80**—Equipment cabinet kit . . . . . **\$27.00** net\*  
**Model 8112**—12" speaker cabinet kit . . . . . **\$18.00** net\*  
**Model 8115**—15" speaker cabinet kit . . . . . **\$18.00** net\*

*All kits include ¾" white pine cut to size, baffle precut for 12" or 15" speaker, Saran plastic acoustic cloth, Kimsul acoustic insulation, assembly and finishing instructions, hardware, plastic wood, sandpaper and glue.*

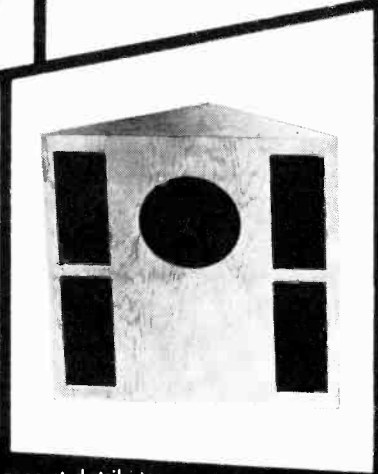

## Corner Folded Horn Enclosures

Reproduces a quality of bass heretofore only possible through the use of far more expensive designs.

**Model 61** **\$19.95**  
(12" speaker kit) net\*  
**Model 63** **\$23.95**  
(15" speaker kit) net\*

\*prices higher west and south.

Write for free catalog and name of nearest distributor

**G & H WOOD PRODUCTS COMPANY • 75 NORTH 11th ST., BROOKLYN 11, N. Y.**



# I WILL TRAIN YOU AT HOME FOR GOOD PAY JOBS IN RADIO-TELEVISION

J. E. SMITH has trained more men for Radio-Television  
than any other man. OUR 40th YEAR.

**America's Fast Growing Industry Offers  
You Good Pay—Bright Future—Security**

## I TRAINED THESE MEN



"Started to repair sets six months after enrolling. Earned \$12 to \$15 a week in spare time."—Adam Kramlik, Jr., Sunneystown, Pennsylvania.

"Up to our necks in Radio-Television work. Four other NRI men work here. Am happy with my work."—Glen Peterson, Bradford, Ont., Canada.



"Am doing Radio and Television Servicing full time. Now have my own shop. I owe my success to N.R.I."—Curtis Stath, Ft. Madison, Iowa.



"Am with WCOC. NRI course can't be beat. No trouble passing 1st class Radio-phone license exam."—Jesse W. Parker, Meridian, Mississippi.



"By graduation, had paid for course, car, testing equipment. Can service toughest jobs."—E. J. Streitenberger, New Boston, Ohio.

**AVAILABLE TO  
VETERANS  
UNDER G.I. BILLS**

## You Learn by Practicing with Parts I Send



Nothing takes the place of **PRACTICAL EXPERIENCE**. That's why NRI training is based on **LEARNING BY DOING**. You use parts I furnish to build many circuits common to Radio and Television. As part of my Communications Course, you build many circuits, including low power transmitter shown at left. You put it "on the air," perform procedures required of broadcast operators. With my Servicing Course you build modern Radio, etc.; use Multitester you build to make money fixing sets in spare time while training. You can stay at home, keep your job, learn Radio-TV in spare time at low cost. Mail coupon for book showing other equipment you build and keep.

**The Tested Way  
To Better Pay!**

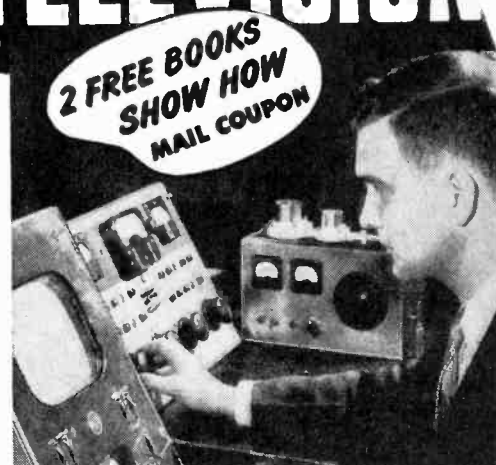

**2 FREE BOOKS  
SHOW HOW  
MAIL COUPON**

Training plus opportunity is the **PERFECT COMBINATION** for job security, good pay, advancement. In good times, the trained man makes the **BETTER PAY, GETS PROMOTED**. When jobs are scarce, the trained man enjoys **GREATER SECURITY**. NRI training can help assure you more of the better things of life.

**Start Soon to Make \$10, \$15  
a Week Extra Fixing Sets**

Keep your job while training. I start sending you special booklets the day you enroll, that show you how to fix sets. Multitester built with parts I send helps you make \$10, \$15 a week extra fixing sets while training. Many start their own Radio-Television business with spare time earnings.

**My Training Is Up-To-Date**  
You benefit by my 40 years' experience training men at home. Well illustrated lessons give you basic principles you need. Skillfully developed kits of parts I send (see below) "bring to life" things you learn from lessons.

**Television Making Good Jobs, Prosperity**—Even without Television, Radio is bigger than ever. 115 million home and auto Radios are big market for servicing. 3000 broadcasting stations use operators, technicians. Government, Aviation, Police, Ship, Micro-wave Relay, Two-way Radio Communications for buses, taxis, trucks, R. R. are growing fields. Television is moving ahead fast.



About 200 Television stations are now on the air. Hundreds of others being built. Good TV jobs opening up for Technicians, Operators, etc.

25 million homes now have television sets. Thousands more are being sold every week. Get a job or have your own business selling, installing, servicing.

## Radio-TV Needs Men of Action—Mail Coupon

Without obligating you in any way, I'll send an actual lesson to prove that my training is practical, thorough; 64-page book to show good job opportunities for you in Radio-TV. Terms for NRI training are as low as \$5 a month. Many graduates make more in two weeks than total cost of training. Mail coupon now. J. E. SMITH, President, National Radio Institute, Dept. 5AD4, Washington 9, D. C. OUR 40TH YEAR.

## Good for Both—FREE

MR. J. E. SMITH, President, Dept. 5AD4, National Radio Institute, Washington 9, D. C.  
Mail me Sample Lesson and 64-page Book, FREE. (No salesman will call. Please write plainly.)  
Name ..... Age .....  
Address .....  
City ..... Zone ..... State .....

**VETS** write in date of discharge .....



POPULAR ELECTRONICS is published monthly by Ziff-Davis Publishing Company, William B. Ziff, Chairman of the Board (1946-1953), at 64 East Lake St., Chicago 1, Ill. Entered as second class matter August 27, 1954 at the Post Office, Chicago, Illinois. SUBSCRIPTION RATES: One Year U.S. and possessions, and Canada \$3.00; Pan-American Union Countries \$3.50; all other foreign countries \$4.00.

# POPULAR ELECTRONICS

JANUARY  
1955  
VOL. 2 - NUMBER 1

Registered U. S. Patent Office

HEAD, WIEN

TE EDITORS

A. STOCKLIN H. S. RENNE  
TEPPER J. FRIEBORN  
B. HOEFER N. EISENBERG

ART

FRANK SAYLES (Director)  
A. T. REICH M. WHELPLEY

CONTRIBUTING EDITORS

J. T. FRYE L. E. GARNER, JR.  
K. R. BOORD R. P. TURNER  
R. HERTZBERG H. POLLACK

DRAFTING

J. A. GOLANEK A. A. GANS

ADVERTISING DEPARTMENT

New York (MU 7-8080)  
L. L. OSTEN - Adv. Dir.  
WM. G. McROY - Sales  
Chicago (AN 3-5200)  
M. B. CROFFORD - Sales  
Los Angeles (Mich. 9856)  
JOHN E. PAYNE - West. Adv. Mgr.



Copyright 1954  
All Rights Reserved

ZIFF-DAVIS  
PUBLISHING COMPANY

W. B. ZIFF (1898-1953) FOUNDER

Also Publishers of  
RADIO & TELEVISION NEWS  
RADIO-ELECTRONIC ENGINEERING  
Editorial and Executive Offices  
366 Madison Ave., New York 17, N.Y.

PRESIDENT

B. G. DAVIS

VICE-PRESIDENTS

H. J. MORGANROTH M. FROELICH

SECRETARY-TREASURER

G. E. CARNEY

CIRCULATION MANAGER

M. McHAELSON

BRANCH OFFICES

Chicago (1), 64 E. Lake St.  
Los Angeles (14), Staller Center,  
900 Wilshire Blvd.

SUBSCRIPTION SERVICE:

All communications concerning subscriptions should be addressed to Circulation Dept., 64 E. Lake St., Chicago 1, Ill. Subscribers should allow at least four weeks for any change of address.

CONTRIBUTIONS:

Contributors are advised to retain a copy of their manuscripts and illustrations. Contributions should be mailed to the New York Editorial Office and must be accompanied by return postage. Contributors will be handled with reasonable care, but this magazine assumes no responsibility for their safety. Any copy accepted is subject to whatever adaptations and revisions are necessary to meet the requirements of this publication. Payment covers all author's, contributor's, and contestant's rights, title, and interest in and to the material accepted and will be made at our current rates upon acceptance. All photos and drawings will be considered as part of material purchased.

## CONTENTS

The High Fidelity Hobby.....	J. D. Goodell & J. O. Fundingsland	13
It's Fun to Lay Out a Chassis.....		18
Adjusting the Power R/C Plane.....	W. Winter	20
It's All on Tape.....	C. Webster	24
The New Sniperscope.....		26
Meet the Transistor.....		28
Build this "2-Way" Electronic Metronome.....		30
The World's Largest Network Calculator.....		33
How to Bend and Form Sheet Metal.....		34
Build this Photoelectric Rifle Range.....	B. G. Wels	37
So You Want to be a Ham (Part 4).....	R. Hertzberg, W2DJJ	41
Tape Tips.....	Major E. F. Coriell, USAF	44
How to Choose the Right Relay.....	H. Pollack	47
Hobby Kit Teaches Children Basic Electronics.....		50
Carl & Jerry.....	J. T. Frye	52
More Energy from a Solar Battery.....		55
A Sound Effects Kit for Home Recordings.....	L. Garner, Jr.	56
Electronic Wife.....	J. DeGood	61
Rumble.....	B. Whyte	64
Disc Review.....	B. Whyte	65
Home Built De Luxe Photographic Timer.....		67
Don't Lose it—Fuse it!.....	J. Frieborn	71
3-Channel Tone R/C Receiver.....	E. L. Safford, Jr.	73
Hi-Fi at the Planetarium.....		76
Fun with a Geiger Counter.....	H. Renne	78
A New All-Transistor Calculator.....		81
The World at a Twirl.....	K. R. Boord	82
Underground Intercom.....		84
3 and 4 Finger R/C Escapements.....	E. L. Safford, Jr.	86
Assemble this Useful "Test Box".....		90
The "Mad Bird".....		93
The Tuning Eye—How it Works.....	E. Bukstein	98

## DEPARTMENTS

Letters from Our Readers.....	10
R/C Notes.....	66
Tools & Gadgets.....	101
Tricks of the Trade.....	107
Book Reviews.....	114
After Class.....	116
Standardized Wiring Diagram Symbols.....	125
Glossary of Terms in This Issue.....	126
Abbreviations.....	127
Resistor Color Code.....	130
Capacitor Color Code.....	130

(Also see page 6)

**COYNE offers  
LOW COST**

# TELEVISION RADIO-ELECTRONICS

Training in  
Spare Time AT HOME



The future is **YOURS** in TV-RADIO!  
A fabulous field—good pay—fascinating work—  
a prosperous future! Good jobs, or independence  
in your own business!

Coyne brings you the first *truly lower cost*, MODERN—QUALITY Television Home Training; training designed to meet Coyne standards. Not an old Radio Course with Television "tacked on". Here is MODERN TELEVISION TRAINING including working knowledge of Radio. Includes UHF and Color TV. No Radio background or previous experience needed. Personal guidance by Coyne Staff. **Practical Job Guides** to show you how to do actual servicing jobs—**make money early in course**. With Coyne Television Home Training you pay only for your training, **no costly "put together kits"**.



B. W. COOKE, President



*Coyne—the Institution behind this training... the largest, oldest, best equipped residential school of its kind. Established 1899. Send coupon for details.*

## COYNE ELECTRICAL SCHOOL

500 S. Paulina St., Dept. 15-HT7, Chicago 12  
A TECHNICAL TRADE INSTITUTE CHARTERED  
NOT FOR PROFIT

### SEND COUPON FOR FREE PICTURE FOLDER

and full details,  
including easy  
Payment Plan. No  
obligation, no  
salesman will call.



#### COYNE ELECTRICAL SCHOOL

Television Home Training Div.  
500 S. Paulina St., Chicago 12, Ill.,  
Dept. 15-HT7

Send Free Picture Folder and details on Television Home Training. This does not obligate me and no salesman will call.

Name \_\_\_\_\_  
Address \_\_\_\_\_  
City \_\_\_\_\_ State \_\_\_\_\_



Train for Better  
Jobs in

# ELECTRICITY OR TELEVISION-RADIO

in Great  
Shops of COYNE

### GREAT OPPORTUNITY FIELDS

Conditions are changing. Many "one operation" jobs that have paid well will not last. *Don't be satisfied with a "no future" job.* Whether 17 or up to 45 years of age, train the Coyne way for a better job and a real future in **ELECTRICITY** or **TELEVISION-RADIO**, *fields that offer a world of opportunities.*

### YOU can TRAIN in great CHICAGO SHOPS

Train on real, full-size equipment at COYNE where thousands of successful men have trained for over 55 years—**largest, oldest, best equipped school of its kind**—established in 1899. No advanced education or previous experience needed. **TRAINING APPROVED FOR VETERANS.**

B. W. COOKE, President

## COYNE FOUNDED 1899 ELECTRICAL SCHOOL

A TECHNICAL TRADE INSTITUTE CHARTERED NOT FOR PROFIT  
500 S. PAULINA STREET, CHICAGO, Dept. 15-71H  
**ELECTRICITY ★ RADIO ★ TELEVISION ★ REFRIGERATION ★ ELECTRONICS**

January, 1955

**START NOW—PAY LATER**—Finance Plan and Easy Monthly Payment Plan. Also part-time employment help for students.

### Get FREE Book

Send coupon for 48 page illustrated book "Guide to Careers in Electricity and Television-Radio." No cost; no obligation; no salesman will call. Get vital facts now!

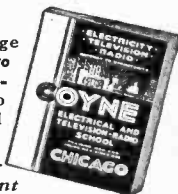

B. W. COOKE, President  
COYNE ELECTRICAL SCHOOL  
500 S. Paulina St., Chicago 12, Ill., Dept. 15-71H

Send **BIG FREE** book and details of your training offer. This does not obligate me and no salesman will call. I am interested in:

Electricity  Television-Radio

Name \_\_\_\_\_  
Address \_\_\_\_\_  
City \_\_\_\_\_ State \_\_\_\_\_

# At Last!

## a complete TUBE TESTER \$24.90 for only

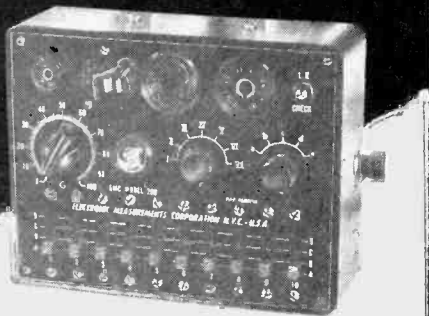

New EMC Model 208\*  
\*Pat. Pending tests all  
tube types quickly  
easily... accurately  
... in the field or shop

The sensational new EMC  
Model 208\* gives you  
for the first time a  
complete precision tube  
tester for less  
than \$25.00.

With it you can quickly  
and accurately test  
all tube types  
for quality as well  
as shorts, leakages,  
filament continuity  
and opens.

MODEL 208 TUBE TESTER  
(COMPLETELY WIRED AND TESTED)  
Only \$24.90

MODEL CRA (PICTURE TUBE  
ADAPTOR OF MODEL 208) \$4.50

Write to Dept. PE-1 today for complete catalog  
of precision test equipment.

### CHECK THIS EXCLUSIVE COMBINATION OF FEATURES:

Lowest market price  
Completely portable  
Checks all popular octal,  
loctal, miniature and novial  
base tubes  
Flexible switching system  
assures complete testing  
of all present and future  
tube types  
Elements numbered according  
to RTMA base system  
Individual sockets for each  
tube type  
Checks completely for qual-  
ity as well as shorts, leak-  
ages, filament continuity  
or opens between any two  
tube elements  
Visual line voltage check  
with adjustable control as-  
sures accurate quality  
testing  
Matches and checks Hi-Fi  
tubes such as 1614, KT 66,  
and 5881  
Space saving, high impact  
case, 5 1/4 x 6 3/4 x 2 7/8"  
Comes complete with de-  
tailed instruction book and  
tube listings

An invaluable tool for Service-  
men, radio hams, Hi-Fi fans,  
students, hobbyists.

EXPORT DEPT.  
36 LIBERTY ST. N. Y. 6, N. Y.

# EMC

ELECTRONIC  
MEASUREMENT  
CORPORATION  
380 LAFAYETTE STREET  
NEW YORK 12, N. Y.

## ITEMS OF INTEREST

This Month's Cover.....	8
Electronic Detector Probes Brain.....	46
Flocked Screening for Loudspeakers.....	54
New Movie Shows Radar Network in Action.....	62
Radio Beam Aids Long Distance Telephone.....	63
Hospitalized "Ham" Wins Scholarship.....	63
Portable Station.....	63
New Antenna to Handle 20,000 Telephone Circuits.....	72
World's Most Powerful TV Station.....	88
Raising Frequencies of Crystals Using Household Cleanser.....	100
Speaker Grille Frame from Picture Moulding.....	100
Phasing Loudspeakers.....	106

## NEW PRODUCTS

New Device Opens Garage Door from Car (Perma-Power Co., 4727 N. Damen Ave., Chicago 25, Ill.).....	60
New Radio Fits Into Pocket (Majestic Radio & Television, 79 Washington St., Brooklyn 1, N. Y.).....	60
Garage Door Operator Kit (Bellford-Matic, Inc., 5900 Maurice Ave., Cleveland 27, Ohio).....	88
Transistor Receiver (I.D.E.A., Inc., Regency Div., 7900 Pendleton Pike, Indianapolis, Ind.).....	100
New Atomic Battery (Mound Laboratory, Miamisburg, Ohio).....	100

If you are unable to find these listed products locally,  
write direct to the manufacturers at the addresses given.  
Also see the monthly review of new items of interest to  
the electronic hobbyist in "Tools & Gadgets" appearing  
on pages 102, 103, and 104 of this issue of POPULAR  
ELECTRONICS.

## COMING NEXT MONTH POPULAR ELECTRONICS

"R/C Garage Door Opener"  
"Novice CW Transmitter"  
"Broadcast Band Receiver"  
"How Vacuum Tube Amplifiers Work"  
"How Tapes Are Made"  
"Servo R/C Escapements"  
Plus More On

High-Fidelity Audio • Kits • Radio  
Control • Short-Wave Listening •  
What's New • How It Works • How to  
Make It • How to Use It • Carl & Jerry

## IN THIS MONTH'S RADIO & TELEVISION NEWS

(January)

"High-Fidelity the Easy Way"  
"Six-Meter Emergency Transmitter and  
Power Supply"  
"A New Pocket Radio"  
"Frequency Standard for the Novice"  
"A Beat-Frequency Audio Oscillator"

# NOW... Start Fixing TV and Radio Sets RIGHT AWAY

TRY IT  
**FREE**  
FOR 10 DAYS IN  
YOUR OWN HOME



McGraw-Hill's Amazing New Low-Cost Instruction Manual Skips "Theories" and "Formulas", Tells How-to-do-it in PLAIN ENGLISH!



**Prove It on Your Own Set**  
Save up to \$50 a year just by installing, repairing, and servicing your own TV set. Book tells which controls to adjust or tubes to replace if picture is entirely dark—blurred—split—distorted—off center—titled—wiggles and weaves—too pale—too black—jitters—snows—drifts—etc., etc.

**PARTIAL CONTENTS**  
Tools Needed • How TV and Radio Sets Work • How to Remove and Replace Tubes • Testing Tubes without a Tester • Using a Tube Tester • Power-Supply Troubles • How to Test and Replace Tubes • How to Switches, Condensers, Coils, Transformers • Tuning Devices • Loudspeakers • Phono Pickups and Repair Antennas • How to Install and MUCH MORE

**TELLS HOW TO "Cash In" ON THE BIG DEMAND FOR RADIO-TV REPAIRMEN**  
Over 25 million TV sets over 100 million radios in this country! Shortage of repairmen! You can make nice extra money just fixing sets for friends and neighbors in your spare time—start your own full-time repair business. Book tells exactly how to get started; how to plan your workshop; which tubes to stock; where to get information now to make a service call. You can start fixing sets and making money before you're halfway through book!



... even if you have never fixed a LAMP or DOOR BELL before!

"Why hasn't somebody done this BEFORE?" That's what you'll say the minute you start browsing through this amazing new and complete one-volume instruction-manual in radio and TV repairs.

For here at last a well-known EXPERT has found a way to tell you in PLAIN ENGLISH how to fix almost ANY radio or television set. (And he even tells you where you can go to have the extra-tough jobs done FOR you . . . at professional rates.) Right from the very first chapters you can start doing simple repairs . . . and before you're HALF way through the book, you can fix HALF the television and radio sets that you encounter. Surprisingly quickly you can fix your own and friends' sets . . . get a service shop job . . . even start your own money-making business right in your own home.

**Why It's So EASY to Understand**

No electronic formulas . . . no algebra . . . no laboratory experiments. Instead you deal only with the things that go wrong in sets—how to recognize and spot the trouble—and what to do about it. "Easy as A-B-C" directions and 700 clear photos, diagrams, and drawings show you exactly WHAT and HOW to fix, step-by-step.

The author is Associate Editor of *Electronics Magazine*. He's a long-recognized expert—not only on radio and TV—but also on making technical subjects easily understood by the average reader. He has spent FOUR years making this one-volume instruction manual so practical and easy-to-understand that even a man who never fixed a door bell before will have no trouble.

Here's everything you need to know about where and how to buy tubes and parts, where and how to get a circuit diagram for any receiver; how to choose and use basic tools; how to test tubes WITHOUT a tube tester; how to adjust 58 common TV controls; how to "diagnose" and "cure" common radio and TV troubles; how to fix or replace loudspeakers, phono pickups; how to install and check antennas; and much, much more.

**SEND NO MONEY**

Examine this big 356-page book for 10 days BEFORE you decide if you wish to own it. Try it out FREE on your own set. See how easy it makes your handling of repairs. Take 10 days to prove it PAYS FOR ITSELF, or don't keep it. Just mail coupon to: McGraw-Hill Book Co., Inc., Dept. PEL-1, 327 West 41st St., New York 36, N. Y.

**FREE 10-DAY TRIAL COUPON**

McGraw-Hill Book Co., Inc., Dept. PEL-1  
327 West 41st St., New York 36, N. Y.

Please send me, for 10 days' FREE EXAMINATION, your one-volume "Television and Radio Repairing," by John Markus. If not delighted with it, I may return book, pay nothing. Otherwise, I will keep book and send only \$1.95 plus postage; followed by 3 monthly installments of \$2.00 each.

Name .....  
Address .....

City ..... Zone ..... State .....

SAVE MONEY. Check here if enclosing full price of \$7.95 WITH this coupon. Then we will pay delivery. Same 10-day return privilege—full refund guaranteed. PEL-10

**Trouble Shooting Chart Tells Where to Look for Bad Tube If:**

No picture; no raster; no sound.  
No picture; raster OK; no sound.  
No picture; no raster; sound OK.  
No picture; raster OK; sound OK.  
Picture wiggles and weaves; lacks blacks, or is very black; raster OK; sound OK.  
Picture jittery, double image; raster OK; sound OK.  
Snow on all channels; raster OK; sound weak.

Snow on all channels, raster OK; sound OK.  
Picture and raster do not fill screen; sound OK.  
Picture drifts up and down but not sideways; raster OK; sound OK.  
Picture muddy and gray; raster OK; sound OK.  
PLUS 29 OTHER COMMON TV TROUBLES.



### This Month's Cover

AS the cover illustration clearly depicts, this month's issue of POPULAR ELECTRONICS features several articles that are of interest to the high fidelity enthusiasts. The Hi-Fi fan is a hobbyist at heart whether he is a music lover and simply enjoys good reproduction or whether he builds his own and derives pleas-

ure from hearing the results obtained from his own equipment. The cost of obtaining the best quality of high fidelity reproduction is relatively high. However, if only limited funds are available, one can build or assemble a wide range system that can provide many hours of high quality entertainment. As a result of the interest in this phase of the electronics industry, there is a wide choice of equipment available to the public today.

Featured in this issue are such articles as: "The High Fidelity Hobby," Page 13; "It's All on Tape," Page 24; "Tape Tips," Page 44; "Sound Effects Kit for Home Recordings," Page 56; "High Fidelity Reproduction," page 64.

Of particular interest to all our readers who are interested in high fidelity, we would like to point out that beginning with this issue Bert Whyte will contribute a monthly feature article covering reviews of the most popular and best quality phonograph records and tapes.

EDITOR

(Cover painting by Leo R. Summers)

**FREE BONUS OFFER!**



**Model 625K**

- Illum. gear-driven "Speed Rollchart"
- New lever-action switches for individual testing of every element
- Tests all conventional and TV tubes

This Eico Tube Tester is yours FREE when you buy \$199 worth of tubes or more within 60 days at Teltron. May be bought outright from Teltron for \$34.95.

**SPECIALS!**

Till February 1st.

1B3GT	.56
1R5	.42
1U4	.42
6AC7	.59
6CP6G	.99
6J6	.49
6SN7GT	.49
6W4GT	.37
12AT7	.59
12SA7	.42
12SK7	.42
12SQ7	.36
25B06GT	.73
50L6GT	.42

# TELTRON TUBES

**Guaranteed! Lowest Prices Ever!**

All tubes individually boxed . . . unconditionally guaranteed for one year.

**GIFT OFFER!**  
One 6BG6G tube will be shipped FREE with any order accompanying this ad.

TYPE	PRICE	TYPE	PRICE	TYPE	PRICE	TYPE	PRICE	TYPE	PRICE
1A7GT	.53	6AF4	1.02	6BN6	.90	6U8	.76	12BY7	.65
1H5GT	.51	6AG5	.52	6BQ7	.85	6V3	.80	12BZ7	.63
1L4	.51	6AH4GT	.65	6BL7GT	.78	6V6GT	.48	12SL7GT	.60
1L6	.51	6AK5	.96	6BQ6GT	.83	6W6GT	.53	12SN7GT	.56
1LC6	.49	6AL5	.43	6BY5G	.60	6X4	.37	19T8	.71
1N5GT	.51	6A05	.48	6BZ7	.95	6X5GT	.38	25CUG	1.09
1T4	.51	6AR5	.48	6C4	.41	6X8	.80	25L6GT	.41
1U5	.43	6AU5GT	.60	6CB6	.51	7F8	.49	25Z5	.55
1X2	.65	6AUG	.43	6CU6	.95	7N7	.49	25Z6GT	.36
2A3	.35	6AV5GT	.60	6F6	.42	12AL5	.43	35B5	.48
2A7	.35	6AV6	.37	6F5GT	.44	12AT6	.37	35C5	.48
3Q4	.53	6AX4GT	.60	6H6	.50	12AUG	.43	35L6GT	.41
3Q5GT	.61	6AX5GT	.60	6J5GT	.49	12AU7	.58	35W4	.33
3S4	.48	6BA6	.56	6K6GT	.39	12AV7	.73	35Y4	.42
3V4	.48	6BA7	.58	6L6	.78	12AX4GT	.60	35Z5GT	.33
5U4G	.43	6BE6	.46	6S4	.41	12AX7	.61	50A5	.49
5V4G	.49	6BF5	.48	6S8GT	.65	12AZ7	.65	50B5	.48
5Y3GT	.30	6BG6G	1.18	6SA7GT	.45	12B4	.72	50C5	.48
5Y4G	.40	6BH6	.51	6SK7GT	.45	12B87	.61	TYPE 80	.40
6A8	.40	6BJ6	.51	6SL7GT	.60	12BA6	.46	117L7GT	1.20
6K7	.40	6BK5	.75	6SQ7GT	.38	12BA7	.58	117Z3	.33
6Q7	.40	6BK7	.78	6T8	.71	12BE6	.46	117Z6GT	.65

**SAME DAY SERVICE**

48 Hour Postal Delivery  
To West Coast

**TERMS:** Save all freight and postage charges. All orders accompanied by full remittance will be shipped POSTAGE PAID anywhere in the continental U.S.A. 2% deposit required on C.O.D.'s. Minimum order \$10.00. Open accounts to rated firms only.

**FREE** \$7.20 list value Bonus Box of three 6SN7 tubes and 25 assorted resistors with each order of \$25 or more.

## TELTRON ELECTRIC COMPANY

428 HARRISON AVE. DEPT. PE-1 Phone HUmboldt 4-9848 HARRISON, N. J.





When Nick Pakinas started my RTTA Radio-FM Television Course his 7-year-old daughter, Sharon, kept right up with him as he progressed in his lessons in their home in Bothell, Washington.

Today, Sharon — shown here in a photograph reproduced from the pages of the Seattle Post-Intelligencer — is the youngest FCC-licensed amateur radio operator in the Pacific Northwest, and possibly the nation.

**If Sharon can do it, why can't you?  
The answer is . . . YOU CAN!**

YOU  
GET ALL  
THE  
EQUIPMENT  
SHOWN  
AND  
MORE!



**PREPARE FOR A BRIGHTER FUTURE**

You can hold down a full-time job and still train AT HOME by the same successful methods I used to help hundreds of men—many with no more than grammar school training — master television!

**GOOD SPARE TIME EARNINGS**

Almost from the very start you can earn extra money while learning by repairing radio-TV sets for friends and neighbors. Many of my students earn up to \$25 a week . . . pay for their entire training from spare time earnings . . . start their own profitable service business.

**Cut out this Coupon and Mail It Now!**

No salesman will call

**Radio Television Training Association**

52 EAST 19th STREET • NEW YORK 3, N. Y.

Licensed by the State of New York • Approved for Veteran Training

# MY TRAINING IS SO SIMPLIFIED EVEN A THIRD-GRADER CAN MASTER IT!

If you've been looking for a chance to improve yourself—to get into a high-paying field with a good future—but have been putting it off because you don't think you have enough schooling, or enough time, here is your chance to make your dreams come true.



I. C. Lane, B.S., M.A. President, Radio-Television Training Association. Executive Director, Pierce School of Radio & Television.

Sharon Pakinas was only in the Third Grade when she studied her father's course from RTTA and passed the FCC Examination for an amateur radio operator's license. Many of my students have had no more than a grammar school education. My easy-to-understand lessons especially prepared for home study make it possible for students with no previous experience to become skilled television technicians.

## VETERANS!

My School Fully Approved to Train Veterans under new Korean G.I. Bill. Available only to veterans discharged in past 36 MONTHS. If eligible, CHECK COUPON.

Mr. Leonard C. Lane, President  
RADIO-TELEVISION TRAINING ASSOCIATION  
52 East 19th Street, New York 3, N. Y.

Dept.  
E-1

Dear Mr. Lane: Mail me your NEW FREE BOOK, FREE SAMPLE LESSON, and FREE aids that will show me how I can make BIG MONEY IN TELEVISION. I understand I am under no obligation and no salesman will call.

(PLEASE PRINT PLAINLY)

Name \_\_\_\_\_ Age \_\_\_\_\_

Address \_\_\_\_\_

City \_\_\_\_\_ Zone \_\_\_\_\_ State \_\_\_\_\_

I AM INTERESTED IN:

- Radio-FM-TV Technician Course
- FM-TV Technician Course
- TV Cameraman & Studio Technician Course

**VETERANS!**  
Write discharge date

# LETTERS

## FROM OUR READERS

THANK YOU KINDLY, SIR!

"I JUST read your first issue. I would like to offer 132 congratulations—one for each page. A friend 'borrowed' it the first day and after much scurrying I located the last one in town. From now on I make the family sign out to read it! . . ."

Richard Sulman  
New London, Conn.

"P. E. . . . is . . . magnificent, the zenith of the electronics experimenters' magazine. . . . Be sure my name gets on that subscribers' list—I don't want to miss out."

Charlie Rawlings  
Paducah, Ky.

*The above are excerpts from letters of praise that are still pouring in. Sorry we haven't room to print more, but our heartfelt thanks to our readers for the many generous letters they have written.*



### READER REQUESTS

"I ENJOY reading about new products in the field of electronics so keep on writing 'em up. But how about including addresses of such products in case I want to buy something or get more information on it?"

Harold T. Burns  
Des Moines, Iowa

*We have received several letters similar to the above. Apparently many of our readers are overlooking the Index of New Products we publish on page 6, in which we list the names of the companies and their addresses for readers' convenience.*

"YOUR construction articles are tops and I'm having a whale of a time with the 'Home Broadcaster' described in the November issue. I don't have too large a supply of parts around the house though, and would appreciate some info on buying more parts. You see, I live in Canada, and would like the story on what's involved in ordering parts from U. S. distributors—what's the deal on shipping, taxes, etc.? Can you help me out?"

Dick Wellerton  
Callander, Ontario

*We are getting together details and information on this very subject and will publish complete information of the kind this reader requests in an early issue of POPULAR ELECTRONICS.*

"NICE going on your series of articles 'So You Want To Be a Ham'. I do, and the information Bob Hertzberg furnishes each month is really helpful. But I know nothing about the field and

very little about what kind of equipment to get. How about some data on communications receivers, transmitters, etc.?"

Bruce Landowne  
Great Falls, Mont.

*See Bob Hertzberg's article in this month's issue; it is on communications receivers, discussing their specifications and uses in different price ranges.*

"WHAT I like about POPULAR ELECTRONICS is that you can read about things in the electronics field that ordinarily don't get much play in the newspapers or other periodicals, like the story in the November issue about painless dentistry. Keep on printing that kind of story as well as the technical construction articles—for example, how about the lowdown on the stereophonic sound being used in the movies—I mean, how does it work and who invented it?"

Kenneth Pace Larkin  
Alexandria, Va.

*Stories along these lines will continue to be an important part of each issue, and, as a matter of fact, a story on stereophonic sound is scheduled for our next issue.*

"LIKE so many others, I am deeply interested in the subject of electronics and find POPULAR ELECTRONICS a welcome addition to my reading hours. I would especially welcome, though, a series of articles in your magazine that would constitute a course in electronics, with a different phase of the subject covered in different installments. . . ."

S. N.  
New York, N. Y.

*We're still on the fence on this question and not yet sure which way we'll go. The idea is not a bad one and we're sure there are many who'd enjoy and benefit from such a series. One serious problem though is that new readers are added to our lists each month, so that if we started such a series, readers who start getting POPULAR ELECTRONICS one or two months later would be coming in on the middle of the course. It would be like arriving in the middle of a movie and not having a chance to stay for the beginning again.*



### HOW "HAMS" GOT THEIR NAME

"IN ANSWER to the question: 'Why do radio amateurs refer to themselves as "hams" . . .?' . . . I think it would have interested your readers had W2DJJ given some of the many reasons (and legends) accounting for the nickname. . . ."

"Perhaps the most logical sounding one . . . and the simplest . . . is that 'Ham' is a corruption of 'Amateur'. This is perhaps the most widely believed explanation. However, there is another one, which is far more interesting, and according to many authorities may be the actual origin of the word. . . ."

# THE DATA THAT LAUNCHED THOUSANDS OF CAREERS

is yours FREE to show

## HOW YOU CAN BE SUCCESSFUL IN RADIO-TV-ELECTRONICS

Send for your booklet today

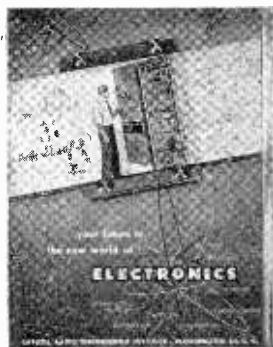

YOU CAN plod along for years, getting a paltry increase now and then, enjoying little security, finding your work dull and drab.

Then something happens. Things look up. You become more confident. Your earnings rise. You feel more important.

"Luck," some may say.

"Contacts," others may suggest.

But in your heart, you will know the answer: "Training." And it all may have started the moment you filled out a coupon requesting a copy of a free booklet named "Your Future in the New World of Electronics." From this data you get knowledge of where you stand in electronics. Tremendous expansion leaves this gigantic industry pleading for trained men. Top manufacturers sold billions of dollars worth of electronic merchandise in 1954. By 1960, the radio-electronics industry should do no less than 10 billion dollars per year, not counting military orders.

Today there are over 107,912 radio-equipped police cars; an even larger number of taxis are radio equipped (at least 94,553); 42,034 civilian planes have radios; 43,823 American ships have radios.

Today there are over 120,000,000 radios in

CREI resident instruction (day or night) is offered in Washington, D. C. New classes start once a month. **VETERANS:** If you were discharged after June 27, 1950—let the new G.I. Bill of Rights help you obtain CREI resident instruction. Check the coupon for full information.

use. There are 33,000,000 TV sets and 413 TV stations in operation. Color TV is coming into its own. Countless positions must be filled—in development, research, design, production, testing and inspection, manufacture, broadcasting, telecasting and servicing. To fill these posts, trained men are needed—men who somewhere along the line take time to improve their knowledge, their skills. Men who, today, perhaps, take two minutes to send for a booklet.

"Your Future in the New World of Electronics" shows you how CREI Home Study leads the way to greater earnings through the inviting opportunities described above.

However, CREI does not promise you a "snap." With an accredited technical school such as this, you must *study* to convert your ambition into technical knowledge you can sell in the fabulous electronics market.

Since its founding in 1927, CREI has provided thousands of professional radio men with tech-

nical educations. During World War II CREI trained thousands for the Armed Services. Leading firms choose CREI courses for group training in electronics, at company expense, among them United Air Lines, Canadian Broadcasting Corporation, Trans-Canada Airlines, Sears, Roebuck and Co., Bendix Products Division, All-American Cables and Radio, Inc., and Radio Corporation of America.

CREI courses are prepared by recognized experts, in a practical, easily understood manner. You get the benefit of time-tested materials, under the personal supervision of a CREI Staff Instructor, who *knows* and *teaches* you what industry wants. This is accomplished on your own time, during hours selected by you, and controlled by your own will power. This complete training is the reason that graduates find their CREI diplomas keys-to-success in Radio, TV and Electronics. CREI alumni hold top positions in America's leading firms. At your service is the CREI Placement Bureau, which finds positions for advanced students and graduates. Although CREI does not guarantee jobs, requests for personnel far exceed current supply.

Now is the time of decision for you. Luck will not propel you forward unless it finds you trained. Contacts won't budge you an inch unless you have the skill to back them up. The answer is: Technical Training . . . and willingness to learn. Together they will bring you increased earnings in this new Age of Electronics. Fill out the coupon shown below and mail it now. We'll promptly send you your free copy of "Your Future in the New World of Electronics." The rest—your future—is up to you.

### MAIL COUPON FOR FREE BOOKLET

#### CAPITOL RADIO ENGINEERING INSTITUTE ECPD Accredited Technical Institute Curricula

Dept. 121B, 3224 16th St., N.W., Washington 10, D. C.  
Send booklet "Your Future in the New World of Electronics" and course outline.

CHECK FIELD OF GREATEST INTEREST

- Practical Radio Engineering
- Aeronautical Radio Engineering
- Broadcast Radio Engineering (AM, FM, TV)
- Practical Television Engineering
- TV, FM & Advanced AM Servicing

Name .....

Street .....

City..... Zone..... State.....

Check  Residence School  Veterans

**DELUXE  
630-TYPE  
TV KIT**

World's  
Finest  
TV Receiver:

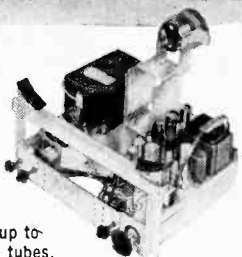

for picture tubes up to  
24" (70° defl.). 29 tubes.  
All principal components mounted

Model 630D24: Complete with all components,  
tubes, brackets, and quality speaker. (Less  
kine, wire and solder).....Net \$159.50

**AC/DC TV KIT**

High Quality TV  
at Low Cost:

for 14" and 17"  
rectangular tubes.

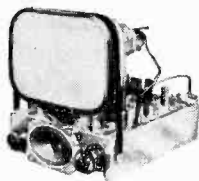

Model 5116: Complete with tubes, hardware  
and mounting brackets. (Less kine, wire and  
solder).....Net \$99.95

**WILLIAMSON-TYPE  
20-WATT  
AMPLIFIER  
KIT**

Famous Williamson  
circuit with full 20  
watt output.

Specially-wound, quality output transformer.  
Model TM-15A, complete with tubes.....Net \$49.95

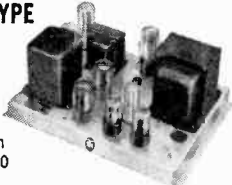

**4-CHANNEL,  
PRE-AMPLIFIER-  
EQUALIZER KIT**

With cathode follower output.  
Inputs for FM tuner, phono, tape recorder and  
other signal sources.

Model TM-15P (with Cabinet).....Net \$19.95



**AC/DC SUPERHET  
RADIO KIT:**

Receives all  
standard AM  
broadcasts, 550-  
1720 KC. 5 tubes  
including rect.  
Super-sensitive  
high gain cir-

cuit with built-in loop antenna.

Model 385-K: Complete with all tubes, and  
handsome bakelite cabinet.....Net \$19.95



Write for latest catalog  
of complete Tech-Master line

**TECH-MASTER CORPORATION**

Television — Radio — Audio  
75 Front Street, Brooklyn 1, N. Y.

"In the early days of radio, around the turn of the century . . . , three short-wave experimenters . . . young men at Harvard . . . set up a station. The three men's names were Hyman, Aylmer, and Murray. Since there were no governing regulations regarding radio transmissions, they signed all transmissions with all three names, resulting in . . . 'Hymanaylmermurray'. This was abridged . . . to 'Hyalmu.' Unfortunately, there was a Mexican freighter equipped with a transmitter . . . signing its call 'Hyalmo' . . . the name of the ship. To avoid further . . . confusion, Hyman, Aylmer, and Murray shortened their call to just the three initials: H.A.M. Naturally, it was inevitable that the station soon came to be called the 'ham' station . . . that all similar stations be called 'ham' stations . . . and that operators of these stations be called 'hams'.

"That's the story as I know it . . . undoubtedly you'll get quite a few more from other readers."

Roger Sklar, W8SFD  
Continuity Dept., WOOD, WOOD-TV  
Grand Rapids, Mich.

★ ★ ★  
**METRONOME RESISTOR CONNECTION**

"IN THE schematic for the metronome on page 46 of your November issue, you show  $R_3$  with one end not connected. Is this a mistake, or is there a reason for not connecting it?"

Adam Furth  
Rochester, N. Y.

*The section of  $R_3$  between the arm and one end provides the required variable resistance between the arm of  $R_2$  and one end of  $R_1$ . The rest of  $R_3$  is not required. Leaving one end free saves a soldering operation.*

★ ★ ★  
**OOPS, PARDON US**

"I RECEIVED my first issue of PE as a charter subscriber and enjoyed it thoroughly. There is certainly a need for such a magazine and I want to wish you all the success in the world.

"As an engineer, I found a small discrepancy in the article on crossover networks (page 115, October issue). The two values of  $L$  and  $C$  given as samples have rather strange conditions. The first pair will be valid for a speaker load of less than 2 ohms. This is not the normal situation. The second pair would be valid for a 2 ohm tweeter and a 16 ohm woofer, again a rather unusual condition. Since someone might attempt to construct such a network and wonder at the poor results, I felt I should bring it to your attention."

Lt. John J. Dougherty, USN  
FPO, New York

*Right, Lieutenant! For a speaker impedance of 2 ohms,  $L$  for 5000 cycles should have been 60  $\mu$ hy instead of 500. For speaker impedances greater than 2 ohms, each successive value of  $L$  should be larger and each value of  $C$  smaller than those given. For an impedance of 8 ohms, each value of  $L$  as given should be multiplied by 4 and each value of  $C$  should be divided by 4. The formulas used are  $L = R/(2\pi f)$  and  $C = 1/(2\pi fR)$ . END*

# The High Fidelity Hobby

By

JOHN D. GOODELL

and

JOHN O. FUNDINGSLAND

International Scientific Industries Corp.  
St. Paul, Minnesota

CONSTRUCTION of a high quality home music system is a project that anyone can undertake with confidence. If you take advantage of the suggestions and instructions available in this and other magazines as well as from the manufacturers of high fidelity audio equipment you can build a system that will give pleasure to every member of your family. Whether you start with extremely simple and inexpensive components or attempt to purchase the finest devices available without regard for



cost you will be proud and pleased with the results but never (except for very short periods of time) entirely satisfied. Consequently this project can, and almost certainly will, go on like the proverbial brook. Irrespective of your education and experience you will learn more about music, sound, electronics and many associated arts, crafts and sciences than you ever before thought possible.

There is an infinite variety of good designs for music reproducing systems and you will be faced continually with decisions of choice between a wide variety of methods and components. The absolutely perfect system is like a flawless diamond—it doesn't exist. In your selection of individual items of equipment you will make a great many compromises involving size, convenience, cost, and endless other factors. No one can give you final and absolute advice because, in the last analysis, you yourself must judge the desirability of results. However, some basic advice can help you to avoid costly and irritating pitfalls.

It is true that you may purchase at random almost any amplifier, loudspeaker, phonograph, radio tuner, and tape recorder and combine them into a system that will produce interesting—even pleasing—sounds, but the total result may be far from satisfactory. The suggestions that follow may seem simple and obvious to many readers, yet some of the principles are often violated even by people with considerable experience in the field.

The components of any music reproducing system are connected in series—in a chain—in such a way that the musical signal passes through (and is affected by) each of them. The first link in the chain will be a record player, a radio tuner, or a magnetic tape player and the musical signal will originate, respectively, from a phonograph record, a radio broadcast, or a magnetic tape. The output of the device being used will be applied to the input of an amplifier. Usually, tone controls and various methods of electrically changing the character of the musical signal will be incorporated in the amplifier. The output of the amplifier is applied to a loudspeaker which has the task of changing the electrical energy into mechanical vibrations, which in turn are transmitted through the air to the ear. The theoretical objective is to reproduce the sound, in such a manner that the ear will observe it as similar in every way to the original source. The practical objective is to reproduce the sound so that it gives pleasure to the listener.

Bearing in mind the simple facts just set forth, let us consider a method of determin-

The final assembly of the various sections of a Hi-Fi system is not an easy task. There are many relatively low-priced commercial cabinets available to house all of your equipment; however in most cases, if cost is not of primary consideration, the assembly can be made custom-built to fit your room decor. A few ideas of what can be done are shown.



ing the selection of components for an initial high-fidelity system, and a basis for the selection of subsequent improved components. Almost everyone will wish to make some major changes in equipment after having a chance to listen to a high-quality music system in his own home over a significant period of time. Consequently it is almost always wise to keep the initial investment in each item modest.

It is desirable for most people to use a record changer as the basic element to start with, because the largest dependable source of music to date is in the form of disc phonograph records. This condition may swing over in the direction of magnetic tape before long according to the announced plans of many of the major recording organizations, but at present there are only about ten companies making pre-recorded tapes and complete libraries are not yet available from the principal collections. At any rate, having selected a record changer or tape recorder the *maximum* quality necessary for the rest of the components in the system may be determined. It is clearly not necessary to have a loudspeaker capable of reproducing 15,000 cycles-per-second if the highest frequency available from your records is very much lower. It is not quite so obvious that a very expensive loudspeaker system may actually be undesirable if the earlier links in the chain are of lower quality and introduce noise. A speaker system of moderate frequency range may often eliminate considerable noise that exists in the source of signal in a given system. Many a high-fidelity enthusiast has been shocked to find that the addition of an extremely wide-range loudspeaker actually reduced the total reproduction quality of his system.

The moral, of course, is that the units of your system should be in the same general quality range for optimum results and that when you decide to purchase improved components you should usually start with the input equipment. As a practical matter even the general advice concerning improvement from the front end first must be modified. It happens to be considerably more difficult to design loudspeaker systems capable of reproducing very high and very low frequencies than phonograph

(Continued on page 16)

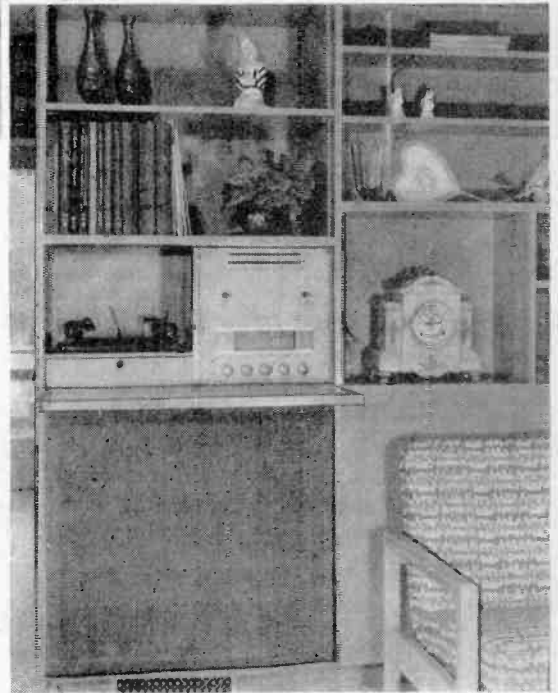
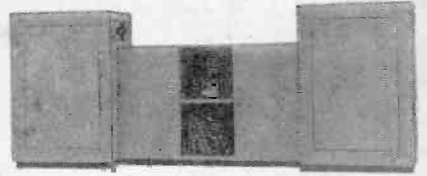
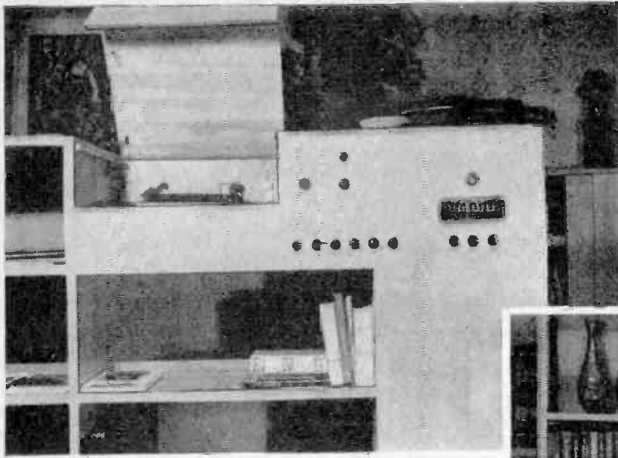

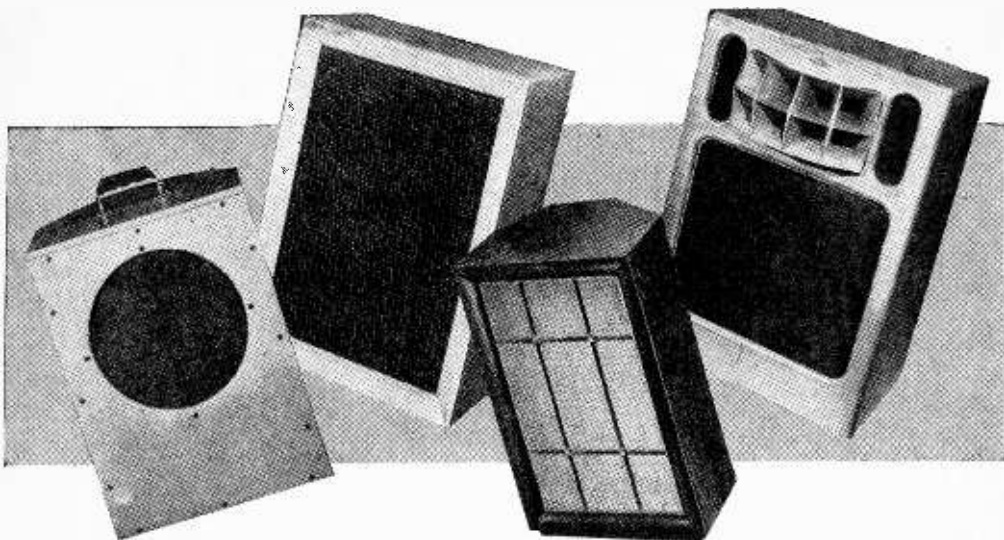

The choice of loudspeaker and cabinet must of necessity be left up to the final user. You can spend anywhere from \$30.00 to \$700.00. There are no specific recommendations as to which type (bass reflex, infinite baffle, corner horn, etc.) is the best. Your ear and pocket-book will have to make the final choice. For the newcomer to the field of high-fidelity, it is advisable to start with a good eight-inch speaker and accompanying cabinet. The fun that is obtained, should Hi-Fi be a hobby, is continuously to improve your system and obtain the pleasure of noting the correspondingly increasing quality in your reproduction.

pickups, tape players, amplifiers, and the like. Consequently most selections of initial equipment will include input devices and amplifiers superior in response range to the loudspeaker that seems comparable in price range. Thus the very *first* improvement for any given system should often be the loudspeaker. An excellent example of the continual back-and-forth compromising that is likely to go on involves your first effort to improve the low-frequency response of your loudspeaker. Almost certainly this will result in amplification of the rumbling noise generated by the record changer motor and you must go back and improve that condition, etc., etc.

Entirely aside from questions involved in keeping the various components of your system in the same general area of quality it is important to recognize that there is such a thing as obtaining greatly improved results by using components together that are suitably matched, *in your specific installation*. Unfortunately this problem is not as simple as it sounds and it is not entirely possible to predict that a given set of components will turn out to be properly and ideally matched for operation in your home, for you. Each person's taste varies, the personal likes and dislikes in musical sound for any individual will vary with his total experience in listening, and furthermore the room in which you install the equipment is actually a basic component of the system and will affect its operation.

Every room has individual acoustical

properties and because of its shape, the materials used in walls and ceilings, the floor covering, the furniture, and even the number of people in the room at a given time it will change the performance of any music reproducing system. This is not necessarily a disadvantage. In fact, by properly choosing the components of your system you may be able to take advantage of the characteristics of your living room in such a way as to obtain superior results from relatively inexpensive devices. It is not at all uncommon for some individual to spend large sums of money on high-fidelity components and find that a friend who spent a fraction of the amount obtains better and pleasanter music reproduction. This does not mean that it is not possible to obtain superior results with high-priced components, but it does mean that the problem is not so simple as the mere purchase of expensive elements. The proper selection of the elements of a high-fidelity music reproducing system to operate in a given home requires judgment and experience. Doing it yourself is interesting and very rewarding. The way to start is to select components of moderate cost, and gradually become educated to the possibilities of fine music in your home. If you are willing to do some of the real work yourself you can start off with a fine system and still have a relatively small financial investment.

Clearly one of the first places that the "do-it-yourself" man can save is in con-



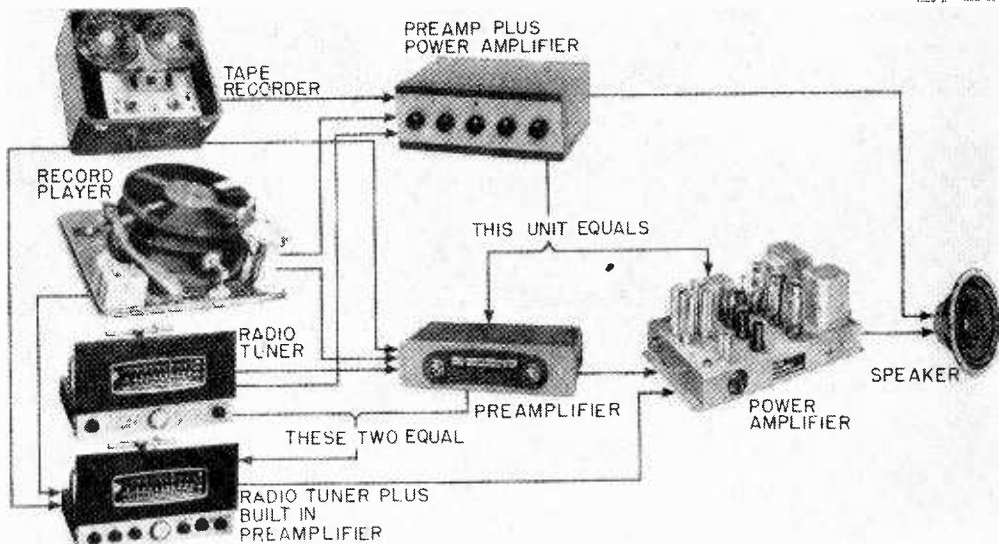

Photo diagram shows general wiring of a Hi-Fi system. Although a radio tuner, phonograph, and a tape machine are shown it is not necessary to include all three of these items. Again, should cost be a factor, it is suggested that either the phonograph or radio tuner be obtained first and then the others can be added to your system at a later date. Note that there is a choice of obtaining the preamplifier and power amplifier as a single unit or as separate items. The single unit is simpler in design and thereby less costly.

nection with cabinets. He may build the equipment into bookshelves, or end tables, or in specially designed cabinets. He will be especially concerned with the cabinet that houses his loudspeaker. The first problem, the first compromise, may well come with the decision as to whether the loudspeaker should be housed in the same cabinet with the balance of the equipment or whether it should be separated. The facts are definite, and simple, but the decision may not be so easy in an individual instance.

Most people, in moderate sized homes, resist the idea of more than one cabinet. It is entirely possible to build an entire system, including the loudspeaker, into a single cabinet and obtain excellent results. However, among the limitations in the single cabinet design is the fact that if good low-frequency response is obtained then it is very difficult to operate the machine at satisfactory loudness levels without vibrating the input device (*e.g.*, the record changer) or the tubes in the amplifier so as to cause the entire system to oscillate. The actual result is a loud and perhaps even destructively violent vibration of the entire system. A small but not unimportant point is the fact that generally the position from which you listen will be physically remote from the cabinet housing the equipment and if you adjust the controls for satisfactory sound when you are standing next to the cabinet containing the loudspeaker it will not be satisfactory in the listening location. With practice you will learn to

solve this by making allowances in the adjustments but it is much more satisfactory to set the controls when you are a fair distance from the loudspeaker location.

One solution to the cabinet problem is to build everything into a convenient bookcase or similar arrangement. The loudspeaker may be mounted in a wall between two rooms, or in the wall of a closet or stairwell. With the exception of certain very special combinations of loudspeakers and cabinet designs most installations will turn out better if the loudspeaker is mounted in a wall so that the back is completely isolated from the front, and yet the size of the area behind the loudspeaker is at least ten or twelve cubic feet. Few homes can readily accommodate cabinets of adequate size to produce ideal results with conventional loudspeakers. The exception is the corner cabinet designs that have been emphasized in recent years. Many rooms have an empty corner suitable for a loudspeaker cabinet. These arrangements have the interesting property of making the room operate essentially as an extension of the cabinet and in effect the listener sits in the center of a horn (the room) to which the loudspeaker is coupled. In any case, it is best if possible to find some way physically to isolate the loudspeaker from the balance of the equipment.

If you feel, at the beginning, that you would like to spend a little extra money to make certain that at least one item in

(Continued on page 123)

# It's Fun to Lay Out a Chassis

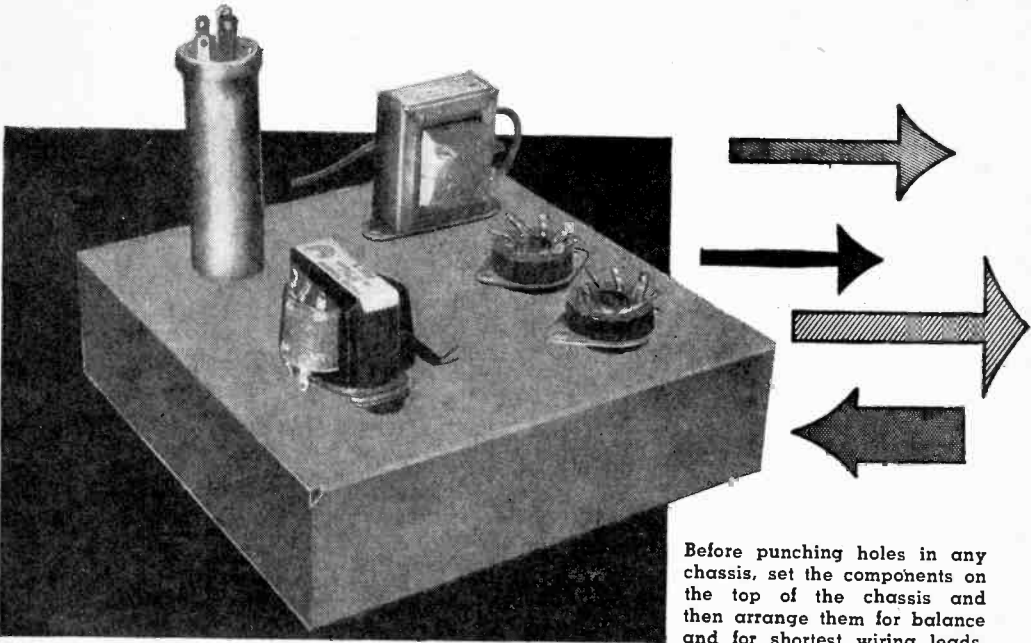

Before punching holes in any chassis, set the components on the top of the chassis and then arrange them for balance and for shortest wiring leads.

AT ONE time the electronic experimenter and home builder had to rely on used chassis bases for most of his construction projects. These were salvaged from discarded receivers, second-hand amplifiers, etc. and, in almost every case, many of the holes could not be used, resulting in an unattractive assembly.

Today, blank chassis bases are available at most electronic parts jobbers and mail-order supply houses. They come in all sizes and shapes and most types are available in aluminum—a metal which is easy to drill, punch, and bend.

When working with a blank chassis, it is first necessary to prepare a layout showing the location and size of every hole to be punched or drilled in the chassis. This layout must then be transferred to the chassis itself before the work is started. In some cases the home builder can follow a prepared layout diagram which is part of the project. In other cases he will have to prepare his own layout.

Determine the basic layout by arranging all of the major parts, including tube sockets, on top of the blank chassis. The parts are then moved around until the most desirable arrangement is found. Measurements may then be taken and recorded and a layout diagram prepared. Since actual parts are used for this step,

proper clearances are automatically provided.

Certain "rules of practice" should be followed when preparing a layout in this manner. First, care should be taken not to crowd large tubes, such as rectifiers and power amplifiers, near electrolytic capacitors or wax impregnated coils since excessive heat may easily damage these units. Tube sockets should be arranged to provide reasonably short connections between stages, but input and output leads of amplifiers should be kept well separated.

In general, power transformers, filter chokes, and output transformers should not be bunched together at one end of the chassis. Try to keep these components spread out enough to distribute the weight evenly across the chassis. If the completed equipment is to be mounted in a cabinet, leave adequate space to provide good air circulation and ventilation.

Try to visualize where volume controls, switches, pilot lights, etc. will be located on the edge or "apron" of the chassis and allow the necessary space. Too often a builder prepares a nice looking layout only to find that a multi-section rotary switch falls right over a tube socket, making the unit difficult to wire. When working with r.f. equipment, receivers and transmitters, a certain amount of interstage shielding



Tools needed for laying out chassis: dividers, center punch, small hammer, scribe, combination square, and can of layout fluid.

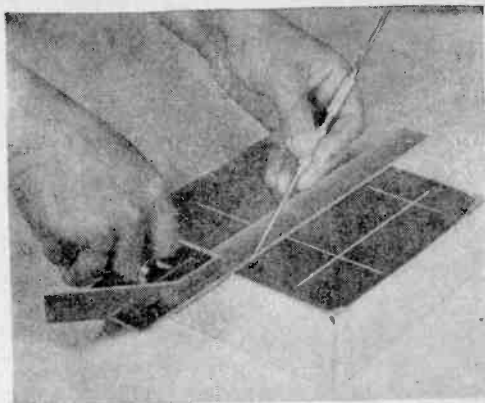

Scribing the center lines for the various holes on the chassis. A coating of layout fluid on chassis provides working surface.

may be required. Although it may not be possible to decide in advance just where such shielding will go, some effort should be made to anticipate these requirements and provide the requisite space.

#### Now the Chassis

The basic tools required for laying out a chassis include a pair of dividers, a center punch, a small hammer, a scribe, a combination square, and a small can of layout fluid. Not all of these items are essential, but if all are available, you will save time and trouble.

Since few commercial chassis are perfectly square, the first step is to determine the best or "squarest" corner of the chassis from which to work. Hold the combination square against each corner of the chassis to check it. Once the "best" corner is determined, make all top-of-chassis measurements from the two sides comprising this corner.

Next, coat the part of the chassis where the layout is to be transferred with a thin coat of layout fluid. This is a deep purple, rapid-drying liquid that is available through industrial and tool supply houses. If not available, a sheet of plain paper may be attached to the chassis.

Center lines for the various holes are then drawn directly on the prepared chassis using the square and a scribe. Use only enough pressure on the scribe to cut through the stain and expose bright metal. Too much pressure will result in a scratch on the metal. If the paper is being used, a sharp pencil, with moderately hard lead (3H or 4H), can be used instead of the scribe.

Where a single dimension is to be repeated several times, the dividers may be set to this measurement and used to mark off all similar dimensions. The final step

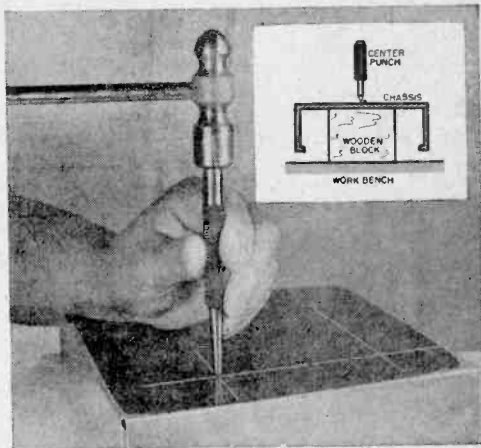

Using the center punch to start hole in a chassis. The chassis should be braced below with block of wood to prevent denting.

is to center-punch carefully each hole to be drilled.

The center punch is held firmly at the point to be marked and tapped lightly with the hammer. Use only enough force to make a distinct mark on the metal. Too hard a blow will result in a large dent and possible chassis deformation.

It is important to brace the chassis as shown in the inset diagram above, since hammering on an unbraced chassis is sure to cause serious trouble.

Once drilling has been completed, the layout stain can be removed with alcohol and you are ready to proceed.

This same basic technique can be used for all of your construction projects—whether you are building a simple, one-tube receiver or an amateur radio transmitter. It is worth mastering because all of your projects will then go faster when you know how to lay out a chassis. END

# ADJUSTING THE POWER

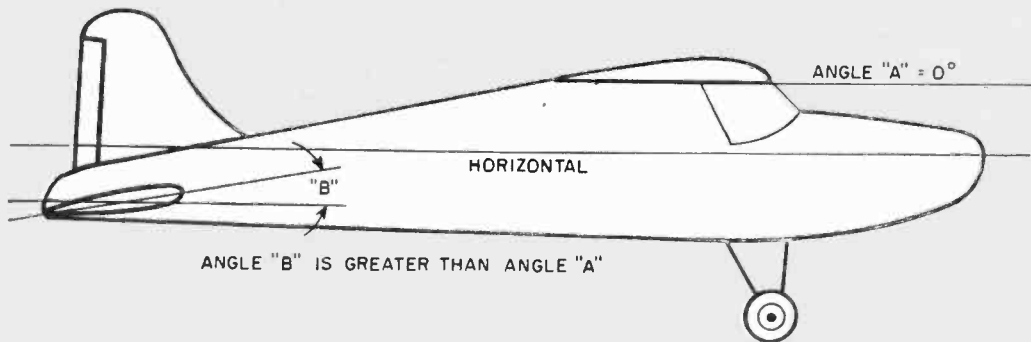
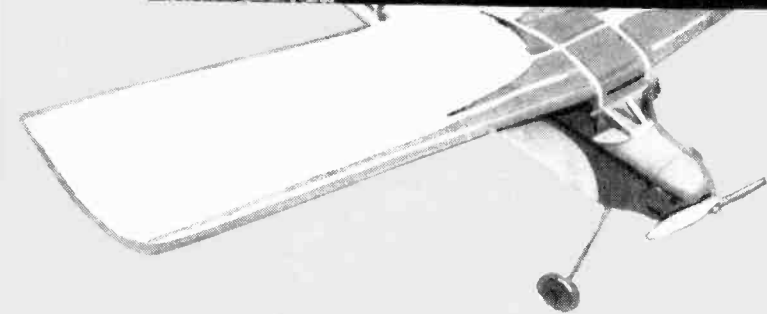

The setup shown here is dangerous. The plane will stall easily and abruptly whenever the nose starts up, and is also apt to remain in dives or enter a death dive out of a spiral or nose down maneuver. This is a trap many model plane fliers fall into when they shim up the tail too much in an effort to stop stalls.

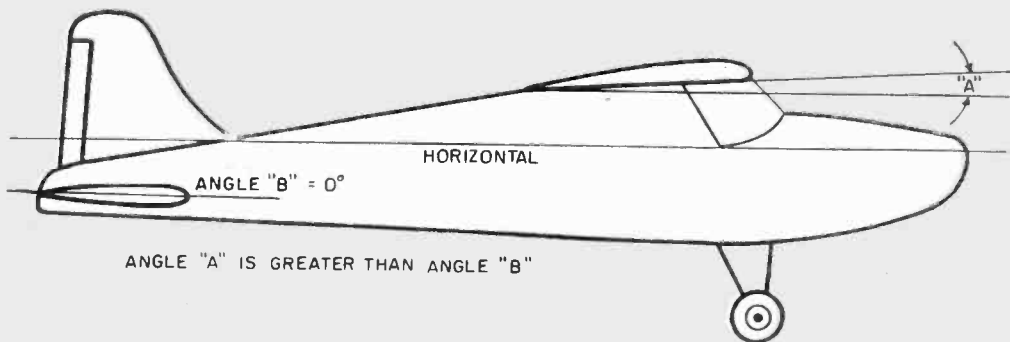

Fore and aft stability of the airplane is greatest when the wing is inclined at a slightly greater angle of incidence to the airstream than the stabilizer. Such a plane will resist stalls, recover from stalls and dives quickly, and maneuver and loop well.

By **WILLIAM WINTER**  
Editor, "Model Airplane News"

## R/C PLANE

**B**EGINNERS launching their powered airplane models on their first flights make two mistakes. One is to use too much or too little power, and the other, often the fatal one, is to use too much fuel or too long an engine run.

It is possible for the plane to fly erratically and finally, uncontrollably, on an early test flight, and still remain in the air to drift away and be lost. Test flights should be short. The amount of power is most easily controlled by opening up the needle valve for a rich mixture, recognized by a smoky exhaust. This assumes that the engine uses a glow plug. If it is a diesel engine, back off the head to obtain a rich mixture; for ignition engines, retard the spark. It is hard to say exactly what power would be required but, if one had to guess, about two-thirds would be best under average conditions.

Another possibility is to place the propeller on backwards, letting the engine "rev up." This cuts effective thrust by a third or more.

Before attempting to fly the plane, run off a measured amount of fuel and time the engine run. You don't want more than a minute, and remember, if you decide to lean out the needle valve the same amount of fuel may double the engine run. A fuel shut-off device is desirable for first tests; back up the device with a limited amount of fuel.

There are many pros and cons as to whether the radio should be operative on a beginner's first test flight. Chances are the radio will be a help.

We'll assume that you have made the necessary ground checks, flight checks, etc. Holding the plane as described in last month's article, run at a moderate speed (a very slow run if the plane is light and there is any wind) into the wind. When lift is felt, push the plane forward as you release it, with the nose ever so slightly above the horizon. You should follow through and use a smooth technique, the same as you would in golf.

While it is essential to handle glide and power-on adjustments separately, it is not always possible to distinguish between the

*You can avoid a lot of grief and lost airplanes if you will follow the practical hints for adjusting and flying your R/C plane given here.*

two in a short first test flight, especially under exciting circumstances. However, if the plane is high enough to glide when the engine stops, try to remember whether it glides too slowly, stalling or appearing to "mush" or falter; or whether it seems to dive ever so slightly. Did it want to turn of its own accord?

Continue to refine the adjustments begun in the hand glide tests, described in last month's article. It is essential to work out glide trim first, if at all possible. If the plane was not in danger of cracking up or getting out of control under power, ignore, for the time being, the power-on adjustments and perfect the glide trim. But if the ship was in danger under power, take the bull by the horns and affect any adjustment that will enable you to get it into the air well enough to observe and evaluate its performance. For example, if the plane turns wildly to the left under power, skimming the ground, adjust the rudder slightly to the right (perhaps 1/16 inch on a small plane, 1/8 inch on a large one). If the plane turns to the right, use left rudder. Naturally, rudder adjustments affect the glide path, but the thrust line (an imaginary line drawn through and parallel to the shaft of the engine) can be offset to one side or the other on subsequent flights, at which time the rudder would be readjusted to normal. Everything is aimed at getting a look at the glide.

### Thrust Line

After the glide is reasonably correct, begin to make thrust line adjustments on subsequent short flights, tilting the engine up or down, left or right, as required to offset the model's power-on tendencies.

If the plane turns under power to the left, the thrust line would have to be inclined to the right. If the plane noses up when the engine runs, but glides perfectly, the thrust line will have to be tilted down, to pull down the nose. The latter is called downthrust. If, under power, the plane noses down, the thrust line should be inclined upward. Downthrust usually is required.

All adjustments should be made minutely

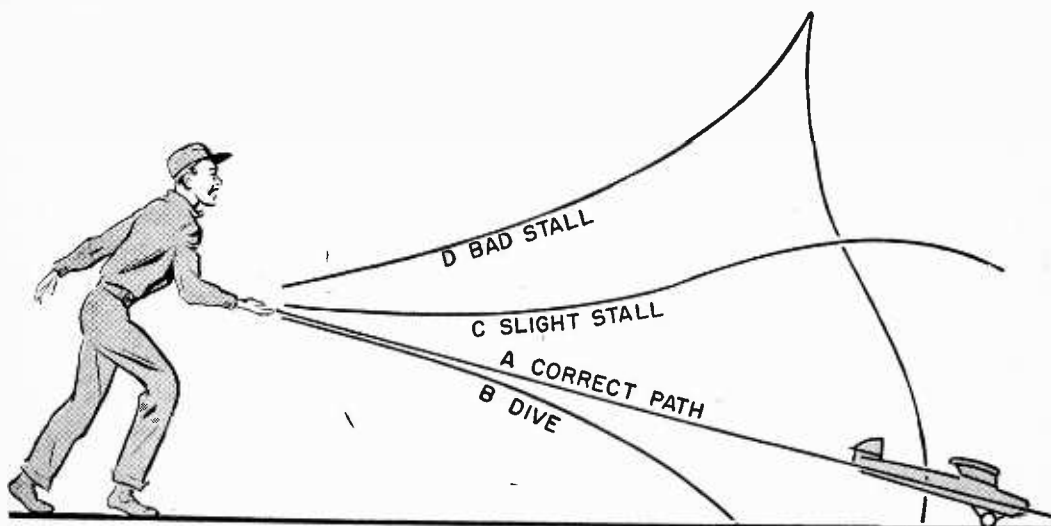

Observe very carefully how the plane behaves during its first hand-launched glide. The proper glide path is straight, smooth, and without dips until the plane strikes on wheels. If the plane dives slightly (B), increase the angle that the wing makes with the airstream, or decrease the angle of the stabilizer. In severe cases, move the weights in the plane backwards. If the plane stalls (C) or (D), increase the positive angle of the tail, or move weights forward. Be certain when you launch the plane that you do not throw it nose up, or too fast, especially in high winds, as this will produce a false stall, giving you an incorrect idea of the model's performance.

and progressively on repeated trials. Down-thrust is imparted to a radially mounted engine by inserting washers between the rear crankcase cover, at the top, and the firewall. The washers may be slid onto the mounting bolts. In the case of a beam mounted engine, put the washers between the mounting lugs and the bearers at the rear of the engine and, again, the washers may be slid onto the mounting bolts.

Bit by bit, the plane can be trimmed perfectly. Don't expect miracles. Walt Good, several times winner of the National's radio-control event, once took over 100 flights to trim out his famous "Rudderbug" exactly the way he wanted it.

Only when unquestionable control can be had all during the flight, should you increase the motor run. Two to three minutes is maximum for safety on the first few dozen flights.

The operator can do much to smooth out a rough flight by careful use of the rudder. Stalls, for example, can be alleviated by beginning a turn. The rudder should be applied as soon as it becomes evident that the plane is going to nose up. Control action is more effective at high speeds; it is usually absent at the point of stall. A plane may be stalled due to a hard launch, especially into the teeth of a wind, or after recovery from a spiral or any descending turn, or upon turning sharply into the wind. A straight ahead, nosing-up action, is a dead-

end street; if the plane can be turned slightly by applying the rudder at the crucial moment, a zoom or stall will be converted into a climbing turn, dissipating the excess speed. Excess speed simply means excess lift, followed by a stall.

Just as some auto drivers have a heavy foot, and others a light touch, so do some people tend to over-control a radio model by forcing it to do things. A heavy hand on the switch prolongs turn entries until the nose of the plane is screaming earthward. When the control is finally relaxed, a zoom results. This makes for roller coaster flying, with narrow squeaks on every flight.

Try to develop a light touch, stay relaxed, don't get rattled—it's only a model, remember? Begin a turn, when it looks steep allow the plane to recover, then resume the turn. The gentler the flying technique, the fewer out-of-control flights.

For some strange reason it is always easier to maintain good control of a plane that is going away from you, out in front of the transmitter, than it is when the ship is downwind and plodding up behind you. Maintain as much distance upwind as possible, recovering ground after every maneuver. Once the plane is downwind, a skilled hand is required to bring it back with surety. In a strong wind the plane can be flown out a quarter mile or more, with the assurance that it will glide back downwind into control again if anything goes wrong. Or at

least, the chase will be shortened. The importance of remaining upwind cannot be overemphasized to the beginner.

### Some Tips

Every flier sooner or later gets himself into hot water. The flier with a little experience may get to stunting too close to the ground, then finds that everything he does magnifies his difficulties. Or the beginner may become excited, turn wildly from side to side. The answer? Relax. The plane is inherently stable and will recover by itself. When it gets right side up and begins to climb, it will slow down and control may be resumed.

Here's another tip: a plane that is trimmed to glide well on a calm day may stall on a windy day. If trimmed on a windy day, it will glide too fast or even dive on a calm day. Rudder control that is adequate in calm weather may be inadequate in a wind. This sometimes fools the flier into thinking he has lost control. In the wind, the same control must be held longer to obtain an equal reaction. It is wise to know how thick a shim it takes to alter a stabilizer angle from windy weather to calm weather trim, or *vice versa*.

The location of the center of gravity of the plane greatly influences the flying characteristics of the plane. The CG should be located no greater than 40% of the chord (width) of the wing back from the leading edge of the wing. The model can be flown successfully with the CG as much as 50%

back on the chord, but the further back the CG is located, the stronger the tendency for the plane to rear up on turning into the wind, or on coming out of fast turns. Forward CG positions are associated with better wind penetration. In fact, some builders place the CG so far forward that a negative angle in the stabilizer becomes necessary to hold up the nose during the glide.

While everything that is known about flying an R/C plane cannot be condensed into two articles, the fundamentals described in this article and last month's will help you get into the air successfully. Once the plane is flying reliably, there is a coordination exercise that will quickly give you the feel of the machine. With plenty of altitude, hold a turn for an eighth to a quarter of a circle, then reverse the direction with opposite rudder, passing by the original heading to a point a similar distance on the other side of the heading. Keep repeating the maneuver "S-ing" upwind. As you gain confidence, hold the turns longer and longer, and you soon will learn how to fly the ship out of any predicament.

Another valuable exercise is to make wide, shallow circles, by repeated applications of the rudder in the same direction. This will teach you how to avoid unwanted rudder positions in the popular self-neutralizing escapements, as well as how to make turns without loss of altitude or picking up excessive airspeed. Repeated short flights is the way to learn safely.

Easy does it.

END

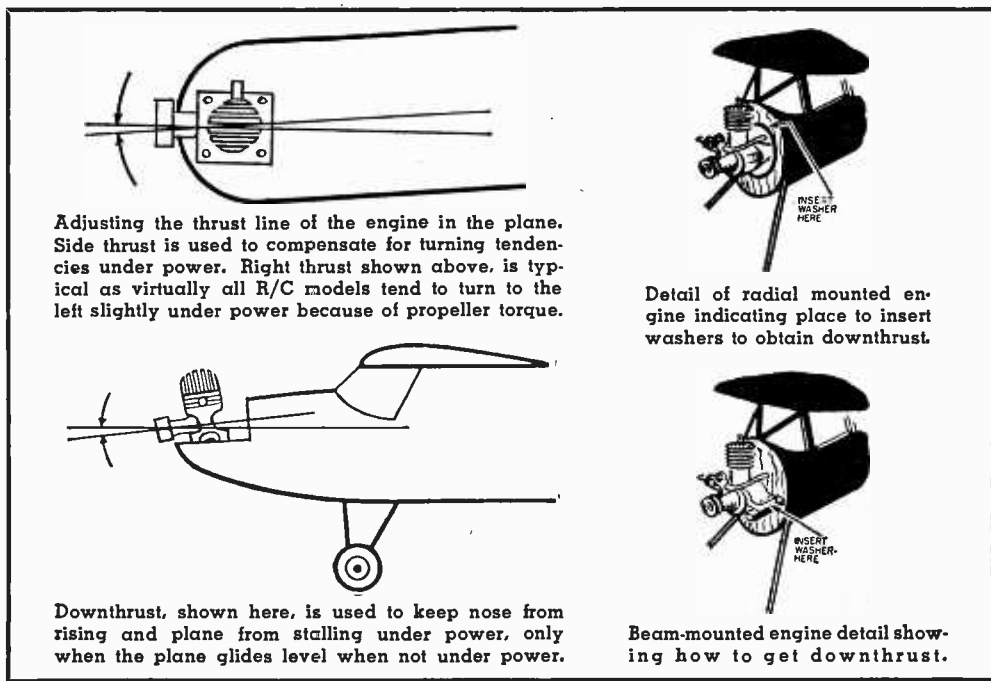

Adjusting the thrust line of the engine in the plane. Side thrust is used to compensate for turning tendencies under power. Right thrust shown above, is typical as virtually all R/C models tend to turn to the left slightly under power because of propeller torque.

Downthrust, shown here, is used to keep nose from rising and plane from stalling under power, only when the plane glides level when not under power.

Detail of radial mounted engine indicating place to insert washers to obtain downthrust.

Beam-mounted engine detail showing how to get downthrust.



## It's All

By CELIA WEBSTER



IF YOU are one of the million owners of the diversified high-fidelity tape or wire recorders, you, no doubt, have found as we have that a recorder is an ingenious mechanism which can do double or triple duty for play as well as for its more practical purposes. We have found it can be a personal album of familiar voices, a family's unforgettable record of special events, a great aid to our children's growth, and a secret method of self improvement.

Our tape recorder has traveled thousands of miles, performing brilliantly for the most part, although there have been times when I wished I were dead or could crawl under the carpeting because of it. You see, our recorder was purchased primarily as a device to be used in my work as a feature writer. I record my interviews with the familiar personalities of television, radio, and the stage. The taped interviews are later transcribed to paper. It has been a most satisfying method inasmuch as my shorthand 'is impossible, and I like being able to carry on a natural, fluent conversation *sans* ringbinder and pencil. I have found it a sincere, look-him-in-the-eye system. I was told by Mel Spiegel, Arthur Godfrey's publicity director, that I was the first to enter the confines of CBS' Press Department to do the interviews with a tape recorder. Since then, many other interviewers use the same method.

The gruesome experiences have been outnumbered by far by the more pleasant ones, but in the few years that I have been operating my "little monster," I have burned out the generator in the Times Building (d.c. current is death to my recorder), I have ruined a few tapes, once by dislodging the microphone connection, another by allowing a subject to hold the mike, still another by forgetting to turn on the volume control until the interview was half over. I have also erased when I thought I was recording. All of these were careless mistakes, my own fault, not that of the recorder, and I know, not uncommon to anyone who has operated a tape recorder for any amount of time.

We have found that this practical machine can be fun at home too. Many times we have turned it on to record family events, and holidays when our children, Jimmie, age 11, and Susie, age 8, first enjoy that magical moment of seeing their presents under the Christmas tree at 6 a.m. on Christmas morning. Jim and I, sleepy parents though we may be at that time, can replay the kiddies' delightful chatter later when we are fully awake.

A few years ago, when Jimmie was in second grade, he expressed the desire to join the school band. His father and I suggested he put in his name for one of the school-owned clarinets. If he liked it, we would invest in one later. We thought the clarinet would be noisy enough for a seven-year-old, and it would be easy for him to blow. When he put in his request he found that the music department was fresh out of



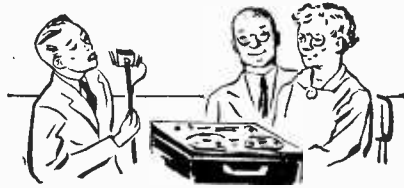
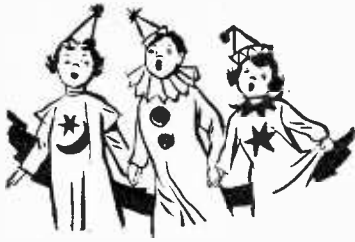

## On Tape



clarinets, and all that remained was one trumpet. He arrived home from school, his small, black satchel clutched in his hand. Once inside the door, he darted to the nearest table to open the precious case to display his newly acquired noisemaker. If you have never witnessed a seven-year-old attempting to blow a trumpet for the first time, you haven't lived! Jimmie's big blue eyes popped, his cheeks bulged, the chords of his neck grew taut, and his small, cherubic face became a brilliant pink. I turned on the recorder. The shrieks emitted from the shiny brass trumpet were ghastly, and we can play the tape made that day to prove it. Though the bout with his musical talents, of which I'm afraid there is little, were short-lived, we taped his progress each week.

We finally agreed with Jimmie (who hated to practice), his teacher, and the recording machine, that maybe he should have waited for the clarinet.

Many of our friends own tape recorders and have found novel and interesting ways to utilize them.

For example, the Martins received their recorder as a Christmas gift from their son and daughter-in-law who now live on the West Coast, and have a recorder too. The Martins Jr. and Sr. exchange tapes by mail. It costs but a few pennies parcel post to hear the familiar voices of their loved ones with thousands of miles separating them. There is no excuse now for not writing. It is effortless to set up the machine and talk to it. The elder Martins derive great joy from hearing the childish voices of their grandchildren.

Many tape recording machines find themselves very important pieces of equipment in the homes of the people in the entertainment field.

Comedian Red Buttons has his recording machine set up in his bedroom. At times,

suffering from insomnia, Buttons finds that some of his best ideas for television routines invade his mind when he is half asleep. When ideas pop into his head, he quickly turns on his recorder and registers the thought for future use.

Ventriloquist Paul Winchell has found that he can time his television sketches almost to the second with his tape recording machine. He can tape, erase, add to, and edit, before he gets to the television studios for the scheduled rehearsals of his show.

Last year at our annual Christmas party in Lakewood, Ohio's Church of the Ascension, the children were shown slides which told the story of "The Littlest Camel." Arrangements had been made beforehand to tape record the story. The tape was made upstairs in the church. The Reverend Dr. Stuart Cole read the enchanting story while the organist played an appropriate musical background. When shown on the day of the party, the results were near professional.

Many humans become frightened and forgetful when facing an audience. The tape recorder has come to the aid of our Cub Scouts when they put on their sketches at the monthly pack meetings. The local den parents have found that their thespian charges do a much better job if their offering is put on tape and the recorder set up at the pack meeting. The children go through the motions, and the continuity is letter-perfect, the audio can be heard

*(Continued on page 124)*



# The



**O**NE of America's latest secret weapons is the new version of the Sniperscope. Used during World War II, this infrared electronic device provides a clear image of distant scenes under conditions of total darkness. Mounted on a weapon, its effectiveness is literally deadly to the enemy.

The device consists basically of an infrared light beam and an electronically operated telescopic sight. Together, these two units convert an invisible image into a clear "picture."

The infrared source resembles a fog light whose glass face has been painted black. It is mounted above the barrel of the gun. The telescope is mounted above the rear sight of the weapon. Both units are connected by means of a cable to a small power supply carried on the user's back.

A fighter armed with this device aims in the general direction of the suspected target, turns on the power supply, and sights through the telescope. He then moves his weapon back and forth across the field until the enemy is sighted. Through the Sniperscope the target appears to be spotlighted

in a light beam of greenish hue. The soldier then focuses the telescope to give the clearest images, and presses the trigger.

Companion piece to the Sniperscope is the Snooperscope. The latter uses the same infrared instrument but not in conjunction with a weapon. The telescopic device is mounted on a hand grip with the infrared unit mounted directly below the telescope. This unit is similarly powered by a portable power supply carried on the back. During the war, the Snooperscope was used to direct gun fire and for signalling.

This "night sight" device works as a result of the combination of electronics and optics. It depends on phototubes and filters to cut out visible light and transmit only the infrared portion of the spectrum. The telescope receives reflected invisible infrared images at the front end and converts this radiation into visible images that are received at the eyepiece.

For the eye to see the scene illuminated by infrared, a special tube, similar to the 1P25 image tube, is used. It operates as a combination "iconoscope-kinescope." The lenses project the incoming infrared radiation upon a photo cathode in the "iconoscope" end of the tube. As this screen is sensitive to infrared light, it emits electrons when exposed to such radiation. These electrons, in an image of the scene illuminated by infrared, pass through a series of electrodes and strike a fluorescent screen in the "kinescope" section of the tube in such a

# New Sniperscope

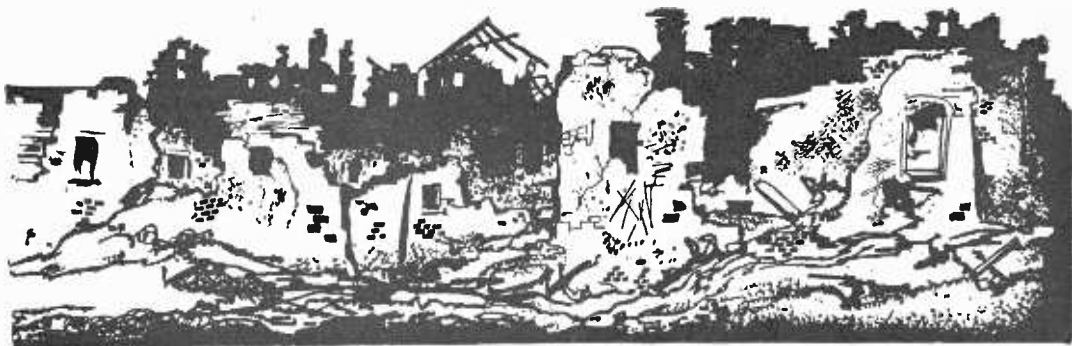

manner that the human eye can see a greenish picture of the original scene. The electron lens systems and the accelerating electrodes increase the sensitivity of the tube, causing the picture on the screen to be brighter and to have greater definition.

Recent improvements on the Sniperscope, accomplished at the Engineer Research and Development Laboratories at Fort Belvoir, Virginia, are intended to allay some of the criticism made by troops using the instrument in combat. For instance, two methods of reducing the Sniperscope's weight are under study: one involves smaller and more dependable batteries; the other would be the use of equipment that could eliminate the battery and light source as parts the soldier would have to carry.

Development of new battery charging kits is also under way. This would simplify the recharging of batteries used not only for the Sniperscope but in any field device.

Greatly increased ranges are made possible by the improved model which now employs an image tube that operates at 20,000 volts as compared with the 4000 volts of the earlier model.

The more rugged construction and simpler operation of the new weapon will reduce by almost 50 per-cent the maintenance problems met in the old model. The new model can be maintained completely in the field. Also, a new electronic maintenance shop is now being tested for its servicing ability and should be ready for operation

soon. Actually, considering its delicate mechanism and sensitive construction, the Sniperscope is more rugged than might be expected—more so than many electronic devices.

Finally, a means for more accurate aiming is being developed. This consists of a projected illuminated and adjustable reticle (graduated horizontal and vertical scales for accurate judgment of targets). The reduction of operator adjustments from four to two also permits simpler operation.

Suggested applications of this equipment for civilian purposes include navigation for ships and other surface craft. Use of the Sniperscope could permit officers and lookouts to see a considerable distance with less eye fatigue on the darkest nights. Obstacles could be detected at sufficiently great distances to prevent collisions. The Army has tested this equipment on other vehicles, such as locomotives, during hours of total darkness. Police departments have expressed an interest in the device as a crime detection and prevention aid.

Regardless of its future, the Sniperscope is a tribute to American "know-how" and is bound to make as many friends of those who use it as it will discourage enemies at the wrong end of it. END

Photograph and information on improvements in the Sniperscope, courtesy of "The Military Engineer," Col. F. H. Kohloss, Ed.

Fig. 1. Miniature vacuum tube dwarfs the transistor which can replace it. Later models are even tinier.

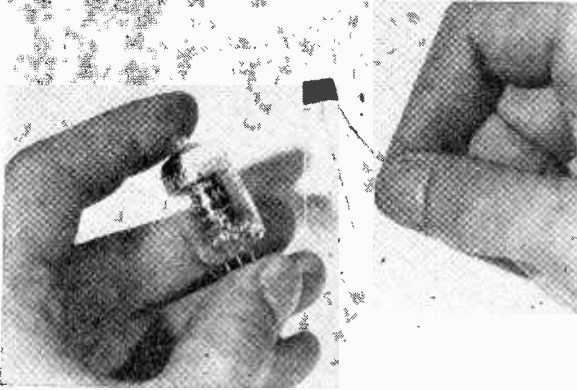

Fig. 2. A cutaway view of a point-contact transistor. Note two "cat's whiskers".

# Meet the Transistor

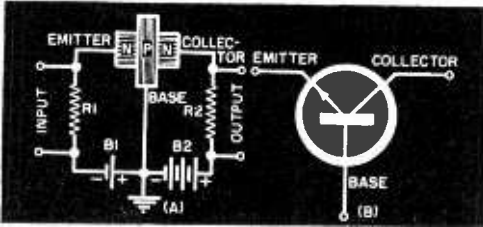

Fig. 3. (A) Basic transistor amplifier. (B) Symbol for an "n-p-n" junction transistor.

*A tiny component that will revolutionize the entire electronics industry—can operate from dry cells.*

**F**EW electronic inventions have captured the public's interest as has the development of the transistor. This device, although requiring but 1/1000th the power and a small fraction of the space of a vacuum tube, may be used as an amplifier, detector, or oscillator and is thus capable of handling many of the jobs that vacuum tubes are normally employed to do. In addition, since the transistor has no filament to burn out and because it operates at comparatively low temperatures, it has a life expectancy from 10 to 20 times greater than the average tube.

For these reasons and because of its small size (see Fig. 1) it has virtually replaced tubes in the manufacture of hearing aids. It is also being used in military equipment, specialized communications gear, and in certain types of instruments. Eventually it will be used in portable receivers, home radio and TV sets, and auto receivers. Tiny transistorized "wristwatch" and pocket-sized transmitters and receivers have already been built experimentally and offer commercial possibilities.

Transistors are made possible by the

electrical properties of a group of materials known as semi-conductors, consisting of substances which may act either as conductors or insulators, depending on their physical conditions. Germanium, silicon, and selenium are the most popular semi-conductors, with germanium being used almost exclusively in the manufacture of transistors.

In a normal conductor, such as copper or silver, current flows when an electrical voltage is applied to the material causing a movement of free electrons through the substance. In a semi-conductor, the application of voltage alone may not be sufficient to initiate current flow—some other physical condition may be necessary such as the presence of light, heat, or of an additional electrical field. The current flow, when it does take place, may consist not only of the movement of free electrons but may also include the movement of electrical "holes" through the material.

A "hole" is formed when an individual molecule loses an electron. The molecule lacking an electron may pick up one from a nearby, electrically neutral molecule,

thus leaving the second molecule with a hole and a net positive charge. In this way, the hole may travel through the substance, jumping from molecule to molecule and producing a current flow which acts just as if it consisted of movement of positively charged particles.

Although current flow through a particular substance may consist of a movement of both holes and electrons, if the current flow is made up primarily of a movement of holes, the material is called a "positive-carrier" or *p*-type semi-conductor. If the current flow is made up primarily of a movement of electrons, it is called a "negative-carrier" or *n*-type semi-conductor. A transistor is made up of a combination of these materials.

### Types of Transistors

Transistors are usually divided into two basic types, depending on their method of construction, *i.e.*, the point-contact and the junction types. A cutaway view of a point-contact type is shown in Fig. 2 while a junction type is illustrated in Fig. 4.

A point-contact transistor consists of a small cube of semi-conductor material with two fine wires or "cat's whiskers" contacting its surface. Electrical connections are made to the semi-conductor, called the "base", and to each of the two contact wires—one of which is called the "emitter", the other the "collector". If *n*-type semi-conductor material is used, it is called an *n*-base point-contact transistor. Small *p*-type areas are formed under the contact wires during manufacture. If *p*-type material is used in the base, the transistor is a *p*-base unit, and small *n*-type areas are formed under the tips of the contacts.

A junction transistor consists of a "sandwich" of two types of semi-conductor material, with the inner layer of different material from the two outer layers. The basic construction is shown in Fig. 4. If the inner layer is of *p*-type material, the unit is called an *n-p-n* junction transistor—if of *n*-type material, a *p-n-p* transistor results. The *n-p-n* type is shown in Fig. 4. Electrical connections are made to the two outer layers and to the inner layer of the "sandwich", with terminals identified as "emitter", "base", and "collector", just as in the case of the point-contact type.

### How Transistors Work

Operation of the transistor may be understood by referring to a basic transistor amplifier circuit (see Fig. 3A). An *n-p-n* junction transistor is used.

In operation, the emitter-base circuit is "biased" by battery  $B_1$  in such a way that a low resistance is offered to the flow of current through the *n-p* emitter-base junc-

tion. The collector-base circuit, on the other hand, is biased with reverse polarity by battery  $B_2$  and offers a high resistance to the flow of current, in fact, current flow can only take place through the *p-n* base-collector junction because of the excess of electrons produced by the current flow in the emitter-base circuit.

If a signal is applied to the input terminals (across  $R_1$ ) the variations in the emitter-base current which result will cause a variation in the number of free electrons in the base, with resulting changes appearing as an amplified signal across  $R_2$ . In practice, the emitter and collector currents may be on the same order of magnitude, but a considerable signal power gain is obtained since the collector circuit represents a high impedance while the input (emitter-base) circuit represents a low impedance.

Operation of a *p-n-p* transistor amplifier is similar except that conduction in the base-collector circuit is principally by means of "holes" instead of electrons.

The schematic symbol used to identify an *n-p-n* type transistor in wiring diagrams is shown in Fig. 3B. The base is represented by a straight line, with the emitter and collector terminals identified by slanting lines to the base with the emitter further identified by an arrowhead pointing away from the base.

The *p-n-p* type transistor is wired directly opposite from the *n-p-n* type, that is, the collector voltage is negative while the emitter voltage is positive. The symbol for the *p-n-p* type is identical to that for the *n-p-n* except that the arrowhead points toward the base instead of away from it.

In this article we have discussed the basic principles of transistors and explained how they can be used in a simple amplifier. Subsequent issues will describe other amplifiers as well as detectors and oscillator circuits using transistors. END

Fig. 4. Diagram and photo of an "n-p-n" junction transistor. Note changes from Fig. 2.

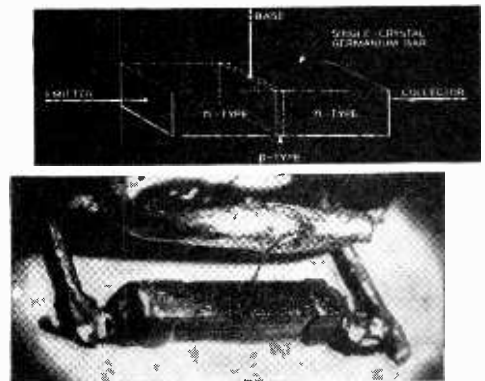

# Build this "2-Way" Electronic Metronome



This metronome for musicians gives both an audible and a visible indication of beats.

**I**F YOU'RE interested in music, you'll enjoy building and using this electronic metronome—or, if you don't play an instrument yourself, you can build the metronome for the talented member of your family or for a friend.

The metronome shown is extremely compact, only 3"x4"x5" over-all, yet it contains its own built-in loudspeaker and will operate on both a.c. and d.c. line voltage. You'll like its unique "two-way" action, for not only does the metronome beat out the time with distinct "plops" from its loudspeaker, but a small pilot light flashes on and off with each beat, permitting you to keep time in a room full of other musicians, whose music would otherwise drown out the beats.

*Construction Hints:* The parts you'll need for the project are given in the parts list. You'll be able to pick up all the items needed at your local radio parts distributor; no surplus or "trick" parts are required.

A standard 3" x 4" x 5" "Minibox" is used for housing the metronome. A 2" diameter hole is required for the PM loudspeaker. Locate the speaker mounting holes by holding the speaker against the case and marking hole locations with a scribe.

Punch a 1" hole in the top of the case for the vent hole snap plug. Another 1" hole is punched in the back of the case, near the bottom, and the second vent hole snap plug inserted. When the unit is assembled, the two vents, together, give a "chimney" cooling effect.

After you've finished the machine work on the case, you can apply decorative musical decals. These are available at radio parts distributors as "Trademark" decals.

An ICA No. 29082 aluminum chassis can be cut down to make the chassis base shown, then holes can be drilled and punched for mounting the octal socket and the output transformer. The only critical dimensions are for the hole for the pilot light bracket; it is used for mounting the chassis to the case.

If you prefer, you can bend a simple chassis out of sheet aluminum, thin brass, or steel. Over-all dimensions are not critical, as long as the chassis will fit within the "Minibox".

*Mounting the Parts:* The "Rate" control (with "On-Off" switch) and loudspeaker are mounted on the front panel; other parts are mounted on the chassis. Use a piece of flocked screening over the loudspeaker opening for protection.

Bend one of the output transformer mounting lips so that the transformer may be mounted in a vertical position.

Mount an insulated "tie-point" below the chassis and use this for all ground connections; *do not ground to the chassis or case at any point.*

*Wiring Suggestions:* As can be seen by reference to the schematic and pictorial wiring diagrams, the circuit is simple and straightforward. A "blocking oscillator" is used to drive a loudspeaker directly, with power obtained from a conventional half-

$R_1, R_3$ —100,000 ohm,  $\frac{1}{2}$  w. carbon res.  
 $R_4$ —5 megohm carbon pot. with switch,  $S_1$  ("Rate"  
 control)

$R_2$ —470 ohm, 2 w. carbon res.

$C_1$ —2  $\mu$ d., 200 v. metalized paper capacitor

$C_2, C_3$ —20/40  $\mu$ d., 150 v. dual elec. capacitor

$S_1$ —S.p.s.t. switch on  $R_4$  ("Power")

$T_1$ —4-watt universal output transformer (Merit  
 #A-2900)

$V_1$ —117L7/M7 tube

NE1—NE-51 neon bulb

SPEAKER—2" PM loudspeaker (Cinaudagraph No.  
 P2A1)

Other parts you'll need: octal tube socket; pilot  
 light jewel and bracket; line cord and plug;  
 rubber grommets; two 1" vent hole snap plugs;  
 knob; dial plate; 3"x3" square flocked screen-  
 ing for speaker; 3"x4"x5" metal box (Bud CU-  
 2105); small chassis (cut down from ICA #29082,  
 4"x3 $\frac{1}{8}$ "x1" chassis base); terminal strips; wire;  
 solder; machine screws and nuts; etc.

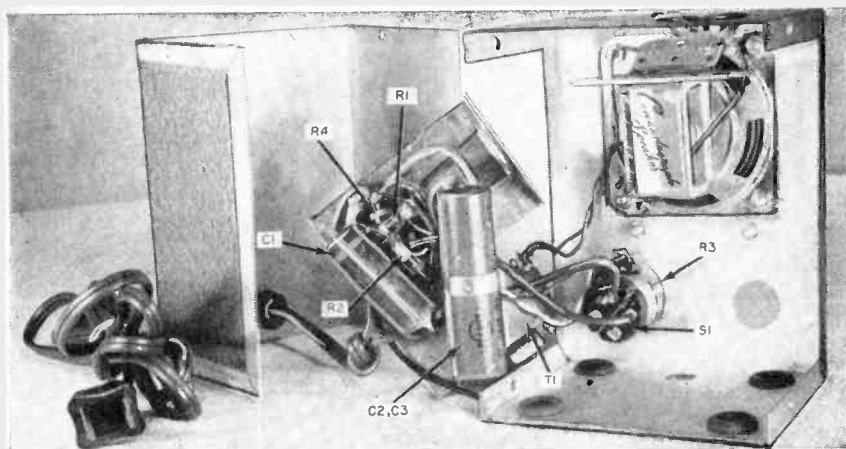
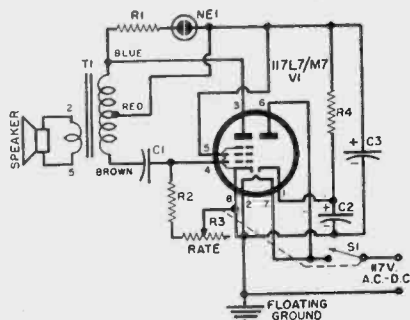

The schematic and pictorial wiring diagrams shown on this page, and the photo-  
 graph above, will help you in wiring and assembling the electronic metronome.

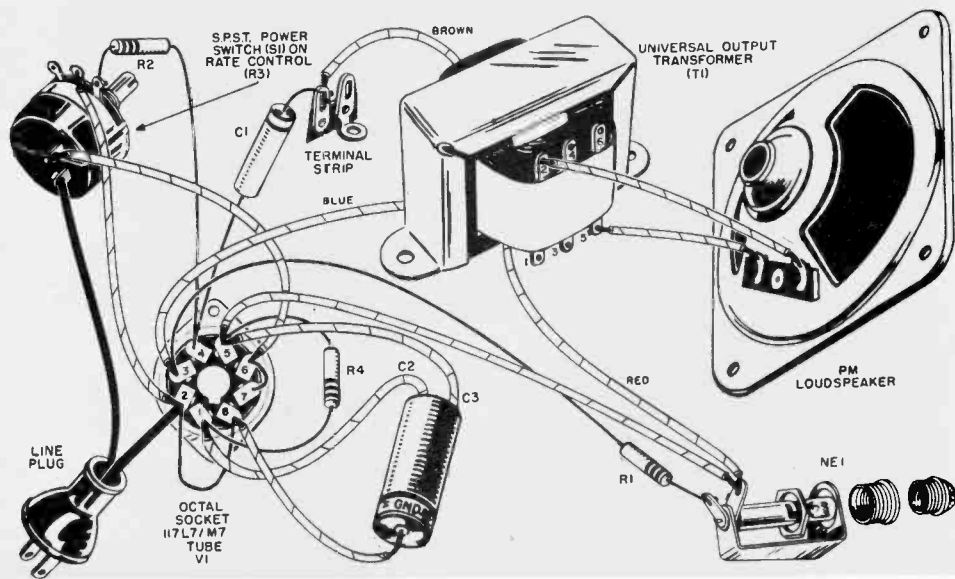

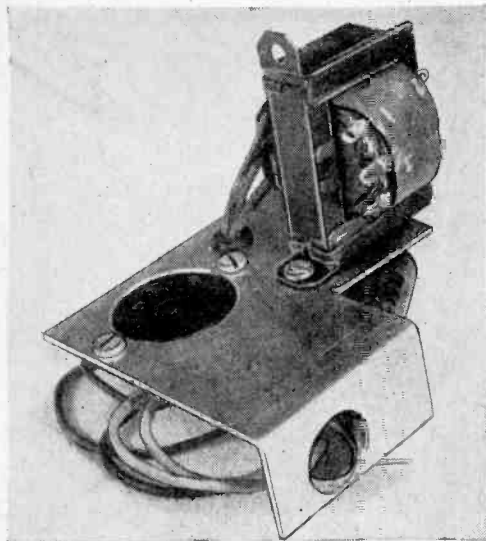

This view of the subchassis shows how one of the lugs is bent to mount the transformer.

wave rectifier circuit. The neon bulb connected across half the output transformer's primary flashes with each "plop" in the loudspeaker.

You'll find it easier to wire as much of the main chassis as possible before final assembly, permitting the leads to the front panel to hang free temporarily.

Once the wiring is completed, double-check each connection for possible errors. And, since the wiring is quite compact, make sure there are no accidental shorts between leads and components.

The pilot light bracket is used for mounting the chassis to the front panel.

With the back of the case in place, the completed metronome looks almost like a factory-built piece of equipment. Its performance will easily equal that of commercial units.

**Circuit Modifications:** With the parts values given, the beat rate can be varied

from about 1 beat every 4 seconds to about 15 per second (from about 15 to 900 beats per minute). This is a much wider range than is normally required. To reduce the maximum beat rate, increase the value of  $R_2$ .

If you wish to reduce the range covered, replace  $R_2$  with a 2 megohm or 1 megohm potentiometer, changing  $C_1$  until the desired range is obtained. Increasing the value of  $C_1$  will reduce the beat rate, decreasing its value will increase the beat rate.

On the other hand, if you have a special application where you require a wider range, replace  $R_2$  with a 10 megohm potentiometer and reduce  $R_2$  to 47,000 ohms.

**Calibration and Use:** With the wiring completed and checked, and the 117L7 tube in place, plug the unit into a wall outlet and turn it "on." Allow about a minute's warm-up time. Don't be surprised if the unit "squeals" as it starts to warm up, gradually changing from a squeal to a series of "plops"; this is normal for a blocking oscillator.

In addition, since the electrolytic capacitors used in the power supply will hold their charge quite well, and the 117L7 tube takes a little time to "cool", the unit may continue to operate for several seconds after it has been turned "off." Again, this is normal and does not indicate a defect.

You'll probably want to calibrate your unit once it is completed and tested. You can do this job by using a stop-watch to check the number of beats per minute obtained at each setting of the "Rate" control.

The final calibration may be a chart listing the dial reading and beat rates or, if you prefer, you can make up a special dial plate for the unit out of cardboard, marking the beat rate directly on the dial plate. If you make up your own dial plate, protect it with two or three coats of plastic or clear lacquer after you've made the calibration markings. END

The metronome with all wiring completed, but before the two sections of the cabinet have been fitted together.

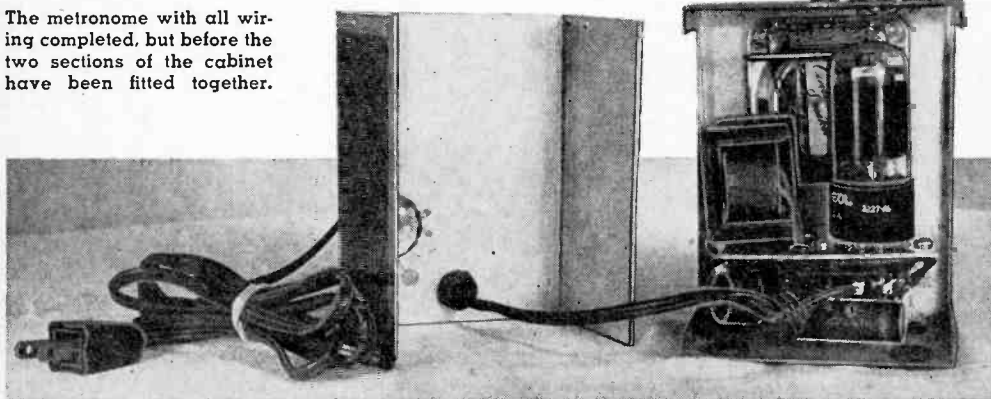



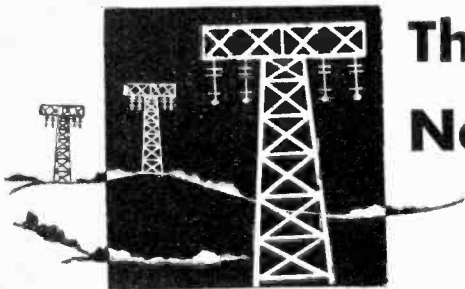

## The World's Largest Network Calculator

**L**ARGEST of its kind in the world is the new a.c. network calculator shown above. Built and put into service by the *Westinghouse Electric Corporation* at its East Pittsburgh plant, the calculator is designed to accommodate the largest interconnected systems and power pools that are in existence today. There are a total of 680 circuit components for representing generators, transformers, transmission lines, and loads.

The purpose of the calculator is to simulate electronically actual power generating and distribution systems, and to provide information regarding operating conditions and results. A power utility company, for instance, could use it in planning a new installation or in modifying an existing set-up, since the calculator would "predict" what would happen if certain changes were made.

Newest feature of the calculator is individual load regulation for the 36 generator units. A preset value of watt output can be held on each generator unit, irrespective of the rest of the system. As a result of this feature, electric utility systems set up in miniature on the device can be operated much like their prototypes; a fixed load is set for each generator in the system except the "swing" unit, which is adjusted to take up the slack. This saves many time-consuming adjustments previously required to divide load properly among calculator generators.

All circuit components can be measured from either of two instrument desks. The calculator can be divided into two completely separate units for handling smaller problems.

The new calculator replaces an earlier model built in 1942, which replaced a still earlier one installed in 1929. The calculator is available on a rental basis to electric utility and industrial companies. **END**

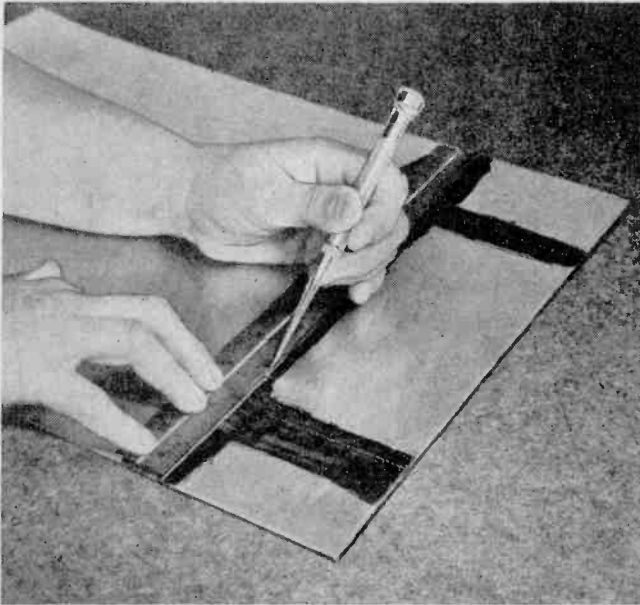

Fig. 1. A scribe and straightedge are used to lay out a basic pattern on sheet metal. Layout fluid is used.



# How to



Fig. 2. Basic layout pattern for channel-type of chassis base.

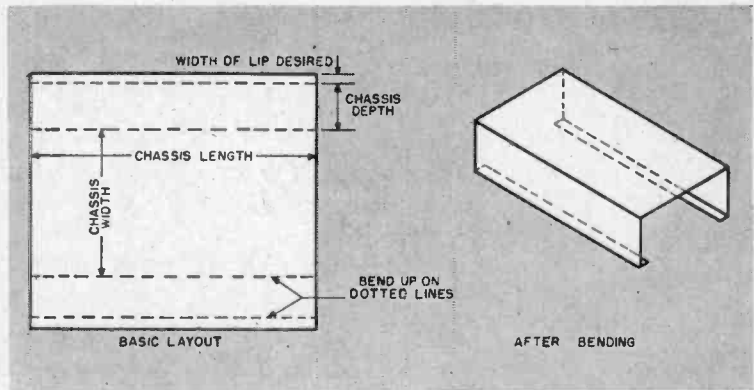
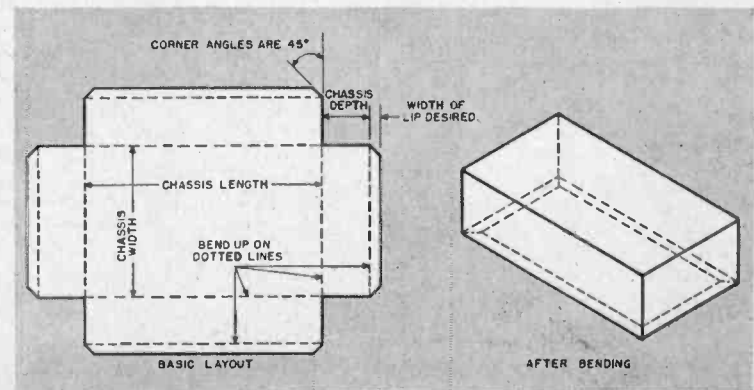

Fig. 3. A box-type chassis is made using a layout of this type.



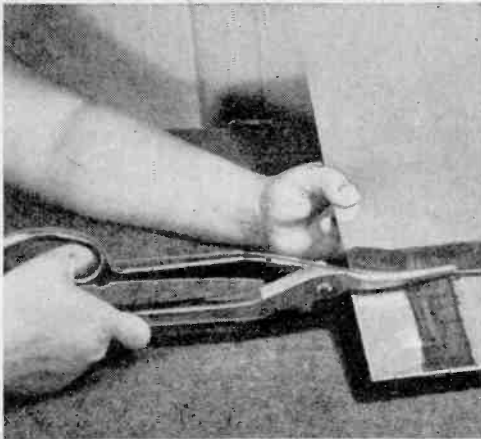

Fig. 4. A pair of hand shears are used to cut the sheet metal, following the scribed lines.

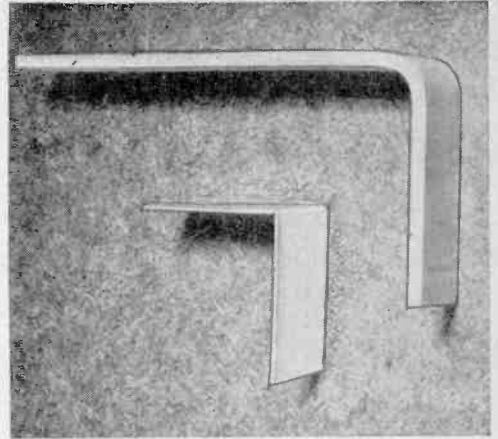

Fig. 5. Two of the basic sheet metal bends, the "right angle" (left) and "radius" (right) bend.

# Bend and Form Sheet Metal

**WHETHER** you want to shape a simple bracket or shield or make a "custom" chassis for a large television receiver, you'll need at least a nodding acquaintance with sheet metal bending techniques.

The first step—no matter what you are planning to build—is to lay out the pattern on a piece of sheet metal. Use the special "layout fluid" to stain the metal, then mark the pattern desired using a scribe, straight-edge, and square, as shown in Fig. 1.

If you're making up a chassis, you can use one of the two basic patterns shown in Figs. 2 and 3. The layout pattern for a *channel* type chassis base is shown in Fig.

2, while a *box* type chassis layout is given in Fig. 3. Choose dimensions to suit your own requirements.

Several modifications of the basic patterns are possible to meet special needs. The lips may be omitted, for example. On the other hand, if considerable strength is required, additional lips along the sides may be provided for the channel chassis. In the case of the box chassis, an extra lip may be left on each apron, to be lapped over and welded or bolted to the adjacent side after bending.

When the basic layout is completed, cut out the pattern. Hand shears may be used

Fig. 6. How a special sheet metal tool can be used to bend a small, lightweight chassis.

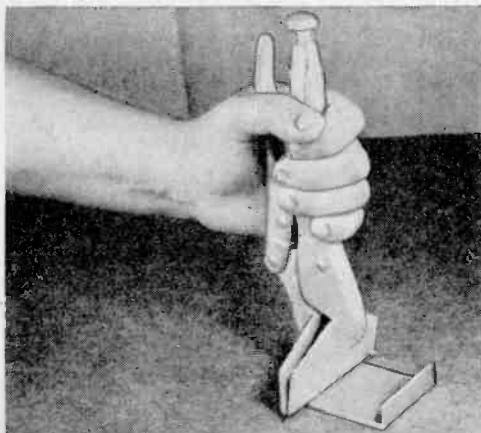
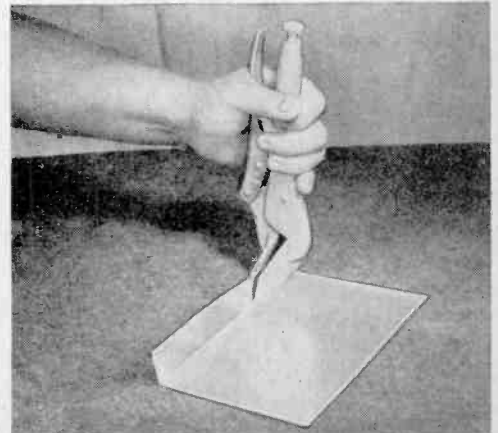

Fig. 7. Using the same special tool to bend a larger chassis by making repetitive bends.



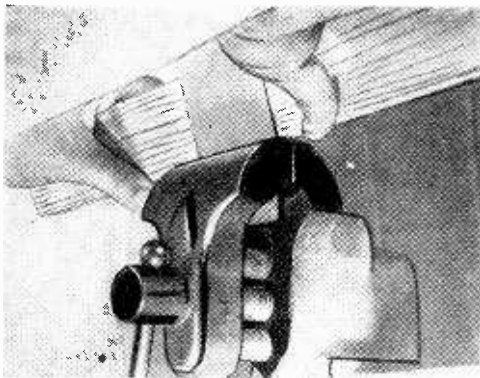

Fig. 8. Bending sheet metal in your bench vise.

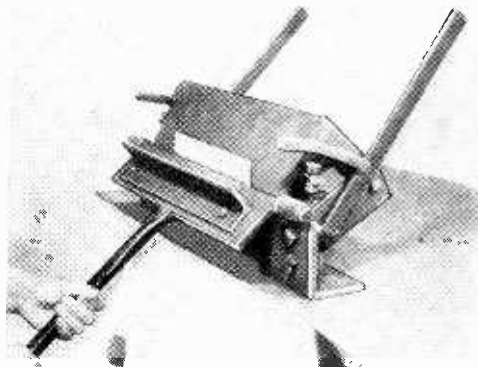

Fig. 9. How special sheet metal "brake" is used.

to cut thin metal, as shown in Fig. 4. Use a hacksaw, a jig saw, or a notching punch for cutting heavier metal. If tube socket, transformer, or mounting holes are needed, they should be made at this time, unless you are making up an assortment of "stock" chassis or brackets for future use.

Two basic sheet metal bends are shown in Fig. 5. The sharp "right-angle" bend shown at the left may be used with thin, soft metals. The curved "radius" bend shown to the right is mandatory for thick material and harder metals to prevent cracks and breaks in the material.

A standard sheet metal tool may be used to make small chassis bases and brackets as shown in Fig. 6. Work the metal against a smooth, flat, hard surface. A workbench top is suitable if covered with hardboard (such as *Masonite*). Be sure the metal is grasped tightly by the tool before applying pressure to make the bend.

Such a tool may also be used to make larger chassis bases by making repetitive bends, as shown in Fig. 7. Advance the tool along the metal after each partial bend, allowing plenty of overlap. In this

manner minimum distortion is introduced.

You can bend small pieces in your workbench vise if you use the technique shown in Fig. 8. Make sure the sheet metal is held firmly in the vise with the line along which the bend is to be made positioned carefully across the top edge of the vise jaws. If the metal is thick, allow a little extra for the material used in making a radius bend.

Place a piece of hard wood behind the metal and bear forward, as shown in the photograph. Be sure contact between the wood and sheet metal is maintained at all points.

A standard sheet metal brake, such as the one shown in Fig. 9, may be used if available. It can sometimes be borrowed from a local sheet metal shop.

Sheet metal may also be bent by using an angle block in conjunction with a wedge as shown in Fig. 10. Such a tool is called a "press brake."

If you are working with fairly heavy metal strap, such as making chassis supports or large transformer brackets, you can bend the metal on a small anvil as shown in Fig. 11. END

Fig. 10. A press-brake can be used but it requires application of heavy pressure.

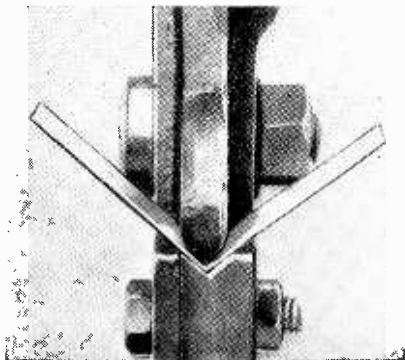
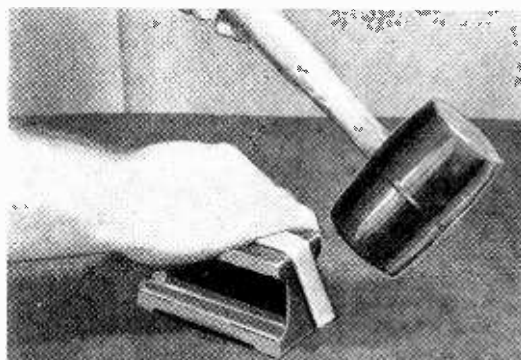

Fig. 11. Heavier metal may be formed over an anvil. Use rubber or rawhide mallet to avoid marring the metal.



# Build this Photoelectric Rifle Range



By BYRON G. WELS

Here is the perfect "ice-breaker" for your next party! Bells ring, pictures pop up—recording "hits".

**WE ALL KNOW** that wherever a pellet, shot, wad, missile, or projectile is required for target practice, the shooter may hurt himself or somebody else.

Here is a weekend project that will keep both you and the kids well occupied for hours afterward. The rifle and/or pistol can be constructed as realistically as you choose, or as simply. The most attractive part of this is that the only "bullets" the guns use are beams of light and light has never been known to knock over vases, punch holes in closet doors, or in other ways destroy property in the manner that we associate with small bore guns or air rifles. In fact, you can aim this gun directly into the human eye and pull the trigger. The most it can make you do is perhaps blink a little bit.

When selecting materials for the rifle and pistol, allow your imagination to run riot. We glued a cardboard mailing tube to a .22 caliber rifle stock, and have also converted five-and-ten-cent store toy rifles. You can go all out and make a really fancy rifle out of ordinary copper tubing of the correct diameter connected to a walnut

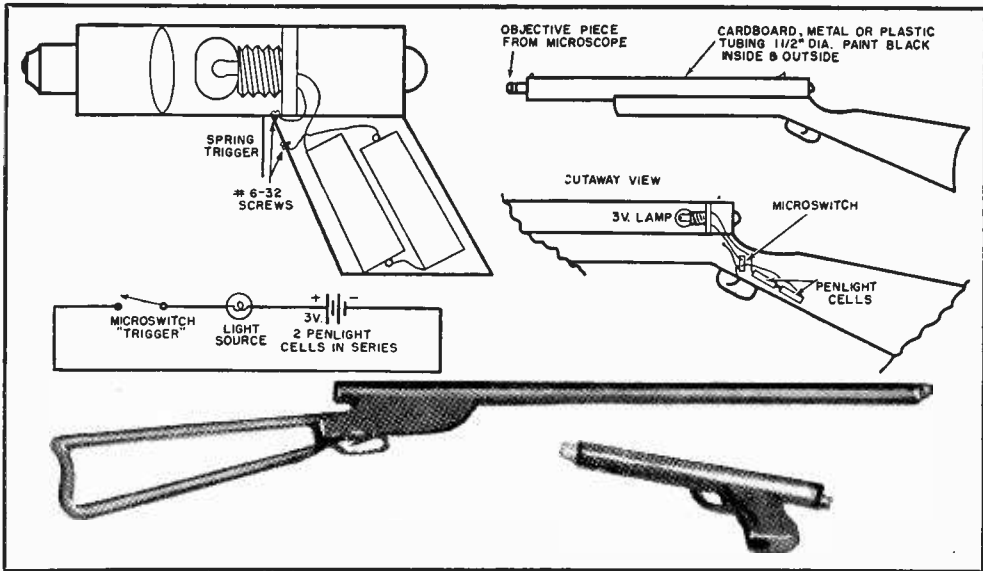

Construction details on the "rifle" and "pistol" to be used with the range. Closeup views of both "firearms" are also shown. A wide latitude is permitted in building these "weapons."

rifle stock that you can finish yourself. The pistol requires more work. Some of the plastic toy pistols are almost perfect as they are. Particularly good are the plastic "space" pistols, as many of them boast a large diameter barrel. In any case, remember to paint the inside of the barrel black, to avoid reflection of light.

The batteries should be mounted internally, out of sight. It is a good idea to lay out roughly where you want to mount the various component parts, and then wire them before installation in the "weapon." In selecting the location for the batteries, take care to place them where they won't throw the "gun" out of balance.

The trigger, of course, is merely an electrical switch. The diagrams illustrate a complex system using a "Microswitch" for the rifle. The pistol is triggered by pressing a piece of spring steel or phosphor bronze against an ordinary screw or bolt.

The lens system is also fairly arbitrary. Perhaps the best source of lenses would be a discarded projector, microscope, or telescope. If none of these is available, cheap magnifying lenses of the convex type are available at most five-and-ten's in the toy department. The placement of the lenses is, of course, critical. However, this will vary with the application you desire for your range. The best way to establish the placement is to mark off a distance of perhaps fifteen feet from the target, and aim the gun at the target. Press the trigger and hold it down, while you adjust the lens, until you see a pinpoint of light. Vary the lens setting until the light is as sharp as

you can get it. If you do all the shooting from this distance, all will go well. In mounting the lenses in the tube, care should be taken that no glue gets on the lens surfaces, as this will tend to attenuate the light and distort it. The rear lens should be mounted fairly close to the light bulb, and the front lens should have provision for sliding it in and out of the barrel for necessary adjustments.

In painting the target face, take care to use flat paint, as a miss on the bullseye will show up better, facilitating scoring. The bullseye should be a 1" diameter hole, and the chassis for the photocell and amplifier should be mounted directly to the back of the target face, with the photocell facing the hole.

Here's how the circuit works: squeezing the trigger on the "gun" sends a beam of light to the target. The circuit is mounted behind the target so that the 927 tube is directly behind the bullseye opening. When light hits the 927 it causes the 927 to conduct current. This current, coming up through resistor  $R_3$ , drives the grid of the 6AQ5 more positive thus causing the 6AQ5 tube to draw current. Current flowing through the plate circuit of the 6AQ5 will energize relay  $RL_1$  and close its contacts. With the contacts of  $RL_1$  closed, current is supplied to the bell which will ring.

$R_2$  is a potentiometer whose resistance can be varied. It serves as a light-sensitivity control. Turning its knob so as to increase the resistance it provides in the cathode circuit of the 6AQ5 means that

(Continued on page 40)

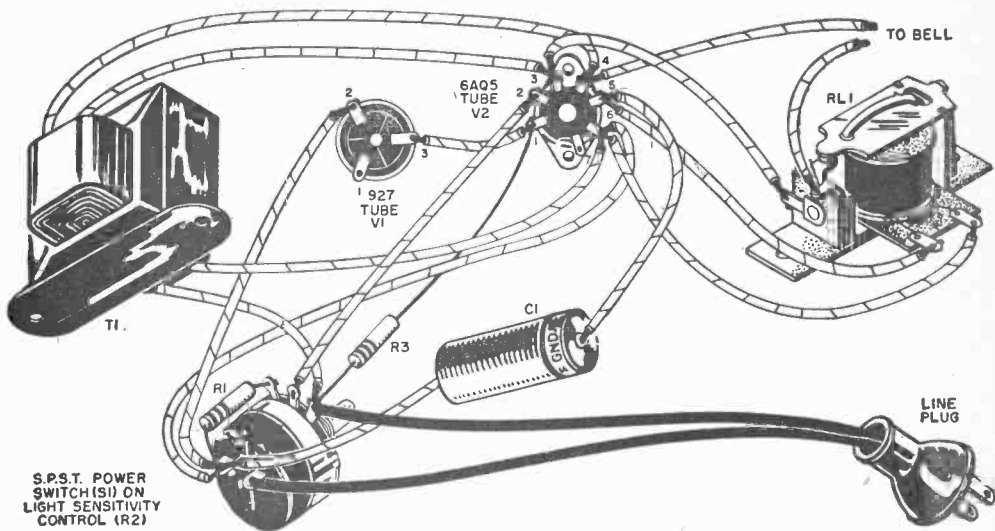

S.P.S.T. POWER SWITCH (S1) ON LIGHT SENSITIVITY CONTROL (R2)

- R<sub>1</sub>—500 ohm, 2 w. res.
- R<sub>2</sub>—3000 ohm wirewound pot, linear taper
- R<sub>3</sub>—20 megohm, 2 w. res.
- C<sub>1</sub>—6  $\mu$ d., 150 v. elec. capacitor
- T<sub>1</sub>—Trans. 117 v. pri., 6.3 v., 3 amp. sec.
- RL<sub>1</sub>—4000 ohm relay, s.p.s.t. normally-open contacts (a s.p.d.t. type relay is more readily available than the type specified. It can be used in this circuit by leaving the second contact unconnected)
- S<sub>1</sub>—S.p.s.t. toggle switch (on R<sub>1</sub>)
- Bell—6.3 volt electric bell
- V<sub>1</sub>—927 phototube
- V<sub>2</sub>—6AQ5 tube

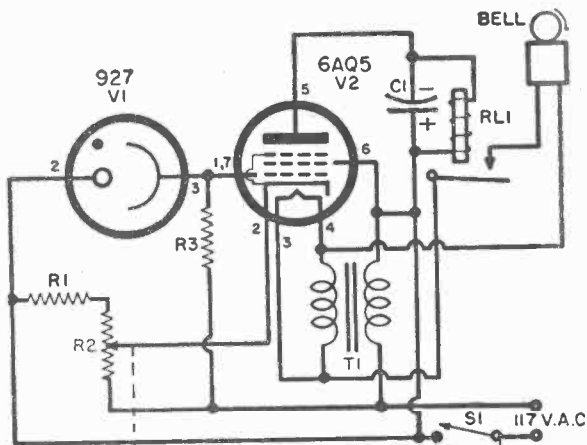

Schematic diagram of photocell unit which is activated by the light "shot" by the "rifle" or "pistol." Hits can be recorded at distances up to 15 feet. This entire circuit is mounted directly behind the "bull's-eye" in the range's target.

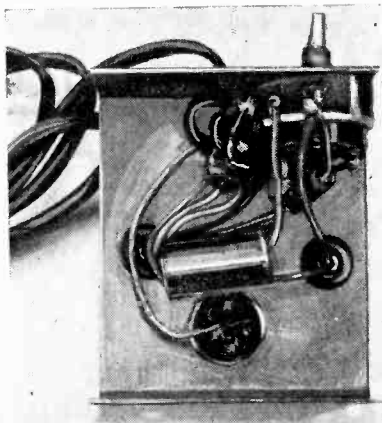

Under chassis view of the photocell unit. All lead wires should be short and run direct. Be sure all joints are well soldered.

How the photocell unit is mounted on back of target. A flat paint must be used on target face. Bull's-eye is 1 inch.

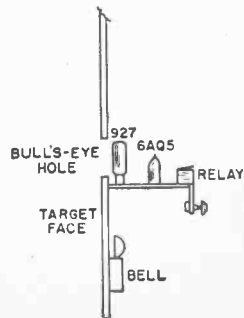

the 927 will need *more* light to activate the circuit. In terms of "shooting" at the target, this means you should stand closer to the target. Decreasing the resistance of  $R_2$  permits a weaker light on the 927 to ring the bell and enables you to stand further back from the target. Of course, if you change your distance from the target, you may have to change the focusing adjustment of the lens. If the resistance of  $R_2$  is much too great, the circuit may not be energized, even with the maximum possible amount of light on the photocell. On the other hand, if the resistance of  $R_2$  is much too small, the circuit may be energized all the time, even with no light on the photocell.

When light strikes the phototube, current flows through  $R_3$  and the phototube in such a direction as to make the grid of the 6AQ5 more positive, resulting in an increase in plate current.  $R_1$  establishes the maximum grid-cathode bias which can be obtained.  $T_1$  is a simple filament transformer which supplies 6.3 volts to the heater of the 6AQ5 tube as well as to the bell.

After you complete this unit, you will want to try it out. These gadgets make a really big hit at a party. Men and women alike get in line to "shoot." When the bell does ring, the guests act like a bunch of kids.

One friend of ours liked the idea so well, that he made two targets. One of them, with the bell, serves to amuse his kids. The other target doesn't have a bell at all. Instead, the relay operates a slide projector. The target is merely a large white piece of cardboard, with the hole and photocell mounted near the bottom. Our friend loads the projector with pin-up pictures, and every time a bull's-eye is made, the picture changes. This has gone over so well that he

is often asked to bring it along to other people's parties as well.

The unit is best used in a subdued light, or where no direct light other than that from the gun, can fall on the target.

Another variation which pleases the youngsters, is to mount a stepping relay behind the target face, and in addition to the bull's-eye, cut an opening near the top of the target, behind which is a wheel. On the face of the wheel glue pictures of various animals cut from magazines, and each time the bull's-eye is hit, another animal will pop into view.

The possibilities of this device are endless. Another interesting variation is to set up a current interrupter, of the type used with Christmas tree lights. A slight change of the basic design makes the rifle over into a sub-machine gun, and as long as the trigger is held down, the light will blink on and off.

If you care to invest a little more money, use a switch of the momentary-contact type, since the ordinary switch will remain "on" as long as the "trigger" is held. This permits a sneaky sort of gunman to hold the trigger and move the light until the bull's-eye is hit and the bell rings.

Construction is fairly simple. Lead wires should be short and direct, and all joints well soldered. To test the finished photocell and amplifier, use as a light source a penlight flashlight that has a pre-focused bulb.

It is likely that most of the parts for this project can be found in a "junk-box." The particular brands listed in our parts list were the ones the author used. Any parts of identical electrical value will, of course, serve just as well.

Take your time wiring the unit and put it together with care. If and when you can get the kids away from it, you'll enjoy many hours of "happy hunting." **END**

The author tests his handiwork. Batteries in the gun stock give the weapon life-like heft.

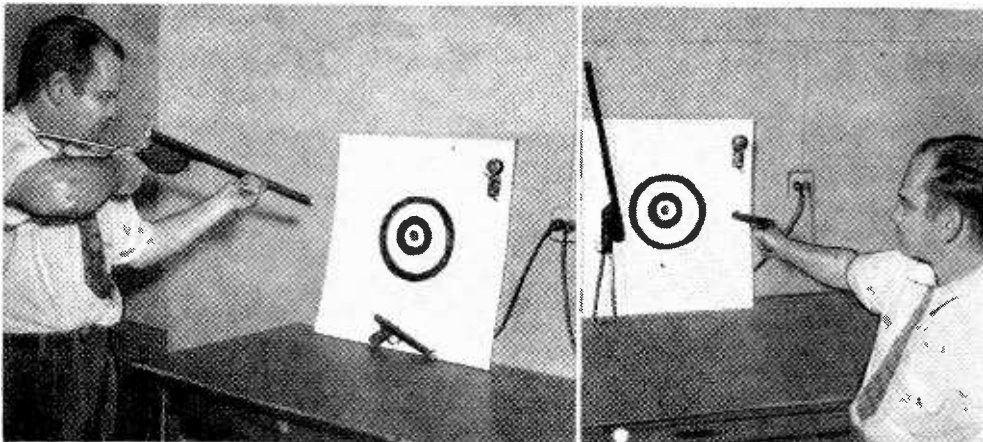



# So You Want to be a Ham-

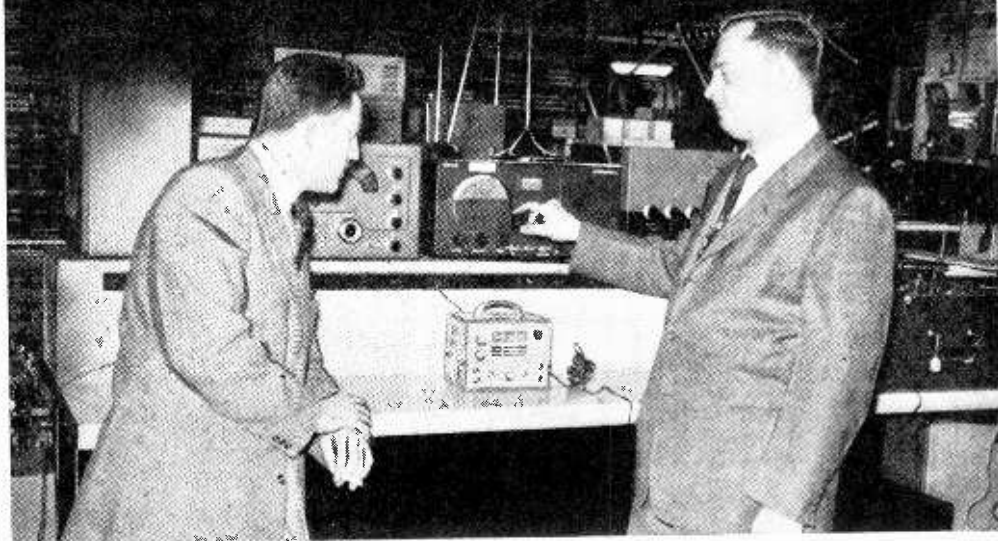

Jobbers usually have representative receivers in operation. Here Lester Klein of Hudson demonstrates a set to interested amateur.

## Buying a Communications Receiver

By ROBERT HERTZBERG, W2DJJ

*Part 4. You have a wide choice of sets—all good in their particular price ranges—so shop carefully.*

A GOOD short-wave receiver is the foundation stone of an amateur radio station. It's an investment that pays off over a period of many years in the form of pleasure, entertainment, and excitement. Literally, the world is at your finger tips as you turn its knobs.

Of the eighteen communications type "short-wave" receivers now on the market, all but one are actually "all-wave" in their tuning coverage. The term "short-wave" is generally understood to mean all frequencies higher than the standard amplitude-modulated (AM) broadcasting band, which goes from 535 to 1605 kilocycles. The term "all-wave" applies to sets that cover both the broadcast band and the various high-frequency bands up to about 40 megacycles.

At first sight, there appears to be no logical reason to include the broadcast band in a receiver intended primarily for short-wave reception. It's done because it adds very little to the cost but a great deal

to the sales appeal of the set. Actually, the broadcast range becomes a convenience when you want to catch a quick news flash, a local weather report, or a time signal. It saves you the bother of getting up from your table and going into another room to turn on the family radio.

The quality of a communications receiver, in a broad way, is measured in three terms:

*Sensitivity or gain.* This is the ability to respond to weak signals. Coupled with this must be a low internal noise factor.

*Selectivity.* This is the ability to separate stations on close-by frequencies.

*Stability.* This is the ability to "stay put," without requiring constant readjustment of the controls to hold a signal steady.

Sensitivity and selectivity are determined largely by the number of tubes and associated tuning circuits. Stability is a matter of circuit design and automatic temperature compensation of components.

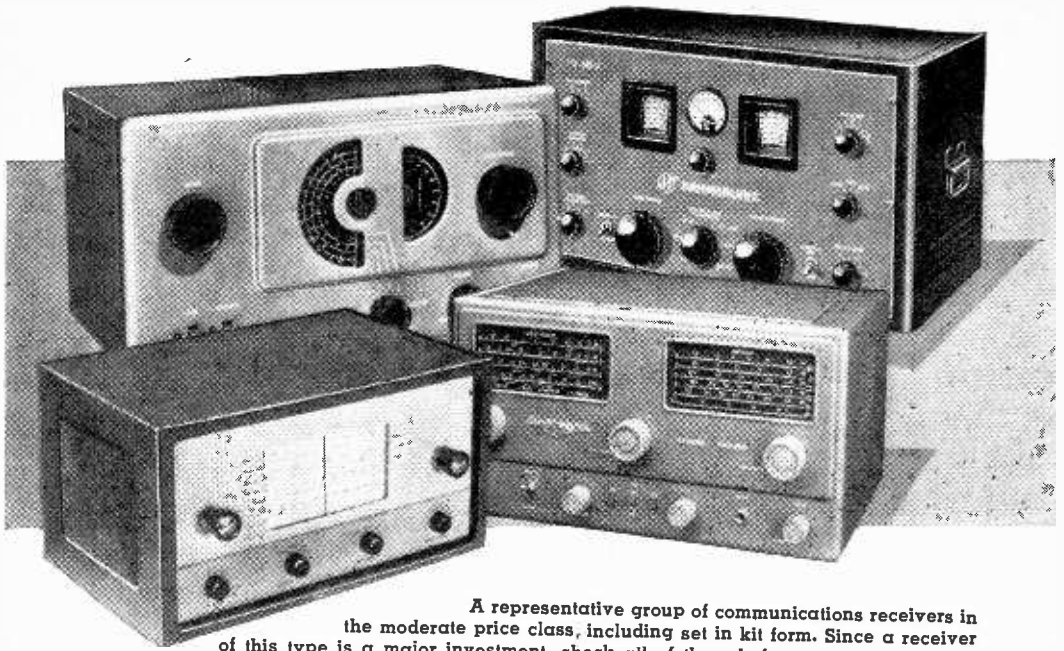

A representative group of communications receivers in the moderate price class, including set in kit form. Since a receiver of this type is a major investment, check all of them before you actually buy.

Amateur receivers have gone through a long period of development and refinement. The 1954-55 models are noted for their precision, reliability, and high level of performance. You can buy one now with the assurance that it will still be giving good service ten or more years from now.

There are five major manufacturers of communications receivers, *Collins, Hallcrafters, Hammarlund, National, and RME*. These are all old, established firms with well-earned reputations for technical accomplishment, and you're safe with any of them.

With their numerous knobs, dials, lights, switches, levers, meters, etc., short-wave receivers have great eye appeal to gadgeteers, of whom the ham is the highest type. It's easy to fall in love with all of them. What you have to decide in advance is your dollar limit. Then, when you visit a radio jobber to drool over the sets and fondle their controls, you can save your time and the salesman's by limiting your attention to a particular price group. If you don't buy on your first visit, the jobber won't mind. He realizes that a communications receiver is a major investment for a new ham, and he'll welcome you back on your next shopping tour. Almost without exception, jobber salesmen in the receiver department are hams themselves, and they'll be sympathetic and understanding.

From the manufacturers directly or from the jobbers, you can get detailed descriptive literature. What you won't find anywhere in print is a breakdown of re-

ceivers by price classification, so this is presented herewith for your guidance. One feature of the list will strike you immediately, and is very significant: There are more high-priced receivers than low-priced ones. In the deluxe "Above \$300" group are seven sets; in the "Under \$100" only two! The correlation between prices and numbers of tubes is also notable. The average numbers of tubes in the price groups run like this: "Under \$100," 5; "\$100 to \$200," 9 3/5; "\$200 to \$300," 12 2/3; "Above \$300," 18.

Because more people like the better sets than the cheaper ones, we'll start at the top. (Prices are approximate.)

#### Above \$300

\$1075. *Hammarlund SP-600-JX*: This 20-tube set was developed originally for the government services and is now on the commercial market. It is a double-conversion superheterodyne, and covers the range of 540 kilocycles to 54 megacycles in six bands, selected by means of a front panel knob. Operation on any of six crystal-controlled fixed frequencies within the range of the receiver is also available. Stability is of a very high order, and very accurate logging and resettability are possible. A crystal filter gives fine control of selectivity to meet interference conditions. Main and vernier tuning dials are controlled from one knob.

\$975. *Hallcrafters SX-73*: Like the *Hammarlund SP-600-JX*, this is essentially a military receiver in commercial dress.

Performance characteristics are practically the same too. Built for mounting in standard 19" racks.

§595. *Hallicrafters SX-88*: A 19-tube receiver, tuning from 535 kilocycles to 33 megacycles in six ranges; bandswitch on front panel. A double-conversion set, with two r.f. stages, crystal-controlled second conversion oscillator, and precision gear-drive tuning. Electrical bandspread dial is calibrated for the top seven amateur bands. Handsome black and gray appearance.

§534. *National HRO-Sixty*: A long-time ham favorite, in its most up-to-date version. Unique among "all-wave" receivers in that it uses plug-in coils instead of coil switching. An 18-tube, dual-conversion job, with accurately calibrated tuning and high order of sensitivity, selectivity and stability. After brief warm-up period, operation is completely free of drift. Plug-in coils provide general coverage from 1700 kilocycles to 30 megacycles or bandspread on amateur 80, 40, 20, and 11-10 meter bands. Other coils available for lower frequency reception.

§530. *Collins 75A-3*: Embodying the most advanced receiver engineering, the 75A-3 is strictly a ham job and nothing else. It covers the 10, 11, 15, 20, 40, 80, and 160 meter bands, and only those bands. As the band change selector is turned, a calibrated tuning scale appears in the long, shallow window in the top center of the front panel. The tuning mechanism is smooth and entirely free of backlash. Stability and frequency accuracy are assured by the use of a precision crystal oscillator in the first conversion circuit. The 75A-3 is the only receiver that contains a mechanical filter, for selectivity purposes, in addition to the conventional crystal filter. A 3 kilocycle filter is standard equipment, and an 800-cycle unit can be plugged in as an optional accessory if maximum selectivity on c.w.

reception is desired. Operating the 75A-3 is a novel experience for anyone accustomed to other types of receivers. Because of the mechanical filter's straight sided selectivity curve, signals appear and then disappear suddenly as the tuning knob is turned; there is neither a weak preliminary signal nor a weak tail-end one.

§495. *Hammarlund Pro-310*. A dual conversion receiver, and this organization's newest entry in the ham field. Continuous coverage from 540 kilocycles to 34 megacycles in six ranges. Printed circuit r.f. section. Logging tuning scale. A highly sensitive job in a very modern type cabinet.

§400. *National NC-183D*: A brother to the HRO-Sixty, but uses fixed coils with bandswitching from the front panel. General coverage from 540 kilocycles to 31 megacycles and 47-55 megacycles in five ranges; calibrated bandspread for six ham bands. Double conversion, with crystal filter for selectivity control. Rigid construction. High order of stability furnished by temperature-compensated tuning elements and voltage regulator tube.

§350. *Hallicrafters SX-62*: This is an "all-wave" receiver intended more for the short-wave listener than for the ham. It covers the unusually wide range of 540 kilocycles to 109 megacycles. Has a 500 kilocycle calibrating crystal and a high-fidelity audio system. Provides FM reception on two highest bands. Has a beat-frequency oscillator so that owner can  
(Continued on page 105)

A complete amateur station needn't occupy too much space. David Talley, W2PF, of Brooklyn, uses a table in the kitchen.

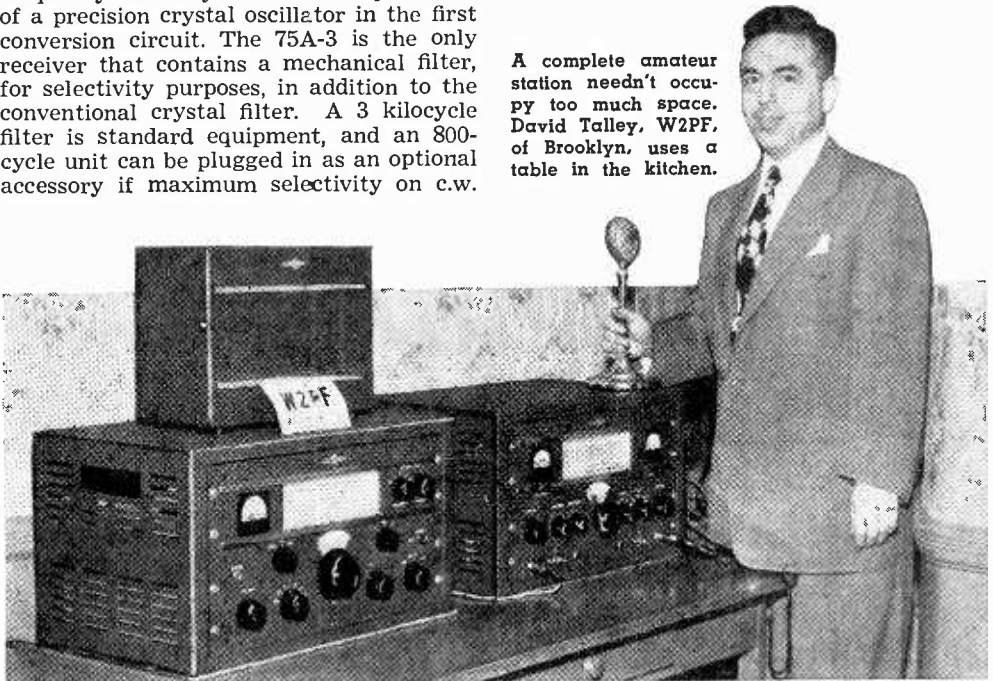



By MAJ. EUGENE F. CORIELL, USAF  
 Armed Forces Radio Service, N. Y.

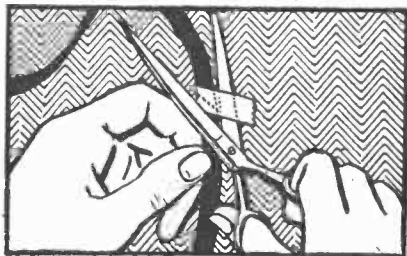
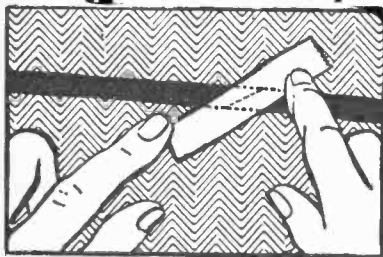

# Tape Tips

←  
 Fig. 1. Steps in splicing recording tape without a splicer block. (Top) Both ends of tape are held and cut at an angle of 30 to 45 degrees. (Middle) Ends are butted together and special splicing tape is applied to joint. During operation, tape edges should be placed against straightedge to preserve original tape alignment. (Left) Excess splicing tape is trimmed off, cutting into recording tape slightly.

**WE HEAR** a great deal about the ease and simplicity of making of tape recordings—"anybody can do it"—and it's true. However, the very simplicity of the process often causes some basic points to be overlooked, with disappointing results. This article discusses precautions and techniques for the home recordist regarding the use and handling of the tape itself.

## Selection and Handling

In general, use the type of tape recommended by the manufacturer of your machine. If no particular type is specified, remember that plastic-base tape, while more expensive than paper-base, has important advantages. It doesn't break as

easily, it causes less noise, and lies flatter against the recording head. This last is important as regards minimizing distortion and reproduction of the higher tones. While both paper and plastic base tapes are available with either red or black oxide (the dull coating on the active side of the tape), red oxide is considered better for general use. If frequent tape breakage cannot be remedied by adjustment of the recorder—a very unusual condition—tape made with a *Mylar* film base will do the trick but costs more than standard plastic-base tape. For recorders which have fallen off in output (why not have them repaired?), or machines with an inherently high noise level, there is a spe-



cial green plastic-base high-output tape (Scotch type HO).

It is often said that, unlike disc records, tape recordings can be played repeatedly without deterioration. This is true in the sense that musical quality will not suffer and the noise not increase—provided the tape is not mechanically or magnetically damaged in use. If the tape should become stretched due to inherent defects or excessive tape tension or other mishandling, or should curl or “cup,” it will not lie flat against the head. This will cause loss of the higher tones to some extent. If the tape should be exposed to extraneous magnetic fields, there may be an increase in the background noise, and in extreme cases, partial erasure of the program. The effect of such fields is discussed more fully in the section on storage. The tape can also be damaged by the solvent action of the carbon tetrachloride used to clean the heads. The heads should therefore be cleaned and wiped dry with the tape removed from the machine.

### Tape Erasure

One of the advantages of tape recording is that previously recorded material on the tape is automatically erased during the next recording by the erase head located just ahead of the recording head. However, very loudly recorded material is sometimes hard to erase, especially on black oxide tapes. In such cases, run the tape through the machine with the volume control turned all the way down and the controls in the “record” position. This will erase most of the old program material, and the remainder will be removed during the next recording operation. However, the best remedy for the home recordist obviously is prevention—don’t record at excessive loudness levels. The professional studios use a “degausser.” This is a large, a.c.-operated electromagnet on which the entire reel of tape is placed for quick erasure in bulk; hence its more familiar name, “bulk eraser.” Smaller models are now available for home use. Degaussers should be used in accordance with the manufacturer’s instructions since their improper use may leave the tape noisy. Most

home recorders are of the double-track type which permits a separate recording on each edge of the tape. While a recording made on a single-track machine can be played back fairly well on a dual-track unit (usually), and *vice versa*, erasure on the wrong type recorder will generally be incomplete.

### Tape Splicing

Everybody knows that tapes can be spliced together to assemble a program or to repair a break. However, some home recordists forget, as they carelessly stick the tape ends together with transparent mending tape, that for practical purposes, the splice must be as good as the original tape, mechanically and magnetically. Otherwise, there will be a noisy “plop” as the splice goes past the head, and/or the adhesive of the sticker tape may bleed out to other tape layers on the reel, causing uneven tape travel or gummed oxide surfaces on the tape. A defective splice may also come apart—an unforgivable sin in tape recording. The best splice is the butt splice made on an angle of 30 or 45 degrees. It is prepared by angle-cutting both ends simultaneously with scissors, butting the ends together in exact alignment, and applying a piece of special splicing tape (Scotch #41) firmly across the joint. The excess splicing tape is then trimmed off, cutting very slightly into the recording tape on both edges to make the splice flexible. While splicing can be done entirely by hand as shown in Fig. 1, it is much easier to use a small tape splicing block (see Figs. 2 and 3) which keeps the ends of the tape in alignment. Be sure you don’t end up with the shiny side of one end spliced to the dull side of the other.

Fig. 2. The Carson tape splicer, an inexpensive unit for home recordists and tape engineers.

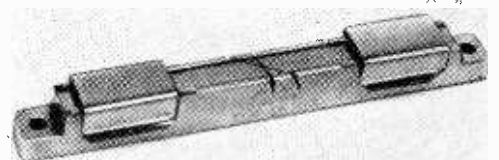

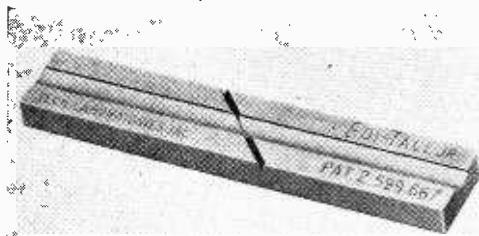

Fig. 3. The "Edi-Tall Jr.," another tape splicer designed especially for home recordists.

Also, it is a good idea not to splice together two different kinds of tape unless their recording characteristics are very similar; otherwise the tonal quality and the loudness may not be the same on the two tapes.

### Tape Storage

The satisfaction you get from your tape library depends to a very considerable extent on the care used in storing the tapes. They should be stored on edge—never flat—and always in their original boxes or in steel cans. The latter can be sealed with adhesive tape to keep out excessive humidity; on the other hand, extreme dryness may cause the tape to become brittle and cracked. If tapes are to be stored for a

long time, don't use high-speed re-wind. If your machine cannot be made to re-wind at slow speed, store the tapes without re-winding. This avoids the creation of stresses in the tape. Tapes should not be stored in a very warm room. Such storage may make it difficult to obtain complete erasure later, which suggests that spare tapes should have their old recordings erased before storage. Warm storage may also aggravate the tendency for recorded material to be transferred from one tape layer to another, which may cause echo or increased background noise. Such transfer or "printing" is further aggravated by exposure in storage to the magnetic fields from electric motors, transformers, and power circuits. Such fields may also increase the noise level as mentioned earlier; however, storage in the steel cans suggested provides adequate shielding from magnetic effects. It is important to note that the use of magnetized tools such as screwdrivers near the tape or the recording head may induce enough magnetism to cause noise on the tape.

Observance of these simple suggestions, which are standard procedures with professional recordists, will pay big dividends in the satisfaction you derive from your home tape recorder. END

## Electronic Detector Probes Brain

THE secrets of the brain, even of the sleeping brain, are being revealed with the aid of electronic detectors and their associated equipment shown in the photo below. At the National Institute for Mental Health, near Washington, D. C., scientists have been mapping areas of the cerebral cortex (outer layer of gray matter of the brain) of ani-

mals. Their findings may be applied to improve human brain surgery techniques.

Measurable electrical signals show, for instance, that the brain of an anesthetized animal may be aware of things going on, although the animal itself is in deep sleep. Such a brain has been found to register awareness of extremely subtle stimuli, such

as the "noise" made by random movements of air, or the sensation of "touch" that has been excited by ordinary conversation.

The electrical results of the activity are observed and recorded by a cathode-ray oscillograph. The specially designed equipment for stimulating and controlling the responses utilizes more than 160 vacuum tubes.

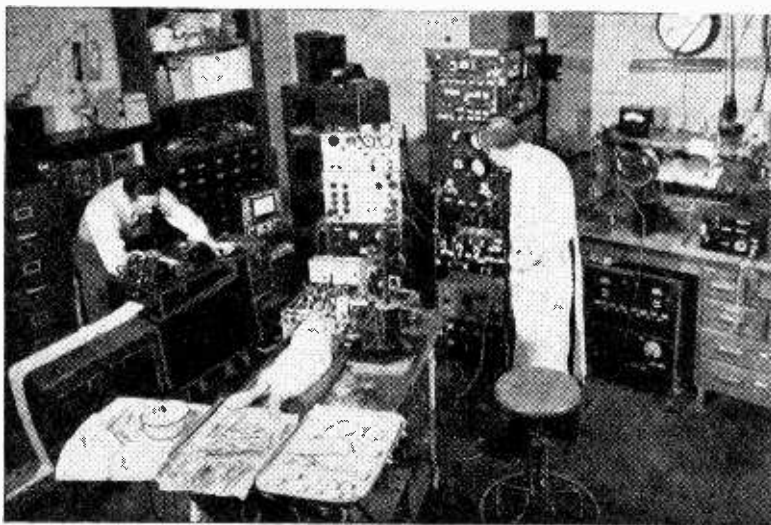

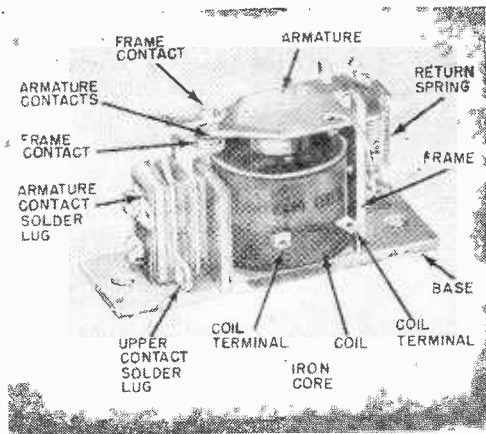

Fig. 1. The chief parts of a typical relay.

# How To Choose The Right Relay

By HARVEY POLLACK



ALL over the world, the click of magnetic relays may be heard any time of the day or night. A marine radio operator touches his press-to-talk button and a half-dozen relay armatures whack into position, switching his antenna from receiver to transmitter, applying power to oscillator, buffer, final amplifier, modulator. A patient crosses the threshold of a physician's office and a relay at the doctor's desk actuates a discreet annunciator chime. A power station timer registers 6:00 p.m., and hundreds of relay armatures flash into position and street lights all over town come to life.

What is a relay and what does it do? What differences exist between relays and how are these variations specified? How can one choose a relay intelligently for a certain job?

A relay is simply a *magnetic switch*. It comprises a *coil* wound around an *iron core*, a moving *armature* which is magnetically attracted to the core when proper current flows through the coil, and two sets of *contacts*, one on the armature and the other fixed to the frame. Most relays are equipped with a *return spring* that keeps the armature in its non-actuated position when the coil is not energized. See Fig. 1.

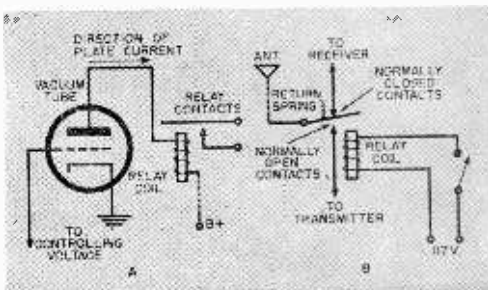

Fig. 2. Relays may be used to do many jobs which cannot be performed by manual switches.

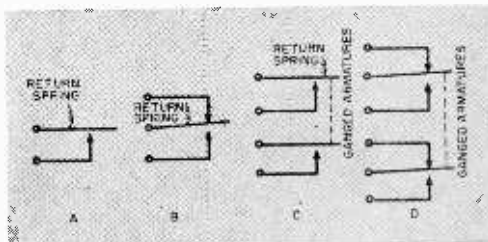

Fig. 3. Relays may be of either single- or double-throw type and have one or more poles.

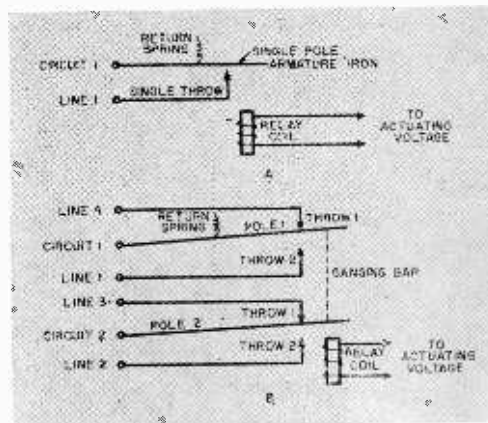
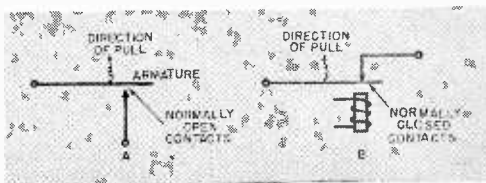

Fig. 4. Single-throw relays open or close circuits; double-throw relays transfer them.

Fig. 5. The contacts of a single-throw relay are either normally open or normally closed.



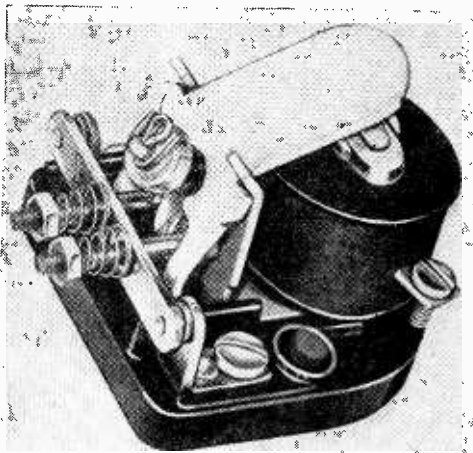

Fig. 6. A relay to control the starting coil of a motor (Potter and Brumfield Type MS-4A).

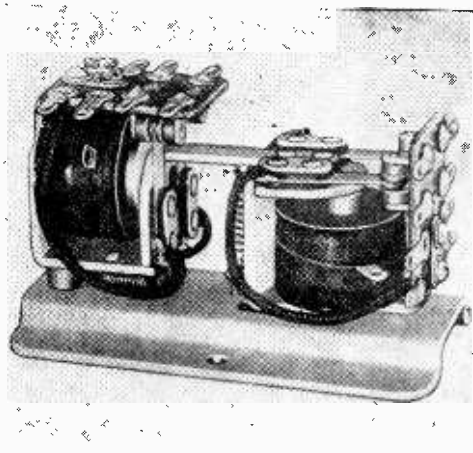

Fig. 7. A latching relay can be energized by a pulse, then must be de-energized by another.

Relays are used to replace manual switches under two general conditions:

(1) A current or voltage which, because of its type, magnitude, or frequency, is not suited to operate an electrical device directly, is fed to the relay coil. The armature pulls in and the power is brought to the device through the relay contacts. In Fig. 2A, the plate current changes in the vacuum tube are insufficient to start or stop a large motor but can actuate the relay. The relay contacts then apply power to or remove power from the motor.

(2) Circuits which carry heavy current or high voltage require either very heavy conductors or very well insulated ones. A relay may be employed to switch such circuits remotely without the need for long critical leads to the operating position. This is illustrated in Fig. 2B; here a relay is used to switch an antenna between a transmitter and a receiver.

### Choosing the Relay Coil

Manufacturers' specifications for coils are given in terms of required operating voltage (6 volts, 12 volts, 24 volts, 110 volts, or 220 volts, a.c. or d.c.) or the minimum current necessary for armature pull-in. In the latter case, the resistance of the coil is generally stated.

A standard relay requires more current to pull in the armature than is needed to hold it in. A plate-circuit relay may be rated at 5 ma. pull-in and only 2.5 ma. drop-out. The plate current fluctuation to operate it in a *positive* fashion must range from more than 5 ma. to less than 2.5 ma.

### Choosing the Right Contacts

Although many varieties of multiple-contact relays are used in industry, run-of-the-

mill electronic applications are generally limited to four types: s.p.s.t.—single-pole, single-throw (Fig. 3A); s.p.d.t.—single-pole, double-throw (Fig. 3B); d.p.s.t.—double-pole, single-throw (Fig. 3C); and d.p.d.t.—double-pole, double-throw (Fig. 3D).

The number of *poles* on a relay indicates the number of *movable armature points*. Each pole can handle a separate circuit. The *lines* into which these circuits can be switched depend on the number of *throws*: a *single-throw* type turns each circuit either into or out of a given line while a set of *double-throw* contacts permits each circuit to be connected to one or the other of two lines. Fig. 4 illustrates this idea.

Other important requirements of relay contacts are:

(1) *Normally-open or normally-closed contacts*. Just as these names imply, a normally-open relay opens a circuit when not activated, as shown in Fig. 5A, while a normally-closed relay completes a circuit when no coil current is flowing. This type is illustrated in Fig. 5B.

(2) *Load current through contacts*. Larger load currents necessitate heavier, more durable contacts. The manufacturer's recommendations on this score must be carefully observed.

(3) *Inductive loads*. When the device which the relay operates is a pure resistance, the relay contacts may be smaller than for the same current in a circuit where there is inductive "kick-back." Catalogue specifications are generally very clear on this point.

(4) *Voltage across open contacts*. Relays which must make and break high voltage circuits have greater contact clearance, to prevent arcing, and very fast action particularly on the break, to prevent sparking.



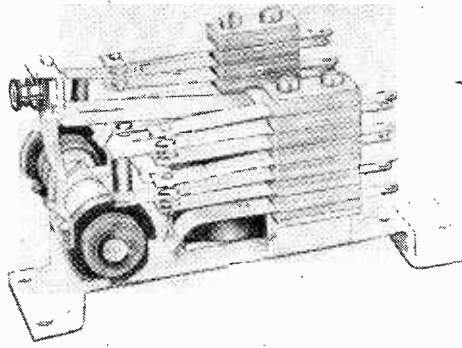

Fig. 8. An impulse relay can control a sequence of operations, depending on its cams.

Some relays for highly specialized jobs are described below:

**Motor starting relay:** (Fig. 6) This relay is used to protect the starting coil of capacitor-type electric motors. The contacts are normally closed and the relay coil is connected across the starting winding. When the motor picks up enough speed, the counter e.m.f. (electromotive force) across the starting coil causes the armature to pull in, opening the contacts and removing the starting coil from the circuit. As long as the motor maintains high speed, the relay remains pulled in but should increased load cause a slow-down, the starting coil is again thrown into the circuit. This adds power and brings the motor back up to speed. Relays like this one have a wide range of pull-in voltages, obtainable by varying the armature gap, and are designed to carry heavy contact currents.

**Latching relay:** (Fig. 7) This relay is

Fig. 9. Telephone type relays feature small size, positive operation, multiple circuits.

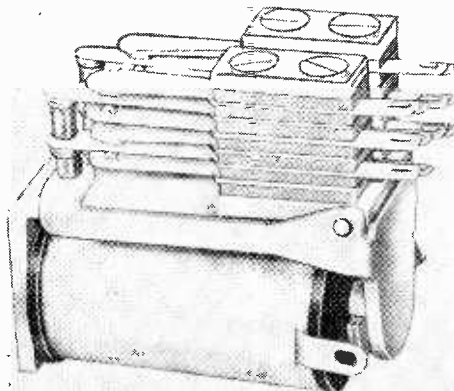

supplied with two coils and provides both electrical latch and electrical release. A short impulse of current to the actuating coil sets the latch which then holds the contacts in place until the release coil is energized. This type of relay can be used to trigger a device into operation and keep it in operation even though the control impulse is very short-lived.

**Impulse relay:** (Fig. 8) An impulse relay of this nature can perform all kinds of tricks. Having multiple contacts operated by molded Bakelite cams, different sets of contacts may be brought into play by adjusting the positions of the lobes. Thus, each successive impulse can start a new sequence of events. Such relays are utilized for control purposes in highly specialized industrial and communications equipment.

**Telephone type relay:** (Fig. 9) The complex switching circuits found in telephone and other communications systems use these relays by the thousands. They feature small size, high coil power to provide maximum contact pressure, and multiple contacts. Normally such units are not used by experimenters, except in certain applications such as the operation of model railroads.

**Multiple-leaf relay:** (Fig. 10) The multiple-leaf relay is similar to the telephone type except for the power-handling capacity of the contacts. The contacts are rated at 5 amperes in this case; the normal rating for telephone relay contacts is only 2 amperes non-inductive.

**Radio control relays:** Tiny sensitive relays are now available which are designed especially for use in radio-controlled model airplanes and railroads. They can be adjusted to provide positive operation with only one one-thousandth of a watt applied to the coil. Yet the contacts will carry up to 2 amperes without pitting. END

Fig. 10. Multiple-leaf relays have higher power handling capacity than telephone types.

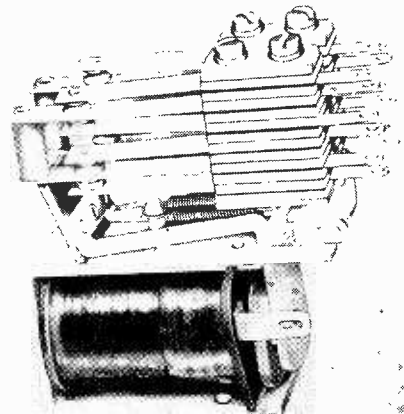



# Hobby Kit Teaches Children Basic Electronics

Two-tube receiver is one of many units and experiments youngsters can enjoy with the new hobby kit.



**T**HE how's and why's of basic electronics are unfolded for youngsters in a new educational hobby kit manufactured for "Industrial America," Inc. by the *Radio Corporation of America*. The kit enables youngsters—with no previous training in electronics—to construct one and two-tube radio receivers and transmitters, chemical batteries, and experiments with sound and electricity.

The electronics kit is the first in a series known as the Educational Hobby Kit program. Launched by "Industrial America," Inc., the program is designed to enable boys and girls to learn-by-doing with the thought that the kits will help youngsters obtain a better understanding of science and industry as well as assist them in choosing careers or lifelong hobbies.

Other industrial concerns in the program and their kits are: *Bauer and Black*, medical training; *Gemological Institute of America*, geology; *American Optical Company*, optics; and *Taylor Instrument Company*, meteorology. A profusely illustrated book of instructions, prepared under the guidance of *Encyclopedia Britannica*, accompanies the kit.

Youngsters working from the electronics kit start by rubbing two pieces of paper to-

gether, thus inducing a flow of electrons. The flow can be detected by a galvanometer built from the contents of the kit. A headset allows the youngsters to hear the electron flow.

By inserting strips of copper and zinc from the kit into ordinary lemon or salt water solution, the child can make a chemical battery. He can then use the battery to power a telegraph and can listen to the message with the earphone.

Additional experiments lead the youngster finally to the stage where he assembles and operates a two-tube radio receiver and a relatively simple low-powered one-tube transmitter.

Contents of the kit include a variable (tuning) capacitor, plate coil, antenna coil, dial, "B" battery clip, ground clamp, wire leads, coil antenna wire, screwdriver, coil magnet wire, steel rod, zinc strip, copper strip, compass, headphone and clamp, (tuning) knob, mounting bracket, coil ground wire, and reversible assembly board.

Also included are two resistors, "A" battery clips, tube sockets, vacuum tubes, three capacitors, and an assortment of Fahnestock clips, screws, nuts, etc. Kits will be sold in department stores, toy shops, and hobby stores.

END

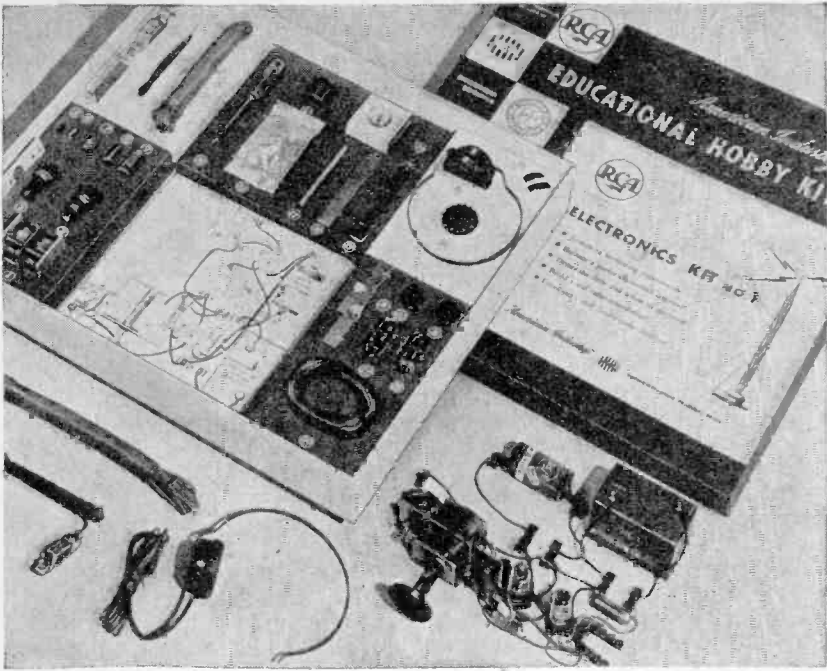

Beginners can learn to transmit and receive radio messages on sets they have built themselves. Included is a book on radio.



Millard (Mike) Deutsch, Jr., 11, gets helping hand from his father, president of "Industrial America," Inc., in assembling electronics kit.

Showing sister how a radio works poses no problem to this young electronics "veteran". Layout of parts aids quick understanding.

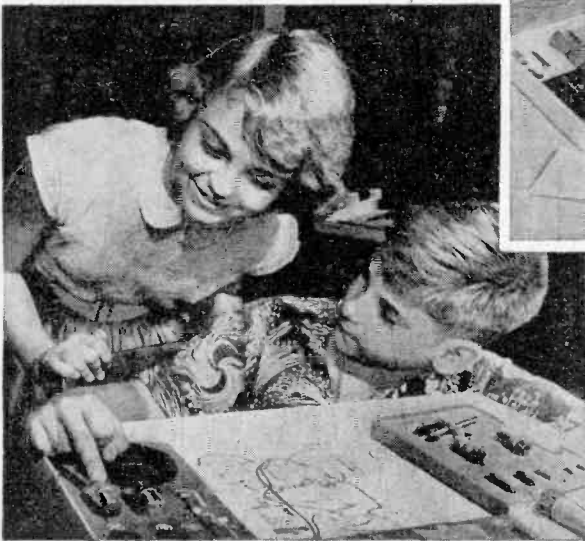

By JOHN T. FRYE



## OPERATION STARTLED STARLING

JERRY BISHOP was in his basement laboratory busily trying to get the sound effect of a horse plodding through deep mud down on the tape of a new recorder he had received for Christmas. He was so engrossed in plopping a couple of his mother's cookie cutters up and down in a shallow dish filled with water near the recorder microphone that he scarcely looked up when the outside door was kicked open and Carl Anderson, his neighbor and best friend, strode in carrying a bird cage held gingerly out in front of him.

"The next time you get a bright idea, Buster, you can do some of the legwork yourself," Carl growled as he set the cage down on the workbench.

"Ah, you got one!" Jerry exclaimed as he shut off the recorder and strolled over to examine the black, medium-sized bird with beady eyes and rather ruffled plumage inside the cage. "He doesn't look like he's hurt a bit. How did you ever catch him?"

"It wasn't easy. Some men were shooting the starlings with shotguns around the courthouse, and that little buzzard had the ends of the feathers on one wing shot off. That didn't hurt him any, but it sure messed up his flying. At that, I had to chase him a couple of blocks before I caught him, and he managed to chew about thirty cents worth of hide off the back of my hand while I was stuffing him into the cage. Believe me, Old Scissorbill here is a crazy, mixed-up starling; he thinks he's an eagle or some other kind of meat-eating bird."

"He does have a kind of nasty expression on his face," Jerry agreed as he looked at the bird glaring defiantly up at him.

"This whole idea sounds strictly for the birds to me," Carl blurted out. "Tell it to me again. Maybe it will sound better if I hear it once more."

"Last winter," Jerry patiently related, "a couple of zoologists at Penn State College captured a live starling and made a

tape recording of its cries of distress. Then the recorder was installed in a truck equipped with a public address system parked beneath some trees infested with an estimated 20,000 starlings. After the birds were settled for the night, the recording, tremendously amplified, was played through the public address speakers. The birds awakened to the distressed screams of one of their fellows, fled in terror, and never returned. We are going to try to work the same thing on the starlings roosting in the trees in the back yard."

"Still sounds wacky," Carl commented; "but let's get on with it. You hold Scissorbill, and I'll work the recorder."

"Now wait a minute," Jerry said hastily. "You'd better hold the bird and let me operate the recorder. After all, you two are already acquainted. On top of that, this is a pretty critical recording, and everything has to be just right. The tape must be run at the right speed; the gain control must be set just so; the—"

"Oh all right," Carl said resignedly. "I didn't really expect to get away with it, but it was worth a try. What do you mean the tape has to be run at the right speed?"

"To make the bird's cries sound natural, we must have good high-frequency response. That means the tape will need to be run at its top speed of  $7\frac{1}{2}$  inches-per-second."

"How come higher tape speed improves the high frequency response?"

"The recording head translates a sound wave of a given pitch into pulses of magnetic energy that 'prints' the magnetic coating of the moving tape with regularly spaced areas of magnetism. As the pitch or frequency of the sound goes up, these areas are spaced closer and closer to each other until finally, when the frequency of the sound wave is high enough, they start to merge together and so lose their separate identity that must be maintained if the sound is to be reproduced naturally. Now if we speed up the tape, this increases

the separation of these magnetized areas; and we can then increase the frequency of the sound wave considerably before the areas start overlapping again."

While Jerry was talking he had removed the tape reels from the recorder and started a short endless loop of tape running through the recording head. The microphone was placed on the edge of the bench, and Carl cautiously opened the door of the cage and reached inside for the bird.

"Yow!" he suddenly yelled as the starling viciously shut down on his finger.

"Shut up," Jerry callously commanded. "We want the starling's cry of distress, not yours. We don't want to scare people."

Carl gave him a scorching look and then, angered, reached inside the cage and hauled the bird unceremoniously forth. Holding it upside down by its feet, he dangled it near the microphone while it screeched and screamed its protest at this treatment.

"That's fine," Jerry said. "Now let's see what we've got."

The recorder was switched to "Play," and instantly the basement was filled with a loud cacaphony of raucous screaming that even seemed to take Old Scissorbill aback. At least he became quiet and listened attentively with his head cocked to one side.

"That certainly ought to do it," Jerry said.

"I don't know," Carl said dubiously. "That bird wasn't scared; he was mad. I'll bet a nickel that instead of calling, 'Help, help!' he was really saying something like, 'Let go of my leg, cuss you!' Can I wring his neck now?"

"Sure, but you won't," Jerry said with a grin on his round face. "You don't fool me. I know how chickenhearted you are."

"Chickenhearted, my eye," Carl said with a fierce scowl. "However, I think I'll just turn him loose and let a cat get him. That will be the kind of fate he deserves. Wringing his neck would be too easy a death."

"Uh huh," Jerry said with a knowing smirk; "but now we've got to arrange a way of putting some real punch behind this recording. I thought we could use that twenty-watt speech amplifier and modulator you use to modulate that command transmitter of your ham station. Let's see, that modulation transformer has a 5000 ohm output, doesn't it?"

"Right."

"And here's the speaker I intended to use," Jerry remarked as he dived into a corner of the basement and pulled forth a large speaker with a bell-shaped trumpet. "I've been hanging on to this for a long time hoping to find a use for it. This

job is rated at twenty-five watts and has an eight-ohm voice coil."

"Not a very good match for 5000 ohms," Carl observed.

"That's where this audio transformer will come in—I hope," Jerry said as he lifted a heavy transformer on to the bench. "Someone gave me the thing, but no instruction sheet came with it. The primary terminals are lettered, and the secondary terminals simply are numbered from 1 to 16. However, by looking up this model in a catalogue, I know the transformer is rated at twenty watts, that the primary is tapped for use across either 3000 or 5000 ohms, and that the secondary is designed to feed any voice coil impedance from one to thirty ohms. All we have to do is figure out which primary and secondary taps to use so that our eight-ohm voice coil will be properly matched to the 5000 ohm output of the modulation transformer."

"How are you going to do that?"

"First, let's use the ohmmeter of our volt-ohm-milliammeter to measure the d.c. resistance appearing between the various primary taps. Across terminals *P-P* we measure 600 ohms, while there is only 500 ohms across *P<sup>1</sup>-P<sup>1</sup>*. We may safely assume that the higher d.c. resistance indicates that the entire primary winding, designed for an a.c. impedance of 5000 ohms, is connected between the two terminals marked *P*."

"That's easy, but how about the secondary taps?"

"Well, we know that the impedance ratio between the primary and secondary of a matching transformer is equal to the square of the turns ratio of these two windings, check?"

"Check."

"Our impedance ratio is equal to 5000/8 or 625/1. The square root of that is—" Jerry settled back on the couch with his



battered slide rule, but Carl interrupted with, "Twenty-five to one."

"You're right, you mathematical genius!" Jerry exclaimed as he double-checked with the rule. "We also know that if we put a certain a.c. voltage into one winding of a transformer and then measure the voltage appearing across the other winding, the ratio between the two voltages is equal to the turns ratio of the two windings. So-o-o-o, all we have to do is put twenty-five volts into the primary winding and then measure the voltages appearing between the various taps of the secondary until we find a pair producing quite close to one volt. When these two taps are found, we can connect our eight-ohm voice coil to them and be sure that when the whole primary is connected to the output of the modulation transformer, we shall have a complete match all the way around, which will insure a maximum transfer of power with a minimum of distortion."

"Well, let's quit yakking and get with it," Carl, the man of action, said impatiently.

"Okay. This war surplus equipment filament transformer puts out almost exactly twenty-five volts of a.c.; so connect it to the primary of the transformer, and we'll start measuring the voltages across the secondary taps."

In a matter of minutes the boys located a pair of secondary taps that indicates precisely one volt on the a.c. scale of their volt-ohmmeter. The ends of a heavy fifty-foot extension cord were soldered to them, and the other ends of this cord were fastened to the speaker terminals. The primary of the matching transformer was connected to the secondary of the modulation transformer of Carl's amateur station speech equipment. A phone plug with a six-ohm, one-watt resistor fastened across

its terminals was plugged in the "External Speaker" jack of the recorder, and a shielded lead went from the two ends of this resistor to the high-level input jack of the speech amplifier. The six-ohm resistor furnished a proper load for the secondary of the recorder's output transformer when the unit's six-ohm speaker voice coil was automatically disconnected by plugging into the jack.

By the time this rather weird lashup of equipment was completed, the boys had already received the third supper call; so they decided to suspend operations until after the evening meal. Right after supper, though, Carl was back over wearing a bright yellow slicker.

"There's a pretty good drizzle going," he announced.

"It takes a pretty mean guy to try and scare a poor little starling out of his nice warm tree on a night like this," Jerry said teasingly.

"Yeah!" Carl snarled as he rubbed his sore finger and made a threatening gesture at Old Scissorbill, still resting in his cage; "I can hardly wait."

"Okay. You get outside the basement window, and I'll hand the speaker out to you. That way our cord will allow us to get right under the tree with the speaker. I want to be out there, too, when the fun starts; so I'm going to get everything down here going but the tape recorder. Then I'll turn it on and dash out there with you while the recorder amplifier is warming up."

This plan was put into action. Jerry switched on the recorder, flipped the volume control well over to the "loud" side of its rotation, took a quick look to make sure the loop of tape was going smoothly past the playback head, and then dashed out

*(Continued on page 122)*

## Flocked Screening for Loudspeakers

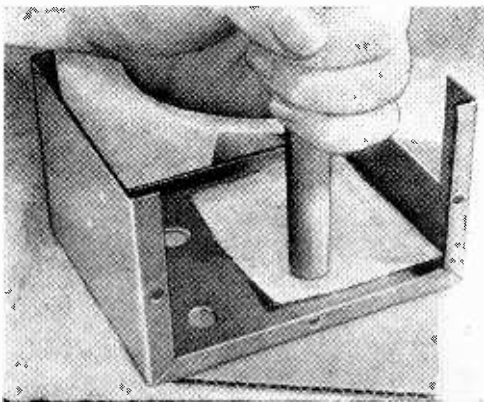

**W**HEN you use flocked screening to cover a loudspeaker opening in a front panel, do a professional job by shaping the screening to fit into the speaker opening and to project slightly from the front panel, instead of lying flat.

You'll need the front panel, a piece of flocked screening cut somewhat larger than the speaker opening, a piece of cardboard, and a  $\frac{3}{8}$ " to 1" wooden dowel rod.

Place the cardboard under the front panel and the flocked screening as shown. Press from the back with the wooden dowel rod to form the screening into the speaker opening. The cardboard will give slightly, permitting the screening to project a small amount. . . . . L. G.

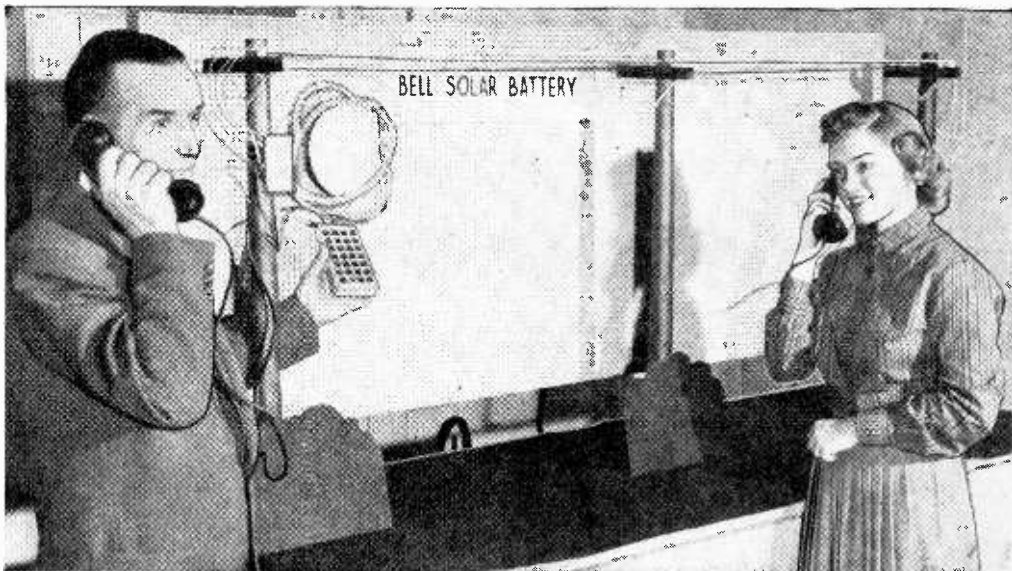

Solar Battery powers telephone in this indoor demonstration.

## More Energy from a Solar Battery

THE power needed to transmit a telephone conversation can now be obtained directly from the sun, according to a recent announcement by *Bell Telephone Laboratories*. Key to the new power source is the Solar Battery (see *POPULAR ELECTRONICS*, Oct., 1954). Recent experiments have resulted in a one-third increase in the efficiency of the battery. Composed of strips of specially prepared silicon, the battery can now achieve an efficiency of eight per-cent, comparable to that of steam and gasoline engines.

According to the battery's co-inventor, Gerald L. Pearson, "this value of eight per-cent is ten to fifteen times better than the best photovoltaic devices available. We are optimistic that in time a 10 or 15 per-cent efficiency can be achieved." The maximum theoretical efficiency is estimated to be 22 per-cent.

The *Bell Solar Battery* is composed of silicon wafers. These wafers are extremely sensitive to light. The improved cells can be electrically linked together to deliver power from the sun at the rate of 80 watts per square yard of surface.

Certain factors that tend to decrease the device's efficiency can be partially eliminated, Mr. Pearson said. At present, much of the radiant energy is lost by reflection from the silicon surface, and a part of the electrical energy is lost within the cell itself. He said that the increased efficiency had been obtained in experimental cells by reducing these losses.

The Solar Battery is a relatively new device and still in the research stage, it was pointed out, but small solar converters like those now produced experimentally could be extremely useful for communication purposes where the power requirements are small.

Research indicates that the batteries could be used as power supplies for low-power portable equipment, or as sun-powered battery chargers for amplifier stations on telephone lines. The ordinary handset telephone, for example, needs only a small fraction of a watt of power.

Recent demonstrations have shown that the Solar Battery could power telephone equipment as well as a portable FM transmitter.

Key to *Bell's* technique for producing the experimental silicon device is the controlled introduction of a foreign element into a microscopic layer near the surface of a thin slice of arsenic-doped silicon.

Treatment under gas at high temperatures permits the introduction of minute traces of impurities into the atomic structure at the surface of the silicon. These impurities reach a depth of less than one ten-thousandth of an inch. This is what is known as a "p-n junction" which is the heart of the device and which, when built into a germanium single crystal, is the basis for the junction transistor.

Mr. Pearson invented the Solar Battery together with chemist Calvin S. Fuller and electrical engineer Daryl M. Chapin. END

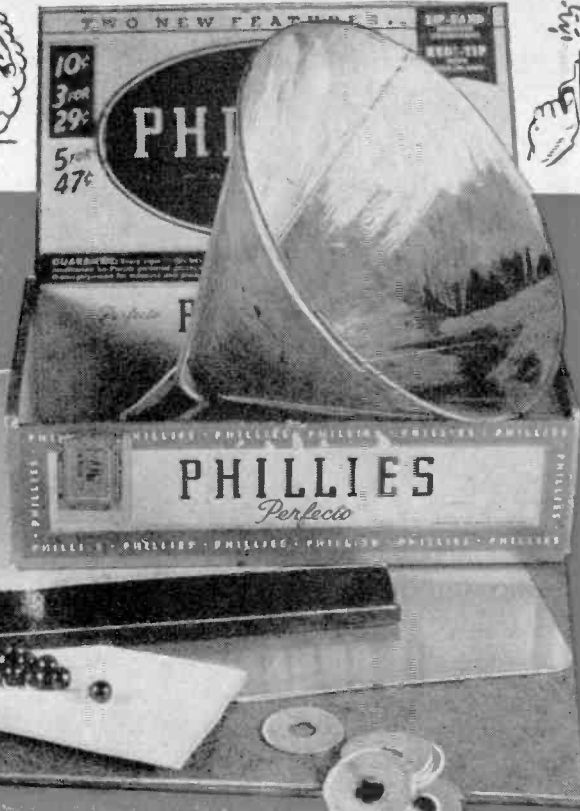

Fig. 1. The basic "sound effects kit." It consists of a cigar box, funnel, paper, cardboard, wooden stick, #00 buckshot, metal washers, metal cookie sheet, and a piece of hardboard.

# A Sound Effects Kit for Home Recordings



Fig. 3. Sound of horse crossing a wooden bridge is made this way.



Fig. 2. The sound of ~~horses~~ hooves is simulated with mike under a hardboard.



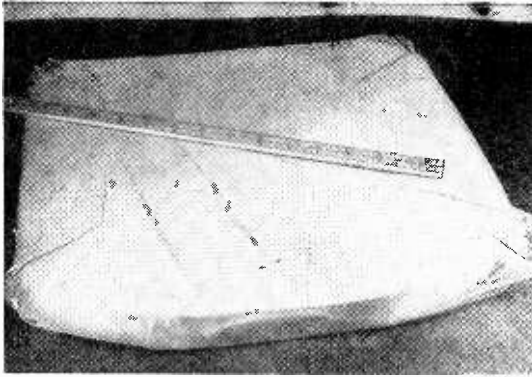
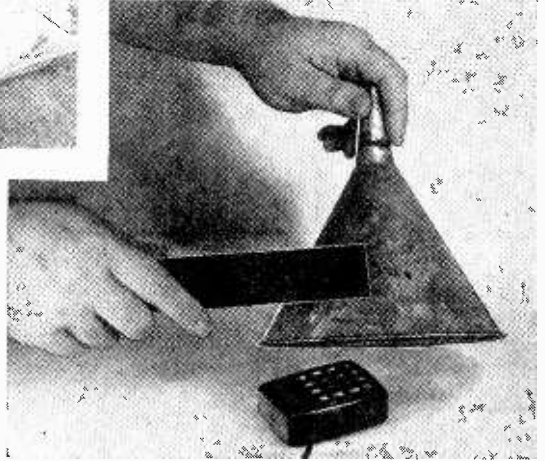

Fig. 4. How to simulate a gun shot.

Fig. 5. The funnel is struck by a wooden stick to simulate an oriental-type gong.



BY LOUIS GARNER, JR.

*Add realism to your home movies and make amateur theatricals realistic with "sound effects".*

IF YOU have or can borrow a tape or wire recorder, you and your friends can have a lot of fun making up programs and putting on "broadcasts". The "broadcasts" may be played back at parties, club meetings, or just plain get-togethers. Or if you belong to an amateur theatrical group, you'll find that recording performances and playing them back is a good way to polish up acting skill and to develop real ability.

You can give a professional touch to your recordings by adding realistic "sound effects" to your programs—the sound of horses' hooves in your "westerns", gun shots in your detective stories, the roar of lions and tigers in your jungle plays, or the "bong" of an oriental gong in your mystery dramas.

Professional sound effects men often have a whole roomful of equipment and devices at their disposal, together with special records that produce almost any desired sound. But you can simulate a good many sounds with the basic "kit" shown in Fig. 1. You probably have or can easily obtain most of the items shown. A few additional odds and ends, available in most homes, will permit you to simulate a number of special effects.

For truly professional results, assign one person as the "sound effects man" while you're making recordings. Provide him with a copy of the "script" and his own microphone. His "mike" should have an independent gain control. If your recorder only has a single input, you can add an addi-

tional mike channel and gain control by using a separate *mixer*, such as the *Switchcraft* models 310 or 320 "Mini-mix" units.

Use the methods to be described and as illustrated in the photographs to simulate the sound effects you need. Remember, however, that a particular technique may not always work due to differences in room acoustics. For best results, first try recording each of the sound effects listed, using different amounts of amplifier gain. Play the recording back, listening to each effect in turn. If you find that a particular method does not produce a realistic sound, try experimenting with variations of the basic technique. Some small change in method may give perfect results in your room and with your recorder.

*Horse's Hooves:* Proper rhythm is the "secret" of simulating the sound of horses' hooves. Place the microphone flat on the table and lay a piece of hardboard against it, as shown in Fig. 2.

To simulate the sound of a single horse galloping, tap the finger tips of one hand against the board. The fingers should strike the board one after the other, not all at one time. Keep repeating this action, doing it faster to simulate a running horse, slower to simulate a slow trot. Use both hands simultaneously to simulate the sounds of several horses. Adjusting the recorder's gain control or tapping the board harder or easier will simulate the sound of a horse approaching or going away in the distance.



To simulate the sound of a horse going over a wooden bridge, place the microphone in a cigar box, close the lid, and tap the characteristic rhythm on the lid, as shown in Fig. 3.

**Gun Shots:** Oddly enough, the discharge of a blank pistol seldom sounds like a "gun shot" over an amplifier. A better "sounding" gun shot may be obtained by slapping a pillow or cushion a sharp blow with a narrow strip of wood, such as a yardstick.

Place the pillow on a table or stool. The microphone should be near the pillow *but not on the same support*. With the recorder's gain control turned up, strike the pillow a sharp, hard blow, as shown in Fig. 4. You'll have to practice a few times to do a really good job. Take special care to avoid "whistling" the stick as you bring it down—remember that guns don't whistle before they fire.

**Kiss:** An easy sound to duplicate—kiss the back of your hand while holding it close to the microphone.

**Knocking:** Another "easy" sound. With the microphone near the piece of hardboard, simply knock on the board with your fist. For special effects and "hollow" sounds, place the microphone in the cigar box, the hardboard on top, and knock on the board.

**Oriental Gong or Church Bell:** A heavy ringing sound may be simulated by using the large metal funnel. Hold the funnel by its spout with one hand and strike the side of the funnel a sharp blow with a short wooden stick. The funnel should be over the microphone, as shown in Fig. 5. Different effects may be obtained by varying the distance between the funnel and the mike

and by striking the funnel at different points.

**Fire:** You can simulate almost every type of "fire sound," from the friendly crackle of an open fireplace to the angry roar of a forest fire, simply by crushing and wrinkling paper close to the microphone, as shown in Fig. 6. Use different types of paper for different effects—cellophane, tracing paper, writing paper, newspaper, and heavy wrapping paper. Vary the distance between the paper and the microphone to change the intensity of the "fire."

**Water Sounds:** The easiest way to simulate the sound of water is with water. For rain on a tin roof, use a garden sprinkling can and pour water on the metal cookie sheet. The metal sheet should be tilted at an angle so the water will run off into a basin. The mike should be close to the cookie sheet—just under it is a good place, *but make sure you don't get water on the mike*.

Other sounds may be simulated by pouring water from a pitcher into a tub or by running your fingers through a flat basin of water. Experiment with different techniques and with the position of the microphone.

**Thunder:** The distant rumbling roar of thunder may be simulated by shaking or rattling a large cookie sheet or other piece of sheet metal close to the microphone, as shown in Fig. 7. The larger the sheet of metal used, the more realistic is the sound produced.

**Wind Sounds—Whistles:** One of those "silent" dog whistles may be used to simulate the eerie whistle of the wind. By vary-

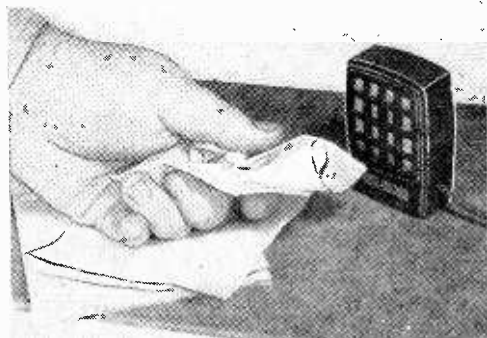

Fig. 6. Wrinkling paper sounds like fire.

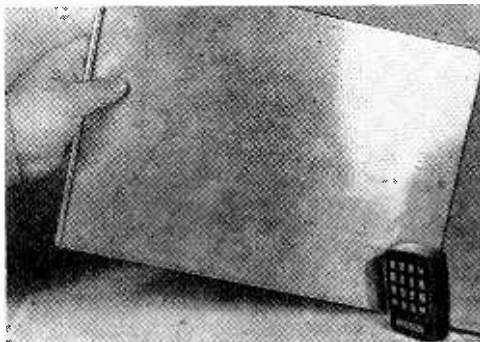

Fig. 7. Rattling sheet metal for "thunder".

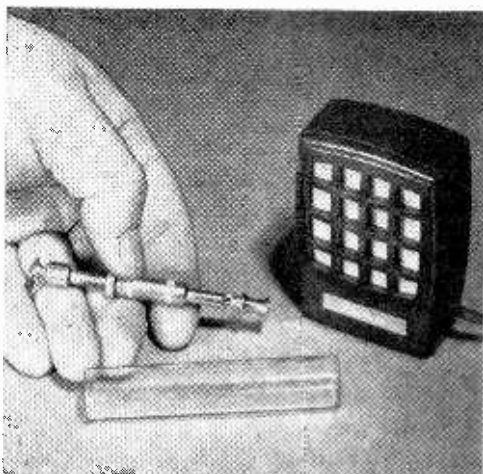

Fig. 8. "Silent" dog whistle produces wind sounds; glass vial a factory-whistle.

Fig. 9. "Tom-tom" from funnel and paper.

ing the distance between the whistle and the microphone and the adjustment of the whistle, you can simulate almost every type of "wind sound" from a gentle breeze to a roaring gale. When combined with the *thunder* effect, a very realistic storm may be produced.

The deep toned sound of a steamship or a factory whistle may be simulated by blowing across the mouth of a vial or bottle. Try different sized bottles, and even large jugs, for different effects.

*Drums or Tom-Toms:* There's nothing like a throbbing tom-tom to heighten suspense in a jungle drama. You can simulate such sounds by stretching a piece of paper across the mouth of the funnel and taping it in position—use *Scotch* tape. With the funnel placed close to the microphone, tap on the paper lightly with your fingers to simulate the beat of tom-toms. Proper rhythm is important. This technique is shown in Fig. 9.

Fig. 10. Buckshot rolled in a cigar box simulates the roar of the "King of the Jungle".

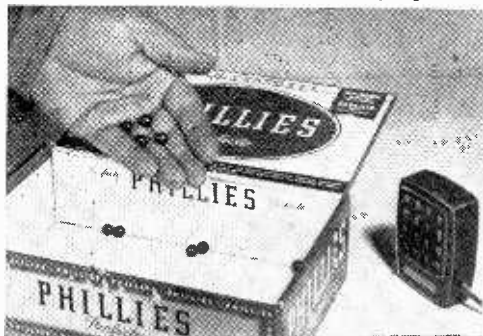

January, 1955

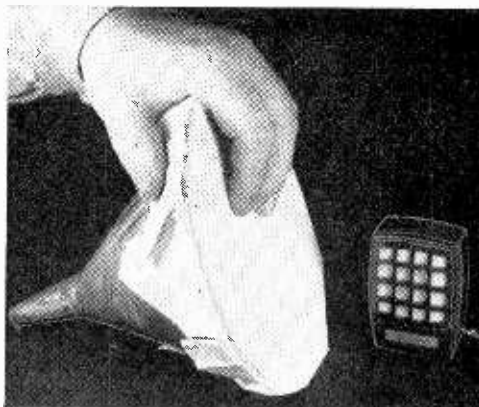
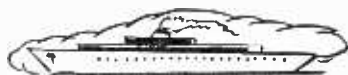

*Lion or Tiger's Roar:* With the mike's gain turned back, drop a handful of #00 buckshot into the cigar box. (Fig. 10). Close the lid and hold the mike against the bottom of the box. Turn the recorder's gain back up and, holding the mike and cigar box together, roll the buckshot around inside the box. Pause from time to time—don't roll the shot continuously.

*Sawing Wood:* This sound may be simulated by placing the microphone inside the cigar box and placing the piece of hardboard on top, then scratching the hardboard with a piece of metal, as shown in Fig. 11. Use a back and forth movement.

*Airplane Motor or Buzz Saw:* Either of these sounds may be simulated by using a piece of stiff paper (or cardboard) and an electric fan. With the fan running, hold the paper against the edge of the blade, as shown in Fig. 12. Changing the pressure and using papers of varying stiffness will enable you to simulate different sounds.

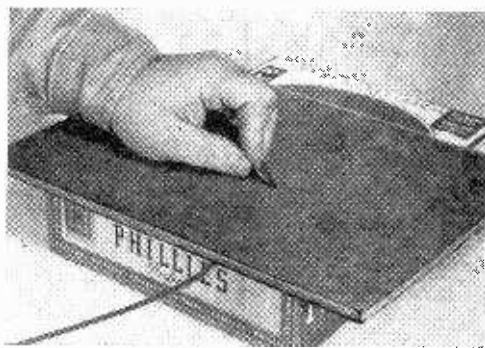

Fig. 11. Scratch the piece of hardboard to duplicate the sound of sawing a wooden board.

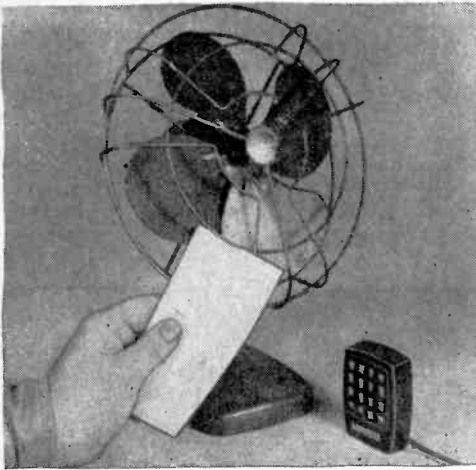

Fig. 12. An electric fan and a piece of stiff paper may be used to make many varied sounds, an airplane motor, a buzz saw, and others.

**Metallic Sounds:** A number of different metallic sounds may be simulated by using large metal washers and small pieces of sheet metal, as shown in Fig. 13. Different types of metal (brass, aluminum, copper, steel) produce different sounds.

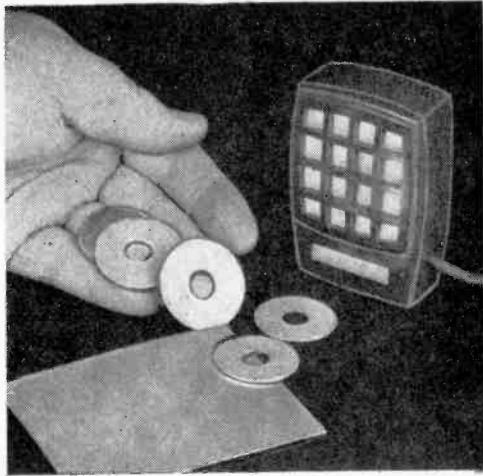
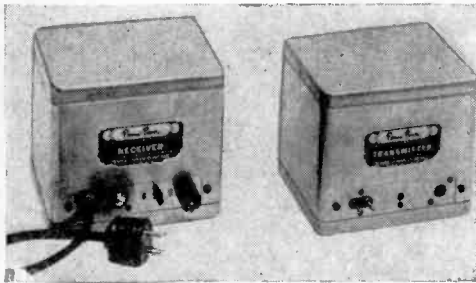

Fig. 13. Metallic sounds and the tinkling of glass may be produced with small pieces of metal dropped on a plate as shown in photo.

**Conclusion:** Space prohibits giving a complete list of possible sound effects. However, the techniques for simulating most basic sounds have been described. You can have a lot of fun trying modifications of these techniques. **END**

## NEW DEVICE OPENS GARAGE DOOR FROM CAR

**T**OUCHING a button in your car will open a garage door 100 to 300 feet away with the aid of a new electronic remote control device made by the *Perma Power Co.*, Chicago.



The push-button control consists of a one tube transmitter installed in the motor compartment of the automobile. It is activated when a button, mounted on the dashboard, is pressed. This transmitter sends out a signal that is received by a two tube receiver located in the garage. The receiver turns on a motor, also installed in the garage, which operates the garage door. The control may also be used to close the door.

The transmitter is crystal controlled, sending out its signal on a frequency of 27.255 megacycles. The Federal Communications Commission has designated this an

authorized frequency for control signals.

When the automobile ignition switch is turned on, the tube in the transmitter is heated, so that the instrument is ready for use at all times. The set is designed to take its power from the 6 volt automobile battery, but an adapter for 12 volt systems is available.

The receiver in the garage will respond only to the given transmitter signal to actuate the motor mechanism that lifts the door.

To facilitate maintenance, the same tube type—a miniature 6U8—is used in both receiver and transmitter.

The system assures against interference from other remote control units. **END**

## NEW RADIO FITS INTO POCKET

**T**HIS unique broadcast radio receiver is designed to fit into the pocket or handbag. Marketed by *Majestic* and known as the "Mini-Boy," it is battery powered, weighs 22 ounces, measures 6¼" x 3½" x 1½", and features a slide rule dial. It is currently retailing for about \$30.



POPULAR ELECTRONICS

# Electronic Wife

By JEANNE DEGOOD

THERE'S something about electronics that's apt to melt the solder on even the strongest family ties. When a man becomes an electronic technician, his wife becomes an electronic widow. Even when her husband is at home, his mind is a hundred miles away.

Take, for instance, the first day a man is exposed to electronics. He comes home that night, and instead of hiding behind a newspaper, he hides behind a book. She knits.

Suddenly, she remembers something. "By the way, Dear, that lady was here again today—the one that's always trying to sell me something. I wish she'd stop bothering me. I just don't know what I'll do about her."

He hunches his shoulders, pulls the book closer to his face, and mumbles, "Transformer."

"Well, I tried, Dear. Last time she was here, I told her that selling was hard work. I said she ought to do something besides selling pots and pans. She was selling vacuum cleaners today. What do you think I ought to do about her, Dear?"

"Resistor."

"Well, I tried that, too. But I'll say one thing for her—she's sure a good saleslady. Want to see my new vacuum cleaner?"

"Stationary spot," he mumbles. "Due to a loose or pulled out plug?"

"Oh, no, Dear. They don't make spotted vacuum cleaners. It's brown, and it's brand new, and I know the plug isn't loose, and of course the plug is pulled out. If the plug wasn't pulled out, you'd hear it running."

He puts a finger on the page, glances at his wife, looks back at the book, shakes his head, and says, "Indicates complete absence of deflection voltages."

She's knitting faster now. Her eyes narrow. "Well, you don't have to talk to me that way about it. I've already bought the vacuum cleaner, and that's that. I don't want to hear any more about it."

He reads. She knits. Her knitting needles click loudly. Click. Click. Click, Click, Click.

"Altering the bias," he mumbles.

The knitting needles click slower. She looks up, smiles, and says, "I'm glad you mentioned that, Dear. I finished making that dress for Judy today. Don't know what in the world's wrong. It just doesn't seem to fit her right."

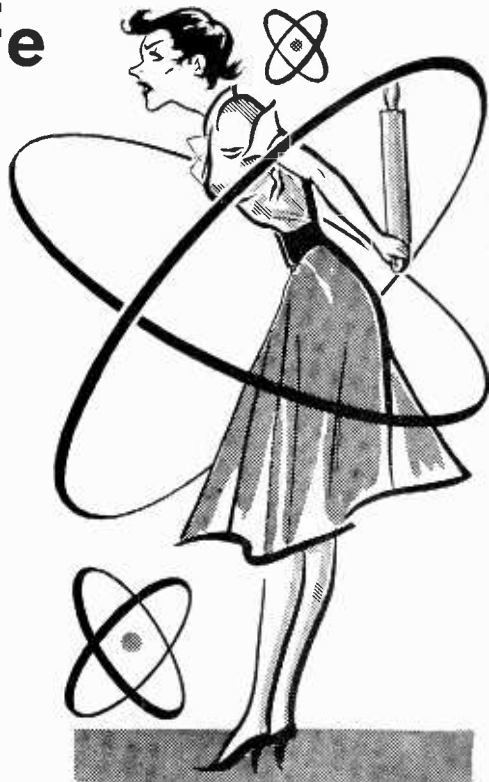

"Characteristic curve is by no means linear."

"I wish you wouldn't say things like that. After all, it's your own daughter, and she may not have the most perfect figure in the world, but you'll have to remember that she's only twelve."

"The straight portion of the curve."

"Well, of course her figure is straight. My figure was straight when I was twelve. I wouldn't worry about it. She'll soon grow up and have a figure just like mine."

He places a finger on the page, glances in her direction, looks back at the page, shakes his head, and says, "Some tonal distortion originates at the transmitting end because of non-linearity of response in the photoelectric device itself."

"The very idea," she says. "The very idea." She glares at him. "Well, I may not have the most perfect figure in the world, but I'll have you know that I'm not the fattest person in the world either."

"Curvature of the earth intervenes."

"Well," she says. "Well." Her knitting needles click faster. Click. Click. Click, Click. He reads.

"Vertical polarization," he mumbles. She glares.

"Horizontally polarized waves," he says. She knits.

"Horizontal radiating system," he says.

She looks up, bites her lip, and says, "Well, I don't know how you always seem to know about these things. I promised Junior I wouldn't tell you, but he was climbing in the apple tree again today, and he fell. Said he was trying to fly."

"Insufficient horizontal deflection?"

"Well, really, Dear. How would I know what made him fall? He just fell, I guess. It was the strangest thing. He just couldn't understand why he couldn't fly."

"Incorrect adjustment of horizontal hold control?"

"Well, I guess you do understand those things better than I do. I wish you'd explain it to him. He said he saw the birds and airplanes flying, and he didn't see any reason why he couldn't fly. He just couldn't understand why he fell."

"Misadjustment of horizontal centering control?"

"Well, I suppose that could be it. He must have been out of control when he fell. Anyway, maybe you'd better explain it to him tomorrow." She stops knitting and shakes her head. "Sometimes I wonder about Junior. He gets the craziest ideas in his mind."

"Deflection yoke twisted?"

"I don't see how you have the nerve to say things like that about Junior. His mind may be a little warped, but after all he's

your son. That's probably why he thinks he can fly. And I wish you'd put that book away when I'm talking to you. Honestly, if you don't start paying more attention to your children, there's no telling what they'll turn out to be."

"Transients?"

"Well, the very idea. The very idea." She bounces up from the chair, throws her knitting on the floor, stalks across the room, points her finger in his face, and says, "If you can't talk decent about our children, I just won't talk to you. I work hard day after day, week after week, and year after year, trying to make something of our children, and all I do is ask you for a little advice. And what do I get? Sarcastic remarks." She places her hands on her hips. He continues reading. She continues, "Well, I've heard all I want to hear about it. I just don't want to talk any more about it now. I'm going to bed." Her voice rises to a near scream. "And you can just go *jump in the lake*."

He places a finger on the page, glances in her general direction, and says, "Uh. What's that? What did you say, Dear?"

Of course, with color television, things will be different. An electronic wife will not only see red—she'll see yellow, cyan, green, magenta, blue, and polka dot patterns. END

---

## NEW MOVIE SHOWS RADAR NETWORK IN ACTION

**A**N EXCITING scene (see photo below) from a new movie titled "Mrs. Jones, Meet Your Partners" occurs when a *Northrop* Scorpion F-89D, America's most heavily armed fighter plane, fires its giant, 104-rocket punch.

The role played by radar in coordinating fighter plane and other defense activity is one of the many dramatic subjects depicted in this film.

Produced by *Northrop Aircraft, Inc.* of Hawthorne, California, with the cooperation of the U. S. Armed Forces and the civilian Ground Observer Corps, the full-color,

16 mm film portrays the constant vigil and vital role of U. S. air defense. Star of the film is Lulu B. Clark, a Los Angeles housewife, who plays the role of a Ground Observer volunteer. Art Baker, TV and film star, narrates the film.

In its twenty-nine minutes of exciting footage, the movie relates the steps involved in detection, identification, interception, and destruction of an attacking enemy bomber.

The film will be released both to TV and group showings on free loan. It may be obtained from *Northrop Public Relations*, Dept. 1310, Hawthorne, California. END



## RADIO BEAM AIDS LONG DISTANCE TELEPHONE

FAMILIES in remote rural areas where no telephone service has been available can now enjoy telephone contact with the "outside world" as a result of a new, simplified, low-cost system. The new equipment uses a radio beam that carries voice messages across 50 miles without wires. Introduced recently by *Raytheon*, the radio beam, which cannot be disrupted by hurricanes, ice, static, etc., shoots across rugged mountain terrain, over rivers, and across wild timber lands.

The new device, the TCR-12, is a microwave relay system designated the "Telelink". Enclosed in the metal box is a klystron transmitter with a power output of 100 milliwatts. Voice messages are impressed on a 6000 megacycle carrier by frequency modulation and then are beamed out by the highly directional antenna.

The signal is aimed at the antenna "dish" in an identical unit located as far as 50 miles away. Two channels permit two 2-way simultaneous voice communications. Dialing and ringing services are included in the newly designed "Telelink" system.



## HOSPITALIZED "HAM" WINS SCHOLARSHIP

"HAM" operator LeRoy Knass, an arthritic patient at Chicago's Wesley Hospital, was recently awarded a \$300 home-study technical radio scholarship by William A. Sawyer, president of Northwest Radio and TV School. Knass, a "ham" operator for 17 years, has undergone surgery nearly thirty times, but continues to communicate cheerfully with fellow "hams" throughout the nation.

## PORTABLE STATION

A PORTABLE radio station, ready to swing into action anywhere in Latin America in event of sudden emergency, has been developed by *Pan American World Airways*. The new equipment can be loaded aboard a clipper, flown to its destination, and be in operation within a few hours.

The 4000 pound station includes an aerophare, a navigational aid for pilots that uses a 110-foot sectional tower. In addition there is a radiotelegraph and a radiotelephone unit. Another section provides v.h.f. short-range voice communication between two points in an airport area. A 100-watt transmitter and receiver supplies air-to-ground as well as point-to-point voice communication. Ten frequencies are available. If local power is not available, the station can operate from its own gasoline generator.

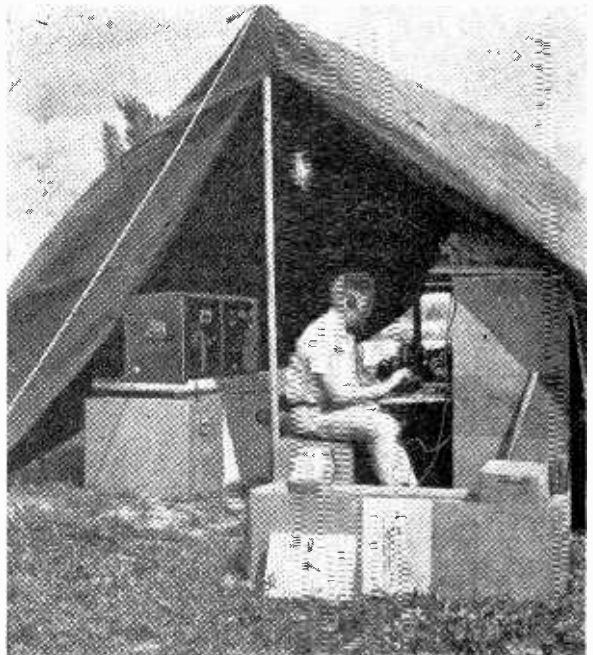

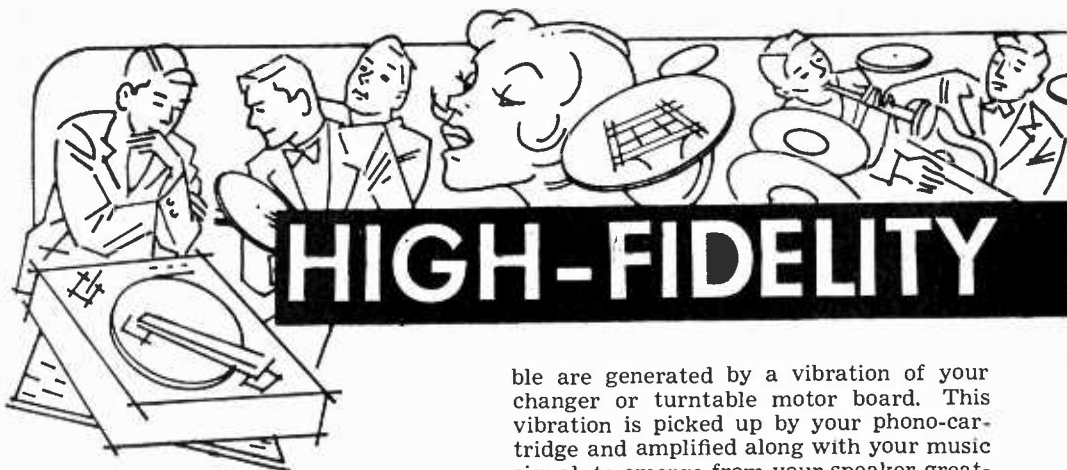

# HIGH-FIDELITY

## RUMBLE

**T**HE high-fidelity reproduction of music is a subject which occupies the attention of a great many people these days. Perhaps you are one of the many who have recently acquired a "hi-fi rig" and have found new enjoyment in music. You may also be one of the many who have become somewhat disillusioned with "hi-fi sound," after your initial excitement and enthusiasm has given way to more critical listening. You have probably become aware of the fact that the possession of hi-fi equipment is no guarantee of quality. You begin to realize that "20 to 20,000 cycles with 2% distortion," is only the beginning in the battle for good sound. True hi-fi sound is not merely wide range and low distortion. It is also a question of eliminating such annoying things as hum, rumble, record scratch, and hiss . . . bass that is too "boomy" and treble that is too screechy . . . "wow" and wavering of sustained musical tones. All these and more can detract from full enjoyment of hi-fi sound. The blame for these troubles lies with the records you play as much as the equipment you use. Let's examine some of these troublesome things a little closer and maybe we can eliminate a few.

*Rumble* is one of the most annoying and most difficult-to-get-rid-of afflictions that can beset a high-fidelity music system. You hear rumble as a very low frequency noise which is superimposed on the music, and which is especially noticeable during quiet passages. The low frequencies of rum-

ble are generated by a vibration of your changer or turntable motor board. This vibration is picked up by your phono-cartridge and amplified along with your music signal, to emerge from your speaker greatly magnified and very disturbing to say the least. What can you do to get rid of rumble? One quick and partially effective answer is to use a manual turntable rather than a changer. You see, changers do a fairly good job and are certainly a convenience, but their mechanical complexity is productive of far more vibration than that of a good turntable. With its relatively few moving parts as compared to a changer, a turntable has a much lower rumble factor.

It goes without saying, good turntables are usually much more expensive than changers, so what can the poor guy who's short on the moola do to cut down on the rumble in the changer he has? He can attack the problem from the suspension viewpoint. Most changers are "floating" on springs, which have screwdriver adjustments for varying the tension or compression of these springs. With your pickup tracking an unmodulated record groove—a groove without signal or music; *The Dubbings Company* makes a test record which has some of these grooves—and with the bass and gain controls of your amplifier at a fairly high level, try tightening and loosening the springs until you obtain minimum rumble. Not too helpful, but you've made a start. Sometimes the substitution of a type of rubber shock mount, called *Lord* mounts, in place of the springs is helpful. These *Lord* mounts can usually be obtained from any radio parts jobber.

Generally speaking, the various suspension techniques are not too successful with changers. There is now available an electronic means of rumble suppression. You may have noticed that the rumble in your system had a "cyclic" quality. The reason it is so easy to distinguish this sound is because of the low frequency at which it occurs . . . 30 cycles per second. Almost all rumble is in this 30-cycle range since the

(Continued on page 120)





By BERT WHYTE

# REPRODUCTION

## DISC REVIEW

THE last link in the chain for true high-fidelity sound is the quality of the records themselves. As you know, there are some records which are lower priced than others. You probably also know that there are a great many companies making LP records today. To make matters complicated, the same piece of music may exist in as many as 25 different recordings. So the question is: what about price *versus* quality, big company *versus* small company recordings, in short, which recording will give the truest high-fidelity sound and listening pleasure?

Since this article is frankly slanted towards the beginning audiophile, who is in the process of building his record library, I will review one work from the "Classical," "Romantic," and "Modern" eras of music. All music should of course be evaluated from the standpoints of both performance and quality of sound. However, in these reviews, the fidelity of sound will be stressed rather than the performance. If co-incidentally the recordings reviewed happen to be the best performances, as well as the best sound, so much the better. With no disrespect intended, you will find that you will listen for the sound quality first, then as you "mature" musically, you will become aware of the fine points of performance. I think everyone will agree that listening to a poor quality recording with distortion and imbalance and restricted range, is hardly the way to learn or appreciate fine music.

One of the great works of the "Classical" era is Beethoven's 5th Symphony. This certainly should be in everyone's library, so let's find out which are the best recordings of this work; there are no less than 19 different versions of the Beethoven 5th in the LP catalogue. Of these, only two recordings can qualify as having high-fidelity sound. The first recording is by Erich Kleiber and the Amsterdam Concertgebouw Orchestra on *London* LL912, and the other disc is by Antal Dorati and the Minneapolis Symphony on *Mercury* MG50017. Here you will find that both recordings are equal as to quality, but that the quality has a difference and was achieved with different recording techniques. Each disc has extremely wide frequency response, very little distortion, and wide dynamics (range between the softest and the loudest passages).

The *London* disc has a smooth "big-hall" type of sound, and was recorded for the "over-all" ef-

fect with enough detail to prevent the sound from becoming blurred or "muddy." The *Mercury* disc was recorded with a single *Telefunken* microphone hung over the conductor's podium, at a height of approximately 15 feet. Because of the particular characteristics of the microphone and the method in which it was employed, the *Mercury* sound is very bright and sharp, full of detail. The acoustical "liveness" or hall reverberation necessary to give the recording "presence" and balance, was achieved by using the microphone in its omnidirectional pattern (sound reaches the microphone from all directions).

In a good recording, such as these two, you can hear every instrument and all the instrumental choirs with perfect clarity. Listen to the string section. Here they are smooth, wide range, edgeless. In a poor recording strings have a screechy "wiriness," (called an "edge") which is most disturbing. Listen to the brass section with its trumpets, trombones, and french horns. This is a nice bright sound with plenty of punch and impact. Contrast this with the stridency and fuzziness of brass in a poor recording. Listen how easy it is to distinguish between the clarinets, the oboes, the flutes and piccolos and the bassoon in the woodwind choirs. Listen and you can hear the sharp rattle of the snare drum, the crystalline shimmer of the cymbals, the tinkle of the triangle. In a good recording the heavy thud of the tympani has tone or timbre. You can feel as well as hear the impact of drumstick against the taut skin of the bass drum.

Happily, in terms of performance both of these recordings happen to be among the very best. The Toscanini recording is generally considered the best performance, but alas, the sound on his disc is not on a par with these two. Until something better comes along (which is not very likely since the work has been recorded so many times) these then are the recordings of choice in the Beethoven 5th.

The recording from the "Romantic" era we will review is the colorful and exciting "Scheherazade" by Rimsky-Korsakov. Here we are faced with 18 versions of the work, and a number of really good recordings. These are the Stokowski on *Victor* LM1732, the Dorati-Minneapolis Symphony on *Mercury* MG50009, the Ormandy-Philadelphia Or-

(Continued on page 121)

# R/C NOTES

THE duration record for R/C planes has been broken again, this time by a walloping margin, with a flight lasting 2 hours and 31 minutes. The record (now awaiting FAI confirmation) was set by Hilton O'Hefferman, of England. The engine was a Mills 1.3 cc Diesel, which means that the model was a relatively small one for duration flying.

IN RESPONSE to many requests from our readers, here is a pictorial diagram of the "Lorenz Sixty-one" R/C receiver. The complete story and wiring instructions were published in our November issue, page 28.

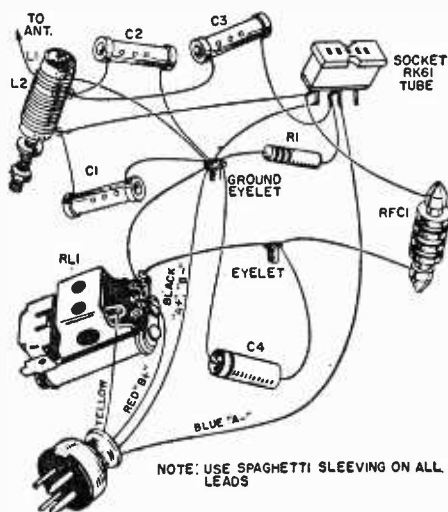

PROBABLY one of the most active of all R/C flying clubs is the Southeast Virginia Radio Control Group which gathers every Sunday afternoon at Langley Air Force Base in Virginia for flying sessions.

We have just received a letter from John Worth, the active corresponding secretary of the Group, and it's so interesting that we'd like to quote the whole thing, but we'd run out of space. One of the highlights of the letter was his report on the August R/C Roundup sponsored by the Group. The purpose of the event was "to assemble other R/C fans from neighboring areas for a weekend of sport flying, information exchanging, and just plain socializing." Six states were represented and the technical

session was recorded on tape for distribution to interested groups who were not able to attend. This will be an annual affair.

THE English Channel has been flown by a radio controlled model airplane. The sensational 22 mile flight from Dover to Calais, France, was made on September 22 by an ED Radio Queen, equipped with a 3-channel receiver and an ED .213 Diesel engine.

Taking 40 minutes to make the crossing, the plane took off under the guidance of a ground transmitter but, once aloft, was controlled from an accompanying lightplane which was forced to fly a steady figure-eight pattern in order to keep the model in sight. Unfortunately, the model was lost from view when the mother plane descended in France, before ground control could be resumed by the disembarking "pilot." After 17 minutes' climbing with three pints of fuel aboard, the model attained over 3,000 feet altitude, and had to be spiraled down several times to 2,000 feet, a tense maneuver.

Radio expert George Redlich did the flying, while the kit was assembled by Sid Allen, noted in Europe for his winning R/C performances.

THE actual control by radio of the flight of a model airplane or course of a model ship is a thrilling thing. You can almost feel yourself at the stick of the plane or wheel of the boat—especially if you have done these things in real life. For many people, however, it's a thrill merely to watch other people do the flying. These are the spectators.

One of the most popular spectator sights in Salisbury Park, Hempstead, Long Island, is the radio controlled model Coast Guard Cutter Campbell, shown here strutting her



stuff. This model was built by Wesley C. Keehlisen of Plainview, Long Island, to a scale of 1/8" to the foot. The over-all length of the hull is 43" and its beam is 5 5/8". It draws 1 1/2". Two Pittman 9002 electric boat motors powered by two Willard NT-6 storage batteries drive the twin screw propellers. A Control Master receiver and Aristrol transmitter are used on the 27.255 mc. Citizens band. An ED clockwork escapement was slightly modified by Keehlisen to give him an off engine position.

END

# Home Built De Luxe Photographic Timer



Fig. 1. The timer, shown here controlling an enlarger, can be used to time "on" or "off" intervals of other equipment drawing as much as five amperes.

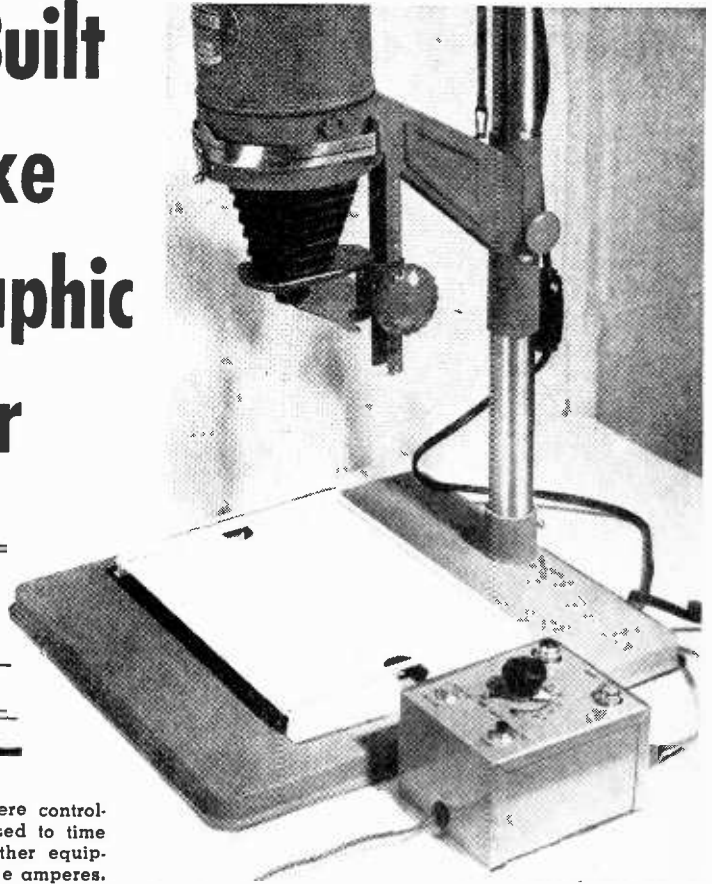

**Y**OU don't need a darkroom to find uses for the electronic timer shown in Fig. 1. Although originally designed for use with an enlarger, it may be used wherever it is desired to turn electrical equipment either "on" or "off" for predetermined intervals.

Although the unit measures only 3" x 4" x 5", it is completely self-contained and provides two separate outlets, one for "on" timing and one for "off" timing. Pilot lights indicate which outlet is energized. In addition, a special "Release" button is provided, permitting the timing interval to be cut short at any time.

You should be able to assemble your own timer in two or three evenings or on a weekend. The basic parts needed are given in the parts list. Standard, commercially available parts are used throughout.

*Construction Hints:* The 3"x4"x5" metal box used for a cabinet is available either with a gray hammerloid or an etched aluminum finish. Either style may be used.

The general layout used for drilling and punching the front panel is shown in Figs. 2 and 7. Dimensions are not given because

the hole locations are not critical; the individual builder may easily modify the layout to suit his own requirements.

Black decals may be used to label the controls and switches on the unit. However, these should not be applied until after all shop work on the panel is completed. After application, the decals should be protected with two or three coats of clear plastic.

The chassis may be bent from a small piece of sheet aluminum or steel. Or, if you prefer, you can cut a standard chassis down to fit within the box (an ICA #29082 chassis base was used in the model, as shown in Fig. 3).

Drill or punch a number of small holes in the back and in one side of the outer case to provide ventilation when the completed unit is assembled. The ventilation holes should be located near the 117L7 tube. See Fig. 6.

*Mounting the Parts:* The two receptacles, the two pilot light assemblies, and the "Time Delay" control and "Power" switch are mounted on the front panel. The

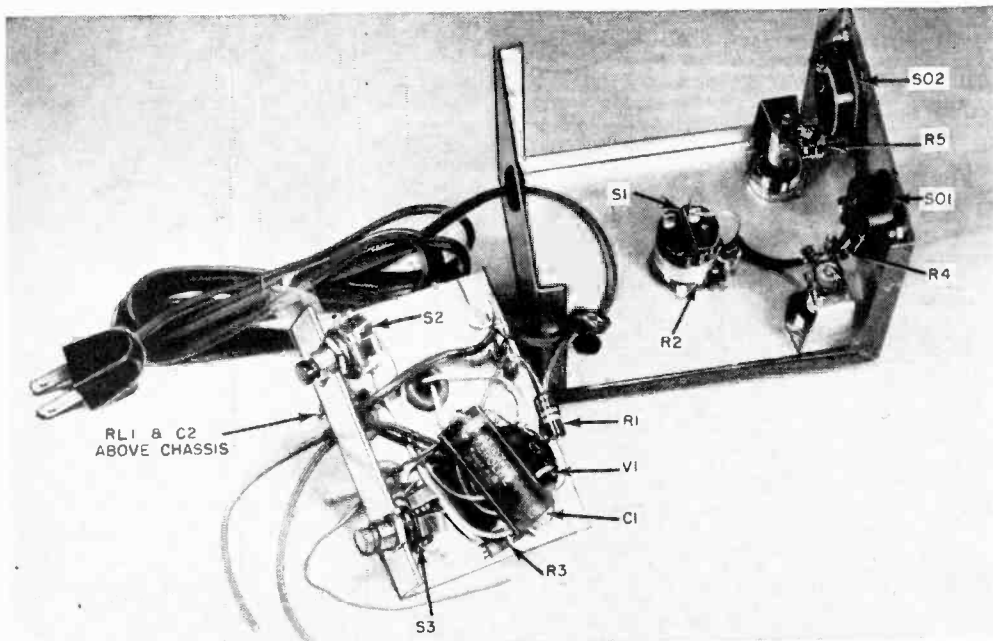

Fig. 2. All possible wiring is done before the subchassis and cabinet are assembled.

relay, octal tube socket, and other parts are mounted on the chassis.

The two push-button switches (the "Reset" and "Release" controls) are used to mount the chassis to the front panel.

*Wiring Suggestions:* Refer to the schematic diagram, given in Fig. 4, and to the pictorial wiring diagram, shown in Fig. 5, when wiring your unit. Parts location is

Fig. 3. Subchassis after the control relay, tube socket, and grommets have been mounted.

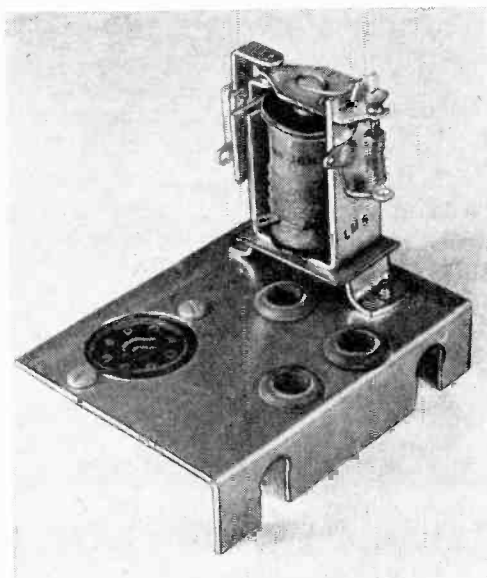

not critical and minor changes may be made without difficulty as long as the proper wiring is followed.

Mount an insulated "tie-point" or terminal strip below the chassis and make all common "ground" connections to it. For safety's sake, do not "ground" any part of the electrical circuit to the chassis or case at any point. A "floating" ground of this type keeps the chassis from being "hot" even though a transformerless circuit is used.

If you use the timer in a damp location, you can connect an earth ground to the outer case for added protection.

Do as much of the chassis and front panel wiring as you can before final assembly, allowing the leads from the chassis to the front panel to hang "free." Fig. 2 shows the partially wired timer before the final front panel connections were made.

After you've completed the wiring, recheck each soldered joint and every lead for possible wiring errors. Make sure, too, that there are no accidental shorts between terminals or leads. And check the operation of the relay by moving the armature with your fingers; make sure that no lead gets in the way of relay operation.

The completely wired model, with the back case removed, is shown in Fig. 6, while the assembled unit is shown in Fig. 7. The completed unit presents a real "commercial" appearance, even though built in a home workshop.

*Circuit Modifications:* If you use the

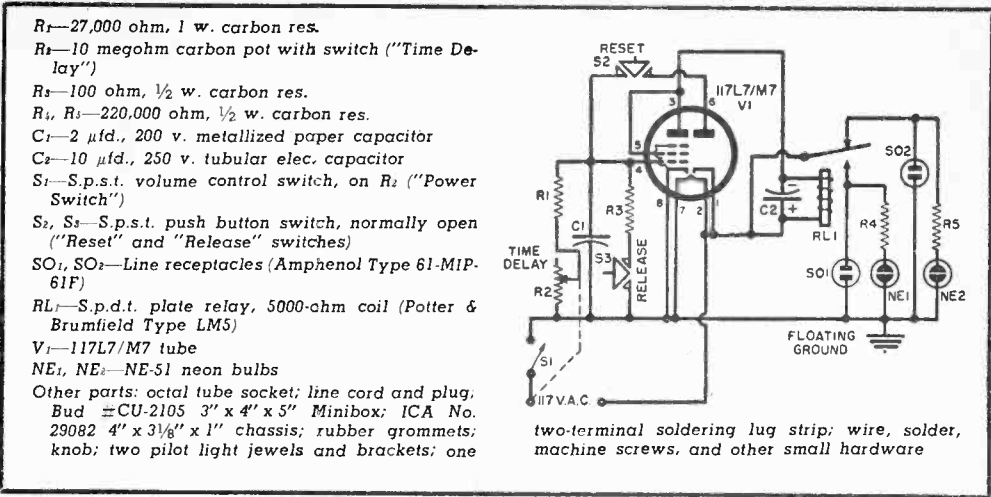

Fig. 4. Here are the schematic diagram and parts list for the home-built timer.

parts values given, the timing range will be from a minimum of slightly less than one second to about 25 seconds. The exact range covered will depend on the tolerances of the parts used, and as much as 25% variation from these values may be expected.

This range is more than ample for many types of enlarging work, especially where a "fast" enlarging paper such as Kodabromide is used.

Should you need a different timing range, you need only change the value of  $C_1$ . Using a larger capacitor here will in-

Fig. 5. This pictorial wiring diagram will help you in connecting the parts.

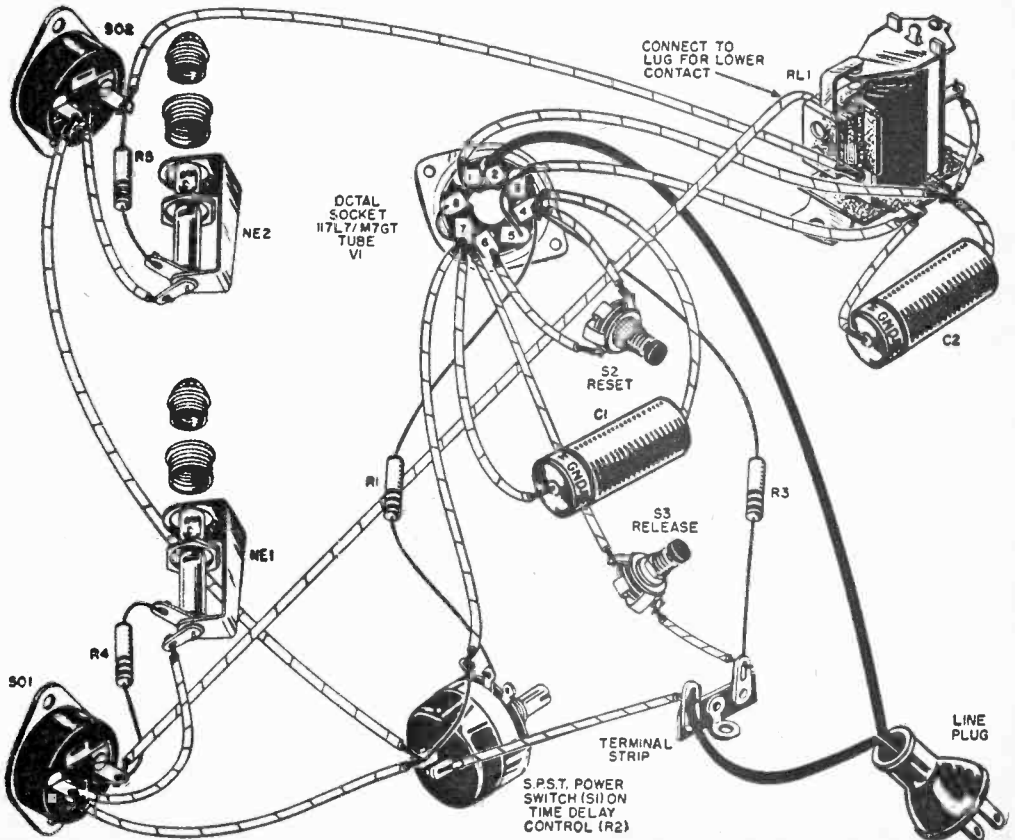

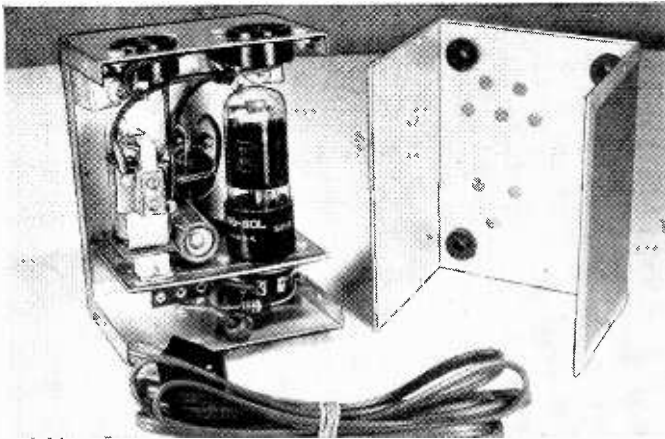

★  
 Fig. 6. The timer is shown here with the wiring and assembly completed, but before the two parts of the cabinet are assembled.  
 ★

crease the time delay; a smaller capacitor will reduce the timing interval.

A narrower range may be covered by replacing  $R_2$  with a 5 megohm or a 2 megohm potentiometer.

Neon bulbs  $NE_1$  and  $NE_2$  indicate which of the sockets,  $SO_1$  and  $SO_2$ , has power applied. They can be distinguished by fitting them with different colored jewels.

**Calibration and Use:** With the 117L7 tube in place, plug the timer into a standard power line outlet and turn it "on." When the unit has warmed up properly, the relay will pull in with a distinct "click."

Set the "Time Delay" control about half way towards maximum. Press the "Reset" button and release it. The relay will drop out immediately and, after an appropriate time interval, will pull in again.

If you wish to stop the timing interval at any time, simply press the "Release" button. The relay will pull in immediately.

You may calibrate the completed timer by checking the delay intervals with a stopwatch or standard "clock type" timer. You can then either make up a calibration chart for the timer or, if you prefer, prepare a hand-drawn scale for the front panel.

If you don't care what makes the timer work, as long as it does, you can skip the remaining paragraphs. The following explanation is for readers who do like to know what goes on in equipment they build.

When  $S_1$  is closed, the a.c. line voltage is applied through the contacts of  $RL_1$  either to socket  $SO_1$  or socket  $SO_2$ , depending on whether relay  $RL_1$  is energized or not. The line voltage is applied also to the heater of  $V_1$  and to the plate-cathode circuit of the amplifier section of the tube and the coil of relay  $RL_1$ , in series. Although a.c. voltage is applied, plate current flows only one way through the tube and thus current flows

only one way through the relay coil. The relay coil is energized and power is transferred from  $SO_2$  to  $SO_1$ .

$S_2$  and  $S_3$  are momentary contact switches, normally open. When "Reset" switch  $S_2$  is depressed, the rectified output of the diode section of  $V_1$  charges  $C_1$  and applies a large negative bias to the grid of the amplifier section of the tube, cutting off plate current flow. The relay is deenergized and power is transferred from  $SO_1$  to  $SO_2$ .

As soon as the "Reset" switch is released,  $C_1$  begins to discharge through  $R_1$  and  $R_2$ , decreasing the bias on the amplifier section of the tube. When the bias drops to a low enough value, plate current flows again, the relay is energized, and power is transferred from  $SO_2$  to  $SO_1$ . The length of time  $RL_1$  remains deenergized after the "Reset" button is released can be varied by means of  $R_2$ , the "Time Delay" control.

If it is necessary to end the interval before the preset time is up, depressing "Release" switch  $S_3$  will allow capacitor  $C_1$  to discharge rapidly through  $R_3$ . END

Fig. 7. Finished timer in its 3"x4"x5" case.

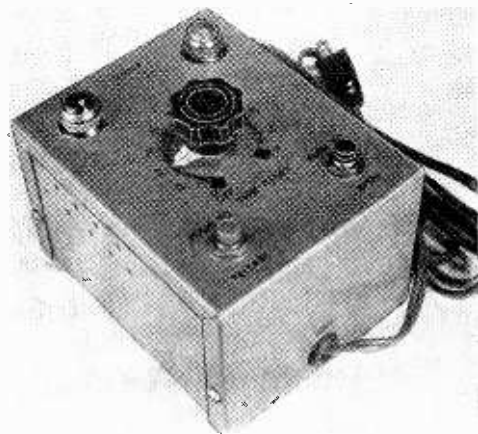

# Don't Lose it — Fuse it!

By JOHN FRIEBORN

Why risk dollars to save cents! An inexpensive fuse can protect your valuable electrical equipment from overloads.

**A** TEN-CENT fuse can save a twenty-dollar TV receiver transformer—and you can add fuse protection to any electronic equipment in a few minutes, without drilling, wire cutting, or soldering. Just use a fused plug or a fused current tap. These fittings are now offered by several manufacturers.

You can use a fused plug in place of the regular plug and install it in the same way—disassemble the plug, loop each of the two a.c. power leads under its screw, tighten the screws, and reassemble the plug. Fig. 1 shows an assembled and a disassembled view of a fused plug manufactured by *Elmenco*.

A current tap has prongs on one end and holes in the other. The prongs fit standard electrical outlets. Inside the holes are clips to fit standard plugs. A current tap does not have to be disassembled. Simply remove the regular plug from the outlet and insert the current tap between them. A fused current tap is shown in Fig. 2.

If you want to include fuse protection in equipment when you build it, you will find the fused plug neat and economical. On existing equipment, you can install a fused current tap more quickly.

Both the fused plug and the fused current tap are made to fit tubular fuses  $\frac{1}{4}$  inch in diameter by  $1\frac{1}{4}$  inches long (the "3AG" and "3AB" size). Two fuses are required for each fitting. To insert fuses in the plug or current tap, simply push them in through the holes at the prong end of the fitting. To remove the fuses, use the small holes at the opposite end of the fitting; insert a small nail or a phone tip and push the fuses out.

Fuses of the proper dimensions are available in current ratings from 1/100th of an ampere to 20 amperes. To determine the required fuse rating, you must know

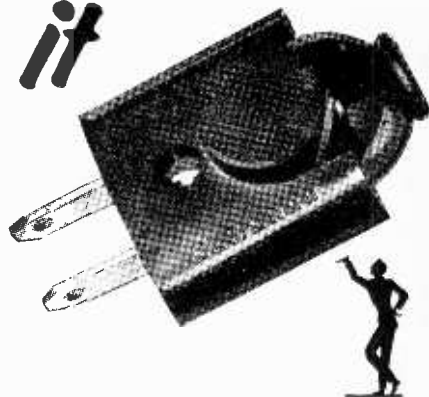

Fig. 1. The assembled (top) and disassembled views of an Elmenco fused plug, suitable for all types of electronic equipment.

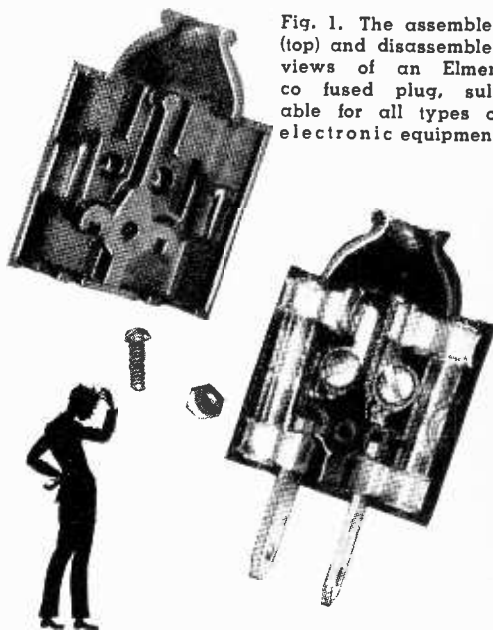
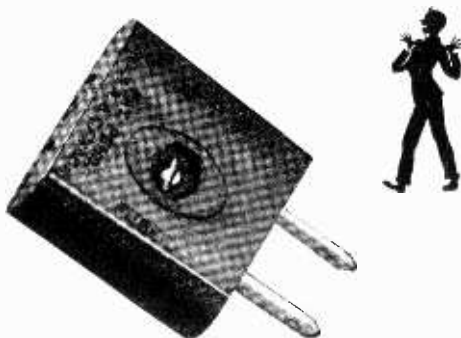

Fig. 2. A fused current tap. The tap plugs into an outlet, cord plugs into tap. By B & M Electric.



the current rating of the equipment. If the current rating is given directly in amperes on the equipment, use that figure. If the ampere rating is not given, but the power requirement is given in watts, divide the number of watts by the rated voltage to determine the current in amperes. For example, a television receiver rated at 117 volts and 275 watts would require  $275/117=2.35$  amperes. Whether you read the ampere rating directly off of the equipment or compute it from the wattage rating, you will have a figure that represents the current you want the fuses to pass without blowing.

You do want the fuses to blow, of course, if the current through them becomes high enough to damage your equipment. Probably you don't know how much current your equipment could take without damage. Trying to find out exactly would be too much like trying to find out how hot a flame you could hold your finger in without getting a blister. Other people's experience has shown that in most equipment a fifty per-cent overload will not do serious damage, but a current more than fifty per-cent above normal probably means a fault in the equipment. A commonly recommended practice, therefore, is to use a fuse rated at 50 per-cent more than the current rating of the equipment. In our example, the fuse rating would have to be at least  $2.35+1.175=3.525$  amperes. A fifty per-cent safety factor may not be enough for equipment which has a relatively high starting current. Two solutions are possible.

First, you can use a fuse of larger capacity. There is no general rule about how much higher starting current may be than

the normal current, so the simplest procedure is to try the next larger rating, then the next, and so on, until you have a fuse which does not blow. This may not seem to be a scientific method of determining the proper fuse size, but it is a good one. You may blow a fuse or two in your trials, but you will find the rating which is high enough, but not too high. It is important, especially on equipment with a high starting current, not to use a fuse with a higher rating than is actually necessary. If you do, you will have less protection against overloads after starting.

As an alternative solution to the high starting current problem, you can use two-element fuses (*Buss "Fusetrons" or Littelfuse "Slo-Blo"* fuses). In these fuses, one of the elements will open the circuit quickly on a large overload. The other opens on a smaller overload, such as might be caused by starting current, but the circuit opening is delayed for a longer time than the starting current normally would last. The over-all result is: first, these fuses do not blow on the starting current; second, if some actual trouble makes a current as high as the starting current last for a relatively long time, the circuit will be opened; and third, if a trouble causes a much larger current than the normal starting current, the circuit will be opened immediately. You can use lower fuse ratings with two-element than with single-element fuses and have more protection against abnormal overloads.

Any electronic equipment you have is worth fuse protection. With a fused plug or a fused current tap, you can provide that protection easily and quickly. **END**

## NEW ANTENNA TO HANDLE 20,000 TELEPHONE CIRCUITS

**A** NEW TYPE of antenna, resembling a giant sugar scoop (see photo at left) has been designed by *Bell Labs* engineers to receive and transmit telephone and television signals.

These horn-reflector antennas, to be used on *Bell* radio-relay routes, may eventually handle up to about 20,000 telephone circuits or 30 TV programs at one time. They can handle, simultaneously, radio signals in the 4000, 6000, and 11,000 megacycle bands.

Microwaves are deflected from the curved back of the receiving or transmitting antennas which will be mounted on towers. Towers as high as 300 feet above ground are often required for radio-relay transmissions. **END**

POPULAR ELECTRONICS

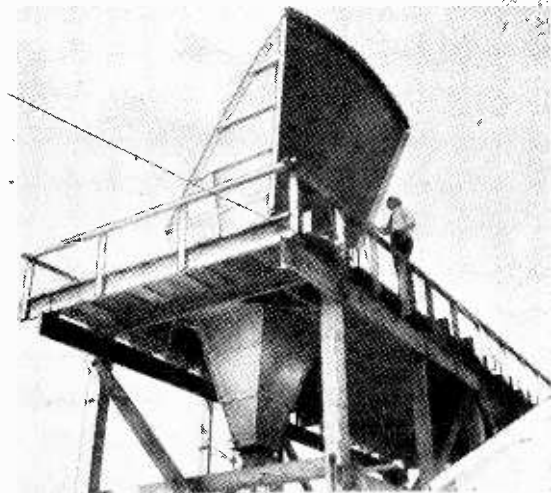



# 3-CHANNEL TONE R/C RECEIVER

By E. L. SAFFORD, JR.

**T**HIS receiver was designed to get the "Mostest for the Leastest." It does operate on tones but these are not critical. It offers three channels with but two relays, requires no bulky or complex filters, has a straightforward simple-to-adjust circuit, and is highly reliable. To operate this receiver on the Citizens band at 27.255 mc. you will have to use a crystal-controlled transmitter and fill out and return an FCC form 505 to the closest FCC office.

The receiver consists of a superregenerative detector, two stages of audio amplification, and two relay stages. To reduce

the number of tubes required, two 3A5 dual triodes are used. The relays energize when the receiver is turned on and de-energize when the tone signals are received. The circuits to be operated should be connected to the normally-closed contacts of the relays.

## Circuit Details

The antenna coil  $L_1$  is inductively coupled to the tank coil  $L_2$ , which is slug tuned. (See the circuit diagram.) The small variable capacitor across the coil should be adjusted in conjunction with the coil slug

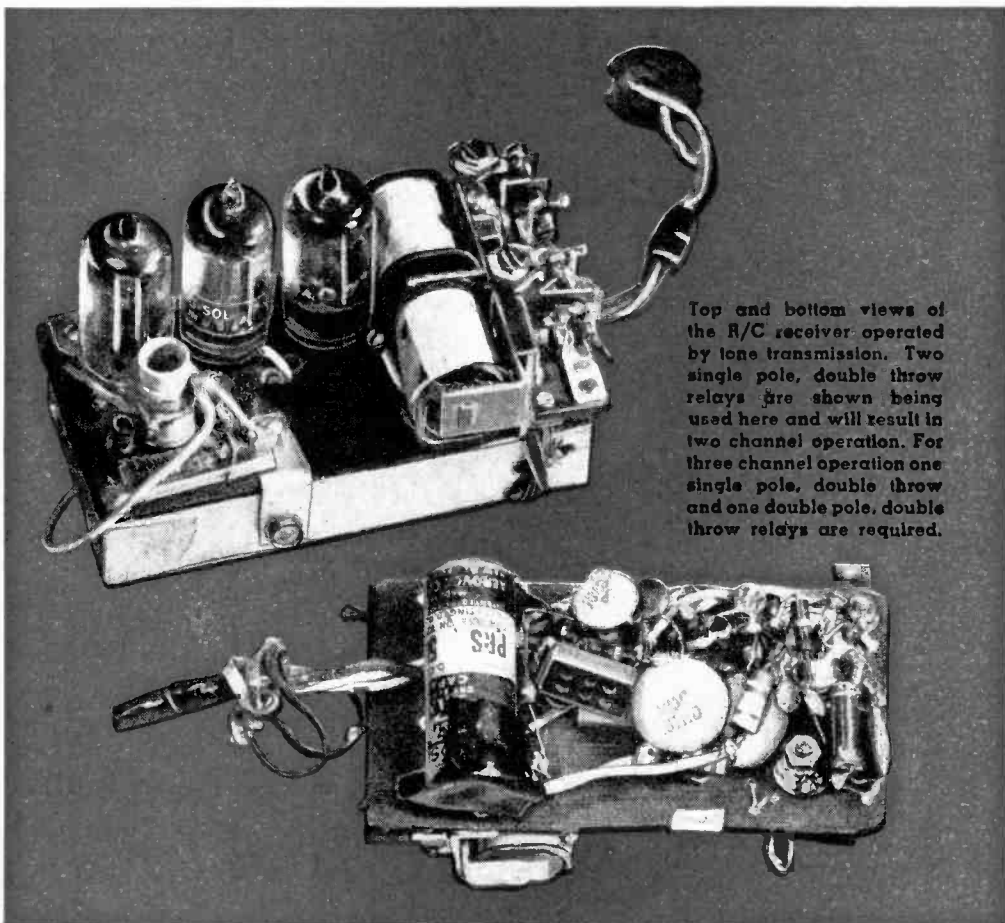

Top and bottom views of the R/C receiver operated by tone transmission. Two single pole, double throw relays are shown being used here and will result in two channel operation. For three channel operation one single pole, double throw and one double pole, double throw relays are required.

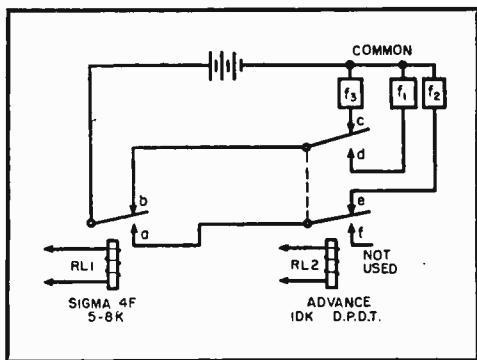

Block diagram showing how three channel operation can be obtained with the receiver described here and the relays specified.

for 27.255 mc. The coil slug is always grounded as this improves circuit stability.

The signal is impressed on the grid of the detector through a small capacitor,  $C_1$ . The plate is connected directly to the opposite end of the coil. The two r.f. chokes are provided to keep the r.f. energy in the tank circuit. The audio take-off is across the grid resistance and capacitance. These are also responsible for the self-quenching action required.

The signal is next coupled to the grid of the first audio stage (the second half of  $V_1$ ) through  $C_2$ . Notice two points here: the grid resistance is high, ten megohms ( $R_2$ ), and a capacitor,  $C_5$ , is used from the plate to ground to reduce the quench voltage but allow the audio signal to pass to the second audio stage.

This second stage is conventional, using a 3Q4 pentode. Notice the decoupling filter,  $C_4-R_4$ , in the "B+" line which is necessary to prevent internal oscillation.

It was desired that one relay open with one tone, and the second relay open with a second tone; these tones to be different, but not critical. To accomplish this,  $C_{10}$ ,  $C_9$ ,  $C_{12}$ , and  $R_6$  form a high- and low-pass filter such as is used in conventional broadcast receivers for tone controls. High-frequency signals can get through to grid 6 of  $V_3$ ; low-frequency signals go on grid 2. When a high frequency tone is received and appears on grid 6 of  $V_3$ , relay  $RL_1$  will open. Relay  $RL_2$  operates in a similar manner.

With this arrangement then, it is possible to transmit a low tone (about 600 cycles) to cause one relay to open, and a second tone (about 3000 cycles) to cause the second relay to open. If an intermediate tone of about 1500 cycles is transmitted, both relays will open and this makes possible the three channels.

If relay  $RL_2$  is opened and relay  $RL_1$  remains closed, energy will flow through contact  $a$  and out  $e$  to energize one function,

$f_2$ , refer to the block diagram. If  $RL_1$  is opened but  $RL_2$  is not, the current will flow through contact  $b$  and out  $d$ , energizing a second function,  $f_1$ . If both relays are opened together, current flows through contact  $b$  and out contact  $c$  to operate function  $f_3$ . The only requirement for three channels is that one relay be a double-pole, double-throw type of about 8000 to 10,000 ohms which will operate on about two milliamperes. For two channel operation, merely use two single-pole, double-throw relays.

## Adjustment

To adjust this receiver, plug a pair of earphones into the jack and listen for the characteristic hiss. The transmitter should be off. Now adjust the relays so that they both pull in, being careful that the armatures do not touch the relay cores; this causes sticking. Now turn on the transmitter. The hiss should die away as the receiver is tuned to the transmitter frequency by means of the slug and/or the variable capacitance. Close the transmitter switch causing the low tone to be transmitted and adjust the spring tension on  $RL_2$  until the relay opens. Release the button and, if necessary, readjust the relay clearance until the relay pulls in again. Repeat this procedure until the relay opens with reception of the low-frequency signal and closes without it.

Now remove the earphones, since they cause a loss in the high frequency tones, and adjust the high-frequency relay in exactly the same manner. Finally, when both are operating satisfactorily, transmit the 1500 cycle tone and both should open and close together. Once adjusted, they need no more attention unless subjected to a severe shock or dust or dirt.

If the receiver does not operate properly, check the voltages at the tube sockets. The correct voltage values are given on the schematic diagram, but these may vary as much as ten per-cent. These voltages were measured with a 5,000 ohms per volt voltmeter. Check the tubes themselves and, if necessary, substitute tubes in the superregenerative stage; some 3A5's work better than others here.

Check the wiring, be certain it is correct and that there are no loose or cold solder joints. Be sure that the filament voltage is above 2.1 volts, erratic relay operation begins when the filament voltage drops to just above this value.

The only stage that is critical in layout is the superregenerative stage. Keep parts spaced here and do not pile components on top of one another, the chokes especially. Allow  $\frac{1}{2}$  inch air space around the coils and  $\frac{1}{4}$  inch around chokes.

END

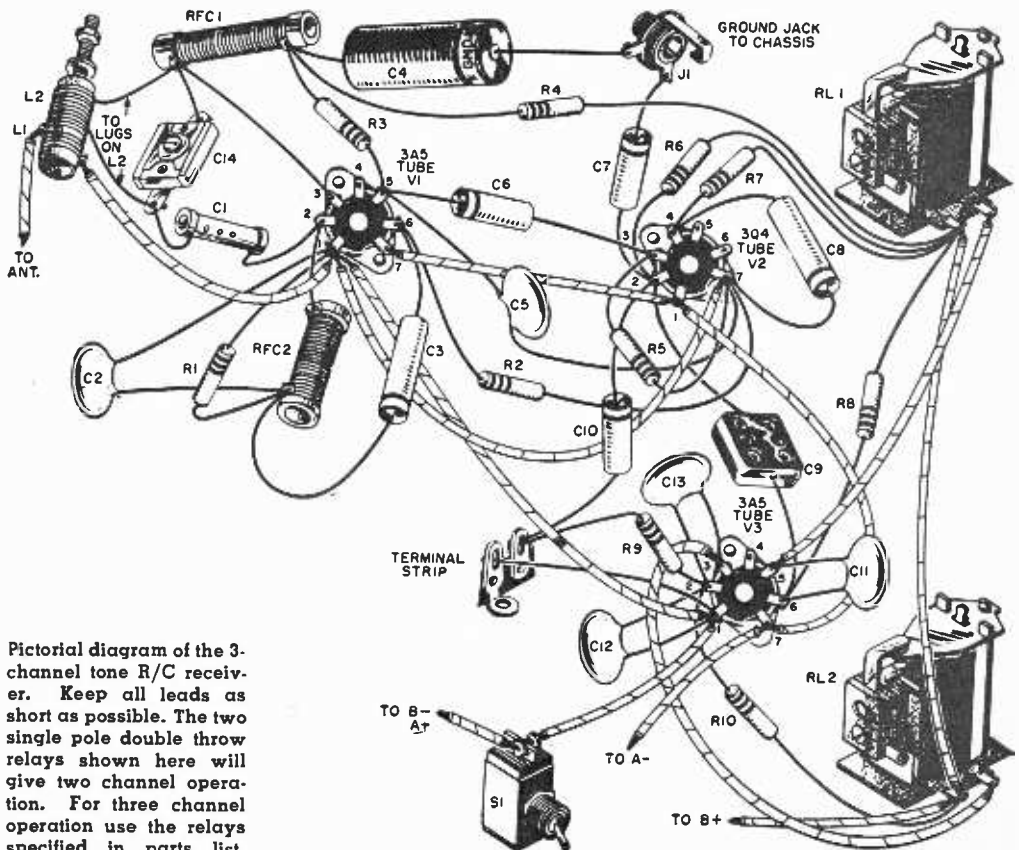
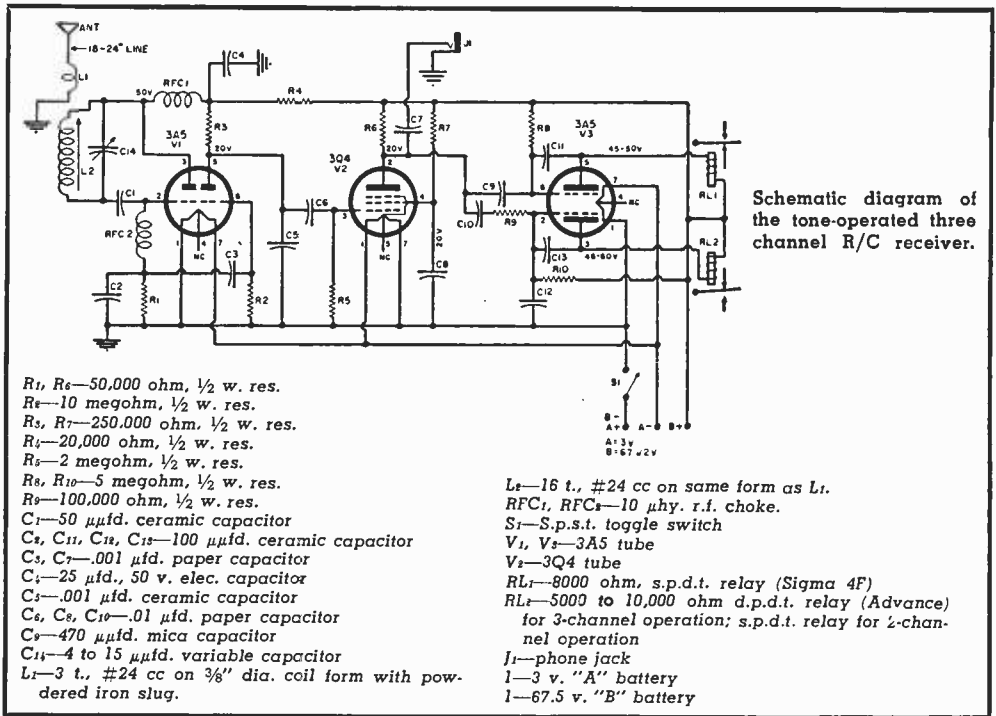

Pictorial diagram of the 3-channel tone R/C receiver. Keep all leads as short as possible. The two single pole double throw relays shown here will give two channel operation. For three channel operation use the relays specified in parts list.

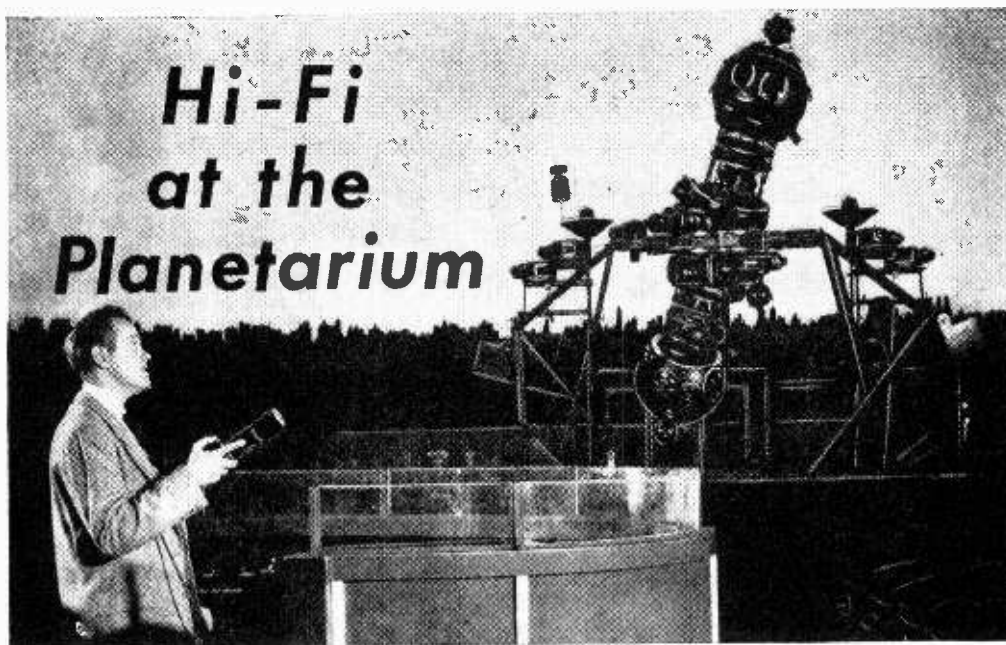

Mr. Joseph M. Chamberlain, Chief Astronomer of the Planetarium, at the new control console.

*New electronic equipment provides breathtaking realism of sight and sound in famous "theater of the skies."*

**A** MAMMOTH electronic control console has been installed in New York City's famous Hayden Planetarium. Synchronizing the Planetarium's Zeiss Projector with an elaborate high-fidelity sound system, the console enables the "theater of the skies" to present its shows with startling realism of both visual and aural effects.

The only instrument of its kind in the world, the new unit, as well as the entire sound system, was designed and installed by the *Altec Service Corporation* of New York, with Mr. Martin Bender, Commercial Engineer attached to *Altec N.Y.*, supervising the entire operation, and Mr. Joseph M. Chamberlain, Chief Astronomer of the Planetarium, contributing to the guidance and scope of the program of improvement.

Almost a mile of wiring is used in the unusual instrument, as well as dozens of switches, knobs, relays, circuit breakers, and other components. The unit weighs 1500 pounds and took a year to design and build. Now in operation, it is capable of controlling 96 different combinations of special effects to enhance the theatrical possibilities of the Zeiss Projector. In addition, it controls any sequence of 15 different lighting machines, each of which includes

up to a dozen different scenes that may be displayed. The resultant combination provides an almost fabulous range of possibilities for showing celestial phenomena. Synchronization of these visual effects with specially prepared sound effects is now so perfect, that the spectacle of a meteor hurtling toward the earth, accompanied by a terrifying noise, is enough to make adult members of the audience duck under their seats.

The new control console is the climax of a five year program of improvement at the Planetarium, during which time *Altec* also installed a complete audio system. Chief problem facing Mr. Bender in this task was to diffuse correctly the sound in the dome-like room that is the Planetarium theater, as well as in the cylindrical room in which lectures are given. In both rooms the shape and architectural material worked *against* good acoustics rather than for it.

The dome, in which music and speech as well as special sound effects were to be reproduced, received two speaker systems, each complete in itself with one woofer and two tweeters for maximum distribution of high frequency sounds. One system handles music and sound effects; the other reproduces the lecturer's voice and serves



Hi-fi record and tape equipment, amplifiers, and controls are housed in soundproof room.

Altec and Planetarium technicians took six days to install the new unit.



U.N. children saw home skies projected.



also as a standby speaker in case of failure of the former.

In the cylindrical room, the saturation method of speaker placement was used by installing a ring of twenty-four speakers around the ceiling.

Feeding these speaker systems are audio program sources and input systems located in a studio-type control room. In addition to the microphone used by the lecturer, the control room houses a *Rek-o-kut* twin turntable with *Pickering* arms and pickups for playing records. Adjacent to these is a twin *Ampex* tape system used both for recording and reproducing. All input signals are fed through *Altec-Lansing* pre-amplifiers and output amplifiers. The system is rounded out with switching and patching panels that provide maximum flexibility in feeding the sound to any or all parts of the speaker system as well as in monitoring programs. Because the output frequency response of the system is flat, radio stations can connect directly to any of the outputs and broadcast programs directly without correcting for local equalization.

Speaker muting is provided at the control console permitting the lecturer to communicate with the control room without the audience being aware of it. END

January, 1955



Martin Bender (right), designer, plans wiring and installation with Planetarium staff.

The new control console after installation.

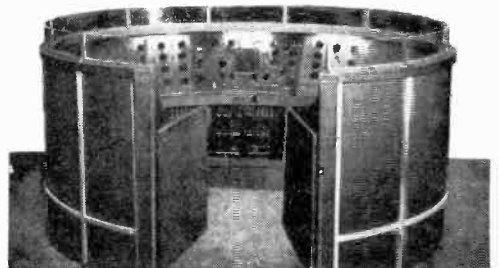

# Fun

with a  
**GEIGER  
COUNTER**

By HAROLD RENNE



Hunting—if there is a great increase in the rate of clicks you hear, that's it!

This counter is compact, inexpensive and easy to operate—flip the switch and listen.

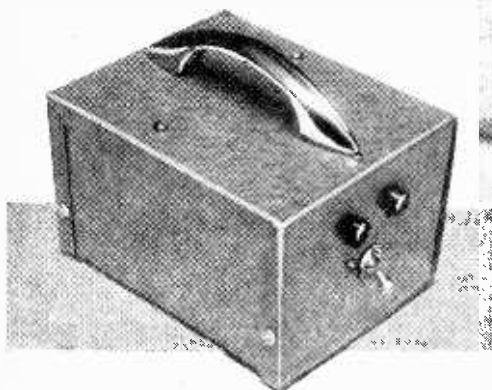

**P**ROWLING around with a Geiger counter in search of uranium is lots of fun, and might also turn out to be very profitable! A little over two years ago, Vernon Pick ran across a rich uranium deposit while prospecting with a Geiger counter, and recently sold his holdings for over nine million dollars! A Mr. Steen, down to his last grubstake less than four years ago, found uranium, and today is numbered among the country's millionaires.

Not all prospectors have been so successful, but it is safe to say that the majority have enjoyed themselves while prospecting. The government offers prices and bonuses which make searching for uranium extremely attractive. Two publications, available from the Government Printing Office, Washington 25, D. C., should be part and parcel of every prospector's library. These are "Prospecting for Uranium," \$0.55, and "Prospecting with a Counter," \$0.30. They give details on government bonuses, tell where ore may be sent for checking, and include a gold-mine of miscellaneous information.

Cost of equipment has undoubtedly been a major deterrent to many who hanker for a spell in the wild country. However, Geiger counters need not be complicated or expensive, and can be built very simply in the home workshop.

A word about the functioning of a Geiger counter is perhaps in order at this time. The heart of the counter is a Geiger tube, a special gas-filled diode which is sensitive to the gamma rays given off by uranium. It is usually cylindrical in shape, can be made of glass or metal, and contains a center electrode which is insulated from the shell. If made of glass, the inside is coated with *Aquadag* or other material to form a conducting layer. Gamma rays, which are similar to x-rays, knock electrons loose from the walls of the tube. The center electrode is kept at a high positive potential, and attracts these electrons so strongly that they ionize the gas in the tube; that is, knock electrons out of some of the gas molecules. These new electrons knock out still more electrons, producing what is known as an avalanche, or pulse of current,

which will produce a click if passed through a pair of headphones.

The simplest Geiger counter, then, consists merely of a battery of the proper voltage in series with the Geiger tube, a pair of headphones, and a protective resistor. Most Geiger tubes require around 900 volts for proper operation, but the *Victoreen Instrument Company* manufactures several models which will operate on 300 volts. The 1B86, used in the instrument to be described, retails for \$8.00. Also, two companies (*Eveready* and *Burgess*) make small, light batteries which provide the necessary 300 volts and which retail for under \$8.00.

Now all we have to do is combine the essential components into a unit which is convenient to carry around. The smaller diagram of the schematic shows the circuit. These components can be combined into a commercial 3"x4"x5" aluminum box, with a kitchen cabinet handle, available at any hardware store, mounted on top for carrying. A word of caution: the 300 volts from the battery can give a nasty bite, so be careful!

Aluminum will screen out some of the gamma rays from uranium, so a series of small holes is drilled in the case immediately beneath the Geiger tube. These holes can be seen behind the tube. The tube is clamped in place by a small clamp made from a *Fahnestock* clip—any kind of small clamp will do. It is a good idea to glue a small piece of sponge rubber, felt, or some other material to the bottom of the case before clamping, to protect the tube. The wire leads of the tube are brought out to the terminal strip and soldered in place.

The battery mounts very nicely in the top part of the case, and is held in place by a strap made of some kind of sheet metal, tin,

aluminum, etc. Use your ingenuity and take advantage of whatever you have available. The two phone jacks are mounted on the rear of the case.

When the parts have been assembled and the leads carefully soldered, put the case together and you are in business. As soon as the headphones are plugged in, you will hear a series of very faint, irregular clicks—about 40 to 60 every minute. This is the so-called background count. If the counter is brought in the vicinity of radioactive material, the clicks will become more frequent. The rate of the clicks gives an indication of the intensity of the radioactivity.

Don't be disappointed if the clicks are very faint. This is the price that must be paid for simplicity. However, with sensitive headphones, the volume will be adequate for quiet locations. No switch has been provided, as unplugging the phones breaks the series circuit and disconnects the battery.

It is a very simple matter to install a one-stage amplifier in the same case with the counter. Such an amplifier can provide adequate headphone volume for all but the noisiest locations.

The circuit for the Geiger counter, complete with amplifier, is shown in the larger diagram of the schematic. A triode-connected 1U5 provides adequate gain and its battery requirements are very small. Here the plate voltage is obtained direct from the 300-volt counter battery. A large load resistor (1 megohm) protects the amplifier tube from the excessive battery voltage. Total current drain for both counter tube and amplifier tube is well under one milliampere, which permits extended battery life. Filament requirements are met by a small penlite cell clamped beside the counter tube. The paper

One section of the cabinet mounts the 300-volt battery, the headphone tip-jacks, and the on-off switch—the other section, all other parts.

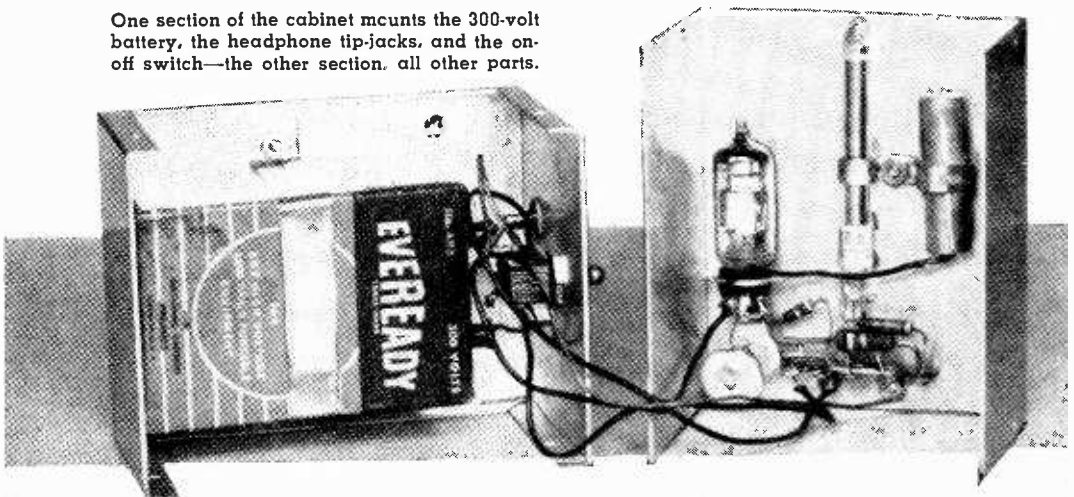

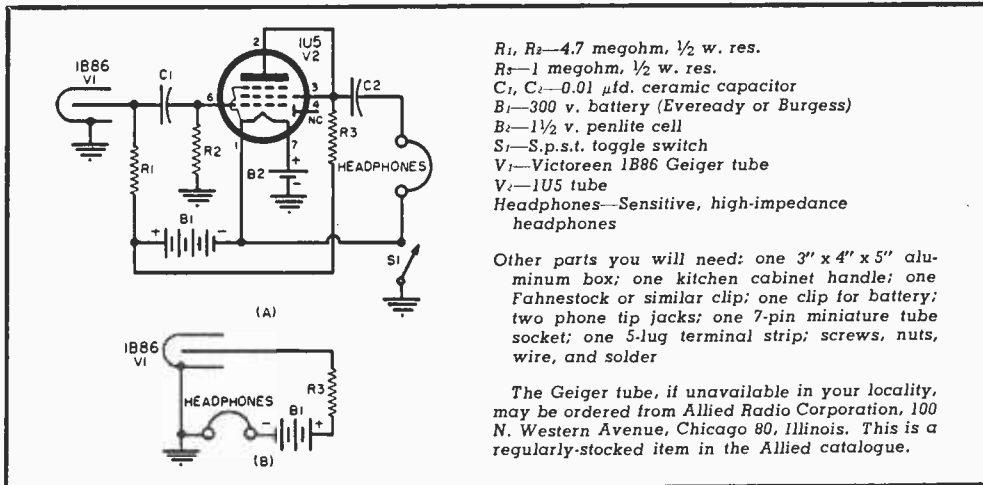

Diagram (A) is the counter with amplifier; diagram (B) is simpler, but less sensitive.

shell on the battery is removed so that the negative terminal is connected direct to the chassis. However, it may be desirable to solder a lead to the battery shell and connect it to the chassis for a more reliable contact. The socket for the 1U5 is mounted on the other side of the counter tube, and is supported only by leads soldered to it. This provides a form of "shock mounting" and protects the 1U5 from severe shock. The "on-off" switch appears just below the phone jacks, and is wired to disconnect both the plate and filament battery when in the "off" position.

A high value load resistor (4.7 megohms)

is used for the Geiger tube to give a large voltage pulse. This pulse is fed to the 1U5 control grid through a .01-μfd. ceramic capacitor, chosen because of its small physical size. Actual value is not at all critical. The amplified pulses in the plate circuit are coupled to the headphones by means of another .01-μfd. ceramic capacitor, which serves to isolate the headphones from "B+" and avoids all possibility of shock.

Now that you have an amplified Geiger counter, you can start prospecting in earnest! Try it out on the luminous dial of your watch or alarm clock, then on the nearest stone quarry. END

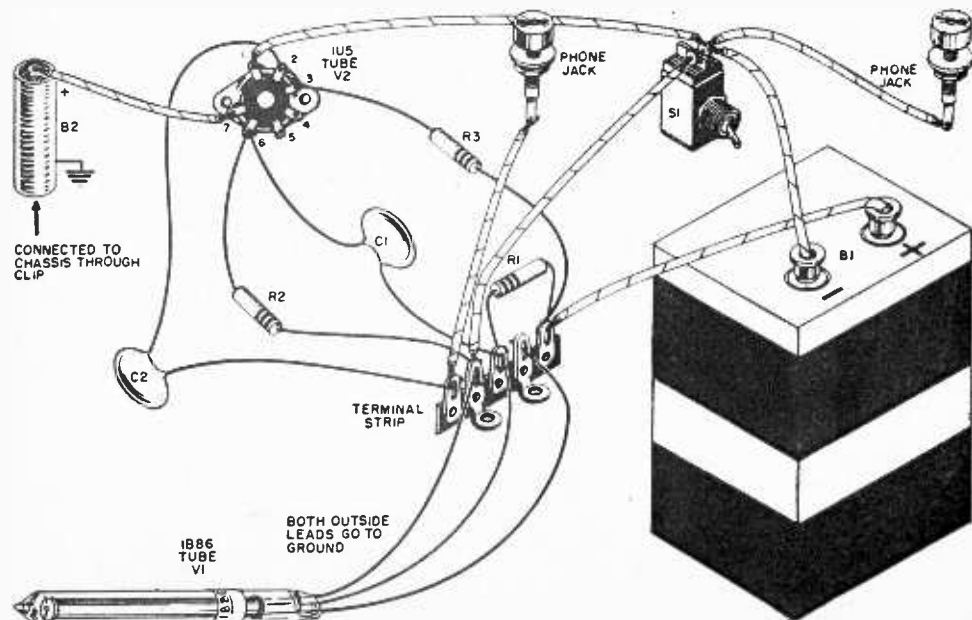



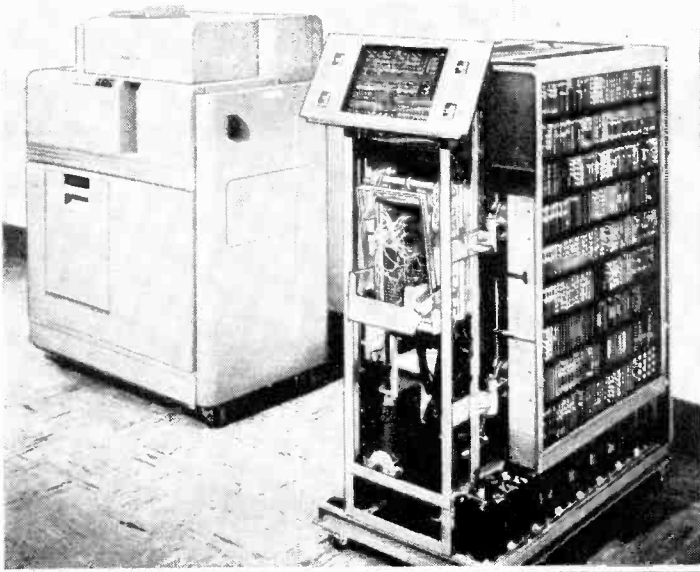

High speed punching unit at left and transistorized calculating unit at right make up the new computer.

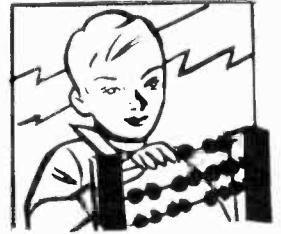

Transistors, resistors, and diodes are mounted on printed wiring panels shown here.

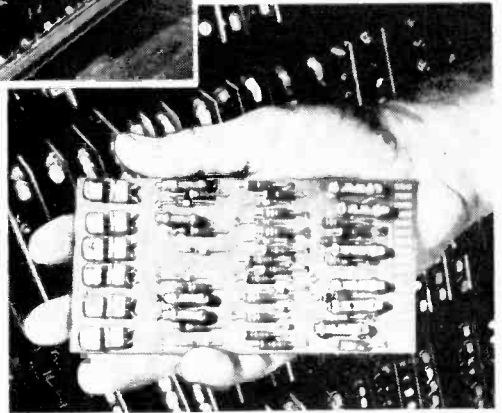

# A New All-Transistor Calculator

**A**N EXPERIMENTAL all-transistor calculator has been developed by the new research laboratory of *International Business Machines Corporation*, Poughkeepsie, N. Y. The new machine includes a computing unit about one-half the size and requiring only 5 per-cent as much power as a comparable vacuum tube computer, yet it does the same work.

The new calculator is comparable in capacity to *IBM's* type 604 electronic calculator, of which over 2000 are in use. These machines are capable of solving rapidly complex problems, including differential equations. Their circuits can be set up to correspond to a given set of conditions for which the operator needs certain answers and results. Accurate results can be supplied in far less time than it takes a skilled mathematician to do the same work.

The type 604 uses 1250 vacuum tubes; the new model uses more than 2200 transistors. While their speeds are similar, the new unit is much smaller in size and requires only as much power to operate as is needed for a television receiver. This eliminates the need for a bulky power supply

and forced air cooling of the components.

This experimental engineering model is believed to be the first fully-operative transistorized computer complete with automatic input and output. Many of the transistors used in it are of a design developed by the company's own engineers to meet the operating characteristics required in computer circuits.

Because transistors have a much longer life than vacuum tubes, it is expected that the necessary maintenance of machines employing them will be greatly reduced from that of vacuum tube machines.

Printed wiring, replacing much of the wiring normally comprising a computer's "nervous system," was used in the design of the new calculator to simplify it, and reduce space requirements. This model contains 595 printed wiring panels, on which the transistors are mounted. Each panel is about two-thirds the size of an *IBM* card.

Mr. W. W. McDowell, *IBM* vice-president in charge of research and engineering, states that the new model is experimental, "... one of the many experimental projects on which our engineers are working. . . ." END

# THE WORLD AT A TWIRL



By K. R. BOORD

**M**OST short-wave stations now use *English* at least part of the time—especially for identification purposes. The best source for identification aids is *World Radio Handbook*, which lists announcements (by languages) used by a station, opening and signature tunes, interval signals, slogans, and so on. (The American agent for WRH is now Gilfer Associates, Box 239, Grand Central Station, New York 17, New York.)

The language *alone* is not conclusive proof of the origin of a broadcast which you may pick up. For instance, if you hear a program in French or Spanish, this does not necessarily mean that it is being transmitted by a station located in France or Spain respectively. Many stations use *multiple* languages, and many short-wave transmitters take *relays* from other stations.

To make sure that you identify a station correctly, it is essential to wait for the announcement which most stations give at regular intervals—*especially on the hour*. If you can't "wait" that long one day, you'd better try it again another day.

Naturally, the more languages with which you are familiar, the easier the identification of the senders. More and more, however, you'll find stations are adding *English*, particularly for identification purposes.

If you know the equivalent of the word "*calling*" in several languages, you usually will be able to spot the location of the broadcaster—such as *Huna* Omdurman (the Anglo-Egyptian Sudan); *Ici* Paris; *Goverit* Moskva (Moscow); *Hona* el Kahera (Cairo); *Aqui* Lisboa (Lisbon); *Govori* Sofia (Bulgaria); *Edho* Athinai (Athens); *Utvarp* Reykjavik (Iceland), and so on.

Listen carefully to foreign languages for their chief characteristics, then pick out repeated words and phrases. Analyze station announcements. It's a good idea to listen to some stations—schedules of which are known, and which broadcast in various languages (such as the BBC or *Voice of America*)—to learn how to recognize the sound of one tongue from another (such

as distinguishing Portuguese from Spanish).

Unless you are quite certain, take nothing for granted! USSR stations, for example, often are mistaken for Chinese broadcasters when the Soviet transmitters are using Chinese. Also, many outlets which announce as "Radio Moscow"—particularly in the North American daily transmission in *English* at 2300-0600—are actually *relay* transmitters in the Soviet's satellite countries—such as Bulgaria, Czechoslovakia, Hungary, and Poland.

*Tuning* and *interval* signals are a reliable guide (it pays to memorize any heard!). Here are some examples of common interval or tuning signals:

Canada's interval signal is the first four notes of the National Anthem, "O Canada"; Denmark's distinctive interval signal is from an old Danish folksong; the BBC uses Morse signal "V" (V for Victory) played on a timpani in its European Service; the general interval signal used by *Radio Nederland* is an old Dutch folksong called "Merk toch hoe sterck," played on carillon or celesta; Rome's interval signal is a bird chirping; Warsaw's interval signal is from the first movement of Chopin's "Polonaise in A-Flat Major"; Lisbon's interval signal is a gong; Sweden uses the first movement of Carl Michael Bellman's "Storm och böljor tystna ren"; Switzerland has a beautiful melody played on a music-box; the *Vatican Radio* uses a caril-

---

(NOTE: Unless otherwise stated, all time herein is expressed in Greenwich Mean Time—GMT—subtract 5 hours for EST, 6 for CST, 7 for MST, 8 for PST. This is on a 24-hour clock basis in which midnight is 2400 (or 0000), 3 a.m. is 0300, 10 a.m. is 1000, and noon is 1200, for example; instead of starting again at 1 p.m., as the 12-hour system does, the 24-hour system continues to increase the number of each hour until 2359 (11:59 p.m.) is reached, thus 1 p.m. is 1300, 5 p.m. is 1700, 10 p.m. is 2200.)

With regards to the terms "wavelength" and "frequency", wavelength is measured in meters. For every wavelength there is a corresponding frequency which is the number of complete waves, or cycles, sent out by a transmitter every second. A "kilocycle" is 1000 cycles, a "megacycle" is 1000 kilocycles or 1,000,000 cycles. As a SWL you will be concerned primarily with megacycles (mc.). To convert megacycles to meters (m.) divide the frequency in megacycles into 300. For example, 6 mc. divided into 300 gives you 50 m. (wavelength) and, conversely, 50 m. (wavelength) divided into 300 gives you 6 mc. (frequency).

lon melody, "Christus Vincit," played on the celesta with orchestral accompaniment; interval signal of *Radio Congo Belge* is a native xylophone beat; *Radio Baghdad* presents the soft chirps of a mechanical nightingale; *All India Radio's* signature tune is a melody of eight seconds' duration repeated with intervals of 10 seconds in between, using violin, viola, cello, and tamera; *Radio Australia* usually plays "Waltzing Mathilda" on a music-box for five minutes preceding transmissions, then has clock chimes and the laugh of the kookaburra, while New Zealand's interval signal is the call of the native bird, the tui.

Now for this month's tips (GMT):

\* \* \*

### For Beginners

*Algeria*—Try for *Radio Algeria*, 6.160, in Arabic, around 2200 to 2244A when closes with the playing of "La Marseillaise." *Argentina*—*Radio Splendida*, 9.310A, should be good level around 0100; all-Spanish. *Azores*—CSA92, 11.925, Ponta Delgada, is now on winter schedule of 2000-2100. *Brazil*—*Radio Cultura*, 6.165A, Sao Paulo, often has *English* around 0400. Try PSL, 7.936A, Rio de Janeiro, around 2230-2300 when has news in Portuguese. For the *English* session, "Brazil Calling," tune ZYK3, 9.565, Recife, weekdays 0105-0130. *Bulgaria*—*Radio Sofia*, 9.700, has *English* for North America now 2245-2300, 0030-0045, 0100-0130, 0400-0430.

*Costa Rica*—TIFC, San Jose, "The Lighthouse of the Caribbean," currently is using 6.037 parallel 9.647 (listed 9.645) around 1100-0500; has *English* 0300 or 0400. *Egypt*—For *English* news from *Radio Cairo*, tune 9.475 at 1830. *Finland*—Tune 15.190 for OIX4, Helsinki, at 1100 when has *English* news. *France*—When this was compiled, Paris was reported heard in east-



This six-story building is the home of Radio Japan in Tokyo. From the studios in this building, broadcasts are fed via landlines to the transmitters located in the city's outskirts.

ern USA with *English* (beamed to Britain) 2000-2100 over 6.045, 9.625A, and 11.700. *French Equatorial Africa*—*Radio Brazzaville* is again back on 9.440, parallel 11.970; closes down 0140; has *English* news for North America 2245-2300. *Greece*—*Radio Athens* now uses 9.607 (instead of 11.718) for *English* news 1745-1800 closedown. *Guatemala*—TGNA seems to alternate between 11.850 and 5.9525, in parallel with  
(Continued on page 112)



An engineer adjusts the power amplifier section of one of the short-wave transmitters aboard the Voice of America's "Truthship," the "Courier." This ship was designed to relay news of a free world to VOA's Iron Curtain listeners.

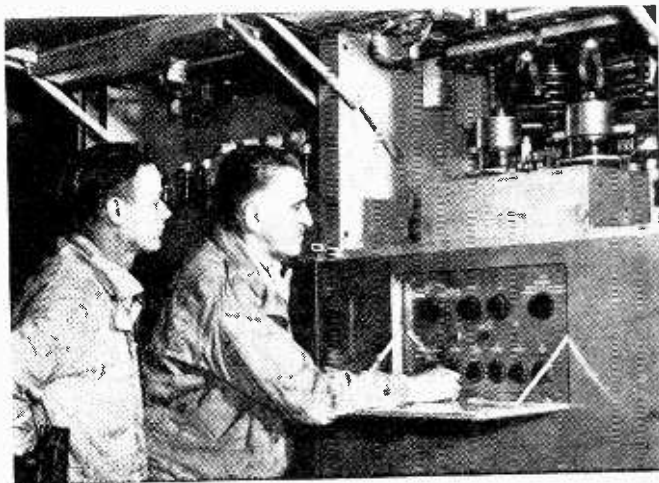



Col. Bingham supervises testing of new intercom in train office. Loudspeaker is wall mounted.

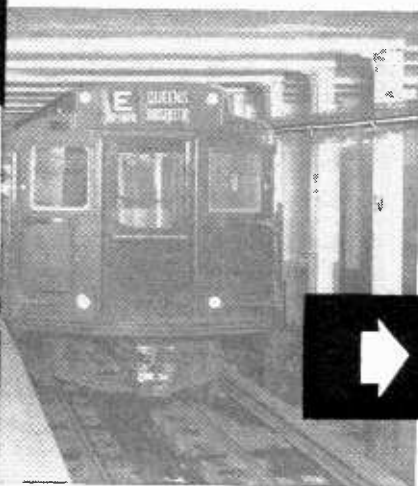

Third rail can be seen in above photo running alongside track. Motorman's cab contains its own sending-receiving unit including microphone and loudspeaker.

### *Third rail, used for carrying railroad power, doubles as signal path in subway's two-way FM voice message system.*

ONE of the most novel intercommunications set-ups in the world is the one nearing completion on New York City's subway railroad. Using the "third rail" (main power line) as the medium of signal transmission, the new system provides for two-way FM communication between a moving train and the dispatcher's or trainmaster's office.

The first of its kind, the new system has been in the process of development for several years by the *Union Switch & Signal Company* and Colonel Sidney H. Bingham, Executive Director and General Manager of New York City's Transit Authority.

A microphone, loudspeaker, and sending-receiving unit are located in the office. An identical unit is installed in the motorman's cab aboard the train. The operator at either end can call or listen to the other. In either case, the transmitter provides a carrier wave that is frequency modulated in accordance with the voice signal into the microphone. The modulated wave is then fed directly to the third rail. Reception of the message is then accomplished by metal contactors from the third rail to the receivers.

Due to the complexity of the third rail

system, the message wave may become dissipated over distances that involve circuit-breakers and bus bars. Consequently, an auxiliary line is sometimes required for carrying the message wave from point to point in the third rail system. For the time being this problem has been solved by using the railroad's signal mains as these auxiliary lines. Signal mains normally carry 660 volts a.c. for operating the subway's complex signalling system. The third rail itself carries 600 volts d.c. which furnishes the power to run the trains. The signal mains and the third rail—two distinct and separate electrical circuits—are now "connected" at certain points to provide a continuous path for the message signal. The connecting or coupling units are so designed, however, as to permit the FM signal to pass, and yet keep the power voltages isolated from each other, so that the high a.c. does not enter the high d.c. line, and vice versa. In addition to the network of transformers and capacitors that does this ticklish job, protective fuses are inserted on each side of the coupling unit to protect against the power voltages mixing with each other in case of breakdown. When the system is finally installed, the

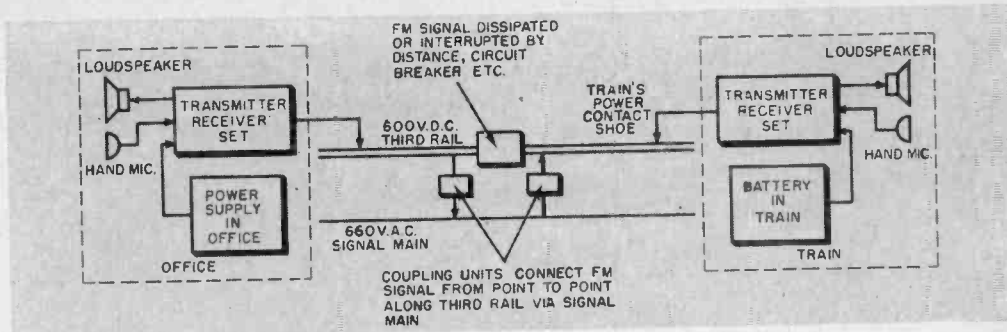

Simplified block diagram shows how the third rail is used for carrying voice messages, and how the a.c. signal mains relay the message from point to point along third rail.

# UNDERGROUND INTERCOM

a.c. signal mains probably will not be used for signal connections, but new wires will be provided for this purpose alone.

A message, sent from the office, is picked up by all trains within a given area. Similarly, messages sent from any train are picked up by the office as well as all other trains in the area. This feature is regarded as an advantage since it means that all train operators will be kept informed of all conditions in their area at any time. Individual calling systems would be very costly and no advantage is seen in developing them. Because of the weight of the equipment in one installation (over 30 pounds), an individual intercom set is not regarded as portable. Therefore, two units will be installed in each train—one at each end—so that the motorman will not have to carry his set back and forth at the end of train runs.

The receiving-sending sets are powered by batteries already contained in train cars, although some thought has been given to obtaining their operating power from the high d.c. present in the third rail.

The new system provides smooth and instant communication between the train and operating supervisors. It eliminates the need for a motorman to stop his train, get out, and walk along the tracks to a wall-phone when he has to call the office. In case of emergencies, information can be obtained by supervisory personnel, and instructions to the train issued almost instantly. Colonel Bingham anticipates greater railroad efficiency as a result of his new system, and expects that similar intercoms will soon be used by other third rail electric railroads.

END

Motorman testing the new intercom on a trial run through subway tunnels of New York City.





By E. L. SAFFORD, JR.

# 3 and 4 Finger R/C Escapements



**A**LTHOUGH the one-arm escapement is capable of allowing the R/C model airplane flier to execute a wide variety of maneuvers, more and more complex escapements are being used. These provide a more flexible system of control, allowing more intermediate positions for the rudder, stabilizer, etc.

In order to describe the operation of the more complex escapements, each extension will be referred to as a finger; each finger is intercepted by catch points as it rotates.

The three-finger escapement is illustrated in Fig. 1. Notice that the fingers are set 120 degrees apart, and that the catch points of the relay armature are located exactly the same as those on the one arm (or two-

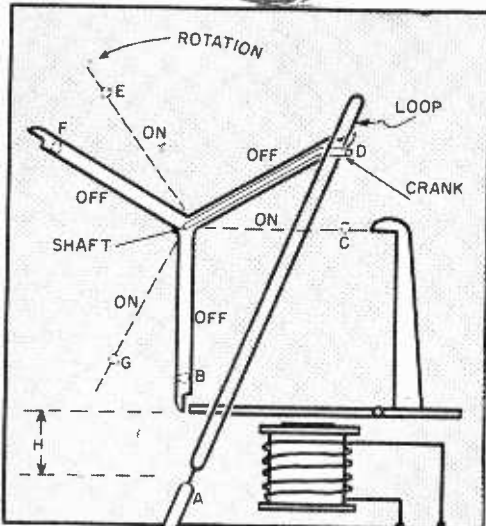

↑ Fig. 1. Three finger R/C escapement furnishing three left positions, two right positions, and one neutral crank position.

↓ Fig. 2. A four finger escapement with three left and three right positions. This of course allows for more flexible control of a model airplane or boat by radio control.

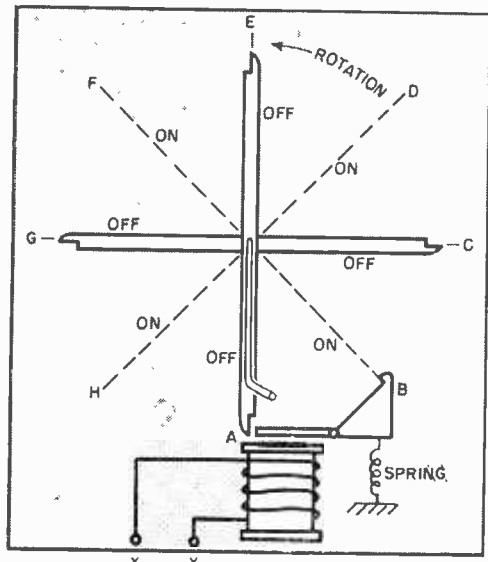

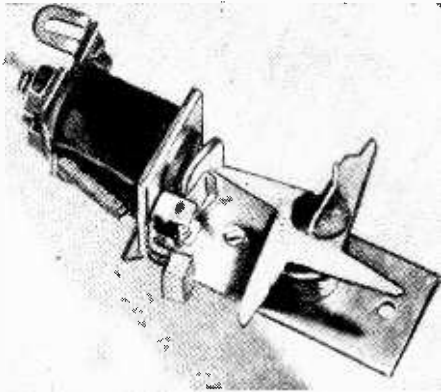

Fig. 3. A four finger escapement. Fig. 2 shows its mode of operation giving three left, three right, and two neutral positions.

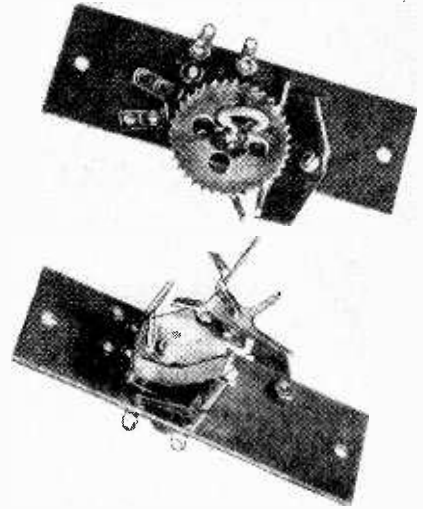

Fig. 4. The Bonner compound escapement used for radio control. Notice the ratchet wheel and rocker arm combination for smoothing out the rotation and the spring contacts on the front view.

finger) escapement. The solid lines represent the signal "off" positions. The dotted lines represent the signal "on" positions.

To complete a 360-degree rotation of the crank, the following signal sequence is necessary: "on-off," "on-off," "on-off." This compares to the sequence for the two-finger escapement which is: "on-off," "on-off."

Why use this type of escapement? The reason is more control. If the distance  $H$  is made equal to the distance from the shaft to the crank, the deflection of the loop to the right and left will be equal in positions  $C$  and  $G$ . These are the first and third "on" positions respectively, and represent the maximum deflection possible. Now notice that the loop will be deflected in positions  $D$  and  $F$ , but not as much. These are the first and second "off" positions. The  $B$  position is neutral;  $E$  is so slightly left that it can be used as a neutral.

Thus, with this type of escapement, it is possible to have two positions to the right and three to the left and also a single neutral. In steering applications a rudder may be placed in the "half" positions and allowed to remain there as long as desired without consuming power. One can also have full deflection in either direction, but only while the push-button is depressed. This is desirable particularly in planes where sharp turns do not want to be sustained.

#### 4-Finger Escapement

A typical four-finger escapement is shown in Figs. 2 and 3. This type is popular for boat steering. The catch points of this escapement move the arms in 45-degree

jumps instead of the 90 degrees of previous types. This type of escapement will provide three positions left or right, as shown in Fig. 2.

To remember just how many times to push the button to get a particular deflection will be a problem. It is possible, however, to design a ground control unit which will send forth the correct sequence for the position desired merely by moving a steering lever or wheel to the left or right.

#### Compound Escapement

To simplify the ground control unit and yet allow particular signals to be transmitted for left and right (and one other function), the *Bonner* compound escapement was developed. (See Fig. 4.)

The sequence of signals is simple and can be readily performed with a push-button. Pushing the button once will give "left." Holding the button down will prolong this position. To obtain "right," push the button down, release, and down again. Hold it down as long as you desire "right." For the third function, the sequence is "on-off," "on-off," "on." If one sends two quick pulses for "right" and desires to repeat "right," he just sends the same two pulses as before. The same applies to "left," or to the third function. This is possible because the escapement is designed with only one neutral or starting position. It returns to this neutral automatically whenever the signal remains off for any length of time. Other escapements can be made to do this, but require that a "neutral" command be transmitted after the steering command ends.

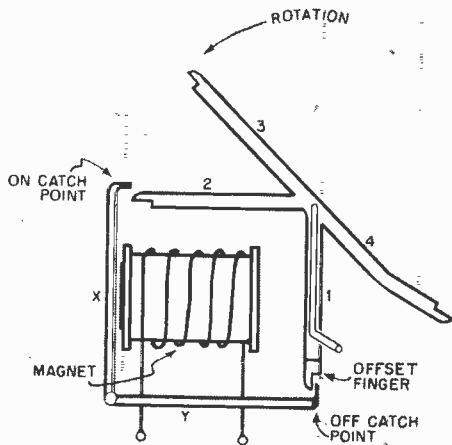

Fig. 5. Diagram of the Bonner compound escapement in the neutral position.

How does the *Bonner* compound work? Refer to Fig. 4. Notice that the fingers are not symmetrically spaced. This is done to allow the crank to be positioned left or right by the "on" catch point only. Notice also that the finger to which the crank is attached is offset. The "off" armature catch point is also offset to intercept it alone. Thus, in the signal "off" position, this finger is intercepted by the armature catch point and this corresponds to the neutral steering position.

Assume that the escapement has a rubber-band attached and is ready to operate. Refer to Fig. 5. If a signal is transmitted, armature Y pulls down releasing the offset finger. At the same instant, the "on" catch

point moves in and finger 3 is intercepted and held. This is "right." If now, the signal is turned off, this catch point moves back, releases finger 3, and the shaft rotates clear around until the offset finger (1) again engages armature Y. The steering element has returned to neutral.

Notice the front of the escapement with its ratchet wheel and rocker arm that engages the teeth on the ratchet wheel (Fig. 4). This prevents the escapement shaft from snapping from one position to another. It causes the fingers to move around at a definite speed.

For example, to obtain "left," a signal is sent causing armature Y to pull down. Finger 3 is intercepted by the "on" catch point. Now, assume the signal is broken for just an instant and transmitted again. The rocker prevents the shaft from snapping around and so, the "on" catch point which moved back when the signal was broken, now moves forward again before finger 4 can get by. While the catch point holds finger 4, the crank is "left." If the signal is turned off momentarily and on again, the offset finger slips by, but finger 2 is caught and held. The crank is almost at neutral and there is no steering, but another part of the escapement now enters the picture to do another job.

Right behind the ratchet wheel is located a set of spring contacts which are now closed by a tiny nub on the bottom of the wheel. This can close a circuit to operate the extra function, which can take the form of a motor speed control, reversing control, gas feed control, etc., depending on the type of model controlled. END

## WORLD'S MOST POWERFUL TV STATION

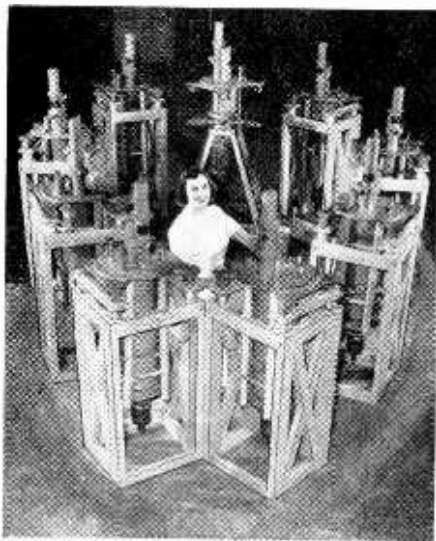

THE nine huge klystrons shown in the photo are awaiting shipment at the *General Electric* tube plant, Schenectady, N. Y. Four will be used in video transmission, two in audio, and three will serve as spares for the first million-watt u.h.f. station, WILK-TV, Wilkes-Barre, Pa. Each tube is over four feet high, weighs over 200 pounds.

## GARAGE-DOOR OPERATOR KIT

A NEW, low cost kit for assembling an automatic garage-door operator is being marketed by *Belford-Matic, Inc.*, of 5900 Maurice Avenue, Cleveland 27, Ohio. The kit includes a  $\frac{1}{4}$  horsepower motor, relays, steel post, switch, lock, keys, hardware, and other essential parts. When assembled, the unit is operated by a key control unit mounted on a steel post. The post control can be located anywhere in the driveway, so that it can be operated by remote control from the user's car. Assembly and installation is said to take one afternoon and is fairly simple.



**It's New! 3 Years in Development**  
**-NOW READY FOR YOU!**



This is the new Sprayberry Training Television Receiver.

You build the new Sprayberry Tester... 18-range Volt-Ohm-Milliammeter readings.

**17" to 24"**  
**PICTURE TUBE**

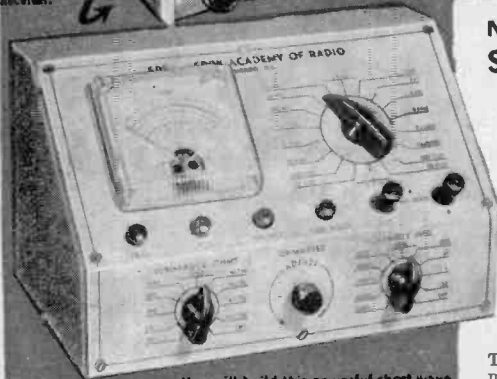

You will build this powerful short wave and broadcast superhet radio receiver.

**New Equipment! New Lessons! Enlarged Course!**  
**SPRAYBERRY PRACTICAL TRAINING IN**  
**RADIO-TELEVISION**

**3 NO OBLIGATION TRAINING PLANS**



**F. L. SPRAYBERRY**  
 Pres.

You have **NO MONTHLY PAYMENT CONTRACT** to sign... pay for this outstanding training as you learn!

Mail the coupon at once for my big all-new 56 page **FREE CATALOG** and **FREE Sample Lesson**. Get the full story of this remarkable new Training Plan. Read about my 3 **NO OBLIGATION PLANS** of "packaged unit" instruction. I can prepare you in as little as **10 MONTHS** to take your place as a **Trained Radio-Television Technician**. You take no risk in enrolling for my Training because you **DO NOT SIGN A BINDING TIME PAYMENT CONTRACT**. I have been training successful Radio-TV technicians for 22 years... I can prepare you, too, to get into your own profitable Service Shop or a good paying job. Full information **FREE** and without any obligation. No salesman will call.

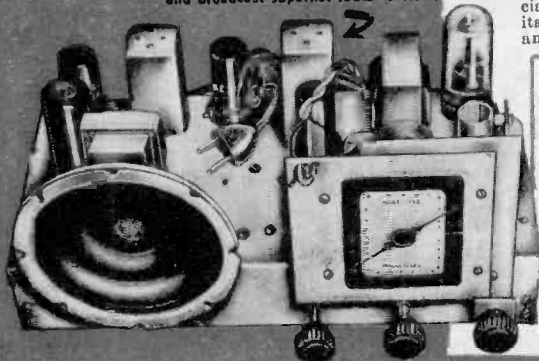

**NEWEST DEVELOPMENTS**

Your training covers **U H F, Color Television, F.M., Oscilloscope Servicing, High Fidelity Sound and Transistors.**

**PRACTICE AND TRAIN AT HOME WITH 25 NEW KITS of EQUIPMENT**

You get valuable practical experience in construction, testing and shop practice. You build a powerful 2 band superhet radio, the all-new 18 range Sprayberry multimeter, the new Sprayberry Training Television receiver, signal tracer and many other projects. All equipment is yours to use and keep. All your training is **IN YOUR HOME** in spare hours. I help you earn extra spare time money while you learn. Rush coupon below for all the facts—**FREE!**

**SPRAYBERRY ACADEMY OF RADIO**  
**111 NORTH CANAL STREET, DEPT. 105-T**  
**CHICAGO 6, ILLINOIS**



**FREE CATALOG AND SAMPLE LESSON**

Rush coupon for my catalog "How to Make Money in Radio-Television". **PLUS** an actual sample Sprayberry Lesson without obligation—**ALL FREE**. Mail coupon **NOW!**

**SPRAYBERRY ACADEMY OF RADIO** MAIL THIS COUPON FOR **FREE** Dept. 105-T 111 N. Canal St., Chicago 6, Ill. **FACTS AND SAMPLE LESSON**  
 Please rush New Catalog and Sample Lesson **FREE**. I understand that no salesman will call.

Name \_\_\_\_\_ Age \_\_\_\_\_  
 Address \_\_\_\_\_  
 City \_\_\_\_\_ Zone \_\_\_\_\_ State \_\_\_\_\_

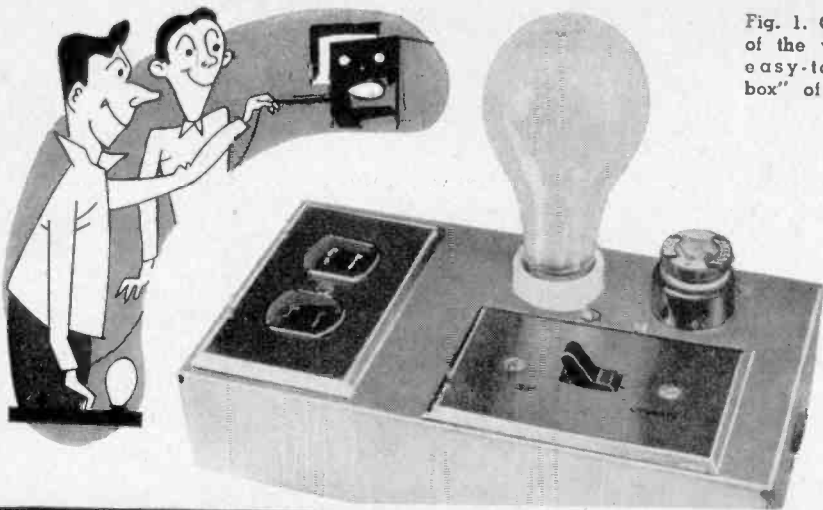

Fig. 1. Over-all view of the versatile and easy-to-build "test box" of many uses.

# Assemble this Useful "Test Box"

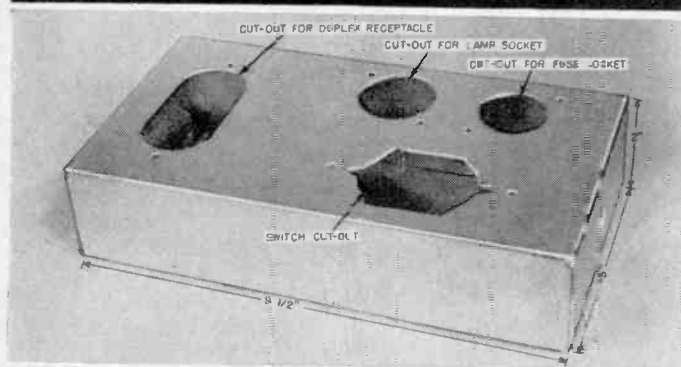

Fig. 2. Author used aluminum chassis, but cigarbox can be used.

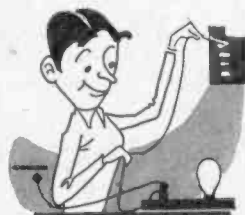
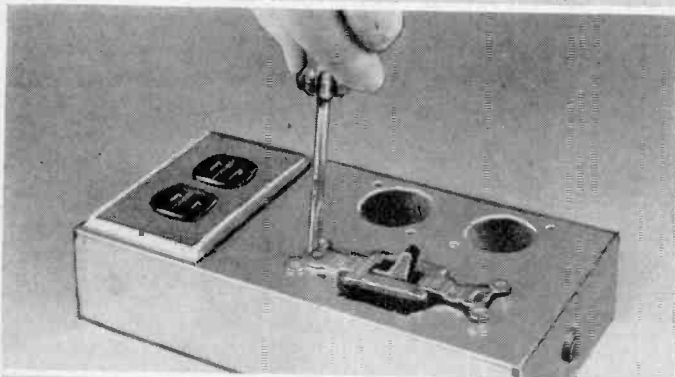

Fig. 3. How parts are mounted on chassis.

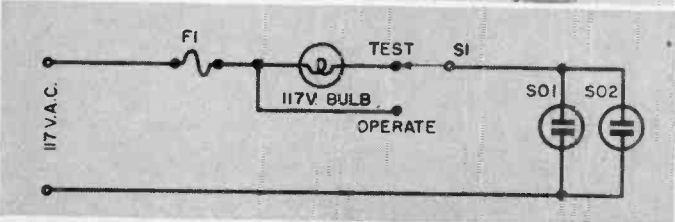

Fig. 4. Schematic diagram and parts list for the "test box."

- S<sub>1</sub>—S.p.d.t. switch (see text)
- SO<sub>1</sub>, SO<sub>2</sub>—Duplex receptacle
- FI—6-10 amp. fuse
- 1—Duplex receptacle cover plate
- 1—5" x 9 1/2" x 2" aluminum chassis base (Bud AC-403)
- 1—Switch cover plate
- 2—Screw-type sockets
- 1—40-100 watt, 117 v. bulb

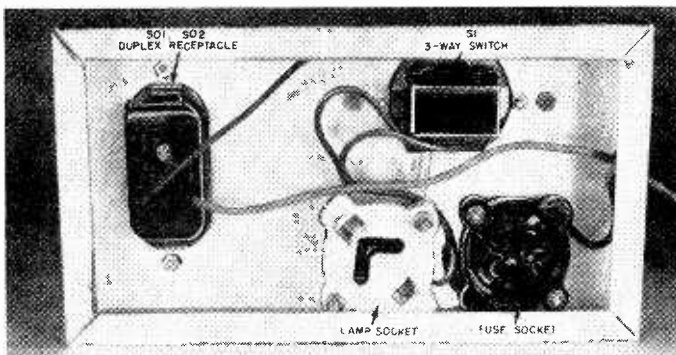

Fig. 5. Under chassis view of complete unit.

*A handy little gadget to have on your bench. It is simple to build yet has innumerable applications.*

**Y**OU'LL find a lot of uses in your home lab for the "test box" shown in Fig. 1. With it you can check experimental equipment without fear of blowing a line fuse in case of accidental shorts. You can use it to drop line voltage slightly for checking critical circuits. And you'll find it handy for keeping a soldering iron warm enough for quick use without allowing it to overheat. You can even use it to estimate the approximate wattage rating of electrically operated equipment.

As you can see by referring to the schematic wiring diagram given in Fig. 4, the circuit is fairly simple; therefore, the unit is quite easy to assemble. Most of the parts can be obtained at your local hardware store, so you won't find it necessary to make a special trip to a radio supply house.

The model is housed in a standard  $9\frac{1}{2}$ " x 5" x 2" aluminum chassis. However, a cigar box makes an equally satisfactory housing. Cutouts are made in the box for the duplex receptacle, for the switch, and for the lamp and fuse sockets, as shown in Fig. 2.

The lamp and fuse sockets are mounted from below using long machine screws or stove bolts. Make sure that these two sockets fit snugly. You can do this by punching a hole slightly smaller than is required and then enlarging the hole slightly by filing with a half-round file, until the proper fit is obtained.

After punching and drilling the required holes in the chassis or box, mount the duplex receptacle, the switch, and the two sockets.

Wiring is straightforward. Simply follow the schematic wiring diagram given in Fig. 4. You may find it necessary to loosen the mounting screws of some of the components in order to reach the terminals easily.

The switch used ( $S_1$  in Fig. 4) is called a "single-pole, double-throw" (s.p.d.t.) switch by electronic technicians and radio men, but you'll have to ask for a "three-way" switch if you buy it at your hardware store or at an electrical supply shop.

The switch cover plate is labeled with the words "Test" and "Operate." These labels were cut from a set of standard decals, purchased at a radio supply house. They were applied to the switch plate and given two coats of clear plastic spray for protection.

An under chassis view of the completed unit is given in Fig. 5.

Once the wiring is completed and gone over for errors, you can check the operation of the unit quite easily. Install a 60 or 100 watt light bulb in the "lamp" socket and a 6 to 10 ampere fuse in the "fuse" socket. Plug a soldering iron into one of the sockets of the duplex receptacle, and plug the "test box" cord into a wall receptacle.

With the switch in the "Test" position, the lamp should light, but with considerably less-than-normal brilliance. The soldering iron should become warm slowly, but should fail to reach normal operating temperature. When the switch is thrown to the "Operate" position, the lamp should go out and the soldering iron should quickly reach its normal temperature.

If the reverse operation is obtained, check the schematic wiring diagram and your wiring and interchange the switch leads to obtain proper operation.

The "test box" is basically a device which permits connecting a high wattage resistor (the lamp bulb) in series with a piece of power-line operated equipment, yet which permits the equipment to be operated at normal line voltage simply by throwing a switch. Thus, a "dead short" in the equipment being tested can cause

no more damage than the lamp bulb lighting to normal brilliance. In addition, by choosing a lamp bulb of the proper wattage, it is possible to introduce either a small or a large voltage drop in the voltage applied to the equipment under test.

For most tests, a 40 to 100 watt bulb may be used, but a larger bulb (150 or 200 watts) should be used for checking high wattage equipment, such as television receivers and high-power public address amplifiers.

**Checking experimental equipment:** Plug the equipment into one of the sockets of the duplex receptacle on the "test box." Throw the switch into the "Test" position. Plug the "test box" into a wall receptacle and turn the equipment "on." If the lamp does not light to normal or near-normal brilliance, the equipment is not shorted, and the switch may be thrown to the "Operate" position.

**Checking critical circuits with low line voltage:** Plug the equipment into one of the sockets of the duplex receptacle. Connect an a.c. voltmeter to the other socket, using a 150 volt or higher range. Throw the switch to the "Test" position and plug the "test box" into a wall receptacle. Turn the equipment "on" to check for shorts. If OK, throw the switch to the "Operate" position and allow the equipment to reach normal operating temperature.

Next, throw the switch on the "test box" back to the "Test" position and note the voltmeter reading. Try different lamp bulbs (both higher and lower wattage units) until the desired drop in line voltage is obtained. A higher wattage bulb will cause less of a voltage drop, a lower wattage bulb a greater drop.

The switch may now be thrown back and forth from "Test" to "Operate" and the effect on equipment operation noted.

You'll find that some radios will work with as low as 95 or even 90 volts even though they are designed normally for 117 volt operation. "Three-way" battery sets are generally quite critical, however, and some will not operate with less than 105 volts on the line.

**Operating a soldering iron:** Install a 100 to 200 watt bulb in the "test box" (depending on the size of your soldering iron). Throw the switch to the "Test" position and plug the soldering iron into one of the sockets of the duplex receptacle. Plug the "test box" into a wall receptacle.

The soldering iron may then be placed on its stand almost indefinitely without fear of overheating. When you are ready to use the iron, throw the switch to the "Operate" position. The iron should heat to full operating temperature in just a few seconds. When finished with the iron for a while, place it back on its stand and throw the switch back to the "Test" position.

**Estimating the wattage rating of equipment:** The brightness with which a given bulb lights with the switch in the "Test" position is determined by the wattage of the equipment being tested. For example, a 40 watt radio may not cause a 100 watt bulb to glow appreciably, but a 200 watt soldering iron will cause a fair glow.

Therefore, if you try different pieces of equipment of *known* wattage and observe the brightness of the glow obtained with a given lamp bulb, you'll soon be able to estimate the approximate wattage rating of equipment of *unknown* wattage by noting the brightness of the lamp. **END**

Fig. 6. How the "test box" can be used in experimental circuit work.

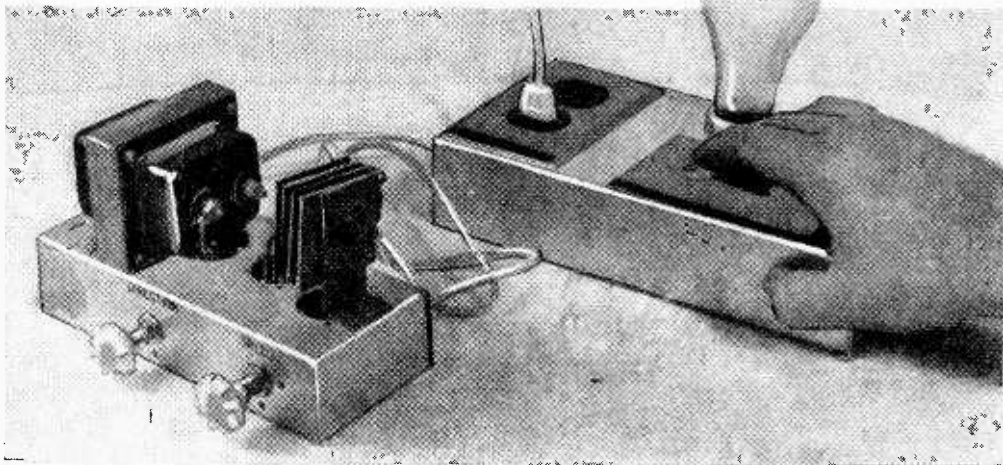

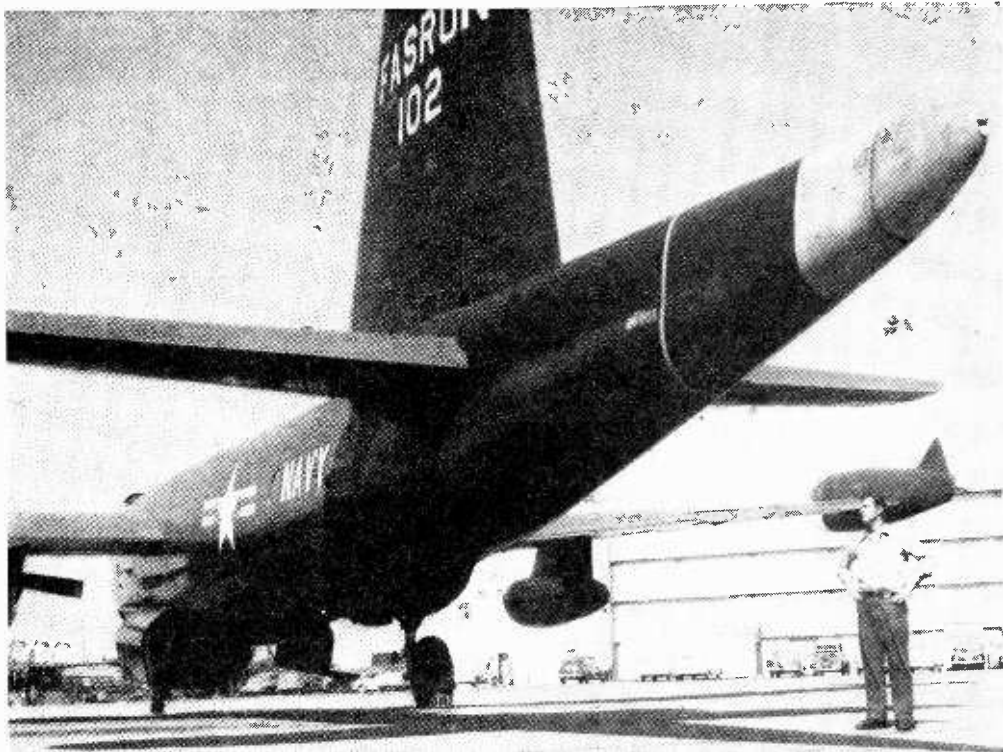

## THE "MAD BIRD"

"SUB NOT sighted, sank same." This strange-but-true message could come from a U.S. Navy Neptune airplane equipped with new "divining rods" to locate submarines hiding submerged beneath the sea.

The Navy has announced officially that the long, pointed tail which appeared recently on its Lockheed-built P2V Neptunes contains special apparatus for spotting underwater vessels.

Pilots call it the "MAD-bird," with MAD standing for magnetic airborne detector. Not to be confused with radar, the new "stinger" does its aerial detective work by registering disturbances in the earth's magnetic field. Once located, the sub can be dispatched with bombs, depth charges, or torpedoes from the Lockheed hunter-killer craft.

Equipment similar to the magnetic airborne detector was used in military operations during World War II, and in oil and other mineral exploration since. New refinements in the MAD-bird permit its incorporation within the aircraft. Formerly, the magnetic device had to be towed far behind the airplane.

Neptune anti-submarine planes are the

first production aircraft delivered to the fleet with the MAD-bird built in. Rather than sacrifice speed or range by merely affixing the new device to the tail of the plane, Lockheed engineers encased the apparatus in a shell-like protuberance resembling a giant wasp's singer. The resultant streamlining has actually increased the aircraft's top speed and over-all range, according to company spokesmen.

The new submarine hunting device is expected to increase the effectiveness of the Neptune as a prime anti-submarine air weapon. Built for a multitude of missions, this aircraft can be armed with bombs, depth charges, and torpedoes, is equipped for fleet mine-laying chores, and is especially effective on long-range patrol duty.

Built by Lockheed of Burbank, California, the new Neptune P2V-7 is the latest in a line of similar aircraft made for the Navy. The photo shows the unusual combination of power-plants the new Neptune boasts: at left is one of the two turbo-compound piston engines which give it hours of long-range cruise speed; at right is one of its two jet pod engines, which provide bursts of speed over target and when taking off from short runways. ENO

# Build YOUR OWN HEATHKITS

INTERESTING—EDUCATIONAL



work has already been done for you. No cutting, drilling, or painting required. All parts furnished including tubes. Knowledge of electronics, circuits, etc., not required to successfully build Heathkits.

## New PRINTED CIRCUIT VACUUM TUBE VOLTMETER KIT

The VTVM is the standard basic voltage measuring instrument for radio and TV servicemen, engineers, laboratory technicians, experimenters, and hobbyists. Because of its extremely high input resistance (11 megohms) the loading effect on the circuit being measured, is virtually negligible. The entire instrument is easy to build from a complete kit, with a detailed step-by-step Construction Manual. Featured in this instrument is an easy-to-wire fool-proof printed circuit board which cuts assembly time in half.

**CIRCUIT AND RANGES:** Full wave AC input rectifier permits 7 peak-to-peak voltage ranges with upper limits of 4000 volts peak-to-peak. Just the ticket for you TV servicemen. Seven voltage ranges, 1.5, 5, 15, 50, 150, 500 and 1500 volts DC and AC RMS. Peak-to-peak ranges 4, 14, 40, 140, 400, 1400, and 4000 volts. Ohmmeter ranges X1, X10, X100, X1000, X10K, X100K, X1 meg. Additional features are a db scale, center scale zero position, and a polarity reversal switch.

**IMPORTANT DESIGN FEATURES:** Transformer operated—1% precision resistors—6AL5 and 12AU7 tubes—selenium power rectifier—individual AC and DC calibrations smoother improved zero adjust control action—new panel styling and color—new placement of pilot light—new positive contact battery mounting—new knobs—test leads included. Easily the best buy in kit instruments.

New charcoal gray baked enamel panel with highly readable white lettering.

New peak-to-peak meter scale—new color harmony—new control knobs.

New printed circuit board for faster, easier construction—exact duplication of Laboratory development model.

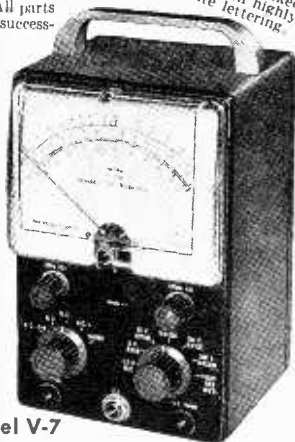

Model V-7

**\$24<sup>50</sup>**

Shpg. Wt. 7 lbs.

New easy-to-read open panel layout. Off-on switch incorporated in selector switch.

## Heathkit HANDITESTER KIT



MODEL M-1  
**\$14<sup>50</sup>**

Shpg. Wt. 3 lbs.

The Heathkit Model M-1 Handitester readily fulfills all requirements for a compact, portable volt-ohm-milliammeter. Its small size permits the instrument to be tucked into your coat pocket, tool box or glove compartment of your car. Always the "handitester" for those simple repair jobs. Packed with every desirable feature required in an instrument of this type. AC or DC voltage ranges, full scale 10, 30, 300, 1000 and 5000 volts. Ohmmeter ranges 0-3000 ohms and 0-300,000 ohms. DC milliammeter ranges 0-10 milliamperes and 0-100 milliamperes. Uses 400 microampere meter—1% precision resistors—hearing aid type ohms adjust control—high quality Bradley rectifier. Test leads are included.

## Heathkit MULTIMETER KIT



MODEL MM-1  
**\$26<sup>50</sup>** Shpg. Wt. 6 lbs.

Here is an instrument packed with every desirable service feature and all of the measurement ranges you need or want. High sensitivity 20,000 ohms per volt DC, 5000 ohms per volt AC. Has the advantage of complete portability through freedom from AC line—provides service ranges of direct current measurements from 150 microamperes up to 15 amperes—can be safely operated in RF fields without impairing accuracy of measurement.

Full scale AC and DC voltage ranges of 1.5, 5, 50, 150, 500, 1500, and 5000 volts. Direct current ranges are 150 microamperes, 15, 150, and 500 milliamperes and 15 amperes. Resistances are measured from .2 ohms to 20 megohms in three ranges and db range from -10 to +65 db. Ohmmeter batteries, and necessary test leads are furnished with the kit.

**HEATH COMPANY**  
BENTON HARBOR 10, MICHIGAN



**New**  
PRINTED  
CIRCUIT

## Heathkit 3" OSCILLOSCOPE KIT

Model  
OL-1

**\$29<sup>50</sup>**

Shpg. Wt.  
15 lbs.

Ideal for individ-  
ual home work-  
shop, ham shack,  
or as extra instru-  
ment for outside  
servicing.

Compact size,  
light weight,  
portable — per-  
fect for service  
work or field  
operation.

New modern  
styling. Gray  
panel with white  
lettering, light  
gray knobs and  
red — contrasting  
terminal posts.

New printed  
circuit for constant  
performance, rugged com-  
ponent mounting —  
assembly time  
cut in half!

Measures only  
11 3/4" x 6 3/4" x  
10 1/2" and weighs  
only 11 pounds.

**USE:** This brand new Utility Scope was designed especially for servicemen and radio amateurs, and is adaptable for use in all general Scope applications. Perfect for modulation monitoring, etc. Use it to tackle alignment or adjustment problems. Equally valuable in breadboard work. A must for ham shack or for outside servicing.

**DESCRIPTION:** Front panel controls of the Model OL-1 are "bench tested" for ease of operation and convenience. Sharp focusing 3" CRT. Printed circuit for ease of assembly and constant performance. Assembly time cut in half! High quality electronic components used. Sensitive hor. and vert. amplifiers with broad freq. response; cathode follower for isolation. Push-pull hor. and vert. output to deflection plates. Int., 60 cycle, or ext. sync. Sweep freq. range 10-100,000 cycles. Direct connection to deflection plates. Provision for Z axis input. Uses 3GP1 CRT, 4-12AU7 hor. and vert. amplifiers, 1-12AX7 sweep gen., 1-6X4 LV rect., and 1-1V2 HV rect. The Heathkit Model OL-1 is a real standout value at only \$29.50, and is another example of the famous Heathkit combination; quality plus economy.

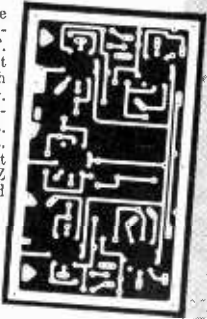

## Heathkit SIGNAL GENERATOR KIT

**USE:** This instrument is "serviceman engineered" to fill the requirement for a reliable basic service instrument at moderate cost. Frequency coverage extends in five bands from 160 Kc to 110 Mc on fundamentals, and dial is calibrated to 220 Mc for harmonics. Pre-wound and pre-aligned coils make calibration unnecessary for service applications.

**DESCRIPTION:** The Heathkit Model SG-8 Signal Generator provides a stable modulated or unmodulated RF output of at least 100,000 microvolts which can be controlled by both a continuously variable and a fixed step attenuator. Internal modulation is at 400 cycles, or can be externally modulated. AF output of 2-3 volts is also available for audio testing. Uses dual purpose 12AU7 as Colpitts RF oscillator and cathode follower for stable, isolated, low impedance output, and type 6C4 tube for 400 cycle oscillator. Operation of the SG-8 is well within the frequency limits normally required for service work. Modern styling features high definition white letters on charcoal gray panel with re-designed control knobs. Modern professional appearance and Heathkit engineering know-how combine to place this instrument in the "best buy" category. Only \$19.50 complete.

New, modern panel  
and knob styling —  
professional appear-  
ance and professional  
performance.

Broad frequency  
coverage — funda-  
mentals from  
160 KC to 110  
MC in 5 bands  
— up to 220 MC  
on calibrated  
harmonics.

Cathode follower  
output for good  
isolation — fixed  
step and continu-  
ously variable  
attenuation.

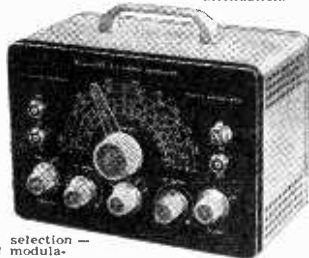

Output selection —  
internal modulation,  
pure r.f.,  
or audio output.

MODEL SG-8 **\$19<sup>50</sup>** Shpg. Wt.  
8 lbs.



MODEL  
AM-1

**\$14<sup>50</sup>** Shpg. Wt.  
2 lbs.

## Heathkit ANTENNA IMPEDANCE METER KIT

The Model AM-1 Antenna Impedance Meter makes an ideal companion unit for the GD-1B Grid Dip Meter or a valuable instrument in its own right. Perfect for checking antenna and receiver impedance and match for optimum system operation. Use on transmission lines, halfwave, folded dipole, or beam antennas. Will double as monitor or relative field strength meter. Covers freq. range of 0-150 Mc and impedance range of 0-600 ohms. Uses 100 microampere meter and special calibrated potentiometer. A real buy at only \$14.50 complete.

## Heathkit GRID DIP METER KIT

Amateurs and serv-  
icemen have proven  
the value of this grid  
dip meter many times  
over. Indispensable  
for locating parasit-  
ics, neutralizing,  
and aligning filters  
and traps in TV or  
Radio and for inter-  
ference problems. The  
Model GD-1B covers  
from 2 Mc to 250 Mc  
with 5 pre-wound coils. Featuring a sensitive 500  
microampere meter and phone jack, the GD-1B uses  
a 6AF4 or 6T4 tube. An essential tool for the ham  
or serviceman.

**ACCESSORIES:** Low freq. coverage to 355 KC with  
two extra coils and calibration curve. Set No. 341A  
for GD-1B and set No. 341 for GD-1A. Shipping  
weight 1 lb. Only \$3.00.



MODEL  
GD-1B

**\$19<sup>50</sup>** Shpg. Wt.  
4 lbs.

**HEATH COMPANY**  
BENTON HARBOR 10, MICHIGAN

# New

# Heathkit VFO KIT



MODEL VF-1

**\$1950**

Ship. Wt. 7 lbs.

- Smooth acting illuminated and precalibrated dial.
- 6AU6 electron coupled Clapp oscillator and Oa2 voltage regulator.
- 7 Band coverage, 160 through 10 meters—10 Volt RF output.
- Copper plated chassis—aluminum cabinet—easy to build—direct keying.

Here is the new Heathkit VFO you have been waiting for. The perfect companion to the Heathkit Model AT-1 Transmitter. It has sufficient output to drive any multi-stage transmitter of modern design. A terrific combination of outstanding features at a low kit price. Good mechanical

and electrical design insures operating stability. Coils are wound on heavy duty ceramic forms, using Litz or double cellulose wire coated with polystyrene cement. Variable capacitor is of differential type construction, especially designed for maximum bandsread and features ceramic insulation and double bearings.

This kit is furnished with a carefully precalibrated dial which provides well over two feet of calibrated dial scale. Smooth acting vernier reduction drive insures easy tuning and zero beating. Power requirements 6.3 volts AC at .45 amperes and 250 volts DC at 15 mills. Just plug it into the power receptacle provided on the rear of the AT-1 Transmitter Kit. The VFO coaxial output cable terminates in plastic plug to fit standard 1/2" crystal holder. Construction is simple and wiring is easy.

Open layout—easy to build—simplified wiring.

Smooth acting illuminated dial drive.

Clean appearance—rugged construction—accessible calibrating adjustments.

Copper plated chassis for shielding.

Ceramic coil forms—differential condenser.

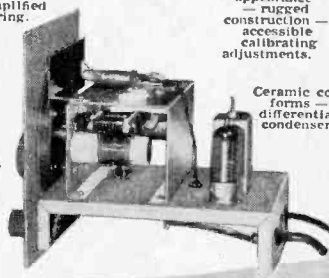

# Heathkit AMATEUR TRANSMITTER KIT



MODEL AT-1

**\$2950**

Ship. Wt. 16 lbs.

### SPECIFICATIONS:

Range 80, 40, 20, 15, 11, 10 meters.  
 6AG7 ..... Oscillator-multiplier.  
 6L6 ..... Amplifier-doubler  
 8U4 ..... Rectifier  
 105-125 Volt A.C. 50-60 cycles 100 watts. Size: 8 1/4 inch high x 13 1/8 inch wide x 7 inch deep.

Crystal or VFO excitation.

Prewound coils metered operation.

Rugged, clean construction.

Single knob switching.

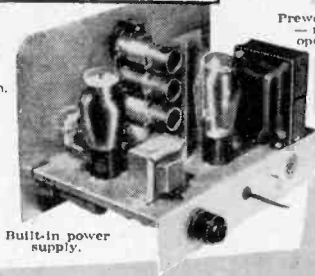

Built-in power supply.

52 ohm coaxial output.

Here is a major Heathkit addition to the Ham radio field, the AT-1 Transmitter Kit. Incorporating many desirable design features at the lowest possible dollar-per-watts price. Panel mounted crystal socket, stand-by switch, key click filter, A. C. line filtering, good shielding, etc. VFO or crystal excitation—up to 35 watts input. Built-in power supply provides 425 volts at 100 MA. Amazingly low kit price includes all circuit components, tubes, cabinet, punched chassis, and detailed construction manual.

# Heathkit COMMUNICATIONS RECEIVER KIT

RF gain control with AVC or MVC.

Electrical bandsread and scale.

Stable BFO oscillator circuit.

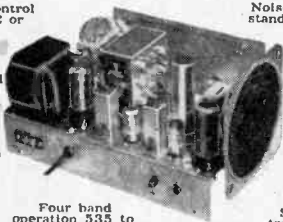

Four band operation 535 to 35 Mc.

Noise limiter—standby switch.

3/2 inch PM Speaker-Headphone Jack.

Six tube transformer operation.

### SPECIFICATIONS:

Range ..... 535 Kc to 35 Mc  
 12BE6 ..... Mixer-oscillator  
 12BA6 ..... I. F. Amplifier  
 12AV6 Detector—AVC—audio  
 12BA6 ..... B. F. O oscillator  
 12AB ..... Beam power output  
 5Y3GT ..... Rectifier  
 105-125 volts A.C. 50-60 cycles, 45 watts.

A new Heathkit AR-2 communications receiver. The ideal companion piece for the AT-1 Transmitter. Electrical bandsread scale for tuning and logging convenience. High gain miniature tubes and IF transformers for high sensitivity and good signal to noise ratio. Construct your own Communications Receiver at a very substantial saving. Supplied with all tubes, punched and formed sheet metal parts, speaker, circuit components, and detailed step-by-step construction manual.



MODEL AR-2

**\$2550**

Ship. Wt. 12 lbs.

CABINET:

Proxylon impregnated fabric covered plywood cabinet. Shipp. weight 5 lbs. Number 91-10, \$4.50.

**HEATH COMPANY**  
 BENTON HARBOR 10, MICHIGAN





# The Tuning Eye—How It Works

By E. BUKSTEIN

THE electron-ray tube, or as it is more familiarly known, the "tuning eye," is a voltage indicator which, in many applications, replaces the far less rugged and far more costly meter movement. As shown in the drawing of Fig. 1, the plate of the tuning eye tube is circular and is known as the "target." This portion of the tube structure is coated with a fluorescent chemical which glows when bombarded by electrons from the cathode. Viewed from the top of the tube (which is usually mounted in a horizontal position so that the top, in reality, becomes the front) the target appears as a ring of green light. The dark disk in the center is a shield to block light from the cathode.

The thin, vertical wire parallel to the cathode is known as the "ray-control electrode." If this electrode is made negative with respect to the target, it will repel some of the electrons. In this way, that portion of the target which does not receive electrons will not glow and will appear as a dark area or a shadow. The more negative the ray-control electrode is made with respect to the target, the wider this shadow

becomes. This action is demonstrated diagrammatically in Fig. 2.

Most electron-ray tubes contain a triode amplifier, housed within the same glass envelope. The plate of the amplifier is internally connected to the ray-control electrode as shown in the diagram of Fig. 4A. The plate current of this triode flows through resistor  $R$  and produces a voltage drop of the polarity indicated on the diagram. This drop makes the ray-control electrode negative with respect to the target and therefore produces a shadow. The greater the triode plate current, the greater the voltage drop across resistor  $R$  and the wider the shadow becomes. If the triode is biased to cut-off, there will be no drop across resistor  $R$  and thus no shadow on the target.

When the electron-ray tube is to be used as a tuning indicator for a broadcast-type receiver, its grid is connected to the a.v.c. (automatic volume control) line as shown in Fig. 4B. When a station is properly tuned in on the broadcast receiver, the a.v.c. voltage will be at its maximum negative value. This negative voltage will then cut off the triode section of the tuning eye

Fig. 1. The target of the electron-ray tube is coated with a fluorescent chemical which glows when bombarded by electrons from the cathode. Photo courtesy of RCA.

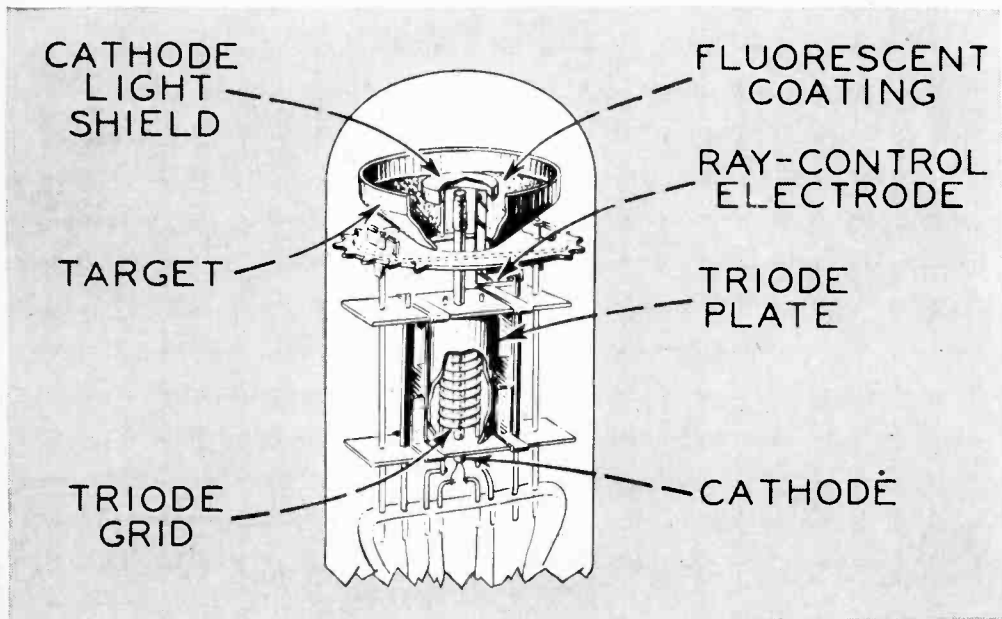

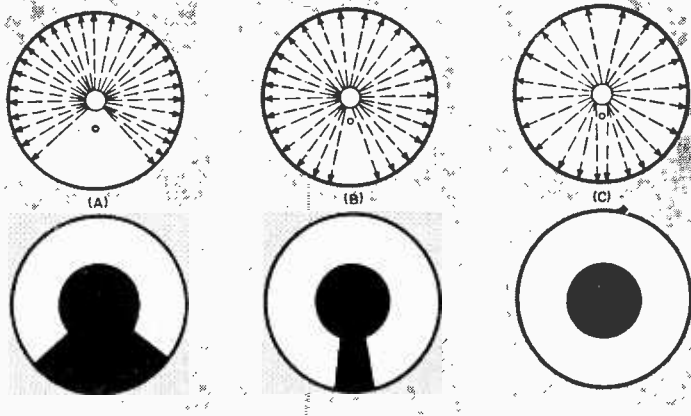

Fig. 2. (A) The top view represents the top view of the tube (for simplicity, only target, cathode, and ray-control electrode are shown). The dotted arrows indicate electron paths from cathode to target. Ray-control electrode is negative and therefore repels electrons. That part of the target which receives no electrons does not glow. The appearance of the shadow is shown in the lower drawing. (B) Here the ray-control electrode is less negative than in (A). Electrons are not repelled as much and shadow is narrower. (C) When ray-control electrode is at same potential as target, electrons are not repelled, there is no shadow.



Fig. 3. The electron-ray tube, in many applications, replaces a more delicate meter.

tube and there will be no shadow. However, if the receiver is mistuned or is "off station" to one side or the other, the a.v.c. voltage will be reduced. With less negative voltage on its grid, the triode will now draw plate current and produce a voltage drop across resistor  $R$ . Under these conditions, a shadow will appear on the target portion of the tube.

Since the width of the shadow appearing on the target of the tube depends on the amount of voltage that is applied to the tube's grid, the electron-ray tube can be used as a simple and rugged voltmeter.

An arrangement of this type is shown in Fig. 5. The type 6E5 electron-ray tube, which is operated with a 1 megohm plate resistor and a 125 volt power supply, will give a zero shadow with  $-4$  volts grid bias. At zero bias, the shadow angle will be 90 degrees. The variable resistor in the cathode circuit serves to bias the tube to cut-off and thus functions as the zero adjustment. The voltage divider and tap switch in the grid circuit provide the three ranges.

The electron-ray tube will serve as a convenient indicator for alignment purposes in receivers which incorporate it. One type of indicator often used for alignment is a d.c. voltmeter to measure the a.v.c. voltage. Only a relative indication of this voltage is needed. The electron-ray tube as connected in a receiver gives just that. END

Fig. 5. Since the width of the shadow depends on the amount of voltage applied to the grid, the electron-ray tube can be used as a voltmeter.

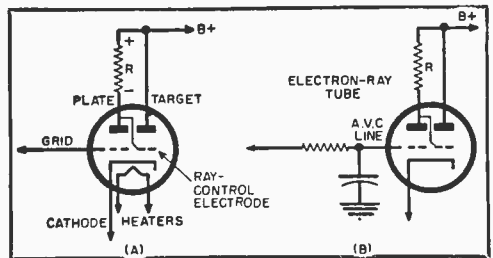
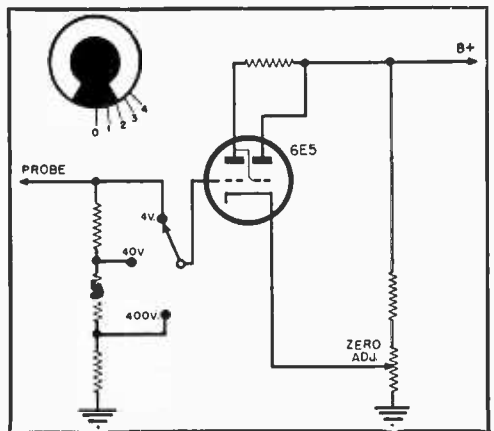
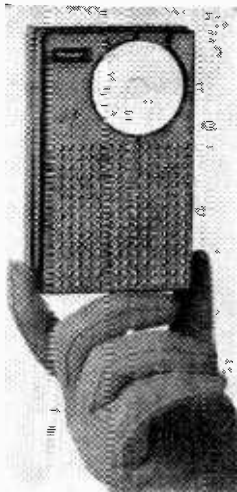

Fig. 4. (A) The ray-control electrode is connected internally to the plate of the triode. The voltage drop across resistor  $R$  makes the ray-control electrode negative with respect to target. (B) When the electron-ray tube is used as a tuning indicator, its grid is connected to the a.v.c. line. When station is properly tuned in, a.v.c. voltage biases the grid to cut-off and the shadow on the eye tube disappears.



## TRANSISTOR RECEIVER

A POCKET SIZE radio, 3" x 5" x 1 1/4", that uses transistors instead of tubes is being produced by *Regency*, Indianapolis. The tiny set is powered by a self-contained battery and plays through its own permanent-magnet loudspeaker. Said to be the first of its kind, it sells for about \$50.



## SPEAKER GRILLE FRAME FROM PICTURE MOULDING

AUDIOPHILES who construct their own speaker enclosures may be unhappy with the results of their efforts to do a job of mitering and fitting the grille frame. However, a professional-looking grille frame made to your exact size requirements can be obtained from your local dealer in art materials. These people supply picture frames to order which are generally of excellent quality and workmanship.

Prices are reasonable too. For example, a 22-inch by 30-inch frame should cost approximately \$5.00 if made of solid oak. So, if you feel at home with a soldering iron in your hand, but do not trust yourself to do fancy sawing, a trip to the art supply store will serve you well indeed. . CARL PERKO

## RAISING FREQUENCIES OF CRYSTALS USING HOUSEHOLD CLEANSER

By

WHITLEY DAVENPORT, JR., W6TLZ

MANY of the quartz crystals found on the surplus market are rugged enough to permit the raising of their frequencies by the "ham". Among these are the crystals from the BC-746 tuning units. These crystals are available for about 80 cents and lie in the 80 and 75 meter bands. The 3700 and 3735 kc. crystals can be moved in the novice band easily and provide a cheap means of having several frequencies available.

For best results, follow this procedure: mix a solution of household cleanser (such as *Old Dutch*, *Bon Ami*, etc.) and water. Spread a thin layer onto a six-inch square surface of flat glass. Remove the crystal carefully from its holder. Lay the crystal on the paste and run it around in figure eights gently with your finger.

Five to fifteen "figure eights" will raise the frequency one kilocycle. To determine the new frequency, wash the crystal thoroughly in running water, dry with a clean, lintless cloth, and replace in its holder. Connect the crystal in an oscillator circuit and find the frequency by using a calibrated receiver or frequency meter.

The only trouble the author encountered in grinding ten of the crystals by this method occurred when one crystal was not completely cleaned, and had to be recleaned to get it to oscillate. END

## NEW ATOMIC BATTERY

SCIENTISTS at Mound Laboratory in Miamisburg, Ohio, have developed a battery that uses a thermopile (series of thermocouples) to convert the heat given off by decaying atoms into electricity. The atomic action is obtained from the element polonium. This substance is essentially a pure alpha-emitting material. The heat created by this emission is converted by the thermopile into electricity.

Advantages of this type of battery are long life, dependability, stable output, and light weight. Large scale production is not yet economical, and depends largely on the availability of the alpha-emitting radioisotopes of polonium.



# TOOLS & GADGETS

**NEW SOLDER PASTE INCLUDES FLUX**  
 "SweTite" Paste Solder, designed for sweat soldering or tinning, consists of a blend of 50/50 powdered solder and an active flux. The paste is applied with a brush or cloth, the parts fitted together, and heat



applied. After heating, the small amount of flux residue can be removed by wiping with a damp cloth. Joints thus made are said to be as strong as those obtained by conventional methods using a separate flux and solid wire. Since this paste uses an active flux, it is not recommended for use in wiring electronic circuits. It is useful, however, on metal joints, brackets, pipes, etc. For further information, write the manufacturer, *Alpha Metals, Inc.*, 56 Water St., Jersey City 4, N. J.

## HANDY SOLDERING KIT

Primarily designed for the homecrafter is a new complete soldering kit designed by the *Weller Electric Corp.*, Easton, Pa. Packaged in a sturdy metal carrying case is a 250-watt soldering gun (Model 8250A), an ample supply of *Kester* solder, one each of new accessory cutting and smoothing tips, a double end wrench for speedy tip interchange or replacement, and two instruction booklets on soldering and home repair.

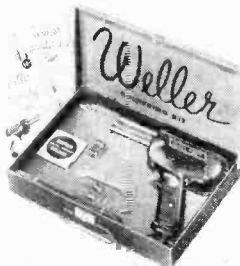

The accessories and useful instruction booklets combine to enhance the use of the soldering kit into the realm of home

# SAVE ON TUBES! STANDARD-BRAND



• New • Boxed • Guaranteed

TUBE	NET	TUBE	NET
1B3GT	.98	6X5GT	.56
1L4	.84	12A7	1.04
1R5	.90	12AU6	.66
154	.98	12AU7	.88
155	.74	12BA6	.72
1T4	.84	12BE6	.74
1U4	.82	12BH7	1.02
1U5	.72	12SN7GT	.86
1X2A	1.04	19BG6G	2.40
3Q5GT	1.12	19T8	1.24
354	.84	25BQ6GT	1.56
3V4	.84	25L6GT	.74
5U4G	.62	35B5	.82
5Y3GT	.48	35C5	.74
6AC7	1.24	35L6GT	.74
6AH6	1.56	35W4	.48
6AK5	1.68	35Z5	.50
6AL5	.60	50B5	.94
6AQ5	.72	50C5	.94
6AG5	.80	50L6GT	.94
6AT6	.58		
6AU6	.66		
6AV6	.58		
6B4G	1.28		
6BA6	.72		
6BC5	.78		
6BE6	.74		
6BG6G	2.10		
6BH6	.92		
6BJ6	.78		
6BL7GT	1.30		
6BQ6GT	1.52		
6BQ7A	1.30		
6BK7	1.14		
6C4	.58		
6C5	.78		
6CB6	.78		
6CD6G	1.88		
6H6	.72		
6J5GT	.72		
6J6	.94		
6K6GT	.66		
65N7GT	.86		
6T8	1.14		
6V6GT	.72		
6W4GT	.68		
6W6GT	.90		

## SPECTACULAR KIT VALUES!

"Portable" KIT #1  
 1R5, 354, 1T4, 155  
**\$2.95**

"Portable" KIT #2  
 1R5, 1U4, 1U5, 354  
**\$2.95**

## TV TUBE KIT

Stock No	List
1-65N7	\$2.35
2-5U4G	3.50
1-6J6	2.50
1-6AU6	1.85
1-1B3	2.65
1-12A17	2.90

**\$15.75 Value**  
**\$5.25**

ALL NEW STANDARD BRANDS FULLY GUARANTEED

"Miniature" KIT  
 12AT6, 12BA6, 12BE6,  
 35W4, 50B5 - **\$3.15**

"All-American" TUBE KIT  
 12SA7, 12SK7, 12SQ7,  
 35Z5, 50L6 - **\$2.99**

810	13.50
811A	3.25
811	2.95
812A	5.00
812	5.00
814	5.25
815	3.70
816	1.50
5610	.95
5654	1.95
5686	2.95
5763	1.55
5829	3.50
6AK5	.99
6J4	5.95
1619	.49
1624	1.74
1625	.49
1626	.37
250TW	22.50
250TL	19.00
872A	4.20

SEND NOW FOR YOUR COPY of our big new complete 1955 Catalog, listing thousands of special purchase values for the Amateur, Serviceman, Experimenter, and Industrial User!

CONCORD RADIO  
 55 Vesey St. N.Y. 7  
 20% deposit with C.O.D.  
 MINIMUM ORDER \$5.00

Please send NEW 1955 CONCORD Catalog!

Dept E3  
 NAME \_\_\_\_\_  
 ADDRESS \_\_\_\_\_  
 CITY \_\_\_\_\_ ZONE \_\_\_\_\_ STATE \_\_\_\_\_

CONCORD RADIO • 53 VESEY ST.  
 NEW YORK 7, N. Y. • Digby 9-1132

improvement, such as heat-sealing, welding thermoplastic fabrics, etc. The gun heats in five seconds and is equipped with dual spotlights, instant "on" and "off" trigger switch, and other features. Available in leading hardware, radio and TV supply stores, the new kit is offered at a saving when compared to the prices of the individual items if purchased separately. Further data is available on request to Mr. J. F. Whitaker at the manufacturer.

#### FLASHLIGHT FREES HANDS

A new service aid is the "Brow-Lite" made by the *Gee-Lar Mfg. Co.*, 819 Elmford Street, Rockford, Illinois. The new device is a flashlight that is worn above the eyes to provide ample light for close work while freeing both hands for action.

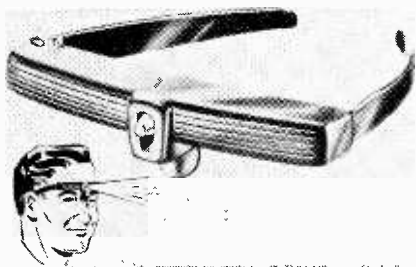

It is adjustable to any angle and fits comfortably above the eyes. It will not interfere with eyeglasses. Its use of a standard magnifying lens bulb puts a concentrated beam of light where the user desires it. Additional information is available from the manufacturer.

#### NEW SOLDERING IRON TIPS

A new line of "Long-Life HEXCLAD Soldering Iron Tips" is said to outlast plain copper tips as much as ten to one with very little loss of heat. Because they last so long and require no filing or dressing, tip maintenance is reduced to a minimum. The new tips have a heavy durable coating of iron alloy over a copper base on all exposed surfaces. The inserted part of the Plug Tips also have a coating (to protect against oxidation of the copper) which is thin enough so that good heat transfer to the tip is maintained. These tips are said to retain their original shape because they do not erode or pit. They are furnished tinned ready to use. For additional information, write to *Hexacon Electric Company*, 569 W. Clay Avenue, Roselle Park, N. J.

#### LIGHTWEIGHT HEADSET

Resembling a pair of thin earmuffs, this new headset weighs only 1.6 ounce and consists of a sensitive plug-in mechanism, a thin stainless steel band that slips over the

head, and two plexiglass air cushions. The cushions slide on the band, adjusting to correct length, and a ball and swivel joint

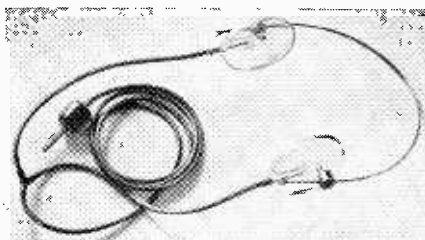

at the base of the cushions permits comfortable adjustment to the ear. Sound—transmitted from the receiver in the plug—is piped into the cushions through hollow plastic tubing. Standard impedances are 120 and 2000 ohms. Special impedances can be provided on request. For further information, write Dept. KP, *Telex, Inc.*, Telex Park, St. Paul 1, Minnesota.

#### NEW BOX FOR STEEL STAMPS

A new indestructible plastic box with a transparent top is furnished with standard sizes of Mecco Safety Letters and Figures, ¼ inch size and smaller. Holes in boxes are square which maintains stamps in proper position to facilitate stamping. The new boxes will be provided with Hevi-Bevl, Wedge-Grip, Nu-Grip and other styles of steel stamps. Further data is available on request to *M. E. Cunningham Co.*, 1025 Chateau Street, Pittsburgh 33, Pa.



#### PERSONALIZED SPEAKER

Normal televiewing for the hard-of-hearing is made possible by a new "personal-

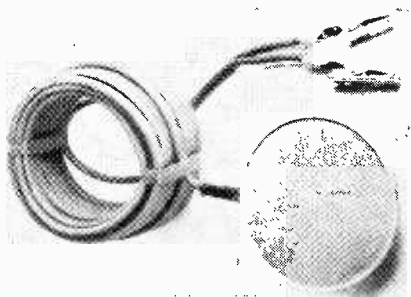

ized" speaker produced and marketed by *Wright-Zimmerman, Inc.*, New Brighton 12, Minnesota.

The speaker is a miniature permanent-magnet type whose terminals are intended for connection to the speaker terminals of any large set such as a TV or radio receiver. The 30 foot leads permit the listener to sit at any comfortable distance from the set and still hear the program. Volume adjustment in the set does not have to be changed, and the use of the new speaker will not interfere with normal reception.

#### FUEL TANK FOR R/C MODELS

A "positive flow" fuel tank for radio-controlled models is announced by *The de-*

*Bolt Model Engineering Co.*, Williamsville, N. Y. This tank is said to provide completely smooth fuel supply to the engine at all times. It uses an internal swivel which is weighted to



move with the random motion of the fuel as it is effected in flight. The size of the tank (1½ inches maximum diameter by 2 inches over-all length) is such that it is very adaptable to .15 and .19 engines which are widely used for flying R/C. Capacity of the tank is 2 fluid ounces, with a 12 minute run on .15 engines and a 6 minute run on .19 engines.

#### CLOTH SANITIZES TELEPHONES

A simple wiping with a new, disposable cloth wafer, impregnated with an active



germicide harmless to human beings, is said to sanitize and deodorize telephone mouthpieces in a few seconds. The cloth pads, named "tel-O-side," are packed in jars of one hundred. Moisture from the pad dries instantly on the mouthpiece and receiver of a telephone, requiring no additional wiping to return the instrument to service after disinfecting. For additional information, contact *General Scientific*

January, 1955

# FREE 1955 ALLIED TV & RADIO CATALOG

THE COMPLETE ELECTRONIC SUPPLY GUIDE



**308**  
**VALUE-**  
**PACKED**  
**PAGES**

Save on  
Everything  
in  
Electronics

**WORLD'S**  
**LARGEST**  
**STOCKS**

Everything for Experimenters,  
Builders, Amateurs,  
Servicemen, Engineers and  
Hi-Fi Specialists

Send for ALLIED's big 308-page value-packed buying guide to *everything* in TV, Radio and Electronics! Largest selections of custom TV chassis, antennas and accessories; FM and AM tuners; High Fidelity systems and components; recorders and phono equipment; Amateur supplies; test instruments; builders' kits; industrial electronic supplies — *plus* the world's largest stocks of electronic parts, tubes, tools and books. Save on everything in Electronics — send today for your FREE 1955 ALLIED Catalog.

**ultra-modern facilities to SERVE YOU BEST**



Send for  
**FREE**  
Catalog

**ALLIED RADIO**

ALLIED RADIO CORP., Dept. 79-A-5  
100 N. Western Ave., Chicago 80, Ill.

Rush FREE 1955 ALLIED 308-Page Catalog

Name \_\_\_\_\_

Address \_\_\_\_\_

City \_\_\_\_\_ Zone \_\_\_\_\_ State \_\_\_\_\_

## SAVE MORE AT HARJO!

**TN-85/APQ-15** for a 2-METER XMTR. Tunes into "2" Little rewiring and adding modulation xfrm. Push-pull 6C4's oscillator driving 832 in parallel. NO tuning from front panel. With 6J6, 2-6C4's, less 832. With schematics and conversation sheet **\$7.95**

**MICRO SWITCH BZ-7RDT** normally open or closed SPDT. New... 5 for \$2 postpaid  
**51.5 OHM COAX. CABLE.** 100' roll \$4.50  
**RG-34U 71-OHM COAX.** .625 dia. 5 KW rating. 85' roll with pl-173 plug at one end. New \$7.95

### RCA SURPLUS TV CAMERA \$225



With 1846 Ieoscope and 6-stage video amplifier and clipper. Complete info. on request.

**MINIATURE LINE MATCHING TRANSFORMER.** \$1 plus 25¢ postage. For blocking oscillators on TV Recvrs. & camera input circuits. Line oscillator transformer for electric organ, for digital computer systems, 1000's other uses.

**24V TRANSFORMER & RECTIFIER COMB.** a basic 24V. DC power supply of 110 V. AC primary. 24V. secondary and Rectox Rectifier. Operates intermittently up to 3 or 4 amps. \$2.95

**APS 13** makes a 420 MC RADIOPHONE when converted. Range in most cases equal to meters. Complete with RF sections, conversion booklet and 30 MC RF strip less tubes, dynamotor and minor parts not needed for conversion. Ship. wt. 13 lbs. \$3.95



WRITE FOR FREE CATALOG! Please send check or MO (no c.o.d.'s please), all shipments F.O.B. warehouse. Californian's add 3% sales tax.

# Harjo Sales Co.

Dept. PEF 4109 BURBANK BLVD.  
BURBANK, CALIF. Phone: Victoria 9-2411

## CORONA RADIO KITS

EASY TO BUILD • EDUCATIONAL • EXCELLENT RECEPTION  
**BROADCAST SUPERHET KIT**  
**\$1475**

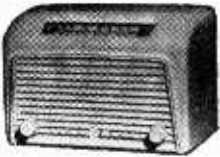

**ROCKET 115K** - Latest Single Band superhet circuit for ultimate in sensitive reception and tonal quality. Kit includes all necessary parts, punched chassis, attractive bakelite mahogany cabinet, built-in loop antenna, iron core IFs, Big Alnico V spkr.; tubes: 12SK7, 12SA7, 12SQ7, 50L6, 35Z5. Automatic vol. control, beam power output. Tunes 540 to 1700 Kc. Simple step-by-step instructions included.

**Plaza 812K 2-Band AC-DC Super Kit** net \$20.75  
**Globemaster 814K 3-Band Super Kit** net \$24.75  
 All kits supplied less wire and solder. Please include 25% deposit with C.O.D. orders. Dept. P-7

CORONA RADIO & TV CO  
 370 Broadway New York 13, N.Y.

## UNLIMITED OPPORTUNITIES IN ENGINEERING

BACH. SC. DEGREE IN 27 MONTHS in Elect., Radio (TV), Mech., Civil, Chem., Aero., Adm. Engineering; Bus. Adm., Acct. Visit campus, see well-equipped labs. Heavy demand for graduates. Placement service. Prep. courses. Approved for Korean Vets. Enter March, June, Sept., Jan. Low cost. Write Jean McCarthy for Catalog, View Book, "Your Career" Book.

3615 College Ave.  
 TRI-STATE COLLEGE Angola, Indiana

## INVENTORS

Send for  
**PATENT INFORMATION**  
 Book and  
**INVENTOR'S RECORD**  
 without obligation

**GUSTAVE MILLER**  
 15-PE WARNER BUILDING  
 WASHINGTON 4, D. C.

**REGISTERED PATENT ATTORNEY**  
 ASSOCIATE EXAMINER  
 U.S. PAT. OFF. 1922-1929

Patent Attorney & Advisor  
 U. S. NAVY DEPT. 1930-1947  
**PATENT LAWYER**

Equipment Co., 27th and Huntingdon Streets, Philadelphia 32, Pa.

### NEW PLIER

A new "Diamalloy" four-inch groove joint ignition plier has been announced by the *Diamond Calk Horseshoe Company* of Duluth, Minnesota.

Drop-forged of tool steel, hardened and tempered to extreme toughness, the new plier is designed for close and exacting work by auto mechanics, electricians, radio repairmen, and the handyman around the house.

Fully chrome plated, it is made to fit snugly between the fingers as its jaws lock into parallel position up to 1/2 inch.



### "THERMOSTAT BRAIN" SOLDERING GUN

Exclusive feature of a new soldering gun offered by *Garden City Industries, Inc.*, Chicago, is a "Thermostatic Brain" unit that heats the soldering gun to the exact required temperature in a matter of seconds, automatically regulates the wattage of the gun from maximum to minimum, and assures constant heat as well as extends the life of the unit. The new guns are lightweight and have built-in, unobstructed 10 watt spotlights with separate

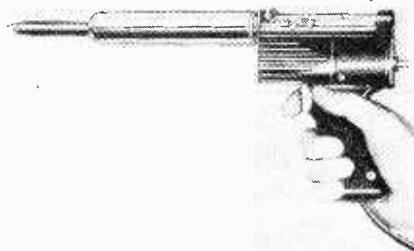

switches. Each gun has a steel clad tip. Models 212LT (shown in photograph) and 214LTN have interchangeable tips and element assemblies which enables the owner to have a wattage power range from 150 watts minimum to 650 watts maximum. Guns operate on either d.c. or a.c. and are U.L. approved. The new guns have no moving parts and no heavy transformers. They are said to deliver 200 per cent more heat than any of the older type. Known as "Trig-R-Heat" electric soldering guns, they are manufactured by *Wall Manufacturing Company* of Grove City, Pa., and distributed by *Garden City Industries* of Chicago. END

POPULAR ELECTRONICS



## So You Want to Be a Ham

(Continued from page 43)

practice code reception when he feels in the mood.

### \$200-\$300 Class

\$265. *Hammarlund HQ-140X*: A band-switching superhet, with a range from 540 kilocycles to 31 megacycles. Any portion of any of the six bands can be "bandspread" by means of the right-hand dial. In addition, this dial bears direct calibration for the 80, 40, 20, 15, and 10 meter amateur bands. Six-position selectivity switch controls the crystal filter circuit.

\$225. *Hallicrafters SX-71*: A double conversion superhet, with built-in provision for narrow-band FM. Temperature compensated and voltage regulated. Covers 538 kilocycles to 56 megacycles in five bands, front-panel selected. Two separate slide-rule type dials; left for general coverage, right bandspread on ham bands only. Both dials have 0-100 logging scales. Carrier level meter in center.

### \$100-\$200 Range

\$180. *Hallicrafters S-76*: Tunes the standard broadcast band plus three high-frequency bands from 1720 kilocycles

through 34 megacycles. Calibrated electrical bandspread for easy tuning. Double superhet, with large 4-inch "S" meter, five-position selectivity control, and automatic noise limiter.

\$200. *National NC-126*: Same general electrical characteristics as S-76, but features large slide-rule type dial.

\$130. *Hallicrafters S-40B*: A lower priced version of the S-76. Tunes from 540 kilocycles to 44 megacycles in four bands. Electrical bandspread, noise limiter, three-position tone control and built-in loudspeaker. A popular little set because it is compact and self-contained.

\$120. *National NC-88*: Pretty much the same electrically as the S-40B, but entirely different in design and appearance.

### Under \$100

\$90. *Hallicrafters S-53A*: A neat handful of self-contained, five-band superheterodyne covering 540 kilocycles to 54.5 megacycles. Electrical bandspread, with slide-rule type dial. Temperature compensated to reduce fading due to frequency drift.

\$50. *Hallicrafters S-38C* and *National SW-54*: These two receivers, practically identical circuit-wise, are frankly "price" jobs. However, they pull in stations by the score and provide an excellent introduction

Perfect  
TV Pictures—  
ON ALL CHANNELS

# 150

Miles or more  
from TV Stations  
UHF and VHF

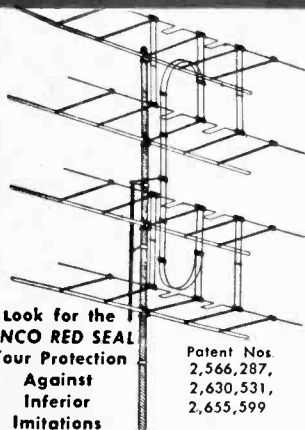

Look for the  
FINCO RED SEAL  
Your Protection  
Against  
Inferior  
Imitations

Patent Nos.  
2,566,287,  
2,630,531,  
2,655,599

WRITE TODAY FOR  
Interesting Free  
LITERATURE.

**FINCO® 400-A**  
Double CO-Lateral  
TV ANTENNA

- Perfect Pictures— ALL CHANNELS, UHF-VHF, COLOR
- Perfect Pictures— TESTED AND PROVED RIGHT HERE  
IN TOWN — IT'S THE BEST!
- Perfect Pictures— ONE TRANSMISSION LINE,  
NO SWITCHING!
- Perfect Pictures— ALL YEAR 'ROUND — WEATHERPROOF,  
ALUMINUM CONSTRUCTION!

**THE FINNEY COMPANY** Dept. PE-15 • 4612 St. Clair Ave. • Cleveland 3, Ohio

SEE THE LATEST IN  
**Electronics**  
EQUIPMENT



FREE

Send for  
**Newark's 1955 Catalog**

Select the fast, easy, dependable way from the New Electronics Reference Book — full of the latest releases and largest selections of High Fidelity, Radio, TV, Amateur and Electronics equipment.

**NEWARK**  
ELECTRIC COMPANY

Dept. P-1 223 W. Madison, Chicago 6, Ill.

**SAVE MONEY! SAVE SERVICE CALLS!**  
**CHECK ALL TV, RADIO & PICTURE TUBES**  
with this **VISULITE TV TUBE CHECKER**



Only **\$3.95**  
Complete  
NO TECHNICAL KNOWLEDGE REQUIRED  
Simple Instructions Furnished  
SAFE — QUICK — FOOLPROOF

Most Radio set failures are due to burned out tubes. Just plug tube into socket provided and Neon Lamp indicates this condition instantly. Operates on 110 Volt AC or DC.

**PERFORMS 1001 ELECTRICAL CHECKS!**

Checks continuity of resistors, appliances, motors or any Electrical device. Sturdily built for long life of trouble shooting. Test Leads included—Nothing else to buy. **SOLD ON 10 DAY MONEY BACK GUARANTEE.** See it at your distributor today. If he can't supply, order direct from factory. \$3.95 Postpaid anywhere in the U. S.

**VISULITE CO., Dept. PE-1 423 Broome St., New York 13, N.Y.**

**RADIO CONTROL for GARAGE DOOR**

FROM YOUR CAR—NO FCC LICENSE REQUIRED

- |   |                |
|---|----------------|
| <b>TRANSMITTER KIT</b> , incl. 6 V. Dynamotor, 27 1/4 Mc Crystal, Tube, Cab., Wound Coil, Switch, Resistors, Condensers, Instructions . . . . .   | <b>\$16.95</b> |
| <b>RECEIVER KIT</b> , 27 1/4 Mc., 110 V., AC/DC, Incl. Sens. Relay, Tubes, Wound Coils, Drilled Chassis, Resistors, Condensers, Instructions . . . . .  | <b>10.95</b>   |
| <b>PARTS AVAILABLE</b> —3 Channel tone operated R/C Receiver; also for any kits described in Popular Electronics; Clockwork <b>ELECTRIC TIMER</b> , 1/2 to 24 min.  | <b>1.00</b>    |
| <b>RADIO CONTROL TRANSMITTER RECEIVER</b> —for model planes, etc. busy operated. Kit of parts incl. Tubes, Sens. Relays, Resistors, Condensers, Instructions, incl. <b>FREE BERKELEY ESCAPEMENT</b> . . . . . | <b>9.88</b>    |
| <b>SIGMA 4F RELAY</b> 8,000 ohm, 1 Ma. \$4.95; 3,000 ohm. Storage <b>BATTERIES</b> —2 Volt 3"x4"x5 1/2", 27 Amp. Hr. . . . .  | <b>5.95</b>    |
| <b>MINI. 6 V. BATTERY</b> —Willard NT6—2 1/2"x1 3/4"x3 1/2" . . . . .   | <b>2.45</b>    |
| <b>G. E. RELAY CONTROL</b> —with sens. 10,000 ohm relay . . . . .   | <b>1.25</b>    |
| <b>2 V. VIBRATOR SUPPLY KIT</b> , 180 V./35 Ma. . . . .   | <b>6.95</b>    |
| <b>2 V. BATTERY CHARGER KIT</b> , \$4.95; wired . . . . .   | <b>6.95</b>    |

ALL MATERIAL GUARANTEED—FREE CATALOG "P"

**GYRO ELECTRONICS, 325 Canal Street**  
WORTH 6-1290 NEW YORK 13, NEW YORK

to short-wave radio for people who aren't quite ready to plank down two, three, or four hundred dollars for a quality communications set. They contain five tubes, built-in loudspeaker, cover four bands and have bandspread facilities.

Unless otherwise stated, communications type receivers do not contain loudspeakers. These are usually available as accessories in boxes of matching design.

There are several short-wave receivers in kit form on the market at the present time. A representative unit is the *Heathkit* AR-2, a 6-tube job that you can put together in a couple of evenings. It costs about \$26. It is a good exercise in radio construction, and performance-wise, is in the class of the S-38C or SW-54.

Relatively few "used" receivers appear on the market. Even after a man drops out of the ham game he usually holds on to his receiver because it is always good for listening to foreign broadcasts, police calls, airplane-to-tower conversations, etc. However, some jobbers accept occasional sets on trade-ins, and are therefore able to offer them for resale at bargain prices.

A communications set rarely wears out electrically. What you should examine particularly in a used job is the tuning mechanism, which might have some play or back-lash from its previous service.

(To be continued)

**PHASING LOUSPEAKERS**

**T**O CONNECT two or more loudspeakers in order to increase coverage or to obtain a greater power handling capacity, be sure the speakers are properly "phased." That is, make sure the connections to the voice coil terminals are such that the cone in each speaker moves in the same direction with similar signals.

You can do this by first checking the individual speakers as shown in the photograph. Use a battery (a flashlight cell will do) and a pair of test leads. Note the

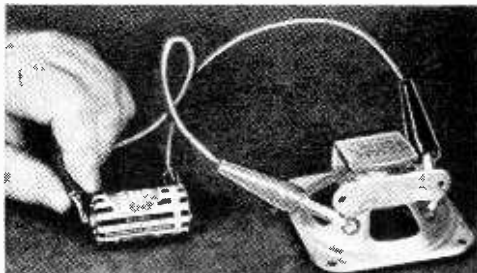

direction ("in" or "out") of speaker cone movement as you make and break the connection.

After checking each speaker, connect the terminals so that all cones move identically. **END**

# TRICKS of the TRADE

## LEATHER BELT TOOL RACK

**D**ON'T throw away your old leather belt when you buy a new one. You'll find that the belt will make an excellent tool rack when attached to a piece of hard-board or plywood.

Lay the tools on the board in the order you wish and form the belt in loops around

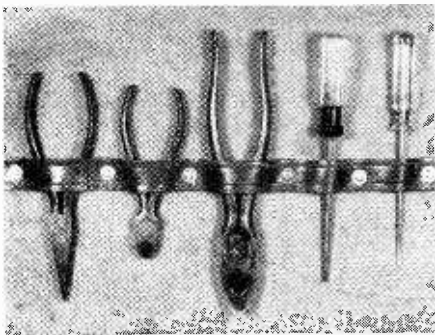

them. Punch holes in the leather at appropriate points. Finally, attach the leather belt to the board with screws, placing a flat washer under each screw head to minimize strain on the leather.

## KEEP CONTACTS CLEAN

**K**EEPING the contacts clean on multi-band switches is very important to the correct functioning of the set using this type switch.

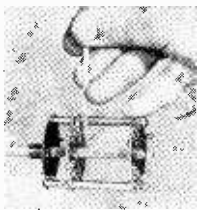

Watch for corrosion and contacts touching each other while cleaning. When in operation in the receiver a trimmer tool that is well insulated may be used

to check for good contact.

## CLEANING METHODS

**K**EEP a few pipe cleaners handy in your workshop. Dipped in carbon tetrachloride, they may be used for such chores as cleaning switch contacts, cleaning between the plates of tuning capacitors, and cleaning out battery sockets. Cut them in convenient lengths with a pair of side-cutters.

Best results can be obtained by first wiping the part with a cleaner soaked with carbon tetrachloride, then wiping a second time with a dry cleaner.

When cleaning between tuning capacitor

plates, make sure you have an easy fit. Some tuning capacitors have closely spaced plates and forcing the pipe cleaner between them may cause damage. Carbon tetrachloride is, of course, non-combustible and non-conductive and may be used on live circuits. Its fumes, however, are toxic so avoid inhaling them.

## CONVENIENT TOOLS

**W**HEN you see a bargain offer, as illustrated, in the drug store, it is well worth the price. The brush is good for cleaning contacts and applying cleaning fluid, or using touch-up stain on cabinets. The dental mirror will show up marked values on the rear sides of resistors or capacitors next to the chassis and other hard to reach spots. It is also invaluable for studying wiring and connections in remote places.



## CLEANING FILES

**W**HEN you use files on aluminum panels, or other soft metal objects, the teeth soon become clogged with the cuttings. These tightly embedded particles can be cleaned out by using a scraper made from a piece of copper tubing. Flatten one end and bend it over as shown, then apply

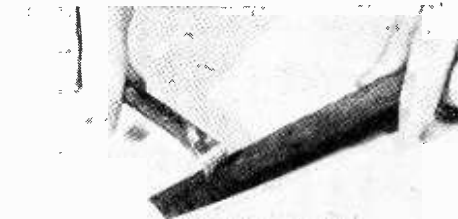

pressure as you draw it across the file along the grooves of the teeth.

## SAVE OLD "RABBIT EARS"

**S**AVE your old TV or FM "Rabbit Ears" antenna when you install that new super deluxe outside antenna. Disassembled, each pair of "Rabbit Ears" will give you two small "whip" antennas for portable

## 46 Surplus Twist DRILLS \$2



For hand or electric drills. Brand new genuine hardened carbon tool steel drills from  $\frac{1}{16}$ " through  $\frac{1}{4}$ ". Each drill designed and tempered to give 1800 drillings through steel, aluminum, iron, wood, plastic. Sells in the stores for up to \$6.

complete set postpaid. \$2

## 6 Pc. METAL CUTTING FILE SET



Made from the best quality tool steel, designed for the requirements of mechanics, instrument watch and jewelry craftsmen. Compartmented plastic kit contains the following  $5\frac{1}{2}$ " long needle files with round shanks and high test cutting qualities: round, half-round, flat, oval, knife, square.

complete set postpaid 98¢

## 6 Pc. POWER AUGER BIT SET

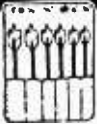

Made of finest tool steel specially tempered and hardened to give years of quick, clean, easy drilling. Shanks will fit all electric drills. Packed in sturdy, heat-treated, compartmented plastic tool roll. Sizes  $\frac{3}{16}$ ",  $\frac{1}{4}$ ",  $\frac{5}{16}$ ",  $\frac{3}{8}$ ",  $\frac{1}{2}$ " and 1".

complete set postpaid \$2.29

## Finest Imported PRECISION PLIERS

For Jewelers, Optical Workers, Hobbyists, Craftsmen of all kinds. Each plier is 4" long and a gem of precision and strength. Seven types to choose from: Flat Nose, Round Nose, Snipe, Combination, Diagonal, End Cutting Nippers, or 1 Side Flat and 1 Side Round.

75c ca.

Minimum Order \$1. No C.O.D. Send Check or Money Order. MONEY BACK GUARANTEE

**SCOTT-MITCHELL HOUSE INC.**  
DEPT. MS-26 611 BROADWAY, NEW YORK 12, N.Y.

# BRAND NEW TUBES FAR BELOW WHOLESALE

Steve-El brings you Fully Guaranteed tubes for one year at Below Wholesale Prices. All tubes individually boxed.

1B3 .52	6B5 .47	6W4 .44	12SN7 .51
1S5 .46	6B6 1.19	6X4 .36	19T8 .64
1T4 .46	6BQ6 .81	7C4 .49	25BQ6 .66
1X2A .61	6CB6 .44	12A6 .46	25L6 .38
6AG5 .51	6J6 .51	12A7 .56	25W4 .47
6AK5 .66	6L6 .86	12AV7 .58	50B5 .47
6AC7 .73	6SL7 .49	12AX4 .52	57AS .49
6AL5 .39	6SN7 .54	12BA6 .43	57S .49
6AT6 .37	6T8 .56	12BE6 .41	117Z3 .39
6AU6 .43	6V6 .39	12SL7 .49	807 .99

Minimum order \$5.00.

FREE 1955 Catalog!

Write Dept. PE-1 for complete list of tubes and other bargains.

**STEVE-EL Electronics Corp.**

61 Reade St.

New York 7, N. Y.

radios, small transmitters, transceivers, and similar portable electronic gear.

The heavy base can be used, too—it makes a handy paperweight for the office or shop.

\* \* \*

## PLASTIC DUST COVERS

WHEN microphones or other parts are not in use, and when they are being transported, or put in storage, etc., it's a good idea to slip a plastic bowl cover over the grille, as shown in the photo, as protection from dust and moisture. These plastic bowl covers have elastic bands which allow them to be quickly installed and removed, and they come in a variety of sizes, so you should have no trouble finding the right ones to fit your mike, etc. These covers are sold in dime stores, and elsewhere, for a few cents each, or you can buy them in sets of various sizes. What you don't use, your wife will be glad to have for her kitchen!



\* \* \*

## CONTACT RESTORER

THERE are various types of volume control contact restorers on the market. You can often use such liquids to clear up control troubles on TV receivers simply by



applying a few drops around the control shaft and working the shaft back and forth. It is a good idea to note the original position of the shaft, by marking, so that it may be returned after cleaning.

\* \* \*

## HANDY REPLACEMENTS

WHEN you need a replacement rubber foot or bumper for some home appliance or other equipment and there are none available, try your stock of faucet washers. In an assortment of faucet washers you can usually find one to replace bumper needed. Either wood or machine

screws may be inserted through the washer as required by the appliance.

\* \* \*

### TUBE PULLER

**M**INIATURE tubes in modern radios and TV receivers are difficult to grasp. Removing and replacing them in certain sections of the receivers sometimes is quite a problem.

A metal tube puller, as shown, makes this work easier with less chance of damaging the small pins at the tube base. The puller is pushed down over the tube top. Suction keeps a tight grip on the tube. The button at the puller top is pushed to re-

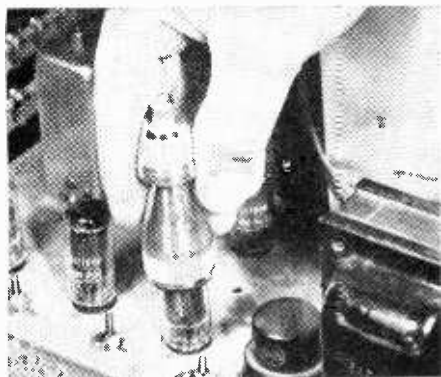

lease the tube when replaced in socket.

Other types of rubber tube pullers are also available.

\* \* \*

### DRY CELL CONNECTORS

**T**HIS easily made twin-connector allows you to make quick connections to a dry cell. The polarity of the connections can be quickly reversed by simply turning the clip over. As shown in the photo, simply cement a 1/2" by 1" piece of sheet copper to the outside end of each "press end" of a wood snap clothes-pin. Next solder a wire lead to each copper.

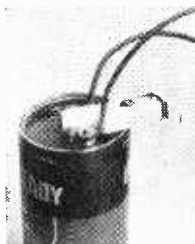

The nose of the clip can be sawed off close to the spring, if desired, to reduce the length of the clip. In use, simply press the ends of the clip together and let the two coppers spring back against the two binding posts on the cell, as shown. The milled screw-caps on the posts of the cells dig into the coppers and prevent slipping of the clip.

\* \* \*

### INSULATOR FROM TUBE CARTON

**W**HEN making temporary test hook-ups, such as using the low voltage alternating current from a tube tester to apply to

# Thrill to "Silk-and-Diamond" highs\*



**12 NOTES  
ABOVE  
HIGH C,  
AND UP**

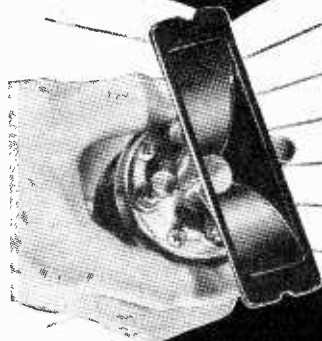

## T 35 Super Sonax

\*Smooth as silk, brilliant as diamonds, the highest octaves you can hear are realistically yours, with an E-V T35 in your high fidelity music installation. This new, very-high-frequency tweeter takes over from 3500 cps to beyond audibility . . . provides 180° dispersion. Is easily installed, along with recommended X36 crossover and AT37 level control.

T35	List \$55.00	Audiophile Net \$33.00
T35B	List \$35.00	Audiophile Net \$21.00
X36	List \$14.00	Audiophile Net \$8.40
AT37	List \$6.00	Audiophile Net \$3.60

The T35B—for lower powered systems and existing quality AM-FM radio or radio-phonographs, finished in flat matte black. Requires only X36 to attach to music system. Impedance 16 ohms. Shipping wt. 2 lbs.

### Beautiful T 35 Accessory Enclosure



Styled in gleaming tropical mahogany or lustrous Korina blonde. Contains T35 Super Sonax X 36 crossover and AT37 level control, wired and ready to connect to your music system. List \$15.00. Audiophile Net \$9.00.

**Prove the performance  
of the T 35 to yourself!**

You hear the difference with this T35 demonstrator. With a flip of the switch you bring in or cut out the T35. Visit your E-V distributor to conduct this amazing test personally.



Today—write for Bulletin 794 and where to buy.

**Electro-Voice** ELECTRO-VOICE, INC.  
BUCHANAN, MICHIGAN

# HERSHEL'S "KIT" SPECIALS

**ALL-PURPOSE FIL TRANSFORMER**  
For Model Trains, Welding, Transmitters, etc.  
PRF-117 v. 60 cyc. sec.  
8.4 V. .... 12A  
8.4 V. .... 10A  
5 V. .... 3A  
5 V. .... 2A  
5 V. .... 1A  
2.5 V. .... 1.75A

**\$495**

**MYSTERY PACKAGE ELECTRONIC PARTS**  
The Surprise of Your Life  
25 pounds of Worth \$50.  
BRAND NEW Our Price  
USABLE GOVT. SURPLUS  
Ideal gift for the ham, etc.

**\$495**

**KIT 1. HARDWARE**  
Over 1,000 pieces, 2 1/2 lbs. of assorted RADIO & TV HARDWARE.

**\$149**

**KITS, RESISTORS**  
100 ASSORTED TYPES. Range from 1 ohm to 15 meg. 1/2 to 5 watt.

**\$198**

**KIT 2. CERAMICONS**  
100 ASSORTED. Range from .75 mmd. to 6,000 mmd.

**\$350**

**KIT 6. R.F. CHOKES**  
25 ASSORTED. Range from .5 mh. to 25 mh.

**\$195**

**KIT 3. Volume Controls**  
25 ASSORTED Range from 2 ohm to 3 meg. Some w/with switch.

**\$475**

**KIT 7. TOGGLE & SLIDE SWITCHES**  
25 ASSORTED. DPST, DPDT, SPST, etc.

**\$495**

**KIT 4. Rotary Switches**  
25 ASSORTED TYPES. A Real Buy at Only...

**\$475**

**KIT 8. PAPER & CAN CONDENSERS**  
25 ASSORTED. Range from 4 mfd. 150 v. to 80 mfd. 450 v.

**\$350**

**HERSHEL RADIO CO.**  
5245 Grand River, Detroit 8, Mich.

Terms: Cash with order or 25% DOWN—Balance will be mailed C.O.D.

a radio output transformer to determine if the output stage is operating, an empty tube carton will serve as an insulator for the test clip.

The tube box is opened at both ends, the test clip slipped through the box and after

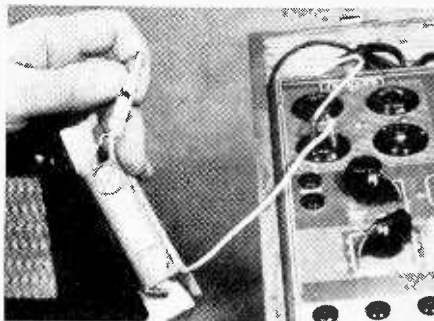

attachment of the clip, the carton may be slid over the clip to insulate it from nearby terminals.

## TAG RESISTORS FOR SPEED

A CIGAR BOX full of unmarked resistors requires a lot of checking with color codes before the proper one is selected. Small cardboard tags are easily attached to the wire leads and marked as "4 meg." or "70 M" or your own code, so that you may quickly find the desired resistor.

## REPLACES TUBE SHIELDS

ONE is often tempted to leave off a tube shield which is particularly hard to replace, as in crowded quarters in a TV receiver.

Removal of the shield may detune a circuit such as the TV oscillator to a point where the Fine Tuning Control may not be able to handle such detuning.

Also radiation effects may result, so be sure to replace the shield.

## SPEAKER PROTECTION

ONE or two pieces of foam or sponge rubber will be found useful when handling radio or TV receivers. In the case shown,

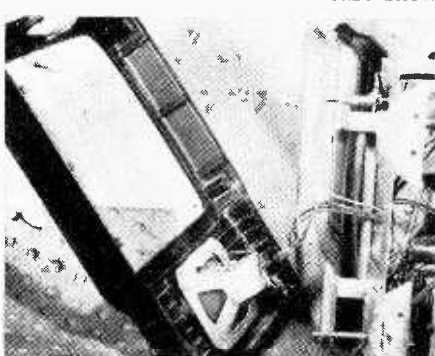

# ELECTRONIC SUPPLIES

For INDUSTRY • AMATEURS • SERVICE

REMOTE CONTROL UNIT—\$20 worth of useful parts including Sensitive Plate Relay, Schematic 79¢ ea.

WESTON 0-20 MICROAMPERE SENSITIVE METER—worth \$2.00—Brand New—Cond. Scale—\$5.95

MARION—0.5 milis DC—3" sq. worth \$8.00. Brand New. Special—\$2.95

FILTER—10 MPD—400 VDC (2x5) 3 Term. oil impregnated. Brand New—worth \$8.98 ea. 3 for \$2.50

THROAT MICROPHONE—Signal Corp. T-31—2 single button carbon elements. New—w/instruction sheet—\$98¢

KOIL KORD—retractable phone cord—4 conductor, same as used in cabs, planes, etc.—worth over \$4 ea.—\$98¢

IRON VANE METER—0-10 amps—2" sq.—(Electro Instr. Mfg.), 99¢

0-1 amp—2" Rd—GF, 98¢ 10 for \$7.50

MAGIC EYE TUBE—1629—New—boxed—worth \$2.65; same as 6E5 but 12V Fil. .7 for \$1.00

SIGNAL CORP. TELEGRAPH KEY—1-51—Brand New—beautiful constr.—Beryllium contacts—\$79¢ ea.; 2 for \$1.50

WESTERN ELECTRIC AC LINE FILTER—oil cond., potted chokes—compact. Brand New. 2 for \$1.50

Q-METERS—Boonton—like new condition—2 for sale; details on request.

1N60—SYLVANIA General Purpose Crystal DIODE—clipped leads—GTD—\$4 for \$1.00

MINIATURE PLASTIC WET CELL BATTERIES

2 volt—20 AH—\$1.95  
6 volt—3 AH—\$1.95

CHEST MIKE—T-26—w/switch and brass plate, F-1 button—boxed—\$2.95

POWER TRANSFORMER—Kenyon T-658 \$40 list—400-0-400

325 MA., 6.3V 6A, 5V 4A, Brand New—\$6.95

POWER TRANSF.—Thordarson T-22R10 300VCT—40MA, 5V—2A, 6.3V—\$2.4

New—boxed—\$3.50  
W. E. STEPPER SWITCH—2 circuit—6 steps—6 or 12V Coll. New—Gtd—\$7.95

DYNAMOTOR—PE 101C—w/conv. sheet 12V; 1N; New—boxed—\$4.49; plus 75¢

ANTENNA ROTATOR (new, not surplus) will handle TV or Ham news—w/indicator box—4 wire—\$19.95

MINIATURE PHONES—1S-30, like new—\$2.49

BC-733D RECEIVER for IIS-108-110MC used—less tubes. Only—\$6.95

89/APN-4—LORAN—used—with some tubes—\$9.95

HEARING AID TUBES—subminiature type—unbranded. 5 for \$1.00

1/2" PANEL LAMP INDICATOR—red or amber—.8 for \$1.00

TUBULAR CONDENSERS—paper and stearite—200-600V. New—popular sizes only—prepared for production. 50 for \$1.00

DISC CONDENSERS—.01 or .005 MFD—prepared for production—\$12 for \$1.00

POWER TRANS.—Kenyon T-664 740-0-740-150 Mils. Brand New—less than cost to make—\$4.95

TOGGLE SWITCHES—all types in stock always:

SPST—3A—125V Carling. 19¢  
SPST—6A—Arrow 125V. 25¢

DPST—3A—Carling 125V. 23¢  
DPST—6A—CH 125V. .49¢

DPDT—3A—250V Arrow. 59¢  
DPDT—6A—125V CH—.89¢  
DPDT—Center off—Carling—.99¢

MINIATURE BLOWER—24V AC, DC—6000 RPM—used—guaranteed OK—\$1.49

WESTINGHOUSE 115VAC 1/16 HP MOTOR—7000 RPM—like new—\$1.95

## REX RADIO SUPPLY

88 CORTLAND ST., NEW YORK 7, N. Y., CO 7-1617

any scratching or damage to a TV speaker and the front panel of the TV receiver is eliminated by placing a piece of foam rubber under the speaker section. Foam rubber is available at most auto or surplus stores.

**TESTING FLASHLIGHT BULB**

**W**HEN you suspect your flashlight bulb or the pilot lamp from your radio or TV set, try using a pair of flexible leads from the filament socket of your tube tester. The voltage from the filament prongs or rather the filament socket may be adjusted to near the normal flash lamp voltage for testing. By clipping one lead to the

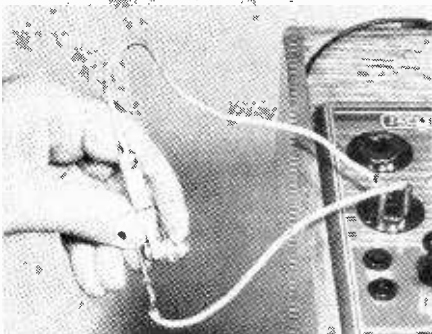

lamp terminal the other may be held in the hand to determine if the lamp is burned out.

**EXPERIMENTAL WOODEN CHASSIS**

**F**OR making quick hook-ups of test circuits, a few pieces of pine material are easily handled. A couple of tube sockets, a

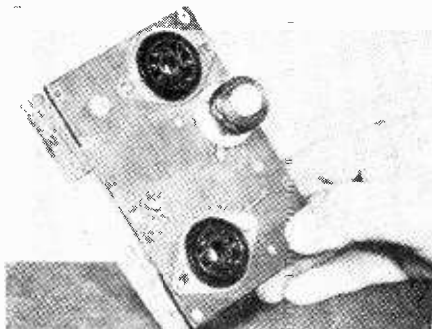

coil, and other desired equipment are satisfactorily mounted on a small section of 1/8 inch material with 1/2 inch strips of wood serving as corner supports.

**SAVE OLD CONTROLS**

**A** DISCARDED volume or other control, which has an "on-off" switch is worth keeping. The switch section still serves its original purpose and may be used on test or experimental equipment. **END**

**PAY ONLY 10% DOWN**  
**ON THESE ITEMS**  
*from* **WRL** LARGEST DISTRIBUTOR OF AMATEUR RADIO EQUIPMENT - THE WORLD'S

**65 Watt Globe Scout**  
**Completely Bandswitching**  
 Ideal Xmtr. for beginner.  
 Fully bandswitching, 160-10M.,  
 65 watts CW., 50 watts on  
 fone. Metering provided. Self-  
 contained power supply. 100%  
 modulation of Final. Comple-  
 tely screened for TVI.  
 Housed in 8"x16"x8", grey  
 cabinet.

**ONLY \$795 Per Mo.**  
**KIT \$89.95 CASH** **WIRED \$99.95 CASH**

**Save Up to 50% . . .**  
**ON TOP-VALUE**  
**RECONDITIONED EQUIPMENT**  
 We have hundreds of Xmtr's, recv's., speakers, test eqpt.,  
 antennas, ham and experimental radio gear of all sorts in  
 factory-new condition, carrying our positive 90-day guarantee!  
 Here, indeed is a bargain for the novice and professional,  
 alike!

**Send for Our Complete, Up-to-Date List Today!**

	<b>TRANSMITTER</b> \$29.40 Complete		<b>RECEIVER</b> \$14.70 Complete
---	--	---	-------------------------------------

Build your own trans-  
 mitter and receiver and  
 "go on the air" with  
 this complete kit and  
 simple instructions.  
 Complete kit only  
 \$43.22. Designed for  
 single wire antenna.  
 Power supply included  
 with transmitter. Units  
 may be purchased sep-  
 arately. Write for full  
 details.

**Plus many, many, more**  
**as shown in our**  
**FREE 1955 CATALOG**  
**Send for Your Copy Now!**

**World Radio Laboratories**  
 1955 CATALOG

**ALL PRICES SUBJECT TO CHANGE WITHOUT NOTICE.**

**WORLD'S MOST PERSONALIZED RADIO SUPPLY HOUSE**  
**World Radio LABORATORIES**  
**ELECTRONIC HEADQUARTERS**  
 3415 W. BROADWAY, CO. BLUFFS, IA., Phone 2-6277

Please Quote Your Top Trade-in Value **PE-1**  
 of My \_\_\_\_\_  
 (Make, Model Eqpt. I Now Own)

On Your \_\_\_\_\_  
 (New WRL Eqpt. Desired)

Send Me:  
 Free Catalog  3'x4' Radio Map (25c)  
 Full Info. On:  Globe Scout  Receiver  
 and Xmtr. Kits  Reconditioned Equip. List.  
 Name: \_\_\_\_\_  
 Address: \_\_\_\_\_  
 City and State: \_\_\_\_\_

## SAVE ON TELEVISION PARTS

HEAVY DUTY 1¼ IN. O.D. TOWERS  
VINYL ALUMINUM FINISH  
SELF SUPPORTING TO 50 FT.

10 ft. section.....\$11.95  
Top section (10 ft.)..... 11.95  
Adjustable house brace..... 4.95  
10 ft. heavy top pipe..... 3.98

All Hardware Included

## SPECIAL PRICES ON T.V. ANTENNAS

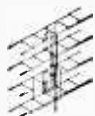

Dbl. Lazy X \$5.95      Skymaster \$19.95      Dbl. LS2 \$18.95

300 ohm lead-in—100 ft.....\$2.98

U83—Alliance .....\$29.95

Rotors TR4—Radiart..... 32.50

Wire for U83 or TR4—5c ft.

Write for Flinco Antenna Prices

Heavy 1¼ in. O.D. self-fitted mast \$3—10 ft.

All Prices F.O.B. Order from This Ad.  
C.O.D. Orders—25% Deposit

**RICHVILLE T.V. SUPPLY**

5666 Navarre Rd. S.W.

R.D. 1, Canton, Ohio

## SUPER POCKET RADIO

Smaller than many hearing aids. Powerful, portable and can be assembled by anyone in one hour. Uses two inexpensive cells that fit within case. Owners report 1,500 mile reception. No antenna or ground required for local use. Complete kit of hearing-aid parts only



**\$3.99** POST-PAID

\$3.99. Batteries extra at \$1.45. Use any regular headphone with Micro or tiny hearing-aid earset, shown in photo, available from us at low cost. Micro is guaranteed to please or return in 10 days for full refund.

SEND ONLY \$1.00  
BALANCE C.O.D.

**TRANSI-MITE RADIO LAB**

MANTEO (3) NO. CAR.

## The World at a Twirl

(Continued from page 83)

9.668, for *English* releases 0300-0445. TGWB, *Radio Nacional de Guatemala*, seems to have settled down on 6.196A; should open 1200 and run to 0500 or later.

*Haiti*—4VEH is easily tuned 1100-1500 (except Thursday when is silent) on 9.656 (listed 9.654); has "Listeners Post" at 1430-1500 Saturdays on 9.656, and Tuesdays 0130-0200 on listed 9.666. *Holland*—For the weekday *English* session from *Radio Nederland*, Hilversum, try 6.025 at 0230-0310. *Hungary*—*Radio Budapest* has *English* for North America 0030-0100, 0400-0430 on 11.910, 9.833, 7.220. *Israel*—Tel Aviv, 9.008, still has *English* news 2015. *Japan*—*The Far East Network*, AFRS, Tokyo, is currently scheduled 1030-1500, 2100-2300 on 6.160, and 2315-1015 on 11.750. *Malaya*—You should easily log the *British Far Eastern Broadcasting Service*, Singapore, on 11.820 and/or 11.955 at 1300 when has BBC news relay from London in *English*.

*Norway*—Winter schedule of *Radio Norway* to East Coast is 0100-0200, to West Coast 0400-0500 over 6.130, 7.210, 9.610; on Mondays extends these transmissions by approximately 20 minutes for "Norway This Week" (news in *English*). *Peru*—When this was written, the *English* news session over Lima's 6.082 channel was at 0430 instead of former 0400. *Poland*—Winter schedules of *Radio Warsaw* to North America in *English* are 1100-1130, 9.570; 1215-1315, 11.740; 2215-2245, 0045-0115, 0415-0445, 0530-0600, 6.025.

*Switzerland*—Winter beams of Berne to Eastern North America, 0130-0315, and to Western North America, at a new time of 0415-0500, are radiated over 6.055, 6.165, 9.535. *Syria*—Try 9.555 for Damascus in *English* 2130-2230 closedown. *Thailand*—Eastern USA SWL's will find HSK9, 11.670A, Bangkok, has an improved signal in Thai transmission around 1300-1400 or later; usually identifies in *English* at 1400A. *Turkey*—*Radio Ankara* has resumed its Mailbag session Sundays 2115-2200 over TAP, 9.465, TAS, 7,285.

\* \* \*

### For Experienced SWL's

*Burma*—*Rangoon*, 4.777A, is heard in California at 1415 when starts "Voice of Burma" session in *English*; closes down 1515 with "God Save the Queen." *Cape Verde Islands*—CR4AA, 7.398A, Praia, should be logged around 2100 to 2200 when closes with "A Portuguesa." *China*—On the West Coast, the 0900-0930 *English* session from *Radio Peking* is usually audible

POPULAR ELECTRONICS



over 6.105, 6.201, 7.500; the 0300 *English* period is heard there over 15.385.

*Hong-Kong*—Worth several tries is ZWB3, 9.525, Victoria, at 1100 with BBC news relay in *English*. *Iceland*—Try TFJ, 12.175, on *Sundays only* 1615-1630 when has news in Icelandic; much CW QRM must be overcome to log this one! *India*—West Coasters are hearing the Asian beam 1330-1445 from *All India Radio*, Delhi, over the new 11.620 outlet; has *English* news 1335. *Indo-China*—*Radio France-Asie*, Saigon, has *English* on 9.755 at 1400; on 11.790 (or alternate 11.830) at 1600. *Iraq*—With lots of luck, you may be able to pick up the *English* session from *Radio Baghdad* at 1915-2000 closedown over 3.295A (announced for local listeners) or 11.705A (announced for overseas listeners).

*Japan*—JOZ, 3.925, and JOZ2, 6.055, Tokyo, commercial stations, are heard on the West Coast to 1410A closedown; news in Japanese is at 1400; has been noted with an "English Hour" feature (of 10 minutes' duration) at 0810 (but printed schedule lists this session for 1050). *Madagascar*—Some days, eastern USA DX-ers are picking up *Radio Tananarive*, 9.515, when it opens 0330 in French.

*Pakistan*—*Radio Pakistan*, Karachi, now uses 9.545 parallel 7.010 for *English* to Turkey 1915-2000 and to the United Kingdom 2000-2045. Is heard on West Coast with *English* news in Home Service at 1445-1500 on 6.235 parallel 9.484.

*South Africa*—The Commercial Service, 4.945, Johannesburg, has been logged in Indiana opening in *English* 0400 with popular recordings. *South Korea*—HLKA, 2.510, Seoul, has been heard in California 1330-1400 in the Korean language, and "Radio Yagabond," 6.890A, the "Armed Forces Korean Network," has been logged there around 1350.

*Tahiti*—FZP8, 6.135, Papeete, is heard on the West Coast around 0430 in Tahitian language, popular music, good level but with much QRN; and on 7.120 around 0515 with French, music, good level.

Next month I'll give you some suggestions on reporting to stations, and I'll have more current "best bets" for you. May lots of DX come your way during 1955 as you "twirl to tune the world!"

(To be continued)

### SWL'S ATTENTION!

For additional and expanded listings of short-wave programs throughout the world see "International Short-Wave" in this month's issue of our sister publication, RADIO & TELEVISION NEWS.

# Never Have You Heard Such Fidelity

READ ABOUT THE  
**GOODMANS**  
*Axiom* **80**  
AND OTHER  
**GOODMANS**  
**LOUDSPEAKERS**

ROCKBAR CORPORATION, DEPT. DA-6  
215 East 37th Street, New York 16, N. Y.

Please send complete description of the  
Axiom 80 and other Goodmans Loud-  
speakers.

Name \_\_\_\_\_

Address \_\_\_\_\_

City \_\_\_\_\_ Zone \_\_\_\_\_ State \_\_\_\_\_

My Dealer is \_\_\_\_\_

# EXPERIMENTERS!

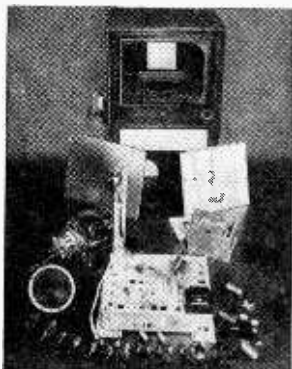

LOOK WHAT YOU GET FOR THE Remarkably LOW PRICE OF ONLY **\$89.50**

(Cabinet as shown \$10.00 extra)

## A COMPLETELY OPERATING PHILIPS PROTELGRAM TV SYSTEM

BRAND NEW—shipped in original factory sealed container

YOU GET A COMPLETE PACKAGE INCLUDING:

• Chassis completely wired and ready for use, including 23 tubes plus one diode • Protelgram projection unit including picture tube • 25,000 volt power supply • 8" dynamic Hi-Fi speaker on large baffle • 23" flat viewing screen and full size reflecting mirror.

NOTE: Chassis circuitry includes . . . Automatic beam suppressor . . . High Fidelity sound system . . . Automatic gain control . . . "Standard Coil" tuner, etc.

\$400.00 original cost of parts, units and accessories to experiment with.

EDUCATIONAL . . . INTERESTING . . . ENTERTAINING

TERMS: F.O.B. N.Y.C. Full remittance with order or 25% Balance C.O.D.—10 day money back guarantee.

**ELECTRONIC SPECIALTY SUPPLY CO.**  
58 Walker St., N. Y. 13, N. Y. Phone: WA. 5-8187

# BOOK REVIEWS

"EXPERIMENTAL ELECTRICITY FOR THE BEGINNER" by Leonard R. Crow. Published by *The Scientific Book Publishing Co.*, Vincennes, Indiana. 284 pages. Price \$2.50 paper bound; \$3.50 cloth cover.

Over 200 experiments are described and illustrated in this book, designed to provide beginners with the basics of electrical theory and the first steps in the intelligent use of electrical equipment.

Subjects covered include magnetism, basic circuits, induction and transformers, bells, thermostats, switches, relays, motors, and controlling devices. An interesting section tells how to use the motor that can be built by the reader to understand such things as centrifugal force, color, and sound phenomena.

The book is primarily intended as a guide to using the *Crow Beginner's Experimental Kit in Magnetism and Electricity*, and as such follows a logical sequence of experiments. Without the kit, the volume may serve as an introductory text to the study of basic electricity, if the reader can manage to perform the experiments, and if—ideally—he can get some supplementary information on the more theoretical aspects of the subject.

\* \* \*

"HOW TO USE TEST PROBES" by Alfred A. Ghirardi and Robert G. Middleton, Published by *John F. Rider Publisher, Inc.*, New York. 172 pages. Price \$2.90. Paper bound.

Two of the radio world's most respected and prolific technician-writers have teamed up to produce an excellent book that may well become the "standard" for the correct use of test probes in circuits.

The need for an understanding of "test probes" has been created in recent years by the ever-increasing use of such complex instruments as the volt-ohm-milliammeter, the vacuum-tube voltmeter, oscilloscopes, etc. No longer in the exclusive domain of the laboratory, these and similar devices are the everyday equipment of most radio and TV technicians, and are essential to service properly TV and FM receivers as well as high fidelity equipment. More than just test leads, the test probes are actually auxiliary testing devices that add new ranges and functions to the conventional testing instruments.

How this is done, and how best to use the  
POPULAR ELECTRONICS

BUY DIRECT FROM FACTORY SAVE MIDDLEMAN PROFITS

**MASTER MECHANIC PORTABLE LIGHT PLANTS**

Push Button Start. 600-700 Watts—A.C. Plant—115 v. 60 cye. Powered by a rugged 2 hp. easy starting Briggs gas engine. No wiring necessary, just plug in and operate. Plenty of current for receivers, transmitters, antenna motors, emergency lights, etc. which require up to 700 watts. Ideal for radio amateurs, Civil Defense, trailers and camps. Complete with Voltmeter and built-in winding to charge 6 v. auto batteries. (Item 24) Wt. 75 lbs. Be prepared if war

**\$143.50**  
**\$199.50**

or storm knock out power lines. . . . .  
1000-1200 Watt Plant (item 45) same as item 24 but with larger generator and engine—50% greater output. . . . .  
Send 10c for big 1955 Catalog. Free with order. Prices f.o.b. factory. 10 Day Money Back Guarantee. Send check or Money Order.

**MASTER MECHANIC MFG. CO., Dept. 50-J, Burlington, Wis.**

## F. C. C. LICENSE

Get Your FCC Commercial Operator License Quickly

We specialize in rapid and thorough preparation for FCC examinations. Correspondence or resident training. Results guaranteed. Write for free booklet.

**GRANTHAM SCHOOL OF ELECTRONICS**  
Dept. 104-C, 6064 Hollywood Blvd., Hollywood 28, Calif. (Phone HO 2-4111)

## SAFFORD—3 CHANNEL TONE R/C RECEIVER

Basic component kit—all resistors, capacitors, wound RFC's and tank coils, sockets, hardware, etc. \$4.50.

3A5 . . . . . \$1.50      3Q4 . . . . . \$1.20  
Sigma 4F8K relays \$6.50—many other values. Free illustrated catalog.

ACE RADIO, Box 301, Higginsville, Mo.

different types of test probes available are admirably treated in this book. Complete with schematic diagrams, clear photos, and a handy index, this lucidly written volume should be a welcome addition to any technician's shelf.

**"OBTAINING AND INTERPRETING TEST SCOPE TRACES"** by John F. Rider. Published by *John F. Rider Publisher, Inc.*, N. Y. 186 pages. Price \$2.40. Paper bound.

An excellent companion piece to the book on test probes is this handy volume which explains oscilloscope trace patterns in clear, non-mathematical terms that almost anyone can understand. Eight hundred traces of all types of AM and FM receivers, TV receivers, audio amplifiers, power supplies, and transmitters are included. Anyone who works with, or plans to work with, a cathode-ray oscilloscope will benefit from going through this book. The text is extremely clear and the illustrations leave nothing to the imagination.

The book opens by answering the question, "What is a waveform?" and closes with a discussion of the special scope pattern known as a Lissajous figure.

All types of waveforms are analyzed and their practical applications in servicing and experimenting are given. In addition, the book contains instructions for setting up an oscilloscope for various uses in analyzing practical circuits.

**"AUDEL'S HOME APPLIANCE SERVICE GUIDE"** by Edwin P. Anderson. Published by *Theo. Audel & Co.*, N. Y. 824 pages. Price \$4.00. Cloth bound.

If you're sick and tired of waiting for that morning toast to get done, better look into this book before throwing out your toaster. For herein are explained many of the mysteries that perplex and, betimes, infuriate the home user of such appliances as toasters, irons, roasters, broilers, waffle bakers, water heaters, ranges, mixers, fans, vacuum cleaners, washing machines, etc.

How these devices work and how to repair them when they go wrong are carefully explained and amply illustrated. The book is thus valuable to the home technician as well as the professional.

Additional "gravy" are chapters on motors and thermostats, and a section dealing with electrical fundamentals. This covers everything from atomic structure through Ohm's Law and into testing instruments, shop technique, and house wiring.

The book does *not* cover electronics, *i.e.*, radio, TV, etc. But practically everything else that uses an electrical current to operate (with the curious exception of electric razors and clocks) is here, and well worth the price. **END**

January, 1955

General Electronic's New Model 137

## 50,000 OHMS PER VOLT 62 Range-Multimeter



### SPECIFICATIONS:

**DC VOLTS** (Pos. & Neg.): 0-1.5/6/30/150/300/600/1500

**AC VOLTS:** 0-1.5/6/30/150/300/600/1500

**OUTPUT VOLTS:** 0-1.5/6/30/150/300/600/1500

**RESISTANCE:** 0-2,000/20,000/200,000 Ohms—0-2/20/200 Megohms

**DC CURRENT:** (Pos. & Neg.): 0-30/300 Microamp, 0-3/30/300/3000 Ma.

**AC CURRENT:** 0-300 Microamp—0-3/30/300/3,000 Ma.

**CAPACITY:** 001 to .1 MFD 1 to 50 MFD

**LEAKAGE:** Good-bad scale for checking quality of Electrolytic condensers

**DECIBELS:** -6 to +18, +14 to +38, +34 to +58

MEASURES 5/8"x6 1/4"x2 1/4"

**FEATURES:** • Input Impedance on 150 Volt scale and up equal to and better than that of most VTVM'S • 10,000 ohms per volt on AC • Polarity reversing switch for DC—No time lost in reversing of leads • Large rugged 4 1/2"-20 Microamp meter—3 color scale • Completely self contained—No external source of power required • Lightweight • Rugged (Send for FREE catalog)

The Model 137 comes housed in an attractive round cornered black bakelite case with a gray easy to read panel. Black designations. Factory calibrated. Test leads and operating instructions included.

**\$49<sup>50</sup>**  
NET

**GENERAL ELECTRONIC DISTRIBUTING CO.**

98 Park Place, Dept. P1, New York 7, N. Y.

IT'S BIGGER AND BETTER THAN EVER!

B-A'S NEW 1955

**FREE CATALOG!**

**164  
PAGES**

LOADED WITH  
SAVINGS AND  
NEW ITEMS  
IN RADIO,  
TV AND  
ELECTRONICS!

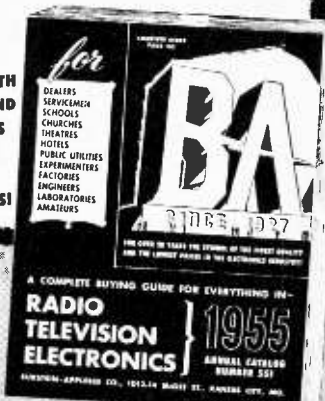

**SEND  
FOR IT  
TODAY!**

**BURSTEIN-APPLEBEE CO.**

Dept. PE, 1012-14 McGee St., Kansas City 6, Mo.  
 Send Free B-A Catalog No. 651.

Name .....

Address.....

City.....

State.....

# AFTER CLASS

## Ohm's Law and the Units of Voltage, Current, and Resistance

**V**OLTAGE can be described as the pressure which forces current to flow through resistance. The amount of current flow can be increased by either (1) increasing the voltage or (2) decreasing the resistance. The mathematician describes this relationship by saying that *current is directly proportional to voltage and inversely proportional to resistance*. This impressive sounding statement means simply that current is equal to voltage, divided by resistance. This may be written:

$$\text{current} = \frac{\text{voltage}}{\text{resistance}}$$

The letters  $I$ ,  $E$ , and  $R$  are used to represent current, voltage, and resistance, respectively, and the above relationship may now be written:

$$I = \frac{E}{R}$$

This formula is known as Ohm's Law and may be used to calculate the current flow in a circuit when the voltage and resistance are known.

*Example:* How much current will flow through a 5 ohm resistor connected across a 6 volt battery?

*Answer:*

$$I = \frac{E}{R} = \frac{6}{5} = 1.2 \text{ amperes}$$

To say that current is equal to voltage divided by resistance is exactly the same as saying that resistance is equal to voltage divided by current. Ohm's Law therefore can be written also:

$$R = \frac{E}{I}$$

Written this way, the formula is useful for calculating resistance when voltage and current are known.

*Example:* The heater of a tube is rated at 6.3 volts, 0.3 ampere. What is the resistance of the heater?

*Answer:*

$$R = \frac{E}{I} = \frac{6.3}{0.3} = 21 \text{ ohms}$$

Since current is equal to voltage divided by resistance, then voltage must be equal to current times resistance. This may be written:

$$E = IR$$

*Example:* What amount of voltage must be applied in order to force 3 amperes of current through an 8 ohm resistor?

*Answer:*

$$E = IR$$

$$E = 3 \times 8$$

$$E = 24 \text{ volts}$$

Amperes, volts, and ohms are the basic units of current, voltage, and resistance, respectively. However, values are often specified in subdivisions or multiples of these units. As shown in the table, the

PREFIX	SYMBOL	EQUIVALENT
milli	m	1/1000
micro	$\mu$	1/1,000,000
kilo	K	1000
meg	M	1,000,000

prefix "milli" means 1/1000 of the basic unit. For example, 3 milliamperes is the same as 3 thousandths of an ampere. The prefix "micro" means 1/1,000,000. 12 microvolts is therefore equal to 12 millionths of a volt. The prefix "kilo" means 1000; 5 kilovolts therefore is equal to 5000 volts. The prefix "meg" means 1,000,000; consequently, 2 megohms means, 2,000,000 ohms. *Examples:* 16 milliamperes = 16 ma. = .016 ampere;

$$245 \text{ microvolts} = 245 \mu\text{v.} =$$

$$.000245 \text{ volts;}$$

$$2.7 \text{ kilohms} = 2.7 \text{ K} = 2700$$

$$\text{ohms;}$$

$$5 \text{ megohms} = 5 \text{ M} = 5,000,000 \text{ ohms.}$$

### QUIZ

1. What value of resistance will draw 0.25 ampere of current from the 110 volt power lines?  
a. 27.5 ohms; b. 440 ohms; c. 110 ohms.
2. A 50K resistor is connected across a 200-volt power supply. How much current flows through the resistor?  
a. 4 ma.; b. 0.25 ma.; c. 10 ma.
3. Calculate the voltage drop across a 40K resistor carrying 3 ma. of current.  
a. 13 volts; b. 75 volts; c. 120 volts.

4. 125 ma. is the same as:

a. .125  $\mu$ a.; b. .125 ampere; c. 125,000 amperes.

5. Which of the following values of resistance is largest?

a. 56K; b. .27M; c. 9100 ohms.

Answers to the quiz are given on page 128. A score of 5 correct is excellent, 4 correct is good, and 3 or less correct is poor.

### POPPING PILOTS

ALTHOUGH most commercial a.c.-d.c. radios can honestly plead "not guilty," many a.c.-d.c. kits now on the market for the home experimenter have the pernicious habit of burning out their pilot lights under certain circumstances. For instance, it is a certainty that the pilot light will flash and fuse if the receiver is turned off after operation and then turned on immediately afterward, before the tubes have a chance to cool.

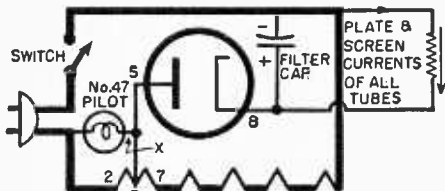

35Z5 50L6 12SA7 12SK7 12SQ7

The accompanying diagram is helpful in accounting for this. The heaters of all five tubes are wired in series as illustrated by the heavy black line with the pilot lamp, a type #47, connected across pins #2 and #3 of the 35Z5 (or pins #4 and #6 of a 35W4 if it is a set using miniature tubes). In addition, the plate of the rectifier obtains its a.c. through the pilot light so that all the plate and screen currents taken by the other tubes in the receiver must also flow through the pilot lamp. This hook-up provides brighter light from the tiny lamp during normal operation of the set and is favored by most manufacturers.

When the receiver has been running for a while, and everything is quite as it should be, opening the "on-off" switch will remove all power and the filter capacitor will rapidly discharge through the plate and screen paths offered by the converter, i.f. amplifier, and the audio amplifiers. If the power is quickly restored by closing the switch, the cathode of the rectifier begins to emit electrons at once since it has not had the time to cool below emission temperature. The filter capacitor now accepts a sudden large surge of current because, having been emptied previously as described, it is in the fully discharged state. This surge, and it may rise as

## BIG NEWS FOR BEGINNERS!

You can save on all your needs at Walter Ashe. See these typical bargains and use the handy order form below.

WEN "Quick-Hot" Soldering Gun. Working hot in 2½ seconds. Shpg. wt. 3 lbs. Model 199. Net \$5.83



WELLER "Junior" Soldering Gun. Over 100 watts. Shpg. wt. 3 lbs. Model 8100. Net \$5.83.



PLIER AND WRENCH SET in plastic case. Shpg. wt. 2 lbs. No. 4014. Net \$2.58.



MAGNETIZED SCREWDRIVER SET. Six tools with metal wall rack. Shpg. wt. 2 lbs. No. 3796. Net 75¢.



### Complete Amateur Station Kit

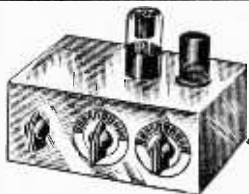

WAR-25 NOVICE RECEIVER KIT. Shpg. wt. 4 lbs. Net \$13.41.

WAP-25 NOVICE POWER SUPPLY KIT. Shpg. wt. 12 lbs. Net \$14.23.

WAT-25 NOVICE TRANSMITTER KIT. Shpg. wt. 4 lbs. Net \$17.31.

All prices f. o. b. St. Louis • Phone Chestnut 1-1125

Get Big New Free Catalog. The "treasure chest" of values. Mail coupon today.

Walter Ashe Radio Co., Dept. PE 1125 Pine St., St. Louis 1, Mo. PE-1-55

RUSH copy of new 1955 catalog.

Please ship following merchandise \_\_\_\_\_

for which is enclosed sum of \$ \_\_\_\_\_

Name \_\_\_\_\_

Address \_\_\_\_\_

City \_\_\_\_\_ Zone \_\_\_\_\_ State \_\_\_\_\_

Note: Include sufficient postage. We refund unused amount. 20% of total purchase required on C. O. D. order.

Walter Ashe RADIO CO.  
1125 PINE STREET • ST. LOUIS 1, MO.

## Perma-Power Radio Controlled Garage Door Opener



DOOR... modern garage doors are either one piece fill-up or sectional roll-up type up to 18' wide. The PERMA-POWER GARAGE DOOR OPENER will operate these doors when equipped with horizontal roller track and a 2 1/2" ceiling clearance is available.

**MOTOR MECHANISM**... Operating force is obtained from an electric motor (1/2 H.P., 117-Volts) coupled to the door through a driving arrangement. Limit switches included to stop door in fully open or fully closed position. In fully closed position, coupling provides self-latching. A quick disconnect device allows for manual door operation in case of power or unit failure. Mechanism includes a light which is on whenever door is open.

**PERMA-POWER REMOTE (PUSH BUTTON) CONTROL** installed in auto motor compartment is a one tube radio transmitter sending a 27.255 MC signal (authorized by F.C.C.) when push button is actuated. Installed with motor mechanism is two tube receiver which operates the motor. Signal from transmitter opens closed door or closes open door. Door may also be operated with a wall mounted switch.

Everyone can afford this modern convenient! It's really... one man can do it easily!  
 • Takes just an afternoon with common hand tools, no soldering.  
 • Complete instructions assure professional-type installation.

Available through recognized electronic parts suppliers  
**PERMA-POWER COMPANY 4722 N. DAMEN AVE CHICAGO 25, ILL.**  
 Manufacturers of electronic equipment since 1928

## Beginners ELECTRONIC KIT

For young and old  
35 EXPERIMENTS

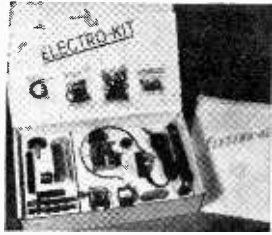

Complete, no extras to buy. Build 5 radios, audio amplifier and oscillator, electronic organ, 2 power supplies plus many others. Kit has duo-purpose tube, selenium rectifier, headphone, crystal, all necessary resistors, condensers, hardware, etc.

Only \$1 with order, pay postman \$8.95 plus charges or \$9.95 prepaid.

**ELECTRO KIT**  
 Box 3468 Dept. PE-2 Maplewood 17, Mo.

## Catalog of 3000 Novelties 10c



Send 10c for amazing catalog of novelties, live animals, scientific supplies, hobbies, funmakers, planes & boats, looms, magic tricks, joke articles, unusual seeds, gadget timesavers, cameras, optical goods, projectors, movies, lucky jewelry, religious novelties, disguises, musical instruments, stamps, coins, puzzles, fortune tellers, radios, auto & bike accessories, telescopes, magnifiers, compasses, banks, smokers' gadgets, artists' supplies, printing sets, engines, motors, shockers, knives, billfolds, fireworks, guns, rifles, sports, books, games, plants, etc. Send name, address & 10c to:

**JOHNSON SMITH & CO., Dept. 861, Detroit 7, Michigan**

## GET INTO ELECTRONICS

You can enter this uncrowded, interesting field. Defense expansion, new developments demand trained specialists. Study all phases radio & electronics theory and practice: TV; FM; broadcasting; servicing; aviation, marine, police radio. 18-month course. Graduates in demand by major companies. H.S. or equivalent required. Begin Jan., March, June, Sept. Campus life. Write for Catalog.

**VALPARAISO TECHNICAL INSTITUTE**  
 Dept. PE Valparaiso, Ind.

high as 200 or 300 ma., flows through the delicate filament of the pilot light and almost invariably burns it out. Part of the same surge flows through the portion of the rectifier heater between terminals #2 and #3, which is in parallel with the pilot lamp.

The pilot lamp can be protected by placing a resistor of from 30 to 50 ohms in series with it, at point X. Both the pilot lamp and the rectifier heater can be protected by placing a resistor in parallel with the pilot. The value of this resistor depends upon the total plate and screen current drawn from the rectifier by the other tubes in the receiver. For a total current of 90 ma., the resistor should be 100 ohms; for 80 ma., 150 ohms; for 70 ma., 300 ohms; for 60 ma. or less, no resistor. To limit the surge of current to the filter capacitor, some manufacturers use a resistor, usually from 22 to 33 ohms, between the rectifier tube cathode and the filter capacitor.

## STROBOSCOPES AND STROBOTRONS

**T**HE advent of the strobe tube as a light source for flash photography has taken some of the technical sting out of the scientific-sounding word, but has contributed somewhat to a confusion in terminology which did not previously exist.

When someone mentions a "strobe" he may be casually referring to any one of three things: (a) a high speed flash unit used for still or repetitive picture-taking; (b) a cardboard disc with alternate black and white radial bars designed to be placed on a phono turntable to measure or adjust the speed of rotation; or (c) an electronic device containing a special type of tube which can provide periodic, high-intensity light flashes of adjustable frequency, each flash being of extremely short duration.

This last interpretation is closer to the original meaning of "stroboscope" than either of the other two, for the word is derived from the Greek root "strobos," meaning "whirling"; the suffix "scope" means "a watcher", so that the whole word may be translated "a watcher for whirling."

Early in the century, perforated-disc stroboscopes were used to view machinery in motion as an aid in localizing mechanical strains and material defects. A stroboscope gives the illusion of arrested motion by allowing a vibrating or rotating object to complete most of its cycle in darkness, then illuminating it for the briefest instant each time it arrives at a particular point.

Ordinary incandescent lamps cannot be used satisfactorily as strobe sources because of their *thermal inertia*; the filament

cannot gain or lose heat quickly enough to provide the necessary sharp rise of illumination and equally sharp decline.

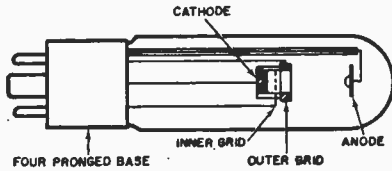

The strobtron is specifically designed for this action. When properly connected in a circuit containing a triggering element such as a thyatron relaxation oscillator or a multivibrator, it yields short light pulses of good enough intensity to be used in a rather brightly lit room. It is neon-filled and has an inner grid, an outer grid, a cathode, and an anode. When excitation is applied, it emits intense red light whose repetition rate is made controllable, so that it may be synchronized with the movement to be "stopped."

### VR TUBE JUMPERS

**P**RACTICALLY all voltage regulator tubes (VR tubes) have an internal jumper wire connecting two of the pins. What is the purpose of this particular jumper?

To answer this question, we should recall how a voltage regulator tube works.

A VR tube is used to regulate the voltage across a load, so that this voltage remains constant in spite of current drain or line voltage variations. If the voltage across the load (and the VR tube) increases slightly above the rated value, the VR tube will draw much more current through a series resistor, thus lowering the voltage. If the voltage decreases slightly, the VR tube will draw much less current.

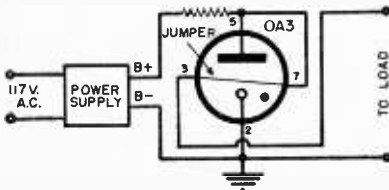

If the VR tube is pulled out of its socket while the power is on, the voltage across the load will rise above the regulated value. This increase of voltage may break down capacitors, overheat resistors, or cause other damage, depending upon the load. However, if the internal jumper in the tube is wired in series with the load, removal of the tube will open the load circuit and prevent damage. An arrangement of this type is illustrated in the diagram directly above. END

# BUILD 15 RADIOS

AT HOME

ONLY

With the New Improved 1955 Progressive Radio "EDU-KIT"

**\$19.95**

NOW INCLUDES

HIGH FIDELITY, SIGNAL TRACER, CODE OSCILLATOR

Complete

- Attractively Gift Packed
- Free Soldering Iron
- Absolutely No Knowledge of Radio Necessary
- No Additional Parts Needed
- Excellent Background For Television
- 10-Day Money-Back Guarantee
- School Inquiries Invited
- Sold in 79 Countries



## WHAT THE PROGRESSIVE RADIO "EDU-KIT" OFFERS YOU

The "Edu-Kit" offers you a Home Radio Technician Course at a rock-bottom price. You will learn how to identify Radio Symbols and Diagrams; how to build radios, using regular radio schematics; how to wire and solder in a professional manner. You will learn how to operate Receivers, Transmitters, and Audio Amplifiers. You will learn how to service and trouble-shoot radios. You will learn code. You will receive training for F.C.C. license. In brief, you will receive a practical basic education in Radio, worth many times the small price you pay.

### THE KIT FOR EVERYONE

It is not necessary that you have even the slightest background in science or radio. The "Edu-Kit" is used by young and old; by radio schools and clubs; by Armed Forces personnel and Veterans for training and rehabilitation. No instructor is required. Instructions are complete, simple and clear. You cannot make a mistake.

### PROGRESSIVE TEACHING METHOD

The "Edu-Kit" uses the principle of "Learn by Doing". Therefore you will build radios, perform jobs, and conduct experiments to illustrate the principles which you learn. You begin by learning the function and theory of each of the radio parts. Then you build a simple radio. Gradually, in a progressive manner, you will find yourself constructing more advanced multi-tube radio sets, and doing work like a professional Radio Technician. The "Edu-Kit" Instruction Books are exceedingly clear in their explanations, photographs and diagrams. These sets operate on 105-125 V. AC/DC. Adapter for 210-250 V. AC/DC available.

### The Progressive Radio "EDU-KIT" Is Complete

You will receive every part necessary to build fifteen different radio sets. Our kits contain tubes, tube sockets, chassis, variable condensers, electrolytic condensers, mica condensers, paper condensers, resistors, line cords, selenium rectifiers, tie strips, coils, hardware, tubing, Instruction Manuals, etc. A soldering iron is included, as well as an Electrical and Radio Tester. Complete, easy-to-follow instructions are provided. All parts are guaranteed, brand new, carefully selected and matched. In addition, the "Edu-Kit" now contains lessons for servicing with the Progressive Signal Tracer, High Fidelity, F.C.C. instructions, quizzes. The "Edu-Kit" is a complete radio course down to the smallest detail.

### TROUBLE-SHOOTING LESSONS

Trouble-shooting and servicing are included. You will be taught to recognize and repair troubles. You will build and learn to operate a professional Signal Tracer. You receive an Electrical and Radio Tester, and learn to use it for radio repairs. While you are learning in this practical way, you will be able to do many a repair job for your neighbors and friends and charge fees which will far exceed the cost of the "Edu-Kit." Our Consultation Service will help you with any technical problems which you may have.

### FREE EXTRAS

• Electric-Radio Tester • Soldering Iron • TV Book • Radio Trouble-Shooting Guide • Consultation Service • Quizzes • F.C.C. Training.  
**PROGRESSIVE "EDU-KITS" INC., 497 Union Ave., Brooklyn 11, N.Y.**  
**MAIL TODAY—Order shipped same day received.**  
**10-Day Money-Back Guarantee. INCLUDE ALL FREE EXTRAS.**

- RUSH ME the Following—Include all Free Extras:
- "EDU-KIT" Postpaid. I enclose full payment of \$19.95
  - "EDU-KIT" COD—I will pay \$19.95 plus postage
  - Outside USA: "Edu-Kit" Postpaid. Enclose full payment \$20.95
  - Outside USA: 210-250V. AC/DC Adapter. Enclose \$2.50
  - More details on "EDU-KIT" Free—No Obligation
  - FREE Radio-TV Servicing Literature. No Obligation

NAME \_\_\_\_\_

ADDRESS \_\_\_\_\_

**PROGRESSIVE "EDU-KITS" INC.**  
 497 Union Ave. Dept. PE-504 Brooklyn 11, N. Y.

## Rumble

(Continued from page 64)

motors used in phonograph changers and turntables have a speed of 1800 revolutions per minute, and dividing the 1800 rpm by 60 (seconds in a minute), and you have . . . 30 cycles per second. Taking advantage of this almost constant rumble frequency, a high-pass filter has been devised which "cuts off" sharply at the 30-cycle point, thereby eliminating your rumble. The high-pass filter is a network of resistors, capacitors, and inductors and if you are good enough on the technical side to do some of your own construction, you can build an excellent unit from circuits and descriptions which appeared in the September 1954 issue of RADIO & TELEVISION News. Rumble filters of similar type are now incorporated in the circuitry of some of the better preamplifiers.

If you have decided to invest in a turntable, there are "do's and don'ts" you should know about mounting the unit for minimum rumble. Never use a motorboard less than 3/4-inch thick, and always use plywood. Don't attempt to cushion with rubber or shock mounts, either the turntable mounting plate or the motorboard. Have the motorboard fit into a rigid frame and screw down the board as tightly as possible. Do use some sort of sheet rubber cushioning under the base of the arm you are using.

There are a few other things you can do to keep rumble out of your musical life. One is to buy a turntable with a special (and expensive) type of motor known as a "hysteresis synchronous," which is just a two-dollar word for a unit that is super quiet and will run at a constant speed re-

gardless of your power line current fluctuations. Now whether you own one of these fancy "hysteresis" turntables or the ordinary 4-pole induction type, there is a method of mounting that will give you the absolute minimum of rumble; but I warn you, you've got to be ambitious to undertake this project. For your mounting "board," you will use *steel boiler plate* at least 1/2 and preferably 3/4-inch thick! It will be necessary to have an acetylene torch to cut out a hole in the plate to accept the turntable motor. Holes must also be drilled so that the turntable motor plate can be securely *bolted* to the boiler plate. Of course, you will also have to drill holes for whatever arm you are going to use. The boiler plate assembly must be supported by a very strong, rigid frame. If the boiler plate fits tightly enough in its frame it is not necessary to bolt frame and plate together. Marble slabs have also been used for this purpose, but are even more difficult to work with than the boiler plate due to their fragility.

The reason for all this hard work is that the mass (weight) of the boiler plate is so great that rumble is, for all practical purposes, eliminated. In one of the newer turntables just now reaching the market, this principle of great mass is applied to the turntable itself which weighs 25 lbs. This heavy turntable is driven by an extremely flexible belt operating from an isolated motor which is completely shock mounted with *Lord* type mounts. Still another new unit uses a unique drive with nylon and stainless steel spur gears running in an oil bath transmission case. The space where an arm would mount is independently sprung apart from the main motor plate. The combinations of mass and mechanical decoupling in these new turntables result in units with extremely low rumble. In fact, and this may really surprise you, these new units are so quiet, it is sometimes possible to hear the rumble inherent in the recording itself!

Here are a few more hints about rumble before going back to the disc review section. Keep your turntable, mounting plate, frame . . . everything as *level* as possible. Use a small spirit level to check this when you are building your units. Be careful when buying records not to get stuck with a "swinger," which is a record with an off-center spindle hole. This can cause a lot of rumble trouble; you can check for this condition by observing the pickup arm on the record while the record is revolving. If there is a pronounced lateral "swing" of the arm from the edge to the center of the record, it's off-center and should not be purchased.

END

**ONLY \$4.95**  
Ppd.  
or C. O. D.  
+ Charge



**THE NEW TV DYNATRACER**

- TRACES TV SIGNALS AND VOLTAGES
- LOCATES DEFECTIVE COMPONENTS
- REQUIRES NO ADDITIONAL EQUIPMENT

This sensationally new piece of test equipment is ideal for trouble-shooting television sets in the home or in the shop. The "DYNATRACER" will out-perform more expensive testers and should pay for itself on the very first repair.

**A Must for Every TV Technician**

**SPECIFICATIONS:** The "DYNATRACER" is a self-powered quality test instrument designed to trace TV signals through any Video, Sound, Sync, AFC, Horizontal or Vertical Sweep Circuit — will isolate trouble to a stage or component.

**ADDED FEATURE:** The "DYNATRACER" will also trace voltages (50/500 V. AC/DC) and instantly locate open, shorted, intermittent or leaky (up to 20 MEGOHMS) condensers, resistors, coils, XFormers, etc.

Instruction and Trouble-Shooting Book Enclosed  
**10 DAY MONEY-BACK GUARANTEE**

**FREE** For prompt action we will include a unique TV HIGH VOLTAGE INDICATOR very useful in your testing work.

Cut out advertisement . . . attach name and address with \$5.00 bill, check or money order and mail to

**Century ELECTRONICS CO.**

211-04 99th Ave., Dept. 604, Queens Village 29, N. Y.



## Disc Review

(Continued from page 65)

chestra on *Columbia* ML4888, and the Dobrowen-Philharmonia Orchestra on *Angel* 35009. I should warn you that there is an old Dorati recording on the *Victor* label, and an old Ormandy disc on *Columbia* (ML4089) which should not be confused with the above recordings. The Dorati version has the most brilliant sound with very clean strings, extra bright brass and some really solid percussion. The Stokowski is also a bright recording, but lacks a little punch in the percussion. The Ormandy disc is very clean in all departments, and has the best orchestra, the Philadelphia. The Dobrowen recording on *Angel* is typical of still another kind of hi-fi sound. This is the more delicate, luminous and finely wrought sort of sound. Not too spectacular, but smooth and wide range just the same. The Dorati version is usually considered the best performance, along with a *Victor* disc of Pierre Monteux and the San Francisco Symphony whose sound is unfortunately not up to snuff.

Perhaps you have been told that modern music is just a bunch of noise and very difficult to listen to. This is definitely not true. While there are many scores which are hard to digest at first hearing, there are many modern works which are most "listenable" and altogether pleasant. One of these will be reviewed for our "Modern" section, the great "Firebird Suite" of Stravinsky. This is music that has color and excitement and some very melodic and beautiful moments. With only eight versions, the matter of choice here is somewhat easier. The outstanding recordings of the work are the Ansermet-Suisse Romande Orchestra on *London* LL889, the Ormandy-Philadelphia Orchestra on *Columbia* ML4700, and the Dorati-Minneapolis Symphony on *Mercury* MG 50004. Once again Dorati takes the honors for sound with some overwhelming brass sounds and tremendous crashing percussion. The Ansermet recording has the virtue of an exceptional balance and superb woodwinds, and the Ormandy is generally clean with the best string tone of any of the three recordings and some huge bell sounds. Performance wise the palm usually goes to Ansermet, who is well known for his interpretations of Stravinsky. There is a good performance by Stravinsky himself on *Columbia* ML4882, but again the sound is not up to the latest standards. In fact this disc is a transfer from an old 78 rpm, and has been around for years.

Well there you have a start on your library. All the recordings listed will give you good sound with varying degrees of quality. One thing you might take into consideration, is what is on the reverse of the disc. Listen to all of these versions and then make your choice between the sound you like best and the work which you like on the reverse of the disc. One last point. A diamond is the perfect material for a stylus or needle. It is the poorest of economy to use osmium or sapphire tipped needles on records. The wear is so fast on these materials, you are soon in danger of ruining your precious recordings. Even if you have to scrimp somewhere else when you buy your hi-fi system, invest and be safe with a diamond! It will cost you more originally but in the long run you will be money ahead.

END

January, 1955

# PASS HAM EXAMS! LEARN CODE and Theory



\$3.95  
up

EASY,  
FAST HOME STUDY

WITH 78 RPM PHONOGRAPH RECORDS  
PASS COMMERCIAL AND AMATEUR  
CODE EXAMS, AMATEUR THEORY  
EXAMS, FOR YOUR FCC LICENSE!

3 AMECO Courses Available:

No. 1—NOVICE CODE COURSE for novice & technician code exams. You get and keep 10 recordings (alphabet through 8 W.P.M.). Includes typical FCC type code exams. Free instruction book on learning how to send and receive code the simplest, fastest way; plus charts to check your receiving accuracy; plus an album; all for the low price of only \$7.95  
No. 2—SENIOR CODE COURSE for all amateur & commercial exams. You get and keep everything given in the Novice Course except that you get 22 recordings (alphabet through 18 W.P.M.), plus typical FCC type code exams for General class and 2nd class commercial telegraph licenses. All this for only \$12.95  
No. 3—COMPLETE RADIO THEORY COURSE. A complete, simplified home study theory course in radio covering the Novice, Technician, conditional and general classes—all under one cover—with nearly four hundred typical FCC type questions to prepare you for license exam. No technical background required. You also get, FREE, a guide to setting up your own Ham station. ALL FOR THE AMAZING, NEW LOW PRICE OF ONLY \$3.95

No. 5—RADIO AMATEUR QUESTION & ANSWER LICENSE GUIDE. A "must" if preparing for Novice, Technician or general class exams. Approx. 200 questions & answers, (most multiple choice type) similar to ones given on F.C.C. exams. Has 2 typical F.C.C. type exams. Other questions by subjects, easier to study. 50c  
At the Low, low price of only \$3.95

FREE LITERATURE AVAILABLE.  
At leading distributors everywhere  
or from Dept. PE2

## AMERICAN ELECTRONICS CO.

1203 Bryant Ave., New York 59, N.Y.



## ITALIAN ACCORDIONS AT LOWEST WHOLESALE PRICES

5-DAY  
FREE  
TRIAL

"PAY AS  
YOU PLAY"

Small Down Payment  
As Little As  
**\$10** per  
month

DIRECT from  
Importer to You!

SATISFACTION GUARANTEED, or your money back! NOW you can save up to 50% by direct purchase from America's leading distributor of famous genuine ITALIAN ACCORDIONS. Trade-Ins Accepted.

Send for FREE Illustrated Catalog!

ACCORDION MANUFACTURERS & WHOLESALE OUTLET  
2003 West Chicago Ave. Dept. PE-15, Chicago 22, Ill.

## ADDRESS POSTCARDS AT HOME!!

write B.I.C. 143 Belmont St., Belmont, Mass.

## Carl & Jerry

(Continued from page 54)

the basement door, slamming it shut behind him. It was so dark in the back yard that he stumbled into Carl before he was able to make out the yellow-coated figure of his friend standing there in the cold drizzle expectantly pointing the open mouth of the loudspeaker straight up into the tree branches overhead.

For what seemed an interminably long time, nothing at all was heard from the speaker; but then a beginning murmur of sound quickly swelled into a screaming roar. Just as a photographic enlargement of some small, familiar object converts it into a grotesque, unrecognizable thing, so did the great amplification of the starling's screeching change the sound into a hoarse, brazen noise totally unlike anything either of the awestruck boys had ever heard before. The thought flitted through Jerry's mind that a dinosaur in his death throes must have made a sound like this. Porch lights flashed on up and down the street, and shafts of light streamed across back yards as rear doors were thrown open.

"Shut it off! Quick!" Carl screamed directly into Jerry's ear.

Released from his trance by this suggestion, Jerry turned and in a stumbling run clattered down the basement steps and threw his weight against the door. It did not budge. The night latch on the inside had locked itself. Hesitating only a minute, Jerry bounded back up the steps with a vigor most unusual to his leisure-loving nature and ran around to the front of the house, through the front door, down the hall, down the basement steps, and into his laboratory. He made a flying leap across the room, and his clawing fingers switched off the tape recorder.

Instantly the bellowing stopped, only to be followed by shouting and the sound of running feet going past the basement windows. Jerry turned off the basement light and stood there panting in the darkness for a few seconds until he could regain his breath; then he very quietly opened the outside basement door and tiptoed up the steps.

The back yard was no longer in darkness. Carl was sitting squarely in the center of a blinding circle of light cast by the spotlight of a police squadcar parked in the alley; and two policemen, who seemed unnecessarily large, were getting out of the car. Neighbors carrying flashlights were flitting around like fireflies.

"All right, all right," one of the policemen said, "which one of you called in that

report about a dog being run over in this alley?"

"Yeah," his fellow officer chimed in, "and which one reported there was a panther ten feet long slinking up and down and screaming its head off back here? Was it you?" he demanded of Carl.

"No sir," Carl promptly replied. "I heard an awful noise, but I didn't see a panther or hear any dog."

For a few minutes the policemen questioned the neighbors without getting any two of them to agree on what the noise sounded like. Then they flashed the spotlight all around, peered into a few garages and basement entrances, and finally decided the whole thing was a false alarm.

"Probably some guy with a stuck automobile horn caused all this hullabaloo," one of them remarked as he got back into the squadcar. "Sonny, you had better get into the house out of this drizzle," he advised Carl as they started to drive away.

"Yes sir," Carl said meekly without moving.

Jerry sidled out to Carl and asked out of the corner of his mouth, "Where the heck is the speaker?"

"What do you think I'm sitting on?" Carl demanded in a hoarse whisper as he spread out the tail of his overcoat a little more. "I was scared to death they'd trip over the cord, but they never even saw it."

In a few minutes the neighbors drifted away, and the boys got the speaker back inside the basement.

"We'll not try that again," Jerry said emphatically; "and the heck of it is I was too excited to notice if we scared any starlings or not."

"I wasn't," Carl answered. "While the cops were playing their spotlight and flashlights around, I kept looking up in the tree. The birds did take off at first, but they just made a little circle and came right back as soon as the noise stopped."

"Those Penn State starlings must be a timid, cowardly crew totally unrelated to Old Scissorbill and his hardboiled chums," Jerry offered.

"Nope," Carl demurred, "I still think that pint-sized eagle crossed us up. During that hour or so while you were leisurely shutting off the recorder, I had to listen to that racket coming right up in my face, and I'll swear that what Old Scissorbill was yelling didn't sound like 'Take to the hills!' at all; instead, it sounded more like, 'Hey, Rube! Come and help me take 'em!'"

"Well," Jerry remarked as he prepared to turn out the lights, "I guess Electronic Experimenters, Ltd., will have to chalk this up as a howling failure—but it had its moments!"

END

## The Hi-Fi Hobby

(Continued from page 17)

your list of components is likely to remain constant for a long period of time it is probably most desirable to concentrate on the amplifier and its associated controls. Here is the device where you may have facilities in the form of controls that will allow you to compensate, in many instances, for faults in your other equipment, as well as for the characteristics of specific recordings, or radio broadcasts. This is also the place where you can save a maximum of money and learn the most in designing and constructing a home music system. A number of kits are available for the construction of amplifiers and the instructions included are so clear and simple that practically anyone willing to invest a little patience and effort can produce excellent results. Later, if your interest grows, you may wish to build more elaborate amplifiers from the many different circuits available in the literature and perhaps even do a little experimenting on your own. Very little is required in the way of tools and the final test of all such equipment is your own ear. If you wish to verify your end results it is likely that some friend or local repair shop will have equipment with which to make various simple and basic tests. Such tests may serve to reassure you about the outcome of your efforts or even indicate some fault that can be readily corrected when it is made apparent.

In any case you will be entering a hobby that has unlimited facets of interest, and endless possibilities for expansion. It may seem as though the problems of making compromises have been over-emphasized in this article and that it should be possible simply to start out with a fully satisfactory system and devote all of the future time to enjoying the music. There are many reasons why this is not usually a practical approach, one of which is financial. Of more real interest and importance is the fact that as you build your system, listen to it, modify it, change its components and improve it in the direction of perfection, your own ideas of perfection will change. A compromise that seems ideal to you at first will seem entirely wrong later on. Your entire family will participate in the improved appreciation of the world of sound that will come with continued listening. This is not only true because you will be improving the quality of the material to which they listen but because the ability to listen with discrimination improves with the education that comes from critical interest in the quality of music reproduction. END

January, 1955

## GET THIS NEW SPRAGUE T-C RULE



Save time . . . avoid mistakes . . . in finding the values of stock N750 and NPO type ceramic capacitors to connect in parallel to equal a capacitor of desired intermediate temperature coefficient of the required capacitance. Just slide this handy, pocket-size rule to the proper values and you'll come up with the right answer quick as a wink every time. On back are complete color codes on all types of ceramic capacitors. Ask your Sprague Distributor for one, or write to Sprague Products Co. 395 Marshall Street, North Adams, Mass. It's only 15c.

**SPRAGUE PRODUCTS COMPANY**

Distributors' Division of the Sprague Electric Co.  
NORTH ADAMS, MASS.

## LEARN ELECTRICAL APPLIANCE

**START YOUR Repairing & Installation  
OWN BUSINESS** Revolutionary NEW TRAINING METHOD, trains you AT HOME . . . in just a few short weeks!

You receive big "ON-THE-JOB" home training kits, test equipment, audio instructions and practical service training lessons. You learn how to Service, Repair and Install all types of ELECTRICAL Appliances and Equipment. How to build and operate your own business, etc.

**You EARN As You Learn**

You charge on basis of \$3.00 to \$5.00 per hour for spare time work! Write now for your Free Book, full details about this amazing opportunity for you in modern Electric Servicing.

**Big Book  
FREE!**

**ADVANCE TRAINING** 5944 NORTH NEWARK AVENUE  
Dept. 751, CHICAGO 31, ILL.

## DELUXE POCKET RADIO



Owners report up to 1500 miles reception. New 1955 electron tube model covers 540-1600 KC. No antenna required for local reception. Assemble kit easily in 1 hour. Batteries, all parts, fit in case. Low price of kit includes tube. (Set, factory wired, \$8.95). Long life batteries \$1.15 per set. Radio headphone \$1.69. High imp. hearing aid earset \$4.95 or use your headphone. All parts FULLY GUARANTEED. Send check or money order for full amount, save C.O.D. fees. If C.O.D., \$1 deposit required.

**\$3.99**  
Post  
Paid

**WESTERN RADIO CO., Box 1526, Sacramento, Calif.**

## ELECTRONICS FOR EXPERIMENTERS

Rectifiers @ 29c ea. Transformers @ \$1.50 ea.  
Controls @ 29c ea. Bulbs @ 2c ea.  
Switches @ 6c ea. Motors @ \$1.79 ea.  
Automatic Steppers @ \$1.75 ea.

Send 10c for giant 16 page catalog listing hundreds of surplus bargains for experimenters.

**SOUNDTRONICS LABS** Dept. P.E.

632 Arch Street

Philadelphia 6, Pa.

## It's All On Tape

(Continued from page 25)

above the din of the chiding Cubs in the audience.

Our friend, Robert Cowen, a Cleveland industrialist, tells of the time, effort, and money that he expended while trying to record a wolf call on tape at his Canadian lodge. Bob had made a moving picture and needed the wolf call for the accompanying sound track. It cost a pretty penny to finally obtain the call. Returning to Cleveland, Bob found that there was a record made of authentic wolf calls which cost two dollars. This easily could have been transcribed to the movie's sound track directly.

Communication across the country or half way around the globe has become a commonplace method by tape through various tape recording groups. One group, which calls itself the Voicesspondence Club boasts of a membership of 600 in various parts of the world. It is composed of people from many walks of life who exchange tapes regularly. The tapes cover many phases and subjects. Its members include teachers, firemen, business executives, artists, writers, professors, students, farmers, truck drivers, policemen, bankers, and grocerymen. One member is a blind man from New England who receives tapes describing the beauties of Southern nature from a native musician. One Chicago housewife exchanges her recipes with an English homemaker. A minister communicates with his family in Norway. Each year at holidaytime, all of his brothers and sisters congregate at the home of his parents in Oslo and record as much as four hours of conversation on tape. The minister says, "I can hear the old clock on the wall and the old pump organ, all of the children. . . . It's like being there myself."

Tape recording has also proved itself a valuable timesaver. To assist busy doctors, the American Medical Association has released tapes already recorded with the newest developments from the medical journal. Our doctor tells us one of his colleagues has a tape recording machine installed in his car. While making his daily calls, he turns the switch of the recorder and the playing tape keeps him well informed.

If you do not own a recording machine, but are intending to invest in one, there are many excellent makes on the market. A few tips may be heeded before you make your final decision. Do not make a purchase before listening to and operating a number of them. Simple operation will help you to avoid many errors. Buy the

machine which will serve your purpose to the best advantage. If you intend to record music, choose a machine with good high frequency response. Better response is usually available on recorders with more than one speed. A one-speed recorder is most satisfactory for recording voices, taking dictation, interviewing, and in recording family fun. (The speed of a recording machine indicates the number of inches-per-second that your tape will travel.) The  $3\frac{1}{4}$  inches-per-second (i.p.s.) machines have an average frequency response from 90 to 6000 cycles, and are useful for ordinary singing, all speaking, pop music, office work, etc. The  $7\frac{1}{2}$  i.p.s. recorders cover wider frequency ranges and form the majority of medium priced machines used in the home and for auditorium applications. Finally there are the 15 i.p.s. recorders used for professional purposes in studios, etc., as well as by those who want, and can pay for, the ultimate in high fidelity.

When I checked with the dealer from whom I purchased my recorder, he said that a tape recording machine will cost from \$100 to \$350 depending on its fidelity and quality. The higher fidelity recorders are the higher priced machines. The tape which you will use is made of durable plastic. It can be used a number of times. The length of maximum recording time will run from one to four hours, again depending upon the machine. The erasing is clean and leaves no sound on subsequent tapings. Take into consideration the weight of the machine you intend to buy. Weight varies from 15 to 35 pounds. If you plan to carry the recorder with any regularity, choose one of the lighter models. (Many is the time I have wished my recorder weighed less than its 22 pounds.) If your recorder is to be a fairly permanent fixture in your home, it is wise to discount the weight, as a heavier motor pays dividends in fidelity.

Operation of the tape recorder is fairly simple. Anyone who can read directions and follow them should have no difficulty in turning out fine tapes. You will find some of the higher priced recorders have push-button controls, while most of them are operated by turn knobs, indicating "Record," "Play," "Reverse," and "Forward." Your microphone will be included with your recorder. When buying a tape recorder, remember the old principle and, "If you don't know your recording machines, be sure you know your dealer."

You will find, as we have, that there are many new and important vistas to conquer with a tape recorder. For years to come, you, too, will be able to enjoy and recapture those happy times which it would be impossible to re-live through any other home media.

END

# STANDARDIZED WIRING DIAGRAM SYMBOLS

<p style="text-align: center;"><b>ANTENNAS</b></p> <div style="display: flex; justify-content: space-around;"> <div style="text-align: center;"> GENERAL</div> <div style="text-align: center;"> DIPOLE</div> <div style="text-align: center;"> LOOP</div> <div style="text-align: center;"> FERRITE TYPE</div> </div>	<p style="text-align: center;"><b>MICROPHONE</b></p> <div style="display: flex; justify-content: space-around;"> <div style="text-align: center;"> SINGLE BUTTON</div> <div style="text-align: center;"> DOUBLE BUTTON</div> <div style="text-align: center;"> CAPACITOR</div> </div> <div style="display: flex; justify-content: space-around; margin-top: 10px;"> <div style="text-align: center;"> DYNAMIC</div> <div style="text-align: center;"> VELOCITY</div> <div style="text-align: center;"> CRYSTAL</div> </div>	<p style="text-align: center;"><b>TELEGRAPH KEY</b></p> <div style="text-align: center;"></div>
<p style="text-align: center;"><b>BATTERIES</b></p> <div style="display: flex; justify-content: space-around;"> <div style="text-align: center;"> SINGLE-CELL</div> <div style="text-align: center;"> MULTI-CELL</div> </div>	<p style="text-align: center;"><b>NEON BULB</b></p> <div style="text-align: center;"></div>	<p style="text-align: center;"><b>PILOT LIGHT</b></p> <div style="text-align: center;"></div>
<p style="text-align: center;"><b>BELL</b></p> <div style="text-align: center;"></div>	<p style="text-align: center;"><b>TRANSFORMERS</b></p> <div style="display: flex; justify-content: space-around;"> <div style="text-align: center;"> AIR CORE</div> <div style="text-align: center;"> IRON CORE</div> <div style="text-align: center;"> AIR CORE VARIABLE</div> </div> <div style="display: flex; justify-content: space-around; margin-top: 10px;"> <div style="text-align: center;"> IRON CORE VARIABLE</div> <div style="text-align: center;"> POWDERED IRON CORE</div> <div style="text-align: center;"> AUTO</div> </div>	
<p style="text-align: center;"><b>CAPACITORS</b></p> <div style="display: flex; justify-content: space-around;"> <div style="text-align: center;"> FIXED MICA OR PAPER</div> <div style="text-align: center;"> ELECTROLYTIC</div> <div style="text-align: center;"> VARIABLE CAPACITORS GANDED</div> </div> <div style="display: flex; justify-content: space-around; margin-top: 10px;"> <div style="text-align: center;"> TRIMMER OR PADDER</div> <div style="text-align: center;"> SPLIT-STATOR</div> <div style="text-align: center;"> FEED-THRU</div> </div> <p style="text-align: center; font-size: small;">T-DESIGNATES TRIMMER OR PADDER</p>	<p style="text-align: center;"><b>PHONO PICKUPS</b></p> <div style="display: flex; justify-content: space-around;"> <div style="text-align: center;"> CRYSTAL</div> <div style="text-align: center;"> MAGNETIC</div> </div>	<p style="text-align: center;"><b>PLUG OR SOCKET</b></p> <div style="text-align: center;"></div>
<p style="text-align: center;"><b>COILS</b></p> <div style="display: flex; justify-content: space-around;"> <div style="text-align: center;"> FIXED R.F. COIL</div> <div style="text-align: center;"> COIL WITH FIXED TAP</div> <div style="text-align: center;"> COIL WITH VARIABLE TAP</div> </div> <div style="display: flex; justify-content: space-around; margin-top: 10px;"> <div style="text-align: center;"> IRON CORE OR CHOKE</div> <div style="text-align: center;"> BIFILAR</div> <div style="text-align: center;"> VARIABLE COIL OR CHOKE</div> </div> <div style="text-align: center;"> SLUG-TUNED COIL</div>	<p style="text-align: center;"><b>RECEPTACLE 117 V.</b></p> <div style="text-align: center;"></div>	<p style="text-align: center;"><b>RECORDING HEAD</b></p> <div style="text-align: center;"> MAGNETIC</div>
<p style="text-align: center;"><b>RECTIFIER</b></p> <div style="text-align: center;"> SELENIUM TYPE</div>	<p style="text-align: center;"><b>RELAYS</b></p> <div style="display: flex; justify-content: space-around;"> <div style="text-align: center;"> S.P.S.T. NORMALLY OPEN</div> <div style="text-align: center;"> S.P.S.T. NORMALLY CLOSED</div> <div style="text-align: center;"> S.P.D.T.</div> </div>	
<p style="text-align: center;"><b>CRYSTALS</b></p> <div style="display: flex; justify-content: space-around;"> <div style="text-align: center;"> CRYSTAL DETECTOR</div> <div style="text-align: center;"> PIEZOELECTRIC CRYSTAL</div> </div>	<p style="text-align: center;"><b>RESISTORS</b></p> <div style="display: flex; justify-content: space-around;"> <div style="text-align: center;"> GENERAL</div> <div style="text-align: center;"> TAPPED OR ADJUSTABLE</div> </div> <div style="display: flex; justify-content: space-around; margin-top: 10px;"> <div style="text-align: center;"> POTENTIOMETER OR RHEOSTAT</div> <div style="text-align: center;"> CONTINUOUSLY VARIABLE</div> </div>	
<p style="text-align: center;"><b>FUSE</b></p> <div style="text-align: center;"></div>	<p style="text-align: center;"><b>SHIELDING</b></p> <div style="text-align: center;"> DOTTED LINES INDI- CATE SHIELDING. COULD BE AROUND ANY COMPONENT OR GROUPS</div>	
<p style="text-align: center;"><b>HEADPHONES</b></p> <div style="display: flex; justify-content: space-around;"> <div style="text-align: center;"> DOUBLE</div> <div style="text-align: center;"> SINGLE</div> </div>	<p style="text-align: center;"><b>SPEAKERS</b></p> <div style="display: flex; justify-content: space-around;"> <div style="text-align: center;"> P.M.</div> <div style="text-align: center;"> ELECTRO- MAGNETIC</div> </div>	
<p style="text-align: center;"><b>JACKS</b></p> <div style="display: flex; justify-content: space-around;"> <div style="text-align: center;"> OPEN CIRCUIT</div> <div style="text-align: center;"> CLOSED CIRCUIT</div> </div> <div style="display: flex; justify-content: space-around; margin-top: 10px;"> <div style="text-align: center;"> 2 CIRCUIT</div> <div style="text-align: center;"> SHORTING TYPE 2 CIRCUIT</div> </div> <div style="display: flex; justify-content: space-around; margin-top: 10px;"> <div style="text-align: center;"> PHONE PLUG</div> <div style="text-align: center;"> PIN PLUG</div> <div style="text-align: center;"> PIN JACK</div> </div>	<p style="text-align: center;"><b>SWITCHES</b></p> <div style="display: flex; justify-content: space-around;"> <div style="text-align: center;"> S.P.S.T.</div> <div style="text-align: center;"> S.P.D.T.</div> <div style="text-align: center;"> PUSH- BUTTON</div> </div> <div style="display: flex; justify-content: space-around; margin-top: 10px;"> <div style="text-align: center;"> D.P.S.T.</div> <div style="text-align: center;"> D.P.D.T.</div> </div> <p style="text-align: center; font-size: small;">BOTH TYPES GANGED</p>	
<p style="text-align: center;"><b>METER</b></p> <div style="text-align: center;"></div>	<p style="text-align: center;"><b>TRANSISTOR (JUNCTION)</b></p> <div style="text-align: center;"> BASE COLLECTOR EMITTER P-N-P TYPE N-P-N TYPE SAME SYMBOL EXCEPT ARROW IS REVERSED</div>	
<p style="text-align: center;"><b>MOTOR</b></p> <div style="text-align: center;"></div>	<p style="text-align: center;"><b>ROTARY TYPE S.P.6.P.</b></p> <div style="text-align: center;"></div>	<p style="text-align: center;"><b>WAFER</b></p> <div style="text-align: center;"></div>
<p style="text-align: center;"><b>VIBRATOR</b></p> <div style="text-align: center;"></div>	<p style="text-align: center;"><b>WIRES</b></p> <div style="display: flex; justify-content: space-around;"> <div style="text-align: center;"> CONNECTION</div> <div style="text-align: center;"> NO CONNECTION</div> </div>	

# GLOSSARY

**a.f.c.**—Automatic frequency control: (1) control of the frequency of the local oscillator in a superheterodyne to keep the receiver in tune with a desired station; (2) control of the frequency of the horizontal oscillator in a television receiver to keep the horizontal deflection in step with the horizontal deflection at the television studio and thus to keep the picture steady horizontally.

**a.g.c.**—Automatic gain control, control of the amplification of an amplifier so that its output is approximately constant in spite of variations in the input signal; especially such control in television receivers to reduce variations in picture contrast produced by variations in r.f. signal strength.

**a.v.c.**—Automatic volume control (a.g.c. used in radio receivers to reduce variations in sound volume produced by variations in r.f. signal strength).

**choke**—An inductance used especially to present a high impedance to a wide range of frequencies. Filter chokes are used in rectifier-type power supplies to remove from the d.c. output hum components equal to the power line frequency and its harmonics; audio-frequency chokes are used in audio amplifiers and radio-frequency chokes are used in r.f. and i.f. amplifiers, to present a high impedance load to a vacuum tube or to block unwanted signals.

**crystal**—1. Rectifying crystal, one which passes electric current more easily in one direction than in the other and thus can be used to change alternating current to pulsating direct current; made of such materials as germanium, silicon, copper oxide, galena, and carborundum. 2. Piezo-electric crystal, one which transforms mechanical energy to electrical and vice versa. Such crystals, made of Rochelle salt or barium titanate, are used in microphones and phonograph pickups. When cut to a certain size and shape, a piezo-electric crystal, usually made of quartz, can be used as a resonant circuit, to control the frequency of an oscillator or as a frequency-selective filter.

**decibel**—A measure of the ratio between two power levels or of a power level with respect to a designated reference level. Basically, the number of decibels is ten times the logarithm of a power ratio. One decibel is approximately the smallest difference in sound power which can be detected by the average human ear.

**db of feedback**—The number of decibels by which inverse feedback in an amplifier reduces its over-all gain and distortion.

**detector**—A circuit used to recover an audio or video signal from a modulated radio signal.

**electrolytic capacitor**—A type of capacitor in which the dielectric or insulator is a thin film of oxide deposited on one aluminum or tantalum plate and an electrolyte is used between the insulator and the other plate. This type of capacitor provides a larger capacitance in a given volume than any other type. However, except for special a.c. electrolytics, this type can be used only in circuits where voltage of constant polarity is applied to it.

**elevator**—Control surface of an aircraft which regulates its pitch attitude (level, climbing, or diving).

**feedback**—Returning part of the output of an amplifier stage to the input of the same or a previous stage. Negative or inverse (out-of-phase) feedback decreases the gain and distortion of the amplifier; positive (in-phase) feedback increases gain and distortion and may produce oscillation.

**frequency response**—The relative ability of an amplifier, loudspeaker, or other device to respond to different frequencies.

**glow plug**—A type of internal-combustion engine used in models, in which starting is assisted by a filament in the combustion chamber, which is energized by an external battery.

**harmonic distortion**—Distortion consisting of addition to the signal of components whose frequencies are multiples (harmonics) of the original signal frequency. It is produced by an amplifier or other device which is nonlinear (does not give the same ratio of output to input for all input amplitudes).

**heterodyne**—A difference frequency (beat) produced by combining two frequencies.

**hole**—Absence of an electron normally present in an atom; a positive charge. The action of some transistors often is explained by referring to movement of holes or positive charges, rather than movement in the opposite direction of electrons or negative charges.

**microammeter**—A meter for the measurement of current flow, which is calibrated in microamperes, or millionths of an ampere.

**milliamperes**—One-thousandth of an ampere.

**modulated**—Varied in amplitude, frequency, or some other quality. Radio-frequency signals are modulated in order to carry signals of lower frequency, such as sound or picture signals.

**multitester**—A meter which is a combination of a voltmeter, an ohmmeter, and (often) an ammeter.

**octal**—Designation of one of the standard types of tube base or the socket to fit it. The base has eight equally spaced pins and a centrally located boss, which is made of insulating material and has a key to prevent improper insertion of the tube in the socket. The octal tube base is similar, except that its pins are smaller in diameter and the central boss is of metal and has a groove which fits a one-turn spring in the socket, to hold the tube.

**oscillator**—A vacuum-tube or transistor circuit or other device which produces an alternating-current power output without mechanical rotation.

**plate dissipation**—The part of the power applied to the plate circuit of a vacuum tube which does not appear as signal output, but is dissipated as heat in the plate of the tube.

**push-pull**—An arrangement of two vacuum tubes in an amplifier so that the input signal is applied in opposite phases to the two tubes and the signal outputs are combined in phase. This arrangement reduces even-harmonic distortion.

**regeneration**—Positive feedback in detectors and amplifiers. Increases gain and distortion and may produce oscillation.

**saturate**—To reach the maximum possible value of some quantity, such as magnetization in the core of an inductor or electron flow in a vacuum tube from cathode to plate.

**servo-motor**—A special electric, hydraulic, or other type of motor used in control apparatus to convert a small movement into one of greater amplitude or greater force.

**signal generator**—A test instrument providing electrical power substantially similar in amplitude, frequency, and other qualities, to signals found in electronic equipment.

**signal tracer**—A test instrument for detecting the presence of a signal in electronic equipment and, with some signal tracers, measuring its amplitude, frequency, or other qualities.

**superheterodyne**—A receiver in which all incoming radio-frequency signals are mixed with the output of an oscillator to produce a heterodyne or beat frequency. The oscillator frequency is variable so that the beat produced with any desired signal can be adjusted to a certain frequency. The beat-frequency

signal is fed to a fixed-frequency (intermediate-frequency) amplifier, where greater and more uniform gain and selectivity can be obtained than at the original radio frequency.

**superregenerative**—A type of regenerative detector in which the tendency to oscillation is controlled by a quenching voltage of ultrasonic frequency which periodically allows the gain to increase, then reduces it. The quenching voltage can be produced by the detector tube itself or by a separate oscillator. This type of detector has great sensitivity, but poor selectivity.

**tone control**—1. In a radio receiver or an audio amplifier, means provided to change the relative response to audio signals of different frequencies; effects which can be produced are treble boost or attenuation and bass boost or attenuation. 2. In radio control of models, a system wherein the radio signal is modulated by audio tones and control is achieved by keying the modulating tones on and off, instead of keying the r.f. carrier.

**v.t.v.m.**—Vacuum-tube voltmeter, a voltmeter using one or more vacuum tubes to increase the sensitivity of the basic meter movement, so that measurements can be made in a circuit without drawing much current and without disturbing very much the normal operating conditions of the circuit. May also be a combination voltmeter, ohmmeter, and ammeter. End

## ABBREVIATIONS

a.c.—alternating current  
a.f.—audio frequency  
a.f.c.—automatic frequency control  
a.g.c.—automatic gain control  
AM—amplitude modulation  
amp.—ampere  
ARRL—American Radio Relay League  
a.v.c.—automatic volume control  
BCI—interference with broadcast reception  
b.f.o.—beat frequency oscillator  
cps—cycles per second  
c.t.—center-tapped  
c.w.—continuous wave  
db—decibel  
dbm—decibels above one milliwatt  
d.c.—direct current  
d.c.c.—double cotton covered (wire)  
d.p.d.t.—double-pole, double-throw  
d.p.s.t.—double-pole, single-throw  
DX—distance  
elec.—electrolytic  
FCC—Federal Communications Commission  
FM—frequency modulation  
freq.—frequency  
GMT—Greenwich Mean Time  
hi fi—high fidelity (of sound reproduction)  
hy.—henry  
i.f.—intermediate frequency  
K—kilo (one thousand)  
kc.—kilocycle  
M—mega (one million)  
ma.—milliampere  
mc.—megacycle  
meg.—megohm  
mike—microphone, microfarad  
mil—milliampere  
m.o.p.a.—master oscillator, power amplifier  
mu—amplification factor  
 $\mu$ fd.—microfarad

$\mu$ fd.—micromicrofarad  
mw.—milliwatt  
m.w.—medium wave  
PA—power amplifier  
p.a.—public address  
PM—phase modulation, permanent magnet (speaker)  
pos.—position (of a switch)  
pot.—potentiometer  
pri.—primary  
R-C—resistance-coupled  
R/C—radio control  
rect.—rectifier  
res.—resistor  
RETMA—Radio-Electronics-Television Manufacturers Association  
r.f.—radio frequency  
r.m.s.—root mean square  
sec.—secondary  
SN—self-neutralizing (escapement)  
s.p.d.t.—single-pole, double-throw  
spkr.—loudspeaker  
s.p.s.t.—single-pole, single-throw  
s.w.—short-wave  
SWL—short-wave listener  
sync.—synchronization  
t.—turns (of a coil)  
trans.—transformer  
TV—television  
TVI—interference with television reception  
u.h.f.—ultra high frequency  
v.—volt  
v.f.o.—variable frequency oscillator  
v.h.f.—very high frequency  
VR—voltage regulator  
v.t.v.m.—vacuum-tube voltmeter  
vu—volume unit  
w.—watt  
wpm—words per minute  
xmtr.—transmitter

THE NEW MODEL TV-11

# TUBE TESTER



## SPECIFICATIONS

- Uses the new self-cleaning Lever Action Switches for individual element testing. Because all elements are numbered according to pin-number in the RMA base numbering system, the user can instantly identify which element is under test. Tubes having tapped filaments and tubes with filaments terminating in more than one pin are truly tested with the Model TV-11 as any of the pins may be placed in the neutral position when necessary.
- The Model TV-11 does not use any combination type sockets. Instead individual sockets are used for each type of tube. Thus it is impossible to damage a tube by inserting it in the wrong socket.
- Free-moving built-in roll chart provides complete data for all tubes.
- Phono Jack on front panel for plugging in either phones or external amplifier will detect microphonic tubes or noise due to faulty elements and loose external connections.

Operates on 105-130 Volt 60 Cycles **\$47.50**  
A.C. Hand-rubbed oak cabinet complete with portable cover.

**SHIPPED ON APPROVAL**  
**NO MONEY WITH ORDER - NO C. O. D.**

Try it for 10 days before you buy. If completely satisfied send \$11.50 and pay balance at rate of \$6.00 per month for 6 months—**No Interest or Finance Charges Added.** If not completely satisfied, return to us, no explanation necessary.

MOSS ELECTRONIC DISTRIBUTING CO., INC.  
Dept. D-88, 3849 Tenth Ave., New York 34, N. Y.  
Please rush 1 Model TV-11. I agree to pay \$11.50 within 10 days after receipt and \$6.00 per month thereafter.

Name .....  
Address .....  
City ..... Zone ..... State .....

## TRANSISTORS!!!

**EXPERIMENTERS** Hurry • limited quantity, marvels of electronics • build your own audio oscillators, personal radios, hearing aids etc. • Price only \$3.00 each postpaid • **SAVE** by buying set of 3 photocells and 1 transistor • Bargain price \$4.95 per set • Learn by doing; Be the first. Don't pay high prices • Act now • **ELECTRONIC'S** greatest development • Marvels of Science.

**TRANSISTOR-PHOTO PRODUCTS**  
Geneva, Illinois

## Something New

Every person, young and old, should read of the new discovery: "WHAT ELECTRICITY IS." These writings reveal just what electricity is, and give 100 facts which substantiate the discovery. They give theories for: Where electricity comes from and where it goes, how electricity is produced, not made, its action in the electric motor and in electrical appliances. Evidence is offered that Electricity is "The VITAL FORCE OF LIFE," that it is the medium of transmission of thought. Tells uses that may be made of the discovery of "WHAT ELECTRICITY IS," etc. The information disclosed in these writings opens up tremendous opportunities for research and invention. Written in the language of the layman. Send \$2.00 for your copy today to JAR Publications, Box 2058, Mokenca, Ill.

## OWN a Business

If employed, start part time. Alert dealers can gross \$5 hourly profit on own service plus \$3 on EACH serviceman. Clean, revive, moth-proof rugs & upholstery on location. No shop needed. Services nationally advertised. Repeat customers. Easy to learn. We locally train and assist you. Quickly established. Easy terms. Send today for FREE booklet. No obligation.

**DURACLEAN CO.,** 5-231 Duraclean Bldg., Deerfield, Ill.

## INDEX OF

# Advertisers

ADVERTISER	PAGE NO.
Accordion Mfrs. & Wholesalers Outlet	121
Ace Radio	114
Advance Training	123
Allied Radio Corp.	103
American Electronics Co.	121
Ashe Radio Co., Walter	117
Burstein-Applebee Co.	2
Business Information Corp.	121
Capital Radio Engineering Institute	11
Century Electronics Co.	106
Concord Radio	101
Corona Radio & TV Co.	104
Coyne Electrical School	5
de Bolt Model Engineering Co.	129
Duraclean Co.	128
Electro Kit	118
Electronic Instrument Co., Inc. (EICO)	129
Electronic Measurement Corporation	6
Electronic Specialty Supply Co.	114
Electro-Voice	109
Finney Company, The	105
G & H Woods Products Co.	2ND COVER
General Electronic Distributing Co.	115
Grantham School of Electronics	114
Gyro Electronics	106
Hallcrafters	4TH COVER
Harjo Sales Co.	104
Heath Company	92, 93, 94, 95
Hershel Radio Co.	110
Jar Publications	128
Master Mechanic Mfg. Co.	114
McGraw Hill Book Co., Inc.	7
Miller, Gustave	104
Moss Electronic Distributing Co., Inc.	128
National Radio Institute	3
National Schools	3ND COVER
Newark Electric Co.	106
Perma Power Company	118
Progressive "Edu-Kits," Inc.	119
Radio-Television Training Association	9
Rex Radio Supply	110
Richville TV Supply	112
Rockbar Corporation	113
Scott-Mitchell House, Inc.	108
Smith, Johnson & Co.	118
Soundtronics Labs.	123
Sprague Products Company	123
Sprayberry Academy of Radio	89
Steve-El Electronics Corp.	108
Tech-Master Corporation	12
Teltron Electric Company	8
Transi-Mite Radio Lab.	112
Transistor Photo Products	128
Tri-State College	104
Valparaiso Technical Institute	118
Visulite Co.	106
Western Radio Co.	123
World Radio Laboratories	111

## PHOTO CREDITS

Page	Credit
16	G & H Wood Products, Inc., Gramercy Sound, Inc., Electro-Voice, Inc., Stephens Manufacturing Corp.
19	U. S. Navy
26	The Military Engineer
33	Westinghouse Electric Corp.
46	National Institute for Mental Health
50, 51	Industrial America, Inc.
55, 72	Bell Telephone Laboratories
62	Northrop Aircraft, Inc.
63	Pan-American World Airways
76	Hayden Planetarium
77	Left, Hayden Planetarium Right, Top to Bottom, Wide World Photo, Altec Service Corp.
81	International Business Machines
84, 85	New York City Transit Authority
88	General Electric Company

## OHM'S LAW QUIZ

(Answers to quiz on page 116)  
1. b 2. a 3. c 4. b 5. b



# Classified

RATE: 35c per word—minimum 10 words

## FOR SALE

**RADIO** Diagrams \$1.00; Television \$2.00. Give make, model. Diagram Service, 672-PE, Hartford 1, Conn.

**RADIO** Parts Assortment \$2, \$5. Ace, 5341 Cordelia, Baltimore 15, Maryland.

**ELECTRONIC** Parts—Controls, Sockets, Transformers, Line Cords, Blank Chassis, Knobs, Hardware, Other Items. Cheap. Free List. P. O. Box 62, Haddon Heights, N. J.

**HI-FI** equipment at lowest prices! Buy direct from manufacturer and save! Top quality HI-FI, AM, FM, AM-FM tuners, audio amplifiers, pre-amplifiers, test instruments—wired or in kit form! Write for free 24-page catalog! Approved Electronic Instrument Corp., Dept. P, 928 Broadway, New York 10, N. Y.

**DIAGRAMS:** Professional Model Timers, Counters, Intercoms, Organs, etc. \$1.00 each. List Free. Parks, 106 S. E. 57th, Portland 15, Oregon.

## INSTRUCTION

**HIGH** School—no Classes. Study at home. Spare time. Diploma awarded. Write for Free Catalog HET-2, Wayne School, 2527 Sheffield, Chicago 14, Ill.

**LEARN** code more easily. Free information. Don Rogers, Ivyland, Pa.

## BUSINESS OPPORTUNITIES

**MAKE** Money at Home. "Mail Trade Magazine" tells how. Issued monthly. Sample copies, 25c. Six months Subscription, \$1.00. Co-Publishers wanted. Write today. Ken-West Distributors, 7-H South Harlem Street, Worcester 4, Mass.

**PROFITABLE** Home Business. Make Fast-Seller. Chenille Monkey Trees, Holiday Flower, Novelties. Literature Free. Velve, Bohemia 24, N. Y.

## INVENTIONS WANTED

**INVENTIONS** wanted. Patented; unpatented. Global Marketing Service, 1404 Mitchell, Oakland 1, Calif.

## MISCELLANEOUS

**HI-FI**—Build 'em yourself. Amplifier Schematics, Baffles, Crossovers. All for \$1.00. "HI-FI," 9529 Claremont N. E., Albuquerque, N. M.

**EXPERIMENTERS:** Let's Exchange Ideas. E. Reeser, RFD 2, Wichita, Kansas.

**BUILD** at no cost: Amplifier from radio, cut no wires, doesn't damage radio. Telephones; intercom; signal generator; tube tester; radios; soldering iron; polarity meter; voltmeter; switches; much more. Book tells how. Clifford M. Gazeway, Garland, Kans. \$75.

**FREE** list, equipment, parts, cheap. W60DD, Box 776, Camarillo, Calif.

**TRANSISTORS** . . . learn theory-operation. Treatise sent postpaid \$1.00. Engineering Service, 1111 Ainslie, Chicago, Ill.

**SEND** us your electrical or electronic drawings or ideas and we will transform them into an easy ready-to-assemble kit. (Anything from a house wiring kit to a radio kit.) Our estimates 50c. Deductible from price of kit. Modern Living, 2990 West Jewell, Denver, Colorado.

**FREE** Condenser and Resistor Code Charts. Largest stock of parts and tubes in West. We can save you money. K. & L. Radio Parts Co., 1406 Venice Blvd., Los Angeles 6, Calif.

**"HOW TO Build crystal sets"** and crystal set—\$1.00. Mailmart-PE, Box 92, Paramus, New Jersey.

**TUBES**—TV, Radio, Transmitting, special purpose types—Bought, Sold, Exchanged. Send details to B. N. Gensler W2LNI, 136 Liberty St., New York 6, N. Y.

**TOP** Dollar Paid for Art-13's, dynamotors, parts racks and all other component parts. Write: Harjo Sales Co., 4109 Burbank Blvd., Burbank, Calif.

**DETECTIVES**—Experience unnecessary. Detective Particulars free. Write, Wargner, 125 W. 86th, N. Y.

**"X-RAY Mind."** Dangerous power over others. (Details—10c.) Krishnar Institute, Box 842-S8, Escondido, Calif.

**LEARN** Code—complete electronic equipment and instructions—\$2.99. Deluxe Set two unit \$4.99. Mailmart—C, Box 92, Paramus, N. J.

### R/C MODELS for BEGINNER AND EXPERT

FOR BEGINNERS:

48" SPAN



#### LIVE WIRE "TRAINER"

WORLDS MOST POPULAR R/C MODEL

A quickly built model of medium size, stable, rugged and simple to fly. Features a removable R/C unit. PRE-FAB. KIT

\$6.95

### MULTI-SERVOS

POWERFUL-DEPENDABLE

MOTOR DRIVEN R/C ACTUATORS

Ample power to move any model control. 4 great models, one for every purpose.



Positive-Flow FUEL TANK

Gives perfect fuel flow under all flight attitudes, upright or inverted. The tank with the internal swivel.

DESCRIPTIVE LITERATURE FREE

SERVO INFO BOOKLET . . . . .75c



\$11.95

TO

\$14.95

\$1.29

### FOR ADVANCED FLYING:

65" SPAN



#### LIVE WIRE "CRUISER"

FOR THE ULTIMATE IN R/C FLYING

A big, high performance, realistic model capable of carrying the heaviest of equipment with ease. Has elevators and a re-movable R/C unit. PRE-FAB. KIT

\$14.95

deBOLT MODEL ENGINEERING CO.

BOX 73

WILLIAMSVILLE, N. Y.

## EASY! BUILD your own Professional Electronic Instruments with EICO KITS! SAVE 50%

• Complete easy-to-follow instructions

• Fully guaranteed

8" PUSH-PULL OSCILLOSCOPE



KIT \$44.95 WIRED \$70.95

VACUUM TUBE VOLTMETER



KIT \$25.95 WIRED \$39.95

1,000 Ohms/Volt MULTIMETER



KIT \$12.90 WIRED \$14.90

6V & 12V BATTERY ELIMINATOR & CHARGER



KIT \$20.95 WIRED \$30.95

Write now for FREE Catalog PE-1 describing 38 EICO KITS.

**EICO**

ELECTRONIC INSTRUMENT CO., INC.  
84 Withers St., Brooklyn 11, N. Y.

© 54

## RESISTOR COLOR CODE

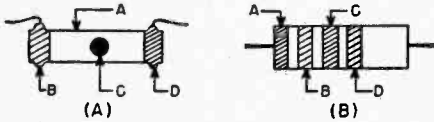

RETMA COLOR CODE CHART

COLOR	VALUE	MULTIPLIER
Black	0	1
Brown	1	10
Red	2	100
Orange	3	1000
Yellow	4	10,000
Green	5	100,000
Blue	6	1,000,000
Violet	7	10,000,000
Grey	8	100,000,000
White	9	1,000,000,000

**TOLERANCE CODE**

Gold—±5%	Silver—±10%
No Color—±20%	

The ohmic value of a resistor can be determined by means of the color code. There are two standard methods of indicating this value.

In Fig. A, the body (A) and end (B) indicate the first and second digits of the value while the dot (C) indicates the multiplier to be used. The tolerance of the unit is indicated by the end color (D). For example, if the body (A) is green the number is 5; if the end (B) is grey the second number is 8. If the dot (C) is red the multiplier is 100 or two zeros should be added. The resistor is then a 5800 ohm unit. If the end (D) has no color, the tolerance is ±20%.

In Fig. B, the first two stripes indicate the first two digits; the third stripe the multiplier; the fourth stripe the tolerance. Thus, if stripe (A) is green, (B) is grey, (C) is red, and (D) is silver, the resistor is a 5800 ohm, ±10% unit.

## CAPACITOR COLOR CODE

Color	MOLDED PAPER		MOLDED MICA		CERAMIC	
	Multiplier	Tolerance	Multiplier	Tolerance	Multiplier	Tolerance
Black	1	20%	1	20%	1	20% or 2.0μfd.*
Brown	10		10		10	1%
Red	100		100	2%	100	2%
Orange	1000		1000	3% (RETMA)	1000	2.5% (RETMA)
Yellow	10,000	5%	10,000		10,000	
Green				5% (RETMA)		5% or 0.5μfd.*
Blue						
Violet						
Gray					0.01	0.25μfd.*
White		100%			0.1	10% or 1.0μfd.*
Gold	0.1	5%	0.1	5% (JAN)		
Silver		10%	0.01	10%		
None		20%				*Capacitance less than 10μfd.

Capacitance is given in μfd. Colors have same values as on resistors, except as indicated in tables. Colors (A) and (B) are for first two digits; (C) is for multiplier. (D) is for tolerance. (E) and (F) give voltage rating in hundreds of volts; (E) is used only for ratings less than 1000 volts, (E) and (F) for first two digits of ratings 1000 volts or more. Values of colors for (E) and (F) are same as in resistance values. (G) is class or characteristic of capacitor, (H), (I), and (J) give temperature coefficient. (G), (H), (I), and (J) are not listed in the tables, since this information is seldom needed by the average home builder.

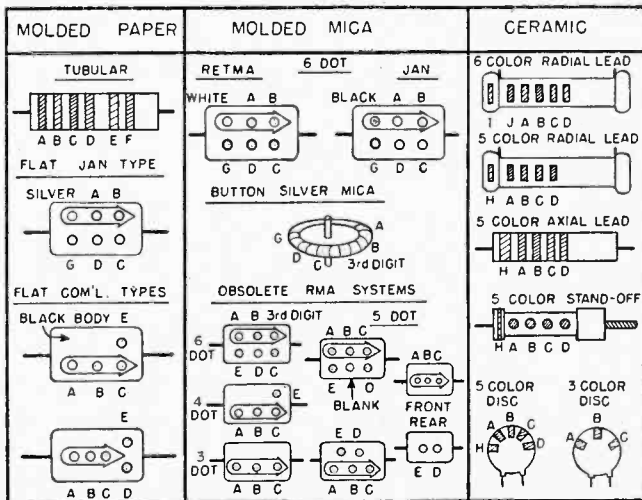



# only



**S-53A** The finest small communications receiver built and ideal where maximum performance is required in small space. Several steps better than the S-38C, but not quite up to larger S-40B. Covers Broadcast Band 540-1630 kc plus four short-wave bands covering 2.5-31 and 48-54.5 Mc.

Electrical bandspread for easy tuning. Two i-f stages. Switches for automatic noise limiter, code reception and high-low tone. Phono jack for records. Headphone tip jacks on rear and built-in PM speaker. Temp. compensated to reduce fading due to frequency shift. For 105/125 V. 50/60 cycle AC.



Brand New and very much wanted—Model HT-30 Single Sideband AM and CW Transmitter/Exciter.

- Highly stable VFO with full 100:1 ratio gear drive system built-in, calibrated in kc.
- Stability comparable to most crystals .009%. Full band switching.
- Ample gain for 55 db microphone. Hum and noise 40 db down.

- Full 50 watt peak power output.
- Complete built-in metering.
- Unwanted sideband at least 40 db down. AM—CW—SSB.
- Undesired beat frequency down 60 db or more. T. V. I. suppressed.
- Stable 50 kc filter system.
- Provisions for coaxial output fitting.
- Built-in voice control circuit with bias switching for final amplifier.

# has



**Model SX-96** Selectable Sideband Receiver

- Covers Broadcast 538-1580 kc plus three S/W 1720 kc-34 Mc.
- Double conversion with selectable crystal controlled second oscillators.
- Selectable sideband reception of both sup-

pressed carrier and full carrier transmissions. Highly selective 50 kc I. F. system.

- CW operation with AVC on. Delayed AVC.
- Calibrated bandspread—"S" meter—double superhet. Precision gear drive dial system.
- 10 tubes, 1 rectifier and voltage regulator.

# COMPLETE

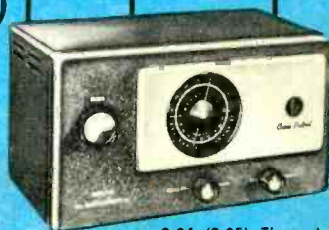

**S-94 (S-95)** These two new Civic Patrol receivers are over 10 times as sensitive as previous models, greater increased audio power output and built-in relay squelch system. Perfect for monitoring, police, fire, taxicab, telephone-mobile, forestry, Civil Defense. The S-94 covers 30-50 Mc and the S-95 150-173 Mc. Built-in speaker and provisions for headphones. Eight tubes plus rectifier. 105/125 V. 50/60 cycle AC/DC.

# HAM



**S-38D** Low cost unit with high priced performance over Broadcast Band 540-1650 kc plus three short-wave bands from 1650 kc-32 Mc. Electrical bandspread operates over large easy-to-read dial. Headphone tip jacks on rear and powerful built-in PM speaker. Oscillator for reception of code signals. Four tubes plus rectifier. 105/125 V. 50/60 cycle AC/DC.

# LINE

Write for complete specifications.

hallicrafters • Chicago 24, Illinois

In Canada:  
The HALLCRAFTERS COMPANY  
Don Mills Road • Box 27, Station R • Toronto 17, Ontario