

POPULAR ELECTRONICS

DECEMBER
1954

25
CENTS

In U.S. and Canada

RADIO • TV • R/C • HI-FI • ELECTRONICS

**ELECTRONIC EAR
MODEL TRAIN CONTROL
LORENZ R/C TRANSMITTER
A TWINKLING CHRISTMAS TREE
ELECTRONIC TRAIN WHISTLE
FLYING THE R/C PLANE
U. H. F. ANTENNAS**

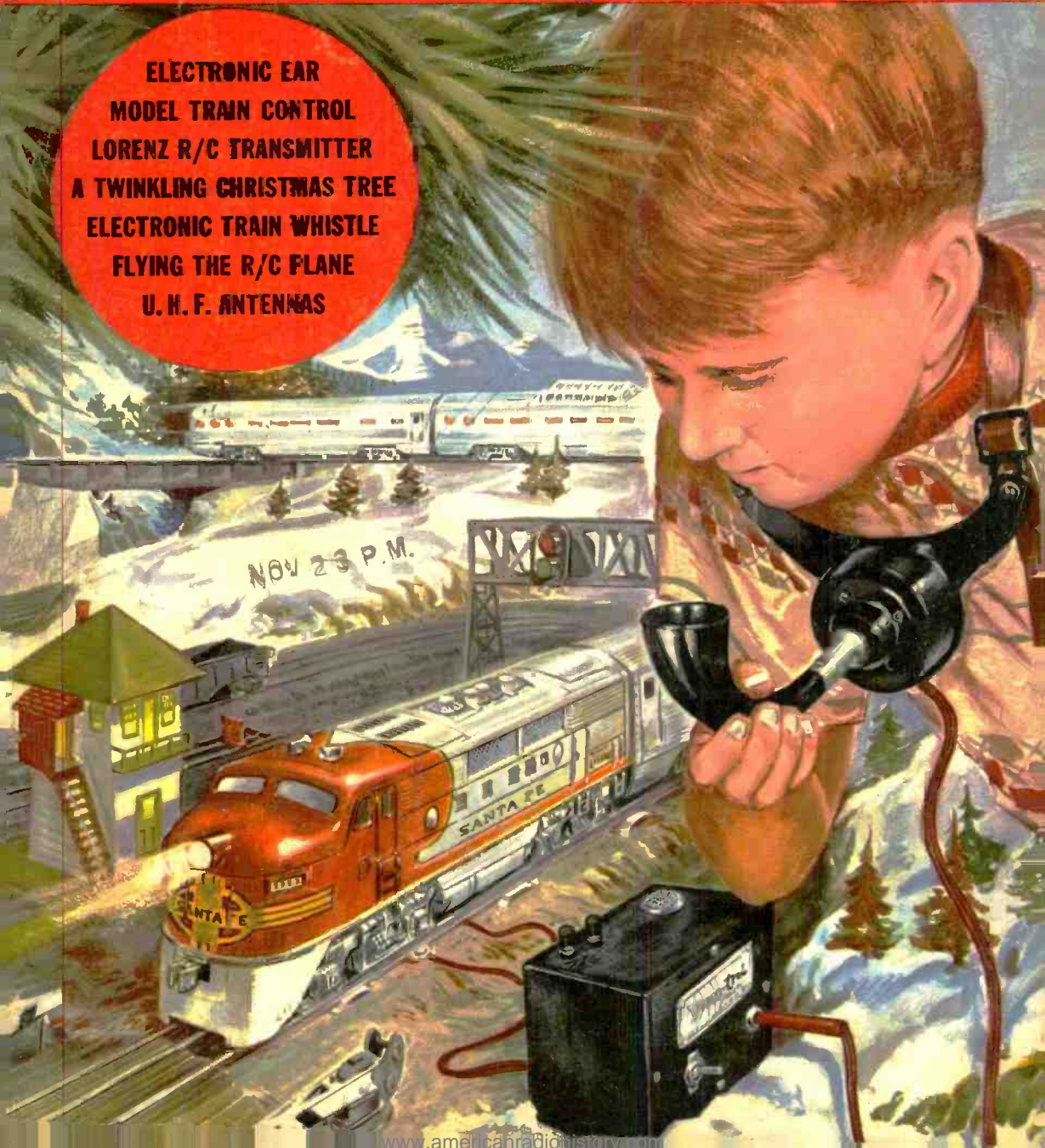

BUILD YOUR OWN HIGH FIDELITY CABINETS AND ENCLOSURES

by **Cabinart**

With a cabinet kit by CABINART you get exactly the style that you want. The finish is up to you. You get top-quality white pine or birch—perfect for any finish that you select. And so easy to put together . . . all you need is a screwdriver.

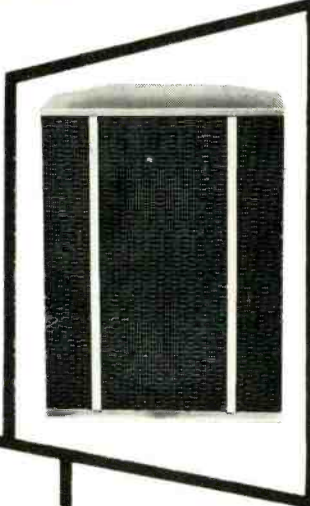

Paul Klipsch-designed Rebel IV

You can now build your own corner horn speaker enclosure . . . designed by Paul Klipsch. Identical in acoustic design to assembled units and easily put together with a minimum of tools. Priced for the home-builder in unfinished birch.

12" model . . . **\$36.00** net*
15" model . . . **\$42.00** net*

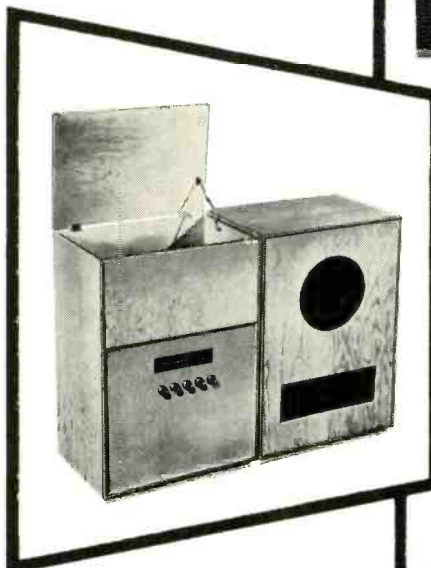

Bass Reflex and Equipment Cabinets

The ideal housing for high fidelity components . . . removable panels make future changes easier. Loudspeaker cabinet acoustically designed for either 12" or 15" speaker. Overall dimensions: 33½" H., 23" W., 16" D. Tuner compartment: 20" H., 21¾" W. (inside dimensions), 15¼" D. Baffle volume: 6 cu. ft.

Model 80—Equipment cabinet kit . . . **\$27.00** net*
Model 8112—12" speaker cabinet kit . . . **\$18.00** net*
Model 8115—15" speaker cabinet kit . . . **\$18.00** net*

All kits include ¾" white pine cut to size, baffle precut for 12" or 15" speaker, Saran plastic acoustic cloth, Kimsul acoustic insulation, assembly and finishing instructions, hardware, plastic wood, sandpaper and glue.

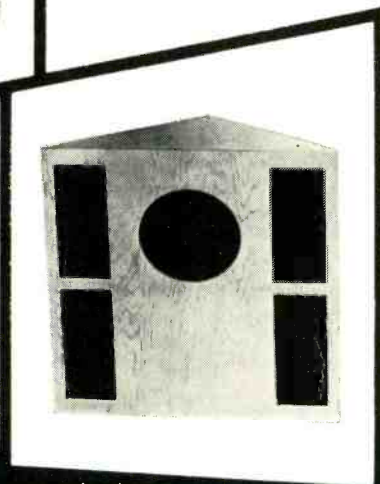

Corner Folded Horn Enclosures

Reproduces a quality of bass heretofore only possible through the use of far more expensive designs.

Model 61 **\$19.95**
(12" speaker kit) net*
Model 63 **\$23.95**
(15" speaker kit) net*

*prices higher west and south.

Write for free catalog and name of nearest distributor

G & H WOOD PRODUCTS COMPANY • 75 NORTH 11th ST., BROOKLYN 11, N. Y.



I WILL TRAIN YOU AT HOME FOR GOOD PAY JOBS IN RADIO-TELEVISION

J. E. SMITH has trained more men for Radio-Television than any other man. OUR 40th YEAR.

America's Fast Growing Industry Offers You Good Pay—Bright Future—Security

I TRAINED THESE MEN

"Started to repair sets six months after enrolling. Earned \$12 to \$45 a week in spare time." —Adm. Kramlik, Jr., Sunneytown, Pennsylvania.

"Up to our necks in Radio-Television work. Four other NRI men work here. I'm happy with my work." —Glen Peterson, Bradford, Ont., Canada.

"Am doing Radio and Television Servicing full time. Now have my own shop. I owe my success to N.R.I." —Curtis Stath, Ft. Madison, Iowa.

"Am with WCOB. NRI course can't be beat. No troubles passing 1st class Radio-phone license exam." —Jesse W. Parker, Meridian, Mississippi.

"By graduation, had paid for course, car, testing equipment. Can secure toughest jobs." —E. J. Streitenberger, New Boston, Ohio.

AVAILABLE TO VETERANS UNDER G. I. BILLS

Training plus opportunity is the PERFECT COMBINATION for job security, good pay, advancement. In good times, the trained man makes the BETTER PAY, GETS PROMOTED. When jobs are scarce, the trained man enjoys GREATER SECURITY. NRI training can help assure you more of the better things of life.

Start Soon to Make \$10, \$15 a Week Extra Fixing Sets

Keep your job while training. I start sending you special booklets the day you enroll, that show you how to fix sets. Multitester built with parts I send helps you make \$10, \$15 a week extra fixing sets while training. Many start their own Radio-Television business with spare time earnings.

My Training Is Up-To-Date
You benefit by my 40 years' experience training men at home. Well illustrated lessons give you basic principles you need. Skillfully developed kits of parts I send (see below) "bring to life" things you learn from lessons.

You Learn by Practicing with Parts I Send



Nothing takes the place of PRACTICAL EXPERIENCE. That's why NRI training is based on LEARNING BY DOING. You use parts I furnish to build many circuits common to Radio and Television. As part of my Communications Course, you build many circuits including low power transmitter shown at left. You put it "on the air," perform procedures required of broadcast operators. With my Servicing Course you build modern Radio, etc.; use Multitester you build to make money fixing sets in spare time while training. You can stay at home, keep your job, I train Radio-TV in spare time at low cost. Mail coupon for book showing other equipment you build and keep.

The Tested Way To Better Pay!

2 FREE BOOKS SHOW HOW MAIL COUPON



Television Making Good Jobs, Prosperity—Even without Television, Radio is bigger than ever. 1.5 million home and auto Radios are big markets for servicing. 3000 broadcasting stations use operators technicians. Government, Aviation, Police, Ship, Micro-wave Relay Two-way Radio Communications for buses, taxis, trucks, E. R. are growing fields. Television is moving ahead fast.



About 200 Television stations are now on the air. Hundreds of others being built. Good TV jobs opening up for Technicians, Operators, etc.

25 million homes now have Television. Thousands more are being sold every week. Get a job or save your own business selling, installing, servicing.

Radio-TV Needs Men of Action—Mail Coupon

Without obligating you in any way, I'll send an actual lesson to prove that my training is practical, thorough. 54-page book to show good job opportunities for you in Radio-TV. Terms for NRI training are as low as \$5 a month. Many graduates make more in two weeks than total cost of training. Mail coupon now. J. E. SMITH, President, National Radio Institute, Dept. 4N4, Washington 9, D. C. OUR 40TH YEAR.

Good for Both—FREE

MR. J. E. SMITH, President, Dept. 4N4 National Radio Institute, Washington 9, D. C. Mail me Sample Lesson and 64-page Book, FREE. (No salesmen will call. Please write plainly.)

Name..... Age.....
Address.....
City..... Zone..... State.....

VETS write in date of discharge



POPULAR ELECTRONICS is published monthly by Ziff-Davis Publishing Company, William B. Ziff, Chairman of the Board (1946-1953), at 64 E. Lake St., Chicago 1, Ill. Second Class Entry pending at Post Office, Chicago, Ill. SUBSCRIPTION RATES: One Year U.S. and possessions, and Canada \$3.00; Pan-American Union Countries \$3.50; all other foreign countries \$4.00.

POPULAR ELECTRONICS

DECEMBER
1954
VOL. I - NUMBER 3

EDITOR

OLIVER READ, W1ETI

ASSOCIATE EDITORS

W. A. STOCKLIN H. S. RENNE
C. TEPPER J. FRIEBORN
P. B. HOEFER N. EISENBERG

ART

FRANK SAYLES (Director)
A. J. REICH M. WHELPLEY

CONTRIBUTING EDITORS

J. T. FRYE L. E. GARNER, JR.
K. R. BOORD R. P. TURNER
R. HERTZBERG H. POLLACK

DRAFTING

J. A. GOLANEK A. A. GANS

ADVERTISING DEPARTMENT

New York (AU 7-8080)
WM. G. McROY
Chicago (AN 3-5200)
M. B. CROFFORD
Los Angeles (Mich. 9856)
JOHN E. PAYNE



Copyright 1954
All Rights Reserved

ZIFF-DAVIS PUBLISHING COMPANY
W. B. ZIFF (1898-1953) FOUNDER

Also Publishers of
RADIO & TELEVISION NEWS
RADIO-ELECTRONIC ENGINEERING
Editorial and Executive Offices
366 Madison Ave., New York 17, N.Y.

PRESIDENT

B. G. DAVIS

VICE-PRESIDENTS

H. J. MORGANROTH M. FROELICH

SECRETARY-TREASURER

G. E. CARNEY

CIRCULATION MANAGER

M. MICHAELSON

BRANCH OFFICES

Chicago (1), 64 E. Lake St.
Los Angeles (14), Stalder Center,
900 Wilshire Blvd.

SUBSCRIPTION SERVICE:

All communications concerning subscriptions should be addressed to Circulation Dept., 64 E. Lake St., Chicago 1, Ill. Subscribers should allow at least four weeks for any change of address.

CONTRIBUTIONS:

Contributors are advised to retain a copy of their manuscripts and illustrations. Contributions should be mailed to the New York Editorial Office and must be accompanied by return postage. Contributions will be handled with reasonable care, but this magazine assumes no responsibility for their safety. Any copy accepted is subject to whatever adaptations and revisions are necessary to meet the requirements of this publication. Payment covers all author's, contributor's, and contestant's rights, title, and interest in and to the material accepted and will be made at our current rates upon acceptance. All photos and drawings will be considered as part of material purchased.

Registered U. S. Patent Office

CONTENTS

Voice Operated Model Train Control	K. Greif	17
A "Universal" Test Speaker for the Home Lab		21
Emergency Radio Truck Covers Detroit Area		24
E, I, R, and P Chart		25
A Twinkling Christmas Tree	E. D. Morgan	26
Photoelectric Plethysmograph		31
Flying the R/C Plane	W. Winter	32
Build Your Own Record Player		37
Electronics Seeks Secrets of Aging	R. E. Atkinson	40
So You Want to be a Ham (Part 3)	R. Hertzberg, W2DJJ	42
An Electronic Train Whistle		44
Electronics Aids International Science	N. Garrahan	47
Carl & Jerry	J. T. Frye	48
A Pie Case Radio	E. V. Stolberg, KL7ALU	50
The Lorenz R/C Transmitter	E. J. Lorenz	52
Kit of the Month		56
Build this Simple Coil-Winding Jig		58
R/C Codes and Escapements	E. L. Safford, Jr.	62
Hints on Meter Care	H. Leeper	65
Light Socket with Guard Converts to Handy Tester		66
Cutting Large Holes in a Metal Chassis		68
How to Repair Your Electric Clock		71
Train Speed to be Controlled Automatically	L. G. Sands	72
The "Electronic Ear"	L. E. Garner, Jr.	74
"Guide-A-Phone"		79
Electronic Baby Sitter	B. G. Wells	80
Choosing a U.H.F. Antenna	C. Tepfer	82
The World at a Twirl	K. R. Boord	84
The TV Web	P. B. Hoefler	86
Electrons Aid Research at P.H.S. Clinical Center		93
How to Test Radio and TV Capacitors		96

DEPARTMENTS

Letters from Our Readers	10
R/C Notes	36
Tools & Gadgets	99
Tricks of the Trade	106
Book Reviews	112
After Class	114
Standardized Wiring Diagram Symbols	125
Glossary of Terms in This Issue	126
Abbreviations	127
Resistor Color Code	130
Capacitor Color Code	130

(Also see page 6)

THESE MEN ARE GETTING PRACTICAL TRAINING

IN ELECTRICITY

—ELECTRONICS

On Real:

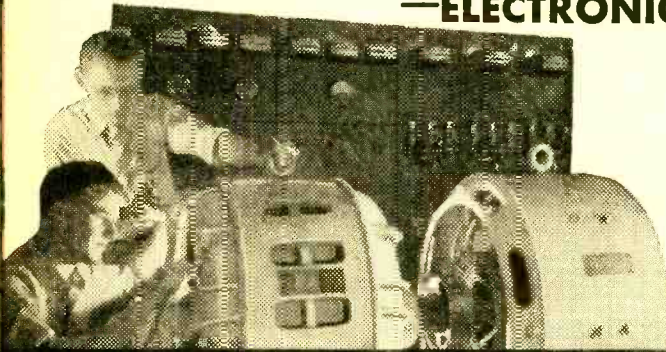

**A.C. and D.C. MOTORS
GENERATORS
SWITCHBOARDS
CONTROLLERS
WIRING JOBS
APPLIANCES
ELECTRONIC UNITS**

(Shown at left - Instructor explaining operation and testing of a large Motor Generator in our A.C. Department.)

AND TELEVISION-RADIO

On Real:

**TELEVISION SETS
RADIO RECEIVERS
F.M.
(Frequency Modulation)
ELECTRONICS
RECORD CHANGERS
AUTO RADIOS
PUBLIC ADDRESS Systems**

(Right - Instructor helping students check the wiring and trace circuits of television receivers.)



Train in the great SHOPS of COYNE

Largest, Oldest, Best Equipped School Of Its Kind In The U. S.

Whether 17 or up to 45 years of age, prepare for your future now. Don't be satisfied with a "No Future" job. Train the Coyne way for a better job in a field that offers a world of opportunities in the years ahead.

FINANCE PLAN Enroll now, pay most of tuition later. Part-time employment service while training, if needed.

WE TRAIN YOU IN CHICAGO. At Coyne you learn on real, full-size equipment. Trained instructors show you how, then you do practical jobs yourself. No previous experience or advanced education needed.

CLIP COUPON NOW for big new illustrated Coyne book "Guide to Careers in ELECTRICITY and TELEVISION-RADIO". No obligation; no salesman will call. Get vital facts now!

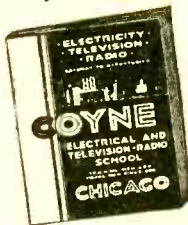

*Mail Coupon for
Big Free Book*

**APPROVED
FOR
VETERANS**

**B. W. COOKE, President
COYNE ELECTRICAL SCHOOL
500 S. Paulina St., Chicago 12, Ill. Dept. 94-71H**

Send **BIG FREE** book and details of your training offer. This does not obligate me and no salesman will call. I am interested in:

ELECTRICITY TELEVISION-RADIO

NAME

ADDRESS

CITY.....STATE.....

B. W. COOKE, Pres. **COYNE** FOUNDED 1899

ELECTRICAL SCHOOL

**A TECHNICAL TRADE INSTITUTE CHARTERED NOT FOR PROFIT
500 S. PAULINA St., CHICAGO, Dept. 94-71H
ELECTRICITY ★ RADIO ★ TELEVISION ★ REFRIGERATION ★ ELECTRONICS**

December, 1954

Make this TRANSISTORIZED "Electric Organ"

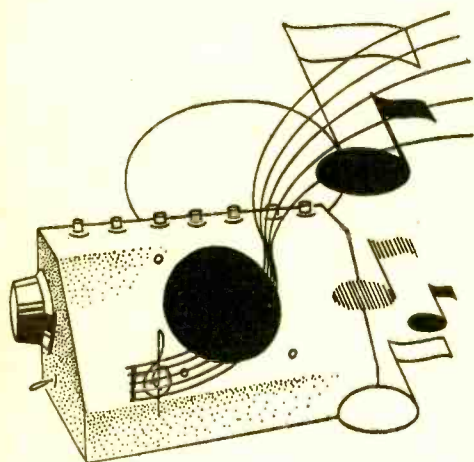

You don't need to be a skilled musician to pick out tunes on this unusual "Electric Organ". It's easy and inexpensive to make using the Raytheon CK722 Transistor (now only \$3.50) and complete information on how to build it is free. Just write to Dept. P2

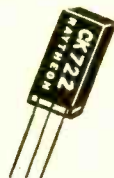

Excellence in Electronics

RAYTHEON MFG. CO.

Receiving and Cathode Ray Tube Operations
Newton 58, Massachusetts

RELIABLE SUBMINIATURE AND MINIATURE TUBES
SEMICONDUCTOR DIODES AND TRANSISTORS
NUCLEONIC TUBES

RECEIVING AND PICTURE TUBES • MICROWAVE TUBES

ITEMS OF INTEREST

This Month's Cover.....	8
Manicure Set Has New Function.....	20
The RCA "Strato-World" on Safari.....	20
Japanese Seek U. S. Geiger Counters.....	61
Jumbo and Junior.....	61
Two-Way Radio Helping Motorists.....	64
"Ham" Operator Receives Award.....	94
Electronic "Lightbulb".....	94
Special Plates for "Hams".....	94
Nominations Open for G-E Amateur Award.....	104
Bent Iron Tip Aids Soldering.....	105
Britons Prefer 17" TV.....	113
Airport Ceiling and Visibility Indicators.....	124

NEW PRODUCTS

Gold Rush of 1954.....	20
(Goldak Co., Glendale, California)	
Build-It-Yourself Organ Kit.....	20
(Electronic Organ Arts, Box 41084, Los Angeles, Cal.)	
New Idea in Clock Radios.....	61
(Radio Corporation of America, Camden, N. J.)	
Inverter Provides 110 Volts.....	94
(American Television & Radio Co., St. Paul 1, Minn.)	

If you are unable to find these listed products locally, write direct to the manufacturers at the addresses given. Also see the monthly review of new items of interest to the electronic hobbyist in "Tools & Gadgets" appearing on pages 99, 100, 102, and 103 of this issue of POPULAR ELECTRONICS.

COMING NEXT MONTH POPULAR ELECTRONICS

Fun with a Geiger Counter
Photoelectric Rifle Range
Two-Tube Broadcast Receiver
A Deluxe Photographic Timer
Novice C. W. Transmitter
"Two-Way" Electronic Metronome
Safford R/C Receiver

Plus More On

High-Fidelity Audio • Kits • Radio Control • Short-Wave Listening • What's New • How It Works • How to Make It • How to Use It • Carl & Jerry

IN THIS MONTH'S RADIO & TELEVISION NEWS

(December)

Build Your Own TV Color Converter
Midget FM Tuner
Choosing Your Hi-Fi Speaker Enclosure
Compact 100-Watt Bandswitching Transmitter
Servicing Printed Wiring TV Sets
A Single-Sideband Audio Test Oscillator
Transistor Vibration Amplifier

How I foxed the Navy

by Arthur Godfrey



The Navy almost scuttled me. I shudder to think of it. My crazy career could have ended right there.

To be scuttled by the Navy you've either got to do something wrong or neglect to do something right. They've got you both ways. For my part, I neglected to finish high school.

Ordinarily, a man can get along without a high school diploma. Plenty of men have. But not in the Navy. At least not in the U. S. Navy Materiel School at Bellevue, D. C., back in 1929. In those days a bluejacket had to have a mind like Einstein's. And I didn't.

"Godfrey," said the lieutenant a few days after I'd checked in, "either you learn mathematics and learn it *fast* or out you go. I'll give you six weeks." This, I figured, was it. For a guy who had to take off his shoes to count

above ten, it was an impossible assignment.

I was ready to turn in my bell-bottoms. But an ad in a magazine stopped me. Here, it said, is your chance to get special training in almost any subject—mathematics included. I hopped on it. Within a week I was enrolled with the International Correspondence Schools studying algebra, geometry and trig for all I was worth.

Came week-end liberty, I studied. Came a holiday, I studied. Came the end of the six weeks, I was top man in the class. Within six weeks I had mastered two years of high school math, thanks to the training I'd gotten.

I. C. S. made the impossible—easy!

GET EXPERT GUIDANCE 3 FREE BOOKS 1. 36-page pocket-size career guide "How To Succeed". 2. Illustrated. catalog on subject you check. 3. Free sample lesson to demonstrate I. C. S. method.

For Real Job Security—Get an I. C. S. Diploma!

I. C. S., Scranton 9, Penna.

INTERNATIONAL CORRESPONDENCE SCHOOLS



BOX 2951-C, SCRANTON 9, PENNA.

(Partial list of 277 courses)

Without cost or obligation, send me "HOW TO SUCCEED" and the opportunity booklet about the field BEFORE which I have marked X (plus sample lesson):

- | | | | | |
|---|--|---|---|--|
| <p>ARCHITECTURE and BUILDING CONSTRUCTION</p> <ul style="list-style-type: none"> <input type="checkbox"/> Air Conditioning—Refrig. <input type="checkbox"/> Architecture <input type="checkbox"/> Building Contractor <input type="checkbox"/> Building Maintenance <input type="checkbox"/> Carpenter and Mill Work <input type="checkbox"/> Estimating <input type="checkbox"/> Heating <input type="checkbox"/> Painting Contractor <input type="checkbox"/> Plumbing <input type="checkbox"/> Reading Arch. Blueprints <input type="checkbox"/> Steamfitting <p>ART</p> <ul style="list-style-type: none"> <input type="checkbox"/> Cartooning <input type="checkbox"/> Commercial Art <input type="checkbox"/> Fashion Illustrating <input type="checkbox"/> Magazine Illustrating <input type="checkbox"/> Show Card and Sign Lettering <input type="checkbox"/> Sketching and Painting <p>AUTOMOTIVE</p> <ul style="list-style-type: none"> <input type="checkbox"/> Auto Body Rebuilding <input type="checkbox"/> Auto Elec. Technician <input type="checkbox"/> Auto-Engine Tune Up <input type="checkbox"/> Automobile Mechanic | <p>AVIATION</p> <ul style="list-style-type: none"> <input type="checkbox"/> Aeronautical Engineering Jr. <input type="checkbox"/> Aircraft & Engine Mechanic <p>BUSINESS</p> <ul style="list-style-type: none"> <input type="checkbox"/> Advertising <input type="checkbox"/> Bookkeeping and Accounting <input type="checkbox"/> Business Administration <input type="checkbox"/> Business Correspondence <input type="checkbox"/> Certified Public Accounting <input type="checkbox"/> Creative Salesmanship <input type="checkbox"/> Federal Tax <input type="checkbox"/> Letter-writing Improvement <input type="checkbox"/> Managing Small Business <input type="checkbox"/> Office Management <input type="checkbox"/> Retail Business Management <input type="checkbox"/> Sales Management <input type="checkbox"/> Stenographic-Secretarial <input type="checkbox"/> Traffic Management <p>CHEMISTRY</p> <ul style="list-style-type: none"> <input type="checkbox"/> Analytical Chemistry <input type="checkbox"/> Chemical Engineering <input type="checkbox"/> Chem. Lab. Technician <input type="checkbox"/> General Chemistry <input type="checkbox"/> Natural Gas Prod. & Trans. <input type="checkbox"/> Petroleum Engineering <input type="checkbox"/> Plastics <input type="checkbox"/> Pulp and Paper Making | <p>CIVIL, STRUCTURAL ENGINEERING</p> <ul style="list-style-type: none"> <input type="checkbox"/> Civil Engineering <input type="checkbox"/> Construction Engineering <input type="checkbox"/> Highway Engineering <input type="checkbox"/> Reading Struct. Blueprints <input type="checkbox"/> Sanitary Engineering <input type="checkbox"/> Structural Engineering <input type="checkbox"/> Surveying and Mapping <p>DRAFTING</p> <ul style="list-style-type: none"> <input type="checkbox"/> Aircraft Drafting <input type="checkbox"/> Architectural Drafting <input type="checkbox"/> Electrical Drafting <input type="checkbox"/> Mechanical Drafting <input type="checkbox"/> Mine Surveying and Mapping <input type="checkbox"/> Ship Drafting <input type="checkbox"/> Structural Drafting <p>ELECTRICAL</p> <ul style="list-style-type: none"> <input type="checkbox"/> Electrical Engineering <input type="checkbox"/> Electrical Maintenance <input type="checkbox"/> Electrician <input type="checkbox"/> Contracting <input type="checkbox"/> Linemen <p>HIGH SCHOOL</p> <ul style="list-style-type: none"> <input type="checkbox"/> Commercial <input type="checkbox"/> Good English <input type="checkbox"/> High School Subjects <input type="checkbox"/> Mathematics | <p>LEADERSHIP</p> <ul style="list-style-type: none"> <input type="checkbox"/> Foremanship <input type="checkbox"/> Industrial Supervision <input type="checkbox"/> Leadership and Organization <input type="checkbox"/> Personnel-Labor Relations <p>MECHANICAL AND SHOP</p> <ul style="list-style-type: none"> <input type="checkbox"/> Gas—Electric Welding <input type="checkbox"/> Heat Treatment <input type="checkbox"/> Metallurgy <input type="checkbox"/> Industrial Engineering <input type="checkbox"/> Industrial Instrumentation <input type="checkbox"/> Industrial Supervision <input type="checkbox"/> Machine Design-Drafting <input type="checkbox"/> Machine Shop Inspection <input type="checkbox"/> Machine Shop Practice <input type="checkbox"/> Mechanical Engineering <input type="checkbox"/> Quality Control <input type="checkbox"/> Reading Shop Blueprints <input type="checkbox"/> Refrigeration <input type="checkbox"/> Sheet Metal Worker <input type="checkbox"/> Tool Design <input type="checkbox"/> Toolmaking <p>RADIO, TELEVISION</p> <ul style="list-style-type: none"> <input type="checkbox"/> Electronics <input type="checkbox"/> Practical Radio—TV Eng'ing <input type="checkbox"/> Radio and TV Servicing <input type="checkbox"/> Radio Operating <input type="checkbox"/> Television—Technician | <p>RAILROAD</p> <ul style="list-style-type: none"> <input type="checkbox"/> Air Brakes <input type="checkbox"/> Car Inspector <input type="checkbox"/> Diesel Locomotive <input type="checkbox"/> Locomotive Engineer <input type="checkbox"/> Section Foreman <p>STEAM AND DIESEL POWER</p> <ul style="list-style-type: none"> <input type="checkbox"/> Combustion Engineering <input type="checkbox"/> Diesel—Elec. <input type="checkbox"/> Diesel Eng's <input type="checkbox"/> Electric Light and Power <input type="checkbox"/> Stationary Fireman <input type="checkbox"/> Stationary Steam Engineering <p>TEXTILE</p> <ul style="list-style-type: none"> <input type="checkbox"/> Carding and Spinning <input type="checkbox"/> Cotton, Rayon, Woolen Mfg. <input type="checkbox"/> Finishing and Dyeing <input type="checkbox"/> Loom Fixing <input type="checkbox"/> Textile Designing <input type="checkbox"/> Textile Eng'g <input type="checkbox"/> Throwing <input type="checkbox"/> Warping and Weaving <p>MISCELLANEOUS</p> <ul style="list-style-type: none"> <input type="checkbox"/> Domestic Refrigeration <input type="checkbox"/> Marine Engineering <input type="checkbox"/> Ocean Navigation <input type="checkbox"/> Shipfitting <input type="checkbox"/> Short Story Writing <input type="checkbox"/> Telephony |
|---|--|---|---|--|

Name _____ Age _____ Home Address _____

City _____ Zone _____ State _____ Working Hours _____ A.M. to P.M. _____

Occupation _____

Canadian residents send coupon to International Correspondence Schools, Canadian, Ltd., Montreal, Canada. . . . Special tuition rates to members of the U. S. Armed Forces.



TRAINED TELEVISION & ELECTRONIC MEN DESPERATELY NEEDED!

BIG PAY — SECURE FUTURE

Why work for low pay jobs or risk being out of a job. The TELEVISION and ELECTRONIC industry is *BOOMING* and *NEEDS MEN NOW!* Why waste valuable time poring over books, graphs and charts? We train you in just a few short months, to get in on the ground floor of this Billion dollar industry. You learn immediately by rebuilding, repairing and operating the most recently developed equipment under the guidance of outstanding experienced instructors.

If you want to really learn television and electronics . . . If you really want to get into the big money fast in this gigantic industry . . . it will *pay you* to find out the outstanding advantages of World Famous Bailey School Training. For big pay, act to-day! Mail coupon now for informative school Brochure—it contains complete information and illustrations of equipment and shop training . . . How we help you find part time jobs while in school . . . full time jobs after graduation . . . Success stories of Bailey Students.

BAILEY Technical SCHOOLS

Veteran Approved

1636 S. Grand St. Louis 4, Mo., T

NAME.....AGE.....
STREET.....
TOWN.....ZONE.....STATE.....

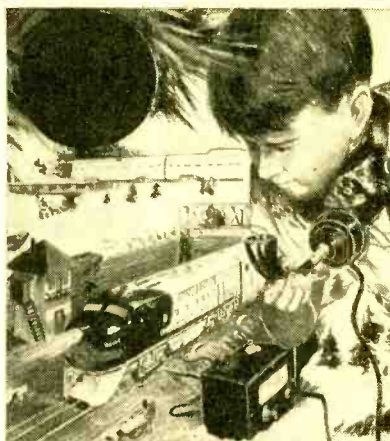

This Month's Cover

PROBABLY by this time you need no special reminder that Christmas is just around the corner! A household with youngsters knows Santa-time is approaching—if only because of the cherubic behavior of the small fry.

Close as Christmas is, there is still plenty of time for you to build one or more of the fascinating electronic devices described in this issue as being especially suitable for Christmas gift-giving.

The "Voice Operated Model Train Control" shown on this month's cover and described in the article on page 17, is a new and exciting accessory for last Christmas' electric train. With this device the train can be made to start, stop, back up, and go forward by means of spoken commands relayed to the train *via* the microphone.

Similarly, the "Electronic Train Whistle," on page 44, can be added to an existing model train system to revive your youngster's interest in his last year's present from Santa.

Fun for the whole family awaits the builder of the "Twinkling Christmas Tree" whose construction is covered on page 26. It is easy to build and can become a permanent addition to your holiday decorations. **END**

(Cover painting by Leo R. Summers)

START YOUR HI-FI RIGHT!

Karlson Handyman KIT

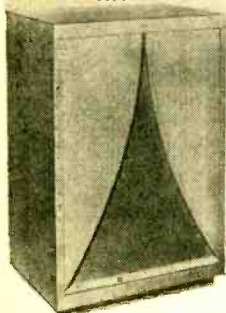

Immediate Delivery

only \$4.500

51 Intricately cut pieces
... 3/4" plywood ...
34 1/2" x 22 1/2" x 18" overall.

Send for Complete Literature

WITH KARLSON ULTRA-FIDELITY ENCLOSURES

The performance of a speaker, like a violin, largely depends upon the cabinet.

The Ultra-Fidelity Karlson is completely NEW and has amazed thousands at every audio show. "A new standard of performance," ... "unsurpassed" ... HI-FI Manual. Send today for information on this exciting new scientific discovery.

Available in kit or finished form from \$45 to \$117.60

If not yet available from your Hi-Fi dealer, order direct

KARLSON ASSOCIATES, INC.

DEPT. M

1483 Coney Island Ave., Brooklyn 30, N. Y.

HOBBY HOBNOB

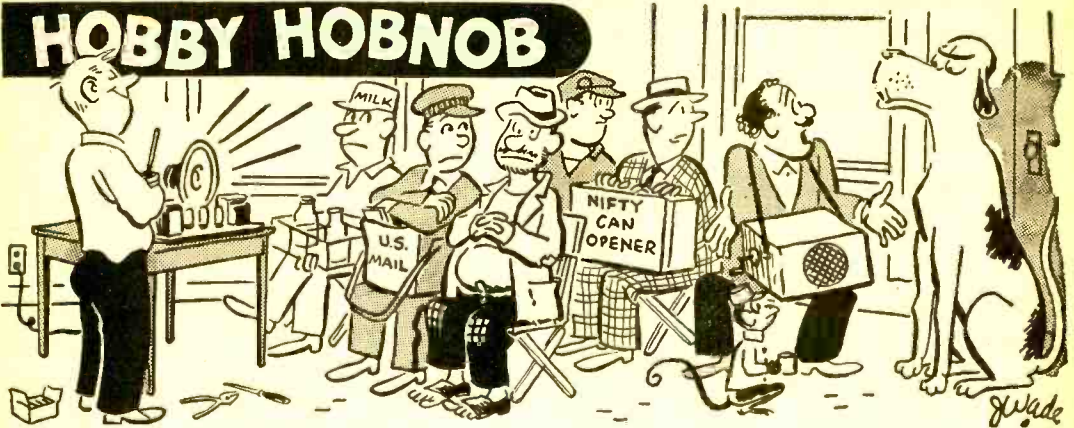

"Datsa the Besta Soundin Amplifier I'va Ever Heard Put Together. Cana we go now?"



ARKAY High Fidelity Amplifier Kit. 10 watts, preamp for reluctance pickup. Tone and treble controls. 5 tubes. Easy to assemble. MODEL A-10. Net \$22.59.

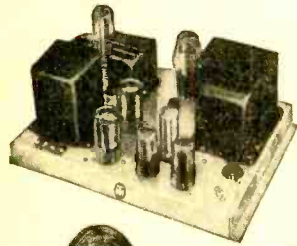

TECH-MASTER 15 Watt Williamson High Fidelity Amplifier Kit. Inputs for crystal pickup, tuner, pre-amp, etc. Major parts mounted on chassis; easy to wire. MODEL TMD-15A. Net \$48.59.



UNIVERSITY low priced 12 Inch Hi-Fi Speaker. 45-10,000 cps response. Handles 30 watts. Excellent for home sound systems. MODEL 6200. Net \$20.47.

TECH-MASTER 4-Channel Pre-Amplifier Kit. Companion to TMD-15A amplifier. Inputs for magnetic and crystal pickups, FM-AM-TV tuner, tape or wire recorder, etc. Full bass and treble controls. Major parts mounted on chassis; easy to wire. MODEL TMD-15P. Net \$19.39.

When it comes to Hi-Fi, kits, supplies, in fact, anything in radio, electronics and TV—you will find it pays to trade at Walter Ashe. Novices and beginners, especially, look to Walter Ashe as the dependable source of supply for all their needs. Our big, new 1955 catalog is now available. To get your free copy, use the handy coupon below.

V-M TRI-O-MATIC Record Changer Attachment. Plays all sizerecords; 3 speeds. Mounted on "plug-in" base. MODEL 956. With dual needle turnover crystal cartridge. Net \$32.59.



MODEL 956-GE. With GE triple play variable reluctance cartridge and dual needles. Net \$35.19.

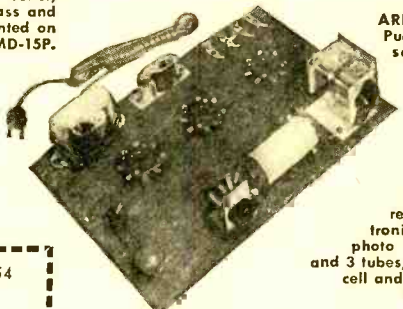

ARKAY Experimenters Multi-Purpose Kit. 10 kits in 1. For schools, beginners, experimenters, etc. You can build any of the following one at a time: BC receiver, phono or mike amplifier, phono oscillator, home broadcast station, code practice oscillator, capacity operated relay, signal tracer, electronic timer, electronic switch, photo cell relay. With all parts and 3 tubes, less headphones, photo cell and socket, wire and solder. MODEL 10-1. Net \$13.59.

Walter Ashe Radio Co. PE-12-54
 1125 Pine St., St. Louis 1, Mo.

RUSH copy of new 1955 catalog.
 Please ship following merchandise _____

for which is enclosed sum of \$ _____

Name _____
 Address _____
 City _____ Zone _____ State _____

Note: Include sufficient postage. We refund unused amount. 20% of total purchase required on C. O. D. order.

All prices f. o. b. St. Louis • Phone Chestnut 1-1125

Walter Ashe
RADIO CO.
 1125 PINE ST. • ST. LOUIS 1, MO.

LETTERS FROM OUR READERS

THANK YOU KINDLY, SIR!

"CONGRATULATIONS on your first issue! The variety of subject matter shows good planning and your articles are well written and well illustrated. The magazine is both interesting and instructive. . . ."

A. D. Davis
Allied Radio Corp., Chicago

"I WAS very pleased to see how complete and well-rounded the first issue was. I think it will fill a very definite need for the beginner in the field of electronics. The articles are well written, plain, and understandable. I am sure it will have a very fine reception with beginners as well as the more advanced experimenters and hobbyists. . . ."

G. L. Dosland
President, American Radio Relay League

"I PURCHASED a copy of PE and took it to the shop to show the fellows. Since then, I have purchased five copies for each one of them. My remarks about this book can be said in one word 'Excellent!' Let's have more. . . ."

Cyril Linek, K2GCT
Bayside, New York

"I APPRECIATED the chance to see and read this much-needed newcomer to our field. I was particularly impressed with the variety of articles and their basic usefulness. . . ."

Avery Fisher
President, Fisher Radio Corp.

"I INTENDED to glance through PE but instead, spent several hours—completely entranced. Without question it fills a real need. . . ."

Albert Kahn
Electro-Voice, Inc.

"I HAVE had only a few minutes to glance through the magazine but find it interesting and look forward to reading it more thoroughly later. I think you are headed in the right direction. . . ."

Norman Krim
Raytheon Manufacturing Co.

"YOUR various color schematics are a nice change and I sure like the pictorial diagrams not so much for myself but for my wife who is interested in radio and hi-fi but has trouble with schematics. . . ."

Ross Sherwood
Olathe, Kansas

"THIS is to extend my hearty congratulations on your introducing PE to we amateurs. It sure is most welcome. Yes, I have read it from cover to cover, even the ads—and I am not jesting either. So keep them coming. . . ."

R. N. Clifford
Upper Darby, Pa.

Perfect
TV Pictures—
ON ALL CHANNELS

150

Miles or more
from TV Stations

UHF and VHF

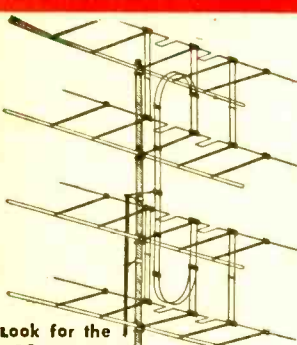

Look for the
FINCO RED SEAL
Your Protection
Against
Inferior
Imitations

Patent Nos.
2,566,287,
2,630,531,
2,655,599

WRITE TODAY FOR
Interesting Free
LITERATURE.

FINCO® 400-A

Double CO-Lateral
TV ANTENNA

Perfect Pictures— ALL CHANNELS, UHF-VHF, COLOR

Perfect Pictures— TESTED AND PROVED RIGHT HERE
IN TOWN — IT'S THE BEST!

Perfect Pictures— ONE TRANSMISSION LINE,
NO SWITCHING!

Perfect Pictures— ALL YEAR 'ROUND — WEATHERPROOF,
ALUMINUM CONSTRUCTION!

THE FINNEY COMPANY Dept. PE-12 • 4612 St. Clair Ave. • Cleveland 3, Ohio

10

POPULAR ELECTRONICS

www.americanradiohistory.com

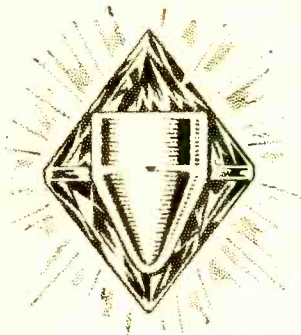

**DIAMOND, THE HARDEST
PHONOGRAPH NEEDLE IS
ALSO THE GENTLEST AND
SAFEST FOR RECORDS.**

REALIZING
THAT THE
MIRACLE OF
SOUND HE HAD
CREATED WITH
HIS "TALKING
MACHINE" WOULD
RAPIDLY DETERIO-
RATE IF THE NEEDLE
BECAME WORN ...

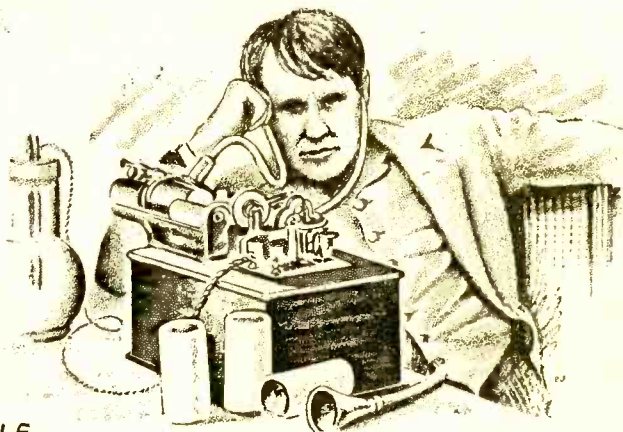

**THOMAS EDISON CHOSE
A DIAMOND NEEDLE...THE
HARDEST, SMOOTHEST AND MOST
DURABLE KNOWN MATERIAL.**

**CONSUMER TESTING LABORATORIES, AUDIO ENGINEERS,
AND RECORD CRITICS HAVE STATED UNEQUIVOCALLY
THAT A DIAMOND STYLUS IS ABSOLUTELY ESSENTIAL
TO HI-FI PERFORMANCE AND PROTECTION OF RECORDS.**

Diamond Phonograph Needles by...

TETRAD

World's Largest Manufacturers of Diamond Styli

REPRINTS OF ARTICLES ON RECORD AND STYLUS WEAR AVAILABLE UPON REQUEST.

Dept. 15-T, 62 ST. MARY STREET, YONKERS, N. Y.



**NEW low-cost
CRYSTAL
MICROPHONE**



the modern
"926"

E-V quality features in handsome new slim design for public address, home tape recorders and communications. Frequency response is smooth peak-free 70-8000 cps. Assures faithful reproduction and clear QSO's. Output level -60 db. Hi-Z. Omnidirectional. Moisture - Sealed crystal. $\frac{5}{8}$ "-27 thread stand coupler. Tiltable, die cast case, finished in Satin Chromium. Size $1\frac{5}{16}$ " x $6\frac{3}{4}$ " including swivel mount. 18 ft. cable. Net wt., 11 oz.

List Price \$24⁵⁰

Ask your E-V Distributor
or write for literature.

NO FINER CHOICE THAN

Electro-Voice

BUCHANAN • MICHIGAN

Export: 13 E. 40th, N. Y. 16, U.S.A. Cables: Arlab

"CONGRATULATIONS on PE. I believe it meets a real need. Most radio magazines are too involved and technical for the average radio hobbyist. Your magazine is just what I have been waiting for. I have been a ham for many years but my main interest is in radio-controlled models. . . ."

Rev. R. W. L. Mark, W3KOJ
Wellsboro, Pa.

The above are excerpts from a few of the many letters we received. Sorry, we haven't room to print them all.

★ ★ ★

NEVER TOO YOUNG NOR TOO OLD . . .

"YOUR magazine is the most marvelous magazine I have ever come across. I am 14 years of age and am interested in amateur radio and just radio in general. If your coming issues are as good as the first one, you will have a lot of sales up my way. I will tell my friends about your magazine. Please continue the story about 'Carl & Jerry'. . . ."

Stanley Christman
Centerport, Pa.

"I HAVE been searching all over for a magazine like yours and now have found just what I wanted.

"About 20 years ago I did some experimenting on d.c. sets but finally got too busy with other work so had to drop it.

"Now that I have retired I am taking it up again but find I have gotten way behind and lost track of all the new modern kinks—so will have to start all over again.

"I think your magazine is just the right ticket for this purpose. It gives the real lowdown in simple language. . . ."

Fred T. Behncke

Glad to hear the magazine appeals to all age groups. Electronics knows no age barrier, as attested by these letters. Thanks for the nice bouquets, gentlemen!

★ ★ ★

OOPS, PARDON US!

"COULD you please explain Question 10 of the Quiz shown on page 118, October issue. If I recall correctly 'if a negative voltage is applied to the grid of a tube, the plate voltage will increase not decrease' as you indicated."

David Goodman
Philadelphia, Pa.

Our faces are red! Mr. Goodman was the first of many readers to spot this error. The question should, of course, read the plate current—not plate voltage. It is obvious that our readers are perusing the magazine thoroughly and that they are really on their toes! Our congratulations to all of the readers who caught this editorial "muffing of the ball."

★ ★ ★

POPULAR ELECTRONICS

**It's New! 3 Years in Development
-NOW READY FOR YOU!**

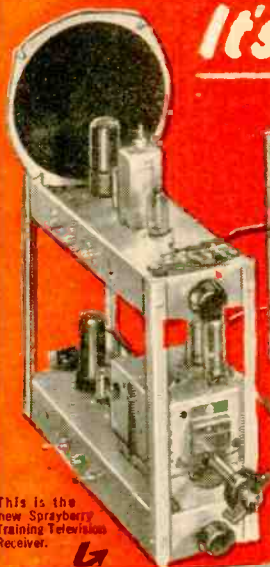

This is the new Sprayberry Training Television Receiver.

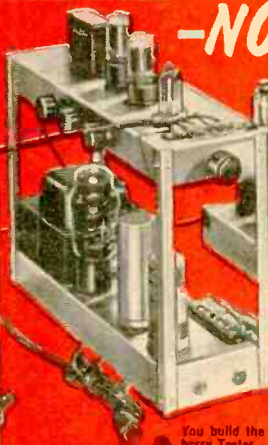

You build the new Sprayberry Tester... 18 range Volt-Ohm-Milliammeter readings

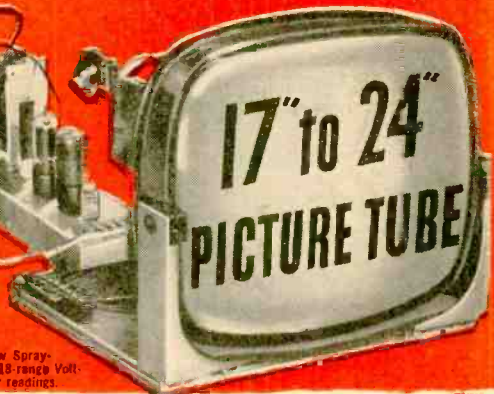

You will build this powerful short wave and broadcast superhet radio receiver.

**New Equipment! New Lessons! Enlarged Course!
SPRAYBERRY PRACTICAL TRAINING IN**

RADIO-TELEVISION

3 NO OBLIGATION TRAINING PLANS



F. L. SPRAYBERRY
Pres.

You have **NO MONTHLY PAYMENT CONTRACT** to sign... pay for this outstanding training as you learn!

Mail the coupon at once for my big all-new 53 page **FREE CATALOG** and **FREE Sample Lesson**. Get the full story of this remarkable new Training Plan. Read about my **3 NO OBLIGATION PLANS** of "packaged unit" instruction. I can prepare you in as little as **10 MONTHS** to take your place as a **Trained Radio-Television Technician**. You take no risk in enrolling for my Training because you **DO NOT SIGN A BINDING TIME PAYMENT CONTRACT**. I have been training successful Rad-o-TV technicians for 22 years. I can prepare you, too, to get into your own profitable Service Shop or a good paying job. Full information **FREE** and without any obligation. No salesman will call.

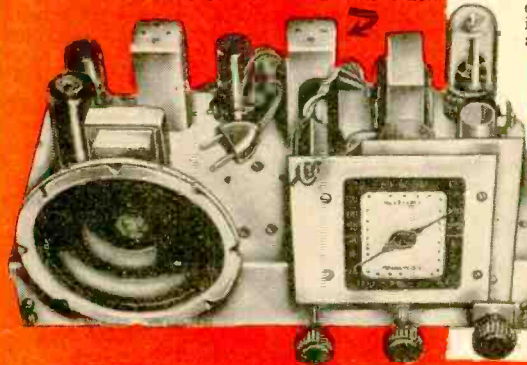

NEWEST DEVELOPMENTS

Your training covers U H F, Color Television, F M, Oscilloscope Servicing, High Fidelity Sound and Transistors.

PRACTICE AND TRAIN AT HOME WITH 25 NEW KITS of EQUIPMENT

You get valuable practical experience in construction, testing and shop practice. You build a powerful 2 band superhet radio, the all-new 18 range Sprayberry multimeter, the new Sprayberry Training Television receiver, signal tracer and many other projects. All equipment is yours to use and keep. All your training is **IN YOUR HOME** in spare hours. I help you earn extra spare time money while you learn. Rush coupon below for all the facts—**FREE!**

SPRAYBERRY ACADEMY OF RADIO
111 NORTH CANAL STREET, DEPT. 105-S
CHICAGO 6, ILLINOIS



FREE CATALOG AND SAMPLE LESSON

Rush coupon for my catalog "How to Make Money in Radio-Television". **PLUS** an actual sample Sprayberry Lesson without obligation—**ALL FREE**. Mail coupon **NOW!**

SPRAYBERRY ACADEMY OF RADIO MAIL THIS COUPON FOR FREE
Dept. 105-S 111 N. Canal St., Chicago 6, Ill. FACTS AND SAMPLE LESSON

Please rush New Catalog and Sample Lesson FREE. I understand that no salesman will call.

Name _____ Age _____
Address _____
City _____ Zone _____ State _____

... COUNT YOUR SAVINGS! ELECTRONIC BARGAINS

RCA SURPLUS TV CAMERAS

Sensational
value at... **\$225**



With 1848 iconoscope and 6-stage video amplifier and clipper. X-ray training and experimental item. Send for complete info.

SIGNAL CORPS PHONE, long range, alum. case with batteries... **\$14.95 pr.**
WESTERN ELECTRIC HANDSET with F-1 unit & cord... **\$2.95**
701A XMTR. TUBES with dope sheet... **\$2.95 or 2 for \$5**
FILAMENT TRANSFORMERS for above... **\$2.95**

24 V. TRANSFORMER & RECTIFIER COMB.

Basic 24 V DC power supply consisting of 110 V. AC primary, 24 V secondary and Rectox Rectifier. Altogether rated at 1 amp will operate up to 3 or 4 amps. **\$2.95**
\$8.95 value

SAVE ON COMMAND EQUIPMENT!

T-21/ARC-5 5.3-7 MC Xmtr... **\$6.95**
R-27/ARC-5 6.9-11 MC Rev... **6.95**
24 V Filament Transformer for above... **1.49**
Command Set Tuning Knobs for above... **59c Ppd.**
Q5'trs, 190-550 KC, like new. Check this at... **\$9.95**

TN-65/APQ-15 Makes a fine 2-METER XMTR. Tunes into "2." Little rewiring & adding modulation Xfrm. Push-pull 6C4's oscillator driving 832 in parallel. MO tuning from front panel. With 6J6, 26C4's, less 832. **\$7.95**
With schematic, conversion sheet

MICRO SWITCH BZ-7RDT normally open or closed. SPDT. New. Postpaid... **3 for \$2**
NOVICE BAND XTALS... **89c**
ROTARY COIL ASSEMBLY. 21 turns of silver-plated wire. With geared precision counter dial & knob. Rated app. 100 W. For all band mobile & single side band linear. Removed from new equip. Shp. wt. 6 lbs. **\$35 value**... **\$5.95**

APS-13 makes a complete 420 MC RADIOPHONE

When converted with our easy-to-follow schematic & instructions. Range equal to 2 meters. For communications, ranches, farms, etc. With RF sections, conversion booklet and 30 MC I.F. Schematic, less tubes, dynamotor and minor parts not needed for conversion. NEW APS-13 Complete... **\$19.95**



METERS

(removed from new equip)
0-4 AMPS RF GE 3" Round... **\$3.95**
for Xmtr. output
3" Black DIALFACE 0-750... **3.95**
MA 300-0-300
MICRO PANEL METERS 3" round... **3.95**
WESTON 0-2.5 AMPS, DC... **3.95**
60-0-60 MICRO AMPS, GE... **4.95**
WESTON FREQ. METER, new... **14.95**

COAX BUYS!

FT&T COAX CABLE RG-8/U 110 FT. roll with PL-259 connectors at each end... **\$5.25**
51.5 OHM similar to above. 500 ft... **\$24.95**
100 ft... **\$4.50**
RG-34/U 71 OHM .025 dia. 5 KW rating, 85' rolls with PL-173 plug at one end, new... **\$7.95**
SO-153 CHASSIS PLUG to match PL-173... **\$.98**
RG-59 25' length with PL-259A at ea. end... **\$1.95**

MINIATURE LINE MATCHING TRANSFORMERS

for blocking oscillators on TV Revs., TV camera input circuits, tone oscillators, etc. Only 4-oz. wt., 4 windings—rated 6 MW **\$1**
200-5000 cy. 500 V. RMS test (plus 25c for handling & shipping)

DUMONT 3CP1 CATHODE RAY TUBES

\$1.79-3 for \$5

With Dumont 224A schematic & parts list. Build your own scope & save! New!

ARC-4 VHF TRANSCEIVER

With Schematic **\$24.50**
For 2 meter CD or CAP including tubes, less dynamotor & xtals. New.

CERAMIC CONDENSERS

Kit of 300 **\$1** postpaid
A s s t. standard brands—with condenser chart. **\$10** value, new!

1000's of ITEMS NOT LISTED—Write for FREE CATALOG! Please send check or money order (no c.o.d.'s please). All shipments FOB warehouse. Californians add 3% sales tax.

Harjo Sales Co.

Dept. PEE, 4109 Burbank Blvd., Burbank, Calif.
Phone: Victoria 92411—Visit our Retail Showrooms.

"WHAT's with this switch on the 'Bike Radio'? In the pictorial, the two right-hand terminals are connected together but my continuity checker shows the two right-hand terminals belong to the same circuit and the path between them is opened and closed when the switch is operated."

Anthony Kingdon
Jersey City, N. J.

Double-pole, single-throw volume control switches made by different companies are connected internally in different ways. If you are in doubt about the proper method of connecting your particular switch, check continuity between terminals or ask the salesman from whom you buy the switch.

★ ★ ★

READER REQUEST

"RECEIVED my first issue of POPULAR ELECTRONICS. It is the best I have read to date.

"How about a series of articles on the conversion of army surplus equipment. . . ."

W. E. Davis
Odessa, Texas

Much as we would like to make all of our readers completely happy, we do not believe it advisable to carry details on surplus conversions.

We have received letters from many other readers asking for articles on building scintillometers, oscilloscopes, small TV receivers, and even color sets! Obviously, articles of this nature are beyond the scope of this publication. There are other magazines in the electronic field which provide information of this type.

★ ★ ★

"I WOULD be greatly interested in more information on how to make an experimental Solar Battery similar to the one reported by the Wright Air Development Center (October, page 25). . . ."

L. A. Quindry
Philadelphia, Pa.

We have received several requests on this but as far as we know the original components used in the experiments described are not available. Basically, the idea is similar to taking a large number of lightmeters or photocells in multiple arrangement to obtain sufficient energy to operate some device. END

The Editors wish to extend to all of our readers their heartfelt thanks for the many generous letters they have written. Frankly, we have been bowled over by this response and only wish it were possible to answer each and every letter individually. Since this is obviously impossible, please accept our warmest thanks for all of your kindnesses. May we take this opportunity to wish you all a Merry Christmas and the Happiest of New Years!

PUT YOURSELF IN THE *High-Paying* TELEVISION PICTURE

R
Radio
T
Television
T
Training
A
Association

Today, when demand for trained men is higher than ever before, pay is higher than ever before, you can train AT HOME in your SPARE TIME to become a Television Technician.



L. C. Lane, B.S., M.A.
President, Radio-Television Training Association. Executive Director, Pierce School of Radio & Television.

PREPARE FOR A BRIGHTER FUTURE AS A TV TECHNICIAN

You can hold down a full-time job and still train AT HOME by the same successful methods I used to help hundreds of men—many with no more than grammar school training—master television!

NO EXPERIENCE NEEDED... I'LL TRAIN YOU AT HOME IN YOUR SPARE TIME

VETERANS!

My School fully approved to train veterans under new Korean G.I. Bill. Available only to Veterans discharged after AUGUST 20, 1951. If eligible, CHECK COUPON.

**GOOD
SPARE TIME
EARNINGS**

Almost from the very start you can earn extra money while learning by repairing radio-TV sets for friends and neighbors. Many of my students earn up to \$25 a week... pay for their entire training from spare time earnings... start their own profitable service business.

**EXPERT FM-TV
TECHNICIAN
TRAINING**

My FM-TV Technician Course can save you months of training if you have previous Armed Forces or civilian radio experience! Train at home with kits of parts, plus equipment to build BIG SCREEN TV RECEIVER. ALL FURNISHED AT NO EXTRA COST!

**NEW!
PRACTICAL TV
CAMERAMAN &
STUDIO COURSE**

I train you at home for an exciting big pay job as the man behind the TV camera. Work with TV stars in the TV studios or "on location" at remote pick-ups! Available if you want it... one-week course of practical work on TV studio equipment at Pierce School of Radio & TV, our associate resident school in New York City.

**OPTIONAL
2 WEEKS TRAINING
IN NEW YORK CITY
AT NO EXTRA COST**

You get two weeks, 50 hours, of intensive laboratory work on modern electronic equipment at our associate school in New York City — Pierce School of Radio and Television. And I give you this AT NO EXTRA COST whatsoever, after you finish your home study training in the Radio-FM-TV Technician Course and FM-TV Technician Course. However, your home study course is complete even without this two-week laboratory session. It is only one of the many Extras available to you from RTTA if you want it.

ENOUGH EQUIPMENT TO SET UP YOUR OWN HOME LABORATORY
As part of your training, I give you all the equipment you need to prepare for BETTER PAY TV job. You build and keep a professional GIANT SCREEN TV RECEIVER complete with big picture tube (designed and engineered to take any size up to 21-inch)... also a Super-Het Radio Receiver, RF Signal Generator, Combination Voltmeter-Ammeter-Ohmmeter, C-W Telephone Transmitter, Public Address System, AC-DC Power Supply. Everything supplied, including all tubes.

FREE FCC COACHING COURSE
Qualifies you for Higher Pay! Given to all my students AT NO EXTRA COST after TV Theory and Practice is completed. Helps you qualify for the TOP JOBS in Radio-TV that demand an FCC License! Full training and preparation at home for your FCC License.

MY 4 FREE AIDS SHOW YOU HOW AND WHERE TO GET A BETTER PAY JOB IN TELEVISION.

See for yourself how my simple, practical methods can make success as easy for you as they have for my hundreds of graduates.



MAIL THIS COUPON TODAY! no salesman will call!

Mr. Leonard C. Lane, President Dept. E-12
RADIO-TELEVISION TRAINING ASSOCIATION
52 East 19th Street, New York 3, N. Y.

Dear Mr. Lane: Mail me your NEW FREE BOOK, FREE SAMPLE LESSON, and FREE aids that will show me how I can make BIG MONEY IN TELEVISION. I understand I am under no obligation and no salesman will call.

(PLEASE PRINT PLAINLY)

Name _____ Age _____
Address _____
City _____ Zone _____ State _____

I AM INTERESTED IN:

Radio-FM-TV Technician Course
 FM-TV Technician Course
 TV Cameraman & Studio Technician Course

VETERANS!
Check here
for Training under NEW
G.I. Bill.

Radio **T**elevision **T**raining **A**ssociation

52 EAST 19th STREET • NEW YORK 3, N. Y.

Licensed by the State of New York • Approved for Veteran Training

How a Capacitor Works

To properly understand how a capacitor works, let's examine what happens when a capacitor is connected to a d-c voltage source.

As soon as the connection is made, charging current begins to flow, rushing in quickly at first and then decreasing until the voltage across the capacitor plates equals the voltage of the energy source. At this point, the capacitor is fully charged and charging current no longer flows.

If, for some reason, there is a decrease in the voltage of the energy source, the capacitor will then discharge stored energy back into the line, tending to keep the voltage of the circuit at its original value.

If the source voltage fluctuates very rapidly as from the output from a tube or disc rectifier, the capacitor will "smooth out" the voltage so that it is at an almost constant level. The larger the capacitance, the better the smoothing. (The maximum amount of capacitance which can be used depends on the electrical characteristics of the rectifier element itself). This "filtering" of voltage fluctuations or ripple in the raw, pulsating d-c output from a rectifier is one of the most widespread applications for capacitors.

The electrical terminology sounds complicated. Let's look at the old-fashioned plunger hand-pump of grandmother's day. When the handle was pumped up and down, water came out in spurts. If the water was pumped into an iced tea crock with a spigot at the bottom, water would come out of the spigot in a steady stream.

Substitute a pulsating electric current for the water and a capacitor for the crock and you have a simple analogy of the action of a filter capacitor in a radio or TV receiver circuit.

Now there are many different kinds of filter capacitors. The Sprague Electric Company, for example, makes numerous types using different dielectrics for filter applications. There is considerable "know how" required in designing the best capacitor of each type for the particular circuit application in which it will be used. Changing capacitor dielectric when making service replacements should be done with mature consideration for the effect of different electrical characteristics found in different types of capacitors. This caution applies also to bypass and coupling capacitors, tuning capacitors, etc., as we will explain later in this series.

Now let's look at a capacitor for energy storage use only. Such a capacitor may be discharged completely after each charge when used in applications such as spot welding and electronic flash photography. This is analogous to dumping the tea crock we spoke about after it has been filled. Paper and electrolytic capacitors are both used as "discharge" capacitors depending on the desired characteristics of the discharge current. Because the current may be very high, ranging up to several thousand amperes in the case of welder capacitors, a special internal construction is usually required. Conventional d-c capacitors will soon short or open circuit in energy storage applications.

—To be continued—

This informative message is No. 2 of a Series contributed by Sprague, the world's largest manufacturer of capacitors. Write Sprague Products Co., N. Adams, Mass., for complete Sprague catalog.

The simple "Voice-trol" for operating a model train. The device can be operated by a child and is 100 per-cent safe.

Voice Operated Model Train Control



By

KARL GREIF

IF JUNIOR is starting to lose interest in that terrific electric train layout that Santa brought him, here's just the thing to revive his enthusiasm. Dad and Junior will battle for turns at the mike and will have no end of fun mystifying the neighbor kids with this electronic ear!

Designed to operate with either *American Flyer* or *Lionel* standard remote-control trains, the terminals of the "Voice-trol" are simply connected in series with one of the track feeders. That is, one of the leads from the train transformer connects to one of the binding posts on the "Voice-trol" unit. A lead from the other binding post then runs to the track. Plug the unit into any 117 volt a.c. line (house current), speak into the mike, and the regular stepping relay in the locomotive does the rest.

The entire unit is built into a 5" x 6" x 4" utility cabinet which comes with an attached chassis. Either a surplus T-17 carbon mike, or a chest set as shown, can be used. The chest set is preferable if you want both hands free. If you do use a T-17 microphone, remove the push-button coil

Talk your model train into performing an interesting series of switching tricks.

spring and lubricate the side of the button, otherwise the noise of pressing the button will trip the relay.

Operation is quite simple although a little careful practice will make for better results and a much more impressive display for your friends. Speak close to the mike. Speak in a sharp, clear commanding tone, making each word distinct, otherwise the signals may run together and give an incorrect message to the locomotive. If the train is moving forward, you know it would require one press of the remote-control button to stop it. Likewise, if you say "Stop!", the "Voice-trol" sees this as a single sound and stops the train. Another single interruption would cause the train to move backward so you can say "Back!". If you had wanted the train to move forward, you could have



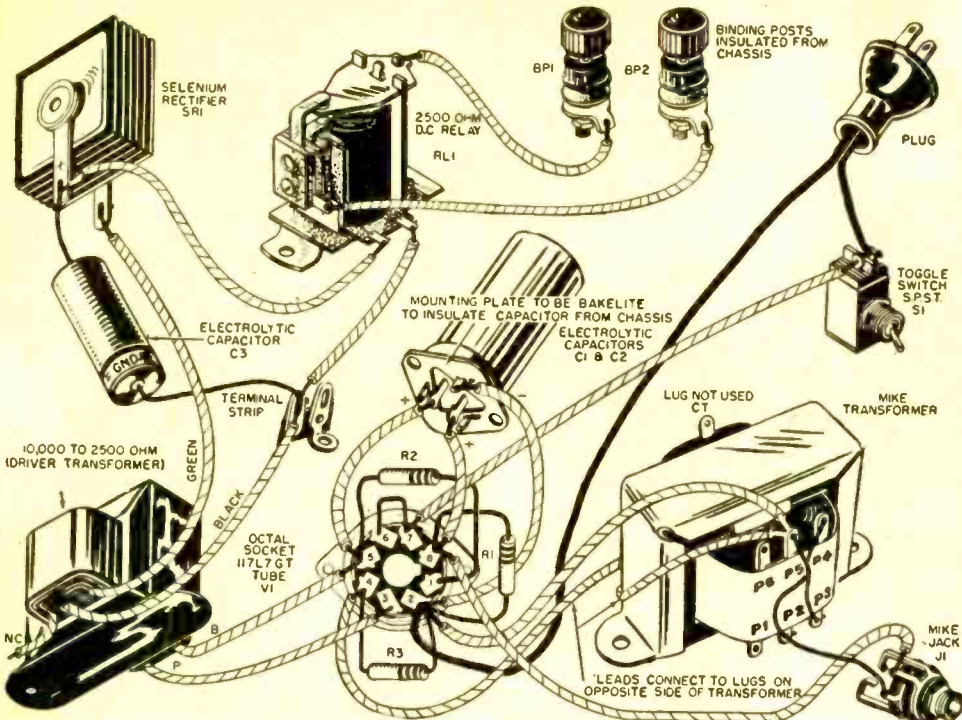

said "Now go forward!", the three words making the three interruptions required for this operation. When moving forward, say "Back up!" and the train will reverse

immediately. The word "Stop!" will halt it.

When moving backward, the command "Now forward!" will send it forward again. It is only necessary to realize the normal sequence of operations of the locomotive stepping relay: forward, stop, reverse, stop, forward, stop, etc. With this in mind, you visualize how many words or syllables are necessary for the desired action. After the train has been stopped for a period of time and the next direction in which it will move is forgotten, just say "Start!" and begin controlling after the train is in motion.

Now to building the unit! The circuit is built around a 117L7GT tube. Power for the carbon microphone is obtained from the cathode circuit of the tetrode half of this tube. (Power is automatically applied to the mike when the mike plug is inserted in the mike jack, J_1 . Note that a three-circuit jack is specified. The shank, which is grounded to the cabinet, is not used. It is necessary, therefore, to use a three-circuit plug with this jack. This method is specified to eliminate the necessity for connecting the shank of the jack to the 117 volt power line which eliminates the possibility of getting a shock from the cabinet or from the phone plug.) A standard single-button mike transformer is used to drive the grid of the tube. The amplified signal is fed to the output of transformer T_2 where it is rectified and filtered. The value of filter capacitor, C_3 , has been chosen so that it smooths out only the individual cycles of a sound and does not

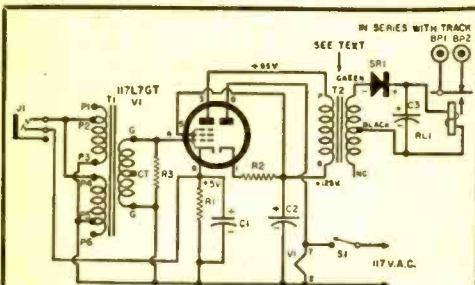

R_1 —150 ohm, 1 w. res.

R_2 —15 ohm, $\frac{1}{2}$ w. res.

R_3 —470,000 ohm, $\frac{1}{2}$ w. res.

C_1, C_2 —100/40 μ d., 25/150 v. elec. capacitor (both units housed in same container)

C_3 —4 μ d., 250 v. elec. capacitor

RL_1 —S.p.d.t. 2500 ohm d.c. relay (Potter & Brumfield LMS used by author. Since second contact was not used, a s.p.s.t. relay could be used instead)

SR_1 —75 ma., 117 v. selenium rectifier (Federal Model 1003)

S_1 —S.p.s.t. toggle switch (power "on-off")

BP_1, BP_2 —Binding post (Eby)

J_1 —Three-circuit microphone jack (see text)

T_1 —Mike-to-grid trans. 500/333/200/125/50 ohms (Stancor A-4352 was used. Connections P_1 and P_2 on the primary and the center tap on the secondary were not used)

T_2 —Output trans. 10,000 ohms to 2500 ohms (Stancor A-4713 or equiv.) The bottom half of the split secondary was not used)

V_1 —117L7GT tube

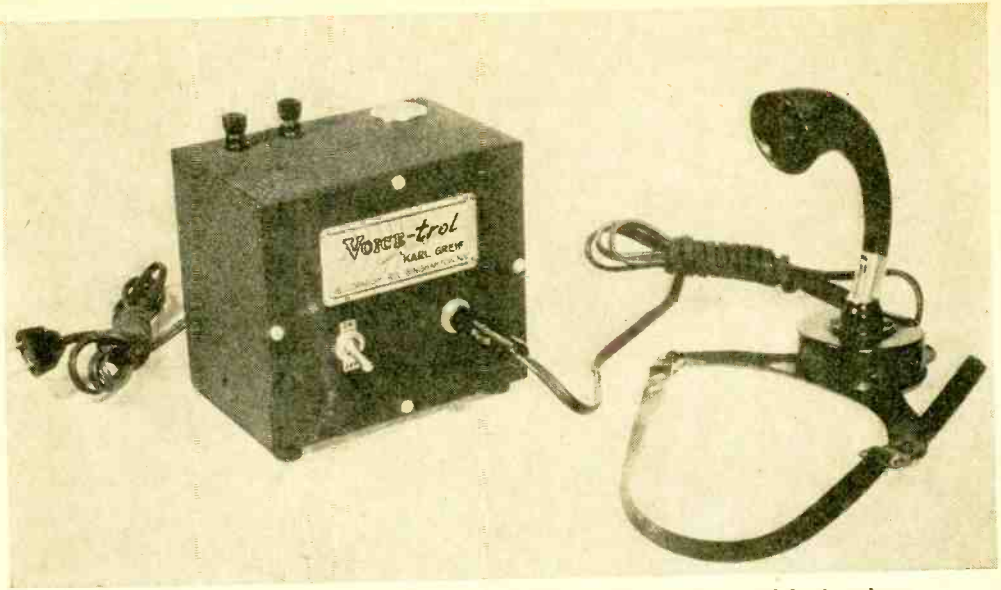

Close-up view of the complete "Voice-trol" system, including chest-model microphone.

tend to "hold up" the d.c. level between syllables or words.

The plate voltage is provided from the diode half of the tube. The relay should have an armature with as little mass as possible so as to be capable of very snappy operation. The relay mechanism should be adjusted to pick up with from 8 to 10 milliamperes of current. The rectifier, SR, in the circuit diagram, is mounted under the relay and held in place by the relay mounting screw.

Only half of the split secondary of T_2 is utilized, the green lead located at the primary end labeled "B" being the correct one to use along with the black center-tap. If you have any doubts about this connection you can find the correct lead as follows.

Whistle loudly and steadily into the mike and try each green lead. The one causing the highest voltage across the relay is correct. The circuit functions only during the period when the tube conducts heavily, or on the negative-going swings at the plate. Because of this the transformer and rectifier polarities are important.

Since the click of the relay in the "Voice-trol" is audible, it is best to just plug in the unit alone, without the train connected and practice the basic commands until you have the technique well in hand, with the relay tripping nicely for each word or syllable. Then, with the train connected, you will be ready to sit back and control your locomotive easily and surely—much to the amazement of your friends! END

Top chassis view. Layout is extremely compact.

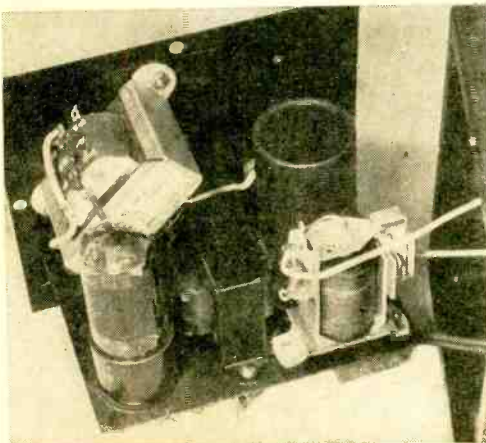

Under chassis mounts rectifier and electrolytic.

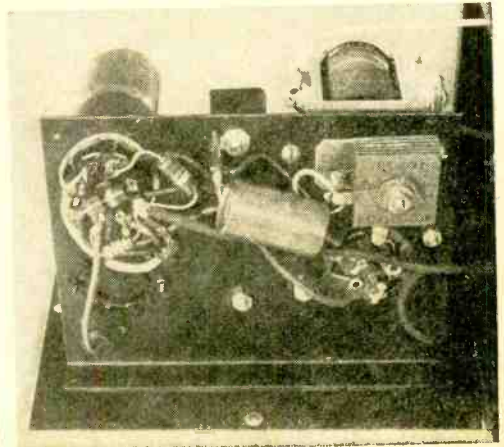



GOLD RUSH of 1954

PROSPECTING for uranium, the "Gold Rush of 1954," is being spurred by a U.S. Government reward of \$35,000 for discovery of uranium ore. In response to a wide demand for a low cost Geiger counter, the *Goldak Company* of Glendale, California has announced the U-238B Geiger counter.

Weighing only 3¼ pounds, the U-238B is easily packed and is designed for long usage under the most rugged conditions.

The unit is powered by batteries and features a voltage regulator tube that adds life to the batteries and guarantees automatic calibration. Other features include a printed circuit and a neon blinker for night readings.

BUILD-IT-YOURSELF ORGAN KIT

A NEW home model organ in a "build-it-yourself" kit is offered by *Electronic Organ Arts* of Los Angeles. The compact console is designed to appeal to the home owner whose space may not warrant larger models.

The tone-generating system consists of vacuum-tube oscillators keyed from the manuals, tone-shaping circuits controlled by standard organ stops, and a hi-fi amplification system. For additional information, write the manufacturer at Box 41084, Los Angeles, California.

MANICURE SET HAS NEW FUNCTION

NEW uses for manicure set items are reported by *General Electric's* publication, "Techni-Talk." Nail polish can double as cement or for color-coding of parts. A filed-down orange stick makes a non-conductive screwdriver. Emery boards and nail files can clean connections to be soldered. Nail clippers can cut and strip small wires. Tweezers can hold tiny parts.



The RCA "STRATO-WORLD" on SAFARI



FOR two months, this *RCA Victor* portable was the only source of news of the "outside" world on a 4000 mile hunting safari into Africa, headed by Barney Berlinger, a Pennsylvania gear manufacturer. Photo, taken in Tanganyika, shows Berlinger with his son, Barney, Jr., and a native guide. Although dumped in the river once, and constantly pounded in truck rides over rough terrain, the "Strato-World" performed without trouble during the entire trip. At the end of the safari, the set was presented as a gift to Harry Selby, guide.

A "UNIVERSAL" TEST SPEAKER

for the HOME LAB



Fig. 1. Front view of home-built "test speaker."

RADIO and TV technicians find that a "test speaker" is an extremely valuable tool. By using a test speaker, they can avoid the necessity of hauling a bulky cabinet or large loudspeaker into the shop when they only have to check out or repair an amplifier or receiver chassis.

A test speaker also enables them to check the condition of an output transformer, a loudspeaker, a filter choke, or a speaker field in a piece of equipment by the very reliable "substitution" method.

But you don't have to be a radio technician to find uses for a test speaker. If you're just an average experimenter, you'll find that a test speaker will enable you to

obtain greater enjoyment from your hobby. Not only can you use the test speaker just like a technician, when you service your own or a friend's receiver, but you can also use it in your experimental work.

If you're working with a new amplifier circuit, for example, you can use the test speaker to check out the amplifier and to iron out "bugs" before you hook in your expensive "hi-fi" speaker. You can use the test speaker to test small radios. You can use it as an extension speaker. And you can use it as an emergency "extra" speaker for a phono or p.a. amplifier system.

Although the test speaker shown in Fig. 1 looks like a "factory built" piece of

Fig. 2. Complete schematic diagram and parts list for the "universal" test speaker unit.

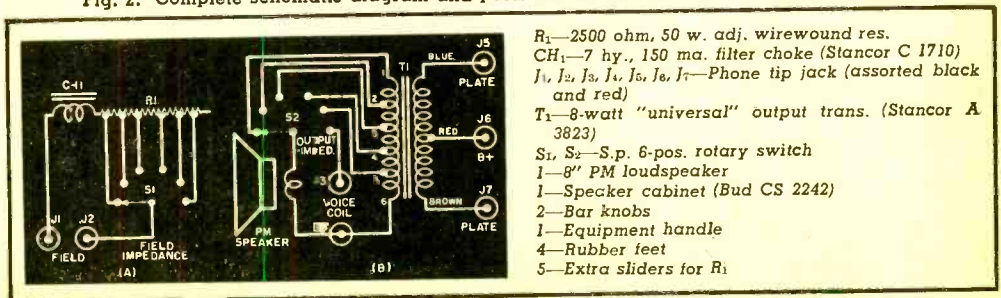

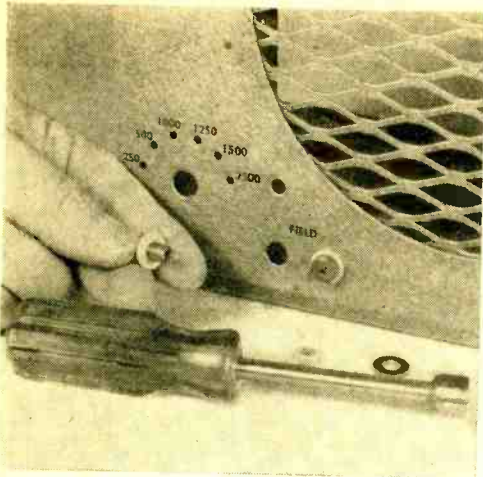

Fig. 3. Use shoulder washers to insulate jacks.

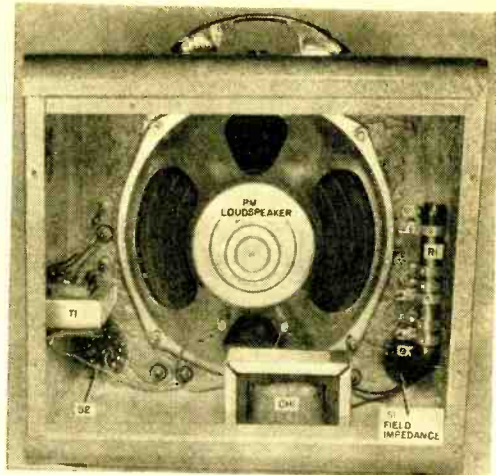

Fig. 4. Rear view of the completed test speaker.

equipment, it is entirely home-made, and may be easily duplicated by the average builder.

The schematic wiring diagram for the test speaker is given in Fig. 2. As you can see, the instrument consists of two completely independent circuits. The "Field" circuit shown in (A) is made up of a filter choke (CH_1), an adjustable resistor (R_1), and a simple selector switch (S_1). The "Speaker" circuit (B) consists of a PM loudspeaker, a universal audio output transformer (T_1), and a second selector switch (S_2).

A standard speaker cabinet is used for housing the entire assembly. Drill the front panel of the cabinet as shown in Fig. 1. Dimensions are not critical.

Additional mounting holes are required in the top, sides, and bottom of the cabinet. Holes are drilled in the top for the handle; in one side for mounting the adjustable 50-watt resistor; in the other side for mounting the audio output transformer; and in the bottom for mounting the filter choke. Four holes are drilled in the bottom for mounting the rubber feet.

You can locate the mounting holes easily by holding the part to be mounted against the cabinet and marking the hole locations with a scribe.

After all machine work on the cabinet is completed, you can, if you wish, label all controls and terminals. Commercially available decals may be used for this job. If you are unable to find a particular word in a standard set of decals, you can make up a label by using individual letters. The design enclosing the words "Test Speaker" on the model was obtained from a set of "Trademark" decals.

At least two coats of clear plastic should be sprayed on the front panel for protec-

tion. Do this after all decals have been applied and are thoroughly dry.

Be sure to use insulating shoulder washers when you mount the phone tip jacks to prevent shorts to the cabinet. See Fig. 3.

The location of all major parts is shown in the rear view of the completed test speaker given in Fig. 4. A two-pole, six-position switch was used for S_2 in the model in place of the single-pole switch specified in the parts list. The unneeded contacts were simply ignored.

Adjusting Test Speaker: After you have completed the wiring and double-checked for errors, you should adjust the taps on R_1 so that the actual resistance values obtained correspond to the settings of the "field impedance" selector switch (S_1). The values of 250, 500, 1000, 1250, 1500, and 2500 ohms used in the model were selected arbitrarily. You may choose other values if you wish. If you need values greater than 2500 ohms, replace R_1 with a 5000 or 10,000 ohm resistor.

To adjust the taps, connect a reasonably accurate ohmmeter to the "field" terminals of the speaker. Set the "field impedance" switch to the lowest resistance value and adjust the corresponding tap on R_1 until the correct total resistance reading is obtained. See Fig. 5. Adjust all the taps in the same way, turning the selector switch to a new position each time.

Using the Test Speaker

Substitute Field or Filter Choke: Connect a pair of test leads to the "field" terminals. Set the "field impedance" switch to the desired d.c. resistance value. Using the leads, connect the "test" field in place of the speaker field or filter choke in the equipment being checked. You'll have to disconnect at least one lead of the filter

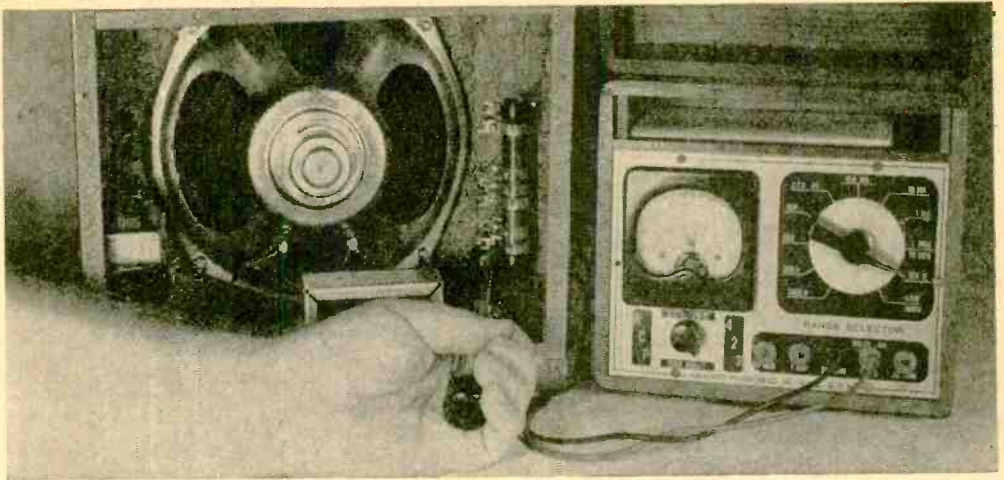

Fig. 5. Adjusting the taps on the series "field" resistor. See text for details on this step.

choke in the equipment in order to do this.

Do not connect the "test" field in parallel with the speaker field or filter choke!

If you need a substitute field or filter choke having a d.c. resistance greater than has been provided, simply connect a wire-wound resistor in series with one of the test leads. For example, if you need a 3000 ohm field, but 2500 ohms is the highest value available in the test speaker, use a 500 ohm series resistor. In most cases, a 10 or 20 watt resistor will be satisfactory.

Substitute Loudspeaker: Connect the test leads to the "voice coil" terminals. Set the "output impedance" switch to the "VC" (voice coil) position. The test leads may then be connected to the secondary winding of the output transformer in the equipment being checked. The test speaker may be connected either in place of, or in parallel with, the speaker in the equipment. If

connected in parallel with the equipment's speaker, both units will operate simultaneously.

Substitute Loudspeaker and Output Transformer: Connect test leads to the "output trans" terminals of the test speaker. Three leads are required if the test speaker is used for checking equipment having a push-pull audio output circuit. Disconnect the primary leads of the output transformer in the equipment being checked and connect the test speaker leads in their place. Finally, rotate the "output impedance" switch until the best quality sound is obtained from the test speaker.

Other Applications: To use the test speaker as an extension speaker or as an "extra" speaker in a p.a. system, connect leads to the "voice coil" terminals and set the "output impedance" switch to the "VC" position. END

Fig. 6. How the test speaker can be used to check a small radio. It has many other uses as well.

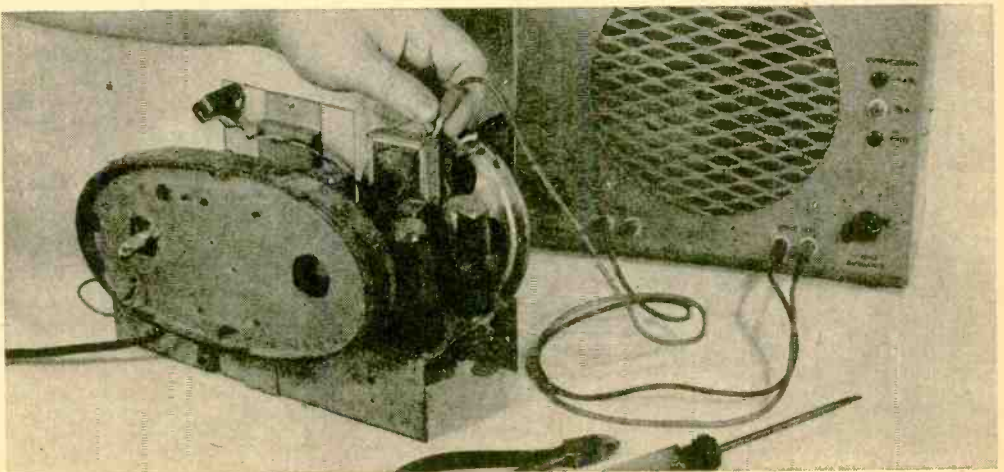



Dodge officials are thanked by "walkie-talkie" for the truck they donated to Inter County Amateur Radio Club. Left to right: William C. Newberg, president of the Dodge Div.; Fred J. Lamborn, vice-president and general manager; L. J. Purdy, vice-president and general manager—trucks; George Wilde, trustee of the radio club; Al Thomas, communications coordinator of the Detroit CD; Ted Hoffman, Detroit assistant executive director of the Red Cross; and John Sauer, coordinator for the ARRL of the mobile unit.

Emergency Radio Truck Covers Detroit Area

A CEASELESS vigil is being maintained by members of the Inter County Amateur Radio Club to provide valuable communications assistance in any disaster in the Detroit area.

An emergency radio truck, donated by the Dodge Division of Chrysler Corporation, serves as a mobile unit for radio station W8GIS. The mobile unit is equipped with a generator and three complete radio stations, including a 2-meter teletype-writer. Many East Coast and Midwest stations have been contacted on the 10-meter band transmitter.

The unit has room for five operators in the 12½ foot body. The 6', 4" headroom permits tall operators to stand erect. A

heating unit keeps the truck comfortable in cold weather.

The Club has built 104 "walkie-talkie" type units at a cost of about \$25 each for use with the mobile unit and in other communications work.

Members of the club are trained and ready to provide vital aid in any emergency or disaster in the Detroit area. They work closely with the Office of Civilian Defense and the American Red Cross in the area.

John Sauer, a Dodge employee, is coordinator on the mobile unit for the ARRL. His car is also equipped so that it can work in conjunction with the mobile unit. END

Interior of mobile unit. Joe Gardella (left) operates 2-meter teletype while Gus Undy (right) vice-president of Multi-Products Co., donor of radio equipment, operates 10-meter transmitter. Looking on are John Sauer, Fred J. Lamborn, L. J. Purdy, and Wm. C. Newberg.

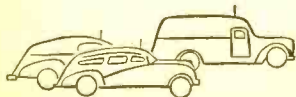

E, I, R, and P Chart

IF YOU know any two of the four quantities, voltage (E), current (I), resistance (R), and power (P), in a circuit, you can find the other two by using this chart. Using the upper part of the chart, just lay a straightedge between the graduations corresponding to the two quantities you know, then read the other two quantities where the straightedge crosses the corresponding lines.

For example, suppose the voltage is 100 volts and current is 30 milliamperes. The resistance is 3330 ohms (approximately) and the power is 3.0 watts.

If the quantities you have are larger or smaller than any shown in the chart, you still can find your answer. Move the decimal point in each quantity to bring it within the range of the chart. In a power figure, move the decimal point a multiple of three places; in a voltage figure, a multiple of two places. In current and resistance, the decimal point can be moved any number of

places. Then, using the lower part of the chart, lay your straightedge between the numbers corresponding to the number of places you must move the decimal point on the chart left or right to get the quantities you actually have. Read along the straightedge the number of places you will have to move the decimal point in each answer as given by the chart, to get the proper decimal point for your actual problem.

For example, suppose that the voltage in the previous example had been 0.01 volt and the current 0.3 milliampere. To go from 100 volts to 0.01 volt, we must move the decimal point four places to the left. To go from 30 milliamperes to 0.3 milliampere, we must move the decimal point two places to the left. In our answers, we must move the decimal point two places to the left in resistance, giving 33.3 ohms, and six places to the left in power, giving 0.000003 watt (0.003 milliwatt or 3 microwatts).

END

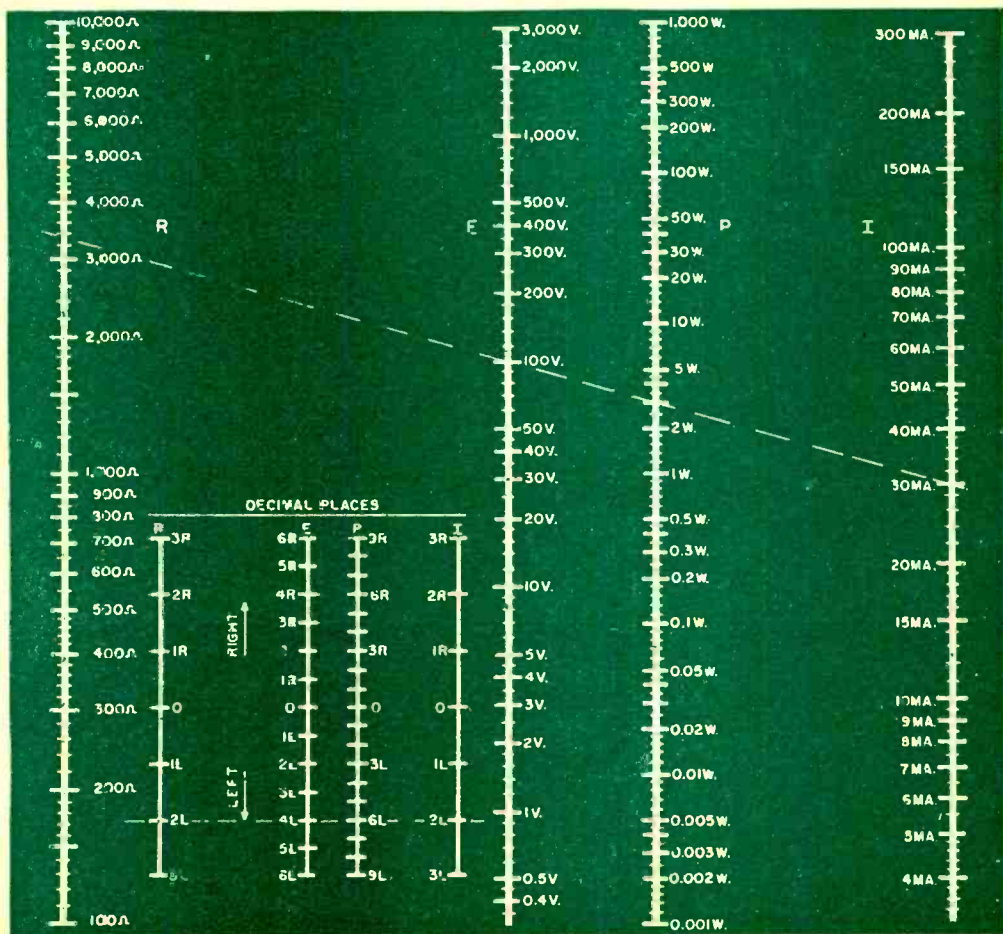



A Twinkling

By
E. D. MORGAN



The completely wired tree. The base, not shown, can be decorated to suit.



THE Christmas season usually stirs an urge in most of us to attempt something different in the way of holiday decorations. Our favorite way of expressing this seems to be either in our Christmas trees or in exterior house lighting. In any case, most people must limit themselves to commercially available items which they simply purchase and install. A worker or hobbyist in any of the electrical fields is not so restricted. He is familiar with the materials and tools required and has the know-how to handle many unusual and novel lighting effects.

The Christmas tree described in this article certainly qualifies as novel. It is a clear, plastic tree about 12 inches high and is decorated with many tiny flickering lights. It makes a fine table centerpiece, mantle decoration, window display, or television lamp. It is portable and there is no need to worry about line cords or the location of the nearest power outlet.



Christmas Tree

The NE-2 neon glow lamps used are the appropriate size to trim a tree this small and they have a soft red glow when lighted. Unlike an incandescent lamp, they have no filament and can be flashed very rapidly. Fifteen of these lights were used because that was the number of major branches on the tree. Fourteen of them blink on and off (about once or twice per second) while the top light remains steady. The power required for these lamps is quite low and a dry cell supply is entirely satisfactory.

It is almost impossible to make the wiring inconspicuous and so an attempt was made to keep it attractive. The wire chosen was AWG No. 22, stranded, with red and green plastic insulation. There is a lot of wiring involved and the smallest wire you can get will be the most desirable. Dark green spaghetti tubing was used to cover bare wires, such as resistor leads. Soldered points were covered with electrical tape, for safety purposes, but the

entire area was then covered with gaily colored gummed tape in a Christmas motif. The battery and capacitors, which are used to cause the lights to flash, were built into a square base. This was, in turn, covered with a bright cloth.

The plastic tree is sold as the "Party Tree" and widely distributed through variety and department stores as well as gift and novelty shops. The same type of tree is probably manufactured and distributed under different names. When purchased, the tree is in two pieces and comes equipped with a base as shown in the accompanying photograph. The two parts are each slotted halfway through the trunk so that they dovetail together and fit into the plastic base. By doing most of the wiring before assembling the two halves, a much neater effect can be obtained as well as simplifying the construction.

The schematic wiring diagram and parts list is shown in Fig. 1. The neon lights

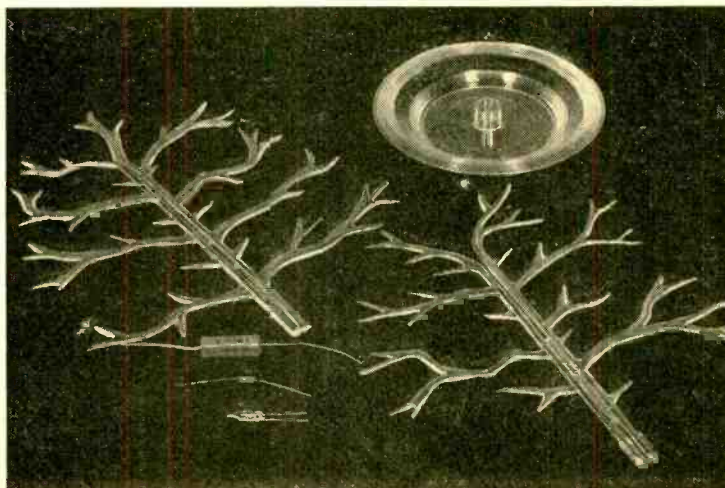

Some of the parts needed to build the tree. The base is used to supply the plastic material needed to secure lamps to branches. A NE-2 neon lamp is also shown along with resistor and capacitor.



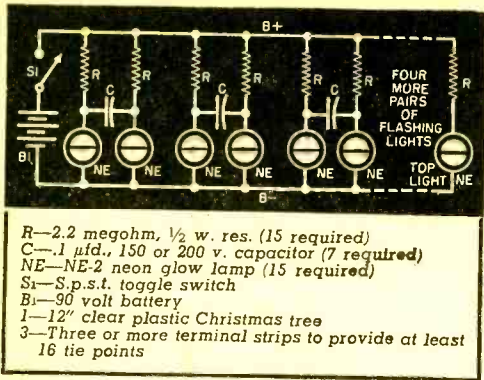

Fig. 1. Schematic diagram and parts list covering the flashing circuit for the tree.

are connected in pairs using the "flashing" circuit indicated, which is an outgrowth of the relaxation oscillator. There are seven flashing pairs while the top light remains steady. Each pair flashes at a slightly different rate and the lights seem to dance from branch to branch.

The neon lamps have no sockets but must be soldered directly into the circuit. There is nothing critical about any of the parts, except that the capacitors and battery should be as small as possible, otherwise, the base size must be increased out of proportion to the size of the tree.

Mounting and Wiring the Lights

The first step in construction is the mounting of the neon lights on the individual branches. After trying several methods of doing this, the simplest way seems to be that shown in Fig. 2A. The tree and base are made of a thermoplastic material, which means that if heated it becomes pliable and when cooled returns to a solid state and the process can be repeated over and over.

Bottom view of the tree stand which contains the circuitry. The battery (left) has been removed so components are visible. Use of other parts may change layout.



As the base serves no purpose in the final mounting, it can be used to help in the securing of the lamps to the tree. Simply break off pieces of the base, place the lights in the desired position and, using a soldering iron to supply heat, literally "weld" the light in place. A small strip of the plastic can be used much as wire solder is manipulated. You can then feed in the plastic and form a smooth covering over the two wires on the lamp base. Be sure to keep the base wires separated so that the plastic, upon cooling, acts as an insulator between them. In this fashion you can proceed to mount all the lights on the two halves of the tree.

The next step is to make the connections to the lamps before assembling the two halves. One side of the lamp connects to both a resistor and capacitor, while the other side returns to the "B—" or common side of the battery. As both the battery and the capacitors are to be mounted in the base, the wiring for them must be carried down the trunk of the tree. Fig. 2B shows the method followed in making these connections. The wire fastened to the resistor side of the lamp must be left long enough to allow it to reach into the base, while the other wire must be long enough to reach the trunk of the tree and connect to a common bus wire there. The resistor leads can be cut so that they, too, reach the trunk of the tree and connect to a "B+" bus running toward the base.

As we have already mentioned that the material is easy to melt with the application of heat, you must take pains that the soldering operation does not undo what you have already accomplished in mounting the lights. The easiest way to insure this is to grasp the wires between the lamp and the soldering iron with pliers and the heat will then tend to flow into

the pliers instead of up the wire to the plastic. Put spaghetti tubing over the resistor leads before soldering. The lamp on the tree top, which will not flash, does not need the extra lead to run down into the base. Connect a resistor to one lead of this lamp and a wire to the other to reach the "B—" bus wire.

Then fold the resistor and the common lead back along opposite sides of the tree branch and tape all exposed wiring as indicated in Fig. 2C. Fold the wires so that the resistors are all on one side of the tree and the common leads on the other.

The wiring is greatly simplified if this is done. The electrical tape should be cut into small widths before taping the exposed joints. In this way you can do a smoother and less bulky taping operation. The neater it is done, the better the finished product will appear. The electrical tape is then covered with Christmas wrapping tape to improve its appearance.

It would be wise to study the wiring diagram of Fig. 3 carefully before proceeding. It will be necessary to put the two halves of the tree together after they are wired and so care must be taken to insure that this is possible. The solid lines represent the "B+" bus and the dotted line the common, or "B—" bus. You can either scrape the insulation back at intervals on these bus wires, or use bare wire and put spaghetti tubing between connections. It is also wise to use different colors for the positive and negative bus wires so they can be easily identified after you later thread them into the base. Note carefully that the wiring is arranged so that the center section of the tree trunk is never crossed by any wire. This is absolutely necessary if the two halves are to fit together when you are finished. Again, tape all exposed wiring. Be careful to keep the wires and the iron away from the plastic to avoid melting or warping it.

Base Construction and Wiring

You must now build a base and wire the bottom section before you can proceed with the tree proper. Many of the construction details for the base can be seen in the photograph. The battery has been removed so the wiring and assembly will be apparent. Other types of bases could be designed and your choice depends upon the materials and tools you have to work with, and on the size of the components. Fig. 4 shows many of the construction details of the base used for this particular tree. It consists mainly of a 6" square piece of $\frac{3}{4}$ " board with a $\frac{1}{2}$ " hole in its center. Mounted on the upper side of this is a small 2" square piece of the same material with a $\frac{5}{8}$ " hole to hold the tree in place.

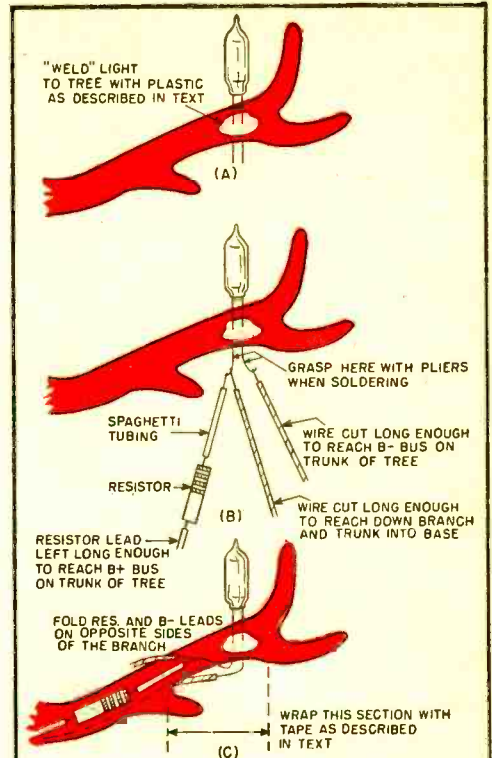
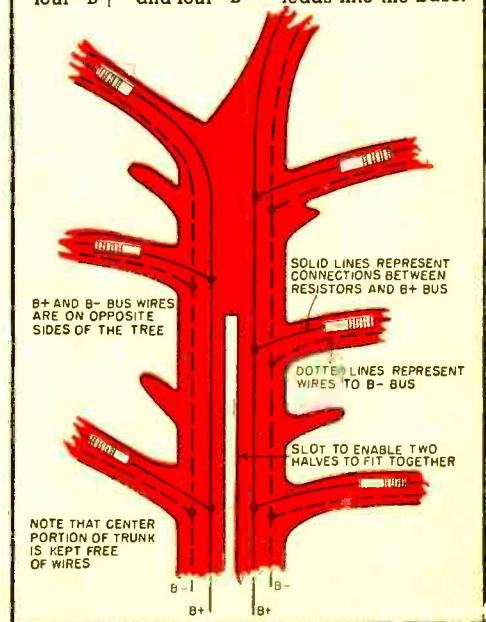

Fig. 2. Method of mounting and wiring neon lamps on individual branches. (A) Using plastic to "weld" light to branch. (B) Fastening resistors and leads to base of lamp. (C) Placement and taping of the wiring used in construction.

Fig. 3. Method of wiring trunk of the tree. Each half is wired in the same manner before they are put together. The assembled tree will have four "B+" and four "B—" leads into the base.



The wiring goes through these two holes into the base.

On the under side of this board are mounted the terminal strips to support the capacitors and provide tie points for the wires coming from each of the fourteen flashing lights. Another terminal strip acts as a tie point for the positive and negative bus leads. Small pieces of wood act as stand-offs for the battery so that the wires have room to run to the various terminals.

A switch is mounted in one corner of the unit on a small L-shaped bracket of thin metal. Two other side braces serve to support the entire unit as well as to secure the battery in place. These pieces are cut long enough to reach the level of the battery when it is inserted against the stand-off strips. A piece of Masonite across the tops of these blocks holds the battery firmly. Furniture glides serve as mounting legs and fasten this piece of Masonite to the blocks.

With this type of construction the sides do not support any weight and so they were cut from a piece of Bainbridge board.

Fig. 4. Suggested layout for building the base of tree. Dimensions must be altered if any of the parts chosen by builder is changed in size.

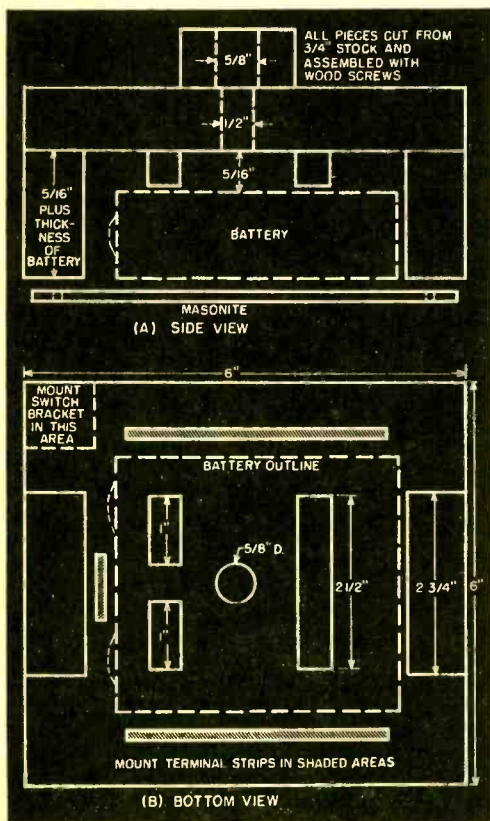

This is a high grade cardboard often used for sign painting. It merely closes in the base as the cloth completely covers this portion of the tree.

Final Assembly

After building the base and mounting the capacitors and switch, the tree may be assembled and inserted in the $\frac{5}{8}$ " mounting hole. The fourteen leads from the lights should be carried straight back along each branch and fed along the trunk into the base. At intervals along the trunk of the tree, tie the wires in place so they will retain their position. Green darning thread is ideal for this purpose. Your neatness will again affect the final appearance.

The leads should be connected to the capacitors in a random fashion, one wire to each end of the seven capacitors. It is not necessary to pair the lights in any particular fashion and only if two lamps side by side appear obviously coupled together when you are through, will there be any reason for further change. The "B+" and "B-" leads should be fastened to their respective terminal strips. The battery can then be connected through a six- or eight-inch pair of wires to the "B-" terminal and through the switch to the "B+" terminal. The battery should have a long life with this small power drain and so you can solder the wires directly to its terminals unless you happen to have the proper connector. Check the entire unit for proper operation and then insert the battery in place, fasten the retaining pieces, and cover the base.

The covering operation is best delegated to the female branch of the family. Mothers, wives, and sisters have a much better knack for this sort of thing than the men of the household and they can cover it as they see fit. The author's unit was covered with a cloth sold at Christmas time for such purposes and often called "glitter cloth" because it is covered with highly reflective colored pieces to catch and reflect the light.

This particular phase of the construction is a good chance for the ladies to display their ingenuity. The family's name can be spelled out in sequins, a model village can nestle in the "snow," or greens can be draped artistically around the "box" to hide its construction.

With that the tree is completed and in a dimly lighted room will soon become the center of conversation. It is certainly unusual and you can be sure that you will be asked many times where you got it. Be prepared with a ready defense, however, or you will find yourself spending the entire holiday season building them for your friends and relatives. **END**

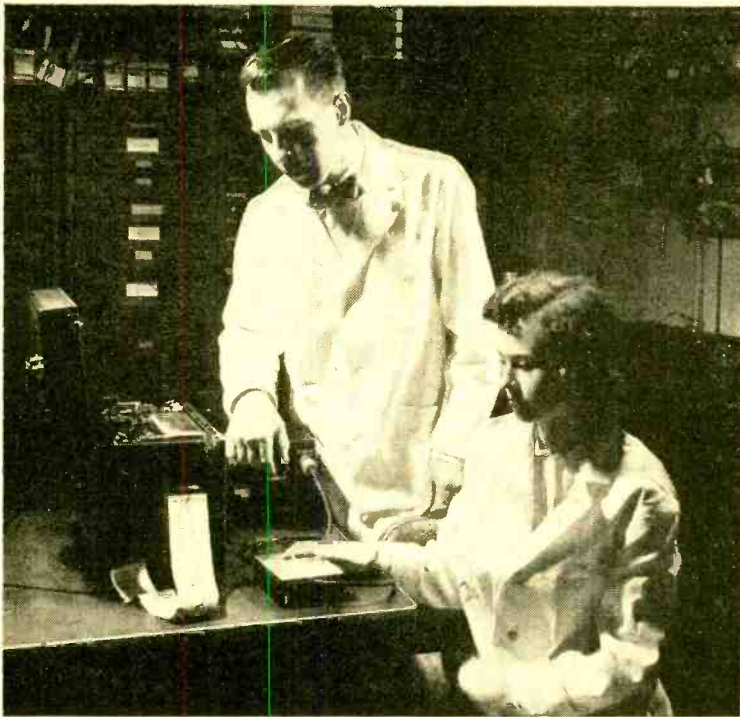

The "photoelectric plethysmograph" in use at the Laboratory of Technical Development of the National Heart Institute. The instrument is operated in conjunction with the electrocardiograph.



Photoelectric Plethysmograph

JUST as detectives identify suspects by taking prints of the fingers, a new research device investigating factors in blood circulation takes the finger for evidence . . . but in this case the scientific "detective" is able to look *into* the finger of his "suspect".

This new research instrument, which is under development by the Public Health Service, is called a "photoelectric plethysmograph." It uses a photomultiplier tube as its essential element and employs an ordinary electrocardiograph to put in writing the electrical translation given by the photomultiplier.

The instrument has applications in the study of diseases of peripheral blood vessels, as in the fingers and toes.

A pulse wave that has been recorded as blood surges out of the heart at the aorta may, for example, be simultaneously recorded with the unit at the finger tip. The time it takes this wave of blood to travel through the blood vessels down the arm to the finger tip is obtained by comparison of two readings, giving one of the circulatory clues this instrument provides.

In operation, the finger is placed on the surface of the box shown in the photo-

graphs. It is placed over two openings, under one of which is a strong light which shines up and penetrates the finger tissue. Under the other opening, which goes down at an angle, is the photomultiplier tube to measure light reflected by the finger tissue. The varying light, caused by the surge of blood in the vessels, is translated into corresponding changes of electric current which are amplified and then recorded. **END**

Closeup view of "box" containing photomultiplier tube. Finger is placed over two openings.

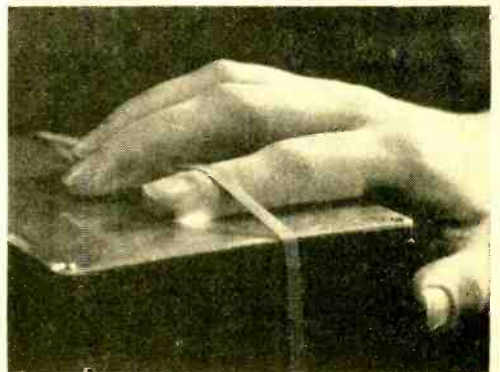

Flying the R/C Plane

Fig. 1. A typical radio-controlled model airplane showing the various axes around which the plane has a tendency to rotate.

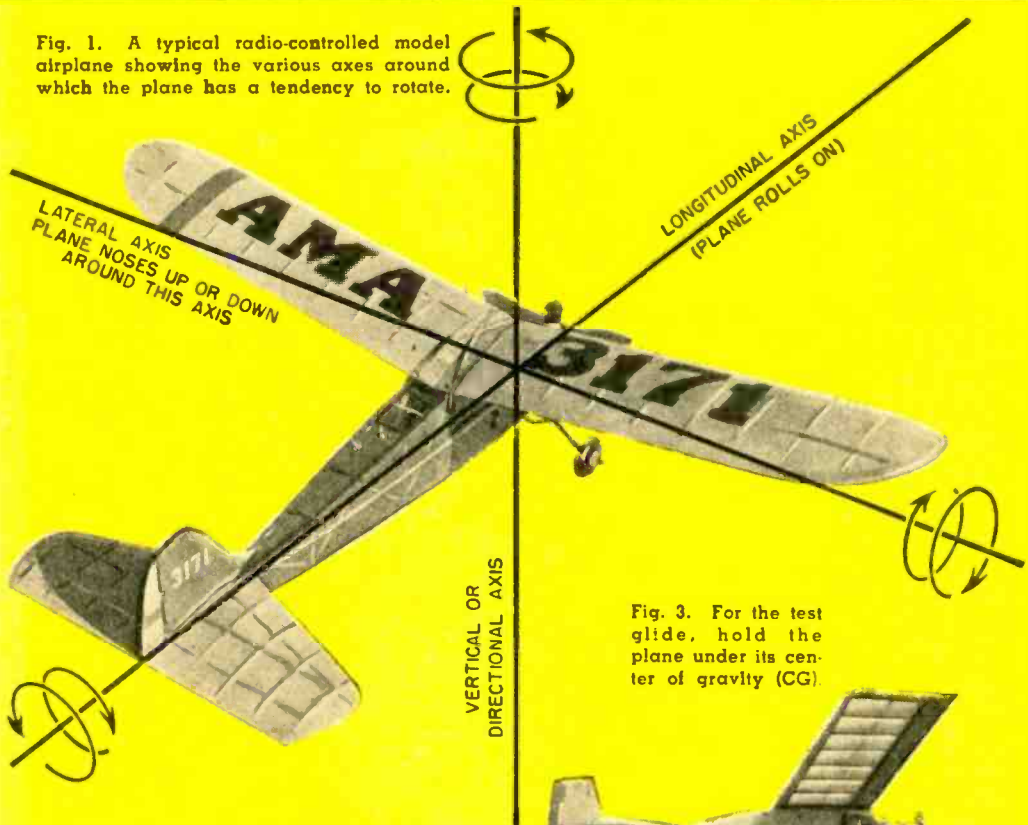

Fig. 2. Running with the model airplane prior to launching it on its important test glide.



Fig. 3. For the test glide, hold the plane under its center of gravity (CG).



By WILLIAM WINTER
Editor, "Model Airplane News"



So you've built a model plane for radio control—will it fly true and handle easily? This is how you find out.

OF THE many important factors involved in successful radio control flying, none is more important than the airplane and the builder's ability to balance and adjust the model (i.e., trim) and fly it properly. A good airplane is as necessary as a good transmitter or receiver; good flying technique as important as ability to tune the electronic equipment. Much has been said about radios. Let's, for a change, take a close look at the plane.

It is not necessary to be an aerodynamicist, or to bone up on aero text books. But let's face it—an understanding of what makes an airplane stable and controllable is as necessary as knowing plus from minus. For the first time in a magazine of this type, we will outline these "trade secrets" in as painless a manner as possible.

In this enlightened air age it is well known that an airplane's wing lifts because of the partial vacuum created above its curved upper surface as the craft travels forward through the air. More properly put, there is a pressure differential between the air over the wing and the air under it, with the result that the wing tends to lift, or move upward. It is also widely understood that the lift offsets the weight of the machine, and that the thrust of the propeller offsets the resistance (drag) of the plane created by its forward passage through the air.

An airplane has movement about three axes (see Fig. 1): one is the longitudinal axis (fore and aft) similar to the barbecue spit, around which the plane rolls; two is the directional axis, like the pivot in a weathervane, around which the plane turns; three is the spanwise axis, like the fulcrum of a child's seesaw, around which the plane noses up or down.

The plane is kept stable, or level, about these three axes, by certain arrangements of its surfaces. See Fig. 4. The dihedral angle, or upward tilt of the wings, is primarily responsible for the plane's resistance to rolling and spiraling into the ground. Therefore, do not depart from the kit maker's plans and specifications.

Stability about the directional axis is governed by the proper size of the vertical

fin; stability on the fore-and-aft axis is achieved by the placement of the wing relative to the center of gravity (CG), or balance point of the machine, and the placement and area of the horizontal tail surface. This is perhaps an oversimplification, but it serves our purpose adequately.

Directional and lateral (rolling) stability does not concern us here because, if the plane is accurately built from a kit, carefully lined up, and free of warps (warps, incidentally, are taboo, as they make the plane unmanageable) it is automatically stable in these two respects.

Our big concern is the spanwise axis (the business of the seesaw). Consider that the lift of the wing, if placed forward of the center of gravity, would tilt upward its end of the seesaw (the nose) if not counter-balanced by some other force. This balancing force is provided by the lifting action of the stabilizer, or horizontal tail. Thus, the greater force of the lifting wing, acting through a small distance or moment arm, about the center of gravity, is offset by the smaller lift of the horizontal tail acting through a greater distance.

Let's assume that the plane is tail heavy—the nose tends to rise toward the point at which normal air flow over the wing breaks down with sudden loss of lift resulting in a *stall*. Our seesaw can be restored to balance in several ways. The lifting force of the wing may be decreased by slightly reducing the angle at which the wing meets the air, the wing may be moved back slightly (reducing its moment arm), the center of gravity may be moved forward with the same effect; or, tackling the problem from the other end, the lift of the stabilizer may be increased by adding to the angle at which it meets the air stream.

Naturally, all of these possibilities may not be available—if the wing rests upon a cabin top, it can hardly be moved forward or backward, but changes in CG position may be made by relocating heavy batteries, and the angle of either wing or tail may be altered by thin shims, such as thin balsa wood, matchbook covers, etc., placed between the wing or tail and the fuselage. In Fig. 5, a shim is shown being

inserted between the tail and fuselage. Permanent shims may be cemented in place after adjustments have been made. Of course, if the plane is nose heavy, tending to dive, the corrective measures are reversed. So much for aerodynamics.

Before launching into the actual trimming and adjusting of that new model, it would be wise to explain one very important stability factor which even model plane fans very often do not appreciate. Regardless of changes and adjustments to the plane's surfaces, always maintain a slight angular difference between the setting of the wing and stabilizer. The wing should be set at a slightly greater positive angle of incidence, at least one degree, but not more than 3 degrees greater than that of the tail (work this out to a fractional part of an inch to facilitate measuring).

Because the tail works at a lesser angle, it will reach the stalling point after the wing has stalled, continuing to lift, and will always exert an increasing leverage as the plane noses up, to restore it to level flight. Should the tail be set at the greater angle, or sometimes even at the same angle, the plane will stall more severely and completely (because the stabilizing effects of the tail suddenly vanish when it

stalls). Moreover, at high speeds, as in a dive or spiral, the extra lift from the tail may overbalance the seesaw and put the ship into a death dive from which recovery is impossible. Many modelers forget this when they balance a tail-heavy plane by excessively increasing the positive angle of the stabilizer—within reason it is safe to so adjust the stabilizer, but never forget the need for angular difference.

The Hand Glide

The first test for any new plane is the hand glide. Perform this test in calm weather or in the slightest possible breeze. Remove the propeller to avoid breakage. If the model is a simple one with simple equipment, it is safe to leave the radio and associated equipment in place. If it is a complicated job with vulnerable, heavy radio, simply remove the radio provided it is located close to the center of gravity of the plane; otherwise replace it with an equal weight.

Pick a grassy area where landings and bumps will be cushioned. Hold the ship two or three inches behind the CG position, level it with the nose pointing at the horizon (see Fig. 3), and run slowly without releasing the plane. Repeat this several

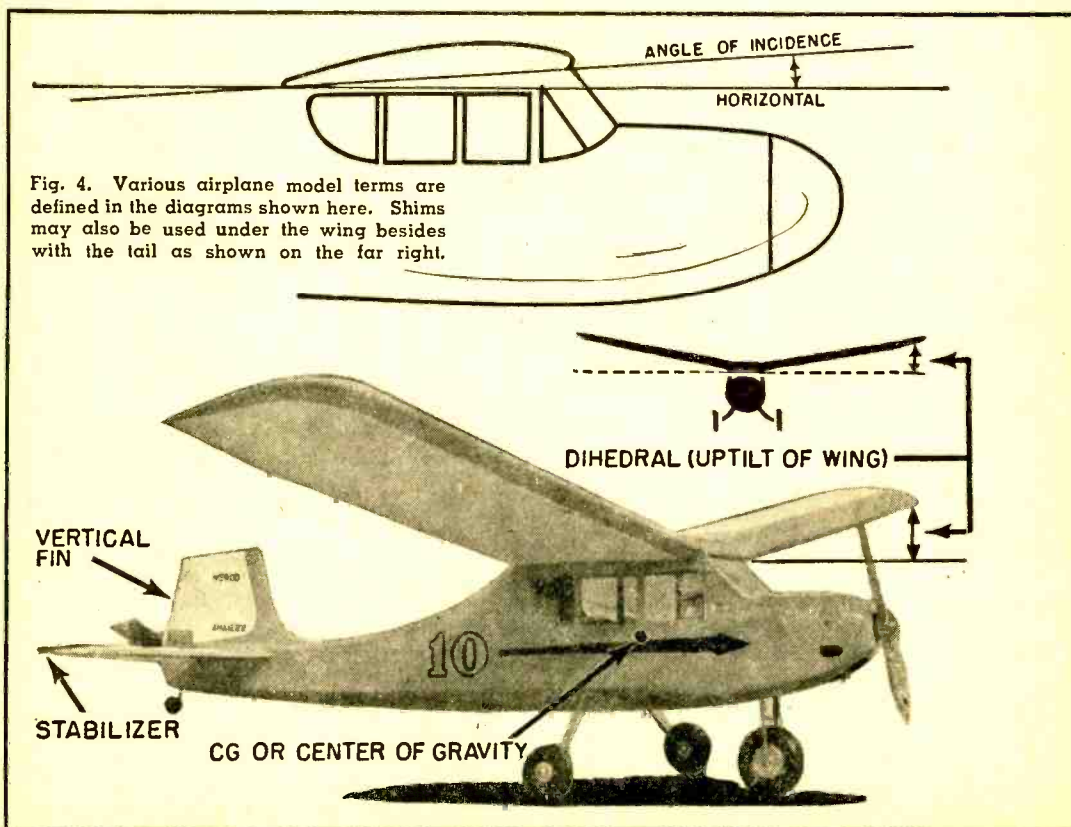

Fig. 4. Various airplane model terms are defined in the diagrams shown here. Shims may also be used under the wing besides with the tail as shown on the far right.

times, running faster and faster, until you can feel the point at which lift is exerted as shown in Fig. 2. Now point the nose of the plane slightly below the horizon, at a spot about 50 feet away. Run at the same speed as before, and as you release the plane, impart the very slightest push. You may have to repeat this step a few times to approximate the gliding speed of the ship.

Never throw the plane, unless it is very heavy, as it will rear upward, irrespective of trim, to stall and then dive into the ground. It is better to launch the ship too slowly at first which, in grass, means a hard landing at the worst.

Observe closely the manner in which the plane glides. Is the plane tail heavy (stalls) or nose heavy (dives)? Usually, all such tendencies can be ironed out by increasing or decreasing, respectively, the angle of incidence of the stabilizer; if not, the CG position should also be altered, forward if tail heavy; backward, if nose heavy. When the plane glides correctly, it should follow a straight flight path from the hand until it lands two-points upon the wheels. It should not float or appear to hover or describe a pretty arc toward the ground, whereby the plane seems to flare

out nicely for a three-point landing. This looks good, but the plane would stall badly in flight, especially with the engine running.

You want a fairly fast and flat glide. If there is a breeze, the model should evidence "penetration," boring straight ahead to a landing and not be buffeted aside by the wind. If the glide path curves to right or left, adjust the rudder slightly to remove the circling tendency but be sure that a warp isn't present in the wing, stabilizer, or fin, and that all the surfaces are accurately lined up. If the wing is slightly askew it will make the plane turn. If one tip is higher than the other, or one stabilizer tip higher than the other, the results will be the same.

Now that we've gone through all the motions of the first trial glide, we will have to check the plane on powered flight. Of course, if the model is a glider, you will merely repeat the hand launched glide tests until the ship is completely checked out and then, you're ready for a glide aloft. Next month, the first power-on test flight will be discussed, and many of the points mentioned will apply equally well to the glider, which uses the same type of flight controls as the gas model. **END**

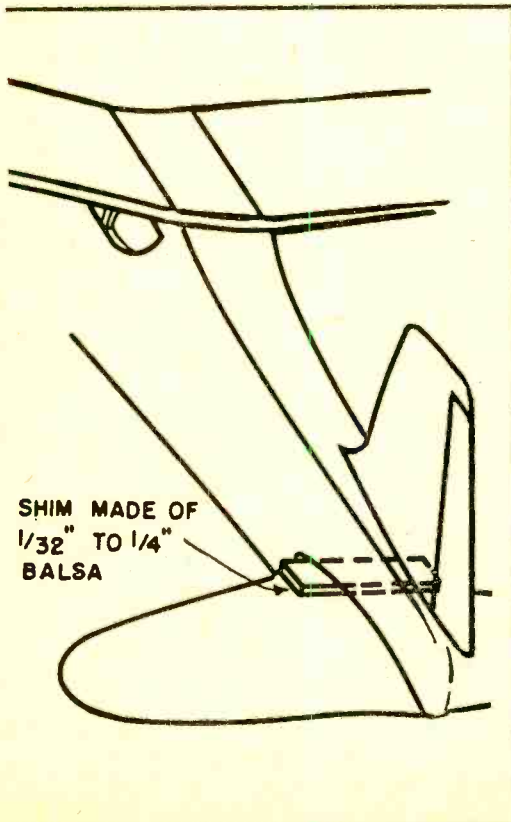

Fig. 5. Slipping a shim between the forward part of the tail and the fuselage.

R/C NOTES

NOW that the frost is on the ground and we are faced with winds and capricious weather, the competitive-minded R/C air modeler in most areas of the country will have to wait until next summer before he can make a stab at adding to his trophy collection. We said, "most areas." Those who live within hailing range of Miami, Florida, will have an opportunity this year to compete in a radio-controlled model airplane event from December 29th through December 31st. This will be part of the first "King Orange Internationals," sponsored by the Association of Florida Model Airplane Clubs, and the Miami Exchange Club. This competition is sanctioned by the Academy of Model Aeronautics. The contest director is Charles R. Quick, 1896 N. W. 36th Street, Miami, Florida, and he can give further particulars.

* * *

CONTINUING the practice begun last month of interviewing various hobbyshop operators all over the country for radio-controlled trends in their bailiwicks, we questioned Mr. Dale W. Root, operator of *Root's Hobby Hut*, Oakland, California, for R/C developments on the West Coast. Dale says, "R/C flying here on the Coast is a continuous, year-round, every-Sunday affair. We haven't missed five Sundays of flying the last year because of bad weather.

"At contests, the single-channel boys seem to outnumber the multi-channel by 5 to 1. There are ever so many more R/C fliers that just don't engage in competition and are good active fliers. I would hazard a guess that of all these fliers, the single-channel outnumbers the multi-channel by at least 20 or 25 to 1. Of all the equipment flown in single-channel, the *Bonner* compound escapement is fast becoming the most popular method of moving rudders. The next control the boys add is motor, and then the bravest ones add a single escapement off of the compound for elevators, sometimes connecting a bleed line to one elevator 'neutral' for low speed. Most single receivers seem to be manufactured ones. Predominant are 'Citizens 27,' *North American* twin-tube kit, and the *Lorenz Twin Tube*. *Babcock's* single-tone receivers

are used in ships of 500 to 600 square-inch wing area."

According to Mr. Root, the most popular airplane models are the "Livewire Trainer," *Triaxter* "Beam," "Flying Ohm," "The Liberty Belle," and variations.

Dale reports that as far as multi-channel is concerned, the *Babcock* 3-channel is probably the most respected for ease of tuning and extreme reliability."

"With flying becoming more popular and consequently more congested, a range of over one or two miles gets too closely grouped fliers into each other's hair. Our club and another group is experiencing such a problem now at 1½ miles between them. We'd like the FCC to cut the power output. An added frequency to use would sure be a help to such a fast-growing hobby."

* * *

POWER and sailboat model radio-control enthusiasts are constantly seeking new ways to liven up their hobby. One way has been found by Theodore Kuron and other members of the Prospect Park Model Yacht Club in Brooklyn. Mr. Kuron's multi-channel radio-controlled sloop is shown in the

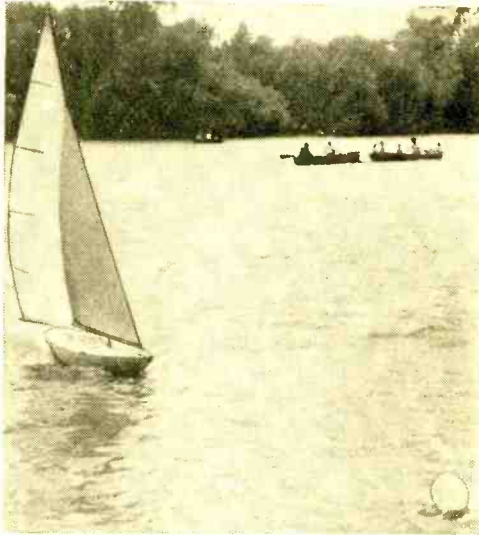

N.Y. DAILY NEWS PHOTO

photo with a pin on its bow going after an air-filled balloon floating on the lake. The object, of course, is to so sail the craft by radio control as to make the pin on the boat prick the balloon which is anchored. He tells us that it isn't easy, but it sure makes for extra excitement and lots of fun. **END**

If you have any news of interest to other R/C hobbyists, be it on model airplanes, boats, racing cars, or what have you, write to the "R/C Notes" Editor, POPULAR ELECTRONICS, 366 Madison Avenue, New York 17, N. Y.

Build Your Own Record Player



This phonograph was built at home, as described below.

You can have fun building this record player — and then you and your friends can have more fun using it.

A SMALL, lightweight phonograph, like the one shown in the photo, can give a good deal of pleasure. It can be taken to parties, to dances, and to club meetings. You shouldn't have much difficulty in building a similar unit in a few evenings' time. The parts you'll need are given in the parts list.

Use a child's or doll's "overnight" bag for the basic case. Be sure to choose one large enough. The one shown measures approximately 10" x 12" x 5" inside. In each corner of the case glue a small triangular wooden block. Exact dimensions of the blocks are not critical but the height should be chosen so the plywood board will fit flush when the case is open.

Cut a piece of $\frac{1}{4}$ " or $\frac{3}{8}$ " plywood to fit the case. The cut-outs needed in the board will depend on the phono motor, loudspeaker, and carrying case you use. Locate the mounting hole for the crystal pickup by using the template furnished by the manufacturer.

Once shop work on the board is finished, you can complete it by painting or staining, or by covering with leatherette or decorative paper.

The output transformer is mounted on the loudspeaker and the entire assembly is then mounted on the board. Use flocked screening over the speaker opening for protection. Mount the phono motor on the board.

The chassis is made up from a piece of .050 aluminum or 20 ga. steel. A single right-angle bend is required, as shown.

Fasten the chassis to the board with the nut that holds the crystal pickup in place. The 6-position terminal strip is held in place with $\frac{1}{4}$ " #8 sheet metal screws. These go right through the chassis and bite into the board, also helping to secure the chassis.

The tube socket is mounted with $\frac{1}{4}$ " 4-40 machine screws and small hex nuts. A long bolt is used to mount the selenium rectifier.

Separate power switch and volume control are used and mounted, respectively, on the board next to the chassis and the side of the carrying case. You may prefer to combine these two parts and mount them where the power switch is shown.

This circuit features "instant-heating" operation—no warm-up time is required.

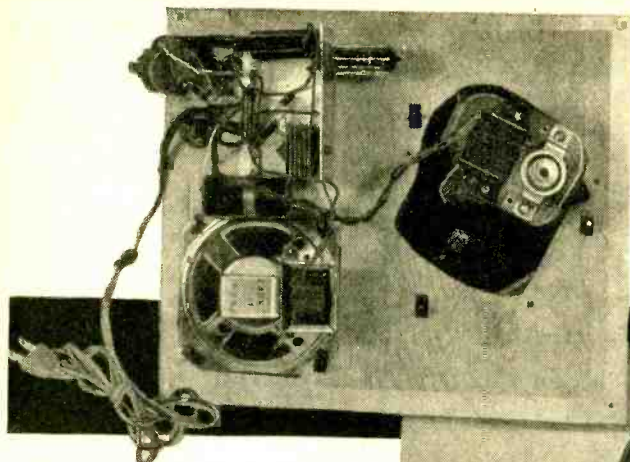

↑ This bottom view of record player motor and amplifier shows them wired and mounted on the plywood board, all ready to be installed in the "overnight bag" carrying case.

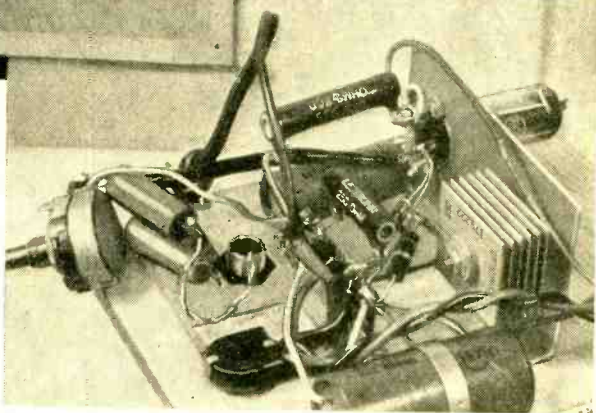

→ An enlarged view of the phonograph amplifier shows the arrangement of small parts. See schematic and pictorial wiring diagrams for more complete details on the wiring.

Because of this, it is practical to have a single power switch for both the motor and the electronic circuit. You can use separate switches for amplifier and phonograph motor if you wish. Switch S_1 may be left as the motor switch and a switch attached to the volume control used for the amplifier. Omit the wire shown between the negative terminal of rectifier SR_1 and the terminal strip. Connect one terminal of the switch to the rectifier and the other terminal to the power line side of S_1 (in the pictorial wiring diagram, the third terminal from the left).

A single 3A4 tube is used as a power amplifier to drive the PM loudspeaker. Only one tube is required because of the high output level of the crystal pickup used.

The schematic and pictorial wiring diagrams are shown on the opposite page. Note that a "floating" ground is employed. No ground connection is made to the chassis at any point.

Although no special precautions are necessary when wiring the circuit, be sure to observe the correct polarity when connecting the selenium rectifier and the electrolytic capacitors. Otherwise, simply follow the schematic and pictorial diagrams. Cover all bare leads with spaghetti tubing.

Several component substitutions are pos-

sible, permitting you to use parts from your junk box. For example, you may use parallel or series combinations of resistors to obtain the indicated values. In the unit shown, two 150-ohm, $\frac{1}{2}$ -watt resistors, in parallel, are used to provide the required 1 watt resistor at 75 ohms.

C_1 and C_2 are not critical. Values from 40 to 80 μ fd. at 150 v. (or higher) may be used here. Any value from 20 to 40 μ fd. may be used for C_3 . Values from .01 μ fd. to .05 μ fd. are satisfactory for C_4 and C_5 .

The phonograph may be assembled either as a three-speed or as a single-speed unit, depending on the choice of phono motor and pickup. Several choices are given in the parts list.

The completed phonograph before mounting in its carrying case and a close-up view of the amplifier circuit are shown in the photos on this page.

Once you've completed all wiring, double check for possible errors. Place the tube in its socket and plug the unit in. Turn the power switch on and the volume control to full output. Touch your finger to the phono needle—you should hear a scratching sound in the loudspeaker.

After testing, mount the wired board in its carrying case and the phonograph is ready for use.

END

Metal-work and wiring details for the phonograph

- R₁—27 ohm, 2 w. res.
 R₂—250 ohm, 10 w. wirewound res.
 R₃—800 ohm, 20 w. wirewound res.
 R₄—75 ohm, 1 w. res. (two 150 ohm, 1/2 w. res. in parallel)
 R₅—2 megohm audio taper pot
 R₆—1 megohm, 1/2 w. res.
 C₁, C₂—50/50 µd., 150 v. dual elec. capacitor
 C₃—20 µd., 150 v. elec. capacitor
 C₄, C₅—.02 µd., 200 v. capacitor
 T₁—Small output trans. to match 8000 ohms to speaker voice coil
 S₁—S.p.s.t. rotary switch
 SR₁—150 ma. selenium rectifier
 V₁—3A4 tube
 PM Spkr.—4" to 6" PM loudspeaker
 Motor—Phono turntable and motor (General Industries Models LC or LX, Alliance Model MP8 (for single-speed 78 rpm) or General Industries Models DSS, SS, or TR or Alliance Model JPT8 (for three-speed)
 I—High-output phono pickup (Astatic P-12, Shure 96A, or American 11 (for 78 rpm), or Astatic P-29 or Shure 92-U (for three-speed)
 Misc.—7-pin miniature tube socket, 6-terminal strip, line cord and plug, knob (volume control), small suitcase (see text), 4" x 6" pc. aluminum, 1/4" or 3/8" plywood to fit case, 6" sq. pc. flocked screening, wire, solder, screws, etc.

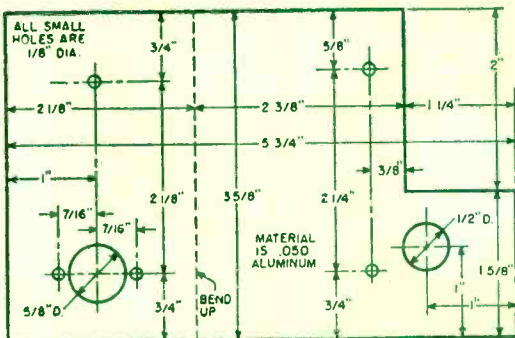
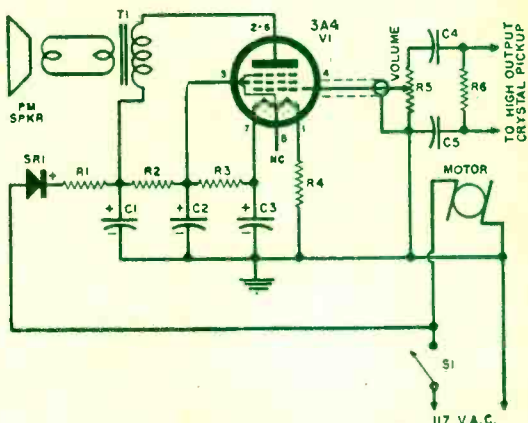

On this page are the schematic diagram (right), and the pictorial wiring diagram (below). These, together with the text and the photographs on the opposite page, give you all the information you need to build yourself a compact record player.

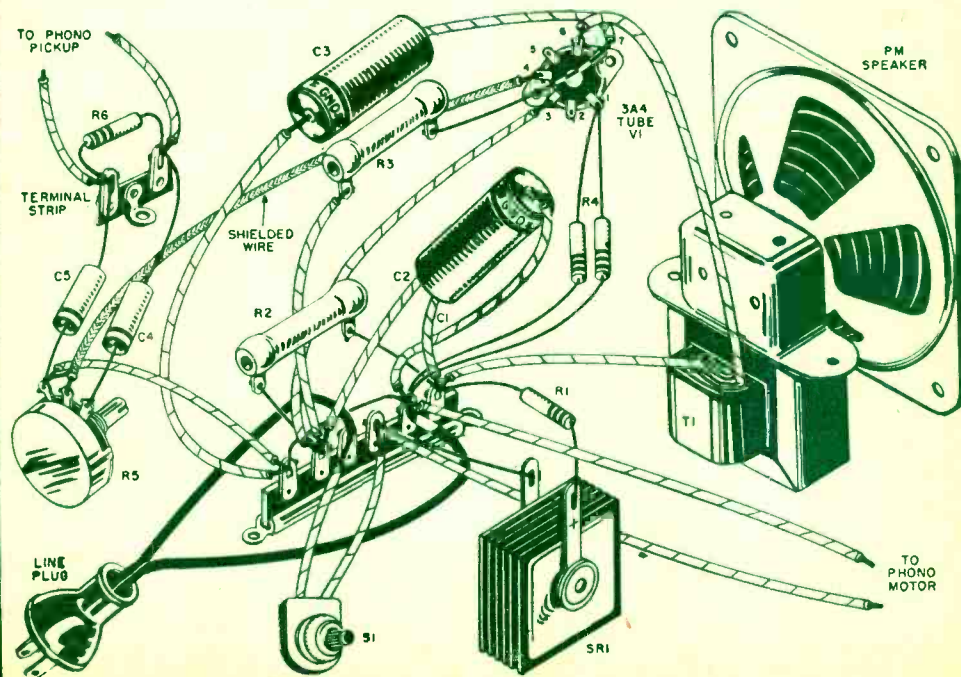

Electronics Seeks Secrets of Aging



By R. E. ATKINSON

ELECTRONICS is helping us understand one of life's most vital processes—that of our aging. We do know that more people are living longer and we can expect that we will too. "Geriatrics" is the study of old age and is concerned with solving the mysteries of aging and, by implication, how to prolong life. Scientists of the National Heart Institute are now studying groups of volunteer patients—most of them past middle age—at Baltimore City Hospital with the aid of several ingenious electronic devices.

One of the key approaches used centers around a study of the arteries. Devised by Dr. Milton Landowne, a special electric hammer creates small waves or vibrations in blood vessel walls of a living person. The resultant wave pattern is picked up by a sensitive electronic high-speed re-

order. Instruments of unusually high fidelity were developed for this job.

Take your own pulse: it feels like very large changes in the size of your blood vessel. Electronic calculations, however, reveal the pulsations to be very small, changing the diameter of the blood vessel by only a few per-cent. What you feel is change in pressure, not size.

The sensitive recorder also reveals facts about the elastic and structural characteristics of the arteries. Blood vessels in older persons, for example, can be likened to a rubber innertube that grows old in much the same way—the walls first stretch and then stiffen, resisting quick stretches and losing elasticity.

How this elasticity is measured is shown in these photographs. END

Preparing to record the pressure waves in the brachial artery of a volunteer patient.



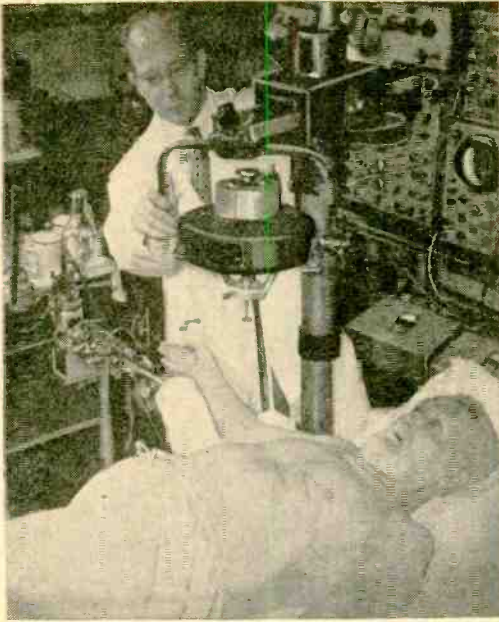

Dr. Milton Landcowne places the electronic "hammer" over the artery. Small pressure waves thus generated within the blood vessel will be detected by the pressure-sensitive device at the left and recorded by apparatus at right rear.

A monitoring cathode-ray oscilloscope which shows how pressure waves travel along a living human artery. The screen displays a series of superimposed oscillations representing the changing pressure conditions as observed at the two points along the artery during the period of a single heart beat. See details in article.

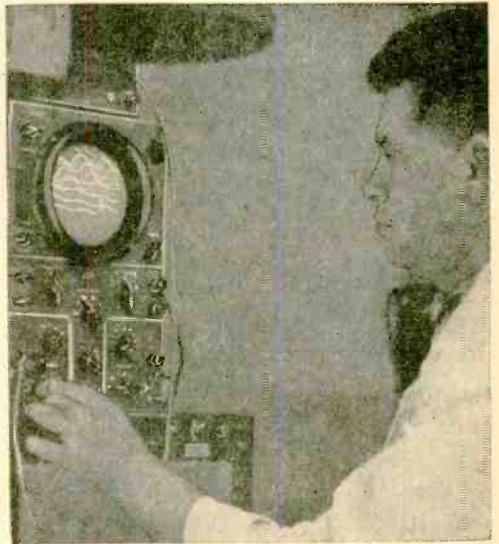

Though electronic devices measure what cannot be seen or felt in this study of aging, these facts must be assessed and checked by the best calculator of all—the human brain.



So You Want To Be a Ham-

YOUR FIRST TRIP TO THE FCC

Charles Finkleman, radio license clerk in the New York FCC office, adjusts speed of automatic tape sending machine to 13 words-per-minute.

By ROBERT HERTZBERG, W2DJJ

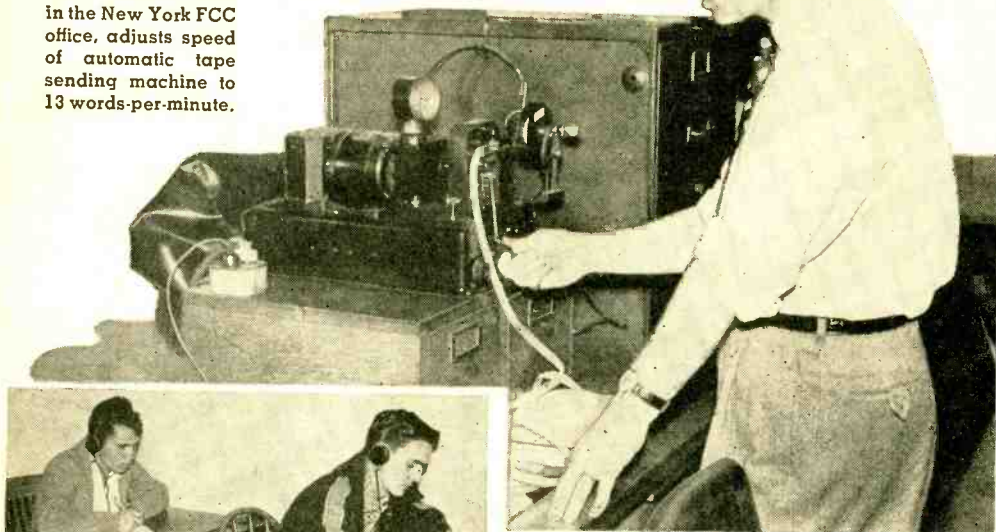

Two ham license applicants take the code receiving test at the New York Office of FCC.

Part 3. "Buck Fever" is a common ailment among prospective license applicants—don't let it get you.

HUNTERS who are anxious to bag a good trophy during the Fall season will practice on a target range all summer to perfect their hold, their trigger squeeze, their judgment of the wind, etc. Then what happens when they actually get into the woods? In many cases, the first time they see a vulnerable animal they can't make the sights stand still, they jerk the trigger off badly, and they virtually collapse into a state of nervous prostration. There's an old name for this affliction: *buck fever*.

Exactly the same thing seems to happen to many prospective hams. They'll practice the code until they can copy as fast as they can write. But when they get down to the nearest Federal Communications Commission field office for the 13 words-per-minute test for the general class license, their ears block up and their fingers freeze on their pencils. In most cases

this condition is common nervousness, but sometimes it isn't.

Listen to the advice of a man who is in a position to give it: Charles Finkleman, radio license clerk in the New York office of the FCC, who gives the tests to as many as 500 applicants each month. He says:

"Too many people rush down after the first time someone checks them off at what they think is thirteen-per-minute. They don't make enough allowance for timing errors, or for the fact that they take the test in strange surroundings. They should protect themselves by becoming really proficient at full fifteen words-per-minute before they try our thirteen. We don't depend on uncertain hand sending. We use an automatic tape sending machine that is periodically checked for timing accuracy. When it's adjusted for thirteen, it sends at thirteen, no more, no less. When a failing ap-

plicant grumbles a little and infers that the sending sounded sort of 'fast,' we just smile."

One nice thing about the FCC code test is that an initial failure doesn't wash you out completely. Just wait thirty days, practice in the meantime, and try again. Three or four attempts before success is achieved are not unusual, says Mr. Finkleman, and he can recall some slow but persistent learners who made it after nine tries!

An important fact to bear in mind is that you wear earphones for the test. Many would-be hams do group practice with a loudspeaker working off an audio oscillator. This is fine, but the signals are likely to sound somewhat different when you put on a strange pair of "cans" (as hams call earphones). It is therefore advisable to do your final practice with phones, to get their feel on your head. Actually, you'll find them an advantage, because they shut out room noises.

The FCC tape runs for five minutes without interruption. The words of the text are "clear" (that is, real words), but they aren't necessarily connected to form completely understandable sentences. This is done to prevent you from guessing at words and filling them in. You don't have the time for this anyway. The instant the tape machine stops, an FCC man rushes by and picks up all the papers. Contrary to the general impression among applicants, you don't have to copy the entire text correctly. You pass if *any one* minute of the transmission is copied down properly. Don't get into a lather, therefore, if you stumble over the first groups of words. Don't attempt to backtrack on them, but relax and concentrate on what's coming. You can afford to spend the first minute or two just listening, getting onto the swing of the transmission, and calming down the butterflies in your stomach. Then when you start copying, make it good.

If you flunk the code receiving test, you're finished for the day, right there. You cannot take the written and hope for a passing mark based on a good average. If you pass, the FCC inspector will listen to your keying for a few seconds, and then give you the papers for the written test. By this time you'll be completely at ease. It's comforting to know that very few people who pass the code fail to make the written.

The latter consists of 45 multiple-choice type questions, each of which has five choices. To answer a question, you merely identify by number one of the five possible answers. Some of the questions, usually about five of them, require you to draw diagrams of simple radio equipment. The questions are mostly technical, but involve



If applicant passes receiving test, he is required to demonstrate his "fist" for examiner.

nothing that you won't find in any ham manual. There's no particular time limit, but you must finish the test at one sitting. You can't go out for lunch, look up some of the answers you don't know, and then come back and check them off! An hour is good average time, and many people breeze through it in thirty minutes.

The written test is usually graded immediately, and you are notified if you passed or failed. If you passed, you have nothing to do but wait for your papers to be processed in the main FCC office in Washington. The license is issued and mailed from there, not from the regional FCC office in which you appeared for the examination. This may take a month or more, so just be patient. *You cannot go on the air until the ticket arrives*, and you won't know what your call letters are until you see the license. It's a waste of time to ask for specific combinations of letters to match your initials, nickname, or anything else. The calls are issued in rotation, and one is as good as another.

If you failed the test, you can return in 30 days for another go at it.

As mentioned in the first article of this series, you are required to take the test in person at an FCC office if you live within 75 miles of it. If you live farther, or are physically disabled, or are serving in the Armed Forces, you can take the test before a volunteer examiner exactly as prescribed for the Novice and technician grade licenses in that article.

In some states you can get special automobile license plates to match your radio call letters. Your license is all the documentation you need. The list of states offering this privilege is growing rapidly. Inquire at your nearest motor vehicle bureau. There is usually a small extra fee for the plates, but it's certainly worth it.

END

An

The author's version of the completed electronic train whistle, without the small speaker and the remote volume control.



Build this remote-control whistle; make your model sound like a real train.

THERE are few of us who can resist the appeal of a toy electric train. As the holiday season approaches, our passive interest often changes to active participation in some phase of this fascinating hobby. And with the trains, go the inevitable accessories: crossing gates, warning lights, switches, bridges, and tunnels.

One accessory which adds to the fun of miniature railroading is a train whistle. These may be purchased, of course. Some you merely place to your lips and blow, while others are elaborately constructed and camouflaged units. But to an electronic experimenter, there is no whistle to compare with an electronic one he has built himself.

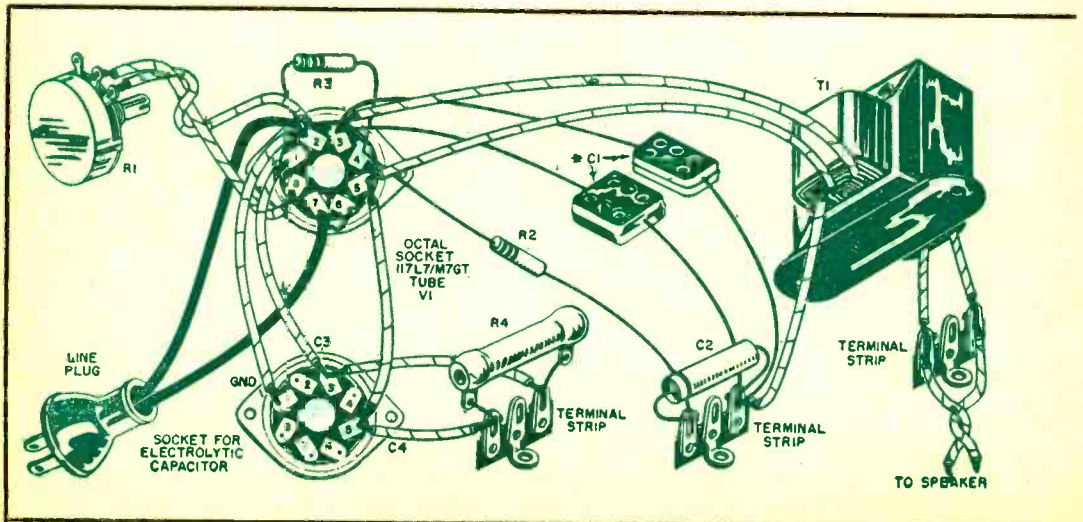
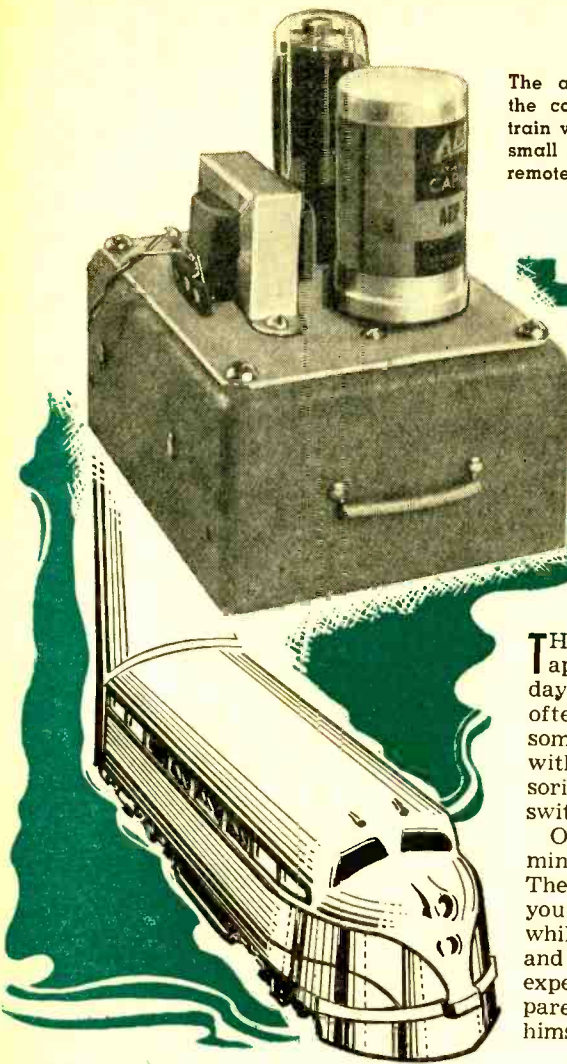

Electronic Train Whistle



This type may also represent many degrees of complexity, depending upon the time, energy, and money one wishes to spend. The whistle described in this article represents an excellent compromise between these factors. It is simple and inexpensive to build, and if the tone is too high, or too low, or too something else, you may alter it to suit your own tastes.

Circuit Description

The circuit was originally designed and built by Willard L. Hayes, an electronic engineer whose children believe he built it for them. There are no expensive or hard-to-obtain parts required in its construction. A cheap transformer and speaker are desired because more expensive units tend to produce a pure tone. This is quite unsatisfactory for our purposes as additional harmonics add richness to the sound. An exact impedance match between speaker and

vacuum tube is not necessary either. This unit was tried with five different speakers of different voice coil impedances and it operated satisfactorily with each of them. The tones were of a different pitch, though, indicating that tuning will be required in almost every case to obtain the desired frequency.

The circuit is shown in the schematic diagram. A 117L7/M7GT vacuum tube is used. This eliminates the need for a separate filament supply and the diode section provides the positive voltage necessary for the pentode half of the tube. The tone generator is basically a Hartley oscillator with a combination of grid leak and cathode bias. When the cathode resistor is at its maximum value, the gain of the pentode is lowered and only a small current flows. As this resistor is decreased, the gain increases until oscillation starts. Further decrease results in a gradually increasing volume

Wiring your electronic train whistle will be easy if you follow the schematic at right and the pictorial wiring diagram on page at left.

- R_1 —1500 ohm, 2 w. pot.
- R_2 —2200 ohm, $\frac{1}{2}$ w. res.
- R_3 —33,000 ohm, $\frac{1}{2}$ w. res.
- R_4 —250 ohm, 5 w. wirewound res. (See text)
- C_1 —.05 μ d., 600 v. capacitor (See text)
- C_2 —.01 μ d., 600 v. capacitor
- C_3, C_4 —20/20 μ d., 450 v. elec. capacitor (Aerovox AEP44J or equiv.)
- T_1 —Output transformer to match 4000 ohms to voice coil impedance (this match is not at all critical)
- V_1 —117L7/M7GT tube

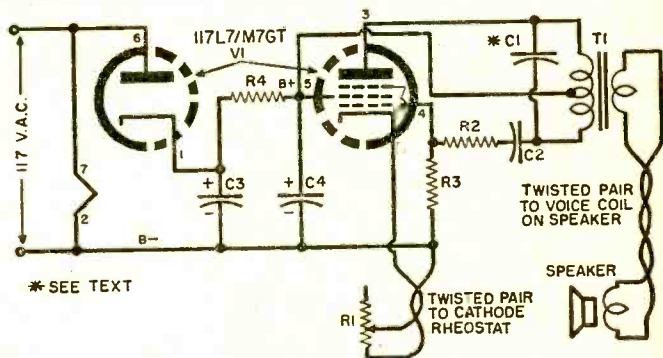

- Speaker—Any small PM speaker
- 1—Cabinet and/or chassis
- 1—Knob for volume control
- 2—Octal sockets
- 3—Two-lug terminal strips (not grounded)
- 1—Line cord and plug

level. Grid leak bias, which operates only after oscillation begins, prevents the current from becoming excessive. With a little practice in "playing" this control the unit can be made to sound much like a train whistle in the distance.

Details of Construction

Construction of the circuit is simple as there is nothing critical about either the components or their placement. The photograph shows the location of the various components above the chassis. As the original whistle was built of parts mainly on hand, some substitutions are desirable and will account for slight differences between the pictured unit and the schematic diagram. These are few, however.

The output transformer can be any unit giving a reasonably close match between the speaker and the recommended load value of 4000 ohms for this tube. A small universal output transformer is best if you must purchase one. Its one requirement is that it have a center-tapped primary so it may be connected as shown in the diagram.

The plug-in electrolytic capacitor shown may be used for C_3 and C_4 , although any electrolytic capacitor with values of 16-20 microfarads and a voltage rating of 200 volts or better will be satisfactory. This circuit operates with very small currents when the whistle is in a stand-by condition and the d.c. voltage increases to 140-145 volts. For this reason, 150-volt capacitors are not recommended and an additional safety factor is desired. The capacitors chosen will determine whether they must be mounted above chassis, as in the picture, or below the chassis as commonly done in table model radios.

The mounting itself may be a box-like unit as shown here (because it happened to be available) or may be simply a U-shaped piece of metal of the dimensions required by your parts. One other modification which might be suggested is the installation of an "on-off" switch in the 117-volt line cord. This is a matter of choice, however, as the final location will determine whether or not it will be easier to just pull out the plug. There is no sound from the speaker if the cathode resistor is left at its maximum value.

One word of caution is necessary, however. This type of transformerless power supply is tied to the a.c. power line and can be dangerous if not treated with proper respect. In most radio circuits utilizing this

circuit, the negative side of the supply voltage is grounded to the chassis through a capacitor and the entire unit insulated, if possible. Otherwise, an accidental contact with a radiator or person might have unfortunate results. In this unit, the difficulty was solved by isolating the entire electronic circuit from the chassis. That is, the negative, or "B-" bus is not fastened to the chassis at all. All return connections are made directly to this wire. This practice is not followed in radio construction as it would cause an intolerable hum in the output. In this case, hum is no problem and it provides an excellent solution resulting in a chassis that is not "hot."

The cathode resistor, which is the control for the unit, has been fastened at the end of a pair of twisted leads so that the unit may be operated remotely. A small speaker can be conveniently mounted behind a signboard or in a building near the train layout and a twisted pair is brought out for this purpose.

(EDITOR'S NOTE: One terminal of the cathode resistor, R_1 , is connected to one side of the a.c. line, and only a small amount of resistance exists between the line and the other terminals. The wiring to the potentiometer is similarly "hot." It is vitally important that adequate precautions be taken to protect the operator from contact with any of these points. The potentiometer should be mounted in a box. If the box is metal, all of the terminals should be insulated from it. Wiring from the main chassis to the potentiometer should be rubber-covered twisted pair or other type adequate for a.c. power wiring.)

Upon completion, the transformer will probably need tuning to suit individual tastes. This is accomplished by altering the value of C_1 . The easiest way to do this is to start with a capacitor which gives a tone higher than desired. Then you can gradually lower the pitch by adding capacitors in parallel with the .05 μ fd. one specified in the parts list. (The pictorial wiring diagram shows one additional capacitor.) An additional .05 μ fd. capacitor would lower the pitch by approximately half an octave; an additional .15 μ fd. would lower the pitch by approximately a full octave; smaller capacitors would change the pitch by smaller (not proportional) amounts.

This unit is a lot of fun to build and even more fun to operate. If there is anything better than an electric train, it must be the equipment that goes with it. **END**



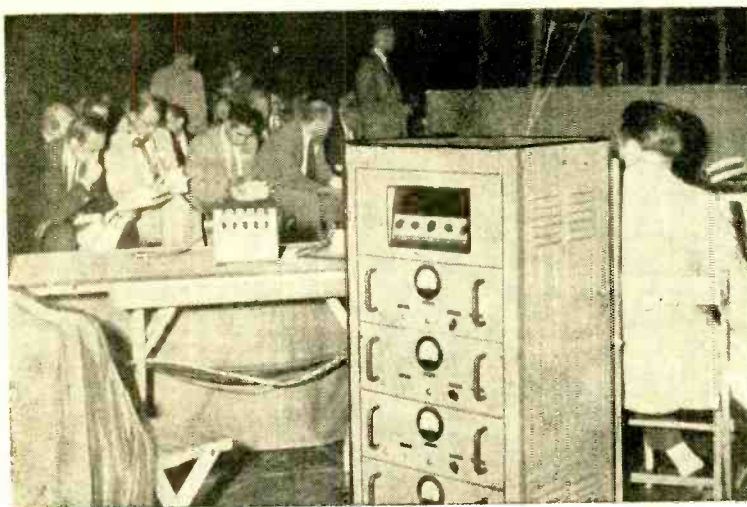

Antenna loop from top of radio (above) serves also as strap for hanging set from listener's neck. Each language requires its own transmitter. Rack (left) mounts several sending units conveniently.

Electronics Aids International Science

By NORMAN GARRAHAN

AT THE Second World Congress of Cardiology held recently in Washington, D. C., a novel method of relaying language translations to the audience of some two thousand world scientists was used. The method avoided complicated cable installations and provided each listener with a translation of the speech being made.

The speaker's words first were fed to booths where interpreters translated the speech into the desired languages. The translations were then piped to individual transmitters connected to a closed loop antenna suspended above the audience.

The doctors were supplied with headphones and miniature radio receivers. The sets had been hung by their antennas from racks at the entrance to the auditorium—convenient for the scientists who came from many lands to hear important lectures on heart disease treatment and research throughout the world.

The choice of language—French, English, Spanish—could be made by rotating the channel selector on the receiver.

The receivers are quite simple. The set is a 3-tube, tuned-radio-frequency (t.r.f.) type, powered by 30-volt "B" batteries and 1½-volt filament batteries. Although automatic volume control (a.v.c.) is used, a definite null could be obtained by rotating oneself slowly.

Frequency range of the set is from 100 to 175 kc., variable in 12.5 kc. steps. This is accomplished by adding capacitors in parallel in the tuned grid circuit of the r.f. amplifier.

The loop antenna is inductively coupled to the tuned grid circuit of the r.f. ampli-

fier (tube type 2E42), then *RC* coupled to a second 2E42 which serves as an additional amplifier and detector. The third stage is audio, using tube type 2E36, with the headphone serving as its plate load impedance.

Magnetic induction pickup of the signal is counted on to restrict the range of transmission. The low frequencies used and the closed loop transmitting antenna system both act to suppress the radiation component of the r.f. current. **END**

Scientists from more than forty nations had a choice of three different languages while listening to lectures. Turning the channel selector knob selects the language desired.



By JOHN T. FRYE



THE HOT DOG CASE

JERRY BISHOP looked up from the transistor oscillator on which he had been working all evening as the door of his basement laboratory was flung violently back against the wall and his chum, Carl Anderson, entered. In one hand Carl carried a small rectangular box into which were plugged a pair of earphones worn loosely around his neck. The other hand firmly clutched the leather collar of a shaggy, stiff-legged Airedale who was obviously accompanying his master under considerable protest.

"Hiya, Carl," Jerry languidly greeted his neighbor. "What kind of a gadget is that? Don't tell me you have invented an electronic flea killer and are about to demonstrate it on poor old Bosco. Here, Bosco; here, boy."

"This thing is a radiation detector," Carl explained as he released the dog and hastily slammed the door shut to cut off his escape. "Aunt Ida out in Denver sent it to me. She says out there these days a person without some sort of Geiger counter feels as naked as a Westerner would have felt a hundred years ago without his shooting iron. But now I want to show you something. Put on these earphones."

As he said this he dragged the wall-eyed dog over to the bench and handed the phones to Jerry. A slow, erratic clicking sound could be heard in the phones, but as Carl unceremoniously grabbed up one of Bosco's front paws and thrust it near the box, the clicks suddenly increased in tempo, and a little neon lamp on the face of the box flashed in unison.

"See!" Carl said excitedly. "That gadget shows all four of Bosco's paws are hotter than a 110 volt lamp in a 220 socket!"

"Makes him a real hot dog, doesn't it?" Jerry murmured facetiously and then backed hastily away from the withering glance Carl directed at him.

"Don't try to be funny, Dope," Carl advised. "This is a serious business. If we can just find where Bosco is acquiring these

hot tootsies, we may locate a big uranium deposit and become independently wealthy. Why, in a couple of weeks we may be rolling in bubble gum and comic books!"

"A fascinating prospect," Jerry observed disparagingly as he tried to conceal how impressed he really was with Carl's discovery. "Have you got any idea how old Torrid Toes here got that way?"

"Not much of one. I just happened to stumble on to his interesting condition the first night I had the detector while I was trying it out on everything in reach. All I know is that every evening Bosco takes off up the alley and is gone for an hour or so, and when he comes back he winds up the radiation detector as he does now. After a while this radiation seems to die out until the next time he makes one of these mysterious disappearances, and then it is right back up there."

"Have you tried following him?"

In answer Carl turned around and displayed a large three-cornered rent in his trousers where a hip pocket used to be. "How else do you think I lost the seat of my pants?" he demanded. "I'll swear Bosco knew I was trying to follow him and deliberately made it tough on me. He ducked through holes in board fences, jumped over barbed wire, cut through gardens, and stopped every now and then and kicked dirt over his tracks. I was trying to follow him over a fence when I suffered this pants casualty—which incidentally I don't think Mom's going to appreciate. I've been thinking about fastening a can of whitewash with a small hole in it around his neck so the whitewash will leak out and leave a trail I can follow."

"Perish the thought!" Jerry exclaimed. "Such a crude mechanical contrivance is not worthy of a member of Electronic Experimenters, Ltd. On top of that, it might lead some curious busybody to our uranium lode. No, we must solve this mystery electronically."

"Such as how?"

"It's coming to me," Jerry said as he looked through Carl with the out-of-focus stare of a crystal-gazer. "Have you still got the dry batteries we used to power your little communications receiver during the radio club's hidden transmitter hunt last month—and the shielded loop we used?"

"Yep, but if you're thinking of loading forty or fifty pounds of transmitter on Old Bosco here, that's out. Pound for pound, he's as tough as any dog in the neighborhood—and maybe a little tougher—but he's no St. Bernard."

"Relax, Buster," Jerry said as he picked up a little clear plastic box not much larger than a package of chewing gum. "Do you think he can stagger along under this load?"

"Don't tell me that's a transmitter!"

For a reply Jerry switched on a small broadcast receiver above the workbench and tuned it to a station on the low frequency end of the band. Then he held the plastic box near the receiver and carefully adjusted a small screw protruding from one side of the box. As he did so, a heterodyning whistle swished down on the station being heard in the radio and, as it came to zero beat, completely blotted out the reception.

"Well I'll be darned," Carl marveled. "That little cuss surely puts out a sock with only one tiny hearing-aid battery for a power supply. But I didn't think transistors could be made to work at radio frequencies."

"The first ones couldn't, but now they have new 'intrinsic-barrier' type transistors that are capable of operating up to 400 megacycles. Even this garden variety junction transistor I'm using will oscillate nicely over the entire broadcast band. We can set it for a dead spot at the low end of the band and then pick it up on the loop antenna for a distance of several yards; yet with no radiating antenna it will not put out enough signal to violate the FCC's regulations concerning such devices."

"How are we going to carry the receiver, loop, and batteries?"

"I've figured that out, too, but I want it to be a surprise. You bring all the stuff and Bosco over right after school tomorrow evening, and I'll show you," Jerry said as he switched off the receiver and started clearing off the bench for the night.

When Carl and Bosco entered the laboratory the next evening, the former stopped dead in his tracks at the sight of a king-size baby buggy standing in the middle of the room.

"Oh no, not that!" he groaned. "I'll die before I'll be caught pushing that overgrown perambulator up and down the

street loaded with radio gear. Think what would happen if some of the high school gang caught us doing it. They'd get out the net for sure. Where did you ever get such a monstrosity, anyway?"

"It belongs to a cousin who used it for her twins. When she moved away from town she stored it in our attic. It's built like a Mack truck and will be just the ticket to carry the receiver and batteries. Aw, Carl, come on! Don't be stuffy. After all, we'll be going up and down the alleys, and it will be dark. Anyway, scientists like us can't be worried about what people may think."

"Well, all right," Carl agreed reluctantly; "but I'm warning you right now that the first guy who makes a crack gets busted right in the kisser."

"Fine," Jerry said. "We'll have to take it outside and load the receiver and batteries in it. The loop can sit right on top of the set, and I've got my flashlight so we can watch the S-meter as we turn the loop. First, though, let's install the transmitter on Bosco."

This was easily and simply done by firmly taping the little transmitter case to the top straps of Bosco's harness that had been put on him for the occasion. The dog promptly gave the transmitter a shake-down test by rolling over and over and trying in vain to scratch it loose with his hind paws. Then apparently satisfied the transistor transmitter could "take it," he proceeded to ignore its presence completely.

By the time the boys were called for supper, the receiver had been installed in the baby buggy and tested. It worked to perfection. Whenever the plane of the shielded loop was at right angles to Bosco, the signal indication from the transmitter on the communication receiver's S-meter fell to zero; but as soon as the loop was rotated slightly on its vertical axis, the meter reading started up and reached a broad maximum as the plane of the loop

(Continued on page 119)



A Pie Case Radio



The receiver in its plastic case, but without the cover

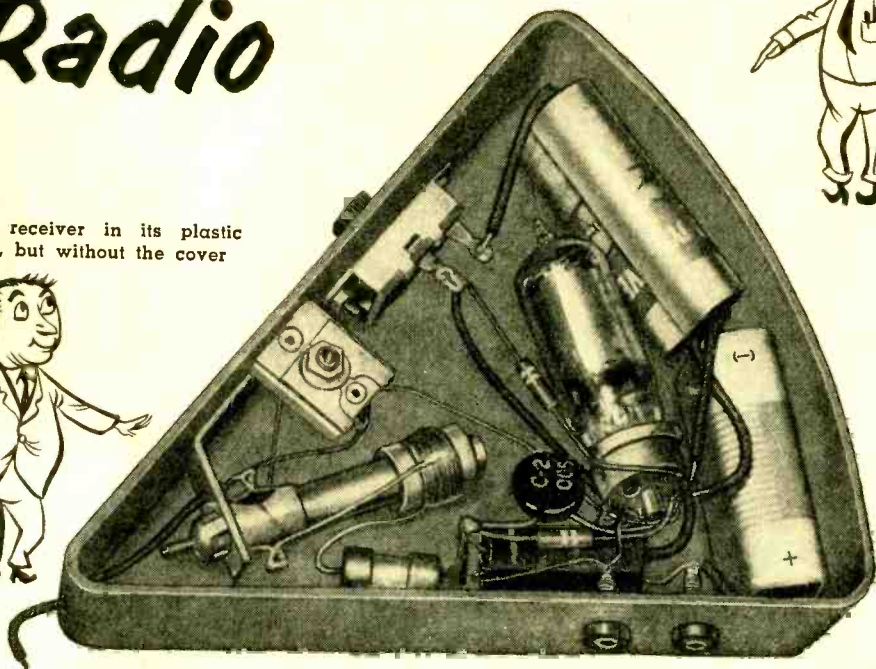

By ELTON V. STOLBERG, KL7ALU

This radio — small in size, inexpensive, and easy to build — gives good headphone volume on local stations.

THIS receiver has given many hours of fun and it is of such simple construction that it should appeal to many of you just getting started in radio. It will provide adequate headphone volume on local stations.

The receiver can be constructed easily in a few hours and uses standard parts available almost anywhere. The "chassis" used is a plastic container made for carrying pie in a lunchbox and, as can be seen from the photo, there is plenty of room. Using this pocket-size plastic case, instead of crowding all of the parts into a smaller case, allows semi-breadboard construction. If the case cannot be obtained at your dime store, another similar-sized container would do.

A high-"Q" "Vari-Loopstick" and midget paddler capacitor give this crystal set sufficient selectivity to separate the stations. A 50-turn coil of very small wire (L_2) is

wound on a paper form that slides easily on the "Vari-Loopstick" form. L_2 should be doped with coil cement to keep it from unwinding. After the receiver has been wired and is operating, the coil can be slid back and forth on the "Vari-Loopstick" and glued where the maximum volume, without interference from unwanted stations, results.

As can be seen from the diagram, the 1S5 is triode-connected. It gives surprising headphone volume with one of the hearing-aid type 22½-volt batteries. Two penlight cells connected in parallel furnish filament voltage and will last quite a while in intermittent use.

The midget socket is supported by a heavy piece of wire that connects pins 2 and 3 together and is soldered to one of the phone tip jacks. As can be seen, the "Vari-Loopstick" is mounted on its bracket, which is bent to fit the peak of the pie

case. The filament switch and the phone jack are the only other parts mounted on the side of the case. All other small parts are self-supported wherever they fit best.

In this receiver, the 1N34 germanium diode can be connected either way (the leads can be reversed). Batteries are wired in separately, since it is easier to resolder the batteries each time than to devise suitable battery clips for the relatively fragile chassis. Care must be used in drilling the case and when soldering. Be careful not to touch the case with a hot iron.

An antenna of very small wire can be wound around the perimeter of the case and doped with coil cement if local signals are not strong enough. Normally, a few feet of wire is all that is required, and an antenna just long enough for adequate pickup of the desired signal is determined by experiment. The set is tuned to the strongest local station by the "Vari-Loopstick" core and the padder capacitor. The "Vari-Loopstick" core can be reached with a thin screwdriver if the antenna wire is pulled out of the hole in the case. Once the tuning is set, the antenna wire can be threaded back through the hole. Then the lid can be placed on the case and fastened with a rubber band. END

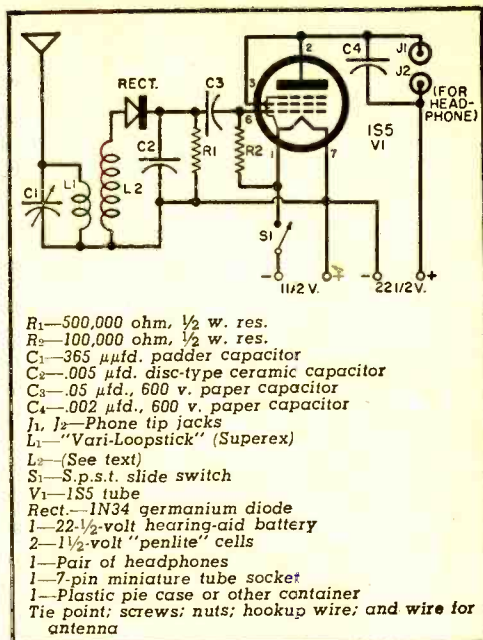

Parts list gives the components required for the pie case radio; schematic diagram shows electrical relations between them.

The pictorial wiring diagram shows which components are connected by each wire.

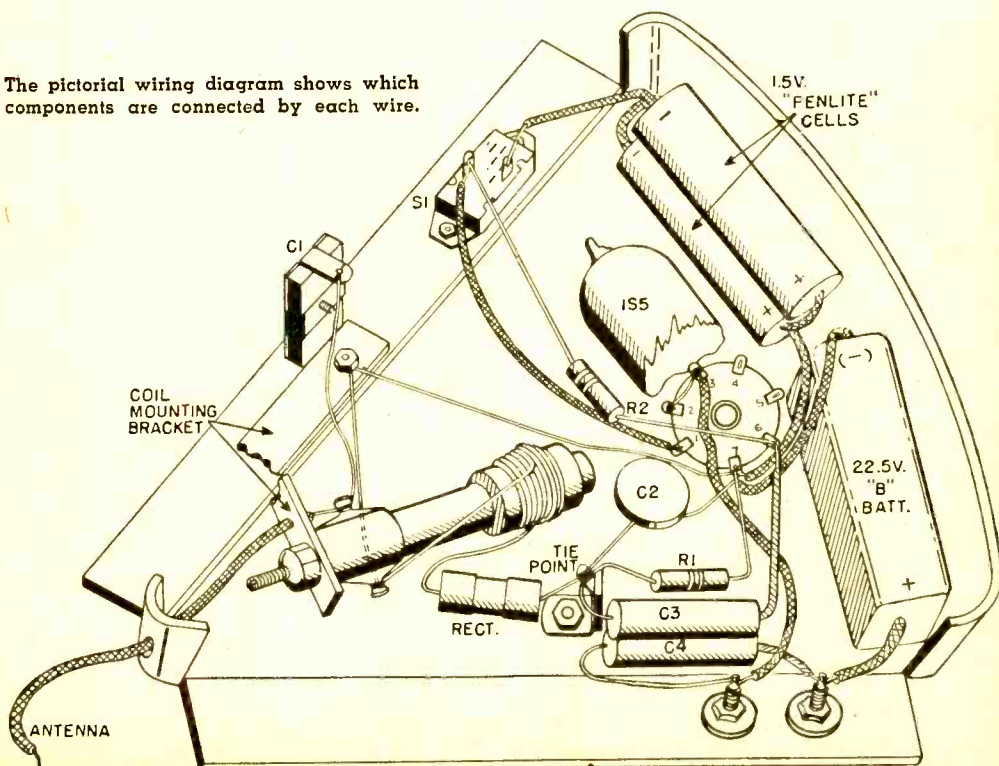



R/C

The Lorenz Transmitter

By
E. J. LORENZ

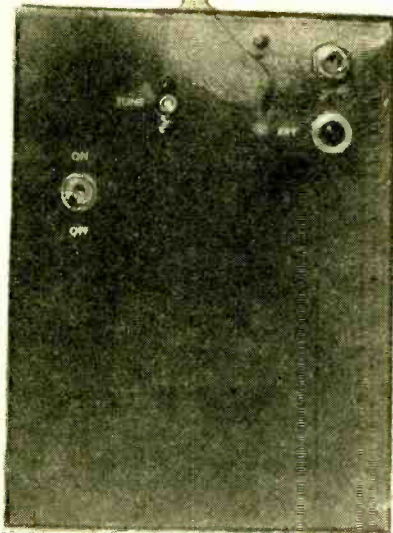

THE transmitter to be described, which is operated on the license-free frequency of 27.255 megacycles, enables the operator to send out a signal which remotely controls model planes, boats, cars, or other mechanical units. It is designed to be used with the receiver (The Lorenz "Sixty-One") presented last month. The only FCC regulation on operating this, or any other crystal-controlled transmitter in the Citizens band, is that an FCC form 505 be filled out and sent to the nearest FCC office. (Check with your local post office for the nearest FCC office.)

The Citizens bands include 27.255 mc. and 465 mc. The only type of transmitter which the radio-control fan may build, if he

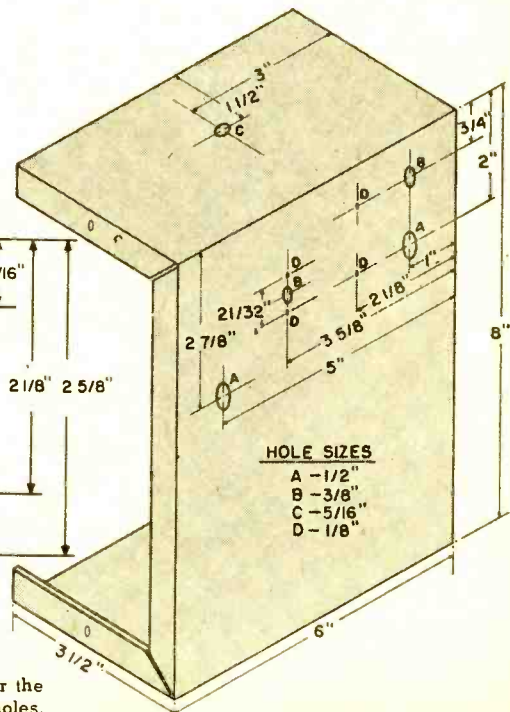
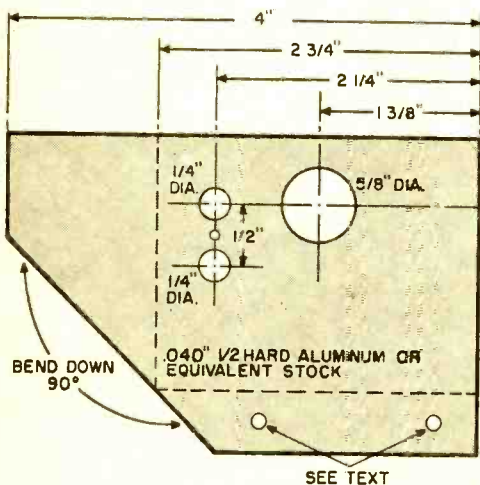

Fig. 1. Dimensional diagram of the subchassis on which the 3A4 tube and crystal are mounted.

Fig. 2. Cover of the "Minibox" used for the transmitter showing the position of the holes.

is not a "ham," is one whereby the frequency is crystal controlled. Since this is rather difficult on the 465-mc. band, we must be content to do our building in the 27-mc. band.

Read this construction article carefully, and study the diagram and photographs before starting work. First of all, the chassis should be cut, drilled, and bent from .040-inch, $\frac{1}{2}$ hard aluminum, or equivalent, as in Fig. 1. Next, the case, which is a $3\frac{1}{2}$ " x 6" x 8" "Minibox," has its cover drilled according to Fig. 2. The chassis holes on the bottom flange, shown in Fig. 1, should be drilled after the front cover holes are drilled. Hold the chassis against the cover and mark holes on the flange as per front cover holes. Mount the tube and crystal socket on the chassis before bolting the chassis to the cover with 4-40 $\frac{3}{8}$ " machine screws.

Mount the antenna feedthrough, the 35- μ fd. variable capacitor, the "on-off" switch, meter jack, and keying switch as shown.

Wind coil L_1 (see Fig. 3) according to the parts list, leaving leads about $\frac{1}{2}$ " long. Be sure the winding is tight and the turns fit tightly against each other. After removing the coil from the form, give it a coat of clear nail polish. Wind the tank coil, L_2 , as specified in the parts list, leaving the leads about $\frac{3}{8}$ " long. Space the turns evenly, after winding, until the length of the coil is 1".

The antenna and loading coils, L_3 and L_4 , are made from a 24" length of #18 solid plastic-coated wire. Leave $1\frac{1}{4}$ to $1\frac{1}{2}$ inches between the two windings. L_3 consists of 3 turns wound on a $\frac{5}{8}$ " diameter form; L_4 is 10 turns closewound on a $\frac{3}{8}$ " diameter form.

We are now ready for final assembly. Follow the schematic in Fig. 4. Although not imperative, it is desirable to have four color-coded wires for hookup. The colors used are: black for "B—," red for "B+," green for "A—," and orange for "A+." About 15" of each are used.

Solder the "A+" filament wire to pin 5 of the socket. (Remember that all socket connections refer to the underside of the socket.) The "A—" wire is soldered to pins 1 and 7 and also to the center eyelet of the socket. Twist the "A+" and "A—" wires together for about 3 inches, cut the "A—" lead and solder it to one side of the single-pole, single-throw switch. The other piece of "A—" lead is soldered to the other side of the switch. Now twist the "A—" and "A+" leads together again for about 6 to 7 inches, then cut, and solder to the "A" battery plug. The large pin on the plug goes to "A+." Place the tube in the socket and check to see that the filaments light when the switch is turned on.

Solder coil L_1 between the ground point at pins 1 and 7 and the outside crystal-socket terminal. Resistor R_1 is soldered between pins 1 and 7 on the tube socket

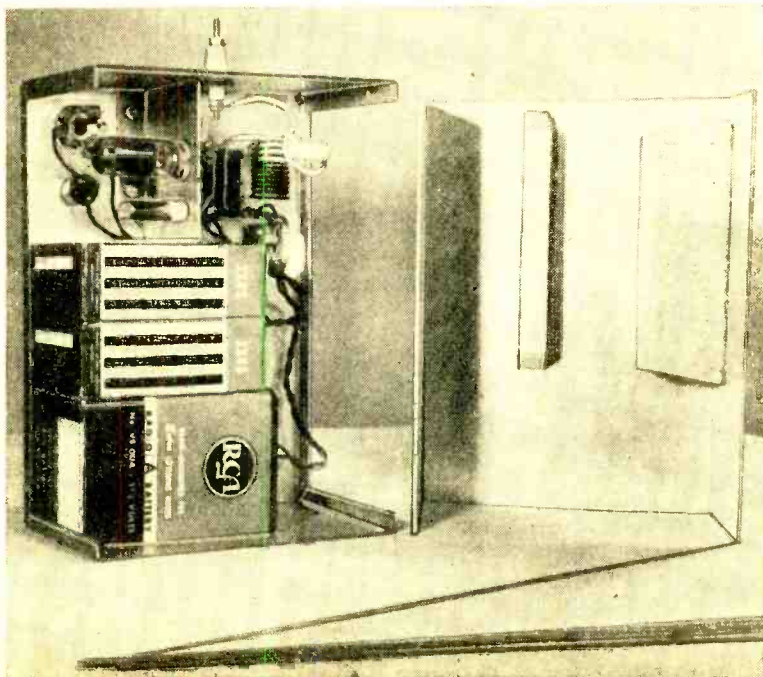

Back view of the R/C transmitter showing the position of the batteries, the subchassis bolted in place, and the position of the antenna loading coil, L_1 , above the tank coil.



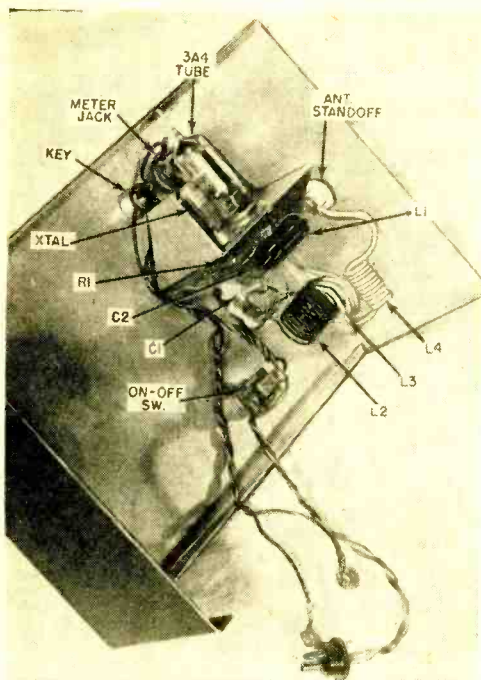

Back view of the transmitter without the batteries, showing location of the various parts.

and the inside crystal terminal. Extend the resistor lead from the crystal socket to pin 4 of the tube socket and solder. The .005- μ fd. plate bypass capacitor, C_2 , is soldered between the ground point and the rotor (movable plates) terminal of the 35- μ fd. variable capacitor, C_1 .

Solder the tank coil, L_2 , between the rotor and stator (fixed plates) terminals of the 35- μ fd. variable capacitor. Solder a short piece of wire between the stator end of the coil and pins 2 and 3 of the tube socket.

This completes the basic oscillator. Before starting the final hookup, be sure the meter jack is insulated, by means of insulated washers, from the case cover. Use a short piece of black wire to connect one of the sleeve terminals of the jack to one side of the keying switch. Connect the two jack sleeve terminals together. Another short length of black wire is soldered between the other jack terminal and the "on" side of the "on-off" switch. The "B—" black lead is soldered to the remaining terminal of the keying switch.

A 6- to 8-inch length of red wire is soldered to the junction of the tank coil, L_2 , and the .005 μ fd. capacitor. Twist the black and red leads together, cut, and attach battery clips.

Now insert the tube and crystal in their respective sockets and attach a 0-25 or 0-50

milliamper d.c. meter to a meter-jack plug and insert in the meter jack. Be sure the polarity is correct—the plus terminal of the meter going to the side of the jack connected to the "on-off" switch.

To tune the transmitter, turn the switch on and set the variable capacitor to minimum, or until the plates are unmeshed. Depressing the key will give a current reading of 25 milliamperes or more. Rotate the variable capacitor until the current drops sharply to about 5 to 6 milliamperes. This indicates that the oscillator is functioning properly. Failure to obtain a current drop indicates an incomplete connection or a short to ground through the meter jack.

Next, install the antenna coil by inserting the three turns of L_3 between the turns of L_2 near the plate end of the coil. Insert L_3 only about two-thirds of the way into the tank coil. The free end of L_3 is soldered to the ground connection of the tube socket, and the free end of L_1 is soldered to the antenna post lug. Upon depressing the key, the variable capacitor will have to be readjusted to give a minimum reading, which will be about 2 milliamperes more than that obtained with the coils not in place. After the minimum reading is obtained, set the variable capacitor to obtain a current rise of about 1 to 2 milliamperes. For bench testing, your transmitter will now operate the receiver in last month's issue of POPULAR ELECTRONICS.

Note the two wood blocks screwed onto the bottom portion of the "Minibox" as seen in the photo on page 53. These blocks serve to hold the "A" and "B" batteries in place and should be added to the transmitter case after it has been completely assembled. Use a grade of soft wood for this purpose. The center strip is about five inches long and one inch wide. It is so placed as to press down on the batteries and hold them in place. The other block is also about five inches long but is 2 $\frac{1}{4}$ inches wide. This screws onto the side of the case and hits up against the end of the batteries keeping them from sliding across the transmitter.

The antenna is made from telescoping brass tubing, using 1/16", 3/32", 1/8" and 5/32" diameters with a short piece of 3/16" to reinforce the base. Tap the base section (5/32" diameter) for a 6-32 screw and lightly crimp the ends of the sections to obtain a good press fit. Attaching the antenna, the current reading should be about 12 milliamperes. Increasing the coupling between L_2 and L_3 and/or adding length to the antenna will increase the current and, hence, the output. Properly adjusted, this transmitter will give a ground range of about 1/2 mile, and is fairly insensitive to hand capacity. END

- R₁—33,000 ohm, ½ w. res. ± 10%
- C₁—35 μfd. variable capacitor
- C₂—.005 μfd. disc capacitor
- L₁—30 t., #20 en. on ⅜" form (see text)
- L₂—11 t., #16 en. on ⅜" form (see text)
- L₃—See text
- L₄—See text
- S₁—S.p.s.t. "on-off" toggle switch
- V₁—3A4 tube
- J₁—Meter jack
- Xtal—27.255 mc. (Peterson Z-9)
- l—Crystal socket (Johnson #126-105)
- 1—7-pin miniature socket
- 1—Keying switch
- 1—1½ v. battery plug
- 4—15" lengths of hookup wire (4 colors)
- 25"—#16 copper enameled wire
- 25"—#18 solid copper plastic-coated wire
- 36"—#20 copper enameled wire
- 4—67½ v. battery clips
- 3—4.40 ⅜" machine screws and nuts
- 1—Antenna feedthrough (Johnson #135-44)
- 1—Case (ICA 29444 or Bud CU-3009)
- 1—Set of batteries

All of the above parts may be obtained in kit form from Electronic Specialties, 58 Walker St., N.Y.C.; Control Research, Box 9, Hampton, Va.; Ace Radio Control, Higginsville, Mo.; and Gyro Electronics Co., 325 Canal St., N.Y.C.

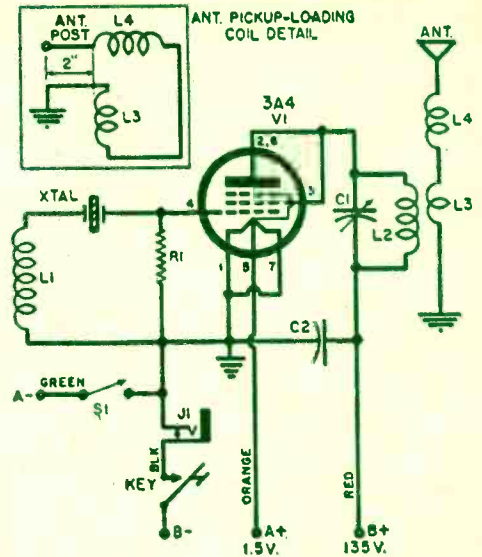
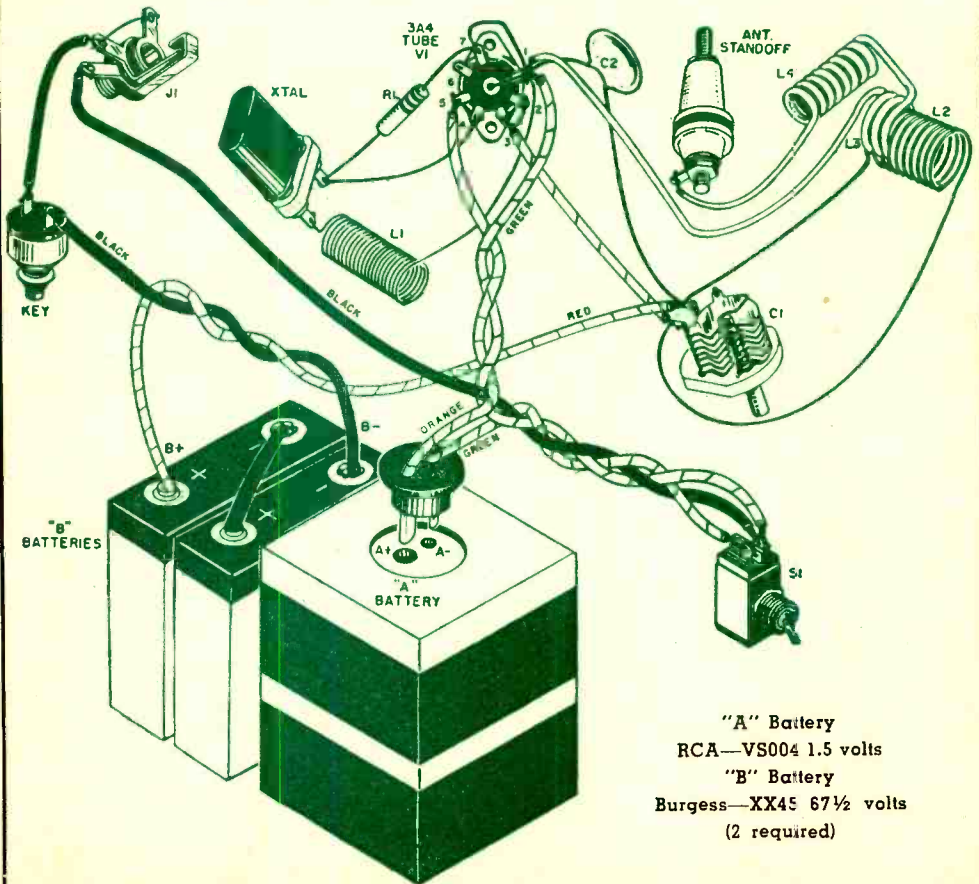

Fig. 3. Schematic diagram and parts list for the complete R/C transmitter. The pictorial diagram below shows the way the antenna pickup and loading coils are positioned.



- "A" Battery
RCA—VS004 1.5 volts
- "B" Battery
Burgess—XX45 67½ volts
(2 required)

Kit of the Month

A v.t.v.m.—the most versatile
of all radio test instruments.

IF YOU are at all serious about building electronic equipment of all types, you will sooner or later need a vacuum-tube voltmeter to test your circuit construction and perform other necessary checks.

If you are interested primarily in getting a completed instrument to use, you can buy any one of the good commercial v.t.v.m.'s made by different manufacturers. Many experienced technicians save money and satisfy their creative urge by buying separate parts and building an instrument according to a published design, with or without their own modifications.

An inexpensive and instructive way to obtain such equipment is to build it yourself from one of the currently-available kits. The assembly of the *Heath* v.t.v.m. is shown in the pictures on these two pages. Although complete instruction books come with each kit, a few off-beat hints are



Easy with that knife! If you slash too vigorously, you may scratch the cabinet or cut some component. Open the box with caution.

included which may make your job a bit easier.

Practically every kit now being offered to the home builder can be assembled in a few hours' time, using common hand tools that are usually found in most home work kits. The only exception might possibly be a "pencil-type" soldering iron. If you don't already own one of these compact little units, it is worth investing in one if you plan to do much construction.

The v.t.v.m. is only one of a wide variety of test instruments you can get in kit form. If you build this unit first, as the cornerstone of your laboratory, you can add such instruments as oscilloscopes, signal generators, signal tracers, capacitor checkers, etc. as the complexity of your construction projects increases, until you have a full-fledged electronic laboratory of which you can be proud. **END**

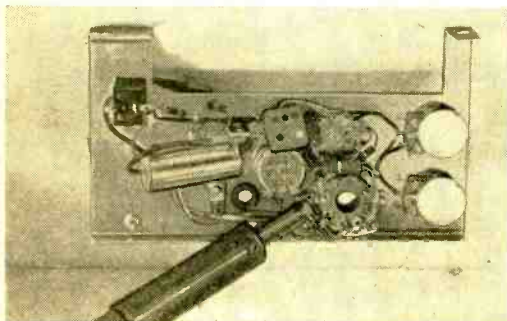

A pencil-type iron, with long, slender tip will enable you to get into the tight spots. An iron of this type is being used to assemble the range switch used within the v.t.v.m.

A soldering iron with too large a tip may burn insulation on adjacent wires, melt wax capacitors, or char resistors as shown.

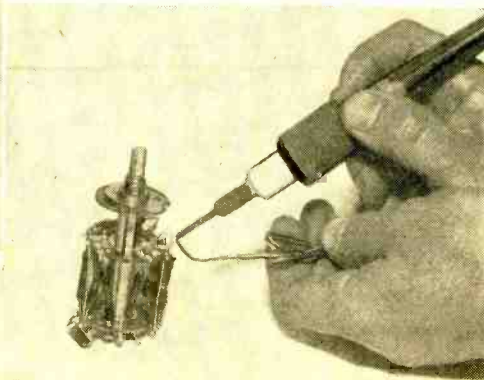

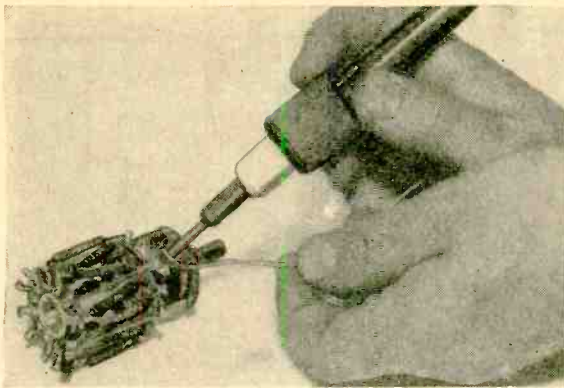

Wiring the range switch in this position will only lead to trouble as the hot solder will drip into the switch blades and adjacent lugs. Hold vertically.

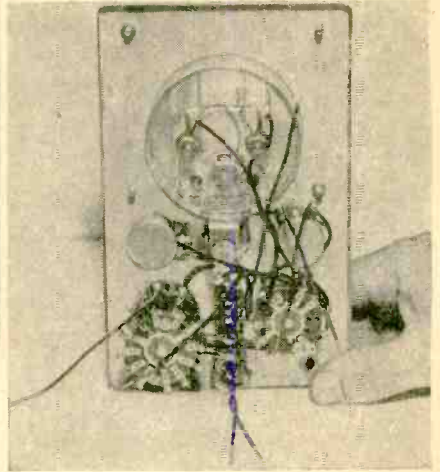

The construction begins to take shape. At this stage front panel has meter, range, and selector switches, and meter adjusting potentiometers in place. Loose wires will connect to parts on the tube chassis later.

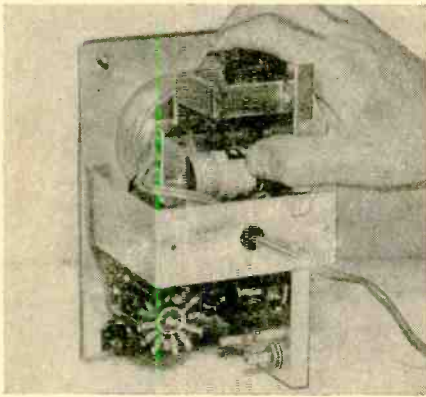

Rear view of the assembled unit. The single flashlight battery that forms part of ohmmeter circuit is being pushed into its clamp. Recheck circuit before housing it.

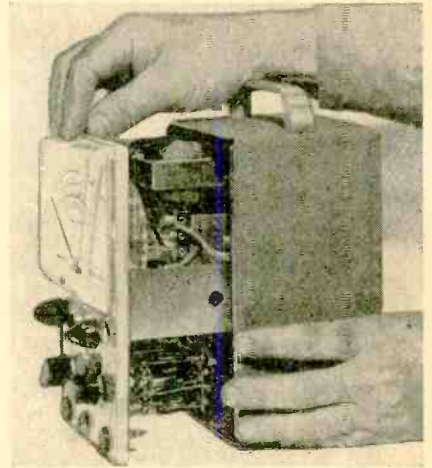

Slide the finished chassis into the cabinet very carefully to avoid bending parts. Hold chassis upright and move cabinet over it, then fasten all the screws.

Checking the completed instrument. In this test meter is set for d.c. on the function switch and for 5 volts on range switch. Battery is 3 volts.

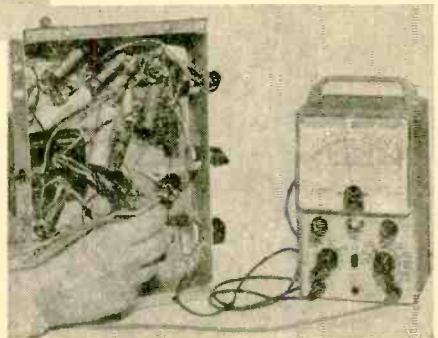
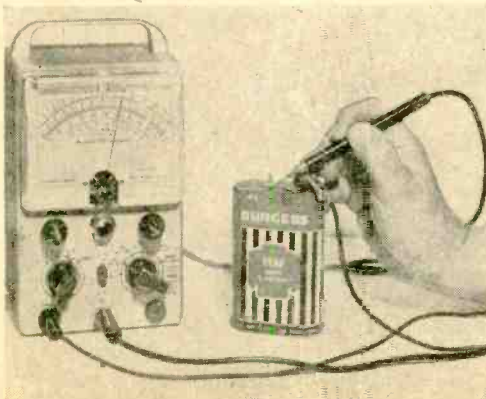

Checking the value of a resistor with v.t.v.m. The unit is switched to "Ohms" scale. One end of resistor must be disconnected when making this type of test.

Fig. 1. Over-all view of the home-built coil-winding jig in operation. A "guide paddle" is used to insure level winding and professional appearance.

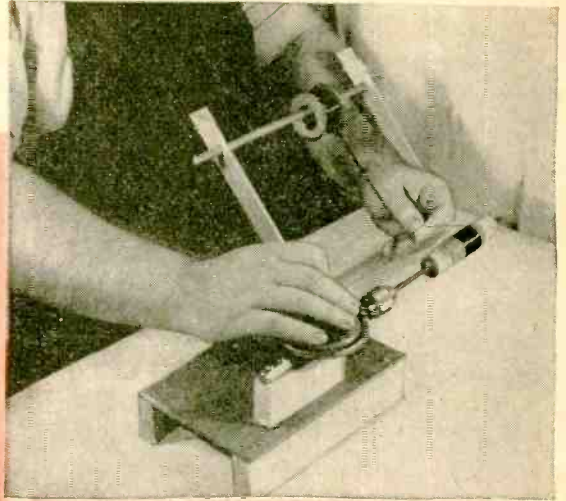

BUILD THIS SIMPLE COIL-WINDING JIG

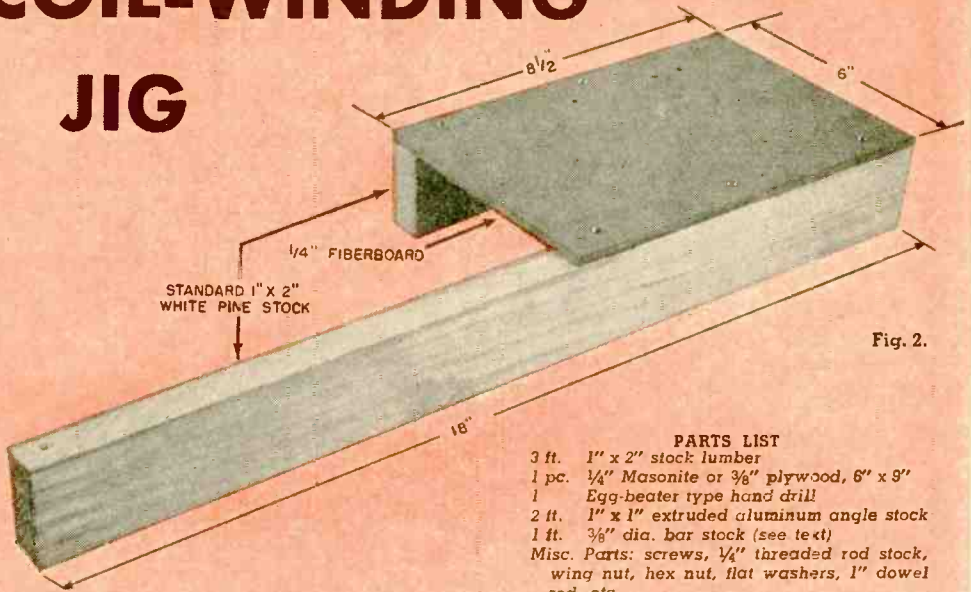

Fig. 2.

PARTS LIST

- 3 ft. 1" x 2" stock lumber
- 1 pc. 1/4" Masonite or 3/8" plywood, 6" x 9"
- 1 Egg-beater type hand drill
- 2 ft. 1" x 1" extruded aluminum angle stock
- 1 ft. 3/8" dia. bar stock (see text)
- Misc. Parts: screws, 1/4" threaded rod stock, wing nut, hex nut, flat washers, 1" dowel rod, etc.



Fig. 3. The winding mechanism is simply an "egg-beater" type hand drill with the handle removed. See article on removing handle without damaging the drill.



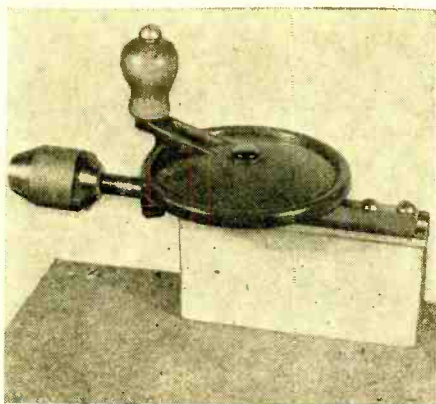

Fig. 4. Mount the drill mechanism on the base with a short piece of 1" x 2" stock and long stove bolts. Perform this operation very carefully.

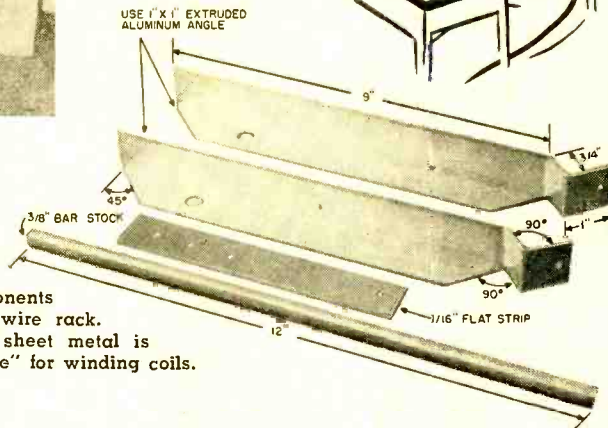
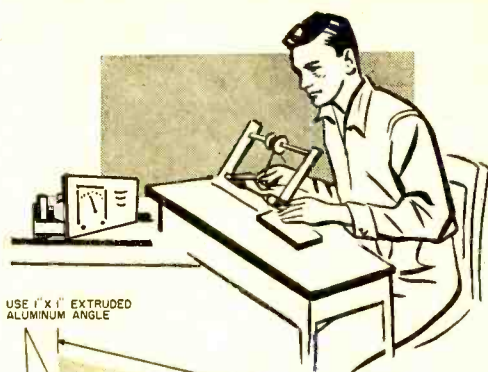

Fig. 5. The various components needed to construct the wire rack. The flat strip of 1/16" sheet metal is used as the "guide paddle" for winding coils.

WHETHER you're a beginner or an advanced experimenter, you'll find that the coil winding jig shown in Fig. 1 will help save you time and money. What's more, you'll be able to do a real professional job on your coils and turn out units that are not only as good looking but which perform as well as "factory made" coils.

All the parts used in assembling the coil winder are easily available . . . you'll probably have most of them on hand. The complete jig may be assembled in only a few hours time. Without working too fast, you should be able to assemble the jig and wind several coils in a single evening.

The base assembly, shown in Fig. 2, is made up of two pieces of 1" x 2" stock and a small rectangular piece of 1/4" hardboard (such as *Masonite*.) Dimensions are not at all critical and you may use the values given in Fig. 2 simply as a guide. Plywood may be substituted for the hardboard.

Although standard round-head wood screws are used to hold the base assembly together in the model, you may prefer glue and nails, stove bolts, or other fasteners.

The model was left unfinished, but if you're handy with a brush, you may wish to stain or enamel the wooden parts of the coil winder. If you do, paint the base assembly before assembling the jig.

The winding mechanism is made up from an "egg-beater" type hand drill. The handle is removed (Fig. 3) and two mount-

ing holes are drilled in the metal shank. On most of these small drills, the handle is simply forced into place over the shank. The handle may be removed by clamping the drill in a vise (taking care not to damage the mechanism) and driving it off with a solid punch and hammer.

Another short piece of 1" x 2" stock is used for mounting the drill mechanism in place on the base assembly, as shown in Fig. 4. Use long stove bolts which extend through the drill shank, the 1" x 2" block, and the hardboard. Use large flat washers under the nuts. One or two wood screws may be driven from underneath, through the hardboard, into the 1" x 2" wooden block for additional strength.

The *wire rack* is made up of two pieces of 1" x 1" extruded aluminum angle stock and a 12" length of 3/8" diameter bar rod. The 3/8" rod may be aluminum, brass, steel, or plain wood doweling. The angle stock is drilled, cut, and formed as shown in Fig. 5. Drill or punch a 3/8" hole near the ends of the angle stock to accept the rod. Take care to insure a good snug fit.

A strip of 1/16" thick aluminum sheet is shown in Fig. 5 in addition to the components used in the *wire rack*. This is a "guide paddle," and is used when winding coils, but it is not assembled as part of the coil winder itself.

After drilling and forming the angle stock, attach these two pieces to the base

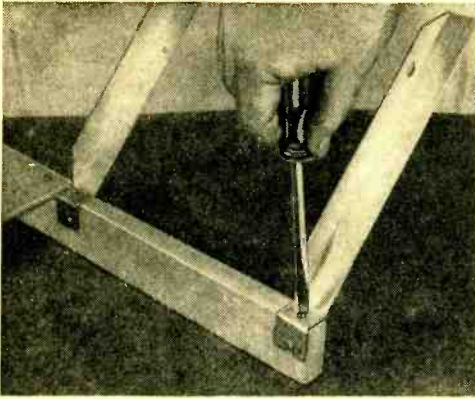

Fig. 6. Attach the wire rack brackets to the base with wood screws as shown in the photo.

assembly with small wood screws, as shown in Fig. 6.

The only remaining part of the coil winder is the *form holder*, shown in Fig. 7. This assembly is used to hold the coil form in place when winding coils. It is made up of a length of $\frac{1}{4}$ " threaded rod stock, two flat washers, a hex nut, a wing nut, and two cone-shaped wooden rods. The cone-shaped rods may be turned in a lathe from 1" dowel rod, or whittled by hand from either dowel or from large thread spools.

After assembly, the *form holder* is clamped in the chuck of the drill mechanism, with the hex nut nearest the drill.

Although the coil winder is quite easy to use, proper technique is essential for smooth operation and to obtain best results. You should follow the basic steps to be outlined when winding coils until you become familiar with the operation of the jig. Afterwards, you can take "short-cuts" to speed up your work. Refer to Fig. 1.

1. Select a spool of the proper type and gauge wire for the coil you wish to wind and place it on the *wire rack*. If you don't have the wire in a regular spool, but in a hank, wind it on an old adhesive tape spool.

2. Drill or punch a small hole in the "guide paddle" (Fig. 5) slightly larger than the wire diameter. De-burr the edges of the hole to obtain a smooth, rounded edge which will not nick the wire.

3. Clamp the coil form on the *form holder* (Fig. 7) between the two wooden

cones. Tighten the wing nut to insure a snug fit.

4. Thread the wire through the hole in the "guide paddle" and attach the free end at the proper point on the coil form. You can use a drop of cement or a small piece of *Scotch* tape for this.

5. Hold the "guide paddle" in one hand with your thumb against the wire and rotate the drill handle with the other hand, as shown in Fig. 1. The guide paddle serves two purposes. First, with your thumb in place over the wire, you can vary tension as necessary to insure a smooth, tight winding. Secondly, you can guide the wire along the form to obtain either a close or a wide-spaced winding.

6. When the coil is completed, keep tension on the wire (using the guide paddle) until you can fasten the end of the coil. Again, you can use a drop of cement or "Q" dope or a small piece of *Scotch* tape for this.

Any one of several methods may be used for counting the number of turns placed on the coil. If the coil is to have 50 turns or less, you can simply keep a mental record as you wind the coil.

Another method is to determine the number of turns of the coil *form holder* obtained with one full rotation of the drill mechanism handle, and then to rotate the drill handle enough times to give the coil desired. In the model, a single rotation of the drill handle gives three and one-third revolutions of the coil form, thus a 110 turn coil may be obtained by rotating the handle fully 33 times.

Still another method is to refer to a standard "Copper Wire Table" as given in handbooks and to determine the number of *turns per linear inch* obtained with the type and size wire you are using. The coil form is then marked off to indicate the length of winding, and wire is wound on the form until the marked space is completely filled. For example, #26 wire (B. & S. gauge) with enamel insulation gives approximately 58 turns-per-inch. A winding two inches long would contain 116 turns. This method is best used with close-spaced coils, but may be used, in modified form, where the spacing is equal to multiples of the diameter of the wire. END

Fig. 7. Details on coil form holder. Cone-shaped rods may be turned on lathe or handmade.



JAPANESE SEEK U. S. GEIGER COUNTERS

DISCLOSURE of radioactive tuna fish in Japanese home waters has led to a world-wide demand for Geiger counters from American suppliers, according to *The Atomic Center, Inc.*, New York, suppliers of atomic instruments and equipment.

The Atomic Center has received inquiries from all over Japan and Europe as well as from Africa and South America, asking for the instruments.

Civil Defense and Public Health authorities and the fishing industry on the West Coast have become keenly aware of the world-wide spread of contamination from A- and H-bomb fission product fall-out, and are studying the problem. This follows reports by the Japanese press that fish abroad the "Fukuryu Maru" were grossly contaminated with radioactive fall-out.

The Sixteenth Semi-Annual Report of the Atomic Energy Commission for 1954 states: "It appears probable that observed contamination consisted largely of radioactive materials on the exterior surfaces of the fish from contact with fall-out material on the ship," adding that analysis of a specimen fish at the A.E.C. laboratory showed "the radioactivity of the edible portions to be . . . acceptable . . . for continuous use by humans," but recommended that fish from the Bikini and Eniwetok Lagoon be "monitored prior to human consumption."

JUMBO AND JUNIOR

JUMBO and Junior among electronic tubes are *General Electric's* giant 15,000 watt klystron for u.h.f. telecasting, and the tiny GL-6299 for radar receiver and other u.h.f. use. The copper-clad klystron, said to be the most powerful tube developed for u.h.f. telecasting, stands 4½ feet high, weighs 200 pounds, and must be moved in a special dolly. Its list price is \$10,000. Since 1953, *G-E* has equipped 35 stations with them on a leasing basis.

The tiny tube, designed to improve reception on long-range search radar receivers, is only one inch high and weighs 1/16 ounce.

Metal construction of the large tube and the metal-ceramic construction of the small tube both differ sharply from the glass-metal of ordinary radio and TV receiving tubes. Both types are produced by *G-E* at its plant in Schenectady, N. Y.

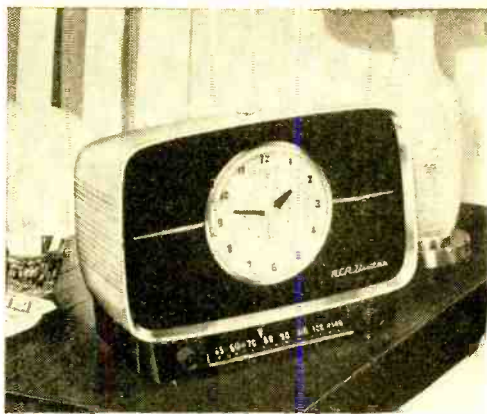

NEW IDEA IN CLOCK RADIOS

RCA's new clock radio, the "Slumber King," is the first of its kind that will automatically change to a preselected station and volume level. "Brain" of the new set is a mechanical device which makes it possible to pre-set the radio to a station and volume level different from those in operation. At a pre-selected time, the radio will automatically switch to the new settings. The set is designed for those who go to sleep listening to musical programs on one station but wish to wake up to a favorite morning program on another station and at a different volume level.

The "Slumber King" will also set off a buzzer alarm and turn on the toaster, coffee-maker, or fan.



R/C



CODES and ESCAPEMENTS

By E. L. SAFFORD, JR.

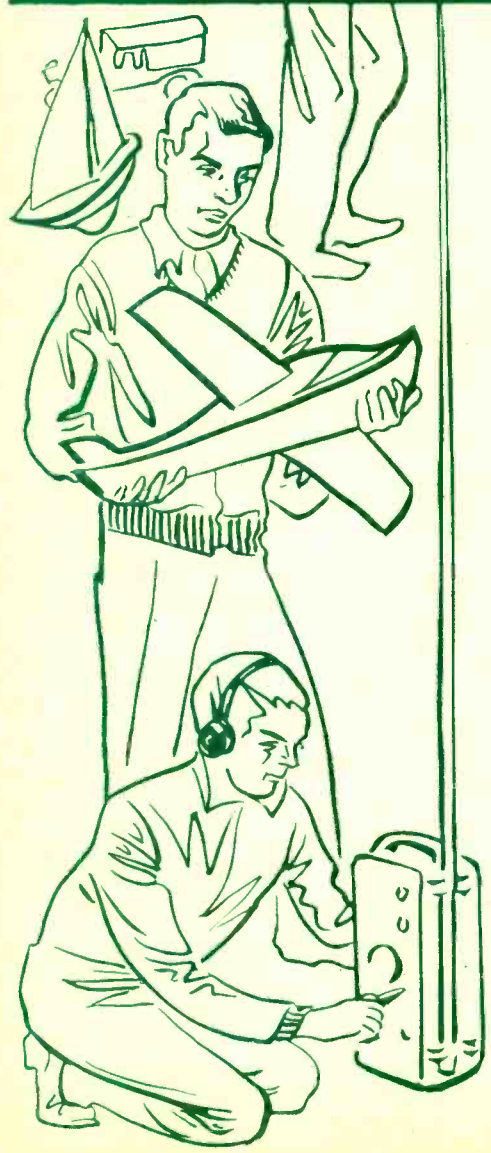

TO GAIN a full understanding of radio control of models, one should understand the methods by which commands are sent and just what kind of signals make up these commands. The hobbyist might think "left" or "right" in his mind as a command for the model to perform. He might then, by depressing a button-type switch, send a signal which the model can interpret to mean "left" or "right." What types of equipment are necessary for the interpretation?

Just a word concerning the communications link. While it is possible to think of using a pressure wave (sound), light, or infrared as the medium, these are subject to interference and suffer some limitations as to range and day or night operation. This discussion will confine itself to the transmission and reception of radio-frequency waves. The methods discussed will, however, apply to any medium of communication.

Examine the transmitter. It can be

Fig. 1. A typical "one-arm" self-neutralizing escapement used in radio-controlled model airplanes or boats. This device translates the receiver signal into a physical control action.

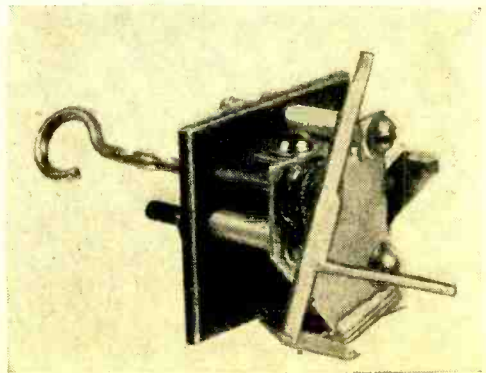

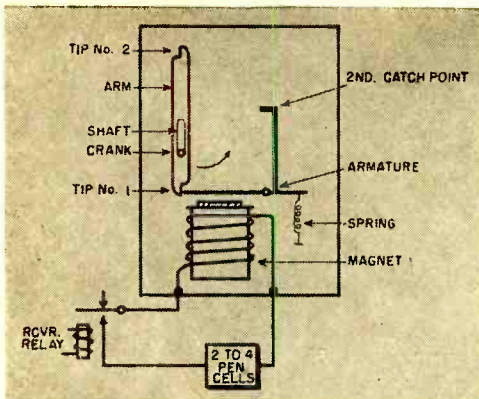

Fig. 2. The vital components of a "one-arm" self-neutralizing escapement as seen from the rear. The shaft is connected directly to the hook on the front of the escapement, see Fig. 1.

turned on and off according to the code used by radio amateurs. Another method is to send forth various tones, or a single tone which might be interrupted according to some code. One might cause the transmitter to send forth different radio frequencies, each one representing a command.

One of the popular codes currently in use to send commands with a single transmitter consists of varying the *rate* at which the r.f. carrier is turned on and off. For example, if the transmitter is turned on and off five times per second, this could mean, say, "left." If the transmitter is turned off and on ten times per second, this could mean "right."

Another code varies the *number of times* the transmitter is turned off and on in a given time interval, say one second. If the transmitter is turned on and off once in one second, it means "left"; twice in one second, "right"; three times, "neutral"; etc. The second code differs from the first in that it is the *number of pulses* that count, not how fast they are transmitted.

Frequently, the time duration that the switch is held in the "on" position determines the command. For example, a short "on" time or "dit" could be "left," a long "on" time or "dah" could be "right."

One method which has unlimited possibilities for performing many functions, but requires complex equipment, is based on the teletype code. The equipment in the model measures time in four-second intervals; each command consists of a different number and sequence of pulses during the interval.

The most popular method used today to control models uses the so-called "one arm" self-neutralizing type escapement. The code is simply a single pulse sequence. When no signal is transmitted, the control mechanism is in "neutral," on is "left," off

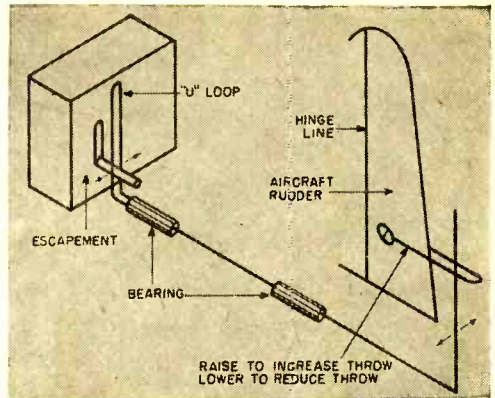

Fig. 3. Equipment for transmitting the motion of the escapement to the part of the model to be controlled (in this case, the rudder of a model airplane). This motion is left and right.

is "neutral" again, and on again is "right." This sequence then repeats.

Let's examine the equipment required for the latter method in greater detail. On the ground, only a means of turning the transmitter off and on is required. The simplest device is a push-button switch. In the model, a receiver and the "one arm" self-neutralizing escapement is required. This escapement unit consists of a magnet, the arm, and the shaft to which the arm is attached. (See Figs. 1 and 2.) Notice that the shaft has a hook at one end and a small crank at the other. It is so mounted that it could rotate freely if it were not for the catch points which are attached to the magnet armature.

The escapement requires two sources of power for its operation—electrical power, which is controlled by the receiver relay, and rubber band or spring power, which is controlled by the electrical power. Thus the receiver, in controlling the electrical power, controls the motion.

One end of a rubber band is attached to the hook and twisted or wound up (the other end is held fixed). The arm and shaft of the escapement would like to rotate, but the armature of the electromagnet is holding one tip (No. 1 in Fig. 2) of the arm. The crank being parallel to the arm is in the down position.

When a signal is received, the receiver relay closes applying electrical power to the magnet. The magnet pulls the armature down, out of the way of tip No. 1, and the arm rotates in the direction shown in Fig. 2. It does not move far, however, since a second catch point, also attached to the armature, now has moved in to engage the arm tip. The arm rotates only one-fourth of a revolution. The crank is now to the right. It will remain there as long as the signal is present and there

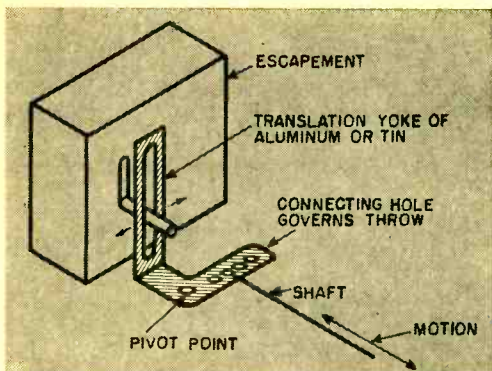

Fig. 4. The yoke shown here will translate the left and right motion of the escapement into a forward and backward motion of the shaft.

is enough electrical power to hold the magnet energized.

Now, the signal is turned off. The second catch point moves back releasing tip No. 1, but the armature has now moved up to engage tip No. 2. Thus, only a quarter of a revolution results. The crank is now vertical. Key the signal on again, and tip No. 2 is engaged by the second catch point. The crank is now to the left. When the signal goes off again, the crank will be back where it started, and the cycle will have been completed.

To convert the rotation of the crank to either left and right, or forward and backward motion, a translating attachment must be provided. Figs. 3 and 4 show two such translators. For left and right motion, a simple "U" bent into a shaft will suffice, as in Fig. 3. The up and down positions of the crank will be neutral, and the left and right positions, left and right shaft outputs.

Fig. 4 shows a "bell crank" arrangement which gives the two neutrals and forward and backward motion.

Escapements are used because they are small, lightweight, have a high reliability, and are economical and versatile. Their electrical power requirements are modest—two to four penlight cells, and the rubber-band power has long life and is economical. They feature the failure-safe factor of neutral with no signal, and they have a very fast response.

Of course, there are many types of escapements, only the most basic type has been discussed here. The codes for other types are more exact; for example, in the *Bonner* compound escapement, no signal is neutral, one pulse is always left, two pulses always right, and three pulses an additional function. These types with their special capabilities will be examined in a future issue. END

TWO-WAY RADIO HELPING MOTORISTS

TWO-WAY mobile radio is rapidly growing in prominence and use. Faster emergency service for motorists is one helpful application. For example, six upstate N. Y. AAA service trucks (see photo) were recently equipped with *General Electric* radiotelephones. They performed satisfactorily in snow, sleet, and rain. The two-way communication between truck and garage eliminates the need for the service-truck to return to its garage to learn where its next call is. Telephone calls from stranded motorists can be relayed by radio to a truck on the road. The truck can then proceed to its next assignment immediately upon completion of its present one.

Similarly, installation of *Bendix* high frequency two-way radio equipment in a service fleet operated in Gastonia, N. C. is resulting in faster service to motorists.

Another use for two-way radio is in stock-car racing. Communication between the racing cars and their pits provides drivers with vital data on lap, position, time, track condition, and other information. In turn, the driver can inform the pit of car condition, the need for more gas, etc.

While some persons now have radiotelephones in the family car, it won't be too long before two-way radio becomes a popular convenience.



POPULAR ELECTRONICS

HINTS ON METER CARE

By H. LEEPER

Most meters have a zero reset screw → which should be adjusted with care. Moving the pointer in a reverse direction may bend it if the adjustment is too roughly done.

With the meter case removed, the → slotted loop into which the reset device fits is clearly visible atop adjustment tool.

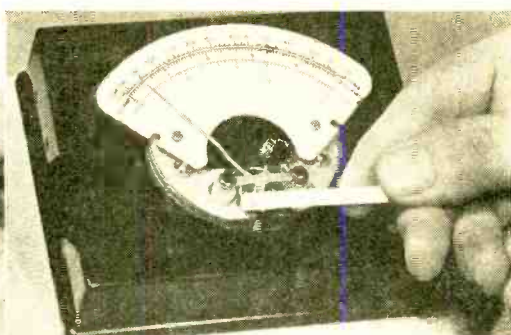
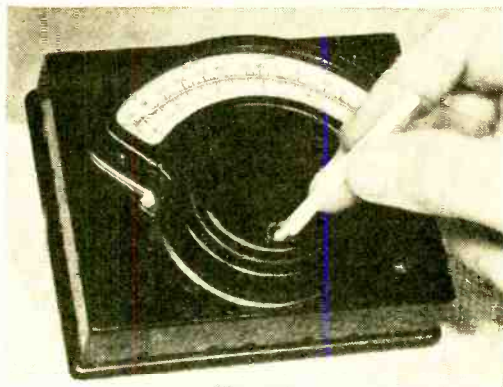

← The thin metal strip which fits into reset loop is attached to the cover of the meter. It is moved by means of the external set screw (top photo).

Note the fine wire leading to back → terminal of the meter and other parts. Current is led through spiral springs to the moving coil which is wound on a bobbin and suspended between jewels. The coil moves in field created by a permanent magnet.

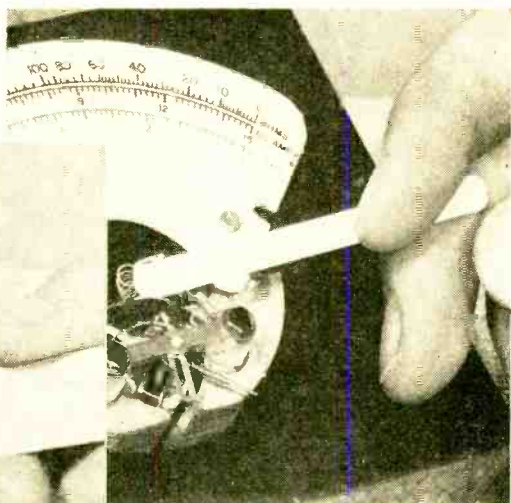
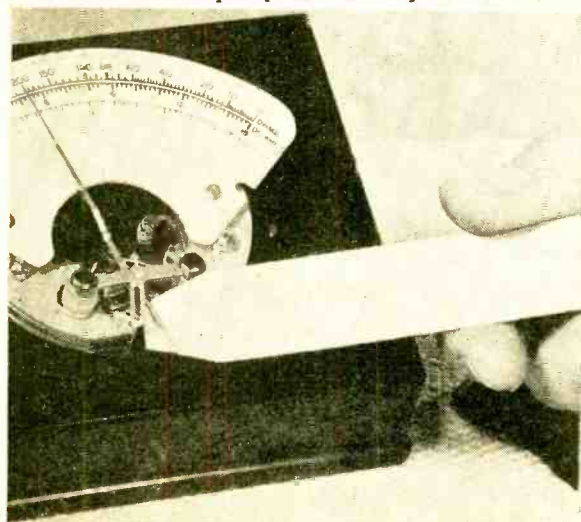

← In checking a sensitive meter for possible damage to springs or other parts, it is often desirable to try the movement of the pointer. Use a light piece of wood or a tongue depressor to perform this operation.

LIGHT SOCKET WITH GUARD CONVERTS TO HANDY TESTER

THE outdoor-type light socket and guard shown were purchased at surplus and arranged for use with two sizes of neon bulbs, a voltmeter, and as a common attachment point for test equipment as well as a holder for tools.

If you cannot locate these exact components, a similar arrangement can be obtained by mounting a standard socket in a thick block of wood and then using a standard steel guard.

The socket shown is located in a circu-

lar base about $4\frac{1}{2}$ " in diameter and $2\frac{1}{2}$ " in thickness. The over-all height of base and guard is 7". Two mounting holes are provided so that the base may be firmly attached to your workbench, if desired.

The test leads were brought through a hole drilled in the bottom of the compound base.

Various uses for this handy aid are illustrated in the photographs on this and the opposite page. More ideas will occur to you as you use the device. END

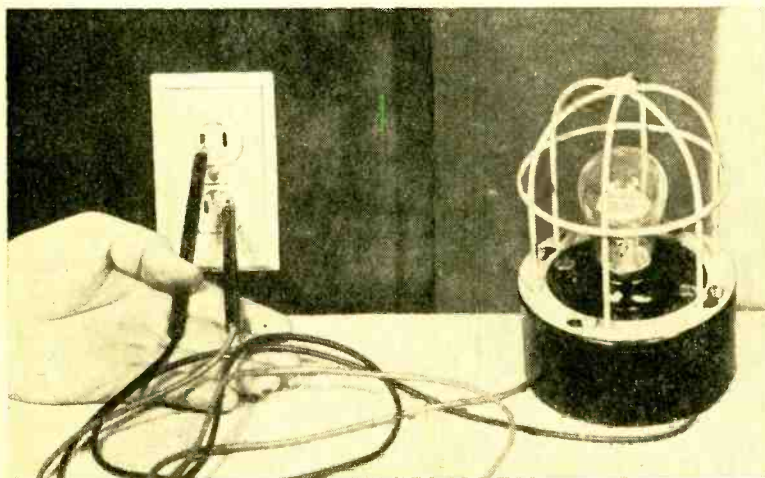

A 2-watt neon lamp was used in Edison base socket with the test leads attached and the prods inserted into the wall outlet to check the presence of voltage.

A candelabra adapter was placed in the Edison socket to permit the use of $\frac{1}{4}$ -watt neon lamp for varied tests.

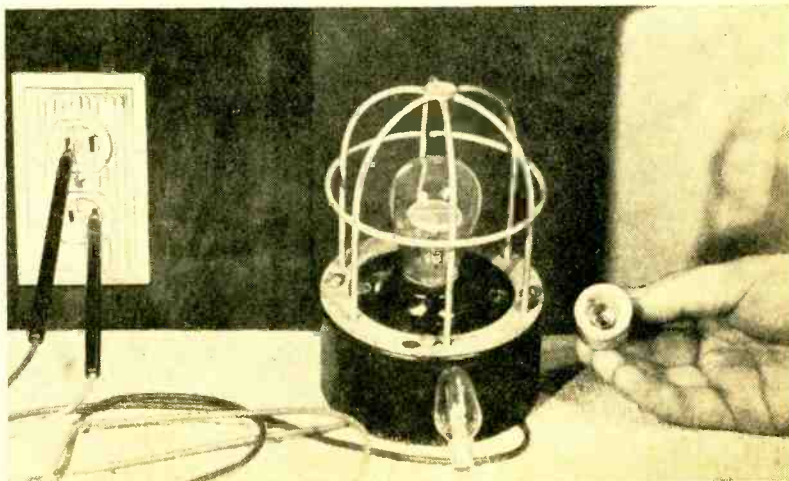

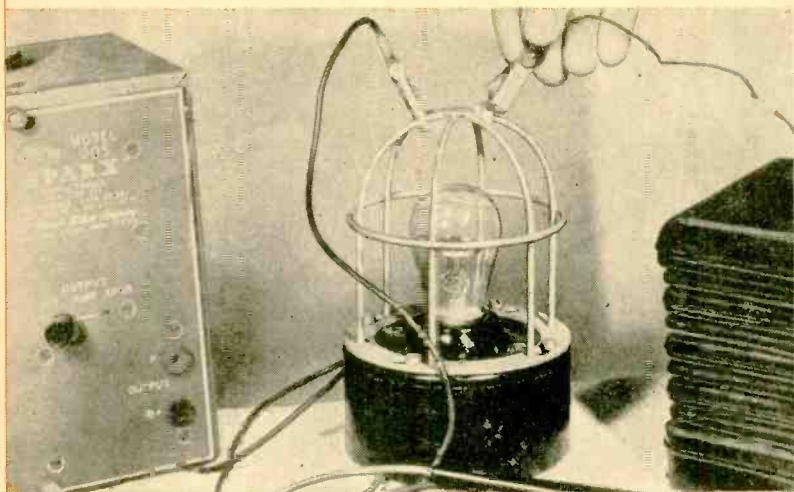

When test prods are not used, unit is not energized and steel guard can be used to attach chassis ground wires from the generator, etc.

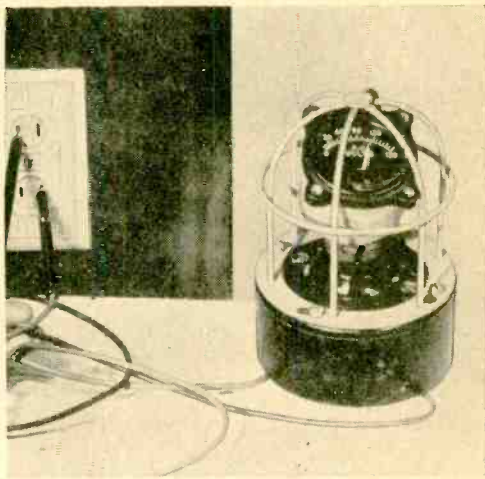
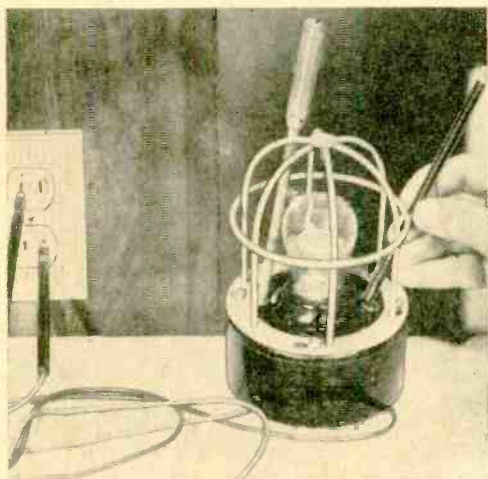

Holes may be drilled in base to hold insulated aligning tools, making sure they cannot touch socket in case it should be used for testing.

A 0-150 volt a.c. voltmeter may be connected to plug and inserted in a screw-in receptacle in socket, for accurate reading of line voltage.



Metal ring holding the guard wires is far enough down from the top to permit inserting of hot soldering iron as is shown here.

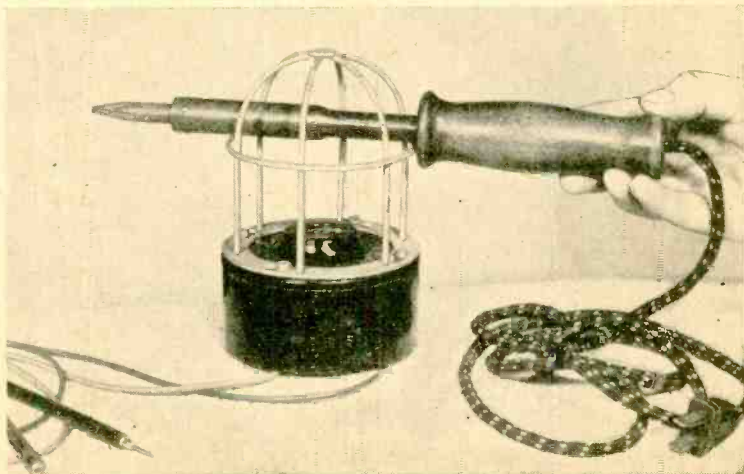

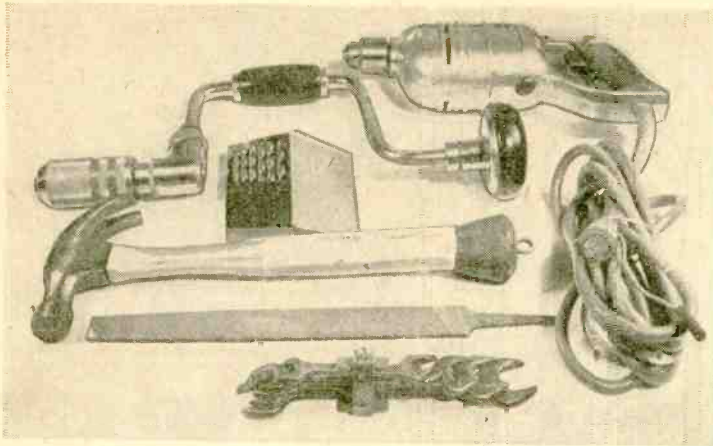

Basic tools you should have: electric drill (a drill press is preferred if you can obtain one), a brace, a set of drills, a hammer, files, and a set of end wrenches. If you can afford them, you'll find that a good assortment of files will make your work a lot easier. As a "starter" set you will probably want half-round and flat files in both fine and coarse cut, two sizes of triangular files, and two sizes of "rat-tails."

CUTTING LARGE HOLES

1 To use a chassis punch, you first drill a pilot hole. Mark the center with a regular center punch before drilling. Back up the sheet metal with a wooden block for easier drilling and better quality work.

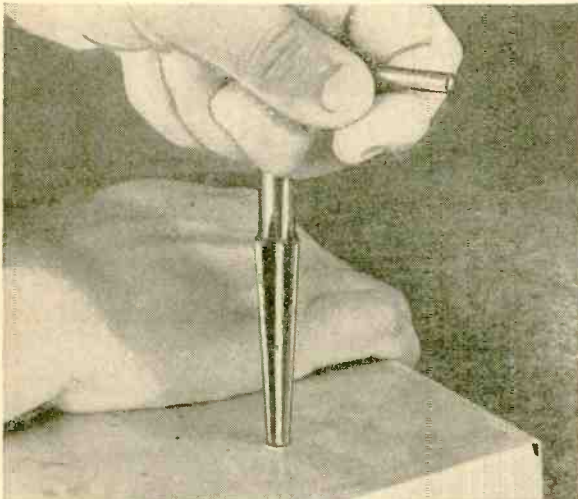
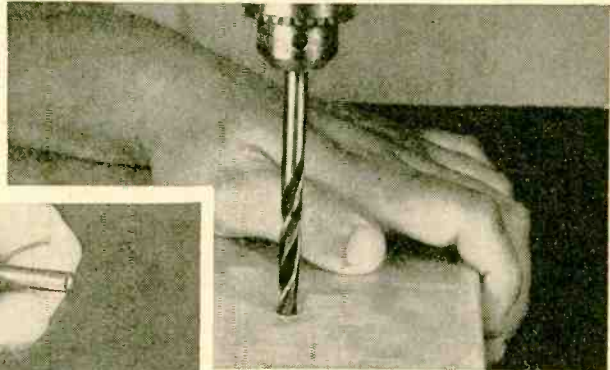

2 If you have only a $\frac{1}{4}$ " drill, but want to drill a larger hole, you can use a tapered reamer. Apply a steady pressure as you turn the reamer, but don't try to cut too rapidly, especially when working steel.

3 Some bits, up to those running $\frac{1}{2}$ " in diameter, have $\frac{1}{4}$ " shanks for use in electric hand drills. This particular type of bit is suitable only for light sheet metals, woods, and plastics. To avoid broken bits and overheated drills don't try to use this equipment on thick pieces of steel or hardened metals of any type. Remember they are designed for light drilling jobs and use accordingly.

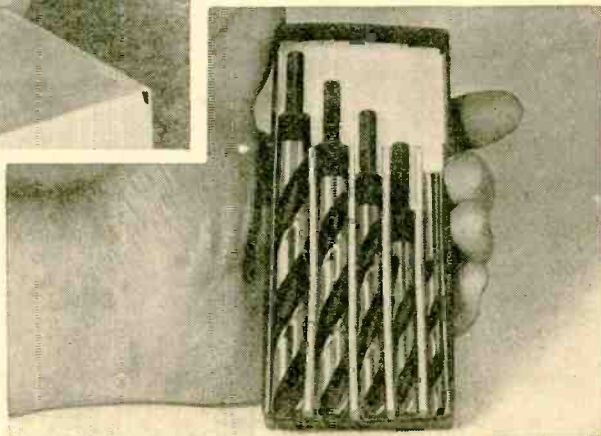

Additional tools that you should have: a hole saw, a round chassis punch, a square chassis punch, a circle cutter, a "keyhole" hacksaw, a cold chisel, a tapered reamer, and a center punch. A complete set of chassis punches and hole saws is desirable but expensive. You will probably want to start with the sizes used for the tube socket holes. For a start you might get the $\frac{1}{2}$ " , $\frac{3}{8}$ " , $\frac{3}{4}$ " , 1" and $1\frac{1}{8}$ " size punches.

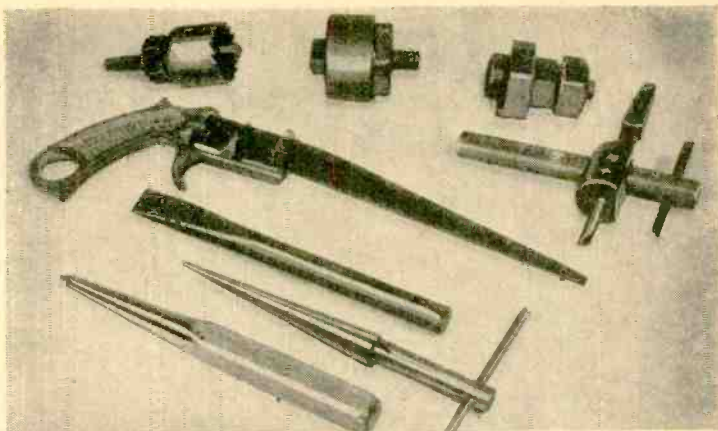

IN A METAL CHASSIS

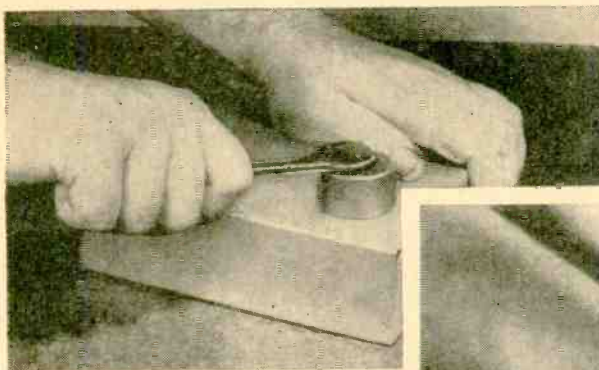

4 How to use a chassis punch. An end wrench is used to rotate the nut, pulling the punch against the die and through the metal. Some experimenters prefer to clamp the nut in a vise and then rotate the chassis.

5 Chassis punches are only suitable for use in sheet metal. For thicker plates, such as $\frac{1}{8}$ " rack panels, many builders prefer to use a hole saw, as shown in photo. Hole saws also require use of the pilot holes.

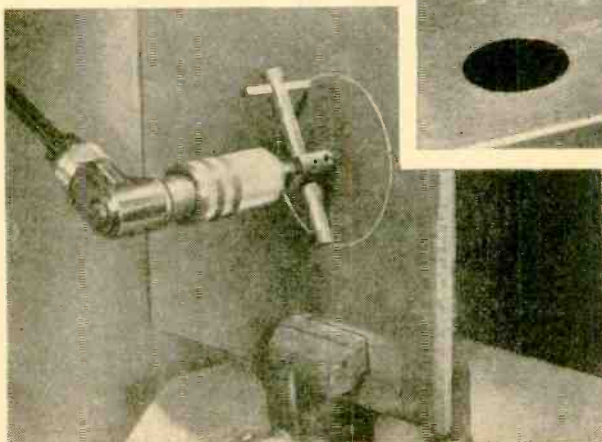
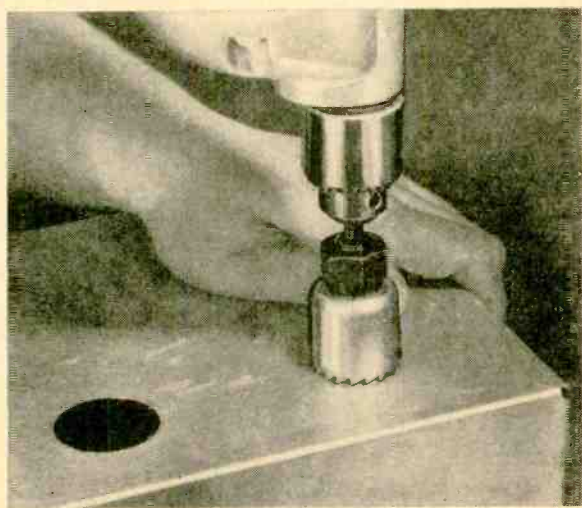

6 Adjustable type circle cutters can be used to drill the large round holes needed for installing loudspeakers and various meters. These cutters are available with square shanks for use with a brace and also with round shanks for use with a low-speed electric drill. Always perform this cutting operation slowly and with care to avoid spoiling a large panel sheet—which may be expensive.

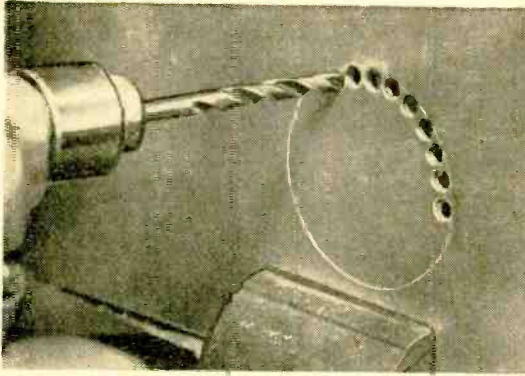

7 Another technique for cutting the large round or rectangular holes. Mark outline on the metal with a scribe, drill a series of holes close inside the scribed line. Knock out the metal with a cold chisel and smooth the surface with a file.

8 A large square, rectangular, or irregularly shaped hole can be cut with your square punch by making a number of cuts until the desired hole is blocked out. A square punch is operated in much the same way that the round punch is employed.

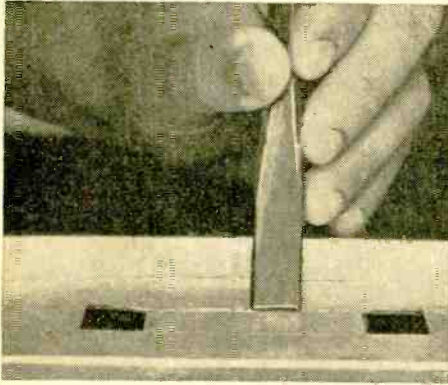
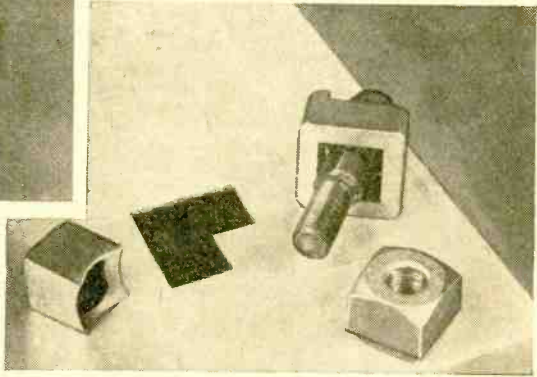

9 Still another technique for making large square and rectangular holes is to punch square corner holes only and then cut between the holes with a cold chisel. When using the chisel, the sheet metal should be backed with anvil or soft iron block.

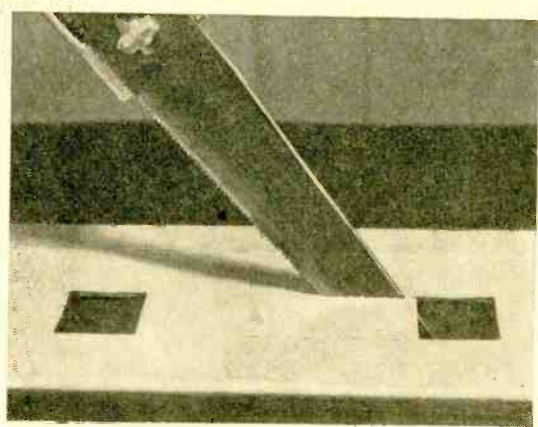

10 If preferred, a hacksaw may be used to cut between corner holes, instead of a cold chisel. If this method is used, it is not necessary to provide backing for the sheet metal. Be sure to use a sheet metal type blade in the hacksaw you use.

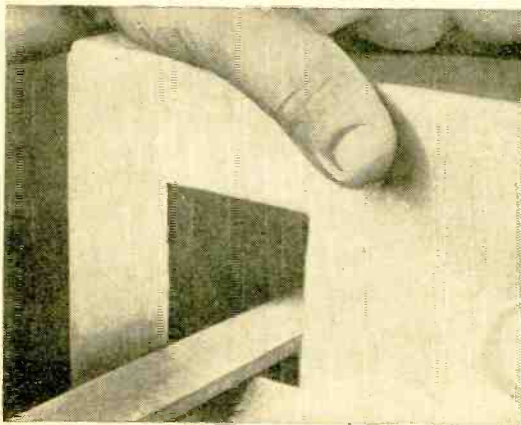

11 Holes cut using a chisel, a hacksaw, or a hole saw should be smoothed with a file. A coarse cut file may also be used for removing large amounts of the metal, as in enlarging a hole to obtain an exact fit for a transformer or other component.

NOTES: When using a center punch, a drill, a hole saw, or circle cutter, back up sheet metal with wood; when using a cold chisel, back up with metal. Don't use a drill, a hole saw, chassis punch, or circle cutter "dry"! Always apply a light oil. Burrs can give a bad cut. Remove them after working sheet metal. **END**

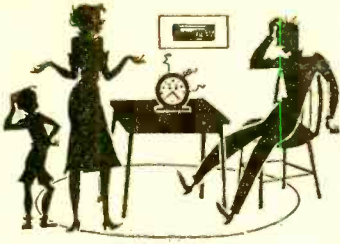

After disconnecting the line plug from the wall outlet, loosen the screws and remove the clock assembly as shown. This is the first step in effecting clock repairs.

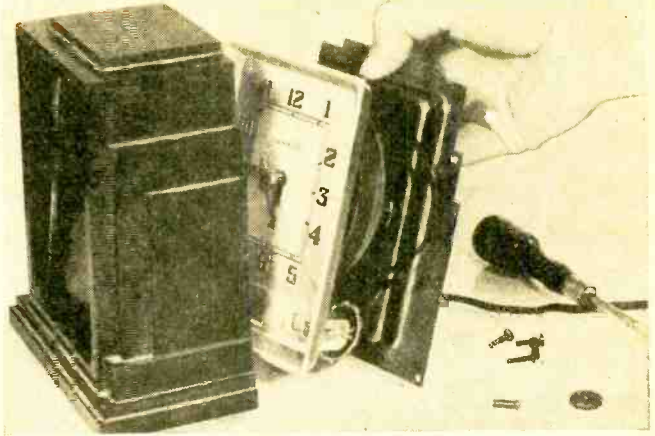

How To Repair Your Electric Clock

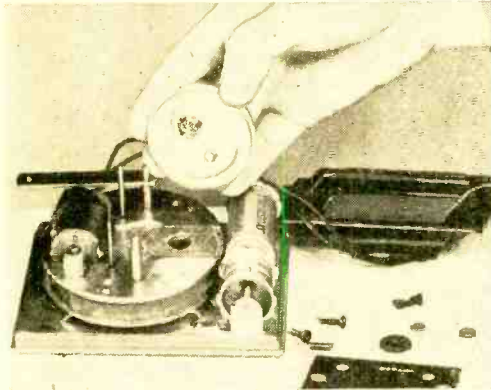

Next, disengage the small motor, or rotor containing gears, from the clock gear by unscrewing the bar or holding clamps as shown here.

If rotor is to be repaired rather than replaced, carefully drill a small hole through the rotor case near top section. Drill from the bottom.

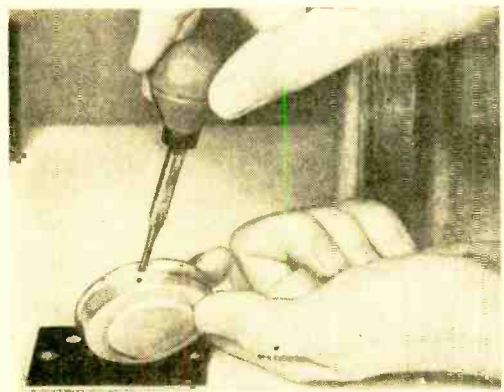
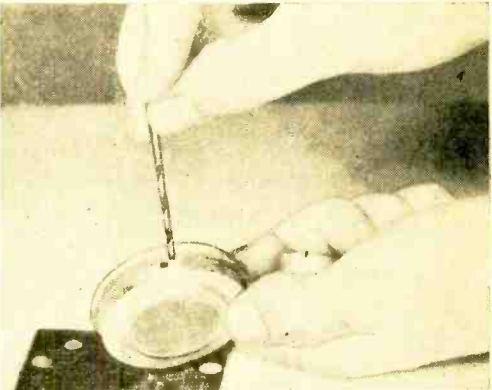

With small syringe or eyedropper, fill rotor with cleaning solution and drain out. Then refill with light oil. "3-in-1" or such will do.

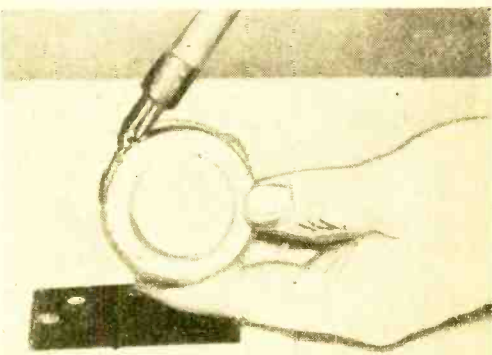

Solder lightly over drilled opening and replace unit as found. Badly worn rotor units should be replaced, not repaired.

Train Speed

By LEO G. SANDS

KEEPING trains on ever faster schedules, an engineer doesn't just go along for the ride while the rails guide the train. He must keep the train at all times at the maximum safe speed. If it is too slow, he will not make his schedule; if it is too fast, there may be an accident. The maximum safe speed varies with the layout and condition of the track. Around a curve it may be only half as great as on a straightaway.

An electronic system has been devised by David Sunstein and Lionel Rodgers of *Philco Corporation* which will permit automatic speed control of trains. The system is simple and uses tape recording principles.

A wire or ribbon of steel, or a nonmagnetic material such as a plastic which has been treated to make it have magnetic properties, may be used for storing musical sounds or other intelligence. The tape is moved lengthwise past a magnet whose intensity is varied in step with the signal to be recorded. The tape is affected by the varying magnetic field through which it is passed and retains the magnetic impression made upon it. To reproduce the sound which has been recorded, the tape is moved past a pickup head which is sensitive to variations in the magnetic field about the tape. The output of the pickup is magnified by an amplifier and converted into audible sound by a loudspeaker. In both recording and reproducing sound, the tape moves at the same speed. Probably you have noticed what happens when a tape or disc record is played back at the wrong speed. If the speed is too slow, the pitch of the sound will be too low; if the speed is too fast, the pitch will be too high. The pitch variation which is unwanted in sound reproduction can be used in train speed control.

A steel rail, as used in railway trackage, can be magnetized and retains its magnetized state for a long time. Suppose we build a tape recorder and reproducer in which a rail is used as the tape. The rail is magnetized by running over it a train equipped with a recording head. This recorder emits a signal of fixed frequency between 5 and 100 cycles-per-second. The train moves over the track at the maxi-

mum allowable speed, slowing down at curves and other sections of track where required. If a subsequent train equipped with a pickup head passes over the track at precisely the same speed as the recorder train, it will pick up the same constant frequency signal as was originally recorded. If the subsequent train moves more slowly than the original recorder train, a lower frequency signal will be picked up. If it moves faster, a higher frequency signal will be picked up. If, for example, the recorder train impressed a 100-cycle signal into the rails when traveling at the desired maximum speed, a subsequent train traveling 10% slower than the recorder train will pick up a 90-cycle signal. A train traveling 10% faster will pick up a signal of 110 cycles. The output of the pickup unit on a train may be fed to an amplifier and thence to a discriminator which will detect differences in frequency. This frequency difference can be indicated on a meter in the locomotive cab calibrated in percentage of maximum allowable speed, to warn the engineer when he is exceeding maximum allowable speed and to advise him when he is traveling below allowable speed.

The information recorded in the rails can be quickly erased and replaced with new information by running a train equipped with a recorder over an already recorded section of track. Therefore, it is practicable to change information in the rails to make special speed restrictions in cases of floods, repair work, or whenever a change in operating speed is considered necessary.

The information from the rails can be used not only to indicate train speed, but to regulate it automatically. The discriminator output can be used to control servo systems which will automatically maintain maximum desired speeds, slowing trains for curves and stopping them when desired. In the foreseeable future, trains can be operated without crews and with complete safety.

This system can even be used to regulate different trains at different speeds on the same track. All that is required is to change the frequency to which the discriminator on the controlled train is tuned.

TO BE CONTROLLED AUTOMATICALLY

For example, if the recorder train impressed a 100-cycle signal into the rails when traveling at a certain speed, a train whose discriminator was tuned to 50 cycles would be regulated at half the speed of the recorder train.

When this idea was first suggested by Sunstein and Rodgers, it was agreed that rails would not retain magnetically recorded information. Tests conducted jointly by *Philco* and the *Pennsylvania Railroad* quickly proved that the rails could retain such magnetized information.

It has been definitely proved that the system will work, but it has not been adopted commercially because it does not integrate into existing railway signal systems. Substitute, half-way measures have been adopted which will provide some of the features of this system without causing obsolescence of existing signal systems. With this system it will be possible to maintain better "on time" performance. In the future, completely automatic operation of trains will be feasible. If this system does not eliminate the locomotive engineer, it will make his job easier. With routine speed control handled automatically, he will be freed to exercise his judgment when special situations and emergencies arise. END

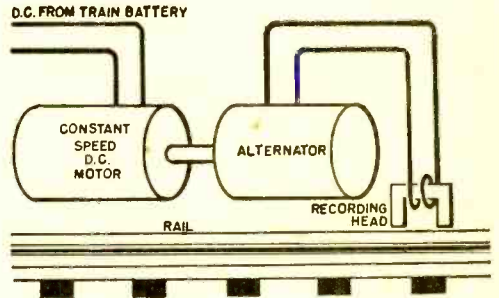

Constant frequency reference signal generator in recorder train would magnetize rails.

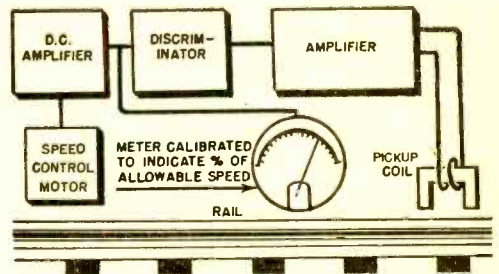

Recorded signal picked up from rails could be used to indicate or to control speed.

Allowable train speed depends upon track layout: it is much lower on curve than on straight section.

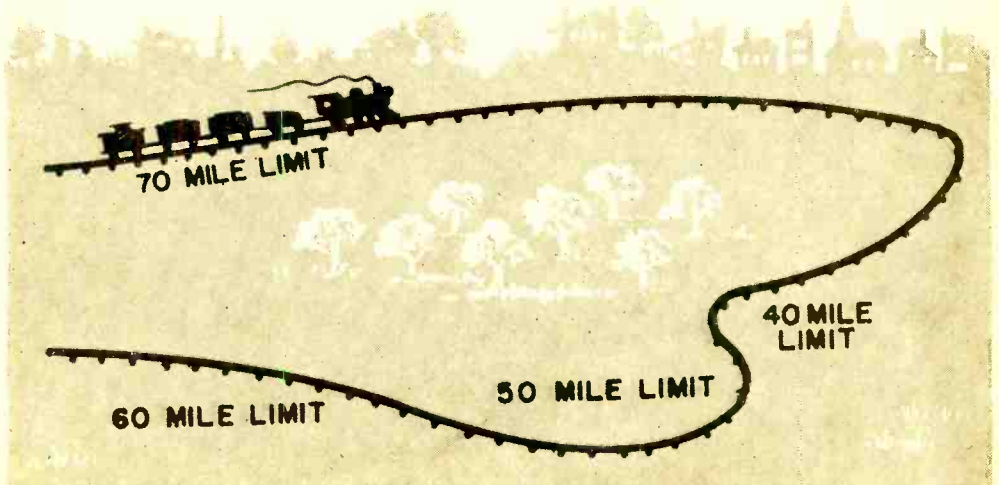
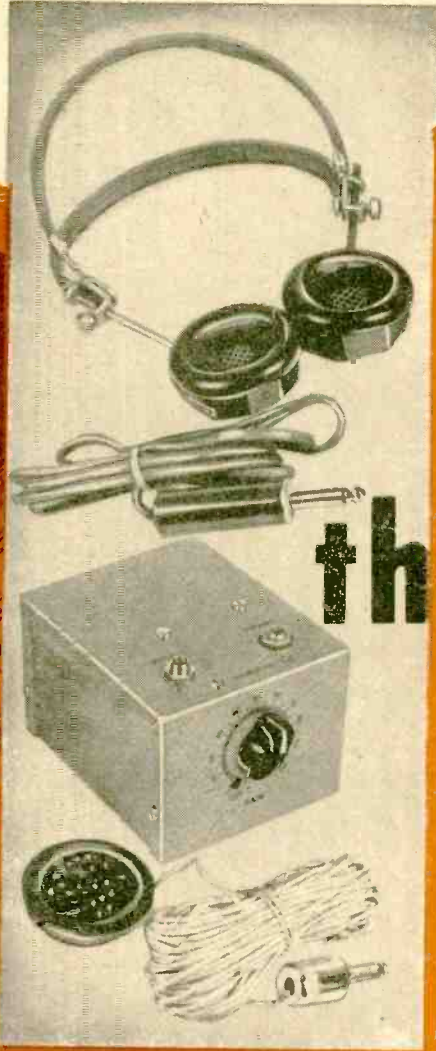

Fig. 1. The "Electronic Ear"—a microphone, an extension cable, a battery-operated amplifier, and a pair of sensitive headphones.



By LOUIS E. GARNER, JR.





A Christmas gift your youngster will enjoy. You can have fun building this amplifier and watching your youngster eavesdrop on his friends with its hidden microphone.

YOU can have a lot of fun building this "Electronic Ear" and your children or those of your friends can have a lot of fun using it. Standard parts, available at your local radio supply house, are used throughout. You should have no difficulty in assembling it in two or three evenings.

The "Electronic Ear" consists of a remote microphone and cable, a compact battery-operated audio amplifier, and a pair of sensitive earphones. With it, the kids can listen to conversations of their friends in other rooms.

To have the most fun, the kids will want to place the microphone in a hidden location where their friends can't easily spot it. Good locations are behind a picture frame, a bookcase, dresser, or other piece of furniture, in a vase of flowers (not in the water!), or hidden behind light draperies. The microphone should be located near the

center of conversation and the front of the microphone should be clear so the sound will not be muffled.

In a typical installation the microphone is attached to the base of a small table lamp with strips of *Scotch* tape. The shielded cable is wrapped lightly around the lamp cord. When the lamp is set upright, the microphone cannot be seen and the small shielded cable is hardly noticeable. The lamp cord should be left unplugged to avoid excessive hum pick-up from the power cord.

You (or the kids) may have to exercise considerable ingenuity to hide the cable properly. It can be run under a heavy rug, behind furniture, or inside the groove of a baseboard, held in place with *Scotch* tape or rubber cement.

The young operator probably will need some instruction in manipulating the

"Gain" control for best results. Normally, the amplifier should be operated with full gain, so that persons entering the room where the microphone is planted can be heard. As they approach the location of the microphone, the "Gain" control should be turned back to maintain a comfortable listening level. This is very important. Otherwise, a sudden approach to the microphone's location might cause "blasting" in the headset, with the result that important parts of the conversation are missed. The kids wouldn't want that to happen!

If you can get the "Electronic Ear" away from the kids, you can have fun with it, too. But, if you do listen in on your friends, either let them know beforehand that you are going to do so or make sure they are the kind of friends who will not mind when they find out afterward.

When the operator becomes familiar with the operation of the "Electronic Ear," he or she will find many other uses for it. It can be used for conducting "mind reading" tricks at parties, for example. With a microphone "planted" in the recreation room, the "mind reader" leaves so that he can't overhear the conversation of his friends. Actually, he goes to a nearby room and dons the headset. When he returns, he is fully informed of all that has taken place in the party room, much to

the amazement of his friends. Another application is as a stethoscope. With the cord coiled up or replaced by a shorter one, the children can listen to their own and each other's heartbeats. Still another use of the amplifier and headset (without the microphone) is to provide additional gain to increase the sensitivity of a crystal receiver.

The audio amplifier is housed in a standard 3" x 4" x 5" "Minibox". The outer case is drilled as shown in Fig. 4. Dimensions are not critical. After the machine work is completed, decals are applied to identify the "Gain" control and the "Input" and "Phones" jacks. The labels are protected by two coats of clear plastic, sprayed on after the decals have dried.

You can bend the small chassis shown in Fig. 5 out of a piece of scrap aluminum sheet, or you can cut a commercial 3/8" x 4" x 1" chassis to the dimensions shown. Holes are drilled and punched for mounting the two 7-pin miniature tube sockets. Short machine screws and hex nuts are used for mounting the sockets.

You'll note that a *printed circuit* coupling plate (PC₁) is used between the 1U5 and 1L4 stages. This coupling plate may be replaced by individual components if desired. Proper parts values are indicated.

Most of the chassis and case wiring may

Fig. 2. With all of the parts mounted and wired and the batteries installed, two parts of the case of the "Electronic Ear" can now be fastened together.

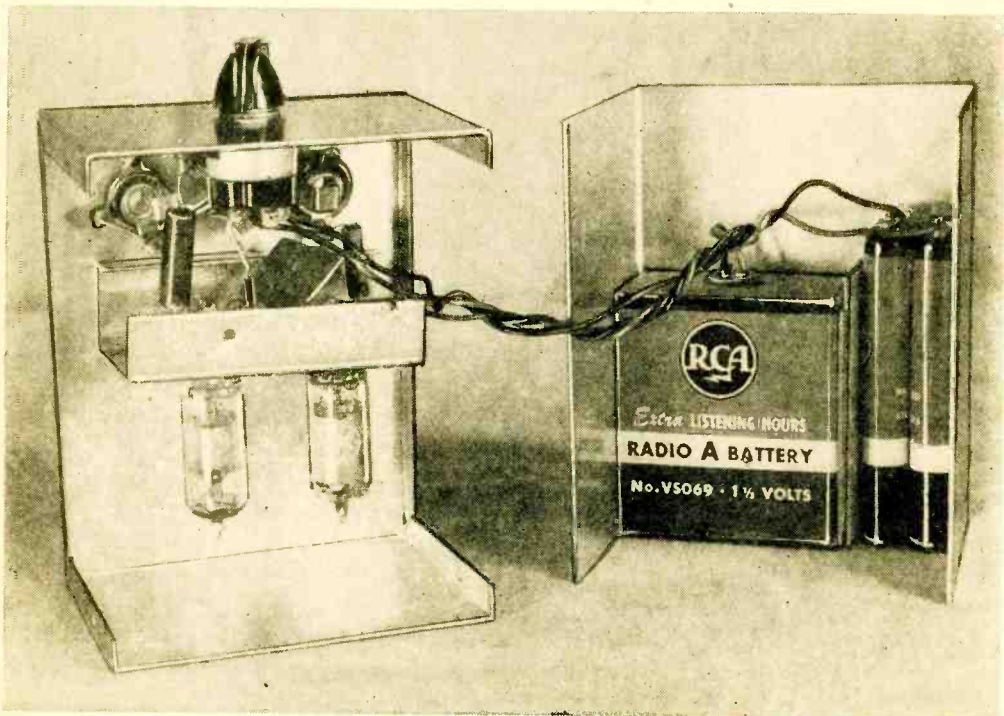

Wiring Diagrams for The "Electronic Ear"

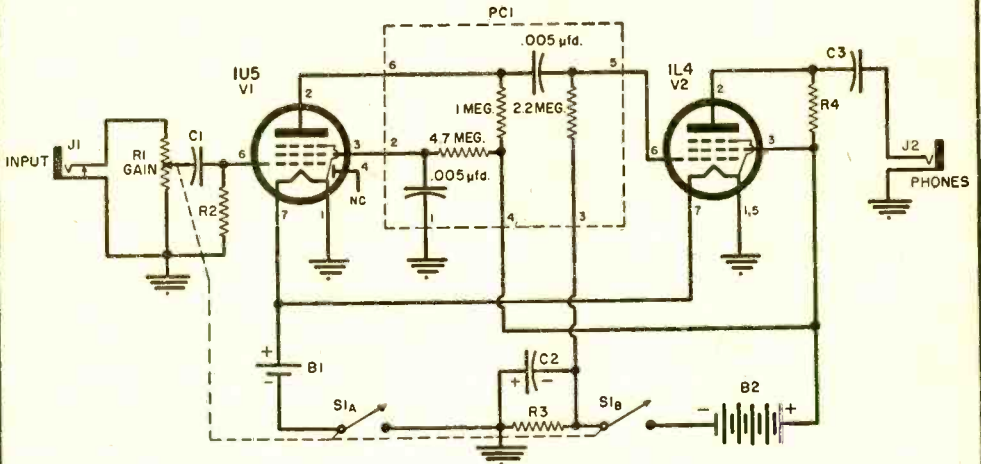

- R*₁—1 megohm potentiometer, audio taper ("Gain")
*R*₂—10 megohm, ½ w. res.
*R*₃—470 ohm, ½ w. res.
*R*₄—47,000 ohm, ½ w. res.
*C*₁—.005 μfd., 200 v. capacitor
*C*₂—10 μfd., 25 v. elec. capacitor
*C*₃—.02 μfd., 150 v. capacitor
*PC*₁—Pentode printed circuit coupling plate (Erie Type 1407-03)
*J*₁—Closed circuit phone jack
*J*₂—Open circuit phone jack
*S*₁—D.p.s.t. switch (on "Gain" control *R*₁)
*B*₁—"A" battery, 1½ volts (RCA Type VS-069)

- B*₂—"B" battery, 90 volts (Two RCA Type VS-096 45-volt batteries connected in series)
*V*₁—1U5 tube
*V*₂—1L4 tube
 Other parts you'll need: 3" x 4" x 5" "Minibox" (Bud Type CU-2105); small aluminum chassis (ICA Type 29082); bar knob for "Gain" control; two 7-pin miniature tube sockets; 50 to 75 feet single-conductor shielded wire; two phone plugs; small crystal microphone cartridge (Shure Type R7); high impedance headphones (preferably crystal headphones); decals; wire; solder; screws; nuts; battery plug; etc.

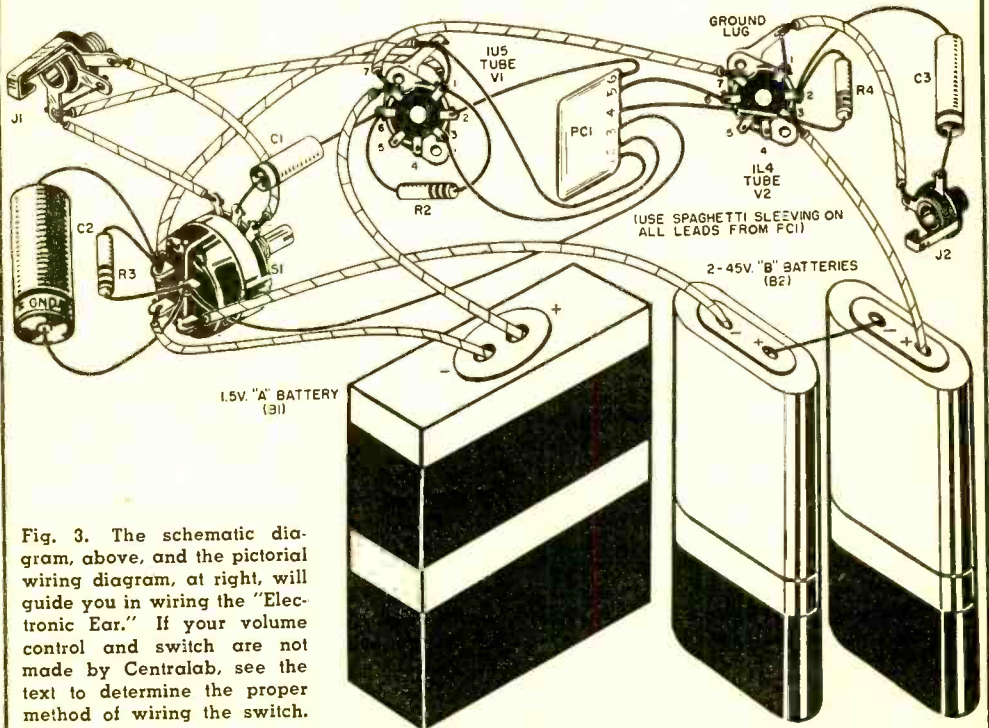

Fig. 3. The schematic diagram, above, and the pictorial wiring diagram, at right, will guide you in wiring the "Electronic Ear." If your volume control and switch are not made by Centralab, see the text to determine the proper method of wiring the switch.

be completed before those two units are assembled. When you have completed as much of the wiring as you can without final assembly, attach the chassis to the case with sheet metal screws and make the final connections.

The wiring of the power switch, *S*₁, is very important. Probably you will get a switch like the one shown in the pictorial wiring diagram and be able to connect it as shown here. However, the switches made by different manufacturers differ slightly in appearance. If you have any doubt about the proper way to connect the switch you have, you can do any one of three things: (1) find out which terminals are connected together when the switch is turned on, by using a continuity tester or short detector such as described on page 56 of October POPULAR ELECTRONICS; (2) wire the switch according to the instruction sheet, if one is furnished by the manufacturer; or (3) ask the dealer from whom you buy your parts, showing him the schematic and pictorial wiring diagrams on the preceding page.

A compact 1½-volt battery, *B*₁, is used to supply filament voltage for the miniature tubes, and two small 45-volt batteries, *B*₂, are connected in series to supply 90 volts for the plate and screen circuits. The batteries are mounted in the back of the case, as shown in Fig. 2. They are held in

place by the pressure exerted by the sides of the case. Several small strips of cardboard are inserted between the batteries to increase this pressure.

A standard crystal microphone cartridge is used as the remote microphone. Attach the microphone cartridge to one end of a fifty- to sixty-foot shielded single-conductor cable and connect a phone plug to the other end. Use the thinnest cable you can obtain. The smaller the shielded cable, the easier it is to conceal it.

After you've completed the wiring and double-checked for possible errors, plug the tubes in their respective sockets. Make sure the switch is "off" and connect the batteries. Plug the microphone cable into the "Input" jack and the headset into the "Phones" jack. For best results, a sensitive crystal headset should be used. Turn up the "Gain" control, switching the amplifier "on". Since battery-type tubes are employed, virtually no warm-up time is required. Have someone talk into the microphone while you listen for his voice. With full gain, you should be able to pick up and hear clearly normal conversation at distances of two to five feet from the microphone. If you want to test the "Electronic Ear" when no one else is at home, to keep the project to yourself until Christmas, place the microphone in a room where a radio or phonograph is playing. END

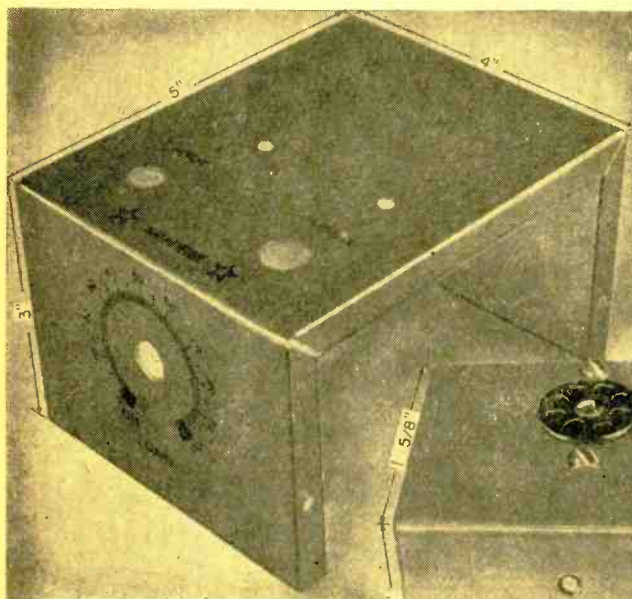
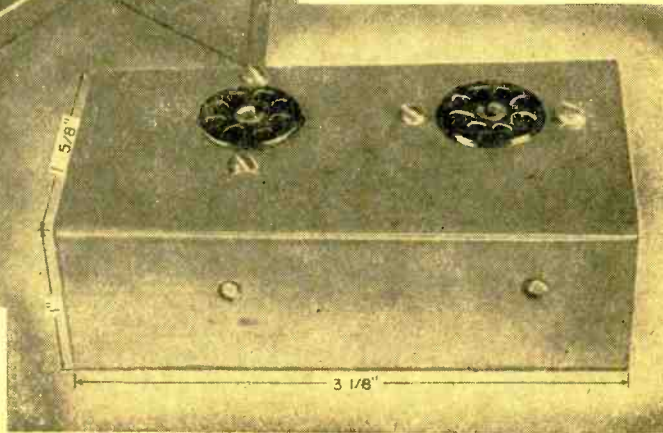

Fig. 4. The amplifier case should be drilled for the microphone and phone jacks and the gain control; then it may be labeled with decals as shown.

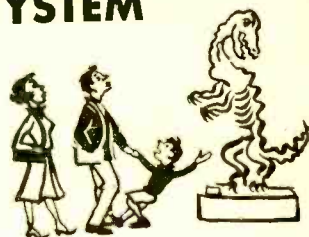
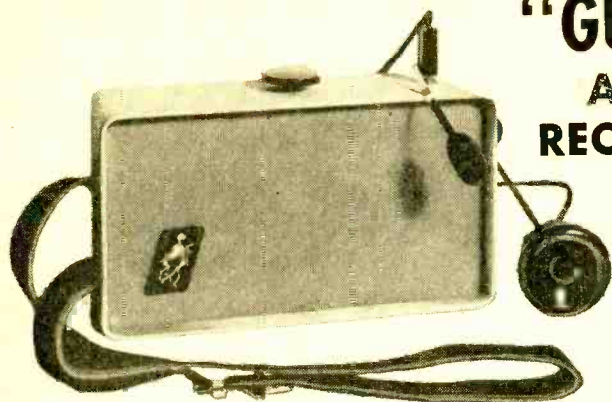

Fig. 5. The amplifier chassis is shown here with the tube sockets mounted and the two holes drilled for the screws to fasten it to the case.



"GUIDE-A-PHONE"

A NEW PORTABLE RECEIVER-TRANSMITTER SYSTEM



VISITORS to New York City's American Museum of Natural History may now listen to lectures over the new "Guide-A-Phone," a portable earphone-and-receiving set that picks up lectures being transmitted in the Museum's halls.

The American Museum is the first institution in the Western Hemisphere to make this type of device available to its public. One hundred and twenty-five sets are now in use. Talks for the "Guide-A-Phone" are first recorded on tape and then transferred to discs. The discs are played on a record changer which feeds into an audio amplifier. The amplifier output is connected to hidden wire loops suspended around the Museum Halls. These wire loops radiate a magnetic field varying at an audio frequency rate.

Receivers are battery powered, and are essentially audio amplifiers with no r.f. or detector stages. An induction coil in the receiver picks up the audio frequencies present in the vicinity of the "transmitting" loops. Thus the closer one stands to the exhibit, the greater the signal strength in the receiver.

Two kinds of earphones are available—one that goes over the head and a lorgnette type that is expected to be popular with the ladies so they won't disarrange their hair. The visitor may adjust the volume to suit himself.

Talks are about twenty minutes long. They provide interesting background information about the exhibits the visitor is viewing. Each talk begins by telling the visitor what route he should take in the Hall. When it is time to move to a new exhibit, a bell sounds and the name of the next exhibit is announced. Talks are transmitted continuously so that the latecomer, like the person who arrives in the middle of a movie, can catch up with the talk by remaining for the next playing of the part he has missed.

Commenting on the "Guide-A-Phone," Dr. Albert E. Parr, Director of the Museum, said: "Its future—how many more halls will be equipped to accommodate it and whether additional sets will be made—depends upon the response of Museum visitors. . . . The project is . . . an experiment at this point. . . ." **END**

Visitors using the "Guide-A-Phone" at one of Museum's exhibits.

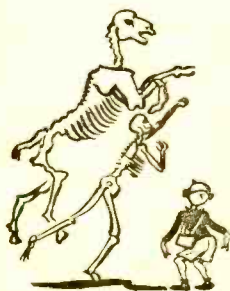

Electronic Baby Sitter

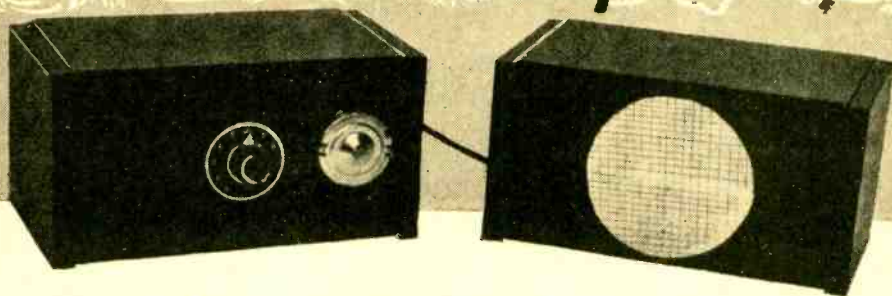

By BYRON G. WELS

Listen to the baby from another room—or another house—with this sound amplifier.

THIS versatile unit is easy to build and low in cost, and the results obtained from it are most gratifying. It is contained in two boxes, one housing a microphone and an amplifier, the other the loudspeaker. The two boxes are connected by means of television twin-lead, which can be of any length up to 150 feet. You can place the unit with the microphone in any convenient place in the baby's room and the loudspeaker box in another room of the house where the parents are likely to be—the bedroom, living room, etc. It has been used even between adjacent houses with good results, permitting neighbors to baby-sit for each other without having to leave their own homes.

The "baby sitter" actually is a one-way intercom. As shown in the small diagram, you can install an additional selector switch and put a loudspeaker box in each of several rooms. By selecting the desired speaker by means of the switch, you can talk to any of the remote stations.

When not being used as a "baby sitter," this unit can provide laughs at parties. It can be used to permit guests to go into other rooms and talk "on the radio." You can conceal the loudspeaker in shrubbery around the house during lawn parties, behind a sofa, or behind the shower curtain in the bathroom, wait with the microphone in another room, then, when one of your guests is "in position," make appropriate remarks. A still more effective way to make enemies is to conceal the microphone unit and pick up and amplify conversations

of unsuspecting guests. Still, the prime purpose of this "baby-sitter" is to baby-sit; it does that job with efficiency. You'll enjoy building it and, if you have a baby, you'll enjoy using it.

The unit can be built very inexpensively, particularly if the required components are purchased carefully. The microphone shown, for example, is a sensitive crystal mike from a hearing aid and is available for about two dollars on the surplus market. The cabinets also were bought surplus, for about sixty-five cents each.

The schematic shows that the circuit is equivalent to the final two stages and rectifier of a small a.c.-d.c. broadcast receiver, with a resistor in the filament circuit to produce a voltage drop equal to that of the filaments of the two additional tubes which normally appear in such a receiver.

The placement of parts is not at all critical. The microphone and volume control are mounted on the front of the cabinet and the other parts on a metal chassis. Before finally mounting the parts, position them tentatively on the chassis. Work out an arrangement in which as many as possible of the wires between parts are short and direct, but space the components far enough apart so that you will not be cramped when doing the actual wiring.

In doing the wiring, follow the schematic and pictorial wiring diagrams carefully, solder all wires properly, and make sure that no short circuits are caused by bare wire or excess solder. If this is done, the

Schematic diagram of the Electronic Baby Sitter. Follow this and the pictorial wiring diagram below in wiring your unit. Notice that chassis ground is not connected to either side of the power line.

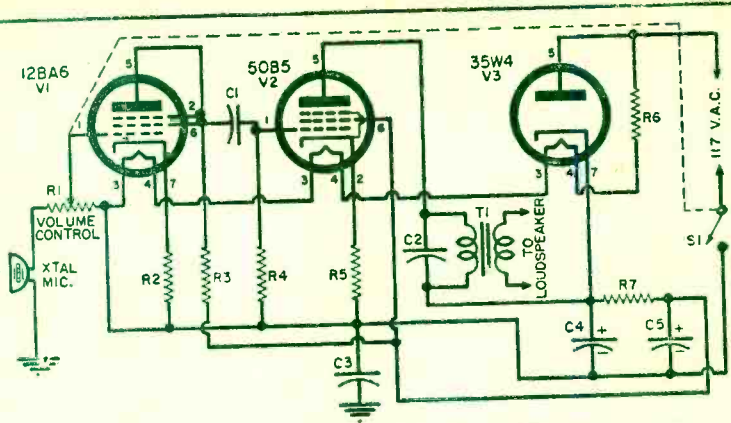

- R₁—1 megohm audio taper pot. with switch, S₁ ("Volume Control")
- R₂—1000 ohm, 1/2 w. res.
- R₃—50,000 ohm, 1/2 w. res.
- R₄—250,000 ohm, 1/2 w. res.
- R₅—150 ohm, 1 w. res.
- R₆—150 ohm, 10 w. wirewound res.
- R₇—10,000 ohm, 1 w. res.
- C₁—.01 μfd., 400 v. capacitor
- C₂—.02 μfd., 400 v. capacitor
- C₃—.1 μfd., 400 v. capacitor
- C₄, C₅—20/20 μfd., 150 v. two-section elec. capacitor

- S₁—S.p.s.t. "Power" switch (on R₁)
- T₁—Audio output trans. to match 10,000 ohms to speaker voice coil (A universal output trans. such as the Stancor A-3856 may be used if desired.)
- V₁—12BA6 tube
- V₂—50B5 tube
- V₃—35W4 tube
- Xtal Mic.—Hearing-aid type crystal microphone
- Loudspeaker—Small PM loudspeaker
- Cabinet; chassis; terminal strip; line cord and plug; knob for volume control; screws, nuts, wire, solder, etc.

unit should perform at the very first try. With the unit plugged in the baby's room and the loudspeaker box in another room, the volume can be regulated to a comfortable level. The sensitivity is so great that, with the microphone fifteen feet from the baby's crib, you can hear every breath the baby takes. While this is novel and makes a good demonstration of the unit, it also can be annoying, as background noise, such as window shades and venetian blinds rattling, also is amplified. It is best to adjust the volume so that no noise comes through until a higher level of sound is reached, such as the baby crying.

END

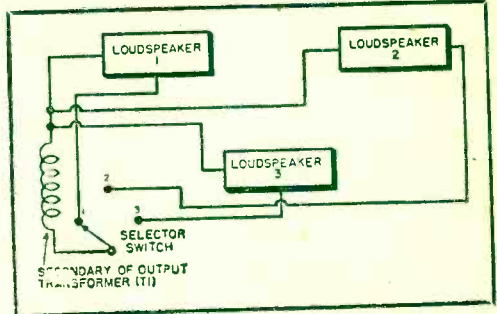

You can use more than one speaker and a switch to place the desired one in operation. Connect the additional parts as shown in this diagram.

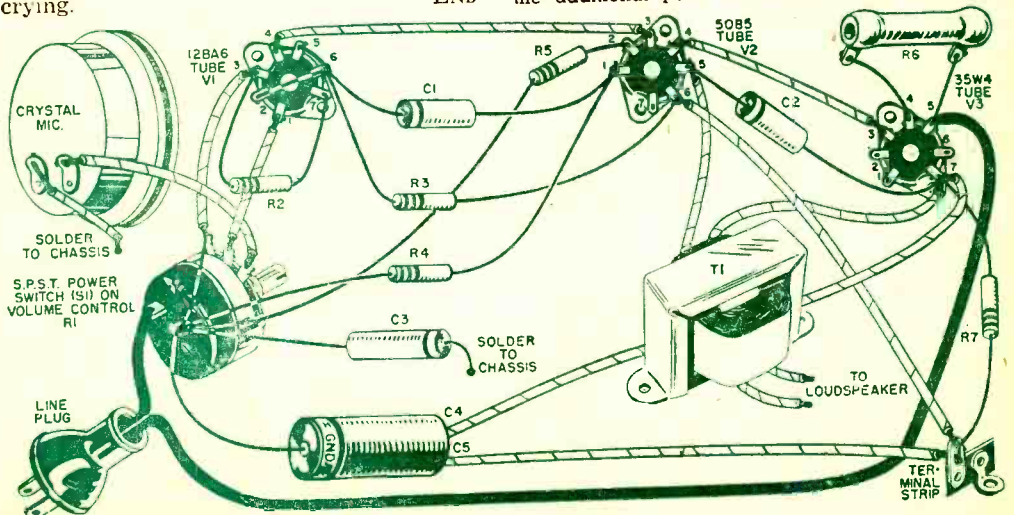

CHOOSING A U.H.F.

TELEVISION at u.h.f. (channels 14 to 83) isn't any more complicated than v.h.f. (channels 2 to 13). The u.h.f. signal generally arrives at the antenna relatively weaker than its v.h.f. brother because it is absorbed more by the air and objects in space, and it doesn't bend as much around obstacles (and the earth) as v.h.f. does. An antenna used for u.h.f. reception, therefore, must pass all of the signal at the receiving site down to the set without losses. As with v.h.f., u.h.f. antennas are divided into *local*, *intermediate*, and *fringe*.

Local—u.h.f. introduced the bow tie to American rooftops. This type of antenna is widely used in the local area, which extends from the TV transmitter out about 10 or 15 miles. The *bow tie* antenna (also called the *fan dipole*) will receive all the channels in the u.h.f. band adequately. It is small and rugged. It is used as an indoor antenna or, when mounted on a mast, outdoors. It may be attached to a v.h.f. antenna to convert it for u.h.f. reception, or used with a screen reflector to eliminate signals from the rear.

Intermediate area u.h.f. viewers must be a little more antenna conscious when it comes to their installations than local-area viewers. In this area, which goes from 15 miles to about 20 or 25 miles from the transmitter, you will definitely require an antenna which has a good directional response. There is probably a v.h.f. signal bouncing around which may interfere with the u.h.f. program you are trying to watch. A highly directional antenna, aimed at the transmitter whose signal you want, will cut out most interfering signals.

The parabolic and corner reflectors used with u.h.f. antennas act on the same principle as the headlight reflector in your car. All TV signals hitting the reflector are focused onto the bow tie and sent down to the receiver. Antennas with such reflectors are excellent for use in areas where there are ghosts in the picture. Combination antennas consist of a u.h.f. and a v.h.f. antenna joined in an efficient manner. They are popular in areas where there are both u.h.f. and v.h.f. stations, and they require only one downlead to the set.

Fringe areas in u.h.f. are even more troublesome than in v.h.f. and they don't extend as far. The u.h.f. fringe area goes from about 20 miles to, at most, 50 miles from the transmitter. Here you have a weak signal, a lot of interference, and the possibility of signals coming from widely different directions. What you need, then, is a highly efficient and directional antenna. To take care of the signals coming from widely different directions, you will need more than one antenna, each aimed at one station, or one antenna with a rotator. The *yagi* antenna answers almost all of the requirements for a good fringe-area antenna. The combination *corner reflector* and wide-band *yagi* is usable over the entire v.h.f.-u.h.f. range, as is the combination *conical-helix*. When two antennas are stacked, one above the other, and connected electrically to the same downlead, the resultant signal is greater than you would get from one alone, but not quite double. Stacking is a method for increasing the amount of signal you can feed to the set. All antennas shown can be stacked.

END

LOCAL

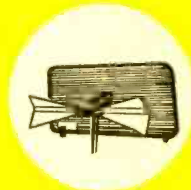

INDOOR BOW TIE

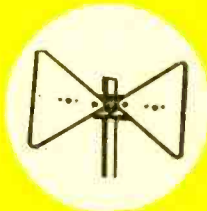

BOW TIE
(FAN DIPOLE)

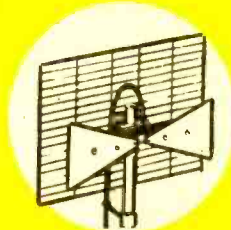

BOW TIE
WITH SCREEN
REFLECTOR

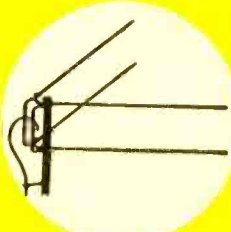

"V"

ANTENNA

By CHARLES TEPFER

INTERMEDIATE

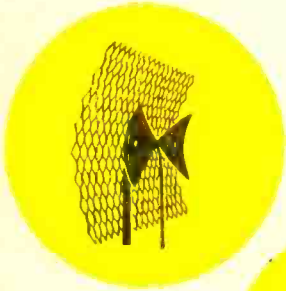

BOW TIE
WITH
PARABOLIC
REFLECTOR

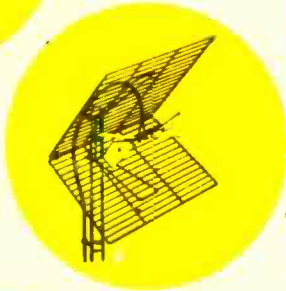

BOW TIE
WITH
CORNER
REFLECTOR

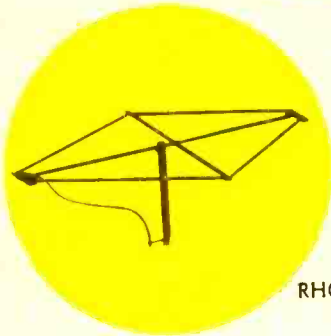

RHOMBIC

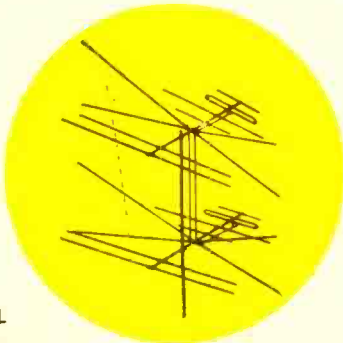

YAGI—
CONICAL

FRINGE

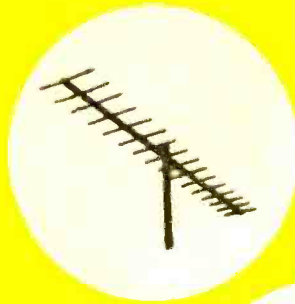

YAGI

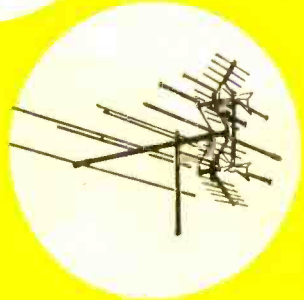

YAGI
WITH
BOW TIES
AND
CORNER
REFLECTORS

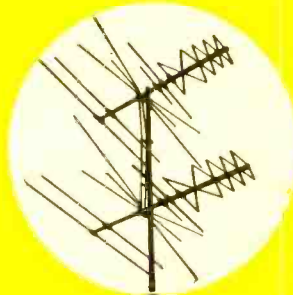

CONICAL—
HELIX

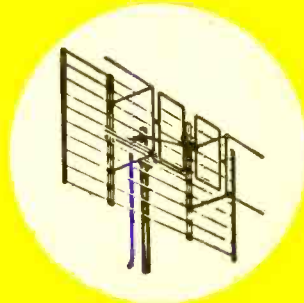

COLINEAR



THE WORLD AT A TWIRL

By K. R. BOORD

REGARDING an antenna for short-wave listening, your location and the space you have available may make the difference. Hence, a good idea is to experiment a little. An outside wire, as high as possible, and clear of all obstructions, is desirable. However, if the erection of such an antenna presents difficulties, try dropping one end of a piece of insulated wire out the nearest window and attaching the other end to the antenna terminal (marked "A" on most receivers) of your set.

For best over-all reception, most experienced SWL's prefer the ordinary straight-wire (sometimes called the "inverted L" or Marconi). Thirty to one-hundred feet seems to give excellent results on most bands. Yes, get your antenna as high as you can, with the shortest-possible lead-in of good, well-insulated wire; and remember that your antenna should hang free and clear of all objects. Carefully solder all connections. It would be wise to use two or more insulators at either end of the antenna wire to prevent signal leak. This also may help to cut down on interference, particularly the man-made sort.

A lightning arrester to protect your receiver is essential. Whether or not to use a ground wire you can determine best by trying one out.

What Is DX?

"DX" normally means *long-distance transmission*. But the answer to the question—"What is DX?"—is almost as varied as there are DX enthusiasts! Here are a few typical examples from experienced SWL's to whom I put this question:

"To me, any low-powered station that I can not hear any night or day is a DX station; that type of station must have favorable reception conditions to be heard. *Choice* DX stations are those elusive, low-powered jobs half-way around the world that I never can quite seem to tune in!"

"It depends on the type of receiver, antenna, distance, power of the station, time of day, season, frequency, and so on. 'Super-DX' is long-distance, low-powered reception, or on a channel unfavorable for

long-distance reception at the time heard—rather a 'miracle'!"

"I feel that any station more than 3000 miles away is DX, regardless of frequency or power," says another experienced SWL, "and there's no doubt that a relatively low-powered station considerably closer can legitimately be considered as DX." Still another veteran DX-er says: "DX is anything of interest to the particular listener. Personally, it's any station that means a new country for my log or any station heard in a rare country. For the beginner, almost anything would be DX."

Both beginning and experienced SWL's will find it well worth the cost to get a copy of the 1955 (*English*) Edition of "World Radio Handbook," which should be available soon. For details on cost and date of availability, I suggest you write to the *new* American agent—Gilfer Associates, Box 239, Grand Central Station, New York 17, New York.

Now, for some tips for both beginners and experienced DX-ers. Remember they're all in *GMT*. And that between the time these schedules were compiled and the time you read this, some stations will have reverted to *winter* schedules (some also may have moved to winter frequencies); in such cases, you may find schedules *one hour later* than listed herein.

For Beginners

Angola—CR6RA, 11.862A, Luanda, should be heard in *eastern USA* around 2045-2200

(NOTE: Unless otherwise stated, all time herein is expressed in Greenwich Mean Time—GMT—subtract 5 hours for EST, 6 for CST, 7 for MST, 8 for PST. This is on a 24-hour clock basis in which midnight is 2400 (or 0000). 3 a.m. is 0300, 10 a.m. is 1000, and noon is 1200; for example, instead of starting again at 1 p.m., as the 12-hour system does, the 24-hour system continues to increase the number of each hour until 2359 (11:59 p.m.) is reached, thus 1 p.m. is 1300, 5 p.m. is 1700, 10 p.m. is 2200.)

With regards to the terms "wavelength" and "frequency", wavelength is measured in meters. For every wavelength there is a corresponding frequency which is the number of complete waves, or cycles, sent out by a transmitter every second. A "kilocycle" is 1000 cycles, a "megacycle" is 1000 kilocycles or 1,000,000 cycles. As a SWL you will be concerned primarily with megacycles (mc.). To convert megacycles to meters (m.) divide the frequency in megacycles into 300. For example, 6 mc. divided into 300 gives you 50 m. (wavelength) and, conversely, 50 m. (wavelength) divided into 300 gives you 6 mc. (frequency).

in Portuguese. *Australia*—Try for VLI6, 6.090, Sydney, New South Wales, around 1100 when should have ABC (Australian Broadcasting Commission) news. For the *Sunday DX* session from *Radio Australia*, western USA DX-ers should tune 15.200 at 0400; eastern USA DX-ers should tune 9.615 at 1330.

Belgium-Belgian Congo—When this was compiled, ORU, Brussels, had returned to 9.767 from 11.850 for the beam to North America 0030-0300 (*English* from 0100), but by now should have moved to winter channel of 6.085, with 9.144 and 9.705 in parallel to Africa, and relayed by OTC2, 9.655, Leopoldville, Belgian Congo, probably your best bet for consistent good reception. OTM2, 9.380A, Leopoldville, is usually fine level in eastern USA around 1900 to 2100A closedown; no *English*, but does identify frequently in French; has fine musical programs.

Canada—Eastern SWL's should try for CBNX, 5.970, St. John's, Newfoundland, when it comes on the air at 1000; CJCX, 6.010, Sydney, Nova Scotia, is good level around 1200 and at 2245 recheck in West Virginia. Western SWL's should be able to log VE9AI, 9.540, Edmonton, Alberta, at 0300 when has news. *Chile*—Sociedad Nacional de Minería, Santiago, was recently noted moved to measured 12.382V, heard well around 0025; all-Spanish.

Cuba—COKG, 8.955A, Santiago, should be a good signal around 0300; all-Spanish. *Czechoslovakia*—Radio Prague has *English* for North America now at 0030-0100 on 9.550, 11.760; at 0405-0430A on 9.550, 9.655; on *Sundays* at 0405 has "Answers to Listeners" session and plays musical request numbers.

El Salvador—YSS, 9.555, San Salvador, can be heard around 0230-0300 with musical programs; all-Spanish. *England*—The

The haunting call of the "kookaburra bird" (or "laughing jackass") is the familiar sign-on signal of Radio Australia. Eastern USA SWL's should listen for "Jacko's" call at 1155 GMT over VLO9, 9.615; western USA listeners should tune for this around 0255 GMT over VLA15, 15.200.



December, 1954



Young Ronald Guentzler, Shaker Heights, Ohio, has the world at his fingertips through the magic of short-wave radio—whether he uses the "home" receiver (left) or his Hallicrafters S-41-G short-wave receiver (center) with a home-built preselector covering 9.50 to 18 mc. With the Zenith 10-S-155, Ron has logged such countries as Saudi Arabia, Indonesia, Mozambique, India, Taiwan (Formosa). At right are his two "command" receivers, BC-454 and BC-455.

North American Service of the BBC is scheduled to Canada-USA 1500-1715 over 17.790; 1800-1915 (*Mon.-Fri.*), 15.360; 1900-2045 (*Mon.-Fri.*), 11.930; 2045-2215, 11.930, 9.825. The *General Overseas Service* is relayed to Canada-USA-Mexico at 2215-0215 over 9.825; 2215-0030, 9.760; 2215-0300, 6.110, and 0430-0615, 6.110. *France*—Try 11.700 for *English* from Paris at 2000-2100 in beam directed to British Isles; 9.625A and 6.045 are used in parallel.

Germany—The *Overseas Service* from Cologne, mostly German, but does identify in *English*, is radiated over 5.980 and 7.290 to North America 0130-0430; should use more *English* soon. *Guatemala*—Radio Nacional de Guatemala's TGWB is back on its old channel of 6.180A, parallel TGW, 9.760; opens around 1200 and is fine level around 0100-0500.

Haiti—Try 4VEH, 9.656 (listed 9.654) at 1100-1500 daily except *Thursdays*; some *English*. *Holland*—For the "Happy Station Programs," produced and presented in multiple languages by Edward Startz for more than 25 years, try Hilversum on 6.025 (best bet) or 9.590 on *Mondays* at 0230-0400 in the North American beam.

Indonesia (USI)—Improved signals are noted in eastern USA from Djakarta, 9.710, around 1115 when has *English* newscast; western SWL's should try this one at 1430 when again has *English*. *Israel*—The "Voice Zion" session in *English* from Tel Aviv, 9.008, relayed from Jerusalem, is now at 2115-221A (may run longer some days).

Italy—Your tuning of 9.575A and/or 11.905

(Continued on page 122)

THE TV WEB

By P. B. HOEFER

An elaborate system of cables and radio-relay towers brings video programs to your screens.

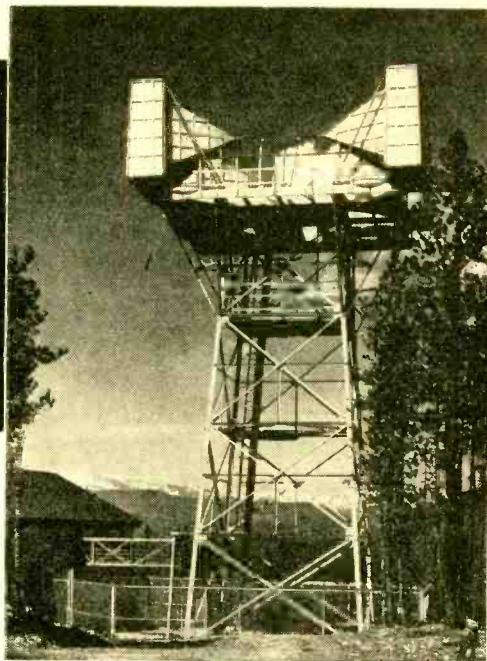

One of the stations on the Bell System's radio-relay route between New York and San Francisco.

DID you ever wonder, sitting comfortably in your easy chair before your TV set, just how that program, originating in New York, Hollywood, or Chicago reaches your local station and, eventually, your set?

Behind each program reaching your screen is a vast network—61,000 channel miles in fact—dedicated to the task of bringing entertainment into your home. A channel mile, incidentally, represents a single TV signal travelling one mile. Since cables and radio-relays often carry several programs simultaneously, a single physical mile of the network may represent two, three, or more channel miles.

This vast network could girdle the globe twice at the equator and lap over another 11,196 miles! Of these 61,000 channel miles 36,000 are already equipped to transmit color programs to approximately 111 stations in 81 cities—a figure that is increasing monthly.

Programs reach you over coaxial cables and/or radio-relays. The cable consisting of 8 tubes shown in a cross sectional view on page 88, is so designed that a pair of tubes can carry two television programs or handle hundreds of telephone calls simultaneously.

Coaxial Cables

Coaxial cables are copper tubes, each of which is about the size of the fountain pen

you carry in your pocket. Down the center of each of these "pipes" is a copper wire held in place by insulating discs spaced about an inch apart. These "pipes" are called "coaxials" because both the tube and the wire have the same axis. Most coaxial cables contain eight of these tubes plus a number of the usual type of wires which are used for maintenance purposes and for carrying some short-distance telephone messages. All of these units are housed in a heavy lead sheath which protects the cables from moisture, rodents, and accidental damage. These cables are laid in the ground by means of an ingenious 27-ton cable plow that is affectionately known as the "Mickey Mouse."

As a rule, coaxial cable routes are maintained between points where the intervening terrain is relatively flat, while the jumps across mountainous areas are made by the second type of transmission medium, the radio-relay.



Radio-Relay

Where it is impractical to lay coaxial cable, the television signal is often sent on its way *via* microwaves. These waves, which are only about as long as a cigarette, are impervious to such static as lightning and man-made interference caused by car ignition systems, etc.

Like light waves, microwaves travel in a straight line and, in general, do not follow

Total Channel Mileage 61,000
 Color TV Channel Mileage 36,000
 TV Stations in Operation 410
 V.H.F. Stations 288
 U.H.F. Stations 122
 Approx. TV Sets in Use 32,900,000

LEGEND

-  Existing
-  Planned
-  Equipped for Color
- Cities preceded with letter "C" equipped for monochrome and color services

BELL SYSTEM TELEVISION NETWORK ROUTES



Cross section view of one of the latest types of coaxial cable. It can be used to transmit hundreds of telephone conversations simultaneously or can be used for television programs.

the curvature of the earth. They can be focused like a searchlight and aimed from point to point.

Microwaves beamed from one tower are gathered in at the next tower by huge lenses, which look like square megaphones. When the microwaves have been gathered in by the lens, they are focused into a hollow tube called a "waveguide." This tube carries the microwaves down the tower and to the amplifying equipment at the base of the tower where they are given a "shot in the arm" and rejuvenated for the journey ahead. While the microwaves are being boosted a million-fold, the wavelength is also changed so that there is no chance of the signals feeding back into the receiving antenna they have just left, thus causing interference. These "abandoned" frequencies are not wasted, though, but are used to transmit the signal headed in the other direction.

Radio-relay towers are not placed in a straight line across the country but zig-zagged to prevent a signal from overshooting its mark and being received by a distant station rather than its adjacent "target."

Ready for Color

Both coaxial cable and radio-relay can be used to transmit the signal for color television programs, after some equipment modifications.

Although most people think of colorcasting as a fairly recent development, actually 1954 marks the 25th anniversary of the first public demonstration of color TV! On June 27th, 1929, a group of newspaper

reporters gathered at the *Bell Telephone Laboratories* in New York to see a colorcast of an American Flag rippling in the breeze.

On January 1, 1954, the first public colorcast was carried from coast-to-coast when the "Tournament of Roses Parade" in Pasadena, California was fed to stations in eighteen cities in the United States.

By May 1st of this year, the first coaxial cable route, which connected Dallas and Houston, Texas, was readied for the task of carrying color programs between these two cities.

Colorcasting has come a long way in 25 years and the improved and refined images require improved facilities to transmit them. In order to handle this new medium, it was necessary for the Long Lines Department of *A. T. & T.* to add equalizers of various types in the radio-relay system. Converter units had to be installed in the coaxial cable system at both the transmitting and receiving ends of the cable. At some facilities, at the transmitter end the signal is "squeezed" into the cable (the bandwidth is narrowed) and at the receiving end this bandwidth is restored to its full size. In addition to adopting these specialized techniques for colorcasting, it has been necessary to add new and more complex test equipment in order to check color register. Such checks are made at "monitoring screens" along the route. These color checks are extremely critical and are done with extra care to insure that the color picture reaching your screen doesn't "bleed"—the color that is, not the subject matter.

Multiple Service

By now you may be wondering just how, by flipping your channel selector, you can get two or three programs originating, say, from New York. The answer is simple. On heavily "travelled" routes *A. T. & T.* has installed multiple facilities in much the same way that states have built four-lane highways between their principal cities to handle the traffic.

Although multiple facilities are not indicated on the network map on the preceding page, many such ties do exist, allowing the telecasting networks to send out their programs simultaneously from the same city to their network affiliates throughout the country.

Although these facilities are fantastically complicated and fabulously expensive, you must remember that, first and foremost, they are doing the job for which they were originally designed—that of providing us with the best telephone service in the world!

END

Build YOUR OWN HEATHKITS

INTERESTING—EDUCATIONAL



work has already been done for you. No cutting, drilling, or painting required. All parts furnished including tubes. Knowledge of electronics, circuits, etc., not required to successfully build Heathkits.

Heathkits are fun to build with the simplified easy-to-follow Construction Manual furnished with every kit. Only basic tools are required, such as soldering iron, long-nosed pliers, diagonal cutting pliers, and screwdriver. All sheet metal

New charcoal gray baked enamel panel with highly readable white lettering.

New PRINTED CIRCUIT VACUUM TUBE VOLTMETER KIT

The VTVM is the standard basic voltage measuring instrument for radio and TV servicemen, engineers, laboratory technicians, experimenters, and hobbyists. Because of its extremely high input resistance (11 megohms) the loading effect on the circuit being measured, is virtually negligible. The entire instrument is easy to build from a complete kit, with a detailed step-by-step Construction Manual. Featured in this instrument is an easy-to-wire fool-proof printed circuit board which cuts assembly time in half.

CIRCUIT AND RANGES: Full wave AC input rectifier permits 7 peak-to-peak voltage ranges with upper limits of 4000 volts peak-to-peak. Just the ticket for you TV servicemen. Seven voltage ranges, 1.5, 5, 15, 50, 150, 500 and 1500 volts DC and AC RMS. Peak-to-peak ranges 4, 14, 40, 140, 400, 1400, and 4000 volts. Ohmmeter ranges X1, X10, X100, X1000, X10K, X100K, X1 meg. Additional features are a db scale, center scale zero position, and a polarity reversal switch.

IMPORTANT DESIGN FEATURES: Transformer operated—1% precision resistors—6AL5 and 12AU7 tubes—selenium power rectifier—individual AC and DC calibrations smoother improved zero adjust control action—new panel styling and color—new placement of pilot light—new positive contact battery mounting—new knobs—test leads included. Easily the best buy in kit instruments.

New peak-to-peak color harmony—new control knobs.

New printed circuit board for faster, easier construction—exact duplication of Laboratory development model.



Model V-7

\$24.50

Shpg. Wt. 7 lbs.

New easy-to-read open panel layout. Off-on switch incorporated in selector switch.

Heathkit HANDITESTER KIT

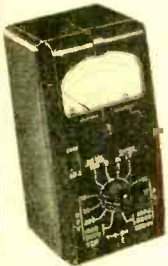

MODEL M-1
\$14.50

Shpg. Wt. 3 lbs.

The Heathkit Model M-1 Handitester readily fulfills all requirements for a compact, portable volt-ohm-milliammeter. Its small size permits the instrument to be tucked into your coat pocket, tool box or glove compartment of your car. Always the "handitester" for those simple repair jobs. Packed with every desirable feature required in an instrument of this type. AC or DC voltage ranges, full scale 10, 30, 300, 1000 and 5000 volts. Ohmmeter ranges 0-3000 ohms and 0-300,000 ohms. DC milliammeter ranges 0-10 milliamperes and 0-100 milliamperes. Uses 400 microampere meter—1% precision resistors—hearing aid type ohms adjust control—high quality Bradley rectifier. Test leads are included.

Heathkit MULTIMETER KIT



MODEL MM-1

\$26.50 Shpg. Wt. 6 lbs.

Here is an instrument packed with every desirable service feature and all of the measurement ranges you need or want. High sensitivity 20,000 ohms per volt DC, 5000 ohms per volt AC. Has the advantage of complete portability through freedom from AC line—provides service ranges of direct current measurements from 150 microamperes up to 15 amperes—can be safely operated in RF fields without impairing accuracy of measurement.

Full scale AC and DC voltage ranges of 1.5, 5, 50, 150, 500, 1500, and 5000 volts. Direct current ranges are 150 microamperes, 15, 150, and 500 milliamperes and 15 amperes. Resistances are measured from 2 ohms to 20 megohms in three ranges and db range from -10 to +65 db. Ohmmeter batteries and necessary test leads are furnished with the kit.

HEATH COMPANY
BENTON HARBOR 10, MICHIGAN



New
PRINTED
CIRCUIT

Heathkit 3" OSCILLOSCOPE KIT

Ideal for individual home work shop, ham shack or as extra instrument for outside servicing.

Compact size, light weight, portable — perfect for service work or field operation.

New, modern styling, gray panel, lettering with white, gray, knobs and red and black terminal posts.

New printed circuit for constant performance, rugged component mounting — assembly time cut in half!

Measures only 11 3/4" x 6 3/4" x 19 1/2" and weighs only 11 pounds.

USE: This brand new Utility Scope was designed especially for servicemen and radio amateurs, and is adaptable for use in all general Scope applications. Perfect for modulation monitoring, etc. Use it to tackle alignment or adjustment problems. Equally valuable in breadboard work. A must for ham shack or for outside servicing.

DESCRIPTION: Front panel controls of the Model OL-1 are "bench tested" for ease of operation and convenience. Sharp focusing 3" CRT. Printed circuit for ease of assembly and constant performance. Assembly time cut in half! High quality electronic components used. Sensitive hor. and vert. amplifiers with broad freq. response; cathode follower for isolation. Push-pull hor. and vert. output to deflection plates. Int., 60 cycle, or ext. sync. Sweep freq. range 10-100,000 cycles. Direct connection to deflection plates. Provision for Z axis input. Uses 3GP1 CRT, 4-12AU7 hor. and vert. amplifiers, 1-12AX7 sweep gen., 1-6X4 LV rect., and 1-1V2 HV rect. The Heathkit Model OL-1 is a real standout value at only \$29.50, and is another example of the famous Heathkit combination; quality plus economy.

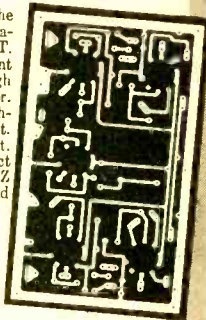

Model
OL-1

\$29.50

Shpg. Wt.
15 lbs.

Heathkit SIGNAL GENERATOR KIT

USE: This instrument is "serviceman engineered" to fill the requirement for a reliable basic service instrument at moderate cost. Frequency coverage extends in five bands from 160 Kc to 110 Mc on fundamentals, and dial is calibrated to 220 Mc for harmonics. Pre-wound and pre-aligned coils make calibration unnecessary for service applications.

DESCRIPTION: The Heathkit Model SG-8 Signal Generator provides a stable modulated or unmodulated RF output of at least 100,000 microvolts which can be controlled by both a continuously variable and a fixed step attenuator. Internal modulation is at 400 cycles, or can be externally modulated. AF output of 2-3 volts is also available for audio testing. Uses dual purpose 12AU7 as Colpitts RF oscillator and cathode follower for stable, isolated, low impedance output, and type 6C4 tube for 400 cycle oscillator. Operation of the SG-8 is well within the frequency limits normally required for service work. Modern styling features high definition white letters on charcoal gray panel with re-designed control knobs. Modern professional appearance and Heathkit engineering know-how combine to place this instrument in the "best buy" category. Only \$19.50 complete.

New, modern panel and knob styling — professional appearance and professional performance.

Broad frequency coverage — fundamentals from 160 KC to 110 MC in 5 bands — up to 220 MC on calibrated harmonics.

Cathode follower output for good isolation — fixed step and continuously variable attenuation.



Output selection — internal modulation, pure r.f., or audio output.

MODEL SG-8 **\$19.50** Shpg. Wt. 8 lbs.



MODEL
AM-1

\$14.50 Shpg. Wt. 2 lbs.

Heathkit ANTENNA IMPEDANCE METER KIT

The Model AM-1 Antenna Impedance Meter makes an ideal companion unit for the GD-1B Grid Dip Meter or a valuable instrument in its own right. Perfect for checking antenna and receiver impedance and match for optimum system operation. Use on transmission lines, halfwave, folded dipole, or beam antennas. Will double as monitor or relative field strength meter. Covers freq. range of 0-150 Mc and impedance range of 0-600 ohms. Uses 100 microampere meter and special calibrated potentiometer. A real buy at only \$14.50 complete.

Heathkit GRID DIP METER KIT

Amateurs and servicemen have proven the value of this grid dip meter many times over. Indispensable for locating parasitics, neutralizing, and aligning filters and traps in TV or Radio and for interference problems. The Model GD-1B covers from 2 Mc to 250 Mc with 5 pre-wound coils. Featuring a sensitive 500 microampere meter and phone jack, the GD-1B uses a 6AF4 or 6T4 tube. An essential tool for the ham or serviceman.



MODEL
GD-1B

\$19.50 Shpg. Wt. 4 lbs.

ACCESSORIES: Low freq. coverage to 355 KC with two extra coils and calibration curve. Set No. 341A for GD-1B and set No. 341 for GD-1A. Shipping weight 1 lb. Only \$3.00.

HEATH COMPANY
BENTON HARBOR 10, MICHIGAN

New Heathkit VFO KIT



MODEL VF-1

\$1950

Ship. Wt. 7 lbs.

- Smooth acting illuminated and precalibrated dial.
- 6AU6 electron coupled Clapp oscillator and OA2 voltage regulator.
- 7 Band coverage, 160 through 10 meters—13 Volt RF output.
- Copper plated chassis—aluminum cabinet—easy to build—direct keying.

Here is the new Heathkit VFO you have been waiting for. The perfect companion to the Heathkit Model AT-1 Transmitter. It has sufficient output to drive any multi-stage transmitter of modern design. A terrific combination of outstanding features at a low kit price. Good mechanical

and electrical design insures operating stability. Coils are wound on heavy duty ceramic forms, using Litz or double cellulose wire coated with polystyrene cement. Variable capacitor is of differential type construction, especially designed for maximum bandspread and features ceramic insulation and double bearings.

This kit is furnished with a carefully precalibrated dial which provides well over two feet of calibrated dial scale. Smooth acting vernier reduction drive insures easy tuning and zero beating. Power requirements 6.3 volts AC at .45 amperes and 250 volts DC at 15 mills. Just plug it into the power receptacle provided on the rear of the AT-1 Transmitter Kit. The VFO coaxial output cable terminates in plastic plug to fit standard 1/4" crystal holder. Construction is simple and wiring is easy.

Open layout — easy to build — simplified wiring.

Smooth acting illuminated dial drive.

Clean appearance — rugged construction — accessible calibrating adjustments.

Copper plated chassis—careful shielding.

Ceramic coil forms — differential condenser.

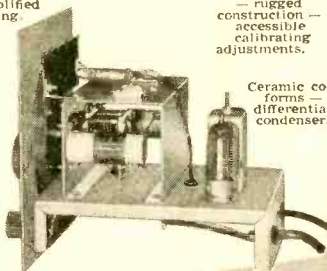

Heathkit AMATEUR TRANSMITTER KIT



MODEL AT-1

\$2950

Ship. Wt. 16 lbs.

SPECIFICATIONS:

Range 80, 40, 20, 15, 11, 10 meters.
 6AG7 Oscillator-multiplier.
 6146 Amplifier-doubler.
 5U4G Rectifier.
 105-125 Volt A.C. 50-60 cycles 100 watts. Size: 8 1/2 inch high x 13 1/8 inch wide x 7 inch deep.

Crystal or VFO excitation.

Here is a major Heathkit addition to the Ham radio field, the AT-1 Transmitter Kit, incorporating many desirable design features at the lowest possible dollar-per-watts price. Panel mounted crystal socket, stand-by switch, key click filter, A. C. line filtering, good shielding, etc. VFO or crystal excitation—up to 35 watts input. Built-in power supply provides 425 volts at 100 MA. Amazingly low kit price includes all circuit components, tubes, cabinet, punched chassis, and detailed construction manual.

Rugged, clean construction.

Single knob band switching.

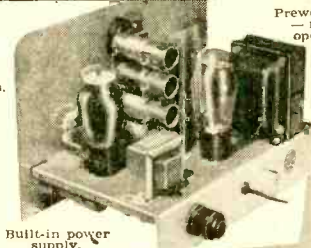

Prewound coils — metered operation.

52 ohm coaxial output.

Built-in power supply.

Heathkit COMMUNICATIONS RECEIVER KIT

RF gain control with AVC or MVC.

Electrical bandspread and scale.

Stable BFO oscillator circuit.

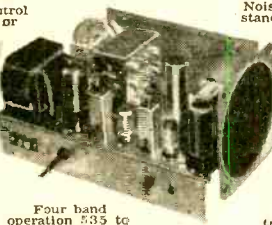

Four band operation 535 to 35 Mc.

Noise limiter—standby switch.

1/2 inch PM Speaker-Headphone Jack.

Six tube transformer operation.

SPECIFICATIONS:

Range.....535 Kc to 35 Mc
 12BE6 Mixer-oscillator
 12BA6 I. F. Amplifier
 12AV6 Detector—AVC—audio
 12BA6 B. F. O. oscillator
 12AF6 Beam power output
 5Y3GT Rectifier
 105-125 volts A.C. 50-60 cycles, 45 watts.

A new Heathkit AR-2 communications receiver. The ideal companion piece for the AT-1 Transmitter. Electrical bandspread scale for tuning and logging convenience. High gain miniature tubes and IF transformers for high sensitivity and good signal to noise ratio. Construct your own Communications Receiver at a very substantial saving. Supplied with all tubes, punched and formed sheet metal parts, speaker, circuit components, and detailed step-by-step construction manual.



MODEL AR-2

\$2550

Ship. Wt. 12 lbs. CABINET:

Proxylite impregnated fabric covered plywood cabinet. Ship. weight 5 lbs. Number 01-10. \$4.50.

HEATH COMPANY
 BENTON HARBOR 10, MICHIGAN

Heathkit ECONOMY SIX-WATT AMPLIFIER KIT



MODEL A-7B

\$15.50 Shpg. Wt.
10 lbs.

Here is an outstanding amplifier value. This economically priced amplifier is capable of performance usually associated only with far more expensive units. Can be nicely used as the heart of an inexpensive high quality home music system. Features inputs for tuner and phono (Model A-7C accommodates a microphone by using an additional pre-amplifier stage). Separate bass and treble boost and

cut tone controls for just the degree of tonal balance you want. The entire kit can be built in a few pleasant hours for years of enjoyment.

Technical features, frequency response $\pm 1\frac{1}{2}$ db 20-20,000 cycles. Full 6 watts output. Push-pull beam power output stage. Output transformer impedances 4, 8, and 15 ohms. Tube lineup, 12J5GT, 12SL7, 2-12A6, 5Y3GT, and 12SJ7 (A-7C only).

All parts including tubes are supplied along with a prefabricated and painted chassis. Detailed step-by-step Construction Manual eliminates necessity for specialized knowledge.

MODEL A-7C incorporates a preamplifier stage with special compensated network to provide necessary gain for operation with variable reluctance cartridge or microphone. \$17.50

BROADCAST
BAND

NEW Heathkit RECEIVER KIT

Here is the ideal radio kit for the student, beginner, or hobbyist. If you have ever had the urge to build your own radio receiver, this kit deserves your attention. Circuit is transformer operated, eliminating shock hazard usually associated with "economy" AC-DC circuits. New high gain miniature tubes and IF transformers—powerful ferrite core built-in rod type antenna—chassis mounted $5\frac{1}{2}$ " PM speaker—optional operation either as receiver or tuner and phono input. Covers broadcast band 550-1600 Kc. Uses 12BE6, 12BA6, 12AV6, 12A6, and 5Y3 tubes.



MODEL BR-2

\$17.50 Shpg. Wt.
10 lbs.

less Cabinet

CABINET: Proxylon impregnated fabric covered plywood cabinet available. Includes aluminum panel, flocked re-inforced speaker grill and protective rubber feet. 91-9. Shpg. Wt. 5 lbs. \$4.50



MODEL FM-2
\$22.50

Shpg. Wt.
8 lbs.

Heathkit FM TUNER KIT

Here is an FM tuner kit designed for simplified construction to operate either through the "phono" section of your radio former operated—8 tube circuit—slide rule type tuning dial—88-108 megacycle coverage—three double tuned IF stages—factory adjusted front end. Experience the thrill of building your own FM tuner and at the same time enjoy all of the advantages of true FM reception.

HEATH COMPANY • BENTON HARBOR, MICH.

MAIL YOUR ORDER
TODAY TO THE
HEATH COMPANY
BENTON HARBOR 10,
MICHIGAN

ORDER BLANK

From _____

SHIP VIA

- Parcel Post
 Express
 Freight
 Best Way

(PLEASE PRINT)

QUANTITY	ITEM	MODEL NO.	PRICE

Enclosed find () check () money order for
Please ship C.O.D. () postage enclosed for _____ pounds.

On Express orders do not include transportation charges—
they will be collected by the express agency at time of delivery.

ON PARCEL POST ORDERS
insure postage for weight shown.

ORDERS FROM CANADA and PO's
must include full remittance.



This instrument array facilitates study of radio-active medicines when the accelerator produces isotopes.



Electrons Aid Research at P.H.S. Clinical Center

TO THE nation's mightiest fortress against disease, the 500-bed, sixty-four million dollar Public Health Service Clinical Center, with its eleven hundred modules for laboratories and offices, and its great vaulted underground areas for atomic medicine, recently came a powerful new electronic weapon.

A 3,000,000-volt Van de Graaff generator, said to be the most powerful electron accelerator of its kind, was presented as a gift from *Liggett & Myers Tobacco Co.* to the Clinical Center at its 300-acre reservation in Bethesda, Maryland.

The 30-ton apparatus has been installed in the radiation wing of the Clinical Center. Here it will be used in research on the biological effects of high-energy radiation. It also will be made available to other agencies of the Federal Government.

The generator will serve primarily as a powerful and accurate instrument for studying the radio-chemical and biological effects of x-rays and electron energy. With modifications, it may be used in the production of short-lived, radioactive isotopes. These isotopes are invaluable in certain medical research experiments such as tracing the path of food and fluids through the body and studying blood circulation. **END**

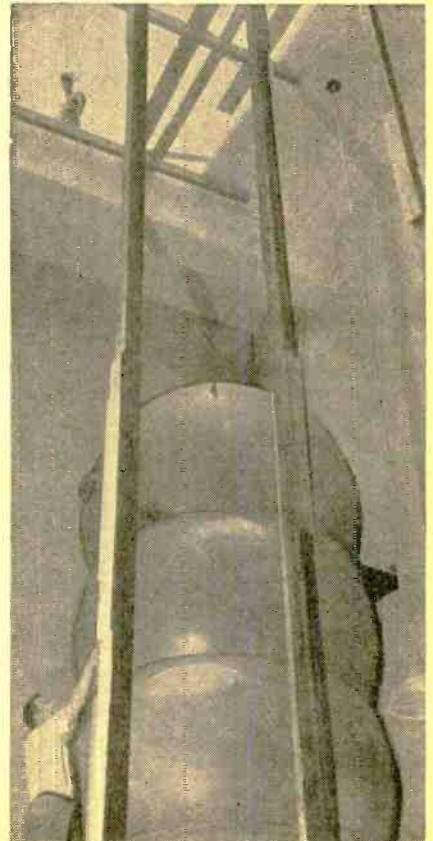

→
Instruments like this were once merely imaginative illustrations in futuristic stories. Here a part of the generator is lowered into place. The accelerator mechanism operates under high pressure inside a steel tank, and is capable of delivering more than 12 kilowatts.

"HAM" OPERATOR RECEIVES AWARD

MRS. GRACE RYDEN, Chicago president of the Young Ladies Radio League, distaff "ham" operators, was awarded a \$300 radio-TV scholarship recently for her outstanding work in organizing Chicago area women into defense groups for emergencies. The award was made by William Sawyer, president of Northwest Radio and Television School, Portland, Ore. Accepting with Mrs. Ryden is her parrot who answers "CQ" when W9GME is contacted.



Inverter Provides 110 Volts for "Rolling Office"

OFFICE equipment such as tape recorders and dictating machines, as well as such items as electric razors can be used right in your car with the help of an ATR inverter. The inverter changes the low d.c. voltage from the car's battery into 110 volts a.c. at 60 cycles which is the required power for most standard equipment. The inverter may be mounted anywhere in the auto. Additional information can be obtained from the manufacturer, *American Television & Radio Co.*, St. Paul 1, Minn.



ELECTRONIC "LIGHTBULB"

HUGE electronic "lightbulb" furnishing reading light in photo is actually a 27-inch TV picture tube in the "aluminizing" process at *General Electric's* plant in Syracuse, N.Y. "Lightbulb" effect results from high current vaporizing aluminum slug inside tube. Metal layer in finished tube makes for brighter and more contrasty picture.

Special Plates for "Hams"

THE driver whose car bears special, distinctive license plates should be a safer driver, according to *General Electric's* amateur radio publication, "Ham News."

Many "hams" may carry their station call-letters on license plates in lieu of standard registration. Besides identifying them as emergency communications sources, the plates bring "hams" the added responsibility to drive carefully.



PROGRESSIVE SPEAKER EXPANSION

a new approach to personalized listening . . .

by *University*

A modest budget need no longer limit the quality and caliber of your hi-fi aspirations. University offers, for the first time in audio history, a tremendous selection of uniquely designed speaker and network components so brilliantly conceived and executed that it is now possible to develop your loudspeaker system in successive, relatively inexpensive stages . . . until what you have meets your listening requirements.

Progressive Speaker Expansion by University makes it possible for you to buy a speaker today in terms of the system you want tomorrow! You are thus able to devote your present budget primarily in the initial selection of quality amplifying and program source equipment which cannot be economically altered or substituted at a later date. **P-S-E** makes your speaker choice an easy one. Depending upon your goal and space limitations, there are numerous University speaker systems that can be started at minimum cost with immediate listening satisfaction.

start planning today . . .
the *University* way!

- Buy good amplifier and program source equipment which will do justice to your eventual University speaker system . . . and start with one of the versatile top quality speakers or combinations recommended in the **P-S-E** chart.*
- Build up to a deluxe speaker system with University components so designed that speaker and network can be easily integrated for better and better sound reproduction—without fear of obsolescence.
- Own a **P-S-E** speaker system which meets hi-fi quality standards from the very beginning—and reach the highest standard of all—YOUR OWN.

Do it with University **P-S-E**! Only University products can meet such flexibility of application and demanding performance requirements.

University Loudspeakers

80 SOUTH KENSICO AVENUE, WHITE PLAINS, NEW YORK

INC.



*Write Desk 37 for the University P. S. E. chart

HOW TO TEST RADIO and TV CAPACITORS

MANY capacitors are used in radio and television receivers and in audio amplifiers. Different methods are required to check different faults. The chief capacitor troubles are excessive leakage (including short circuits) and improper capacitance value (including open circuits).

To check electrolytic and other fairly large capacitance types for shorts and high leakage current, use an ohmmeter. Turn the power off, disconnect one capacitor lead, set the ohmmeter on a high scale, and connect it across the capacitor. The resistance of non-electrolytic capacitors, read after the meter pointer has stopped moving, should be many megohms.

In the case of electrolytic capacitors, be careful to place the correct polarity of ohmmeter voltage on the capacitor. Polarity of the leads when a multimeter is used as an ohmmeter may not be the same as when it is used as a voltmeter. On new elec-

trolytic capacitors the reading with proper polarity should be 1 megohm or more. A capacitor may still be good with a reading as low as 200,000 ohms. A reading much less than this would indicate excessive leakage. If the ohmmeter test leads are reversed and the wrong polarity of voltage is applied, a much lower reading will be obtained, possibly 50,000 ohms.

A capacitor suspected of being open can be checked quickly by bridging it with another capacitor known to be good and of suitable value for the circuit. In this case it is not necessary to disconnect the suspected component. Remove power from the equipment, connect the good capacitor in parallel with the doubtful one, and check functioning of the equipment.

Paper capacitors of fairly high value can be checked for opens by the use of an ohmmeter. If the capacitor is good, when the ohmmeter is first connected, current from its battery or rectifier will charge the capacitor and cause a momentary movement of the meter pointer from infinite resistance to some lower value and back. If the pointer does not move, the capacitor is open or of too small a capacitance to give a noticeable indication on your ohmmeter. Check a number of good capacitors of various values to learn what to expect from the particular meter that you are using.

To check for opens in small capacitors or to determine the actual value of capacitance for comparison with the nominal value, use a capacitance bridge. See the illustrations on this page. Some bridges give quantitative leakage; some apply normal d.c. to electrolytic capacitors. **END**

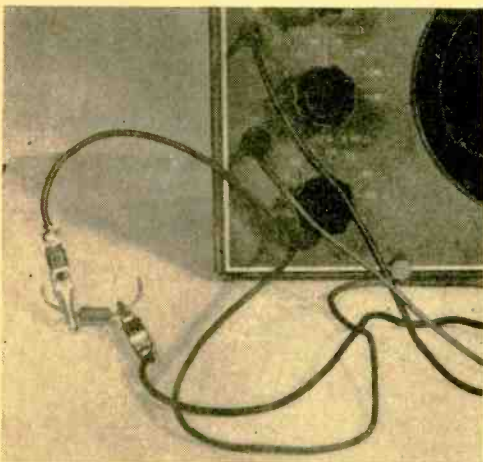

↑ For testing small size capacitors, a capacitance bridge serves best. (There are several on the market.) With small capacitance values, long test leads usually give misleading results. Here a new 50 μfd . capacitor with long test leads measures 75 to 80 μfd .

↓ Measuring the same capacitor shown at left with very short test leads gives a bridge balance at close to marked value of 50 μfd .

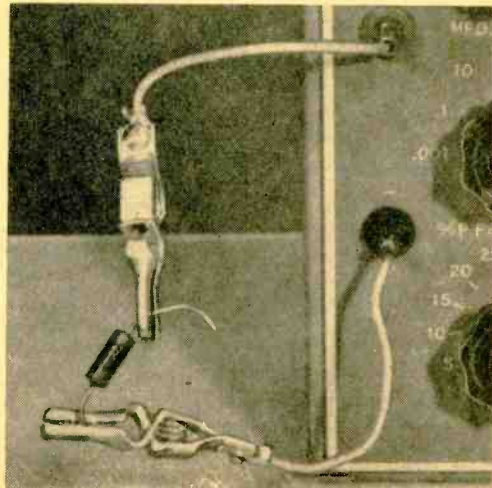

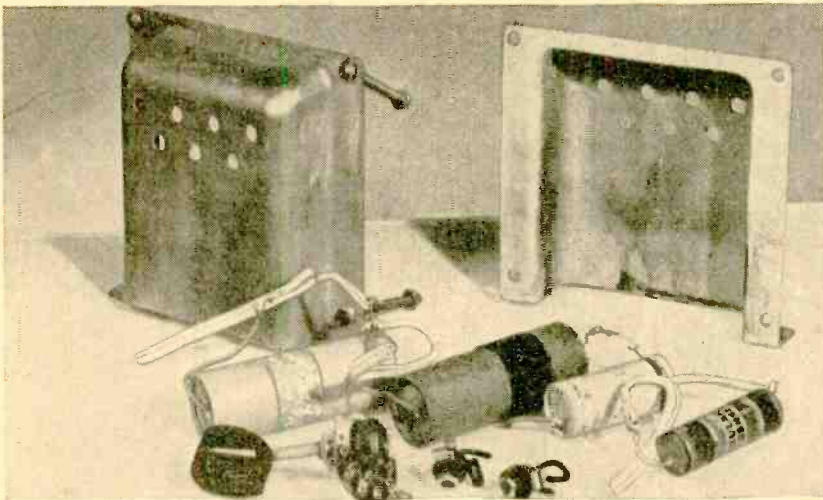

↑ A capacitor substitution box can be assembled from parts such as shown: capacitors, the case from a discarded transformer, a single-pole, three-position switch, and insulated pin jacks.

→ The substitution box is shown with the switch and jacks mounted and all parts wired. Capacitors used happened to be available; any desired values could be used.



↓ A substitution capacitor has been placed across a suspected one in a radio. If bare test clips are used, turn off the radio before you attach them.

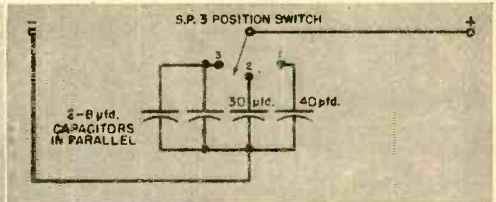
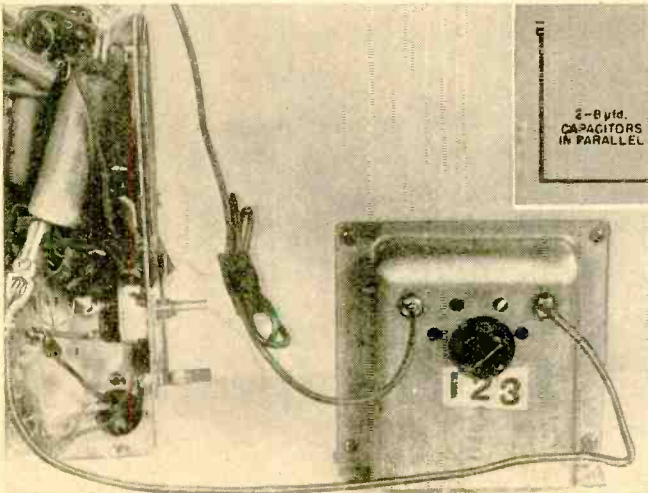
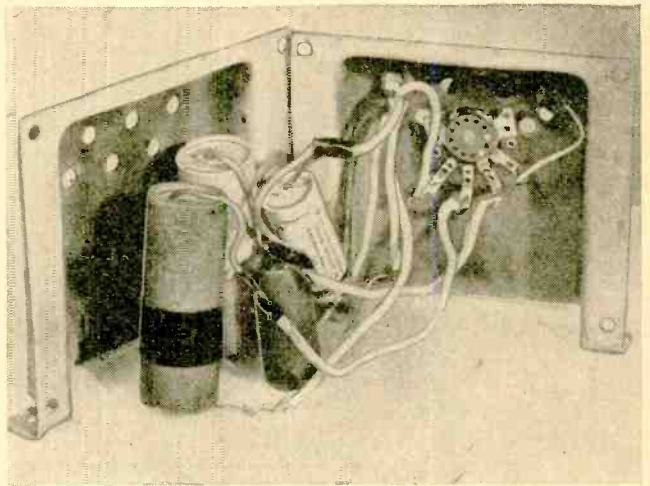

↑ This schematic diagram shows wiring of the capacitor substitution box illustrated on this page.

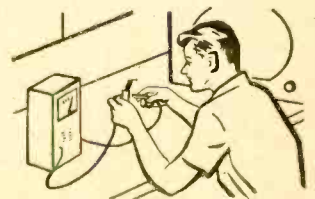

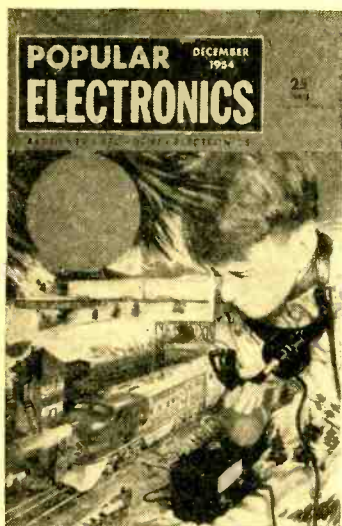

1954's MOST EXCITING CHRISTMAS GIFT

**A nationwide smash hit
in only a few short months!**

Unsurpassed for the hobbyists, the experimenters,
the electronics-minded friends on your gift list!

it's practical . . . tells you how-to-build-it . . . how-to-use-it . . .
how it works.

it's information packed . . . keeps you up-to-the-minute on the latest
developments in color television—Hi-Fi—radio
communications—radar—all phases of electronics.

it's easy to understand . . . tells you all you need to know about electronic
components, instruments and systems—and does
it in language everyone can understand.

**ORDER CHRISTMAS GIFT SUBSCRIPTIONS FOR ALL
YOUR FRIENDS AT THESE SPECIAL LOW RATES:**

1st GIFT SUBSCRIPTION . . . ONLY \$3.00 2nd GIFT SUBSCRIPTION . . . ONLY \$2.00

EACH ADDITIONAL GIFT SUBSCRIPTION ONLY \$1.50

**AND DON'T FORGET TO INCLUDE YOUR OWN SUBSCRIPTION!
USE THE HANDY ENVELOPE FACING THIS PAGE.**

TOOLS

GADGETS

SAFETY PLIERS

Diagonal and side cutting pliers made by the *Utica Drop Forge & Tool Corp.*, Utica 4, N. Y., can now be equipped with a new safety feature known as "Cushion Throat." This patented feature is useful in electronics work where cuts can be made inside a chassis without the danger of snips of wire falling into the set. On live

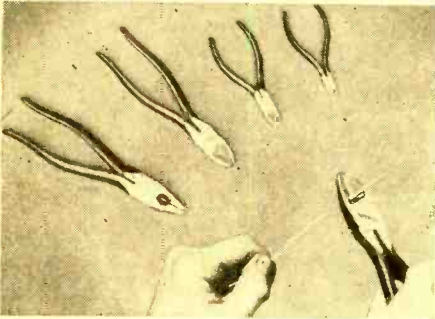

connections this helps prevent short circuits. When cutting springs or hard wire, "Cushion Throat" eliminates the "flying chips" hazard.

The "cushion" is a tough, rubbery plastic piece, bonded inside the pliers' cutting edges. As the pliers close, the cushion grips the short end of the wire tightly, holding as the cut is made. "Cushion Throat" has been designated N. *Utica* pliers with this new feature can be ordered by adding N to the tool number desired.

ELECTRIC SANDER

Home craftsmen will be interested in a new, popular-priced electric sander, developed by the *Weller Electric Corp.*, 808 Packer St., Easton, Pa. The new sander

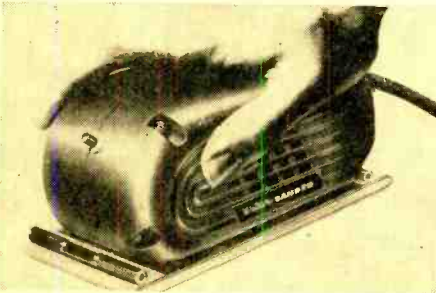

is a vibratory type and is said to meet professional standards. Known as Model 700, it features a full 25 square inches

of sanding area, yet its design permits use under radiators and other restricted places.

All cabinets and shelves, particularly those constructed for housing hi-fi and other electronic equipment can be sanded, rubbed, waxed, and polished with the Model 700. Other uses include feather edging, cleaning metal, waxing cars, paint removing, and polishing leather. No lubrication is ever needed, and sanding dust cannot affect its operation. For additional information write Joseph F. Whitaker at the *Weller Electric Corp.*

TEST PROD ADAPTOR KIT

A new roll-up kit for convenient wall-mounting of "Klipzon" test prods and self-holding points for radio, TV, and laboratory circuit work has been announced by *United Technical Laboratories*, Morristown, N. J.

The kit contains test prods and leads, alligator adaptors, banana plug adaptors, longie adaptors, and jumbo heavy duty adaptors.

PRECISION METER

A new high precision miniature meter has been developed by *DeJur-Amsco Corp.*,

45-01 Northern Blvd., Long Island City 1, N. Y. Designated as Model 152, the 1½" square instrument is designed for panel mounting and is internally sealed for waterproofing.

Accuracy and stability of adjustment between jewels and pivots is gained by the use of miniaturized external pivots with *DeJur's* D'Arsonval movement. Another feature of this meter is the use of high torque *Alnico* magnets. Additional information is available from the manufacturer.



NEW SOLDERING FLUX

A new liquid soldering flux that makes solder flow and hold on iron and steel as easily as on copper, bronze, zinc, etc. has been announced by *Industrial Craftsmen, Inc.*, 145 High St., Boston, Mass. Known as "Poly-Flux," the new liquid removes sur-

THE NEW MODEL TV-11
TUBE TESTER

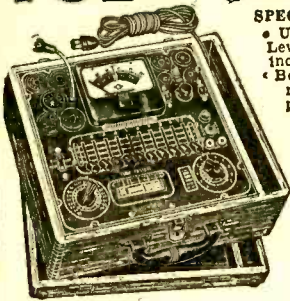

SPECIFICATIONS

- Uses the new self-cleaning Lever Action Switches for individual element testing.
- Because all elements are numbered according to pin-number in the RMA base numbering system, the user can instantly identify which element is under test. Tubes having tapped filaments and tubes with filaments terminating in more than one pin are truly tested with the Model TV-11 as any of the pins may be placed in the neutral position when necessary.

- The Model TV-11 does not use any combination type sockets. Instead individual sockets are used for each type of tube. Thus it is impossible to damage a tube by inserting it in the wrong socket.
- Free-moving built-in roll chart provides complete data for all tubes.
- Phono Jack on front panel for plugging in either phones or external amplifier will detect microphonic tubes or noise due to faulty elements and loose external connections.

Operates on 105-130 Volt 60 Cycles \$ **47 50**
 A.C. Hand-rubbed oak cabinet complete with portable cover.

SHIPPED ON APPROVAL
NO MONEY WITH ORDER — NO C. O. D.

Try it for 10 days before you buy. If completely satisfied send \$11.50 and pay balance at rate of \$6.00 per month for 6 months—No Interest or Carrying Charges Added. If not completely satisfied, return to us, no explanation necessary.

MOSS ELECTRONIC DISTRIBUTING CO., INC.
 Dept. D-82, 3849 Tenth Ave., New York 34, N. Y.
 Please rush 1 Model TV-11. I agree to pay \$11.50 within 10 days after receipt and \$6.00 per month thereafter.

Name

Address

City..... Zone..... State.....

LEARN ELECTRICAL APPLIANCE

START YOUR Repairing & Installation OWN BUSINESS

Revolutionary NEW TRAINING METHOD, trains you AT HOME... in just a few short weeks! You receive big "ON-THE-JOB" home training kits, test equipment, audio instructions and practical service training lessons. You learn how to Service, Repair and Install all types of ELECTRICAL Appliances and Equipment. How to build and operate your own business, etc.

You EARN As You Learn

You charge on basis of \$3.00 to \$5.00 per hour for spare time work! Write now for your Free Book, full details about this amazing opportunity for you in modern Electric servicing.

Big Book FREE!

ADVANCE TRAINING 5944 NORTH NEWARK AVENUE Dept. 7412, CHICAGO 31, ILL.

Catalog of 3000 Novelties 10c

Send 10c for amazing catalog of novelties, live animals, scientific supplies, hobbies, funmakers, planes & boats, looms, magic tricks, joke articles, unusual seeds, gadget time-savers, cameras, optical goods, projectors, movies, lucky jewelry, religious novelties, disguises, musical instruments, stamps, coins, puzzles, fortune tellers, radios, auto & bike accessories, telescopes, magnifiers, compasses, banks, smokers' gadgets, artists' supplies, printing sets, engines, motors, shockers, knives, billfolds, fireworks, guns, rifles, sports, books, games, plants, etc. Send name, address & 10c to:

JOHNSON SMITH & CO., Dept. 860, Detroit 7, Michigan

face oxides. Tests indicate that joints soldered on iron and steel with "Poly-Flux," solid solder, and a regular soldering iron, or by the flame or dip methods, are as strong as the solder itself. Descriptive literature will be sent on request to the manufacturer.

MAGNETIC POWER-LATCH

A powerful new low-priced magnetic door latch for heavier doors has been announced by *Hepner Sales Co.*, Round Lake, Ill. The 10-lb. holding force exerted by the magnetic latch is enough to keep screen, closet, and other heavier doors firmly closed

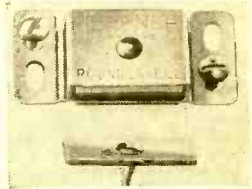

even if the doors are warped or sagging. The device is compact, measuring 2 1/2" by 1/2" and weighing 1 3/4 ounces. Since it works equally well on wood or metal doors, the new latch is recommended for every type of home and industrial cabinet or locker door, including kitchen, tool, music cabinets, etc. Further details are available from the company.

CONTACT BURNISHING TOOL

A new tool for burnishing electrical contacts has been announced by *P. K. Neuses, Inc.*, W. Euclid and Dwyer Sts., Arlington Heights, Ill. Known as the No. 3-316, the tool is non-residual leaving no filings, grit,

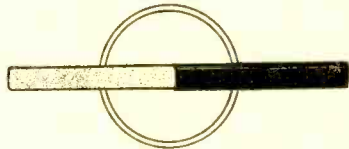

dust, or film on the contact point. It was developed for any type of contact. It is flexible to permit getting into cramped places. The handle is plastic and acts as an insulator for working on live contacts.

INSULATING SPRAY

"E-26," a new air-dry coating may be used for insulation and protection in nearly every place that electricity is found. Sprayed from a can, "E-26" can be used to protect and insulate such items as bus bars, transformer leads, motor coils, switchgear, etc.

It will insulate and moistureproof terminal boards and permanent electrical connections such as those behind wall sockets, fuse boxes, and panel boards. It may be sprayed on short leads and pigtails as a

POPULAR ELECTRONICS

Something Too Good to Miss, for HI-FI ENTHUSIASTS

IT STUMPS THE EXPERTS

Ever since it was first described four years ago the performance of Air-Coupler speaker systems has delighted and mystified the most critical listeners. Hundreds of hi-fi enthusiasts who have built Air-Couplers to reproduce the low frequencies say that they now hear tones that they *never knew were recorded on discs and tapes!*

The Air-Coupler is unique in two respects — it gives clean reproduction on fundamental frequencies from 200 down to 20 cycles *with such power as to blow a match held in front of the port*, and yet, operated at low volume, it gives rich, proportionate bass reproduction when the system is turned down to *bare audibility*.

YOU CAN BUILD IT

The enclosure is easy to build from 11 pieces of plywood. No special tools are required. Use any good 12-in. speaker. Added to your present speaker system, the Air-Coupler will make such a dramatic improvement that your friends will ask if they may bring over their records to play on your system.

THE AIR-COUPLER UP TO DATE

The origin of the Air-Coupler was never disclosed until the story was told in the March-April issue of MUSIC at HOME Magazine. Since then, requests have poured in for up to date information on this remarkable enclosure. Accordingly, in response to this demand, a series of three articles has been prepared, starting in the September-October issue.

The series will present 1) detailed drawings and instructions of the latest, improved design, 2) diagrams and information on fixed and variable networks, amplifiers, and speaker systems, and 3) drawings which show how to conceal the Air-Coupler in bookshelves or storage walls, under the floor, or in simple, useful furniture pieces.

ORDER YOUR COPIES NOW!

You can get the next three issues with the new Air-Coupler series, *plus* the March-April issue containing the article "Origin of the Air-Coupler", at the reduced price of \$1.00. MUSIC at HOME is a large-size magazine, elaborately illustrated and printed on fine paper. Edited for hi-fi enthusiasts, it covers all phases of music from records, tape, and FM, with more information on hi-fi equipment, installation, and operation than any other magazine. The four issues you buy for \$1 are equivalent to a \$5 book of 550 pages!

HOW YOU CAN SAVE \$2.00

Here's how you can save \$2.00, and get the complete Air-Coupler series absolutely FREE! If you order a year's subscription to MUSIC at HOME immediately, you will receive the 4 big issues which contain the Air-Coupler articles WITHOUT CHARGE, and your subscription will run through the January-February 1956 issue! In this way, you will have the complete Air-Coupler series, PLUS a full year's supply of fascinating, new ideas on the latest equipment for music from records, tape, and FM radio. TAKE ADVANTAGE OF THIS SAVING!

MILTON B. SLEEPER, Publisher
207-G East 37th St., New York 16, N. Y.

Enclosed is my remittance for
 \$1.00 for 4 issues containing Air-Coupler series
 \$3.00 for 1 year PLUS 4 Air-Coupler issues FREE

Name

Address

.....
Add \$1.00 per year for foreign postage

there's always something new
being developed by *Perma-Power*

TV VOLTAGE REGULATOR

10 Volt Line Adjuster • Normal
Line Volts • 10 Volts Increase
• 10 Volts Decrease. 300 Watts
Returns full height &
width of picture.
Eliminates intermit-
tent sync.

\$675



UNIVERSAL TV TUBE BRITENER



\$445

Isolation type transformer gives 6.3 V
for cathode — filament short or 7.8 V
to increase emission. • It's parallel
• It's series • It's isolation • It's
electrostatic • It's universal.

Available through recognized electronic parts suppliers

Perma-Power COMPANY 4727 N. DAMEN AVE.
CHICAGO 25, ILL.
Manufacturers of electronic equipment since 1928

EXPERIMENTERS!



LOOK WHAT
YOU GET
FOR THE
Remarkably
LOW PRICE
OF ONLY
\$89.50

(Cabinet as shown
\$10.00 extra)

A COMPLETELY OPERATING PHILIPS PROTELGRAM TV SYSTEM

BRAND NEW—shipped in original factory sealed container
YOU GET A COMPLETE PACKAGE INCLUDING:

• Chassis completely wired and ready for use, including 23
tubes plus one diode • Protelgram projection unit including
picture tube • 25,000 volt power supply • 8" dynamic Hi-Fi
speaker on large baffle • 23" flat viewing screen and full size
reflecting mirror.

NOTE: Chassis circuitry includes . . . Automatic beam suppres-
sor . . . High Fidelity sound system . . . Automatic gain con-
trol . . . "Standard Coil" tuner, etc.
\$400.00 original cost of parts, units and accessories to experi-
ment with.

EDUCATIONAL . . . INTERESTING . . . ENTERTAINING
TERMS: F.O.B. N.Y.C. Full remittance with order or 25%
Balance C.O.D.—10 day money back guarantee.

ELECTRONIC SPECIALTY SUPPLY CO.
58 Walker St., N. Y. 13, N. Y. Phone: WA. 5-8187

substitute for tubing, where necessary. Sprayed on surfaces of equipment, it provides protection against corrosion.

It is available clear and in colors and may be applied by dip and brush as well as by spray. Complete information is available from the *Inst-X Sales Co.*, 26 Rittenhouse Place, Ardmore, Pa.

"BALANCED GRIP" SOLDERING GUN

A new "balanced grip" soldering gun has been announced by *Paul C. Roche Co., Inc.*, 11 Park Place, N.Y. Known as the "Primax-Solderer," this tool contains an exclusive alloy tip that is said

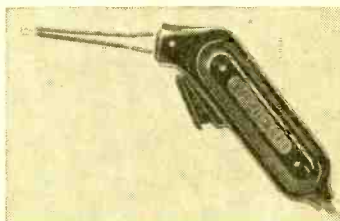

never to need retinning. Fast heating action makes it ready for use in 6 seconds. The gun is compact and weighs only 22 ounces. It can be slipped easily into the pocket or your tool kit. The grip is balanced and includes a trigger control. Tips are designed for easy soldering on hard-to-reach jobs.

TIP-OVER SAFETY SWITCH

A new tip-over safety switch for heaters and other portable electric appliances is announced by the *Stevens Manufacturing Co., Inc.*, Mansfield, Ohio. Known as the "Stemco Tip-Off Switch," the unit is mounted inside the base of the appliance. A pin, or similar device, projecting through

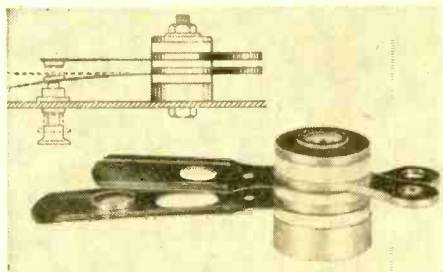

the base presses against the lower contact spring to close the switch contacts. Immediately the appliance is overturned, or lifted from the floor, the contact spring opens the contacts to shut off the unit. Full details are available from the manufacturer.

CONNECTING KIT

An assortment of wire joint connectors and terminals, providing fittings for the widest range of uses for electrical technicians has been announced by *The Thomas*

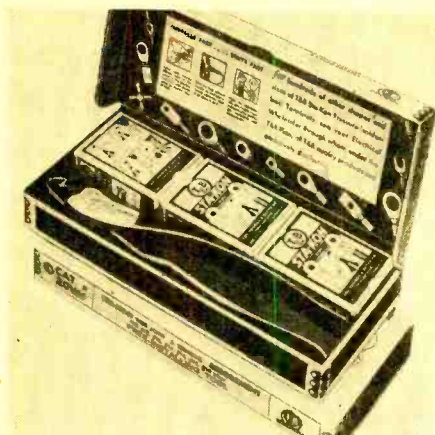

& Betts Co., Elizabeth, N. J. Known as the new "Sta-kon Kit," the package includes, free of extra charge, an installing tool capable of cutting wire and crimping terminals, or joining terminals to the wire. The kit can be used for terminating and splicing all conductors from No. 20 to No. 10 AWG.

NEW "LOOPSTICKS"

Of interest to all who build electronic equipment of various types is the announcement by *Superelex Electronics Corp.*, 23 Atherton St., Yonkers, N. Y. of the availability of two "Loopstick" antennas.

The "Ferri-Loopstick" model is designed for fixed, permanent installations, either new or replacement, where no adjustments are required after installation.

The second type, the "Vari-Loopstick," is adjustable permitting maximum efficiency on several consecutive stations.

Both antennas have a "Q" which averages $2\frac{1}{2}$ times that of current loop antennas. Both units are omni-directional and

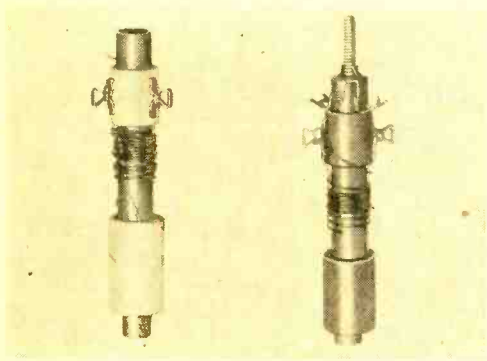

provide equal sensitivity in any position.

The compact size, $7\frac{1}{16} \times 2\frac{1}{4}$ ", of these units makes them especially suitable for all types of miniature and subminiature construction work. A data sheet is available on request.

END

December, 1954

free!

VALUE-PACKED PAGES

308

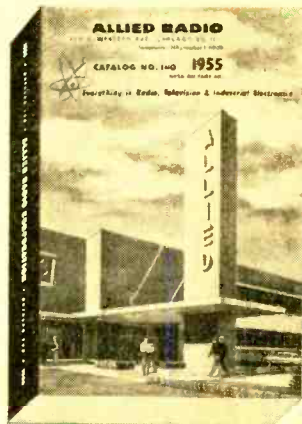

1955 ALLIED TV & RADIO CATALOG

SAVE ON EVERYTHING IN ELECTRONICS

World's Largest Stocks... Everything for Experimenters, Builders, Amateurs, Servicemen, Engineers & High Fidelity Specialists.

BUILDERS' KIT Headquarters

Featuring Famous Knight Kits

Send for ALLIED's big 308-page value-packed buying guide to *everything* in TV, Radio and Electronics! Largest selections of custom TV chassis, antennas and accessories; FM and AM tuners; High Fidelity systems and components; Amateur supplies; recorders and phono equipment; test instruments; builders' kits; industrial electronic supplies—plus the world's largest stocks of electronic parts, tubes, tools and books. Get *everything*—get *more* for your money—send today for your FREE 1955 ALLIED Electronic Supply Catalog.

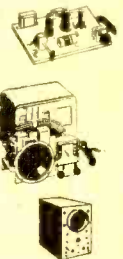

ultra-modern facilities

TO SERVE YOU BEST!

Send for FREE Catalog

ALLIED RADIO

ALLIED RADIO CORP., Dept. 79-M-4
100 N. Western Ave., Chicago 80, Ill.

Rush FREE 1955 ALLIED 308-Page Catalog

Name _____





Address _____



City _____ Zone _____ State _____

ONLY 75c EACH FOR FINEST IMPORTED PRECISION PLIERS

only **75c** ea.

For Jewelers, Optical Workers, Hobbyists, Craftsmen of all kinds. These superb German instruments are of drop-forged, heat-treated high quality tool steel, fabricated, ground and polished to most exacting specifications. Smooth working joints. Jaws meet perfectly to hold the most delicate objects. Each plier is 4" long and a gem of precision and strength. 7 types to choose from: Flat Nose, Round Nose, Snipe, Combination, Diagonal, End Cutting Nippers, or 1 Side Flat and 1 Side Round.

-  **FLAT NOSE**
-  **ROUND NOSE**
-  **DIAGONAL**
-  **END CUTTING NIPPERS**
-  **1 SIDE FLAT - 1 SIDE ROUND**

- COMBINATION** 
- SNIPE** 



11 Pc. DRAFTING SET only \$2.98

(plus 30c handling & postage)

High lustre chrome plated instruments of outstanding quality and accuracy. Set includes Plain and Ringhead Bow Dividers. Compasses for use with ink or pencil. Ruling Pens and all necessary parts. Packed in a velvet lined, snap button closure, simulated leather case.

Minimum Order \$1.00. Send check or M.O., C.O.D. charges extra. **MONEY BACK GUARANTEE.**

SCOTT MITCHELL HOUSE, INC.
Dept. P.D., 611 BROADWAY, NEW YORK 12, N. Y.

ELECTRONIC SUPPLIES

FOR EXPERIMENTERS—SERVICE—INDUSTRY

CLEAN, USEFUL ITEMS SOLD ON SATISFACTION GUARANTEED BASIS—WHOLESALE AND RETAIL

ELECTRONIC REMOTE CONTROL UNIT

Contains a multitude of new, valuable, useful parts. Including 3000 ohm sensitive plate relay—transformer, switch, tube sockets, panel lamp, condensers, resistors, potentiometer, etc. Including schematic instruction sheet. Ridiculous sale price of 79c complete while they last. 4 for \$3.00 Same chassis less relay and transformer. New, with sheet 3 for \$1.00

HOW CAN YOU GO WRONG?

● ● ●
\$28.00 VALUE \$28.00 VALUE

Sensitive Microammeter

0-20 Microamps condensed scale, Weston 301—3 1/2" round bakelite. Lowest advertised price before this special sale was \$10.00—Now to close out remaining few \$5.95 in original Weston boxes. Brand new.

RETRACTABLE PHONE CORD

Worth \$4.00 each—Special. New. Over 6' long—4 conductors. 3 for \$4.00

TUBE Type 1629
Magic eye tube, New, Boxed 15c ea. 7 for \$1.00

ELECTROLYTIC CONDENSER
Assortment of 6 fresh multiple Can types Worth over \$1.00 ea. 6 for \$1.00

INCLUDE POSTAGE WITH ORDER

REX RADIO SUPPLY

88 CORTLANDT STREET, NEW YORK 7, N. Y., CO 7-1617

Germanium Crystal Diode

General purpose—1N60—Prepared for production. 4 for \$1.00

Worth 65c each.

HOW CAN YOU GO WRONG?

MAGNA CRYSTAL SET KIT

Complete with phone pictorial, instructions. Nothing else to buy. \$2.95

PLASTIC WET CELL BATTERIES

- 2 Volt—20 amp. \$1.90
- 6 Volt—5 amp. 1.95
- New-Dry Charged—less Electrolyte.
- 20x20 MFD—450 VDC ELECTROLYTIC Plug into Octal Socket 6pc: 4 for \$2.25

Small Parts Values

- Steatite Octals—worth 24c ea. 7 for \$1.00
- Mica Condenser—.01 worth 40c ea. 6 for \$1.00
- Carbon Chest Mike/w Breast Plate 2.95
- Dozen 1/2 meg. Resistor on Mycalex board—Long Leads—6 boards 1.00
- Brand New Telephone Handsets 5.95
- Heating Aid Tubes—unbranded—New. 5 for 1.00
- 1/2" Panel Lamp Indicators—red or amber. 6 for 1.00
- Carbon Throat Microphone—New—w/Instr.98
- Carbon Lip Mike—MSA/UR—New—w/Boom 1.95
- Slug Term'l Bd. 20 for 1.00

Nominations Open for G-E Amateur Award

A NATION-WIDE search for the top amateur radio operator has been opened by General Electric Company which annually recognizes the "key man" among the country's 100,000 ham operators.

The ham selected will be the top "good neighbor" among hams—the one who performs the outstanding public service of 1954. Anyone may nominate a ham for the honor. Next February, General Electric will present the winner the third annual Edison Radio Amateur Award, following selection by four impartial judges.

The initial two Edison Awards were made for widely diverse service. The first went to 20-year-old Don L. Mullican, a Harding College student in Searcy, Arkansas.

Mr. Mullican stuck to his radio set for five days and nights, almost without relief, to direct emergency aid to tornado victims in two nearby towns.

The award for 1953 went to a "Polar Postman"—46-year-old J. Stan Surber, a Chesapeake and Ohio Railway dispatcher in Peru, Indiana. He spent almost 50 hours a week at his hobby which is relaying radioed messages between men at isolated Arctic Islands' weather stations and their families in U. S. and Canada. During the year he handled 12,000 messages.

Winner of the award for 1954 will be chosen for the ham activity which brings the greatest benefit to an individual or group, and for the amount of ingenuity and personal sacrifice displayed in performing the service.

Anyone can nominate a candidate. Nominating letters should include the candidate's name, address, ham call letters, and a full description of the service performed. Letters must be sent, before January 3, 1955, to Edison Award Committee, General Electric Tube Department, Schenectady, N. Y.

Judges will be E. Roland Harriman, president of American National Red Cross; Val Peterson, administrator of Federal Civil Defense Administration; Edward M. Webster, FCC Commissioner; and Goodwin L. Dosland, president of the American Radio Relay League, the national ham organization.

The winner, and the person responsible for his nomination, will receive expense-paid trips to a centrally located city for presentation of the award next February.

END

Bent Iron Tip Aids Soldering

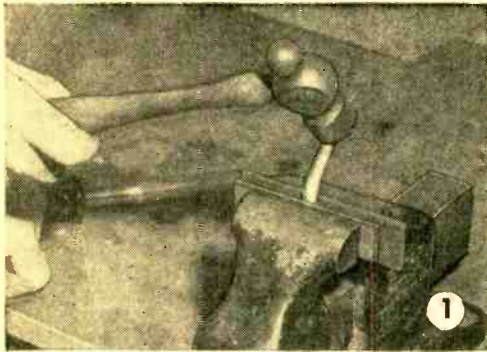

FOR those hard-to-get-at places on a chassis, a soldering iron tip with a 90 degree bend will prove useful. Remove the tip from your iron and bend it as shown in the photo of Fig. 1.

Replace the tip, as shown in Fig. 2, and the iron can then be used as shown in Fig. 3. Any soldering iron that uses a straight round bar for a tip can be bent as shown. Irons with heavy tapering copper tips are not suitable in this particular application. Try this idea the next time you have a tricky solder job to do. It is a real time and temper saver. . . . Parker Strand

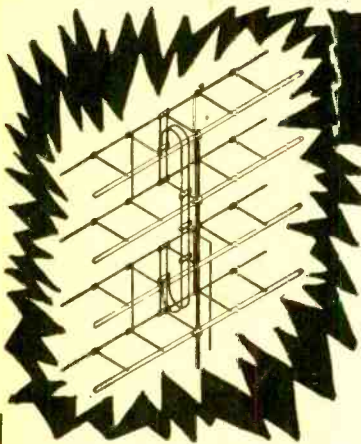
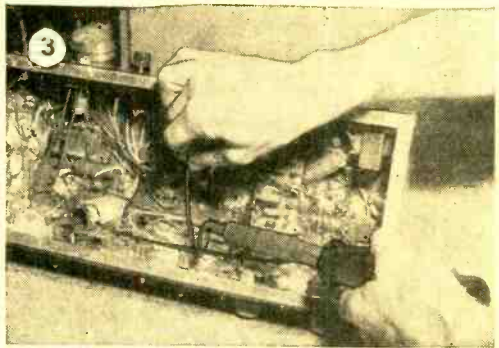
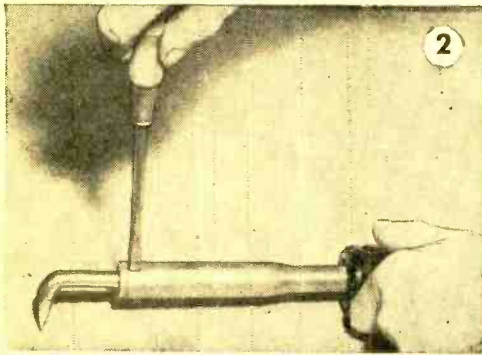

Amazing Long Distance TV Reception
Clear Sharp Pictures up to 120 Miles From Station

SKYMASTER SUPER FRINGE UHF-VHF TV ANTENNA

FOR ALL CHANNELS

This famous colinear long-range TV antenna offers the ultimate in long-range UHF-VHF reception. Spacing has improved front-to-back ratio, helping to minimize co-channel interference. Twenty-four driven elements provide a high, sustained gain that produces superb results at 120 miles from station if needed—and greatly improving picture quality because of evened impedance match across channels. Field tests confirm our belief that this powerful antenna is one of the finest Super-Gain TV antennas available today.

- No. 9 Anodized Aluminum Elements (guaranteed against staining or tarnishing)
- Aluminum Back-up Blocks
- Plexi-glass Hi-dielectric Insulators
- Aluminum Washers and Stand-offs
- Light Weight—no thrust bearing required on Rotor for average installation
- Cadmium-plated Nuts & Bolts
- 3 1/2" Dowel Pins
- Size: 92" wide—30" high

LOOK AT THESE AMAZING FEATURES:

- Clear pictures up to 120 miles and more from station!
- 12 driven elements on high band!
- 12 driven elements on low band!
- High gain—low noise ratio!
- One transmission line!
- Total weight only 8 lbs.

Rocket Super-Fringe, series JJ, Co-linear All-Channel TV Antenna provides superior fringe reception. Primarily designed for long-range VHF reception, field tests show that this unit also provides top-notch UHF reception at distances up to 40 and 50 miles. At our low price, this Super-antenna is "Tops" in its field.

NATIONAL ELECTRONICS OF CLEVELAND
912 DELCO BLDG., CLEVELAND 3, OHIO

Model JJ **\$23⁵⁰**
EACH

MONEY-BACK GUARANTEE

If you are not convinced that the merchandise we ship you is satisfactory in every way, if you are not 100% sure that it will do everything we claim for it and more, you may return it and receive your money back.

HERE'S HOW YOU BUY

All prices F.O.B. Cleveland, Ohio. You may remit with order or order C.O.D. Do not remit more than complete purchase price. Pay shipping charge on receipt of goods. On C.O.D. orders, please enclose 25% deposit. Same money back guarantee on C.O.D. orders. All prices subject to change without notice.

TRICKS of the TRADE

DRY CELLS IN SERIES

WHEN using flashlight cells in radio and electrical experiments, there is the problem of making quick series connections when more than one cell is used. One solution to the problem is to push two cells

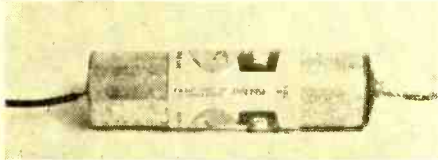

into a single cardboard sleeve, as shown in the photo. Use two sleeves when you want to connect three cells in series. If the sleeves fit the cells a little too loosely to hold a good connection, simply wrap a turn or two of Scotch tape around the cells so they will fit the sleeves tightly.

Make connections to the cells by soldering wire leads to the ends of the outer cells, as shown. If desired, the string of cells can be mounted on a wood base provided with two spring-brass angle-brackets; the brackets contact the ends of the outer cells and make soldered leads unnecessary.

* * *

PHONE CUSHIONS 10c A PAIR

THOSE "airfoam" sponge-rubber powder puffs, sold in dime stores and elsewhere for 5c and 10c each, make very comfortable cushions for earphones. They are available in different diameters and thicknesses. You simply punch a hole in

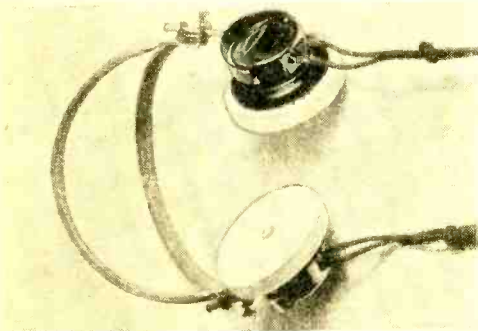

the center of the puffs and then cement them onto the outsides of the phone caps, using rubber cement. When the puffs get

dirty, simply screw off the caps, wash the puffs in warm soapy water, rinse and dry, and then screw the caps back onto the phones again.

To punch the holes in the center of the puffs, put a sharp edge on one end of a thin-wall metal tube of the correct diameter, lay the puff on a piece of wood and hold it firmly, then twist the metal tube through the exact center of the puff and cut out a neat plug of the rubber. Be sure that the hole is large enough to clear the hole, or holes, in the phone caps. First spread a little cement on the puff, and then spread a little on the cap, and when tacky press the two together firmly (making sure that the holes line up) and hold until the cement sets. A. T.

* * *

SPRING CORD TROUBLE LAMP

A 7½-WATT, 120-volt lamp with holder and shade may be arranged with coiled,

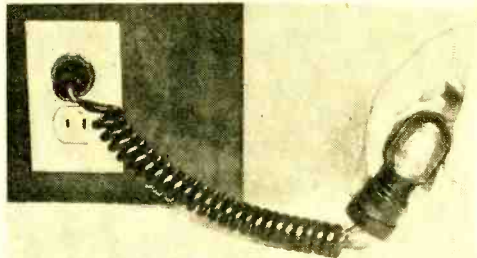

spring-type wire which will assist in pulling lamp away from other test equipment when not needed.

The wire shown is telephone wire purchased from a camera shop and is of the type sold for flash guns. However, there are coiled test leads on the market which may also be used in this application.

* * *

DRILLS AS SPACING GAUGES

FINDING the capacitance of surplus capacitors or other units of unfamiliar design or characteristics requires knowledge of plate area and spacing. Area is easily found with a common scale, but the spacing cannot be found accurately without a thickness gauge.

An inexpensive and ready substitute for such a gauge is the numbered drill set. Using the shank of the drill as a feeler,

find the largest one that will just slip between the plates of the capacitor. Any mechanic's handbook has tables giving the

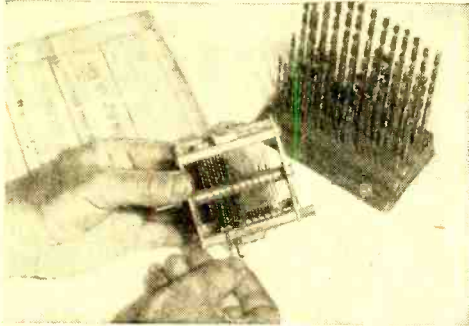

diameter of numbered drills. From this table, find the spacing.

In the example shown, a No. 50 drill gauges the plate spacing of this surplus capacitor as .070".

Numbered drills can be used in this manner to gauge spacings of from .0135" (#80 drill) to .2280 (#1). Safety gaps, relay contacts, or key points can likewise be set accurately.

* * *

MIRROR FOR TV ADJUSTMENT

A MIRROR with clips for attaching to the auto sun visor may be quickly adapted for viewing the television receiver picture tube face while making adjustments at the back of the chassis.

It is only necessary to bend the clips of the visor mirror so they will fit over a chair back or the cover lid of a test kit.

* * *

BONDING STRAPS

WHEN you work with experimental setups involving two or more separate chassis, you'll have less trouble with stray signal pick-up, ground loops, and interference, if you bond the individual chassis together with heavy conductors.

Excellent bonding straps may be made

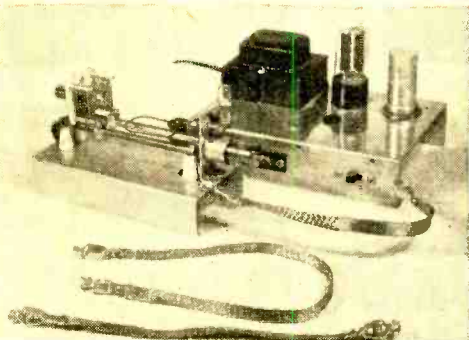

up by using $\frac{3}{8}$ " to $\frac{1}{2}$ " tinned shielding braid and small battery clips. Make up several in different lengths. Good sizes for

learn MORE about electronics with these easy-to-understand RIDER BOOKS:

OBTAINING AND INTERPRETING TEST SCOPE TRACES by John F. Rider

The "Dean of American servicemen" explains the traces you see on the oscilloscope screen as they've never been explained before! Clear, non-mathematical language! Illustrates and identifies over 800 scope traces, covering radio, TV, amplifiers, power supplies, generators! Everyone in electronics has to use the 'scope—and this book tells and shows you how!

CHAPTERS: Sine & complex waveforms—Square waveforms—Rectangular waveforms—Sawtooth & Trapezoidal waveforms—Differentiated & integrated waveforms—Amplitude modulated waveforms—Response & S curves—Interpretation of test scope traces—Phase & frequency scope traces—Test set-ups.

#146, 192 (5½ x 8½") pp., only \$2.40

PICTURE BOOK OF TV TROUBLES, Vol. I (Horizontal AFC-Oscillator Circuits)

by the Rider Laboratory Staff

The first book in a new "TV Case History" series! Shows how to diagnose TV receiver troubles by picture and waveform observation. This book is the result of actual troubleshooting done in the Rider labs! Over 65 "faulty" picture tube patterns—150 normal and abnormal waveforms! Not a theory book—shows you what to look for, and what to do about it!

#168, 80 (5½ x 8½") pp., only \$1.35

HOW TO USE TEST PROBES

by Ghirardi and Middleton

A complete explanation of test probes, written by two electronics experts! Covers all types of probes used with meters and oscilloscopes—actually tells you how a probe works—how to make your own probes—which probe to use for any particular job! Clear, step-by-step explanations, with practical examples of the results you get when you use the right probe!

#165, 176 (5½ x 8½") pp., only \$2.90

Rider books are available at your parts jobber or book store. If your dealer doesn't have these books, MAIL THIS COUPON TODAY!

**John F. Rider Publisher, Inc.
Dept. PE, 480 Canal St., N.Y.C.**

Please send me a copy of:

- TEST SCOPE TRACES
- PICTURE BOOK OF TV TROUBLES
- HOW TO USE TEST PROBES

Name

Street

City & State

- Payment enclosed; postal charges prepaid
- Send C.O.D.; plus postal charges

"DO IT YOURSELF" TELEVISION GUIDE

Look at the features of this sensational new guide before buying any other TV book!

- Written so everyone can understand it! — Tells all about TV in simple language. — No technical knowledge required!
- Learn how to select a TV set best suited for your location and budget.
- Explains what you should know about warranties and servicemen. Protect yourself against overcharges and gyp repairmen.

DO IT YOURSELF—SAVE TIME AND MONEY!

- Special "Do It Yourself" chapters explain every repair and adjustment that you can make yourself!
- Tells how to install your own TV set. — How to select and install antennas. All about boosters, indoor antennas, fringe areas, etc., etc.
- Over 20 easy-to-understand illustrations of faulty pictures and simple hints on how to correct them.
- Hundreds of other features too numerous to list.

Pays for itself! Get more enjoyment from your TV set — No more missed programs. An ideal Xmas gift for your friends. Rush order for your copy of "What You Should Know About Television" written by foremost TV authorities. Only \$1.00 postpaid. (Three for \$2.50.)

J. H. Ruiter Publishing Co.

Somerville Box 151 New Jersey

HOMEMADE JOBS MADE PROFESSIONAL

with **PREMIER**

HOUSINGS for HOBBYISTS

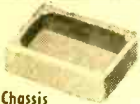

Blank Chassis



Utility Cases



Aluminum Miniature Cases



Open End Chassis

Experiment to your heart's content with Premier housings. Used by the largest electronics manufacturers. Ruggedly constructed, handsomely finished, economically priced.

Write for name of nearest distributor or **SEND FOR COMPLETE CATALOG**



PREMIER
METAL PRODUCTS CO.

3160 WEBSTER AVE. • DEPT. P • BRONX 67, N. Y.

the home lab are 3", 6", 9", 12", 18", and 24". In a particular set-up, use the shortest bonding straps practical for the experiments you're carrying out.

* * *

DON'T LOSE SMALL PARTS

THE next time you disassemble the family radio for testing or repairs, keep the knobs, mounting screws, and other small parts together in a box. Not only will you keep the workbench neater, but you'll find there is less chance of losing an important screw when all the parts are kept together.

* * *

LOW COST RUBBER FEET

THE next time you need rubber feet for a piece of equipment you're building and find you don't have any in stock, try thick rubber grommets instead. They make excellent rubber feet and are not only cheaper than conventional rubber feet, but a lot easier to mount.

Just make a hole of the right size in

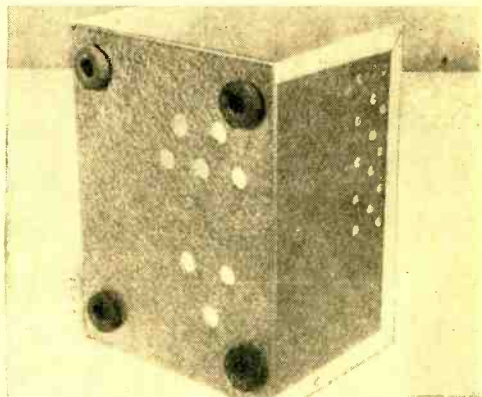

the cabinet. No machine screw, lock-washer, or nut is needed for mounting.

* * *

SKINNING WIRES

SKINNING wires seems such an inconsequential thing in these days of higher electronics that insulation is usually just torn, scraped, whittled, or pulled from the end of a wire. The usual result is nicked conductors (which in the case of solid wire invites early breakage) or severed strands.

Here is how to bare hookup wire without causing damage to the conductor. First, squeeze the end between the jaws of a pair of flat-grip pliers (without cutters). Pressure alone will cut the insulation neatly on each side of the conductor. This will leave the wire sticking out of the center of the two fanned pieces of the split insulation. With a pair of diagonal cutters, snip off the insulation ends, leaving only the

POPULAR ELECTRONICS

bared conductor. The wire will now be clean without anything sharp having touched it. E. R.

"HIDDEN" TV TUBES

IF YOU are unable to see all the tubes on top of the TV chassis shown on the

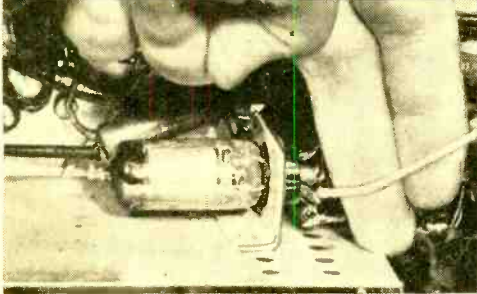

print, check diagram for note of tubes beneath the chassis.

Do not handle wiring as shown unless receiver has been disconnected from line outlet for some time.

DISCONNECT RESISTOR TO CHECK

WHEN checking a single resistor for ohms at least one end of the resistor must be disconnected from the circuit. When testing a multiple resistor with one or more tap, the safest method is to loosen all wires (marking with tags where they were connected) and test each section of the resistance with an ohmmeter in rotation. H. L.

HOLDING WIRE AND CABLE

MANY experimenters use either tape, string, or rubber bands for securing rolls of wire and cable. All three serve the purpose, but not one is completely satisfactory . . . tape generally leaves a sticky residue when it is removed, string

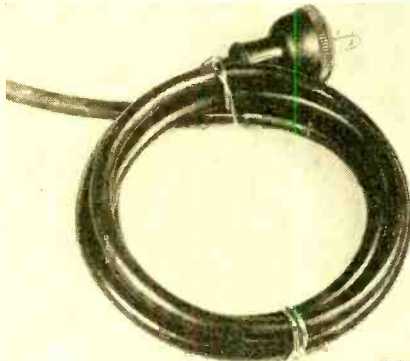

is difficult to put on and take off, and rubber bands not only are difficult to use, but break with repeated usage and age.

BUILD YOUR OWN
with **AMPLIFIER**
Concord's



**10 WATT
AMPLIFIER KIT**

\$6.95 ea.



Without a doubt, the most sensational amplifier kit value ever offered. We were fortunate enough to purchase a large quantity of these fine amplifier kits at a close-out price, and we're passing the savings on to you. Complete 3 tube amplifier kit with every part necessary to successful construction and operation. Components are of the very finest available quality, and the transformer and power supply can be used to operate equipment using four or more tubes. Amplifier has separate mike and phono volume controls, on-off switch, mike and phono inputs. Complete with instructions and schematic. Uses 6X5, 6SL7 and 6L6. Less Tubes Shpg. wt 8 lbs. **Stock No. 99-F-K3TK. \$3.50**

Kit of tubes for above

"Build Your Own Kits!"

2 TUBES (PLUS RECTIFIER)
AC-DC RADIO KIT



This more advanced kit is perfect for the beginner in radio. Offers an excellent opportunity to learn radio fundamentals and at the same time to build a high quality radio superior in tone and selectivity to many manufactured sets. Receives broadcast and shortwave (6-18mc). Complete with spkr. Less tubes. Shpg. Wt. 4 lbs.

Stock No. F7001C Net \$11.76

**5 TUBE
AC-DC RADIO KIT**

Superbly engineered for finest performance, this outstanding kit incorporates the latest in superhetrodyne circuits. Designed for sensitive reception and quality of tone. Tunes with easy selectivity on large, handsomely styled slide rule dial. Includes built-in loop antenna for powerful performance. "Big Beam" power output tube and 5" Alnico V speaker give "Big Set performance". Compact cabinet of durable bakelite. Mahogany. Kit includes all instructions, parts, chassis, tubes, speaker. Easily assembled with simple tools.

Stock No. F-115K Shpg. Wt. 8 lbs. Net 14.95



Please send NEW 1955 CONCORD Catalog!

CONCORD RADIO 55 Vesey St., N. Y. 7, Dept E2
20% deposit with C.O.D. **MINIMUM ORDER \$5.00**

NAME _____

ADDRESS _____

CITY _____ ZONE _____ STATE _____

**CONCORD RADIO • 55 VESEY ST.
NEW YORK 7, N. Y. • Digby 9-1132**

109

www.americanradiohistory.com

HEAVY-DUTY TOWERS

USED TO HOLD T.V. ANTENNAS,
FLOODLIGHTS, SIGNS, ETC.

Made of 1 1/4 In. O.D. Tubing Painted In-
side Out—Vinyl Aluminum

10-Foot Section \$11.95
Top Section (10-Foot) 11.95
Adjustable House Brace 4.95
10-Foot Heavy Top Mast 3.98
Includes All Hardware

SAVE ON T.V. ANTENNAS

\$19.95—Aluminum—Dbl. Lazy X—\$9.95
5 Element—Dbl. Phoenix—in Line—\$14.95

Lazy X—Special— 8 Element—\$2.98 Single
\$6.98 Double

ROTORS

U-83—Alliance \$29.95
TR4—Radiart \$32.50
Wire for U-83 or TR4 5c Per Ft.

NEW—UHF-VHF SKYMASTER ANTENNA

Model J—Reg. 40—Special. \$19.95

All Aluminum Construction

All Prices F.O.B.—Order Direct

From This Add C.O.D. 25% Deposit

RICHVILLE T.V. SUPPLY

5666 NAVARRE RD. S.W., R.D. 1, CANTON, OHIO

KITS by ELECTRONIC CRAFTS

For The Finest Equipment in Kit Form

5 WATT AC AMPLIFIER KIT

MOST Versatile . . . assures full, clear tone at practically all settings of volume control. Includes bass compensation control that lessens needle noise, and two inputs—one for reluctance or microphone—other for crystal pickup.



Some Important Features:

- 117 Volts, 50-60 cycles
- Heavy gauge steel chassis fully enclosed, beautiful gold baked enamel hammer-tone finish.
- All jacks, connections and controls clearly imprinted on chassis
- Tubes: 1 6X5, 1 6V6GT, 1 6S17GT

Kit includes only matched parts, each carefully engineered for long service and peak performance. Complete with easy to follow instructions—lots of fun building. Learn by doing.

SPECIAL! THIS ISSUE ONLY—

KIT, complete with tubes \$15.95
WIRED, complete ready to use \$18.95

5 TUBE, AC/DC SUPERHET. RADIO KIT

See October Popular Electronics (page 108) for complete specifications.

SPECIAL (less cabinet) \$14.95

TERMS: F.O.B. NYC. Include 20% dep. with order. bal. C.O.D. WRITE TODAY FOR FREE CATALOG!

We manufacture all types of kits, tell us your needs. Satisfaction Guaranteed—Huge Savings Assured. SCHOOLS, COLLEGES, DISTRIBUTORS: Write for special discounts.

Electronic Crafts Co.

74 Cortlandt St. New York 7, N. Y.
REctor 2-4352

Short pieces of wire solder are excellent for holding wire and cable in coils . . . the solder is easy to manipulate, even with one hand, easy to apply and to remove, and may always be salvaged for soldering jobs. The solder will hold the cable securely almost indefinitely, yet leaves no sticky residue and doesn't deteriorate with age.

SOLDERING IRON HOLDER

A TV antenna mounting base of the type shown will clamp down on the handle of almost any type of soldering iron and hold it in an upright position whether hot or disconnected.



This base is about 4 inches high and 3 inches wide with a clamping device to fit handle.

For intermittent use the iron may be held with the base attached and then the complete assembly set aside.

"C" CLAMP HOLDS CHASSIS

SMALL radios and amplifiers are sometimes hard to handle on the workbench. However, you'll find you can save time and your work will be easier if you clamp the

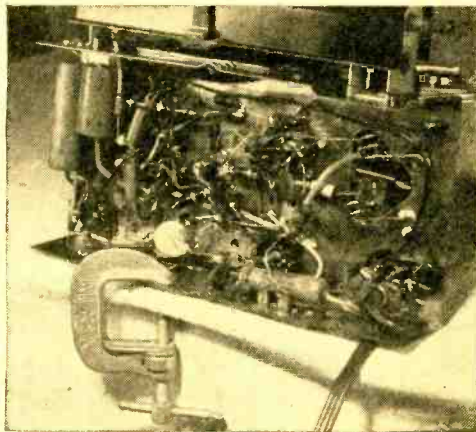

equipment upright along the edge of the bench.

A single small "C" clamp will do the job if the chassis is small. Use two "C" clamps for large chassis . . . one at each end.

BENDING LARGE CHASSIS

YOU can bend fairly large pieces of sheet metal in your small workbench vise if you extend the vise jaws with pieces of an-

gle as shown in the photograph. It isn't necessary to fasten the angles permanently

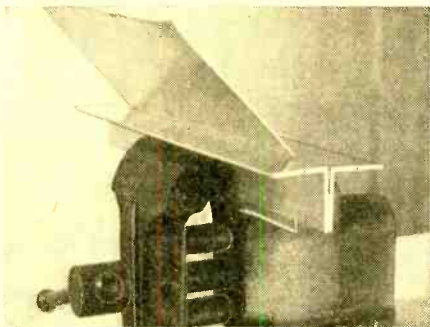

to the vise; normal vise pressure will do the job.

Extruded aluminum angle is satisfactory for bending thin, soft metals (aluminum and copper). For thicker and harder metals, use angle iron.

* * *

SPLIT RIVET REPLACEMENT

IF YOU have lost a split rivet or bolt which holds one corner of the board on

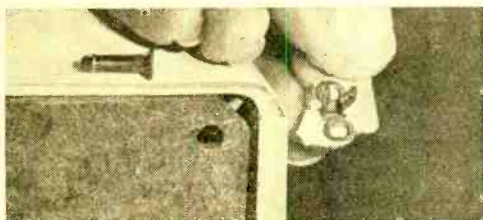

the back of your radio, try the clasp from a large size mailing envelope.

The clasp may be left attached to a small piece of the envelope as it will not be seen behind the radio. The two metal strips of the clasp may be bent to fit.

* * *

REMOVING SOLDER

WHEN removing old solder from closed terminals, as found on bandchanging

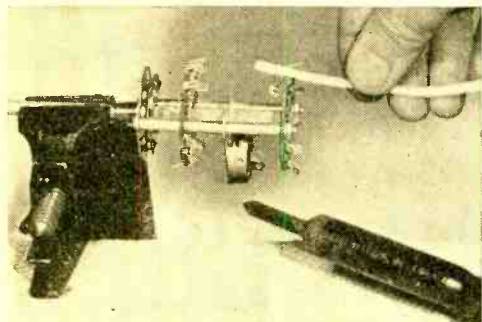

switches, try a pipe cleaner while the terminal is hot.

Such cleaners are also suitable for applying contact cleaner, and general work in close quarters. **END**

December, 1954

**IF YOU'RE
INTERESTED
IN
HIGH FIDELITY
RECORDS ...**

then
**YOU'LL WANT
TO KNOW MORE
ABOUT THE
Collaro
High Fidelity
RECORD CHANGER**



Mail This Coupon Today

ROCKBAR CORPORATION, Dept. LM-18
215 East 37th Street, New York 16, N. Y.

Please send me literature describing COLLARO
High Fidelity RECORD CHANGERS.

NAME

ADDRESS

CITY ZONE STATE

IT'S BIGGER AND BETTER THAN EVER!

B-A's NEW 1955

FREE CATALOG!

**164
PAGES**

**LOADED WITH
SAVINGS AND
NEW ITEMS
IN RADIO,
TV AND
ELECTRONICS!**

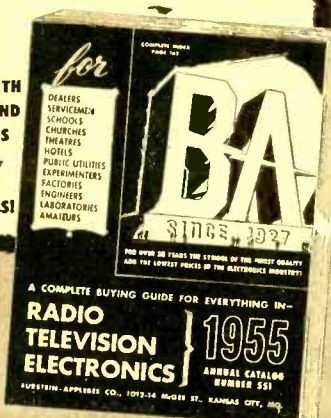

**SEND
FOR IT
TODAY!**

BURSTEIN-APPLEBEE CO.

Dept. PE, 1012-14 McGee St., Kansas City 6, Mo.
 Send Free B-A Catalog No. 551.

Name

Address

City

State

BOOK REVIEWS

"**RADIO AMATEUR QUESTION & ANSWER LICENSE GUIDE**" compiled and published by *American Electronics Company*, 1203 Bryant Ave., New York. 32 pages. Price \$.50. Paper bound.

This compact handbook carries sample questions and answers for Novice, general, and technician classes of license examinations.

The material is divided into sections, one covering the Novice class and the balance the general and technician classes. Practice questions cover the basic electricity, power supplies, transmitters and receiver, and rules and regulations elements for the Novice class and the same elements for the other two classes with the addition of the elements covering vacuum tubes and audio amplifiers.

* * *

BASICS OF RADIO CONTROL FOR THE MODEL BUILDER, compiled and published by *Hobby Helpers*, N. Y. 59, N. Y., 22 pages. Price \$.35. Paper bound.

This is a selection of articles from "Air Trails" magazine on radio control of flying models and should be of interest to builders and experimenters in this field. Topics covered include the basics of radio control, R/C equipment, how to plan an R/C set-up, R/C model clubs, R/C parts and supplies, etc.

The text is informative and well-written. Schematic drawings are mostly clear although a bit crowded together. Photos, illustrating many important R/C parts, are too dark, obscuring details. Probably were once good shots that suffered in the reproduction process used in getting out the book, which still is a good buy at the price for R/C fans.

* * *

HIGH FIDELITY, Trend Book No. 115, compiled and published by *Trend, Inc.*, 5959 Hollywood Blvd., Los Angeles 28, Calif. 128 pages. Price \$.75. Paper bound.

The attractive book covers the field of home music systems for the layman who likes his sound but may not know what is meant by "20 db feedback." A fairly rounded picture is given, including the aesthetic as well as many of the technical aspects of hi-fi. Subjects covered include components, "how hi-fi works," "hi-fi for your car" and even the relatively ad-



NOW...

**Pick up broadcasts
2,000 miles away!**

WITH NEW

**SUPERKIT
CRYSTAL
RADIO**

only \$2.95

(completely wired in plastic case...\$3.95)

Finest crystal set yet designed. The Superkit Crystal Radio is the ONLY crystal set featuring the world-famous powerful LOOPSTICK for loud volume, long distance reception . . . and the only one with all these: professional metal chassis . . . slide rule dial for precision tuning . . . radar type fixed crystal . . . simple illustrated step-by-step instructions . . . full guarantee. No electricity, no batteries. Only a screwdriver is needed for assembly.

SEE your neighborhood electronic parts supplier or hobby shop dealer TODAY . . . or order direct, Dept. PE.

SupereX CORP.
ELECTRONICS

23 Atherton Street, Yonkers, N. Y.

1 tube Superkit radio, finest, most sensitive of its type . . . fully guaranteed . . . only \$3.95

vanced discussion of manual vs. automatic record players. Some of the most recent hi-fi products are described and illustrated, including the new "Fold-a-Flex" speaker enclosure which can serve as infinite baffle, bass reflex, or folded horn enclosure.

A number of the components made by representative manufacturers are illustrated and described. In addition, there is a fairly large section devoted to housing hi-fi equipment and fitting it into the home.

We rather like little books of this type. Within its limitations it is informal yet attractive, and shows a good deal of care in the preparation of its material, especially the illustrations and general layout. Most of it is clearly written with a high degree of technical accuracy. And above all, it treats hi-fi not only as a matter of frequency response curves on a scope, but as a vital part of the enjoyment of leisure time in the American home.

* * *

RCA RECEIVING TUBE MANUAL, compiled and published by *Radio Corporation of America*, Harrison, N. J., new 1954 edition, 320 pages. Price \$.60. Paper bound.

Many people know about the RCA "Tube Manual" but not too many realize that a new, revised edition is out. This new one, Series RC-17, brings the tube situation up to date. The schematic section shows sev-

eral new diagrams and is heavy on hi-fi items. The theory section, a reliable source of solid information, has been enlarged. Although the price is up a dime over previous editions, the RCA "Tube Manual" is easily one of the best buys in the technical literature field, and an invaluable aid to the experimenter and electronics enthusiast. **END**

SURPRISINGLY ENOUGH, BRITONS PREFER 17-INCH TV SCREENS

WHY do the British, who've had television since 1937, prefer the 17-inch picture tube size while Americans prefer larger sizes such as the 21-inch screen?

The answer lies largely in the difference between home heating systems in the two countries, according to a British electronics specialist who recently visited *General Electric's* pix tube plant at Syracuse, N. Y.

H. G. Foster, managing editor of "Electronic Engineering," a British publication, said Americans, with central heating in their homes, can spread out in their living rooms and watch TV from a distance.

In England, Mr. Foster said, the common living room coal fireplace tends to group people more closely, making the smaller screen size preferable.

**COYNE offers
LOW COST**

**TELEVISION
RADIO-ELECTRONICS**
Training in
Spare Time **AT HOME**



The future is **YOURS** in TV-RADIO!
A fabulous field—good pay—fascinating work—
a prosperous future! Good jobs, or independence
in your own business!

Coyne brings you the first *truly lower cost*, MODERN—QUALITY Television Home Training; training designed to meet Coyne standards. Not an old Radio Course with Television "tacked on". Here is MODERN TELEVISION TRAINING including working knowledge of Radio. Includes UHF and Color TV. No Radio background or previous experience needed. Personal guidance by Coyne Staff. **Practical Job Guides** to show you how to do actual servicing jobs—*make money early in course*. With Coyne Television Home Training you pay only for your training, *no costly "put together kits"*.

B. W. COOKE, President



Coyne—the Institution behind this training... the largest, oldest, best equipped residential school of its kind. Established 1899. Send coupon for details.

**COYNE
ELECTRICAL SCHOOL**
500 S. Paulina St., Dept. 94-H17, Chicago 12
**A TECHNICAL TRADE INSTITUTE OPERATED
NOT FOR PROFIT**

SEND COUPON FOR FREE PICTURE FOLDER

and full details,
including easy
Payment Plan. No
obligation, no
salesman will call.



COYNE ELECTRICAL SCHOOL
Television Home Training Div.
500 S. Paulina St., Chicago 12, Ill.,
Dept. 94-H17

Send Free Picture Folder and details on Television Home Training. This does not obligate me and no salesman will call.

Name _____
Address _____
City _____ State _____

PROTECT YOUR HOME AND TV FROM . . .

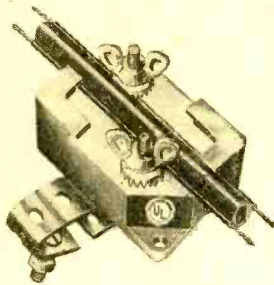

LIGHTNING with JFD ULTRA LOW LOSS

LIGHTNING ARRESTER

1. Grounds any high voltage that develops in antenna system.
2. Bypasses picture-smearing static charges—improves reception.
3. Installs in a wink anywhere.
4. Exclusive patented retaining lips protect your line.

No. AT110 \$1.50, List
 No. AT110S (with stainless steel strap) \$1.75, List

JFD MFG. CO., Inc.
 6102 16th Ave., Brooklyn 4, N. Y.
 Please send me more information and the name of the nearest TV dealer where I can buy JFD ATT10 arrester.

Cut Out
and Mail
Coupon
Today

Name

Address

City..... State.....

Here is the finest Tuner-Amplifier of an unbelievably low, low price!



Hi-Fidelity AM-FM Tuner with built-in 10 Watt Amplifier

Here's a superb tuner and amplifier integrated as a single unit and featuring extreme sensitivity, selectivity, low distortion. Plug it into any custom music system you're planning and you'll be amazed when you compare its outstanding performance with its price. Shock mounted, it comes complete with 10 tubes for high efficiency, push-pull audio output, full range bass and treble control, large illuminated slide rule dial, tuner and chassis, built-in FM antenna, provision for phonograph input. 10" Hi-Fi Speaker. FM band 88 to 108 MC.

Only
\$52.49

List Price \$139.50

Pre-amplifier \$7.50 additional

Write Dept. PE-12 for latest FREE catalog.

STEVE-EL Electronics Corp

61 Reade St.

New York 7, N. Y.

(a) increase; (b) decrease; (c) remain the same

VANISHING VOLTS

THE odd behavior of a common voltmeter when used to measure the plate potential of an electron tube amplifier is very mystifying unless one remembers that the meter itself is a part of the circuit being measured. This idea will be clarified by referring to the schematic diagram of the resistance-capacitance coupled amplifier shown in the diagram.

If the amplifier is performing properly—and this we shall assume—it is fair to anticipate a voltage drop of perhaps 150 volts in the plate load resistor, R . This would leave 150 volts for the plate. A voltmeter, connected as shown in the diagram, ought to read this voltage but, surprisingly, it will probably register a great deal less—possibly as little as 10 or 15 volts. If your reaction to this reading is to conclude that the meter is delinquent, forget it! You couldn't be wronger!

But the fact remains that the plate voltage has vanished! Where?

The explanation involves two distinct considerations: first, the ordinary voltmeter generally requires about 1 ma. of current through its coil to make it read full scale; second, this additional current is being drawn through a relatively high resistance, that of the plate load resistor R .

With the meter disconnected from the circuit, the voltage drop across R is, as mentioned, about 150 volts. The fall of potential results from the flow of plate current through the resistor which, of course, is in series with the tube plate circuit. Just as soon as the meter is connected from plate to ground it, too, draws current to make its needle deflect, producing an additional voltage drop which may be quite high. On the other hand, the decrease in plate voltage will produce some decrease in plate current.

For example, let us suppose that our tube is the triode section of a 12SQ7GT, with -1.5 volts grid leak bias. The plate current

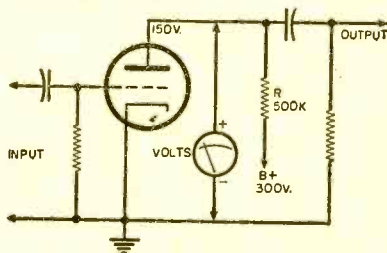

will be approximately 0.31 milliampere, the voltage drop across R will be $0.00031 \times 500,000$, or 155 volts, and the plate-to-cathode voltage will be 145 volts. Now suppose we

connect a 1000 ohms-per-volt meter, set to its 250-volt range, between the plate and cathode of the tube. The meter reading would be approximately 94 volts. With this plate voltage and the same bias as before, the tube would draw only 0.036 milliamperes. The meter, which draws 1 milliamperes for a full-scale reading of 250 volts, would draw $94/250$ or 0.376 milliamperes. The total current through R would be 0.376 plus 0.036, or 0.412 milliamperes. The total drop across R is $0.000412 \times 500,000$, or 206 volts. 300 minus 206 equals 94 volts.

If we set the meter on its 100-volt range, the reading would be approximately 50 volts. With this plate voltage, and bias as before, plate current of the tube would be practically cut off, and meter current would be 50/100, or 0.50 milliamperes, which is enough to account for the entire 250-volt drop across R . Similarly, on the 50-volt range, the reading would be approximately 27 volts, and on the 25-volt range, 14 volts. The lower the range we use, the less the resistance of the meter will be, the more current will flow through R , and the greater the voltage drop across R will be.

Colloquially, this is known as "loading down" the circuit. The only way to avoid it is to take all such measurements with a good vacuum-tube voltmeter (v.t.v.m.), an instrument which draws practically no current at all through the plate load.

STARTING FLUORESCENTS

A MODERN fluorescent lighting tube emits light as a result of the excitation received by its inner, chemical coating from the ionized gas contained within it. A somewhat unfortunate characteristic of ionization is that the striking potential required is much greater than the operating potential. Ordinary household fluorescent lighting fixtures must incorporate a starting scheme which applies a sudden surge of high voltage across the tube,—voltage which is removed once the arc has been struck.

Two methods for obtaining starting potentials are now in common use. The first, generally found in desk and floor lamps, is a manual starting system requiring a spring push-button (see diagram A). A ballast coil having a relatively high inductive reactance is in series with a filament at each end of the tube and with the starting switch. When the switch is closed, current flows through the series circuit causing the filaments to heat and emit electrons but no arc discharge can occur between them because the closed switch keeps the potential difference quite low. When the button is released, however, the usual inductive voltage kick-back appears across the tube of sufficiently large magni-

HERE'S HOW TO GET YOUR START

IN RADIO-TV-ELECTRONICS

Here's basic training you can really understand... training that can help fit you for a good paying radio-television-electronic career! No matter what part of the work you want to do, this is the kind of training you need **FIRST!**

Ghirardi's RADIO PHYSICS COURSE is the oldest book of its kind... and still a best seller **BECAUSE IT IS SO AMAZINGLY CLEAR AND COMPLETE.** Thousands now in electronics got their start from this great book—**AND THEY'LL RECOMMEND IT TO YOU TODAY!**

Starts with Basic Electricity (over 300 pages) then takes you step by step through the entire radio-electronics field. Covers principles, theories and practices that are basic to even the most modern equipment. 972 pages; 508 pictures; 856 helpful self-review test questions. Price only \$6.50.

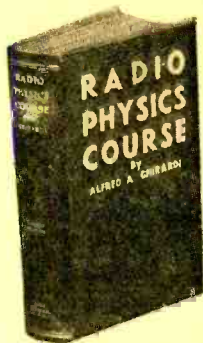

More experts got their basic training from this big book than any other of its type!

36 courses in one!

DON'T THROW OLD RADIOS AWAY!



This giant book shows exactly how to fix them... without a lot of previous experience!

There's a "secret" to repairing old radios fast and profitably... and this big RADIO TROUBLESHOOTER'S

HANDBOOK is it!

Just look up the old make and model you want to fix. This manual-size, 3½ pound 744-page Ghirardi handbook tells what the trouble is likely to be... AND SHOWS YOU EXACTLY HOW TO FIX IT. No useless testing! No wasted time! Even beginners can handle jobs "slick as a whistle." *The only guide of its kind... cuts repair time in half!*

Included are common trouble symptoms and remedies for over 4,800 models of home and auto radios and record changers. Actual case histories cover practically every model made by 202 manufacturers between 1925 and 1942—Air-line, Apex, Arvin, Atwater Kent, Belmont, Bosch, Brunswick, Clarion, Crosley, Emerson, Fada, G-E, Kolster, Majestic, Motorola, Philco, Pilot, RCA, Silvertone, Sparton, Stromberg AND DOZENS MORE. Gives how-to-do-it data on SPECIFIC jobs—NOT general theory. Includes hundreds of pages of invaluable tube and component data, service short cuts, etc. Price \$6.50. 10-day free trial.

10 DAYS FREE TRIAL

Dept. PE-124, RINEHART & CO., INC.
232 Madison Ave., New York 16, N. Y.

Send book(s) checked for free examination. In 10 days, I will either send price shown (plus postage) or return books postpaid and owe nothing.

Ghirardi's RADIO TROUBLESHOOTER'S HANDBOOK, \$6.50. Ghirardi's RADIO PHYSICS COURSE, \$6.50.

Name

Address

City, Zone, State.....

(OUTSIDE U.S.A.—\$7.25 each, cash only. Money back if books are returned in 10 days.)

tude to initiate the discharge. Once started, the arc continues since the voltage across the tube is in the region of 100 volts. To extinguish the light, a separate series switch is incorporated in the line to open the circuit.

Ceiling fixtures use an automatic starting method involving plug-in starters. A starter is a rather interesting combination of glow-discharge tube and a bi-metallic element. The latter is made by bonding together two dissimilar metals having widely different coefficients of expansion; when heated, such an element bends, with the metal having the lower coefficient on the inside of the curve. In diagram (B), the bi-metallic element is shown straight and upright; application of heat, however, would cause it to bend toward the contact point.

When the unit is switched on, a glow discharge begins in the area indicated in the diagram. The heat from the discharge is conducted to the bi-metallic element, causing it to bend toward the contact point and close the circuit. Now the filaments heat up since a complete circuit through the filaments has been established through the ballast coil, but the little glow discharge ceases since the contact between the bi-metallic element and the point has short-circuited the discharge path. The bent bi-

metallic element thus begins to cool and, after a short time, opens the contact. Upon

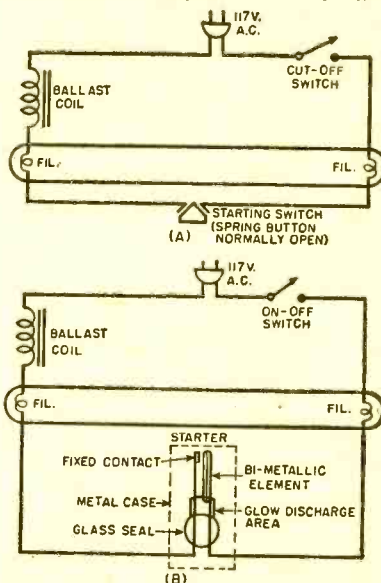

opening, the same inductive kick-back encountered in the manual case appears to initiate the discharge arc. Once the lamp discharge starts, the voltage across the starter is not high enough to restrike the glow and it remains out. **END**

MAKE CRIME YOUR BUSINESS

ON THE SIDE OF THE LAW!

Help fight crime! . . . Earn steady good pay as a Finger Print Expert or Investigator. I.A.S. trains you—by easy, low-cost home study lessons. Learn this exciting work in spare time. Write for full details now!

OVER 800 POLICE BUREAUS...

Employ I.A.S.-trained men . . . proof of what I.A.S. can do. Write today (state age) for details. No obligation. No salesmen will call.

INSTITUTE OF APPLIED SCIENCE

(A Correspondence School Since 1916)

1920 Sunnyside Ave., Dept. 6549, Chicago 40, Illinois

RADIO CONTROL EQUIPMENT

ALL PARTS FOR LORENZ XMITTER AT LOWEST PRICES

LORENZ, 1-TUBER KIT—all parts & tube less relay . . .	\$6.45
TRANSMITTER & RECEIVER KIT—27.255 Mc band license free. All parts & diagrams (less tubes & crystal) to build 5 Watt Transmitter Unit & 2-Tube Lightweight Receiver, including SIGMA 10,000 ohm Relay . . .	9.95
SIGMA 4F RELAY 8,000 ohm; 1 Ma. \$4.95; 3,000 ohm . . .	5.95
Storage BATTERIES—2 Volt 3"x4"x5 1/2" 27 Amp. Hr. . . .	2.75
MINI 6 V. BATTERY—Willard NFG—2 1/2"x1 3/4"x3 1/2" . . .	2.45
1 1/2 Volt TINY MOTOR, 6,000 RPM with double shaft . . .	1.95
GEARBOX, 800/1, 2 1/2" x 2", 5,000 RPM	1.45
TOY ELECTRIC MOTOR KIT—Special30
GROUND PLANE ANTENNAS, 10-20-40-Meters; easily made with our painted copper-plated WHIPS—threaded tapered sections; 16 ft.	6.95
G. E. RELAY CONTROL—with sens. 10,000 ohm relay . . .	1.25
6 VOLT DYNAMOTOR—300 V. @ 100 Ma.	9.50
2 V. VIBRATOR SUPPLY KIT, 180 V./35 Ma.	6.95
2 V. BATTERY CHARGER KIT, \$4.95, wired	6.95
TELEGRAPH SOUNDER—adjustable, new	1.95
IGNITION COIL—mini, ideal fotoflash HV PS	1.10

ALL MATERIAL GUARANTEED—FREE CATALOG "P"

GYRO ELECTRONICS

325 CANAL STREET

NEW YORK 13, NEW YORK

DESIGNED FOR

Radio Control

* All parts die-cut or shaped for simple construction and easy assembly!
* Complete, easy-to-read step-by-step plans and instructions included! At your local hobby shop now!



R.C. PIPER TRI-PACER
KIT FS-1—SPAN 58 3/4"
Length 39 1/2"

\$1095
for Class A, B, or C engines

... and a Cinch To Build

Actual photographs of models built from kits.

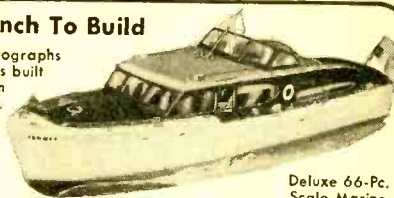

CHRIS-CRAFT 50' CATALINA
Kit B-7M—Length 31 1/4" Beam 8 3/8"

Deluxe 66-Pc. Scale Marine Fittings—Kit B-7F
\$495

\$1195

(less scale marine fittings)

STERLING MODELS

Write for new '55 catalog featuring a complete line of model boats and plans—many designed for radio control. Send 10c in coin to Dept. PE 11

1530-34 N. Hancock St.
Philadelphia 22, Pa.

Carl & Jerry

(Continued from page 49)

became parallel to a line drawn to it from the transmitter's location. By using the sharp null reception position as a pointer, the shifting direction of the dog as he gambolled about the yard could be easily followed; furthermore, the intensity of the received signal gave a rough idea of the animal's distance from the receiver.

Bosco was chained to the clothes line to prevent his taking off while the boys were eating, but as soon as they had bolted their meals they unfastened him and waited impatiently for him to start his mysterious journey. Perversely, though, he seemed to be in no hurry as he casually disinterred a couple of buried bones for critical inspection and then curled up under the perambulator for a short nap. Finally, though, he crawled out from beneath the baby buggy, stretched luxuriously, and then trotted purposefully out the gate into the alley.

"There he goes," Carl whispered excitedly. "He's got that faraway look in his eyes he always has just before he starts."

"Well don't just stand there; let's get going!" Jerry exclaimed as both boys grabbed the broad handle of the baby buggy and started off in rattling pursuit of the dog. For a short distance Bosco trotted straight down the middle of the alley, but then he stopped and looked questioningly at the two boys who had also stopped a half block behind him. Then the animal abruptly dived through a hole in a board fence at the side of the alley and disappeared from view.

"He's starting evasive action," Jerry exclaimed as they hurried to the spot where the dog had last been seen. Stopping here, Jerry began swinging the loop back and forth as Carl held the flashlight on the S-meter of the receiver.

"Contact!" Jerry announced dramatically. "He's moving parallel to the alley, but he's staying in the back yards to our left. Now he's cutting back to the alley. Can you see him?"

"There he is," Carl announced. "He's back in the alley but a whole block away. Let's take after him!"

The boys took off in hot pursuit, and immediately Bosco faded back into the shadows on the right side of the alley this time. His attempt to shake off his pursuers did him no good, though, for whenever they stopped they could spot his direction as easily as if they could see him. Fortunately his zig-zag course kept on in the general direction of the alley, and from time to time the boys would get a glimpse of him in the distance by the light of an

BUILD 15 RADIOS

AT HOME

ONLY

With the New Improved 1955 Progressive Radio "EDU-KIT" NOW INCLUDES

\$19⁹⁵

HIGH FIDELITY, SIGNAL TRACER, CODE OSCILLATOR

- Attractively Gift Packed
- Free Soldering Iron
- Absolutely No Knowledge of Radio Necessary
- No Additional Parts Needed
- Excellent Background For Television
- 10-Day Money-Back Guarantee
- School Inquiries Invited
- Sold in 79 Countries



WHAT THE PROGRESSIVE RADIO "EDU-KIT" OFFERS YOU

The "Edu-Kit" offers you a Home Radio Technician Course at a rock-bottom price. You will learn how to identify Radio Symbols and Diagrams; how to build radios, using regular radio schematics; how to wire and solder in a professional manner. You will learn how to operate Receivers, Transmitters, and Audio Amplifiers. You will learn how to service and trouble-shoot radios. You will learn code. You will receive training for F.C.C. license. In brief, you will receive a practical basic education in Radio, worth many times the small price you pay.

THE KIT FOR EVERYONE

It is not necessary that you have even the slightest background in science or radio. The "Edu-Kit" is used by young and old; by radio schools and clubs; by Armed Forces personnel and Veterans for training and rehabilitation. No instructor is required. Instructions are complete, simple and clear. You cannot make a mistake.

PROGRESSIVE TEACHING METHOD

The "Edu-Kit" uses the principle of "Learn by Doing". Therefore you will build radios, perform jobs, and conduct experiments to illustrate the principles which you learn. You begin by learning the function and theory of each of the radio parts. Then you build a simple radio. Gradually, in a progressive manner, you will find yourself constructing more advanced multi-tube radio sets, and doing work like a professional Radio Technician. The "Edu-Kit" Instruction Books are exceedingly clear in their explanations, photographs and diagrams. These sets operate on 105-125 V. AC/DC. Adapter for 210-250 V. AC/DC available.

The Progressive Radio "EDU-KIT" is Complete

You will receive every part necessary to build fifteen different radio sets. Our kits contain tubes, tube sockets, chassis, variable condensers, electrolytic condensers, mica condensers, paper condensers, resistors, line cords, selenium rectifiers, tie strips, coils, hardware, tubing, Instruction Manuals, etc. A soldering iron is included, as well as an Electrical and Radio Tester. Complete, easy-to-follow instructions are provided. In addition, the "Edu-Kit" now contains lessons for servicing with the Progressive Signal Tracer, High Fidelity, F.C.C. instructions, quizzes. The "Edu-Kit" is a complete radio course down to the smallest detail.

TROUBLE-SHOOTING LESSONS

Trouble-shooting and servicing are included. You will be taught to recognize and repair troubles. You will build and learn to operate a professional Signal Tracer. You receive an Electrical and Radio Tester, and learn to use it for radio repairs. While you are learning in this practical way, you will be able to do many a repair job for your neighbors and friends and charge fees which will far exceed the cost of the "Edu-Kit." Our Consultation Service will help you with any technical problems which you may have.

FREE EXTRAS

- Electrical & Radio Tester • Electric Soldering Iron • TV Book
- Radio Trouble-Shooting Guide • Consultation Service • Quizzes
- F.C.C. Training

PROGRESSIVE "EDU-KITS" INC.

497 Union Ave., Dept. PE-503, Brooklyn 11, N. Y.

MAIL TODAY—Order shipped same day received.
10-Day Money-Back Guarantee. INCLUDE ALL FREE EXTRAS.

- RUSH ME the Following—include all Free Extras:
- "EDU-KIT" Postpaid. I enclose full payment of \$19.95
 - "EDU-KIT" COD—I will pay \$19.95 plus postage
 - Outside USA: "Edu-Kit" Postpaid. Enclose full payment \$20.95
 - Outside USA: 210-250V. AC/DC Adapter. Enclose \$2.50
 - More details on "EDU-KIT" Free—No Obligation
 - FREE Radio-TV Servicing Literature. No Obligation

NAME _____

ADDRESS _____

PROGRESSIVE "EDU-KITS" INC.

497 Union Ave. Dept. PE-503 Brooklyn 11, N. Y.

ATTENTION

- Hobbyists
- Club Members
- Study Groups

Subscriptions to POPULAR ELECTRONICS at special bulk rates are available to club members, study groups, employee groups, schools, etc.

For information, write to:

POPULAR ELECTRONICS
Dept. 1016
366 Madison Ave., New York 17, N. Y.

INVENTORS

Send for
PATENT INFORMATION
Book and
INVENTOR'S RECORD
without obligation

GUSTAVE MILLER
124-PE WARNER BUILDING
WASHINGTON 4, D. C.

REGISTERED PATENT ATTORNEY

ASSOCIATE EXAMINER
U. S. PAT. OFF. 1922-1929

Patent Attorney & Advisor
U. S. NAVY DEPT. 1930-1947
PATENT LAWYER

MAKE EXTRA MONEY!!

Spare time work at home. Big mail-order firm needs men and women to send out postcards. Easy! No experience necessary. Just address and mail. Steady work every month. Act now—write at once.

BUSINESS INFORMATION CORPORATION

143 Belmont Street, Belmont, Mass.

alley lamp. These glimpses and the weakening indication on the S-meter soon revealed that Bosco, in spite of his circuitous course, was making much better time than the perambulator.

"At this rate," Jerry announced breathlessly, "he's going to get beyond the reach of that little transmitter soon. It's having to stop to take a reading that slows us down. Hm-m-m-m, I do believe there is room for me in the back of that buggy if you think you can push me. That way I could keep a continuous check on him as we went along and we could soon catch up, but—"

"Get in, get in!" Carl commanded. "The way you're puffing, you'd not last more than a block or so anyway; and while you're yakking, that uranium mine is slipping through our fingers."

Jerry promptly clambered into the back of the buggy. Before handing him the flashlight, Carl couldn't resist bending over to tickle his chum beneath his round chin as he said in syrupy tones, "Kitchee, kitchee, coo; whose little baby are you?" Then he jumped back just in time to avoid being kicked violently in the stomach by Jerry's fast-moving foot.

With the new arrangement the boys rapidly closed the gap between them and Bosco. While Carl pantingly propelled his strange cargo over the rough bricks of the alley, Jerry kept up a continuous patter of: "He's about thirty degrees off the starboard bow—now he's stopped—there he goes again—whoa, slow down; we've gone past him—okay, lift the anchor; he's starting forward."

So intent were the boys on the pursuit that before they realized it they were almost a mile from home, and the houses were beginning to thin out.

"Hey," Jerry suddenly announced over his shoulder, "he's heading for the city dump."

"Good," Carl muttered darkly. "I know something I'd like to dump right now."

It was not difficult to follow the dog along the winding paths through the rubbish left open for the dump trucks, and finally Jerry announced that Bosco had stopped moving just a short distance to the right of the path. Carl stopped the perambulator, and Jerry turned the flashlight on the miniature cliff of ashes, tincans, and paper boxes that rose in that direction. Suddenly revealed in the bright circle of light stood Bosco, but he was not alone. Standing at his shoulder was a smooth-haired little brown dog of uncertain ancestry, and around their feet played two roly-poly little puppies.

"Well what do you know!" Carl said softly; "Old Bosco is a family man."

POPULAR ELECTRONICS

"No doubt about that," Jerry agreed as he climbed out of the creaking perambulator; "and that explains why Bosco takes off every evening, but it still does not explain where he picks up the radiation. Bring along your detecting gizmo, and let's climb up there."

In a moment the two boys were squatted at the mouth of the shallow little cave in which Bosco's wife and children had been living—and the radiation detector was clicking away in rising excitement.

"The hot spot is right here in front of the den," Carl announced as he moved the detector back and forth. Reaching down he brushed away the dirt at that point and quickly came to four or five pieces of thin metal about three inches square. As he picked up one of these and held it close to the detector, the clicking rose to a crescendo.

"Pure plates of uranium," Carl said with wide eyes.

"Turn over that pure plate," Jerry suggested with a grin.

As Carl obeyed, he gasped in surprise and then began to chuckle.

"Discarded clock faces with fluorescent numbers," he exclaimed. "They doubtless are rejects from that alarm clock factory on the other side of town. Bosco has been getting a little of the fluorescent material

on his feet whenever he called on his family, and then the stuff gave my radiation detector fits until it wore off. Oh well, I never wanted to be rich anyway."

"Me neither," Jerry said as he fondled one of the cuddly little puppies; "but what are we going to do with Bosco's family. We can't leave them here."

"And why should we when we have a carriage awaiting that was built especially for twins?" Carl demanded as he waved at the perambulator down below.

In a few minutes the mother dog and her two offspring were comfortably bedded down in the perambulator, and the boys were pushing it along toward home. Overhead a bright moon smiled down on them and on Bosco trotting proudly ahead and glaring fiercely into the shadows for any lurking dangers that might threaten the group under his protection.

"This has been fun," Carl announced contentedly. "There's something about solving a mystery that makes you feel good."

"Yes," Jerry agreed, "and the thing I like is that our electronic apparatus worked so well. If there had been a uranium deposit, we'd have found it just as easily as we found those clock faces. Guess we can chalk up a victory for Electronic Experimenters, Ltd." END

**NEW STOCK
OF FIRST
QUALITY**

**SPECIAL! . . .
till JAN. 1st**

TYPE	PRICE
1R5	.44
1X2	.57
5U4G	.40
6AF4	.89
6AU6	.36
6AX4GT	.49
6BA6	.48
6BA7	.49
6BL7GT	.65
6BQ6GT	.73
6BZ7	.83
6K6GT	.34
6SN7GT	.48
6U8	.65
12SQ7	.34
25BQ6GT	.75
25L6GT	.37
50L6GT	.44

**EXTRA
Bonus of
Radio & TV
Parts**

3 lbs. of parts including resistors, controls, coils, IF cans, etc. Easily worth \$10.00.

\$1.95

TELTRON TUBES

Guaranteed! Lowest Prices Ever!

All tubes individually boxed . . . unconditionally guaranteed for one year.

GIFT OFFER!
One 6BG6 tube will be shipped FREE with any order accompanying this ad.

TYPE	PRICE	TYPE	PRICE	TYPE	PRICE	TYPE	PRICE	TYPE	PRICE
1A7GT	.53	6Q7	.40	6BN6	.90	6V3	.80	12BE6	.46
1B3GT	.62	6AC7	.65	6BQ7	.85	6V6GT	.48	12BY7	.65
1H5GT	.51	6AG5	.52	6BY5G	.60	6W4GT	.43	12BZ7	.63
1L4	.51	6AH4GT	.65	6C4	.41	6W6GT	.53	12K7	.40
1L6	.51	6AJ5	.96	6CB6	.51	6X4	.37	12SA7	.45
1LC6	.49	6AK5	.96	6CD6G	1.63	6X5GT	.38	12SK7	.40
1N5GT	.51	6AL5	.43	6CU6	.95	6X8	.80	12SL7GT	.60
1T4	.51	6AQ5	.48	6F6	.42	7F8	.49	19T8	.71
1U4	.51	6AR5	.48	6F5GT	.44	7N7	.49	25T5	.55
1U5	.43	6AU5GT	.60	6H6	.50	12AL5	.43	25Z6GT	.36
2A3	.35	6AV5GT	.60	6J5GT	.49	12AT6	.37	35B5	.48
2A7	.35	6AV6	.37	6J6	.61	12AT7	.71	35C5	.48
3Q4	.53	6AX5GT	.60	6L6	.78	12AU6	.43	35W4	.33
3Q5GT	.61	6BE6	.46	6S4	.41	12AU7	.58	35Y4	.42
3S4	.48	6BF5	.48	6S8GT	.65	12AV7	.73	35Z5GT	.33
3V4	.48	6BF6	.48	6SA7GT	.45	12AX4GT	.60	50A5	.49
5V4G	.49	6BG6G	1.18	6SK7GT	.45	12AX7	.61	50B5	.48
5Y3GT	.30	6BH6	.51	6SL7GT	.60	12AZ7	.65	50C5	.48
5Y4G	.40	6BJ6	.51	6SQ7GT	.38	12B4	.72	TYPE 80	.40
6A8	.40	6BK5	.75	6T8	.71	12BA6	.46	117Z3	.33
6K7	.40	6BK7	.78			12BA7	.58	117Z6GT	.65

SAME DAY SERVICE
48 Hour Postal Delivery
To West Coast

TERMS: Save all freight and postage charges. All orders accompanied by full remittance will be shipped POSTAGE PAID anywhere in the continental U.S.A. 25¢ deposit required on C.O.D.'s. Minimum order \$10.00. Open accounts to rated firms only.

Send for Free complete tube listing and monthly specials! Get on our mailing list.

TELTRON ELECTRIC COMPANY

428 HARRISON AVE

DEPT. PE-12

Phone Humboldt 4-9848

HARRISON N.J.

New COMPLETE PROFESSIONAL TUBE TESTER

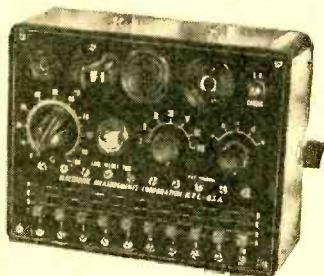

ONLY \$24.90

Sensational new Model 208 tube tester quickly, accurately and easily tests all radio and TV tubes (including Picture tubes*) for quality, shorts, leakages and opens.

TEST YOUR OWN TUBES — SAVE 50% OR MORE

- Lowest price tester • New Design
 - Matches Hi-Fi Tubes • Detailed, easy to use, instruction book and tube listings included • Earn money by making repair calls
- *picture tube adaptor available, only \$4.50

MONEY-BACK GUARANTEE!

When you receive New Model 208 keep it 10 days, if not completely satisfied return instrument for full refund—no explanation needed!

SAVE! ORDER DIRECT! SEND NO MONEY!

Use the handy coupon below to order your Sensational New Model 208 today!

Tear off on dotted line

TESTMASTER, INC.

280 LAFAYETTE STREET N.Y. 12, N.Y.

Yes, Testmaster, send me a New Model 208 tube tester at once! When I receive the Model 208 by return mail I will pay only \$24.90 (Testmaster will pay all other charges).

I understand that a 10 day free examination offer applies to every Model 208 purchased through this ad.

NAME.....

STREET.....

CITY.....

ZONE.....STATE.....

The World at a Twirl

(Continued from page 85)

should give you a good-to-excellent signal from Rome at 0015A and again around 0230 when *Radio Italiana* has *English* for North America. *Japan*—*Western* SWL's should be able to log *Radio Japan's* JOA3, 9.695, and/or JOB4, 11.780, during the beam to western North America 0500-0600.

New Zealand—You should be able to tune *Radio New Zealand*, Wellington, in some of its transmissions; revised schedule is to Australia 1800-2145, ZL18, 9.520; 2200-0545, ZL19, 11.830; 0600 to closedown, ZL18, 9.520. To Pacific Islands 1800-2145, ZL7, 6.080; 2200-0445, ZL3, 11.780; 0500-closedown, ZL7, 6.080. Closedown times are 1045 weekdays, 1120 Saturdays, 1000 Sundays. Has special DX session—"This Radio Age"—on the first Tuesday of the month at 0920A. *Nicaragua*—YNWW, *Radio Sport*, Granada, has moved from 7.850 to 5.943A; opens 1200A and has been heard in Texas going past 0130; uses *Spanish*.

South Africa—Worth several "trys" is Johannesburg, 4.895, which opens 0445 with setting-up exercises in Afrikaans; has news in Afrikaans 0500. *Spain*—Madrid is being widely heard in eastern USA on 6.135A (announced 6.134), parallel with 9.335AV, around 2115-2215A in beam in Spanish to Spanish Africa; Madrid is expected to expand its *English* broadcasts soon. *Sweden*—*Radio Sweden* now uses 9.935 to western North America 0500-0545, 1600-1645. *USSR*—*Radio Moscow*, 9.593A, usually has a powerhouse-like signal in eastern USA with *English* around 1900; listen for its distinctive interval signal. *Vatican*—*Eastern* SWL's should try 11.685 and/or 9.646A for *English* from HVJ at 1500 and 1815. *Yugoslavia*—*Radio Belgrade*, 6.100, now has *English* 2215-2230.

For Experienced SWL's

Albania—Occasionally, *Radio Tirana*, 7.852A, can be heard in eastern USA with *English* 2200-2230A closedown. *Andorra*—Try for *Radio Andorra*, measured recently on 5.985, around 2145-2230 or later; identifies in both *French*, *Spanish*. *British Borneo*—*Radio Sarawak*, 4.870A, Kuching, is now scheduled 1030-1330A; has BBC news relay now 1300. *Ceylon*—*Western* SWL's should be able to log *Radio Ceylon*, 9.520, Colombo, around 1300-1730, and the *Voice of America relay* from around 1330. *China*—*West coast* listeners report improved signals from *Radio Peking's* 15.385 channel with *English* news 0300; and at 1430 over 11.650A. *Cook Islands*—*New Zealanders* say that Raratonga, now on 6.180, has a new session *Thursdays* 0430-0500 (*English*

news, music). *Cyprus*—ZJM5, 6.170 (*best*), and ZJM6, 6.790, Limassol, have been logged recently in *eastern USA* around 0410 in Arabic.

Ethiopia—With lots of luck, you may be able to “pull” *Radio Addis Ababa* from underneath VOA, Tangier, on 15.345A, around 1830-1930 closedown (*English*). *Fiji Islands*—VRH4, 4.980, Gladstone Road, Suva, is having verification cards made up; try for this one around 0900 (*English*); should be fairly easy to log on *west coast USA* and, *under favorable conditions*, by *eastern USA* DX-ers. *Germany*—RIAS, 6.005, Berlin, has been heard in New Hampshire at 0100 with news in German. *India*—Although *tightly squeezed*, *All India Radio* on 9.755 may be heard with *English* news at 0030; opens on this channel to *West Indies* 2330. *Indo-China*—“*Voice of Vietnam*,” Saigon, now has *English* news 1330 over 9.625, 6.170; heard on *west coast*. *Radio France-Asie*, 11.830, also Saigon, has *English* for *India* and *Southeast Asia* at 0130 and 1400.

Indonesia (USI)—*West coast* DX-ers report *improved* signals from YDQ2, 9.550, Makassar, Celebes, which closes 1457A with a selection on a Hawaiian guitar; *no English*. *Japan*—The *Far East Network*, AFRS, Tokyo, is now on *announced* 11.750, instead of 11.760 as formerly; heard in California as early as 0400; closes 1015. The *British Commonwealth Forces Station*, 6.105A, Kure, is noted on *west coast* at 0900 with an ABC (*Radio Australia*) news relay. *Malaya*—*Westerners* should try 6.025 at 1130 for *English* news from *Radio Malaya*, Kuala Lumpur. *Mozambique*—CR7BU, Lourenco Marques, is noted now close 4.928 in *English*, opening, 0400 with popular request numbers.

Nigeria—With *patience and persistence*, *eastern DX-ers* may be able to log *Radio Nigeria*, 4.800, Lagos, around 2100-2200A when closes with “*God Save the Queen*.” *Turkey*—By now, *Radio Ankara* should again be using TAS, 7.285, parallel with TAP, 9.465, for *English* to western Europe 2100-2145A.

Next month I'll give you some suggestions on how to identify short-wave signals. And I'll have more tips for you. In the meantime, *good holiday listening*, fellows, as you “*twirl to tune the world!*”

(Continued next month)

SWL'S ATTENTION!

For additional and expanded listings of short-wave programs throughout the world see “*International Short-Wave*” in this month's issue of our sister publication, **RADIO & TELEVISION NEWS**.

December, 1954

PASS HAM EXAMS!

LEARN CODE

and Theory

\$3⁹⁵ up

EASY,
FAST HOME STUDY

PASS COMMERCIAL AND AMATEUR
CODE EXAMS, AMATEUR THEORY
EXAMS, FOR YOUR FCC LICENSE!

4 AMECO Courses Available:

78 RPM

No. 1—NOVICE CODE COURSE for novice & technician code exams. You get and keep 10 recordings (alphabet through 8 W.P.M.). Includes typical FCC type code exams. Free instruction book on learning how to send and receive code the simplest, fastest way; plus charts to check your receiving accuracy; plus an album; all for the low price of only . . . \$7.95

No. 2—SENIOR CODE COURSE for all amateur & commercial exams. You get and keep everything given in the Novice Course except that you get 22 recordings (alphabet through 18 W.P.M.), plus typical FCC type code exams for General class and 2nd class commercial telegraph licenses. All this for only . . . \$12.95

No. 3—COMPLETE RADIO THEORY COURSE. A complete, simplified home study theory course in radio covering the Novice, Technician, conditional and general classes—all under one cover—with nearly four hundred typical FCC type questions to prepare you for license exam. No technical background required. You also get, FREE, a guide to setting up your own Ham station. ALL FOR THE AMAZING, NEW LOW PRICE OF ONLY . . . \$3.95

No. 4—NEW ADVANCED COURSE. Prepares Novice operators for the amateur general class and second class commercial license tests. Contains 12 recordings (8 through 18 W.P.M.) PLUS the complete code book—PLUS typical F.C.C. code examinations for general and commercial tests. ALL for only . . . \$6.95

No. 5—RADIO AMATEUR QUESTION & ANSWER LICENSE GUIDE. A “must” if preparing for Novice, Technician or general class exams. Approx. 200 questions & answers, (most multiple choice type) similar to ones given on F.C.C. exams. Has 2 typical F.C.C. type exams. Other questions by subjects, easier to study. **50c**

At the Low, Low price of only . . .

FREE LITERATURE AVAILABLE
at leading distributors everywhere
or from Dept. PEI

AMERICAN ELECTRONICS CO.

1203 Bryant Ave., New York 59, N.Y.

ONLY
\$4⁹⁵
Ppd.
or C.O.D.
+ Chgs.



THE NEW TV DYNATRACER

- TRACES TV SIGNALS AND VOLTAGES
- LOCATES DEFECTIVE COMPONENTS
- REQUIRES NO ADDITIONAL EQUIPMENT

This sensationally new piece of test equipment is ideal for trouble-shooting television sets in the home or in the shop. The “DYNATRACER” will out-perform more expensive testers and should pay for itself on the very first repair.

A Must for Every TV Technician

SPECIFICATIONS: The “DYNATRACER” is a self-powered quality test instrument designed to trace TV signals through any Video, Sound, Sync, A.F.C., Horizontal or Vertical Sweep Circuit.

Isolate trouble to a stage or component. **ADDED FEATURE:** The “DYNATRACER” will also trace voltages (50/500 V. AC/DC) and instantly locate open, shorted, intermittent or leaky (up to 20 MEGOHMS) condensers, resistors, coils, XFormers, etc.

Instruction and Trouble-Shooting Book Enclosed
10 DAY MONEY-BACK GUARANTEE

FREE

For prompt action we will include a unique TV HIGH VOLTAGE INDICATOR very useful in your testing work.

Cut out advertisement . . . attach name and address with \$5.00 bill, check or money order and mail to

Century ELECTRONICS CO.

211-04 99th Ave., Dept. 603, Queens Village 29, N. Y.

123

HERSHEL'S XMAS SPECIALS

ALL-PURPOSE FIL. TRANSFORMER
For Model Trains, Welding, Transmitters, etc.
PRI. 117 v. 60 cyc. sec.
6.4 v. 12A
6.4 v. 10A
5 v. 3A
5 v. 3A
5 v. 3A
2.5 v. 1.75A

\$495

MYSTERY PACKAGE ELECTRONIC PARTS
The Surprise of Your Life
25 pounds of BRAND NEW USABLE GOVT. SURPLUS. Ideal gift for the ham, etc.

\$495

KIT 1. HARDWARE
Over 1,000 pieces. 2 1/2 lbs. of assorted RADIO & TV HARDWARE.

\$149

KITS, RESISTORS
100 ASSORTED TYPES. Range from 1 ohm to 15 meg. 1/2 to 5 watt.

\$198

KIT 2. CERAMICONS
100 ASSORTED. Range from .75 mmfd. to 6,000 mmfd.

\$350

KIT 6. R.F. CHOKES
25 ASSORTED. Range from .5 mh. to 25 mh.

\$195

Kit 3. Volume Controls
25 ASSORTED. Range from 2 ohm to 3 meg. 5 o m o with switch.

\$475

KIT 7. TOGGLE & SLIDE SWITCHES
25 ASSORTED. DPST, DPDT, SPST, etc.

\$495

Kit 4. Rotary Switches
25 ASSORTED TYPES. A Real Buy at only...

\$475

KIT 8. PAPER & CAN CONDENSERS
25 ASSORTED. Range from 4 mfd. 150 v. to 80 mfd. 450 v.

\$350

HERSHEL RADIO CO.
5245 Grand River, Detroit 8, Mich.

Terms: Cash with order or 25% DOWN—Balance will be mailed C.O.D.

AIRPORT CEILING & VISIBILITY INDICATORS

TWO new devices designed to improve the already phenomenal air safety records set by commercial airlines have been installed at Idlewild International Airport in New York.

The "transmissometer" consists of a projector, installed along the runway, which sends a concentrated light beam across a 500-foot span to a receiver. The receiver transforms the beam into an electronic signal. This signal is transmitted to charting equipment at the air field control tower where it is recorded on a strip-type chart, thereby accurately indicating actual runway visibility conditions. The control tower may be located as far as ten miles away from main runways and still pick up sensitive readings from the transmissometer receiver.

A new weather instrument that tells pilots what sort of weather conditions exist over runway approach zones is the *Crouse-Hinds* "rotating-beam ceilometer." This device registers a new cloud ceiling every six seconds, enabling control tower personnel to relay almost instantly to incoming aircraft the exact locations and movements of clouds or fog layers.

The rotating-beam ceilometer, invented by L. W. Foskett of the U.S. Weather Bureau, is located in the main runway approach zone between the middle marker beacon and the end of the runway. Because it measures the penetration as well as the height of ceilings, it is an invaluable aid during foul weather. Irrespective of the type of ground approach system used, an airport operations center equipped with this new unit has an almost instantaneous record of the heights of cloud layers above the touchdown point. These readings and those of the transmissometer provide an accurate picture of weather above and along the runway and runway approach zone.

END

How the rotating beam ceilometer operates.

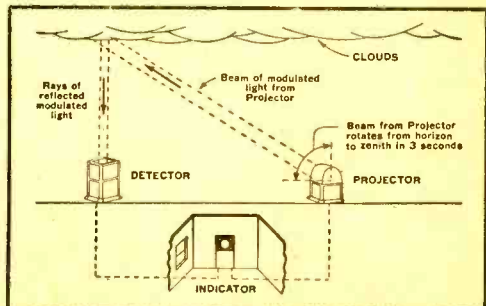

CORONA RADIO KITS
EASY TO BUILD • EDUCATIONAL • EXCELLENT RECEPTION

BROADCAST SUPERHET KIT
\$1475

ROCKET 115K—Latest Single Band superhet circuit for ultimate in sensitive reception and tonal quality. Kit includes all necessary parts, punched chassis, attractive Bakelite mahogany cabinet, built-in loop antenna, iron core IFs, big Alnico V speaker; tubes: 12SK7, 12SA7, 12SQ7, 50L6, 35Z5. Automatic vol. control, beam power output. Tunes 540 to 1700 kc. Simple step-by-step instructions included.

Plaza 812K 2-Band AC-DC Super Kit.....net \$20.75
Globemaster 814K 3-Band Super Kit.....net \$24.75
All kits supplied less wire and solder. Please include 25% deposit with C.O.D. orders. Dept. P-7

CORONA RADIO & TV CO.
370 Broadway New York 13, N.Y.

When you order by mail . . .
please print your name and address clearly, be specific in your order, enclose proper amount, allow ample time for delivery.

ELECTRONICS FOR EXPERIMENTERS

Rectifiers @ 29c ea. Transformers @ \$1.50 ea.
Controls @ 29c ea. Bulbs @ 2c ea.
Switches @ 6c ea. Motors @ \$1.79 ea.
Automatic Steppers @ \$1.75 ea.

Send 10c for giant 16 page catalog listing hundreds of surplus bargains for experimenters.

SOUNDTRONICS LABS Dept. P.E.
632 Arch Street Philadelphia 6, Pa.

STANDARDIZED WIRING DIAGRAM SYMBOLS

<p style="text-align: center;">ANTENNAS</p> <div style="display: flex; justify-content: space-around;"> </div> <p style="font-size: small;">GENERAL DIPOLE LOOP</p> <p style="font-size: small;">FERRITE TYPE</p>	<p style="text-align: center;">MICROPHONE</p> <div style="display: flex; justify-content: space-around;"> </div> <p style="font-size: small;">SINGLE BUTTON DOUBLE BUTTON CAPACITOR</p> <div style="display: flex; justify-content: space-around;"> </div> <p style="font-size: small;">DYNAMIC VELOCITY CRYSTAL</p>	<p style="text-align: center;">TELEGRAPH KEY</p>
<p style="text-align: center;">BATTERIES</p> <div style="display: flex; justify-content: space-around;"> </div> <p style="font-size: small;">SINGLE-CELL MULTI-CELL</p> <div style="display: flex; justify-content: space-around;"> </div> <p style="font-size: small;">BELL BUZZER</p>	<p style="text-align: center;">NEON BULB</p>	<p style="text-align: center;">PILOT LIGHT</p>
<p style="text-align: center;">CAPACITORS</p> <div style="display: flex; justify-content: space-around;"> </div> <p style="font-size: small;">FIXED MICA OR PAPER ELECTROLYTIC VARIABLE CAPACITORS GANGED</p> <div style="display: flex; justify-content: space-around;"> </div> <p style="font-size: small;">TRIMMER OR PADDER SPLIT-STATOR FEED-THRU</p> <p style="font-size: x-small;">T-DESIGNATES TRIMMER OR PADDER</p>	<p style="text-align: center;">PHONO PICKUPS</p> <div style="display: flex; justify-content: space-around;"> </div> <p style="font-size: small;">CRYSTAL MAGNETIC</p>	<p style="text-align: center;">PLUG OR SOCKET</p>
<p style="text-align: center;">COILS</p> <div style="display: flex; justify-content: space-around;"> </div> <p style="font-size: small;">FIXED R.F. COIL COIL WITH FIXED TAP COIL WITH VARIABLE TAP</p> <div style="display: flex; justify-content: space-around;"> </div> <p style="font-size: small;">IRON CORE OR CHOKE BIFILAR VARIABLE COIL OR CHOKE</p> <div style="display: flex; justify-content: space-around;"> </div> <p style="font-size: small;">SLUG-TUNED COIL</p>	<p style="text-align: center;">RECEPTACLE I17V.</p>	<p style="text-align: center;">RECORDING HEAD</p> <p style="font-size: small;">MAGNETIC</p>
<p style="text-align: center;">RECTIFIER</p> <p style="font-size: small;">SELENIUM TYPE</p>	<p style="text-align: center;">RELAYS</p> <div style="display: flex; justify-content: space-around;"> </div> <p style="font-size: small;">S.P.S.T. NORMALLY OPEN S.P.S.T. NORMALLY CLOSED S.P.D.T.</p>	
<p style="text-align: center;">CRYSTALS</p> <div style="display: flex; justify-content: space-around;"> </div> <p style="font-size: small;">CRYSTAL DETECTOR PIEZOELECTRIC CRYSTAL</p>	<p style="text-align: center;">RESISTORS</p> <div style="display: flex; justify-content: space-around;"> </div> <p style="font-size: small;">GENERAL TAPPED OR ADJUSTABLE</p> <div style="display: flex; justify-content: space-around;"> </div> <p style="font-size: small;">POTENTIOMETER OR RHEOSTAT CONTINUOUSLY VARIABLE</p>	
<p style="text-align: center;">FUSE</p>	<p style="text-align: center;">SHIELDING</p> <p style="font-size: x-small;">DOTTED LINES INDICATE SHIELDING. COULD BE AROUND ANY COMPONENT OR GROUPS</p>	
<p style="text-align: center;">HEADPHONES</p> <div style="display: flex; justify-content: space-around;"> </div> <p style="font-size: small;">DOUBLE SINGLE</p>	<p style="text-align: center;">SPEAKERS</p> <div style="display: flex; justify-content: space-around;"> </div> <p style="font-size: small;">P.M. ELECTRO-MAGNETIC</p>	
<p style="text-align: center;">JACKS</p> <div style="display: flex; justify-content: space-around;"> </div> <p style="font-size: small;">2 CIRCUIT 3 CIRCUIT CLOSED CIRCUIT</p> <div style="display: flex; justify-content: space-around;"> </div> <p style="font-size: small;">PHONE PLUG PIN PLUG PIN JACK</p>	<p style="text-align: center;">SWITCHES</p> <div style="display: flex; justify-content: space-around;"> </div> <p style="font-size: small;">S.P.S.T. S.P.D.T. PUSH-BUTTON</p> <div style="display: flex; justify-content: space-around;"> </div> <p style="font-size: x-small;">D.P.S.T. D.P.D.T. BOTH TYPES GANGED</p> <div style="display: flex; justify-content: space-around;"> </div> <p style="font-size: x-small;">ROTARY TYPE S.P.S.P. WAFER</p>	
<p style="text-align: center;">METER</p>	<p style="text-align: center;">TRANSISTOR (JUNCTION)</p> <p style="font-size: x-small;">BASE COLLECTOR EMITTER</p> <p style="font-size: x-small;">P-N-P TYPE N-P-N TYPE SAME SYMBOL EXCEPT ARROW IS REVERSED</p>	
<p style="text-align: center;">MOTOR</p>	<p style="text-align: center;">VIBRATOR</p>	
<p style="text-align: center;">WIRES</p> <div style="display: flex; justify-content: space-around;"> </div> <p style="font-size: small;">CONNECTION NO CONNECTION</p>		<p style="text-align: center;">TUBES</p> <div style="display: flex; justify-content: space-around;"> </div> <p style="font-size: small;">DIODE TRIODE TETRODE</p> <div style="display: flex; justify-content: space-around;"> </div> <p style="font-size: small;">PENTODE DUO TRIODE COLD CATHODE PHOTO-ELECTRIC</p>
<p style="text-align: center;">TRANSFORMERS</p> <div style="display: flex; justify-content: space-around;"> </div> <p style="font-size: small;">AIR CORE IRON CORE AIR CORE VARIABLE</p> <div style="display: flex; justify-content: space-around;"> </div> <p style="font-size: small;">IRON CORE VARIABLE POWDERED IRON CORE AUTO</p>		<p style="text-align: center;">POWER TRANSFORMER</p> <p style="font-size: small;">PRIMARY I17V. FILAMENTS HIGH VOLTAGE FILAMENTS</p>

GLOSSARY

a.f.c.—Automatic frequency control: (1) control of the frequency of the local oscillator in a superheterodyne to keep the receiver in tune with a desired station; (2) control of the frequency of the horizontal oscillator in a television receiver to keep the horizontal deflection in step with the horizontal deflection at the television studio and thus to keep the picture steady horizontally.

a.g.c.—Automatic gain control, control of the amplification of an amplifier so that its output is approximately constant in spite of variations in the input signal; especially such control in television receivers to reduce variations in picture contrast produced by variations in r.f. signal strength.

a.v.c.—Automatic volume control (a.g.c. used in radio receivers to reduce variations in sound volume produced by variations in r.f. signal strength).

choke—An inductance used especially to present a high impedance to a wide range of frequencies. Filter chokes are used in rectifier-type power supplies to remove from the d.c. output hum components equal to the power line frequency and its harmonics; audio-frequency chokes are used in audio amplifiers and radio-frequency chokes are used in r.f. and i.f. amplifiers, to present a high impedance load to a vacuum tube or to block unwanted signals.

crystal—1. Rectifying crystal, one which passes electric current more easily in one direction than in the other and thus can be used to change alternating current to pulsating direct current; made of such materials as germanium, silicon, copper oxide, galena, and carborundum. 2. Piezo-electric crystal, one which transforms mechanical energy to electrical and vice versa. Such crystals, made of Rochelle salt or barium titanate, are used in microphones and phonograph pickups. When cut to a certain size and shape, a piezo-electric crystal, usually made of quartz, can be used as a resonant circuit, to control the frequency of an oscillator or as a frequency-selective filter.

decibel—A measure of the ratio between two power levels or of a power level with respect to a designated reference level. Basically, the number of decibels is ten times the logarithm of a power ratio. One decibel is approximately the smallest difference in sound power which can be detected by the average human ear.

db of feedback—The number of decibels by which inverse feedback in an amplifier reduces its over-all gain and distortion.

detector—A circuit used to recover an audio or video signal from a modulated radio signal.

electrolytic capacitor—A type of capacitor in which the dielectric or insulator is a thin film of oxide deposited on one aluminum or tantalum plate and an electrolyte is used between the insulator and the other plate. This type of capacitor provides a larger capacitance in a given volume than any other type. However, except for special a.c. electrolytics, this type can be used only in circuits where voltage of constant polarity is applied to it.

elevator—Control surface of an aircraft which regulates its pitch attitude (level, climbing, or diving).

feedback—Returning part of the output of an amplifier stage to the input of the same or a previous stage. Negative or inverse (out-of-phase) feedback decreases the gain and distortion of the amplifier; positive (in-phase) feedback increases gain and distortion and may produce oscillation.

frequency response—The relative ability of an amplifier, loudspeaker, or other device to respond to different frequencies.

glow plug—A type of internal-combustion engine used in models, in which starting is assisted by a filament in the combustion chamber, which is energized by an external battery.

harmonic distortion—Distortion consisting of addition to the signal of components whose frequencies are multiples (harmonics) of the original signal frequency. It is produced by an amplifier or other device which is nonlinear (does not give the same ratio of output to input for all input amplitudes).

heterodyne—A difference frequency (beat) produced by combining two frequencies.

hole—Absence of an electron normally present in an atom; a positive charge. The action of some transistors often is explained by referring to movement of holes or positive charges, rather than movement in the opposite direction of electrons or negative charges.

microammeter—A meter for the measurement of current flow, which is calibrated in microamperes, or millionths of an ampere.

milliampere—One-thousandth of an ampere.

modulated—Varied in amplitude, frequency, or some other quality. Radio-frequency signals are modulated in order to carry signals of lower frequency, such as sound or picture signals.

multitester—A meter which is a combination of a voltmeter, an ohmmeter, and (often) an ammeter.

octal—Designation of one of the standard types of tube base or the socket to fit it. The base has eight equally spaced pins and a centrally located boss, which is made of insulating material and has a key to prevent improper insertion of the tube in the socket. The loctal tube base is similar, except that its pins are smaller in diameter and the central boss is of metal and has a groove which fits a one-turn spring in the socket, to hold the tube.

oscillator—A vacuum-tube or transistor circuit or other device which produces an alternating-current power output without mechanical rotation.

plate dissipation—The part of the power applied to the plate circuit of a vacuum tube which does not appear as signal output, but is dissipated as heat in the plate of the tube.

push-pull—An arrangement of two vacuum tubes in an amplifier so that the input signal is applied in opposite phases to the two tubes and the signal outputs are combined in phase. This arrangement reduces even-harmonic distortion.

regeneration—Positive feedback in detectors and amplifiers. Increases gain and distortion and may produce oscillation.

saturate—To reach the maximum possible value of some quantity, such as magnetization in the core of an inductor or electron flow in a vacuum tube from cathode to plate.

servo-motor—A special electric, hydraulic, or other type of motor used in control apparatus to convert a small movement into one of greater amplitude or greater force.

signal generator—A test instrument providing electrical power substantially similar in amplitude, frequency, and other qualities, to signals found in electronic equipment.

signal tracer—A test instrument for detecting the presence of a signal in electronic equipment and, with some signal tracers, measuring its amplitude, frequency, or other qualities.

superheterodyne—A receiver in which all incoming radio-frequency signals are mixed with the output of an oscillator to produce a heterodyne or beat frequency. The oscillator frequency is variable so that the beat produced with any desired signal can be adjusted to a certain frequency. The beat-frequency

signal is fed to a fixed-frequency (intermediate-frequency) amplifier, where greater and more uniform gain and selectivity can be obtained than at the original radio frequency.

superregenerative—A type of regenerative detector in which the tendency to oscillation is controlled by a quenching voltage of ultrasonic frequency which periodically allows the gain to increase, then reduces it. The quenching voltage can be produced by the detector tube itself or by a separate oscillator. This type of detector has great sensitivity, but poor selectivity.

tone control—1. In a radio receiver or an audio amplifier, means provided to change the relative response to audio signals of different frequencies; effects which can be produced are treble boost or attenuation and bass boost or attenuation. 2. In radio control of models, a system wherein the radio signal is modulated by audio tones and control is achieved by keying the modulating tones on and off, instead of keying the r.f. carrier.

v.t.v.m.—Vacuum-tube voltmeter, a voltmeter using one or more vacuum tubes to increase the sensitivity of the basic meter movement, so that measurements can be made in a circuit without drawing much current and without disturbing very much the normal operating conditions of the circuit. May also be a combination voltmeter, ohmmeter, and ammeter. End

ABBREVIATIONS

a.c.—alternating current
a.f.—audio frequency
a.f.c.—automatic frequency control
a.g.c.—automatic gain control
AM—amplitude modulation
amp.—ampere
ARRL—American Radio Relay League
a.v.c.—automatic volume control
BCI—interference with broadcast reception
b.f.o.—beat frequency oscillator
cps—cycles per second
c.t.—center-tapped
c.w.—continuous wave
db—decibel
dbm—decibels above one milliwatt
d.c.—direct current
d.c.c.—double cotton covered (wire)
d.p.d.t.—double-pole, double-throw
d.p.s.t.—double-pole, single-throw
DX—distance
elec.—electrolytic
FCC—Federal Communications Commission
FM—frequency modulation
freq.—frequency
GMT—Greenwich Mean Time
hi fi—high fidelity (of sound reproduction)
hy.—henry
i.f.—intermediate frequency
K—kilo (one thousand)
kc.—kilocycle
M—mega (one million)
ma.—milliampere
mc.—megacycle
meg.—megohm
mike—microphone, microfarad
mil—milliampere
m.o.p.a.—master oscillator, power amplifier
mu—amplification factor
 μ fd.—microfarad

μ fd.—micromicrofarad
mw.—milliwatt
m.w.—medium wave
PA—power amplifier
p.a.—public address
PM—phase modulation, permanent magnet (speaker)
pos.—position (of a switch)
pot.—potentiometer
pri.—primary
R-C—resistance-coupled
R/C—radio control
rect.—rectifier
res.—resistor
RETMA—Radio-Electronics-Television Manufacturers Association
r.f.—radio frequency
r.m.s.—root mean square
sec.—secondary
SN—self-neutralizing (escapement)
s.p.d.t.—single-pole, double-throw
spkr.—loudspeaker
s.p.s.t.—single-pole, single-throw
s.w.—short-wave
SWL—short-wave listener
sync.—synchronization
t.—turns (of a coil)
trans.—transformer
TV—television
TVI—interference with television reception
u.h.f.—ultra high frequency
v.—volt
v.f.o.—variable frequency oscillator
v.h.f.—very high frequency
VR—voltage regulator
v.t.v.m.—vacuum-tube voltmeter
vu—volume unit
w.—watt
wpm—words per minute
xmtr.—transmitter

10 - 1 - 3402

Beginners ELECTRONIC KIT

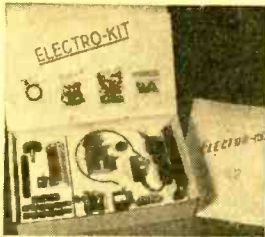

For young and old
35 EXPERIMENTS

Complete, no extras to buy. Build 5 radios, audio amplifier and oscillator, electronic organ, 2 power supplies plus many others. Kit has duo-purpose tube, selenium rectifier, head phone, crystal, all necessary resistors, condensers, hardware, etc.

Only \$1 with order, pay postman \$8.95 plus charges or \$9.95 prepaid.

ELECTRO KIT

Box 3468 Dept. PE-1 Maplewood 17, Mo.

DELUXE POCKET RADIO



Owners report up to 1500 miles reception. New 1955 electron tube model covers 540-1600 KC. No antenna required for local reception. Assemble kit easily in 1 hour. Batteries, all parts, fit in case. Low price of kit includes tube. (Set, factory wired, \$3.95), long life batteries \$1.15 per set. Radio head phone \$1.69. High imp. hearing aid earset \$4.95 or use your head phone. All parts FULLY GUARANTEED. Send check or money order for full amount, save C.O.D. fees. If C.O.D., \$1 deposit required.

\$3.49
Post Paid

WESTERN RADIO CO., Box 1526, Sacramento, Calif.

F. C. C. LICENSE

Get Your FCC Commercial
Operator License Quickly

We specialize in rapid and thorough preparation for FCC examinations. Correspondence or resident training. Results guaranteed. Write for free booklet.

GRANTHAM SCHOOL OF ELECTRONICS

Dept. 104-B, 6064 Hollywood Blvd., Hollywood 28, Calif. (Phone HO 2-1411)

SAVE MONEY! SAVE SERVICE CALLS! CHECK ALL TV, RADIO & PICTURE TUBES with this VISULITE TV TUBE CHECKER



NO TECHNICAL KNOWLEDGE REQUIRED
Simple Instructions Furnished
SAFE - QUICK - FOOLPROOF

Most Radio set failures are due to burned out tubes. Just plug tube into socket provided and Neon Lamp indicates this condition instantly. Operates on 110 Volt AC or DC.

PERFORMS 1001 ELECTRICAL CHECKS:

Checks continuity of resistors, appliances, motors or any Electrical device. Sturdily built for long life of trouble shooting. Test Leads included—Nothing else to buy. **SOLD ON 10 DAY MONEY BACK GUARANTEE.** See it at your distributor today. If he can't supply, order direct from factory. \$3.95 Postpaid anywhere in the U. S.

VISULITE CO., Dept. PE-12 423 Broome St., New York 13, N.Y.

Ship's Wheel Barometer



Beautiful mah. case. Bright brass finish. Forecasts weather days in advance. Screw adjustment to set altitude. Dial calibrated in inches with hand setting feature. For desk or wall mounting. An ideal gift for dad. Accurate precision imported movement. 5" diameter.

Reg. \$12.95. Add 30c shipping & handling chgs. Sent for FREE brochure. **\$4.95**

AIREX RADIO CORP., 171 Washington St. N.Y. 7

INDEX OF

Advertisers

ADVERTISER PAGE NO.

Advance Training	100
Airex Radio Corp.	128
Allied Radio Corp.	103
American Electronics Co.	123
Ashe Radio Co., Walter	9
Bailey Technical Schools	122
Burstein-Applebee	112
Business Information Corp.	120
Century Electronics Co.	123
Concord Radio	109
Corona Radio & TV Co.	124
Coyne Electrical School	5, 113
deBolt Model Engineering Co.	129
Electronic Crafts	110
Electro Kit	128
Electronic Instrument Co., Inc. (EICO)	129
Electro-Voice	12
Electronic Specialty Supply Co.	102
Finney Company, The	10
G & H Wood Products Co.	SECOND COVER
Grantham School of Electronics	128
Gyro Electronics	118
Hallcrafters	FOURTH COVER
Harjo Sales Co.	14
Heath Company	89, 90, 91, 92
Hershel Radio Co.	124
Institute of Applied Science	118
International Correspondence Schools	7
JFD Manufacturing Corp.	116
Karlson Associates, Inc.	120
Miller, Gustave	120
Moss Electronic Distributing Co., Inc.	100
National Electronics of Cleveland	105
National Radio Institute	3
National Schools	THIRD COVER
Perma Power Company	102
Popular Electronics	98
Premier Metal Products	108
Progressive "Edu-Kits," Inc.	119
Radio-Television Training Association	15
Raytheon Manufacturing Co.	6
Rex Radio Supply	104
Richville TV Supply	110
Rider, John F., Publisher, Inc.	107
Rinehart & Co., Inc.	117
Rockbar Corporation	111
Ruiter, J. H., Publishing Co.	108
Scott-Mitchell House, Inc.	104
Sleeper, Milton B., Publisher	101
Smith, Johnson & Co.	100
Soundtronics Labs.	124
Sprague Products Co.	16
Spragberry Academy of Radio	13
Sterling Models	118
Steve-El Electronics Corp.	116
Superec Electronics Corp.	112
Teltron Electric Company	121
Testmaster, Inc.	8
Tetrad	11
Transi-Mite Radio Lab.	122
University Loudspeakers	95
Visulite Co.	128
Western Radio Co.	128
World Radio Laboratories	115

ALTERNATING CURRENT QUIZ

(Answers to quiz on page 115)

1. b 2. a 3. a 4. b 5. c

Classified

FOR SALE

RADIO Diagrams \$1.00; Television \$2.00; Give make, model. Diagram Service, 672-PE, Hartford 1, Conn.

INCREDIBLE! One tube radio receives television, FM, CAP, and amateur broadcasts. Very easy and inexpensive to build. Diagram with special tube only \$2.00. Springfield Enterprises, Box 54X Springfield Gardens 13, New York.

SOLAR battery converts light into electrical energy. Lasts indefinitely. Excellent for operating transistors. 5000 microamps maximum output. Only \$2.00. Springfield Enterprises, Box 54X Springfield Gardens 13, New York.

INSTRUCTION

AUCTIONEERING Home Study Course. Diploma granted. Auction School, Ft. Smith, Ark.

LEARN code more easily. Free information. Don Rogers, Ivyland, Pa.

BUSINESS OPPORTUNITIES

PROFITABLE Home Business. Make Fast-Seller. Chenille Monkey Trees, Holiday Flower, Novelties. Literature Free. Velva, Bohemia 24, N. Y.

INVENTIONS WANTED

INVENTIONS wanted. Patented; unpatented. Global Marketing Service, 1404 Mitchell Oakland 1, Calif.

MISCELLANEOUS

DETECTIVES—Experience unnecessary. Detective Particulars free. Write, Wargner, 125 W. 86th, N. Y.

"X-RAY Mind." Dangerous power over others. (Details—10c.) Krishnar Institute, Box 842-S8, Escondido, Calif.

FREE "Do-It-Yourself" Leathercraft Catalog. Tandy Leather Company, Box 791-J6, Fort Worth, Texas.

TELEVISION Interference eliminated with effective high-pass filter. Guaranteed \$1.00 postpaid. BMB Co., Box 25, Bethpage, New York.

QSLs! SWL Cards! Interesting Samples 10c. Tooker Press, Lakehurst, New Jersey.

TUBES—TV, Radio, Transmitting, special purpose types—Bought, Sold, Exchanged. Send details to B. N. Gensler W2LNI, 136 Liberty St., New York 6, N. Y.

TOP Dollar Paid for Art-13's, dynamotors, parts racks and all other component parts. Write: Harjo Sales Co., 4109 Burbank Blvd., Burbank, Calif.

TUBE socket and shield kit, 20 items, 7, 8, 9 pin sockets and shields. \$2.25. Enmar Electronics Co., 120 Liberty St., New York 6, N. Y.

BUILD your own electronic organ. Sample circuit, 25¢. Jim Kirk, WDEG 1552 Church Street, San Francisco 14, Calif.

1000 BUSINESS Cards Printed \$3.95. Gummed Labels \$2.95. Trowbridge, 312 West 75th, Chicago.

EXPERIMENTERS! Beginners! SWL's!—Latest Issue "Radio Science" 35¢. 52 Backmen, Westfield, New York.

IT WILL PAY YOU

to read and answer the ads in this section or to place your own ad at these thrifty rates.

35c per word—minimum 10 words

R/C MODELS for BEGINNER AND EXPERT

FOR BEGINNERS:

48"
SPAN



LIVE WIRE "TRAINER" WORLDS MOST POPULAR R/C MODEL

A quickly built model of medium size, stable, rugged and simple to fly. Features a removable R/C PRE-FAB. unit. KIT **\$6.95**

MULTI-SERVOS

POWERFUL-DEPENDABLE

MOTOR DRIVEN R/C ACTUATORS

• Ample power to move any model control. 4 great models, one for every purpose.
• 2 oz. CAP.



Positive-Flow FUEL TANK

• Gives perfect fuel flow under all flight attitudes, upright or inverted. The tank with the internal swivel.

\$11.95

TO
\$14.95

\$1.29

DESCRIPTIVE LITERATURE FREE
SERVO INFO BOOKLET 75c

FOR ADVANCED FLYING:

65"
SPAN



LIVE WIRE "CRUISER"

FOR THE ULTIMATE IN R/C FLYING

A big, high performance, realistic model capable of carrying the heaviest of equipment with ease. Has elevators and a re- PRE-FAB. movable R/C unit. KIT **\$14.95**

deBOLT MODEL ENGINEERING CO.

BOX 73
WILLIAMSVILLE, N. Y.

EASY! BUILD your own Professional Electronic Instruments with EICO KITS! SAVE 50%

• Complete easy-to-follow instructions

• Fully guaranteed

8" PUSH-PULL OSCILLOSCOPE

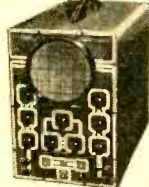

KIT \$44.95 WIRED \$79.95

VACUUM TUBE VOLTMETER



KIT \$25.95 WIRED \$39.95

1,000 Ohms/Volt MULTIMETER



KIT \$12.90 WIRED \$14.90

6V & 12V BATTERY ELIMINATOR & CHARGER

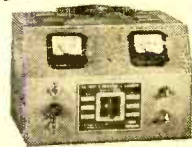

KIT \$29.95 WIRED \$38.95

Write now for FREE Catalog #E12 describing 38 EICO KITS.



ELECTRONIC INSTRUMENT CO., INC.
84 Withers St., Brooklyn 11, N. Y.

© 54

RESISTOR COLOR CODE

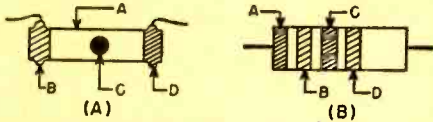

RETMA COLOR CODE CHART

COLOR	VALUE	MULTIPLIER
Black	0	1
Brown	1	10
Red	2	100
Orange	3	1000
Yellow	4	10,000
Green	5	100,000
Blue	6	1,000,000
Violet	7	10,000,000
Grey	8	100,000,000
White	9	1,000,000,000

TOLERANCE CODE

Gold—±5%	Silver—±10%
No Color—±20%	

The ohmic value of a resistor can be determined by means of the color code. There are two standard methods of indicating this value.

In Fig. A, the body (A) and end (B) indicate the first and second digits of the value while the dot (C) indicates the multiplier to be used. The tolerance of the unit is indicated by the end color (D). For example, if the body (A) is green the number is 5; if the end (B) is grey the second number is 8. If the dot (C) is red the multiplier is 100 or two zeros should be added. The resistor is then a 5800 ohm unit. If the end (D) has no color, the tolerance is ±20%.

In Fig. B, the first two stripes indicate the first two digits; the third stripe the multiplier; the fourth stripe the tolerance. Thus, if stripe (A) is green, (B) is grey, (C) is red, and (D) is silver, the resistor is a 5800 ohm, ±10% unit.

CAPACITOR COLOR CODE

MOLDED PAPER			MOLDED MICA		CERAMIC	
Color	Multiplier	Tolerance	Multiplier	Tolerance	Multiplier	Tolerance
Black	1	20%	1	20%	1	20% or 2.0μfd.*
Brown	10		10		10	1%
Red	100		100	2%	100	2%
Orange	1000		1000	3% (RETMA)	1000	2.5% (RETMA)
Yellow	10,000	5%	10,000	5% (RETMA)	10,000	5% or 0.5μfd.*
Green						
Blue						
Violet						
Gray					0.01	0.25μfd.*
White		10%			0.1	10% or 1.0μfd.*
Gold	0.1	5%	0.1	5% (JAN)		
Silver		10%	0.01	10%		
None		20%				

*Capacitance less than 10μfd.

Capacitance is given in μfd. Colors have same values as on resistors, except as indicated in tables. Colors (A) and (B) are for first two digits; (C) is for multiplier. (D) is for tolerance. (E) and (F) give voltage rating in hundreds of volts; (E) is used only for ratings less than 1000 volts, (E) and (F) for first two digits of ratings 1000 volts or more. Values of colors for (E) and (F) are same as in resistance values. (G) is class or characteristic of capacitor, (H), (I), and (J) give temperature coefficient. (G), (H), (I), and (J) are not listed in the tables, since this information is seldom needed by the average home builder.

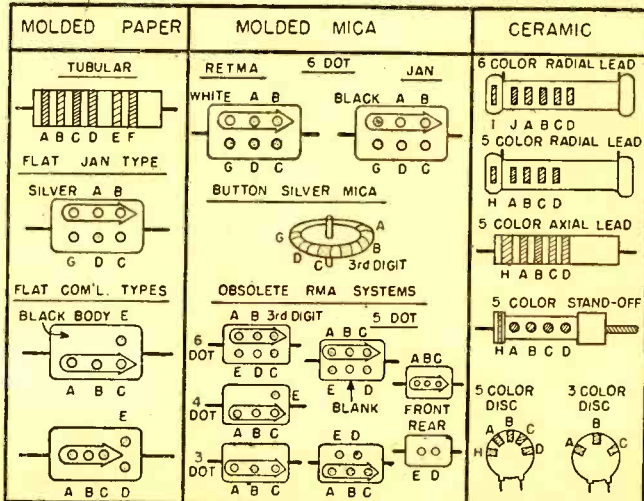

ADVANCE! Raise your earning power—learn RADIO-TELEVISION-ELECTRONICS by SHOP-METHOD HOME TRAINING

GOOD JOBS AWAIT THE TRAINED RADIO-TV TECHNICIAN

There is a place for you in the great Radio-Television-Electronics industry when you are trained as National Schools will train you at home!

Trained technicians are in growing demand at good pay—in manufacturing, broadcasting, television, communications, radar, research laboratories, home Radio-TV service, and other branches of the field. National Schools Master Shop-Method Home Training, with newly added lessons and equipment, trains you in your spare time, right in your own home, for these fascinating opportunities. **OUR METHOD IS PROVED BY THE SUCCESS OF NATIONAL SCHOOLS TRAINED MEN, ALL OVER THE WORLD, SINCE 1905.**

EARN WHILE YOU LEARN

Many National students pay for all or part of their training with spare time earnings. We'll show you how you can do the same! Early in your training, you receive "Spare-time Work" Lessons which will enable you to earn extra money servicing neighbors' and friends' Radio and Television receivers, appliances, etc.

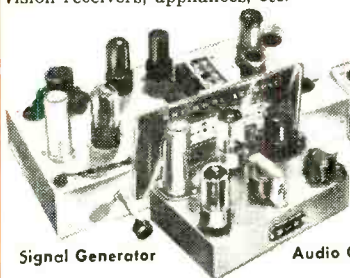

Signal Generator



T. R. F. Receiver

Audio Oscillator

National Schools Training is All-Embracing

National Schools prepares you for your choice of many job opportunities. Thousands of home, portable, and auto radios are being sold daily—more than ever before. Television is sweeping the country, too. Co-axial cables are now bringing Television to more cities, towns, and farms every day! National Schools' complete training program qualifies you in all fields. Read this partial list of opportunities for trained technicians:

- Business of Your Own • Broadcasting
- Radio Manufacturing, Sales, Service • Telecasting
- Television Manufacturing, Sales, Service
- Laboratories: Installation, Maintenance of Electronic Equipment
- Electrolysis, Call Systems
- Garages: Auto Radio Sales, Service
- Sound Systems and Telephone Companies, Engineering Firms
- Theatre Sound Systems, Police Radio
- And scores of other good jobs in many related fields.

TELEVISION TRAINING

You get a complete series of up-to-the-minute lessons covering all phases of repairing, servicing and construction. The same lesson texts used by resident students in our modern and complete Television broadcast studios, laboratories and classrooms!



MASTER ALL PHASES!

Get Master Shop-Method Home Training from an Established Practical Resident School with its own Training Shops, Laboratories, Studios—almost 50 Years of Successful Experience in Training Ambitious Men.

We Bring National Schools To You!

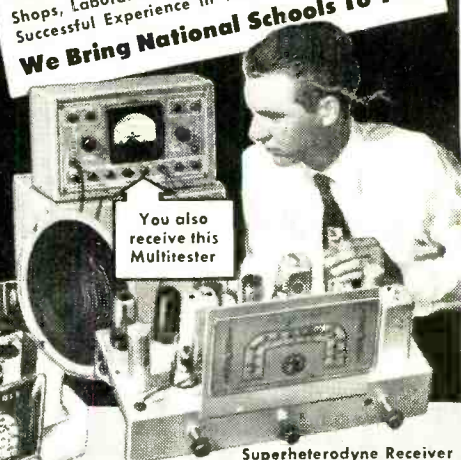

You also receive this Multitester

Superheterodyne Receiver

LEARN BY DOING

You receive and keep all the modern equipment shown above, including tubes and valuable, professional quality Multitester. *No extra charges.*

FREE! RADIO-TV BOOK AND SAMPLE LESSON!

Send today for National Schools' new, illustrated Book of Opportunity in Radio-Television-Electronics, and an actual Sample Lesson. No cost—no obligation. Use the coupon now—we'll answer by return airmail.

APPROVED FOR VETERANS AND NON-VETERANS
Check coupon below

Both Resident and Home Study Courses Offered!



NATIONAL SCHOOLS

LOS ANGELES 37, CALIFORNIA • ESTABLISHED 1905
IN CANADA: 811 W. HASTINGS STREET, VANCOUVER, B.C.

GET FACTS FASTEST! MAIL TO OFFICE NEAREST YOU!

(mail in envelope or paste on postal card)

NATIONAL SCHOOLS, Dept. R2G-124

4000 S. Figueroa Street or 323 West Polk Street
Los Angeles 37, Calif. Chicago 7, Ill.

Send FREE Radio-TV Electronics book and FREE sample lesson. No obligation, no salesman will call.

NAME _____ BIRTHDAY _____ 19 _____

ADDRESS _____

CITY _____ ZONE _____ STATE _____

Check here if interested in Resident School Training at Los Angeles.
VETERANS: Give Date of Discharge _____

Again, Two New Leaders Bear a Famous Brand*

We're proud of our name and the twenty years of electronic leadership it represents. Our brand new communications line is in keeping with the high standards we have always maintained. Hallicrafters respects the recognition it has achieved by never compromising quality for price or sacrificing craftsmanship for mass production. These new models are the ultimate in precision-built communications equipment.

W. J. Halligan

Biesel Halligan, Jr.

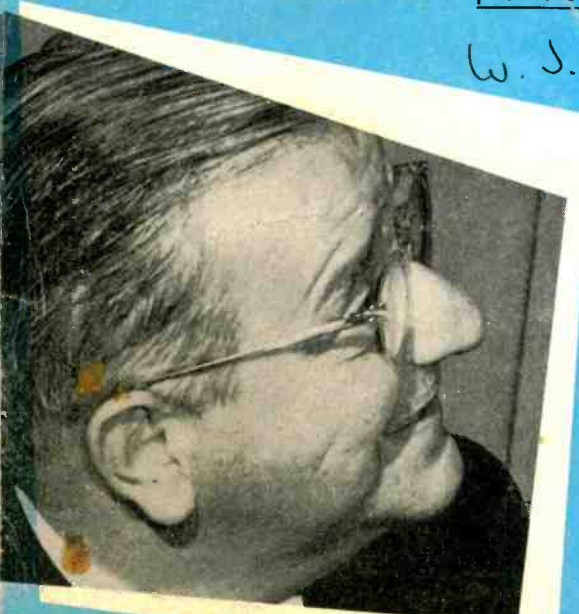

This new receiver reflects the dependable performance of 500,000 Hallicrafters radios with basically this chassis now in the field. Covers Broadcast Band 540-1650 kc plus three short-wave bands from 1650 kc—32 Mc. Electrical bandspread operates over large, easy-to-read dial. Headphone tip jacks on rear and built-in PM speaker. Oscillator for reception of code signals.

Gray steel cabinet with silver frame trim 12 $\frac{1}{8}$ " x 7" x 7 $\frac{1}{4}$ ". Shipping weight 13 lbs. Four tubes plus rectifier. 105/125 V. 50/60 cycle AC/DC \$49.95



Model S-38D

These two new Civil Patrol receivers replacing the popular S-81 and S-82 are over ten times as sensitive, have greater increased audio power output, and include an extremely reliable *built-in relay squelch system*. This type of squelch system *completely* disables the entire audio system so that not a murmur is heard from the speaker until a signal is received making the unit perfect for monitoring of police, fire, taxi, mobile-telephone, forestry, civil defense. The S-94 covers from 30—50 Mc and the S-95 from 150—173 Mc. Built-in speaker and provisions for headphones. Gray steel cabinet with silver trim panel and red pointer. 12 $\frac{1}{8}$ " x 7" x 7 $\frac{1}{4}$ ". Shipping weight approximately 12 $\frac{1}{2}$ lbs. Eight tubes plus rectifier. 105/125 V. 50/60 cycle AC/DC \$59.95



CHICAGO 24, ILLINOIS



Model S-94 (S-95)



hallicrafters