

# POPULAR ELECTRONICS

NOVEMBER  
1954

INC

25  
CENTS

U.S. and Canada

RADIO • TV • R/C • HI-FI • ELECTRONICS

OCT 21 P.M.

BLACK LIGHT  
R/C RECEIVER  
CROOKS OF THE ETHER  
CHOOSING YOUR TV ANTENNA  
THE HOME BROADCASTER  
BURGLAR ALARM  
P. A. SYSTEM



# HOBBY HOBNOB

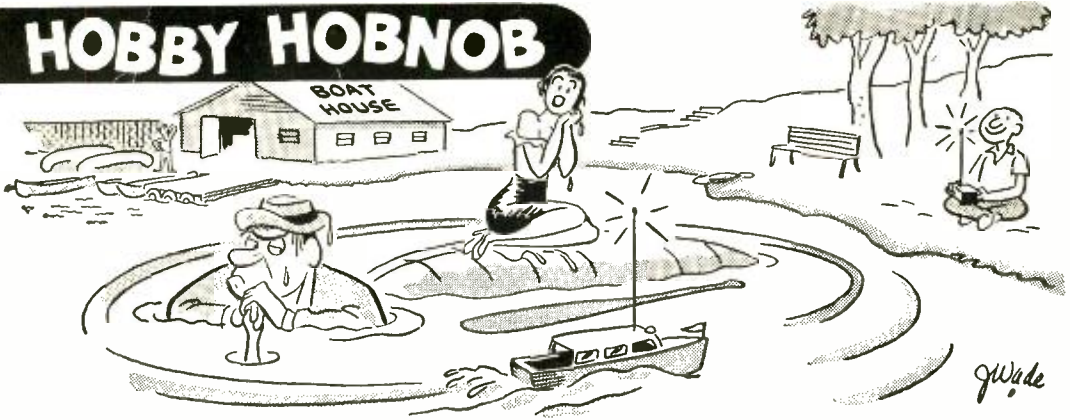

"Henry, don't just stand there! Run over and find out how to make one of those dar-r-r-ling radio controlled boats."

**NEW**  
**WEN "Quick-Hot"**  
**Soldering Gun**  
**NEW DESIGN—**  
**NEW LOW PRICE**

Working hot in 2½ seconds.  
 Shpg. Wgt. 3 lbs. Model 199.  
**Net \$5.83**



## OUTSTANDING TOOL BARGAINS

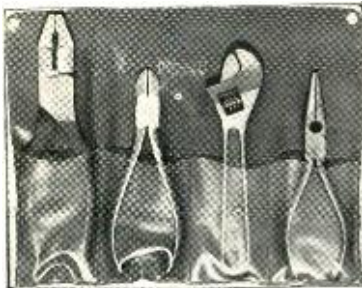

**PLIER AND WRENCH SET.** Precision made. High grade steel, polished heads. Includes 7" Linesman Slip Joint Pliers, 5¾" Diagonal Plier, 6" Adjustable Wrench, 5¾" Long Nose Plier. In plastic case. Shpg. Wgt. 2 lbs.  
**No. 4014 . . . . . Net \$2.58**

**MAGNETIZED SCREWDRIVER SET.** Six tools with blade lengths ranging from 1½ to 7½ inches. Best quality hardened and tempered steel blades. Plastic handles are unbreakable, flame-proof and shockproof. With metal wall rack. Shpg. Wgt 2 lbs. No. 3796.  
**Only .75¢**



## ATTENTION NOVICES . . . BEGINNERS!

**Complete Amateur Station in Kit Form for Only \$44.95**

Learn while you build these easy-to-assemble kits which really perform. Hundreds of Amateurs and Novices are on the air with these fine units. Each kit is complete with all parts and punched chassis. Kits may be purchased separately. Send for full particulars.



**WAT-25 Novice Transmitter**  
 Kit. Shpg. Wgt. 4 lbs.  
**Net \$17.31**

**WAR-25 Novice Receiver Kit.**  
 Shpg. Wgt. 4 lbs.  
**Net \$13.41**



**WAP-25 Novice Power Supply**  
 Kit. Shpg. Wgt. 12 lbs.  
**Net \$14.23**

**All prices f. o. b. St. Louis • Phone: Chestnut 1-1125**

**Walter Ashe Radio Co.**  
 1125 Pine St., St. Louis 1, Mo.

PE-11-54

- Send free NOVICE KIT Circular.
- RUSH copy of new 1955 catalog.
- Please ship following merchandise \_\_\_\_\_

for which is enclosed sum of \$ \_\_\_\_\_

Name \_\_\_\_\_

Address \_\_\_\_\_

City \_\_\_\_\_ Zone \_\_\_\_\_ State \_\_\_\_\_

Note: Include sufficient postage. We refund unused amount. 20% of total purchase required on C. O. D. order.

**Walter Ashe**  
**RADIO CO.**  
**1125 PINE ST. • ST. LOUIS 1, MO.**



# I WILL TRAIN YOU AT HOME FOR GOOD PAY JOBS IN RADIO-TELEVISION

J. E. SMITH has trained more men for Radio-Television than any other man. OUR 40th YEAR.

**America's Fast Growing Industry Offers You Good Pay—Bright Future—Security**

## I TRAINED THESE MEN

"Started to repair sets six months after enrolling. Earned \$12 to \$15 a week in spare time."—Adam Kramlik, Jr., Suncoytown, Pennsylvania.

"Up to our necks in Radio-Television work. Four other NR men work here. Am happy with my work."—Glen Peterson, Bradford, Ont., Canada.

"Am doing Radio and Television Servicing full time. Now have my own shop. I owe my success to NRI."—Curtis Stah, Ft. Madison, Iowa.

"Am with WCOC. NRI course can't be beat. No trouble passing 1st class Radio-Phone license exam."—Jesse W. Parker, Meridian, Mississippi.

"By graduation, had paid for course, car, testing equipment. Can service toughest jobs."—E. J. Streibenberger, New Boston, Ohio.

**AVAILABLE TO VETERANS UNDER G. I. BILLS**

Training plus opportunity is the PERFECT COMBINATION for job security, good pay, advancement. In good times, the trained man makes the BETTER PAY, GETS PROMOTED. When jobs are scarce, the trained man enjoys GREATER SECURITY. NRI training can help assure you more of the better things of life.

## Start Soon to Make \$10, \$15 a Week Extra Fixing Sets

Keep your job while training. I start sending you special booklets the day you enroll, that show you how to fix sets. Multitester built with parts I send helps you make \$10, \$15 a week extra fixing sets while training. Many start their own Radio-Television business with spare time earnings.

## My Training Is Up-To-Date

You benefit by my 40 years' experience training men at home. Well illustrated lessons give you basic principles you need. Skillfully developed kits of parts I send (see below) "bring to life" things you learn from lessons.



**Television Making Good Jobs, Prosperity**—Even without Television, Radio is bigger than ever. 115 million home and auto Radios are big market for servicing. 3000 broadcasting stations use operators, technicians. Government, Aviation, Police, Ship, Micro-wave Relay, Two-way Radio Communications for buses, taxis, trucks, R. B. are growing fields. Television is moving ahead fast.

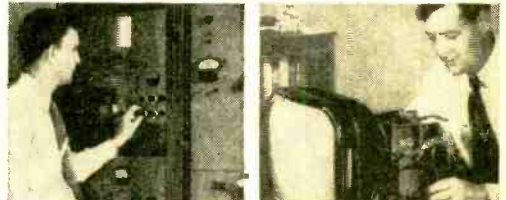

About 200 Television stations are now on the air. Hundreds of others being built. Good TV jobs opening up for Technicians, Operators, etc.

## Radio-TV Needs Men of Action—Mail Coupon

Without obligating you in any way, I'll send an actual lesson to prove that my training is practical, thorough; 64-page book to show good job opportunities for you in Radio-TV. Terms for NRI training are as low as \$5 a month. Many graduates make more in two weeks than total cost of training. Mail coupon now. J. E. SMITH, President, National Radio Institute, Dept. 4MD1, Washington 9, D. C. OUR 40TH YEAR.

## You Learn by Practicing with Parts I Send

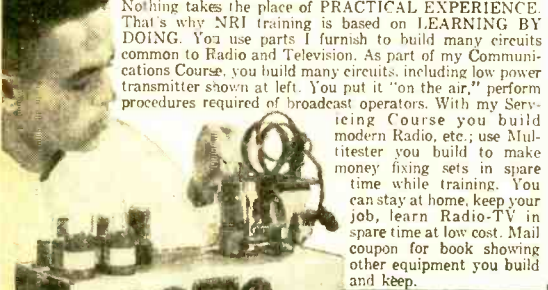

Nothing takes the place of PRACTICAL EXPERIENCE. That's why NRI training is based on LEARNING BY DOING. You use parts I furnish to build many circuits common to Radio and Television. As part of my Communications Course, you build many circuits, including low power transmitter shown at left. You put it "on the air," perform procedures required of broadcast operators. With my Servicing Course you build modern Radio, etc.; use Multitester you build to make money fixing sets in spare time while training. You can stay at home, keep your job, learn Radio-TV in spare time at low cost. Mail coupon for book showing other equipment you build and keep.

**The Tested Way To Better Pay!**

## Good for Both—FREE

MR. J. E. SMITH, President, Dept. 4MD4 National Radio Institute, Washington 9, D. C. Mail me Sample Lesson and 64-page Book, FREE. (No salesman will call. Please write plainly.)

Name \_\_\_\_\_ Age \_\_\_\_\_  
 Address \_\_\_\_\_  
 City \_\_\_\_\_ Zone \_\_\_\_\_ State \_\_\_\_\_  
**VETS** write in date of discharge \_\_\_\_\_



POPULAR ELECTRONICS is published monthly by Ziff-Davis Publishing Company, William B. Ziff, Chairman of the Board (1946-1953), at 64 E. Lake St., Chicago 1, Ill. Second Class Entry pending at Post Office, Chicago, Ill. SUBSCRIPTION RATES: One Year U.S. and possessions, and Canada \$3.00; Pan-American Union Countries \$3.50; all other foreign countries \$4.00.

# POPULAR ELECTRONICS

NOVEMBER  
1954  
VOL. I - NUMBER 2

## EDITOR

OLIVER READ, WIETI

## ASSOCIATE EDITORS

W. A. STOCKLIN H. S. RENNE  
C. TEPPER J. FRIEBORN  
P. B. HOEFER

## ART

FRANK SAYLES (Director)  
A. J. REICH M. WHELPLEY

## CONTRIBUTING EDITORS

J. T. FRYE L. E. GARNER, JR.  
K. R. BOORD R. P. TURNER  
R. HERTZBERG H. POLLACK

## DRAFTING

J. A. GOLANEK A. A. GANS

## ADVERTISING DEPARTMENT

New York (MU 7-8080)  
L. L. OSTEN  
Chicago (AN 3-5200)  
M. B. CROFFORD  
Los Angeles (Mich. 9856)  
JOHN E. PAYNE



Copyright 1954  
(All Rights Reserved)

## ZIFF-DAVIS PUBLISHING COMPANY

W. B. ZIFF (1898-1953) FOUNDER  
Editorial and Executive Offices  
366 Madison Ave., New York 17, N.Y.

## PRESIDENT

B. G. DAVIS

## VICE-PRESIDENTS

H. J. MORGANROTH M. FROELICH

## SECRETARY-TREASURER

G. E. CARNEY

## CIRCULATION MANAGER

M. MICHAELSON

## BRANCH OFFICES

Chicago (1), 64 E. Lake St.  
Los Angeles (14), Statter Center,  
900 Wilshire Blvd.

## SUBSCRIPTION SERVICE:

All communications concerning subscriptions should be addressed to Circulation Dept., 64 E. Lake St., Chicago 1, Ill. Subscribers should allow at least four weeks for any change of address.

## CONTRIBUTORS:

Contributors are advised to retain a copy of their manuscripts and illustrations. Contributions should be mailed to the New York Editorial Office and must be accompanied by return postage. Contributions will be handled with reasonable care, but this magazine assumes no responsibility for their safety. Any copy accepted is subject to whatever adaptations and revisions are necessary to meet the requirements of this publication. Payment covers all author's, contributor's, and contestant's rights, title, and interest in and to the material accepted and will be made at our current rates upon acceptance. All photos and drawings will be considered as part of material purchased.

Registered U. S. Patent Office

## CONTENTS

Home Broadcaster . . . . .	L. E. Garner, Jr.	11
A Code Practice Set—The Simple Way . . . . .	A. Trauffer	15
An All-Wave Receiver Kit . . . . .		16
Command Post of the Future . . . . .		18
Am I Too Old to Learn Television? . . . . .	J. Wilson	20
Choosing Your TV Antenna . . . . .	C. Tepfer	22
The World at a Twirl . . . . .	K. R. Boord	24
An Easily Built "Black Light" Source . . . . .		26
The Lorenz "Sixty-One" . . . . .	E. J. Lorenz	28
Parallel Resistance Chart . . . . .	R. F. Graf	31
Dentistry—The Painless Way . . . . .	P. B. Hoefler	32
Nine Chassis Bases for the Home Builder . . . . .		34
Hints on Reading Schematic Diagrams . . . . .		36
So You Want to Be a Ham (Part 2) . . . . .	R. Hertzberg, W2DJJ	39
Radio Catches Crooks of the Ether . . . . .	A. Weinstein	42
Neon Tube Metronome and Seconds Timer . . . . .	H. Pollack	45
How to Use an Oscilloscope . . . . .		49
Timing Relay Experiments . . . . .		53
Time-Delay Burglar Alarm . . . . .		55
How Radar Works . . . . .		58
Carl & Jerry . . . . .	J. T. Frye	62
Equipment for Radio Control . . . . .	E. L. Safford, Jr.	64
Checking and Changing Phonograph Pickup Units . . . . .		66
Width Control Adjustments in TV Receivers . . . . .		68
The Electronic Flight Trainer . . . . .	L. G. Sands	70
The Electric Eye—How It Works . . . . .		72
A Compact Public Address System . . . . .		75
New Airborne Radar Unit . . . . .		79
Build this Plug-in Absorption Wavemeter . . . . .		80
How Many Controls? . . . . .	W. Winter	83
Using and Understanding the Neon Glow Lamp . . . . .	E. D. Morgan	90

## DEPARTMENTS

R/C Notes . . . . .	74
Tools & Gadgets . . . . .	92
Book Reviews . . . . .	96
After Class . . . . .	99
Tricks of the Trade . . . . .	110
Glossary of Terms in this Issue . . . . .	126
Resistor Color Code . . . . .	128
Capacitor Color Code . . . . .	128
Standardized Wiring Diagram Symbols . . . . .	129

(Also see page 6)

**It's New! 3 Years in Development  
-NOW READY FOR YOU!**

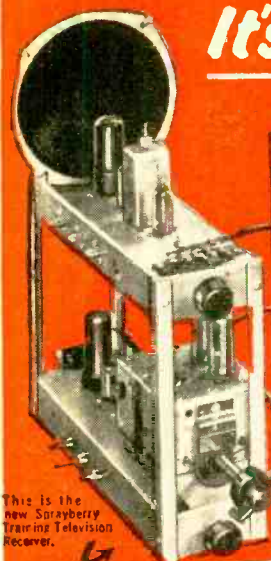

This is the new Sprayberry Training Television Receiver.

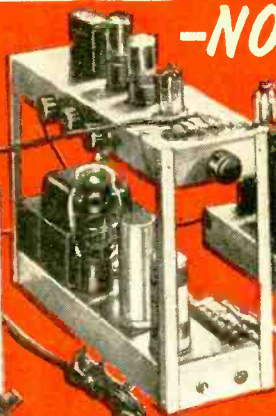

You build the new Sprayberry Tester... 18-range Volt-Ohm-Milliammeter readings.

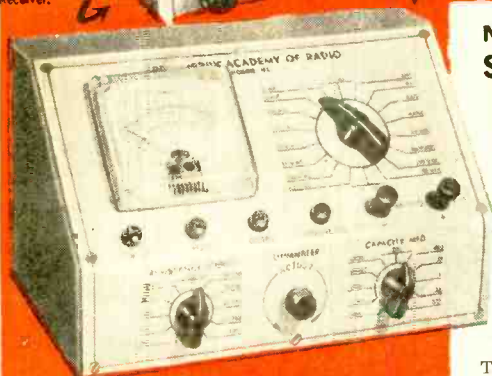

You will build this powerful short wave and broadcast superhet radio receiver.

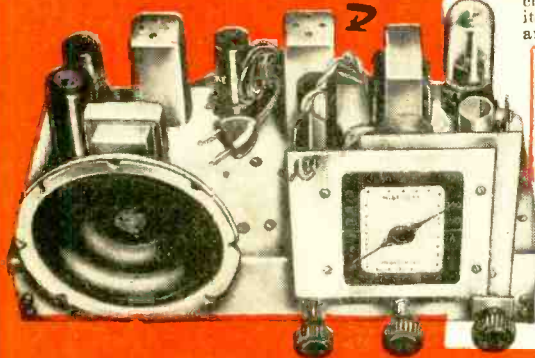

**New Equipment! New Lessons! Enlarged Course!**  
**SPRAYBERRY PRACTICAL TRAINING IN**  
**RADIO-TELEVISION**

**3 NO OBLIGATION TRAINING PLANS**



F. L. SPRAYBERRY  
Pres.

You have **NO MONTHLY PAYMENT CONTRACT** to sign... pay for this outstanding training as you learn!

Mail the coupon at once for my big all-new 56 page **FREE CATALOG** and **FREE Sample Lesson**. Get the full story of this remarkable new Training Plan. Read about my 3 **NO OBLIGATION PLANS** of "packaged unit" instruction. I can prepare you in as little as 10 MONTHS to take your place as a Trained Radio-Television Technician. You take no risk in enrolling for my Training because you **DO NOT SIGN A BINDING TIME PAYMENT CONTRACT**. I have been training successful Radio-TV technicians for 22 years... I can prepare you, too, to get into your own profitable Service Shop or a good paying job. Full information **FREE** and without any obligation. No salesman will call.

**NEWEST DEVELOPMENTS**

Your training covers U H F, Color Television, F.M. Oscilloscope Servicing, High Fidelity Sound and Transistors.

**PRACTICE AND TRAIN AT HOME WITH 25 NEW KITS of EQUIPMENT**

You get valuable practical experience in construction, testing and shop practice. You build a powerful 2 band superhet radio, the all-new 18 range Sprayberry multimeter, the new Sprayberry Training Television receiver, signal tracer and many other projects. All equipment is yours to use and keep. All your training is **IN YOUR HOME** in spare hours. I help you earn extra spare time money while you learn. Rush coupon below for all the facts—**FREE!**

**SPRAYBERRY ACADEMY OF RADIO**  
111 NORTH CANAL STREET, DEPT. 105-R  
CHICAGO 6, ILLINOIS



**FREE CATALOG AND SAMPLE LESSON**

Rush coupon for my catalog "How to Make Money in Radio-Television". PLUS an actual sample Sprayberry Lesson without obligation—**ALL FREE**. Mail coupon NOW!

SPRAYBERRY ACADEMY OF RADIO MAIL THIS COUPON FOR FREE Dept. 105-R 111 N. Canal St., Chicago 6, Ill. **FACTS AND SAMPLE LESSON** Please Rush New Catalog and Sample Lesson **FREE** I understand that no salesman will call.

Name \_\_\_\_\_ Age \_\_\_\_\_  
Address \_\_\_\_\_  
City \_\_\_\_\_ Zone \_\_\_\_\_ State \_\_\_\_\_

# RAYTHEON CK722 TRANSISTORS

now only \$ **3**<sup>50</sup>

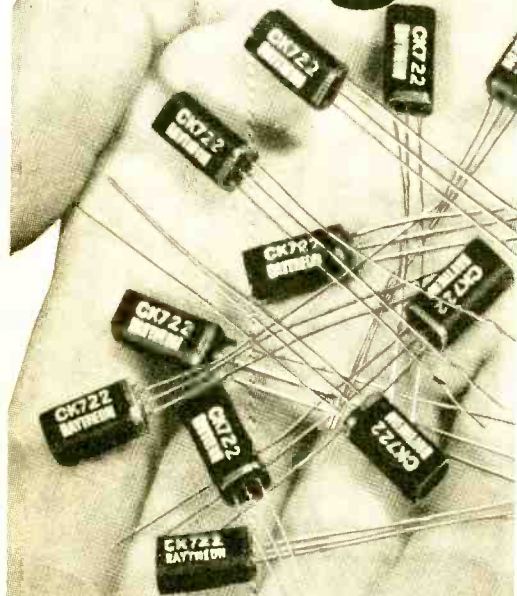

Raytheon Transistors are neither expensive nor hard to get. As a matter of fact for the price of a tube you can use this newest electronic development in your rigs. And Raytheon Transistors are so practical and popular you'll find many transistorized circuits available.

Your nearest Raytheon Tube Supplier has Raytheon Transistors in stock. For a free characteristics chart, write to Department P.



*Excellence in Electronics*

## RAYTHEON MFG. CO.

Receiving and Cathode Ray Tube Operations  
Newton 58, Massachusetts

RELIABLE SUBMINIATURE AND MINIATURE TUBES  
SEMICONDUCTOR DIODES AND TRANSISTORS  
NUCLEONIC TUBES

RECEIVING AND PICTURE TUBES • MICROWAVE TUBES

### ITEMS OF INTEREST

This Month's Cover	8
Rio de Janeiro's New Radiophone Net	44
Where's Willis?	48
Recording World Church Council Assembly	48
Landmark Demolished	52
Calling All Inventors!	52
RCA-NBC Mobile Unit for Color Television	52
Make a "Fountain Pen" Radio for Your Pocket	54
Grommet for Twin-Lead	60
Polarity Tester for Crystal Diodes	60
.4-Watt Transmitter for Local Contacts	60
Giant Klystron Electronic Tube	61
Out to Sea with Television	61
How Smart Are You?	104
Drapery Rod as an Adjustable Support	107
Soldering Coil Pins	117
Millionth Transistor	124
A "Satin" Finish for Your Aluminum Chassis	125

### NEW PRODUCTS

Pocket Civil Defense Radio	30
(General Electric Company, Syracuse, N. Y.)	
"Portafane" Used in Civil Defense Test	44
(Stewart-Warner Corporation, Chicago, Ill.)	
Electronics Reduces Noise on Telephone	48
(Stromberg-Carlson Co., Rochester, N. Y.)	
RCA Hobby Kit for Novices	52
(Radio Corp. of America, Camden, N. J.)	
The First FM Tuner for Cars	82
(Hastings Products, Inc., 171 Newbury St., Boston 16, Mass.)	
New Indoor TV Antenna	82
(Tentenna, Inc., 122 E. 42nd, N. Y. C., distributor)	
A Portable Tape Recorder	82
(Broadcast Equipment Specialties Corp., 135-01 Liberty Ave., Richmond Hill, 19, N. Y.)	
TV-Telephone Intercom	97
(Kay Lab, Inc., 1090 Morena Blvd., San Diego 19, Cal.)	
"Smallest Relay in the World"	109
(G. M. Giannini & Co., Inc., East Orange, N. J.)	
If you are unable to find these listed products locally, write direct to the manufacturers at the addresses given.	

## COMING NEXT MONTH POPULAR ELECTRONICS

- Voice-Operated Model Train Control
- Miniature Lighted Christmas Tree
- "Detective's Special" Amplifier
- A Photoelectric Rifle Range
- Transmitter for Model Control
- Train Speed Controller

Plus More On

- High-Fidelity Audio • Kits • Radio Control • Short-Wave Listening • What's New • How it Works • How to Make It • How to Use It • Carl & Jerry

## IN THIS MONTH'S RADIO & TELEVISION NEWS

(November)

- Choosing Your Hi-Fi Loudspeaker
- Junk Box "Sending Iron"
- The Practical Switchless Intercom
- The Poor Man's "3D" Converter
- A Four-Channel Audio Mixer
- A Simple-Yet Good Quality-Preamp
- A Transistor Power Supply
- Servicing Record Changers
- Transistor Amplifier for Meters
- All-Purpose Enclosure for 12" Speakers

# HOW TO MAKE YOUR TIME WORTH \$95 AN HOUR!

Here's part of a letter we got from an I. C. S. student—

"Every spare-time hour I spent earning my I. C. S. diploma has been worth \$95 to me! My position, my \$7000 a year income, my home, my family's happiness—I owe to I. C. S."

Hardly a day goes by without a letter like this coming in from an I. C. S. student... from men and women of all ages who, in their spare time, at home, pulled themselves out of the small-pay rut and put themselves on the road to success.

Take the case of I. C. S. student Frank B. "I was making \$152 a month when I signed up with I. C. S.," he writes. "My present income is \$395.25 a month."

I. C. S. is the oldest and largest correspondence school. 277 courses. Business, industrial, engineering, academic, high school. One for you. Direct, job-related. Bedrock facts and theory plus practical application. Complete lesson and answer service. No skimping. Diploma to graduates.



**3 FREE BOOKS**—a 36-page pocket-size guide to advancement, a gold mine of tips on "How to Succeed." Also a big catalog outlining opportunities in your field of interest and a sample I. C. S. lesson text.

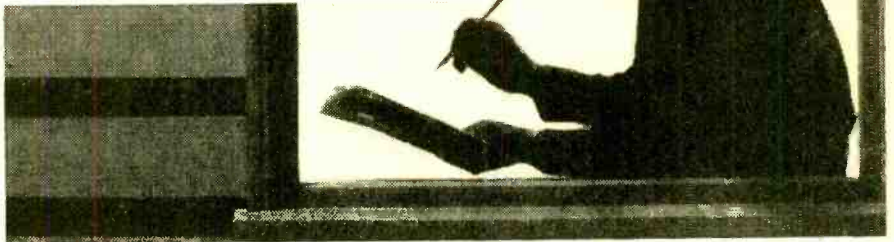

For Real Job Security—Get an I. C. S. Diploma!

I. C. S., Scranton 9, Penna.

## INTERNATIONAL CORRESPONDENCE SCHOOLS



BOX 2951-B, SCRANTON 9, PENNA.

(Partial list of 277 courses.)

Without cost or obligation, send me "HOW TO SUCCEED" and the opportunity booklet about the field

BEFORE which I have marked X (plus sample lesson):

### ARCHITECTURE and BUILDING CONSTRUCTION

- Air Conditioning—Refrig.
- Architecture
- Building Contractor
- Building Maintenance
- Carpenter and Mill Work
- Estimating
- Heating
- Painting Contractor
- Plumbing
- Reading Arch. Blueprints
- Steamfitting

### ART

- Cartooning
- Commercial Art
- Fashion Illustrating
- Magazine Illustrating
- Show Card and Sign Lettering
- Sketching and Painting

### AUTOMOTIVE

- Auto Body Rebuilding
- Auto Elec. Technician
- Auto-Engine Tune Up
- Automobile Mechanic

### AVIATION ENGINEERING BUSINESS

- Aeronautical Engineering Jr.
- Aircraft & Engine Mechanic
- Advertising
- Bookkeeping and Accounting
- Business Administration
- Business Correspondence
- Certified Public Accounting
- Creative Salesmanship
- Federal Tax
- Letter-writing Improvement
- Managing Small Business
- Office Management
- Retail Business Management
- Sales Management
- Stenographic-Secretarial
- Traffic Management

### CHEMISTRY

- Analytical Chemistry
- Chemical Engineering
- Chem. Lab. Technician
- General Chemistry
- Natural Gas Prod. & Trans.
- Petroleum Engineering
- Plastics
- Pulp and Paper Making

### CIVIL, STRUCTURAL ENGINEERING

- Civil Engineering
- Construction Engineering
- Highway Engineering
- Reading Struct. Blueprints
- Sanitary Engineering
- Structural Engineering
- Surveying and Mapping
- DRAFTING
- Aircraft Drafting
- Architectural Drafting
- Electrical Drafting
- Mechanical Drafting
- Mine Surveying and Mapping
- Ship Drafting
- Structural Drafting

### ELECTRICAL

- Electrical Engineering
- Electrical Maintenance
- Electrician  Contracting
- Lineman
- HIGH SCHOOL
- Commercial
- Good English
- High School Subjects
- Mathematics

### LEADERSHIP

- Foremanship
- Industrial Supervision
- Leadership and Organization
- Personnel-Labor Relations

### MECHANICAL AND SHOP

- Gas—Electric Welding
- Heat Treatment  Metallurgy
- Industrial Engineering
- Industrial Instrumentation
- Industrial Supervision
- Machine Design-Drafting
- Machine Shop Inspection
- Machine Shop Practice
- Mechanical Engineering
- Quality Control
- Reading Shop Blueprints
- Refrigeration
- Sheet Metal Worker
- Tool Design  Toolmaking

### RADIO, TELEVISION

- Electronics
- Practical Radio—TV Eng'ring
- Radio and TV Servicing
- Radio Operating
- Television—Technician

### RAILROAD

- Air Brakes  Car Inspector
- Diesel Locomotive
- Locomotive Engineer
- Section Foreman

### STEAM AND DIESEL POWER

- Combustion Engineering
- Diesel—Elec.  Diesel Eng's
- Electric Light and Power
- Stationary Fireman
- Stationary Steam Engineering

### TEXTILE

- Carding and Spinning
- Cotton, Rayon, Wooler, Mfg.
- Finishing and Dyeing
- Loom Fixing
- Textile Designing
- Textile Eng'g  Throwing
- Winding and Weaving

### MISCELLANEOUS

- Domestic Refrigeration
- Marine Engineering
- Ocean Navigation
- Shipfitting
- Short Story Writing
- Teletphony

Name \_\_\_\_\_ Age \_\_\_\_\_ Home Address \_\_\_\_\_

City \_\_\_\_\_ Zone \_\_\_\_\_ State \_\_\_\_\_ Working Hours \_\_\_\_\_ A.M. to P.M. \_\_\_\_\_

Occupation \_\_\_\_\_

Canadian residents send coupon to International Correspondence Schools, Canadian, Ltd., Montreal, Canada. . . . Special tuition rates to members of the U. S. Armed Forces.

# TERADO



## Trav-Electric CONVERTERS

### House Current Anywhere

—from battery in car, truck, boat. At the beach-picnic grounds—at cabin—on trips—anywhere! Easy. No installation! Just plug Trav-Electric into cigar lighter on dash.

#### Trav-Electric Operates:

- Tape Recorders
- Electric Shavers
- Radios
- Soldering Irons
- Dictating Machines
- Small Electric Drills
- Portable Phonographs
- Etc., etc., etc.

#### 6 Models — 10 to 100 Watts

A Size for Every Need



PORTABLE PHONOGRAPH

**"MIDGET"** Model 6-11160  
10-15 Watts. About as small as a pack of cigarettes.  
List \$11.95

**"JUNIOR"** Model 6-110  
115 Cycles. 30-40 Watts.  
List \$12.95



DICTATING MACHINE

**"SENIOR"** Model 6-1160  
Size 2 1/2 x 2 1/2 x 4 1/2.  
35-40 Watts.  
List \$15.95

**"MASTER"** Model 6-51160  
40-50 Watts.  
Size 4" x 5" x 6".  
List \$27.50



ELECTRIC SHAYER

**"SUPER"** Model 6-71160  
(Shown at top of ad.) 60-75 Watts. 4" x 5" x 6".  
List \$37.95

**"CHIEF"** Model 6-81160  
75-100 Watts. Automatic On-Off Switch.  
List \$49.95

See your Electronic, Hardware, or Automotive Jobber or Dealer

### Terado Company

Designers and Mfrs. of Electronic Equipment  
1053 Raymond Ave. St. Paul 14, Minn.

In Canada Write: Atlas Radio Corp., Ltd.  
560 King St. West, Toronto 28, Ont.  
Export Sales Division: Scheel International, Inc.  
4237 N. Lincoln Ave., Chicago 18, Ill., U.S.A.  
Cable Address—Harsheel



### This Month's Cover

THE fascination of free-flight model planes has captured the imagination of young and old alike but sooner or later the radio control "bug" bites every modeler and the fun begins!

The model plane, the "Maybe," shown on this month's cover with its pilots, Larry Nuesslein (left), Pete Hartzell (center) and "aid" J. Higgenbotham (right), started life as a free-flight job and was recently converted to R/C operation.

As converted, the plane incorporates a home-built "Mac II" 5-watt transmitter and a Lorenz 2-tube receiver. While 5 watts is more power than required in this application, the reserve power is handy to have.

The receiver employs RK61 and XFG1 tubes. It is characterized by good sensitivity, long tube life, and positive relay action. The design is one dreamed up by that pioneer radio controller, Ed Lorenz.

In R/C flying there is no substitute for careful installation. The builders have mounted and cushioned the receiver with generous amounts of foam rubber to protect the equipment in case of a crash.

Before each flying session, batteries are tested under load and the receiver checked for proper tuning to get maximum dip in plate current for the first tube when the signal is transmitted. END

(Ektachrome by Jay Seymour)



# LOOKING FOR JOB SECURITY AND SUCCESS? LET MY STUDENTS AND GRADUATES TELL YOU —

## ABOUT MY TRAINING —

### \$60 A WEEK IN SPARE TIME



I have the skill and know-how to do the work I love best and to enjoy better things in life, thanks to RTTA. I am working at TV servicing and making \$60 a week sparetime.

Harold Gimlen, Flint, Mich.

### AIRCRAFT INSPECTOR



With RTTA training and through repairing radios and televisions for the right people at the right price, I was able to make the right contacts. I am now an Inspector for Douglas Aircraft at about \$125 a week.

Hugh Maddox, Los Angeles, Calif.

### ELECTRICAL TESTER



RTTA training has helped me understand TV and many variations of simple circuits. The course covers all subjects very clearly. I am now an Electrical Tester for Western Electric Co. at \$83.42 a week.

Raymond Lapan, Burlington, N. C.

### HAS OWN BUSINESS



I have a shop at home and have been working on radio and TV after working hours of my regular job. I average \$50 a week for this part time work. RTTA training helped me in making extra money and giving me experience in the electronic field.

Richard Hennis, Little Rock, Ark.

### SERVICE MANAGER



I manage two radio and television shops, one here and one in Pompano Beach. RTTA training increased my knowledge of TV circuits and showed me new, quicker methods of repairing. Lessons as presented are very concise and clear.

William Phillips, Fort Lauderdale, Fla.

### REPAIRED EVERY SET



RTTA training helped me to understand TV more thoroughly. I have repaired every set that I was called on to repair.

Andrew Busi, Jr., Iselin, Pa.

L. C. Lane, B.S., M.A.  
President, Radio-Television Training Association.  
Executive Director, Pierce School of Radio & Television.



## — ABOUT MY EQUIPMENT

YOU GET ALL THIS EQUIPMENT AND MORE

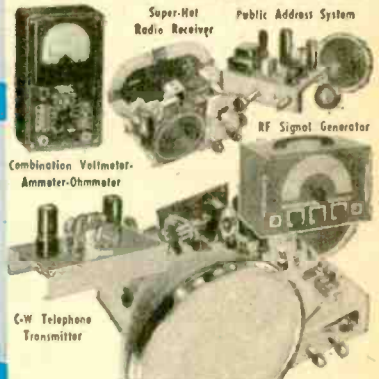

"... a money making little gem."

I have completed kit #6 and was amazed at how it works. I showed it to a friend of mine and he asked me to set it up for one of the picnics his social club was having. That sure is a money making little gem.

John Fernandez, Fresno, Calif.

"We get excellent pictures..."

I would like to compliment you on an excellent and complete course. We get excellent pictures on my TV set from WSYR (Syracuse, N.Y.), approximately 110 air miles away. The set is working good and I have had to replace only three tubes since I assembled it two years ago.

Larry M. Stafford, Kingston, Ont., Canada

"... very good reception..."

I have really enjoyed the course and have come a long way in TV servicing. I am getting very good reception on my TV station considering that the nearest VHF station is 120 miles.

J. W. Hanlon, Jr., Henderson, Texas

## YOU, TOO, CAN GET A BETTER-PAYING JOB IN THE EVER-EXPANDING RADIO-TELEVISION-ELECTRONICS FIELD

Why limit yourself and your earnings because of your lack of training. Learn AT HOME in your SPARE TIME to be an electronic technician, television repairman, or studio technician. You don't need any experience whatsoever. Many students earn up to \$25 weekly in spare time while learning.

After you finish my Radio-FM Television Course or FM-Television Course you can have, if you want it, two weeks of laboratory training at my associate resident school in New York City—AT NO EXTRA COST.

If you have had previous radio and television experience you can take my practical TV Cameraman and Studio Technician Course to qualify for a good-paying job in a TV studio.

Write to me today and let me show you how you can begin now to put yourself on the road to a better future.

## VETERANS!

My school fully approved to train veterans under new Korean G.I. Bill. Available only to veterans discharged after AUGUST 20, 1951. If eligible, CHECK COUPON.

## Radio Television Training Association

52 EAST 19th STREET • NEW YORK 3, N. Y.

Licensed by the State of New York • Approved for Veteran Training

YOU GET ALL FOUR FREE



MAIL THIS COUPON TODAY!  
NO SALESMAN WILL CALL

Mr. Leonard C. Lane, President  
RADIO-TELEVISION TRAINING ASSOCIATION Dept. Ell  
52 East 19th Street, New York 3, N. Y.

Dear Mr. Lane: Mail me your NEW FREE BOOK, FREE SAMPLE LESSON, and FREE aids that will show me how I can make BIG MONEY IN TELEVISION. I understand I am under no obligation and no salesman will call.

(PLEASE PRINT PLAINLY)

Name \_\_\_\_\_ Age \_\_\_\_\_  
Address \_\_\_\_\_  
City \_\_\_\_\_ Zone \_\_\_\_\_ State \_\_\_\_\_

I AM INTERESTED IN:

Radio-FM-TV Technician Course  
 FM-TV Technician Course  
 TV Cameraman & Studio Technician Course

**VETERANS!**  
Check here   
for Training under NEW  
G.I. BILL

# RAD TEL

**TUBES  
GUARANTEED**

**1 FULL  
YEAR**

**70%  
TO  
90%  
OFF!**

**300  
TYPES  
ALWAYS  
IN STOCK**

**ALL TUBES  
INDIVIDUALLY  
BOXED**

Please send full re-  
mittance — allow  
for postage and  
save C.O.D.  
charges! We re-  
fund all unused  
money.

**FOR QUALITY, PERFORMANCE, DEPENDABILITY**

**SAME DAY SERVICE!**

## Fix It Yourself and SAVE!

Type	Price	Type	Price	Type	Price	Type	Price	Type	Price
OA2	.74	6AC7M	.86	6L6	.64	7S7	.79	14J7	.30
OA4	.68	6AF4	.90	6L7M	.68	7V7	.89	14N7	.84
OB2	.81	6AG5	.56	6N7M	.63	7X6	.54	14R7	.79
OC3	.72	6AG7M	.99	6Q7	.45	7X7	.70	14S7	.89
OD3	.70	6AH4	.57	6R7	.69	7Y4	.69	14W7	.30
OZ4M	.65	6AH6	.73	6S4	.48	7Z4	.59	14X7	.69
1A5	.49	6AJ5	.65	6S7M	.79	12A6	.54	14Y7	.62
1A7GT	.47	6AK5	.55	6S78	1.90	12ABGT	.61	19BG6	1.39
1AX2	.62	6AK6	.59	6S8GT	.53	12AL5	.37	19T8	.69
1B3GT	.73	6AL5	.42	6SA7GT	.55	12AQ5	.52	19V8	.79
1C5	.43	6AM8	.78	6SD7GT	.41	12AT6	.41	24A	.39
1E7	.29	6AQ5	.50	6SF5GT	.46	12AT7	.72	25AV5GT	.83
1G6	.24	6AQ6	.37	6SG7GT	.41	12AU6	.46	25BQ6GT	.98
1H4	.30	6AQ7	.70	6SH7GT	.49	12AU7	.60	25L6GT	.51
1HSGT	.49	6AR5	.45	6SJ7GT	.41	12AV6	.39	25W4GT	.59
1L4	.46	6AS5	.50	6SK7GT	.53	12AV7	.73	25Z5	.66
1LA4	.59	6AS6	1.49	6SL7GT	.48	12AX4	.67	25Z6	.49
1LA6	.69	6AT6	.41	6SN7GT	.59	12AX7	.63	26	.45
1LB4	.69	6AU4GT	.68	6SQ7GT	.46	12AY7	.69	27	.39
1LC5	.59	6AU5GT	.82	6SR7GT	.45	12AZ7	.59	32L7	.89
1LC6	.79	6AU6	.46	6SS7GT	.42	12B4	.60	35	.58
1LD5	.59	6AV5GT	.83	6T4	.99	12BA6	.49	35A5	.58
1LE3	.59	6AV6	.40	6T8	.80	12BA7	.60	35B5	.52
1LG5	.69	6AX4GT	.65	6U5	.57	12BD6	.45	35C5	.51
1LH4	.69	6B4	.54	6U6	.59	12BE6	.51	35L6GT	.51
1LN5	.59	6BA6	.49	6U8	.78	12BF6	.39	35W4	.47
1NSGT	.67	6BA7	.57	6V6GT	.50	12BH7	.63	35Y4	.54
1P5GT	.57	6BC5	.54	6W4GT	.47	12BY7	.65	35Z3	.59
1Q5GT	.58	6BD5	.59	6W6GT	.57	12BZ7	.65	35Z4	.47
1R5	.62	6BD6	.45	6X4	.37	12C8M	.34	35Z5GT	.47
1S4	.59	6BE6	.51	6X5GT	.37	12H6	.56	36	.39
1S5	.51	6BF5	.41	6X8	.75	12J5	.42	36	.55
1T4	.58	6BF6	.37	6Y6G	.48	12K5	.49	45Z5	.49
1T5	.59	6BG6G	1.25	7A4	.47	12K8	.59	50A5	.55
1U4	.57	6BH6	.53	7A5	.59	12Q7	.59	50B5	.52
1U5	.50	6BJ6	.49	7A6	.69	12S8GT	.62	50C5	.51
1V	.43	6BK5	.80	7A7	.69	12SA7GT	.65	50L6GT	.61
1X2A	.63	6BK7	.80	7A8	.68	12SC7M	.63	50X6	.49
2A3	.30	6BL7GT	.83	7AD7	.79	12SF5	.50	50Y6	.49
2W3	.38	6BN6	.59	7AF7	.53	12SG7	.51	50Y7	.50
2X2	.49	6BQ6GT	.98	7AG7	.69	12SJ7M	.67	55	.49
3A4	.45	6BQ7	.90	7AH7	.79	12SK7GT	.63	56	.49
3B7	.27	6BZ7	.90	7B4	.44	12SL7GT	.57	57	.58
3D6	.27	6C4	.40	7B5	.45	12SN7GT	.52	58	.60
3E5	.46	6C5	.39	7B6	.69	12SQ7GT	.56	70L7	.97
3LF4	.69	6C6	.58	7B7	.49	12SR7M	.49	75	.49
3Q4	.48	6CB6	.54	7C4	.59	12V6GT	.46	76	.44
3Q5GT	.69	6CD6	1.11	7C5	.69	12X4	.38	77	.57
3S4	.58	6CF6	.64	7C6	.59	14A4	.69	78	.47
3V4	.58	6CS6	.51	7E5	.59	14A5	.59	80	.43
5AZ4	.59	6D6	.59	7E6	.30	14A7	.63	83V	.68
5T4	.79	6E5	.48	7E7	.59	14AF7	.59	84/6Z4	.46
5U4G	.55	6F5GT	.39	7F7	.79	14B6	.63	85	.59
5W4GT	.50	6F6	.59	7F8	.79	14B8	.63	117L7	.99
5Y3GT	.37	6G6	.42	7G7	.89	14C5	.79	117P7	.99
5Y4	.51	6H6GT	.41	7H7	.59	14C7	.79	117Z6	.69
5Z3	.45	6J5GT	.43	7J7	.79	14E6	.75	807	.99
6A6	.51	6J6	.52	7K7	.69	14E7	.65	866A	1.39
6A7	.69	6J7	.43	7L7	.59	14F8	.69	1274	.30
6A8	.62	6K5	.47	7N7	.69	14H7	.59	Hi-Po #567	1.39
6AB4	.44	6K6GT	.45	7Q7	.66				
6AC5	.69	6K7	.44	7R7	.89				

**RAD-TEL TUBE CO.**

P-E  
11

115 Coit St., Irvington 11, N. J. "Integrity Is Our Chief Asset"

**TERMS:**

A 25% deposit must accompany all orders—balance C.O.D. All shipments F.O.B. Irvington warehouse. ORDERS UNDER \$10—\$1.00 HANDLING CHARGE. . . . Subject to prior sale.

Tubes in Bold Type Cover 90% of Demand



*From room-to-room or house-to-house you can broadcast your voice or recording with this miniature transmitter.*



By **LOUIS E. GARNER, JR.**

**Y**OU can have a lot of fun conducting your own "radio programs" with this compact home broadcaster. It is inexpensive and easy to build. Since it is battery-operated, you can use it anywhere there is a broadcast receiver to pick up its signals.

The best way to have fun with your friends in using this broadcaster is not to tell them you have it; let them find it out. Go "on the air" unknown to them and put their names into a gossip program. You know the type: "Who was the young lady who was seen with Humphrey Gable at which night club doing you know what at 2:57 this ayem?" The results should be particularly interesting if Humphrey Gable (or your friend, whatever his name is) happened to tell his wife he was out of town on business and she hears your "item." After a little of this, the riot squad and the ambulance should arrive.

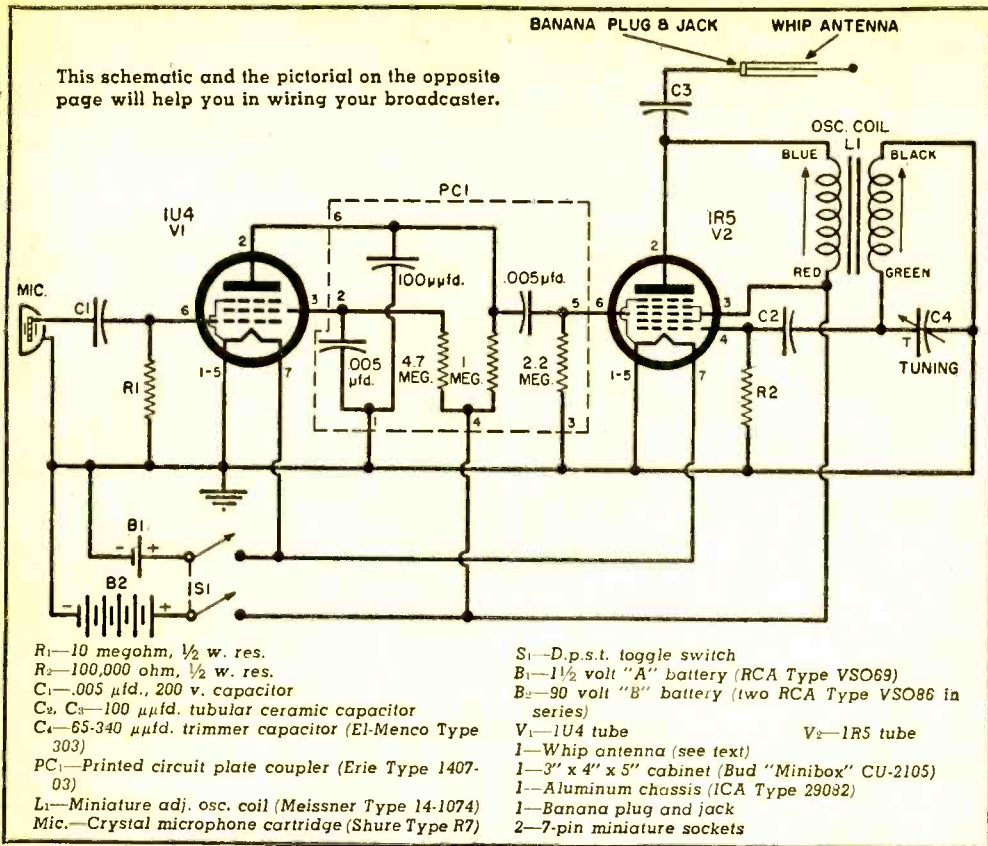

This would be a good time for you to be out for another case.

When you get back, if you have any friends left (those who were not mentioned by you and who were not battle casualties), try the next step. Put yourself on a regular program: sing with a band, heckle a political commentator, add your own sound effects. Make your contributions short and time them to fit into natural gaps in the program, as when a speaker stops for breath or dramatic effect. You can keep this up until someone says, "It sounds just like that so-and-so," meaning you. Soon after that everyone will catch on to what has been happening.

You can now appear and show just how the thing works. Then some brave character will step forward and say, "Let's you and him try it," pointing to two other people. If no one volunteers, you can use a little psychology. Say, "I don't think Witherspoon would like to do it; Bumstead would probably be better." They'll both want the first turn, although for different reasons. That will get everyone started and all you'll have to do is encee—or referee.

If you would rather put your friends on

the radio unknown to themselves, that can be arranged too. Put the broadcaster behind a sofa or some other piece of furniture where interesting events are likely to occur, wait until a couple of promising but unsuspecting "actors" approach it, then gather the "audience" before the radio in another room to listen in on the "drama."

You can even have professional singers and orchestras broadcast for you if you substitute a phonograph for the microphone. With a tape recorder you can rebroadcast regular radio programs, complete with authentic station announcements. This might win you a bet or two on when a certain program is aired, provided you leave out the original time signals.

There are just two small obstacles to your fun: First, using this gadget could get you arrested, even if you confine your transmissions to such unslenderous remarks as "testing, one, two, three, four." It can radiate a signal healthy enough to travel to radios several blocks or miles away. There ought to be a law against that—and there is. Be sure to adjust your antenna length so that you can reach your own radio and no more.

The second hitch is that, before you can



← External view of completed broadcaster. The antenna can be removed when unit is not in use.

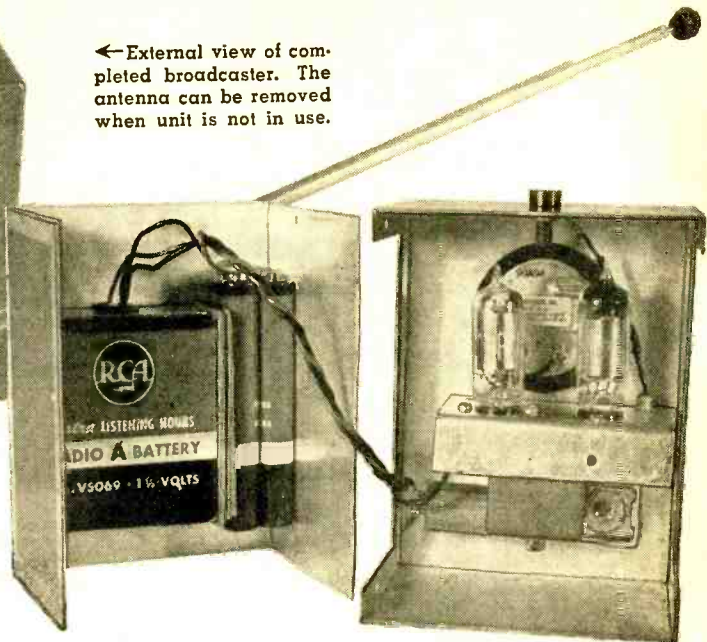

→ Inside view of broadcaster with the two parts of the cabinet separated showing all of the parts mounted and wired.

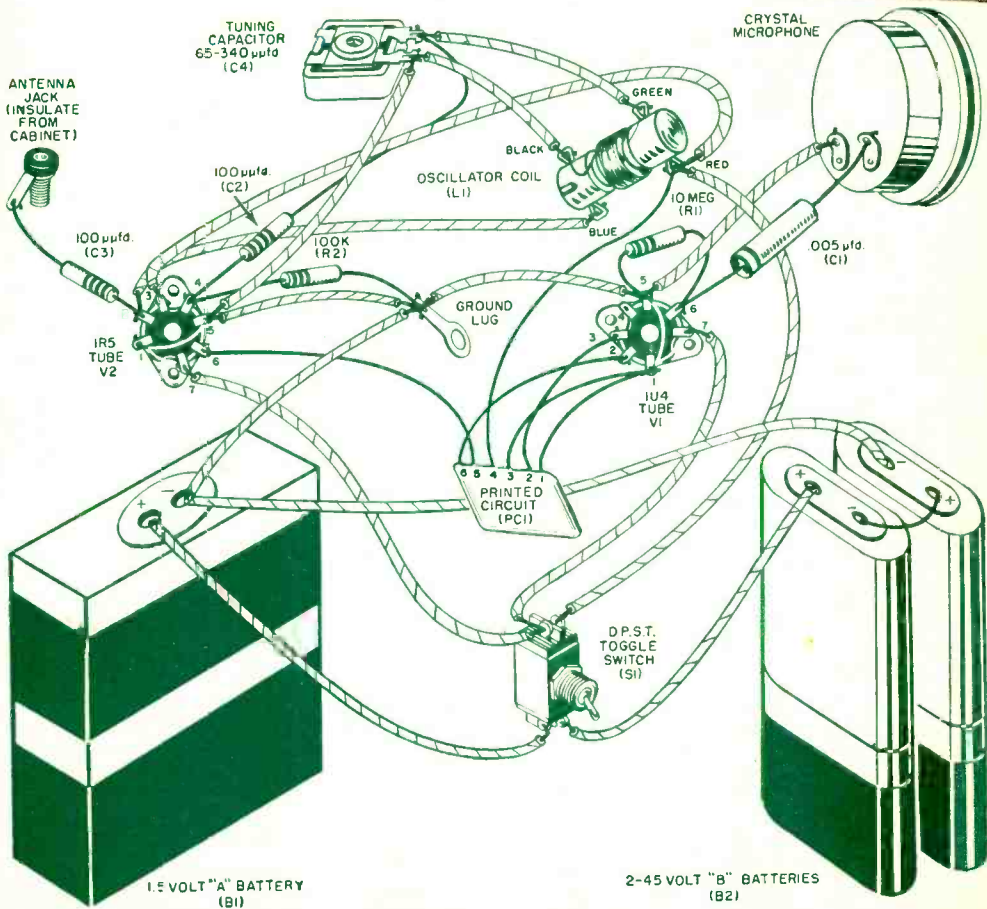

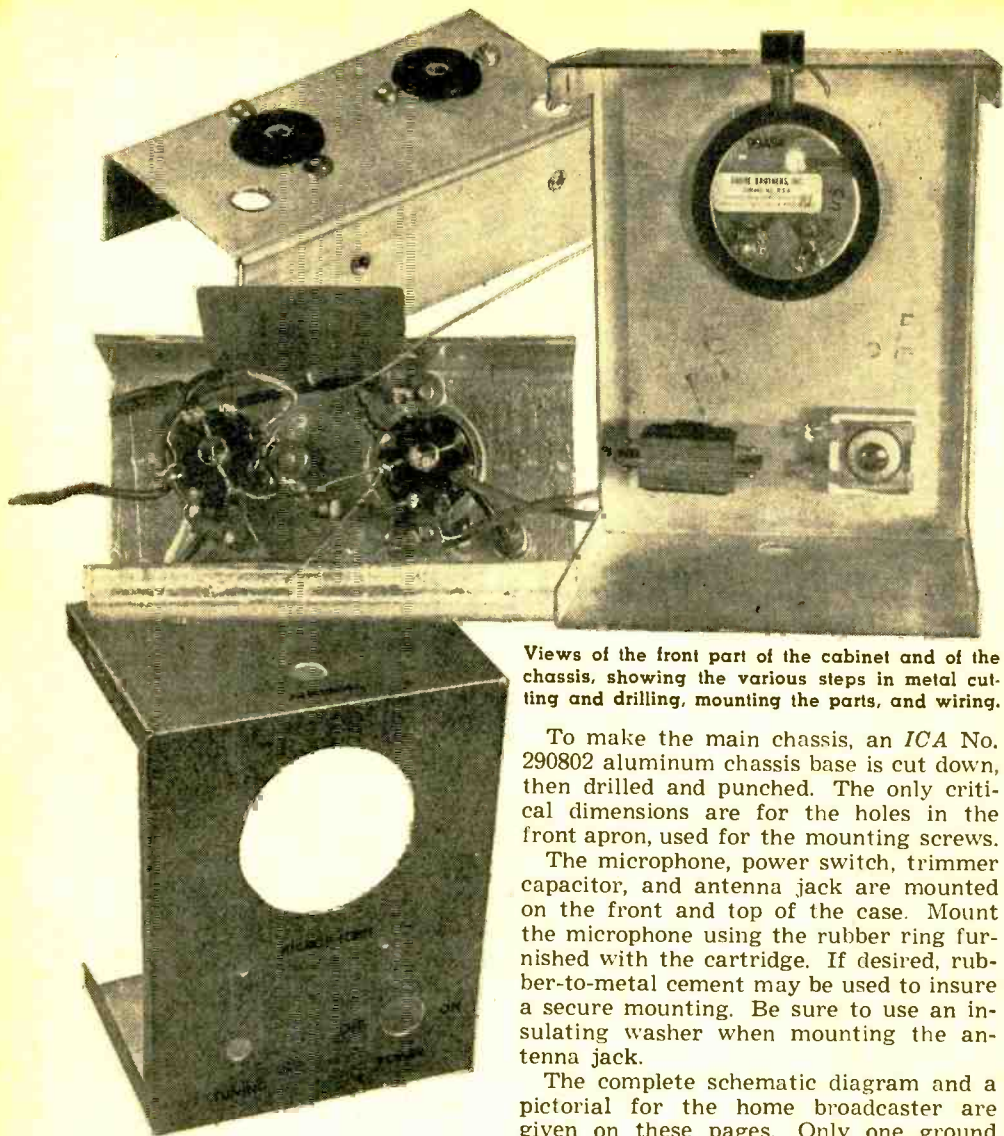

Views of the front part of the cabinet and of the chassis, showing the various steps in metal cutting and drilling, mounting the parts, and wiring.

use the broadcaster, somebody has to build it. It isn't hard to do, so you might as well do it yourself.

A standard *Bud* "Minibox" is used for the case. The large opening for the microphone can be made by cutting a hole slightly smaller than 2" diameter and filing until a snug fit is obtained. The banana jack hole for the antenna on top of the case is made with a  $\frac{1}{4}$ " drill, then enlarged slightly with a tapered reamer to accommodate the insulating washer. After the front panel is drilled, decals may be used to identify the controls. Follow the manufacturer's instructions for applying the decals and spray on two or three coats of transparent plastic after they are dry.

To make the main chassis, an *ICA* No. 290802 aluminum chassis base is cut down, then drilled and punched. The only critical dimensions are for the holes in the front apron, used for the mounting screws.

The microphone, power switch, trimmer capacitor, and antenna jack are mounted on the front and top of the case. Mount the microphone using the rubber ring furnished with the cartridge. If desired, rubber-to-metal cement may be used to insure a secure mounting. Be sure to use an insulating washer when mounting the antenna jack.

The complete schematic diagram and a pictorial for the home broadcaster are given on these pages. Only one ground lug is used, mounted under one of the nuts used on the 1U4 tube socket. No terminal strips are needed. You'll find it easier to wire as much of the chassis as possible before mounting. Front panel connections and battery leads are left hanging free. Attach the partially wired chassis to the front panel using two  $\frac{3}{8}$ " #6 sheet metal screws and make the final connections. The oscillator coil is mounted by soldering it to the trimmer capacitor lugs. Use enough solder to insure a strong joint. A standard, commercially available, printed circuit plate is used for coupling the 1U4 preamplifier tube and the 1R5 oscillator-mixer. However, you can use individual parts here if you wish. These parts values are given on the schematic.

Once the wiring is completed, double

check each connection for possible errors. Mount the batteries in the back of the case by simply wedging them in position with narrow pieces of cardboard, then connect them to the chassis and switch with at least 6" leads. The two 45-volt batteries are connected in series to deliver 90 volts. The removable "whip" antenna is made up by mounting a banana plug in the end of half of a pair of TV "rabbit ears." An old auto radio antenna may be used instead, if preferred. Finally, place the tubes in their respective sockets and fit the two halves of the case together.

To adjust the broadcaster, place the an-

tenna in its jack, but don't extend it. Turn on a broadcast receiver and tune it to some "dead" spot near the middle of the broadcast band (700 to 1200 kc.). Throw the power switch on and, whistling or counting into the microphone, gradually adjust the tuning control with a screwdriver until you can hear yourself in the receiver. Adjust for best reception. You can now back away from the receiver gradually, extending the antenna slightly and readjusting the tuning if necessary. But remember: don't extend your range too far; the FCC will get you if you don't watch out. Have fun! **END**

# A Code Practice Set

—*the simple way*

By **ARTHUR TRAUFFER**

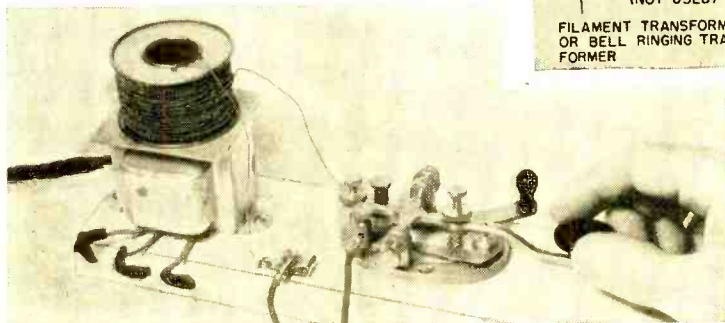
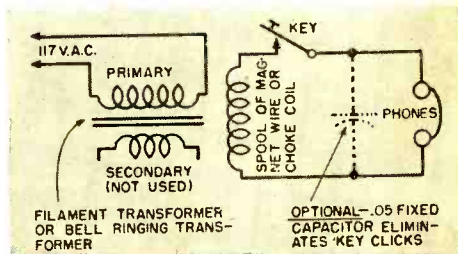

The simple code practice oscillator which can be built from surplus or junk box parts.

The spool of wire set on a transformer picks up a.c. hum by induction. When the key is pressed, tone is heard.

**While commercial code sets are nice to have, don't put off learning Morse just because you haven't one. Build this one from spare parts.**

**S**INCE a neighbor lad wanted a code practice outfit and since neither he nor I had a buzzer and I had no vacuum-tube code practice oscillator on hand, I decided to see what I could make out of my radio scrap box.

I plugged an old 2.5 volt filament transformer into the 117-volt line and taped the three secondary leads to prevent shorting. I connected an old half-pound spool of #24 silk-covered magnet wire, a key, and a pair of 2000-ohm phones in series and set the spool of wire on top of the transformer.

The spool of wire picks up a.c. hum from the transformer by induction and when the key is pressed, a pleasant low-frequency hum is heard in the phones. The volume of the hum depends on the

location of the spool of wire in relation to the transformer. If the hum is too loud for comfort with the spool placed on top of the transformer, place the spool somewhere else but close to the transformer.

If the key clicks are bothersome, connect a .05 or .1  $\mu$ f. fixed capacitor across the phone terminals. This cuts the high-frequency response of the phones and gives a beautiful low-frequency hum almost entirely free from clicks.

There is no shock hazard when using this outfit and you won't bother the other members of the family while practicing code.

A bell-ringing transformer can be used instead of the filament transformer and a choke coil can be substituted for the spool of wire as the pickup coil if desired. **END**

A "professional-looking" receiver built from the Heath AR-2 kit. It covers amateur, short-wave, and the AM broadcast bands.

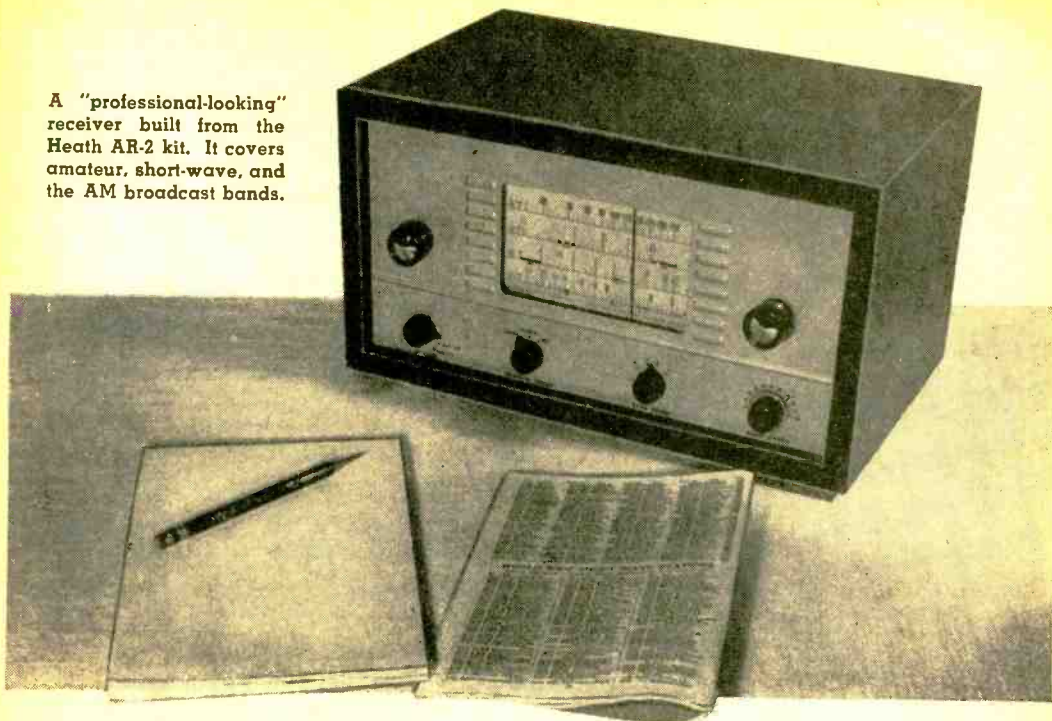

## An All-Wave Receiver Kit

IT IS a rare occasion when one is able to find complete construction details on a tuner that is home-built from scratch. The reason for this is that most publishers believe that the home design of a set, such as a tuner, lacks some essentials which characterize good design. In addition, it is a well-known fact that by the time the home builder goes out and buys the various component parts to make up such a unit, the cost far exceeds that of commercially available kits. It is, therefore, obviously foolish for anyone to build such a tuner rather than buying the kit. The kits, irrespective of manufacturer, are well-designed, include complete details, large-scale drawings, etc., so that anyone, even a novice who has not touched a soldering iron, can build it without trouble. Most manufacturers will give technical assistance, if necessary, after you are through.

Today's kit manufacturers are displaying a degree of ingenuity and foresight that staggers the imagination. Almost any piece of electronic gear anyone could desire is now available in kit form!

One example of such a kit is the *Heath*

AR-2 communications receiver. This 6-tube set, although designed primarily for short-wave listening and amateur use, will also tune the standard AM broadcast band.

The receiver covers the range from 550 kc. to 35 mc. in four bands. The six tubes include a 12BE6 local oscillator and mixer; a 12BA6 i.f. amplifier; a 12AV6 second detector and first audio amplifier; a 12BA6 beat frequency oscillator; a 12A6 power amplifier; and a 5Y3 rectifier. The set operates from line voltages ranging between 105 and 125 volts a.c., 50 or 60 cycles. The set draws 45 watts.

A cabinet to house the receiver measures 11½" wide, 5¾" high, and 6¾" deep.

As shown in the photographs on these two pages, the kit comes complete with all of the components needed to build the set, a pre-punched chassis, and complete instructions for assembling the kit.

If you can read and follow instructions accurately, you too can build this compact and professional-looking receiver that will give you hours of listening pleasure and open new world-wide vistas *via* the short-wave programs and amateur radio bands you can tune.

END





The entire waveband switching assembly, including the bandswitch, the six coils, and six trimmer capacitors, is assembled and wired by the home builder as a separate unit—then mounted on the chassis and wired in.

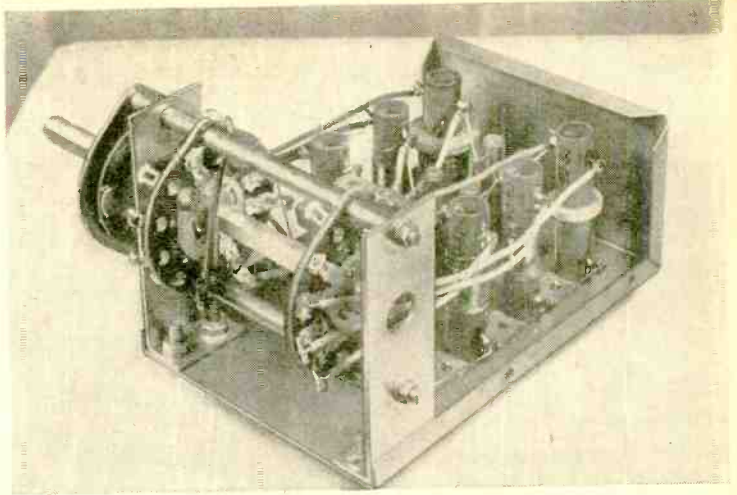

Under chassis view of completed AR-2 communications receiver. Before installing in a cabinet, align the receiver according to instructions provided in the handbook accompanying the kit. Set is then ready for use.

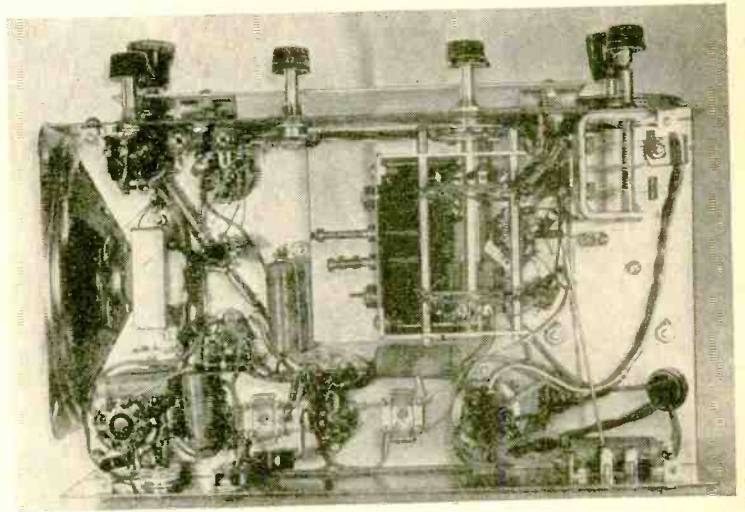

Rear view of the completed receiver chassis. Receiver may be used "as is" or installed in cabinet available from the kit manufacturer. If builder prefers, he can obtain a cabinet elsewhere or build one.

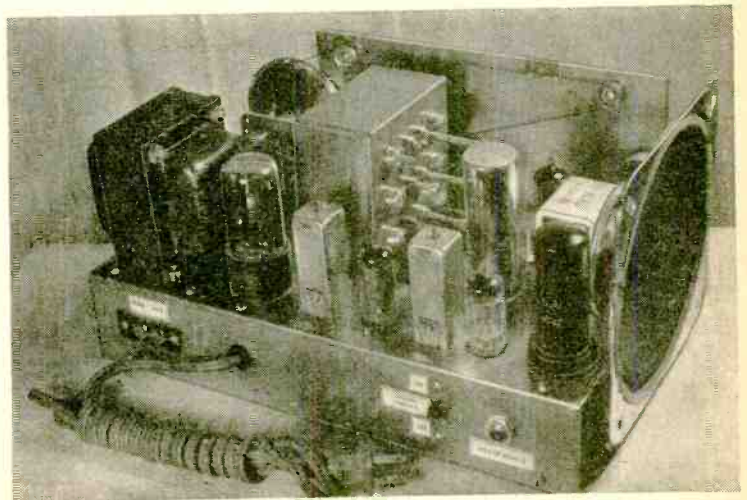

# Command Post of the Future

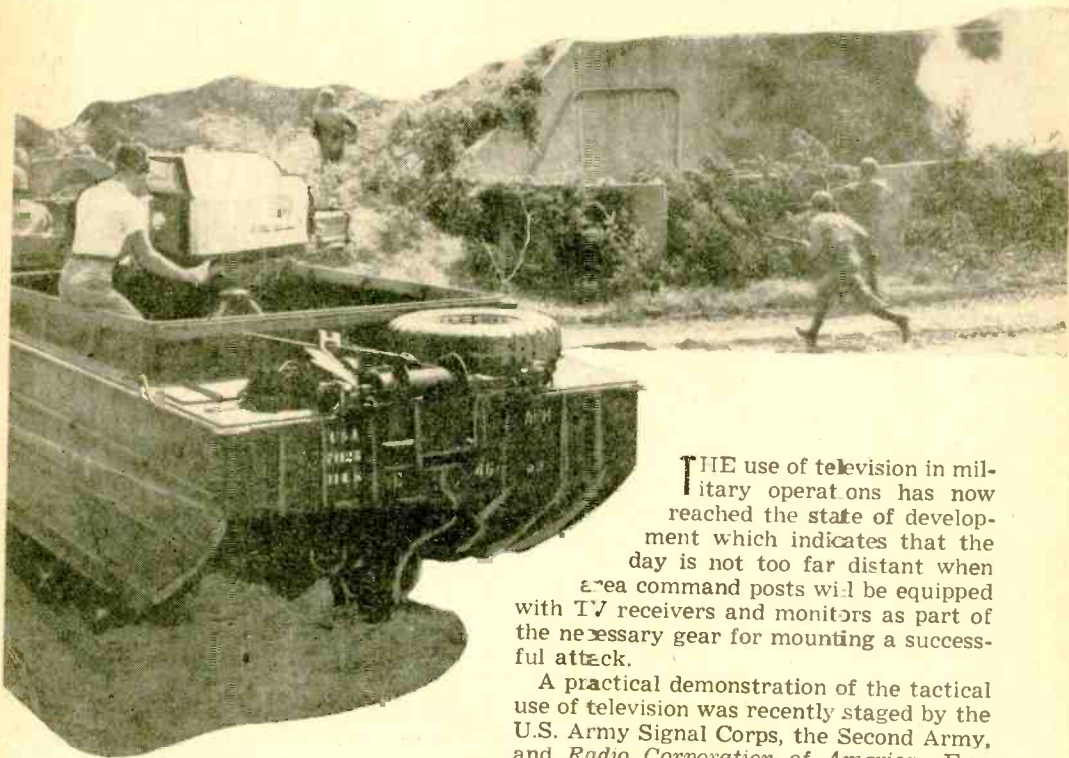

A military maneuver recorded by color camera.



A compact RCA Vidicon camera is shown in operation at demonstration of TV for warfare.



THE use of television in military operations has now reached the state of development which indicates that the day is not too far distant when area command posts will be equipped with TV receivers and monitors as part of the necessary gear for mounting a successful attack.

A practical demonstration of the tactical use of television was recently staged by the U.S. Army Signal Corps, the Second Army, and *Radio Corporation of America*. Employing current black-and-white combat TV equipment, a simulated armored and amphibious attack was staged by elements of the Army's Third Armored Cavalry Regi-

The hand-carried Vidicon is used to spot an "invading force" during mock battle at Ft. Meade, Md.





Gen. Matthew Ridgway, Army Chief of Staff, sights through the view-finder of RCA combat-type Vidicon while Brig. Gen. David Sarnoff of RCA looks on.



ment at the Army's Ft. Meade in Maryland.

Coverage in the combat area was provided for the unit by RCA "Vidicon" TV cameras, each carried by a single cameraman and feeding back to a transmitter built into a  $\frac{1}{4}$  ton truck. From each truck, the TV image was transmitted by microwave relay to a larger monitoring truck located near headquarters. The airborne system comprised two larger RCA cameras mounted in an L-20 reconnaissance plane—one of the cameras being fixed to cover the terrain directly below the plane and the other set on a movable mounting to permit oblique views of the surrounding areas. Information from the airborne cameras was trans-

mitted directly from the plane to the mobile monitoring unit. Two-way radio facilities permitted instructions to be sent from headquarters or the monitoring truck to the camera locations.

The command post in this exercise was set up in a large tent arranged to represent the field headquarters of an armored cavalry regiment equipped with full combat TV facilities. As combat cameras in the field, including an airborne unit, covered their assigned areas of action, scenes from various parts of the simulated battlefield appeared on small monitors giving the commander a true "picture" of the entire action. END

Part of NBC's mobile color unit used to cover the maneuvers. This unit, the only one of its kind, was designed by NBC engineers to provide coverage of outdoor features and remotes.

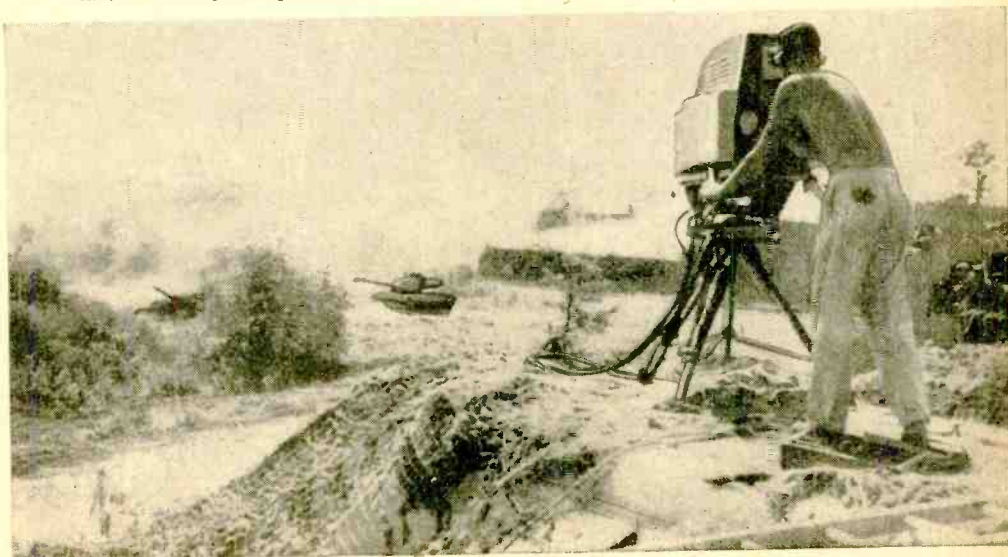



# AM I TOO OLD TO LEARN TELEVISION?

By JACK WILSON  
Pierce School of Radio-TV

"WHEN I was a young fellow of forty-five, we didn't hear much about television. If we did we didn't think much about it. I guess it was like when radio first came in, not too many people took it seriously. But now things are sure different than they were then. Television is here to stay and is America's fastest growing industry. The way I figure it is: I want to learn as much as I can during my lifetime. I don't want something new to happen and I miss out on it. So I am in training for TV. A lot of my friends said I was too old to start learning about television, and this sunk in and I tossed the thought around in my mind for several weeks before getting started. As far as I'm concerned I wasted those weeks, because I could have been well advanced in training instead of just starting."

Not one, but many men over fifty are joining the ranks of TV service people. Some are learning TV in order to have a hobby when they retire from their jobs, some want to start a small servicing business when they complete their training, and others just don't know yet what they will do with it, but they are eager to gain knowledge.

Here at *Pierce*, we had two fellows in one class who were well past the fifty year mark. They completed the course and near the end of their training they opened a small shop in Brooklyn. They now have three younger graduates working for them and are getting more than their share of business. It is interesting to note what these men did for a living before learning TV. One was a musician in a symphony

orchestra and the other had retired after forty years with an oil company.

You might say at this point, "How can I compete with the younger fellows?" I will answer that by saying that people naturally have more confidence in the mature man. When a technician is called in to look at a set, and he is a mature person, the set owner immediately feels he is more capable than a young fellow of twenty-three or so. Now I am not saying that the young fellow is not a good technician, nor am I saying he does not know as much if not more than the older fellow, but let's face it, maturity does have an edge over youth in this case.

One father and son team who graduated from our school are in business together. The father makes all of the house calls and if a set has to be pulled out for repair, the son is the bench mechanic.

A fifty-five-year-old cabinet maker commenced training recently. He had been making custom TV cabinets for some time and gradually became interested in the set itself. He plans on combining both skills upon completion of his course.

The manager of a drug store in one of New York's major hotels had always been interested in radio and television, but had never received any formal training in either. He decided to go to school in the evenings and on weekends he serviced a few sets in his neighborhood. Upon completion of TV troubleshooting he obtained the job of servicing all the radio and TV sets in the hotel. After a few months he was offered a more lucrative position in another large hotel. One day he was called in to look at a set and the guest in the room happened to be an important TV dealer from Canada. He offered the technician almost twice the



money he was presently making if he would come to Canada and take charge of his service department. This former drug store manager not only changed his vocation, but changed his whole life and he was fifty-two when he started training in television.

It seems that when a fellow passes forty he sort of gives up and feels he hasn't a chance of starting anything new. When these men come in to see me they are immediately on the defensive. The first thing they say is: "I know I am too old, I haven't been to school in a long time and I know I can not keep up with the younger fellows in theory and all of my friends say I shouldn't waste my time and money on a course in television, but I want you to tell me your candid opinion of a man my age and his chances of getting into TV servicing." I ask the applicant to follow me and I will let men older than he is answer his questions. We take a tour through the shops and he talks to several of the older men who are busily constructing radio or TV receivers. Shortly he is no longer on the outside looking in, but is one of them. Some men forget that several years of living can produce more knowledge than a hundred textbooks. If a person has enough interest he can learn anything.

In my opinion, the man over fifty should not say: "Am I too old, but am I interested, do I want to learn television?" If the answer is "yes," then to heck with the age. That is secondary because the will to learn has no age limits.

Some men in their late forties and early fifties who have qualms about starting to learn our business, would kick themselves for putting it off after talking to men who are ten and fifteen years their senior and making money in television. One fellow in training now is and has been in a furniture factory ever since he can remember starting to work. After graduation, he is not retiring, but quitting his job and moving his family to Florida where he plans on setting up a TV service shop of his own. He is so interested in his new field that he subscribes to three trade journals and reads

everything he can get his hands on about television. Over weekends he sets up shop on the kitchen table and makes a few extra dollars by servicing and repairing his neighbors radio and TV sets. This extra money, he says, will pay his expenses to Florida. He celebrated his sixtieth birthday in June.

People from all walks of life enter the television profession and do not necessarily give up their previous job or business. They merely combine TV servicing with their present work. One enterprising fellow I know has a fleet of five taxicabs. Upon graduation from training, he set up a shop in his basement at home and serviced sets in his spare time. His business gradually grew and he employed an assistant. Now he hands out business cards to his fares and has the four other drivers pass out the cards also. The number of people who respond to this small investment in business cards is amazing. It is a different approach and the passengers respond by giving their business to the fellow who was farsighted enough to learn TV and have two businesses going for him instead of just the one, and more than doubling his income. He celebrated his fifty-second birthday in October.

About five minutes ago while writing this, a fellow came into the office for a transcript of his records. He graduated on June 3rd. Before coming to *Pierce* he was a manager for a large restaurant chain in New York City. He entered the TV field because he felt that it offered unlimited opportunities for a man, no matter what his age. He is now a lab technician for a major television company. He is just as excited about his training as an eighteen-year-old entering a beginner's class for the first time. There is, however, some difference in the ages, but no difference in the enthusiasm and the urge to learn a new field. He was fifty last January.

So, if you are a young man past forty and you have been toying with the idea of learning television, consult a school offering this training and meet and talk to students who were pedaling their own bicycles before you were even born.

END

# Choosing Your TV Antenna

By CHARLES TEPFER

*Rabbit ears, trombone, yagi or what? Here are the facts to help you find the best antenna for your area.*

**T**HERE are at the present time more than 50 different types of television antennas, all designed to do the same general thing—capture a TV signal from the air and send it on its way to the TV receiver. What's the reason for so many variations?

You're wrong if you think that most of them are dreamed up by frustrated ladies' hat designers. Each type is an engineer's answer to a particular set of TV reception problems. And there are plenty of problems!

The strength of a TV signal at any point depends upon the strength of the signal as it leaves the transmitting antenna and the distance between the transmitter and the receiving point. Also important are the terrain between the transmitter and the receiving location and the frequency of the signal.

The region surrounding a TV transmitter is divided into different reception areas according to the strength of the signal in each area; thus, we have the *local*, *intermediate*, and *fringe* areas.

No matter where a receiver is, it must obtain a certain minimum amount of signal before it will give a clear picture. For most modern TV sets, this minimum is about 50 microvolts per meter ( $\mu\text{v./m.}$ ). Deluxe model TV receivers require less.

What does this mean? Merely that the signal passed from the receiving antenna to the receiver must be equivalent to what a sensitivity meter with an antenna tuned to that signal would show as 50 microvolts for each meter length of antenna. When a receiver obtains at least this amount of signal, all of its circuits will function normally and give a stable, good contrast picture.

Whether the receiver obtains this minimum signal depends upon its antenna and where it is. A local area for a particular TV transmitting station will contain approximately 10,000 microvolts of signal as a minimum. Here, in many cases, you can use the built-in antenna furnished in the set, or a "rabbit-ear" job on top of the set. The only trouble is that you are going to have to tune the built-in antenna or rotate the "rabbit ears" for each station to receive

the best picture if there is more than one TV station in the area. Also, if you have two stations, one may be strong and the other weak—too weak for the indoor antenna.

"What do you do then?" you ask. Before we hop off the deep end and run out and get some monstrosity of an antenna that claims it can bring in the penguin broadcast from Antarctica, let's get two important antenna concepts down pat. These are *gain* and *directivity*.

Where an indoor antenna will not furnish a receiver with its required minimum amount of signal, it is necessary to use an antenna that passes more of the signal in the air on to the receiver. Such an antenna is, first of all, an outdoor one—mounted on top of a building to get a clear sight of the transmitting antenna. Also, it will probably have longer arms than the indoor antenna and, in addition, more of them.

The simplest type of outdoor antenna is the *dipole*, consisting of two equal and unconnected arms of aluminum tubing or similar material positioned in a straight horizontal line. If one single length of tubing is used, folded so as to resemble a curtain rod, it is called a *folded dipole*. The length of these arms correspond to the wavelength of the received station (or the center of a received band of stations). Because this antenna is high above obstructions and has long arms, it will generally furnish a stronger signal than that which could be obtained from an indoor antenna.

If the signal furnished by this antenna is still not strong enough for the receiver (they are not all as sensitive as the modern sets), an antenna which will furnish more signal to the receiver is required. In other words, we want an antenna with more gain. If we use an antenna which furnishes twice as much signal to the receiver from the same position as a folded dipole, we say the antenna has a gain of two. All outdoor antennas are rated relative to the amount of signal furnished by a folded dipole.

The dipole antenna is so simple that it is too simple. It will furnish antenna signal

*(Continued on page 120)*

# TV ANTENNA SELECTOR



STACKED YAGI

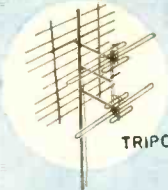

## FRINGE

TRIPOLZ

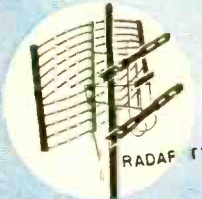

RADAF TYPE

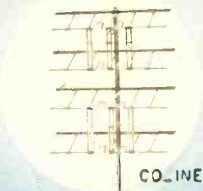

CO-LINEAR



ZIG-ZAG

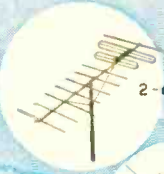

2-CHANNEL YAGI

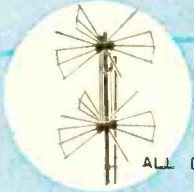

ALL DIRECTIONAL

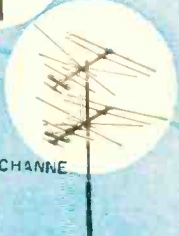

STACKED 82-CHANNE



5-ELEMENT YAGI



STACKED INLINE

## INTERMEDIATE



DOUBLE "V"



TROMBONE



PIGGY BACK



CONICAL

## LOCAL



DIPOLE



WINDOW



INDOOR



# THE WORLD AT A TWIRL

By K. R. BOORD

THE property possessed by short-wave radio, that of spanning great distances with strong signals, has encouraged the nations of the world to make wide use of the short-wave spectrum for broadcasting purposes. For instance, the British Broadcasting Corporation (BBC), the Voice of America (VOA), the Canadian Broadcasting Corporation (CBC), All India Radio (AIR), the Australian Broadcasting Commission (ABC), the Soviet Union, and many of the other larger nations radiate on short-wave. These organizations have extensive short-wave services, in fact, for the benefit of listeners all over the world.

Most of these broadcasters use *directional* antennas, that is, their broadcasts are directed toward particular areas, and these give names to their various services—such as the European Service, Near Eastern, Middle Eastern, Far Eastern, Pacific, North American, and so on. Some broadcasters also have a General Overseas Service (such as that of the BBC or of Radio Pakistan). Language and frequency (or wavelength) used vary according to the area to which broadcasts are directed. Channels also may be varied according to the hour of reception in the target area.

Some countries—such as Portugal—broadcast in their own language to former residents now living in foreign countries. Norway broadcasts also to its seamen on ships in various parts of the globe.

\* \* \*

## How to Tune

A "must" for the short-wave listener (SWL) is to learn *how* to tune the receiver. You must know *what* to look for; *when* to listen for it and, above all, be able to *recognize* it when you do *hear* it. This is largely a combination of knowledge, skill, and patience.

It's a good idea for the beginner to first familiarize himself with the operation of his receiver on *all* bands. Then he can decide what he gets the most fun from in his DX hobby and henceforth pursue that phase to his utmost enjoyment!

If possible, your receiver should have

some method of bandspreading to help you separate stations in the crowded short-wave bands. It's helpful to select "key" stations from which to cover the different sections of the particular band in use. WWV, the Bureau of Standards Station in Washington, D. C.—which operates on such channels as 2,500, 5,000, 10,000, 15,000, and 20,000 mc.—and any other stations which do not drift appreciably may be used for this purpose.

Operate your receiver at maximum sensitivity and broadest possible selectivity when "fishing" for a station. Once the station is located, adjust from there for "best listening" position. Ordinary "home" receivers and other smaller sets must be tuned "very slowly" and carefully (with volume turned up a plenty!) or you may pass by a weak signal and never realize it was there (don't forget there's a wide frequency range covered in each dial division of the short-wave bands).

As the "slow technique" of tuning is mastered, you'll log more and more DX (*distant*) stations. Patience, perseverance, and persistence may be pretty big words—but they are essential to successful SWLing, the kind that pays off!

Always tune carefully for the center—best reception point—of any desired signal. Realize the possibility of images and other spurious (illegitimate) signals.

And don't be frightened by squeals, whistles, and interference while tuning, for these may lessen greatly or completely disappear once the receiver's mechanism is centered properly on the desired signal. After the set is centered on the signal, the volume and tone controls often can be adjusted to reduce noise and interference.

Be prepared for dial calibration (numbering) being "off"; in some cases, a care-

(NOTE: Unless otherwise stated, all time herein is expressed in Greenwich Mean Time—GMT—subtract 5 hours for EST, 6 for CST, 7 for MST, 8 for PST. This is on a 24-hour clock basis in which midnight is 2400 (or 0000), 3 a.m. is 0300, 10 a.m. is 1000, and noon is 1200, for example; instead of starting again at 1 p.m., as the 12-hour system does, the 24-hour system continues to increase the number of each hour until 2359 (11:59 p.m.) is reached, thus 1 p.m. is 1300, 5 p.m. is 1700, 10 p.m. is 2200.)



ful alignment by a qualified service technician may help, but it's seldom possible to get highly accurate readings across the entire spectrum (all bands).

In tuning, when interference is present from closely-adjacent stations, always tune in the opposite direction from the interfering signal for least *QRM* (interference from another station). For instance, if a station you wish to listen to is on 9.500 and another which is interfering with it is on 9.505, adjust the receiver so reception of the 9.500 outlet is towards 9.495 on the fringe of the 9.500 station's lower sidebands. This may produce some distortion but it often helps you to identify the station you're after!

Be sure your receiver is warmed up—15 minutes at least—to get the best results. Even then give the signal time to "build up." You might "hit" a station just when it has a slow fade (*QSB*), which in a little while might come up to fair listening level. So don't try to hurry; stick to it!

Be persistent—and, in time, you'll find it pays not to overlook any weak signal—it may mean a fine DX "catch." You cannot judge on signal strength alone. Perhaps reception may be exceptional that day from a particular area, from a station seldom heard that well—since at times even a station of only 50 or 100 watts may sound like a 50 kilowatt! (One kilowatt is equal to 1000 watts.)

(NOTE: Around this time of year, some stations will be reverting to winter schedules (some also will move to winter frequencies); in such cases, you may find schedules one hour later than listed herein—the schedules which were in effect when this was compiled.)

This month I'm listing some additional tips for beginners—with a few included for experienced DX-ers. Remember, time is given in *GMT*.

### For the Beginner

*Azores*—Tune for CSA92, 11.925, Ponta Delgada, 1900-2000 (will be on winter schedule of 2000-2100 soon); all-Portuguese. *Belgium*—ORU, 11.850, Brussels, beams to North America daily 0000-0300, *English* from 0100; is relayed by OTC, 9.655, Leopoldville, Belgian Congo. *British Guiana*—Radio Demerara, ZFY, 3.255, Georgetown, usually can be heard through *QRM* (interference) around 0100-0200. *British Honduras*—Check Radio Belize, 3.300, at 2000 when should have *English* news.

*Costa Rica*—Try TIFC, 9.647, San Jose, "Lighthouse of the Caribbean," for religious broadcast in *English* around 0400. *Czechoslovakia*—Prague is using *new*

Graham Hutchins. DX Editor for Radio Australia, presents his DX tips each Sunday from Radio Australia, Melbourne. Best times to listen for this session are (for Western DX-ers) 0400 GMT (Saturday 2000 PST) over 15.200, and (for Eastern and Central DX-ers) 1330 GMT (Sunday 0830 EST or 0730 CST) over 9.615. By listening to such DX news from Australia, Sweden, Belgium-Belgian Congo, Denmark, and Switzerland regularly, the SWL can keep up-to-date on all the latest tips on short-wave developments.



9.650A (*approximately*) channel in parallel with 9.550 for *English* to North America 0400-0430. *Egypt*—Try Radio Cairo's recently added channel of 9.795A around 2100-2330 closedown for the Arabic Service. Its 9.475 outlet has *English* news 1830. *Finland*—If you're lucky, you may be able to log Helsinki on 15.190 when it has *English* 0945-1100.

*Guatemala*—Check 6.375A around 0300 for the official government radio in Guatemala City which now announces "Radio Nacional de Guatemala" instead of former "La Voz de Guatemala"; or try TGWA, 9.760, same slogan, which opens 1230 with the National Anthem sung by a choral group. TGNA, 5.952A has replaced TGNC, 11.850; has *English* 0300-0445 sign-off. *Haiti*—For an *English* session, added recently by Radio Commerce, tune 9.485 on Sun. at 2200-2230. *Indonesia (USI)*—By careful tuning, you may pick up "Voice of Indonesia," 9.710, (Djakarta, in *English* around 1100-1200. (Continued on page 118)

### TIME CONVERSION CHART (24-Hour System)

GMT	EST	CST	MST	PST
0000*	1900	1800	1700	1600
0100	2000	1900	1800	1700
0200	2100	2000	1900	1800
0300	2200	2100	2000	1900
0400	2300	2200	2100	2000
0500	0000*	2300	2200	2100
0600	0100	0000*	2300	2200
0700	0200	0100	0000*	2300
0800	0300	0200	0100	0000*
0900	0400	0300	0200	0100
1000	0500	0400	0300	0200
1100	0600	0500	0400	0300
1200	0700	0600	0500	0400
1300	0800	0700	0600	0500
1400	0900	0800	0700	0600
1500	1000	0900	0800	0700
1600	1100	1000	0900	0800
1700	1200	1100	1000	0900
1800	1300	1200	1100	1000
1900	1400	1300	1200	1100
2000	1500	1400	1300	1200
2100	1600	1500	1400	1300
2200	1700	1600	1500	1400
2300	1800	1700	1600	1500

\* Or 2400

# An Easily Built

# "Black Light" Source

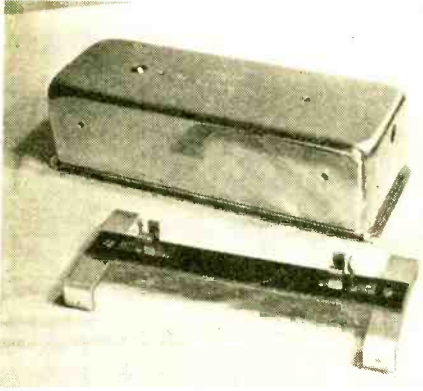

**1** The method used for mounting the lamp socket is shown here. Two "U" brackets are used. Drilled and punched fruitcake pan shown in background is used to house unit.

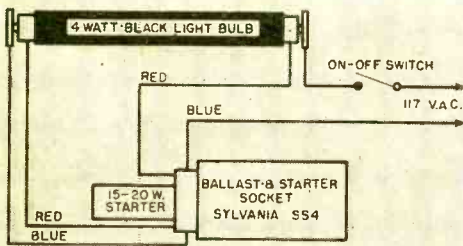

**2** Complete schematic for the "Black Light." See opposite page for parts list.

**3** Interior view of assembled and wired unit. No reflector is used in the author's model, but one can be easily added if desired.

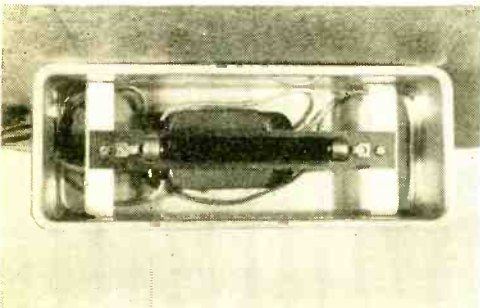

**H**ERE'S an "off beat" project you can complete in an evening's time, but one that will give you many hours of enjoyment—a simple source of "Black Light." With it you can mystify and amaze your friends, conduct scientific experiments, and even do a little prospecting.

"Black Light" is ultraviolet radiation. It is virtually invisible to the human eye, but will cause many minerals, dyestuffs, and organic compounds to glow with a weird light of their own.

The basic parts you'll need for building your own unit are shown and listed on the opposite page. Mount the socket with two "U" brackets made up out of  $\frac{3}{4}$ " x  $\frac{1}{8}$ " aluminum bar stock as shown in Fig. 1. A fruitcake pan is used to house the completed unit—drill mounting holes in it for the socket brackets, for the "on-off" switch, for the ballast, and for the handle. Drill one large hole in the end for the rubber grommet and the line cord.

The wiring diagram is given in Fig. 2 while the interior and exterior views of the assembled unit are shown in Figs. 3 and 4 respectively. No reflector was used in the model but one can be easily added by the builder if desired.

Cement bright aluminum foil to a piece of cardboard somewhat wider than the top of the fruitcake pan. Use household cement for this job, and smooth out the foil to obtain an unwrinkled surface.

Cut the completed reflector to exactly the same length as the interior of the



**4** Exterior view of completed unit. Despite fruitcake pan housing, the finished unit has a "commercially-built" appearance.



### PARTS REQUIRED

- 1—4 w. "Blacklite" bulb
- 1—Socket for bulb
- 1—Sylvania SS4 ballast with starter socket mounted
- 1—15-20 w. fluorescent light starter
- 1—S.p.s.t. toggle switch, S<sub>1</sub>
- 1—6 foot POSJ line cord
- 1—Rubber grommet
- 1—Kitchen cabinet handle
- 1—Fruitcake pan
- 1—8" pc. of 3/4" x 1/8" aluminum bar stock

Misc: sheet metal screws, machine screws and nuts, wire, solder, etc.

The first four basic items are available as a low cost "kit" from Herbach and Rademan, Inc., 1204 Arch St., Philadelphia 7, Pa.

Parts required for building the "Black Light" source described in article.

housing and make cut-outs for the socket contacts. Be sure to leave sufficient clearance so there is no danger of short circuits.

Bending the reflector to form a curved surface, slip it inside the housing (remove the "Black Light" bulb first, of course) and fasten it in place with screws used to hold the socket to the "U" brackets.

Once the wiring is completed and checked, plug the unit into any wall outlet (115-120 volts a.c.) and turn it "on." Turn off the room lights. You will have to wait several seconds for the unit to operate, so don't expect it to come "on" immediately.

Hold the unit so that the "Black Light" shines on a friend's face. You will notice that his teeth and eyeballs glow with an unearthly light. False teeth can be spotted immediately, for they glow differently than natural teeth.

Examine clothing under the "Black Light." You will find that many dyes glow brightly while others are dull. Some dyes

glow with one color under "Black Light" but reflect a totally different color under normal light. You may be able to spot "invisible" laundry marks and identification symbols.

Examine household and lab chemicals under the unit. Rosin soldering paste, *Vaseline*, oil, and many other household and electronic lab chemicals will be found to glow, often with a light other than their "natural" daylight color.

You can use the completed unit to study minerals, as shown in Fig. 5. Scheelite, fluorspar, willemite, and calcite are a few of the minerals that fluoresce or glow under ultraviolet light. A number of radioactive salts also fluoresce. Check standard handbooks and the encyclopedia for a complete list of such minerals if you plan to use your "Black Light" for prospecting.

Even if you can think of no aching void in your life that needs to be filled by a "Black Light" unit, it is fun to have around for party stunts of all kinds, if for no other reason. END

**5** Using the "Black Light" to examine minerals for fluorescence. This is only one of the uses for this handy portable instrument.



**6** By adding a standard inverter, you can operate the "Black Light" from your 6-volt auto battery and thus use it for field work.

# The Lorenz "Sixty-One"

By E. J. LORENZ

Construction details on an R/C receiver for model boats, airplanes, etc. Its companion 27.255 megacycle transmitter will be covered in next month's issue.

**I**F YOU'VE wanted to control a model airplane, boat, or racing car by radio, and want a receiver that is simple but highly efficient and reliable, here's the one for you. When used with the transmitter to be presented next month, this receiver will enable you to operate model planes, boats, cars, or perform other remote functions over a ground distance of  $\frac{1}{2}$  mile. This equipment operates on the license-free band of 27.255 mc.

The receiver is a completely new circuit designed around the recently-introduced Sigma 8000-ohm CDS 26F relay. This is a very stable superregenerative gas-tube circuit which is simple to construct and operate. The RK61 gas tube has a relatively short life when used in regular circuits as compared to a high-vacuum tube. However, it has the big advantage of being easier to work with and is more sensitive than the average single vacuum-tube receiver. Due to the characteristics of the Sigma 26F relay, it is possible to operate the RK61 tube at a reduced plate current setting, thus adding measurably to its life.

The parts in the list accompanying Fig. 1 are obtainable from most radio supply houses or by writing to *Control Research*, Box 9, Hampton, Virginia.

And now to begin construction. It is important when building any electronic unit from a set of plans to use the exact compo-

nents specified if the originator's operating characteristics are to be obtained. The chassis is cut from a piece of  $\frac{1}{16}$ " Micarta, or similar material, and drilled as shown in Fig. 4. Next, wind coil  $L_2$ , as shown in the inset drawing of Fig. 1 and according to the specifications in the parts list.

The tube socket and eyelets are pressed into place, as shown in Fig. 4. Following the schematic diagram in Fig. 1 and the top view in Fig. 3, solder capacitors  $C_1$ ,  $C_2$ , and  $C_3$  in place. A short piece of small-size insulated wire is jumpered from the coil end of the 15- $\mu$ fd. capacitor,  $C_1$ , to the outside terminal of the tube socket. This outside terminal should be indicated by a small dot of red nail polish or paint to indicate the plate connection for the tube and provide proper positioning of the tube. The 10- $\mu$ hy. r.f. choke is next soldered in place between the plate terminal of the socket and the eyelet shown in Fig. 2. The .03- $\mu$ fd. ( $C_4$ ) plate bypass capacitor is also soldered in place.

The 2-megohm resistor,  $R_1$ , is soldered in place between the third terminal connection on the socket (from the red dot side) and the ground connection eyelet. Incidentally, the tube connections, as taken from the red dot on the tube base, are: plate, filament, grid, and filament.

A short piece of insulated wire is soldered between the ground eyelet and the second terminal connection from the red dot on

Fig. 1. Schematic and parts list for the radio control receiver.

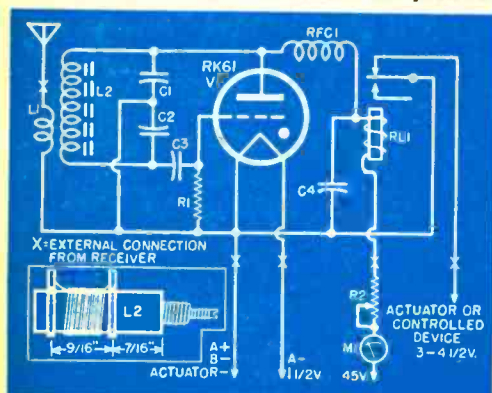

- $R_1$ —2 megohm,  $\frac{1}{2}$  w. res.
- $R_2$ —25,000 ohm subminiature pot
- $C_1$ —15  $\mu$ fd. tubular ceramic capacitor
- $C_2$ —47  $\mu$ fd. tubular ceramic capacitor
- $C_3$ —100  $\mu$ fd. tubular ceramic capacitor
- $C_4$ —.03  $\mu$ d., 200 v. tubular paper capacitor
- RFC1—10  $\mu$ hy. r.f. choke (National)
- RL—8000 ohm relay (Sigma CDS 26F)
- $L_1$ —4 t. lightweight plastic covered wire (see text)
- $L_2$ —15 t. No. 26 en. copper wire wound on Cambridge Thermionic  $\frac{3}{8}$ " dia. coil form with red dot slug (see text) Powdered iron slug to have no brass slug attached
- $M_1$ —0.2 or 0.3 d.c. milliammeter
- V1—RK61 tube (Raytheon)
- Misc. Parts:
  - 1—6-prong subminiature socket (Cinch)
  - 1—4-prong miniature plug and socket (Cinch or Amphenol)
  - 1— $\frac{1}{16}$ " x  $1\frac{3}{4}$ " x  $2\frac{1}{2}$ " Micarta chassis (see text)
  - 5— $\frac{3}{32}$ " dia. eyelets

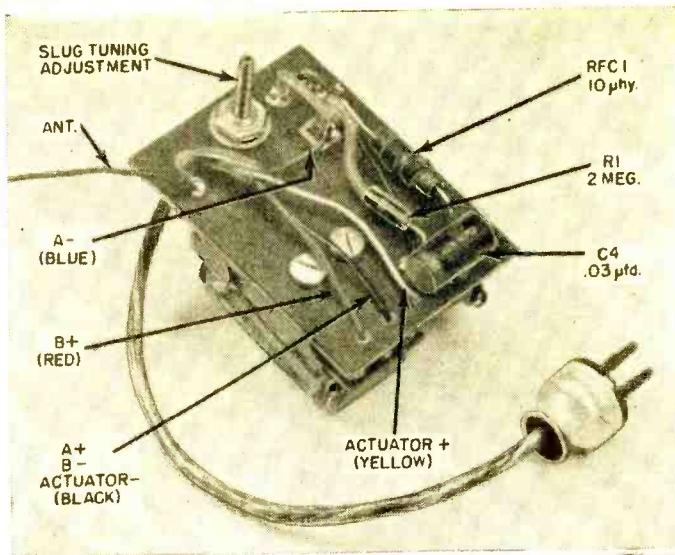

Fig. 2. Bottom view of the radio control receiver, showing the tuning adjustment and some of the parts.

the socket. Be sure the center connections between the 15- $\mu$ fd. and 47- $\mu$ fd. capacitors are soldered to the eyelet near the coil, and a short insulated lead run from the eyelet to the second socket terminal which has been grounded by a jumper to the ground eyelet connection.

Before mounting the relay and the power wires or cable, check your connections again using the schematic and Figs. 2 and 3. Mount the relay as shown in the photographs. Note that this receiver will function with peak performance *only* with the *Sigma* 26F relay. A slightly larger *Sigma* relay, the 10,000-ohm 5F will also work fine, but due to its larger size and weight, a new chassis layout would have to be made.

The power cable is inserted from the top side of the chassis. It is desirable to use color-coded wire for this work. The cable we used contained red, black, blue, and yellow wires, and we'll follow this color code in making the hook-up. The red wire, which is "B+" and goes to 45 volts positive, is connected to one side of the relay coils. (Of the three in-line terminals on the relay, the two outside ones are coil connections and the center one is the common for the relay points.) The other outside coil connection is connected by a short piece of insulated wire to the junction of the r.f. choke and the .03- $\mu$ fd. capacitor. The black wire, which is "A+" "B-" and the minus side of the relay points, goes to the ground connection eyelet and the center of the three in-line terminals on the relay. The yellow wire goes to the normally-closed relay point. The blue wire, which is "A-", goes to the 4th tube socket terminal. (Note that only 4 of the 5 tube socket terminals are used; the fifth is left blank.) Now attach a four-prong plug to the other end of the cable,

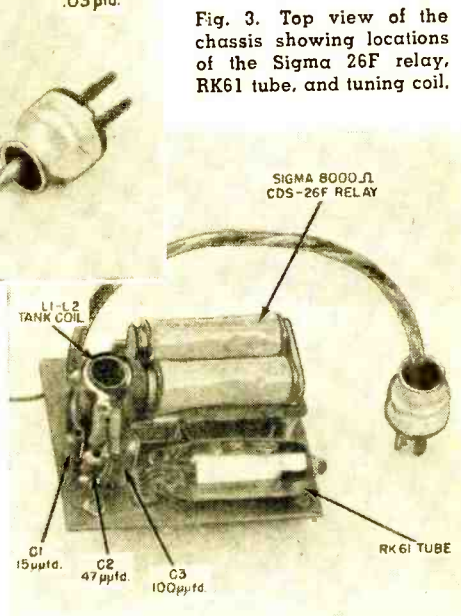

Fig. 3. Top view of the chassis showing locations of the *Sigma* 26F relay, RK61 tube, and tuning coil.

making sure you identify each pin with the proper wire before applying voltage.

The antenna coil,  $L_1$ , is made from light-weight plastic-covered wire and wound near the grid end of coil  $L_2$ . Wind in the same direction as  $L_2$ , and solder one end to the eyelet next to the coil which has been grounded. The other end is soldered to the antenna eyelet. The antenna coil may be held in place by several small dabs of nail polish. The leads of the RK61 tube should be cut off to a length of about  $\frac{1}{2}$ " and then bent at a 90-degree angle. Be sure to keep the red dot on the tube towards the outside terminal of the tube socket, since the red dot on the tube indicates the plate lead. This completes the receiver and we are ready for testing.

The  $1\frac{1}{2}$  volts for the filament may be obtained from a medium-size flashlight cell, or larger. The plate voltage of 45 volts may be obtained from two 22 $\frac{1}{2}$ -volt hearing-aid cells connected in series, or a 45-volt portable radio battery. An "on-off" switch (not shown) should be placed in the black lead. A 25,000-ohm potentiometer is placed in series with the red lead. For tuning pur-



Fig. 4. The chassis for the receiver is a rectangular piece of Micarta drilled and cut for the various components as shown.

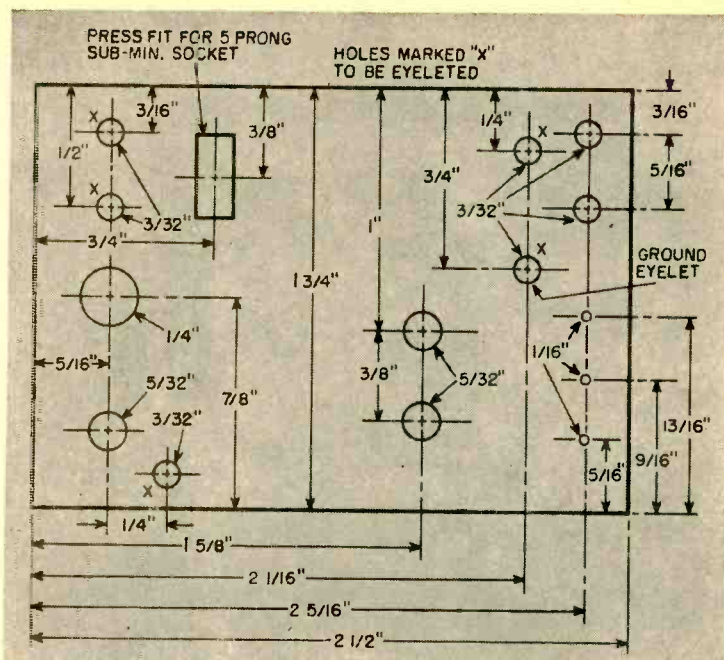

poses, a 0-2 or 0-3 d.c. milliammeter is also placed in series with the potentiometer in the red lead, and  $R_2$  set for maximum resistance before the 45 volts are applied.

After turning the "on-off" switch "on," check to see if the filament is glowing in the tube; if not, check the wiring again (black and blue wires and the tube socket). Upon applying the 45 volts to the receiver, the plate current reading should be about .4 to .6 milliamperes. Touching the antenna

should raise the current slightly. The relay will close when the current gets up to about .7 to .9 ma. A small flashlight bulb and battery connected between the yellow and black wire will go on when the relay is not picked up, and will go out when the plate current rises to .7 to .9 ma.

Your receiver is now in working order and needs only to be tuned to a 27 mc. signal to actuate it. Next month we'll build the transmitter and you'll be in business! END

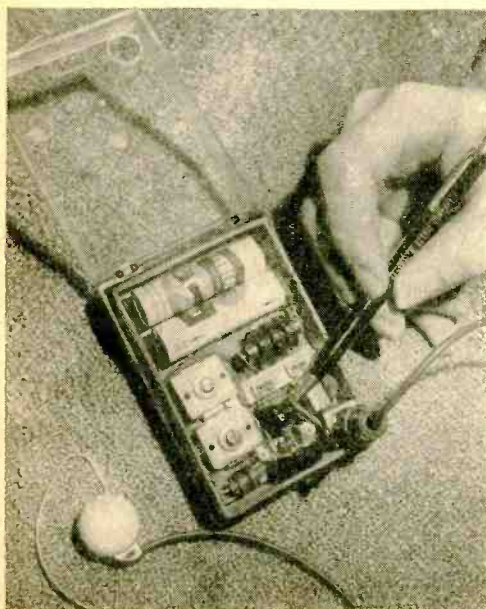

## Pocket Civil Defense Radio

A SMALL radio receiver which can be worn like a hearing aid, has been developed by two *General Electric* engineers.

Reception is limited to a single broadcast frequency, 1240 kilocycles, which is one of the two channels to be used by radio stations in broadcasting civil defense instructions to the general public during emergency periods.

The receiver, which weighs about five ounces and can be slipped into a shirt or vest pocket, uses a hearing-aid type earphone. It is said to be capable of continuous operation for more than a month without battery replacement.

Two penlight-sized flashlight batteries power the radio. Long battery life is obtained through the use of a germanium diode and a transistor, which require less power than conventional radio tubes.

The receiver needs further development before it can be mass-produced.

# Parallel Resistance Chart

You can quickly determine the effective resistance of a parallel combination of two resistances by simply laying a straightedge across the chart. **TO USE:** Place the straightedge across the values of  $R_1$  and  $R_2$  and read effective resistance in center scale:

For example:  $R_1 = 68$  ohms,  $R_2 = 91$  ohms, then  $R_T = 39$  ohms.  
(The calculated value of  $R_T$  is actually 38.918 ohms.)

For larger values, simply multiply all three scales by any multiple of 10.

For example:  $R_1 = 6800$  ohms,  $R_2 = 9100$  ohms, then  $R_T = 3900$  ohms.

Should the desired values come near the apex (0 point on graph), simply divide (or multiply) both  $R_1$  and  $R_2$  by any convenient value, then multiply (or divide) the result by the same value.

For example: To find parallel resistance of 2000 ohms and 500 ohms, divide both by 20 (2000 then equals 100 and 500 equals 25). Using a straightedge across 100 and 25, read result from center scale and multiply by 20.  $R_T$  would be  $20 \times 20 = 400$  ohms.

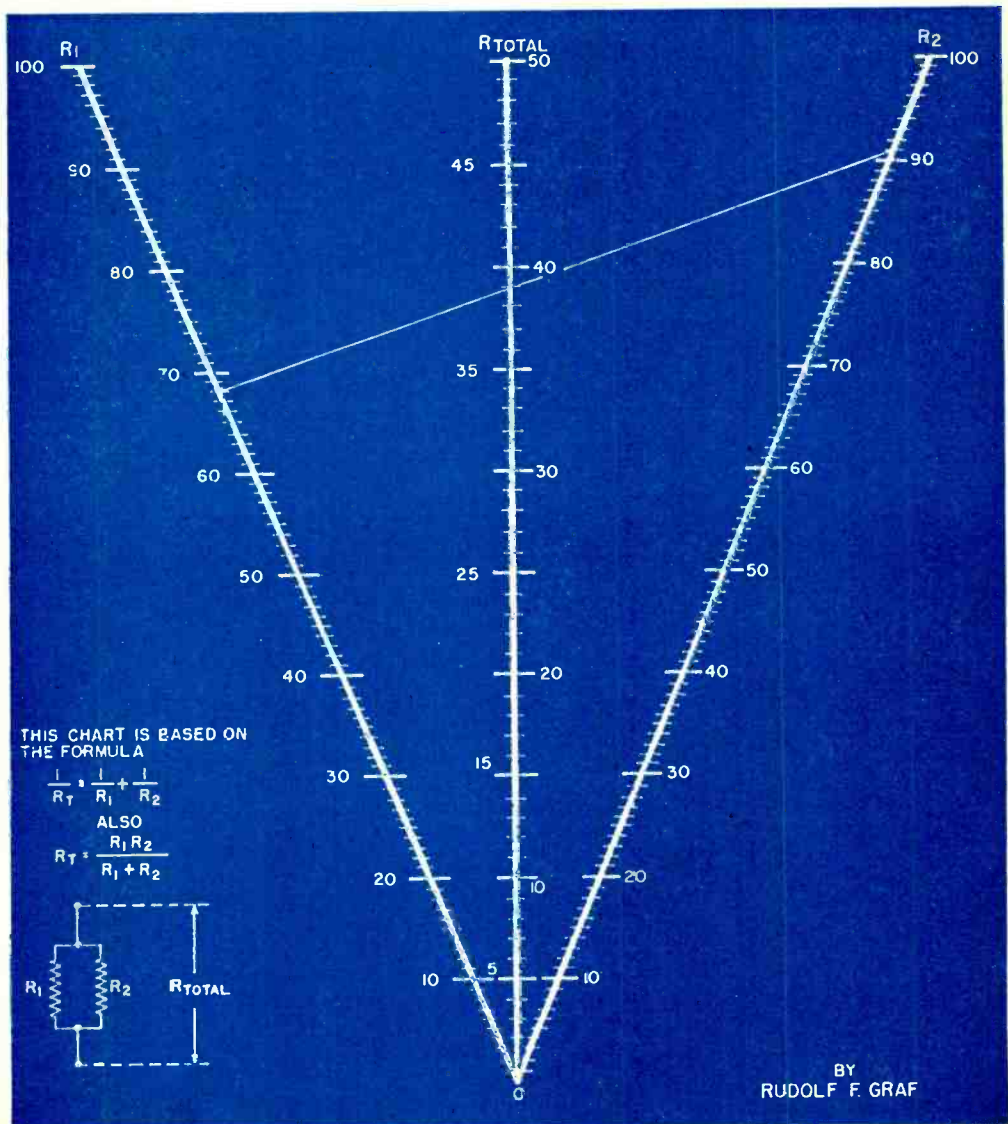

# Dentistry- the painless way

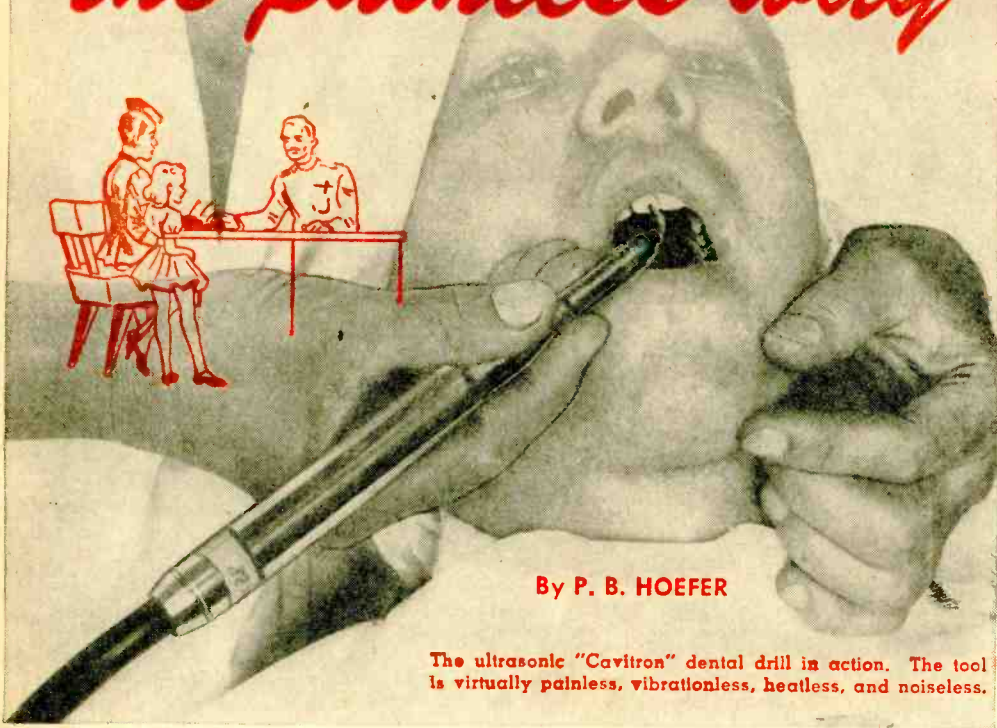

By P. B. HOEFER

The ultrasonic "Cavitron" dental drill is in action. The tool is virtually painless, vibrationless, heatless, and noiseless.

**T**HEY'VE taken the "ouch" out of dentistry! This welcome news comes from Columbia University's School of Dental and Oral Surgery where they have been experimenting with an ultrasonic process which, while originally intended for the precision cutting of metals, luckily turns out to be admirably suited to drilling teeth—without pain!

By early next year your own dentist may be drilling your teeth by means of the "Cavitron." The instrument, now in the hands of clinical investigators at dental schools, clinics, and in private practice throughout the country, will be available for general distribution to the dental profession early next year.

The "Cavitron," as shown in the photographs, consists primarily of a ferromag-

netic metal stack activated by an alternating magnetic field. The resultant expansion and contraction of the metal creates the high-speed vibration. The magnetostrictor, which vibrates 29,000 times a second, has been built into a cigar-shaped handpiece. These mechanical vibrations, at the cutting tip of the handpiece, activate particles of aluminum oxide in a water solution which is applied to the tooth surface. These particles, in turn, do the actual cutting.

Unlike the traditional dental drill which cuts with a continuous grinding motion, the "Cavitron" is not in constant contact with the tooth as it travels up and down with a reciprocal stroke whose amplitude is a mere one-thousandth of an inch. In reality, the tool does not do the cutting job at all. Thus, since there is no vibration and no



heat generated in the tooth and since heat and vibration are the primary causes of pain, the "Cavitron" is virtually painless.

The over-all effect of this ultrasonic cutting process is somewhat similar to a soothing massage, because the vibrating tool moves up and down so rapidly, it is only in contact with the tooth a very small percentage of the time. If, by chance, the tool should slip against your tongue, cheek, or gum, you would feel nothing more than a soothing massaging sensation. This is due to the fact that the ultrasonic cutting action is ineffective against soft materials, hence the tool cannot injure soft tissues.

If all this sounds good to you, think how wonderful it will be for Junior and Sis whose semi-annual trips to the dentist have been nightmares for the whole family. While dentists have, it is true, taken infinite pains with their young patients and have tried in every way possible to disassociate dental care with pain in the children's minds, the fact remains that no matter how much a child likes his dentist personally, when he is hurt he becomes definitely soured on the charms of having "pearly white teeth"—no matter what his parents tell him. With the "Cavitron," there is no noise, no heat, and virtually no pain—the child merely feels a tickling sensation that

is far from unpleasant and before he knows it the job is done and he is on his way to enjoy some promised treat "for being a brave boy"—a rather undeserved award, incidentally, because no "bravery" was required of the young Spartan.

The man responsible for the development of this unique boon to those of us with dental caries is Arthur Kuris, president of the *Cavitron Equipment Corp.* of Long Island City, N. Y. Back in 1944 he applied the ultrasonic cutting process to the cutting of gem stones and in 1947 realized the potentialities of this tool for dental drilling. Dr. Carl R. Oman, professor of dentistry at Columbia, worked with Mr. Kuris in conducting clinical and laboratory experiments at Columbia. Dr. Oman has reported that the use of the instrument requires no new skills and virtually no practice.

When medals are being struck for those whose "humanitarian services" have made the world a pleasanter place in which to live, we hope the august body of judges will not overlook Mr. Kuris and Dr. Oman.

"What, you're ready for me so soon, Doctor? Well, it's just a little cavity and I was hoping you could put off drilling until next year sometime—you see there is a new ultrasonic method for drilling teeth that doesn't hurt at all. . . ." **END**

Dr. Carl R. Oman, professor of dentistry at the Columbia University School of Dental and Oral Surgery, tunes the "Cavitron" unit. Dr. Oman has been conducting the laboratory and clinical investigations in connection with adapting what was, essentially, an industrial process to the drilling of human molars.

Close-up view of the handpiece which is part of the "Cavitron" unit. A magnetostrictor, which vibrates 29,000 times a second, has been built into this cigar-shaped handpiece. Mechanical vibrations, focused at the tip, activate particles of aluminum oxide in a water solution which is applied to the tooth surface.

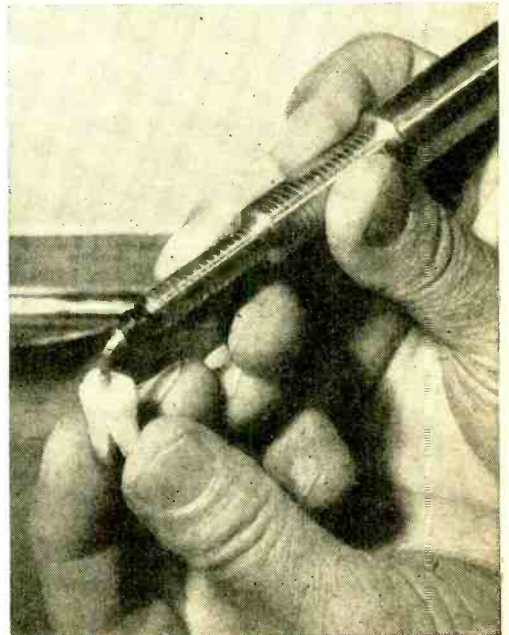

# Nine for



Commercial chassis are available in a wide variety of shapes and sizes to fit almost any project. Radio supply houses have them.

Old radios can be a source of chassis and other parts. Try your neighborhood radio service shop or local parts distributor.

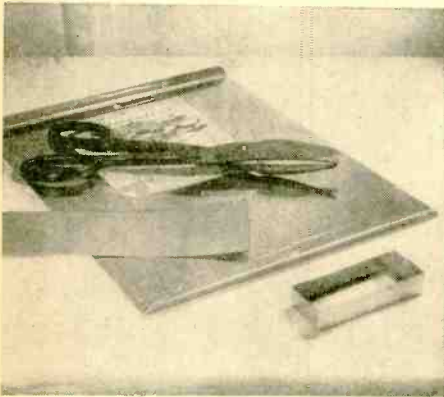

You can bend your own chassis bases from sheet metal. Cookie sheets and "do-it-yourself" aluminum may be used for raw material. Visit your dime store.

Household pots and pans can be used as chassis bases. A loaf pan (left) or fruit cake pan (right) are good bets from the dime or local hardware stores.

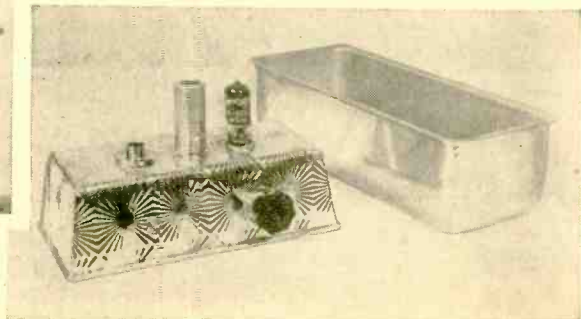

# Chassis Bases the Home Builder



Discarded cans make good chassis bases for one-tube circuits such as preamps, code-practice oscillators, etc. Your own trashcan will yield the cans.

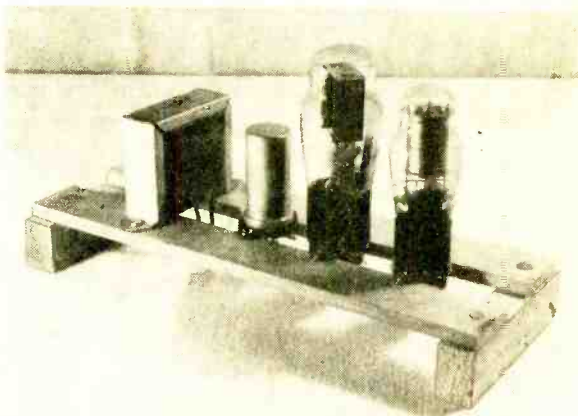

Scraps of wood may be used to make a chassis base if shielding is not important. Unit shown is an experimental power supply. Lumber yards have scraps.

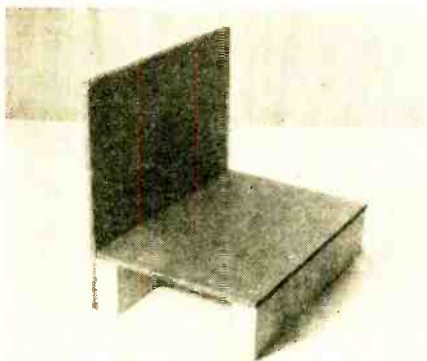

Hardboard, such as Masonite, may be used for both chassis bases and front panels where shielding is not critical in circuit.

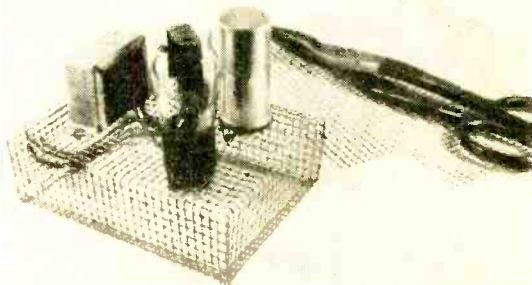

Hardware cloth may be cut with ordinary metal shears and shaped to form chassis. Hardware stores have it.

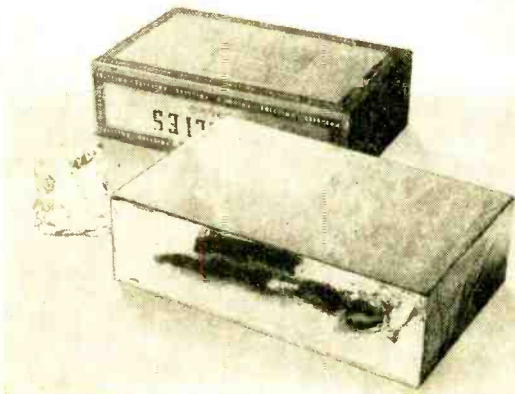

Cover an old cigar box with aluminum foil for a good shielded chassis. Use "heavy-duty" type foil and cement it to the box with household cement. Raid your kitchen!

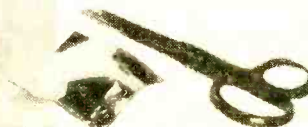

# Hints on

**YOU'LL** find that you'll enjoy working with electronic circuits if you learn to read schematic wiring diagrams. For although beginners often have difficulty following schematics, most technicians and "old timers" actually prefer a schematic to a pictorial diagram. To the experienced man, the schematic shows the scheme of the wiring and not only gives the

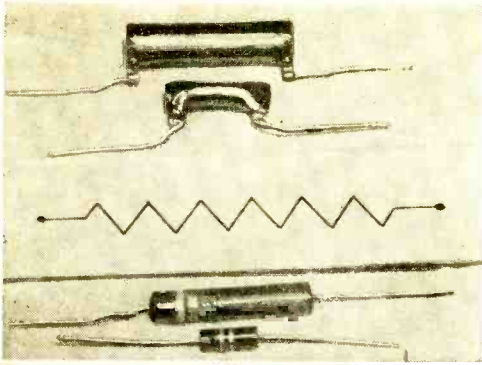

Fig. 1. Fixed resistors (top) and variable resistors (bottom) with their corresponding symbolic schematic representation.

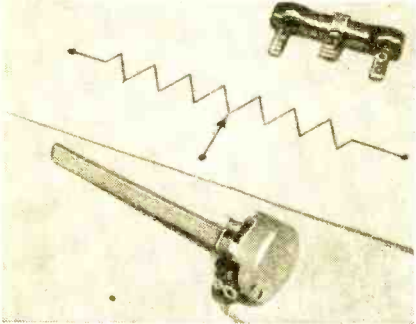

Fig. 2. Fixed capacitors (right) and variable capacitors (below) with the symbols used to designate them on circuit diagrams.

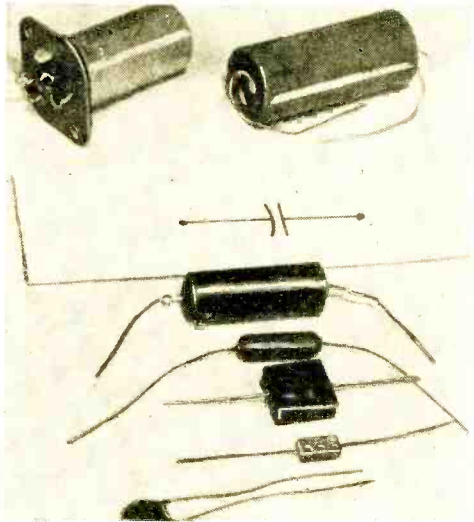

Fig. 4. Air-core coils and chokes with the corresponding symbols used in schematics.

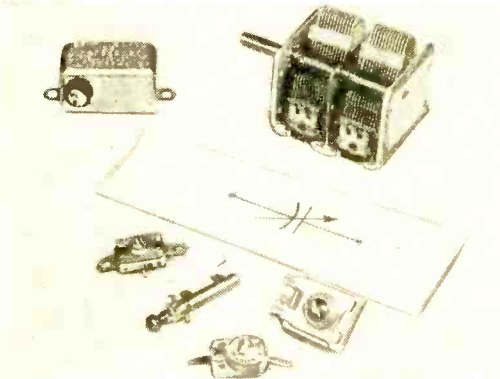
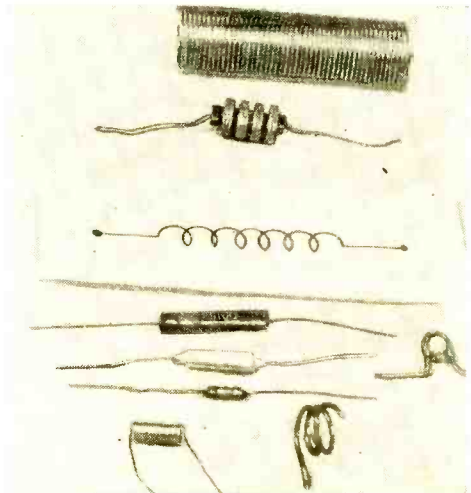
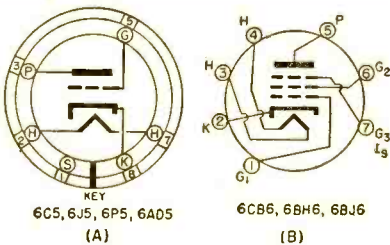

Fig. 3. Typical tube base diagrams. Pins are numbered clockwise looking at bottom of socket. (A) Octal and (B) 7-pin miniatures.



# Reading Schematic Diagrams

electrical connections, but also shows him how the circuit works and what it does. The pictorial diagram, preferred by the newcomer, gives a *picture* of the actual wiring and is easier to follow when assembling and wiring a circuit.

The chief difference between a schematic and a pictorial wiring diagram is that symbols, rather than outline sketches, are used to represent parts and electrical connections. The first step in learning to read a schematic, therefore, is to learn what symbols are used to represent various electronic components. Basic symbols, together with the parts they represent, are shown in Figs. 1, 2, 4, 5, 6, and 7. A condensed chart, showing the symbols most commonly used, appears on page 129.

## Resistors and Capacitors

The symbols used for fixed and variable resistors and for fixed and variable capacitors are given in Figs. 1 and 2, respectively. On a schematic diagram, in addition to the symbol, the value of the component will be given, or it will be identified by a letter and number code referring to a parts list. The letter *R* is used to identify resistors ( $R_1$ ,  $R_2$ ,  $R_3$ , etc.), and *C* to identify capacitors ( $C_1$ ,  $C_2$ ,  $C_3$ , etc.).

In the equipment itself, resistor and capacitor values may be either marked on the component or given by means of a color code. The basic coding arrangement used

for small resistors and disc ceramic and mica capacitors is given on page 128.

## Coils and Transformers

Air-core coils and transformers are shown in Figs. 4 and 5 and powdered-iron coils are shown in Fig. 7. Both types are used in i.f. and r.f. applications.

Transformer leads are generally color-coded for ease of identification. For r.f. and i.f. transformers, the plate lead is blue, the "B+" lead red, the grid or diode lead green, and the ground or a.v.c. lead black. The color scheme for audio transformers is blue for the first plate lead (primary), red for "B+", brown for the second plate lead (on center-tapped primaries), green for the first grid or line lead, yellow for the second grid or line lead (on center-tapped secondaries), and black for the grid return or ground lead.

Power transformer leads are identified as follows: primary, black; high-voltage (rectifier plate), red; high-voltage center-tap, red and yellow; rectifier or first filament, yellow and blue; second filament, green; and second filament center-tap, green and yellow.

## Other Components

Symbols used to represent other electrical components are given in Fig. 6. Some modification of the symbols shown may be encountered in special cases.

For example, only one type of selector

Fig. 5. How air-core transformers are designated in diagrams and units themselves.

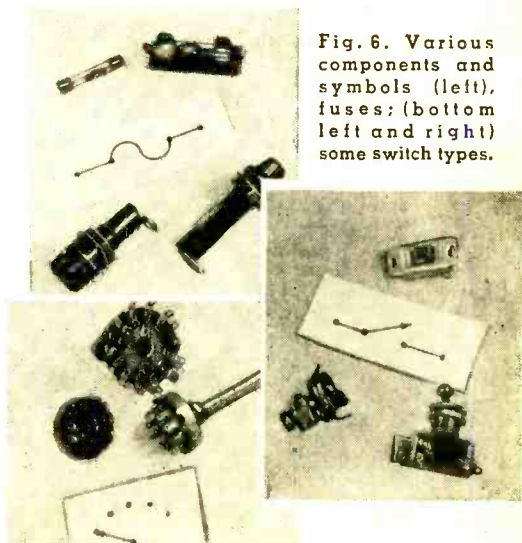
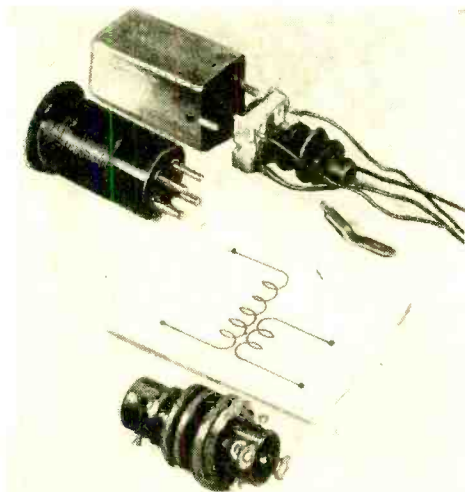

Fig. 6. Various components and symbols (left), fuses; (bottom left and right) some switch types.

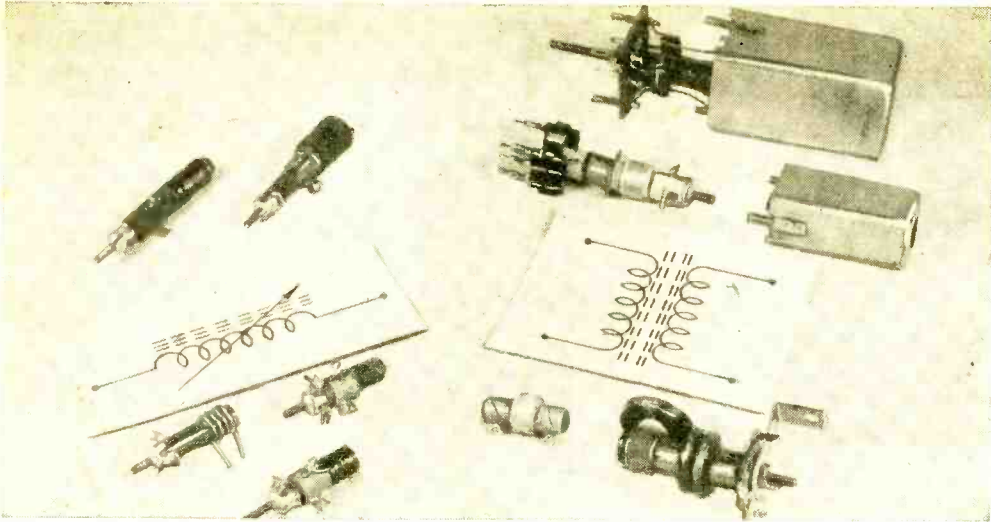

Fig. 7. Powdered iron core chokes (left) and transformers (right). Arrow indicates a unit is variable.

switch symbol is shown. A number of different symbols are actually used, depending on the arrangement and number of contacts. If two or more switches (or other controls) are mechanically connected together ("ganged"), a dotted line will be drawn between the contact arms (arrows) on the symbols, as shown on page 129.

### Tube Socket Connections

Because there are so many different types of vacuum tubes, even experienced technicians find it necessary to refer to *tube manuals* and charts to identify pin connections. Such manuals and charts are available, at nominal prices, through radio parts distributors and mail order houses.

Typical tube base diagrams, such as are given in tube manuals, are shown in Fig. 3. Tube pins are numbered in a clockwise direction, looking at the *bottom of the tube socket*.

When tracing through a circuit in a piece

of commercial electronic equipment, you may sometimes find that connections are made to certain tube pins even though the tube manual may indicate that no tube electrodes connect to those pins. Manufacturers frequently use "blank" pins on tube sockets as tie points to avoid the use of a separate terminal strip.

### Practical Circuit

A one-tube resistance-coupled amplifier stage is shown in Fig. 8, along with the schematic diagram. You can gain valuable practice in reading schematic diagrams by tracing through to identify corresponding components, then finding those components in the photograph.

Once you have mastered simple circuits, try your hand at more complex circuits. One good trick is to try tracing out and sketching the schematic diagram for a complete receiver or amplifier, working from the equipment itself. END

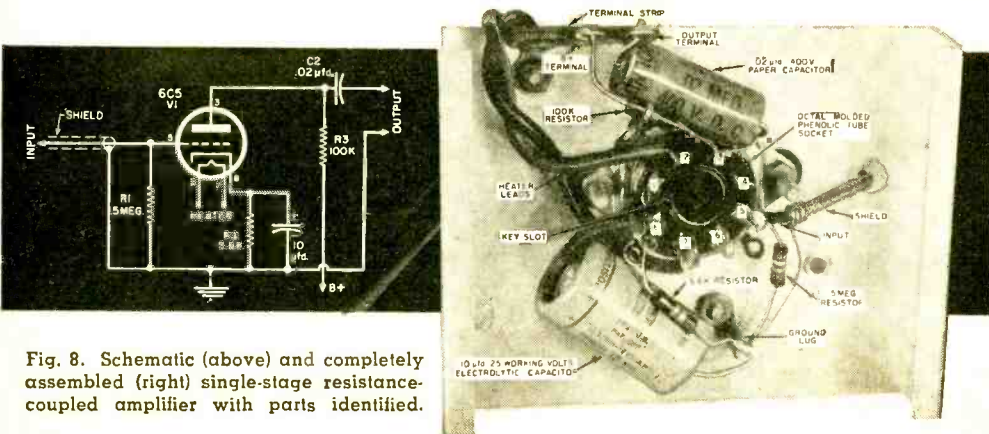

Fig. 8. Schematic (above) and completely assembled (right) single-stage resistance-coupled amplifier with parts identified.

# So You Want To Be A Ham

## LEARNING THE CODE

By ROBERT HERTZBERG, W2DJJ

A	· —	S	· · · ·
B	· · · ·	T	—
C	· — · —	U	· · —
D	· · ·	V	· · · · —
E	·	W	— · —
F	· · · ·	X	· · · · —
G	· — · —	Y	· — · —
H	· · · ·	Z	— · · ·
I	· ·	1	· — · —
J	· — · —	2	· · — · —
K	· — ·	3	· · · —
L	· · · ·	4	· · · · —
M	— · —	5	· · · · ·
N	· ·	6	— · · · ·
O	— · — · —	7	· — · · ·
P	· — · · ·	8	· — · · · ·
Q	— · · · ·	9	— · — · —
R	· · · ·	0	— · — · —
Period			· · · · ·
Comma			— · · · —
Question mark			· · · · ·
Error			· · · · ·
Double Dash (BT)			— · — · —
Wait (AS)			· · · · ·
End of Message (AR)			· · · · ·
Invitation to transmit			— · —
End of work (SK)			· · · · ·

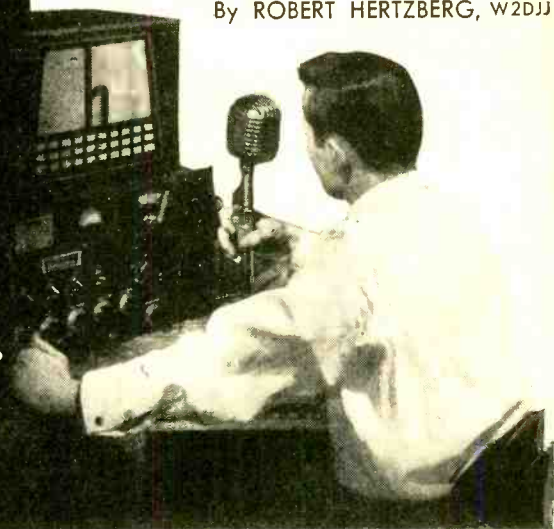

"Ham shack" with a Hallicrafters SX-73 receiver, speaker, and HT-20 transmitter.

*Part 2. The second step in becoming a radio amateur is learning code. Minimum of 5 words-per-minute is required of would-be hams.*

**T**O OBTAIN a license to operate an amateur radio station of any type or size, you must be able to send and receive simple words at the minimum rate of five-per-minute. This actually is a very slow speed, and you should be able to attain it after a couple of weeks of practice.

That last word, *practice*, is the whole secret of learning the code. No tricky "system" is a substitute for diligent, steady practice. The military services learned that basic fact during World War II, when radio operators had to be trained in a hurry. They found that they just couldn't beat the clock and the calendar. They fed trainees the code until the dots and dashes spilled out of their ears . . . literally! . . . but the process still took time.

The letters of the alphabet and the ten numbers are represented in the radio code by combinations of short and long sounds. The short ones can best be described as "dits," and the long ones as "dahs." In

printed code charts, the dits are usually shown as heavy dots and the dahs as dashes. Ideally, the dah sound is supposed to be three times as long as the dit sound. The spacing between dits and dahs of the same character is equivalent in duration to that of a dit; between letters three dit spaces; and between words five dits. Actually, it makes little difference how long or short the sounds are, providing the dahs are noticeably longer than the dits. An operator makes the dits and dahs by tapping on the knob of a telegraph "key," which is nothing more than a lever action switch. A person's keying, or "fist," is as individual as his voice and his handwriting. Experienced operators can readily identify friends by their fists even before they transmit their station call letters.

By agreement among nations, the code used for all radio communication is "International Morse," often also called "Continental" because it was first used in

You can assemble this code practice set in half an hour. The base is wood, about 5" x 6". Fasten the key and buzzer with wood screws, the batteries with a tin strap. Note position of the fingers for comfortable work.

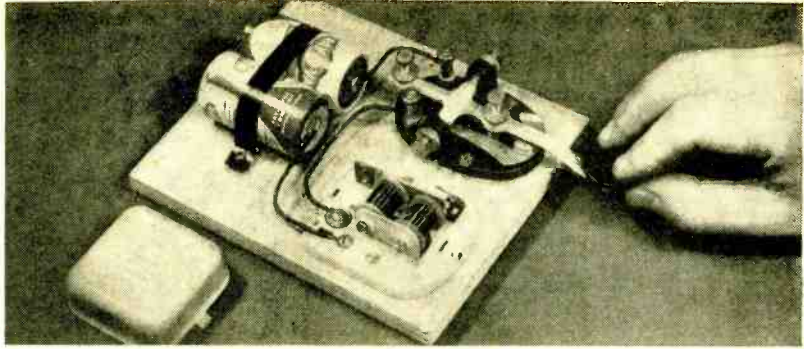

Europe. The "Morse Code," also often called "American Morse," is something quite different. In the International Code, the characters consist only of dits, dahs, combinations of dits, combination of dahs, and combinations of dits and dahs, and the spacing of sounds within characters is uniform. In the Morse Code, which is named after the inventor of the telegraph and was used for many years on American telegraph lines, the spacing *between* sounds is part of some characters. For instance: in both International Morse and American Morse the letter "S" is "dit-dit-dit." In the first code, the letter "C" is "dah-dit-dah-dit," but in the second the same letter is "dit-dit-(space, no sound)-dit." You need a sharp ear to distinguish between "dit-dit-dit" for "S" and "dit-dit-dit" for "C." With teletypewriter machines replacing the old-fashioned clicking telegraph sounder, American Morse is rapidly dying out. However, many old-time operators like to use it, just to show that they're old-timers, and you will hear it on the air now and then.

"What's the best way to start on the code?" you're probably asking. My recommendations are based on long experience. Over a period of thirty years I have taught the code to individuals, to small groups, and to 150 reluctant GI's at a time.

First, make or buy some sort of a code practice set. It can be a line-powered audio oscillator with a built-in loudspeaker, or it can be the very simple, cheap, and easily-made buzzer outfit pictured herewith. This consists of a standard radio key (which you'll use later when you go on the air with c.w.), a common house buzzer, and two flashlight cells. The parts are mounted on a piece of scrap wood and wired in series. Adjust the side nuts of the key so that the lever moves freely without binding. Adjust the back lever nut so that the spacing of the contact points is a little less than about  $\frac{1}{16}$  inch. Adjust the spring tension nut so that the lever returns to its up position quickly after you take your fin-

gers off the knob. Now you are ready to go.

With a copy of the code in front of you, start with the first letter and go through the alphabet. *Look* at the chart, but *do not* read the dots and dashes out loud. Where you see a dot, press the key down for an instant; where you see a dash, hold it down a little longer. Sending this way to yourself, you force your brain to associate the combinations of sounds with particular letters.

Learning the code is almost like learning another language. Don't overload yourself the first few times with too much new information for the memory cells in your head. Give yourself fifteen or twenty minutes an evening for about a week. At the end of this period you should be able to tap out all the letters without having to look at the chart.

Of course, sending is easier than receiving, because you know what the text matter is. To get receiving practice you need either a partner or a short-wave receiver. Initially, a partner is more helpful. You should be able to find one among your friends. What usually happens, if you announce that you're learning the code and intend to go on the air, is that *too* many assistants volunteer their services!

Two people, sending to each other in turn, can learn the code and build up speed in one-fourth the time each would require working alone. Don't be surprised if your father or brother or sister show an unexpected interest in the proceedings and invite themselves in. Father-and-son teams are a common sight at FCC examining offices.

Concentrate initially on the letters of the alphabet. The numbers will come along naturally later, as will the punctuation marks. For text, use any newspaper or magazine clipping. When receiving, use a soft pencil or a smooth-writing fountain pen, and write down each letter as you recognize it. When you do the sending, watch your partner's "copy." If he writes down the correct letter, quickly start the next



one. If he writes down an incorrect one, merely say "No, here it is again," and repeat it.

Do not drag out the dits and dahs, but make them snappy. You'll probably have to experiment with the contact spacing and the spring tension quite a bit until you hit the right combination for easy sending. Incidentally, because most keys are made of brass, hand sending is usually called "pounding brass," and c.w. operators refer to themselves as "brass pounders."

Code "speed" is figured on the basis of words of five letters. A single minute of transmission at 5 w.p.m. would thus consist of only 25 letters, giving you almost 2½ seconds for each. Initially, don't even attempt to time yourself. Just concentrate on the letters themselves, and speed will build up naturally as you continue your practice.

Don't rush down to the nearest FCC office the first time you check yourself out

at 5 w.p.m. You need a little margin of safety, because you'll be slightly nervous when you sit down in a strange room and hear tone signals somewhat different from those of your practice set. I've heard people say, "Gosh, that automatic machine in the inspector's office sure must have been fast"; this, of course, after they flunked. It isn't. It's adjusted very accurately, and if it *sounds* too fast you just haven't had enough practice.

You want to remember something in connection with the ham examination: Uncle Sam *encourages* ham radio, because hams contribute a great deal to the development of radio communication. (In fact, they're responsible for short-wave radio as we know it today.) The FCC engineers, most of whom are hams themselves, will feel disappointed if you don't pass. So clock yourself to at least 8 w.p.m. and you'll find 5 smooth sailing.

If you are forced by unusual circumstances to study the code all by yourself, use the basic buzzer set for sending practice and a short-wave receiver for receiving practice. There are hundreds of stations on the air at all hours of the day and night, and you can easily pick out some slow ones. Also helpful in this connection are code records that you can play on a standard phonograph, and inked and perforated tapes that require special transcription machines. Whatever means you use, steady practice is still the prime requirement. (To be continued)

← This commercially-made code practice set has the buzzer and batteries under cover. The International Code is printed on the cover.



Various code practice records are available. They can be repeated until code is mastered.

If you learn code by yourself, a good receiver is a help. Wear earphones to spare your family. Speed rises with practice.

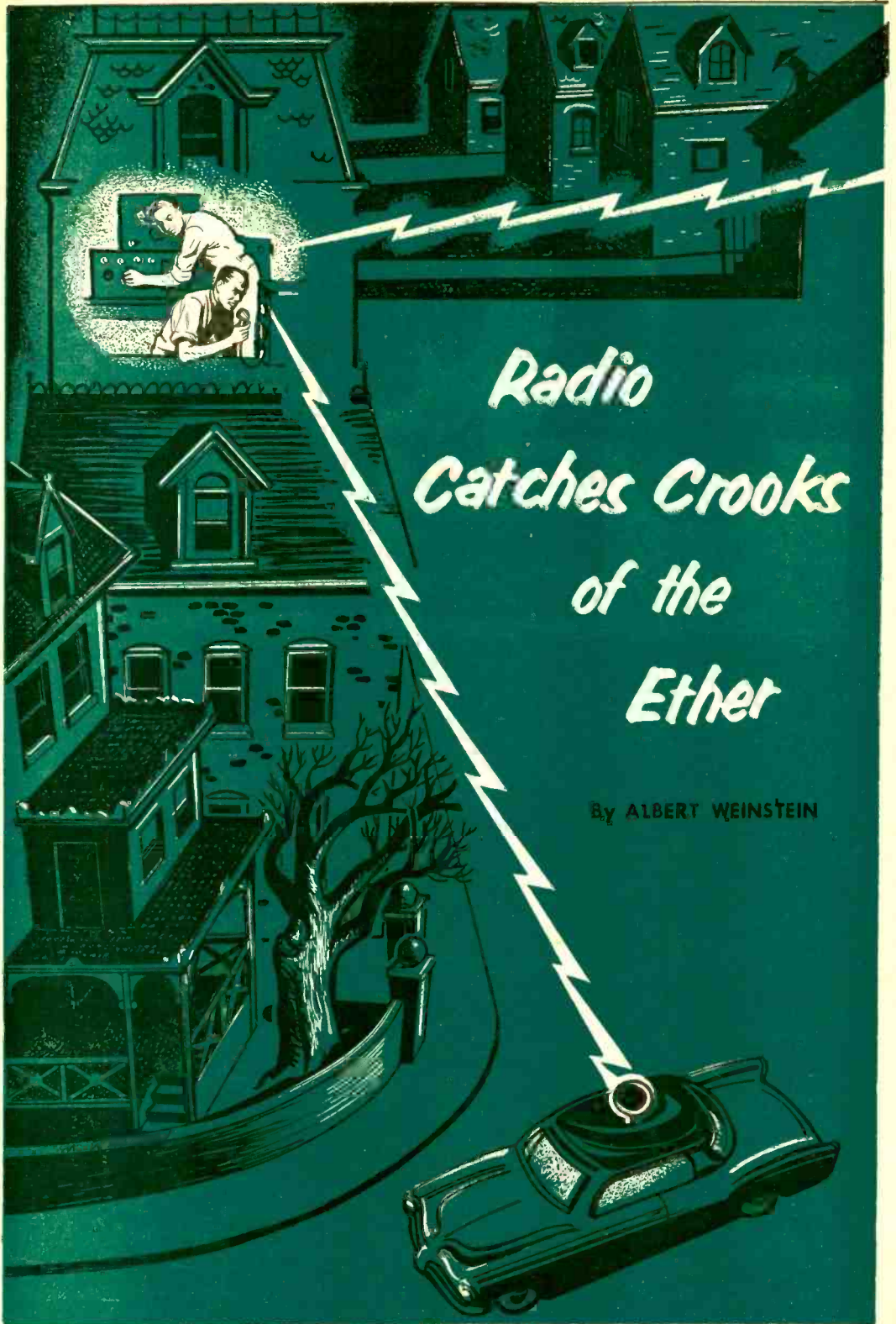

# Radio Catches Crooks of the Ether

By ALBERT WEINSTEIN

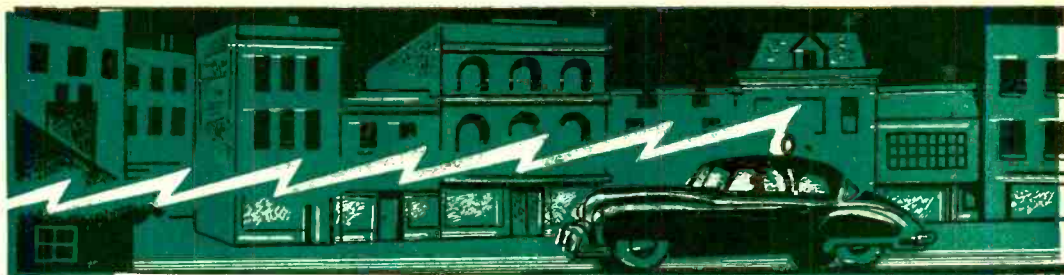

## Two-hundred pairs of "educated ears" monitor the ether for the FCC to prevent illegal use of transmitters and radio spectrum.

IMAGINE 200 policemen in a city of more than 1,000,000. Then imagine that they're all blindfolded. Not much protection, is it? But there's a group of 200 "policemen" in this country who have been so successful that each year finds fewer and fewer crooks daring to break the law—yet their main crime detection instruments are nothing more than 200 pairs of highly-educated ears listening to special radio receivers.

These men are the engineers of the Field Engineering and Monitoring Bureau of the Federal Communications Commission—located at 18 monitoring stations and manning the mobile investigative units at 24 field offices in the United States, Alaska, and Hawaii.

More than 1,000,000 radio licenses of all kinds have been issued by the FCC, and each station license specifies a "traffic lane of the ether" out of which each licensee cannot stray without blocking traffic on another lane. It's a tribute to the FCC men that this vast volume of communications is kept moving with a minimum of interference.

Deliberate law-breakers in radio have become quite scarce in recent years, thanks to the uncanny ears of FCC's field men. Most of the work nowadays is in tracking down and eliminating "interference"—those radio waves which accidentally get out of bounds—usually without the knowledge of the people who operate the faulty equipment.

Nevertheless, there is always a handful of characters who think that because radio waves move with the speed of light that they have a valuable tool for outwitting the police carrying on some shady business. These folks have to be taught the hard way.

Take the case of one "sharpie." He and his friends, like everyone else, knew you can't pick the winner at the track every time. But they knew of something just

as good, that is, knowing which horse won before the bookies did.

The technique was simple. Attending the races at Hialeah, near Miami, he would watch to see which horse won. Then, he'd reach into his pocket and manipulate a key; this would operate a tiny transmitter strapped to his body. His buddies outside the track would pick up the message, rush to a bookie, place their bets on a sure thing before the bookie had received word of the winner through his regular wire service.

The FCC's job is not to protect bookies. But the law says there must be no unlicensed transmitters, and the various States have laws about transmission of racing information. But how to detect a moving transmitter in a crowd of 25,000 racing fans?

Here's how it was done. Knowing the information was coming from Hialeah, the FCC field men moved their radio-equipped cars into the general area of the track. With direction-finding equipment, they were able to tell from what part of the track the signal was being transmitted.

Shortly thereafter, another "racing fan" joined the crowd. This dignified looking gentleman happened to be wearing a hearing aid. However, his hearing aid wasn't tuned for a hot tip on the second race. It was connected to a tiny radio hidden in his hat, and it was listening for an even hotter tip—our "sharpie's" moving radio station.

The FCC engineer was using the "hot and cold" method of detection, which means simply that the closer he got to the transmitter the stronger the signal. It didn't take long. Soon the man with the hearing aid was seated in the grandstand beside the man who fiddled around in his pocket after each race. A much-surprised "fan" was shortly paying a \$2000 bond, and his case was bound over to the grand jury.

*(Continued on page 122)*

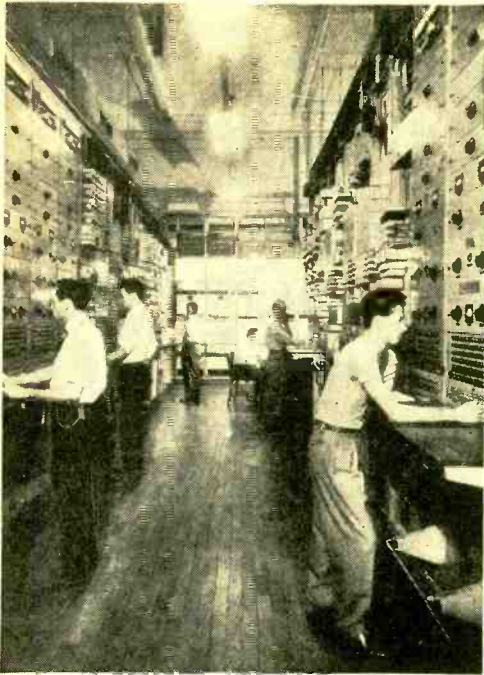

## RIO de JANEIRO'S NEW RADIOPHONE NET

**B**RAZIL has recently completed one of the world's most unique communications networks—a radiotelephone system that interconnects twenty-two of its state capitals and principal cities for domestic as well as international service.

Brazil is now the only country in the world with so many of its remote capitals interconnected telephonically to the federal capital and to each other solely by radio. The system has made possible interconnection of approximately 600,000 telephones throughout the country. As a result, areas previously without long-distance service can now reach phones throughout the world.

The system, built by *International Telephone and Telegraph Corp.*'s Brazilian affiliate, took ten years to complete.

The photograph at the left shows the control terminal room in Rio de Janeiro, one of the stations in this far-flung network.

## "PORTAFONE" USED IN CIVIL DEFENSE TEST

**A** RECENTLY-DEVELOPED emergency radio set has been used successfully in several Civil Defense exercises to supplement regular communications facilities involving two-way radio and amateur networks.

The new unit, the *Stewart-Warner* "Portafone," operates on the Citizens band of frequencies authorized by the FCC for widespread use by civilians. In times of emergency this gear can be used by CD

personnel without radio training since it operates on a fixed frequency and requires no adjustments or technical know-how from the user.

Both receiver and transmitter are incorporated in the compact unit shown below in the photographs. A "press-to-talk" button switches the unit from reception to transmission instantly. The unit weighs 28 oz. and measures 10½" high without its 6½" antenna.

Dick Miller of Stewart-Warner operates a fixed-station "Portafone" at CD center.



E. Neumann, an amateur, receives messages to be relayed by mobile W9LOY.



# Neon Tube Metronome and Seconds Timer

By  
**HARVEY POLLACK**  
Physics Instructor

THE dependable electronic metronome pictured and described here was constructed for about half the cost of a similar commercial unit. An instrument of this type serves as an aid to musicians who are striving for precision timing, and may also be used as a seconds timer in the photographic dark-room to measure the exposure of contact prints and enlargements. The speed of its beat is governed by the setting of a single knob on the front panel, each click being accompanied by a short flash of the neon lamp just under the timing knob. Although traditional metronome design calls for a range from 40 to 208 beats-per-minute, this model was provided with a somewhat greater range to permit other appli-

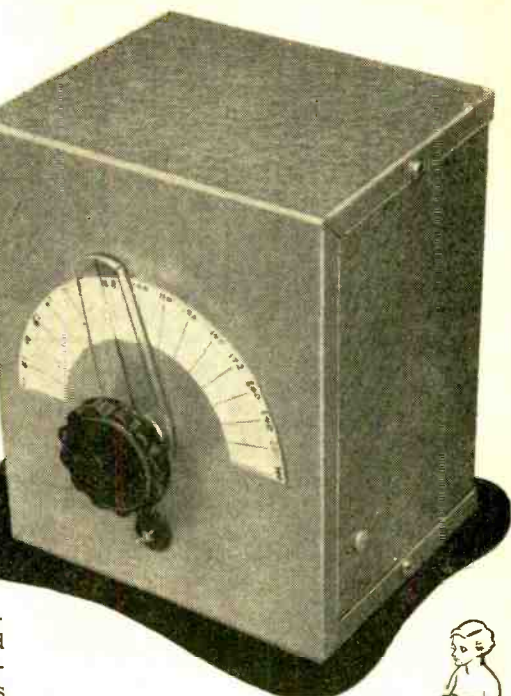
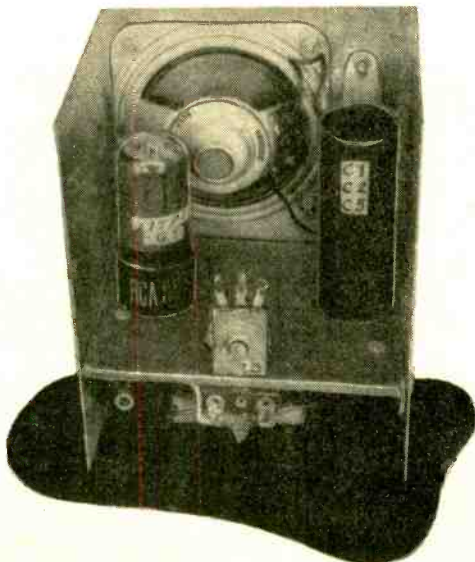

Front view showing main timing dial and neon lamp peeping through the rubber grommet just below knob.



cations requiring higher click frequencies. The rectifier section of a 117P7GT vacuum tube provides a source of d.c. which is filtered by  $C_1$ ,  $R_1$ , and  $C_2$ .  $R_2$ , the calibration control, governs the voltage applied to the capacitor,  $C_3$ , through  $E_3$  and  $R_4$ .  $R_3$ , the main timing control,  $R_1$ , and  $C_3$  form a timing circuit, in which  $C_3$  charges slowly or rapidly depending upon the setting of  $R_3$ . As the voltage across  $C_3$  builds up, the neon tube suddenly "fires" and discharges  $C_3$ , after which the charge-discharge cycle begins once more. The change in voltage across  $C_3$  is transmitted to the beam-power section of the 117P7GT and is heard as a click in the loudspeaker.  $R_5$ , the volume control, permits the sound to be varied in volume or eliminated entirely if desired, leaving only the flashing of the neon lamp.  $T_1$  is a standard type of output transformer to match the speaker used to the 117P7GT.

The metronome is housed in a 6" x 5" x 4" aluminum utility case. Most of the components are mounted on a small Masonite shelf secured to the case by small right-angle brackets. The speaker, output transformer, calibration potentiometer, and volume control are fastened to the

View with one section of cabinet removed, showing the speaker, rectifier and amplifier tube, capacitor, timing control, and neon lamp.

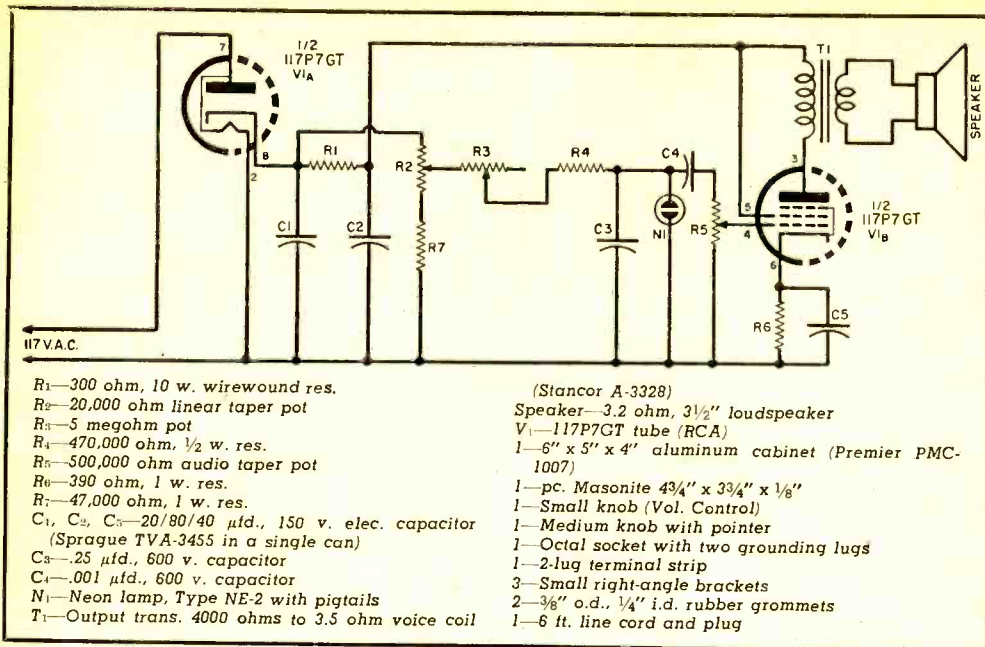

rear of the case itself, while the neon tube is visible through a hole in the front panel. Thus, the front half of the case can be removed easily without disconnecting wires between the two halves.

The first step in construction is to drill the holes needed to mount the speaker, transformer, and two potentiometers on the back of the case. At the same time, drill five 3/8" holes for easy sound passage and one for the line cord grommet, as shown in the rear view photograph. Next, lay out and drill the Masonite shelf for the octal socket, the filter unit, the angle bracket which supports the timing control, and the terminal strip on which the timing capacitor and neon lamp are mounted.

Once the various components are in position, hold the shelf in position inside the case and mark it for angle brackets. Doing it this way will help avoid overcrowding and will assist in locating the timing control shaft so that the knob will occupy the position which is shown in the front-view photograph.

No special wiring precautions need be taken since lead length is not critical. Make sure that the case is not connected to either leg of the a.c. line. The case is purely ornamental and does not play a part in grounding or wiring.

When the wiring is complete, test the unit for correct operation as follows: 1. Rotate the calibration control fully clockwise. 2. Set the timing knob at about half-scale (pointer straight up). 3. Rotate the volume control fully clockwise. 4. Plug

the unit into an a.c. outlet and allow about one minute for warm-up. The neon tube should start to flash at medium speed and clicks should be heard in the speaker. 5. Rotating the timing control clockwise should now cause the flash and click rate to increase, and *vice versa*.

The front panel may now be marked and drilled with 3/8" holes for the timing control shaft and the neon tube grommet. Assemble the case and fasten the timing knob to the shaft so that the pointer will move the same amount in either direction from a straight-up position.

There are several different ways to calibrate the metronome. The writer calibrated his instrument by establishing 100 beats-per-minute when the timing pointer was straight up. To do this, set the pointer in position, then slowly back off the calibration control while timing successive one-minute intervals until exactly 100 beats-per-minute are heard. Leave the calibration control in the same position while you adjust the frequency control and mark the dial for other frequencies.

Assuming that all of the wiring has been done correctly, troubles may appear due to defective components or poor placement of parts. Some of these, with possible causes, are given below:

1. *Does not flash or click at any setting:* Trouble indicated in rectifier or oscillator section. Check for defective tube or neon lamp, leaky filter capacitor, **C<sub>1</sub>**, or timing capacitor, **C<sub>3</sub>**, or open resistors **R<sub>2</sub>**, **R<sub>5</sub>** or **R<sub>7</sub>**.

(Continued on page 48)

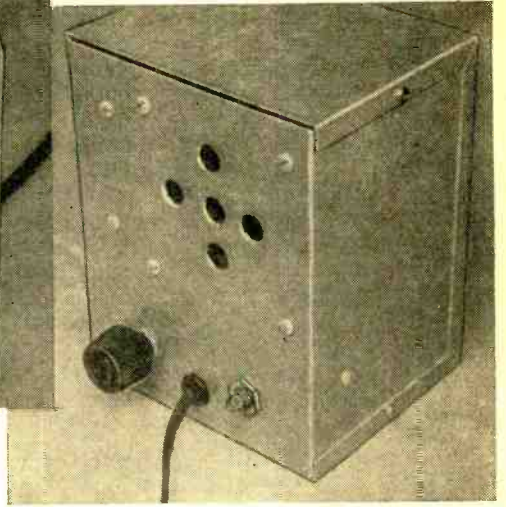
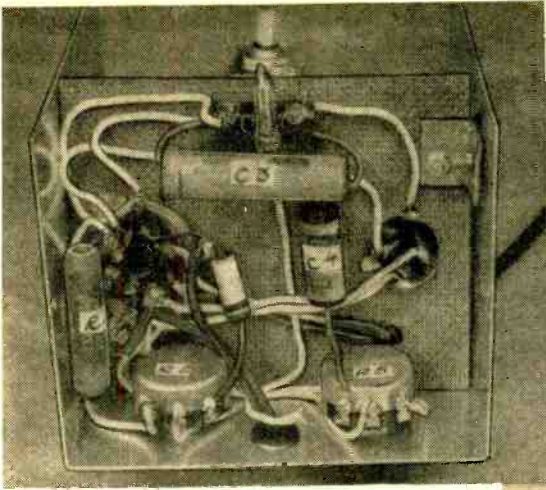

View of lower rear section of cabinet showing calibration control, R<sub>2</sub>, and volume control, R<sub>5</sub>. One mounting bracket for the Masonite shelf is hidden by resistor, R<sub>1</sub>, at left.

Rear view of the timer in its cabinet, showing speaker through sound outlet holes, with volume control at lower left, line cord in center, and calibration control shaft at right.

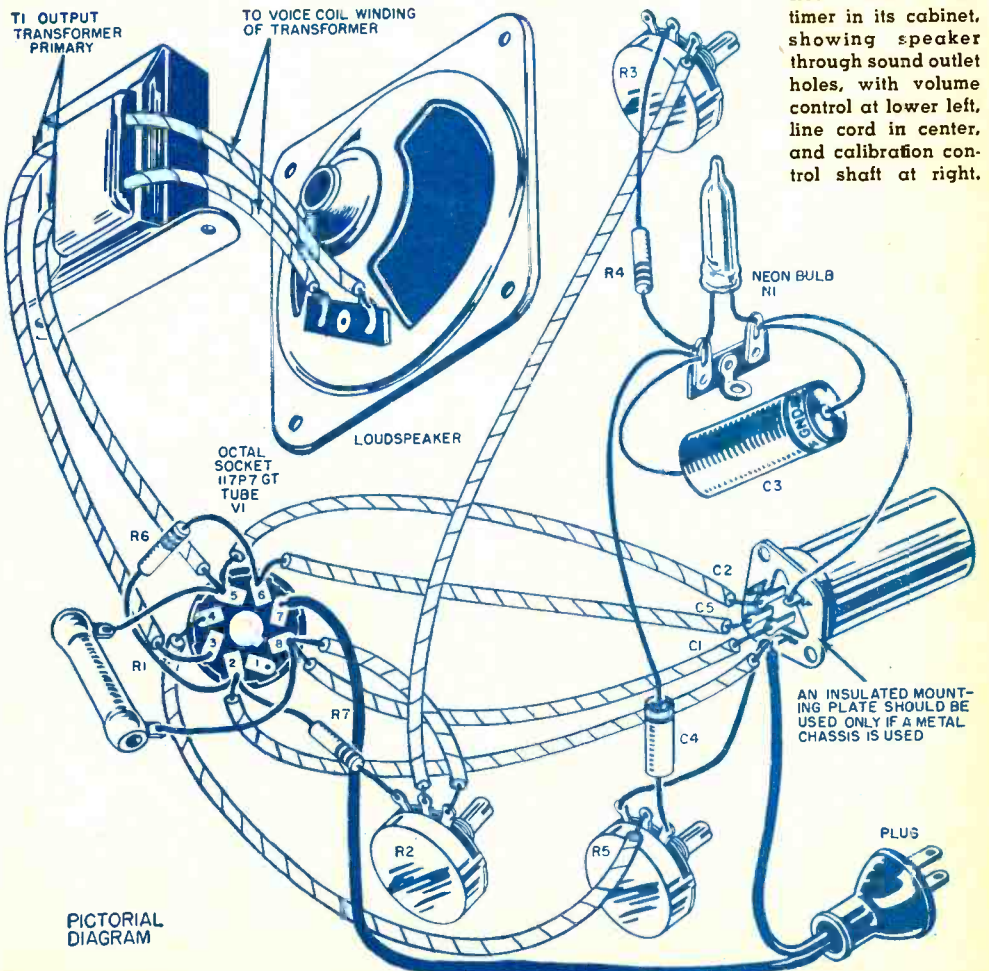

PICTORIAL DIAGRAM

2. *Flashes but does not click:* Trouble indicated in the beam power amplifier section. Check continuity of resistors, condition of tube, and condition of the speaker and output transformer.

3. *Flash rate too fast:* Defective neon lamp, too small a value of timing capacitor, values of charging resistors too low.

4. *Flash rate too slow:* Timing capacitor too large or leaky, timing resistors too large in value.

5. *Does not retain calibration with use:* Almost always due to leaky timing capacitor. Incorrect placement of parts may also cause overheating and change in resistor values.

END

## WHERE'S WILLIS?

**A**MATEUR radio ops! Listen for signals from William Willis, who is on a one-man Pacific raft trip. He left June 22 hoping to sail to Samoa, then Australia, twice as far as the "Kon-Tiki" expedition. Both started from Callao, Peru. His last word, June 28, to the Peruvian government, was "adelante" (forward).

Willis' frequency is 8364 kc., for 11 a.m. and 6 p.m. EST bare-necessity messages only. His call letters are 7HTAS.

Any amateur hearing his signals may telegraph details collect to the *National Company, Inc.*, 51 Sherman St., Malden, Mass., who made Willis' receiver.



## Electronics Reduces Noise on Telephone

**S**TROMBERG CARLSON is now marketing the "Gai-Phone," an electronic telephone designed for noise-free communication in extremely noisy areas. Using a special dynamic transmitter and a vacuum-tube amplifier, the new telephone makes a clear conversation possible in a noisy location without a noise-proof enclosure.

Concealed controls allow adjustment by the installer of incoming and outgoing volume and "side-tone."

The "Gai-Phone" requires 117-volt, 60-cycle power, but it is otherwise interchangeable with standard telephones and is operated in exactly the same way.

## RECORDING WORLD CHURCH COUNCIL ASSEMBLY

**R**EV. James W. Kennedy, radio, television, and film director for 2nd Assembly, World Council of Churches, listens in during recording by *Magnecord* tape equipment of proceedings at Evanston, Ill., meet-

ing of church leaders from 48 countries, August 15-31. At controls are Rev. Eugene Schneider, left, of Assembly recording staff, and Thomas Stocker, Northwestern University radio technician.





# How To Use An Oscilloscope

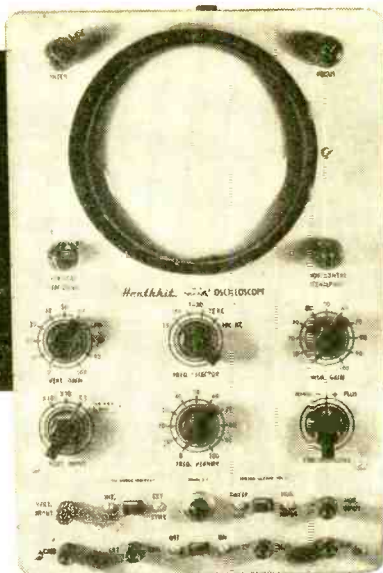
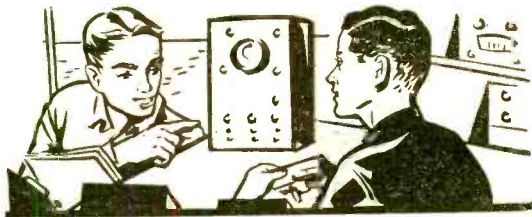

**1** A cathode-ray oscilloscope. Although it has numerous controls and terminals, this instrument really isn't difficult to operate.

**B**ECAUSE it has so many controls, the oscilloscope is often avoided by beginners. Actually, it is not difficult to operate and is one of the most versatile of electronic test instruments. With it you can actually see what happens in electronic circuits—how signals are amplified, how distortion occurs, how signal waveforms are changed. You can use it to measure voltages, frequencies, and phase relationships, and to determine other important information about the operation of circuits. The heart of the oscilloscope is a cathode-ray tube similar to the one used in a television receiver or radar set. In operation a beam of electrons is focused on a fluorescent screen to form a spot of light, then made to move horizontally and

vertically on the screen to trace out the pattern of electrical signals.

Aside from the *on-off* switch, the controls of an oscilloscope may be divided into three groups: (1) those affecting the intensity (brightness), focus (sharpness), and position of the pattern; (2) those affecting the vertical (up and down) movement of the electron beam; and (3) those affecting the horizontal (left and right) movement of the beam.

Referring to Fig. 1, the *Inten* (intensity), *Focus*, *Vertical Centering*, and *Horizontal Centering* controls belong to the first group. They are adjusted when the oscilloscope is first turned on and then left more or less fixed in position. Their effects are shown in Figs. 2 through 5.

**2** Adjusting the "Inten" control varies the intensity or brightness of the spot of light.

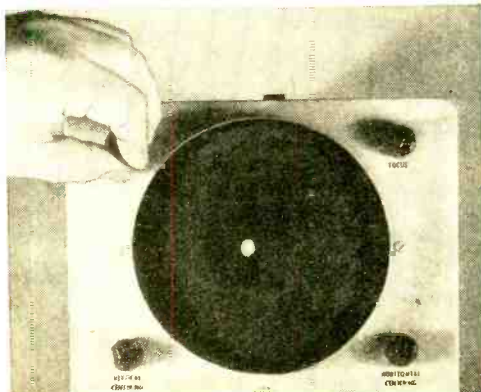

**3** The sharpness of the spot or pattern can be varied by adjusting the "Focus" control.

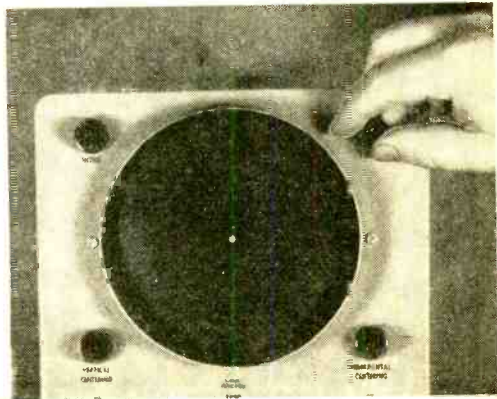

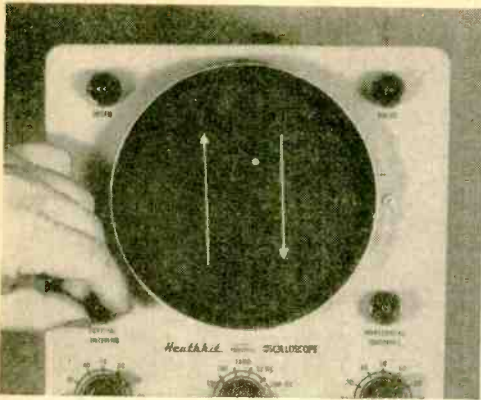

**4** The "Vertical Centering" control can be used to move the spot or the pattern up or down.

The *60 Cy. Test* terminal provides a 60-cycle sine-wave signal which can be applied to the *Vert. Input* or *Hor. Input* for test purposes.

The *Vert. Input* and *Vert. Gain* controls adjust amplification of a signal applied to the *Vert. Input* and *Gnd.* terminals and thus the vertical size of the pattern. The *Vert. Input* switch adjusts the input in steps, while the *Vert. Gain* control gives a continuous adjustment. Operation of the *Vert. Gain* control is shown in Fig. 6.

The *Hor. Gain* control is similar to the *Vert. Gain* control, but affects the horizontal movement of the electron beam, as shown in Fig. 7.

Either a built-in signal source or an external signal may be used to provide hori-

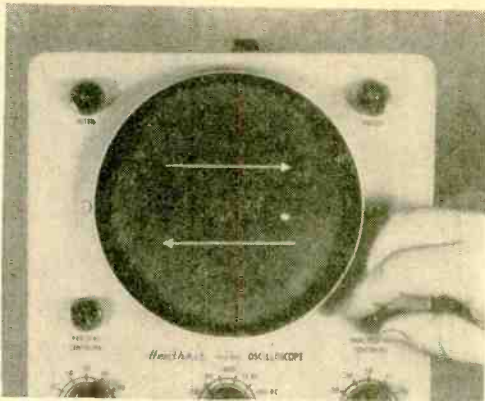

**5** The spot or pattern can be moved right or left with the "Horizontal Centering" control.

zontal movement of the electron beam. To use an external signal the *Sweep Gen.-Hor. Input* switch is placed in the *Hor. Input* position and the signal is applied to the *Hor. Input* and *Gnd.* terminals.

If the built-in horizontal "sweep" signal is to be used, the selector switch is placed in the *Sweep Gen.* position, and the *Freq. Selector* and *Freq. Vernier* controls used to adjust the frequency of the horizontal sweep. This signal may be synchronized or "locked-in" with other signals by adjusting the *Int. Sync.-Ext. Sync.* switch and the *Synchronizing* control. When the selector switch is in the *Int. Sync.* position, the horizontal sweep may be locked in with any signal applied to the *Vert.*

(Continued on page 52)

**6** When a signal is applied to the "Vert. Input" and "Gnd." terminals, the amount of vertical deflection depends upon the setting of the "Vert. Gain" control and the "Vert. Input" switch.

**7** The "Hor. Gain" control adjusts the amount of the horizontal deflection, whether the internal linear sweep of the oscilloscope is being used or an external signal is applied.

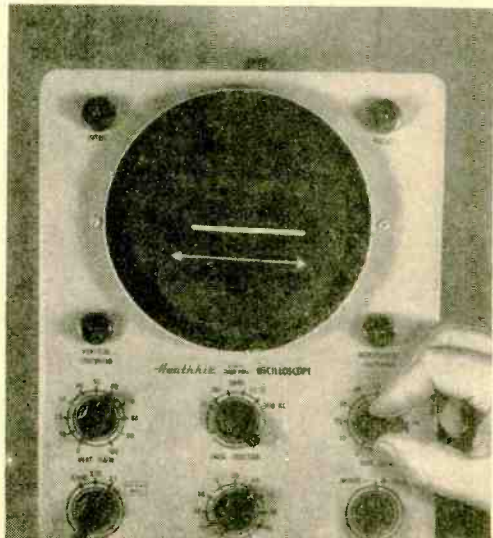
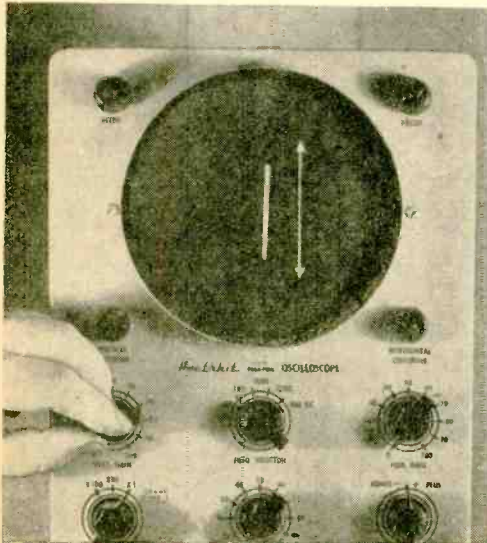

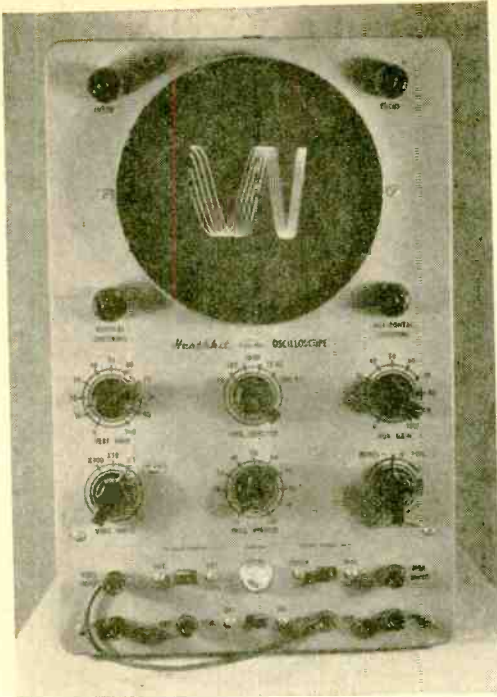

**8** When signals are applied to both the horizontal and the vertical circuits, the spot of light will produce a pattern, possibly moving, upon the screen of the test oscilloscope.

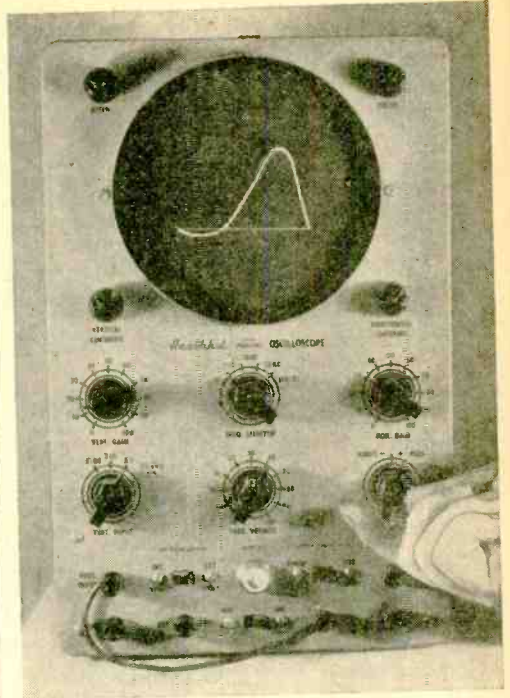

**9** When the "Sweep Gen." is used, adjust the "Synchronizing" control to "lock in" the sweep signal with that applied to the "Vert. Input" terminal and produce a steady pattern.



**10** In Fig. 9, the frequency of the signal applied to the "Vert. Input" terminals is equal to that of the horizontal sweep and one cycle of the signal appears. Here, the horizontal sweep is higher in frequency and the signal cycle is broken up into a number of segments.

**11** If the horizontal sweep is lower in frequency than the signal applied to the "Vert. Input" terminals, more than one cycle will appear. (Note that the pattern is traced during almost five cycles of the signal and the retrace lasts only a fraction of a cycle.)

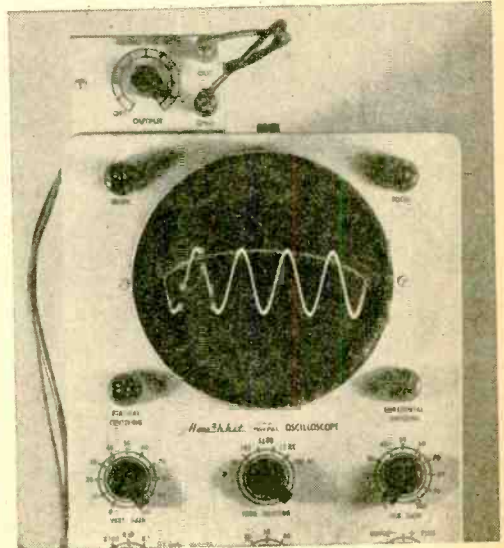
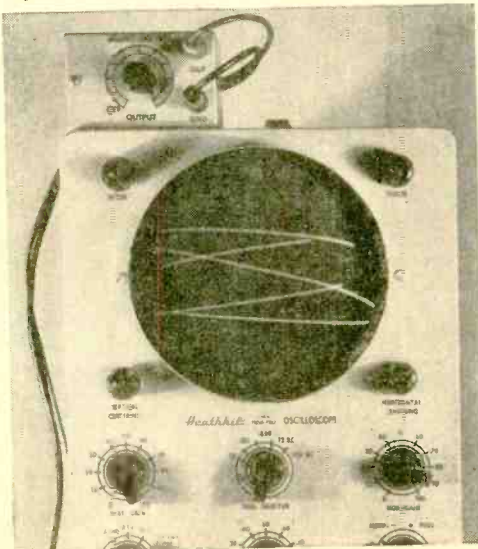

*Input* and *Gnd.* terminals. When in the *Ext. Sync.* position, it may be locked in with signals applied to the *Ext. Sync.* terminal.

When a signal is applied to the *Vert. Input* and *Gnd.* terminals, and the built-in linear sweep of the oscilloscope used, the controls may be adjusted so that the actual waveform of the signal is displayed on the screen of the cathode-ray tube. The adjustment of the oscilloscope controls to observe a signal is shown in Figs. 8 to 11.

For steadiest synchronization with minimum distortion of the pattern, manipulate the controls as follows: First, turn the *Synchronizing* control to minimum (in the

case of the *Heathkit* oscilloscope, with the pointer straight up). Then adjust the *Freq. Selector* and *Freq. Vernier* controls to give a stationary pattern with the desired number of cycles on the screen. Next, turn the *Freq. Vernier* control very slightly counterclockwise, to reduce the sweep frequency and make the pattern drift slowly. (On most oscilloscopes, the direction of drift will be to the left.) Finally, turn the *Synchronizing* control just far enough to make the pattern stop drifting. Note that with an oscilloscope having *Plus* and *Minus* synchronization, like the *Heathkit*, the pattern can be made to start at either of two points in a cycle. END

## LANDMARK DEMOLISHED

**A** WELL-KNOWN American landmark has been leveled, bowing before the inexorable march of communications progress.

The lofty 365-foot radio tower of marine coastal station WCC at Chatham, Mass. has been razed after 40 years of service. Its position atop a hill placed the tower 477 feet above sea level and its flashing lights had been seen by captains 40 miles at sea.

The structure, part of the network of marine coastal stations operated by *Radio-marine Corporation of America*, has served throughout an entire epoch of radio communications. It was originally erected for receiving signals from Europe but was later used to support antennas which received messages from ships afloat on all waters of the world.

Today's methods of communication have rendered the tower unnecessary.

## CALLING ALL INVENTORS!

**G**ADGET-MINDED Americans will be interested in the word that a new firm, New Products Enterprises has been formed at 213 N. E. Second Avenue in Miami.

The firm will market and promote practical, labor-saving gadgets, products, and inventions in the electronics field.

Solomon Balsam, Ph.D., heads the new firm and all inquiries regarding this service should be addressed to him.

## RCA Hobby Kits for Novices

**T**HE hows and whys of basic electronics are unfolded for youngsters in a new educational hobby kit being manufactured by *Radio Corporation of America*.

The child can construct one- and two-tube receivers and transmitters, chemical batteries, and experiment with sound and electricity from materials in the kit. It will be handled by department stores.

## RCA-NBC Mobile Unit for Color Television



**D**ESIGNED by *NBC* engineers and fitted with *RCA* equipment, the color mobile unit shown at left is the only one of its kind in existence.

The unit consists of two custom-built trucks. It normally handles three color cameras. It can generate its own electrical power and transmit signals with its own radio relay system, permitting it to operate many miles from the nearest available network facilities.

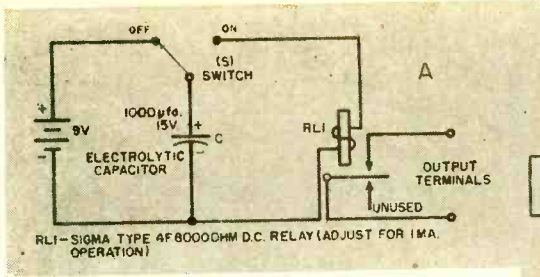

RLI—SIGMA TYPE 4F 8000 OHM D.C. RELAY (ADJUST FOR 1MA. OPERATION)

Fig. 1. Circuit diagrams of three simple time-delay circuits. See text for applications. (A) Instant pickup, delayed release. (B) Delayed pickup, quick dropout. (C) Delayed pickup, delayed dropout. Each of these circuits has a specific use.

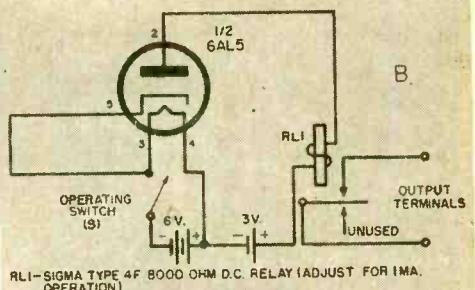

RLI—SIGMA TYPE 4F 8000 OHM D.C. RELAY (ADJUST FOR 1MA. OPERATION)

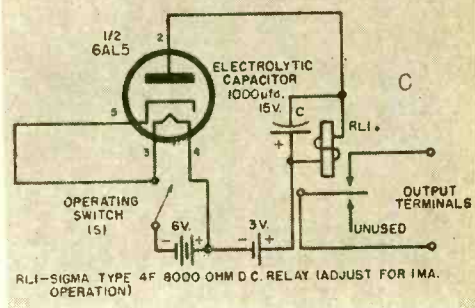

RLI—SIGMA TYPE 4F 8000 OHM D.C. RELAY (ADJUST FOR 1MA. OPERATION)

# TIMING RELAY EXPERIMENTS

Here are three interesting and useful circuits which have numerous applications around your home or in the workshop.

EVERYONE who uses electricity knows about the instant action obtained by working a switch. Close a switch and a lamp lights. Open the switch and the lamp goes out. This is how most of our familiar electrical equipment operates.

In some electronic circuits, this quick action is not wanted. Sometimes, we desire that a device start working a short time *after* a switch is closed. In other cases, we want a circuit to *continue* operating for a short time after a switch is opened. Both of these cases are called *time delays*. An electronic photo printer is a device making use of time delay. When its switch is closed, the printing lamp lights up and continues to glow long enough to print the picture, then it goes out.

There are many ways to obtain time delay in electronic circuits. Some of these methods require amplifier tubes and complicated hookups. Others are more simple. If you are interested in circuits and already have had some experience in building and testing electronic gadgets, you will enjoy experimenting with simple time-delay devices like those shown in this article. You will learn some things you can use later on as you advance in your studies.

For these experiments, you will need a high-resistance, low-current d.c. relay. A

1-milliampere, 8000-ohm unit is recommended. The *Sigma* Type 4F relay is a good one and can be adjusted for 1-milliampere operation by turning its setscrew so as to loosen its spring. This relay is a little expensive when bought new but a few still can be found in surplus. Even if you must buy it new, it is a good investment, since you can use it in other projects, such as model airplane control, which will be described in this magazine.

You will also need: one 6-volt battery and one 3-volt battery (1½-volt flashlight cells can be connected in series to make these); 1 single-pole, single-throw toggle switch; 1 single-pole, double-throw toggle switch; 1 midget 1000-microfarad 15-volt electrolytic capacitor (*Cornell-Dubilier* Type BRH 1510); 1 Type 6AL5 twin diode tube; and one 7-pin miniature tube socket. You can mount the components on a wooden "breadboard" or simply lay them on the bench top and run wires between them.

### Delayed Release

Fig. 1A shows the first circuit. Here, the relay operates ("picks up") as soon as the switch is closed. The relay then continues to be held-in for a short time and finally releases. This is called *delayed release* or *delayed dropout*.

Here is how the circuit works. When

switch *S* is in its "off" position, capacitor *C* is connected automatically to the 6-volt battery and becomes charged. Now, when the switch is thrown to its "on" position, the stored charge flows out of the capacitor and through the relay which it operates. The current continues to flow and hold the relay closed until the useful part of the charge is used up. At that time, the relay is released. To repeat the operation, all you need to do is flip the switch back to its "off" position for a few seconds to re-charge the capacitor, and then throw it back to its "on" position to operate the relay.

With the 1000-microfarad capacitor and 8000-ohm relay, the relay holds-in for 3 or 4 seconds. Larger capacitors will hold it in for longer time intervals.

The circuit shown in Fig. 1B gives a somewhat opposite effect. The relay closes a few seconds after the operating switch is closed and continues to hold-in until the switch is opened.

Here is how it happens. When switch *S* is closed, the 6AL5 tube begins heating.

When the tube is fully hot a little while later, enough current flows from the two batteries in series to pick up the relay. When the switch is opened, the tube begins to cool and the relay drops out almost instantly.

Starting with the tube completely cold, 7 seconds pass between the time the switch is closed and the relay is picked up. Before operating the circuit again, enough time (usually 10 seconds) must be allowed for the tube to cool off after the switch has been opened. If this is not done, the relay will pick up quickly with very little time delay. As a tube becomes older, the time delay will grow longer, so make allowances for this.

The circuit in Fig. 1C combines the features of the two previous circuits to give both delayed pickup and delayed release.

Delayed pickup results from slow heating of the tube. Delayed dropout results from the charge that is held in the 1000-microfarad capacitor, *C*, after the operating switch has been opened. END

## Make a "Fountain Pen" Radio for Your Pocket



**B**UILDING a pen radio is simple but requires patience. Remove the point, bladder, and small metal ornamental ring from the cap. Drill and tap the top of the pen cap to fit the adjustment screw of the "Loopstick" antenna coil used. The clip which holds this adjustment screw will probably have to be removed unless you use a very large pen. Drill a hole in the bottom of the case for the antenna and earphone wires.

The small mica capacitor chosen to tune the "Loopstick" antenna coil will have to be soldered across the coil wires with long leads, so all the parts can be mounted in a line. The antenna and earphone wires should be soldered next and run through the hole in the bottom of the pen. After the whole unit is wired and operating OK give the coil form a coat of service cement and slide it up into the pen cap, using a small screwdriver to screw the adjustment screw through the top cap.

After the cement has dried thoroughly, slide the body of the pen up and screw it into the top cap. Be careful that the parts do not drag on the inside of the pen body as this might twist the wires off while screwing the body into the pen top.

The reason for removing the ornamental metal ring is that the ring falls so near the "Loopstick" coil that it will lower the "Q" of the coil. It can be replaced with plastic tape.

As the coil's tuning slug will tune only about half of the broadcast band, the capacitor tuning the coil should be chosen (usually 25 to 100  $\mu\text{fd.}$ ) so that the local station with the highest frequency tunes in with the tuning slug almost all the way out of the coil. If the local station or stations are near the low end of the broadcast band, a capacitor larger than 100  $\mu\text{fd.}$  will have to be used. If available, a silver mica capacitor should be used in preference to a regular one. The detector is a 1N34 diode and the antenna coil is a standard "Loopstick".....M. E. Quisenberry.

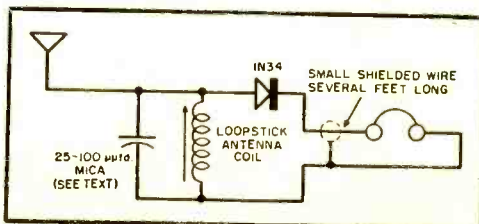



This burglar alarm can be built at home economically and has some interesting features.

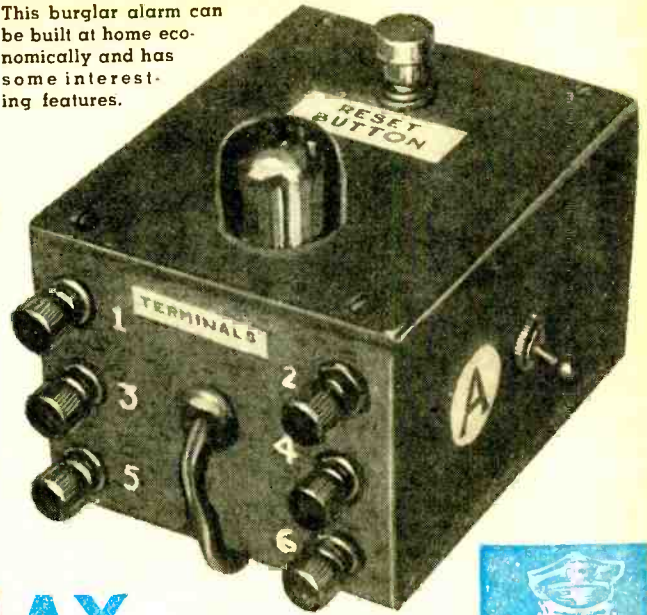

# TIME-DELAY BURGLAR ALARM

**F**OR just a few dollars and a little effort, you can build this foolproof burglar alarm system which has all the advantages of commercial installations plus some unique features of its own. It will protect a door and any number of windows in a business establishment or home; it takes no power most of the time; it is tested automatically each morning; if power fails, it will operate when power is restored.

The two problems inherent in any system of this kind are solved electronically: first, the owner is able to *set* the alarm from inside the premises without triggering the alarm as he opens the door to leave for the night; second, once the circuit is actuated by a nocturnal intruder, a control relay "latches in" so that the alarm bell continues to sound even though the door or window is immediately closed again.

Time delay action is realized by using the *cool-off* time of an indirectly-heated vacuum tube. As the owner prepares to close up shop, he flicks on a switch and leaves it on for about 30 seconds. When he is ready to go out the door, he moves the switch to the "off" position and leaves through the protected exit. About 25 seconds later, the system is ready to operate. When the door is next opened, the alarm bell will commence ringing. It will continue to ring until

the door is closed and a reset button,  $S_2$ , is pressed.

Operation of this alarm system depends upon the functioning of certain switches and two relays. Door and window contact switches *close* a circuit when the door or window is opened. Many places of business already have "make-break" buttons on their doorways to announce the opening of the door; these can be used without change. If windows as well as doors are to be protected, their contacts must be wired in *parallel* with the door contact. Small strips of spring steel may be bent to shape so that a momentary contact is made when the window is opened an inch or two. The drawing illustrates one possible design as well as the parallel wiring. The reset switch,  $S_2$ , is a push-button switch which *opens* the circuit when the button is depressed. Relay  $RL_1$  is a 110-volt d.c. relay of the single-pole, double-throw variety, having a 1.5 to 2 watt coil.  $R_1$  is used to drop the output of  $V_1$  to the proper voltage for the coil. Only the upper, normally-closed, stationary contact is used. When  $RL_1$  is energized, one circuit is broken.  $RL_2$  is a 117-volt a.c. relay which provides double-pole, double-throw switching. Only the lower, normally-open, contacts are used. When  $RL_2$  is energized, two circuits are closed.

Functioning of the alarm can be followed on the schematic. After  $S_1$  has been turned "on" for about 30 seconds and then "off" as mentioned previously, the cathode of  $V_1$  continues to emit electrons for 20 or 30 seconds, so that  $RL_1$  is energized while the owner leaves through the door.  $RL_2$  cannot energize and the bell cannot ring. After the cathode of  $V_1$  cools,  $RL_1$  is de-energized and the circuit from the left side of the a.c. line to the door contact is completed. If the door is opened, the door contact completes the circuit through  $S_3$ , through the reset switch, through the alarm bell, and to the right side of the line. The bell rings. At the same time, the circuit is completed through the door contact, through  $S_3$ , and through the coil of  $RL_2$ , to the right side of the line, so that  $RL_2$  is energized. The relay is latched, that is, held energized by the action of a circuit which the relay itself completes when it is energized. The latching circuit is from the left side of the line, through the contacts of  $RL_2$ , through  $S_2$ , through the coil of  $RL_2$ , and to the right side of the line. Once energized, the relay cannot be de-energized except by pressing the reset button. As long as  $RL_2$  remains energized, there is a second path of current to operate the alarm bell, from the left side of the line, through the contacts of  $RL_2$ , through the alarm bell, and to the right side of the line. The bell will continue to ring until the door is closed and the reset

button is pressed. The functioning of the alarm system, as described, assumes the use of a 117-volt a.c. bell. If a low voltage d.c. bell is used, its circuit is completed through the second pair of contacts on the relay, as shown in the diagram, and the bell will ring when the relay is energized.

The system can be disabled, so that the alarm bell will not ring when the door is opened, by placing a switch in one leg of the a.c. line, as indicated at X. Alternatively, the door contact can be used to operate a conventional door chime during the day, by inserting the single-pole, double-throw switch,  $S_3$ , as indicated by the dotted lines.

The metal box used in the construction of the model measures 3"x4"x5" and has top and bottom plates secured to the frame with self-tapping screws. All the components except the switch, reset button, and terminals are fastened to the bottom plate and wired before the case is assembled. The switch, button, and binding posts are wired in last, using rather long tie leads to facilitate the final assembly. The binding posts must be carefully insulated from the panel to prevent short circuits.

The tube socket is mounted on one-inch brass cylinders tapped top and bottom for 6-32 machine screws; the hole in the top plate permits the tube to peep through and serve as an "on-off" indicator while, at the same time, the danger of overheating is eliminated.

END

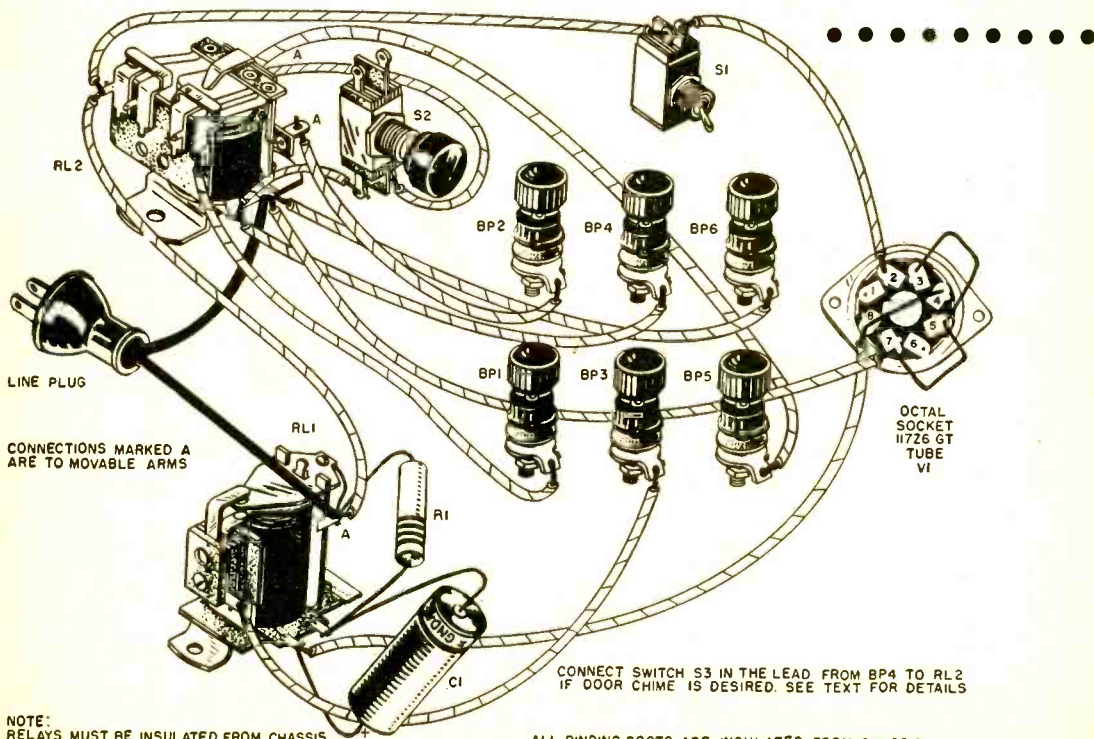

NOTE:  
RELAYS MUST BE INSULATED FROM CHASSIS

ALL BINDING POSTS ARE INSULATED FROM CHASSIS



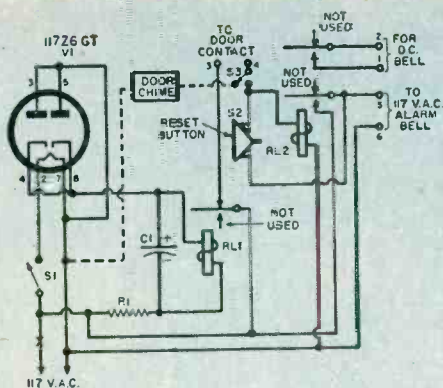

117 V.A.C.

R<sub>1</sub>—1000 ohm, 2 w. res.

C<sub>1</sub>—8 $\mu$ d., 150 v., electrolytic capacitor

RL<sub>1</sub>—S.p.d.t. relay, 110-volts d.c. (see text)

RL<sub>2</sub>—D.p.d.t. relay, 117-volts a.c.

S<sub>1</sub>—S.p.s.t. toggle switch

S<sub>2</sub>—Push-button switch, reset spring, normally closed

S<sub>3</sub>—S.p.d.t. toggle switch (optional, see text)

V<sub>1</sub>—11726GT tube

"Make-break" chime-ringing door contact switch and window contact switches as required

3"x4"x5" steel cabinet with removable top and bottom plates

Octal socket, molded Bakelite

Two 1" long brass cylinders, tapped at both ends for 6-32 screws

Six insulated binding posts with fiber shoulder washers

Eight 6-32 machine screws

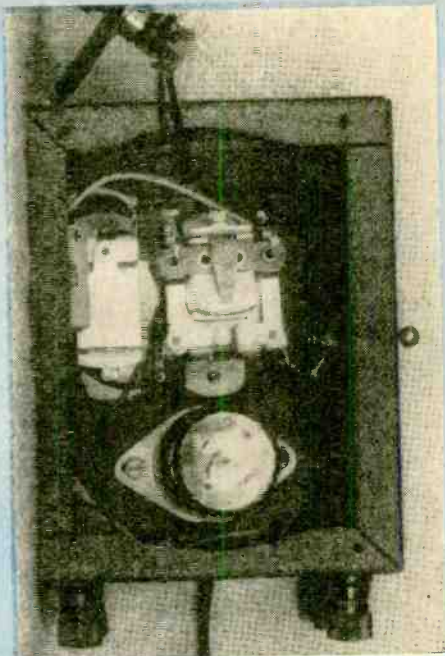

Top view of the completed unit with the cover removed, showing the tube and the two relays in the cabinet, the binding posts below, S<sub>1</sub> at right, and S<sub>2</sub> above.

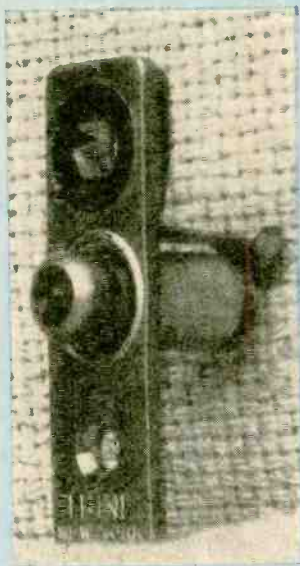

The flush mounting door switch used with the burglar alarm is of the type often used to operate a door chime when the door is opened.

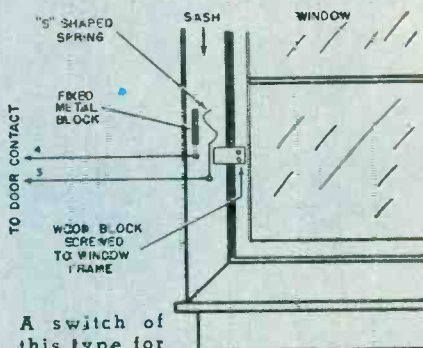

A switch of this type for window protection can be homemade. Note: One side is connected to the a.c. line. To avoid a shock hazard, the contact should be covered so it cannot be touched accidentally.

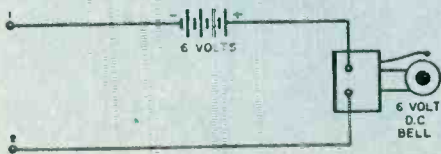

To control a d.c. alarm bell, connect this circuit to the indicated contacts on RL<sub>2</sub>.

# HOW RADAR WORKS

By G. LOUIS ENEGUE

**I**F YOU'VE ever shouted towards a cliff-side or a large building and heard your echo return, you've demonstrated the basic operating principle of radar. An echo occurs because sound is bounced back or "reflected" by the distant cliff or building: similarly, radar may be used to locate unseen objects because such objects reflect high-frequency radio signals.

"Radar" is a coined word, made up from the initial letters in the expression *R*ADIO *D*ETECTION *A*ND *R*ANGING. Radar, then, is used to detect the presence of some object, such as an airplane, a ship, or an iceberg.

The function of radar is to first establish the presence of an object and then to provide pertinent information regarding its location (*i.e.*, the distance, azimuth, and height) on a cathode-ray screen in such a

manner that it can be quickly interpreted by the radar operator.

To determine the position of an object in space, we need three pieces of information. First, of course, we must know its distance or *range*. Then, if we consider a straight line to be drawn from our position to the unknown object, we must know the angle this line makes with some predetermined reference line along the ground (such as true North). This measurement is called the *azimuth*. Finally, we must know the angle this line makes with respect to the ground plane, or the angle of *elevation*. These three factors are illustrated in Fig. 1.

Before considering how the radar system is used to determine azimuth and elevation, let's first consider the type of antennas used at most television transmitters. These antennas transmit equally well in all directions and are said to be omnidirectional. In a radar system, on the other hand, a reflector is used behind the antenna proper in order to concentrate the radio energy into a narrow beam, much like the reflector used in a searchlight to concentrate the light into a tight beam—in fact, in some radar installations, the appearance of the antenna and reflector assembly closely resembles that of a high-power searchlight.

In commercial radar installations, the antenna is generally rotated and tilted by motors, with remote indicating devices at

Fig. 1. The three factors that must be determined in order to provide the radar indication.

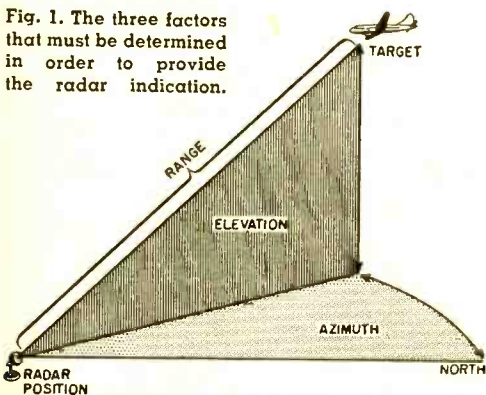

Block diagram showing essential components which constitute a complete radar system.

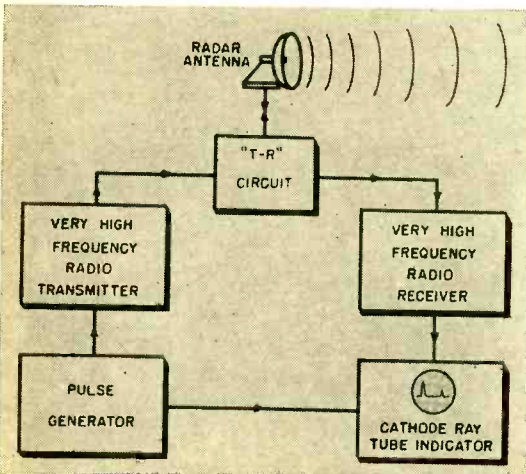

Indicators used with radar antenna.

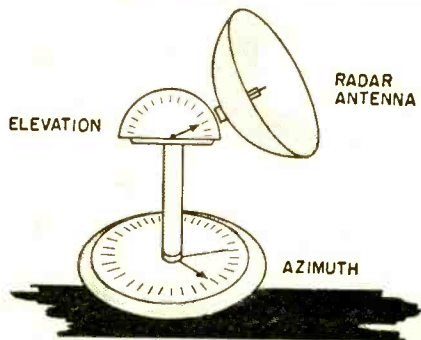

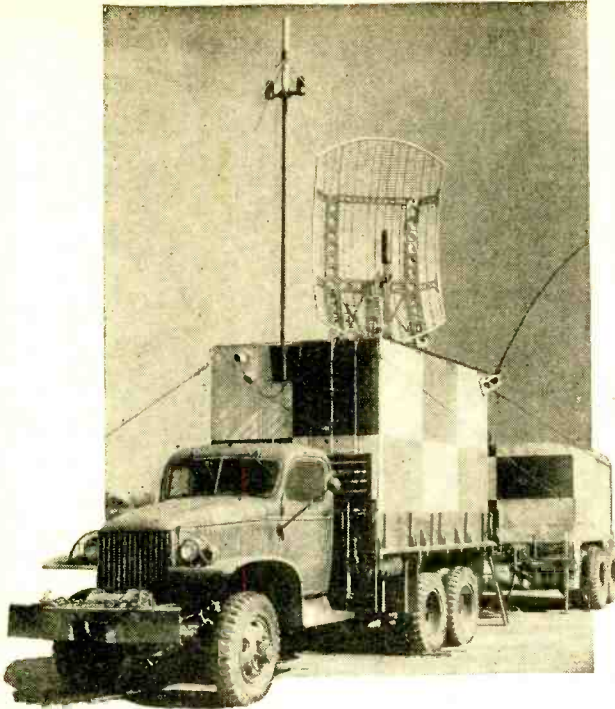

Radar equipment mounted in a truck and trailer, used primarily for airport surveillance.

the operator's position to show the setting of the antenna, and hence the azimuth and elevation of a detected object.

Since the velocity of a radio wave in space is accurately known (186,000 miles-per-second) it is relatively easy to determine the range of the target object. If, therefore, we know how long it takes the transmitted radio signal to reach the unknown target object and return, we can calculate the distance to the object. We simply multiply the speed by the time required for the signal to go out and return. This gives us the *total* distance the radio wave has traveled. The actual distance to the target is half this value.

The actual mechanics of sending out a signal and picking up its echo to determine the azimuth and height of an object are rather simple and can be easily understood even though the operation of the entire radar system is complex and hard to grasp.

To determine how long the radar signal takes to travel from the antenna to the target object is not as simple. A radar system transmits the signal in short, high-powered bursts, or pulses, of energy. At the same time a portion of this transmitted pulse signal serves to control the horizontal movement of an electron beam

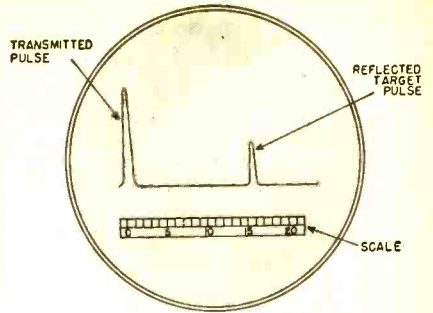
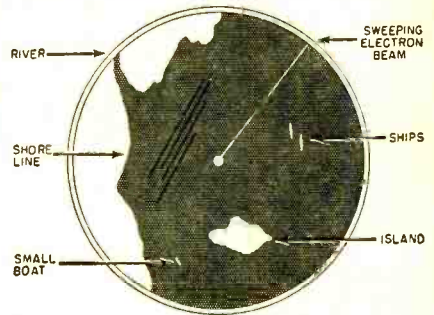

Fig. 2. "Pips" on radar screen representing both transmitted signal and an echo.

Fig. 3. The "shadow map" pattern produced by a second type of radar unit. See Fig. 2.



across the face of a cathode-ray tube (somewhat similar to the picture tube used in television receivers and in oscilloscopes). Simultaneously a portion of this transmitted pulse is picked up and amplified by the very-high-frequency radio receiver used in the system. The output of the receiver is used to control the vertical movement of the electron beam in the cathode-ray tube. Thus a heavy pulse, known as a "pip," appears on the screen of the tube at the beginning of the horizontal sweep, with this pulse representing the outgoing signal. See Fig. 2. If the transmitted signal strikes an object and is reflected back to the antenna, the receiver will detect and amplify it, and apply it to the cathode-ray tube, producing another vertical deflection on the screen of the tube. This is the target pulse.

The distance between the transmitted pulse and the reflected pulse on the screen of the cathode-ray tube is directly proportional to the distance to the target, and it is only necessary to know the scale relationships of the equipment to determine the distance to the object. It is possible, if desired, to calibrate the cathode-ray tube directly in yards or miles.

In addition to the functions just described, another type of radar unit has

the electron beam of the cathode-ray tube sweep outward from the center instead of horizontally across the screen. At the same time, the beam is rotated around the tube face in synchronization with a continuously rotating antenna. This type of radar will produce a "shadow map" of nearby objects and terrain, similar to the one shown in Fig. 3. Although all details are not visible, a skilled operator is able to identify ships, rivers, islands, and other objects appearing on the screen. **END**

## GROMMET FOR TWIN-LEAD



**W**hen twin-lead is run through chassis, make a slot for the grommet rather than a hole for better fit.

For standard lead, use grommet with  $\frac{5}{16}$ " hole and  $\frac{5}{8}$ " o. d. The slot in chassis should be  $\frac{1}{2}$ " long and  $\frac{3}{16}$ " wide with round ends, carefully filed. . . **A.T.**

## POLARITY TESTER FOR CRYSTAL DIODES

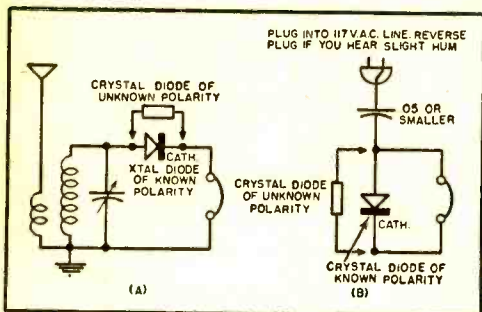

ing you have at least one crystal on hand of known polarity.

As shown in the diagram, (A), connect the crystal of known polarity into the crystal receiver circuit (it doesn't matter which way you connect this crystal just so you get a good signal from a local station) and then shunt the crystal of unknown polarity directly across it.

If the signal is not affected or only slightly affected, then the diode under test has the same polarity as the one in the circuit. If the signal cancels out then the polarity of the diode under test is the direct opposite of the one in the circuit. Mark the polarity on the tested crystal with India ink or a little spot of red paint.

A simple circuit for those who do not own a crystal receiver is shown in diagram (B) . . . . . **A.T.**

**C**RYSTAL set experimenters and other users of crystal diodes often run across diodes from which the polarity markings have been worn. Since the polarity cannot be determined by inspection, here is a quick and accurate way to determine the polarity of these "mystery" units, provid-

## .4-WATT TRANSMITTER FOR LOCAL CONTACTS

**J**OHAN H. T. HINTON of Atlanta, Georgia, a 16-year-old radio amateur, has passed along this circuit as his answer to the problem of constructing a compact, low-power c.w. transmitter.

According to John, despite its size this .4 watt unit is capable of surprising performance for local work when used with a good antenna. He has had good reports at distances up to 25 miles. When used as a portable, an 80-meter whip antenna can be used for short distances (up to 5 miles).

Using a 1S4 oscillator, the circuit can be loaded up to 6 ma. at 67½ volts. Any crystal on the 80-meter band may be used, although John used a 3735 kc. one.

With another coil, other bands may be covered but must be operated straight-through on the crystal frequency.

The whole unit, including batteries, may be constructed in a box 7" x 3½" x 2". The key is mounted on top of the box. A phone-tip jack is used for the antenna lead so the whip can be plugged into it. The

pi-output enables random lengths of wire to be used as the antenna.

If desired, a 90-volt battery can be substituted to provide greater output. **END**

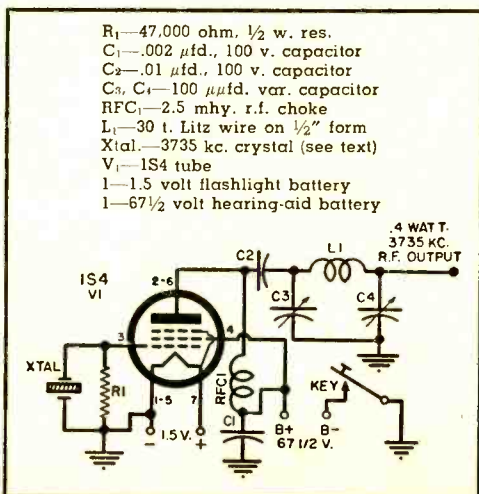

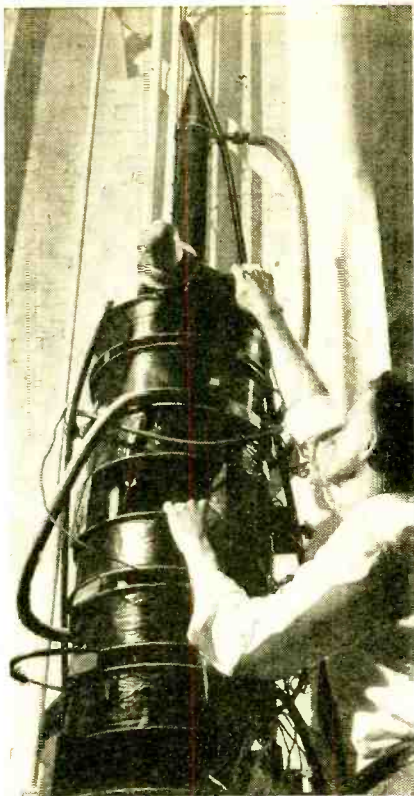

## GIANT KLYSTRON ELECTRONIC TUBE

**R**ADAR units capable of reaching far beyond present limits are a step closer to reality with the development of a powerful giant electronic tube, the megawatt klystron.

The tube is eight feet tall and is the first capable of producing millions of watts of precisely-controlled radar power for military systems. A new "electron packing" technique, developed by *Sperry Gyroscope Company*, made possible the tremendous powers of this new tube.

The new tube produces 4,000,000 watts of peak power—more than 250 times that developed in the radar that beamed pulses to the moon and back in 1946. The frequency of this power can be held 20 to 200 times closer than the frequency limits of ordinary radio or TV transmitters in the United States.

An electron gun in the base of the tube shoots a stream of electrons through the vacuum of three hollow copper doughnuts, called rhumbatrons, so named because of the rhythmic motion of electrons within these cavities. Power output of the tube depends on the number of electrons that can be forced through the holes in the rhumbatrons. These electrons can be increased up to a certain point, then are thrown out of the beam and dissipated as heat. END

## OUT TO SEA WITH TELEVISION

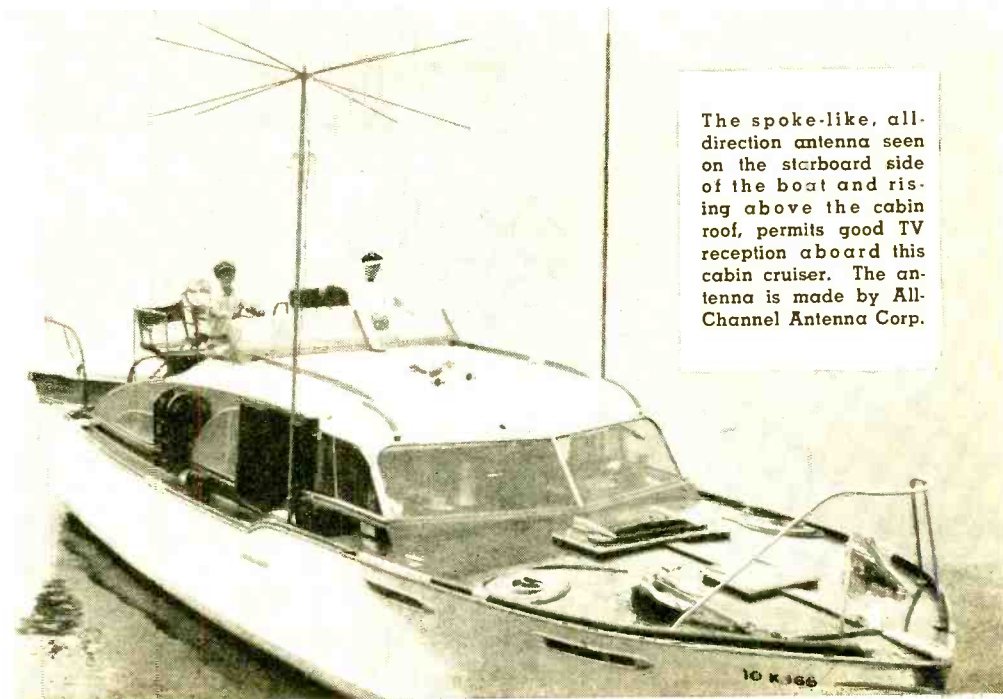

The spoke-like, all-direction antenna seen on the starboard side of the boat and rising above the cabin roof, permits good TV reception aboard this cabin cruiser. The antenna is made by All-Channel Antenna Corp.

By JOHN T. FRYE



## A LIGHT SUBJECT

CARL ANDERSON entered his home in his usual forceful manner. That is, he took a giant step across the threshold and clung tightly to the doorknob until the slamming door stopped him in mid-stride. He next dog-trotted down the hall to the open door of the living room where he stopped briefly to execute a graceful push-shot with his schoolbooks to the davenport cushions. Finally he sailed into the kitchen like a whirling dervish. With almost a continuous motion he jerked open the refrigerator door, lifted out a pint bottle of chocolate milk, downed it with four or five thirsty gulps, and banged the door shut. The empty bottle went into the sink with a jangling clatter as the boy slammed out the back door.

Upstairs in her sewing room Mrs. Anderson listened to the progress of this miniature door-slamming tornado through the downstairs part of her house without any particular sign of annoyance. In the first place, she was used to it; and in the second, she experienced that warm feeling of contentment a mother always knows when her children, be they four or forty years of age, are safely home. Even though Carl had gone out the back door she knew he was headed no farther than the basement "laboratory" of his friend, Jerry Bishop, next door.

As Carl skipped down the outside basement steps and burst through the door, his eyes were met by a singular sight. Jerry's well-padded form was sprawled on the couch at one side of the room. Although it was still broad daylight, he held a lighted flashlight in his hand and was waving the narrow beam languidly back and forth across the face of what looked like a small birdhouse sitting on the workbench along the opposite wall. Each time the spot of light passed over the quarter-sized opening in the face of this box, an electric bell lying on the bench beside it gave out with a brief "br-r-r-ing" of sound.

Carl slumped against the doorjamb and

said lugubriously, "I've been afraid of this. The mad genius has finally flipped his lid. That's what comes of reading physics texts and tube manuals instead of comic books like any other red-blooded American boy. I'm a little disappointed, though, in the lack of originality. Old Diogenes used that carrying-a-light-in-the-daytime routine several centuries ago."

"That's our boy!" Jerry murmured as he grinned across at Carl. "If you can't understand it, belittle it, is the motto, huh? Had you not been so busy trying to lash your feeble intellect into thinking up a wisecrack about the flashlight, you might have noticed some connection between my moving its beam back and forth and the ringing of the bell."

"So-o-o-o," Carl drawled with quizzical-ly arched eyebrows.

"So I'm experimenting with photoelectric cells. Notice that as long as I keep the beam of light on the cell through that small opening in the box the bell continues to ring, but it stops as soon as the light is turned away."

"Say, how about that! That's pretty neat!" Carl said with sudden enthusiasm. "Let me do it. How does it work?" he asked as Jerry let him take the flashlight and play it back and forth across the opening in the box.

"You really want to know or are you just asking to be polite?" Jerry demanded.

"I really want to know, Stupid!" Carl growled, "and you're just aching to lecture; so quit stalling and get on with it."

"Okay, but first I've got to know if you remember anything at all of what you learned in physics about the construction of an atom."

"Of course I remember," Carl said indignantly. "An atom has a positive nucleus about which circle tiny negative do-jiggers of electricity called electrons. There are always just enough of these electrons in a normal atom so that their total negative charge is equal to the posi-

tive charge of the nucleus, leaving the atom with a neutral charge. Under some circumstances, though, an electron can be pried loose from its atom and go bucketing around by itself. An atom that has lost an electron assumes a positive charge and is called an ion. Electrons are attracted to any positively charged object; ions have a yen for negatively charged things."

"You amaze me!" Jerry remarked as he lifted up the lid of the box on the bench and pulled out a small glass photoelectric cell. "You can see this cell only has two elements in it. That half-cylinder is the cathode, and the little rod in the middle is the anode. Notice the inside surface of the semi-cylinder is coated with a kind of silvery-colored gunk. The stuff may be one of several different substances, but whatever one is used in this particular tube, its main characteristic is that electrons are given off from its surface whenever light falls upon it. Up to a certain point, the more light that falls on this cathode coating the more electrons are emitted."

"What's inside the bulb besides the cathode and anode?"

"Mostly plenty of nothing. Maintaining a high vacuum inside the bulb greatly aids the emission of electrons from the cathode and helps them cross over to the anode."

"Why do they go to the anode?"

"Because it is positively charged with respect to the cathode. You will remember you told me a positively-charged object has a great attraction for free electrons. In this case the anode is ninety volts positive with respect to the cathode, and there is a steady stream of electrons from the cathode to the anode. Any time you have a stream of electrons all moving in the same direction you have an electrical current, for an electric current is made up of a movement of electrons. Before I forget it, I had better mention that while this particular tube is of the high vacuum type, some photoelectric cells have a controlled amount of gas inside the bulb."

"What's the idea?"

"It increases the sensitivity. Let me think how I can explain this. Oh yes, now I've got it. Did you ever see an apple fall from the very tiptop of a tree heavily loaded with dead-ripe fruit?"

"Suppose I have, but what's that got to do with photocells?"

"Perhaps you noticed that on the way down the falling apple struck other apples and dislodged them so they fell with it. The branches on which these apples had been clinging jerked upward as they were freed of the weight of the dislodged fruit, and this movement knocked loose still more

apples from the branches above them. The net result could easily be a dozen apples falling to the ground as the result of the loosening of that first apple from its stem.

"The same thing happens inside the gas type photoelectric cell. As an electron is scampering merrily along toward the anode, it collides with a gas atom and knocks loose one or more electrons from the atom that immediately join it on its short and speedy journey. The gas atom, converted into an ion by the loss of an electron, is attracted to the cathode. As it falls into the cathode the smash knocks loose still more electrons that are then free to go to the anode. Just as happened with the apples, for every electron that is freed from the cathode by the influence of light falling upon it, a half-dozen or so electrons may reach the anode. This greatly increases the sensitivity of the cell."

"Then why aren't all photoelectric cells of the gas type?"

"A shrewd question, *Carlos mi amigo*, but there is an answer: while gas cells have a higher sensitivity than vacuum types, the latter have higher internal resistance, maintain a more constant sensitivity throughout their life, and are not so easily damaged by applying higher than rated voltages."

"How come you've got other parts in this box? I see another tube in here besides a relay and a bunch of resistors. Why don't you just put the relay that turns the bell on and off in the anode circuit of the photoelectric cell and let the current flowing through the cell open and close it?"

"Because the current through the cell is very tiny, being measured in microamperes. A relay that would work on such a tiny current would be very delicate and undependable. It is much better to employ some sort of current amplifying tube between the cell and the relay. That tube

(Continued on page 108)

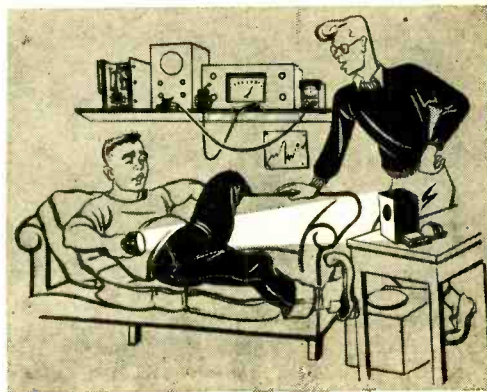

# Equipment for Radio Control

By  
E. L. SAFFORD, Jr.



Fig. 1. Radio controlled model airplane shown with its transmitter and control switch. The switch resembles the "joystick" in life-sized planes; its position determines the model's flight direction.

ONE of the most fascinating and educational hobbies to have appeared in recent years is the use of radio to control airplane and boat models. This is a natural outgrowth of the use of radio for performing various chores, from opening garage doors to operating automatic fire-alarm systems. Radio control of models also is intriguing to the experimenter because it enables him to imitate, in a small way, such military techniques as radio control of target planes and certain types of missile guidance.

No matter what its function, most radio control apparatus consists, in general, of the transmitter, the receiver, and an actuator or performer, see Fig. 2.

The transmitter, of course, generates the

controlling signal and sends it *via* an antenna into space. The signal may be a continuous wave (c.w.) or tone modulated. The frequencies usually used are the 27.25 mc. and 465 mc. Citizens band, for which an operator's license is not required. A switch is included in the transmitter to either make and break the circuit or, in more complicated arrangements, to cause a completely automatic sequence of signals to be sent out. The switch associated with the latter type of control often is a lever or wheel which is moved in a manner similar to the actual control on the life-sized equipment, see Fig. 1.

Power for the transmitter is generally obtained from a self-contained power supply using "B" and "A" batteries. The an-

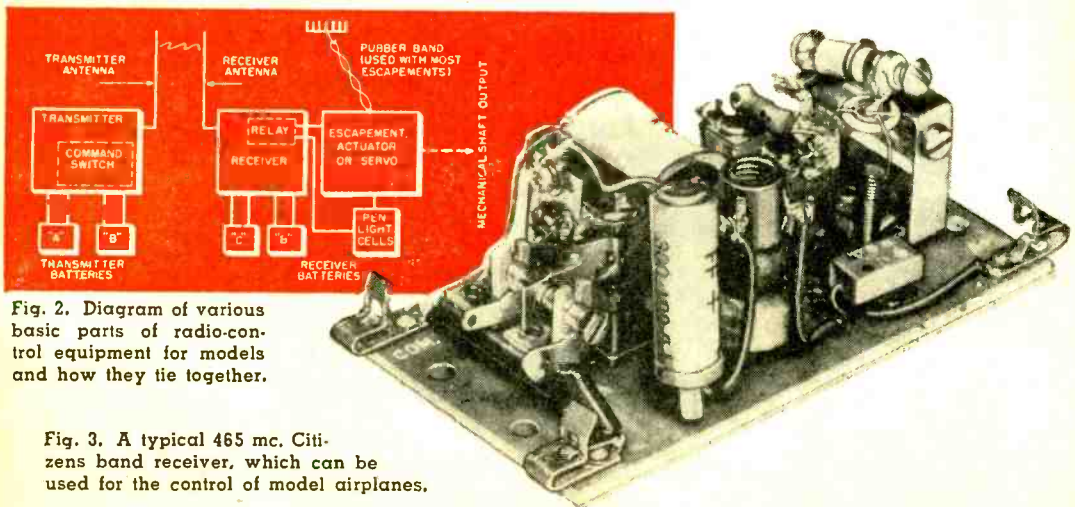

Fig. 2. Diagram of various basic parts of radio-control equipment for models and how they tie together.

Fig. 3. A typical 465 mc. Citizens band receiver, which can be used for the control of model airplanes.



tenna usually plugs right into the transmitter case. Its length is critical, being  $\frac{1}{4}$  or  $\frac{1}{2}$  of the wavelength of the controlling signal.

The receiver detects the signal sent out by the transmitter, separates the various control signals, and routes each one to the proper relay for fulfillment, see Fig. 3. Since the receiver must be small and lightweight to interfere as little as possible with the operation of the model in which it is mounted, its power supply must also be small and light. Usually, hearing-aid "B" and "C" batteries and penlight cells are used.

On 27.25 mc. the receiving antenna consists of stranded copper wire from 18 to 24 inches long. For 465 mc. part of the receiver input circuit may be used.

The actuator or performer is the device which is operated by the receiver relay to cause mechanical motion. Various types of actuators or "escapements" are shown in Fig. 4.

Which type of radio-control equipment is used for any particular model depends upon the size of the model, the type (air, marine, etc.), the number of controls desired and, of course, the cost. However, no matter what the application, a good radio-control system should meet the following criteria:

1. It must operate on the Citizens band if you have no license, or on 50 mc. and above if you are a licensed amateur. (The higher frequencies have less interference and require smaller components.)

2. The size and weight of the receiver and its power supply must be compatible with the space available in the model. A minimum number of batteries, with the longest life possible, should be used.

3. The receiver should be capable of supplying the necessary number of channels for the number of functions desired.

4. The operation of the transmitter control switch should be relatively simple. The ideal might be a "joystick" for model aircraft, or a steering wheel for cars and boats.

5. The receiver should be capable of correct operation at a range of from  $\frac{1}{4}$  to  $\frac{1}{2}$  mile from a transmitter whose output is from  $\frac{1}{2}$  to 5 watts.

6. The receiver should be able to reject signals other than the frequency of its own transmitter.

7. The receiver and actuator should be so constructed as to be able to take normal usage shocks.

8. The system should be capable of reliable operation. Circuits should not drift.

9. The transmitter and receiver should contain a minimum number of special parts for easy serviceability. The equipment should be capable of being tested with a minimum amount of external test equipment.

10. The number of adjustments should be of a minimum, and these should be of a permanent nature when once set.

Future articles will describe in greater detail each of the vital parts of typical radio-control systems. END

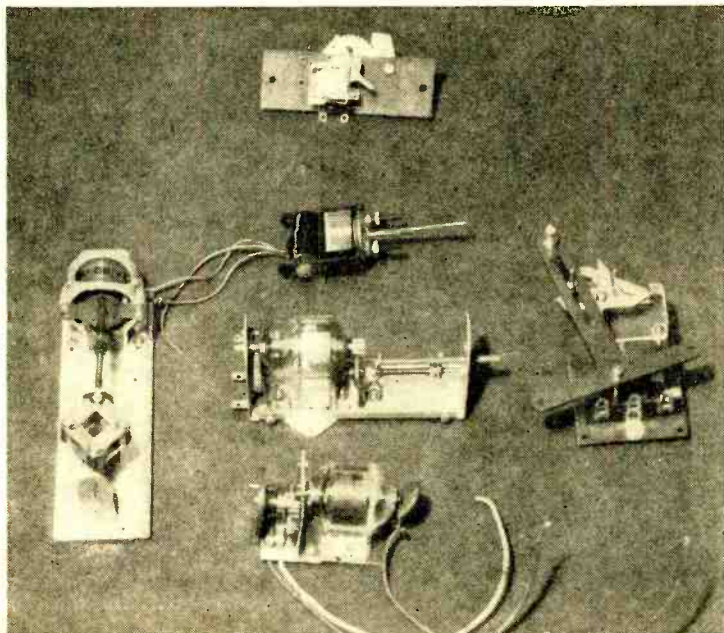
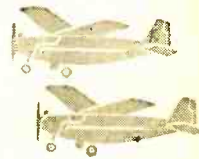

Fig. 4. Various types of escapements and actuators used in radio control: at the top, an escapement; below it, a motor actuator and two servos; to the left, a "flyball" actuator; on the right, a heavy escapement.



# CHECKING AND CHANGING PHONOGRAPH PICKUP UNITS

Worn crystal units are often detected → by lightly trying the movement of the needle. Excessive back and forth movement indicates a defective unit. Removing pickup from arm, as was done here, is not necessary for test.



**A** DEFECTIVE pickup may be indicated if the phonograph output is absent, weak, or distorted. The same symptoms can be due to other causes. If the phonograph is part of a radio-phonograph combination, check performance on both radio and phonograph. If the radio is normal, the fault probably is in the pickup or its connecting cable. Other checks and replacement hints are given in the illustrations. END

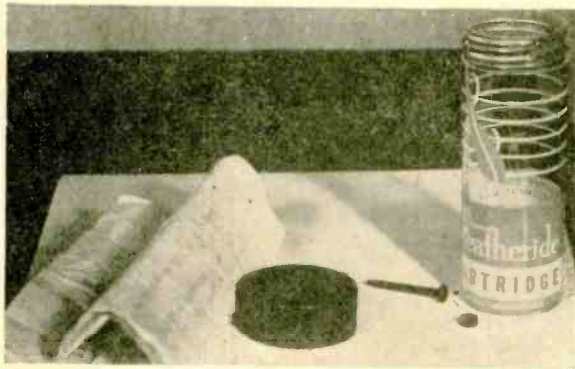

↑ If unit is defective, it is advisable to buy a new one having the same characteristics as the original one. Obtaining the number from the old one will enable radio dealer to supply you with a proper replacement cartridge.

← Holding the pickup arm in an upright position permits screws holding crystal to be removed.

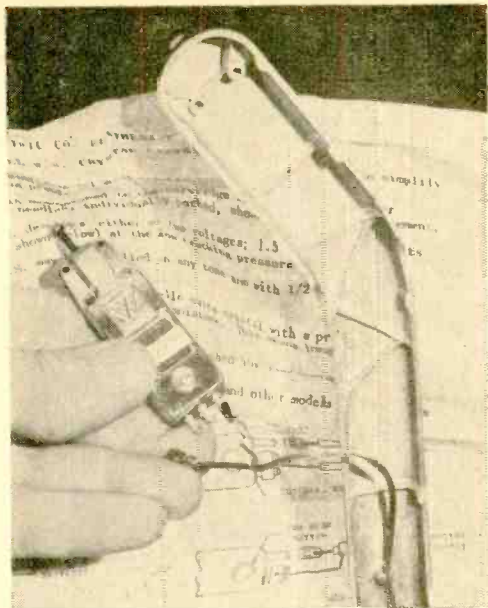

← Slip-on clips which are usually found on crystal cartridge terminals may be pulled off and later gently pushed onto new unit.

↓ Any necessary soldering should be done with clips removed from the cartridge as any heat applied to crystal may damage it.

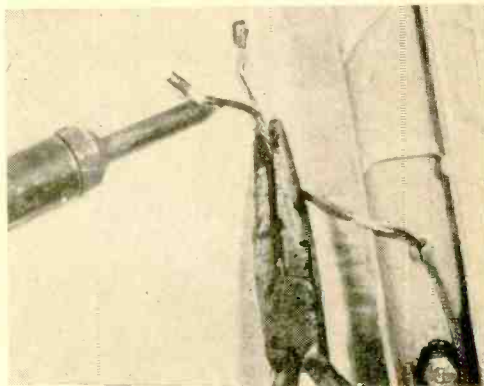

After replacing crystal unit, → make sure you have sufficient slack in the wires feeding into the back of the pickup arm for the arm to complete its cycle without binding. Note piece of argum under needle of new crystal unit for protection while making this particular check.

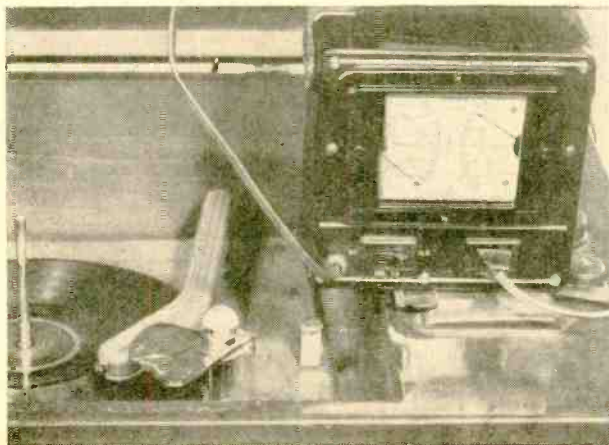
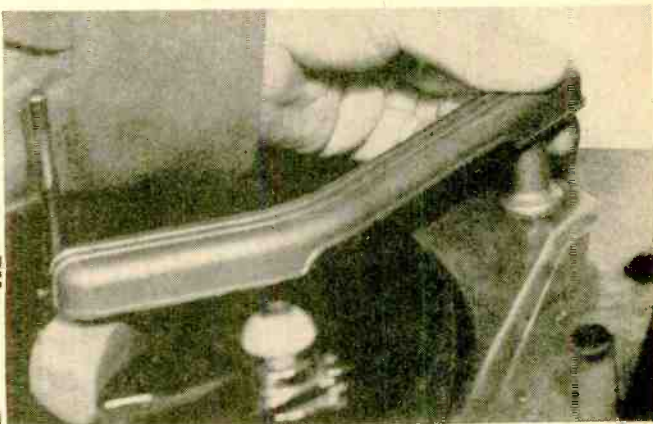

← If you have a wattmeter, you can check the power consumption of your phono motor, radio, or amplifier. Compare the reading with the value obtained from the nameplate or the manufacturer's service data, or with readings which were taken when equipment was operating normally.



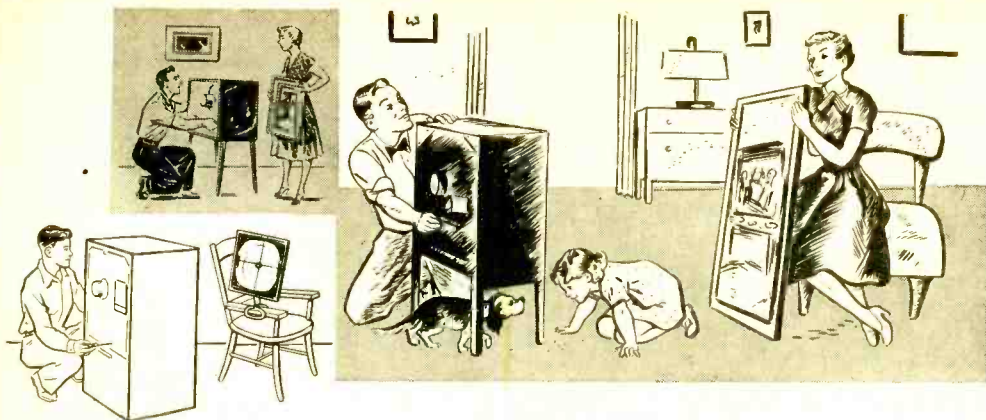

# Width Control Adjustments

IN LAST MONTH'S ISSUE we discussed the adjustment of the height control in a television receiver. Several items of importance noted there are worth repeating again because they apply to width control adjustments as well.

1. A receiver manufacturer generally divides his operating controls into two or three groups. The first group is placed prominently in view on the front panel or, in more recent models, they may be found either on the side or top of the receiver.

2. A second group of controls is frequently placed on the front panel, but hidden from view by a hinged metallic plate or cover. If the width control is not found in this group, then it will be found on the back panel of the receiver. This is at the rear of the set and should be accessible without removing the back cover of the set.

3. The only equipment required for making the width adjustment is a fairly large mirror and possibly a screwdriver. The mirror enables you to see the screen while making adjustments on rear mounted controls. Position the mirror in front of the set so that you can see the screen by reflection and then proceed to make the necessary adjustments while keeping your eye on the screen.

Now, let us assume that the picture is too narrow. The first job is to locate the width control. This can take one of three forms. It can have a knurled shaft end which you simply grasp with your fingers and rotate. It can also be a slotted shaft for screwdriver adjustment. If the slot is very narrow, a special thin bladed screw-

driver will be needed. The third form which the width control can take consists of a bolt coming through a slot in the chassis and held in place by a wing nut. This nut is loosened, the bolt is slid back and forth along the slot for proper width, then the nut is tightened.

Whatever form the control assumes, the resulting effect on the picture is always the same. As you rotate (or slide) the control, picture width will change. The width variation over the range of the control may not be very much, but it should enable you to obtain some width increase.

If the foregoing adjustment does the job you want, then of course there is no need to seek any further. However, it may be that the picture is still not wide enough to fill the screen. In this case there is another control that may be helpful if it is available on the back panel without removing the back cover. This is the drive control and in its adjustment the following instructions should be carefully followed, else you may blow a fuse (in the set) or perhaps damage a tube or receiver component. (There will be no difficulty as long as the instructions are followed carefully!)

With your eye on the mirror so that you can see the picture, slowly rotate the drive control in a clockwise direction. The picture will become wider if the set and its circuits are functioning normally. It may be that even when this control has been turned to the end of its range the picture still does not fill the screen. In that event there is usually nothing more you can do control-wise since it indicates that some tube or circuit in the receiver is not oper-

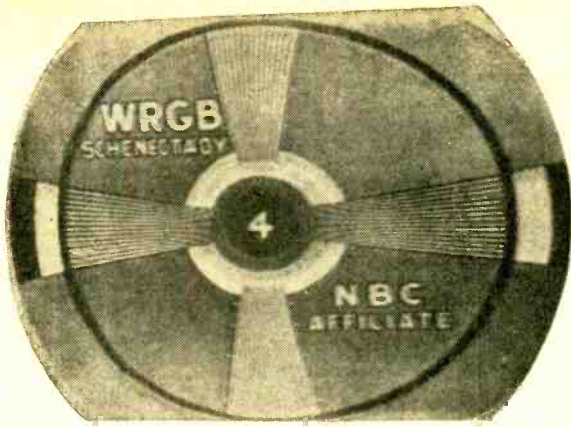

A picture with horizontal non-linearity. Note how the right-hand side of the picture is stretched out in contrast to left.

## in TV Receivers

...

ating properly. The job should now be turned over to a professional technician.

On the other hand, you may find that as you rotate this control, the picture becomes wider but, at the same time, a vertical white line appears in the center of the screen. If this happens, slowly back off the control until the white line disappears. Caution: Do not back it off too far.

The reason for all of these precautionary warnings is simply this: The drive control regulates the amount of signal voltage which is fed to the horizontal output amplifier. This is a large tube, drawing a considerable amount of current. As long as it receives the proper amount of signal or driving voltage, the current drawn by the tube is held within safe bounds and everything is fine. But if the drive signal is reduced below a certain level, the tube current rises sharply and the protective fuse blows. In the absence of a fuse or if the fuse is defective, the tube may burn out, together with the horizontal output transformer. Both are rather costly components.

Enlargement of the picture width may affect picture linearity. That is, the picture may be stretched out or squeezed together on one side, while normal over the rest of its extent. To correct this condition, there is a horizontal linearity control and this is rotated or slid back and forth until the picture is linear across its entire width. It may be necessary to make slight retouching adjustments on the width and drive controls in order to obtain best picture linearity, but the procedure is not very difficult to carry out. **END**

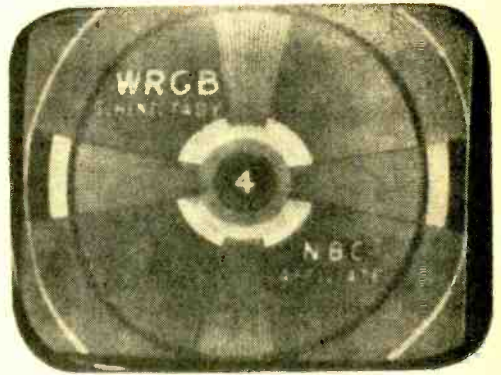

The dark strips on either side of the picture indicate that picture is too narrow.

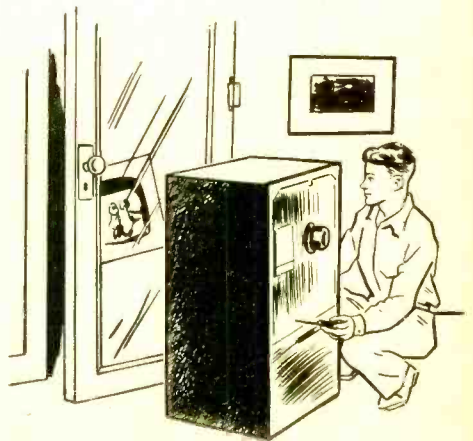

# The Electronic Flight Trainer

By LEO G. SANDS



This electronic flight simulator electronically duplicates the performance of the Convair 340.



**T**HE versatile vacuum tube that made possible such diverse devices as long distance telephones, radios, TV sets, and the electron microscope has also made feasible the exact simulation of flight without leaving the ground!

Dr. Richard C. Dehmel, chief engineer of *Curtiss-Wright*, has developed a new type of flight trainer which can simulate the characteristics of an actual airplane. The Dehmel trainer, which is more accu-

rately designated as a "flight simulator," utilizes electron tubes and is, in reality, a complex analog computer, truly an electronic brain.

This fantastic "flying machine" which never leaves the ground gives the pilot the sensation of flight. The instruments and controls look and respond exactly like the instruments and controls of the particular type of aircraft it is designed to simulate.

Dr. Richard C. Dehmel, Curtiss-Wright chief engineer (right), demonstrates Convair 340 radio aids simulator to Allen Bonnalie, director of flight training for United Air Lines.

Closeup of the Trouble Console of Electronic Simulator for USAF Convair B-36 built by Curtiss-Wright. A wide variety of problems can be introduced into training "flights."

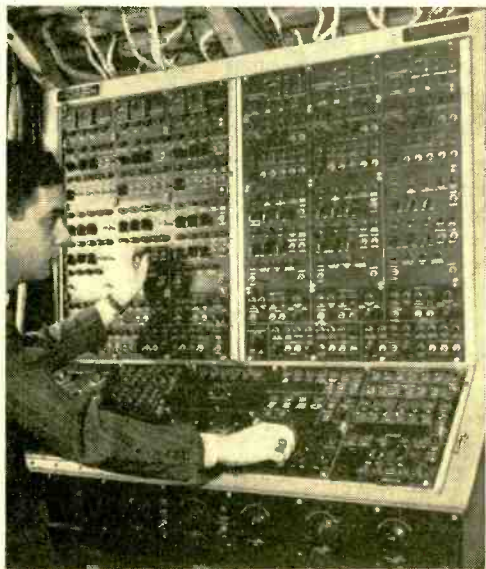



Cockpit of flight simulator which electronically duplicates performance of Type C-124 aircraft.

Not only is the Dehmel trainer used by the armed services for training military pilots but it is used by the leading airlines to afford their skilled pilots on-the-ground checkouts on new planes. With the electronic flight simulator, airline pilots can practice on the ground without piling up unnecessary hours on expensive airliners. The cost of on-the-ground training runs about \$30 per hour as against actual flying costs ranging from \$250 to \$2000 per hour. In addition to the cost, planes normally required for training flights are thus released for payloads.

A flight simulator costs about \$1,000,000 and uses approximately 1300 electron tubes. With this device the electrically-operated controls and instruments of the real plane are electrically operated in the simulator. The devices in the plane which normally react to pressure are actuated in the simulator by servo and related electromechanical systems. Complete navigational and landing aids are faithfully simulated. Trainees and veteran pilots alike can thus become thoroughly familiar with any established airway in the world without leaving their training base! END

So large is the Curtiss-Wright Electronic Simulator for the Convair B-36 bomber that men are dwarfed by the unit. Simulator built for the Air Force contains an actual B-36 flight deck connected to the Instructor's compartment at the rear that houses flight recording instruments and radio aids equipment. To the right are the 14 analog computers needed to reproduce flight characteristics of the giant, ten-engine plane. Use of an actual airplane cockpit, sound effects, and proper control loading lends sense of realism to air crews who use Simulator either for training or to keep flight skills at peak efficiency.

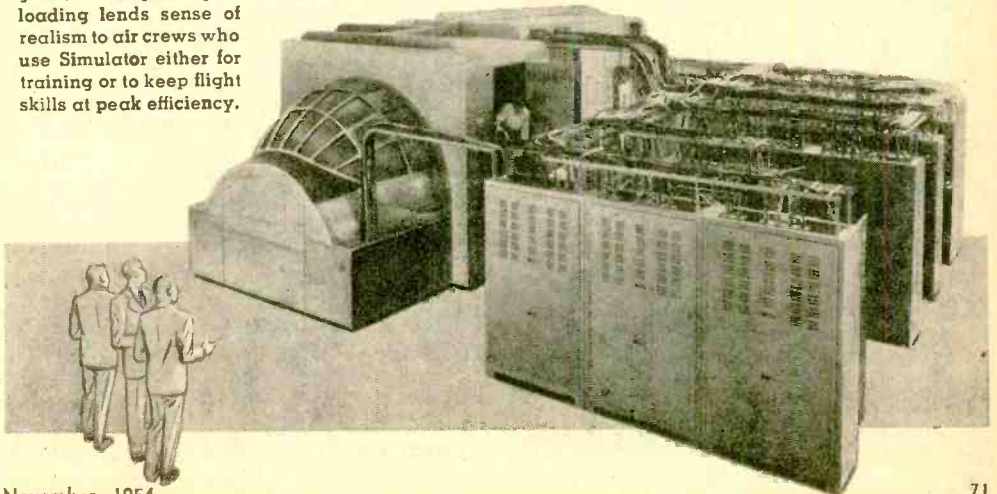

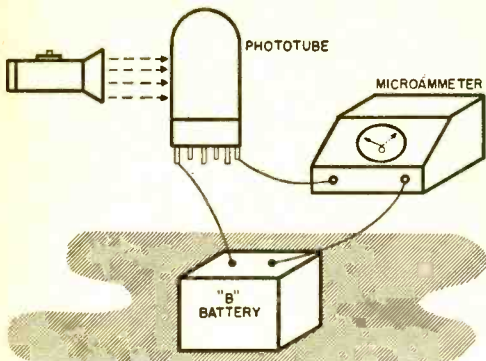

Fig. 1. A phototube can distinguish light from dark. In the dark, the tube is cut off. In the light, the tube becomes conductive, the amount of plate current depending upon the amount of light on tube.

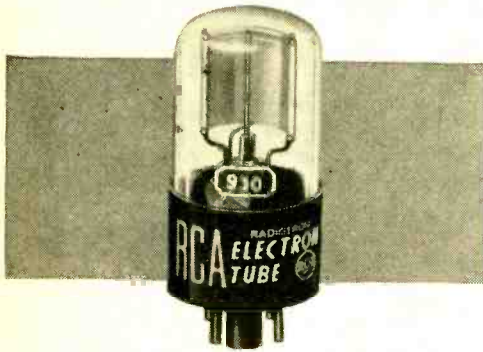
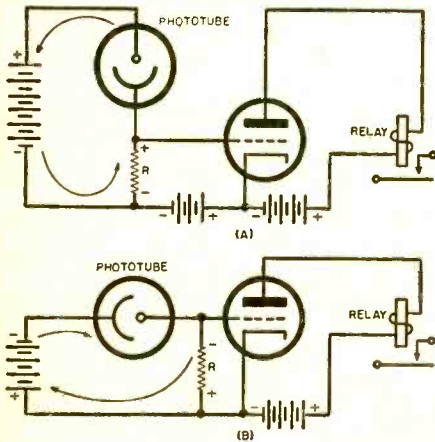

Fig. 2. The cathode of the phototube emits electrons when illuminated but stops emitting in the dark. A straight piece of wire is used for the anode so that it will not block light to the cathode. (RCA tube.)

Fig. 3. Photo-relay circuits. In the forward-acting circuit (A), the relay becomes energized when the phototube is illuminated. In the reverse-acting circuit (B), relay is energized when light is blocked.



# The Electric Eye- How it Works

THE electric eye or phototube is useful in so many inspection, sorting, and counting applications because it is able to distinguish light from dark. In the dark, the tube becomes cut off (its plate current drops to zero). In the light, however, the tube carries current, the amount of current depending upon the amount of light.

As shown in the photograph (Fig. 2), the phototube is simple in structure. Its cathode consists of a curved piece of metal coated with a light-sensitive chemical. This chemical emits electrons when it is illuminated, but stops emitting in the dark. The plate or anode of the phototube consists of a straight piece of wire so that it will not cast a large shadow on the cathode.

Even when it is strongly illuminated, the phototube draws only a small amount of plate current. Typical values of phototube current range from about 5 to 20 microamperes. Although there are relays available which will operate at these low values of current, they are, in general, both delicate and expensive. Common practice is to use a less-sensitive, more rugged type of relay; this relay is connected in the plate circuit of an amplifier tube whose bias is controlled by the phototube. Two such circuits are shown in Fig. 3. A circuit in which the relay becomes energized when the phototube is illuminated is known as a forward-acting circuit. A reverse-acting circuit is one in which the relay becomes energized when the light is blocked.

A forward-acting circuit is shown in Fig. 3A. When light is allowed to reach the phototube, electrons flow as indicated by the arrows. This current produces a voltage drop across resistor  $R$ . Because the current flow through the phototube is small,  $R$  is made large in value in order to produce an appreciable voltage drop. Typical values of  $R$  range from 5 to 20





Fig. 4. General Electric's Model CR7505-K100 photo-relay unit with cover removed showing phototube, control tube, sensitivity control, transformer, and the relay.

megohms. As shown on the diagram, the polarity of the drop across  $R$  is such that it makes the triode grid positive. The resulting increase of triode plate current causes the relay to energize. The relay contacts can be used to close an external circuit to a light, bell, motor, or other device. Such circuits are used to (1) open garage doors when the phototube is illuminated by automobile headlights, (2) sound an alarm and turn on sprinklers in case of fire, (3) turn off power and sound an alarm in case of arcing or flashover in electrical equipment, etc.

A reverse-acting photo-relay circuit is shown in Fig. 3B. As long as light reaches the phototube in this circuit, electrons flow as indicated by the arrows. The resulting voltage drop across resistor  $R$  makes the triode grid negative and keeps this tube cut off. If the light to the phototube is now blocked, there will be no current flow through the phototube and no voltage drop across  $R$ . The triode will now conduct and its plate current will energize the relay. Reverse-acting circuits are used to (1) count objects passing on a conveyor belt, (2) sound an alarm in case of intrusion, (3) turn on lights at sundown or during overcast weather, etc.

Most commercial photo-relays are a.c. operated, that is, they are designed to operate without a rectifier tube. This reduces the size, weight, cost, and operating temperature of the unit. A unit of this type is shown in the photograph of Fig. 4. The cover for this unit, not shown in the photograph, contains a circular opening or window to allow the light beam to reach the phototube inside. The control tube whose plate current energizes the relay is shown to the left of the phototube. The sensitivity control is at the right. In the background are the transformer and relay.

November, 1954

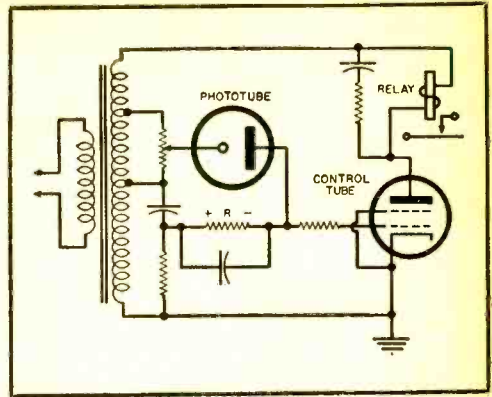

Fig. 5. Schematic of a commercial photo-relay. With light on phototube, drop across  $R$  keeps grid of control tube negative. Tube operates when light is blocked.

As shown in the circuit diagram of Fig. 5, the control tube and relay are connected in series across the secondary of the transformer. As long as light reaches the phototube its plate current produces a voltage drop across resistor  $R$ . The polarity of this drop is such that it makes the grid of the control tube negative. When the light beam is blocked, there is no longer a drop across  $R$  and the grid of the control tube is no longer negative. The control tube now draws plate current and energizes the relay. The filter (resistor and capacitor) across the relay prevents the relay from chattering by holding it closed during the half-cycle of transformer voltage when the plate of the control tube is negative.

The following listing shows the wide variety of the applications of the phototube: counting objects passing on conveyor, assembly line, etc.; foul line detector in bowling alleys; smoke and flame alarms; detecting holes in sheet metal; turning on lights at sundown; intrusion and burglar alarms; controlling photographic printers and enlargers; leveling elevators; opening doors; sorting objects according to size, shape or color; headlight dimmer for automobiles; color comparison of paints, textiles, dyes, etc.; gas detectors; control of liquid level in tanks; control of packaging machines; temperature controls; automatic weighing equipment; and traffic light controls.

The use of such devices is on the upswing and their applications have become more and more commonplace. No longer do "self opening" doors attract curious spectators at locations where such devices are installed. Gradually electric eyes have taken their place in our way of life and been accepted as an addition to the American "way of life."

END

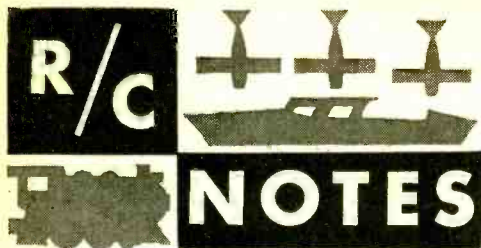

FOR trends around the country, look to the hobby shop operator. This month, a nationally known dealer, Mr. John Hillegas, proprietor of "Reds" *Hobbycraft Models*, Cleveland, Ohio, takes the soap box; trends from other sections of the country will be reviewed by other well known dealers in succeeding months.

"Berkeley 'Aerotrol' has been the most popular rig here," states Hillegas, "probably due to price, with *MacNabb* ('Citizenship') 27.255 and 465 running in second and third spots. For second receivers, either as replacement for the original or for use in a second ship, *North American's* twin tube in kit form (plus some assembled jobs) and *Control Research's* 'Mini-Mac,' are the best sellers.

"Most popular relays have been the *Sigma* 4F with *Neomatic* now taking the lead. Most popular escapements have been the *Bonnors*, with *DMECO's* servos now in greatest demand.

"Trend seems to be toward tone control, even for rudder only," Hillegas continues. "With the increase in popularity of boats, some interference has been noted by fliers, and could well be from some R/C boat in a not-too-distant lake or pond.

"Multi-control operation just beginning to take hold here. Like the weather, everyone talks about it. Sure we get them: like the fellow who is going to build a B-36 (or something) with flaps, retractable landing gear, revolving turret, gun cameras, powered by four *Morton* M-5's.

"Power trend is upward. Planes formerly powered by .19's are now getting .29's. Most popular single kit has been the 'Live Wire Trainer,' with *Sterling's* 'Tri-Pacer' getting a good play."

\* \* \*

THE Bristol, Pa., Hydro Meet (August), with an event for R/C boats, brought out a flotilla of interesting craft. First place was taken by a *Sterling* kit of a "Chris Craft Catalina." Its powerplant was a *Pittman* electric motor, connected to a 6-volt *Willard* battery. Radio was the *Babcock* single-channel modulated tone equipment, the actuator a *DMECO* 2PN electric motor-driven servo. Both are hobby shop items. Experience shows that this combi-

nation will operate continuously for at least an hour.

Another version of the same boat featured an inboard-mounted *Cameron* .09 glow-plug motor with two-speed control. Radio was a *Lorenz* two-tuber, with a home built clockwork escapement.

The very excellent suggestion was made that course marker flags be in two colors, say red and black, so that the pilot would always steer to the right of the one color, and to the left of the other.

\* \* \*

TAKE-OFFS of R/C model planes would seem to be the easiest of all maneuvers yet, for most models, take-offs are impossible. Most jobs are hand launched. Two-wheel gears are prone to ground looping. Seen by your *PE* reporter at the 23rd National Model Airplane Championships was a development by Claude McCullough, Ottumwa, Iowa, which virtually insures arrow straight take-off runs. Tandem wheels are arranged in pairs, the rear-most wheel on each side being somewhat smaller than the front wheel. The normal landing gear strut attaches in such manner that the spring-loaded rear wheels are free to bump up and down. In action, the rear wheel resists any tendency of the plane to deviate from a straight line. Rudder control is effective for steering but does not force the plane into a ground loop. Another variation that works equally well is a double set of normal two-wheel landing gears, one about six inches behind the other. Credit Ernest Kratzet, Detroit, for this one.

\* \* \*

HAROLD DEBOLT, Williamsville, N. Y., pioneer of the full symmetrical wing section in radio control—similar to control line stunt models—which allows him to fly inverted, do successive outside loops, and other breath-taking maneuvers, states that the future in stunt design lies in bigger, lighter, slower, easier-to-fly machines. Under construction is a ship having 1300 sq. in. of wing area. This model will weigh only four pounds without radio, despite its huge size. The *Schmidt* five-channel radio will weigh another two pounds, with batteries and servos for rudder, elevators, and engine control.

\* \* \*

MYSTERY of the frequently occurring "death dives" with servo-operated elevators has been solved. Air loads upon the down elevator, it was discovered, so jammed the gear train (etc.) that the electric motor was not always capable of starting the control surface back to neutral. Now being developed is a new servo capable of producing a 20-ounce load from the neutral position, or a 32-ounce load in coming back to neutral from the on-control position. END



# A Compact Public Address System

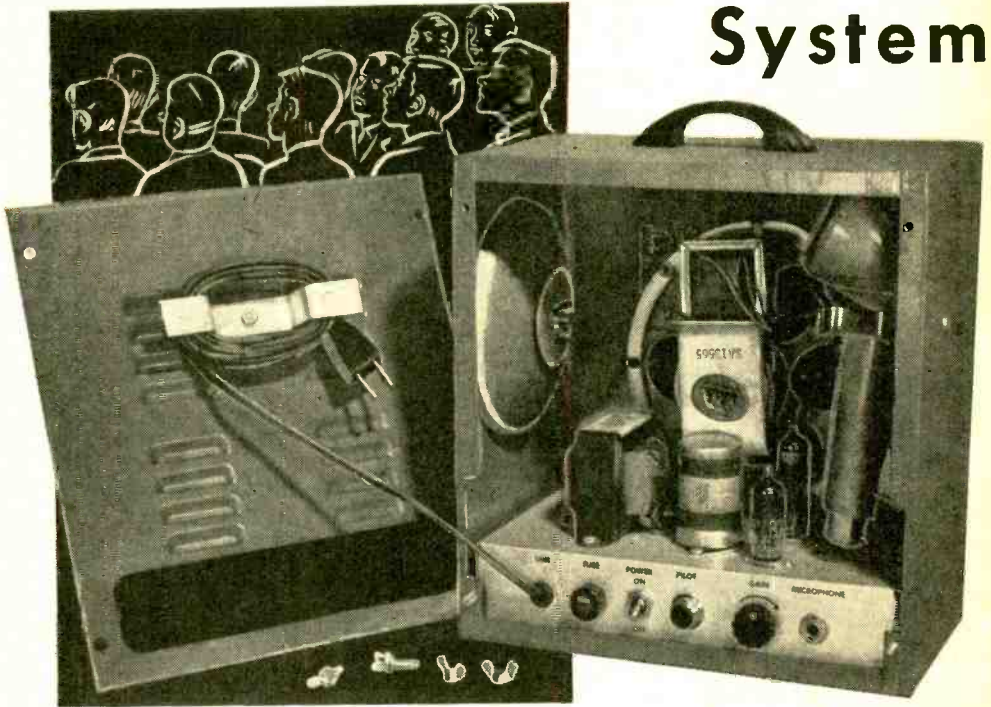

Fig. 1. Rear view of complete system showing how microphone and cord fit into cabinet.

**S** MALL club, church, and civic group meetings can be a lot more enjoyable if the chairman and guest speakers use a public address system. You can do your club or civic group a good turn by assembling a small p.a. system similar to the one shown in Fig. 5. Chances are the club membership will be happy to vote sufficient funds to cover all material costs.

Although fairly small (only 10"x10"x6" over-all) and completely self-contained, the system shown has ample power for the average small club or school room. The average hobbyist should be able to assemble the entire system in a single weekend.

## Amplifier Construction

A standard 5"x9½"x2" aluminum chassis is used for the amplifier. The layout is not critical. Just remember to keep the two tube sockets reasonably close together, with one socket close to the "Gain" control.

If you want to give your completed unit a "professional" appearance, use decals to

label all controls. These may be applied directly to the bare metal, but should be protected, after application, with two or three coats of clear plastic. In any case, don't apply the decals until you've completed all drilling and punching operations. Black decals were used on the model, but red decals show up almost as well on an aluminum background.

Drill at least four holes in the bottom lips of the chassis. These are used when the chassis is mounted in the cabinet.

Tube sockets and other parts are mounted with standard machine screws and hex nuts. The location of all major parts is clearly visible in Fig. 3. Use rubber grommets for protection wherever wires pass through the chassis.

## Wiring the Amplifier

The complete schematic diagram for the amplifier is given in Fig. 4, and below and above chassis views of the wired unit are given in Figs. 3 and 5, respectively. The

location of resistors, capacitors, and other electrical parts is clearly shown in the pictorial diagram of Fig. 2 and in Fig. 3. All important parts are identified in Fig. 3.

Lead dress is not especially important and most of the wiring is noncritical. Just keep the leads in the signal circuits as short as practicable.

A printed circuit coupling plate is used to couple the 6AU6 amplifier and the 6AS5

power output stages. This part may be replaced by individual components, if desired. Parts values are given on the circuit diagram of Fig. 4.

The output transformer ( $T_1$ ) is mounted on the loudspeaker and a 4-pin plug and socket used for coupling the loudspeaker assembly and the amplifier chassis. An electrodynamic loudspeaker is used, with the speaker field serving as a filter choke.

Fig. 2. Pictorial diagram of p.a. system showing correct hookup of all components.

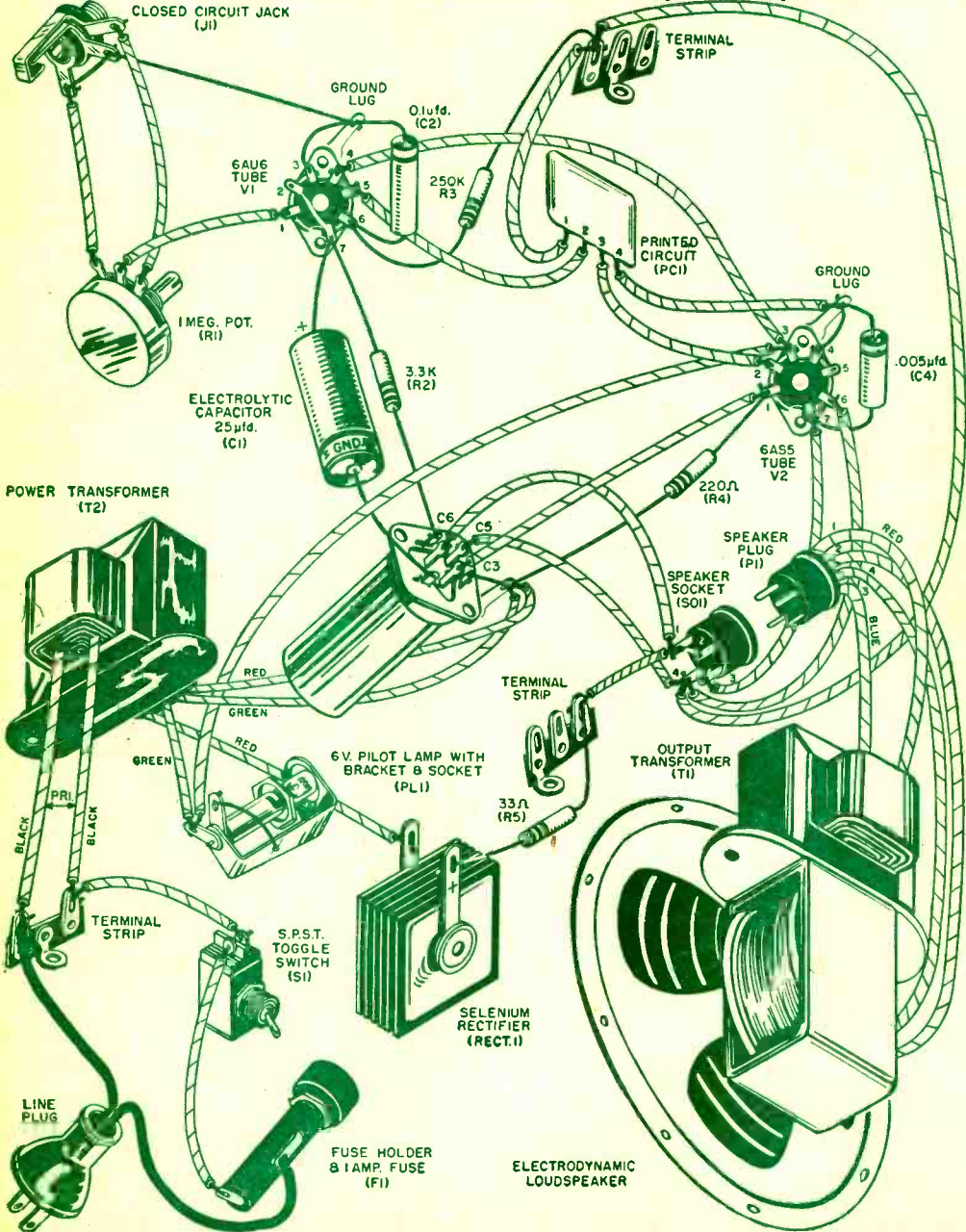
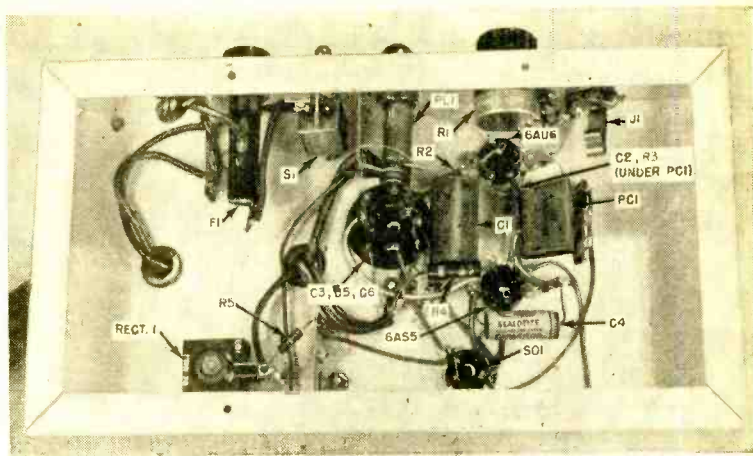



Fig. 3. Underchassis view of the wired amplifier with the various parts identified.



If you prefer, you can substitute a PM (permanent magnet) speaker for the electrodynamic unit. If you do, install a 10 henry, 50 ma. choke in place of the speaker field. There is ample room on the chassis for mounting a small choke.

### Cabinet Modifications

The cabinet used for the small p.a. sys-

tem is designed to serve simply as a loud-speaker baffle and, therefore, several modifications are necessary if the cabinet is to give satisfactory service as an amplifier carrying case. These modifications are clearly shown in Fig. 1.

First, locate the speaker mounting holes by holding the loudspeaker centered over the round speaker opening. Mark the

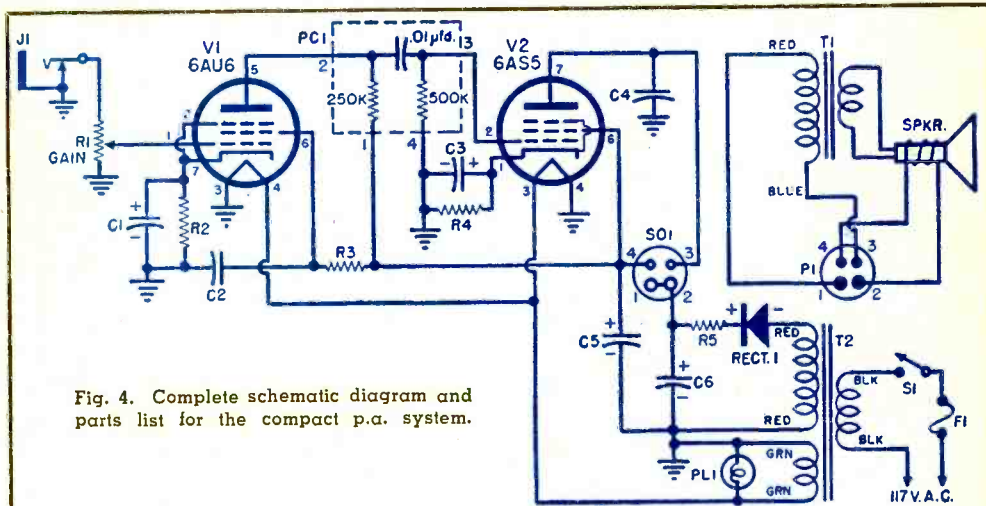

Fig. 4. Complete schematic diagram and parts list for the compact p.a. system.

- R<sub>1</sub>—1 megohm audio taper pot
- R<sub>2</sub>—3300 ohm, ½ w. res.
- R<sub>3</sub>—250,000 ohm, ½ w. res.
- R<sub>4</sub>—220 ohm, 2 w. res.
- R<sub>5</sub>—33 ohm, ½ w. res.
- C<sub>1</sub>—25 μfd., 25 v. elec. capacitor
- C<sub>2</sub>—1 μfd., 200 v. capacitor
- C<sub>3</sub>, C<sub>4</sub>, C<sub>5</sub>—20/80/40 μfd., 150 v. elec. capacitor (Mallory FP-311.7 in single can)
- C<sub>4</sub>—0.05 μfd., 400 v. capacitor
- J<sub>1</sub>—Closed circuit jack
- PC<sub>1</sub>—Printed circuit coupling plate (Erie #1404-02)
- T<sub>1</sub>—Output trans. to match 6AS5 (4500 ohms) to 6 ohm voice coil. ("Universal" type such as Merit A-2900 may also be used)
- T<sub>2</sub>—Power trans. 117 v. @ 50 ma.; 6.3 v. @ 2 amps. (Merit P-3045)

- SO<sub>1</sub>—4-prong speaker socket
- P<sub>1</sub>—4-prong speaker plug
- RECT. I—65 ma. selenium rectifier
- PL<sub>1</sub>—6 v. pilot light assembly
- S<sub>1</sub>—S.p.s.t. toggle switch
- F<sub>1</sub>—1 amp. fuse with holder
- Spkr.—6" electrodynamic speaker, 6-ohm voice coil, 1000 ohm field winding (see text)
- V<sub>1</sub>—6AU6 tube
- V<sub>2</sub>—6AS5 tube
- I—Cabinet (ICA #3935)
- 1—5" x 9½" x 2" aluminum chassis (Bud #AC 403)
- 1—Crystal microphone (Philmore #34)
- 1—Phone plug
- 1—Knob
- 2—7-pin miniature tube sockets
- 1—Line cord and plug

mounting hole locations with a pencil or scribe.

Drill four holes in the bottom of the case to correspond to the holes previously drilled in the lips of the amplifier chassis.

The amplifier chassis is slightly longer than the opening in the back of the cabinet. Therefore, cut a  $\frac{3}{8}$ " by 3" notch in the two side lips at the back of the cabinet. These will permit the chassis to be slipped into place.

Sheet metal screws are normally used to hold the back panel in place. Replace these with bolts and wing nuts so that the back can be removed without tools.

Mount a 3" bolt in one side of the cabinet and a tool rack spring clip in the opposite side (you can obtain these at hardware and dime stores). The bolt is used with a flat washer and wing nut to hold the microphone base. The spring clip holds the microphone itself. See Fig. 1.

Cut a  $1\frac{3}{4}$ "x $8\frac{1}{4}$ " rectangular hole near the bottom of the back panel, as shown in Fig. 1. You can do this easily by punching a  $\frac{5}{8}$ " round hole in each corner of the area to be removed and sawing between the punched holes with a keyhole hacksaw.

Make up a simple bracket out of aluminum bar stock to hold the line cord and mount this bracket on the back panel (see Fig. 1).

### Final Assembly and Testing

Once all wiring is completed and double-checked for errors, install the fuse, the tubes, and plug in the speaker. Attach a standard phone plug to the shielded microphone cable.

Plug the line cord into a standard wall outlet and turn the amplifier "on." After one or two minutes warm-up, plug in the microphone and turn up the "Gain" control.

Holding the "mike" fairly close, speak in a normal voice. Don't expect high gain. Since this amplifier has been designed specifically for use in small rooms, the overall gain has been kept low to minimize squealing and feedback.

The amplifier has sufficient gain for normal use if the microphone is held reasonably close, and the speaker uses a normal voice. However, it is almost impossible to get feedback and squealing under normal operating conditions, even with the "Gain" control full up.

Once the system has been checked out, install the amplifier chassis in the cabinet, using sheet metal screws.

When the line cord is coiled on its bracket, and the microphone and its stand mounted inside the cabinet, the entire system may be "buttoned up" in one compact carrying case as shown in the illustrations of Figs. 1 and 5. END



Fig. 5. Front and rear views of the completely assembled system and top chassis view of the wired amplifier before it is slipped into the cabinet. The unit is fully self-contained.

# New Airborne Radar Unit

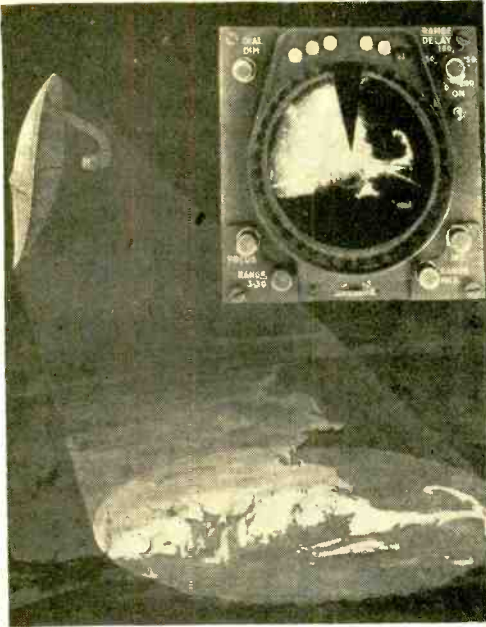

An artist's conception of the way the USAF's new airborne Sperry radar reproduces what the "turtle shell" antenna sees on the surface.

**A** NEW, compact airborne radar unit that assures greater safety for troop-carrying transports and essential cargo planes has been unveiled by the Air Research and Development Command in Baltimore.

The new device, made by *Sperry Gyroscope Co.*, is the smallest and lightest radar system, for its high power and wide range, for aircraft uses thus far publicly announced.

The entire system weighs only 150 pounds. This includes the 18" "turtle shell" antenna which is gyro stabilized for positive steadiness against the pitch and roll of the plane.

Besides storm warning, other multi-purpose advantages of the combination suggest equal military value for Army and Navy aircraft as well, in air-sea rescue, special patrol and refueling missions, among many other tactical uses for the APN-59.

Tests have shown that the radar has sufficient power to "see" all around one of the Great Lakes at a single "glance." One photo clearly showed Buffalo and Detroit, Toledo and Toronto at opposite extremities of Lake Erie, 250 miles apart.

A wide choice of range scales is available to the operator including close-up enlargements variable from 3 to 30 miles; or fixed ranges of wider areas at 50, 100, and 240 miles.

The new radar operates in the 10,000 mc. or "X-band" of the spectrum. **END**



The new APN-59 radar is compact enough to fit into single-passenger space. Left to right, in the rear, are stabilizing gyro and transceiver units, front, radar screen, synchronizer, control.

Compact "turtle shell" antenna. It scans terrain, clouds, and other aircraft. It can be altered for fan beam or pencil beam operation.

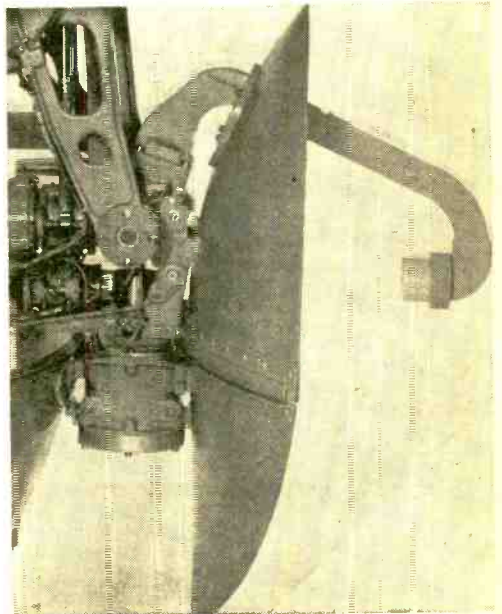

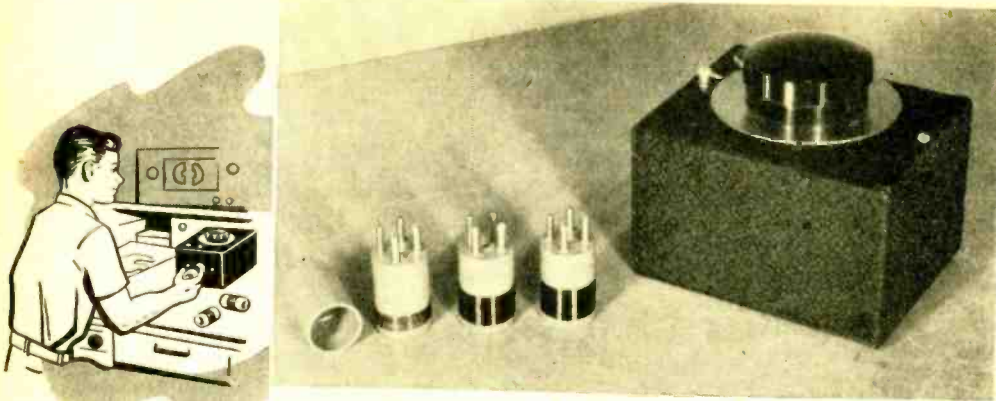

Fig. 1. Absorption wavemeter with complete set of coils. From left to right, Coils D, C, B, and A, as described in article.

## Build this Plug-in Absorption

THE absorption wavemeter is a simple and inexpensive frequency-measuring radio instrument. It is especially useful for checking the frequency of radio transmitter stages. When the exciter section of a transmitter is being adjusted or its coils are being pruned to size, the wavemeter is almost unequalled in showing quickly whether the stages are operating on the correct harmonics. While the absorption wavemeter is not a precision instrument, there are many applications in which its accuracy is entirely satisfactory. The wave-

meter is essential equipment in every ham station—novice or advanced.

The instrument described in this article has been designed expressly for transmitter measurements, although it can be used in any other wavemeter application. Its indicating device is a filament-type pilot lamp which glows brightest when the wavemeter is tuned to the frequency of the r.f. source under test. Using four plug-in coils, this instrument covers the frequency range 1.1 to 150 megacycles in the following bands: 1.1 to 3.8, 3.7 to 12.5, 12 to 39, and 37 to 150 mc. This range embraces all amateur bands up to and including the 2-meter band.

The simple circuit is shown in Fig. 2. A plug-in coil, variable capacitor, and pilot lamp are wired in series. The coil is held reasonably close to the source of r.f. energy and the capacitor is varied for tuning. When in tune, maximum energy is absorbed and the lamp glows brightly. The unknown frequency is then read from the wavemeter calibration data. (Calibration instructions are given later in this article). Use of a 2-volt, low-current indicator lamp improves sensitivity of the instrument.

### Constructional Details

The wavemeter is built in an easily-obtained metal chassis box 5" long, 4" wide, and 3" deep. The photographs (Figs. 1, 3, and 4) show outside and inside views of the instrument.

The coils are wound on 1"-diameter, 4-pin, plug-in forms. In use, they are plugged singly into a 4-pin socket mounted in the front end (bottom lip) of the box. (See Fig. 3).

Fig. 2. Complete schematic, parts list, and coil winding data for the wavemeter.

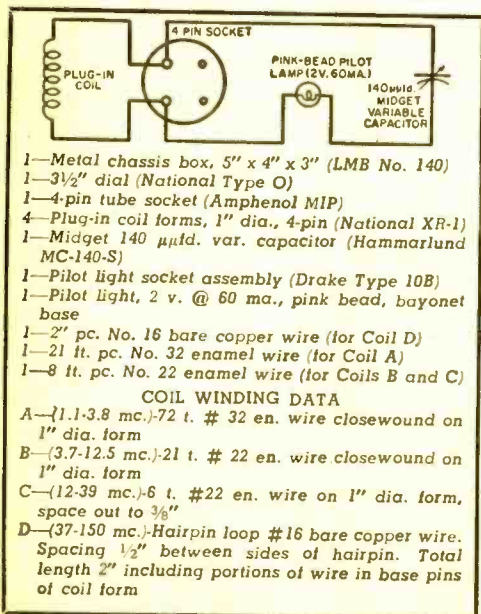





Fig. 3. "Nose"-end view of wavemeter with Coil A plugged in. Pilot lamp is at left.

# Wavemeter

The tuning capacitor is mounted through a single, centered hole in the top (front lip) of the box. A 3½-inch dial is attached to this capacitor. The pilot lamp assembly is mounted through a single hole, above the dial, in the upper right-hand corner of the top of the box. In this position, the lamp can be easily observed while the dial is being "tuned." The pilot light jewel should be of the clear, uncolored type, in order that low brilliance of the lamp can be seen.

Using the make of components specified in the accompanying parts list, the following hole sizes are required: tuning capacitor ⅜", pilot lamp assembly ⅜", and coil socket 1⅛".

The plug-in coils are wound on 1-inch-diameter low-loss phenolic 4-pin forms (*National XR-1*). All four coils are shown in Fig. 1. Fig. 5 shows details of coil construction. Winding instructions are given in the coil table accompanying the parts list.

Coils *A*, *B*, and *C* are of the type shown in Fig. 5A. The windings must be placed as close as possible to the tops of the forms, so that the coil can be "poked"

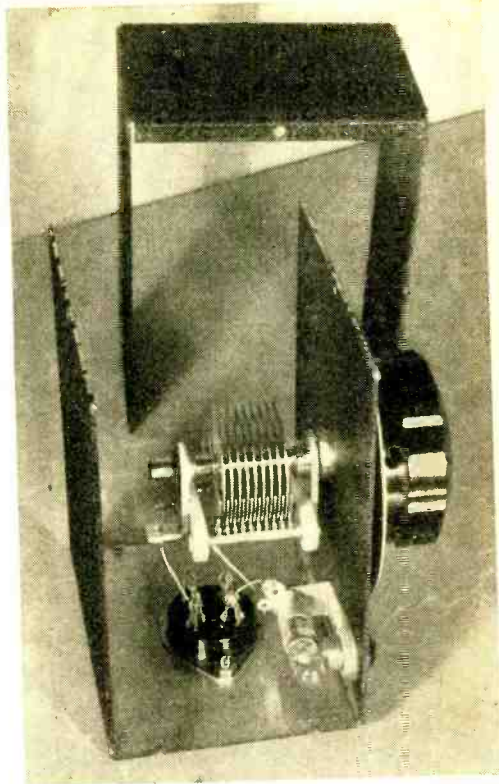

Fig. 4. Wavemeter opened up to show detail.

close into a circuit under test. The ends of the winding are pulled through the two large base pins, after tinning, and soldered. In each of the coil forms *A*, *B*, and *C*, two ⅛-inch wire holes are drilled (See Fig. 5A). These hole pairs are spaced as follows: *A*-1¼", *B*-⅝", and *C*-⅜".

In order to obtain the low value of inductance required for the highest-frequency range, coil *D* is a "hairpin" loop of No. 16 bare copper wire. This loop stands upright inside one of the coil forms, as shown in Fig. 5B. It can be seen also in the overturned coil in Fig. 1. The total length of the loop is 2 inches, including the part of the wire that extends into the base pins of the coil form (Fig. 5B). The

Fig. 5. Mechanical details on plug-in coils.

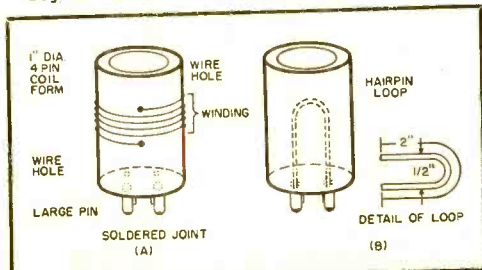
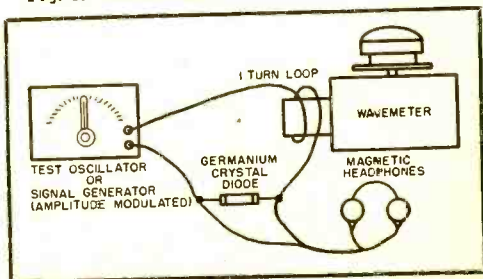

Fig. 6. Test set up for calibrating wavemeter.



½-inch spacing allows the hairpin ends to be inserted easily into the base pins.

### Calibration

Absorption wavemeters can be calibrated in a number of ways. The scheme shown in Fig. 6 probably is the simplest and easiest for the instrument described here. Needed are an amplitude-modulated r.f. test oscillator or signal generator covering 1.1 to 150 mc. on *fundamentals*, a germanium crystal diode, and a pair of high-resistance headphones. The type of oscillator used by radio service technicians will be satisfactory. Do not connect the diode in series with the headphones, as an isolating capacitor inside the oscillator would prevent it from working.

Follow this procedure: (1) Set the oscillator for highest output. Note that a signal tone is heard in the headphones. (2) Set oscillator to 1.1 mc. (3) Plug coil A

into wavemeter. (4) Run one of the oscillator output leads into a 1-turn loop around the wavemeter coil, as shown in Fig. 6. (5) Rotate wavemeter dial slowly until a dip point is found where signal almost drops to zero in headphones. Record this dial point which corresponds to 1.1 mc. (6) Advance oscillator frequency to 1.5 mc. and retune wavemeter for null point. Record. (7) Repeat this procedure at as many points as possible, to cover entire wavemeter dial. (8) Successively plug in coils B, C, and D, resetting the oscillator and repeating the procedure to cover the frequency ranges shown in the coil table.

Obtain as many calibration points as possible for each coil range. After the calibration points are collected, they may be used to plot a tuning curve for each coil, or to graduate the dial of the wavemeter into four frequency ranges corresponding to the four coils. END

## THE FIRST FM TUNER FOR CARS

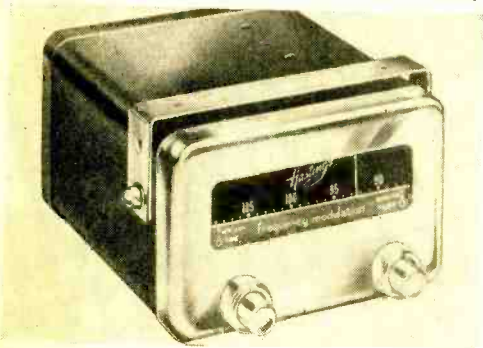

THOSE who enjoy FM reception at home can now have the same hi-fi programs in their cars, thanks to a new 88-108 mc. FM tuner recently introduced by *Hastings*.

Designed to operate from either a 6 or 12 volt auto battery system, the tuner can be used with the car's AM radio system or with a separate amplifier and speaker unit which is available from the company. The set needs no external antenna, a plastic windshield antenna strip is used instead.

## Portable Tape Recorder

ASPRING-wound, battery-powered tape recorder which will operate anywhere, anytime is now being marketed as the "Tapak" by *Broadcast Equipment Specialties Corp.*

It is available in two models. The standard provides 50 minutes recording or playback at 3¾" speed with a frequency response of 100-4000 cps. The frequency response of the custom model is to 5000 cps. The entire unit weighs only 19 pounds.

## New Indoor TV Antenna

AN electronic indoor antenna for all TV bands, AM-FM radio, and color TV is now available from *Tentenna, Inc.* The compact plastic-encased unit incorporates ten tuned circuits. It is available in red, ivory, maroon, yellow, or black to match any decorating scheme.

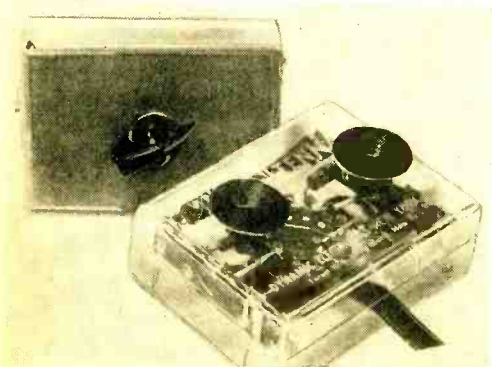

# How Many Controls?

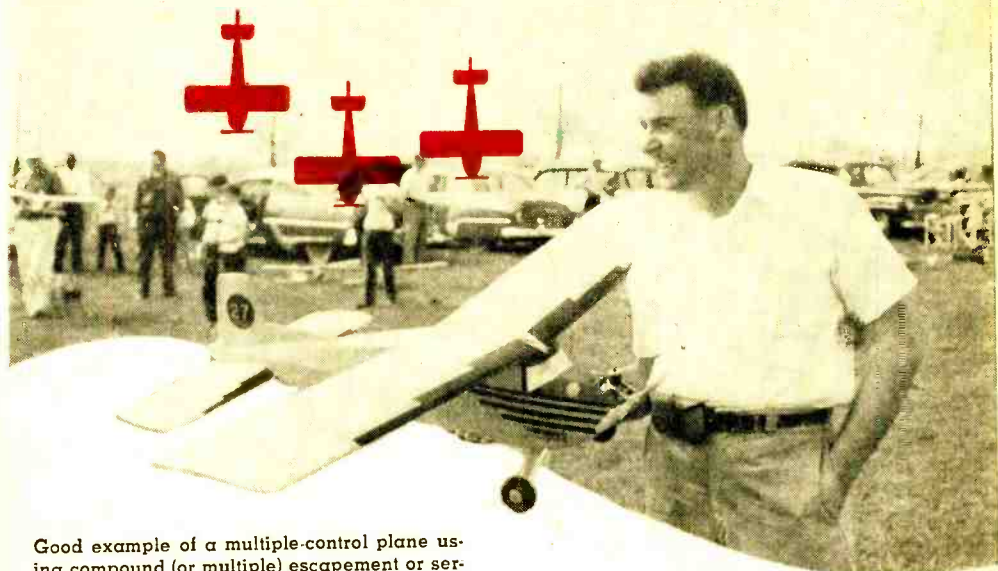

Good example of a multiple-control plane using compound (or multiple) escapement or servo (servo in this case) to work second actuator and control. Marty Siel is the "pilot."

By **WILLIAM WINTER**  
Editor, "Model Ai-plane News"

**H**OW a man drives a car is hardly as tell-tale as the kind of radio control model he flies. One chap delights in electronics, spends contented weeks at the bench, then tinkers most of day on the flying field, earphones on head, tuning wand in hand. Another just wants to fly.

The one wants multiple controls, with gadgets and gismos, the other ultimate simplicity. Since the airplane size varies according to its master's interests, the logical jumping off place for that first R/C model is the consideration of the controls desired and the methods of operating them.

What the beginner doesn't realize is that the big problem is not the radio, or the controls it will operate, but the successful, reliable flying of the plane. There is an understandable, though regrettable, tendency to assume that radio enables the operator to make up for the deficiencies in the plane, its lack of stability, poor balancing, inaccuracies in construction, warps, and so on. Overcontrolling, with a building up of violent, involuntary maneuvers is a typical beginner problem. The more controls the beginner is saddled with, and tries to use, the more likely he is to tear up the turf on a first flight. Until he has acquainted

himself with handling the simple model, preferably by rudder only, he should stay away from elevators.

Before analyzing the various control systems, we should distinguish between single- and multi-channel radios. The latter are selective, because the pilot can choose any of the controls directly. The former involves sequences, and auxiliary actuators for more than one control. The added control cannot be used with the same flexibility and precision of the multi-channel unit, although the latter yields maximum results only when the hobbyist is able to use it intelligently. Let's begin, therefore, with the single-channel setups.

1. *Rudder Only*: Because of relatively low cost and simplicity, rudder is ideal for beginners and has the added advantage of permitting more advanced maneuvers when

This model plane by Carl Schmaedig won the 1954 Mirror Meet. It uses a Babcock three-channel for elevator, motor, rudder control.



↓ Citizen-Ship Radio Corp's self-neutralizing escapement. The resistance is 5 ohms. The unit works on 3 volts and will operate down to 1½ volts on a loop of 3/16 rubber which has been twisted in two rows of knots.

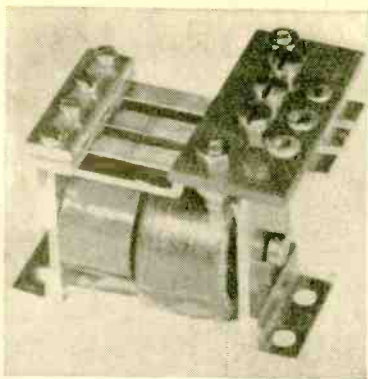
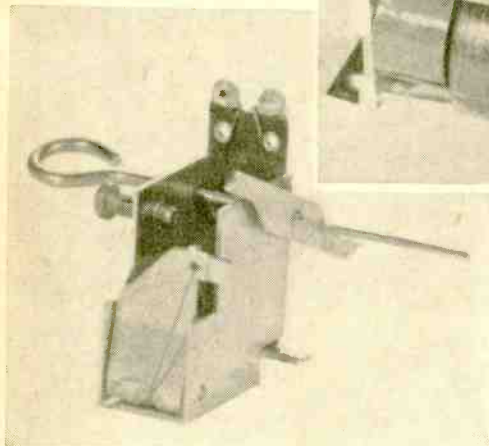

← Typical reed bank by Radio Control Specialties. This one has three reeds and can operate three different actuators by means of a modulated tone receiver (three channels).

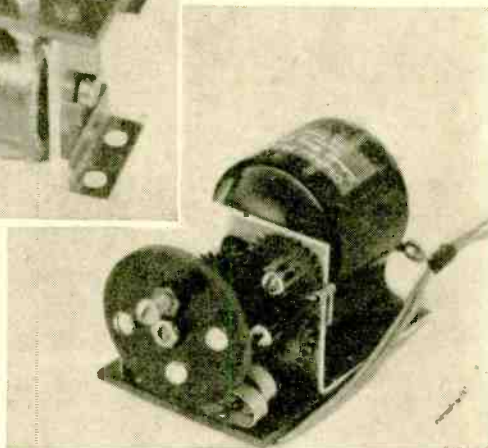

A "multi-servo" unit for rudder-only control.

experience is gained. Although the man who knows something of electronics and mechanics can use trick controls, such as solenoids, commercially available equipment includes several types of escapements, electric motor-driven servos, and magnetic actuators. Rudder only should not be underestimated; skilled fliers have won the National Contest without benefit of additional controls.

2. *Rudder and Motor Control:* Usually, the motor has two speeds. If ignition, it has two sets of points; if it runs on glow fuel, two needle valves, or a butterfly valve in the engine's venturi, a restrictor in the exhaust stack, or a special throttle. Normal escapements and servos may be

modified to work the auxiliary actuator for the second control, but virtually all single-channel, two-control jobs involve a special type of actuator, known as the compound escapement or compound servo, which closes an electrical contact when given the second-control signal from the transmitter.

Motor control allows powered descents and, if the pilot is skilled and the plane possessed of enough sinking speed, touch-and-go landings, one of the truly difficult maneuvers. Adjusted to give either high or cruising power, the engine can be throttled back to cruise, once aloft, making for smooth, precise maneuvers. This also minimizes the "kiting" effects of a

The Schmidt "Multichannel" receiver, showing two servos. Elevator servo (top) trims elevators for up or down; rudder servo (bottom) moves rudder left or right and is self-neutralizing. On receiver itself, note five "Neomatic" relays in foreground and reed bank with five reeds (upper right).

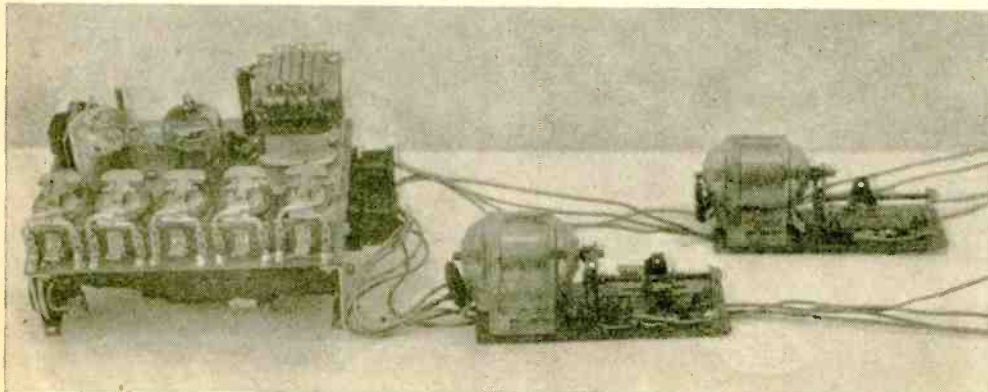

Tail section showing torque rod drive to rudder from Bonner compound escapement. Note the yoke at rear and the pin in the rudder trailing edge. Moved up on the rudder, this pin would give more rudder movement, down would give less. This feature provides adjustment to suit pilot's desires.

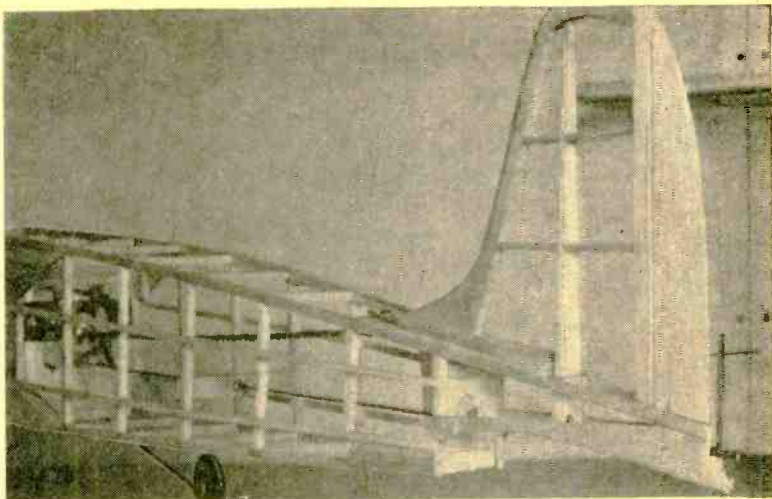

wind or even allows shutting off the engine when in trouble.

3. *Rudder and Elevator:* A second, or auxiliary escapement or servo, is energized by the primary, compound-type of actuator, to move the elevators. The elevators will have a sequence operation, since their movement is up, back to neutral, then down, back to neutral, etc. The pilot passes quickly through the unwanted position. The plane cannot be flown precisely by elevator, but is handled like a rudder-only airplane and is positioned for special elevator maneuvers, such as steep dives, to complete a loop, or to flare out for a soft landing. A competent pilot using this system can be beaten only by an expert handling multi-channel.

One limitation is that escapements, etc., give an "all or nothing" position of the controls. If the elevator movement is adjusted for violent maneuver, such as an outside loop, the controls react too violently for more gentle maneuvers, as pulling up from a dive to round out a loop. The abrupt reaction builds up such a *g*-load on the ship that a high-speed stall takes place, visible as "mushing" of the flight path. Actually, only the experienced flier is concerned with this fine point.

The system has tricky mechanical aspects, however. On bigger models, where heavy weight and high speeds are encountered, the escapements are hard put to displace the big control area. Required is aerodynamic balancing (part of the control area forward of the control axis, so that an airgap is formed between the leading edge of the control and the stabilizer surface when the control is actuated), and static balancing (counterweight forward of the surface to balance its dead

*(Continued on page 105)*

A Bonner compound escapement mounted in a Berkeley "Bootstraps." Note toe torque rod extending to rear to operate rudder and the twisted rubber motor that supplies the physical power to the escapement for moving controls. This unit is by S. T. Babcock.

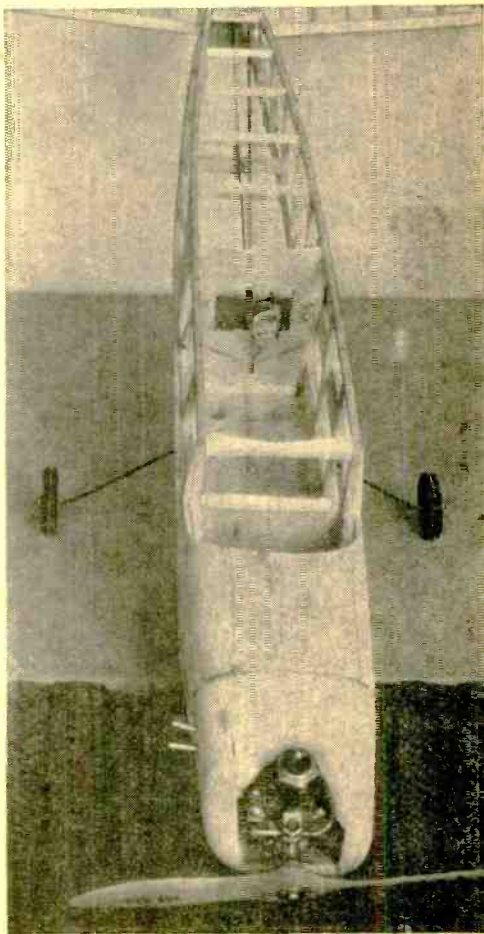

# Build YOUR OWN HEATHKITS

INTERESTING—EDUCATIONAL



work has already been done for you. No cutting, drilling, or painting required. All parts furnished including tubes. Knowledge of electronics, circuits, etc., not required to successfully build Heathkits.

## New PRINTED CIRCUIT VACUUM TUBE VOLTMETER KIT

The VTVM is the standard basic voltage measuring instrument for radio and TV servicemen, engineers, laboratory technicians, experimenters, and hobbyists. Because of its extremely high input resistance (11 megohms) the loading effect on the circuit being measured, is virtually negligible. The entire instrument is easy to build from a complete kit, with a detailed step-by-step Construction Manual. Featured in this instrument is an easy-to-wire fool-proof printed circuit board which cuts assembly time in half.

**CIRCUIT AND RANGES:** Full wave AC input rectifier permits 7 peak-to-peak voltage ranges with upper limits of 4000 volts peak-to-peak. Just the ticket for you TV servicemen. Seven voltage ranges, 1.5, 5, 15, 50, 150, 500 and 1500 volts DC and AC RMS. Peak-to-peak ranges 4, 14, 40, 140, 400, 1400, and 4000 volts. Ohmmeter ranges X1, X10, X100, X1000, X10K, X100K, X1 meg. Additional features are a db scale, center scale zero position, and a polarity reversal switch.

**IMPORTANT DESIGN FEATURES:** Transformer operated—1% precision resistors—6AL5 and 12AU7 tubes—selenium power rectifier—individual AC and DC calibrations smoother improved zero adjust control action—new panel styling and color—new placement of pilot light—new positive contact, battery mounting—new knobs—test leads included. Easily the best buy in kit instruments.

New Peak-to-peak  
meter scale—new  
color harmony—  
new control knobs.

New printed circuit  
board for faster,  
easier construction  
—exact duplication  
of Laboratory de-  
velopment model.



New charcoal gray baked  
enamel panel with highly  
readable white lettering.

Model V-7

**\$24.50**

Shpg. Wt. 7 lbs.

New easy-to-read  
open panel layout.  
Off-on switch incor-  
porated in selector  
switch

## Heathkit HANDITESTER KIT



MODEL M-1  
**\$14.50**

Shpg. Wt. 3 lbs.

The Heathkit Model M-1 Handitester readily fulfills all requirements for a compact, portable volt-ohm-milliammeter. Its small size permits the instrument to be tucked into your coat pocket, tool box or glove compartment of your car. Always the "handitester" for those simple repair jobs. Packed with every desirable feature required in an instrument of this type. AC or DC voltage ranges, full scale 10, 30, 300, 1000 and 5000 volts. Ohmmeter ranges 0-3000 ohms and 0-300,000 ohms. DC milliammeter ranges 0-10 milliamperes and 0-100 milliamperes. Uses 400 microampere meter—1% precision resistors—hearing aid type ohms adjust control—high quality Bradley rectifier. Test leads are included.

## Heathkit MULTIMETER KIT



MODEL MM-1  
**\$26.50** Shpg. Wt.  
6 lbs.

Here is an instrument packed with every desirable service feature and all of the measurement ranges you need or want. High sensitivity 20,000 ohms per volt DC, 5000 ohms per volt AC. Has the advantage of complete portability through freedom from AC line—provides service ranges of direct current measurements from 150 microamperes up to 15 amperes—can be safely operated in RF fields without impairing accuracy of measurement.

Full scale AC and DC voltage ranges of 1.5, 5, 50, 150, 500, 1500, and 5000 volts. Direct current ranges are 150 microamperes, 15, 150, and 500 milliamperes and 15 amperes. Resistances are measured from .2 ohms to 20 megohms in three ranges and db range from -10 to +65 db. Ohmmeter batteries and necessary test leads are furnished with the kit.

**HEATH COMPANY**  
BENTON HARBOR 10, MICHIGAN

**New**

PRINTED  
CIRCUIT

# Heathkit 3" OSCILLOSCOPE KIT



Model  
OL-1

**\$29.50**

Shpg. Wt.  
15 lbs.

Ideal for individual home shop, ham shack or as extra instrument for outside servicing.

Compact size, light weight, portable — perfect for service work or field operation.

New, modern styling, gray lettering with white gray knobs and light case — contrasting red and black terminal posts.

New printed circuit for constant performance, rugged component mounting — assembly time cut in half!

Measures only 11 3/4" x 6 3/4" x 1 9/16" and weighs only 11 pounds.

**USE:** This brand new Utility Scope was designed especially for servicemen and radio amateurs, and is adaptable for use in all general scope applications. Perfect for modulation monitoring, etc. Use it to tackle alignment or adjustment problems. Equally valuable in breadboard work. A must for ham shack or for outside servicing.

**DESCRIPTION:** Front panel controls of the Model OL-1 are "bench tested" for ease of operation and convenience. Sharp focusing 3" CRT. Printed circuit for ease of assembly and constant performance. Assembly time cut in half! High quality electronic components used. Sensitive hor. and vert. amplifiers with broad freq. response; cathode follower for isolation. Push-pull hor. and vert. output to deflection plates. Int. 60 cycle, or ext. sync. Sweep freq. range 10-100,000 cycles. Direct connection to deflection plates. Provision for Z axis input. Uses 3GP1 CRT, 4-12AU7 hor. and vert. amplifiers, 1-12AX7 sweep gen., 1-6X4 LV rect., and 1-1V2 HV rect. The Heathkit Model OL-1 is a real standout value at only \$29.50, and is another example of the famous Heathkit combination; quality plus economy.

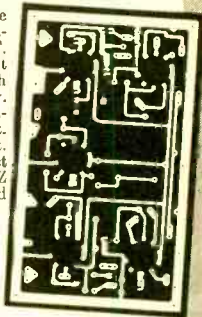

**Heathkit**

# SIGNAL GENERATOR KIT

**USE:** This instrument is "serviceman engineered" to fill the requirement for a reliable basic service instrument at moderate cost. Frequency coverage extends in five bands from 130 Kc to 110 Mc on fundamentals, and dial is calibrated to 220 Mc for harmonics. Pre-wound and pre-aligned coils make calibration unnecessary for service applications.

**DESCRIPTION:** The Heathkit Model SG-8 Signal Generator provides a stable modulated or unmodulated RF output of at least 100,000 microvolts which can be controlled by both a continuously variable and a fixed step attenuator. Internal modulation is at 400 cycles, or can be externally modulated. AF output of 2-3 volts is also available for audio testing. Uses dual purpose 12AU7 as Colpitts RF oscillator and cathode follower for stable, isolated, low impedance output, and type 6C4 tube for 400 cycle oscillator. Operation of the SG-8 is well within the frequency limits normally required for service work. Modern styling features high definition white letters on charcoal gray panel with re-designed control knobs. Modern professional appearance and Heathkit engineering know-how combine to place this instrument in the "best buy" category. Only \$19.50 complete.

New, modern panel and knob styling — professional appearance and professional performance.

Broad frequency coverage — fundamentals from 130 Kc to 110 Mc in 5 bands — up to 220 Mc on calibrated harmonics.

Cathode follower output for good isolation — fixed step and continuously variable attenuation.



Output selection — internal modulation, pure r.f. or audio output.

MODEL SG-8 **\$19.50** Shpg. Wt. 8 lbs.

# Heathkit ANTENNA IMPEDANCE METER KIT



MODEL  
AM-1

**\$14.50** Shpg. Wt. 2 lbs.

The Model AM-1 Antenna Impedance Meter makes an ideal companion unit for the GD-1B Grid Dip Meter or a valuable instrument in its own right. Perfect for checking antenna and receiver impedance and match for optimum system operation. Use on transmission lines, halfwave, folded dipole, or beam antennas. Will double as monitor or relative field strength meter. Covers freq. range of 0-150 Mc and impedance range of 0-600 ohms. Uses 100 microampere meter and special calibrated potentiometer. A real buy at only \$14.50 complete.

# Heathkit GRID DIP METER KIT

Amateurs and servicemen have proven the value of this grid dip meter many times over. Indispensable for locating parasitics, neutralizing, and aligning filters and traps in TV or Radio and for interference problems. The Model GD-1B covers from 2 Mc to 250 Mc with 5 pre-wound coils. Featuring a sensitive 500 microampere meter and phone jack, the GD-1B uses a 6AF4 or 6T4 tube. An essential tool for the ham or serviceman.



MODEL  
GD-1B

**\$19.50** Shpg. Wt. 4 lbs.

**ACCESSORIES:** Low freq. coverage to 355 KC with two extra coils and calibration curve. Set No. 341A for GD-1B and set No. 341 for GD-1A. Shipping weight 1 lb. Only \$3.00.

**HEATH COMPANY**  
BENTON HARBOR 10, MICHIGAN

# New Heathkit VFO KIT



MODEL VF-1

**\$1950**

Ship. Wt. 7 lbs.

- Smooth acting illuminated and precalibrated dial.
- 6AU6 electron coupled Clapp oscillator and OA2 voltage regulator.
- 7 Band coverage, 160 through 10 meters—10 Volt RF output.
- Copper plated chassis—aluminum cabinet—easy to build—direct keying.

Here is the new Heathkit VFO you have been waiting for. The perfect companion to the Heathkit Model AT-1 Transmitter. It has sufficient output to drive any multi-stage transmitter of modern design. A terrific combination of outstanding features at a low kit price. Good mechanical

and electrical design insures operating stability. Coils are wound on heavy duty ceramic forms, using Litz or double cellulose wire coated with polystyrene cement. Variable capacitor is of differential type construction, especially designed for maximum bandspread and features ceramic insulation and double bearings.

This kit is furnished with a carefully precalibrated dial which provides well over two feet of calibrated dial scale. Smooth acting vernier reduction drive insures easy tuning and zero beating. Power requirements 0.3 volts AC at .45 amperes and 250 volts DC at 15 mills. Just plug it into the power receptacle provided on the rear of the AT-1 Transmitter Kit. The VFO coaxial output cable terminates in plastic plug to fit standard 1/2" crystal holder. Construction is simple and wiring is easy.

Open layout — easy to build — simplified wiring.

Smooth acting illuminated dial drive.

Clean appearance — rugged construction — accessible calibrating adjustments.

Copper plated chassis — easy to build — direct keying.

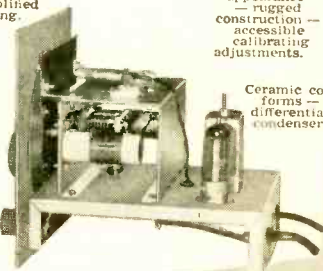

Ceramic coil forms — differential condenser.

# Heathkit AMATEUR TRANSMITTER KIT



MODEL AT-1

**\$2950**

Ship. Wt. 16 lbs.

### SPECIFICATIONS:

Range 80, 40, 20, 15, 11, 10 meters.  
 6AG7 ..... Oscillator-multiplier.  
 6BQ7 ..... Amplifier-doubler  
 5U4C ..... Rectifier.  
 105-125 Volt A.C. 50-60 cycles 100 watts. Size: 8 1/4 inch high x 13 1/8 inch wide x 7 inch deep.

Crystal or VFO excitation.

Prewound coils — metered operation.

Rugged, clean construction.

Single knob band switching.

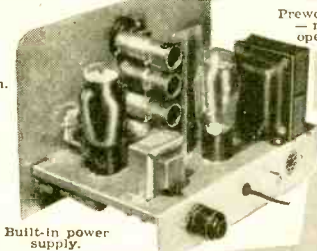

Built-in power supply.

52 ohm coaxial output.

Here is a major Heathkit addition to the Ham radio field, the AT-1 Transmitter Kit, incorporating many desirable design features at the lowest possible dollar-per-watts price. Panel mounted crystal socket, stand-by switch, key click filter, A. C. line filtering, good shielding, etc. VFO or crystal excitation—up to 35 watts input. Built-in power supply provides 425 volts at 100 MA. Amazingly low kit price includes all circuit components, tubes, cabinet, punched chassis, and detailed construction manual.

# Heathkit COMMUNICATIONS RECEIVER KIT

RF gain control with AVC or AVC.

Electrical bandspread and scale.

Stable BFO oscillator circuit.

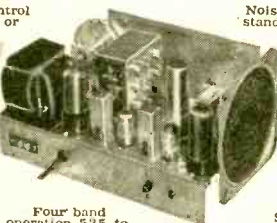

Four band operation 535 to 35 Mc.

Noise limiter—standby switch.

1/2 inch PM Speaker-Headphone Jack.

Six tube transformer operation.

### SPECIFICATIONS:

Range.....535 Kc to 35 Mc  
 12BE6 ..... Mixer-oscillator  
 12BA6 ..... I. F. Amplifier  
 12AV6 Detector—AVC—audio  
 12BA6 ..... E. F. O. oscillator  
 12AB6 ..... Beam power output  
 5Y3GT ..... Rectifier  
 105-125 volts A.C. 50-60 cycles, 45 watts.

A new Heathkit AR-2 communications receiver. The ideal companion piece for the AT-1 Transmitter. Electrical bandspread scale for tuning and logging convenience. High gain miniature tubes and IF transformers for high sensitivity and good signal to noise ratio. Construct your own Communications Receiver at a very substantial saving. Supplied with all tubes, punched and formed sheet metal parts, speaker, circuit components, and detailed step-by-step construction manual.



MODEL AR-2

**\$2550**

Ship. Wt. 12 lbs.

### CABINET:

Proxylon impregnated fabric covered plywood cabinet. Ship. weight 5 lbs. Number 91-10. \$4.50.

**HEATH COMPANY**  
 BENTON HARBOR 10, MICHIGAN





# USING AND UNDERSTANDING

## THE NEON GLOW LAMP



By  
E. D. MORGAN

ONE of the most fascinating, useful, yet inexpensive devices available to the experimenter is the neon bulb or glow lamp. While some of its applications are familiar to all of us, its basic principles are often misunderstood. These same principles form the basis for many more complicated devices. Gas rectifiers, thyratrons, mercury vapor lamps, and fluorescent lighting all depend upon the same fundamentals. Simple experiments can readily illustrate these fundamentals and require no elaborate laboratory equipment. Neon lamps can be purchased for as little as a dime, they have a long life, and can serve many practical purposes in addition to their educational value.

The tubes used in radio and television receivers require a very high vacuum and every effort is made to eliminate as many gas molecules as possible. They are often referred to as "hard" tubes, while those in which gas is purposely introduced, such as a neon lamp, are known as "soft" tubes. The presence of this gas changes the behavior of the tube entirely. Instead of a current consisting entirely of a stream of electrons, the gas molecules themselves contribute to the current flow after undergoing a process known as ionization. While a detailed study of the entire phenomenon can be very complex, a simple explanation of how ions can be produced will illustrate the point sufficiently.

The atomic structure of an element is composed, basically, of a nucleus, which is a group of particles with a positive charge and containing most of the mass of the atom; and a number of loosely bonded electrons, negatively charged and of comparatively little mass. Under normal conditions the positive and negative charges are equal and the atom has no net electrical charge. If, for some reason, an atom or molecule loses one of these electrons, it is said to be ionized and called a positive ion. It is the process whereby these positive ions are generated that is the heart of the operation of a neon lamp.

A perfect gas, if such could exist, would

be a perfect insulator, that is, no current would flow if a voltage were applied across two electrodes immersed in the gas. On the other hand, such perfect gases do not exist. Instead, there is present in any practical gas, positive ions of the type just described, as well as free electrons. If a voltage is applied across two electrodes in such a gas, the electrons are attracted to the positive electrode, or anode, and the positive ions are likewise attracted to the negative electrode, or cathode. Under normal circumstances, with low voltages applied, this flow of electrons and positive ions, constituting a current, is very small, often a microampere or less.

If the applied voltage is raised sufficiently, however, and the electrode spacing and gas pressure are proper, the electrons, having little mass, acquire high speeds and consequently, large amounts of kinetic energy. If one of these collides with a gas molecule, the force of the collision can knock an additional electron free from the electrostatic forces holding it to the nucleus. The additional electron joins the stream flowing to the anode and it can, likewise, acquire sufficient energy to free additional electrons by collision. This is a cumulative effect, then, and when the applied voltage is raised enough to start the ionization process, there is a sudden increase in current; many, many times that flowing before ionization.

Several interesting things happen when this process occurs. The ionization, or breakdown, is accompanied by a sudden drop in voltage, and for nearly all values of current within the rating of the tube, the terminal voltage remains practically constant at this lower value. This proper-

Fig. 1. (A) A simple relaxation oscillator. A frequency of about 2 cycles-per-second is obtained with the component values shown and 135 volts applied. (B) Graph showing how voltage across the capacitor varies to produce the saw-tooth waveforms.

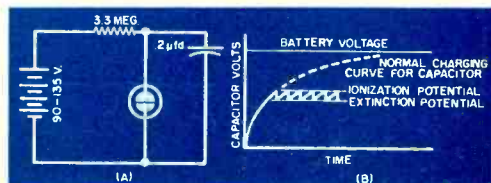

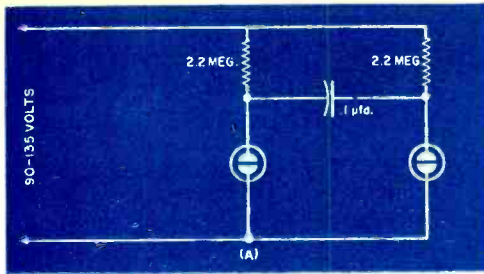

Fig. 2. Novel flashing lamp circuits easily obtained using neon glow lamps. Orderly flashing sequences may be altered by small changes in the component values. These circuits are adaptable for display purposes or for lighting small models. See article.

ty forms the basis for the voltage regulator tubes widely used in electronic circuitry. Another noteworthy occurrence is the emission of light. As the electrons collide with the gas molecules, they impart some of their energy to them. This energy must be dissipated in some way and as the molecule returns to its normal state, it gives off this surplus energy in the form of light. This is the familiar glow that surrounds the cathode of a neon bulb and the principle that makes neon lighting possible. A third interesting point is that the breakdown voltage, the voltage which must be impressed to cause this phenomenon to start, is usually several volts higher than the extinction potential, least voltage capable of supporting the ionization when once started. This property is utilized for many useful purposes, the generation of particular types of waveforms being the most familiar.

### Relaxation Oscillators

One of the most interesting applications of the glow lamp is its use as a relaxation oscillator. Its primary application in this respect is to generate saw-tooth or triangular waveforms, which are widely used as linear time base sweep voltages in cathode-ray oscilloscopes. More refined circuits than the one discussed here are in general use but the underlying principle is the same. The basic circuit is shown in Fig. 1A. The battery voltage must be above the breakdown voltage of the neon bulb, which for most types is about 90 volts.

When the circuit is first energized, an initial surge of current flows into the capacitor and it charges toward the applied voltage in an exponential fashion as usual. The initial voltage across the capacitor and neon bulb is zero and as the voltage rises, the bulb remains in a nonconducting state until the voltage

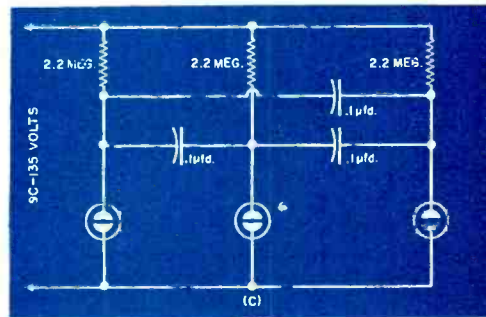
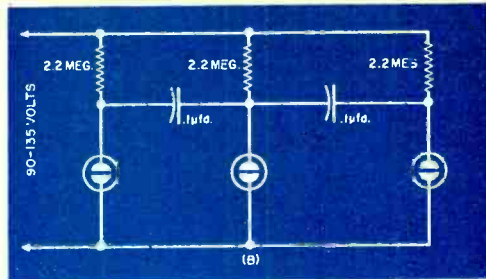

reaches the firing, or breakdown potential of the bulb. At this point, the gas ionizes, the tube fires and presents an essential short circuit across the capacitor. This effectively discharges the capacitor and the voltage across it drops rapidly. When it falls below the extinction potential of the neon lamp, de-ionization occurs and the capacitor again begins to charge toward the applied battery voltage. Each time the voltage reaches the breakdown potential, the rapid discharge through the lamp takes place and the cycle repeats. The waveform examined across the capacitor has a saw-tooth form as the capacitor charges slowly through the resistor on one-half the cycle and discharges very rapidly on the other half of the cycle. The resulting waveform is shown in Fig. 1B. By placing a resistance in the discharge path through the lamp the discharge time can be slowed down to give a triangular waveform.

A great many combinations of resistance  
(Continued on page 115)

Fig. 3. (A) Diagram of voltage regulator circuit. (B) Current-voltage characteristic of the voltage regulator tube indicating the region of regulation and operation.

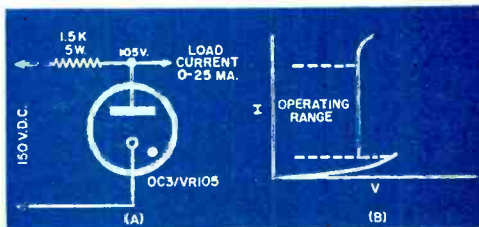

# TOOLS & GADGETS

## SOLDER FLUXES

For electrical, electronic, and printed circuit work of all types, *Alpha Metals, Inc.* has introduced a line of external soldering fluxes which is available in 1 ounce bottles as well as quart and gallon sizes.

The non-corrosive rosin types for electronic work are formulated to give maximum wetting and rapid fluxing power. For a bulletin on the various fluxes in the line write the company at 56 Water Street, Jersey City 4, N. J.

## LATCHING RELAY

*C. P. Clare & Co.*, 3101 W. Pratt Blvd., Chicago 45, Ill. is announcing the availability of the Type G electromechanical latching relay which consists of two of the company's Type GAC a.c. relays with inter-

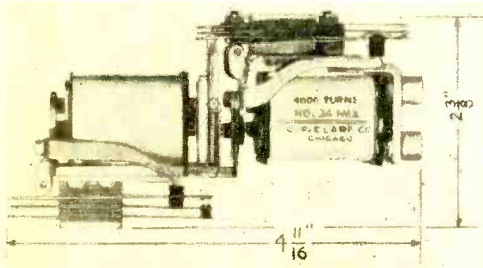

locking armatures. They are aligned one above the other on a common mounting bracket to save chassis space. The assembly may also consist of two Type G d.c. relays or one a.c. and one d.c. relay.

Typical circuit functions performed by this relay include: hold contacts operated any length of time without consuming power; operate contacts over one lead and release them over another; act as an overload relay—electrically reset from a remote point when tripped; act as interlocking relay pair on either a.c. or d.c. or a combination of both.

Bulletin 118 on these latching relays is available on request.

## TV "DYNATRACER"

For those with a flare for servicing their own television receivers, *Century Electronics Co.* of 211-04 99th Ave., Queens Village 29, N. Y. is offering its new TV "Dynatracer."

With this compact, self-contained unit, it is possible to trace all TV signals and

voltages, and locate defective components, whether they be capacitors, resistors, coils, transformers, or chokes.

A complete instruction manual and a helpful repair guide are included with each instrument.

## "PHANTOM FEED-THRU"

*Industrial Television Inc.*'s expanding line of television accessories now includes the "Phantom Feed-Thru," a recently-developed device for bringing the TV signal through a window pane.

Eliminating the work of drilling and the problems of defacing or cracking the glass, the "Phantom" is attached to the pane with a special waterproof adhesive substance which is easy to use.

Tests have shown an insignificant loss of 2 per-cent on channel 2, .005 per-cent on channel 6, and no measurable loss on the upper v.h.f. and u.h.f. bands. On u.h.f., the "Phantom" acts as an automatic impedance matching device.

For additional details on this device, write the company at 359 Lexington Ave., Clifton, N. J.

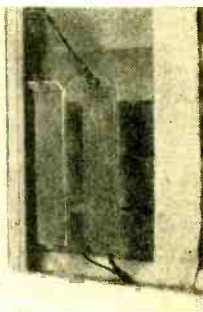

## MAGNETIC COUNTER

A precision counter that is adaptable in its various models to many industrial and experimental applications is now being offered by *Abrams Instrument Corp.*, 606 E. Shiawassee St., Lansing 1, Michigan.

The new counter is additive or subtractive, three or four digit models with manually reset counter wheels which records at maximum recommended speed of 1200 counts per minute. The weight of the mechanism is 2 ounces. It is mounted in a die-

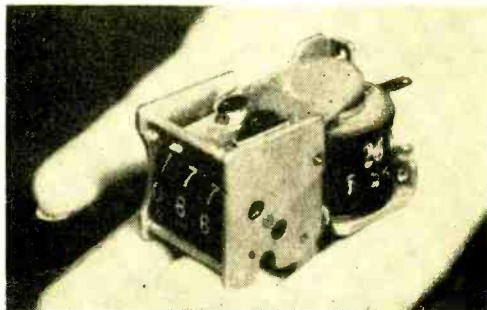

cast, lacquer-finished case which weighs 5 ounces. The counter measures  $\frac{7}{8}$ " high and less than 2" deep.

Actuated electro-magnetically, these

POPULAR ELECTRONICS

counters can be connected in vacuum-tube plate circuits or operated by any contacting device. The units may be used with or without cases. They are wound to any voltage from 6 to 110 volts d.c.

#### INEXPENSIVE MICROPHONES

In answer to the demand for low-cost microphones, *The Astatic Corporation* of Conneaut, Ohio has recently introduced two new microphones, the Model M101 ceramic and the Model M102 crystal units.

These compact little units are housed in rugged light tan plastic cases. The low price tags on these microphones can be directly attributed to the use of the plastic housing rather than the more conventional metal enclosures.

Output of the M102 is -46 db and that of the M101 is -53 db. Frequency range of the ceramic model is 30 to 10,000 cps with flat response while the crystal unit covers from 30 to 8000 cps with slightly rising characteristics in the high range.



#### ADJUSTABLE THERMOSTAT

A new series of hermetically-sealed adjustable thermostats, suitable for direct

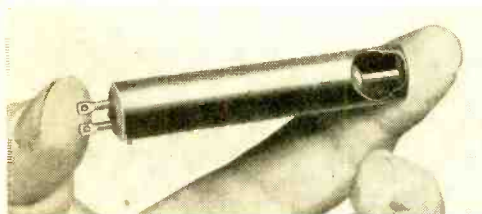

control of heaters and for temperature alarm or cut-off service is now in production by *G-V Controls Inc.*, 28 Hollywood Plaza, East Orange, N. J.

The new unit can be set to operate at any temperature down to 100 degrees F below zero or up to 300 degrees above zero. It may be exposed to any temperature within this range without change of control point.

The basic electrical thermostat is  $\frac{1}{2}$ " in diameter and  $2\frac{3}{4}$ " long. Weight is .04 pound. Forms are available with mounting flanges, mounting brackets, and pipe threaded fittings.

A technical data bulletin with outline drawings and complete specifications is available on request.

#### "JUNIOR" SOLDERING GUN

A new low-cost "Junior" soldering gun is now being marketed by *Weller Electric Corporation* of Easton, Pa.

The new Model 8100 incorporates many

## ENJOY CITIZENS BAND...

### Radio Control with TELECOMMANDER

The thrill of radio control is yours . . . easily, enjoyably and at low cost. You do not have to take a test or have special knowledge to operate on the Citizens Band (27.255 Mc). All you need is a FCC certificate\* and Telecommander R/C equipment . . . a complete line of transmitters, receivers, relays and escapements for operating planes, boats and cars on the Citizens Band. Telecommander offers light weight, sturdy, reliable units . . . all very reasonably priced and fully guaranteed.



951B RECEIVER

The finest unit of its kind. Housed in the strong bakelite case is a field-tested hard tube circuit and the P-100 sub-miniature high sensitivity relay. Permeability tuned for positive hairline adjustment. The six pin plug accommodates all external attachments. Ready to install and operate.

#### SPECIFICATIONS

Frequency: 27.255 Mc. Size:  $1\frac{1}{2} \times 2\frac{1}{2} \times 1\frac{1}{4}$ ". Weight: 3 oz. "A" voltage: 1.5v. "B" voltage: 67.5v. Price (complete with 3Q4 tube, P-100 relay and 6-pin socket) \$21.95

#### T061 TRANSMITTER

Crystal controlled 3A5 twin-triode circuit. Reliable, stable, high performance.

#### SPECIFICATIONS

Frequency: 27.255 Mc. "A" Voltage: 1.5v. "B" voltage: 120-150v. Input: 4.8 watts. Size:  $10 \times 6.2\frac{1}{4}$ ". Weight (with batteries): 3 lbs. Price (complete with crystal, tube, antenna, keying and battery switches) \$27.95



**FREE!**

\*Write for complete information on how to get your Citizens Band License.

For additional information on Telecommander equipment write for Brochure #1154.

#### ATTENTION JOBBERS AND DEALERS

Meet the growing demand for R/C with the finest... TELECOMMANDER radio control. Write ECC (TELECOMMANDER) Ltd. 166 Spring Road Huntington, N. Y.

of the features found in larger models and is suited to the role of second soldering gun in the maintenance man's or hobbyist's tool kit.

Instant heat at a power rating in excess of 100 watts is ample for practically every

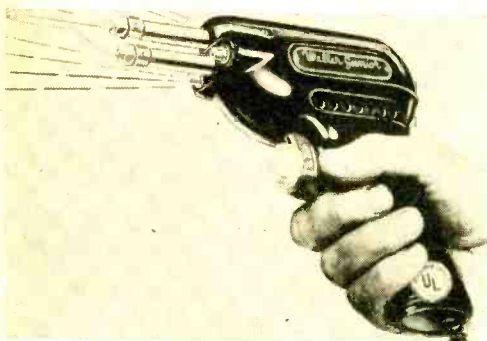

type of general soldering job. A trigger control switches the heat on or off instantly. Dual pre-focused spotlights illuminate the work area.

For additional information write Joseph F. Whitaker in care of the company at 808 Packer Street in Easton, Pa.

#### VARIABLE-JAW VISE

The *Custanite Corporation* of Larchmont, N. Y. is now marketing its improved Model B "Prestoflex Varijaw" speed vise. This new device is designed primarily to hold irregularly shaped objects.

Incorporating a unique system of self-contouring floating jaws, this tool can be used as a variable jig or fixture set-up, a speed vise, or an assembly clamp, without

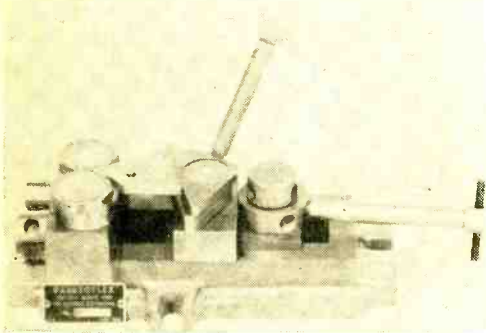

time-consuming set-ups. A screwless locking mechanism can be set for adjustable locking pressures or parts relocation.

#### HANDY SOLDERING PENCIL

Of interest to hobbyists and home workshop owners is the *Ungar* soldering pencil which is available with four interchangeable "Super Hi-Heat" soldering tips.

The new tips are suitable for heavy-duty service since they reach tip temperatures

of from 850 to 1000 degrees C. The iron draws only 47½ watts.

The four special tips include a chisel type, a pyramid tip, a heavy chisel tip, and a heating unit—all precision machined of tellurium copper, processed with a special iron plating which eliminates the need for grinding, filing, and other maintenance procedures.

For further details, see your dealer or write *Ungar Electric Tools, Inc.*, 4101 Redwood Ave., Venice, California direct.

#### PLATE CIRCUIT RELAY

*Potter & Brumfield* of Princeton, Ind. is in production on the series "LB," a new, low-cost, long-life plate circuit relay.

Available in coil resistances up to 34,000 ohms with a pull-in rating of 3 ma., the "LB" is equipped with a one-piece back spring and contact arm which can be adjusted for desired pull-in. A permanent air armature gap eliminates residual sticking.

Contacts are s.p.d.t., rated at 5 amperes, 115 volt a.c. non-inductive load. The coil is varnish impregnated, centrifugally.

The dimensions of the unit are 2½"x1"x1¾" with 2¼" mounting centers.



#### D.C. TACHOMETER GENERATOR

A new line of d.c. tachometer generators incorporating a permanent-magnet field assembly has been introduced by *Servo-Tek Products Co., Inc.*, 1086 Goffle Road, Hawthorne, N. J.

These generators are notable for their small size. The overall body length is less than 1½" and they weigh less than 3 ounces. Although used principally as a rate generator in servo systems, these units have many other uses. When combined with a standard 100 ohms-per-volt voltmeter, they make an excellent direct-reading tachometer.

Models are available with an output of 2.5 volts per 1000 rpm as well as with 7 volts per 1000 rpm. A flange mounting arrangement is usually used, although a synchro type mount is available at no extra cost.

END



## LOCATING OPEN HEATERS IN A.C.-D.C. RECEIVERS

**H**EATERS of a.c.-d.c. radio tubes, particularly numbers like the 50L6 and 35Z5, often become intermittent in a particularly annoying way: when the tube is cold and inoperative, the heater reads continuous on an ohmmeter, yet when power is applied and the heater begins to glow the mechanical expansion of tube parts and connections causes the heater to open.

As the heaters are all in series, an open circuit in any one of them results in extinguishing the entire string making it impossible to tell by inspection which is the intermittent or open heater. An ohmmeter, too, fails miserably because it may be used *only* when the power is removed and the heater has restored itself, having had a chance to cool and contract.

A positive check for locating intermittent heaters is available to anyone who has a 120-volt neon lamp and a couple of wire leads. Simply connect the lamp across (in parallel with) each pair of heater pins in turn; if a heater is open, the lamp will glow with full intensity; an intermittent heater will be indicated by a flashing of the neon lamp, and a good heater will produce no glow at all.

A standard neon lamp needs about 65 volts to "strike" or start. As long as all the heaters in an a.c.-d.c. set are good, the highest voltage available across any one of them is 50 volts (across the 50L6), which is insufficient to ignite the lamp. But the moment a heater opens, the full line voltage appears across the heater pins; thus the lamp ignites instantly to show the open circuit.

For the standard *All-American* five tube line-up, the heater pins are:

- 12SA7GT ..... #2 and 7
- 12SK7GT ..... #2 and 7
- 12SQ7GT ..... #7 and 8
- 35Z5GT ..... #2 and 7
- 50L6GT ..... #2 and 7

If the set consists of miniature tubes, the heater pins for all the tubes are 3 and 4.

The drawings illustrate the bottom view of each of these types of sockets to facilitate locating the heater pins. . H. Pollack

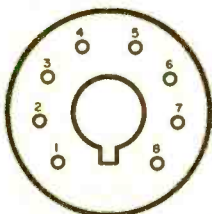

(A) BOTTOM VIEW OF STANDARD OCTAL SOCKET

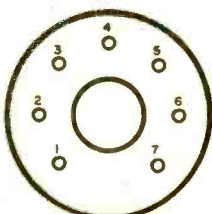

(B) BOTTOM VIEW OF MINIATURE TUBE SOCKET

November, 1954

## COMPARE THESE PRICES . . . . . . COUNT YOUR SAVINGS! ELECTRONIC BARGAINS

### RCA SURPLUS TV CAMERAS

Sensational value at... **\$225**

With 1846 iconoscope and 6-stage video amplifier and clipper. Xlnt. training and experimental item. Send for complete info.

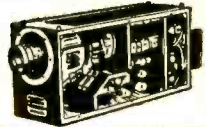

**SIGNAL CORPS PHONES**  
Long range, aluminum case with batteries.  
Save at... PAIR **\$14.95**

**WESTERN ELECTRIC HANDSET**  
For mobile & home phone systems. With P-1 unit & cord... **\$2.95**

**TELESCOPIC ANTENNA**  
7', 3-section for portable or mobile. New.  
69¢ ea. . . . . 2 for **\$1.25**

**TV TUNERS**  
Standard coll. Cascoe with 6BQ7, 646,  
New... **\$13.95**

### METER SPECIAL!

Choice of 3" Black Dialface, 0-750 MA, 500-0-500 Micro 3" Panel Meters, Round—or Weston 0-2.5 amps, DC.

**YOUR CHOICE . . . . . \$3.95**

### 7D1A XMTR TUBES

Complete with dope sheet. New! FILAMENT TRANSFORMERS for above... **\$2.95 2 for \$5**

### 24 V. TRANSFORMER & RECTIFIER COMB.

Basic 24 V DC power supply consisting of 110 V. AC primary, 24 V secondary and Rectox Rectifier. Altogether rated at 1 amp will operate up to 3 or 4 amps. \$8.95 value... **\$2.95**

### SAVE ON COMMAND EQUIPMENT!

T-21/ARC-5 5.3-7 MC Xmtr. . . . . \$6.95  
R-27/ARC-5 6-9.1 MC Rcvr. . . . . 6.95  
24 V Filament Transformer for above. . . . . 1.49  
Command Set, Tuning Knobs for above. . . . . 59¢ Ppd.  
Q'srs, 100-550 KC. like new. Check this at. . . . . \$9.95

### PORTABLE KILOWATT HOUR KIT

Contains new standard kilowatt meter and hvy duty lab-type case with handle. Complete with instructions. A \$50 value... **\$9.95**

**DUMONT 3P1 CATHODE RAY TUBES**

\$1.79-3 for \$5

With Dumont 224A schematic & parts list. Build your own scope & save! New!

**ARC-4 VHF TRANSCEIVER**

With Schematic \$24.50

For 2 meter CD or CAP including tubes, less dynamotor & xtals. New.

**CERAMIC CONDENSERS**

Kit of 100 \$1 postpaid

Asst. standard brands—with condenser chart \$10 value, new!

### APS-13 makes a complete 420 MC RADIOPHONE

When converted with our easy-to-follow schematic & instructions. Range equal to 2 meters. For communications, ranches, farms, etc. With RF sections, conversion booklet and 30 MC I.F. Strip, less tubes, dynamotor and minor parts not needed for conversion. **\$3.95**



### BARGAIN CORNER—CHECK THESE!

**NOVICE BAND CRYSTALS** . . . . . 89¢  
FT & T COAX CABLE RG-8/U, 110 Ft. roll complete with PL-259 connectors at each end. Individually boxed and branded FT & T. While they last. . . . . \$5.95  
500 OHM BRIDGE T PAD. . . . . 79¢ or 2 for \$1.50  
SOUND-POWERED HEAD & CHEST SET. Navy type, no batteries required. For TV antenna installations, etc. 20" cord. . . . . \$7.95  
NEW POWER TRANSFORMER 110 V. 60 cy. primary, 150 V. 30 MA secondary. 6.3-1 amp fil. FB for grid dip kits, test equip. & bias supplies. . . . . 79¢ ea. or 4 for \$3

### ORDER BY MAIL & SAVE!

1000's of ITEMS NOT LISTED—Write for FREE CATALOG! Please send check or money order (no c.o.d.'s please). All shipments FOB warehouse. Californians add 3% sales tax.

**Harjo Sales Co.**

Dept. PED, 4109 Burbank Blvd., Burbank, Calif.  
Phone: Victoria 92411—Visit our Retail Showrooms.

# BOOK REVIEWS

"**RADIO CONTROL FOR MODEL AIRCRAFT AND BOATS**" edited by Bill Winter. Published by *Berkeley Models Inc.*, West Hempstead, N. Y. 72 pages. Price \$1.00. Paper bound.

This book is intended to bridge the gap between theory and practice in the field of radio control of models—a job which has been neatly handled.

It contains practical information on building and operating radio control equipment, using commercially-built equipment most effectively, and troubleshooting and servicing equipment.

The text is divided into eleven chapters covering transmitters, receivers, relays, batteries, actuators, installation procedures, the plane, how to fly by radio control, operation, and R/C for boats.

The text is written in simple, easy-to-understand language, copiously illustrated with line drawings, schematics, and pictorial diagrams.

\* \* \*

"**THE RADIO AMATEUR'S LICENSE MANUAL**" by ARRL Staff. Published by *American Radio Relay League*, West Hartford, Conn. 112 pages. Price \$5.00. Paper bound.

The 32nd edition of this well-known manual is a "must" for all those studying for any of the FCC radio license examinations. The book includes the pertinent FCC regulations, a study guide for the exams, details on renewing and modifying station licenses, provides the dope on the new "mail-examination" regulations, and outlines the best and easiest way of getting amateur radio licenses.

If you are thinking of working for that coveted "ticket"—save yourself a lot of headaches by getting a copy of this book first!

\* \* \*

"**THE BEGINNER'S RADIO CONTROL MANUAL**" by R. S. Haney. Published by *Scientific Hobbies Co.*, P.O. Box 7334, Chicago, Ill. 82 pages. Price \$1.15. Paper bound.

This is a basic text for those just starting out in the absorbing field of radio control. You don't have to know a thing about radio—or models—to understand this complete and concise exposé. The author has, considerably, substituted familiar terminology for technical jargon with the result

that even if you have never seen the inside of a 5-tube a.c.-d.c. receiver—you can understand this text.

The book includes sections on what constitutes a radio control system; the functions of the transmitter, receiver, and escapement; elements of electricity and radio as applied to radio control; standard symbols and terms the R/C fan is likely to encounter; transmitters; receivers; and actuators. The text material is supplemented by schematics, line drawings, and pictorial diagrams.

\* \* \*

"**TV AND ELECTRONICS AS A CAREER**" by Ira Kamen and Richard H. Dorf. Published by *John F. Rider Publisher, Inc.*, New York. 319 pages. Price \$4.95.

This book is an authoritative, graphically presented account of the workings of the burgeoning field of electronics.

In addition to authors Kamen and Dorf, such well-known figures in the industry as W. H. Bohlke of *RCA Service Co., Inc.*, R. W. Peterson of *Admiral*, and J. R. Popple of *WOR-TV* have contributed sections on their specialized fields. These men, who have gained their knowledge and experience directly from their work in radio and television broadcasting, communications, manufacturing, engineering, sales, and servicing, offer expert guidance to those considering a career in TV and/or electronics.

Extensive descriptions of the various jobs available in the industry are included along with details on the job itself, preparation required, and how to go about landing the job you want.

\* \* \*

"**AMATEUR RADIO THEORY COURSE**" prepared and published by *American Electronics Co.*, 1203 Bryant Ave., New York 59, N. Y. 295 pages. Price \$3.95. Paper bound.

This compact "course" has been prepared for the benefit of those working toward their FCC amateur license exams. The material covers the written examination requirements for the Novice, technician, general, conditional, and advanced classes of licenses.

The book is divided into three sections. The first section contains basic a.c. and d.c. theory; the second section covers vacuum tubes, microphones, and speakers, while the third section covers transmitters, receivers, antennas, and the FCC rules and regulations.

A study guide is included for each section. Self-check questions and the correct answers are provided for those using this book as a home-study course. Sample exams are also carried to give the student an idea of the type of question he will encounter when he tackles the "real" thing. END



## TV-TELEPHONE INTERCOM

A TELEVISION telephone (TV-T) intercom system has been developed by *Kay Lab*. The equipment at each station resembles a conventional 17" television receiver with a telephone handset beside the screen.

When a TV-T call is made, the caller's image appears simultaneously on one-half of his screen and on one half of the screen of the called party. When the latter answers, his image is shown on the remaining half of each screen.

Either party can make the entire screen area available to view documents, signatures, blueprints, and other articles.

When the set is not in use as a TV-T intercom, the screen may be used to monitor another industrial television system or to receive subscription television or standard television programs.

As many TV-T intercom stations as desired can be installed in a single system. Picture and sound are carried in both directions between stations over an inexpensive coaxial cable. Intercity connections will be possible through the use of either coaxial cable or microwave link.

The system is designed primarily for industrial applications. With it, executives can conduct conferences and purchasing agents can view stocks at their desks.

TV-T is especially applicable to surveillance. A unit can be installed at each guard post. People entering a plant or institution can be identified over the intercom, without a full-time guard at each post. When watchmen or guards call in, TV-T assures positive identification. In banks, department stores, and other institutions, signature checking, customer identification, personal interviews, etc., can be greatly facilitated. **END**

How the TV-telephone intercom operates. Both parties to a call are visible to each other on one-half of the split television screen.



November, 1954

# free!

VALUE-PACKED PAGES

308



## 1955 ALLIED TV & RADIO CATALOG

### SAVE ON EVERYTHING IN ELECTRONICS

World's Largest Stocks... Everything for Experimenters, Builders, Amateurs, Servicemen, Engineers & High Fidelity Specialists.

Send for ALLIED's big 308-page value-packed buying guide to *everything* in TV, Radio and Electronics! Largest selections of custom TV chassis, antennas and accessories; FM and AM tuners; High Fidelity systems and components; Amateur supplies; recorders and phono equipment; test instruments; builders' kits; industrial electronic supplies—plus the world's largest stocks of electronic parts, tubes, tools and books. Get *everything*—get *more* for your money—send today for your FREE 1955 ALLIED Electronic Supply Catalog.

**BUILDERS' KIT Headquarters**

Featuring Famous Knight Kits



ultra-modern facilities

TO SERVE YOU BEST!

Send for FREE Catalog

**ALLIED RADIO**

ALLIED RADIO CORP., Dept. 79-L-4  
100 N. Western Ave., Chicago 80, Ill.

Rush FREE 1955 ALLIED 308-Page Catalog

Name \_\_\_\_\_

Address \_\_\_\_\_

City \_\_\_\_\_ Zone \_\_\_\_\_ State \_\_\_\_\_

IF YOU LIKE  
THIS MAGAZINE . . .  
**DON'T RISK MISSING  
ANY FUTURE ISSUES!**

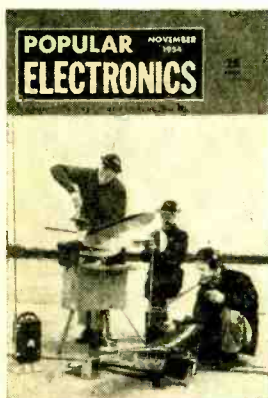

The first issue was a virtual sell-out . . . many people were unable to get their copies at newsstands.

This issue will undoubtedly repeat the performance

**MAKE SURE YOU GET EVERY ISSUE OF  
POPULAR ELECTRONICS WITHOUT FAIL  
BY SUSCRIBING TODAY AT THIS  
MONEY-SAVING INTRODUCTORY RATE:**

**5 ISSUES FOR ONLY \$1.00**

This is the last time this special introductory offer will be made. And remember—*every* issue of **POPULAR ELECTRONICS** will bring you the newest and best how-to-build-it . . . how-to-use-it . . . how-it-works electronics information.

The handy postage-free envelope facing this page makes it easy to subscribe. And don't forget, **POPULAR ELECTRONICS** is a fine gift for Christmas. We'll send a handsome gift card to those you name.

**DECEMBER POPULAR ELECTRONICS**

**ON SALE AT ALL NEWSSTANDS NOV. 23**

# AFTER CLASS

## Basics of series and parallel circuitry

**C**IRCUITS which, at first glance, may seem very complex and elaborate can usually be broken down into simple series or parallel connections or combinations of the two. For this reason, it is very important that the student of radio and electronics has a good understanding of the characteristics of series and parallel circuits.

A series circuit is one in which the components are so connected that there is only one path for current flow. An arrangement of this type is shown in Fig. 1A. Here, the three light bulbs are connected in series, and the one path for current flow is shown by the arrow.

In a parallel circuit there are two or more paths for current flow. Fig. 1B shows three light bulbs connected in parallel. As indicated by the arrows, there are three separate paths for current flow.

In the series circuit of Fig. 1A, if one of the light bulbs burns out or is removed from the socket, the other two bulbs cannot light. This is because there is only one pathway for current, and no current can flow if this pathway is broken at any point. In the parallel circuit, the remaining light bulbs will stay lit if one bulb is removed, because there will still be two unbroken pathways for current.

The characteristics of series and parallel circuits are given below:

*In the series circuit:*

1. The amount of current flow is the same at all points.
2. The sum of the voltage drops across the series components is equal to the applied voltage.

*In the parallel circuit:*

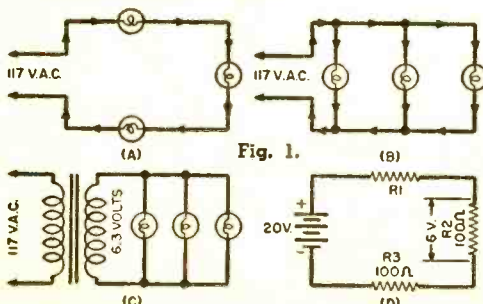

Fig. 1.

1. The same amount of voltage exists across each of the parallel components.

2. The total current is equal to the sum of the branch currents.

Note that the current remains the same in the series circuit and that voltage remains the same in the parallel circuit. In other words, if the current through one of the series bulbs of Fig. 1A is 500 ma., the current through each of the other bulbs is also 500 ma. It would be impossible to have, for example, 500 ma. through one of the series bulbs and 400 ma. through another. In the parallel circuit, the voltage across each bulb is 117 volts. Here, it would be impossible to have 117 volts across one bulb and 100 volts across another.

In a series circuit, the voltages add and in a parallel circuit, the currents add. In Fig. 1A, for instance, if the voltage drops across two of the light bulbs are 30 volts and 60 volts, then the voltage drop across the third bulb must be 27 volts. The sum of the three voltage drops is therefore equal to the applied voltage of 117 volts.

In Fig. 1B, if the currents through the three light bulbs are 0.5 ampere, 1 ampere, and 2 amperes; then the total current drawn from the power lines is 3.5 amperes.

### Check Your Knowledge

1. Three resistors (5000, 15,000 and 25,000 ohms) are connected in series and placed across a 90 volt battery. The current through the 15,000 ohm resistor is 2 ma. The current through the 5000 ohm resistor is:

(a) 0.666 ma.; (b) 2 ma.; (c) 6 ma.

2. The heaters of three tubes are connected in parallel across a 6.3 volt transformer winding as shown in Fig. 1C. The voltage across each heater is:

(a) 2.1 volts; (b) 6.3 volts; (c) 18.9 volts.

3. In Fig. 1C, if the currents drawn by the three heaters are 0.3, 0.3 and 0.6 ampere, the current drawn from the 6.3 volt winding is:

(a) .3 amp.; (b) .6 amp.; (c) 1.2 amp.

4. If one of the bulbs shown in Fig. 1B should burn out, the other two bulbs will:

(a) become brighter; (b) become dimmer; (c) remain the same.

# 46 Surplus Twist \$2 DRILLS

**BRAND NEW, GENUINE HI-GRADE  
HARDENED CARBON TOOL STEEL!**

**Less Than 4½¢ Each**

**FOR HAND OR ELECTRIC DRILL:**

1/4" 3/16" 5/32" 3/8" 1/2" 5/8" 3/4" 7/8" 1" 1 1/8" 1 1/4" 1 1/2" 1 3/4" 2" 2 1/2" 3" 3 1/2" 4" 4 1/2" 5" 6" 8" 10" 12" 14" 16" 18" 20" 24" 28" 32" 36" 40" 44" 48" 52" 56" 60" 64" 68" 72" 76" 80" 84" 88" 92" 96" 100" 104" 108" 112" 116" 120" 124" 128" 132" 136" 140" 144" 148" 152" 156" 160" 164" 168" 172" 176" 180" 184" 188" 192" 196" 200"

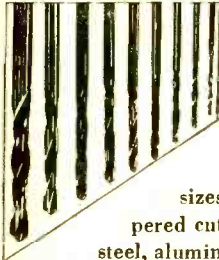

**Hobbyists! Home-owners! Carpenters!**  
Almost your last chance to get these 46 tool steel twist drills for \$2 on this close-out offer. Sells in stores for up to \$6! You get up to 5 each of the most used sizes from 1/16" to 1 1/4". Tempered cutting edges easily bite through steel, aluminum, iron, wood, plastic. Hardened and designed to give 1800 drillings.

**Limited supply going fast. ORDER TODAY! Money back if not convinced this is one of greatest drill values ever! Rush \$2 for each set ordered and we pay postage. If C.O.D., you pay postage.**

**Scott-Mitchell House, Inc.**

611 Broadway, Dept. OX-249, New York 12, N. Y.

## HEAVY-DUTY TOWERS

**USED TO HOLD T.V. ANTENNAS  
FLOODLIGHTS, SIGNS, ETC.**

10 Foot Section Only \$13.95  
(Top 10 Foot Same Price)

Includes All Hardware

Made of high tensile .065 gauge 1 1/4 in. O.D. tubular steel.

Wash primed and vinyl aluminum-coated salt spray resistant.

Self supporting to 50 ft.

Adjustable house brace..... \$4.95

Heavy duty top mast—10 ft. .... \$3.98

Special Prices on T.V. Antennas

\$19.95 Dbl. Aluminum Lazy X... \$9.95

400A—UHF-VHF ..... \$32.50

400SA—UHF-VHF .... \$39.95

5 Element (2-13) Dbl. Phoenix Inline.. \$14.95

\$48.95 Heavy Duty TR4 Rotor..... \$34.50

Rotor cable (4 cond.)—5c ft. for above rotor

300 ohm UHF-VHF Tubular Leadin.. 4½¢ ft.

Write for circular. All price F.O.B. You pay delivery charges. All C.O.D. orders must have 25% deposit.

**RICHVILLE T.V. SUPPLY**

5666 NAVARRE RD., R. D. 1, CANTON, OHIO

5. The voltage drop across  $R_1$  in Fig. 1D is:

(a) 4 volts; (b) 6 volts; (c) 8 volts.

Answers are given on page 127. A score of 5 correct is excellent, 4 correct is good, and 3 or less correct is poor.

## TERMINOLOGY TIP

**A**S THE art of electronics progresses, we witness the growth of a string of abbreviations which, like the governmental bureaus whose names are too long to repeat, begin to cause bewilderment and confusion, especially to the novice.

Let us clarify and differentiate between three such terms; a.v.c., a.f.c., and a.g.c.

Probably the oldest term of all is a.v.c. which stands for *automatic volume control*. It is a process usually associated with radio receivers in which the received signal is made to control its own volume by automatically adjusting the grid bias and the gain of amplifiers in the receiver. A good a.v.c. circuit minimizes fading and maintains approximately the same signal output level for all stations.

Next in chronological line is a.f.c. or *automatic frequency control*. It made its appearance early in the history of radio in the form of a circuit which corrected slight mis-tuning of a superheterodyne by automatically adjusting the local oscillator frequency to the point where the signal was best. More recently, it has found important application in television where it is used to keep the horizontal oscillator of the television set properly locked-in with the received synchronization pulses in the television signal.

*Automatic gain control*, a.g.c., is very similar in basic nature to a.v.c. in that an incoming signal is made to control its own output amplitude. The use of the word *volume* is avoided, however, since it applies particularly to sound or loudness and a.g.c. circuits do not necessarily involve sound. In a television set, the a.g.c. circuit helps to maintain constant *contrast* between the blacks and whites of the picture. Without an a.g.c. circuit in operation, the picture is flat and lifeless if the received wave is weak and "chalk and charcoal" if the signal is too strong.

## TIMING WITH ELECTRONS

**A** CAPACITOR is an electronic storage device. A battery connected across the terminals of a capacitor will force an electric charge into it until the voltage across the capacitor is the same as the battery potential. But just as it takes a longer time to fill a 5-gallon can when a very thin-bored pipe is used as the water inlet, a capacitor

requires a longer period to reach the battery voltage when it is charged through a high resistance.

Two things govern the time required to charge a capacitor fully: (1) the capacitance of the capacitor. Larger capacitances require more time. This is the equivalent of saying that it takes longer to fill a 5-gallon can than a 1-gallon can if the inlet pipe and velocity of water flow are the same for both; (2) the size of the resistance through which the capacitor is charged (see Figs. 1A and 1B).

This slow-charge effect is very useful in

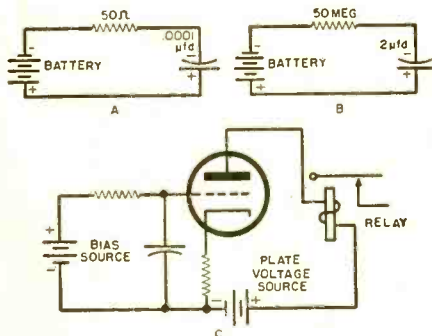

all kinds of electronic timers. In most timing circuits, a capacitor and a resistor are connected to the grid of an electron tube in such a way that the grid voltage (bias) is dependent upon the extent to which the capacitor is charged. A slowly charging capacitor, for instance, may slowly raise the bias positively with an accompanying slow increase in plate current which, at some predetermined value, triggers a relay (see Fig. 1C). This is literally timing with electrons.

Circuits in which time-delay arrangements are found are photographic exposure timers, x-ray timers, time-delay circuits in transmitters which do not permit high voltage to be applied until all the tubes are fully warmed up, electronic metronomes, and countless others.

### SERIES DROPPING RESISTORS

**F**ILAMENT or heater transformers used with tubes such as those of the 6.3 volt series provide a reliable and not-too-expensive source of heater voltage for any type of electronic device. Yet it seems inevitable that every experimenter, sooner or later, runs into a gadget in which series heaters are used and for which he must calculate a line-dropping resistor. Should this happen to you, don't let it scare you because the calculations and precautions are simple indeed. Take it in easy steps, this way:

(1) Make certain that all the tubes are rated at the *same heater current*, as given in any tube manual.

## HERE'S HOW TO GET YOUR START IN RADIO-TV-ELECTRONICS

Here's basic training you can really understand . . . training that can help fit you for a good paying radio-television-electronic career! No matter what part of the work you want to do, this is the **FIRST!**

Ghirardi's **RADIO PHYSICS COURSE** is the oldest book of its kind . . . and still a best seller **BECAUSE IT IS SO AMAZINGLY CLEAR AND COMPLETE.** Thousands now in electronics got their start from this great book—**AND THEY'LL RECOMMEND IT TO YOU TODAY!**

Starts with Basic Electricity (over 300 pages) then takes you step by step through the entire radio-electronics field. Covers principles, theories and practices that are basic to even the most modern equipment. 972 pages; 508 pictures; 856 helpful self-review test questions. Price only \$6.50.

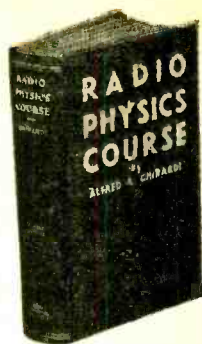

More experts get their basic training from this big book than any other of its type!

36 courses in one!

## DON'T THROW OLD RADIOS AWAY!



This giant book shows exactly how to fix them . . . without a lot of previous experience!

There's a "secret" to repairing old radios fast and profitably . . . and this big **RADIO TROUBLESHOOTER'S**

**HANDBOOK** is it!

Just look up the old make and model you want to fix. This manual-size, 3½ pound 744-page Ghirardi handbook tells what the trouble is likely to be . . . **AND SHOWS YOU EXACTLY HOW TO FIX IT.** No useless testing! No wasted time! Even beginners can handle jobs "slick as a whistle." **The only guide of its kind!** . . . cuts repair time in half!

Included are common trouble symptoms and remedies for over 4,800 models of home and auto radios and record changers. Actual case histories cover practically every model made by 202 manufacturers between 1925 and 1942—Airline, Apex, Arvin, Atwater Kent, Belmont, Bosch, Brunswick, Clarion, Crosley, Emerson, Fada, G.E., Kolster, Majestic, Motorola, Philco, Pilot, RCA, Silvertone, Sparton, Stromberg **AND DOZENS MORE.** Gives how-to-do-it data on **SPECIFIC** jobs—**NOT** general theory. Includes hundreds of pages of invaluable tube and component data, service short cuts, etc. Price \$6.50. 10-day free trial.

**--- 10 DAYS FREE TRIAL ---**

Dept. PE-114, RINEHART & CO., INC.  
232 Madison Ave., New York 16, N. Y.

Send book(s) checked for free examination. In 10 days, I will either send price shown (plus postage) or return books postpaid and owe nothing.

Ghirardi's **RADIO TROUBLESHOOTER'S HANDBOOK**, \$6.50.  Ghirardi's **RADIO PHYSICS COURSE**, \$6.50.

Name .....

Address .....

City, Zone, State .....

(OUTSIDE U.S.A.—\$7.25 each, cash only. Money back if books are returned in 10 days.)

the TV world is yours with

# WARD TV ANTENNAS

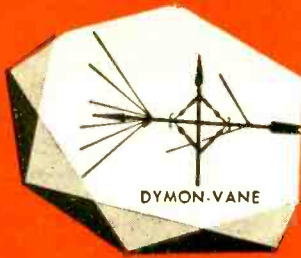

DYMON-VANE



FRINGEMASTER



WARRIOR



TROMBONE

## WARD ANTENNA RAMA

Only Ward presents such an outstanding array of precision-engineered TV antennas. Among them is "Dymon-Vane", the first to combine distinguished beauty with superb reception. Consult your local TV dealer about WARD antennas or mail coupon below.

**WARD PRODUCTS CORP.**

DIV. OF THE GABRIEL CO.

1148 Euclid Avenue, Cleveland 15, Ohio

WARD PRODUCTS CORP., DIV. THE GABRIEL CO.  
Dept. PM-1054, 1148 Euclid Avenue, Cleveland 15, Ohio  
Send me free additional information on Ward's complete line of TV antennas.

Name \_\_\_\_\_  
Address \_\_\_\_\_  
City \_\_\_\_\_ State \_\_\_\_\_

(2) Add up the rated heater voltages of all the tubes to be used. The first digits of the tube nomenclature give the voltage accurately enough. (12SQ7, 12 volts; 50L6, 50 volts; etc.)

(3) Subtract the sum obtained in step (2) from the line voltage. Throughout the country, the average line voltage is 115 volts.

(4) Divide the result obtained in step (3) by the rated current of the tubes. This gives the needed resistance in ohms. In most cases, your answer will be some unrounded number that you would find difficulty in buying. Use a figure which is *higher* than the computed one just so you reach a value you can purchase, that is, a standard value. The example below will make this clear:

A phono-amplifier is to be constructed using a 70L7 rectifier-beam-power tube and a 12SQ7 voltage amplifier. Using the steps outlined, we have:

(1) Both of these tubes take the same heater current, *0.15 ampere*.

(2) Adding the first digits in the tube numbers:  $70 + 12 = 82$ .

(3) Subtracting:  $115 - 82 = 33$

(4)  $33$  divided by  $0.15 = 220$  ohms

You must also know the *power dissipation* that will occur in the resistor. This is easily calculated merely by multiplying the answer to step (3) by the heater current, or:  $33 \times 0.15 = 4.95$  watts. To be certain that the resistor will not overheat, most technicians *double* the computed value in making their purchases. In this case, they would buy a *10 watt* resistor. Although some distributors might carry 220-ohm resistors that is not a standard value for 10-watt wirewounds; it is much easier to buy a 250-ohm resistor. This would cut down the heater current somewhat, but the operation of the tubes would be quite satisfactory.

## POLARITY CHANGER

**E**VERY normal electron tube amplifier is a polarity changer or, more conventionally, a *phase inverter*. This action is very important in television circuits and, if disregarded, can cause complete loss of synchronization and pictures that look like photographic negatives.

To see how phase inversion occurs, let us imagine that we observe the circuit at the instant when the applied e.m.f. (electromotive force) is going in a *negative* or *minus* direction. The control grid is thus swung negatively causing a reduction in plate current through the tube. With this decrease in plate current—current which flows through  $R_L$  on its way to ground—comes a reduction of the *voltage drop*

# the sensational "QUICK-HOT" SOLDERING GUN

Built-In Spotlight

STEVE-EL "jumped the gun" by introducing the "QUICK-HOT" before anybody else. We have never been so excited about a soldering gun development as we are about "QUICK-HOT". It is without a doubt, the most efficient soldering gun of all 175 watt guns.

- ★ Extra long narrow tip for easy reach.
- ★ Lifetime tip.
- ★ Built-in spotlight.
- ★ Soldering heat in 2½ seconds.



**EXTRA SPECIAL**  
16 RP4  
**PICTURE TUBE**  
\$16.49  
Brand new.  
Guaranteed 1 year

**\$ 5.96**  
Only **5** **FREE!**

Write Dept. PE-11 for  
New BARGAIN BULLETIN

**STEVE-EL Electronics Corp.**

61 Reads St.

New York 7, N. Y.

across  $R_L$ . (Voltage drop in plate load resistor = plate current times resistance of plate load resistor, or  $E_L = I_p \times R_L$ ). If the voltage drop decreases, then there must

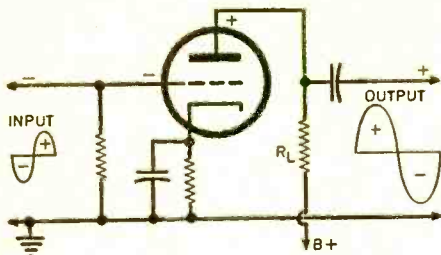

be a greater positive potential on the plate as compared with its previous value, that is, the plate is going in a more *positive* direction. Thus, a negative-going grid results in a positive-going plate, an *inversion of phase*. Exactly the same thing, in the opposite sense, occurs when the positive part of the input cycle appears at the grid. In this case, the *positive-going* grid causes a rise in plate current, an increase in the voltage drop across  $R_L$ , and a reduction in plate voltage. Plate voltage which is in the act of dropping is said to be *negative-going*, so that a positive-going grid has resulted in a negative-going plate—again inversion of phase.

### HILLS OF POTENTIAL

**H**AVE you ever looked at a simple little diagram like that of Fig. 1 (page 104) and wondered how a certain point, point *B* for example, could be both *positive and negative* at the same time? This baffles lots of people, so cheer up.

Here is an analogy which should help you overcome all difficulties usually encountered in puzzling out circuits in which there are voltage drops and which, incidentally, shows why a given point may be both positive and negative at the same time.

Imagine a peculiarly formed hill as shown in Fig. 2 whose peak rises 30 feet above the ground. Ten feet below the peak is a plateau (*B*), then a sharp decline into a 10 foot hole. The average person would describe the formation as one in which *A* is 30 feet above ground, *B* is 20 feet above ground, and *C* is 10 feet below ground. He would also accept without question an alternative description which goes like this: assigning the designation *zero* to the ground level, calling all points above ground *plus* and all points below ground *minus*, then *A* is +30 feet, *B* +20 feet, and *C* -10 feet. Carrying the same idea just a bit farther, let us designate *any point* which is above an-

November, 1954

# RIDER BOOKS MAKE ELECTRONICS EASY!...

## RADAR, WHAT IT IS

Complete, non-technical explanation of radar . . . what it is, how it works, how it's used. Covers types of gear used by ground, sea, and air forces. Illustrated. 8 1/2" x 11", soft cover, only \$1.00.

## HOW TO USE METERS

Explains everything about using all kinds of meters! Shows what to use, how to use it, where to use it! For everyone interested in electronics, this book is a must! 160 (5 1/2" x 8 1/2") pages, soft cover, only \$2.40.

## HIGH FIDELITY SIMPLIFIED

The complete Hi Fi story! How to get concert hall reception in your own home! Answers all questions about Hi Fi tuners, amplifiers, speakers, tape recorders, record players and changers. 224 (5 1/2" x 8 1/2") pages, soft cover, only \$2.50.

## GUIDE TO AUDIO REPRODUCTION

Covers design, construction, assembly, and testing of sound reproduction systems, and includes circuits for home construction of these units. Explains circuitry of pre-amps and amplifiers, pick-up devices, loud speakers and enclosures. 250 (5 1/2" x 8 1/2") pages, soft cover, only \$3.50.

## HOW TO TROUBLESHOOT A TV RECEIVER

A step-by-step guide to systematic troubleshooting. Tells how to service your own set quickly, easily, economically! 128 (5 1/2" x 8 1/2") pages, soft cover, only \$1.80.

## FUNDAMENTALS OF TRANSISTORS

An expert explains, in easy-to-understand terms, the basic operation, characteristics, and performance of transistors. This book is for every hobbyist, student, experimenter! 144 (5 1/2" x 8 1/2") pages, soft cover, only \$2.70.

## HOW TO SERVICE TAPE RECORDERS

Everything you need to know about what's inside a tape recorder . . . recording heads, drive mechanisms, circuits. Practical suggestions for troubleshooting. 176 (5 1/2" x 8 1/2") pages, soft cover, only \$2.90.

## TV AND ELECTRONICS AS A CAREER

Written by 5 prominent electronics experts, this book is crammed full of solid facts about the field . . . what the different jobs are, what training each one requires, what salaries they pay, how to get the job. If you're thinking about a career in TV and electronics, you MUST read this book! 5 1/2" x 8 1/2", cloth bound only \$2.50.

Write for free catalog!

All Rider books are available through electronics parts jobbers and book stores throughout the country. If unavailable in your area, write to:

**JOHN F. RIDER PUBLISHER, INC.**  
480 Canal Street, New York 13, N. Y.

other as *plus with reference to the other point*, and likewise, any point which is be-

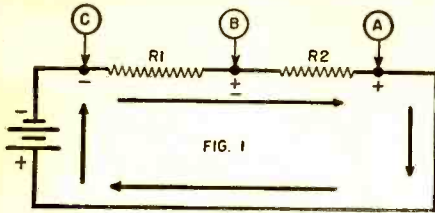

Referring again to the resistors in Fig. 1, the electrons flow clockwise in this circuit and voltage drops occur across both resistors. Since the end into which electrons go is always more negative than the end from which they emerge, the left side of  $R_1$  is more negative than the right side; but now the electrons move into  $R_2$ , causing its left end to become more negative than the right. Hence, point  $B$  is *plus* with

low another as *minus with reference to the other point*.

For instance, point  $B$  is minus with respect to point  $A$  by 10 feet. But point  $B$  is plus 20 feet with respect to ground so this point *seems* to be both plus and minus at the same time. As a matter of fact, as long as we have gone this far, carry this same thinking to the labels we could apply to ground level: ground is arbitrarily zero, but it is *plus* with respect to point  $C$  since it is higher up, and it is *minus* with respect to point  $B$ . Thus, ground could be tagged with three different labels!

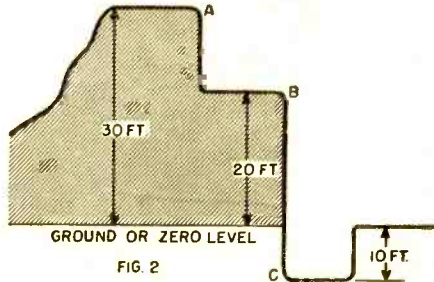

respect to point  $C$  but *minus* with respect to point  $A$ , just as it was in the "hill of potential" analogy just discussed. END

### HOW SMART ARE YOU?

The following quiz is designed to test your knowledge. Each correct answer is worth 10 points. A score of 60 or less—poor, 70—fair, 80—good, 90—very good, 100—excellent. (Answers on page 127)

- If two equal capacitors are connected in series, the total capacity will be:
  - greater than the value of each capacitor
  - less than the value of each capacitor
  - the same as the value of each capacitor
  - the vector sum of the values of the two capacitors
- Which of the following types of capacitors may be damaged if connected with reversed polarity?
  - mica; b. paper;
  - oil; d. electrolytic
- A 25  $\mu\text{fd}$ . capacitor is to be used as a cathode bypass in a receiver. In which of the following stages is it most likely to be used?
  - r.f. amplifier
  - local oscillator
  - i.f. amplifier
  - a.f. amplifier
- If two capacitors rated at 400 volts each are connected in parallel, the voltage rating of the combination will be:
  - 200; b. 400; c. 800
- In a capacitive circuit:
  - current leads voltage
  - current lags voltage
  - current and voltage are in-phase
- When the amount of capacity in a resonant (tank) circuit is increased, the frequency of resonance will:
  - increase
  - decrease
  - remain the same
- If a .1  $\mu\text{fd}$ . capacitor and a .05  $\mu\text{fd}$ . capacitor are connected in series across an a.c. source:
  - a greater voltage will appear across the larger capacitor
  - a greater voltage will appear across the smaller capacitor
  - equal voltages will appear across the two capacitors
- If a 500,000 ohm resistor is connected in series with a .1  $\mu\text{fd}$ . capacitor, the time constant will be:
  - 50,000 seconds
  - 5 seconds
  - .05 second
- The color code of a 270  $\mu\text{fd}$ . capacitor is:
  - red-violet-black
  - red-violet-brown
  - red-blue-brown
  - orange-violet-brown
- The circuit shown below is:
  - low-pass filter
  - high-pass filter
  - bandpass filter



## How Many Controls?

(Continued from page 85)

weight). Long, heavy push rod systems are bad in a dive or climb because the dead weight of the rod is added to the load the escapement must move. Powerful servos are preferred on such machines.

4. *Rudder, Elevator, and Motor*: When a compound actuator is used, many builders install both engine and elevator controls, although both may not be used on the same flight. A throw-over switch selects between them. However, an additional yoke or linkage may be attached to the elevator actuator drive pin. This linkage moves mechanically and directly, the air bleed device, butterfly throttle, etc., and permits use of all three controls on one flight with a compound. The motor linkage functions, say, after down elevator and the motor will not be changed until the elevator actuator is used again. As long as the pilot remains on rudder, not working the elevator actuator, he can maintain the last throttle setting.

Now, in addition to such systems, the enterprising modeler with a smattering of electronics can work up some terrific arrangements on pulse. If, for instance, he uses a pulse length deal to work rudder, he can, by changing the pulse rate, operate other controls as well. But, at this writing, there is only one pulse length, pulse rate item at larger hobby shops—it is imported and in limited supply. (Numerous pulse length items exist for rudder only.) The receiver is any single channel set; the actuator, in this case, reacts to a pulse rate change.

### Multi-channel Units

Several makes of modulated tone receivers and transmitters are on the market. The *Babcock* three-channel receiver operates various controls by means of filtered tones. It does not require the familiar reed bank, usually associated with tone receivers. In the reed bank, reeds of various lengths vibrate in resonance to their particular frequency, closing a relay to work their particular control. In the *Babcock*, one channel is connected to a compound escapement, giving left, right rudder, and engine as the second control. The remaining two channels provide up and down elevator respectively, via a special servo which allows the pilot to position the elevator with any degree of down and up he requires.

E. L. Rockwood, who pioneered commercial tone receivers in the model plane field, uses three channels to obtain left,

"Learn and Earn with

## Concord's Electronic Kits"

### SUPERTONE CRYSTAL RADIO KIT

This crystal set provides lots of fun and amazing reception. Kit consists of bakelite base with contact slider, crystal holder, detector and cover, cats whisker, wound tuning coil, headphone. All hardware and instructions included.  Net \$3.15  
Stock No. F-7001-A

### CRYSTAL RECEIVER KIT

This remarkable set is built to give everlasting service. The receiver will bring in loud, clear signals without distortion or noise. Equipped with supersensitive crystal to give excellent results. No batteries needed.  Net \$1.49  
Stock No. F-7001

### PEANUT TUBE RADIO KIT

A complete one tube tuner and amplifier, ready to assemble. Operates on batteries and provides excellent reception. Base and coil form of lucite. No soldering necessary. Works anywhere with short antenna. Complete with tube. Stock No. F-200  Net \$2.99

\$7.35

### Beginner's Special

### ONE TUBE (PLUS RECTIFIER) AC-DC RADIO KIT

Designed for easy construction and good performance. Kits are replicas of circuits used in master models and standardized. This permits anyone without previous knowledge or experience to obtain excellent results by following simple instructions and diagrams. Supplied with punched and formed chassis. All parts less tubes and headset. Uses 35Z5GT and 12S17 tubes. 110-120 volts AC-DC operation. Shpg. Wt. 2 lbs.  Stock No. F7001B

### \$3.95 Electronic REMOTE CONTROL UNIT

This Electronic thyatron is easily modified for many remote control uses. PARTS ALONE WORTH MORE THAN TWICE THE COST. Includes Plate circuit trigger relay, 6.3V fil. trans., precision resistors, condensers, switches, etc. Use for burglar alarm, opening or closing doors, turning appliances on or off, etc. Size 6" x 5 1/2" x 3". (FREE with each unit.—\$1 book "Model Control by Radio".)  Stock No. 89-A-15088 Remote control and book \$3.95

Please send NEW 1955 CONCORD Catalog!

CONCORD RADIO 55 Vesey St., N. Y. 7, Dept E10

20% deposit with C.O.D.

MINIMUM ORDER \$5.00

NAME \_\_\_\_\_

ADDRESS \_\_\_\_\_

CITY \_\_\_\_\_ ZONE \_\_\_\_\_ STATE \_\_\_\_\_

CONCORD RADIO • 55 VESEY ST.  
NEW YORK 7, N. Y. • Dlgby 9-1132

right rudder with one servo, and engine speed with another. His five-channel receiver operates elevators, up and down, by a third servo. Schmidt's "Channel-master" does the same job. E. D., of England, lately has marketed a six-channel receiver using reeds.

With separate channels devoted to left and right rudder, quick, repeated movements of the control stick to the same side, produce a kind of proportionate control, the plane banking smoothly as desired. All these receivers are operated by a ground control unit, with a stick that moves left or right, front or back. However, controls are not simultaneous. The man who really knows radio can dream up some fascinating multi-channel arrangements by various methods, ten or more channels not being unheard of!

So much for the popular systems. What about the actuators that provide the muscle to move the controls?

Most commonly used is the self-neutralizing escapement (SN). An escapement is an electromechanical device, weighing as little as ½ ounce. When energized, the magnet pulls in an armature which frees a revolving arm or claw to move to the next position. Power for the revolving arm is a twisted loop of model airplane rubber. When the arm moves, the rudder is displaced to a full left or right position, where it remains until the escapement is de-energized. Thus, when the pilot cuts off the signal, the SN returns to neutral.

Since there is a sequence of left rudder following right, or *vice versa*, the pilot must pass through the unwanted position if he means to continue to turn in the same direction. Thus, if he had right rudder and wanted it again, he would send two quick signals. If he wanted opposite rudder, he would send one signal.

There also is a four-arm escapement which goes to the half control position on signal, then to the full control position when de-energized, where it remains until further signaling returns it to neutral and on to left rudder. Fliers who use it (it has no battery drain when in the full control position) usually depend on a "beep box" or some other special control stick which causes the transmitter to send out the proper number of signals as the stick is moved from side to side. "Beep boxes," either electronic or involving a revolving motor-driven drum, are sometimes used with other escapements as well, including the second control.

The compound escapement eliminates the sequence. It is designed to give, say, right rudder on one impulse; left rudder, on two; and the second control, on three.

Thus, if the pilot punches out two signals, the plane will always turn left. When the craft is in the distance and hard to see, the flier can be positive about which way it turned. There is no sequence to forget and it is unimportant which way the plane turned the last time.

Multiple escapements are seeing wider use. These escapements may utilize two revolving arms, two pawls, and two or three loops of rubber. Moving both rudder and elevator, sometimes motor controls as well, they involve a complicated sequence in which elevator positions follow rudder positions, and *vice versa*. A ground control box with a movable stick determines the proper number of signals put out by the transmitter to obtain the desired control.

The fact that escapements are "all or nothing" devices, moving controls their full travel, has led to the development of the magnetic actuator, which gives true proportionate rudder for proper turning, and without sequence. This actuator consists of a pivoted magnet, free to revolve in two directions within limit stops. This actuator "slaves" to the relay armature in the receiver. Movement of the armature between two contacts, keeps reversing the polarity of current to the actuator. When the relay drops out, say, the actuator swings against the stop in one direction and the rudder goes to full left. When the relay is pulled in, the actuator swings against the other stop and full right rudder is had. If the relay is pulsed rapidly, the actuator and the rudder swing back and forth so rapidly that the rudder does not change the flight path of the plane. Now, if the ground control unit (variation of a "beep box") changes the length of the pulses, the relay tends to stay pulled in, or dropped out, the greater portion of the time. The rudder likewise tends to stay on one side more than the other, and a turn results. Unless some added safety feature is incorporated this system will spin in the plane if it flies out of range or if there is a transmitter failure—but a spin-in is better than a lost plane.

Two sets of actuator batteries are required, the relay armature movement alternating between them. However, some actuators (Adams) have two coils with a common ground, and the relay armature then directs current first to one coil, then the other. This makes possible a single set of batteries.

There are two classifications of servos. In their simplest form, they can be substituted for escapements, performing the same job, but more slowly and with superior power. Other servos intended for trimming elevators on multi-channel jobs

or for obtaining progressive engine settings are somewhat more elaborate—one utilizes an electric motor drive and a slipping clutch in lieu of limit switches. All escapements and servos operate on  $1\frac{1}{2}$  to  $4\frac{1}{2}$  volts, depending on manufacturers' directions. Reliable operation is obtained on penlight batteries.

To relate these systems to plane size, the popular, practical sizes seem to run from approximately three- to six-foot wing span. There's the midget model powered by .049 cu. in. displacement engines; the four- to  $4\frac{1}{2}$ -foot size, powered by .074's to .15's; and the five- to six-foot size, powered by .19's to .35's, depending on gross weight and air drag.

Multi-channel installations require the five- to six-foot plane, although lighter units may be crammed into the  $4\frac{1}{2}$  footer, servos and all. Single-escapement, rudder-only ships may be any size. Multiple escapement designs fall into the middle and top categories.

If you are limited to single-channel, rudder-only, plane size is a matter of taste and pocketbook. Otherwise, why not choose a plane kit which, with later modifications and additions, will accommodate added controls? END

## DRAPERY ROD AS AN ADJUSTABLE SUPPORT

**A** METAL drapery rod can be cut down to desired lengths to form an adjustable support for a variety of items on the work bench.

Photo at left shows two 10-inch lengths which have been drilled at 2-inch intervals to permit a nail or like object to be inserted when rods are telescoped.

The assembly may be extended 16 inches or more. Photo at right shows rod holding a radio chassis for repair work.

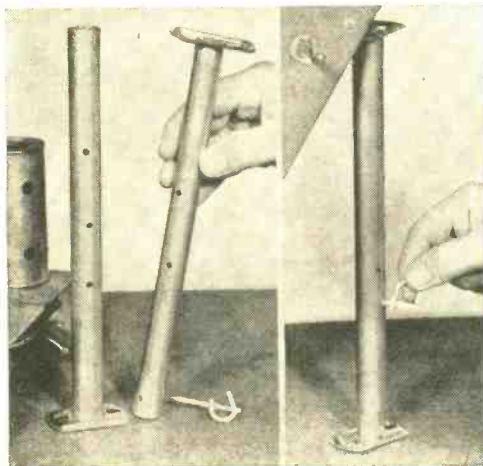

November, 1954

## Get New FREE PUBLIC ADDRESS HANDBOOK



### Valuable Facts Help You Install Better PA Systems

- Shows how to make sound surveys and recommendations for factories, arenas, etc. Gives typical examples and results.
- Discusses public address requirements in relation to characteristics of auditoriums, stadiums, large rooms, etc.
- Explains operational factors of importance in public address speaker systems for all types of applications, indoors and outdoors.
- Tells what the CDP Compound Diffraction Projector is—what it does—and how it provides a PA speaker system of much greater range, efficiency and dispersion.
- Includes illustrations, diagrams, charts, formulas, engineering data, technical and architectural specifications.

Send for your **FREE** copy now

**Electro-Voice**®

## Carl & Jerry

(Continued from page 63)

you see in there is one particularly suited for this job and is called a thyatron."

"What the heck's a thyatron? Sounds like a glandular disease."

"Well, it's not. A thyatron is sometimes called a relay tube because its action is very much like that of a relay. As long as the negative potential on the grid of such a tube remains above a certain critical value, no current at all flows through the plate circuit of the tube; but when the negative grid voltage is lowered to that critical value, the plate current suddenly rises from zero to a comparatively high value. If we adjust the grid voltage of a thyatron very close to the critical value and then arrange for the current through our photoelectric cell to influence this grid potential, very slight changes in illumination of the cell can produce rapid and positive operation of a relay in the plate circuit of the thyatron tube. Photoelectric cells and thyatrons go together like hot dogs and rootbeer."

"Are there any other kinds of photoelectric cells besides the vacuum and gas types?"

"Sure thing. Both of these are what are known as 'emissive' types. In addition we have the 'conductive' type of cell. This cell has two electrodes connected by a material that exhibits a change in resistance in accordance with the light falling on it. A typical cell will display 30 megohms of resistance in the dark and only one megohm in bright sunlight. Such a cell behaves much the same as the emissive type with this exception: it displays no polarity and is less subject to damage by high voltages. Conductive cells may or may not be mounted in a vacuum, for low pressure is not necessary for their proper action."

"What kind of a cell is in the light meter my dad uses in taking pictures?"

"That's still another type called the 'generative' cell. In many ways, particularly at this time, it is the most interesting of the lot. Several materials, including selenium when spread in a thin film

connected together so that the meter reading indicates the footcandles of light falling on the cell window."

"Why do you say these cells are the most interesting 'particularly at this time'?"

"For one thing these cells convert light energy directly into electrical energy without first going through some other form, such as heat. That has tremendous and exciting significance. Every single day the sun bathes the earth in more than 1,000,000,000,000 kilowatt hours of energy. This daily gift of radiated energy is equal to all that is contained in the world's reserves of coal, oil, natural gas, and uranium. The sad part of it is, though, that practically all of this energy goes to waste, at least as far as man's attempt to harness it is concerned. Your dad's photoelectric exposure meter represents about the best we have been able to do in converting light into electricity until very recently, and it has an efficiency of only about one per-cent.

"Just a few months ago, however, the *Bell Laboratories* that invented the transistor, came up with a new solar energy converter that is six times as efficient as the light meter. Each cell in this converter is made up of a wafer of two types of specially treated silicon—the main ingredient of common sand. One of these silicon cells in full sunlight will produce about a half a volt with no load. When the load is adjusted to take maximum power, the voltage falls to about one-third of a volt and stays close to that figure over a wide range of illumination. A short-circuited cell in bright sunlight will deliver about one-eighth of an ampere for each square inch of active surface or about one-tenth ampere at a load causing a one-third volt output. Groups of cells can be connected in parallel for additional current or in series for additional voltage. As long as this 'solar' battery is working into a high impedance load, good voltage output is had with much less than full illumination. On quite cloudy days the silicon cell will produce usable output with the radiation that comes from the sky."

"How much power have they managed to get out of thing?"

"Silicon solar batteries have been used to power transistorized radios and transmitters and to operate a toy ferris wheel. Telephone engineers are already thinking about using them to run low-power mobile equipment or as battery chargers for amplifiers in rural telephone systems. At present it takes a ten-cell battery to produce a quarter of a watt, and *Bell* engineers estimate you would need about twenty-

five square feet of silicon wafer to keep a hundred-watt lamp burning and about a quarter of an acre of the stuff to power a small home.

"Keep in mind, though, that we have just got a toe-hold in this field, and improved efficiencies are bound to appear. In fact the Wright Air Development Center of the Air Research and Development Command has already announced a new solar generator using cadmium sulphide instead of silicon, and it has been estimated that a thin crystal slab of this material with an area of only sixty square feet could be built into the roof of a house and would supply all its electrical requirements."

Carl stood up and stretched until his joints cracked. "That's the way it goes," he mourned. "No longer will I be able to draw a simple pleasure from watching the electric eye door at the super market swing open at my approach. Now I'll be thinking about thyratrons, electrons, silicon cells, and cadmium sulphide. Worse yet, when I'm trying to get a sun tan, I'll be feeling guilty about all that solar energy I'm squandering!"

END

#### "SMALLEST RELAY IN THE WORLD"

WHAT is claimed to be the "smallest relay in the world" has been recently announced by the Electromechanical Division of *G. M. Giannini & Co., Inc.*, East Orange, N. J. Despite its small size, the relay is completely functional and can be actuated by a solar battery or photocell since it requires only 18 milliwatts to effect contact closure.

The contacts and actuating elements are made of magnetic rods and sealed in glass. This same type of relay is available in a variety of sizes for different uses.

END

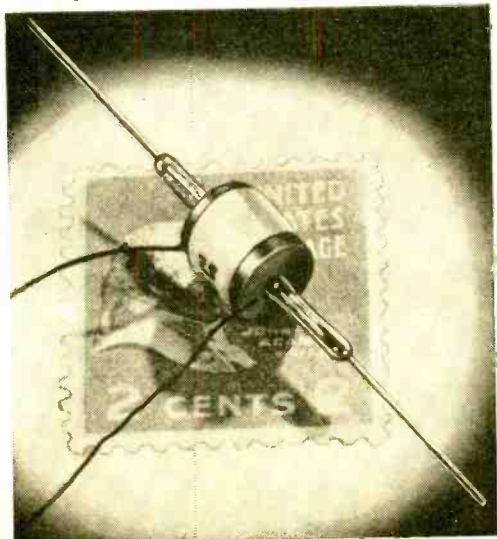

November, 1954

**IF YOU'RE  
INTERESTED  
IN  
HIGH FIDELITY  
RECORDS ...**

*then*  
**YOU'LL WANT  
TO KNOW MORE  
ABOUT THE**  
**Collaro**  
*High Fidelity*  
**RECORD CHANGER**



*Mail This Coupon Today*

ROCKBAR CORPORATION, Dept. LL-18  
215 East 37th Street, New York 16, N. Y.

Please send me literature describing COLLARO  
High Fidelity RECORD CHANGERS.

NAME.....

ADDRESS.....

CITY.....ZONE.....STATE.....

# TRICKS of the TRADE

## TIGHTENING MASK BAND

**M**ANY TV receivers use a band, of the type shown, to clamp the safety mask in place.

When adjusting the clamping screws,

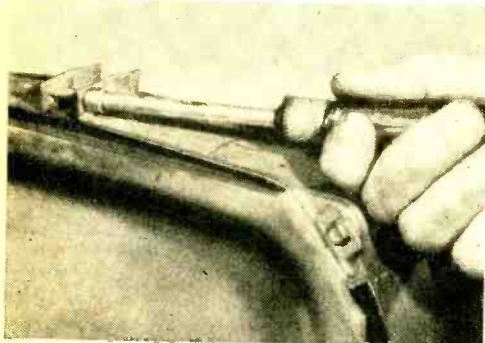

make the connection snug, to prevent as much dust from entering as possible, but do not use excessive tightening force as strain might be placed on the picture tube.

## STRANDED WIRE EYE-SPLICE

**T**HE usual radio antenna today is a job that would make old-time wire benders shudder. Modern practice, in the absence of a trick fastener (which for some reason is usually absent) is just to wrap the wires together, whether stranded or solid, making a relatively insecure joint, as well as a hazard to the hands and clothing of anyone unfortunate enough to get caught on the barbed ends.

Here is a simple, strong, and safe way to make stranded wire splices. Form the eye through the insulator (or eye-bolt and thimble) leaving an end a few inches long. Unravel one of the strands back to the eye, then wrap it tightly around both parts. With pliers, tuck the end between the two

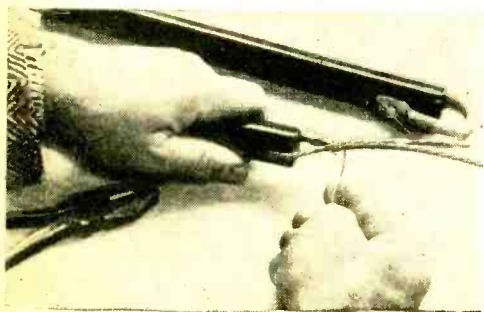

parts, then peel back the next strand to this point. Taking up where the first strand ended, wrap this one tightly and end it in the same way. The core wire should be last. Twist its last few turns tightly in place with the pliers.

The resulting eye-splice will hold any strain the wire can stand and will make the antenna look as if it were put together by a professional. *Elbert Robberson*

## EXPERIMENTAL SHIELDS

**T**EMPORARY interstage shields for experimental circuits may be easily cut from household aluminum foil. The "heavy duty" or "freezer wrap" type foil should be used, as this is usually heavy enough to hold its shape.

Tear off a piece of the foil large enough for the shields needed and smooth the foil against a flat surface. A small piece of



doweling rod makes a handy smoothing tool.

Using a pair of household shears, cut out the shields needed. Where bends in the shields are necessary, these may be made by hand. However, for a really "professional" looking job, the bends should be made by forming the foil over small blocks of wood.

When using the shields in a circuit, make sure that a good electrical connection is made to ground. A wire may be connected to the foil by first soldering the wire to a paper clip, then attaching the paper clip to the foil.

## RACK FOR HOOK-UP WIRE

**H**ERE'S a handsome rack which takes only a few minutes to build and which will keep your spools of hook-up wire in apple-pie order.

Take a fruit cake pan (salvage from the kitchen or pick up a new one at the grocery

or hardware store) and drill two holes in the back for screws. Punch a 3/4" hole in each end. Drill a series of 1/8" holes close

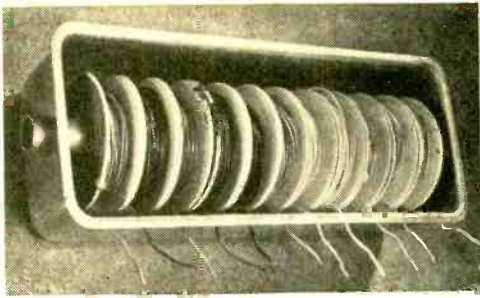

to one edge, spaced the width of your wire spools.

Finally, assemble the rack as shown in the photograph, using a piece of 3/4" tubing (or a 3/4" wooden dowel rod). Feed the ends of the wire through the small holes along the edge.

If you have a really large lab, you'll probably want three racks, one for solid wire, one for stranded, and one for magnet and coil wire.

\* \* \*

### REPLACING SUPPORT CORDS

**B**EFORE disconnecting guide cords or B wires used to dress various TV wires in a certain manner, it is a good idea to make a sketch or good mental note of the original arrangement.

Then when a tube is replaced or other adjustments made you will be able to replace the guide cord as found.

The manufacturer had a reason for holding certain leads in a desired position, so why invite trouble?

Any handling of wires as shown should

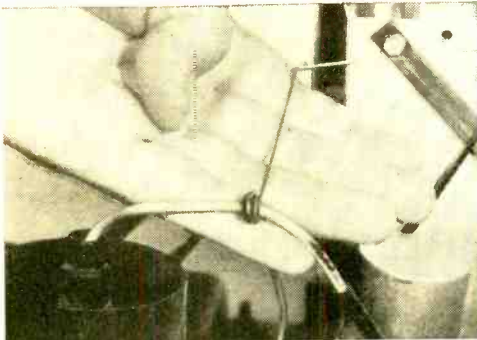

be done with the line plug disconnected from the wall outlet and preferably after the receiver has been so disconnected for some time.

\* \* \*

### TERMINATING CABLES

**A** PROPERLY terminated shielded cable should have no loose or frayed braid showing. Several methods are used by

November, 1954

# BIGGEST BARGAINS FOR BEGINNERS!

from  
**WORLD RADIO LABS**

WRL'S FAMOUS  
BANDSWITCHING  
GLOBE SCOUT  
TRANSMITTER



Only \$7.95 per Mo.  
\$10 DOWN AND  
12 MOS. TO PAY

COMPLETE  
AMATEUR RADIO  
KITS FOR THE NOVICE!



RECEIVER  
\$14.70 Complete  
Stock No. 75A008



TRANSMITTER  
\$29.40 Complete  
Stock No. 81A052

This 65 watt, complete bandswitching Globe Scout is ideal for beginners. Compact, 8 1/2" x 8 1/2" case and operating 160 thru 10M. Fone and CW. P1 Network antenna tuner. Fully TVI screened cabinet. Send for complete information today!

Stock No. 1000A020W

Build your own transmitter and receiver and "go on the air" with this complete kit and simple instructions. Complete kit only \$43.22. Designed for single wire antenna. Power supply included with transmitter. Units may be purchased separately. Write for full details.

World Radio Laboratories is the world's largest distributor of amateur radio and electronic equipment. Over 15,000 items of the latest design on the market. Including WRL's own famous 500 watt, completely bandswitching Globe King. That can be yours for only \$36.78 per month! Write today for our new FREE catalog, showing our entire list of items for the novice and the professional. It's easy to do business with WRL.

- ★ Only 10% down payment
- ★ "10 Day Free Trial" Plan
- ★ More Money-Value for Trade-ins
- ★ Over 600 Bargains in reconditioned transmitters, receivers, etc.



**FREE!**  
1955 CATALOG

Your Permanent Guide To Over 15,000 Top-Value Items!

SEND FOR IT!

WORLD'S MOST PERSONALIZED RADIO SUPPLY HOUSE



WRITE - WIRE - PHONE 2-0277 COUNCIL BLUFFS, IOWA

Address To: WRL—BOX 811—CO. BLUFFS, IA. (PE-11)

Please Quote Trade-In Value of My:

(Make and Model of Equipment)

On Your \_\_\_\_\_ (Make, Model Equipment Desired)

Send Free Catalog  3'x4' Radio Map (25c). Full Information on  Globe Scout,  Amateur Radio Kits,  Reconditioned Equipment,  Globe King,  E-Z Pay Plan, to:

NAME Louis Hoffart ADDRESS 20267

Chickasaw Euclid, Ohio

# Make YOUR Picture Taking PAY!

- ✓ —in a high-paid job
- ✓ —your own studio
- ✓ —as a free lance
- ✓ —for extra income



## NYI'S BIG FREE BOOK SHOWS YOU HOW SEND FOR IT TODAY!

Find out why today's money-making opportunities are the biggest ever. NYI's big FREE illustrated book takes you behind the scenes in professional photography, shows what the tremendous opportunities are in every major branch. It shows how NYI's famous low-cost LEARN-BY-DOING method and PERSONALIZED guidance train you quickly, easily AT HOME in spare time—how you can EARN AS YOU LEARN to make money 90 ways for extra income or a lifetime career. Get started NOW! Send for FREE book. Our 45th year. Resident Training also available. G.I. Approved.

**NEW YORK INSTITUTE OF PHOTOGRAPHY**  
Dept. 13, 10 W. 33 St., N. Y. 1, N. Y.

Please send me complete information regarding

Correspondence Course       Resident Training

Name \_\_\_\_\_

Address \_\_\_\_\_

City \_\_\_\_\_ Zone \_\_\_\_\_ State \_\_\_\_\_

Check if eligible under G.I. Bill.

"old timers," one of which is shown in the diagram.

First (A) strip the end of the cable, removing a portion of the outer insulation, part of the shielding braid, and part of the inner insulation, thus exposing the inner conductor.

Next (B) spread a thin layer of soldering paste or liquid over the exposed shield and wrap the braid with a piece of tinned bus bar. Use 18 or 16 gauge bus bar for medium-sized cables and 14 gauge for larger cables.

Finally (C), using a hot soldering iron and good grade of solder, flow molten solder around wrapped braid and bus bar. The solder should flow under the bus bar and between turns of the wrapping, bond-

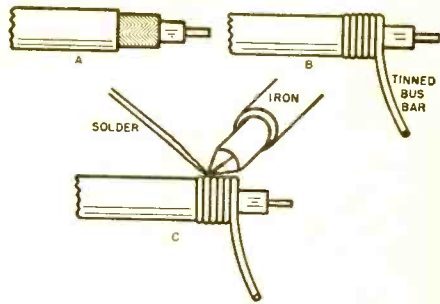

ing the braid to the bar as well as connecting the individual turns of the bus together . . . . . L.G.

### SHOCK MOUNTS FOR SOCKETS

**T**ROUBLES due to microphonic tubes may be minimized by shock-mounting tube sockets in critical circuits. Octal sockets can be shock-mounted as shown in the photograph.

Punch the socket hole at least 3/16" larger than normal and drill the two mounting holes large enough to take small rubber grommets. Finally, mount the tube

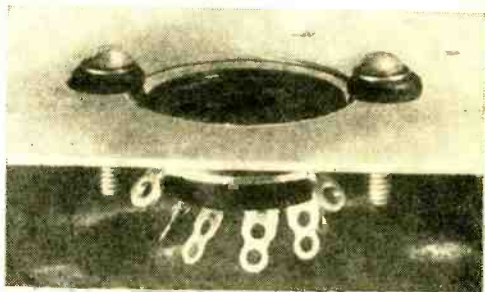

socket using rubber grommets, flat washers (small cup washers are preferred, if available) and long machine screws.

Miniature tube sockets can be shock-mounted in a similar fashion. First mount them normally on small metal plates, then

**ONLY \$495**  
Ppd.  
or C.O.D.  
+ Chgs.

## THE NEW TV DYNATRACER

- TRACES TV SIGNALS AND VOLTAGES
- LOCATES DEFECTIVE COMPONENTS
- REQUIRES NO ADDITIONAL EQUIPMENT

This sensationally new piece of test equipment is ideal for trouble-shooting television sets in the home or in the shop. The "DYNATRACER" will out-perform more expensive testers and should pay for itself on the very first repair.

**A Must for Every TV Technician**

**SPECIFICATIONS:** The "DYNATRACER" is a self-powered quality test instrument designed to trace TV signals through any Video, Sound, Sync, AFC, Horizontal or Vertical Sweep Circuit—will isolate trouble to a stage or component.

**ADDED FEATURES:** The "DYNATRACER" will also trace voltages (50/500 V. AC/DC) and instantly locate open, shorted, intermittent or leaky (up to 20 MEGOHMS) condensers, resistors, coils, XFormers, etc.

Instruction and Trouble-Shooting Book Enclosed  
**10 DAY MONEY-BACK GUARANTEE**

Cut out advertisement, attach name and address with \$4.00 bill, check or money order and mail to:

**Century ELECTRONICS CO.**  
211-04 99th Ave., Dept. 602, Queens Village 29, N. Y.

## MAKE EXTRA MONEY!!

Spare time work at home. Big mail-order firm needs men and women to send out postcards. Easy! No experience necessary. Just address and mail. Steady work every month. Act now—write at once.

**BUSINESS INFORMATION CORPORATION**  
143 Belmont Street, Belmont, Mass.



shock-mount the plates on the main chassis, using rubber grommets and washers.

### HOOKUP WIRE SPOOLS

**Y**OU'LL find it easier to keep hookup wire neat and usable if it is wound on small metal spools. If you don't have regular

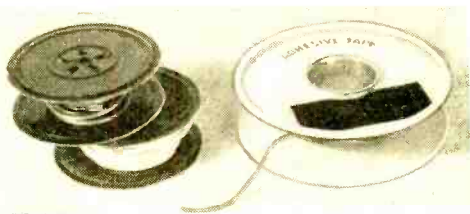

wire spools on hand, there are lots of substitutes—use empty adhesive tape spools or old typewriter ribbon spools.

Try to keep the wire even and straight as you wind it on the spool. It will re-wind easier if you do. Kinks can develop into knots!

### WORKING ON FINISHED PANELS

**W**HENEVER you have to do additional machine work on a finished panel—painted, and with decals or nameplates in place—be sure to protect its surface. If you need to clamp the panel in a vise, use

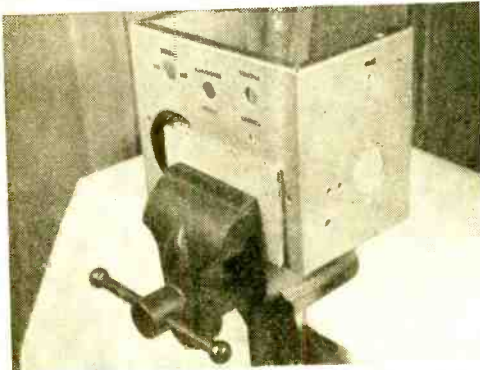

pieces of cardboard on either side of the panel, as shown in the photo. (Some technicians use small wooden blocks covered with several layers of soft cloth instead of cardboard.)

If you lay the panel flat on the top of the workbench, first brush off any stray scraps of metal and filings, then use at least two layers of soft cloth as a cushion.

### OUTLET BOX USE

**P**ANEL-TYPE indicating voltmeters are often available at low cost. One method of mounting such an instrument for portable use is to install the meter in a metal outlet box, such as used in electrical wiring.

The outlet box shown is a three inch one. Mounting lugs may be arranged on the

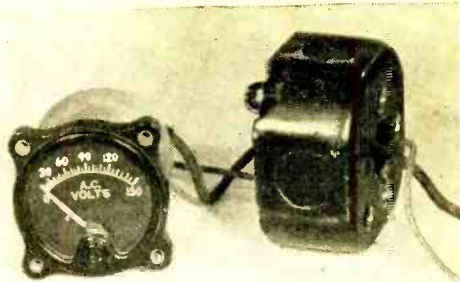

front to secure the meter to the box and any bare terminals on the back of the meter should be well taped. Test leads or wires are brought out through the back of the box.

### LOW COST "SPAGHETTI"

**K**EEP those short lengths of hookup wire you have left over after a wiring or dis-assembly job. If you strip the insulation

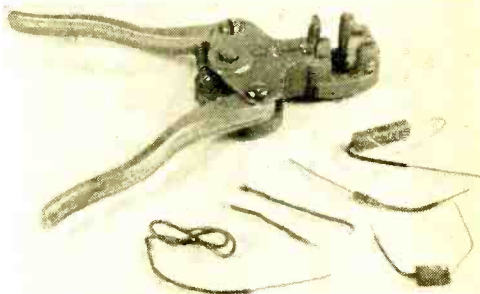

from them, you'll find it's just the right size to use as insulating spaghetti tubing on resistor, capacitor, and small coil leads.

In addition to saving wire scraps, save the short pieces of insulation removed during an original wiring job. In this way it is often unnecessary to use a single piece of fresh spaghetti tubing in a whole project.

### "ZIP-CORD" HINT

**S**OME types of POSJ line cord will continue to separate once a small portion has been split. This trouble may be avoided

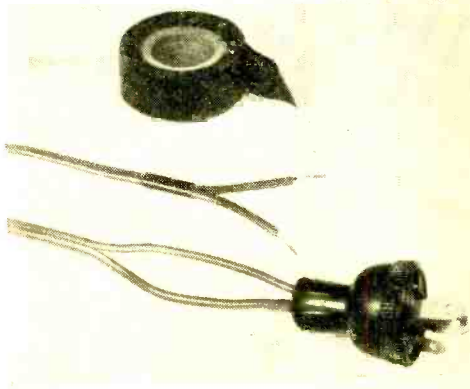

by wrapping a few turns of tape around the cord, as shown in the photograph. Plastic base electrical tape is less bulky, but ordinary friction tape will also do the job.

### CHECKING TUBE FILAMENTS

**W**HEN any one tube filament burns out in a string of tubes which are in series in a radio or TV receiver, an ohmmeter simplifies the work of locating the defective tube.

After placing the ohmmeter on a high scale so there is no danger of damaging a good tube filament, it is only a matter of connecting the meter across the filament prongs of the various tubes in the series string.

Zero readings of the meter indicate that the tubes are good while no indication or movement of the meter pointer is a sign that you have spotted a tube with its filament open.

### SOCKET ADAPTERS HANDY

**T**UBE socket adapters for miniature and other tubes are available in some makes. The adapter is plugged in, in place of the tube, with the tube then being placed in the adapter.

Terminals near the top of the adapter



permit the attachment, temporarily, of thin terminals on leads from the voltmeter.

Many radios use miniature tubes and considerable time may be saved in checking voltages without removing the chassis.

### RUBBER CEMENT—A TIME SAVER

**P**ROBABLY you'll never find rubber cement on sale in your radio supply store since it is a product used by artists and editors more frequently than by service technicians and radio hobbyists. Despite this, you'll find it mighty useful around your radio lab or electronics workshop.

You can use it to attach a screw to a screwdriver blade or to hold a nut in a "Spintite" when reaching those hard-to-get-at places. You can also use it to fasten temporary labels on jars, parts bins, and chassis. You can also use it to attach a piece of paper to a chassis when you are making up a drilling layout before processing the chassis.

Once the job is finished, the rubber cement can be removed simply by rubbing it gently with your finger. It will leave a clean, dry surface which can be painted, sprayed, or otherwise processed without difficulty.

### USE BATTERY CLIPS

**W**HEN you discard dry batteries which have clips of the type illustrated, it is worth while to salvage such clips for ex-

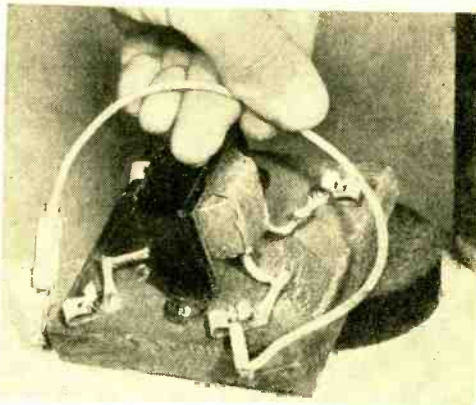

perimental or the test attachment of wires.

By drilling the flat end of the clip it may be mounted with wood or machine screws.

An output transformer is quickly substituted for checking purposes when mounted on a wood base and its leads terminated in the battery clips.

### EAR SYRINGE USE

**C**HANCES are you have one of those rubber bulb ear syringes in your medicine cabinet. You'll find it worthwhile to get another to keep in your electronics workshop.

Use it as a miniature blower. You can blow dust and metal filings out of hard to

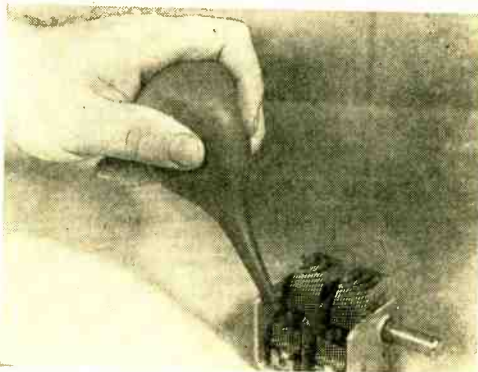

reach corners, and it's especially valuable for blowing out the dust that accumulates between variable capacitor plates. **END**

## Neon Glow Lamp

(Continued from page 91)

and capacitance values can be utilized in this circuit. The values shown in the diagram give a saw-tooth wave with a period of about  $\frac{1}{2}$  second with 135 volts applied. An increase of either the resistance, the capacitance, or both will lower the frequency and make the lamp flash more slowly. When very low frequencies are chosen, each discharge cycle can be observed by a flashing of the lamp. A high resistance d.c. voltmeter across the capacitor will follow the voltage variations and give a graphic illustration of the operation without the necessity for an oscilloscope to observe the presentation.

A slight variation of the same circuit will produce a series of positive pulses. A small resistor is placed in series with the lamp. Since current will flow through the lamp only when it is conducting, the voltage measured across this resistor will be zero except during the discharge period when a positive voltage will appear. When the lamp stops conducting, this voltage will again drop to zero. Thus, the same circuit can produce a saw-tooth wave across the capacitor and at the same time, a string of pulses of the same frequency across the auxiliary resistor.

## Circuit Variations

Many amusing and educational experiments can be performed using the general principles of the relaxation oscillator circuit just discussed. By using more than one lamp and changing the values of the resistors and capacitors, lighting circuits with many flashing characteristics can be designed. Just a few are shown in Fig. 2. A very interesting circuit is shown in Fig. 2A. With two lamps connected as shown, they will alternately flash in a very mysterious way. If the resistors are equal, each lamp will remain on the same length of time, and the frequency with which they alternate can be changed by altering the component values. If two different values of resistance are used, the lamp connected to the voltage source through the smaller resistance will glow longer than the other.

The circuits of Figs. 2B and 2C are outgrowths of the one just described. They each use three lamps and the only difference between them is the addition of another capacitor. This will, however, change the flashing sequence from a left-to-right, right-to-left order, into a ring sequence in which the lamps follow a fixed succession. If the symmetry is changed by altering some of the values, certain lamps may flash at higher rates than others, but the particular sequence followed is ordered,

**NEW STOCK  
OF FIRST  
QUALITY**

# TELTRON TUBES

**SPECIAL! . . .  
till DEC. 1st**

**Guaranteed! Lowest Prices Ever!**

**GIFT OFFER!**  
One 6BG6G tube  
will be shipped  
FREE with any  
order accompanying  
this ad.

TYPE	PRICE
1B3GT	.55
5U4G	.40
6AC7	.65
6AG5	.44
6AL5	.28
6AU6	.35
6AV6	.34
6BA6	.38
6BK7	.78
6BQ6GT	.75
6BZ7	.80
6J6	.48
6SN7GT	.48
6T8	.57
6W4GT	.35
12A7	.53
12AU7	.47
12BA6	.36
12BE6	.40
12BY7	.62
12SA7	.43
12SK7	.43
12SL7GT	.35
12SQ7	.35
25L6GT	.35
50L6GT	.49

All tubes individually boxed . . . unconditionally guaranteed for one year.

TYPE	PRICE	TYPE	PRICE	TYPE	PRICE	TYPE	PRICE
1A7GT	.53	6AC7	.65	6BK7	.78	6SQ7GT	.38
1H5GT	.51	6AG5	.52	6BL7GT	.78	6T8	.71
1L4	.51	6AH4GT	.65	6BN6	.90	6U8	.76
1L6	.51	6AJ5	.96	6BQ7	.85	6V3	.80
1LC6	.49	6AK5	.96	6BY5G	.60	6V6GT	.48
1N5GT	.51	6AL5	.43	6BZ7	.95	6W6GT	.53
1T4	.51	6AQ5	.48	6C4	.95	6X4	.37
1U4	.51	6AR5	.48	6CB6	.51	6X5GT	.38
1U5	.43	6AU5GT	.60	6CD6G	1.63	6X8	.80
2A3	.35	6AV5GT	.60	6CU6	.95	7F8	.49
2A7	.35	6AV6	.37	6F6	.42	7N7	.49
3Q4	.53	6AX4GT	.60	6F5GT	.44	12AL5	.43
3Q5GT	.61	6AX5GT	.60	6H6	.50	12A76	.37
3S4	.48	6BA7	.58	6J6	.61	12AU6	.43
3V4	.48	6BE6	.46	6J5GT	.49	12AU7	.58
5V4G	.49	6BF5	.48	6K6GT	.39	12AV7	.73
5Y3GT	.30	6BF6	.48	6L6	.78	12AX4GT	.60
5Y4G	.40	6BG6G	1.18	6S4	.41	12AX7	.61
6A8	.40	6BH6	.51	6S8GT	.65	12AZ7	.65
6I7	.40	6BJ6	.51	6SA7GT	.45	12B4	.72
6Q7	.40	6BK5	.75	6SK7GT	.45	12BA6	.46
				6SL7GT	.60		

**EXTRA  
Bonus of  
Radio & TV  
Parts**

3 lbs. of parts including resistors, controls, coils, IF cans, etc. Easily worth \$10.00.

**\$1.95**

**SAME DAY SERVICE**  
48 Hour Postal Delivery  
To West Coast

**TERMS:** Save all freight and postage charges. All orders accompanied by full remittance will be shipped POSTAGE PAID anywhere in the continental U.S.A. 25¢ deposit required on C.O.D.'s. Minimum order \$10.00. Open accounts to rated firms only.

Send for Free complete tube listing and monthly specials! Get on our mailing list.

# TELTRON ELECTRIC COMPANY

428 HARRISON AVE.

DEPT. PE11  
Phone HUmboldt 4-9848

HARRISON, N. J.

not random. With this as a starting point, additional effects are limited only by one's ingenuity and patience. The circuits can be used for many purposes wherever novel lighting is desired, as on miniature railroads and models. By using large resistors, the current drawn from the source can be kept small and long periods of operation are possible without seriously draining the battery.

Another effect that can be observed in many of these circuits is their sensitivity to light. The rapidity with which one of these gases ionizes is dependent upon the number of already ionized particles present when the voltage is applied. If more are present, less voltage is necessary to start the cumulative generation of ions as previously described. The energy in a strong source of light is capable of supplying many of these already ionized particles and the gas is thus more readily ionized with the application of voltage. The flashing rate of these circuits may be altered slightly by changing their environment from a very dark to a brightly illuminated one.

One caution should be mentioned at this point. If the source of voltage is capable of delivering more current than the neon bulb is rated to carry, a protective resistor should be placed in series with the bulb. As there are many types of neon glow lamps available, the value of this protective resistor should be noted as given by the manufacturer's data or catalogue. Bulbs with screw-type bases usually have a protective resistor built into the base, but other types require this resistor to be supplied externally.

### Voltage Regulators

The property of maintaining a constant voltage over a wide range of currents makes the glow lamp ideally suited as a voltage regulator. When placed across a load of varying size, the current through the voltage regulator tube will vary so that the voltage across the combination remains constant.

The glow lamp previously discussed will operate in this fashion and can be used satisfactorily, although it is surpassed by tubes designed especially for this purpose using neon, or some other gas with similar properties. Unlike the usual neon glow lamp, the two electrodes of a voltage regulator tube are of different sizes and conduction is intended in one direction only. A large cathode is necessary to enable the tube to handle a large range of currents while maintaining its regulatory features. Ordinary neon glow lamps usually have both electrodes of the same size and can be used on either polarity. They

will fire on each half cycle if an a.c. voltage is impressed upon them. In this case, each electrode alternately acts as the cathode when the polarity of the voltage changes.

The basic circuit for a voltage regulator is shown in Fig. 3A. It is designed to maintain a constant output voltage of 105 volts when the load current varies from 0-25 milliamperes. With the dropping resistor shown (1500 ohms), there is a voltage drop of 45 volts across it and a current of 30 milliamperes flowing through it. If the load resistance is as low as 4200 ohms (which would draw 25 ma. from a 105 volt source) then the additional 5 ma. would flow through the voltage regulator, or VR tube. If the load resistance is removed, so that no load current can flow, then the entire 30 milliamperes will pass through the VR tube and the output voltage will still remain at 105 volts. If a load resistance were used that demanded 50 ma., for instance, then the drop across the 1500 ohm resistor would exceed 45 volts and the output voltage would be forced below the extinction potential. The VR tube would de-ionize and voltage regulation would be lost. Values of minimum and maximum currents for this type of gas tube are given in appropriate tube manuals. The graph of Fig. 3B illustrates the current-voltage relationship existing in a normal VR tube and it should be operated on the nearly vertical straight portion of the curve.

In addition to the applications already described, many purposes are served by the neon lamp and other gas tubes using the same principles. Lighting applications are well known and range from small pilot and indicator lamps to the large signs lighting our highways and business places. Neon bulbs are in widespread use as blown-fuse indicators and as protective devices where an abnormal voltage surge causes ionization and thus protects other equipment from power surges by providing a bypass. Still other gas tubes utilize an arc rather than a glow discharge. If the current is not limited by a resistor in a glow lamp, an arc may ensue and usually results in the destruction of the electrodes. This occurs when the cathode becomes heated from the excess current and begins to emit electrons. These electrons add further to the increase in current and the process becomes destructive. Some tube types, however, are built to withstand this effect and they can thus handle many times more current than the simple glow lamp.

Another common type of gas tube uses a hot cathode. Just as in many high vacuum tubes, the cathode is heated by a filament. This causes electrons to be emitted and

thus makes ionization simpler and the current handling capabilities greater. Hot-cathode diodes are usually used for rectification of a.c. and are more efficient than high vacuum tubes for this purpose. Multi-electrode tubes are in common usage and may be of either the hot-cathode or cold-cathode type. The thyratron is a very useful and popular type of gas triode and is capable of handling large amounts of power under precise control.

The basic fundamentals of these and many more types of gas-filled tubes are the same as in the simple glow discharge lamp. By studying its principles and learning to use its capabilities, it is a short step to the understanding and application of its bigger brothers. END

### SOLDERING COIL PINS

**E**XPERIENCED technicians, as well as beginners, frequently use the method shown in Fig. 1 for soldering connections to coil pins. The soldering iron tip is held alongside the pin and the solder is run in from above. As can be seen, this method generally results in solder running down the side of the pin in droplets. Not only is the final job messy but it's usually hard to clean off the solder so that the pins fit properly into their sockets.

A professional technique is shown in Fig. 2. Melt a drop of solder on the tip of the iron. Using a thin wire, coat the inside of the coil pin with paste flux. Then, holding the coil form above the soldering iron, touch just the tip of the pin against the drop of molten solder. As soon as the pin heats, capillary action will draw the solder up into the pin, leaving the outside of the pin clean and smooth and ready for use.

Fig. 1

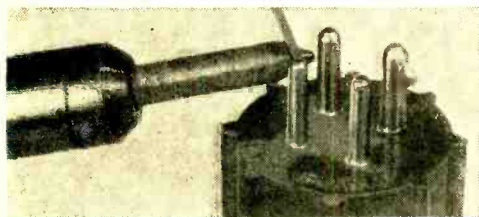
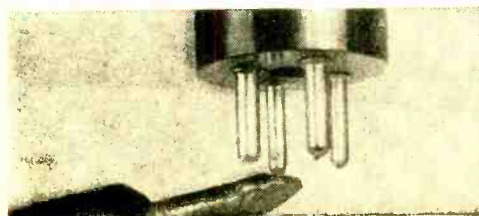

Fig. 2



November, 1954

# BUILD 15 RADIOS

AT HOME ONLY

With the New Improved 1955 Progressive Radio "EDU-KIT" **\$19.95**

NOW INCLUDES  
**HIGH FIDELITY, SIGNAL TRACER, CODE OSCILLATOR**

- Attractively Gift Packed
- Free Soldering Iron
- Absolutely No Knowledge of Radio Necessary
- No Additional Parts Needed
- Excellent Background For Television
- 10-Day Money-Back Guarantee
- School Inquiries Invited
- Sold in 79 Countries



## WHAT THE PROGRESSIVE RADIO "EDU-KIT" OFFERS YOU

The "Edu-Kit" offers you a Home Radio Technician Course at a rock-bottom price. You will learn how to identify Radio Symbols and Diagrams; how to build radios, using regular radio schematics; how to wire and solder in a professional manner. You will learn how to operate Receivers, Transmitters, and Audio Amplifiers. You will learn how to service and trouble-shoot radios. You will receive a practical basic education in Radio, worth many times the small price you pay.

### THE KIT FOR EVERYONE

It is not necessary that you have even the slightest background in science or radio. The "Edu-Kit" is used by young and old; by radio schools and clubs; by Armed Forces personnel and Veterans for training and rehabilitation. No instructor is required. Instructions are complete, simple and clear. You cannot make a mistake.

### PROGRESSIVE TEACHING METHOD

The "Edu-Kit" uses the principle of "Learn by Doing". Therefore you will build radios, perform jobs, and conduct experiments to illustrate the principles which you learn. You begin by learning the function and theory of each of the radio parts. Then you build a simple radio. Gradually, in a progressive manner, you will find yourself constructing more advanced multi-tube radio sets, and doing work like a professional Radio Technician. The "Edu-Kit" Instruction Books are exceedingly clear in their explanations, photographs and diagrams. These sets operate on 105-125 V. AC/DC. Adapter for 210-250 V. AC/DC available.

### The Progressive Radio "EDU-KIT" is Complete

You will receive every part necessary to build fifteen different radio sets. Our kits contain tubes, tube sockets, chassis, variable condensers, electrolytic condensers, mica condensers, paper condensers, resistors, line cords, selenium rectifiers, tie strips, coils, hardware, tubing, Instruction Manuals, etc. A soldering iron is included, as well as an Electrical and Radio Tester. Complete, easy-to-follow instructions are provided. In addition, the "Edu-Kit" now contains lessons for servicing with the Progressive Signal Tracer, High Fidelity, F.C.C. Instructions, quizzes. The "Edu-Kit" is a complete radio course down to the smallest detail.

### TROUBLE-SHOOTING LESSONS

Trouble-shooting and servicing are included. You will be taught to recognize and repair troubles. You will build and learn to operate a professional Signal Tracer. You receive an Electrical and Radio Tester, and learn to use it for radio repairs. While you are learning in this practical way, you will be able to do many a repair job for your neighbors and friends and charge fees which will far exceed the cost of the "Edu-Kit." Our Consultation Service will help you with any technical problems which you may have.

### FREE EXTRAS

- Electrical & Radio Tester • Electric Soldering Iron • TV Book
- Radio Trouble-Shooting Guide • Consultation Service • Quizzes
- F.C.C. Training

PROGRESSIVE "EDU-KITS" INC.  
497 Union Ave., Dept. PE-502, Brooklyn 11, N. Y.  
MAIL TODAY—Order shipped same day received.  
10-Day Money-Back Guarantee. **INCLUDE ALL FREE EXTRAS.**

- RUSH ME the Following—Include all Free Extras:
- "EDU-KIT" Postpaid. I enclose full payment of \$19.95
  - "EDU-KIT" COD—I will pay \$19.95 plus postage
  - Outside USA: "Edu-Kit" Postpaid. Enclose full payment \$20.95
  - Outside USA: 210-250V. AC/DC Adapter. Enclose \$2.50
  - More details on "EDU-KIT" Free—No Obligation
  - FREE Radio-TV Servicing Literature. No Obligation

NAME \_\_\_\_\_

ADDRESS \_\_\_\_\_

### PROGRESSIVE "EDU-KITS" INC.

497 Union Ave. Dept. PE-502 Brooklyn 11, N. Y.

**START YOUR HI-FI RIGHT!**

**Karlson Handyman KIT WITH KARLSON ULTRA-FIDELITY ENCLOSURES**

The performance of a speaker, like a violin, largely depends upon the cabinet. The Ultra-Fidelity Karlson is completely NEW and has amazed thousands at every audio show. "A new standard of performance,"... "unsurpassed"... Hi-FI Manual. Send today for information on this exciting new scientific discovery.

Immediate Delivery  
**only \$45.00**  
 51 Intricately cut pieces  
 ... 3/4" plywood ...  
 34 1/2" x 22 1/2" x 18" overall.

Send for Complete Literature

**KARLSON ASSOCIATES, INC.**  
 DEPT. M  
 1483 Coney Island Ave., Brooklyn 30, N. Y.

**The World at a Twirl**  
 (Continued from page 25)

**Japan**—The new commercial outlets, JOZ, 3.925, fair, JOZ2, 6.050, good, have been logged in Calif. around 0900-1100. JK12, 9.655, JKJ, 7.285, in Home Service, carry five minutes of *English* news before closing down 1000 (not Sun.); also heard in Calif. In some areas, the Far East Network (AFRS), Tokyo, may be picked up on this revised schedule—2100-2300, 6.160; 2315-1015, 11.750 (actually 11.760); 1050-1500, 6.160. **Malaya**—British Far Eastern Broadcasting Service, 1.820, Singapore, has BBC news relay at 1300. **Norway**—Radio Norway, 9.610, Oslo, is good level to Eastern North America 0100-0200 (Mon. has "Norway This Week" in *English* 0200-0220—remember, that would be Sun. 2100-2120 EST); to Western North America, same channel, 0400-0500 ("Norway This Week" on Mon. 0500-0520—that would be Sun. 2100-2120 PST).

**Pakistan**—Radio Pakistan, 11.885, 15.255, beams to Southeast Asia 0045-0130, news in *English* 0100. **Peru**—Try for *English* from Radio Nacional, Lima, on 9.562A, 6.082A, at 0400. **Portugal**—You should get a good signal from "Emissora Nacional," Lisbon, on 9.746A in its all-Portuguese beam to North America 0000-0200. **Spain**—Madrid now has one or more new (reportedly 100 kw.) transmitters on the air; at press time the listed 9.363 outlet was measured 9.339—for *English* to North America try at 2300-2340A, 0300A-0350A. **Syria**—Some days you may "catch" Damascus, 9.555, with *English* 2130-2230 close-down.

**Thailand**—Worth many attempts—and possible to log in many areas—is HSK9, 11.670, Radio Bangkok, around 1000-1200; should have *English* news around 1015. **Turkey**—TAU, 15.160 (if not found there, try TAS 7.280, used in winter), has *English* for Western Europe 2100-2145 closedown. **Yugoslavia**—Radio Belgrade, 6.100, has *English* news 2245-2300.

**For Experienced DX-ers**

(Several new stations, mostly low-powered, have taken to the short-waves lately. Veteran SWL's can have fun in "fishing" for some of these.)

**British Borneo**—Radio Sarawak, 4.870, is a newcomer, 5 kw., with *English* 1030-1130 and 1330-1340A when closes with "God Save the Queen." Heard in Calif. QRA (address) is Radio Sarawak, Kuching, Sarawak, Brt. Borneo. Verified for New Zealanders via airmail. Sarawak is a region of highlands broken up by wide

**WHEN YOU BUY R/C MATERIALS FROM "ESSCO—TOPS IN RC" YOU BUY INTEGRITY & QUALITY AT LOW COST**

**WHAT IS THE MOST POPULAR RECEIVER WITH THE R/C HOBBYISTS TODAY?**

**THE ESSCO LORENZ 2 TUBE**—uses the new long life (150 hours) RK-81 1st stage and the ESSCO MPC-1 wonder TUBE 2nd stage. Extreme sensitivity, long, reliable range, trouble free tuning. There is no equal to this receiver, and best of all—low initial cost, low tube and battery replacement costs. Be convinced, order an ESSCO Lorenz Receiver kit today. Consists of both tubes, wound coils, cond., resistors, drilled chassis, cable socket and plug with 25K pot. 20 min. work will complete the ESSCO Kit. . . . . Only \$8.45  
 Wired and tested ready for installation in your model with sensitive relay & Lord shock mount. Unbeatable value at. . . \$13.95

**THE new E. J. LORENZ SINGLE RK RECEIVER.** Featured in this issue. The ESSCO parts pkg. is the most complete, includes all specified parts, drilled base, wound coils and NEW LONG LIFE RK-61 . . . . . \$ 6.95

**WITH NEW SIGMA 26F 8000 CDS relay** . . . . . 14.95  
 THE above relay only . . . . . 8.50

**THE ESSCO SUBMINIATURIZED TONE RECEIVER KIT—MODEL #BECERIII.** A complete parts kit to build your own receiver for use with Babcock and other similar units. Smaller size, lower battery drain, higher sensitivity due to use of modern submini. tubes, complete kit . . . . . \$19.95

**THE ESSCO MODULATOR.** A 400 cy. Audio tone Modulator to use with your MAG II and other types of transmitters. A high quality stable unit easily connected to any transmitter. Enables you to easily change your R/C equipment over to the Audio tone system. Complete parts package . . . . . \$5.95  
 Wired and tested, ready for use . . . . . 8.95

**IMPROVED ESSCO WAG AUDIO TONE RECEIVER.** ESSCO's modern version uses 3 high efficiency subminiature hard tubes, resulting in improved performance, smaller size, lighter weight. Will fit 1/2A size models. Only 100 ma. tube filament drain. Complete tested receiver w/relay, ready to operate . . . . . \$24.95  
 In kit form . . . . . 19.95

Complete parts kit per original writeup, less relay . . . . . 7.95

**THE IMPROVED NEW ESSCO LORENZ MORA TRANSMITTER.** Complete parts kit of highest grade components to build your own per August MAN. Includes wound coils, drilled chassis, tubes, case and crystal. . . . . \$17.95  
 A completed unit ready for use, nothing else to buy (batteries excepted) . . . . . \$34.95

**THE DELUXE ESSCO-LORENZ,** a completed unit with built-in vibrator power pack, 2 volt rechargeable cell, with 110 volt AC and 6-12 VDC charger. Meter switching features same as our ESSCO RCX HP, as shown in our A. T. Sept. ad. Complete set ready to go . . . . . \$49.50

Special Free Bonus—Large pig. high-grade rosin core solder. **MONEY BACK GUARANTEE ON ALL ITEMS.** Send for free catalog. FOR FAST, INTELLIGENT, FRIENDLY SERVICE ON YOUR R/C ORDERS, CALL ON ESSCO!

Serving The West  
**ESSCO-WEST COAST**  
 670 Bell Street,  
 Palo Alto, Calif.

Serving The Entire R/C Field  
**ESSCO-NEW YORK**  
 58 Walker St.,  
 New York City 13, N. Y.

valleys and plateaus, about 50,000 square miles in area with a population of about 550,000. In 1841 the sultan of Brunan ceded the area to James Brooke, an Englishman, who became rajah of the independent state. As a British protectorate (1888-1946) Sarawak was ruled by the Brooke family; it became a colony in 1946.

**China**—Latest schedule for *English* news sessions from Radio Peking is 0300-0330, 11.690, 15.060, 15.385; 0900-0930, 6.100, 7.500, 9.040, 10.260, 11.690, 15.060; 1430-1500, 11.690, 15.060 (you may find 11.650 used instead of 11.690). **Cook Islands**—A station was established recently at Rarotonga, at present radiates on 6.180 on Thursdays 0430-0500, also on Wednesdays and Fridays 0100-0200. Hopes to extend transmissions soon with an "evening" broadcast (likely on 3.390).

**Fiji Islands**—VRH4, 3.890, 500 watts, is scheduled Sat. to Sun. 2000-1000; weekdays 1830-2200, 0000-0200, 0400-1030 (Sat. to 1100); is now operated by Fijian Broadcasting Commission from new studios at Broadcasting House, Suva. **Gilbert Islands**—New is Radio Tarawa, 6.050, on the air Sun. only 0200-0230 in Gilbertese, but transmissions will be extended later; power is unknown. **Hong-Kong**—ZBW3, 9.525, has BBC news relay 1100. **South Korea**—Try 6.895 for Armed Forces Korean Network, Seoul, around 1030; you may hear calls of "Radio Vagabond" or "Radio Troubadour," from medium-wave outlets relayed; *English* news 1200. **Tahiti**—West Coasters may pick up Radio Tahiti, 7.025, Papeete, in French around 0500-0600.

Next month I'll discuss identification of short-wave signals, short-wave antennas, and frequency and wavelength. And I'll have more tips for you. In the interim, good listening, fellows, as you "twirl to tune the world!"

(Continued next month)



"We've got TV, phonograph, five radios—and he's building a crystal set!"

November, 1954



## BLOWERS

115 volts  
60 cy. A.C.

REDMOND 5" 18 watts ..... \$ 8.95  
DELCO 60 cfm, 40 watts ..... \$14.50  
#3062369 used in 584 RADAR

EASTERN AIR DEVICES 70 watts, 3400 RPM,  
labeled 80 cfm, but blows like blazes! ..... \$17.50

POTTER & BRUNFIELD 5000 OHM RELAY ..... \$2.35

CAPACITY RELAY ALL BUILT READY TO USE ..... \$19.50

PHOTO ELECTRONIC KIT WITH SELF GENERATING CELL  
AND METER RELAY ..... \$9.95

SMALLEST MOTOR IN THE WORLD ..... \$2.50

4-NEON LAMPS 1/25 W-1/4 W-1 W-3 WATT ..... \$1.00

4-MICRO SWITCHES ASSORTED ..... \$1.00

GENERAL ELECTRIC BLANKET CONTROL, CONTAINS  
SIGMA, 8000 OHM RELAY AND OTHER PARTS ..... \$1.25

NITELIGHTER (see page 79 October POPULAR ELEC.  
TRONICS) ..... \$15.95

ALL PRICES F.O.B. NEW YORK

BLAN  
ELECTRONICS SINCE 1923

64 DEY STREET

NEW YORK 7, N. Y.

## BUILD THE R/C RECEIVER! DETAILED IN THIS ISSUE!

### BASIC PARTS PKG. ACCESSORIES:

SLUG COIL FORM, TUBE	RK61 TUBE — 3.50
SKT, RFC, ALL CONDENSERS, RESISTOR, BASE,	C26 RELAY — 8.50
ALL WIRE, PLUG & SKT,	25K POT — 1.50
EYELETS.	ALL COMPONENTS NEW
A BEST BUY... 2.95	AND GUARANTEED TOP
	QUALITY. NO SURPLUS.

ALL ITEMS POSTPAID FOR... 16.50

SEND FOR FREE CATALOG OF VALUES

CONTROL RESEARCH!  
P. O. BOX 9 HAMPTON, VIRGINIA

IT'S BIGGER AND BETTER THAN EVER!

B-A's NEW 1955

## FREE CATALOG!

164  
PAGES

LOADED WITH  
SAVINGS AND  
NEW ITEMS  
IN RADIO,  
TV AND  
ELECTRONICS!

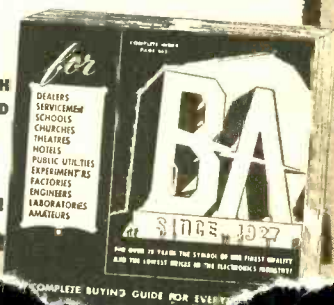

COMPLETE BUYING GUIDE FOR EVERYONE

## Choosing Your TV Antenna

(Continued from page 22)

to a very sensitive receiver in a strong-signal area, but if there are two stations in opposite directions, the picture on the receiver will show interference. This appears as a cross-hatched, diagonal, or wavy pattern on the screen.

This brings us to directivity. TV signals, unlike radio-broadcast ones, are not bent back to the earth by the ionized layer surrounding the earth, nor do they bend around the earth to any appreciable extent. As a rule of thumb, if the receiving antenna can "see" the transmitting antenna, there will be dependable reception; otherwise, chances are that any reception obtained will be undependable and full of snow. To "see" the transmitting antenna, the receiving antenna must be pointed directly at it.

This is all very well if there is only one station. However, if there is more than one station and they are not in the same exact direction from the receiver, where do you point the antenna?

To solve this problem to some extent, antennas that are broadly directional have been designed. This means they will receive signals satisfactorily from a broad area facing the antenna. Such antennas are the *conical* and "*V*" types, for example.

In the case of interference, as mentioned previously, a directional antenna is required because we want an antenna which will receive from one general direction only. A reflector, nothing more than a rod slightly longer than the active arms of the antenna, is positioned immediately behind the antenna to give it greater directivity. Even more directivity is obtained by the use of directors. These are rods slightly shorter than the arms of the antenna positioned immediately in front of the antenna.

A concept that was passed over lightly in the previous discussion is that of bandwidth. It was mentioned, in connection with the dipole, that the antenna arms are cut to the wavelength of the received signal. Fine, if all we get is one station. What do we want more than one station?

channels equally well. Unfortunately, we can't. These antennas will receive the stations for which they are cut well, and all others in their band not as well. There are, however, antennas that are so designed that they will receive a number of stations equally well. These are termed "broadband" antennas. Some of these are designed to receive the entire v.h.f. band.

This covers local areas pretty well. What about intermediate and fringe areas? Well, to begin with, the average signal strength in an intermediate area is about 2000  $\mu\text{v}/\text{m}$ . In terms of distance from the transmitting antenna, the intermediate area may extend to about 40 miles. If the area is relatively flat, it will extend to perhaps 60 miles or more. What are the special antenna problems of these areas?

First, by the time the signal has gotten out this far, it has been bounced around and absorbed by the air and all types of obstructions. This means that the signal is weaker and is not coming from one single direction. Also, two or three stations which are widely separated for a local area receiver may appear to be in the same general direction to an intermediate area set. Wide directivity for an intermediate-area antenna is not too important, therefore, but an antenna should have more gain and about the same bandwidth as the local-area antenna. To obtain more gain, we use an antenna with more active arms or elements. This is done by making the antenna more complicated, or by combining two or more antennas—one above the other. The latter technique is called "stacking."

Typical antennas for intermediate areas are the *2-bay* (stacked) *conical* or "*V*," the wideband *5-element yagi*, and the *stacked inline* types.

Of course, as fate would have it, the more gain an antenna has, the narrower its bandwidth. The conical antenna, for example, will accommodate more channels than will the yagi which has more gain. Therefore, in an intermediate area, where we want to get reception from two or more channels which are widely separated in the TV band (as are 2 and 10, for example), two or more antennas will be required.

There are wideband antennas for the intermediate area. Whether they are usable or not in your particular locality depends upon the signal available and the directions from which the individual stations broadcast. Sometimes a single antenna can be used with an electric rotator, a multiple-contact switch, or a system of couplers. The best device for any particular installation depends on the signal available and the amount of money you want to spend.

Now we come to the most difficult area of all—the fringe area. Here you really



have problems! You are at least 40 to 60 miles away from the transmitting antenna, and chances are that there are lots of hills between you and the station. Also, every time you try to get a program, some station in the opposite direction will come riding in as if you were its long-lost cousin.

What can you expect? Your signal strength is seldom more than 500  $\mu\text{V}/\text{m}$ . Your greatest trouble is lack of signal strength, so the principal antenna requirement is high gain. Since the greatest gain goes hand-in-hand with sharpest directivity and narrowest bandwidth, fringe-area antennas are more often than not pointed directly at a single station for which they are cut. If you are going to try for more than one station, you will probably need separate antennas. You can even try a broadband high-gain antenna with some rotating scheme. It may be successful.

To knock out that interfering station coming from the back, most fringe-area antennas use a large screen-type reflector or a great number of directors. Here's where you see plenty of those 10-element yagis or those antennas that look like grandma's bedsprings.

We haven't said anything about ghosts, but they have a sneaky way of getting into any discussion on antennas. As you may unfortunately be aware, these are multiple images of a TV picture appearing slightly to the left or to the right of the main picture on the TV screen; the sort of thing you get when you move a still camera while taking a time exposure. Ghosts result when the signal from a single TV station is received twice in the receiver. This happens if the signal is bounced off obstructions and arrives at the set a little behind a signal from the same station which travelled directly to the set; or, perhaps, the signal is being picked up by the antenna and also the lead-in wire from the antenna to the set (or at the set directly).

The best way of combating ghosts is to use a highly directional antenna with a substantial amount of gain, and to shield the wire from the antenna to the receiver.

The various types of antennas, and the areas for which each is most applicable, are shown on the chart (page 23). This should be regarded as only a very general guide. The over-all performance you will obtain from an antenna depends on many factors, including the particular combination of channels available in your area. If you wish to receive stations on widely separated channels or if you have difficult weak signal or ghost problems, consult a good service technician in your own area.

This article dealt only with v.h.f. antennas. We will tackle u.h.f. antennas next month. END

## SUPER POCKET RADIO

Smaller than many hearing aids. Powerful, portable and can be assembled by anyone in one hour. Uses two inexpensive cells that fit within case. Owners report 1,500 mile reception. No antenna or ground required for local use. Complete kit of hearing-aid parts only



\$3.99 POST-PAID  
\$3.99. Batteries extra at \$1.45. Use any regular headphone with Micro or tiny hearing-aid earset, shown in photo, available from us at low cost. Micro is guaranteed to please or return in 10 days for full refund.

SEND ONLY \$1.00  
BALANCE C.O.D.

### TRANSI-MITE RADIO LAB

MANTEO (2) NO. CAR.

## RADIO CONTROL EQUIPMENT

LORENZ, 1-TUBE KIT—all parts & tube less relay	\$6.45
TRANSMITTER & RECEIVER KIT—27.255 Mc. band license free. All parts & diagrams (less tubes & crystal) to build 5 Watt Transmitter Unit & 2-Tube lightweight Receiver, including SIGMA 10,000 ohm Relay	\$9.95
SIGMA 4F RELAY 8,000 ohm, 1 Ma.	\$4.95; 3,000 ohm 5.95
Storage BATTERIES—2 Volt 3" x 4" x 5 1/2"	27 Amp. Hr. 2.75
MINI. 6 V. BATTERY—Willard NT6—2 1/2" x 1 3/4" x 3 1/2"	2.45
1 1/2 Volt TINY MOTOR, 6,000 RPM with double shaft	1.95
ABOVE MOTOR with VARIABLE SPEED GEARBOX	3.95
GEARBOX, 2 1/2" x 2" 5,000 RPM	1.45
TOY ELECTRIC MOTOR KIT—Special!	.30
GROUND PLANE ANTENNAS, 10-20-40-Meters: easily made with our painted copper-plated WHIPS—threaded tapered sections; 16 ft.	\$3.95; 32 ft. 6.95
Electronic Toy Train Whistle Unit—less tubes, as is	.95
G. E. RELAY CONTROL—with sens. 10,000 ohm relay.	1.25
6 VOLT DYNAMOTOR—300 V. @ 100 Ma.	9.50
MINI. 6 V. Vibrator Supply, 135 V. 30 Ma.	6.95

PARTS FOR ALL KITS—FREE CATALOG "P"

### GYRO ELECTRONICS

325 CANAL STREET NEW YORK 13, NEW YORK



## LEARN ANOTHER LANGUAGE

EASILY, QUICKLY, at HOME in 20 Minutes a Day with

### LINGUAPHONE

World's Standard Conversational Method

You LISTEN and LEARN to speak:—

FRENCH • SPANISH • GERMAN • RUSSIAN • JAPANESE  
MODERN GREEK—any of 29 languages

It's quick, easy, natural . . . you listen to real life recordings of native men and women making everyday conversation—you understand—you SPEAK! Add to job, armed services, travel opportunities. Save time, work money. Endorsed by educators; used in colleges and by business firms. Over one million home-study students. FREE BOOK, "Passport to a New World of Opportunity," gives fascinating facts. Write TODAY!

LINGUAPHONE INSTITUTE

8911 RCA Building New York 20, N. Y.

## Crooks of the Ether

(Continued from page 43)

Then there was the case of the "wetbacks." For some time, the U. S. Immigration and Naturalization Service was baffled by the success of Mexican laborers in wading across the Rio Grande and entering the U. S. illegally. The "wetbacks" always seemed to be crossing just where the Immigration inspectors weren't.

The FCC and Immigration Department sleuths found out why. Tuning his special receiver one day, an FCC engineer suddenly pricked up his sensitive ears. On a frequency intended for communications between farming trucks and tractors, he heard messages that certainly didn't have anything to do with fertilizing asparagus.

Use of mobile direction-finding equipment brought the engineers and the Immigration inspectors directly to a sadly-mistaken individual and his wife who were using their transmitter to tell the laborers (and the unscrupulous people who planned to employ them) the whereabouts of the inspectors.

Down on the Chesapeake Bay, as in most places, the best fishing is usually where the law says you can't fish. Energetic patrolling by inspectors of the Maryland Tidewater Fisheries Commission keeps illegal fishing to a minimum—generally.

Recently, however, they became suspicious when they found that all fishermen had become models of law-abiding anglers. No longer were high-powered boats seen scuttling into secret bays when the inspector hove into sight.

The reason was soon apparent. A not-too-clever character was apparently using a small craft radiotelephone transmitter to warn his brethren. When nabbed, he admitted he was operating an unlicensed transmitter but tried to explain that it was for "emergency purposes only." The FCC took a dim view of his explanation.

As interesting as such cases of law-breaking may be, there were only 52 of them last year, down from 92 the previous year and the more than a hundred in each of the preceding years. Much more important were the 100 times last year that the FCC supplied lost military and civilian planes and ships with their correct positions. These were termed "emergencies," meaning there was serious danger of loss of life.

Here's how FCC's direction-finding net works. An agency, such as the Coast Guard or Civil Aeronautics Administration, calls the FCC with a report that the pilot on a plane en route from, say, Hawaii to San Francisco, has lost his way, is

urgently requesting a "fix," that is, his exact location.

Immediately, from the "brain center" in Washington or from the monitoring station receiving the request directly a message goes out by teletype directly to the monitoring stations strategically located throughout the nation. At each of these a giant structure, called an Adcock antenna, starts swinging back and forth. An engineer tunes his receiver to signals coming from the lost plane. He rotates the antenna until the signal is weakest. That means the antenna is positioned exactly at right angles to the incoming signal.

The engineer translates this angle into degrees and teletypes it into Washington. In Washington, strings are extended on a map from each station supplying a bearing. The point where these strings cross is the location of the plane.

The process is remarkably accurate. Using the FCC information together with information collected by themselves or other agencies, the Coast Guard or the CAA can radio the pilot the exact course to fly.

Though the technique is seemingly simple, there's a tremendously important human element—the skill of the engineers. Obtaining a fix on a weak and fading signal is a painstaking and nerve-racking job. However, the FCC field men are best equipped for it of all the engineers in the world. The average is 15 years on the job; many of the field men have earned their 25-year pins.

To illustrate their skill, take the case of the flyer who was forced down at sea north of Honolulu. FCC's bloodhounds of the ether hate to give a fix unless they have bearings from several of their stations. In the Honolulu case, however, they were able to obtain only one before the flyer "hit the drink."

The FCC engineer in Hawaii was forced to make an educated guess. Knowing the power of the transmitter on the plane, and calculating the loudness of the signal he had heard against the range of the transmitter, he guessed that the plane was 75 miles out. His estimate turned out to be remarkably accurate and the pilot was found.

Though such work is the most dramatic aspect of the Bureau's duties, the old bugaboo "interference" is its main occupation. A major airline will report that communications with its planes has been rendered impossible by a strange signal that completely disrupts reception over a 500-mile radius. FCC's Adcock antennas begin swinging all over the country.

Who's the culprit? Incredibly, it's a device for drying glue in a Memphis plywood products plant. The plant owner is

ordered to get his faulty equipment back on its own beam, pronto—or else!

Or consider the pesky hum that was fouling up communications and radios in Portland, Ore. To the amazement of FCC's sleuths, the guilty apparatus turned out to be an abandoned short-wave radio set that had been plugged in and operating for two solid years—without the knowledge of the owner. Although it was still operating, some parts had worn out, starting the dangerous and annoying hum.

The growth of television has increased interference complaints many fold. A viewer in Beaumont, Tex., tired of getting little but snow trying to pick up a distant station, attached a booster to his set. The results delighted him—but not his neighbors. The booster was faulty, and no less than 3000 other TV viewers as far as one mile from the booster found their reception ruined.

The FCC doesn't aim to haul such offenders to court. In fact, its main goal is to get communities to handle these problems themselves. It has encouraged formation of local TV interference committees and has seen 370 of them organized in 351 communities.

In 99 cases out of 100, these TVI committees can eliminate the problem by discussion with the owners of faulty equipment, leaving the highly-trained FCC engineers free to track down the difficult and dangerous cases.

More illegal transmissions are carried on by persons who are too lazy, slow-witted, or ill-informed to pass the FCC examinations for amateur licenses than any other single type.

FCC engineers were taken aback, not too long ago, to find a full-fledged standard broadcasting station, WKGR, operating on 650 kilocycles in Marysville, Ohio. There was nothing secret about it. It carried commercials, had a full staff, was operating more efficiently than many small-town stations with FCC licenses tacked to their walls.

When apprehended, the 19-year-old "manager" was aghast to learn they had been breaking the law. "Gee," said the "business manager," 22, "if we had known we were operating outside the law, we wouldn't have done it." The Commission let them off with a warning after they closed down.

The FCC was tougher on one amateur in Savannah. His transmitter had been interfering with TV reception in the neighborhood, ill feelings arose and he began indulging in profanity over his transmitter. This, the FCC official report said, "came out loud and clear in the midst of a TV program being watched by a neighbor-

## ELECTRONIC SUPPLIES FOR EXPERIMENTERS—SERVICE ORGANIZATIONS—AMATEURS—AND INDUSTRY

CLEAN, USEFUL, ITEMS AT LOW COST ALWAYS—  
WHOLESALE AND RETAIL  
ALL MERCHANDISE SOLD ON A SATISFACTION  
GUARANTEED BASIS

### ELECTRONIC REMOTE CONTROL UNIT

Contains a multitude of new, valuable, useful parts. Including 3000 ohm sensitive plate relay—transformer, switch, tube sockets, panel lamp, condensers, resistors, potentiometer, etc.  
Including schematic instruction sheet. Ridiculous sale price of 79¢ complete while they sell elsewhere for \$3.00  
Some chassis less relay and transformer. New, with sheet . . . . .3 for \$1.00  
HOW CAN YOU GO WRONG?

### LINE FILTER . . . .

To eliminate interference from line sources . . . Potted chokes, oil condensers—100 Watts housed on chassis 2 1/2 x 2 1/2 . . . With diagram.  
Packed 2 in a box. 2 for \$1.50  
HOW CAN YOU GO WRONG?

### \$28.00 VALUE \$28.00 VALUE EXTREMELY SENSITIVE MICROAMMETER

0-20 Microamps condensed scale. Weston 301—3 1/2" round bakelite. Lowest advertised price before this special sale was \$10.00—Now to close out remaining few \$5.95 in original Weston boxes. Brand new.

All Items Shipped FOB New York

## REX RADIO SUPPLY

88 CORTLANDT STREET, NEW YORK 7, N. Y., CO 7-1617

### U. S. NAVY SOUND POWER HEAD AND CHEST SET

The tiny voltages created by the sound of your voice carried for great distances (miles) over wire with no external power source. All Guaranteed Operating.  
New or near new . . . . \$6.95  
These are currently being advertised at \$20.00.

**SOUND POWER CAPSULES**  
(Removed from Headsets)  
Used as Transmitter or Receiver . . . . . \$1.49 pr.  
HOW CAN YOU GO WRONG?

### GERMANIUM CRYSTAL DIODE

General purpose—1N60—Prepared for production.  
Worth 65¢ each.  
4 for \$1.00  
HOW CAN YOU GO WRONG?

**RETRACTABLE PHONE CORD**  
Worth \$4.00 each—Special.  
New. Over 6' long—4 conductors . . . . .3 for \$4.00

### 4 FOR THE PRICE OF 1 ELECTROLYTIC CONDENSER— DUAL 20 MFD

450 VDC Can Plug In. Brand new. Sprague Manufacturing. 4 for \$2.25—69¢ each.



**OPPORTUNITIES AHEAD!**  
TRAIN FOR A FUTURE IN  
**DIESEL**

Prepare for the big earning power of Diesel Trained Men. Start learning at home, in spare time. UEI's easy, practical training covers all phases of DIESEL engine operation, fuel systems, auxiliary equipment, repairs and maintenance. Also new Scientific Auto Motor Tune-up. After home course, you come to Chicago for actual practice in UEI's modern shop under experienced instructors. GET ALL THE FACTS FREE. WRITE TODAY!

**DIVISION UTILITIES ENGINEERING INSTITUTE**  
2521 Sheffield Avenue, Dept. DBK-1 Chicago 14, Illinois



Importers Loss **MICROSCOPES** Terrific Value  
**100 x 200 x 300 POWER**  
• A precision instrument • 3 turret lenses • 2 wheel focusing • Tilts all angles • High grade optics • Flat field • Color corrected • Makes a wonderful student's gift  
WITH SLIDES & HARDWOOD FITTED CASE  
Send for free catalog  
AIREX RADIO CORP. 171 WASHINGTON ST., N. Y. P.P. 75c Fully Guar.

## Catalog of 3000 Novelties 10c

Send 10c for amazing catalog of novelties, live animals, scientific novelties, hobbies, fun-makers, planes & boats, looms, magic tricks, luke articles, unusual seeds, gadget timesavers, cameras, optical goods, projectors, movies, lucky jewelry, religious novelties, disguises, musical instruments, stamps, coins, puzzles, fortune tellers, radios, auto & bike accessories, telescopes, magnifiers, compasses, banks, smokers' gadgets, artists' supplies, printing sets, engines, motors, shavers, knives, billfolds, cards, guns, rifles, sports, books, games, plants, etc. Send name, address & 10c to:  
**JOHNSON SMITH & CO., Dept. 859, Detroit 7, Michigan**

# LEARN MORSE CODE

**EASILY . . .  
QUICKLY . . .  
AT HOME!**

Here's the fastest, easiest way to learn Morse Code. Proven EYE-EAR method has already taught thousands successfully. Complete course includes 5 unbreakable 78 rpm double-faced records (10 lessons) in durable album, and instruction book. In a few days . . . you're an expert!

Sold at all leading radio distributors — or write us!  
**DEPT. PE-11. INSULINE CORP. OF AMERICA**  
 MANCHESTER, NEW HAMPSHIRE

## CORONA RADIO KITS

EASY TO BUILD • EDUCATIONAL • EXCELLENT RECEPTION

### BROADCAST SUPERHET KIT

# \$14.75

**ROCKET 115K**—Latest Single Band superhet circuit for ultimate in sensitive reception and tonal quality. Kit includes all necessary parts, punched chassis, attractive bakelite mahogany cabinet, built-in loop antenna, iron core IF's, big Alnico V spm.; tubes: 12SK7, 12SA7, 12SQ7, 50L6, 45Z5. Automatic vol. control, beam power output. Tunes 540 to 1700 Kc. Simple step-by-step instructions included.

Plaza 812K 2-Band AC-DC Super Kit . . . . . net \$20.75  
 Globemaster 814K 3-Band Super Kit . . . . . net \$24.75  
 All kits supplied less wire and solder. Please include 25¢ deposit with C.O.D. orders. Dept. P-7

**CORONA RADIO & TV CO.**  
 370 Broadway New York 13, N.Y.

## Get Your F. C. C. LICENSE Quickly!

**Correspondence or residence preparation for F.C.C. examinations. Results guaranteed.**

An FCC commercial operator license means greater opportunities and higher pay. We are specialists in preparing you, in a **MINIMUM OF TIME**, to pass FCC examinations for all classes of licenses. Beginners get 2nd class license in 5 weeks and 1st class in 3 additional weeks. Write for free booklet.

### GRANTHAM School of Electronics

Dept. 104A, 6064 Hollywood Blvd., Hollywood 28, Calif.

# INVENTORS

Send for  
**PATENT INFORMATION**  
 Book and  
**INVENTOR'S RECORD**  
 without obligation

**GUSTAVE MILLER**  
 114-PE WARNER BUILDING  
 WASHINGTON 4, D. C.

**REGISTERED PATENT ATTORNEY**  
 ASSOCIATE EXAMINER  
 U.S. PAT. OFF. 1922-1929

Patent Attorney & Advisor  
 U. S. NAVY DEPT. 1930-1947  
**PATENT LAWYER**

ing mother and young daughter." Result: amateur license suspended.

A more amusing example was that of a 15-year-old who was entertaining the town for a distance of 7 miles by playing records over a 15-watt transmitter. Here's how the FCC report reads:

"Verbal warning was given the 15-year-old operator in the presence of his father and was followed by appropriate warning to the youth's father who advised that the equipment is being dismantled to prevent any possibility of recurrence. An interesting sidelight in this case, and a further assurance that operation will not again occur, is the fact that the subject's father was an FCC employe during the last war."

The official report is silent on what the father said to the son, but it takes little imagination to figure it out! END

### MILLIONTH TRANSISTOR

**T**HE millionth germanium junction transistor produced at the Raytheon plant in Newton, Mass. was presented by the president of the firm, Charles F. Adams, Jr. to Gov. C. A. Herter of the Bay State.

Since the first of these components rolled off the line, the transistor has found hundreds of applications in fields ranging from hearing aids to telephone amplifiers.

New and interesting applications are being developed almost daily as more and more firms recognize the advantages of transistor circuitry.

Charles F. Adams, Jr. (left) presents Raytheon's millionth transistor to Gov. Christian A. Herter.





Basic equipment required: a hot plate, enamel container to hold chassis, lye, rubber hose for rinsing, wire, rod, and gloves.



Dip chassis in hot solution several times. Don't inhale fumes!

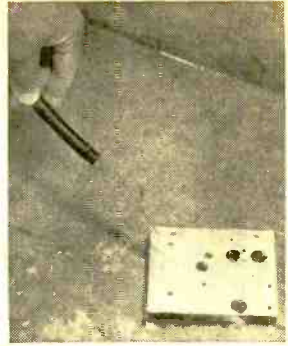

Rinse chassis thoroughly with clear water. Repeat the dipping and rinsing.

## A "Satin" Finish for Your Aluminum Chassis

YOU can add a "professional" touch to your equipment by giving a "satin" finish to your chassis. Use a solution of one part lye to ten parts of hot water, stirring with a wooden or glass rod. Use an enamel, iron, or glass container. Do not use aluminum. Suspend the chassis with a piece of iron wire and dip it into the solution.

Do all mixing and dipping out-of-doors or in a well-ventilated spot. Avoid contact with the lye or inhaling the fumes.

"Satin" finished chassis after dipping and rinsing (left) compared with unfinished unit (right).

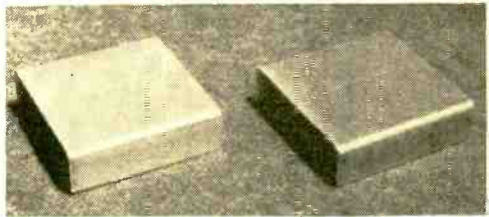

DESIGNED FOR

*Radio Control*

\* All parts die-cut or shaped for simple construction and easy assembly!  
\* Complete, easy-to-read step-by-step plans and instructions included! At your local hobby shop now!



**R.C. PIPER TRI-PACER**  
KIT FS-1—SPAN 58 3/4"  
Length 39 1/2"

**\$10.95**

for Class A, B, or C engines

... and a Cinch To Build

Actual photographs of models built from kits.

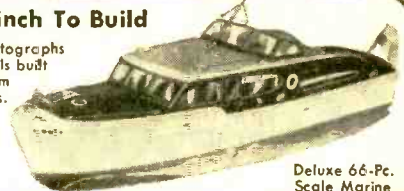

**CHRIS-CRAFT 50' CATALINA**  
Kit B-7M—Length 31 1/4" Beam 8 3/8"

**\$11.95**

(less scale marine fittings)

Deluxe 66-Pc. Scale Marine Fittings—Kit B-7F  
**\$4.95**

**STERLING MODELS**

Write for new '54 catalog featuring a complete line of model boats and plans—many designed for radio control. Send 10c in coin to Dept. PE 1

1530-34 N. Hancock St. Philadelphia 22, Pa.

## EASY! BUILD your own Professional Electronic Instruments with EICO KITS! SAVE 50%

• Complete easy-to-follow instructions

• Fully guaranteed

5" PUSH-PULL OSCILLOSCOPE



KIT \$44.95 WIRE \$79.95

VACUUM TUBE VOLTMETER



KIT \$25.95 WIRE \$39.95

1,000 Ohms/Volt MULTIMETER



KIT \$12.90 WIRE \$14.90

6V & 12V BATTERY ELIMINATOR & CHARGER



KIT \$29.95 WIRE \$38.95

Write now for FREE Catalog describing 38 EICO KITS.



ELECTRONIC INSTRUMENT CO., INC.  
84 Withers St., Brooklyn 11, N. Y.

# GLOSSARY

**a.g.c.**—Automatic gain control, control of the amplification of an amplifier so that its output is approximately constant in spite of variations in the input signal; especially such control in television receivers to reduce variations in picture contrast produced by variations in r.f. signal strength.

**a.v.c.**—Automatic volume control (a.g.c. used in radio receivers to reduce variations in sound volume produced by variations in r.f. signal strength).

**crystal**—1. Rectifying crystal, one which passes electric current more easily in one direction than in the other and thus can be used to change alternating current to pulsating direct current; made of such materials as germanium, silicon, copper oxide, galena, and carborundum. 2. Piezo-electric crystal, one which transforms mechanical energy to electrical and vice versa. Such crystals, made of Rochelle salt or barium titanate, are used in microphones and phonograph pickups. When cut to a certain size and shape, a piezo-electric crystal, usually made of quartz, can be used as a resonant circuit, to control the frequency of an oscillator or as a frequency-selective filter.

**decibel**—A measure of the ratio between two power levels or of a power level with respect to a designated reference level. Basically, the number of decibels is ten times the logarithm of a power ratio. One decibel is approximately the smallest difference in sound power which can be detected by the average human ear.

**db of feedback**—The number of decibels by which inverse feedback in an amplifier reduces its over-all gain and distortion.

**detector**—A circuit used to recover an audio or video signal from a modulated radio signal.

**elevator**—Control surface of an aircraft which regulates its pitch attitude (level, climbing, or diving).

**feedback**—Returning part of the output of an amplifier stage to the input of the same or a previous stage. Negative or inverse (out-of-phase) feedback decreases the gain and distortion of the amplifier; positive (in-phase) feedback increases gain and distortion and may produce oscillation.

**frequency response**—The relative ability of an amplifier, loudspeaker, or other device to respond to different frequencies.

**glow plug**—A type of internal-combustion engine used in models, in which starting is assisted by a filament in the combustion chamber, which is energized by an external battery.

**harmonic distortion**—Distortion consisting of addition of components to the signal whose frequencies are multiples (harmonics) of the original signal frequency. It is produced by an amplifier or other device which is nonlinear (does not give the same ratio of output to input for all input amplitudes).

**heterodyne**—A difference frequency (beat) produced by combining two frequencies.

**Immelmann turn**—A maneuver in which an airplane is made to complete half of a loop and then rolled half of a complete turn. (Named after Max Immelmann, World War I German aviator.)

**microammeter**—A meter for the measurement of current flow, which is calibrated in microamperes, or millionths of an ampere.

**milliampere**—One-thousandth of an ampere.

**modulated**—Varied in amplitude, frequency, or some other quality. Radio-frequency signals are modulated in order to carry signals of lower frequency, such as sound or picture signals.

**multitester**—A meter which is a combination of a voltmeter, an ohmmeter, and (often) an ammeter.

**oscillator**—A vacuum-tube or transistor circuit or other device which produces an alternating-current power output without mechanical rotation.

**plate dissipation**—The part of the power applied to the plate circuit of a vacuum tube which does not appear as signal output, but is dissipated as heat in the plate of the tube.

**push-pull**—An arrangement of two vacuum tubes in an amplifier so that the input signal is applied in opposite phases to the two tubes and the signal outputs are combined in phase. This arrangement reduces even-harmonic distortion.

**regeneration**—Positive feedback in detectors and amplifiers. Increases gain and distortion and may produce oscillation.

**saturate**—To reach the maximum possible value of some quantity, such as magnetization in the core of an inductor or current flow in a vacuum tube from cathode to plate.

**servo-motor**—A special electric, hydraulic, or other type of motor used in control apparatus to convert a small movement into one of greater amplitude or greater force.

**superheterodyne**—A receiver in which all incoming radio-frequency signals are mixed with the output of an oscillator to produce a heterodyne or beat frequency. The oscillator frequency is variable so that the beat produced with any desired signal can be adjusted to a certain frequency. The beat-frequency signal is fed to a fixed-frequency (intermediate-frequency) amplifier, where greater and more uniform gain and selectivity can be obtained than at the original radio frequency.

**superregenerative**—A type of regenerative detector in which the tendency to oscillation is controlled by a quenching voltage of ultrasonic frequency which periodically allows the gain to increase, then reduces it. The quenching voltage can be produced by the detector tube itself or by a separate oscillator. This type of detector has great sensitivity, but poor selectivity.

**transconductance**—A characteristic of a vacuum tube which indicates the effectiveness of the grid in controlling the plate current and the all-around effectiveness of the tube as an amplifier.

**v.t.v.m.**—Vacuum-tube voltmeter, a voltmeter using one or more vacuum tubes to increase the sensitivity of the basic meter movement, so that measurements can be made in a circuit without drawing much current and without disturbing very much the normal operating conditions of the circuit. May also be a combination voltmeter, ohmmeter, and ammeter.

# INDEX OF Advertisers

## INDEX OF

ADVERTISER	PAGE NO.
Airex Radio Corp.	123
Allied Radio Corp.	97
Ashe Radio Co.	7
Better Values Co.	130
Blan	119
Burstein-Applebee Co.	119
Business Information Corp.	112
Century Electronics Corp.	112
Concord Radio	105
Control Research	119
Corona Radio & T.V. Co.	124
Electro-Voice	8
Electronic Instrument Co., Inc. (EICO)	125
ESSCO	118
G & H Woods Products Co.	4th Cover
General Electronic Inst. Company	127
Grantham School of Electronics	124
Gyro Electronics	121
Harjo Sales Co.	95
Heath Company	86, 87, 88, 89
Insuline Corp.	124
International Correspondence Schools	7
Karlson Associates	118
La Salle Extension University	127
Linguaphone Institute	121
Miller, Gustave	124
Moss Electronic Distributing Co., Inc.	127
National Radio Institute	3
National Schools	3rd Cover
New York Institute of Photography	112
Popular Electronics	98
Progressive "Edu-Kits," Inc.	117
Radio-Television Training Association	9
Rad-Tel Tube Co.	10
Raytheon Manufacturing Co.	6
Rex Radio Supply	123
Richville TV Supply	100
John F. Rider Publisher Inc.	103
Rinehart & Co., Inc.	101
Rockbar Corp.	109
Scott-Mitchell House, Inc.	100
The Shaler Co.	95
Smith Johnson & Co.	123
Soundtronics Labs.	127
Sprayberry Academy of Radio	5
Sterling Models	125
Steve-El Electronics Corp.	102
Telecommander	93
Teltron Electric Company	115
Terado Company	107
Transi-Mite Radio Lab.	121
Utilities Engineering Institute	123
Ward Products Corp. Div. The Gabriel Co.	102
World Radio Laboratories	111

### ADDENDUM

It has been called to our attention that the "Home-Built Loudspeaker Enclosure," covered on page 34 of our October issue, is now being built commercially by University Loudspeakers, Inc.

### CHECK YOUR KNOWLEDGE

(Answers to Quiz on page 99)

1. b                      2. b                      3. c  
4. c                      5. c

### HOW SMART ARE YOU?

(Answers to Quiz on page 104)

1. b                      3. d                      5. a                      7. b                      9. b  
2. d                      4. b                      6. b                      8. c                      10. a

### THE NEW MODEL TV-11

# TUBE TESTER



#### SPECIFICATIONS

- Uses the new self-cleaning Lever Action Switches for individual element testing.
- Because all elements are numbered according to pin-number in the RMA base numbering system, the user can instantly identify which element is under test. Tubes having tapped filaments and tubes with filaments terminating in more than one pin are truly tested with the Model TV-11 as any of the pins may be placed in the neutral position when necessary.

• The Model TV-11 does not use any combination type sockets. Instead individual sockets are used for each type of tube. Thus it is impossible to damage a tube by inserting it in the wrong socket.

• Free-moving built-in roll chart provides complete data for all tubes.

• Phono Jack on front panel for plugging in either phono or external amplifier will detect microphonic tubes or noise due to faulty elements and loose external connections.

Operates on 105-130 Volt 60 Cycles \$47.50  
A.C. Hand-rubbed oak cabinet  
complete with portable cover.

**SHIPPED ON APPROVAL  
NO MONEY WITH ORDER—NO C.O.D.**

Try it for 10 days before you buy. If completely satisfied send \$11.50 and pay balance at rate of \$6.00 per month for 6 months—No Interest or Carrying Charges Added. If not completely satisfied, return to us, no explanation necessary.

MOSS ELECTRONIC DISTRIBUTING CO., INC.

Dept. D-75, 3849 Tenth Ave., New York 34, N. Y.

Please rush 1 Model TV-11. I agree to pay \$11.50 within 10 days after receipt and \$6.00 per month thereafter.

Name .....

Address .....

City..... Zone..... State.....

# ACCOUNTANT

BECOME AN EXPERT

### SEND FOR FREE SAMPLE LESSON

Executive Accountants and C. P. A.'s earn \$4,000 to \$10,000 a year. Thousands of firms need them. We train you thoroughly at home in spare time for C. P. A.'s examinations or executive accounting positions. Previous experience unnecessary. Personal training under supervision of staff of C. P. A.'s Placement counsel. Write for free book, "Accountancy, the Profession That Pays," and sample lesson.

LASALLE Extension University, 417 So. Dearborn St.  
A Correspondence Institution Dept. H-824, Chicago 5, Ill.

## ELECTRONICS FOR EXPERIMENTERS

- Rectifiers @ 29c ea. Transformers @ \$1.50 ea.  
Controls @ 29c ea. Bulbs @ 2c ea.  
Switches @ 6c ea. Motors @ \$1.79 ea.  
Automatic Steppers @ \$1.75 ea.

Send 10c for giant 16 page catalog listing hundreds of surplus bargains for experimenters.

### SOUNDTRONICS LABS Dept. P.E.

632 Arch Street Philadelphia 6, Pa.

## FACTORY REPAIRS

on All Makes and Types of

# TEST EQUIPMENT

Write For Big New Free Catalogue

GENERAL ELECTRONIC INST. COMPANY

Dept. PE 98 Park Place N. Y. 7, N. Y.

## RESISTOR COLOR CODE

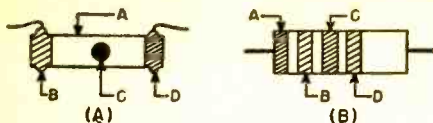

RETMA COLOR CODE CHART

COLOR	VALUE	MULTIPLIER
Black	0	1
Brown	1	10
Red	2	100
Orange	3	1000
Yellow	4	10,000
Green	5	100,000
Blue	6	1,000,000
Violet	7	10,000,000
Grey	8	100,000,000
White	9	1,000,000,000

### TOLERANCE CODE

Gold—±5%	Silver—±10%
No Color—±20%	

The ohmic value of a resistor can be determined by means of the color code. There are two standard methods of indicating this value.

In Fig. A, the body (A) and end (B) indicate the first and second digits of the value while the dot (C) indicates the multiplier to be used. The tolerance of the unit is indicated by the end color (D). For example, if the body (A) is green the number is 5; if the end (B) is grey the second number is 8. If the dot (C) is red the multiplier is 100 or two zeros should be added. The resistor is then a 5800 ohm unit. If the end (D) has no color, the tolerance is ±20%.

In Fig. B, the first two stripes indicate the first two digits; the third stripe the multiplier; the fourth stripe the tolerance. Thus, if stripe (A) is green, (B) is grey, (C) is red, and (D) is silver, the resistor is a 5800 ohm, ±10% unit.

## CAPACITOR COLOR CODE

MOLDED PAPER			MOLDED MICA		CERAMIC	
Color	Multiplier	Tolerance	Multiplier	Tolerance	Multiplier	Tolerance
Black	1	20%	1	20%	1	20% or 2.0 $\mu$ fd.*
Brown	10		10		10	1%
Red	100		100	2%	100	2%
Orange	1000		1000	3% (RETMA)	1000	2.5% (RETMA)
Yellow	10,000	5%	10,000		10,000	
Green				5% (RETMA)		5% or 0.5 $\mu$ fd.*
Blue						
Violet						
Gray					0.01	0.25 $\mu$ fd.*
White		10%			0.1	10% or 1.0 $\mu$ fd.*
Gold	0.1	5%	0.1	5% (JAN)		
Silver		10%	0.01	10%		
None		20%				





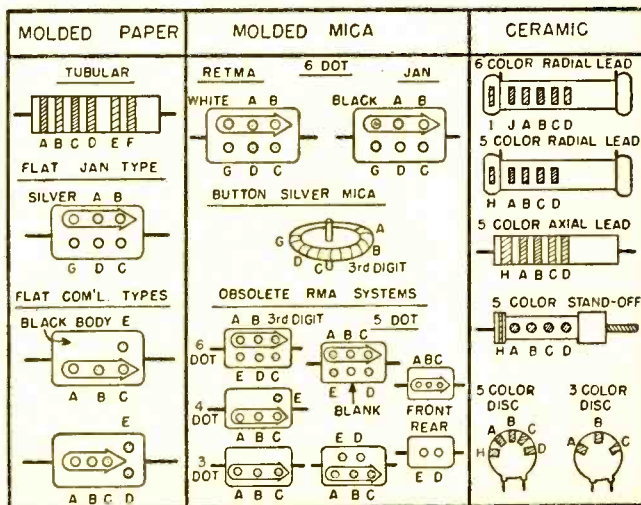



























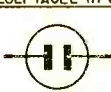











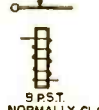
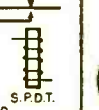























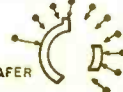

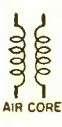

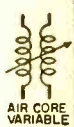



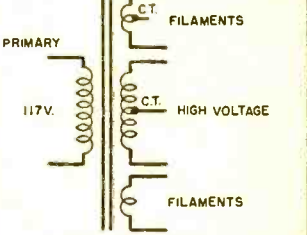

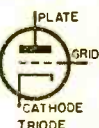
\*Capacitance less than 10 $\mu$ fd.

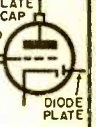
Capacitance is given in  $\mu$ fd. Colors have same values as on resistors, except as indicated in tables. Colors (A) and (B) are for first two digits; (C) is for multiplier. (D) is for tolerance. (E) and (F) give voltage rating in hundreds of volts; (E) is used only for ratings less than 1000 volts, (E) and (F) for first two digits of ratings 1000 volts or more. Values of colors for (E) and (F) are same as in resistance values. (G) is class or characteristic of capacitor, (H), (I), and (J) give temperature coefficient. (G), (H), (I), and (J) are not listed in the tables, since this information is seldom needed by the average home builder.





# STANDARDIZED WIRING DIAGRAM SYMBOLS

<p style="text-align: center;"><b>ANTENNAS</b></p>  <p style="text-align: center;">GENERAL</p>  <p style="text-align: center;">DIPOLE</p>  <p style="text-align: center;">LOOP</p>  <p style="text-align: center;">FERRITE TYPE</p>	<p style="text-align: center;"><b>MICROPHONE</b></p> <p>SINGLE BUTTON    DOUBLE BUTTON    CAPACITOR</p>  <p style="text-align: center;">DYNAMIC</p>  <p style="text-align: center;">VELOCITY</p>  <p style="text-align: center;">CRYSTAL</p>	<p style="text-align: center;"><b>TELEGRAPH KEY</b></p> 
<p style="text-align: center;"><b>BATTERIES</b></p>  <p style="text-align: center;">SINGLE-CELL</p>  <p style="text-align: center;">MULTI-CELL</p>	<p style="text-align: center;"><b>NEON BULB</b></p> 	<p style="text-align: center;"><b>PILOT LIGHT</b></p> 
<p style="text-align: center;"><b>BELL</b></p> 	<p style="text-align: center;"><b>PHONO PICKUPS</b></p>  <p style="text-align: center;">CRYSTAL</p>  <p style="text-align: center;">MAGNETIC</p>	
<p style="text-align: center;"><b>BUZZER</b></p> 	<p style="text-align: center;"><b>PLUG OR SOCKET</b></p> 	
<p style="text-align: center;"><b>CAPACITORS</b></p>  <p style="text-align: center;">FIXED MICA OR PAPER</p>  <p style="text-align: center;">ELECTROLYTIC</p>  <p style="text-align: center;">VARIABLE CAPACITORS GANGED</p>  <p style="text-align: center;">TRIMMER OR PADDER</p>  <p style="text-align: center;">SPLIT-STATOR</p>  <p style="text-align: center;">FEED-THRU</p> <p style="text-align: center;">T-DESIGNATES TRIMMER OR PADDER</p>	<p style="text-align: center;"><b>RECEPTACLE 117V.</b></p> 	<p style="text-align: center;"><b>RECORDING HEAD</b></p>  <p style="text-align: center;">MAGNETIC</p>
<p style="text-align: center;"><b>COILS</b></p>  <p style="text-align: center;">FIXED R.F. COIL</p>  <p style="text-align: center;">COIL WITH FIXED TAP</p>  <p style="text-align: center;">COIL WITH VARIABLE TAP</p>  <p style="text-align: center;">IRON CORE OR CHOKE</p>  <p style="text-align: center;">BIFILAR</p>  <p style="text-align: center;">VARIABLE COIL OR CHOKE</p>  <p style="text-align: center;">SLUG-TUNED COIL</p>	<p style="text-align: center;"><b>RECTIFIER</b></p>  <p style="text-align: center;">SELENIUM TYPE</p>	
<p style="text-align: center;"><b>CRYSTALS</b></p>  <p style="text-align: center;">CRYSTAL DETECTOR</p>  <p style="text-align: center;">PIEZOELECTRIC CRYSTAL</p>	<p style="text-align: center;"><b>RELAYS</b></p>  <p style="text-align: center;">S.P.S.T. NORMALLY OPEN</p>  <p style="text-align: center;">S.P.S.T. NORMALLY CLOSED</p>  <p style="text-align: center;">S.P.D.T.</p>	
<p style="text-align: center;"><b>FUSE</b></p> 	<p style="text-align: center;"><b>RESISTORS</b></p>  <p style="text-align: center;">GENERAL</p>  <p style="text-align: center;">TAPPED OR ADJUSTABLE</p>  <p style="text-align: center;">POTENTIOMETER OR RHEOSTAT</p>  <p style="text-align: center;">CONTINUOUSLY VARIABLE</p>	
<p style="text-align: center;"><b>GROUNDS</b></p>  <p style="text-align: center;">WIRING</p>  <p style="text-align: center;">CHASSIS</p>	<p style="text-align: center;"><b>SHIELDING</b></p>  <p style="text-align: center;">DOTTED LINES INDICATE SHIELDING. COULD BE AROUND ANY COMPONENT OR GROUPS</p>	
<p style="text-align: center;"><b>HEADPHONES</b></p>  <p style="text-align: center;">DOUBLE</p>  <p style="text-align: center;">SINGLE</p>	<p style="text-align: center;"><b>SPEAKERS</b></p>  <p style="text-align: center;">P.M.</p>  <p style="text-align: center;">ELECTRO-MAGNETIC</p>	
<p style="text-align: center;"><b>JACKS</b></p>  <p style="text-align: center;">2 CIRCUIT</p>  <p style="text-align: center;">3 CIRCUIT</p>  <p style="text-align: center;">CLOSED CIRCUIT</p>  <p style="text-align: center;">PHONE PLUG</p>  <p style="text-align: center;">PIN PLUG</p>  <p style="text-align: center;">PIN JACK</p>	<p style="text-align: center;"><b>SWITCHES</b></p>  <p style="text-align: center;">S.P.S.T.</p>  <p style="text-align: center;">S.P.D.T.</p>  <p style="text-align: center;">PUSH-BUTTON</p>  <p style="text-align: center;">D.P.S.T.</p>  <p style="text-align: center;">D.P.D.T.</p> <p style="text-align: center;">BOTH TYPES GANGED</p>  <p style="text-align: center;">ROTARY TYPE S.P.S.P.</p>  <p style="text-align: center;">WAFER</p>	
<p style="text-align: center;"><b>METER</b></p> 	<p style="text-align: center;"><b>MOTOR</b></p> 	
<p style="text-align: center;"><b>TRANSFORMERS</b></p>  <p style="text-align: center;">AIR CORE</p>  <p style="text-align: center;">IRON CORE</p>  <p style="text-align: center;">AIR CORE VARIABLE</p>  <p style="text-align: center;">IRON CORE VARIABLE</p>  <p style="text-align: center;">POWDERED IRON CORE</p>  <p style="text-align: center;">AUTO</p>	<p style="text-align: center;"><b>POWER TRANSFORMER</b></p>  <p style="text-align: center;">PRIMARY 117V.    FILAMENTS    C.T. HIGH VOLTAGE    FILAMENTS</p>	
<p style="text-align: center;"><b>TUBES</b></p>  <p style="text-align: center;">DIODE</p>  <p style="text-align: center;">TRIODE</p>  <p style="text-align: center;">TETRODE</p>  <p style="text-align: center;">PENTODE</p>  <p style="text-align: center;">DIODE PLATE</p>  <p style="text-align: center;">DUO TRIODE</p>  <p style="text-align: center;">COLD CATHODE</p>  <p style="text-align: center;">PHOTO-ELECTRIC</p>		
<p style="text-align: center;"><b>TRANSISTOR (JUNCTION)</b></p>  <p style="text-align: center;">BASE    COLLECTOR    EMITTER</p> <p style="text-align: center;">P-N-P TYPE N-P-N TYPE SAME SYMBOL EXCEPT ARROW IS REVERSED</p>		
<p style="text-align: center;"><b>VIBRATOR</b></p> 		<p style="text-align: center;"><b>WIRES</b></p>  <p style="text-align: center;">CONNECTION</p>  <p style="text-align: center;">NO CONNECTION</p>

# Classified

## FOR SALE

**DIAGRAMS:** Professional Model Timers, Counters, Intercoms, Organs, etc. \$1.00 each. List Free. Parks, 103 S. E. 57th Ave., Portland 15, Oregon.

## INSTRUCTION

**AUCTIONEERING** Home Study Course. Diploma granted. Auction School, Ft. Smith, Ark.

**F.C.C. Operator**, license, quickly. Grantham, 6064-E, Hollywood Blvd., Hollywood, California.

## BUSINESS OPPORTUNITIES

**MONEYMAKING** opportunities galore! Free copy. Popular Mechanics Classified, 205-EP, East Ontario, Chicago 11.

**WOMEN** wanted to sew ready-cut neckties at home. No selling. No machine necessary. No experience needed. Details Free: Fashion Ties, P. O. Box 2066-E, Inglewood 4, California.

## INVENTIONS WANTED

**INVENTIONS** wanted. Patented; unpatented. Global Marketing Service, 1404 Mitchell, Oakland 1, Calif.

**INVENTIONS** wanted. Patented and unpatented. Free particulars. Invention Records, and advice. America's foremost promotion service. Superior Inventions Agency, 340-342 North Rodeo, Beverly Hills, Calif.

## MISCELLANEOUS

**FREE "Do-It-Yourself"** Leathercraft Catalog. Tandy Leather Company, Box 791-J6, Fort Worth, Texas.

**DETECTIVES**—Experience unnecessary. Detective Particulars free. Write, Wargner, 125 W. 86th, N. Y.

**"X-RAY Mind."** Dangerous power over others. (Details—10c.) Krishnar Institute, Box 842-S8, Escondido, Calif.

**LORENZ** One Tube Receiver—complete kit all parts exactly as specified; wound coil, RFC, condensers, resistors, hardware, etc., less relay and tube \$3.75. RK61 \$3.30. Sigma 26F \$8.95. Sigma 5F \$5.95. New Free Illustrated Catalog. Ace Radio Control, Box 301, Higginsville, Mo.

**TUBES**—TV, Radio, Transmitting, Special Purpose Types. Bought, Sold, Exchanged. Send Details B. N. Gensler W2LNI, 136 Liberty St., New York, N. Y.

## IT WILL PAY YOU

to read and answer the ads in this section or to place your own ad at these thrifty rates.

35c per word—minimum 10 words

# Hit Parade RECORDS!

## 18 SONGS \$2.98

Now! 6 complete hits on 1 break-resistant standard speed 78 or 45 R.P.M. record.

**MONEY BACK GUARANTEE**  
**MAKE WONDERFUL GIFTS**  
**ORDER NOW!**

### 18 HIT PARADE SONGS by DEAN MARTIN and OTHERS only \$2.98

- |  |                                      |
|--|--------------------------------------|
| 1. Rock of Ages                        | 11. Stormy Waters                    |
| 2. Beautiful Isle                      | 12. Glory Land March                 |
| 3. When They Ring Those Golden Bells   | 13. Just A Closer Walk With Thee     |
| 4. My Friend                           | 14. I Can't Help What Others Do      |
| 5. As Life of a Flower                 | 15. I Know Who Holds Tomorrow        |
| 6. The Touch of God's Hands            | 16. Mansion Over The Hilltop         |
| 7. Invisible Hands                     | 17. The Family Who Prays             |
| 8. Let The Spirit Descend              | 18. Too Much Smiling                 |
| 9. Home of The Soul                    | 19. Supper Time                      |
| 10. A Pretty Wreath For Mother's Grave | 20. The Lord Will Make A Way Somehow |

### 20 COUNTRY HYMNS—ONLY \$2.98

- |                                   |                                 |
|-----------------------------------|---------------------------------|
| 1. Cinnamon Stinner               | 10. What A Dream                |
| 2. This Ole House                 | 11. I'm A Fool To Care          |
| 3. Skoklan                        | 12. Little Things Mean A Lot    |
| 4. Sh-Boom                        | 13. Three Coins In The Fountain |
| 5. The Little Shoemaker           | 14. Dream                       |
| 6. The High and The Mighty        | 15. I Cried                     |
| 7. Hey There                      | 16. Oh! Marie                   |
| 8. In The Chapel In The Moonlight | 17. I Need You Now              |
| 9. They Were Both The Mambo       | 18. Hernando's Hideaway         |

### 20 HILLBILLY HITS only \$2.98

- |                                      |                           |
|--------------------------------------|---------------------------|
| 1. Hep Cat Baby                      | 10. Sparkling Brown Eyes  |
| 2. You Can't Have My Love            | 11. Even Tho              |
| 3. Place For Girls Like You          | 12. Go Boy Go             |
| 4. This Is The Thanks I Get          | 13. Looking Back          |
| 5. What's Ch Gonna Do Now            | 14. To See                |
| 6. Don't Drop It Out Behind The Barn | 15. Courtin In The Rain   |
| 7. Goodnight Sweetheart, Goodnight   | 16. My New Love Affair    |
| 8. I Don't Hurt Anymore              | 17. One By One            |
|                                      | 18. Cry Cry Darling       |
|                                      | 19. Honky Tunk Girl       |
|                                      | 20. Thank You For Calling |

### 18 CHRISTMAS SONGS—\$2.98

- |                                     |                                      |
|-------------------------------------|--------------------------------------|
| 1. Sleigh Bells                     | 11. 'Twas the Night Before Christmas |
| 2. Jingle Bells                     | 12. Let It Snow                      |
| 3. White Christmas                  | 13. Santa Claus Is Coming to Town    |
| 4. I'll Be Home For Christmas       | 14. Frosty the Snowman               |
| 5. Silent Night                     | 15. You're All I Want for Christmas  |
| 6. Adeste Fideles                   | 16. Silver Bells                     |
| 7. Winter Wonderland                | 17. Rudolph the Red Nosed Reindeer   |
| 8. Happy Holiday                    | 18. Christmas Island                 |
| 9. All I Want For Christmas         |                                      |
| 10. I Saw Mommy Kissing Santa Claus |                                      |

### 18 MAMBO SONGS—\$2.98

- By Joe Loco, Tito Puente & Tito Rodriguez
- |                     |                       |
|---------------------|-----------------------|
| 1. Aprieta El Pollo | 11. Quero Na Ma       |
| 2. No Cuentes       | 12. Besos De Caramelo |
| 3. Mambolero        | 13. Quilo El Bon Bon  |
| 4. El Campanero     | 14. Mambo Neuva       |
| 5. Tu Plato         | 15. Choroppine        |
| 6. Sagueboroco      | 16. Sans Souci        |
| 7. Esy              | 17. Rumba             |
| 8. El Mambo Hop     | 18. Solos Tu Y Yo     |
| 9. Yumbambe         |                       |
| 10. El Nuevo Mambo  | 18. En Bolondron      |

### 46 CHILDREN'S SONGS, illustrated with words and music—\$2.98

- |   |                            |
|---|----------------------------|
| 1. Twinkle, Twinkle Little Star           | 9. Lazy Mary               |
| 2. Old King Cole                          | 10. A Tisket A Tasket      |
| 3. Little Tommy Tucker                    | 11. Old MacDonald          |
| 4. Jack & Jill                            | 12. Farmer in the Dell     |
| 5. Pease Porridge Hot                     | 13. Baa Baa Black Sheep    |
| 6. Where, Oh Where Has My Little Dog Gone | 14. Pop Goes the Weasel    |
| 7. Humpty Dumpty                          | 15. Three Blind Mice       |
| 8. London Bridge                          | 16. Mary Had a Little Lamb |

Plus 30 other most popular songs and book of illustrations with words and music.

### 12 SQUARE DANCES & BOOK—\$2.98

You get 12 Square Dance Songs by Hap Williams and others plus Gift Book "Square Dancing" for \$2.98

- |                   |                         |
|-------------------|-------------------------|
| 1. Mockin' Bird   | 8. Golden Slipper       |
| 2. Top Eared Mule | 9. Red River Valley     |
| 3. Buffalo Gal    | 10. Arkansas Traveler   |
| 4. Oh, Susanna    | 11. Little Brown Jug    |
| 5. Soldier's Joy  | 12. Turkey in the Straw |
| 6. Devil's Dream  |                         |
| 7. Chicken Reel   |                         |

PLUS BOOK:  78 RPM  45 RPM  
"Square Dancing For Young And Old"

**NOTE: ALL RECORDS ARE HI-FI QUALITY!**

**Mail No Risk Coupon Today**  
**BETTER VALUES CO., Dept. 487**

318 Market St.  
Newark, New Jersey

- |                          |   |
|--------------------------|---|
| <input type="checkbox"/> | I enclose \$2.98. Send the 18 Hit Parade Songs.       |
| <input type="checkbox"/> | I enclose \$2.98. Send the 18 Hillbilly Songs.        |
| <input type="checkbox"/> | I enclose \$2.98. Send the 20 Country Hymns.          |
| <input type="checkbox"/> | I enclose \$2.98. Send the 18 Christmas Songs.        |
| <input type="checkbox"/> | I enclose \$2.98. Send the 46 Children's Songs.       |
| <input type="checkbox"/> | I enclose \$2.98. Send the 18 Mambos.                 |
| <input type="checkbox"/> | I enclose \$2.98. Send the 12 Square Dances and Book. |

Name .....

Address .....

City ..... Zone ..... State .....

**SOLD ON MONEY-BACK GUARANTEE!**

# ADVANCE! Raise your earning power—learn RADIO-TELEVISION-ELECTRONICS by SHOP-METHOD HOME TRAINING

## GOOD JOBS AWAIT THE TRAINED RADIO-TV TECHNICIAN

There is a place for you in the great Radio-Television-Electronics industry when you are trained as National Schools will train you at home!

Trained technicians are in growing demand at good pay—in manufacturing, broadcasting, television, communications, radar, research laboratories, home Radio-TV service, and other branches of the field. National Schools Master Shop-Method Home Training, with newly added lessons and equipment, trains you in your spare time, right in your own home, for these fascinating opportunities. OUR METHOD IS PROVED BY THE SUCCESS OF NATIONAL SCHOOLS TRAINED MEN, ALL OVER THE WORLD, SINCE 1905.

## EARN WHILE YOU LEARN

Many National students pay for all or part of their training with spare time earnings. We'll show you how you can do the same! Early in your training, you receive "Spare-time Work" Lessons which will enable you to earn extra money servicing neighbors' and friends' Radio and Television receivers, appliances, etc.

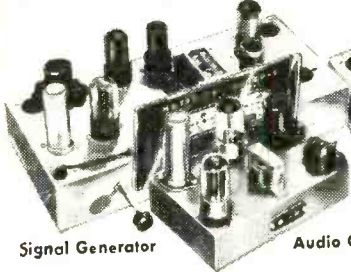

Signal Generator

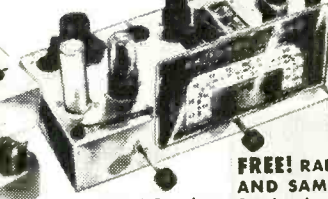

T. R. F. Receiver

Audio Oscillator

## National Schools Training is All-Embracing

National Schools prepares you for your choice of many job opportunities. Thousands of home, portable, and auto radios are being sold daily—more than ever before. Television is sweeping the country, too. Co-axial cables are now bringing Television to more cities, towns, and farms every day! National Schools' complete training program qualifies you in all fields. Read this partial list of opportunities for trained technicians:

- Business of Your Own • Broadcasting
- Radio Manufacturing, Sales, Service • Telecasting
- Television Manufacturing, Sales, Service
- Laboratories: Installation, Maintenance of Electronic Equipment
- Electrolysis, Call Systems
- Garages: Auto Radio Sales, Service
- Sound Systems and Telephone Companies, Engineering Firms
- Theatre Sound Systems, Police Radio
- And scores of other good jobs in many related fields.

## TELEVISION TRAINING

You get a complete series of up-to-the-minute lessons covering all phases of repairing, servicing and construction. The same lesson texts used by resident students in our modern and complete Television broadcast studios, laboratories and classrooms!



## MASTER ALL PHASES!

Get Master Shop-Method Home Training from an Established Practical Resident School with its own Training with almost 50 Years of Successful Experience in Training Ambitious Men.

We Bring National Schools To You!



You also receive this Multitester

Superheterodyne Receiver

## LEARN BY DOING

You receive and keep all the modern equipment shown above, including tubes and valuable, professional quality Multitester. No extra charges.

## FREE! RADIO-TV BOOK AND SAMPLE LESSON!

Send today for National Schools' new, illustrated Book of Opportunity in Radio-Television-Electronics, and an actual Sample Lesson. No cost—no obligation. Use the coupon now—we'll answer by return airmail.

APPROVED FOR VETERANS AND NON-VETERANS Check coupon below

Both Resident and Home Study Courses Offered!



## NATIONAL SCHOOLS

LOS ANGELES 37, CALIFORNIA • ESTABLISHED 1905  
IN CANADA: 811 W. HASTINGS STREET, VANCOUVER, B.C.

## GET FACTS FASTEST! MAIL TO OFFICE NEAREST YOU!

(mail in envelope or paste on postal card)  
NATIONAL SCHOOLS, Dept. R2G-114  
4000 S. Figueroa Street Los Angeles 37, Calif. or 323 West Polk Street Chicago 7, Ill.  
Send FREE Radio-TV Electronics book and FREE sample lesson. No obligation, no salesman will call.

NAME \_\_\_\_\_ BIRTHDAY \_\_\_\_\_ 19 \_\_\_\_  
ADDRESS \_\_\_\_\_  
CITY \_\_\_\_\_ ZONE \_\_\_\_\_ STATE \_\_\_\_\_  
 Check here if interested in Resident School Training at Los Angeles. VETERANS: Give Date of Discharge

# BUILD YOUR OWN HIGH FIDELITY CABINETS AND ENCLOSURES

by **Cabinart**

With a cabinet kit by CABINART you get exactly the style that you want. The finish is up to you. You get top-quality white pine or birch—perfect for any finish that you select. And so easy to put together . . . all you need is a screwdriver.

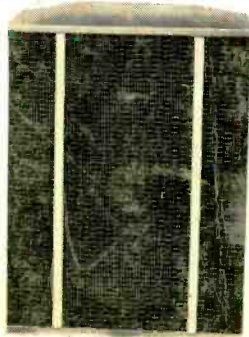

## Paul Klipsch-designed Rebel IV

You can now build your own corner horn speaker enclosure . . . designed by Paul Klipsch. Identical in acoustic design to assembled units and easily put together with a minimum of tools. Priced for the home-builder in unfinished birch.

12" model . . . **36.00** net\*  
15" model . . . **42.00** net\*



## Bass Reflex and Equipment Cabinets

The ideal housing for high fidelity components . . . removable panels make future changes easier. Loudspeaker cabinet acoustically designed for either 12" or 15" speaker. Overall dimensions: 33½" H., 23" W., 16" D. Tuner compartment: 20" H., 21¼" W. (inside dimensions), 15¼" D. Baffle volume: 6 cu. ft.

Model 80—Equipment cabinet kit . . . **27.00** net\*  
Model 8112—12" speaker cabinet kit . . . **18.00** net\*  
Model 8115—15" speaker cabinet kit . . . **18.00** net\*

All kits include ¾" white pine cut to size, baffle pre-cut for 12" or 15" speaker, Saran plastic acoustic cloth, Kimsul acoustic insulation, assembly and finishing instructions, hardware, plastic wood, sandpaper and glue.

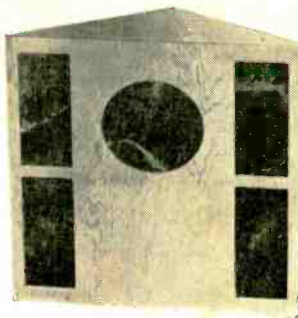

## Corner Folded Horn Enclosures

Reproduces a quality of bass heretofore only possible through the use of far more expensive designs.

Model 61 **19.95**  
(12" speaker kit) net\*  
Model 63 **23.95**  
(15" speaker kit) net\*

\*prices higher west and south.

Write for free catalog and name of nearest distributor

G & H WOOD PRODUCTS COMPANY • 75 NORTH 11th ST., BROOKLYN 11, N. Y.