

# POPULAR ELECTRONICS

OCTOBER  
1954

AMC

1st  
ISSUE

25  
CENTS

In U.S. and Canada

RADIO • TV • R/C • HI-FI • ELECTRONICS



- RADIO CONTROL OF MODELS
- FUN WITH NEON BULBS
- KITS OF THE MONTH
- SO YOU WANT TO BE A HAM

## CONSTRUCTION DETAILS ON—

- Capacity-Operated Relay
- Light Meter
- Speaker Cabinet
- Code Practice Set
- Crystal Receiver
- Electronic Fire Alarm

# HOBBY HOBNOB

ED, HOW DID YOU GET STARTED IN THE RADIO HOBBY?

I ANSWERED A *Walter Ashe* AD AND GOT THEIR **FREE** CATALOG. IT'S CRAMMED FULL OF SWELL RADIO AND TV KITS AND EQUIPMENT.

THIS LITTLE RADIO KIT IS OUT OF THE CATALOG. PUTTING IT TOGETHER IS FUN AND IT'S EASY!

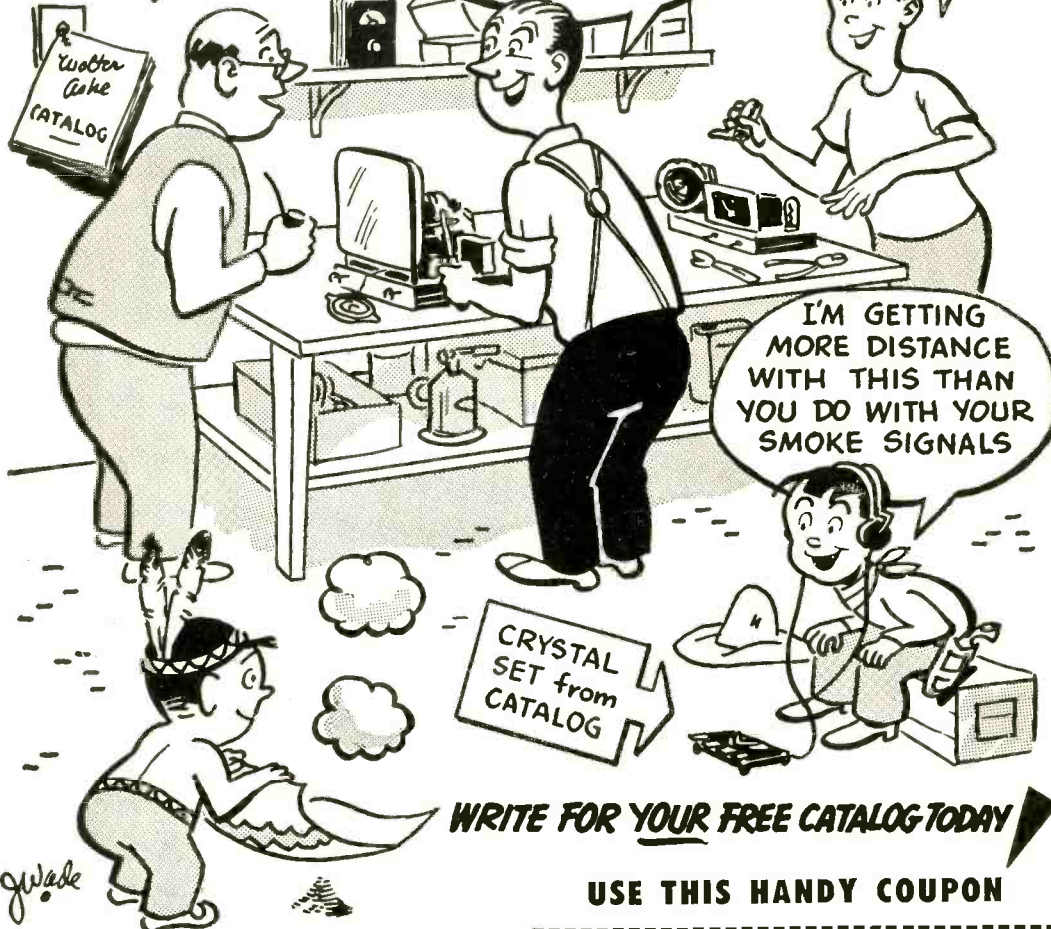

I'M GETTING MORE DISTANCE WITH THIS THAN YOU DO WITH YOUR SMOKE SIGNALS

CRYSTAL SET from CATALOG

**WRITE FOR YOUR FREE CATALOG TODAY**

**USE THIS HANDY COUPON**

All prices F. O. B. St. Louis • Phone CHestnut 1-1125

**Walter Ashe**  
**RADIO CO.**  
 1125 PINE ST. • ST. LOUIS 1, MO.

Walter Ashe Radio Co. PE-10-54  
 1125 Pine St., St. Louis 1, Mo.  
 "Please rush latest catalog"  
 Name \_\_\_\_\_  
 Address \_\_\_\_\_  
 City \_\_\_\_\_ Zone \_\_\_\_\_ State \_\_\_\_\_



# I WILL TRAIN YOU AT HOME FOR GOOD PAY JOBS IN RADIO-TELEVISION

J. E. SMITH has trained more men for Radio-Television than any other man. OUR 40th YEAR.

**America's Fast Growing Industry Offers You Good Pay—Bright Future—Security**

## I TRAINED THESE MEN



"Started to repair sets six months after enrolling. Earned \$12 to \$15 a week in spare time."—Adam Kramlik, Jr., Sunnyside, Pennsylvania.

"Up to our necks in Radio-Television work. Four other NRI men work here. Am happy with my work."—Gen Peterson, Bradford, Ont., Canada.



"Am going Radio and Televis on Servicing full time. Now have my own shop. I owe my success to N.R.I."—Curtis Statb, Ft. Madison, Iowa.



"Am with WCOC. NRI course can't be beat. No trouble passing 1st class Radio-phone license exam."—Jesse W. Parker, Meridian, Mississippi.



"By graduation, had paid for course, car, testing equipment. Can service toughest jobs."—E. J. Straitenberger, New Boston, Ohio.

**AVAILABLE TO VETERANS UNDER G. I. BILLS**

## You Learn by Practicing with Parts I Send



Nothing takes the place of PRACTICAL EXPERIENCE. That's why NRI training is based on LEARNING BY DOING. You use parts I furnish to build many circuits common to Radio and Television. As part of my Communications Course, you build many circuits, including low power transmitter shown at left. You put it "on the air," perform procedures required of broadcast operators. With my Servicing Course you build modern Radio, etc.; use Multitester you build to make money fixing sets in spare time while training. You can stay at home, keep your job, learn Radio-TV in spare time at low cost. Mail coupon for book showing other equipment you build and keep.

**The Tested Way To Better Pay!**

**2 FREE BOOKS SHOW HOW MAIL COUPON**



**Television Making Good Jobs, Prosperity**—Even without Television, Radio is bigger than ever. 115 million home and auto Radios are big market for servicing. 3000 broadcasting stations use operators, technicians. Government, Aviation, Police, Ship, Micro-wave Relay, Two-way Radio Communications for buses, taxis, trucks, R. R. are growing fields. Television is moving ahead fast.



About 200 Television stations are now on the air. Hundreds of others being built. Good TV jobs opening up for Technicians, Operators, etc.

25 million homes now have Television sets. Thousands more are being sold every week. Get a job or have your own business selling, installing, servicing.

## Radio-TV Needs Men of Action—Mail Coupon

Without obligating you in any way, I'll send an actual lesson to prove that my training is practical, thorough; 64-page book to show good job opportunities for you in Radio-TV. Terms for NRI training are as low as \$5 a month. Many graduates make more in two weeks than total cost of training. Mail coupon now. J. E. SMITH, President, National Radio Institute, Dept. 4KD4, Washington 9, D. C. OUR 40TH YEAR.

## Good for Both—FREE

MR. J. E. SMITH, President, Dept. 4KD4  
National Radio Institute, Washington 9, D. C.  
Mail me Sample Lesson and 64-page Book, FREE.  
(No salesman will call. Please write plainly.)

Name..... Age.....

Address.....

City..... Zone..... State.....

**VETS** write in date of discharge



POPULAR ELECTRONICS is published monthly by Ziff-Davis Publishing Company, William B. Ziff, Chairman of the Board (1946-1953), at 64 E. Lake St., Chicago 1, Ill. Second Class Entry pending at Post Office, Chicago, Ill. SUBSCRIPTION RATES: One Year U.S. and possessions, and Canada \$3.00; Pan-American Union Countries \$3.50; all other foreign countries \$4.00.

# POPULAR ELECTRONICS

OCTOBER  
1954  
VOL. I - NUMBER 1

## EDITOR

OLIVER READ, W1ET1

## ASSOCIATE EDITORS

W. A. STOCKLIN H. S. RENNE  
C. TEPPER J. FRIEBORN  
P. B. HOEFER

## ART

FRANK SAYLES (Director)  
A. J. REICH M. WHELPLEY

## CONTRIBUTING EDITORS

J. T. FRYE L. E. GARNER, JR.  
K. R. BOORD R. P. TURNER  
R. HERTZBERG H. POLLACK

## DRAFTING

J. A. GOLANEK A. A. GANS



Copyright 1954  
(All Rights Reserved)

## ZIFF-DAVIS PUBLISHING COMPANY

W. B. ZIFF (1898-1953) FOUNDER

Editorial and Executive Offices  
366 Madison Ave., New York 17, N.Y.

## PRESIDENT

B. G. DAVIS

## VICE-PRESIDENTS

H. J. MORGANROTH M. FROELICH

## SECRETARY-TREASURER

G. E. CARNEY

## CIRCULATION MANAGER

M. MICHAELSON

## BRANCH OFFICES

Chicago (1), 64 E. Lake St.  
Los Angeles (14), Statter Center,  
900 Wilshire Blvd.

## SUBSCRIPTION SERVICE:

All communications concerning subscriptions should be addressed to Circulation Dept., 64 E. Lake St., Chicago 1, Ill. Subscribers should allow at least four weeks for any change of address.

## CONTRIBUTIONS:

Contributors are advised to retain a copy of their manuscripts and illustrations. Contributions should be mailed to the New York Editorial Office and must be accompanied by return postage. Contributions will be handled with reasonable care, but this magazine assumes no responsibility for their safety. Any copy accepted is subject to whatever adaptations and revisions are necessary to meet the requirements of this publication. Payment covers all author's, contributor's, and contestant's rights, title, and interest in and to the material accepted and will be made at our current rates upon acceptance. All photos and drawings will be considered as part of material purchased.

## CONTENTS

Meet Popular Electronics	O. Read	13
Amateur Radio—The International Hobby	G. L. Dosland, WØTSN	15
Build Your Own Bike Radio	L. E. Garner, Jr.	17
Studio from Egg Crate Separators	J. Corey	23
Solar Battery		24
Build Your Own Fire Alarm	R. Sandretto	26
A Light Meter You Can Build	R. P. Turner	28
Hi-Fi at Low \$\$\$	R. Hertzberg	30
Radar for Small Boats		33
Home-Built Loudspeaker Enclosure	A. B. Cohen	34
How to Test and Replace Radio and Television Controls	H. Leeper	36
Carl & Jerry	J. T. Frye	38
So You Want to Be a Ham—	R. Hertzberg, W2DJJ	40
Radio Control of Models	W. Winter	43
"Collision-proof" Model Train System		47
Small Fi	P. Popenoe, Jr., W6IWM	48
Capacity Relay	H. Pollack	53
How to Align Receivers		57
Flashing Lamps—An Experimenter's Delight	E. D. Morgan	61
Experimenter's Laboratory—A Modern "Breadboard" Chassis		65
Battery Eliminator-Charger Kit		67
Fun with Neon Bulbs		69
Build this Code Practice Set		72
How to Fix Home Radios		75
The World at a Twirl	K. R. Boord	80
Adjusting Your TV Height Control		82
Learn Electronics with Multi Use Kits	J. K. Frieborn	84
Crystal-Type Broadcast Receiver		92

## DEPARTMENTS

R/C Model News	60
Book Reviews	95
Tricks of the Trade	100
Tools & Gadgets	110
After Class	114
Resistor Color Code	128
Capacitor Color Code	128
Standardized Wiring Diagram Symbols	129
Glossary of Terms in this Issue	130

(Also see page 6)

**COYNE offers  
LOW COST**

# TELEVISION RADIO-ELECTRONICS

Training in  
Spare Time **AT HOME**



The future is **YOURS** in TV-RADIO!  
A fabulous field—good pay—fascinating work—  
a prosperous future! Good jobs, or independence  
in your own business!

Coyne brings you the first *truly lower cost*, MODERN—QUALITY Television Home Training; training designed to meet Coyne standards. Not an old Radio Course with Television "tacked on". Here is MODERN TELEVISION TRAINING including working knowledge of Radio. Includes UHF and Color TV. No Radio background or previous experience needed. Personal guidance by Coyne Staff. **Practical Job Guides** to show you how to do actual servicing jobs—*make money early in course*. With Coyne Television Home Training you pay only for your training, no costly "put together kits".



B. W. COOKE, President



*Coyne—the Institution behind this training... the largest, oldest, best equipped residential school of its kind. Established 1899. Send coupon for details.*

## COYNE ELECTRICAL SCHOOL

500 S. Paulina St., Dept. 74-HT7, Chicago 12

A TECHNICAL TRADE INSTITUTE CHARTERED  
NOT FOR PROFIT

### SEND COUPON FOR FREE PICTURE FOLDER

and full details,  
including easy  
Payment Plan. No  
obligation, no  
salesman will call.



#### COYNE ELECTRICAL SCHOOL Television Home Training Div.

500 S. Paulina St., Chicago 12, Ill.,  
Dept. 74-HT7

Send Free Picture Folder and details on Television Home Training. This does not obligate me and no salesman will call.

Name \_\_\_\_\_

Address \_\_\_\_\_

City \_\_\_\_\_ State \_\_\_\_\_

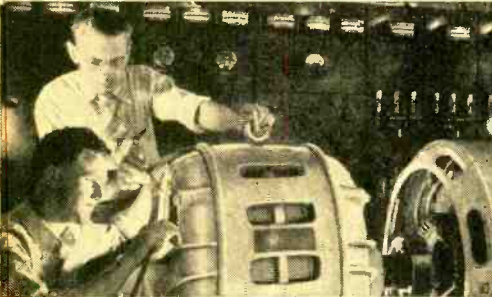

Train for Better  
Jobs in

# ELECTRICITY OR TELEVISION-RADIO

in Great  
Shops of COYNE

### GREAT OPPORTUNITY FIELDS

Conditions are changing. Many "one operation" jobs that have paid well will not last. *Don't be satisfied with a "no future" job.* Whether 17 or up to 45 years of age, train the Coyne way for a better job and a real future in ELECTRICITY or TELEVISION-RADIO, fields that offer a world of opportunities.

### YOU can TRAIN in great CHICAGO SHOPS

Train on real, full-size equipment at COYNE where thousands of successful men have trained for over 55 years—largest, oldest, best equipped school of its kind—established in 1899. No advanced education or previous experience needed. TRAINING APPROVED FOR VETERANS.

B. W. COOKE, President

## COYNE FOUNDED 1899 ELECTRICAL SCHOOL

A TECHNICAL TRADE INSTITUTE CHARTERED NOT FOR PROFIT  
500 S. PAULINA STREET, CHICAGO, Dept. 74-71H

ELECTRICITY ★ RADIO ★ TELEVISION ★ REFRIGERATION ★ ELECTRONICS

October, 1954

**START NOW—PAY LATER**—Finance Plan and Easy Monthly Payment Plan. Also part-time employment help for students.

### Get FREE Book

Send coupon for 48 page illustrated book "Guide to Careers in Electricity and Television-Radio." No cost; no obligation; no salesman will call. Get vital facts now!



B. W. COOKE, President  
COYNE ELECTRICAL SCHOOL  
500 S. Paulina St., Chicago 12, Ill., Dept. 74-71H

Send BIG FREE book and details of your training offer. This does not obligate me and no salesman will call. I am interested in:

Electricity  Television-Radio

Name \_\_\_\_\_

Address \_\_\_\_\_

City \_\_\_\_\_ State \_\_\_\_\_



It's easy and  
inexpensive to build an  
**ELECTRONIC TIMER**

with **RAYTHEON** CK722

**TRANSISTORS**

Yes, and it gives  
you a chance to experiment  
with the latest in  
electronics. Raytheon will  
supply you with  
complete information free.  
Just write to Department P.

\*Raytheon — pioneers in large scale  
production of transistors.

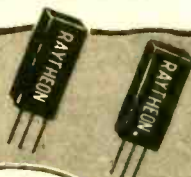

**RAYTHEON**

*Excellence in Electronics*

**RAYTHEON MFG. CO.**

Receiving and Cathode Ray Tube Operations  
Newton 58, Massachusetts

RELIABLE SUBMINIATURE AND MINIATURE TUBES  
SEMICONDUCTOR DIODES AND TRANSISTORS  
NUCLEONIC TUBES

RECEIVING AND PICTURE TUBES - MICROWAVE TUBES

**ITEMS OF INTEREST**

Nature on the Loose	32
Components Assembled Automatically	52
Code Practice Set Serves as Continuity Tester	56
Short Detector	56
Adaptor Connects Phone Plugs to Tip Jacks	56
Automatic Oven Temperature-Recorder	56
New CD Communications System in Los Angeles	66
W3NKF on the Air	68
Extending the Range of Your Coil Calculator	74
Wooden Dowels are Handy Items for Workshop	78
A Quick, Easy Way to "Drill" Plastics	78
Piscatorial "Bass Response"	79
General Purpose Line Cord	79
World's Most Powerful Airborne Radar Unit	86
Six Hours of TV on One Gallon of Gas	87
Fuse Saver	87
Versatile Load for Your Ham Transmitter	94
Running TV Lead-in Through Window Panes	94
The Mighty Midget Converter	99
Make This Handy Sorting Tray	107
New Airborne Radar System	113
Multichannel R/C Wins Meet	119
Safety First!	122

**NEW PRODUCTS**

"Portable" TV Receiver	32
(Majestic Radio & Television, 70 Washington St., Brooklyn 1, N. Y.)	
"Universal" Breadboard Chassis for Experimenters	32
(Allen B. Du Mont Laboratories, Inc., 750 Bloom- field Ave., Clifton, N. J.)	
Transistor Experiment Kit	32
(Sutton Electronic Company, Lexington, Ky.)	
Photoelectric Cell	68
(International Rectifier Corp., 1521 E. Grand Ave., El Segundo, Cal.)	
Oscillator-Monitor	68
(Gonset Company, 801 S. Main St., Burbank, Cal.)	
The "Heart Microphone"	79
(Altec Lansing Corporation, 161 Sixth Ave., New York 13, N. Y.)	
Photoelectric Switch Controls House Lights	79
(The Fisher-Pierce Co., Inc., 63 Pearl St., Boston 85, Mass.)	
TV Commercial "Eliminator"	87
(Vocatrol Corporation, Cambridge, Mass.)	
Portable Direction Finder	87
(Raytheon Manufacturing Co., Waltham 54, Mass.)	
If you are unable to locate any of these products at your local radio parts jobber, write direct to the manufacturer.	



**COVER PHOTO:** This young experimenter, shown testing the Heathkit A-7B audio amplifier, is not only acquiring valuable "know-how" by assembling and testing such a unit but is adding to his hi-fi system at low cost. This is only one of a wide variety of kits available to experimenters. Such kits offer the twin benefits of practical experience with electronic circuitry and a carefully-engineered unit which makes a professional addition to the workshop or home music system. See article on page 30 for details on this amplifier. (Ektachrome by John Deejen)

# CAN YOU PROFIT BY THEIR MISTAKES?



**"I didn't get enough education"**

You needn't make that mistake. You can get that better job, those big promotions, the regular raises that so many I.C.S. students report. And you can do it without "going to school," without interfering with your present job or your social life.

**YOU can study with I.C.S. at home, in your spare time!**



**"I chose the wrong career"**

When you study with I. C. S. you have 277 courses to choose from. And part of our job here at I. C. S. is not only giving you sound, practical, up-to-date instruction, but making sure you pick the course that's right for you!

**YOU get expert guidance FREE when you mail the I. C. S. coupon!**



**"I failed to seize opportunities"**

Your opportunity—the turning point in your life—may be right here on this page. Don't pass it by. Don't put off mailing the coupon. Send it now and let us return to you the free book, "How to Succeed," opportunity catalog and free lesson.

**YOU can start cashing in on opportunities by acting now!**



**3 FREE BOOKS** 36-page, pocket-size guide to advancement, a gold mine of tips on "How to Succeed." Also big catalog outlining opportunities in your field of interest. And free sample I. C. S. lesson text.

**For Real Job Security — Get an I. C. S. Diploma!**

**I. C. S., Scranton 9, Penna.**

## INTERNATIONAL CORRESPONDENCE SCHOOLS



**BOX 2951, SCRANTON 9, PENNA.**

(Partial list of 277 courses)

Without cost or obligation, send me "HOW TO SUCCEED" and the opportunity booklet about the field BEFORE which I have marked X (plus sample lesson)

### ARCHITECTURE and BUILDING CONSTRUCTION

- Air Conditioning—Refrig.
- Architecture
- Building Contractor
- Building Maintenance
- Carpenter and Mill Work
- Estimating
- Heating
- Painting Contractor
- Plumbing
- Reading Arch. Blueprints
- Steamfitting

### ART

- Cartooning
- Commercial Art
- Fashion Illustrating
- Magazine Illustrating
- Show Card and Sign Lettering
- Sketching and Painting

### AUTOMOTIVE

- Auto Body Rebuilding
- Auto Elec. Technician
- Auto-Engine Tune Up
- Automobile Mechanic

### AVIATION

- Aeronautical Engineering Jr.
- Aircraft & Engine Mechanic

### BUSINESS

- Advertising
- Bookkeeping and Accounting
- Business Administration
- Business Correspondence
- Certified Public Accounting
- Creative Salesmanship
- Federal Tax
- Letter-writing Improvement
- Managing Small Business
- Office Management
- Retail Business Management
- Sales Management
- Stenographic-Secretarial
- Traffic Management

### CHEMISTRY

- Analytical Chemistry
- Chemical Engineering
- Chem. Lab. Technician
- General Chemistry
- Natural Gas Prod. & Trans.
- Petroleum Engineering
- Plastics
- Pulp and Paper Making

### CIVIL, STRUCTURAL ENGINEERING

- Civil Engineering
- Construction Engineering
- Highway Engineering
- Reading Struct. Blueprints
- Sanitary Engineering
- Structural Engineering
- Surveying and Mapping

### DRAFTING

- Aircraft Drafting
- Architectural Drafting
- Electrical Drafting
- Mechanical Drafting
- Mine Surveying and Mapping
- Ship Drafting
- Structural Drafting

### ELECTRICAL

- Electrical Engineering
- Electrical Maintenance
- Electrician Contracting
- Lineman

### HIGH SCHOOL

- Commercial
- Good English
- High School Subjects
- Mathematics

### LEADERSHIP

- Foremanship
- Industrial Supervision
- Leadership and Organization
- Personnel-Labor Relations

### MECHANICAL AND SHOP

- Gas—Electric Welding
- Heat Treatment  Metallurgy
- Industrial Engineering
- Industrial Instrumentation
- Industrial Supervision
- Machine Design-Drafting
- Machine Shop Inspection
- Machine Shop Practice
- Mechanical Engineering
- Quality Control
- Reading Shop Blueprints
- Refrigeration
- Sheet Metal Worker
- Tool Design  Toolmaking

### RADIO, TELEVISION

- Electronics
- Practical Radio—TV Eng'ng
- Radio and TV Servicing
- Radio Operating
- Television—Technician

### RAIL ROAD

- Air Brakes  Car Inspector
- Diesel Locomotive
- Locomotive Engineer
- Section Foreman

### STEAM AND DIESEL POWER

- Combustion Engineering
- Diesel—Elec.  Diesel Eng's
- Electric Light and Power
- Stationary Fireman
- Stationary Steam Engineering

### TEXTILE

- Carding and Spinning
- Cotton, Rayon, Woolen Mfg.
- Finishing and Dyeing
- Loom Fixing
- Textile Designing
- Textile Eng'g  Throwing

### MISCELLANEOUS

- Domestic Refrigeration
- Marine Engineering
- Ocean Navigation
- Shipfitting
- Short Story Writing
- Typography

Name \_\_\_\_\_ Age \_\_\_\_\_ Home Address \_\_\_\_\_  
 City \_\_\_\_\_ Zone \_\_\_\_\_ State \_\_\_\_\_ Working Hours \_\_\_\_\_ A.M. to P.M. \_\_\_\_\_

Canadian residents send coupon to International Correspondence Schools, Canadian, Ltd., Montreal, Canada. . . . Special tuition rates to members of the U. S. Armed Forces.

# RAD TEL TUBES

GUARANTEED

FULL  
YEAR

70%  
TO  
90%  
OFF!

300  
TYPES  
ALWAYS  
IN STOCK

ALL TUBES  
INDIVIDUALLY  
BOXED

Only a few  
parts values  
listed. Send for  
FREE illustrated  
catalog.

FOR QUALITY, PERFORMANCE, DEPENDABILITY

FIX IT YOURSELF and SAVE! SAVE!

Type	Price	Type	Price	Type	Price	Type	Price	Type	Price
OA2	.74	6AK5	.55	6S8GT	.53	12AL5	.37	14W7	.30
OA4	.68	6AK6	.59	6SA7GT	.55	12AQ5	.52	14X7	.69
OB2	.81	6AL5	.42	6SD7GT	.41	12AT6	.41	14Y7	.62
OC3	.72	6AM8	.78	6SF5GT	.46	12AT7	.72	19BG6	1.39
OD3	.70	6AQ5	.50	6SG7GT	.41	12AV6	.46	19T8	.69
OZ4M	.65	6AQ6	.37	6SH7GT	.49	12AV7	.60	19V8	.79
1A5	.49	6AQ7	.70	6SI7GT	.41	12AV6	.39	24A	.39
1A7GT	.47	6AR5	.45	6SK7GT	.53	12AV7	.73	25AV5GT	.83
1AX2	.62	6AS5	.50	6SL7GT	.48	12AX4	.67	25BQ6GT	.98
1B3GT	.73	6AS6	1.49	6SN7GT	.59	12AX7	.63	25LG6T	.51
1C5	.43	6AT6	.41	6SQ7GT	.46	12AY7	.69	25W4GT	.59
1E7	.29	6AU4GT	.68	6SR7GT	.45	12AZ7	.59	25Z5	.66
1G6	.24	6AUSGT	.82	6SS7GT	.42	12B4	.60	25Z6	.49
1H4	.30	6AU6	.46	6T4	.99	12BA6	.49	26	.45
1H5GT	.49	6AV5GT	.83	6T8	.80	12BA7	.60	27	.39
1L4	.46	6AV6	.40	6U5	.57	12BD6	.45	32L7	.89
1LA4	.59	6AX4GT	.65	6U6	.59	12BE6	.51	35	.58
1LA6	.69	6B4	.54	6U8	.78	12BF6	.39	35A5	.58
1LB4	.69	6BA6	.49	6V6GT	.50	12BH7	.63	35B5	.52
1LC5	.59	6BA7	.57	6W4GT	.47	12BY7	.65	35C5	.51
1LC6	.79	6BC5	.54	6W6GT	.57	12BZ7	.65	35L6GT	.51
1LD5	.59	6BD5	.59	6X4	.37	12C8M	.34	35W4	.47
1LE3	.59	6BD6	.45	6X5GT	.37	12H6	.56	35Y4	.54
1LG5	.69	6BE6	.51	6X8	.75	12J5	.42	35Z3	.59
1LH4	.69	6BF5	.41	6Y6G	.48	12J7	.49	35Z4	.47
1LN5	.59	6BF6	.37	7A4	.57	12K8	.59	35Z5GT	.47
1N5GT	.67	6BG6G	1.25	7A5	.49	12Q7	.59	36	.39
1P5GT	.57	6BH6	.53	7A6	.69	12S8GT	.62	45	.55
1Q5GT	.58	6BJ6	.49	7A7	.69	12SA7GT	.65	45Z5	.49
1R5	.62	6BK5	.80	7A8	.68	12SC7M	.63	46	.69
1S4	.59	6BK7	.80	7AD7	.79			50A5	.55
1S5	.51							50B5	.52
1T4	.58							50C5	.51
1T5	.59							50L6GT	.61
1U4	.57							50X6	.49
1U5	.50							50Y6	.49
1V	.43							50Y7	.50
1X2A	.63	6BL7GT	.83	7AF7	.53	12SF5	.50	55	.49
2A3	.30	6BN6	.59	7AG7	.69	12SG7	.51	57	.58
2W3	.38	6BO6GT	.98	7AH7	.79	12SJ7M	.67	58	.60
2X2	.49	6B7	.90	7B4	.44	12SK7GT	.63	70L7	.97
3A4	.45	6BZ7	.90	7B5	.45	12SL7GT	.57	74A5	.59
3B7	.27	6C4	.40	7B6	.69	12SN7GT	.52	74A7	.63
3D6	.27	6C5	.39	7B7	.49	12SNQ7GT	.56	74AF7	.59
3E5	.46	6C6	.58	7C4	.59	12SR7M	.49	14B6	.63
3LF4	.69	6CB6	.54	7C5	.69	12V6GT	.46	14B8	.63
3Q4	.48	6CD6	1.11	7C6	.59	12X4	.38	14C5	.79
3Q5GT	.69	6CF6	.64	7E5	.59	14A4	.69	14C7	.79
3S4	.58	6CS6	.51	7E6	.30	14A5	.59	14E6	.75
3V4	.58	6D6	.59	7E7	.59	14A7	.63	14E7	.88
5A24	.59	6E5	.48	7F7	.79	14AF7	.59	14F7	.65
5T4	.79	6F5GT	.39	7F8	.79	14B6	.63	14F8	.69
5U4G	.55	6F6	.59	7G7	.89	14B8	.63	14H7	.59
5W4GT	.50	6G6	.42	7H7	.59	14C5	.79	14J7	.30
5Y3GT	.37	6H6GT	.41	7I7	.79	14C7	.79	14N7	.84
5Y4	.51	6J5GT	.43	7K7	.69	14E6	.75	14R7	.79
5Z3	.45	6J6	.52	7L7	.59	14E7	.88	14S7	.89
6A6	.51	6J7	.43	7N7	.69	14F7	.65		
6A7	.69	6K5	.47	7Q7	.66	14F8	.69		
6AB4	.44	6K6GT	.45	7R7	.89	14H7	.59		
6AC5	.69	6K7	.44	7S7	.79	14J7	.30		
6AC7M	.86	6L6	.64	7V7	.89	14K7	.59		
6AF4	.90	6L7M	.68	7X6	.54	14L7	.30		
6AG5	.56	6N7M	.63	7X7	.70	14M7	.84		
6AG7M	.99	6Q7	.45	7Y4	.69	14N7	.84		
6AH4	.57	6R7	.69	7Z4	.59	14R7	.79		
6AH6	.73	6S4	.48	7Z4	.59				
6AJ5	.65	6S7M	.79	12A6	.54				
		6S78	1.69	12A8GT	.61				

SAME DAY SERVICE!

No. 125			No. 97			SELENIUM RECTIFIERS		
PHILCO TV BOOSTER			WEN SOLDERING GUN			Mfd. by Federal		
Made by Philco, famed for quality and precision communications equipment. Completely self-contained, including 2 6J6 tubes . . . 1 for high channels and 1 for low channels and selenium rectifier. Plastic cabinet. In factory-sealed cartons, complete with instructions. NEW			3 seconds on 120 Volt AC readies it for any soldering requirement. 250 Watt size. Also cuts plastic tile (with special tip). Built in spot light.			Item No. DC-Ma Price		
LOW PRICE . . . \$9.95			List price - \$12.95			Item No. DC-Ma Price		
			9.71 ea.			113 65 \$5.99		
			Please send full remittance—allow for postage and save C.O.D. charges! We refund all unused money.			114 75 .69		
						115 100 .79		
						116 150 .84		
						117 200 1.25		
						118 300 \$1.39		
						119 350 1.59		
						120 400 1.59		
						121 500 1.99		

RAD-TELTUBE CO.



115 Coit St., Irvington 11, N. J. "Integrity Is Our Chief Asset"

TERMS:

A 25% deposit must accompany all orders—balance C.O.D. All shipments F.O.B. Irvington warehouse. ORDERS UNDER \$10—\$1.00 HANDLING CHARGE. . . . Subject to prior sale.

Tubes in Bold Type Cover 90% of Demand





L. C. Lane, B.S., M.A.  
President, Radio-Television  
Training Association,  
Executive Director, Pierce  
School of Radio & Television.

Study AT HOME in your SPARE TIME  
to be a TELEVISION TECHNICIAN

**VETERANS!**  
**NON-VETERANS!**

# YOU LEARN MORE because I GIVE YOU MORE!



Super-Het  
Radio Receiver



C-W Telephone Transmitter



Public Address System



Combination Voltmeter-  
Ammeter-Ohmmeter



21 in.



RF Signal  
Generator

## LEARN BY DOING

Every one of my students gets enough equipment to set up his own home laboratory. You learn to be a television technician by actually doing what a TV technician must do on the job. With the equipment I send you, you build and keep a professional GIANT SCREEN TV RECEIVER complete with big picture tube (takes any size up to 21-inch) . . . also a Super-Het Radio Receiver, AF-RF Signal Generator, Combination Voltmeter-Ammeter-Ohmmeter, C-W Telephone Transmitter, Public Address System, AC-DC Power Supply. Everything supplied, including all tubes. No experience is necessary . . . My practical, easy-to-understand lessons have brought success to hundreds of men, many with no more than a grammar school education.

## CHOOSE FROM 3 COMPLETE COURSES

My Courses cover all phases of radio, FM and television.

### 1. Radio, FM and Television Technician Course

(No Previous Experience Necessary)

You learn by practicing with the professional equipment I send you. Many of my graduates now hold down good paying technician jobs with such firms as RCA, NBC-TV, CBS-TV, DUMONT TV and numerous other TV studios and plants.

### 2. FM-TV Technician Course

(Previous Training or Experience in Radio Required)

You can save months of time if you have previous Armed Forces or civilian radio experience! Train at home with kits of parts, plus equipment to build BIG SCREEN TV RECEIVER. ALL FURNISHED AT NO EXTRA COST!

### EXTRA TRAINING IN NEW YORK CITY AT NO EXTRA COST!

After you finish your home study training in Course 1 or 2 you get two weeks, 50 hours, of intensive Laboratory work on modern electronic equipment at our associate school in New York City, Pierce School of Radio & Television. THIS EXTRA TRAINING IS YOURS AT NO EXTRA COST WHATSOEVER. My courses are complete without this extra training, however. It is just an added opportunity for review and practice.

### 3. TV Cameraman and Studio Technician Course

(Advanced Training for Men with Radio or TV Training or Experience)

I train you at home for an exciting high pay job as the man behind the TV camera. Work with TV stars in TV studios or "on location" at remote pick-ups!

An optional 30 hour one-week course of practical work on TV studio equipment at Pierce School is offered upon completion of Course 3.

## EARN WHILE YOU LEARN

Almost from the very start you can earn extra money while learning by repairing Radio-TV sets for friends and neighbors. Many of my students earn up to \$25 a week . . . pay for their entire training from spare time earnings. . . start their own profitable service business.

### FREE FCC COACHING COURSE!

Important for BETTER PAY JOBS requiring FCC License. You get this training AT NO EXTRA COST. Top TV jobs go to FCC-licensed technicians.

## VETERANS!

My school fully approved to train veterans under new Korean G. I. Bill. Available only to Veterans discharged after June 27, 1950. If eligible, CHECK COUPON!

**YOU GET ALL FOUR FREE**

MAIL THIS COUPON TODAY!  
NO SALESMAN WILL CALL!



Mr. Leonard C. Lane, President  
RADIO-TELEVISION TRAINING ASSOCIATION  
52 East 19th Street, New York 3, N. Y. Dept. E-10

Dear Mr. Lane: Mail me your NEW FREE BOOK, FREE SAMPLE LESSON, and FREE aids that will show me how I can make BIG MONEY IN TELEVISION. I understand I am under no obligation and no salesman will call.

(PLEASE PRINT PLAINLY)

Name \_\_\_\_\_ Age \_\_\_\_\_

Address \_\_\_\_\_

City \_\_\_\_\_ Zone \_\_\_\_\_ State \_\_\_\_\_

I AM INTERESTED IN:

- Radio-FM-TV Technician Course
  - FM-TV Technician Course
  - TV Cameraman & Studio Technician Course
- VETERANS!**  
Check here   
for Training under NEW  
G. I. Bill.

## Radio Television Training Association

52 EAST 19th STREET • NEW YORK 3, N. Y.

Licensed by the State of New York • Approved for Veteran Training

# BUILD YOUR OWN HIGH FIDELITY CABINETS AND ENCLOSURES

by **Cabinart**

*With a cabinet kit by CABINART you get exactly the style that you want. The finish is up to you. You get top-quality white pine or birch—perfect for any finish that you select. And so easy to put together . . . all you need is a screwdriver.*

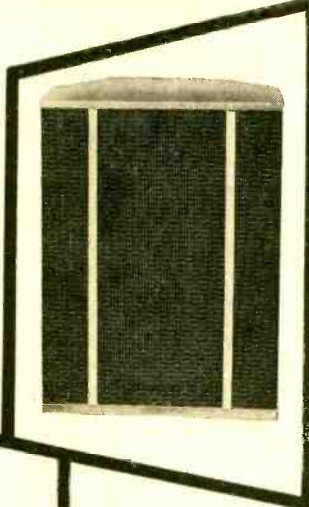

## Paul Klipsch-designed Rebel IV

You can now build your own corner horn speaker enclosure . . . designed by Paul Klipsch. Identical in acoustic design to assembled units and easily put together with a minimum of tools. Priced for the home-builder in unfinished birch.

12" model . . . **\$36.00** net\*  
15" model . . . **\$42.00** net\*

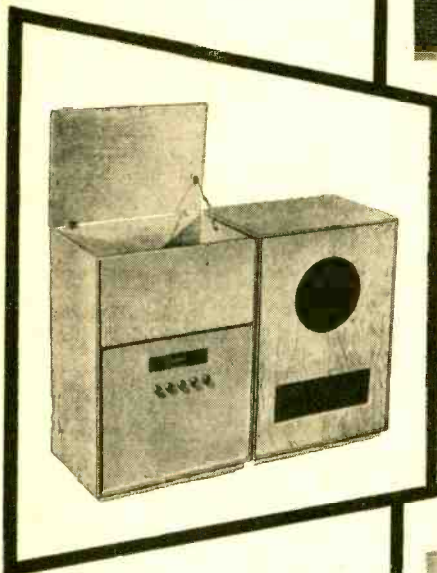

## Bass Reflex and Equipment Cabinets

The ideal housing for high fidelity components . . . removable panels make future changes easier. Loudspeaker cabinet acoustically designed for either 12" or 15" speaker. Overall dimensions: 33½" H., 23" W., 16" D. Tuner compartment: 20" H., 21¾" W. (inside dimensions), 15¼" D. Baffle volume: 6 cu. ft.

**Model 80**—Equipment cabinet kit . . . **\$27.00** net\*  
**Model 8112**—12" speaker cabinet kit . . . **\$18.00** net\*  
**Model 8115**—15" speaker cabinet kit . . . **\$18.00** net\*

## Corner Folded Horn Enclosures

Reproduces a quality of bass heretofore only possible through the use of far more expensive designs.

**Model 61** **\$19.95**  
(12" speaker kit) net\*  
**Model 63** **\$23.95**  
(15" speaker kit) net\*

\*prices higher west and south.

*All kits include ¾" white pine cut to size, baffle precut for 12" or 15" speaker, Saran plastic acoustic cloth, Kimsul acoustic insulation, assembly and finishing instructions, hardware, plastic wood, sandpaper and glue.*

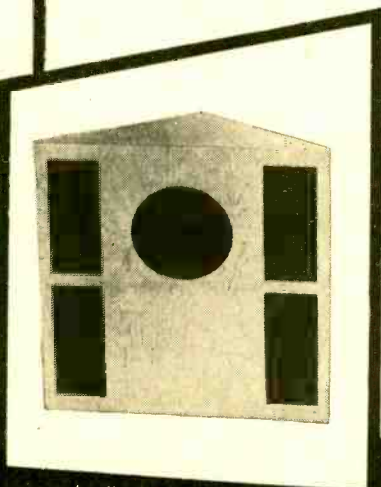

Write for free catalog and name of nearest distributor

G & H WOOD PRODUCTS COMPANY • 75 NORTH 11th ST., BROOKLYN 11, N. Y.

# ADVANCE! Raise your earning power—learn RADIO-TELEVISION-ELECTRONICS by SHOP-METHOD HOME TRAINING

## GOOD JOBS AWAIT THE TRAINED RADIO-TV TECHNICIAN

There is a place for *you* in the great Radio-Television-Electronics industry when you are trained as National Schools will train you at home!

Trained technicians are in growing demand at good pay—in manufacturing, broadcasting, television, communications, radar, research laboratories, home Radio-TV service, and other branches of the field. National Schools Master Shop-Method Home Training, with newly added lessons and equipment, trains you in your spare time, right in your own home, for these fascinating opportunities. OUR METHOD IS PROVED BY THE SUCCESS OF NATIONAL SCHOOLS TRAINED MEN, ALL OVER THE WORLD, SINCE 1905.

## EARN WHILE YOU LEARN

Many National students pay for all or part of their training with spare time earnings. We'll show you how you can do the same! Early in your training, you receive "Spare-time Work" Lessons which will enable you to earn extra money servicing neighbors' and friends' Radio and Television receivers, appliances, etc.

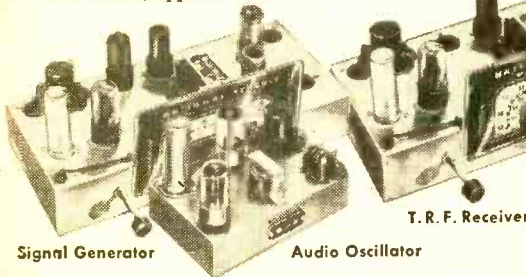

Signal Generator

Audio Oscillator

T. R. F. Receiver

## National Schools Training is All-Embracing

National Schools prepares you for your choice of many job opportunities. Thousands of home, portable, and auto radios are being sold daily—more than ever before. Television is sweeping the country, too. Co-axial cables are now bringing Television to more cities, towns, and farms every day! National Schools' *complete* training program qualifies you in all fields. Read this partial list of opportunities for trained technicians:

Business of Your Own • Broadcasting  
Radio Manufacturing, Sales, Service • Telecasting  
Television Manufacturing, Sales, Service  
Laboratories: Installation, Maintenance of Electronic Equipment  
Electrolysis, Call Systems  
Garages: Auto Radio Sales, Service  
Sound Systems and Telephone Companies, Engineering Firms  
Theatre Sound Systems, Police Radio  
And scores of other good jobs in many related fields.

## TELEVISION TRAINING

You get a complete series of up-to-the-minute lessons covering all phases of repairing, servicing and construction. The same lesson texts used by resident students in our modern and complete Television broadcast studios, laboratories and classrooms!



## MASTER ALL PHASES!

Get Master Shop-Method Home Training from an Established Practical Resident School with its own Training Shops, Laboratories, Studios — almost 50 Years of Successful Experience in Training Ambitious Men.

**We Bring National Schools To You!**

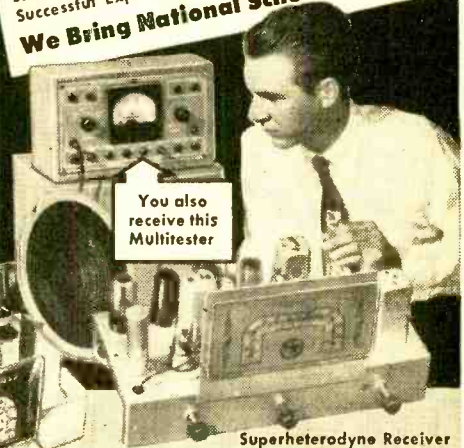

You also receive this Multitester

Superheterodyne Receiver

## LEARN BY DOING

You receive and keep all the modern equipment shown above, including tubes and valuable, professional quality Multitester. No extra charges.

## FREE! RADIO-TV BOOK AND SAMPLE LESSON!

Send today for National Schools' new, illustrated Book of Opportunity In Radio-Television-Electronics, and an actual Sample Lesson. No cost—no obligation. Use the coupon now—we'll answer by return airmail.

**APPROVED FOR VETERANS AND NON-VETERANS**  
Check coupon below

**Both Resident and Home Study Courses Offered!**



## NATIONAL SCHOOLS

LOS ANGELES 37, CALIFORNIA • ESTABLISHED 1905  
IN CANADA-811 W. HASTINGS STREET, VANCOUVER, B.C.

## GET FACTS FASTEST! MAIL TO OFFICE NEAREST YOU!

(mail in envelope or paste on postal card)

**NATIONAL SCHOOLS, Dept. R2G-104**

4000 S. Figueroa Street or 323 West Palk Street  
Los Angeles 37, Calif. or Chicago 7, Ill.

Send FREE Radio-TV Electronics book and FREE sample lesson. No obligation, no salesman will call.

NAME \_\_\_\_\_ BIRTHDAY \_\_\_\_\_ 19 \_\_\_\_

ADDRESS \_\_\_\_\_

CITY \_\_\_\_\_ ZONE \_\_\_\_\_ STATE \_\_\_\_\_

Check here if interested in Resident School Training at Los Angeles.  
VETERANS: Give Date of Discharge \_\_\_\_\_

## What is a Capacitor?

A capacitor—or electric condenser, as it was once known—is a device for storing electrical energy and returning it as desired. It has storage space—*i.e.*, *capacity* for electricity; hence, capacitor.

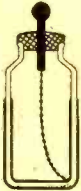

Basically, a capacitor consists of two plates or systems of material that are capable of conducting electricity, separated by an insulating material. The oldest man-made capacitor of record is the Leyden jar, a glass bottle whose inner and outer surfaces were covered with copper foil. Invented in Holland in the mid-18th century, it was first used in America by Benjamin Franklin in his classic experiments with natural lightning. These Leyden jar condensers and the glass plate condensers which succeeded them were used in the early spark wireless sets.

Today's capacitors usually use aluminum foil electrodes or plates, although Invar steel, copper, and tantalum plates; lead, copper, and tantalum foils; as well as thin zinc and silver films are in use for specialized applications.

The dielectric or insulating materials may be paper impregnated with an oil or wax, electrolytically formed oxide films, plastic films, ceramics, glass, air or a compressed gas.

The combination of electrodes and dielectrics may be a rolled assembly such as the ordinary "tubular" paper capacitor; a fixed or adjustable mechanical plate structure; a disc or hollow tube; a stacked series of plates or wafers; or a series of coaxial cylinders.

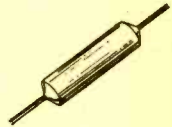

Capacitors are essential components in electronic and electrical circuits. They are used everywhere in our modern electrical life—on power lines, TV and radio sets, in automobiles, in aircraft, in fluorescent lamps, electric refrigerators, air conditioners, oil burners, etc., etc.

One capacitor manufacturer alone—Sprague Electric Company—has made well over a billion capacitors in the last 25 years. Where do they go? Well, remember that a table model radio uses about 15 and a table model television set about 115.

Among the basic uses of this important circuit component are the suppression of sparks across contacts as in auto distributors and fluorescent starters; filtering or bypassing unwanted radio and TV signals; coupling electronic circuits together; tuning circuits; reducing "waste" circulating currents by improving "power factor"; suppressing radio and TV noise; supplying electrical energy for conversion to light in "pulsed photographic lighting systems"; and "phase splitting" or changing the nature of alternating current electricity supplied to motors used with various appliances.

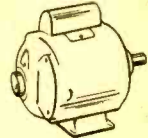

—To be continued—

This informative message is No. 1 of a Series contributed by Sprague, the world's largest manufacturer of capacitors. Write Sprague Products Co., N. Adams, Mass., for complete Sprague catalog.

(Advertisement)



YOUR EDITOR, OLIVER READ

# Meet

## POPULAR

## ELECTRONICS

### An Editorial

FROM modest basement shops and attic experimental laboratories have emerged the fundamental ideas that have resulted in the fastest growing industry of our times—electronics. Our vast radio communications systems—spread like a giant web over the entire world—keep us informed of news almost as soon as it happens. The radio “ham,” using simple electronic equipment, communicates with his fellow hobbyists throughout the world as simply as the housewife talks to her neighbor *via* telephone.

A large group of medics watch a delicate operation on a color TV screen. Every detail seen by the operating surgeon and the color camera is observed in isolated rooms. Instructions and comments of the surgeon are heard clearly from the loud-speaker system.

An airplane is lost and is forced down at sea. Its call for help is heard by or made known to the FCC monitoring stations. A “fix” is made by electronic direction finders and the position of the lost plane is flashed to nearby vessels which then proceed to the rescue.

A hostile airplane is spotted on a radar screen. Interceptors are dispatched to engage the enemy. Radio navigational aids protect us as we fly in an airliner and bring us to a safe landing on a fog-bound runway.

These are but a few of the thousands of applications for electronic devices that serve to protect life, limb, and property and that provide means of education and entertainment never dreamed of by our forefathers.

Many electronic devices are born in the great laboratories of the industry—but a

greater number of pioneer developments have emerged from the experimenter’s bench and the ham shack. So-called tinkers or gadgeteers have contributed many valuable ideas and important discoveries that have led to valuable patents.

The problem of maintenance of electronic devices, especially home units such as radio, television, and hi-fidelity equipment has been a real bottleneck and will become an even greater problem as we reach sizable production of color television.

A vast field of opportunity in electronics awaits the individual who will learn, by simple experiments, the fundamentals of circuitry, components, and equipments. Others will become indoctrinated with electronics at a hobby level. The fascinating hobby of radio control finds thousands of youngsters and oldsters meeting frequently to fly their airplanes and to sail their boats. And many a garage door is opened and closed by radio impulses from simple devices made in the home shop.

One of the greatest hobbies in the world—amateur radio—has been tremendously stimulated by relaxed requirements to qualify for a coveted license. A new “novice” class license is attracting thousands of newcomers to this world-wide hobby.

Industry has recognized the importance of training new engineers, scientists, and technicians and our trade schools have produced thousands of technicians and other specialists. But many thousands more are needed to meet the ever-increasing demand for new blood in industry.

Those of us who have grown up with electronics have been forced to keep pace

*(Continued on page 125)*

# Something Too Good to Miss, for HI-FI ENTHUSIASTS

## IT STUMPS THE EXPERTS

Ever since it was first described four years ago the performance of Air-Coupler speaker systems has delighted and mystified the most critical listeners. Hundreds of hi-fi enthusiasts who have built Air-Couplers to reproduce the low frequencies say that they now hear tones that they *never knew were recorded on discs and tapes!*

The Air-Coupler is unique in two respects — it gives clean reproduction on fundamental frequencies from 200 down to 20 cycles *with such power as to blow a match held in front of the port*, and yet, operated at low volume, it gives rich, proportionate bass reproduction when the system is turned down to *bare audibility*.

## YOU CAN BUILD IT

The enclosure is easy to build from 11 pieces of plywood. No special tools are required. Use any good 12-in. speaker. Added to your present speaker system, the Air-Coupler will make such a dramatic improvement that your friends will ask if they may bring over their records to play on your system.

## THE AIR-COUPLER UP TO DATE

The origin of the Air-Coupler was never disclosed until the story was told in the March-April issue of MUSIC at HOME Magazine. Since then, requests have poured in for up to date information on this remarkable enclosure. Accordingly, in response to this demand, a series of three articles has been prepared, starting in the September-October issue.

The series will present 1) detailed drawings and instructions of the latest, improved design, 2) diagrams and information on fixed and variable networks, amplifiers, and speaker systems, and 3) drawings which show how to conceal the Air-Coupler in bookshelves or storage walls, under the floor, or in simple, useful furniture pieces.

## ORDER YOUR COPIES NOW!

You can get the next three issues with the new Air-Coupler series, *plus* the March-April issue containing the article "Origin of the Air-Coupler", at the reduced price of \$1.00. MUSIC at HOME is a large-size magazine, elaborately illustrated and printed on fine paper. Edited for hi-fi enthusiasts, it covers all phases of music from records, tape, and FM, with more information on hi-fi equipment, installation, and operation than any other magazine. The four issues you buy for \$1 are equivalent to a \$5 book of 550 pages!

## HOW YOU CAN SAVE \$4.50

Here's how you can save \$4.50, and start a complete file of MUSIC at HOME from the very first issue: If you order a 3-year subscription now (a saving of \$3 over the 1-year rate) you will receive at once the first 3 issues without extra charge (a saving of \$1.50). In case your order is received after our supply of the first 3 issues is exhausted, your subscription will be extended for 3 extra issues. Act now while you can start a complete file and save \$4.50!

MILTON B. SLEEPER, Publisher  
207-F East 37th St., New York 16, N. Y.

Enclosed is my remittance for

- \$1.00 for 4 issues containing Air-Coupler series  
 \$6.00 for 3 years, plus first 3 issues (Save \$4.50)

Name .....

Address .....

.....  
Add \$1.00 per year for foreign postage

# Amateur Radio

## THE INTERNATIONAL HOBBY



GOODWIN L. DOSLAND, WØTSN  
Pres., American Radio Relay League

### GUEST EDITORIAL

"THIS AFTERNOON, I hooked an SV, CN, and LU on 15, flipped over to 20 and got a couple of ZD's and a CR4. How'd you do?"

"Well, I stuck to 10 today. Not much doing, but the band opened up for some PY's and a CE."

Hard to imagine what this conversation is all about? Not if you're an amateur radio operator, one of more than 160,000 who daily engage in short-wave talk around the world. The letters are radio call sign identifications for various countries. For instance, the first "ham" said he made short-wave radio contact with other hams, in Greece, French Morocco, and Argentina on the fifteen-meter band, then switched to the twenty-meter band for chats with West Africa and the Cape Verde Islands. The other operator said that he stayed on the ten-meter band, and conditions were not too good for distance, or "DX," but he did "work" stations in Brazil and Chile.

Who are these hams? The Federal Communications Commission defines an amateur operator as a "person interested in radio technique solely with a personal aim and without pecuniary interest, holding a valid license." Can anyone get a license? Yes—provided they are enough interested in radio to learn some of the radio theory, the International Morse Code, and the regulations which govern the amateur radio service.

"But," you say, "don't all amateurs have to know how to speak Greek and French and so on?"

No. The hams of the world have developed a sort of international shorthand, mostly based on English, in which phrases like "I'll be seeing you" become simply

"BCNU" and "thanks" is "Tks." This is implemented by an arbitrary "Q" code, where three letters stand for a phrase or sentence, such as QRS—"Please send more slowly"; QTH—"My address is—" and so on. These phrases are translated into all languages, permitting a free exchange of conversation despite the language barrier.

Many strong international friendships have grown out of casual talks on the air. Recently, an American amateur, Mrs. Evelyn Scott, toured South Africa. She and her husband were entertained royally by hams whom she had "met" by radio. After each visit, word was flashed, *via* amateur radio, to the next town, and another group of hams would take their turns as hosts. Similarly, a South African, Louis Nel, who was undergoing medical treatment in a Boston hospital, was visited by American hams, treated to a party on his birthday, provided with a receiver so he could keep up with the goings-on, and given a fine send-off when he left for home.

"Well, it's natural for people to treat well the members of their own group. What do hams do for others?"

Amateurs provide communications for the public during fires, floods, blizzards, hurricanes, and all sorts of emergencies, widespread or localized. Recently a young patient in Coro, Venezuela, was seriously ill with leukemia. The drug aminopterin which was needed for the child's treatment was not available in that country, so Enrique Torres, a Venezuelan ham, started a search *via* the airwaves to locate some. He contacted an amateur in Raleigh, N. C. who relayed the plea to another ham in New York; *Lederle Laboratories* were in-

*(Continued on page 108)*

# NOW... Start Fixing TV and Radio Sets RIGHT AWAY

TRY IT  
**FREE**

FOR 10 DAYS IN  
YOUR OWN HOME

## TELEVISION AND RADIO REPAIRING

McGraw-Hill's Amazing New Low-Cost Instruction Manual Skips "Theories" and "Formulas", Tells How-to-do-it in PLAIN ENGLISH!

### PARTIAL CONTENTS

Tools Needed • How TV and Radio Sets Work • How to Remove and Replace Tubes • Testing Tubes without a Tester • Using a Tube Tester without Test and Replace Resistors, Controls, Switches, Condensers, Coils, Transformers • Tuning Devices, Loudspeakers • Phono Pickups and Repair Antennas • How to Install and MUCH MORE

### TELLS HOW TO "Cash In" ON THE BIG DEMAND FOR RADIO-TV REPAIRMEN

Over 25 million TV sets over 100 million radios in this country! Shortage of skilled repairmen! You can make nice extra money just fixing sets for friends and neighbors in your spare time or start your own full-time repair business, with steady profits. Book tells exactly how to get started; how to plan your workshop; which tubes to stock; where to get information; how to make a service call; how to start fixing sets and making money. Author tells how tough jobs can be done so you STILL make money before you're halfway through.



### Prove It on Your Own Set

Save up to \$50 a year just by installing, repairing, and servicing your own TV set. Book tells which controls to adjust or tubes to replace if picture is entirely dark—blurred—split—distorted—off center—titled—wiggles and weaves—too pale—too black—jitters—snows—drifts—etc., etc.

### Trouble Shooting Chart Tells Where to Look for Bad Tube If:

No picture; no raster; no sound.  
No picture; raster OK; no sound.  
No picture; no raster; sound OK.  
No picture; raster OK; sound OK.  
Picture wiggles and weaves, jacks blacks, or is very black; raster OK; sound OK.  
Picture jittery, double image; raster OK; sound OK.  
Snow on all channels; raster OK; sound weak.

Snow on all channels, raster OK; sound OK.  
Picture and raster do not fill screen; sound OK.  
Picture drifts up and down but not sideways; raster OK; sound OK.  
Picture muddy and gray; raster OK; sound OK.  
PLUS 29 OTHER COMMON TV TROUBLES.

... even if you have never fixed a LAMP or DOOR BELL before!

"Why hasn't somebody done this BEFORE?"

That's what you'll say the minute you start browsing through this amazing new and complete one-volume instruction manual in radio and TV repairs.

For here at last a well-known EXPERT has found a way to tell you in PLAIN ENGLISH how to fix almost ANY radio or television set. (And he even tells you where you can go to have the extra-tough jobs done FOR you... at professional rates.) Right from the very first chapters you can start doing simple repairs... and before you're HALF way through the book, you can fix HALF the television and radio sets that you encounter. Surprisingly quickly you can fix your own and friends' sets... get a service shop job... even start your own money-making business right in your own home.

### Why It's So EASY to Understand

No electronic formulas... no algebra... no laboratory experiments. Instead you deal only with the things that go wrong in sets—how to recognize and spot the trouble—and what to do about it. "Easy as A-B-C" directions and 700 clear photos, diagrams, and drawings show you exactly WHAT and HOW to fix, step-by-step.

The author is Associate Editor of *Electronics Magazine*. He's a long-recognized expert—not only on radio and TV—but also on making technical subjects easily understood by the average reader. He has spent FOUR years making this one-volume instruction manual so practical and easy-to-understand that even a man who never fixed a door bell before will have no trouble.

Here's everything you need to know about where and how to buy tubes and parts, where and how to get a circuit diagram for any receiver; how to choose and use basic tools; how to test tubes WITHOUT a tube tester; how to adjust 58 common TV controls; how to "diagnose" and "cure" common radio and TV troubles; how to fix or replace loudspeakers, phono pickups; how to install and check antennas; and much, much more.

### SEND NO MONEY

Examine this big 536-page book for 10 days BEFORE you decide if you wish to own it. Try it out FREE on your own set. See how easy it makes your handling of repairs. Take 10 days to prove it PAYS FOR ITSELF, or don't keep it. Just mail coupon to: McGraw-Hill Book Co., Inc., Dept. PEL-10, 327 West 41st St., New York 36, N. Y.

### FREE 10-DAY TRIAL COUPON

McGraw-Hill Book Co., Inc., Dept. PEL-10  
327 West 41st St., New York 36, N. Y.

Please send me, for 10 days' FREE EXAMINATION, your one-volume "Television and Radio Repairing," by John Markus. If not delighted with it, I may return book, pay nothing. Otherwise, I will keep book and send only \$1.95 plus postage; followed by 3 monthly installments of \$2.00 each.

Name .....

Address .....

City..... Zone..... State.....

SAVE MONEY. Check here if enclosing full price of \$7.95 with this coupon. Then WE will pay delivery. Same 10-day return privilege—full refund guaranteed. PEL-10



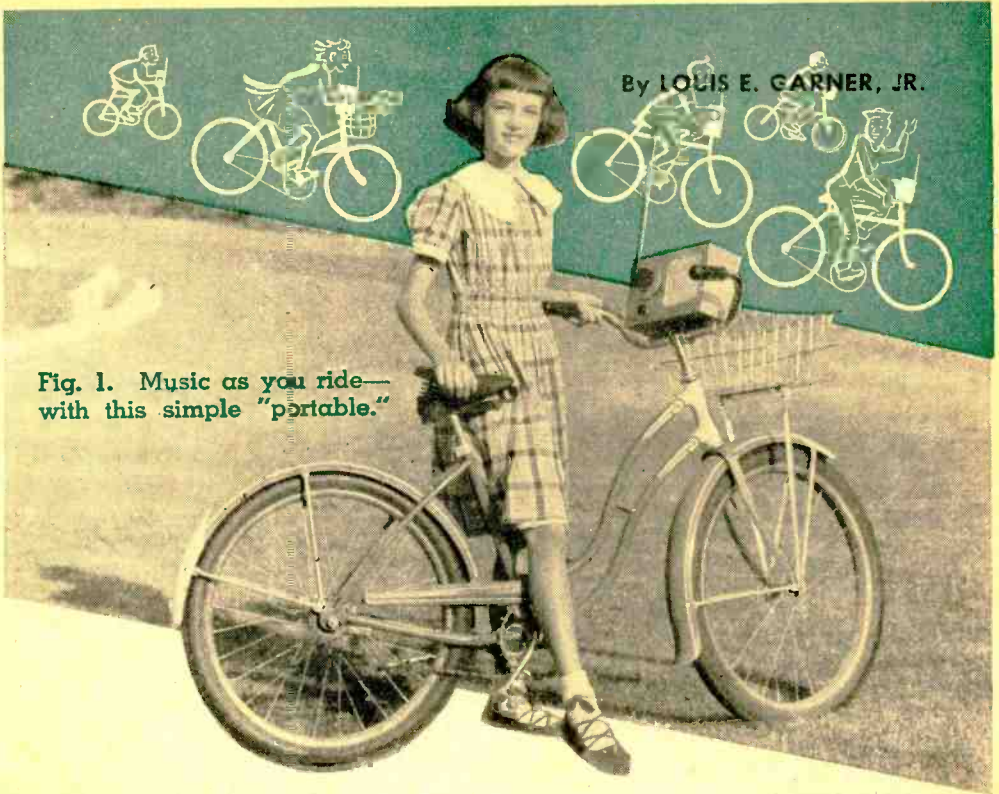

Fig. 1. Music as you ride—  
with this simple "portable."

## BUILD YOUR OWN



# Bike Radio

**H**OW about a little music while you ride? Or would you rather listen to the football games as you pedal your way through the early October Saturday afternoons? You can enjoy both of these experiences if your bike is radio equipped like the one shown in Fig. 1. Or have you often thought it would be nice to have a good-looking portable receiver for those camping trips, days at the beach, or just as an "extra" set around the house? Such a portable radio is easy to build and will only take a few spare evenings to put together. Here is how it is done!

First assemble all of the parts specified

in the parts list. You will note that a commercially-available cabinet and chassis are used which eliminates the problem of bending and finishing. These are drilled and punched as shown in Fig. 10. The large opening for the loudspeaker is made by punching a 1" round hole in each corner and sawing between them with a keyhole hacksaw. Final smoothing is done with a small, flat file. If you clamp the cabinet in a vise during drilling, use a few layers of cloth between the vise jaws to keep from marring the finish.

Dimensions for the loudspeaker mounting holes will vary with the brand of



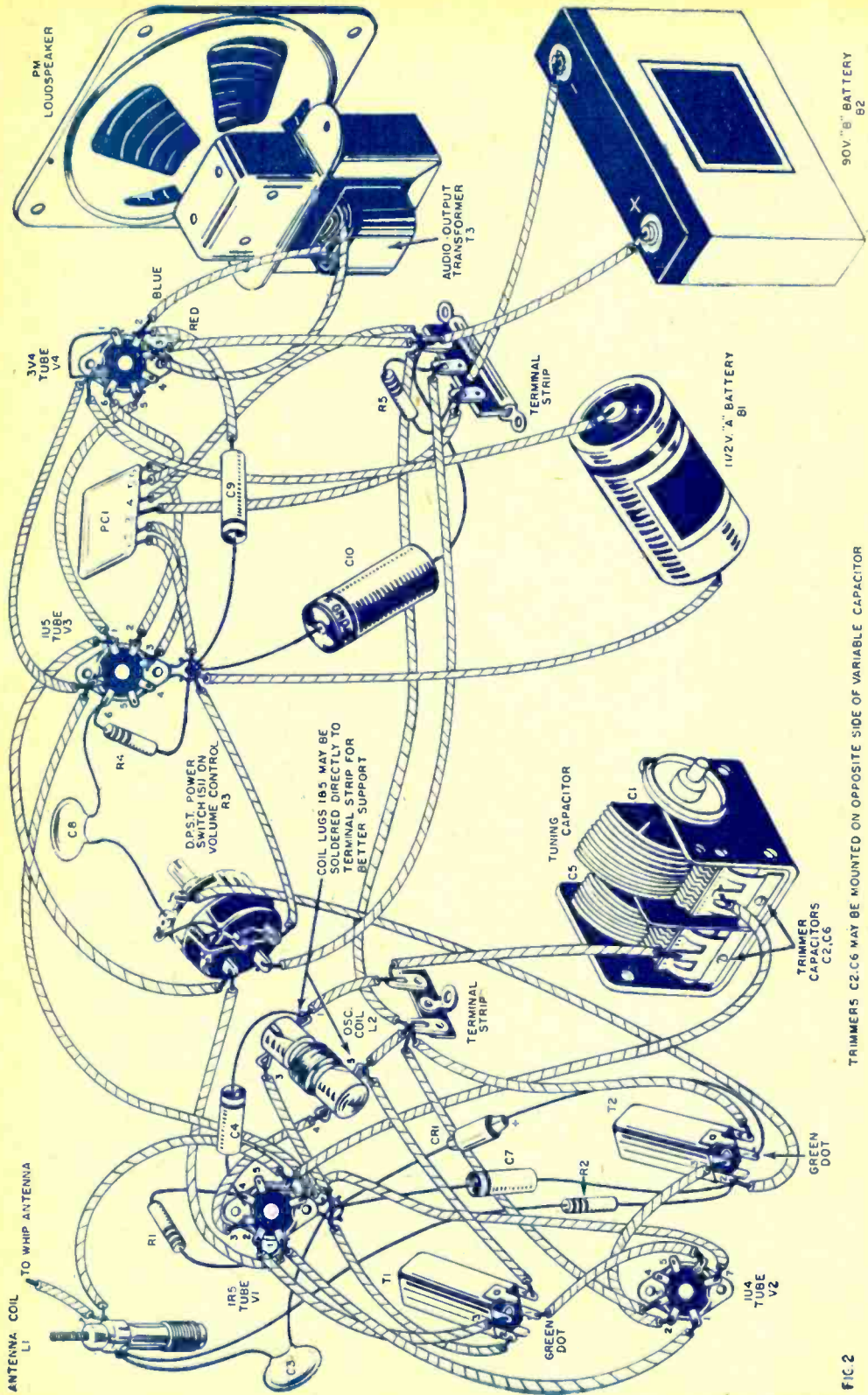

TRIMMERS C2,C6 MAY BE MOUNTED ON OPPOSITE SIDE OF VARIABLE CAPACITOR

FIG 2

Fig. 3. Complete schematic and parts list for the four-tube "bike" radio receiver.

- R<sub>1</sub>—100,000 ohm, 1/2 w. res.
- R<sub>2</sub>—4.7 megohm, 1/2 w. res.
- R<sub>3</sub>—1 megohm potentiometer with switch (S<sub>1</sub>), audio taper ("Volume Control")
- R<sub>4</sub>—10 megohm, 1/2 w. res.
- R<sub>5</sub>—470 ohm, 2 w. res.
- C<sub>1</sub>, C<sub>2</sub>—Two-gang broadcast-type tuning capacitor (Philmore No. 304S) with trimmers (C<sub>3</sub>, C<sub>4</sub>)
- C<sub>3</sub>—0.1 µfd. disc ceramic capacitor
- C<sub>4</sub>—50 µfd. ceramic capacitor
- C<sub>5</sub>—100 µfd. ceramic capacitor
- C<sub>6</sub>—0.02 µfd. disc ceramic capacitor
- C<sub>7</sub>—0.05 µfd., 200 v. capacitor
- C<sub>8</sub>—8 µfd., 150 v. elec. capacitor
- L<sub>1</sub>—Antenna coil (Superex "Vari-Loopstick")
- L<sub>2</sub>—Miniature broadcast osc. coil (Miller No. 70-Osc.)
- S<sub>1</sub>—D.p.s.t. "power" switch (on R<sub>3</sub>)
- T<sub>1</sub>—455 kc. input i.f. trans. (Miller No. 10-C1)
- T<sub>2</sub>—455 kc. output i.f. trans. (Miller No. 10-C2)
- T<sub>3</sub>—Audio output trans. to match 10,000 ohms to speaker voice coil (A "universal" output trans. such as the Stancor A-3856, may be used if desired)
- PC<sub>1</sub>—Printed circuit pentode plate coupler (Erie No. 1407-03)
- CR<sub>1</sub>—1N34 germanium crystal diode
- B<sub>1</sub>—1 1/2 volt "A" battery (RCA VS-236, size G)
- B<sub>2</sub>—90 volt "B" battery (Burgess No. N60)
- V<sub>1</sub>—1R5 tube
- V<sub>2</sub>—1U4 tube
- V<sub>3</sub>—1U5 tube
- V<sub>4</sub>—3V4 tube
- V<sub>5</sub>—1U5 tube
- 1—3 1/2 inch PM loudspeaker
- 1—Whip antenna (salvage from TV "rabbit ears" or use an auto antenna)
- 1—Tuning dial (National Type AM was used)
- 1—Cabinet (Bud No. CU-2110 "Minibox")
- 1—Chassis (Insuline No. 29080)
- 4—7-pin miniature tube sockets
- Misc. 1 knob for volume control; 1 standoff insulator; 1 feedthrough insulator; 1 kitchen cabinet handle; 3" x 5" flocked screen material; 2 ground lugs; 1 two-terminal strip; 1 three-terminal strip; 90-volt battery harness; 2 "U" bolts to fit bike handle bars; rubber tubing to cover "U" bolts; 8" strip of 1/2" wide, .050 aluminum or 20 ga. steel (for battery brackets); screws; nuts; wire; solder; etc.

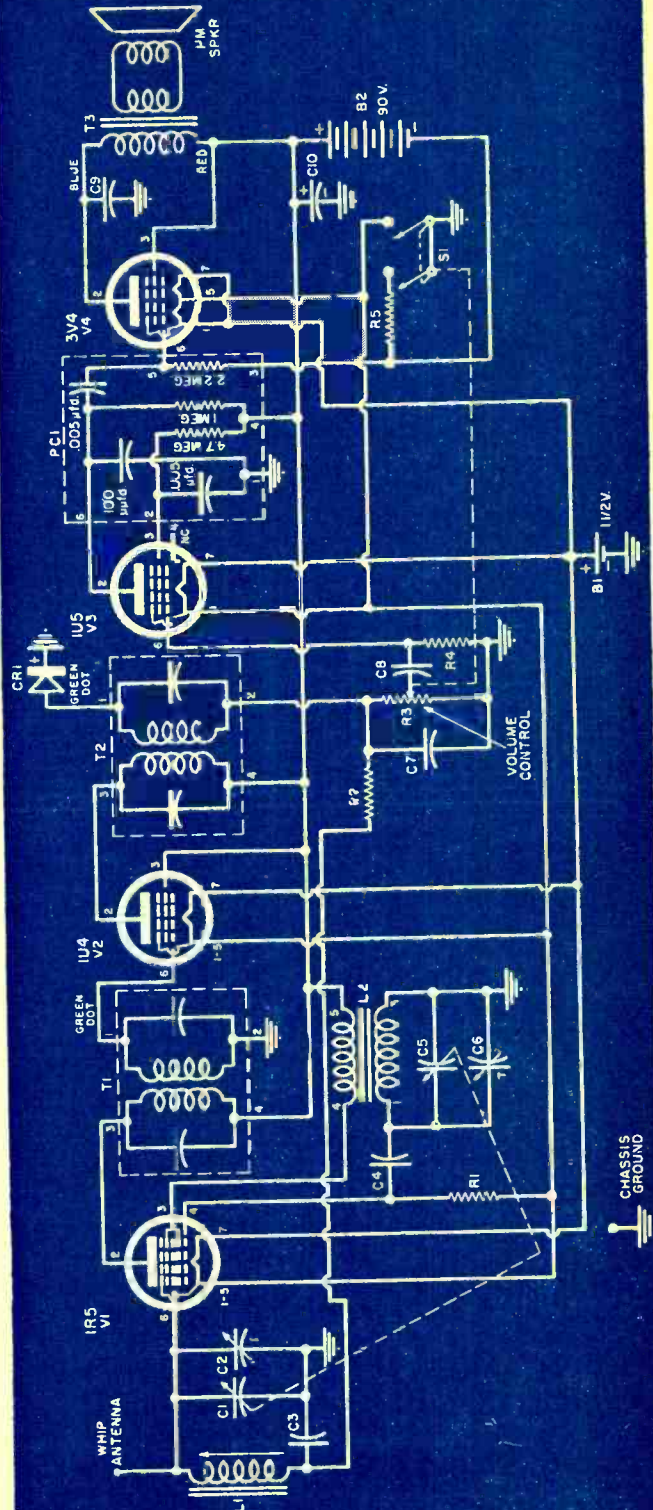

speaker you use. Determine the correct location by holding your speaker against the back of the front panel, then mark the correct spots.

After you have finished all drilling and filing operations on the front panel you can apply decals to identify the "Tuning" and "Volume" controls. Follow the manufacturer's instructions for applying these. When the decals are dry, spray the front panel with about three coats of transparent plastic spray for protection.

The square mounting holes for the i.f. transformers can best be made by first cutting or punching a  $\frac{1}{2}$ " x  $\frac{1}{2}$ " square hole, as shown in Fig. 10 (top), then filing until the transformer just slips into place. Use a square *Greenlee* or *Pioneer* punch or a cold chisel for making the initial hole.

The tube sockets and other parts are mounted on the chassis as shown in Fig. 7. Use  $\frac{1}{4}$ " 4-40 machine screws and small hex

nuts for the tube sockets and terminal strip and  $\frac{1}{4}$ " 6-32 screws for the tuning capacitor. Mount the i.f. transformers by bending the mounting lugs flat against the chassis.

The tuning dial, volume control, and loudspeaker are mounted on the front panel. Use flocked screening to protect the speaker. You may wish to reinforce the screening with cardboard over the speaker opening but if you do, cut a 1" x 3" hole in it as an air passage (see Fig. 8) otherwise the sound will be muffled when the radio is mounted in its cabinet.

Details for mounting the antenna are shown in Fig. 4. A feedthrough insulator is used for the bottom mounting and a simple standoff insulator used for the top mounting. The upper mounting ring was made by soldering a flat washer to a machine screw. The antenna itself was salvaged from a discarded TV "rabbit ears" antenna. A small auto antenna may be used instead, if desired.

The batteries are mounted to the back of the case by a single bracket and a  $\frac{3}{8}$ " 8-32 screw and nut, as shown in Fig. 6. Simply bend a strip of  $\frac{1}{2}$ " wide sheet metal to fit over the two batteries, as shown.

A kitchen-cabinet door handle is mounted on the top of the case with two machine screws to make the receiver "portable."

The pictorial wiring diagram and the complete schematic are given in Figs. 2 and 3 respectively. The author found it easier to wire the chassis as a separate unit before attaching it to the front panel. Final connections to the antenna, volume control, loudspeaker, and batteries may be made after mounting.

A commercially-available printed circuit is used for coupling the 1U5 and 3V4 stages. If you prefer, however, you may use individual parts in place of the printed circuit. Parts values for these components are given on the diagram of Fig. 3.

The oscillator coil,  $L_2$ , is mounted simply by soldering it to the two-terminal "tie-

Fig. 4. Details of antenna mounting. One feedthrough and one standoff are needed.

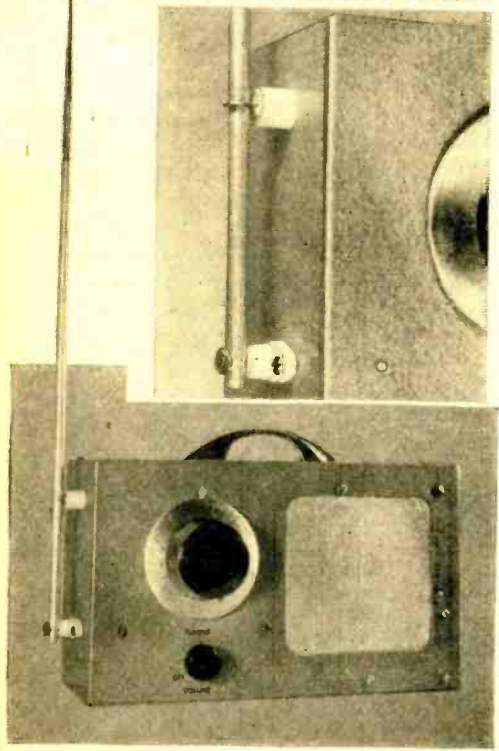
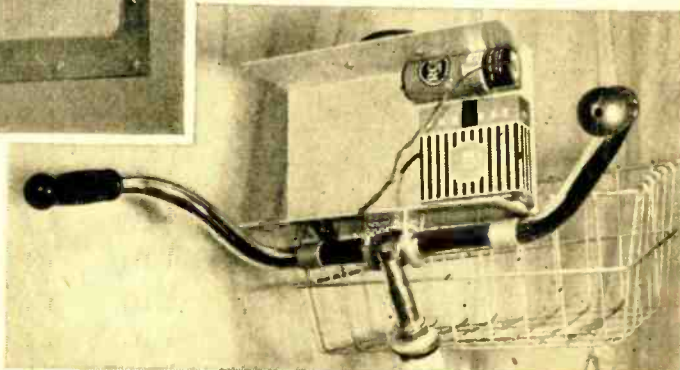

Fig. 5. The completed receiver is a handsome and compact portable anyone will be proud to claim.

Fig. 6. Mounting the completed receiver on a bike. Case is affixed to handle bars with "U" bolts, then chassis is mounted in case.



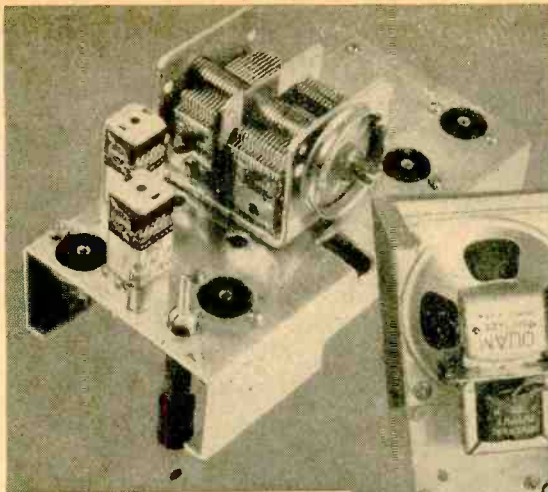
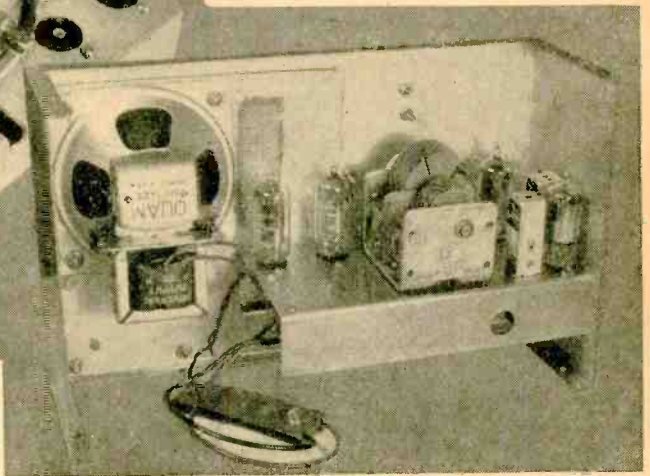

Fig. 8. Interior view of the → completed receiver. Because of the roomy layout, the builder should experience no construction difficulty. Mount all parts rigidly.

← Fig. 7. Above-chassis view of the receiver showing the major parts mounted. Section of tuning capacitor with small rotor plates is the "oscillator" unit.



point" strip, as shown in Fig. 2. Flow sufficient solder over the connections to insure a strong joint.

Once the wiring is completed and double checked for errors, the receiver may be aligned. You'll need an r.f. signal generator and a small alignment tool for this operation. Place all tubes in their proper sockets and connect the batteries.

Turn on the signal generator and allow it to warm up for a few minutes. It isn't necessary to let the receiver warm up. Couple the signal generator loosely to the antenna by wrapping two turns of insulated wire around the antenna and connecting the "hot" lead of the signal generator to them. The "ground" lead should be connected to the receiver chassis.

With the signal generator set to deliver a 455 kc. modulated signal, turn on the receiver and turn up the volume control to full volume. Connect a wire between the stator plates of the oscillator section of the tuning capacitor and ground. Close the tuning capacitor plates.

Adjust the i.f. transformers for maximum output as determined by the tone heard in the loudspeaker. Use the minimum signal from the signal generator needed to permit a tone to be

heard with the maximum setting of the "Volume" control.

If oscillation occurs during this part of the alignment procedure, use the best i.f. peaking you can obtain before oscillation takes place—you can touch up the i.f. transformers later.

Once the i.f. transformers are peaked, remove the wire from the tuning capacitor's oscillator section and set the tuning capacitor to minimum capacity. Set the signal generator to 1600 kc. and adjust the local oscillator and antenna trimmer capacitors for maximum output ( $C_2$  and  $C_6$ , Fig. 3, mounted on the tuning capacitor).

Set the signal generator to 1400 kc. and adjust the tuning dial until the signal is heard in the loudspeaker. Then adjust the antenna coil,  $L_1$ , for maximum output.

Next set the signal generator to 550 kc. and adjust the tuning dial until the capacitor plates are fully closed. "Rock" the

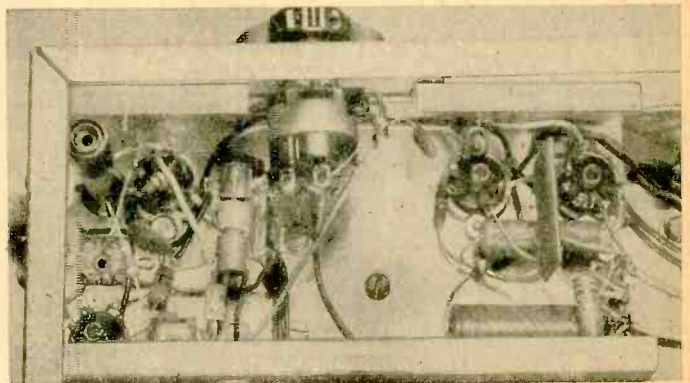
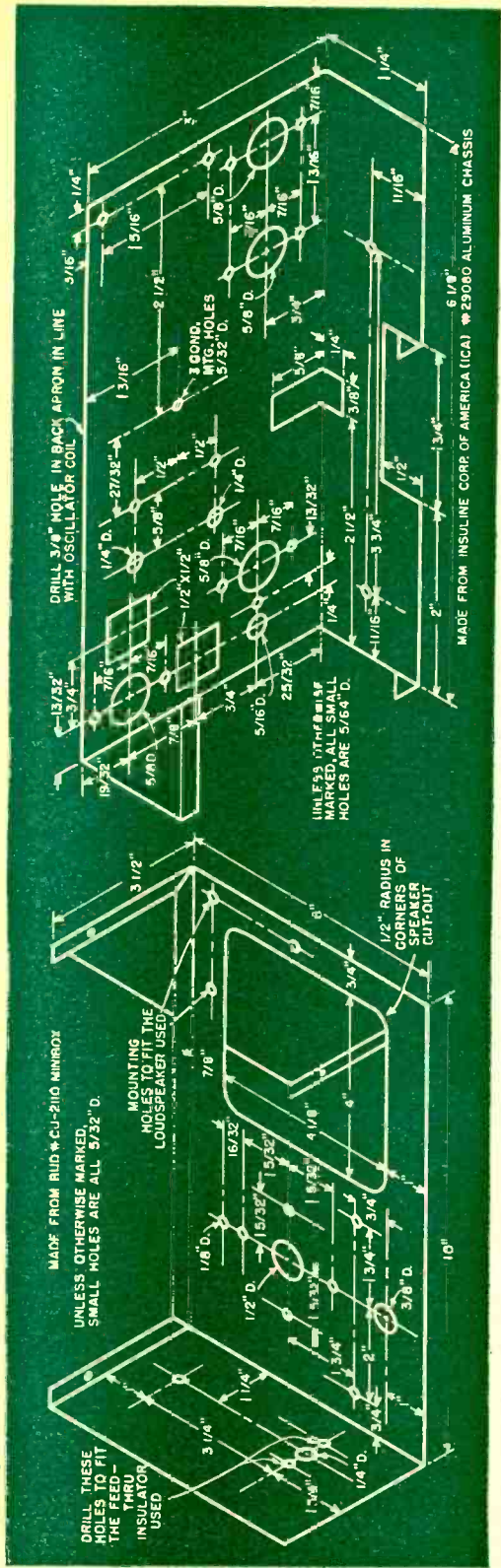

Fig. 9. Under chassis view of the completely wired radio. →



capacitor plates slowly back and forth and adjust the oscillator coil,  $L_2$ , for maximum output.

Repeat the adjustments at 1600, 1400, and 550 kc. at least three times, as one adjustment will affect the others. Try to obtain the best possible compromise during the operation.

If the thought of trying to align your receiver gives you a weak-in-the-knees feeling or you can't locate a signal generator with which to perform this operation, your local radio technician or a friendly radio amateur with a small lab will probably be glad to do the job for you—so don't hesitate to build this handy portable on that account.

You may mount the completed receiver on the bicycle handle bars by using small "U" bolts, as shown in Fig. 6. Use cardboard or small wood blocks between the receiver case and the handle bars to protect the finish on both the case and the bicycle. For the same reason, slip short pieces of rubber tubing over the "U" bolts.

Just a word of caution when using this portable receiver as a bike radio. Don't become so engrossed in the radio programs while riding that you fail to watch the traffic. It only takes a moment's inattention to cause an accident!

If the idea hasn't already occurred to you, I would like to suggest that the cabinet can be dressed up and "personalized" by the addition of some snappy decals in color or the cabinet itself may be sprayed with enamel to match or contrast with the bike's paint job. Since the receiver isn't hard to build, clubs could construct a number of these portables on an "assembly line" basis so that members could have matching portables when the group goes on bike jaunts together. We are willing to bet that once you start the fad, other groups will be following suit in short order.

If you don't want to mount the bike radio permanently, you can carry it in your bicycle basket. You will find that the completed receiver makes a compact and handsome portable you will be proud to use anywhere!

For trouble-free performance the author suggests that the novice builder duplicate the instructions and dimensions given in the mechanical diagrams exactly. Those with a little more experience in building electronic gear can take some liberties with chassis layout and cabinet size and shape. END

**← Fig. 10. (Top) Mechanical details of the chassis layout. A standard chassis base is used. (Bottom) Front panel layout. Take care not to mar the finish while drilling.**



The home-made studio at Boone (N.C.) High School. The egg crate separators break the room sound, providing "broadcast" quality.

# STUDIO FROM EGG CRATE SEPARATORS

By JOHNNY COREY

**C**OST-FREE egg crate separators, linoleum seal, and carpet tacks are all the "equipment" needed to provide acoustical treatment for a room used as a broadcast "studio"—at least that is all an ingenious group of teenagers at Boone, N. C. high school required to fit out a studio in their school building.

Unable to buy expensive acoustical materials, two teachers, Merrill Snyder and Bill Ross, and several students, tacked over 760 molded egg crate separators to

the walls and ceiling of the 7 by 15 foot room.

Programs from this improvised "studio" have almost broadcast quality, according to Boyd Dougherty, station engineer at WTAR, the outlet that airs the programs.

A 600-ohm line hooks up the school studio directly with the radio station, enabling the students to send out live programs of their activities to the community.

This same technique can be used in ham shacks and home recording studios. **END**

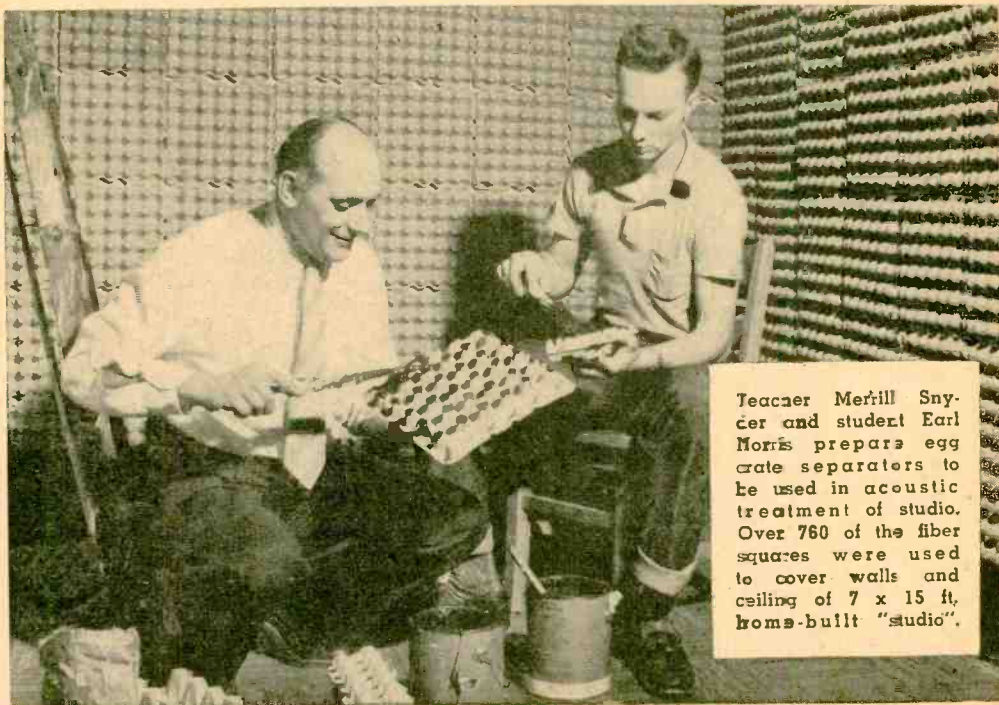

Teacher Merrill Snyder and student Earl Morris prepares egg crate separators to be used in acoustic treatment of studio. Over 760 of the fiber squares were used to cover walls and ceiling of 7 x 15 ft. home-built "studio".



G. L. Pearson, D. M. Chapin, and C. S. Fuller of Bell Labs checking sample devices for amount of electricity derived from "sunlight" (lamps).

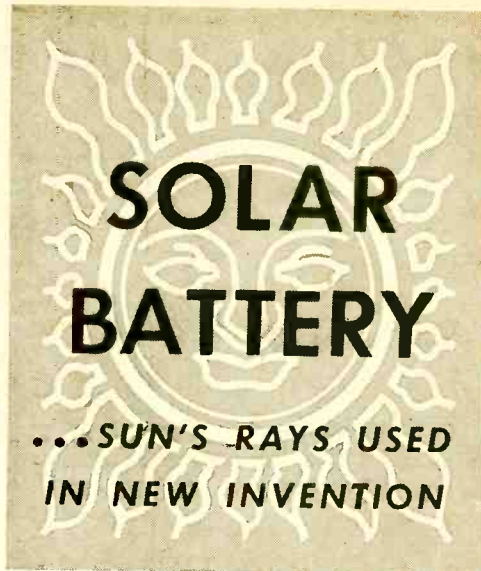

**T**HE universe's greatest source of potential power—even greater than the atom—has been harnessed experimentally and offers great promise for future commercial applications.

A solar battery, the first successful device to convert useful amounts of the sun's energy directly and efficiently into electricity, has been demonstrated by the *Bell Telephone Laboratories*.

With an amazingly simple-looking apparatus made of strips of silicon, the scientists demonstrated how the sun's rays could be used to power the transmission of voices over telephone wires. These strips are extremely sensitive to light. Linked together electrically, they can deliver power at a rate of 50 watts per square yard.

According to the *Laboratories*, it is possible to achieve 6 per-cent efficiency in converting sunlight directly into electricity. This compares favorably with the efficiency of steam and gasoline engines in contrast with other photoelectric devices which have never been rated higher than about 1 per-cent.

With improved techniques, the *Bell Laboratories'* scientists expect to be able to increase this efficiency substantially. Nothing is consumed or destroyed in the energy conversion process and there are no moving parts so, theoretically, the solar battery should last indefinitely.

The specially prepared silicon used is obtained, originally, from common sand, one of the world's most abundant ma-

terials. Silicon is a semiconductor, chemically related to germanium, the material used in most transistors. Silicon has a much greater electronic stability at higher temperatures than other semiconductors.

Although work is still in the laboratory stage, actual use of the solar battery in telephone work is a strong possibility. For example, silicon solar batteries might be used as power supplies for low-power mobile equipment or as sun-powered battery chargers which could be used at am-

**The solar battery, composed of strips of specially prepared silicon, has been used to power transmission of voices over telephone wires.**

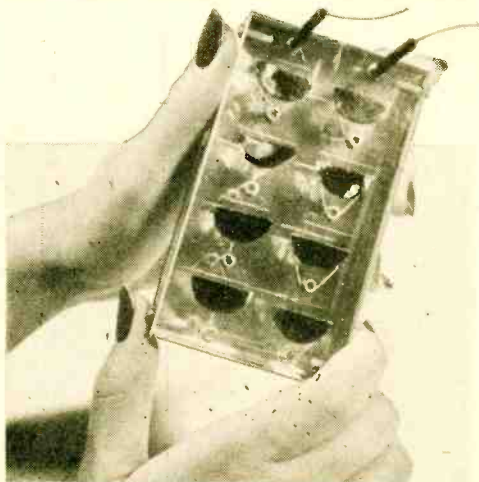



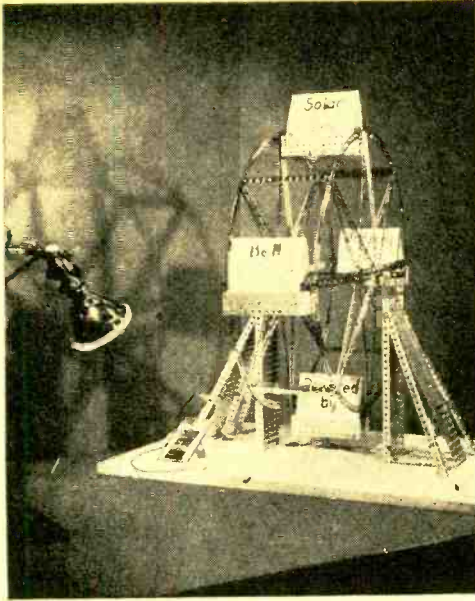

A toy ferris wheel which receives its power from light falling on a tiny piece of silicon. It was used to demonstrate principle.



Sunlight provides the power to turn this motor-driven wheel held by D. M. Chapin, one of the three inventors of the Bell solar battery.

plier stations along a rural telephone system such as that now being tested at Americus, Georgia. This system, using transistors, points to greatly increased service on rural telephone lines without the addition of new wires.

Although the sun supplies over a thousand trillion (1,000,000,000,000,000) kilowatt hours of energy daily—comparable with all the reserves of coal, oil, natural gas, and uranium found on earth—man has never been able to convert more than

Detailed and close-up views of the razor-blade-sized silicon strips. The strips are connected in series in device shown here.

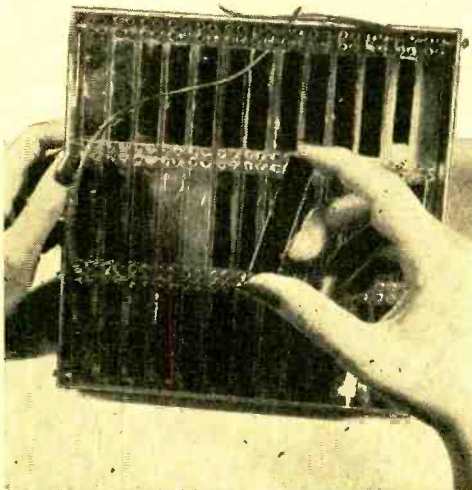

a small fraction of this energy directly to his use.

### WADC Engineers Also Convert Sun's Energy Into Electricity

**A**NOTHER successful attempt at converting light into electrical energy has been reported by the Wright Air Development Center in Ohio.

Their method differs from that of the *Bell Labs* development in that cadmium sulfide was used in place of silicon. Donald C. Reynolds and Lt. Col. Gerard M. Leies discovered the excellent properties of this substance while collecting data for rectifiers.

The barrier layer cell, as developed by the WADC scientists, consists of cadmium sulfide processed into crystal form. The crystal used in the first model was about the size of a sugar cube but it need be only wafer thin to work efficiently.

Although the first model was crude, the inventors foresee that with several improvements and by hooking a number of the units into relays it is possible to step up the voltage to unlimited quantities. According to their report, the conversion powers are so great that a wafer-thin slab of crystal, 4 ft. x 15 ft., either resting on or built into the roof of a house, could supply enough current to operate all the lights, stove, refrigerator, and other appliances in the house—24 hours a day. END

# BUILD YOUR OWN FIRE



**A FEW CENTS** a year pays for the power this alarm consumes while standing guard duty. It is intended for power-line operation and draws approximately 50 milliwatts (.05 watt). Simply as a comparison, this unit could be operated continuously for 1000 hours yet cost no more than operating a standard 60 watt electric light bulb for one hour.

Its design is relatively simple, consisting of one tube, a relay, a bell transformer, and a few additional miscellaneous components. Its operation is based on the use of detector links made of a low-melting-point alloy. In operation, a number of these detector links are placed throughout your home—in the attic, basement, or garage—and, when wired in series, form a closed circuit. When the heat of a fire melts any one of the alloy links, the circuit is broken, tripping the relay in the unit, and setting off the alarm system. Once the alarm is set off, it will positively lock; thus a continuous alarm is given until reset by momentarily disconnecting the power cord. A normally-closed switch could be included in your power-line circuit to reset a unit that has been permanently wired to the power line.

The control unit photographed was built into a 2" x 4" x 4" aluminum chassis box. Actually, any size cabinet could be used. Make sure that all the parts used are the same as those specified in the parts list. If a very long detector line is used, it may be necessary to change the value of resistor  $R_2$ . This can best be done on a trial and error basis.

- $R_1$ —4.7 megohm,  $\frac{1}{2}$  w. res.  
 $R_2$ —2.2 megohm,  $\frac{1}{2}$  w. res.  
 $C_1$ —8  $\mu$ d., 250 v. elec. capacitor  
 $SR_1$ —40 ma. selenium rectifier. (Precision Rectifier NTS-40. The one shown in the photograph is no longer available. The NTS-40 specified has the same electrical specifications but is physically smaller)  
 $T_1$ —Bell transformer  
 $RL_1$ —S.p.s.t., 5000 ohm relay (Advance "Tiny-Mite")  
 $I$ —1C21 tube

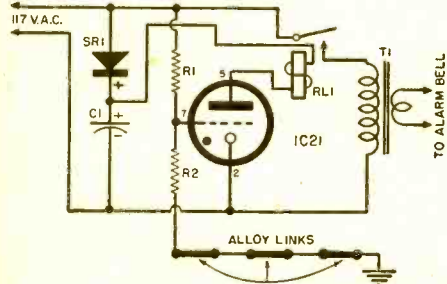

# ALARM

By RICHARD SANDRETTO



As mentioned previously any number of detector links can be hooked up in series, with one end grounded by clamping it to a cold-water pipe. The detector links are short pieces of low-melting-point alloy such as Woods metal (160 degrees F.) that are placed in key locations like rafters, etc. One way to obtain this alloy is to buy several automatic sprinkler links. In these the alloy is sandwiched between layers of common metal. Use a soldering iron to melt the alloy out and shape it into small narrow bars. Mount each alarm link so that the electrical connection between its ends will be broken when the alloy melts. It is suggested that connections between the links and insulated hook-up wire be made with small alligator clips.

After the wiring is completed and the detector circuit hooked up, connect the unit to the power line.

One word of caution, the power cord must be inserted so that the grounded side of the power line goes to the tube cathode. Should the alarm be set off when plugging the unit into your power line, reverse the position of the plug. Other causes of improper operation could include a poorly grounded detector link circuit and the need for a slightly lower value for resistor  $R_2$ .

The fire alarm unit will not operate if your home power fails. To eliminate this possibility, you could operate the unit direct from dry batteries in which case the rectifier, capacitor  $C_1$ , and transformer  $T_1$  could be omitted. Battery operation offers the advantage of complete independence from the power lines. **END**

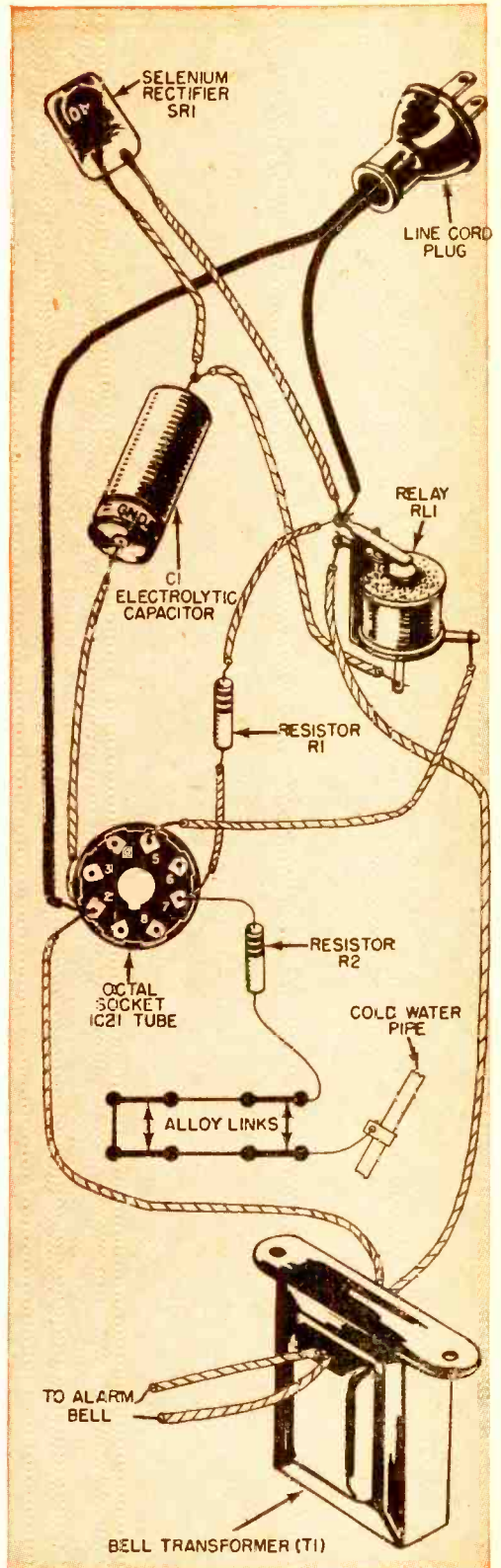

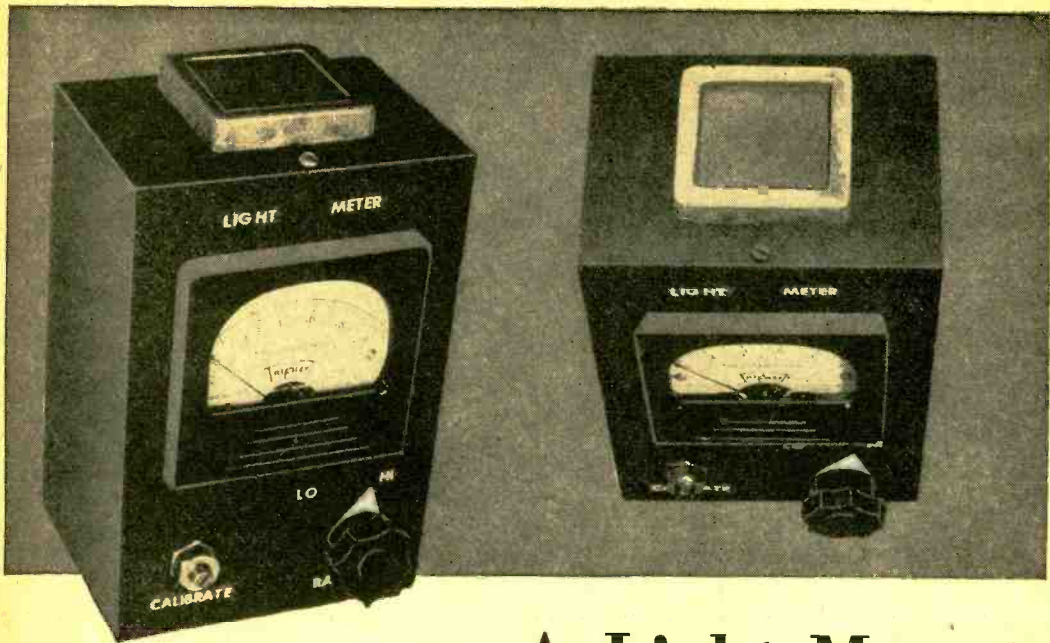

## A Light Meter

A LIGHT meter is invaluable for measuring illumination levels in the home, office, or factory—and outdoors as well as indoors. It can be used, with proper calibration, as a photographic exposure meter and also in conjunction with enlargers and printing boxes in the darkroom.

The basic light meter circuit consists of a self-generating photocell connected in series with a d.c. microammeter. When the photocell is exposed to light, it generates a small direct current which deflects the meter in proportion to the amount of light received. No batteries or tubes are needed.

Most professional light meters are both delicate and expensive because of the sensitive microammeters employed. The instrument shown here is able to use an inexpensive 0-1 d.c. milliammeter by employing a high-output photocell. The cell is an *International Rectifier Corp.* Type DP-5, which is designed to supply relatively high d.c. output to a low-resistance load such as a 1-ma. meter. With this photocell, about 150 footcandles will deflect a 55-ohm, 1-ma. meter to full scale. The cell is 2 inches square.

This light meter is light in weight and can easily be held in the hand when necessary. A smaller-sized instrument can be made by using a 1- or 2-inch meter.

The unit is built in an aluminum radio chassis box, 6" long, 4" wide, and 3" deep.

A s.p.d.t. wafer-type switch (*S*) is provided for two sensitivity ranges. In the

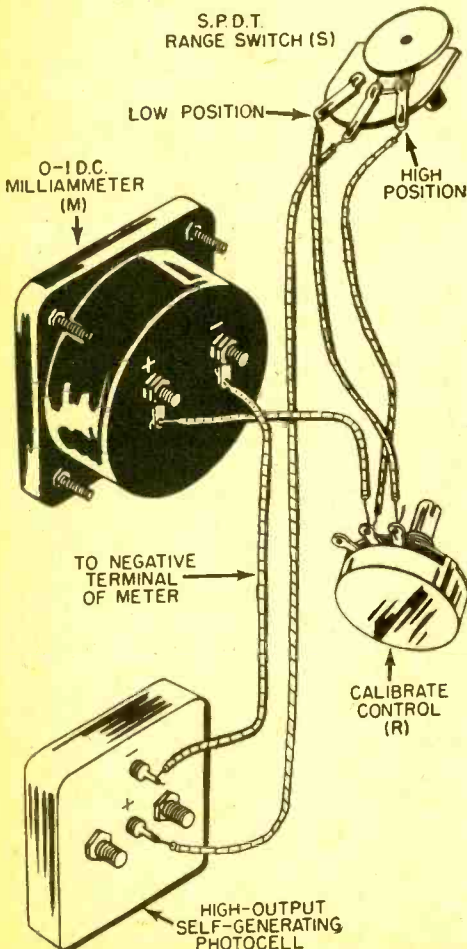

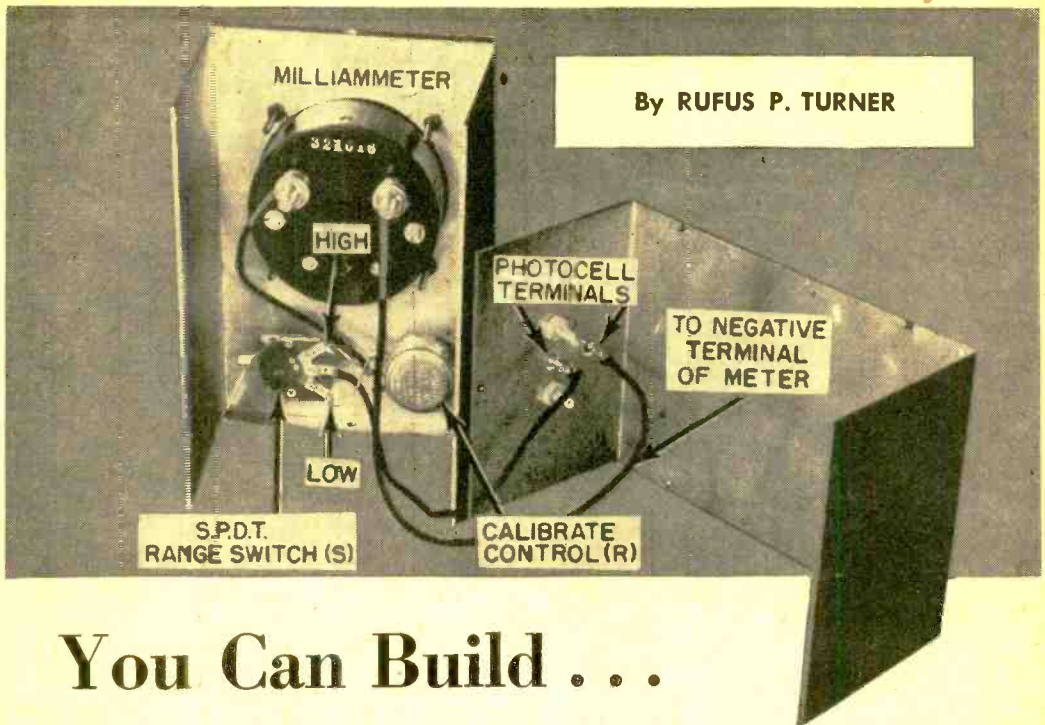

By RUFUS P. TURNER

## You Can Build . . .

high position of this switch, the photocell is connected directly to the milliammeter (*M*). Very little light then is required for full-scale deflection. In its low position, the 1000-ohm radio volume-control-type rheostat (*R*) is switched in series with the cell and meter, so that higher illumination levels can be accommodated by the same meter.

The rheostat shaft is slotted for screw-driver adjustment and provided with a shaft-locking nut to prevent accidental movement, once it has been adjusted.

After the light meter has been wired, set switch *S* to its high position and point the cell toward a source of light. This can be a lamp or a window opening toward daylight. Adjust the amount of light reaching the cell by moving the instrument toward or away from the source of illumination until the meter reads exactly 1 ma. Now, without disturbing the position of either the instrument or the light source, throw switch *S* to its low position

and adjust rheostat *R* for half-scale (0.5 ma.) deflection of the meter. Tighten the rheostat shaft lock. This completes the adjustment.

The meter scale may be calibrated directly in footcandles, for each range of the switch, by comparison with another light meter or photographic exposure meter (such as *General Electric Mod. 8DW58Y4*) having a similar calibration. The two instruments must be placed close together and pointed toward the same light source.

As shown in the diagrams and photographs, this device is simple, compact, and easy-to-build. If the constructor lays out his cabinet carefully and proceeds slowly, there is no reason why "professional" looking equipment which gives "professional" performance shouldn't result.

The diagram on the opposite page clearly indicates how the various components are to be hooked up. Note that the *polarity* (+ and -) is marked on some of the terminals. These indications must be observed in order for the device to operate properly. There is the added danger that the meter might be burned out if the circuit is hooked up "backwards."

The time and effort involved in building a light meter are returned a hundredfold. You can have many hours of enjoyment from this simple device and the added satisfaction of knowing you have built a valuable instrument.

END

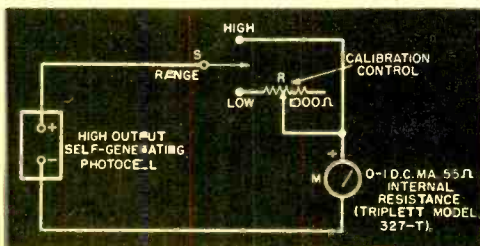

This is what you find when you open the box of the Heathkit A-7B audio amplifier: instruction book; bag containing resistors, capacitors, hardware, wire, etc.; tubes; punched and formed chassis; power transformer; control panel; filter capacitor; and output transformer. Check the parts.

# Hi-Fi

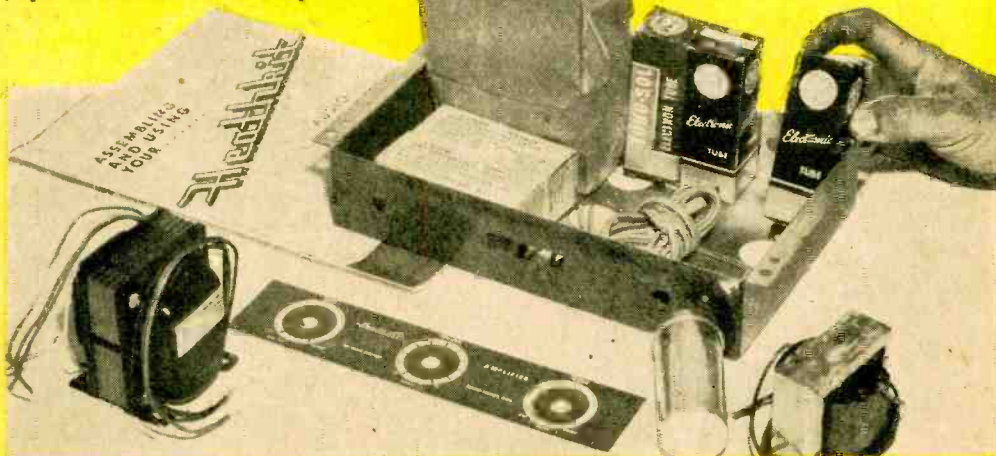

Underchassis view after "fixed" components are mounted. Wires at top are from output (left) and power transformer (right).

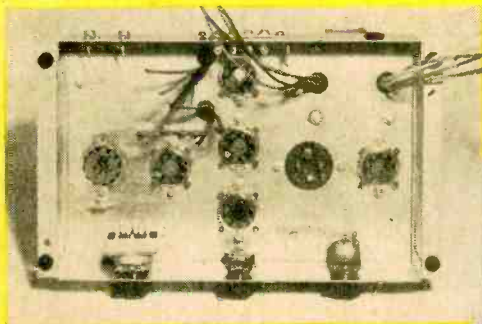

Note how leads from output transformer are cut and connected to strip. Power transformer leads go to the tube sockets.

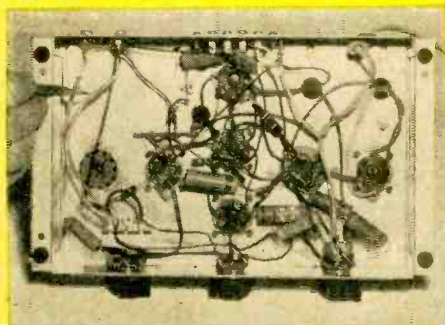
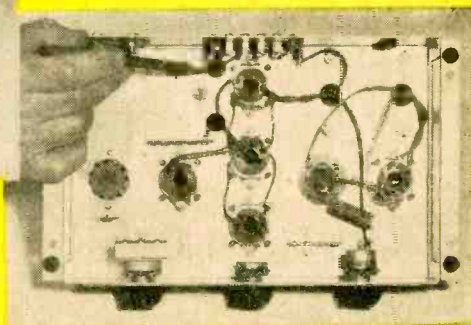

Chassis completely wired. Leads are short, direct. Note shielded input leads which are isolated to help minimized hum pickup.

Inserting tubes is final step. Blank tube socket (right) is for optional preamp. Unit is now ready for an initial trial run.



at low \$\$\$ \$ \$ \$ \$ \$ \$ \$

**I**F YOU'RE interested in high-fidelity reproduction of radio and record music—and who isn't these days?—maybe you've been investigating prices and have been somewhat shocked by them. You may have learned, for instance, that just an amplifier alone costs more than you paid for the big console radio up in the living room. Of course, there's a difference in the size and quality of the component parts, but perhaps the price differential strains your budget, and makes you dubious about the whole subject of hi-fi.

There's a simple, easy, and economical way out: Assemble your own basic amplifier from a kit. Not only will you save considerable money, but your enjoyment of the music will be doubled by the knowledge that you did the job yourself. Audio amplifiers are particularly rewarding projects because they are reliable and virtually foolproof and require no finicky tuning or alignment. If you wire one correctly, it will work properly the first time you turn it on.

A small amplifier naturally costs less than a big one. If you don't want to shatter the windows or entertain all your neighbors within a half-mile circle, you will find a modest 6-watt unit entirely adequate and satisfactory. Even with this "small" amplifier, that is, "small" compared with 20- or 30-watt jobs, you can't possibly turn up the volume to the maximum position and stay in the same room

with the loudspeaker. For comfortable listening under normal home conditions, you'll probably use only a fraction of its power capability.

After assembling the *Heathkit* Model A-7B amplifier shown in the accompanying pictures, I tried it alongside a commercial amplifier that cost more than six times as much and that had better remain nameless in this article. Switching the same loudspeaker quickly back and forth between the two units, I must confess that it was difficult to tell which one was in the circuit. The difference was not appreciable until the volume was advanced to the point where the curtains in the room started to shudder.

The Model A-7B is a straightforward 6-tube amplifier having excellent frequency response and a rated output of 6 watts. It uses a push-pull output stage and a husky output transformer. It will operate from a radio tuner, a tape recorder, or a phono pickup of the ceramic or crystal type. It has effective bass and treble tone controls that enable you to alter the reproduction to suit your taste. Initially, you'll undoubtedly jiggle these controls a lot, but eventually you'll leave them alone and be satisfied to hear a soprano sound like a soprano and not like a basso profundo.

By  
**ROBERT HERTZBERG**

Does it work? The best way to find out is try it. Here is amplifier hooked up to tuner and a large-sized loudspeaker unit.

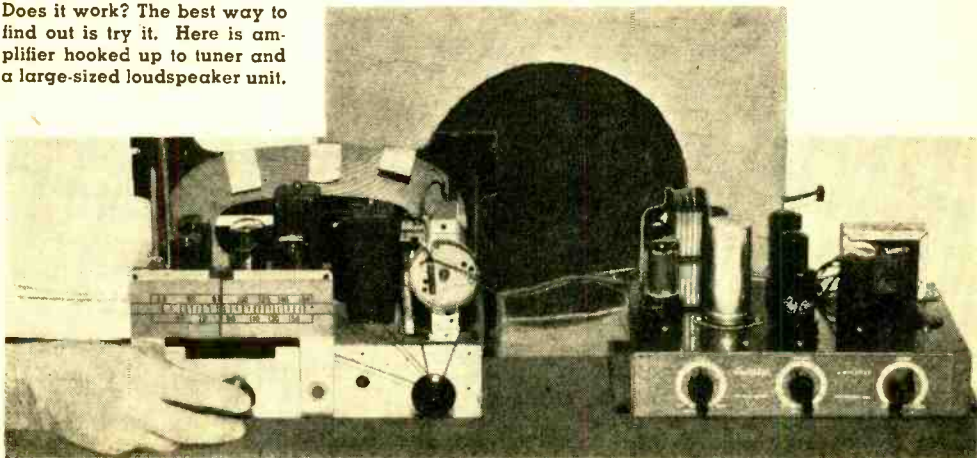

The chassis of the amplifier has a blank tube-socket hole. When this is filled with another tube, the unit is suitable for use with reluctance type phono pickups, which require the additional amplification provided by the extra tube. You can add this preamp stage any time, or you can buy the amplifier complete with it as the Model A-7C kit.

Assembly of the kit is a "nut-and-bolt job." The various resistors and capacitors that comprise the amplifier circuits are soldered in place by means of their own pigtail leads. About the only point to watch is lead dress. Make the connections as short and direct as possible. Separate them in depth as much as the chassis permits, and make them cross at right angles to minimize coupling effects. You should be able to do the assembly and about half the wiring in one evening after supper, and finish the job the next evening, or if you feel ambitious you can knock it off complete on a rainy Sunday afternoon. **END**

## "UNIVERSAL" BREADBOARD CHASSIS FOR EXPERIMENTERS

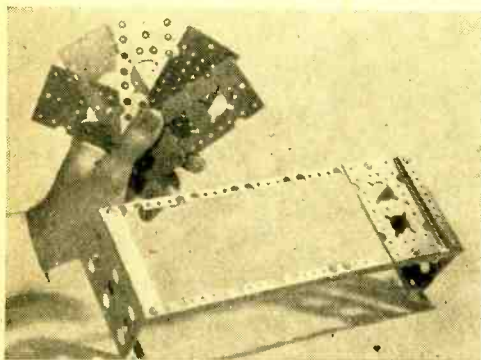

## TRANSISTOR EXPERIMENT KIT

**T**HE development of the transistor has opened whole new fields of electronics to the experimenter. These tiny, low-powered components make possible the construction of subminiature equipment of all types.

*Sutton Electronic Company* of Lexington, Ky. is now marketing a new transistor experiment kit which allows users to build twelve different fundamental circuits, using transistors. An additional fourteen circuits can be built by adding components to the kit.

The kit consists of a specially-designed chassis on which is mounted the necessary components to build the fundamental circuits. Two manuals come with the kit—one providing general information on transistors and the other giving details on the experiments that can be performed with the kit.



## "PORTABLE" TV RECEIVER

**F**OR those who like their television wherever they go, *Majestic Radio* has come out with a lightweight "Port-A-Vision" TV set which is housed in a luggage carrying case, with leather handle and controls on top of the case.

The unit weighs only 39 pounds and uses a 14" picture tube. Over-all dimensions are 12½" high, 15" wide, and 18½" deep.

**E**LECTRONIC projects of all types will go faster and look neater with the "universal" breadboard circuit chassis recently introduced by *Allen B. Du Mont Labs., Inc.*

The new "breadboard" and its component parts accommodate a complete variety of components without the need for a single power tool. It promotes neat wiring above and below the chassis, facilitates rapid modifications on circuit components, simplifies circuit layout, and provides prototype wiring for the design of printed circuits.

The foundation kits include a complete assortment of all components.

## NATURE ON THE LOOSE

**D**A<sup>M</sup>E Nature springs all sorts of surprises. One of the most unusual came to light recently when engineers were seeking the cause of interference on a radiotelephone line on Vancouver Island.

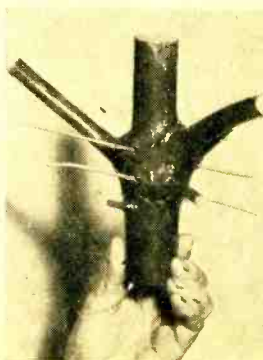

An innocent-looking arbutus tree, behind which the wires seemed to pass was, in reality, growing completely around the wires. During wet weather, the saturated wood caused the wire's resistance to change . . .

. . . F. Dickie.





The small radar unit is compact enough to fit into the cockpit of a motor cruiser.

# RADAR FOR SMALL BOATS

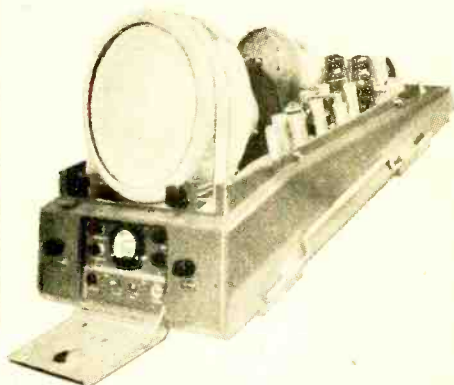

Close-up view of "Mariners Pathfinder" radar unit with the chassis cover removed.

**YACHTSMEN**, fishermen, and other small boat enthusiasts can now have radar protection—thanks to a scaled-down, moderately-priced unit being marketed by *Raytheon* as its "Mariners Pathfinder" Model 1500.

The compact "all-seeing eye" has all of the essential features of its bigger brothers. It is capable of penetrating darkness and fog to spot objects and navigational hazards at points ranging from a few yards' distance up to 16 miles away.

The Model 1500 radar unit. Skipper points to meter used to test circuit condition.



The unit installed on a tug for harbor navigation. It can also be used on liners.

# Home-Built Loudspeaker Enclosure

By ABRAHAM B. COHEN  
University Loudspeakers, Inc.

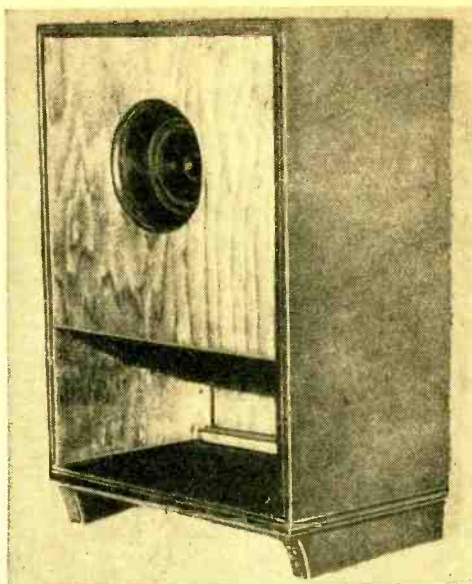

Designed and tested by University's engineers, this cabinet is a "natural" for the home carpenter. It is not available in commercial form.



**I**F YOU are handy with tools and have had a little woodworking experience, you can build an excellent, thoroughly-tested enclosure to house your loudspeaker at a very moderate cost.

This enclosure is designed to be used with 8" loudspeakers. Although it does not provide true high-fidelity reproduction since no single speaker possesses the ability to cover the frequency range demanded of a hi-fi system, it does provide excellent quality within the range of 100 to 10,000 cps. It drops off rapidly beyond these limits.

Construction of this cabinet is not difficult. While a bench saw will speed the job this cabinet can be built using an ordinary handsaw. Use a carpenter's square to insure that all panels are squared up properly. Follow the mechanical drawing on the opposite page. Be sure all sections fit snugly and are firmly screwed and glued.

The entire upper portion of the enclosure is lined with *Kimsul* insulation to provide the necessary internal damping. This ma-

terial is used by the building trades and should be available at your local lumberyard or building supply firm. If you can't get *Kimsul*, rockwool, cotton batting, or *Fiberglas* can be used.

The grille cloth which covers the speaker opening should be selected on the basis of acoustic transparency rather than artistic appearance.

Note that  $\frac{3}{4}$ " plywood is specified for all but the reflector panel. Remember that the thicker the wood and the more rigid the construction the better the performance. The type of plywood used will depend on the finish desired on the completed enclosure. If the cabinet is to be painted or covered with leatherette, inexpensive fir or pine plywood can be used. If a furniture finish is the goal, an oak, mahogany, or walnut plywood should be used.

While the finished cabinet represents quite a few hours' work, the excellent results obtainable from this enclosure make the project truly worthwhile. **END**

Frequency response of the enclosure using a "Diffusicone-8," 8-inch speaker. This curve is presented for the benefit of those desiring such data on their cabinets.

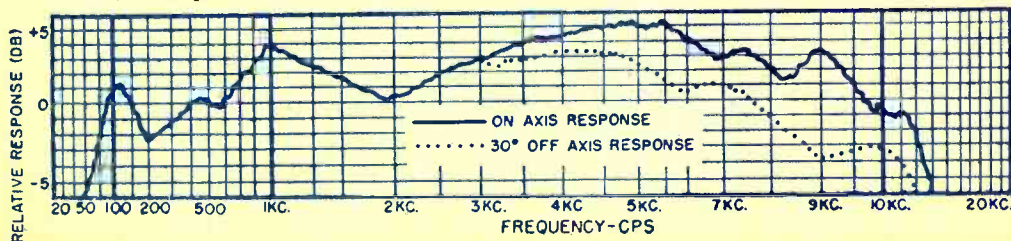

Mechanical details of cabinet construction. The original design was based on the use of the University 'Diffusicone-B' speaker. It is fundamentally a bass reflex cabinet with a horn flare. Dimensions for the legs are not given and can be designed to suit the builder.

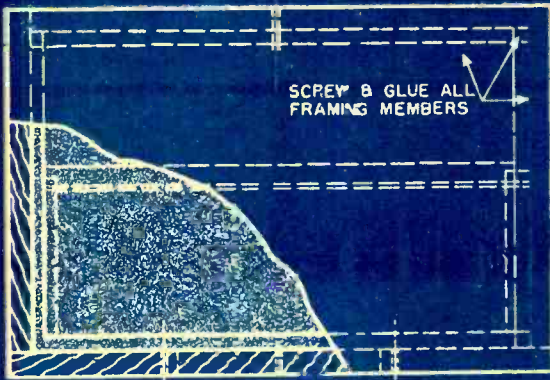

LUMBER BILL OF MATERIAL		
PANEL	QTY	SIZE
A	1	18" x 15 3/4" x 3/4"
B	2	23 1/2" x 12" x 3/4"
C	2	18" x 12" x 3/4"
D	1	23 1/2" x 16 1/2" x 3/4"
E	1	16 1/2" x 6 3/4" x 1/2"

18"

PANEL "C" (TOP & BOTTOM)

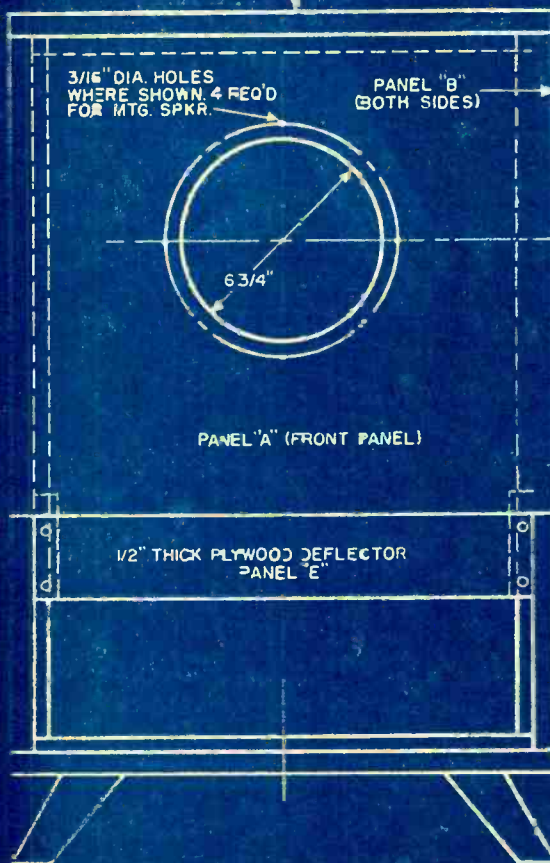

REMOVABLE BACK PANEL SECURE WITH (10) #8 X 1 1/4" WOOD SCREWS. LINE INNER SURFACE WITH "KIMSUL"

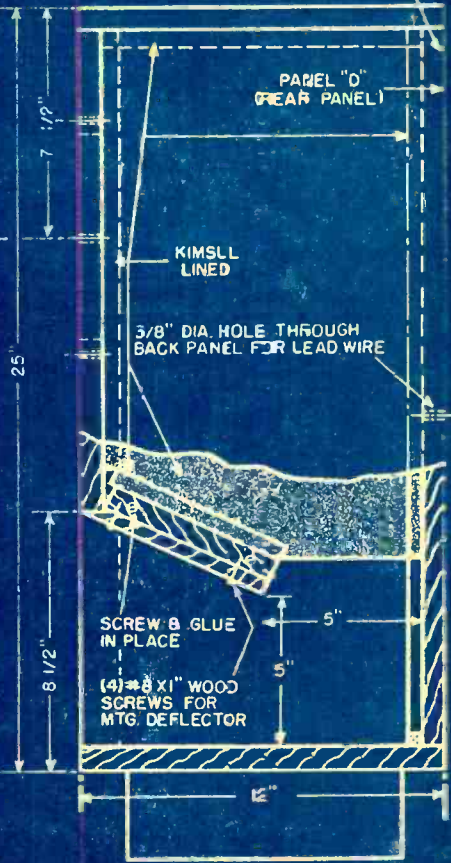



Manufacturer's control guides or handbooks are of help in selecting a proper replacement and in determining approximate resistance needed if you don't have the schematic of your set.



## How to Test and Replace

By H. LEEPER

MODERN receivers contain many different controls, any of which can cause trouble. Here are hints for testing and changing these components—operations that can be performed by the set owner himself.



A typical volume control with the cover removed to show the sliding arm and circular contact. Dirt often appears between the arm and contact ring, resulting in noisy reception.

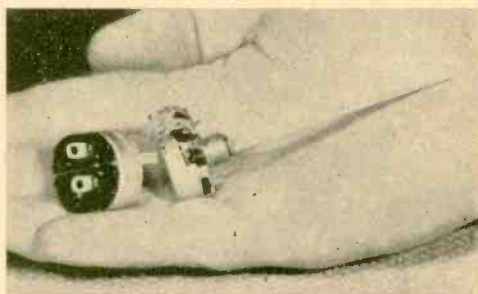

Most radios and TV sets have "on-off" switch attached to and operated by the volume control shaft. The switch section fits over back of control after the cover plate has been removed.

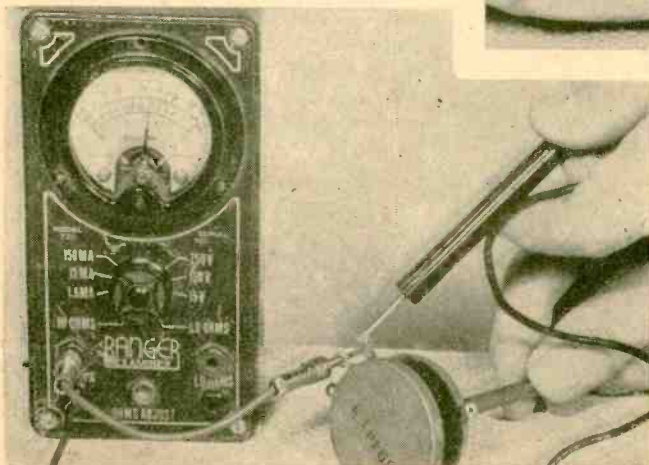

By disconnecting the suspected control from its circuit, with receiver inoperative, an ohmmeter may be connected from middle terminal to first one and then other terminal and by moving the shaft slowly, operation of control can be checked.

POPULAR ELECTRONICS

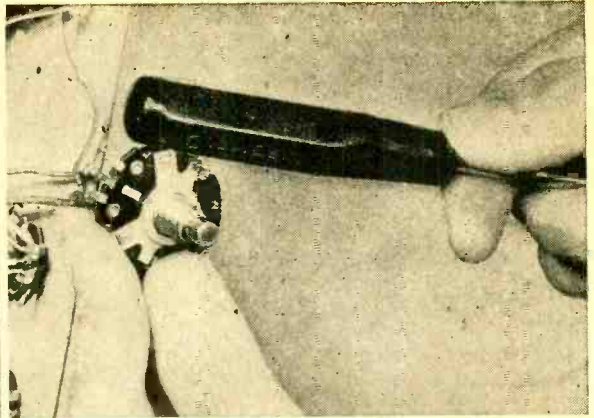
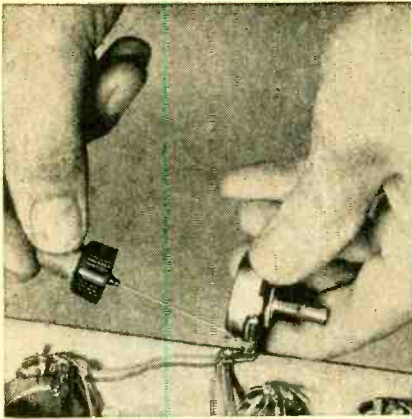

(Left) Before changing a control try a drop of contact cleaner. This fluid may be inserted where there is an open place or allowed to slide down the shaft. This is usually a temporary expedient. (Right) Another technique that produces the same results is tapping the control case with a hard rubber tool, as shown.

## Radio and Television Controls

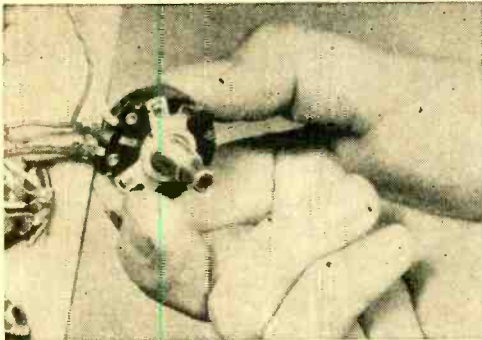

For a permanent repair, it is best to install a new control. After obtaining the correct replacement, loosen mounting nut and permit control to hang. Use it as gauge to cut new shaft.

Extension shafts are available for the various radio and TV controls if need arises.

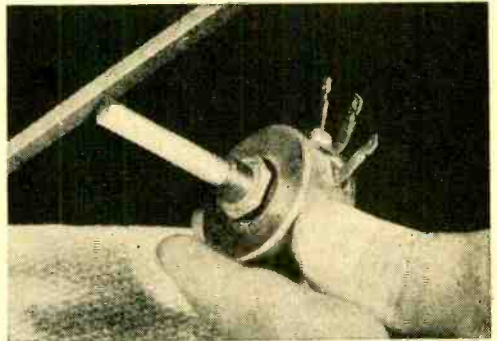
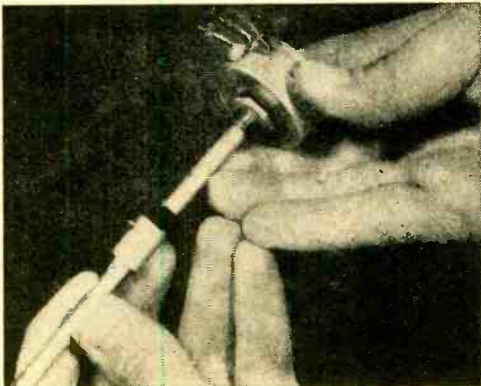

Any saw burrs on the new shaft should be filed off. Wires may be shifted one at a time from old to new control or a sketch of the original wiring may be made before removal of control.

Some controls have round shafts, others are ribbed or split (as shown). In latter case knob adjustments are made by adjusting gap.

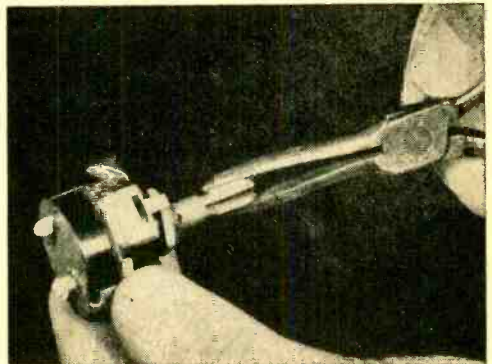

By JOHN T. FRYE



## A NEW COMPANY IS LAUNCHED

JERRY BISHOP was in his basement "laboratory," but the teenager was not exactly laboring. Instead, with his well-padded frame stretched out comfortably on a leather couch, his dark crew-cut pillowed on his clasped hands, and his round face staring vacantly up at the ceiling, he was listening blissfully to Patti Page inviting him to "Cross Over The Bridge." The invitation was being issued by a spinning record on a player resting on the floor beside the couch. The throbbing volume that issued from a speaker cabinet in the corner was just barely below the threshold of pain.

Suddenly, riding over Patti's dulcet tones, there came a strong youthful voice saying with great deliberation, "One, two, three, four test. This is W9EGV testing. One, two, three, four."

Jerry was a firm believer in the conservation of energy; so it was strictly in character that his only immediate reaction to this surprising development was to bat his eyes rapidly like a toad in a hailstorm and continue to listen. Only after the voice continued its rude accompaniment of the singer, now and then alternating the counting and alphabetical-numerical mumbo jumbo with shrill whistles such as one uses in calling a dog, did the boy finally turn over on his side and experimentally lift the needle from the record. As he did this, the singing stopped abruptly; but the strange voice went right on proving it could count—at least as far as four.

"It's not on the record," was Jerry's brilliant muttered deduction. He heaved himself to his feet and walked over to the phono-amplifier sitting on a workbench and turned it off. The voice dropped in volume, but it did not disappear. Instead its source switched from the speaker to the open basement window.

Determined to get to the bottom of the mystery, Jerry padded up the outside basement steps and stood in the back yard

listening. The voice clearly came from an open upstairs window of the house next door, a house into which new neighbors had just moved the day before. As Jerry stared upward, debating his next move, a boy's reddish-tinged curly blond head popped out of the window. He was holding a microphone in his hand and was looking upward at a wire that ran from the top of the window frame to a tree back near the alley.

"Hey, you, what do you think you're doing?" Jerry demanded.

The head in the window turned and stared disinterestedly down at Jerry with a pair of bright blue eyes behind horn-rimmed glasses.

"I don't 'think'; I *know* what I'm doing," the boy in the window replied coldly. "I'm seeing if my amateur transmitter will load up this new antenna I've put up."

"As loud as you were yelling, you wouldn't need a transmitter," Jerry observed tartly.

"I wouldn't have to yell if some dope wasn't running his platter-player wide open. Was that you?"

"Never mind that," Jerry said hastily. "What I want to know is how come I'm picking up what you say into that microphone on my record player?"

"Are you?" the new boy said with quick interest. "Wait a minute and I'll be over."

In a few seconds he burst out the back door and vaulted easily over the low fence between the yards. His tall, lean, well-muscled figure was clothed in a pair of baggy-pocketed army fatigue pants and a torn sweat shirt.

"My name's Carl Anderson," he offered. "Guess we're neighbors. What's your handle?"

"Handle?" Jerry repeated with a puzzled look.

"Sure; I mean your name. That's ham talk."

"Oh, I'm Jerry Bishop. Come on down into my lab, and I'll show you the player."

As the two boys stepped inside the basement door, Carl stopped and took a searching look around. The first thing that caught his eye was the fine wide workbench that ran clear across one end of the room. On a board above the bench was a miscellaneous collection of hand tools. Carl walked over and disapprovingly ran a finger along the edge of a snaggle-toothed handsaw and inspected a pair of screwdrivers with broken, twisted bits and battered handles. Then he turned his attention to the amplifier sitting on the end of the bench and followed with his eye a long line from the amplifier to the record player sitting on the floor by the couch across the room. Another line went from the amplifier to what looked as though it might be a birdhouse for an ostrich sitting over in a corner of the room.

"That's my bass-reflex cabinet," Jerry announced. "I built it myself."

Carl walked over to the crude speaker cabinet and examined it closely.

"Did you really manage to saw those boards that crooked or have you got a pet beaver that gnaws them off like that?" he inquired disparagingly.

"So I can't saw straight!" Jerry admitted with a good natured grin; "but take a listen."

As he said this, he turned on the amplifier. The whole basement was flooded with a sea of music. The volume was so great that the whumping of the bass drum actually made the tools jangle on the tool board.

Carl strode over and turned the volume down to a mere roar.

"It doesn't sound too bad," he grudgingly admitted, "but I'll never know why. I never saw a more haywire layout. That long lead from the player to the amplifier is what is picking up my signal. Wait until I get my solder gun and a capacitor and we'll see if we can cure it."

He took the cellar steps two at a time as he said this; and Jerry, exhausted by the sight of so much energy, sank back on the couch to await his return. He did not have long to wait, for in a minute Carl was back, carrying a device that looked like a Buck Rogers ray gun in one hand and a little brown Bakelite object with two wire leads coming out of it in the other. In a flash he had the amplifier turned over and was probing around in the wiring with the tip of the solder gun as he explained:

"The trouble is caused by the strong signal from my transmitter collecting on the input element of the first amplifier tube."

"You mean on the grid?" Jerry asked. Carl shot a surprised look at him and went on, "That's right. This strong radio frequency signal upsets the normal operating conditions of the tube and makes the amplifier act more like a radio receiver than a plain amplifier. I'm going to connect this small condenser—capacitor is a more accurate name—between the grid of the first tube and the chassis so that signals from my transmitter will be bypassed to ground—"

"And then," Jerry smoothly interrupted, "the grid will no longer be swung positive on peaks, grid rectification will stop, and the tube will cease to be biased by grid leak action to the point where it acts as a detector."

"Hey, where'd you learn that electronic jive?" Carl demanded. "You got a ham ticket?"

"Nope," Jerry answered, vastly pleased at the impression he had made on his new neighbor. "And don't be afraid I'll steal too much of your thunder." He walked over to a bookshelf on the wall that, in contrast to the workbench, was in perfect order. On it were a few books of elementary physics and several stacks of radio magazines.

"I get a large charge out of reading anything about electricity or electronics," he explained. "It just happens that the last issue of the magazines in this stack contained an explanation of how radio signals could cause interference to audio amplifiers; so that is why I had that one little item so pat."

"Well, all right," Carl remarked as he finished soldering in the capacitor and turned the amplifier on. "We hams get so used to people not understanding what we're talking about that it makes us feel funny when we hear a stranger spouting

*(Continued on page 120)*



# So You Want to be a Ham-

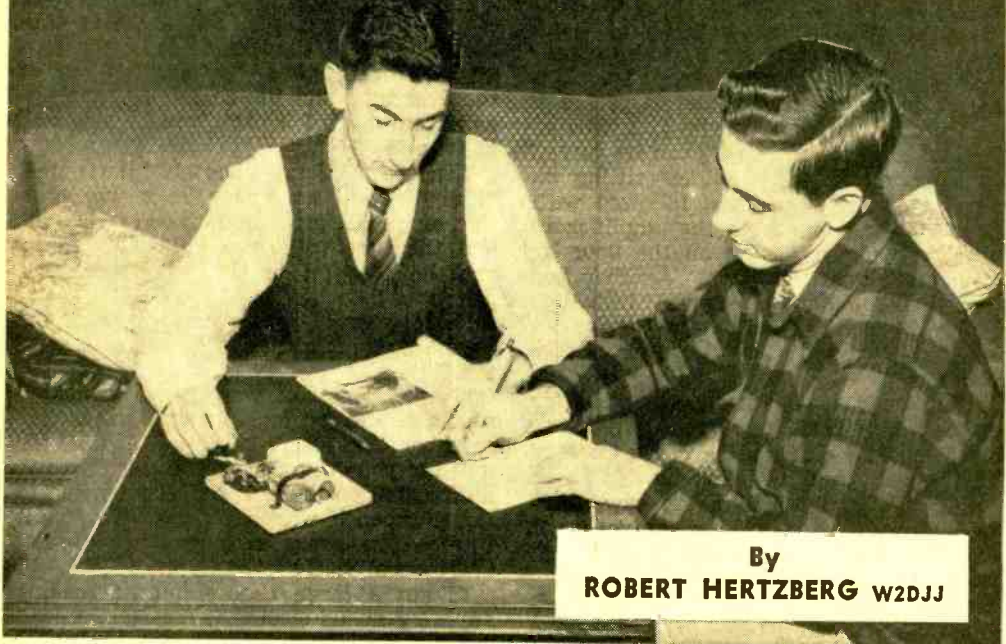

By  
**ROBERT HERTZBERG W2DJJ**

One of the first steps toward becoming an amateur is learning code. It can be done with equipment as simple as that shown.

*Part 1. One of the world's most fascinating hobbies knows no limits as to age, time, space, or physical condition.*

**T**HE greatest hobby in the world! That's what thousands of "hams" say about amateur radio. You too can get into it with only a small amount of preliminary study. After you qualify for an FCC license you can have a "fixed" station in your home or a "mobile" one in your car, or both. You will then enjoy thrilling two-way communication by code or voice, often over great distances. You will make lots of friends. You will learn a great deal about electronics. This knowledge will prove extremely valuable to you later in life, especially if you decide to go in for engineering.

What does amateur radio involve? That's a big question, and the easiest way to answer it is to break it into a series of little ones. Let's go!

*Q. Why do radio amateurs always refer to themselves as "hams"? To most people the term has an uncomplimentary meaning.*

A. No one knows. In the radio game it's been a term of distinction for almost half a century. When a man says, "I'm a ham," he speaks with pride in his voice.

*Q. What's the "FCC"?*

A. The Federal Communications Commission. This is a government body charged with the supervision of all radio, television, telephone, and telegraph services in the United States.

*Q. What sort of license must I get?*

A. There are five classes of ham licenses or "tickets": novice, technician, general, advanced, and amateur extra. The easiest one to get is the novice. To qualify for it, you must be able to send and receive the dot-and-dash characters of the International Morse Code at a speed of five words-per-minute and pass a written examination in elementary radio theory and FCC regulations. This license entitles you to operate a transmitting station on three different frequency bands using code, or



on one particular frequency band with voice. The novice class ticket is good for one year and is *not* renewable. At the end of the year you must qualify for a slightly more advanced license or go off the air. You don't have to wait out the year before applying for the second ticket; you can take the test any time you think you're ready for it.

*Q. How old must I be for an FCC license?*

A. There is no age restriction of any kind. Girls as well as boys are eligible.

*Q. What does a license cost?*

A. Heretofore radio licenses have been absolutely free of charge. However, by the time this article appears in print the FCC may have announced a scale of fees. At the most, the cost of a ham license probably won't exceed a couple of dollars.

*Q. How can I get a novice license?*

A. Novice and technician class licenses are now given *only* by mail, regardless of where the applicant lives. Write to the nearest FCC office (see accompanying list), and request the application blanks and tests. The papers will come in a sealed envelope, with detailed instructions. Read these carefully and *don't* break the seal. First, your code ability must be checked by an operator who holds a general class or higher amateur ticket, or within the last five years has been a commercial radiotelegraph operator or a radiotelegraph operator in the service of the United States. (This takes in military and naval personnel.) If this operator is over 21, he or she can open the sealed envelope, hand you the test papers, and then certify that you answered the questions by yourself. You seal the test papers and mail them off. If the operator is under 21, get a person of voting age to perform the second part of the act. He need not be a radio technician. His only function is to monitor the paper work.

*Q. How can I qualify for a general class license?*

A. If you live within 75 miles of an FCC

examining point, are in normal health, and can travel, you must report there in person and take the test under the supervision of an FCC engineer.

*Q. What can I do if I live more than 75 miles from an FCC office?*

A. You can take the general "conditional" class license by mail, under the same circumstances specified for the novice and technician type tickets.

*Q. Assuming I pass the code and written tests, when will I receive the actual license?*

A. Not for several weeks, as a minimum. The FCC is overloaded.

*Q. Suppose I flunk the test. Can I try again?*

A. Yes, but not sooner than thirty days. You can take the test any number of times, either by mail or in person.

*Q. I expect to be drafted soon, but I'd like to get my license so that I can operate a station if I'm sent overseas. Is there any way I can qualify?*

A. By all means try to get your license before your draft number comes up. All the services keep an eye open for hams and give them plenty of opportunity to apply their knowledge. Show your license the first time you appear before a classification officer, and the chances are 99% in your favor that you'll be assigned to signal communication or related duties. If you are drafted before you are ready for your FCC test, you can take it by mail, regardless of where you are stationed. With your request to the FCC for the mail forms, send along a letter from your commanding officer certifying that you are in military service and unable to appear in person. You'll have little difficulty finding someone to give you the test. Ham clubs and big ham stations are common at military installations, and you'll meet plenty of kindred souls there.

*Q. A friend of mine is bedridden with polio. Ham radio would be wonderful to keep him occupied. How can he meet the FCC requirements?*

Partial listing of regional offices of the Federal Communications Commission.

Tests for the "general class" license are given not less than four times a year at about 60 regional offices of the FCC. In cities like New York, Chicago, Boston, Los Angeles, etc., they are held every day. No matter where you live, you can take the exam at any FCC office you happen to be near. Tests may be given in some remote areas only once or twice a year. To check on dates and locations where tests will be given, write Engineer-in-Charge, Federal Communications Commission at any of the following cities:

Boston	Miami	Portland, Ore.	Detroit
New York	New Orleans	Seattle	Buffalo
Philadelphia	Houston	Denver	Honolulu, T.H.
Baltimore	Dallas	St. Paul	San Juan, P.R.
Norfolk, Va.	Los Angeles	Kansas City, Mo.	Juneau, Alaska
Atlanta	San Francisco	Chicago	Washington, D.C.

A. Very easily. Regardless of where he lives, he can take the mail test if his request for it is accompanied by a doctor's certificate that he is unable to travel. Special provisions are even made for the blind.

Q. *I'm brand-new to amateur radio and don't know any local hams. If I want to take the mail examination, how do I find the necessary licensed operator?*

A. Look in your local newspaper for announcements of meetings of ham clubs. Amateurs are known to travel hundreds of miles at their own expense to help newcomers. Ask the science teacher in school. Inquire at nearby veteran organizations like the American Legion and the Veterans of Foreign Wars. Try the nearest Boy Scout headquarters. As a last resort, you can write to the FCC and ask them to designate someone within reasonable distance.

Q. *Must a beginner start with the novice class license and then work up.*

A. No. With a little more study than the novice license requires, lots of people qualify immediately for the general class ticket. This carries with it the right to unlimited operation in all 18 frequency bands assigned to amateur use by international agreement. It is good for five years and can be renewed, period after period, without examination. To obtain a general class license, you must do 13 words-per-minute in code and pass a written test in general radio theory and FCC rules. The written exam is much more technical than its counterpart for the novice class license.

Leo T. Meister, W2UMB, lets his daughter Helene Donna have a turn at the mike. Leo is active on MARS nets and in 80-meter mobile operation. He has contributed many hours of service during civil emergencies.



Q. *What about the other types of licenses? Are they worth aiming at?*

A. The technician class license is a hybrid. It requires the 5 words-per-minute code test given for the novice class and the written test given for the general class. It is good for five years and is renewable, but a holder can operate only in the very high frequency bands (above 220 megacycles). It is intended to encourage experimenting on the high frequencies and is provided specifically for people who are strong on theory and weak on the code.

The advanced class license is not available to new applicants. It is merely a holdover type of license for former holders of Class "A" licenses, which no longer exist. Until recently, only Class A operators could operate phone in the 14 and 3.5 megacycle bands. Today any general class operator can use phone in all bands in which phone is permitted.

The amateur extra license is strictly for hot shots. It requires a minimum of two years of previous experience (except as novice or technician), a 20 words-per-minute code test, and a very stiff technical exam. It carries no privileges not afforded to all holders of general class licenses. All a ham gets out of it is the satisfaction of qualifying for it.

Q. *I intend to operate only a voice transmitter. Can I skip the code part of the test?*

A. Definitely not. You must know the code for any type of amateur license. In fact, if you flunk the code test, either in an FCC office or at home in a mail test, you don't even get the written part. Don't worry about the code. It's easy to learn. And it's a lot of fun to operate with a key. The next article of this series will tell how you can master the dots and dashes painlessly.

Q. *What's the point of punching a key when voice operation is so much easier?*

A. It isn't always easier. When voice signals are cut up by noise and interference you can't understand what the other fellow is saying. Distortion doesn't affect the intelligibility of dots and dashes. As long as you can hear them at all, you can tell the long sounds from the short ones and thus form the letters of the alphabet. "CW" ("continuous waves"), as code operation is called, is also much more economical for a young ham who wants to get on the air at minimum cost. With a transmitter no larger than a cigar box, assembled from surplus parts, you can readily "work" other CW stations all around the globe.

The "code" is the language of radio. It will add considerably to your enjoyment of ham radio. (Continued Next Month)

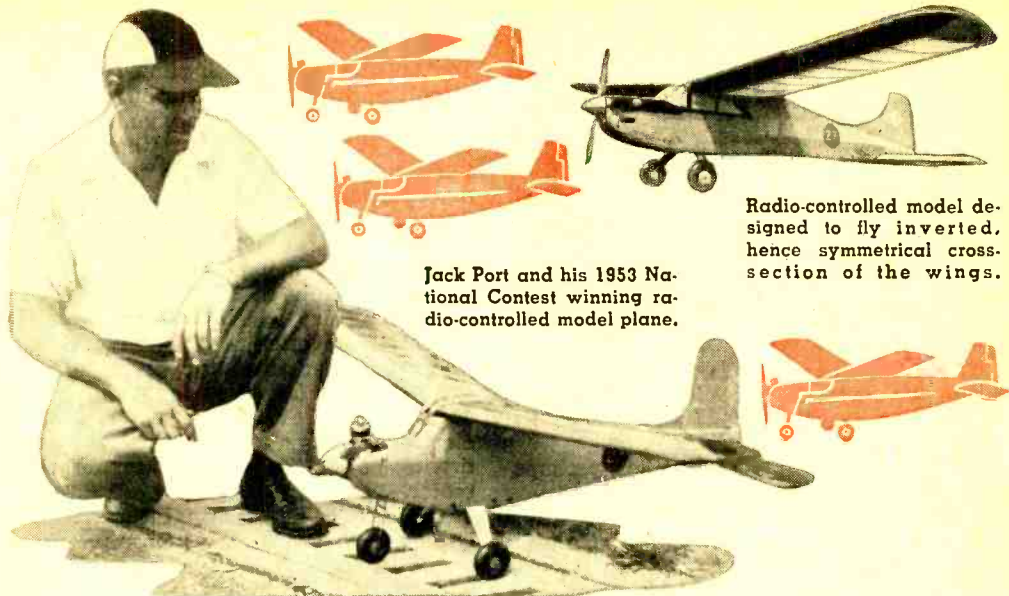

Jack Port and his 1953 National Contest winning radio-controlled model plane.

Radio-controlled model designed to fly inverted, hence symmetrical cross-section of the wings.

# RADIO CONTROL

OF

# Models

By WILLIAM WINTER

Editor, "Model Airplane News"

ONE of the most interesting ramifications of the Citizens Radio Service, created by the Federal Communications Commission a few years after the war, has been the sensational growth of the radio-controlled plane and boat hobby. Operating on two examination-free frequencies of 465 and 27.255 megacycles, tens of thousands of radio-control fans assemble every weekend on fields, farms, and airports to put aloft their small planes. Many a lake or park pond supports a motley fleet of boats including scale *Chris-Craft*, tugs, PT's, Mississippi stern-wheelers, and roaring outboards. Grocery clerk, engineer, architect, airline pilot, high school boy—everybody is doing it.

Catering to this fast-growing hobby are some two dozen manufacturers of transmitters and receivers, of airplane and boat kits, of escapements, servos, and accessories. Many of the nation's 10,000 hobby shops stock these items. "Radio Row" advertisers offer electronics kits, meters, power packs, storage batteries, dynamotors—things that once were considered the hams' private do-

main. One of Uncle Sam's biggest suppliers of electronic equipment for guided missiles, offers one- and three-channel equipment exclusively to modelers. Complete with radio, a model may cost anywhere from \$20 to \$400, depending on its size and capabilities.

Considering the ultimate simplicity of his equipment, the radio control plane builder works wonders. He is limited by the FCC to an input of five watts maximum to the last stage of his transmitter. What he gets out of his transmitter is anybody's guess

Spot landing by radio-controlled model. It has 5-channel receiver controlling unit.



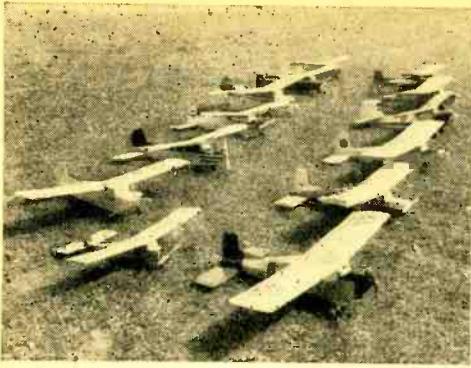

These planes turned out at the first flying session last Spring of the Buffalo Bisons model airplane club. Sizes varied from 4½ to 5 feet.

but, if it is tuned properly, it has, perhaps, as much as 1½ to 2 watts output.

His receiver may be two or three inches square, consisting of a relay, a tube, a tank coil, perhaps a quench coil, and a few resistors and capacitors. Nevertheless, he blithely sends out his plane to the limits of vision, a sight which makes any visiting ham turn pale. The ham who joins in the fun, usually turns up with a 25- to 40-watt transmitter, and then flies the plane in circles around his head!

Most of the transmitters are simple, single-tube, crystal-controlled affairs. They usually operate on straight continuous wave, or "c.w." Some are two tubers of the "m.o.p.a." type (master oscillator—power amplifier). Still others use audio, imposing from one to six modulated tones upon the carrier wave to operate multiple controls, such as elevators or engine speed on a plane, or horn, throttle, reverse, on a boat. Probably nine out of ten hobbyists operate

c.w. (continuous wave). Signals are transmitted to the plane or boat by means of a keying switch in the "B-plus" lead of the transmitter. The switch simply closes the circuit and the signal goes out.

Simple electronic or mechanical pulsing devices exist which vary either, or both, pulse rate and pulse length to accomplish a proportional rudder effect, plus a second control, with but single-channel radios.

When a signal is detected, the resulting change in the amount of current flowing through the tube in the receiver is used to operate a relay which, in turn, completes an electrical circuit to the escapement, servo, or other actuating device to move the control surfaces. The most widely used actuator is the escapement. This is an electromechanical device which takes its driving power from a twisted rubberband motor. When current flows through the coil of the escapement, its armature pulls in, releasing a revolving arm whose movement displaces the control surface *via* a steel wire linkage. Many types of escapements are on the market including several imported models.

Most typical is the self-neutralizing escapement. As long as current flows in this escapement it holds the control hard over but, when the current is cut off, the escapement and control automatically return to a neutral position. Thus, the amount of turn imparted to the vehicle is governed by the length of time the operator keeps the keying switch closed. Another escapement, the compound type, will give one control position on one signal, another on two, and a third on three, and always return to the same neutral position.

The real miracle is the amazing maneuvers that are performed with this rudi-

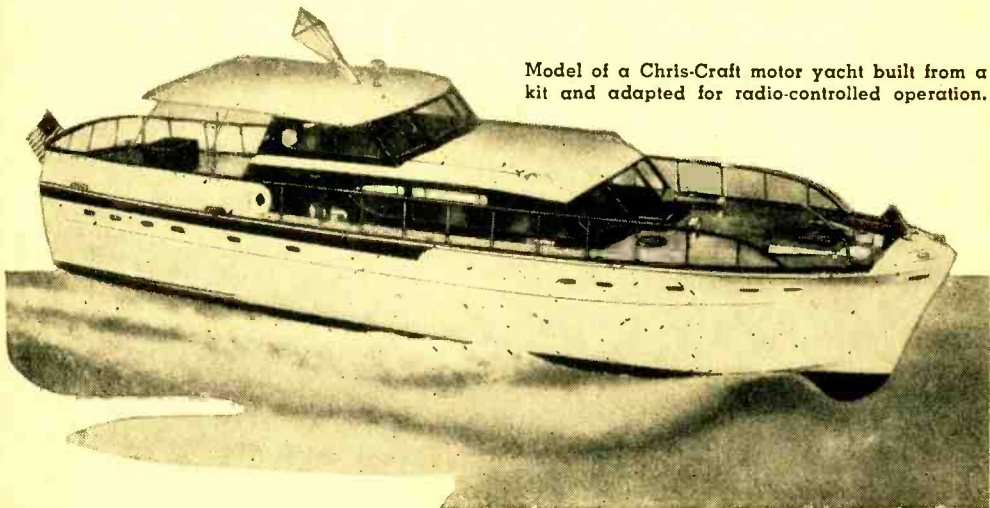

Model of a Chris-Craft motor yacht built from a kit and adapted for radio-controlled operation.

mentary equipment. With rudder only, the pilot performs spirals, zooms, wingovers, lazy eights, Immelmans, and loops. With the compound escapement, dives, consecutive loops, and, perhaps, inverted flight becomes possible. When "deluxe" multichannel equipment comes into the picture, the more skilled fliers do outside loops, inverted turns, horizontal and vertical eights, and other maneuvers formerly possible only with captive-type models on the ends of control wires.

The planes themselves may be original, that is, designed by the builder, or they may be assembled from any one of several dozen kits. Size varies from 3 to 9 feet, but 4½ feet is the popular average. Weighing 2½ to 3½ pounds, the typical plane is powered with a two-cycle, glow-plug engine (or perhaps a Diesel) of from .09 to .15 cubic inch displacement. Other planes may have power plants of from .030 to 1.25 cu. in. displacement. The planes are of balsa wood, covered with tough paper, silk, or nylon. Speed varies from 15 to 40 mph in level flight, depending on the plane's size, weight, and power.

Boats are constructed in an infinite number of sizes and types. Engine manufacturers have lately turned out an intriguing variety of power plants, ranging from beautiful scale-model outboards of only .049 displacement (and do these kick up a storm in a test barrel!) through water-jacketed inboard types to deluxe numbers with all the gadgets and gismos such as water pumps. Yet some boat fans stick to sail—and wouldn't you expect it!

Now that the "R/C" fans have a few years' experience under their belts, more of them are eyeing the multichannel radios newly-available at the hobby shops. So far

it is a toss-up between proponents of the "reed bank jobs" and those of the bandpass or filtered receivers which electronically direct the particular tone detected to an appropriate relay and control surface. In the reed bank, one of the three to six or more reeds become agitated in response to its particular tone and then operates a relay.

Under the guidance of the Academy of Model Aeronautics, the national rules-making and record-keeping body, rules and procedures have been developed for radio-control contests. At small contests a precision type of pattern is flown, consisting of a take-off, 500 feet straightaway, a 90 degree left turn, a 270 degree right turn, straight flight back to the transmitter, followed by an S-turn, pylon eight, rectangular pattern, and a spot landing. Sometimes a stunt pattern is flown as well. Other than take-off and spot landing, the maneuvers are limited only by the flier's imagination and pocketbook. The National Contest radio control event was won in 1953 by an airplane having rudder control only.

Not to be outdone by his aeronautical cousin, the "RC" boat builder has his own contests with a rather difficult pattern to steer through marking buoys. Plane and boat fans both are organizing clubs by the hundreds.

The radio control hobby is international. Western European nations gather for team competition every year. The Federation Aeronautique Internationale, with headquarters in Paris, confirms all full scale as well as model plane international records. One duration mark has been bitterly contested between Russia, Great Britain, and America. British hobbyists sent a radio-controlled boat across the Channel. It fared

Radio-controlled boat built from kit. The control is a three-channel unit.

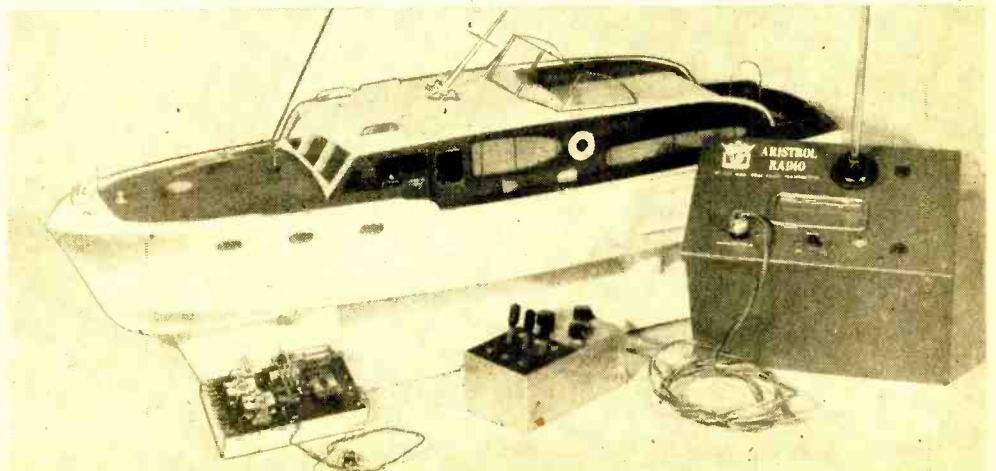

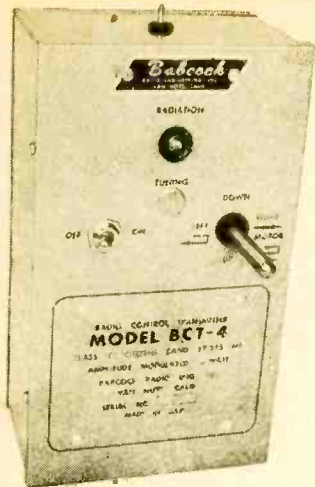

Radio-control transmitter which operates on the 27.255 mc. band.

Companion radio-control receiver made by Babcock Radio Engineering, Inc., of Van Nuys. Metal "tubes" are sealed relay units.

better than the queasy crew of the following boat. There's a distance record where the model must be kept in sight, without judges or pilot leaving the launching site. Pylon closed-course races have been held—everyone agreed that man is a terrible judge of distance! Radio-controlled models have towed gliders, carried movie cameras (the color film might have been taken from an airliner, so well did it turn out), flown the Detroit River to Canada in public demonstration, the Potomac with a pay load of silver dollars on Washington's birthday (the wrong river, 'tis true).

Occasionally, of course, such a model gets away from its master, usually with comic results. If he has put too much gas in the tank, the flier is led a merry chase by

automobile. Small boys may hold the plane for ransom. But even when the plane comes down far afield, the canny hobbyist has a trick or two up his sleeve. Since the receiver broadcasts mildly on its own, while the batteries last, he may carry a special receiver to detect the model up in some tall tree, or hidden between rows of corn. An errant flight is the exception and not the rule.

Ninety-nine times out of 100, the model can be landed nearby. That the flier gets a bang out of every flight and landing is obvious. What is not so apparent is the business created or, what is even more important, the widening appreciation of electronics by so many people, thanks to the cooperation of the FCC! END

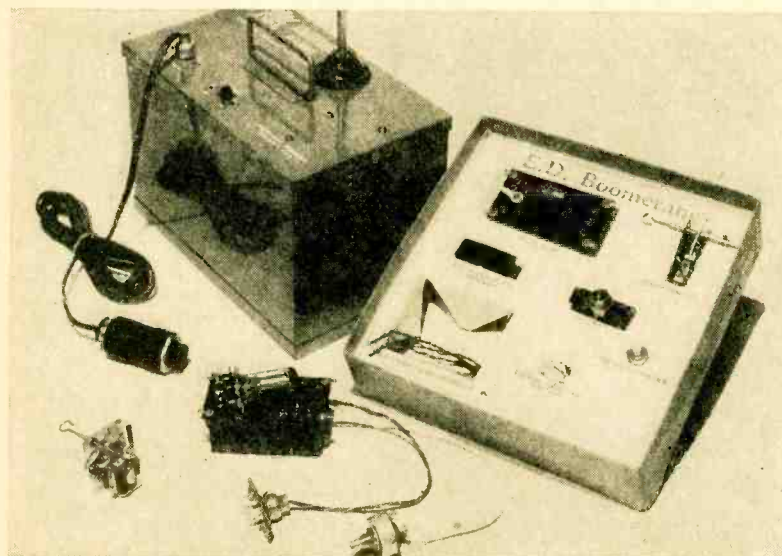

One of the transmitters and receivers currently on the market. Receiver is 1-tube.

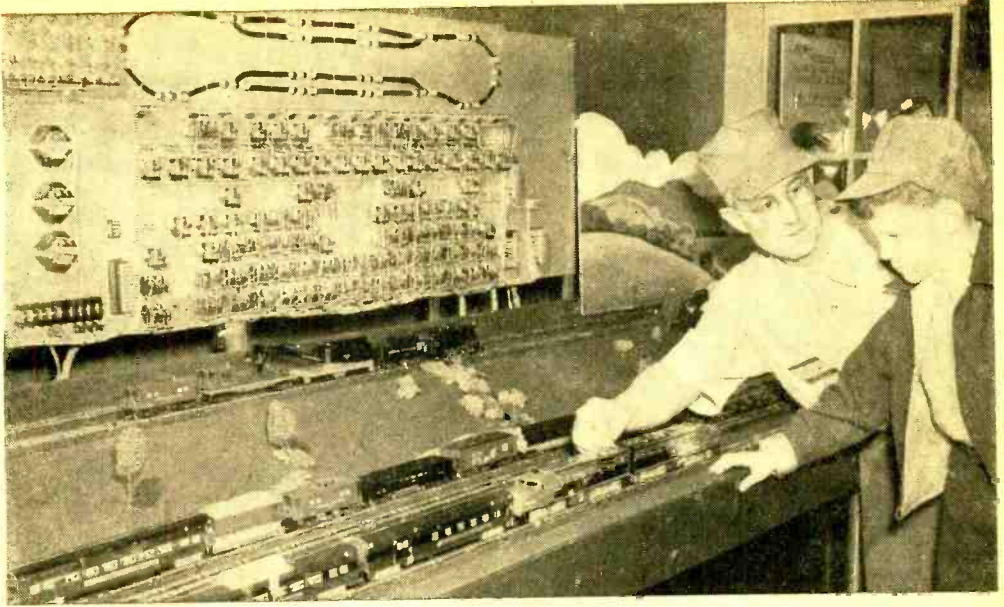

A. C. Kidder of General Electric Company explains how electronic circuitry prevents collisions of the three trains to an interested "junior engineer," Roger Lancaster, Jr.

## "Collision-proof" Model Train System

**E**VEN such industrial giants as *General Electric* like to "play" with model railroad trains, although such "play" usually has a serious purpose.

The model train display shown above incorporates special electronic circuitry which prevents collisions of the three trains comprising the system. Operation of the trains and switches is automatically controlled by the presence of the trains on various sections of the track system.

The trains in this system operate on 12 volts d.c. The direction of operation is determined by the polarity of the rails and not by the familiar sequence relay found in many toy trains.

The secret of the operation of this system lies in the special detection circuit employed. It uses a germanium diode to prevent the relay from staying operative after the train leaves the block or track connected to the relay. From this detection circuit all of the other control circuits are regulated in their sequence of functions, such as the signal lights which are lighted and changed when the relay that controls them is operated by the detection relay.

Each train in this layout is supplied with power from its own power pack in which the a.c. is converted to d.c. by germanium diodes. The power is supplied to the train through the "cab circuit" which

progresses from one relay to the next as the train goes around the track. Again germanium diodes are used to release the relay after the train has left the block by preventing the current from the next block from feeding back along the progression circuit. The second diode in this circuit is used to prevent the progression from going beyond the block the engine has just entered.

The basic operating principles embodied in such a setup apply equally well to industrial control circuitry of a more complex nature. That the company chose to demonstrate this principle with a "toy" is not to be construed as a sign of frivolity! The circuitry of this model is sound from an engineering standpoint and is equally applicable to more complex operations.

Actually, this demonstration setup was on exhibit at a recent convention of the Institute of Radio Engineers held in New York City. While the lure of "railroading" originally attracted most visitors to the display, the practical application of germanium diodes kept them around the exhibit to study the interesting possibilities of this semi-conductor component.

Those desiring a more detailed description of this equipment can obtain it either from *General Electric*, Syracuse, N. Y., or The National Model Railroad Assn., Inc., Box 1238, Station C, Canton 8, Ohio. **END**

# Small

# fi

By

Paul Popenoe, Jr.  
W6IWM

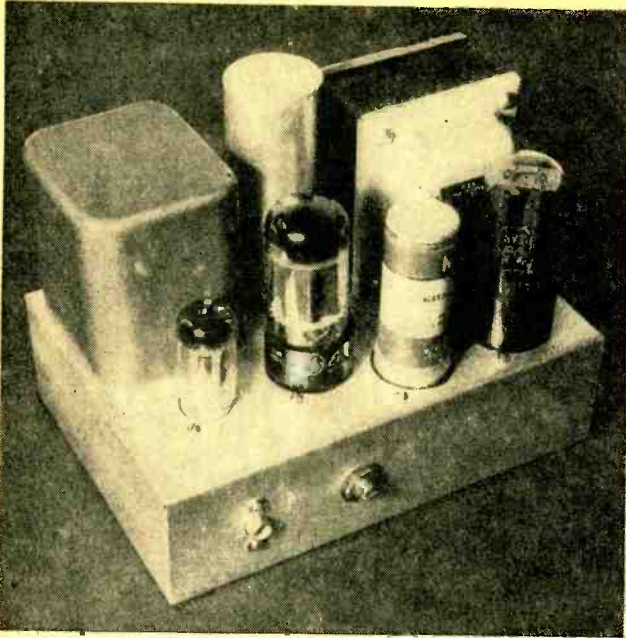

Fig. 1. Home-built amplifier measuring 5" x 7" x 2".

## An economical approach to good quality

THE amplifier shown in Fig. 1 should provide an answer to those who require a high-quality power amplifier of small physical dimensions. This unit is constructed on a 5" x 7" x 2" steel chassis base and has an over-all height of 6 inches. It may be operated from most tuners and preamplifiers to give adequate output for ordinary home requirements. The total cost of parts is under \$35.

To many people, this unit, with its 4-watt rated output, may seem underpowered. There is no need to recount the usual arguments as to desirable power levels. Many of our ideas about power requirements are handed down from the days of high-distortion amplifiers and low-efficiency speakers. With modern speakers an average listening level of 250 milliwatts is a very loud level indeed—louder than most people can comfortably enjoy in the average living-room. Those who wish to verify this statement may do so by actually measuring the output of an amplifier while listening to it. Many will be surprised at the small amount of audio required to provide comfortable listening.

If 250 milliwatts is considered as maximum average listening level, it can be seen from the graph, Fig. 2, that the distortion of this amplifier is negligible. Allowing 10 db for peaks of recorded or

broadcast music, we have a peak power requirement of 2.5 watts. Looking again at the graph, it can be seen that the peak level will still be under one per-cent distortion. The graph, Fig. 2, represents actual total harmonic distortion across a 16-ohm resistive load measured at 1200 cycles. Operation into a voice coil may result in somewhat higher distortion due to non-linear speaker response.

The amplifier has low transient distortion due to a good damping factor. The damping factor is 8, which is equivalent to a 2-ohm generator across the 16-ohm speaker tap. This allows the speaker to deliver good, clean bass, an important requirement for hi-fi amplifiers.

A listening test was made operating the amplifier into a *Jim Lansing* rear-horn-loaded speaker system, model D-34001. The unit described compared favorably with much larger and more expensive amplifiers.

Other characteristics of this amplifier are frequency response flat within 1 db from 20 to 100,000 cycles measured at 1-watt output, response flat 20 to 30,000 cycles measured at 4-watts output, and an input requirement of 1.5 volts r.m.s. for 4-watts output. Approximately 8.5 db of feedback is provided around a loop which includes the output transformer and the



input stage. The hum and noise are so low as to be inaudible with the ear placed next to the speaker.

Examination of the circuit diagram, Fig. 4, will show that the circuit is very simple, requiring only two tubes plus a rectifier tube. The first tube,  $V_1$ , is a 12AX7 which operates as a voltage amplifier and phase splitter. Feedback is applied to the unbypassed cathode of the voltage amplifier. The output of this stage is resistance-capacitance coupled to the other half of the 12AX7, the phase splitter. There is nothing critical in this circuit, and ordinary tolerance components may be used.

The phase splitter provides a push-pull signal to the grids of the output tube by means of equal 47,000 ohm load resistors in the cathode and plate. These two resistors,  $R_1$  and  $R_2$ , should be matched in value as closely as possible. Matching within one per-cent is desirable. It should be possible to accomplish this with an ordinary ohmmeter. It is also desirable to match the grid resistors,  $R_3$  and  $R_4$ , of the output stage, but these are not as critical as the plate resistors.

The output stage makes use of a 6BX7GT dual triode,  $V_2$ , as a push-pull power amplifier. Although this tube was developed for use in television receivers, it makes an ideal audio tube. It has high transcon-

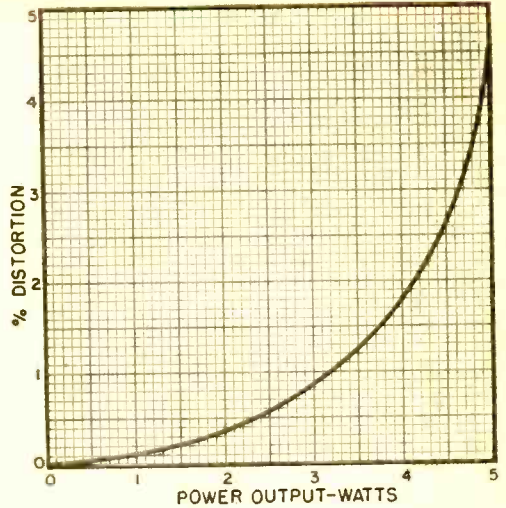
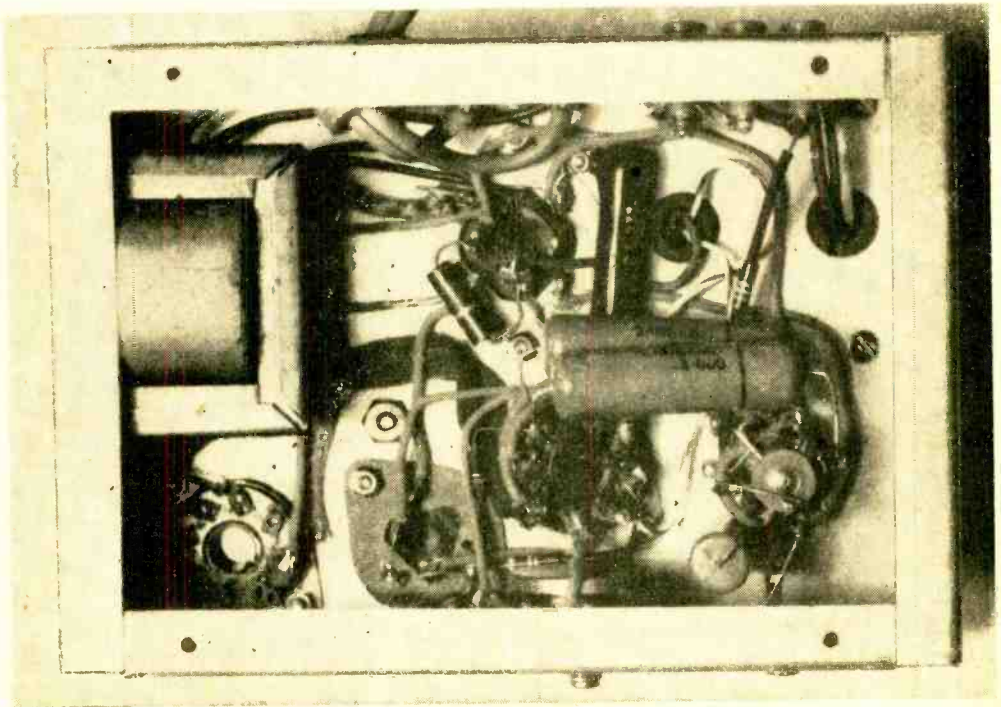

Fig. 2. Total harmonic distortion of the amplifier measured at 1200 cycles across a 16-ohm resistive load. Refer to article.

ductance, indirectly heated cathodes, and a 12-watt combined plate dissipation. A 100-ohm potentiometer,  $R_{11}$ , is provided in the cathode circuit to balance the plate currents. The tube requires an 8000 ohm plate-to-plate load which is provided by a Peerless type S-510-F output transformer coupling into an 8- or 16-ohm voice coil. The output taps are brought out to tip

Fig. 3. Under chassis view of the amplifier showing how components are mounted.



capacitor make a convenient ground point. The dual cathode capacitor of  $V_2$ , the 6BX7GT, should be mounted on a plastic plate to prevent grounding at that point.

For ease of construction wire all capacitors and resistors related to the 12AX7 to the socket before mounting it on the chassis.

Before operation, the wiring should be double-checked to see that it is correct. Particular attention should be paid to the output transformer leads to see that they correspond to the color code shown on the diagram of Fig. 4. If the plate leads are

reversed, positive feedback will cause oscillation.

After applying power, the output stage should be balanced. This may be done by measuring the voltage drop across the two sides of the output transformer primary and adjusting the balancing potentiometer,  $R_{11}$ . When the voltage drops are equal, equal plate currents will be indicated. Each section of the 6BX7GT draws about 20 milliamperes.

The set is now ready for the "listening" test. We are sure the builder will find the results pleasing. END

## COMPONENTS ASSEMBLED AUTOMATICALLY

**E**VEN an automatic punch press operated by an "electronic brain" can appreciate a pretty girl as witness the press' reaction, punched out below, when introduced to Connie Hodgson.

The brainy machine spelled out its 82-hole expression in less than three minutes. Developed by scientists at *General Electric's* Electronics Laboratory in Syracuse, N.Y., the punch press is actually a by-product of development work being done toward an automatic component assembly system, under a Signal Corps contract. The press was made automatic as a proving ground for techniques to be used in the automatic assembly system.

The machine, incidentally, cannot think entirely by itself. Directions are fed to the punch press by an electronic digital computer, which "reads" information on size, number, and location of holes to be punched from a man-made perforated card. The punch press automatically positions the material to be perforated and performs its punching operations within an accuracy of a few thousandths of an inch.

The automatic assembly system, of which the punch press is to be a part, will place from 10 to 50 standard components, such as resistors and subminiature tubes, on printed wiring boards at a rate of 30 per minute. This rate can be increased on any production line by using additional placement machines. The final system will also provide for preparation and testing of components, for transporting them to the assembly machine, and for soldering and testing the completed subassemblies.

This entire system, scheduled for completion in 1955, will be supervised electronically by means of perforated cards, which will contain the various programming information.

The automatic assembly system is not intended to produce completed products such as radar or television sets, but will

produce printed circuit subassemblies for electronic equipment. The subassemblies will be manually combined into complete products, until other machines may be devised to perform the task.

*G-E* has developed most of the component elements for this system. These elements include mechanisms to move printed wiring boards on assembly machine, a component placement device, electronic equipment to dictate action to machines, and various component preparation equipment for cutting and shaping wire leads as well as other related operations. END

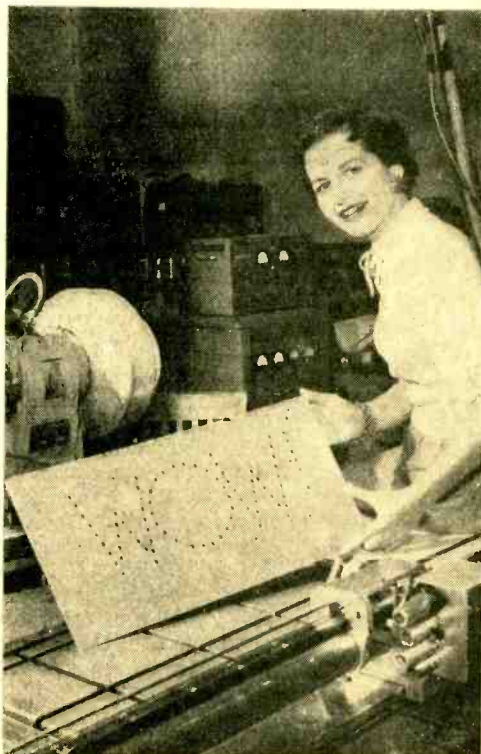

Over-all view of the home-built capacity relay. The author's model was built on a metal chassis but plywood base can be used.



By HARVEY POLLACK

## CAPACITY RELAY

**A**LTHOUGH the capacity relay to be described was designed to actuate a display case motor upon the approach of an onlooker, it has a host of other fascinating household and business applications. Its sensitivity to the changing position of the human body immediately suggests its use as a burglar alarm without the need for beams of light and electric eyes, a baby "sitter", an automatic light operator, an annunciator, or the control device for automatic garage door openers.

Essentially, the action of the capacity relay consists of closing an electrical circuit when someone moves into the immediate vicinity of its alarm wire. The body acts as one capacitor plate with the wire acting as the other. As the distance between the two decreases, the capacitance increases, changing the circuit conditions so that a magnetic relay is energized. The closed relay contacts then provide the power to operate a bell, one or more lights, or any other controlled appliance.

The use of a metal chassis is optional in the construction of this device. The unit may be built on a Masonite or plywood base with  $\frac{1}{2}$ -inch front and rear aprons or it may be built on the lid of a cigar box. A metallic base is unnecessary since it is not needed for electrical or ground connections. The chassis used in the model built by the author measured  $4\frac{1}{2}$  inches by 8 inches by 2 inches.

If a metal chassis is used, all "live" parts (the variable capacitor, alarm wire binding

post, oscillator coil, etc.) must be well insulated from it if maximum stability and sensitivity are to be obtained.

Before starting to build this unit it is advisable for you to decide how long an alarm wire you will need. The author's model was designed for use with a wire up to 3 feet in length as it was to be placed inside a rather small display case. Should you plan to use a longer antenna, say 12 to 15 feet or so, you will have to use a larger variable capacitor than the one specified in the parts list and, in addition, you will have to connect another very small air variable in parallel with it. For long alarm wires use a  $365 \mu\text{fd.}$  capacitor (standard broadcast receiver type) in place of  $C_2$  with a  $10\text{-}25 \mu\text{fd.}$  midget variable capacitor in parallel with it. The reason for using two paralleled variables will be explained when "adjustments" are discussed. If this change is made, remember to plan on two capacitor shaft holes—near each other—so placed that the rotor plates do not touch irrespective of the setting of either capacitor. There is no reason why these cannot be mounted on the front apron of the base, positioned to permit short leads between them.

The oscillator coil should be prepared before starting to wire the set. The coil in the model was wound on an old radio oscillator coil form from which the wire had been removed. A fiber, wood, or Bakelite cylinder about  $\frac{1}{2}$ " in diameter will do. The coil form used by the author had a small mounting bracket which proved convenient.

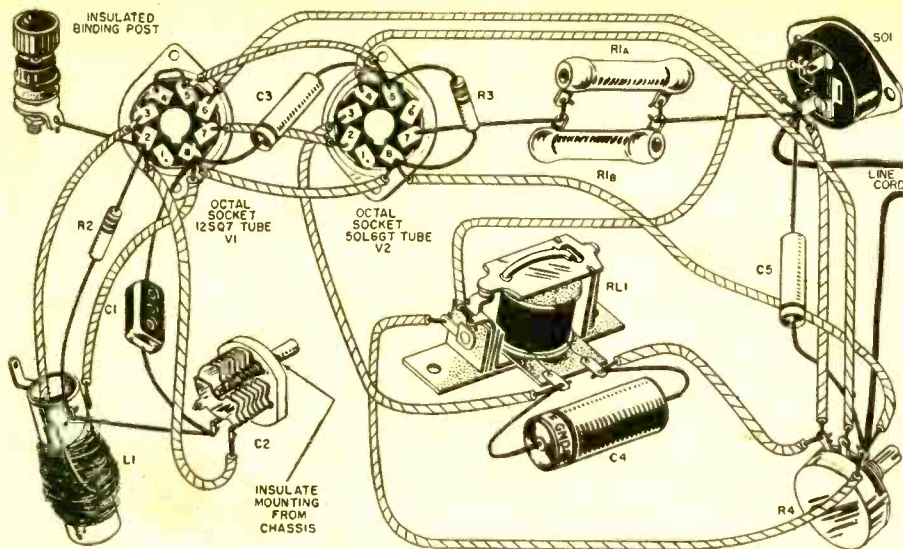

If you use a dowel stick, however, the finished coil may be mounted by means of a wood screw through the end of the cross-section.

The coil is "scramble-wound" with #30 enameled wire. It has a total of 150 turns, center-tapped. First wind 75 turns over a distance of 1 inch, bring out a doubled-back lead, and then wind the remaining 75 turns *in the same direction* right over the full length of the first layers. Scrape the enamel from the ends of the three leads and solder to the lugs on the coil form. If your form does not have lugs, be sure to leave the wire ends long enough to reach the terminal points on the components to which they will be soldered. The finished coil should be given a coat of white shellac or polystyrene coil "dope" to keep it from unravelling.

The wiring of the unit is quite easy, even for the novice. The hints to follow will help you construct a neat, dependable piece of equipment.

1. Wire in the line cord and tube heaters first. Keep these wires close to the chassis edges and down flat against the base.

2. Next wire in the relay, all a.c. connections, and the 50L6GT ( $V_2$ ) connections. These leads may be as long as necessary to keep them tucked away along the inner edges of the base.

3. Complete the connections by wiring the oscillator and the circuit for the diode,  $V_1$ . Keep these leads as short and direct as possible, using bare wires where there is no danger of short circuits.

The first step after any electronic device has been constructed is to check all connections step-by-step. Even though visual inspection fails to disclose any wiring er-

rors, it is still advisable to test for short circuits before applying power.

An ordinary ohmmeter is excellent for this purpose—the owner of such an instrument needs no instruction in its use as a continuity and short tester. If an ohmmeter is not available, you might want to make up a flashlight short-circuit detector. Simply wire a flashlight bulb in series with a  $1\frac{1}{2}$  volt battery.

When checking for a short circuit, touch the bare tips of the test leads to the two points being tested. If the lamp lights, a

- $R_{1A}$ - $R_{1B}$ —Two 750 ohm, 10 w. wirewound res. in parallel or one 375 ohm, 20 w. wirewound res.
- $R_2$ —4.7 megohm,  $\frac{1}{2}$  w. res.
- $R_3$ —2.2 megohm,  $\frac{1}{2}$  w. res.
- $R_4$ —20,000 ohm wirewound pot
- $C_1$ —100  $\mu$ f.d. mica capacitor
- $C_2$ —100  $\mu$ f.d. midget air variable capacitor (with insulating bushings)
- $C_3$ —1  $\mu$ f.d., 400 v. capacitor
- $C_4$ —10  $\mu$ f.d., 150 v. elec. capacitor
- $C_5$ —.05  $\mu$ f.d., 400 v. capacitor
- $L_1$ —Osc. coil 150 t. #30 en. wire, scramble-wound, center-tapped. Winding length 1". (See text and inset diagram below)
- $RL_1$ —5000 ohm plate circuit relay, single-pole, single-throw, normally-open (Potter & Brumfield Type LS-5)
- $SO_1$ —A.c. receptacle
- 1—Insulated binding post
- $V_1$ —12SQ7 or 12SQ7GT tube
- $V_2$ —50L6GT tube

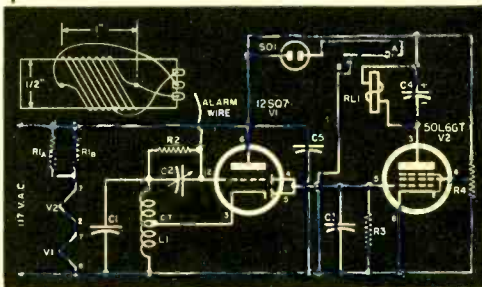

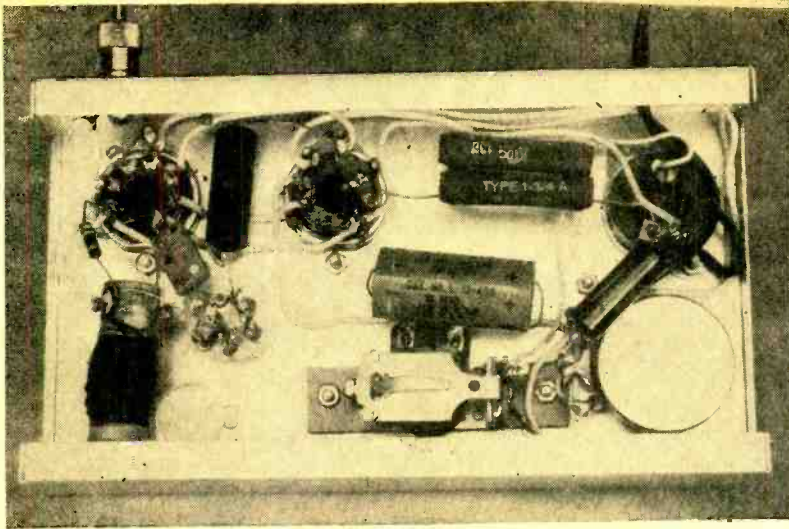

Bottom view showing how parts are wired. Lead length is not critical.

short circuit is indicated. If it remains dark, there is no short circuit.

Using either the ohmmeter or the flash-light detector unit, test for short circuits across the line cord prongs, across  $R_{1A}$ - $R_{1B}$ , and across  $C_2$ . Use the same method to make certain that none of the leads or components are shorting to the metal chassis, if one is used.

The unit is now ready for adjustment if everything checks out OK up to this point.

To adjust the capacity relay perform the following operations:

1. Connect the alarm wire to the antenna binding post and plug a floor or desk lamp into the chassis a.c. receptacle,  $SO_1$ . Work on a table and lay the alarm wire flat, well away from your hand or body. Apply power and allow the unit to heat for 60 seconds.
2. Rotate the relay current control knob fully *clockwise* and set  $C_2$  at maximum capacitance (fully meshed plates). If two variables are used, set *both* at maximum capacitance.
3. Place your finger on the antenna binding post and slowly rotate the relay current control knob,  $R_1$ , counterclockwise until the floor or desk lamp lights. Continue rotating the knob just a bit beyond this point.
4. Remove your finger from the binding post. The lamp should go out. If it doesn't the antenna is too long.
5. Rotate the sensitivity control,  $C_2$ , very slowly in the direction of reduced capacitance. A setting will be found where the lamp will light again. If it fails to do so when minimum capacitance is reached, the antenna wire is too short.
6. Keeping as far away from the alarm wire as possible, back off the sensitivity

control very slightly and carefully until the lamp again extinguishes. The unit is now ready to operate.

Moving your hand toward or away from the alarm wire will cause the lamp to go on and off. Any other device may now be substituted for the lamp.

When two variable capacitors are employed, coarse adjustments are made with the larger of the two and fine adjustments with the smaller.

For those who are technically inclined and enjoy knowing why a device works as well as the fact that it does work, a brief description of the "why's and wherefore's" may be in order.

The relay is actuated by the plate current flowing through the 50L6GT but is normally open because the control grid is held sufficiently negative to keep the plate current low.

The 12SQ7 triode,  $V_1$ , is wired as a Hartley oscillator, thus producing strong oscillations as long as the alarm wire is clear of foreign objects—objects that have capacitance to ground. This oscillatory voltage is picked up and rectified by the diode section of the tube, and applied to the 50L6GT control grid as negative bias.

Upon the approach of a body, the oscillation is weakened causing a reduction of diode current through the 2.2 megohm resistor,  $R_2$ . The control grid of the 50L6GT then becomes *less* negative, the plate current rises to a value which is high enough to pull in the relay armature, and the controlled device is operated.

A last word of caution: The final adjustment on the relay should be made when the alarm wire is in its ultimate position. END

## CODE PRACTICE SET SERVES AS CONTINUITY TESTER

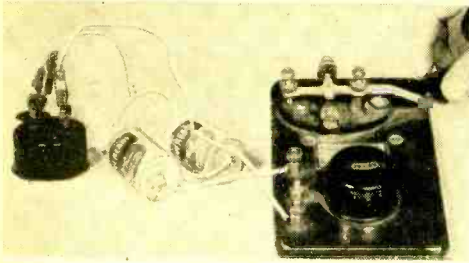

### ADAPTOR CONNECTS PHONE PLUGS TO TIP JACKS

**T**HE two simple adaptors shown make it unnecessary to disconnect earphone cords from the plug every time you want to connect the phones to a pair of tip jacks or binding posts. Simply plug the phones into the adaptor and then insert the tips of the adaptor into the tip jacks or binding posts.

The top photo shows an adaptor made from a surplus JK-26 jack which fits PL-55 plugs that are found on many surplus phones. Simply connect two flexible insulated wire leads and solder a phone tip to the end of each lead, as shown.

The lower photo shows a unit made from midget jack and a pill box with lid. Mount jack inside container and bring leads out through two holes.

**A** CODE practice set with key and buzzer is easily convertible into a continuity checker. All that is necessary is to open the circuit from the batteries and attach two clips to the free ends of this opened wire.

These clips become connecting terminals to be attached across the points to be tested. When pressing the key results in a buzzing sound, the circuit under test is closed.

### SHORT DETECTOR

**A** SIMPLE short-circuit detector can be assembled in a jiffy from readily-available parts.

The only parts needed are a flashlight battery, a low-voltage flashlight bulb, and some wire, connected as shown.

To check for a short-circuit, touch the bare tips of the test leads to the two points being tested. If the bulb lights, a short-circuit is indicated. If it remains dark, there is no short-circuit.

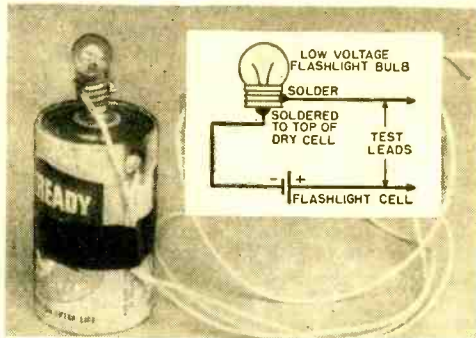

## AUTOMATIC OVEN TEMPERATURE-RECORDER

**B**AKED GOODS—with that “home-made” flavor—can be produced day-in and day-out by commercial bakeries thanks to a new recording thermometer which has recently been developed.

Designed to pass through a traveling oven along with the bread or other baked goods, the instrument is laid on its back next to the pan of baked goods. When it emerges at the discharge end, a complete record of the actual temperatures encountered at each point along the way is inscribed on its smoke-covered chart.

With this information, bakers and bakery maintenance men are able to make necessary oven adjustments or repairs to insure uniform bakery products.

This new *Bristol* recorder can also be used in non-food baking applications—anywhere where a low-clearance instrument is required for continuous conveyer, traveling

tray, or other traveling ovens are used.

The photograph below shows the instrument attached to the side of the conveyer carrying loaves of bread from the oven after the baking process is completed.

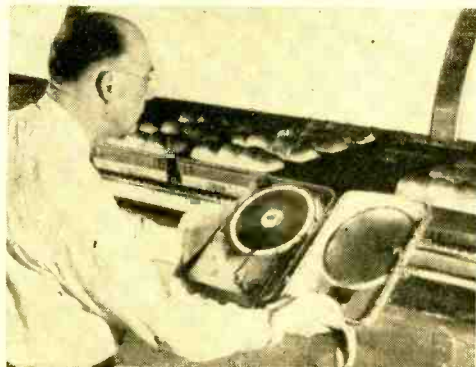

# HOW TO ALIGN RECEIVERS

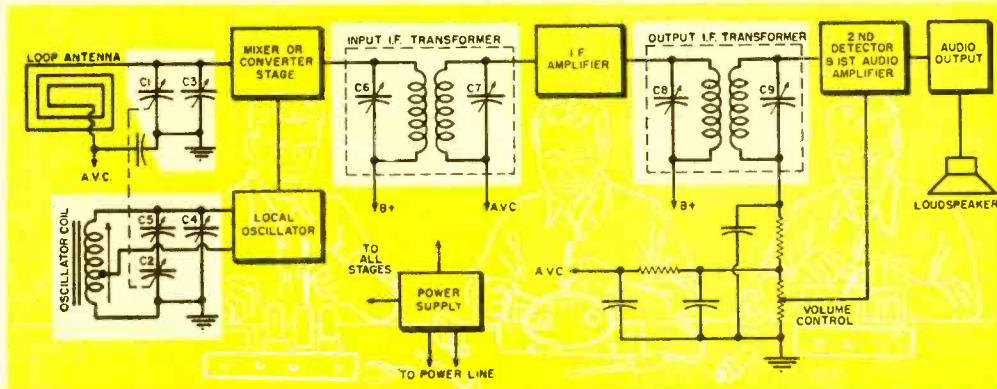

Fig. 1. Basic receiver adjustments (dotted boxes) that a layman can make. See text.

**M**ODERN superheterodyne receivers have a number of tuned circuit adjustments which must be set properly if top performance is to be obtained. This is as true of small table model receivers as it is of large AM-FM-short-wave consoles. The more complex sets simply have more adjustments and, where FM or TV is provided, may require slightly different techniques for adjustment. The entire adjustment procedure, whether applied to a table model receiver or a large console, is called *receiver alignment*.

While the beginner should steer clear of FM and TV sets and the more complex consoles, there is no reason why he shouldn't

undertake the alignment of table model AM broadcast-band receivers, if he has or can borrow the necessary test equipment—a multimeter (not absolutely essential), an insulated alignment tool, and an r.f. signal generator.

The basic adjustments made in a table model receiver during the alignment procedure are shown within the dotted line boxes in the simplified diagram of Fig. 1.

No attempt should be made to align a receiver unless it performs poorly and preliminary tests indicate that the set is out of alignment. Alignment is not a magic "cure-all" that will correct hum, noise, distortion, weak operation, and other com-

Fig. 2. A typical set up for making receiver alignments as described in the article.

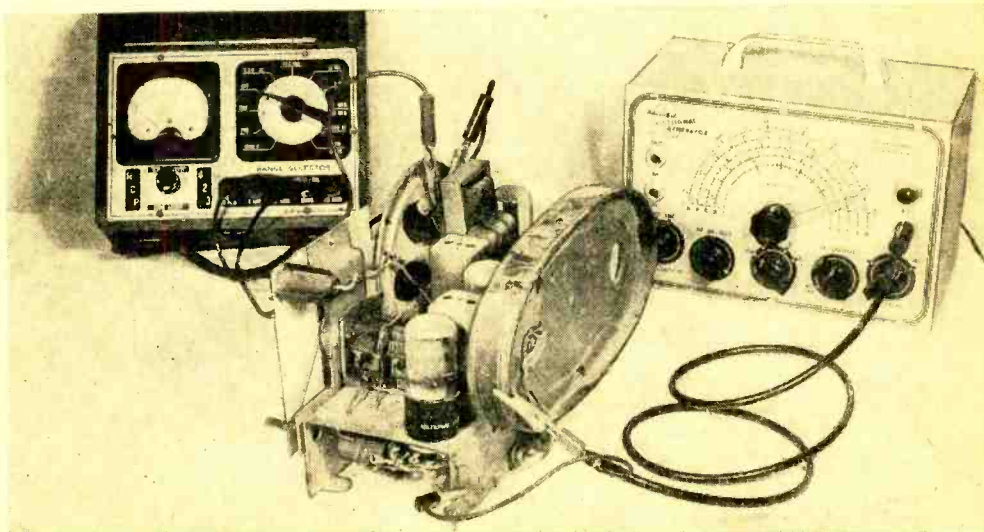

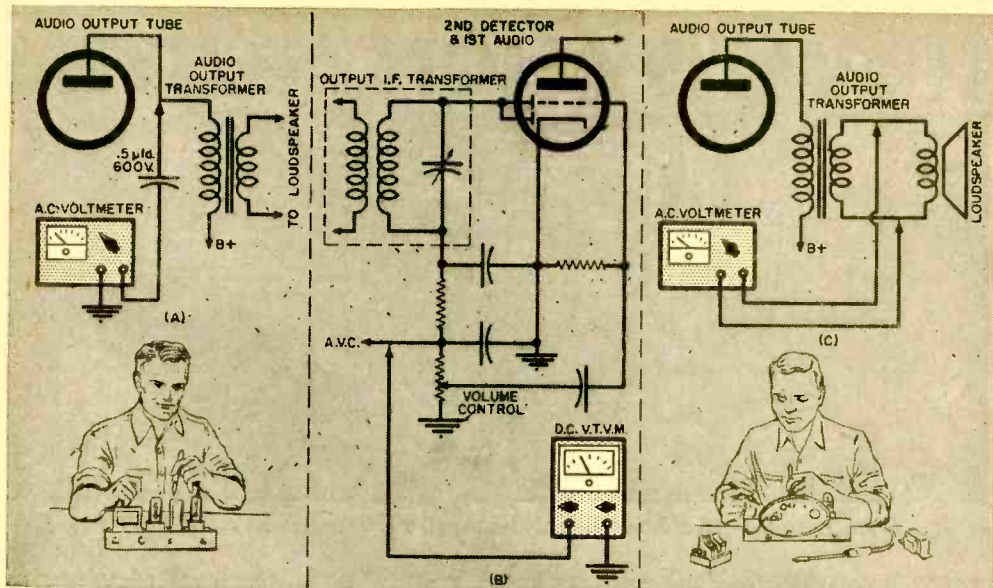

Fig. 3. Three methods of connecting receiver and the test meter. (A) Meter connected through a capacitor. (B) With a v.t.v.m. (C) Meter connected across voice coil.

plaints, irrespective of the actual cause.

Many beginners make the mistake of trying to align sets to correct defects which they are unable to find because they lack the necessary training and experience. *The fact is, the average receiver seldom requires re-alignment unless it has been mistreated.*

Here are the symptoms which *may* indicate the need for alignment:

(1) If the set is weak, but all tubes test good and d.c. voltages in the receiver are normal (check these against the voltage values listed in the service manual for the receiver).

(2) If the receiver does not "track" its dial (that is, if the dial readings do not correspond to the frequency or wavelength values for the station tuned in) but make sure that it isn't just a case of the dial pointer slipping.

(3) If the receiver squeals or oscillates, but tubes are good and all d.c. voltages seem normal, and bypass and filter capacitors are in good condition or, if the oscillation occurs only at one end of the band (generally the low frequency end).

Above all, take care not to confuse other tuning circuit troubles with the need for alignment. For example, a common complaint is that the receiver picks up one station over the entire tuning range. *This is not generally due to misalignment;* rather, it is usually the result of a defective local oscillator.

The operation of a local oscillator may be checked by using a d.c. voltmeter to check for d.c. voltage *across* the oscillator

grid resistor (identify the grid pin connection by referring to a tube manual). If there is a reasonable d.c. voltage here, generally 5 volts or more, the oscillator is probably OK. If not, check plate and screen grid voltages in this stage and, if these are normal, try a replacement tube, no matter how the original tube checks in a tube tester. Make sure the oscillator section of the tuning capacitor is not shorted (we'll discuss the identification of this section later) and, as a final step, replace the oscillator coil.

For alignment work you'll need an r.f. signal generator and an insulated alignment tool. In addition, you'll need an output indicator of some sort. A d.c. vacuum-tube voltmeter is the preferred instrument for this job, but you can get by with an ordinary multitester, or, in a pinch, by using the loudspeaker of the set as an output indicator. A typical set-up for receiver alignment is shown in Fig. 2.

The output meter may be connected to the receiver in one of several ways. Three good methods are shown in Fig. 3. If a d.c. vacuum-tube voltmeter is available, connect its common lead to chassis ground and the negative d.c. lead to measure receiver a.v.c. (automatic volume control) voltage, as shown in Fig. 3B. In many sets, this connection will be to the "hot" side of the volume control.

If a multitester is to be used as an output indicator, set it up for use as an a.c. voltmeter. The meter may be connected between chassis ground and the plate pin of the audio output tube through a .5 μfd.,



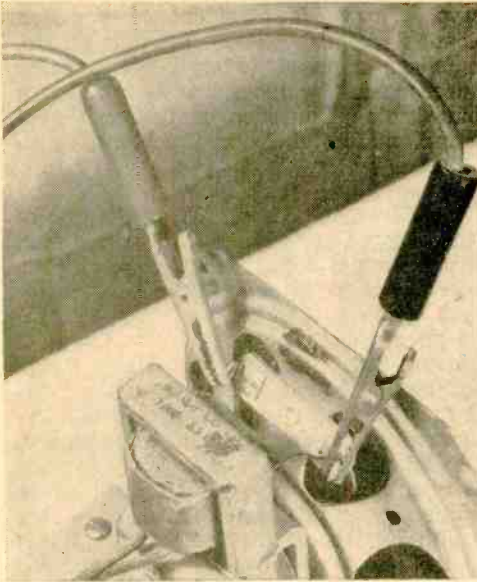

Fig. 4. How a multimeter can be connected across the loudspeaker voice coil terminals.

600 volt capacitor, as shown in Fig. 3A. If preferred, the meter may be connected directly across the loudspeaker voice coil terminals, as shown in Fig. 3C. A typical connection is shown in Fig. 4.

If the loudspeaker is to be used as an output indicator, you'll listen for changes in the loudness of a tone.

The outer shield of the signal generator lead should be connected to chassis ground and the "hot" center lead should be connected through a .001  $\mu$ fd. paper capacitor (600 volt) to the control grid terminal of the mixer tube for i.f. transformer alignment. (Identify the proper pin connection by using a tube manual. Typical mixer tubes are the 6K8, 6A8, 6A7, 6SA7, 6BE6, 12SA7, 12BE6, etc.) For "front end" alignment, the hot lead of the signal generator may be simply clipped to the loop antenna, as shown in Fig. 2. No direct electrical connection is made to the set.

Finally, plug in the test equipment and the receiver, turn on all units, and allow a few minutes warm-up time before starting alignment.

The i.f. transformers are generally located in rectangular metal cans on top of the receiver chassis, as shown in Fig. 5. Two adjustments are usually provided in each transformer. These may both be on the top or sides of the can, or one may be on the top and the other on the bottom (below chassis).

Most modern receivers use a two-gang tuning capacitor. Either of the two types shown in Fig. 6 may be used. Trimmer ca-

(Continued on page 123)

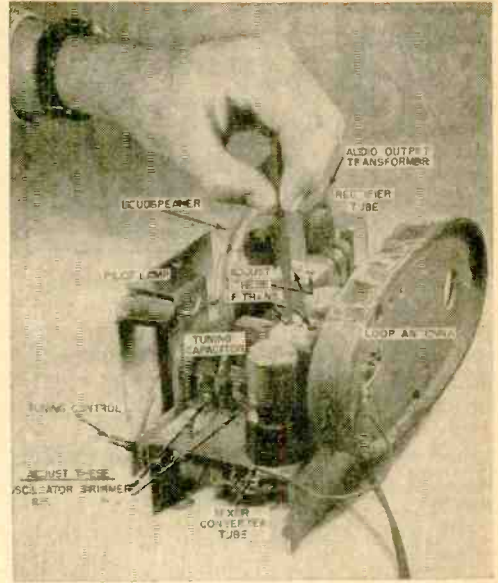

Fig. 5. Receiver adjustment points on top of the chassis. See text for full details.

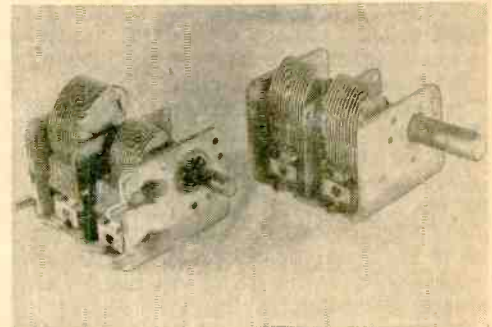
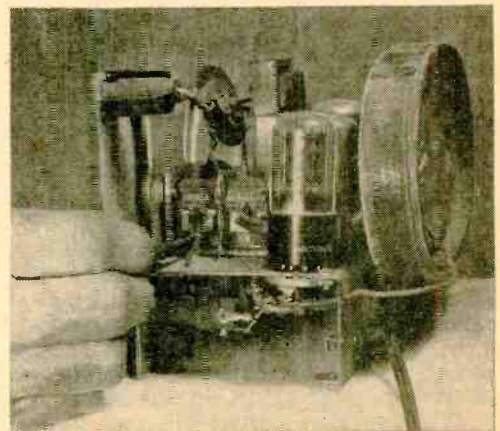
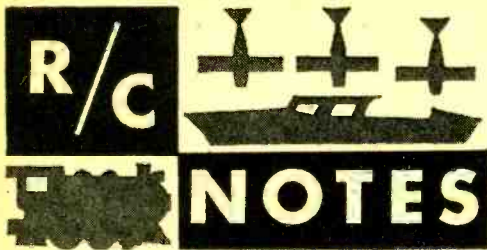

Fig. 6. Two types of radio tuning capacitors. The one on the left is found in broadcast-only receivers while the one on the right will be more often encountered in combination short-wave and broadcast type sets.

Fig. 7. Adjusting the local oscillator trimmer.





# R/C NOTES

ON July 25th an attempt was made upon the world's radio control endurance record, currently held by Russia (1 hr., 31 min., 14 sec.), during the International Power and Wakefield Trophy model meet at Suffolk Air Force Base, N. Y. Henry Struck, designer for *Berkeley Model Supplies*, flew a "Sea Cat" amphibian, built from plans in "Model Airplane News" magazine. The flight ended at 23.5 minutes when changing fuel level stopped the engine.

FROM New Zealand comes word of a 2 hr., 5 sec. endurance flight, by Frank Bethwaite, using a large model glider which he caused to soar—to the interest of numerous gulls—upon an onshore wind blowing up the face of a seaside cliff.

Earlier, Geoffrey Pike (manufacturer of the *Fenners-Pike* British actuators) improved upon the Russian record but not by the 2% margin necessary for recognition. Pike got around the fuel flow problem by using an inflated balloon to pressurize the tank for the .87 cc. displacement Diesel mounted above the wing of his 7-foot powered glider-type machine.

SOARING flights with gliders and powered R/C models from which the propellers have been removed, are made regularly along the Redondo and Palos Verdes Cliffs, Cal., by Webb Hill, Jim Jensen, Louis Culler, and others. Culler's heavyweight sailplane has an 11-ft. wing, cruises at 25 mph, which gives it a 5 mph headway in a typical 20 mph wind. Duration of all these models is limited only by battery life and the flier's wishes. The models are sometimes dived below eye level and then climbed swiftly overhead—all by radio control.

A MARINE Nationals, including radio-controlled boats, has been suggested by R. L. Brown, in a California interclub publication. R/C boat contests take place regularly, especially on the Pacific Coast. Brown, incidentally, is readying a twin O & R powered boat for an attempt at a Catalina Island crossing. He uses *Babcock* three-channel radio with a *Bonner*

servo. Brown is president of the San Diego Radio Modelers. In competition, boats are required to steer an intricate course marked by buoys, and are rated on a point basis. One such contest was held recently at Bristol, Pa. by the Bristol Aero-modelers.

THE Milwaukee Flying Electrons, one of the biggest R/C clubs in the midwest, have been developing a six-channel tone receiver using *Hammond* organ chokes instead of reeds. Another project is a 20 ft., 125 pound plane, powered by a *Briggs & Stratton* 2½ hp motor. San Diego Radio Modelers borrowed an idea from the British to reduce interference during group flying sessions. Transmitters are impounded, released when the owner is ready to take his turn flying. Scale-type R/C models are popular in the Los Angeles area, according to Jim Kerley of the Los Angeles Radio Controllers. A club workshop, equipped with jigsaw, drill press, and various pieces of electronic gear, is a feature of the program by Skydippers RC Club, High Rock, Pa.

FIBREGLAS is finding increased usage in radio modeling. Available at some hobby shops, and at marine supply houses as boat patching kits, the *Fibreglas* package contains approximately a yard square piece of material (like a heavy, glossy cloth), a pint of resin, and a small bottle of catalyst. Mixed with the resin, the catalyst will cause the resin to harden in about an hour, when brushed over the glass cloth-covered sections. This material can be molded into fuselages, wings, hulls, and other assemblies, or to cover the vulnerable noses of model planes. *Fibreglas* renders the structure almost indestructible. It is fuel-proof and takes a good finish.

DURING the past season, the social, "bring your family" type of radio get-togethers have been held in an increasing number of cities. The custom began three years ago with the Pittsburgh Flying Circuits, who organized the first of these fly-for-fun sessions at Selinsgrove, Pa. over Labor Day weekend. The Buffalo Flying Bisons organized a similar affair over the Fourth of July weekend and a group in Hampton, Va., put on a get-together visited by hobbyists from the southern seaboard states. The custom is expected to spread to the west. Non-competitive flying includes demonstrations, balloon bursting, combat between three planes on separate frequencies, and plenty of high, wide, and handsome flying throughout the country's wide open spaces.

END



# FLASHING LAMPS

## AN EXPERIMENTER'S DELIGHT

By EDGAR D. MORGAN

**S**CIENTIFIC curiosities which appear to defy explanation usually delight the electrical experimenter. The principle described here, which causes arrays of ordinary incandescent lamps to flash in an orderly fashion, fits well into this category. With no moving parts employed, the incredible flashing in sequence promises to baffle the uninitiated observer.

The basic principle was introduced by R. Stuart Mackay of the University of California. The parts needed are iron core inductances, some large capacitors, and ordinary 117 volt incandescent lamps. An adjustable source of line voltage helps but is not absolutely necessary. By connecting these components in various series and parallel arrangements, the lamps can be made to flash in orderly sequences and, in some cases, at multiple rates.

Operation of the circuit is possible because two of the elements are non-linear, *i.e.*, the usual relationship between voltage and current does not hold and if we double the voltage across one of the elements, it does not follow that we will double the current through it. Iron core inductances are well known for this property as they tend to saturate when large currents pass through them and the inductance value rapidly decreases. The primary windings of small filament transformers meet this requirement satisfactorily. An incandescent lamp has the property that its resistance is dependent upon the temperature of its tungsten filament. Thus, whether the filament is hot or cold, that is, whether the lamp is on or off, determines the resistance of its filament. Lamps of 75, 100, and 150 watt ratings have been used in most of these experiments.

These two unusual effects must combine in a particular way to obtain the result we are seeking, but they may be examined

separately to better understand the principles. The coil and capacitor are connected in a series circuit as shown in Fig. 1A. At the resonant frequency of the combination such a circuit exhibits a condition of high current and low voltage. In this case, we tune the capacitor so that with little or no current flowing, the combination is resonant below the line frequency of 60 cycles-per-second. We know, of course, that a decrease in inductance will then tend to resonate this series circuit at 60 cps. An increase in current through this non-linear inductance will reduce the inductance value toward this condition.

We can now investigate the graphical relationship between  $I$ , the current through the network, and  $E$ , the voltage across the combination. Certainly, if  $E$  is zero, then  $I$  is also zero. At low values of current, the inductance acts normally, and  $E$  and  $I$  will increase together in a fashion similar to Ohm's law for a.c. circuits. As the current approaches a value sufficient to saturate  $L$ , the inductance value reduces and tends to resonate the series combination. Thus, a condition of high current and low voltage will be reached. With still further increase of current, however, the inductance value is further reduced and destroys the resonant condition. Then the current and voltage begin to increase proportionately again as they did at low values of current. The graph of Fig. 1A illustrates this relationship.

Now let us add an incandescent lamp in series with the network. The filament is characterized by a high resistance when it is hot and a low resistance when it is out, or cold. One must also realize that an appreciable time is required for it to change from one resistance state to the other and that the resistance change is manifold. We can represent the series re-

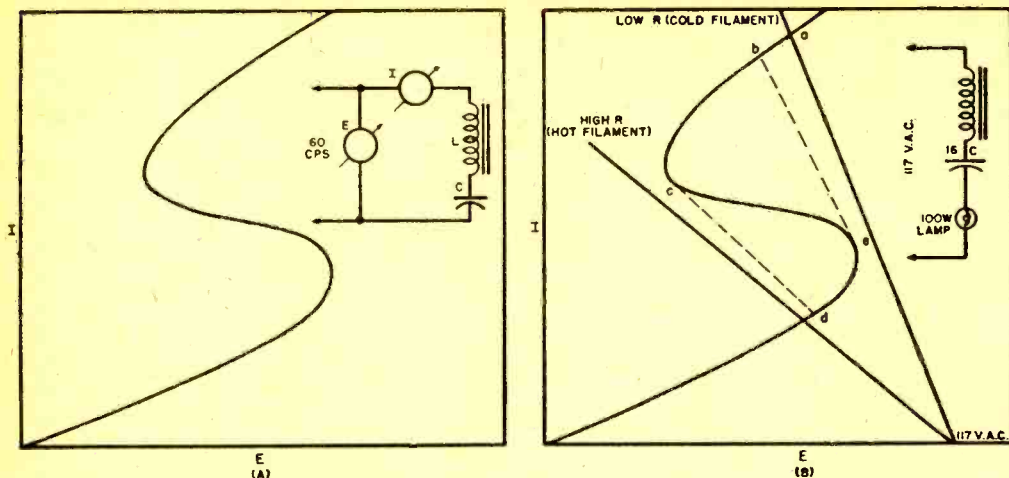

Fig. 1. (A) Relationship between current and voltage with a saturable inductance in series with capacitor chosen. See text. (B) Series circuit of L and C with tungsten filament lamp added. Load lines corresponding to hot and cold resistance values are indicated.

sistance of the lamp on the  $E$ - $I$  chart of Fig. 1B as a load line, just as we do on vacuum-tube characteristic curves. What is more, we may plot the two load lines representing the extreme hot and cold states of the filament. This has been done in Fig. 1B. The load line at any instant lies between these two extremes.

Now we are in a position to examine the action when voltage is applied to the combination. When first turned on, the lamp is cold, the resistance is low, and current corresponding to point  $a$  of Fig. 1B starts to flow. This current is sufficient to light the lamp and the filament starts to warm. The load line slowly rotates counterclockwise toward the hot position. When point  $c$  is reached, the current is still sufficient to light the lamp so the load line continues to rotate toward its hot position. The current is then literally forced to snap to the value of  $d$  to satisfy the enforced conditions. This current value, though, is not sufficient to keep the lamp lighted, it goes out, and the filament starts to cool. The load line, then starts to rotate in the opposite direction, or clockwise. The current follows the path  $d$ - $e$  and then snaps to the value of  $b$ . This causes the lamp to flash on, heats the filament, and the current traverses the same path,  $b$ - $c$ - $d$ - $e$ , again.

As one might suspect, it can be a tedious task to satisfy all of these conditions. For a single unit, such as just examined, it is almost a necessity to have an adjustable line voltage source, such as a *Variac*. On the other hand, as combinations of these units are built up, dependence upon line voltage becomes less and the adjustments are not so critical.

Let us now examine some of the peculiarities of the units. In setting up the system, if the value of  $C$  is slightly high, the lamp will not light, and if too low, the lamp remains on. Also if the line voltage is too low, the lamp will not light and if too high, it remains on. Over a limited range of line voltage the flashing rate is dependent upon the applied voltage.

### Variations of Basic Circuit

It is through the use of multiple arrangements of the circuit of Fig. 1B that the results really become interesting. Combinations are limitless, but a few representative circuits will indicate some of the possibilities. In Fig. 2A, a basic two lamp circuit is shown. The capacitor,  $C_0$ , presents an impedance common to each of the other branches. When either lamp is on, the voltage drop across this common impedance is sufficient to lower the voltage applied to the other unit and keep it from operating. When the resistance of the heated filament changes enough to cause the snapping action described previously, the other lamp immediately flashes on. Its filament undergoes the same resistance change and it soon extinguishes, transferring control to the first lamp, and so on.

Fig. 2B shows another interesting variation of this same unit. The secondary windings of the transformers have been connected in parallel opposition through a suitable small protecting resistor and a push-button switch. This circuit can exhibit several distinct states dependent upon adjustment of either the applied voltage or the capacitance values. It can be adjusted so that one lamp is normally on, the other off. A press on the push button

and the light will change to the other lamp and then back to the original. It will remain in this state until pulsed by the switch and again it will cycle once and stop. It can also be adjusted so that it is stable in either of the lighted positions. That is, when the switch is pulsed, the lighted lamp is extinguished and the other one lights and remains on. Each succeeding pulse will transfer the light from one lamp to the other. This action is analogous to the monostable and bistable operation of multivibrators.

Fig. 3 shows additional parallel branches added to the basic circuit. The lamps will continuously follow a set flashing sequence. There is considerable tolerance in the manufacture of commercial incandescent lamps and the resultant differences in their characteristics are sufficient to determine the order in which they flash. Once a given sequence has started the different temperatures of the filaments will insure that the order will continue. As indicated in the diagram, a lamp may also be placed across the common capacitor,  $C_c$ , and it will flash in unison with each other lamp.

There are other effects that are worthy of mention. As each inductance saturates, a change will occur in its magnetic field. This changing field will, in turn, affect other iron core circuits in the vicinity. This has either a triggering or retarding influence on the saturation of adjacent inductances. By mere placement of the parts, a given sequence can sometimes be changed. A three lamp circuit may then flash 1-2-3, 1-2-3, or 1-2-3-2-1.

Tuning each branch can be somewhat tedious and if the circuit is altered by the addition of another branch, all units usually need retuning. Once the components are established, however, the only noticeable sensitivity is a slight change in flashing rate with line voltage. If all the branches are symmetrical, that is, all the

transformers and lamps identical units, this tuning procedure is simplified as all the series capacitors will be nearly the same value. This is by no means necessary, though. The author has used *Stancor* P-3062, *Stancor* P-6135, *Kenyon* T-351, and *Thordarson* T21F01 transformers with success. Additional effects can be procured by purposely mixing up transformer types and lamp sizes. This will sometimes lead to one lamp flashing at double the rate of all the others or flashing only on alternate cycles.

The capacitors may be of almost any type. Paper or oil-filled units are probably best, although electrolytics, placed back-to-back, can also be used. Considerable care should be exercised if the latter procedure is followed as overheating of the capacitors may occur. A considerable selection of capacitors is required for tuning, but seldom are the final values lower than 8 microfarads. Padding with smaller units is usually necessary to bring the total capacitance to the desired amount. The values given in the diagrams are approximate and the exact values are influenced by the other parts used with it.

Many practical applications have been suggested for these units but much experimentation will be necessary before their ultimate use is known. Inquisitive and ingenious manipulations with the basic circuits will soon turn up more effects than noted here. Even if approached purely as a scientific novelty the unexpected action is both startling and instructive.

These flashing lamps can be just sheer fun and are well worth building if for no other reason than their entertainment value.

#### REFERENCE

Mackay, R. Stuart: "Interesting Nonlinear Effects", *Journal of Applied Physics*, Vol. 24, No. 3, March 1953. END

Fig. 2. (A) Circuit for two parallel branches as shown in Fig. 1B. (B) Variation possible by adding a switch in secondary windings which act as nonlinear inductances.

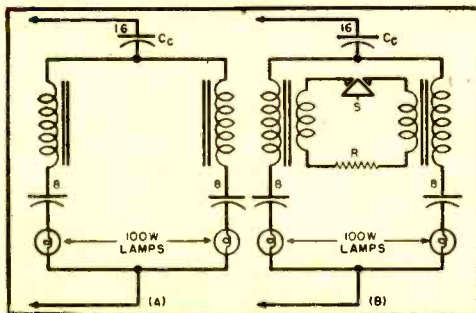
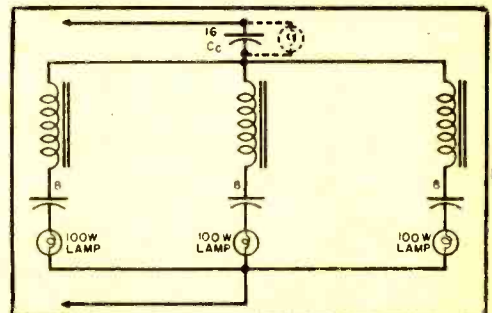

Fig. 3. Addition of another parallel branch to give greater flexibility to possible modes of operation. Addition of lamp across the common impedance is also shown.





# Experimenter's Laboratory

## A MODERN "BREADBOARD" CHASSIS

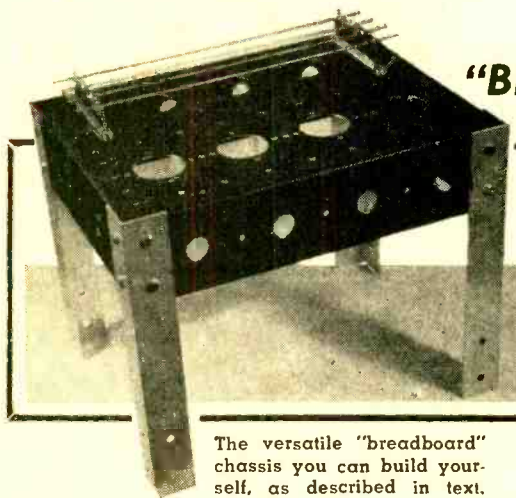

The versatile "breadboard" chassis you can build yourself, as described in text.

IF YOU'RE a hobbyist who works frequently with new circuits, you'll soon feel the need for a permanent experimental chassis. A suitable "breadboard" chassis is shown above. The name "breadboard" dates back to the early days of radio, when almost all experimental as well as many permanent circuits were wired on wooden boards, with parts mounted by means of wood screws. Today, the name is applied to any general experimental chassis or circuit.

The chassis itself is drilled and punched from a standard 7" x 9" x 2" chassis base, available from most parts distributors. The drilling layout for the top of the chassis as well as end and side layouts are shown on the opposite page. Both ends and both sides are identical. Drill the small holes and use *Greenlee* or *Pioneer* punches for making the large holes.

The completely drilled and punched chassis should look like the one in the photo across the page.

Four leg brackets are needed. These are made up from 1" x 1" x 1/16" thick extruded aluminum angle. *Reynolds* "Do-It-Yourself" aluminum, available at most hardware stores, may be used for making these.

Socket holes in the main chassis are for standard octal sockets. If you work with miniature tubes, you'll need adaptor plates for 7-pin and 9-pin miniature sockets. Di-



Mechanical details for constructing the experimental "breadboard" chassis. Photos show prepared chassis and the "accessory" units.

### PARTS LIST

- 1—7" x 9" x 2" aluminum or steel chassis. (Bud CB-790, CB-1192, AC-406; ICA 29006, 4004, 1569; Par-Metal B-4511, C-4511; Premier CH-404)
- 3—Ft. #12 tinned bus bar; 4—Ground lugs
- 30—Inches 1" x 1" x 1/16" extruded aluminum angle. (Reynolds "Do-It-Yourself")
- 2—7-terminal tie-point strips (Jones #2007)
- 2—Sq. ft. .050 sheet aluminum or 20 ga. steel. (Amount depends on number of brackets and adaptor plates)
- 1—Pkg. #6 x 3/8" sheet metal screws

mensions for these adaptors are included in the mechanical diagram at left. Make as many as you think you'll need.

Any number of small accessory brackets may be made, depending on your individual requirements. Typical dimensions for a volume control bracket are given. You may wish to make brackets either larger or smaller, however, or may wish to make special brackets for particular jobs.

Typical small accessories, together with the four leg brackets, are shown in the photo on the opposite page.

Mount the four leg brackets on the chassis using 3/8" #6 sheet metal screws. Mount the two terminal strips and four ground lugs with similar screws.

Run four or more straight pieces of #12 tinned bus bar between corresponding positions on the terminal strips, soldering at both ends.

When finished, the completed "breadboard" chassis should appear as shown at the top of this page.

When you're ready to wire an experimental circuit, mount all tube sockets,

A partially wired circuit on "breadboard."

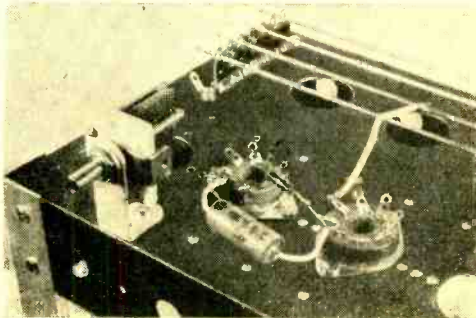

brackets, and special terminal strips on the "breadboard" chassis using # 6 sheet metal screws.

If the adaptor plates are to be used, mount the miniature tube sockets in them using 1/4" 4-40 machine screws and small hex nuts. Mount the adaptor plates, in turn, on the chassis proper using longer sheet metal screws and 1/4" stand-off spacers. They are mounted right over the large tube socket holes.

All tube sockets are mounted so that the tubes plug in below the chassis, permitting all wiring to be kept above chassis

and exposed. This makes it easy to make tests and experimental circuit changes.

Lap joints are used for all wiring, with ground. "B plus." and filament connections made through the bus bars. A typical experimental circuit, partially wired, is shown at lower right of the previous page.

In addition to simplifying the original assembly and wiring job of an experimental circuit, the use of a "breadboard" also makes the disassembly job easier. The exposed wiring and lap joints permit the experimenter to tear down a circuit in "jig" time. END

## New CD Communications System in Los Angeles

**T**HE new Civil Defense communications system now in operation in Los Angeles is believed to be the first and largest city-owned system of its type in the nation.

Radio equipment used throughout the system was built by *General Electric*. It is designed around four master-control stations, three of which are housed in trailer trucks and the fourth a permanent installation adjacent to the Coliseum.

Each master control station is equipped to transmit and receive messages from any part of a far-flung communications network. The new system will, in an emergency, coordinate activities of thousands of municipal and private vehicles now

equipped with two-way radiotelephones.

Tied together by the radio system are the city commissioners and executives; municipal departments such as public works, fire, police, health, transportation, water and power, and harbor; private companies operating radio-equipped vehicles such as taxicabs and electric utilities; the Red Cross; and a vast network of volunteer amateur radio operators.

A microwave radio transmission system, installed between City Hall and Mt. Lee in the Hollywood Hills, allows the Commissioner of Public Works to maintain radio contact with his far-flung forces *via* high-power transmitting and receiving equipment installed on Mt. Lee. The radio station on Mt. Lee also serves as contact with the State Civil Defense control system.

The Los Angeles Civil Defense communications system is designed to be used in "natural disasters" such as fire, tornado, earthquake or flood, as well as during defense emergencies. The system has already proved effective in communication with city trucks and vehicles at work maintaining and repairing segments of Los Angeles' vast network of transportation facilities.

The necessity for a well-planned communications network, nerve center of every Civil Defense operation, was originally envisioned by Colonel K. C. Bean, manager of the city's Department of Public Utilities, in 1951. The realization of the plan has been brought about by Colonel P. B. McCarthy, senior deputy director, Civil Defense, and the *General Electric* communication advisory service, working cooperatively under the direction of T. M. Chubb, Col. Bean's successor.

At the present time, the major components in the system include 150 radio-equipped cars and trucks, two-way radios, 100 "walkie-talkies", and 60 medium-power transmitting and receiving stations. END

One of the three truck trailers which house master control stations in Los Angeles' new Civil Defense communications system. These truck trailers can be moved rapidly to strategic sites, if necessary, during emergencies.





# BATTERY ELIMINATOR-CHARGER KIT

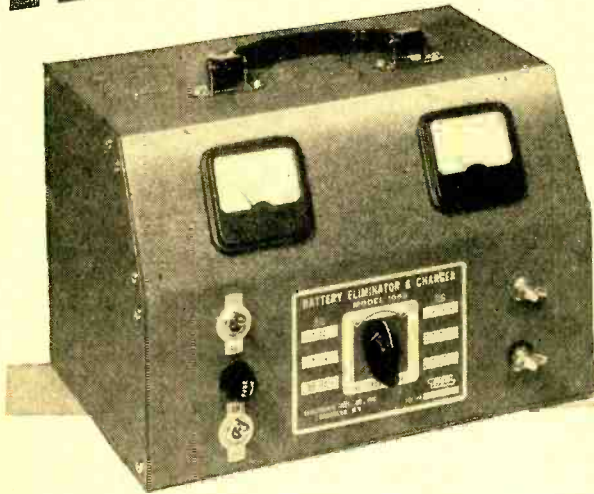

**YOU** can own a professional-type 6- and 12-volt battery eliminator and charger at a small cash outlay by building it yourself from one of the currently-available, commercially-engineered kits.

This unit has literally hundreds of uses in your home, in your workshop, on your boat, etc. It can be used as a work-bench power supply for operating 6- or 12-volt auto radios under repair. Its metered variable output voltage permits determination of minimum voltage required for solenoid actuation. It can be used for charging 6- and 12-volt storage batteries and *Edison* batteries. It can also be used to operate marine receivers and transmitters, boat lights, and other equipment at dockside where a 117 volt a.c. line is available from shore.

It is a natural for operating mobile re-

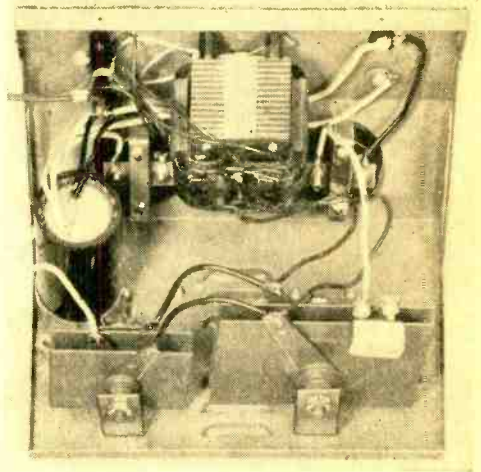

- C*<sub>1</sub>—6000  $\mu$ d., 20 v. elec. capacitor
- M*<sub>1</sub>—0-20 volt d.c. voltmeter
- M*<sub>2</sub>—0-20 ampere d.c. ammeter
- F*<sub>1</sub>—2 ampere fuse (Littelfuse 312005)
- S*<sub>1</sub>—S.p.d.t. heavy-duty toggle switch (A d.p.d.t. switch with circuits in parallel may be used)
- S*<sub>2</sub>—S.p.s.t. toggle switch
- RL*<sub>1</sub>—20 ampere overload relay
- SR*<sub>1</sub>-*SR*<sub>4</sub>—9.9 volt d.c. @ 6 amp. selenium rectifier, input 24 v. a.c.
- SR*<sub>5</sub>-*SR*<sub>8</sub>—9.9 volt d.c. @ 10 amp. selenium rectifier, input 24 v. a.c.
- T*<sub>1</sub>—Power trans., 115 v., 60-cycle pri.; 20 v. a.c. sec. @ 10 amp. (total) open center tap
- I*<sub>1</sub>, *I*<sub>2</sub>—Output terminals
- Variat*—Mechanical assembly riding on secondary winding. Varies voltage to rectifiers. See inset

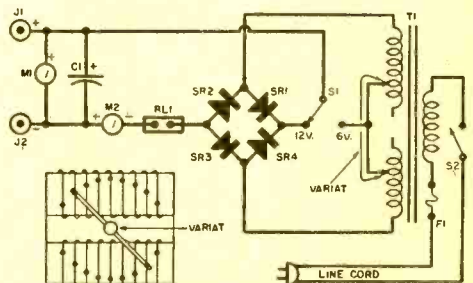

ceivers and transmitters, mobile projection equipment, etc. from the 117 volt a.c. line. It can also do duty in light electroplating work as well as operate electric trains, toys, relays, pin-ball machines, 6-volt or 12-volt electric shavers, etc.

The circuit design is quite conventional for this type of unit. When used for 12-volt output the rectifiers form a bridge circuit supplying 12 volts at 6 amperes. For 6-volt operation rectifiers  $SR_2$  and  $SR_3$  form a full-wave rectifier circuit supplying 6 volts at 10 amperes. For intermittent operation outputs of 6 volts at 20 amperes or 12 volts at 12 amperes can be obtained.

The switch,  $S_1$ , should be a heavy-duty type unit.

The design of the unit is such that the output voltage is variable from 0 to maximum. This is obtained by a mechanical slide contact. It is referred to as a *Variat* and consists of a double arm mounted in

such a way that the arms slide across the bare wires of both halves of the secondary windings of the transformers,  $T_1$ . Its operation is such that the output a.c. voltage from the transformer, applied to the rectifiers, varies from 0 to 20 volts.

The overload relay,  $RL_1$ , is a thermal-type unit. When the current exceeds 20 amperes, the heated element opens up. It automatically closes again as soon as it cools off. It is a relatively inexpensive item which may be found at most automobile parts supply houses.

A separate voltmeter and ammeter permit the simultaneous observation of the output voltage and current.

Even an inexperienced hand at building such equipment can assemble this *Eico* Model 1050 kit in approximately two hours—a small expenditure of time considering the many uses for which this device is suited. END

## PHOTOELECTRIC CELL

**A** NEW, low-cost, mounted selenium photoelectric cell which has been designed especially for engineers and experimenters has been introduced by *International Rectifier Corp.* as the B 2 M. It measures  $2\frac{3}{32}$ " x  $\frac{7}{16}$ " and is mounted by a self-contained

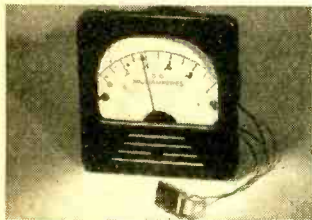

foot bracket extension. The active area is only .26 sq. inch yet generates an average output of 60 microamperes at 100 foot-candles illumination. It could be used as a "solar battery" for transistor gear.

## W3NKF ON THE AIR

**A** NEW amateur radio station, W3NKF, owned and operated by the Naval Research Laboratory Amateur Radio Club, is now on the air.

During 1923-1943 the Laboratory station worked with amateurs in connection with experimental work. Its call was "NKF."

Ethel M. Smith, president of the club, Dr. Wayne C. Hall, president-elect, and Leo C. Young, trustee for the new station, are shown sending out a call at the new station.



## OSCILLATOR-MONITOR

**A** COMBINATION code practice oscillator and monitor for both phone and c.w. is currently available as the *Gonset* "Monitone." The unit includes an audio oscillator which may be controlled by the external keying circuit to provide a tone signal for practice purposes. The monitor feature is especially effective with a c.w. transmitter and when checking AM phone operation.



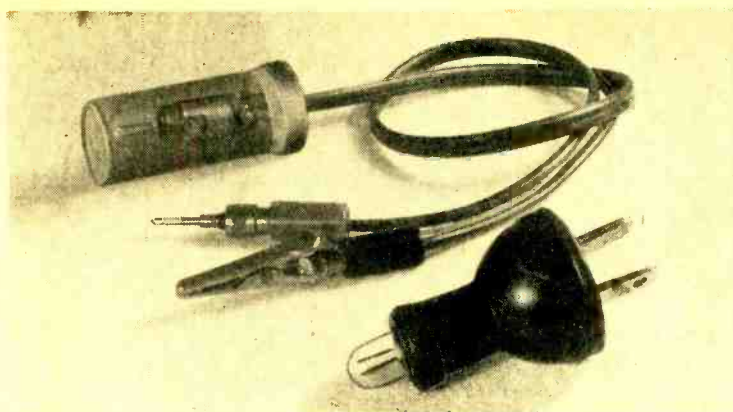
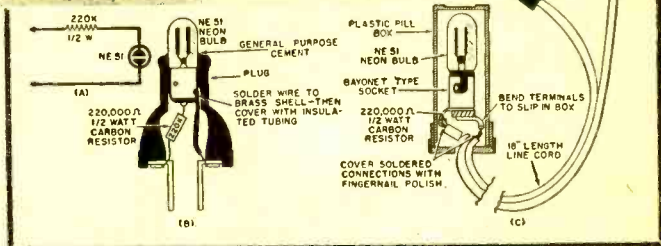

Fig. 1. A general purpose tester (rear) and power line tester (foreground). (A) Schematic for both units. (B) Construction details on power line tester. (C) Details on the general purpose tester. Parts values shown on diagram.



## WITH NEON BULBS

NEON bulb circuits have been popular with experimenters for years. Home builders, particularly, have liked them because of their simplicity and versatility. Beginners find that such circuits are easy to wire and quite inexpensive, since so few parts are needed for the average circuit, and the cost of the individual items is generally low.

Five interesting neon bulb gadgets are shown in the photographs and sketches. They are neither complicated nor expensive to build, and the average experimenter should have no difficulty in wiring several of the items shown in a single evening. The circuits shown are not all new. Several have been favorites with experimenters for years and have proven their reliability through the "test of time."

Three different types of neon bulbs are used in the circuits shown, the NE-2, the NE-51 and the NE-48. Of these three, the NE-2 and the NE-51 are interchangeable in the circuits where they are used. The chief difference between these two bulbs is in the basing. The NE-2 has no base, only wire leads, while the NE-51 has a miniature bayonet base.

A general purpose tester (background) and a combination night light and power line tester (foreground) are shown, along with circuits and construction data, in Fig. 1. Note that both devices are electrically the same, with the schematic diagram given in Fig. 1A applying to both.

Construction details for the night light and power line tester are given in Fig. 1B. The only parts needed are an NE-51 bulb, a 220,000 ohm, 1/2 watt carbon resistor, together with a standard rubber plug. Assemble the unit as shown, cementing the neon bulb in the neck of the plug with Duco cement (or any equivalent household cement). *Be sure that the brass shell is below the neck of the plug . . . no part of the shell should be exposed.*

To use as a night light, simply plug the unit into any standard wall receptacle. The bulb will give off a soft glow with virtually no heat, and may be safely left on all night. Power consumption is almost insignificant.

To use as a power line tester, plug the unit into the suspected receptacle. If the bulb glows, power is available. If not, either the receptacle or wiring is defective,

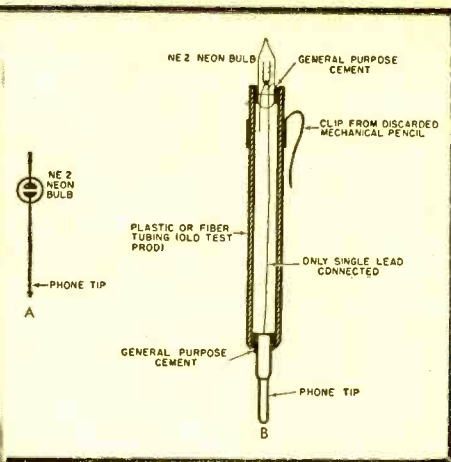
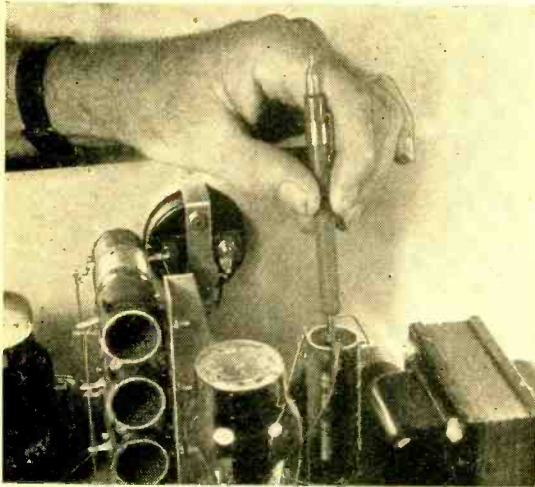

Fig. 2. Photo and schematic of the r.f. tester for hams. Use it to check for presence of r.f. energy in oscillators and amplifiers.

or the line fuse is blown. Lamp fixtures may be checked by using a standard screw-type adaptor.

The *general purpose tester* operates in much the same manner, with the only difference being in the method of construction. Full details are given in Fig. 1C. If preferred, connections may be soldered directly to the base of the neon bulb and the socket omitted. Once the wiring is completed, cover the connections with fingernail polish or lacquer to prevent accidental shorts.

Either a.c. or d.c. voltages from around 90 to 250 volts may be checked with this device. To use the tester, connect the test leads to the points where voltage is to be checked. If both electrodes glow, the voltage is a.c. If only one electrode glows, the voltage is d.c. (the negative electrode is the one that glows). In both cases, the higher the voltage, the brighter the glow obtained.

The "hot" side of a power line (110-220 volts) may be identified by connecting one lead of the tester to a good ground and then touching first one, then the other wire of the power line with the free lead. A glow will be obtained when the "hot" power line wire is touched.

Hams will find the *r.f. tester* shown in Fig. 2 useful. The schematic diagram is given in Fig. 2A, while construction details are given in Fig. 2B.

To check for the presence of r.f. energy in low and medium power oscillators and amplifiers, hold the tester as shown in the photograph of Fig. 2 and touch the metal tip to a "hot" terminal. If r.f. energy is present, the neon bulb will glow. Where a moderate to large amount of r.f. power

may be present, *do not touch any terminals with the metal point*, instead, simply bring the *bulb end* of the tester in close proximity to the hot terminal. If sufficient energy is present, the bulb will glow without actual contact.

Radio service technicians will be able to use the *60-cycle stroboscope* shown in Fig. 3 when testing and adjusting phonograph motors. The audiophile, too, will find the gadget useful for checking the speed of his favorite record player.

The schematic diagram of the unit is given in Fig. 3A, while construction details are shown in Fig. 3B. An ordinary plastic pill box or vial is used for housing the device. The NE-48 neon bulb is simply forced through a hole in the flexible plastic cap of the pill box. Take care that the brass shell is not exposed outside the box, however. If necessary, a little cement might be used when assembling the unit.

The completed *stroboscope* is used with a standard "stroboscope disk" (available at most radio supply houses) when checking the speed of a phonograph turntable. The proper technique is shown in the photograph of Fig. 3. When the turntable is rotating at proper speed, one of the circles will appear stationary when viewed in the light of the *stroboscope*. One circle is for 33½ rpm, while the other is for 78 rpm turntables.

Learning the radiotelegraph code may be a little easier for the beginner if the *code practice oscillator* shown in Fig. 4 is used. The neon bulb "blinks" each *dot* and *dash* at the same time that the tone is heard in the earphone. The schematic diagram for the unit is given in Fig. 4A, while the pictorial wiring diagram is given in Fig. 4B.

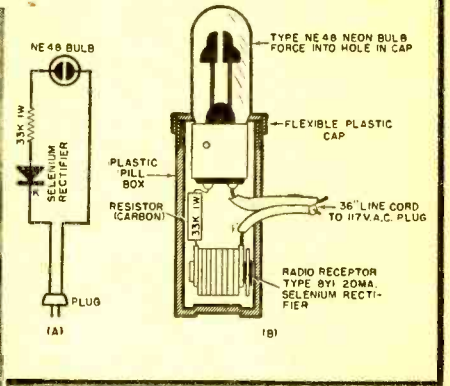
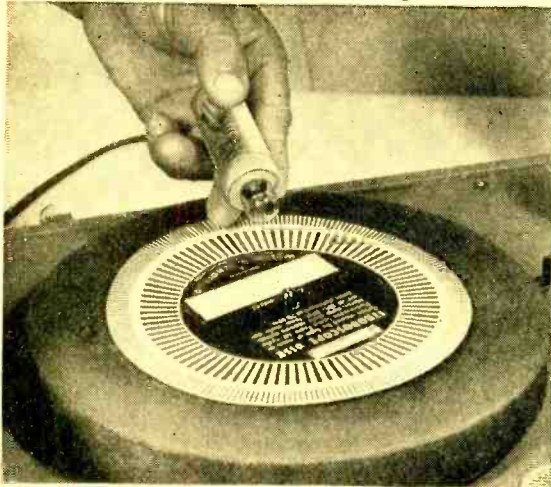

Fig. 3. Proper way to use the 60-cycle stroboscope diagrammed above. Technicians and audiophiles will find this handy for checking the speed of phonograph turntables.

Construction is simple and straightforward and no difficulty should be encountered if the wiring diagrams are followed carefully. The *hand-key* may be connected in series with either the positive or negative lead of the battery, and on either side of the 470,000 ohm, 1/2 watt resistor. In the model shown in the photograph, it is connected between the 470,000 ohm resistor and neon bulb. The tone may be changed by varying the value of the series resistor. A lower value resistor will give a higher pitch, a higher value resistor a lower pitch.

All of the devices described and pictured in this article are easy to build, offer a practical solution to some specific problem, and present a "professional" appearance. Pick your instrument and then have the fun of building it! **END**

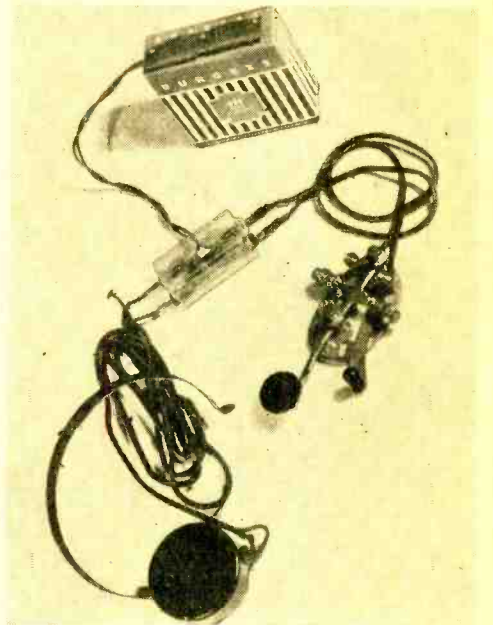
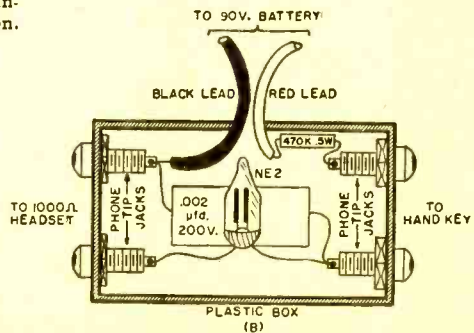
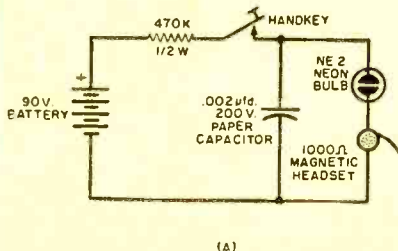

Fig. 4. A simple code practice oscillator. The neon bulb "blinks" each dot and dash at the same time that the tone is heard in the earphones. The schematic and pictorial diagrams shown below should be followed exactly to insure best results. Parts values are also given.



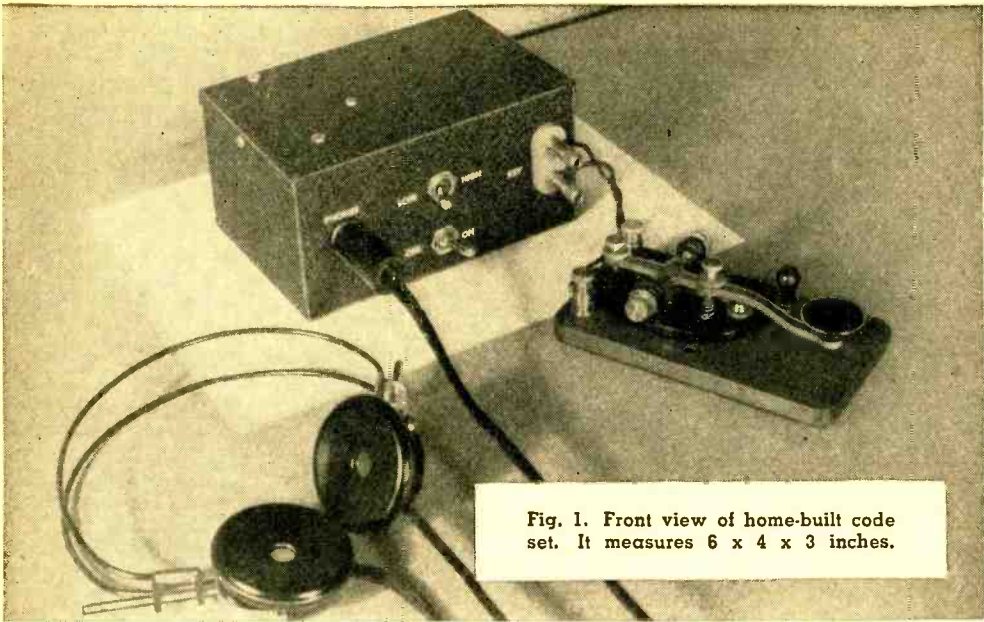
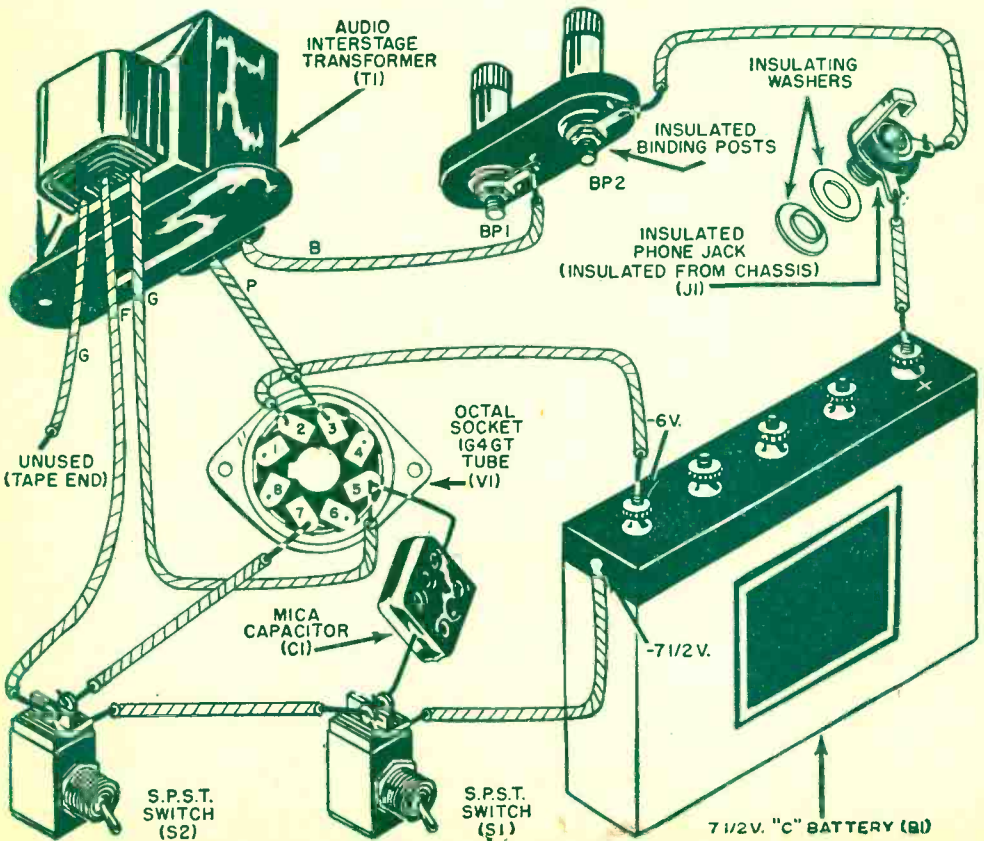
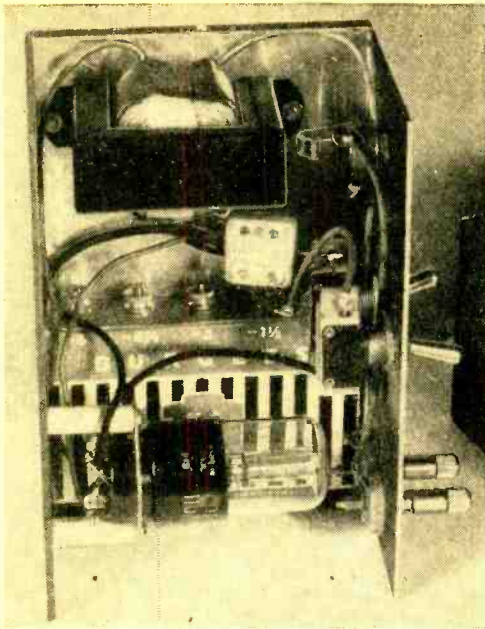

Fig. 1. Front view of home-built code set. It measures 6 x 4 x 3 inches.

# Build This Code Practice





# Set . . .

IT IS FUN to communicate by Morse code. And it is fun to get your amateur radio license, but you must know the code to be a "ham."

A lot of practice is needed to build up speed and accuracy both in sending and reading code. Like steady music practice, code study improves both the hand and the ear.

A necessary instrument for code study is an electronic code practice set. Connected to headphones and a telegraph key, it provides the dot-and-dash signals that spell out words. Some students use a buzzer to make the signals. But a buzzer is noisy. The tube-type practice set makes no noise to disturb others. If you have a study partner, he can work the hand key while you listen. If you must study alone and want to build up speed quickly, you can rent or buy a code machine and connect it to the practice set in place of the key.

This article describes a simple, inexpensive, tube-type code practice set which can be built with ordinary tools. The set is completely self-contained and requires no connection to the power line. Hence, you can use it at any location. It is built in a 6" x 4" x 3" enameled aluminum radio chassis box. Fig. 1 shows the unit connected to headphones and key and ready for operation.

Fig. 3 is the complete circuit. A 1G4GT

Fig. 2. Internal view of the code practice set showing how the various parts are placed inside of the box. Other arrangements may be followed by the builder if desired.

Fig. 3. Complete schematic diagram of set.

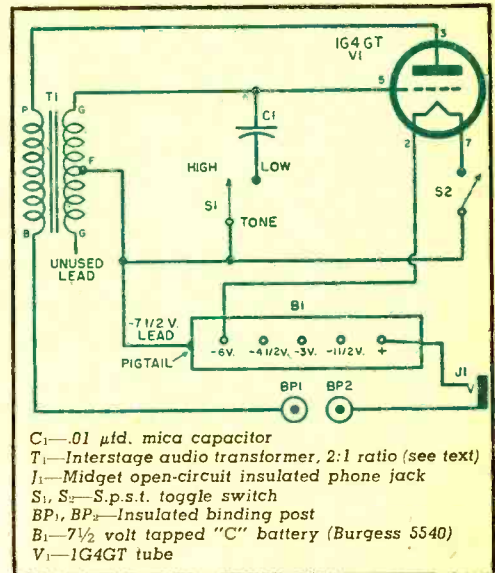

battery-operated tube is used in a simple hookup. The transformer, *T*<sub>1</sub>, is a small audio unit. Almost any audio transformer sold as an "interstage coupling" unit will work in this circuit.

Two tones are generated. You can select the one you like best by flipping the tone switch. The highest pitch is obtained when the tone switch *S*<sub>1</sub> is thrown to its "high" position. In the "low" position of the switch, an external *.01*  $\mu$ fd. capacitor, *C*<sub>1</sub>, is connected across the transformer. With the *United Transformer Corp.* Type R-56 transformer used by the author the low pitch is around 260 cycles and the high pitch 550 cycles. These are pleasing tones, but the reader may choose another low pitch by using some other value of capacitor *C*<sub>1</sub>. The higher the microfarad figure of this capacitor, the lower will be the pitch.

Fig. 3 shows how a single 7½ volt tapped "C" battery (*Burgess 5540*) is connected to operate the tube.

The headphones (plugged into phone jack *J*<sub>1</sub>) and the key (connected to the two binding posts, *BP*<sub>1</sub> and *BP*<sub>2</sub>) are wired in series between the battery and the "B" lead of the transformer. The headphones must be of the magnetic type and should be rated at 2000 to 3000 ohms resistance. Only one switch, *S*<sub>2</sub>, is needed to turn the instrument off when not in use.

The circuit gives a strong headphone

signal and works well at all code speeds.

Fig. 2 and the pictorial diagram illustrate the constructional details. All of the parts are mounted on the inside walls of the 6" x 4" x 3" metal chassis box (an *L.M. Bender Co.* Type 141).

The transformer is mounted to the inside top of the case by means of short 6-32 screws. The tube socket is held to the rear panel with two threaded 1-inch studs held by screws. These studs space the socket away from the panel, keeping the socket terminals from touching the latter.

A pair of 6-32 screws holds the battery in place, keeping it from sliding along the floor of the case. These screws do not penetrate the battery but press against its paper cover.

The front panel has been "dressed up" as may be seen in Fig. 1, by labelling it with instrument decals.

The layout of parts and wiring are merely suggestions. We believe this to be the most convenient arrangement, but the

reader can suit himself as to where he wants to place a particular part if he feels "inventive."

Use insulated hookup wire for all wiring. Use rosin-core solder, never acid-core nor corrosive flux, for all joints. The wiring is not fussy, and any lead may be run in the most convenient manner.

Check the wiring carefully against the diagrams before inserting the tube into its socket. After you are satisfied that the wiring is correct, insert the tube and connect the headphones and key. Throw switch  $S_2$  to its "on" position. Set switch  $S_1$  to its "high" position, and press the key. A tone should be heard in the phones as long as the key is held down. If this tone is not heard, the circuit is not working, probably because the transformer is hooked up incorrectly. To remedy this trouble, reverse the *P* and *B* leads of the transformer. With the set working, now throw switch  $S_1$  to its "low" position and notice that the tone drops to a lower pitch when the key is depressed. END

## EXTENDING THE RANGE OF YOUR COIL CALCULATOR

ONE of the experimenter's most useful aids is the *Allied* "Coil Winding Calculator." It has the single disadvantage of not continuing its scale to include windings of spacings greater than 1/10th inch. This prevents calculations for coils of wire heavier than about #10 and completely rules out one of the most popular ham coil inductors, copper tubing. By means of a simple modification the range may be increased to include coils of winding pitches as low as 3 turns-per-inch.

The scales are logarithmic, so intervals of a given length are halved in value, going to the left of the scale. This means that calibrations may be transferred to the unmarked portion of the rule as long as the relationship is retained.

First mark a card opposite the graduations for 15, 20, 25, 30, 35, 40, 45, and 50 turns per inch. Then move the card to the left so the 50 turn mark is opposite 10

turns on the calculator scale. Transferring graduations from card to calculator body will now give points for spacings of from three up to ten turns-per-inch.

Now, remove the slide, insert a strip of sheet metal and, with a razor blade, extend the window to the new 3 turn marking. Reassemble, and the calculator may now be used for figuring any practical size of coil. . . . . E. R.

Cutting the new window in the calculator to extend range down to the 3 turn mark.

Setting up the new scale using the markings already on calculator. See article.

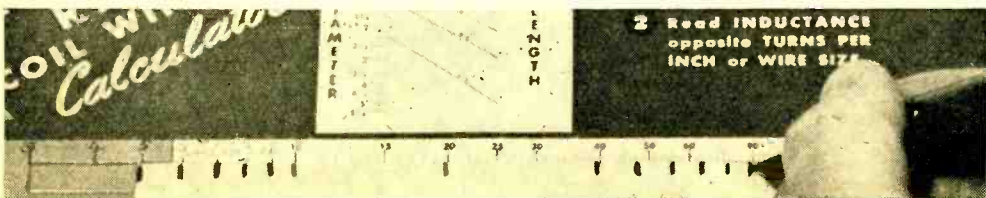



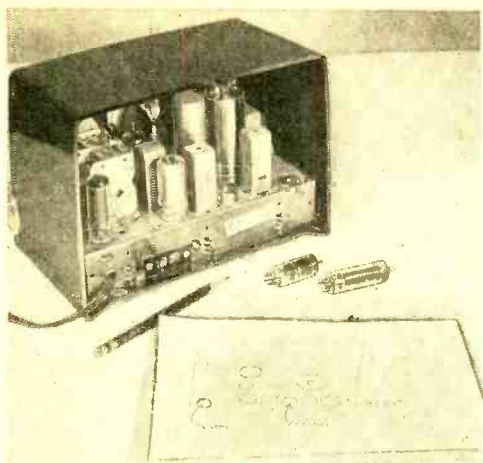
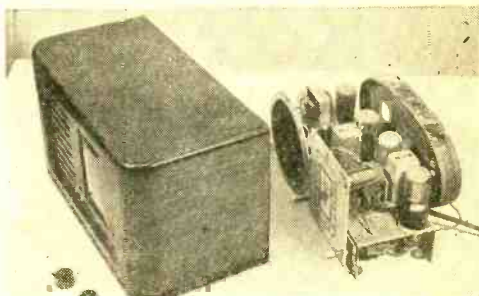

Fig. 1. Always make a diagram of tubes' location before removing them from chassis for testing so they can be replaced in the correct sockets.

Fig. 2. Where the loop antenna is in the way, the chassis must be removed before you can get at the tubes. See Fig. 3 on removing the knobs.



# How To Fix Home Radios

**T**HE first step in repairing any piece of electronic gear, whether a home radio or a complicated piece of radar equipment, is to *pinpoint the complaint of "improper operation" in terms of actual performance.* Find out if the radio is *weak, completely inoperative (dead), noisy, has hum, distortion,* or is *intermittent* ("works now and then"), or if the complaint involves some mechanical defect, such as a broken dial cord. Do this job by turning the set on and checking its operation.

If the set is *dead*, check for a burned out tube. In a.c. sets (those having a power transformer), a burned out tube can generally be spotted immediately. It will be dark when the others are lit or, if a metal tube, will not be warm to the touch. In a.c.-d.c. sets, on the other hand, all the heaters are in series and one burned out tube will cause all the tubes to go dark. In this case, you can identify the faulty tube by checking across the heater pins (identify these by using a tube manual) with an ohmmeter or continuity tester. Remove the tubes from the chassis for this test.

However, since a tube may be weak, gassy, or have internal leakage between electrodes without being burned out, the best policy is to check all tubes in the receiver. This is especially true if the complaint involves *weak or noisy operation, hum, distortion,* or a similar electrical defect. Since a large percentage of receiver defects can be traced directly to poor tubes, it is best to eliminate these parts as a possible cause of trouble at the very beginning of the service procedure.

Remove the tubes carefully, noting their locations as shown in Fig. 1. In some cases,

it may be necessary to remove the receiver from the cabinet in order to reach the tubes. See Fig. 2.

If this is the case, remove the knobs first. Receiver knobs are generally of two types, those having a flat internal spring and which "push on" the control shaft, and those having a set screw. "Push on" knobs may be a little difficult to remove if the wrong technique is used. *Don't try to pry the knobs off with a screwdriver.* You may scratch the cabinet, bend the control shaft, or break the knob. Instead, proceed as shown in Fig. 3, and remove the knob by pulling on the cloth.

If you have a tube tester available and can check the tubes yourself—fine! If not, take the tubes to a friend who has a tube tester or to the nearest radio repair shop for testing. Most repair shops will check the tubes free or for a nominal charge.

Replace any burned out, weak, or shorted tubes. If the rectifier tube is defective (this may be a 35Z5GT, 5Y3, 80,

Fig. 3. "Push on" control knobs can be damaged if removed by force. Use a cloth behind knob to prevent damage. Set-screw types are removed by loosening screw with a tiny screwdriver.

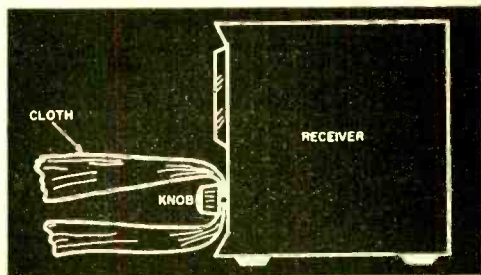

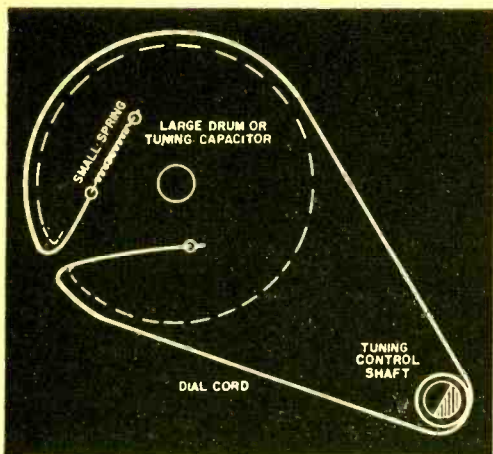

Fig. 4. Basic technique for replacing worn or broken dial cord. Special stringing arrangements may involve reference to service books.

5U4, 35W4, or similar tube), check the filter capacitor before turning the set on as it may be shorted. In most sets you can do this by using an ohmmeter to check between the cathode terminal pin of the rectifier tube socket (identify this terminal by using a tube manual) and chassis ground. Reverse the meter leads and use the highest reading obtained as the correct value. If the filter capacitor is not shorted or leaky, the resistance should be 50,000 ohms or more.

While the set is out of the cabinet, correct any obvious defects such as a loose antenna or ground wire (some a.c.-d.c. sets do not use a ground so *don't connect a ground unless a special terminal is provided for one*), broken dial cord, burned out pilot lamp bulb, and similar defects. Blow out dust using a hand hair drier or a vacuum cleaner.

If the dial cord is broken, you'll probably have to string a new one. Obtain dial cord material and small springs from your nearest radio supply house. The basic stringing diagram, which will apply, in modified form, to many table model receivers is shown in Fig. 4. However, for the exact diagram of your set, you may wish to refer to a "Dial Cord Stringing Guide." These may be purchased, in book form, at most radio parts distributors. Each book contains diagrams for many different receivers. Since several volumes are available, check the index to make sure your receiver is covered before buying the book.

If the set has a power transformer, you can frequently use almost any pilot lamp bulb as a replacement provided it has the same voltage rating and base connection as the original. *But always use an exact duplicate replacement bulb on a.c.-d.c. sets.*

Suppose replacing defective tubes and correcting obvious defects doesn't clear up the trouble. What next? That depends on the complaint. Here are a few hints:

Hum is most frequently caused by defective filter capacitors or heater-to-cathode leakage in one of the tubes. Tube defects should have been caught when the tubes were tested. Filter capacitors are best checked by the "substitution" method or by using a special capacitor tester, if available. The "substitution" technique is simple and consists of trying a replacement capacitor in place of the suspected one—a technique frequently employed by professional technicians.

Filter capacitors are generally of the two types shown in Fig. 5. A tubular type capacitor is generally mounted below the chassis while the upright mounting or "can" type is usually mounted above the chassis, with only the terminals below.

When replacing filter capacitors, two precautions should be followed: (a) Observe the correct polarity when connecting leads. If in doubt, make a sketch of the actual connections before removing the old unit; (b) use a replacement capacitor with a working voltage at least as high as the original unit. As far as electrical capacity is concerned, simply be sure it approximates, or is higher than, that of the original. For example, a 25  $\mu$ fd., 250 volt capacitor may be used as a replacement for a 30  $\mu$ fd., 250 volt unit. However, don't use a 150 volt replacement for a 250 volt original.

If the set is noisy as you tune in different stations, the tuning capacitor is probably dirty. Clean this part carefully, making sure you don't bend the plates. If possible, blow out any dust between plates.

If the set is noisy as you adjust the

Fig. 5. Two common types of electrolytic capacitors, can-type in rear and tubular in front.

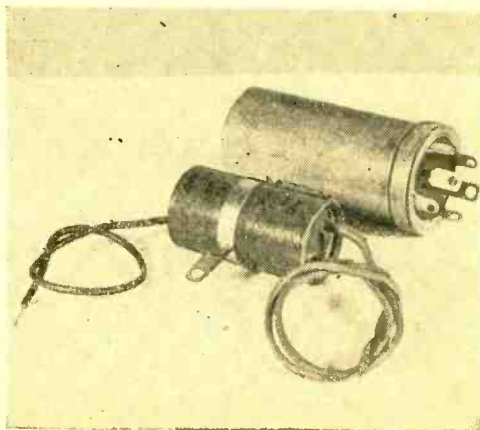

volume or tone controls, the control might be dirty inside. Using an eye-dropper, try running *Carbena* cleaning fluid or carbon tetrachloride inside the control, then rotating the control vigorously back and forth.

Sometimes better results can be obtained by using one of the new "hypodermic" injectors to squirt the cleaning fluid inside the control, as shown in Fig. 6. If preferred, one of the special volume control cleaning fluids, available at radio parts distributors, may be used instead of carbon tetrachloride.

Three common defects which may cause distortion are: (a) a defective loudspeaker, (b) a leaky coupling capacitor, and (c) a "gassy" audio output tube. A loudspeaker may cause distortion if the frame warps so that the voice coil rubs against the central pole piece.

Frequently, the complaint will be "the set plays fine for a while, then the sound becomes mushy," or "the radio plays good out of the cabinet but sounds fuzzy inside the cabinet." Both complaints may be caused by a defective loudspeaker. In the first case, as the set heats up, the loudspeaker frame warps slightly, causing the voice coil to touch either the pole piece or the field. In the second case, placing the set in the cabinet may warp the chassis or loudspeaker mounting slightly, resulting in a similar condition.

To check a loudspeaker, hold the unit by the edges and *very gently* move the cone back and forth by pressing on it with your thumbs. The cone should move easily and freely. If not, repairs may be in order.

In the case of small loudspeakers, of the type used in inexpensive table model receivers, it is generally cheaper to install a new speaker than to attempt repairs. In other cases, repairs may be made.

Fig. 6. A noisy volume control can be repaired by cleaning with carbon tet from eyedropper.

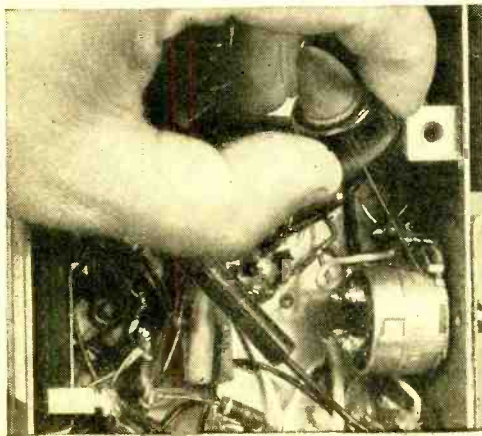

October, 1954

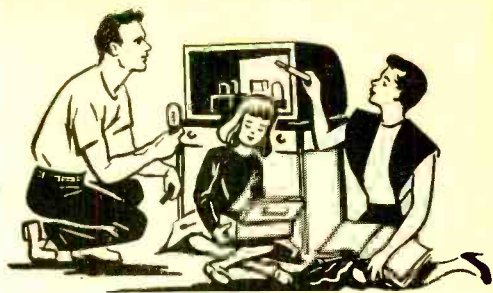

The loudspeakers used in many older receivers are provided with a central adjusting screw which holds the voice coil "spider" in place. The voice coil may be re-centered by adjusting this screw.

With newer speakers, the spider and screw are generally not used and it is necessary to soften the cement around the edges of the cone and to center the voice coil with small shims placed between the voice coil and the speaker pole piece. The cement is then allowed to harden before the shims are removed. Use regular cement solvent for softening the cement on the loudspeaker cone.

Where the distortion is caused by a warped loudspeaker frame, it is sometimes possible to correct the trouble by using small rubber washers under the loudspeaker mounting screws. This step permits the loudspeaker frame to "float" and prevents excessive strains.

A single test permits checking for a leaky coupling capacitor or a gassy output tube. Using a high impedance d.c. voltmeter, check for a d.c. voltage *across* the grid resistor of the audio output tube (this may be a 50L6GT, 35L6GT, 25L6, 6L6, 50B5, 6F6, 6K6, 6V6, 6AQ5, or similar tube.) Identify the grid connection by

Fig. 7. The "brute force" technique for locating faults involves moving parts around in set.

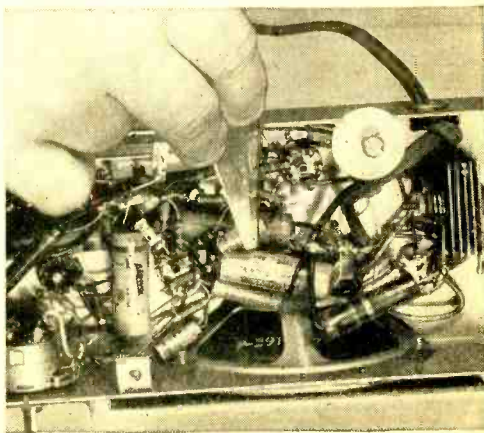

referring to a tube manual. If there is a d.c. voltage across this resistor, with the grid end positive, either the coupling capacitor is leaky or the output tube is "gassy" (a tube tester check will frequently fail to identify a "gassy" tube).

To determine which is the case, disconnect the coupling capacitor lead. If the d.c. voltage disappears, the capacitor is leaky. If not, the tube is gassy. The defective part (capacitor or tube) should be replaced.

The "standard" technique for testing an intermittent receiver (a set which works "now and then") is the *brute force* test. This technique involves wiggling or moving various parts or connections in the receiver, using a pair of plastic pliers or

tweezers, as shown in Fig. 7. When you can cause the trouble to come and go as you move a particular part or connection, you have isolated the defect!

A defective part should be replaced. A loose connection should be resoldered.

The test and repair methods we've discussed are those that can generally be undertaken by the hobbyist with a limited amount of experience. For more extensive repairs, it is best to turn the set over to an experienced technician, rather than to run the risk of causing more damage.

Of course, as the home experimenter gains experience and knowledge, he soon finds himself able to take on virtually any repair job, even the most difficult and complex. END

## WOODEN DOWELS ARE HANDY ITEMS FOR WORKSHOP

**K**EEP an assortment of wood dowel rods handy in the home lab. These low-cost items may be used in many ways in elec-

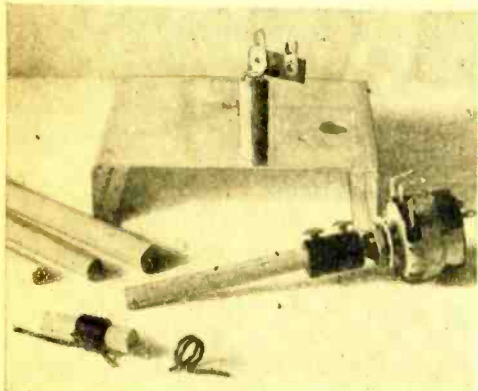

tronic work. Three typical applications are shown in the photograph.

Short lengths of dowel rod may be used as insulated "standoffs" for mounting brackets, terminal strips, and other components above a chassis.

Quarter-inch (outside diameter) dowels may be used as extension shafts for volume controls. A standard coupler may be used to connect the dowel rod to the volume control shaft.

Dowel rods also make excellent forms for winding small self-supporting coils. After the coil is wound, the wooden dowel form should be removed, otherwise the coil may have low  $Q$  due to losses introduced by the wood.

Undoubtedly as you start using these dowels you'll think of dozens of ways in which they can be employed.

## A QUICK, EASY WAY TO "DRILL" PLASTICS

**L**UCITE, polystyrene, and similar thermoplastic materials are frequently used by the electronics worker for coil forms, insulators, and small brackets. Even though a drill press or hand drill is not available, holes may still be "drilled" in such materials by using a "hot wire" technique.

Use a piece of tinned copper wire with a diameter slightly larger than the desired hole. Form a tight coil in one end of the wire to fit over the copper tip of a soldering iron, leaving one end of the wire straight, as shown in the photograph.

After the iron has been allowed to heat thoroughly, press the straight tip of the wire against the plastic at the point where the hole is to be made, use a slight twisting motion and apply pressure slowly. As the plastic ahead of the wire melts, the wire may be pushed through the material. Once through, the wire should be worked

back and forth a few times and then removed.

As a final step, any excess plastic or "burrs" may be removed by using a pocket knife.

A number of "hot wire drills" may be made up at one time, if desired. Three different sizes are shown in the photograph.

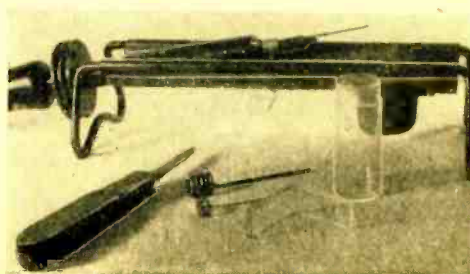

## THE "HEART MICROPHONE"

**A** NEW microphone system, specifically designed for research, diagnosis, and teaching of cardiology, permits all types of heart sounds to be picked up and fed into a tape recording machine, a headphone set, or a loudspeaker.

The system, developed and manufactured by *Altec Lansing Corporation*, consists of a capacitor microphone, a special base, a power supply, and a mike attachment.

The microphone used in the system is so designed that it can be sterilized in dry heat at 350 degrees F.

At present the new system is being used at Johns Hopkins Hospital in Baltimore, at Children's Hospital in Los Angeles, and Georgetown University, Washington, D. C., for diagnostic and research applications.

The photograph at the right shows the complete unit along with its accessory stethoscope head.

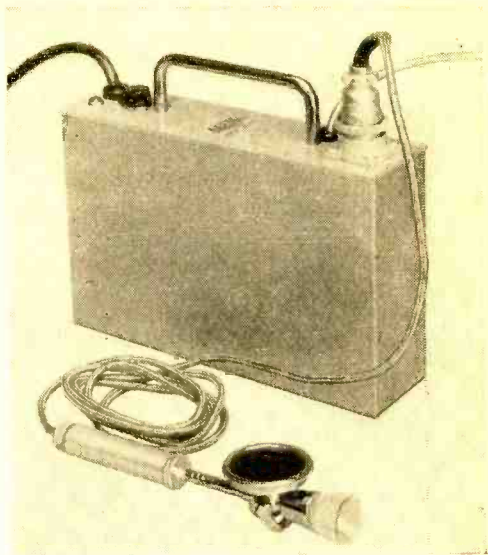

## PISCATORIAL "BASS RESPONSE"

**F**ISH hear lower tones than humans but their range is not as high, according to Dr. H. Kleerekoper, head of an experiment being conducted at Hamilton College in Hamilton, Ontario.

The research group trained fish to associate sounds of a certain frequency with meal time. Since fish can hear only in the range of a few cycles to 7000 cycles, microphones in each corner of the tank were set up to carry the sound.

Movie cameras showed the minnows following the curving paths of certain sound waves to the mikes, rather than swimming in straight lines.

Not only was it discovered that fish can distinguish clearly between two sounds but that they have a memory for a few others.

Fish have to be taught to associate certain sounds with danger as such fear is not instinctive, according to Dr. Kleerekoper.

..... A. L. H.

## GENERAL PURPOSE LINE CORD

**A** HANDY and useful gadget can be constructed using a line cord from 8 to 10 feet long made of ordinary "Zip-cord." At one end attach an *El-Menco* fused plug. About 2 feet from the other end install a line-cord switch. And at the free end, separate the cord for about 8 inches and attach insulated alligator or battery clips.

You can change the fuses in the plug to suit the work you're doing, but you will find a 5 ampere fuse the most convenient size as it can be used for most electronic gear. . . . . L. G.

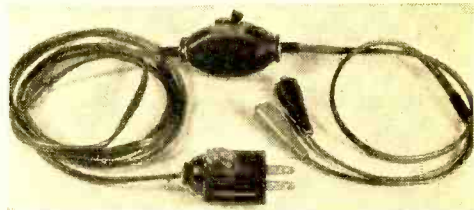

## PHOTOELECTRIC SWITCH CONTROLS HOUSE LIGHTS

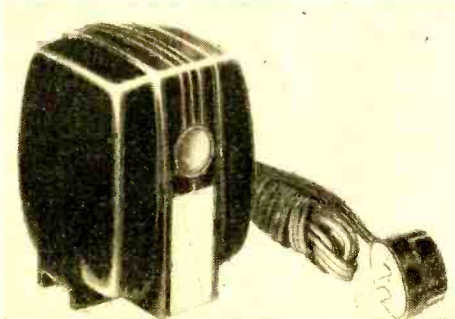

**A** NEW light control which operates automatically when darkness comes is now available for home applications. Known as the "Nitelighter," the control turns on hall, porch, or living room lights the moment darkness comes so that you never come home to a dark house and would-be burglars are fooled into thinking the house occupied.

The unit, shown at left, plugs into any house lighting socket. It will control up to a 300 watt load. Besides turning lights on, it will extinguish them when daylight returns.



# THE WORLD AT A TWIRL

By K. R. BOORD

THE haunting call of Australia's kookaburra bird . . . weird Arabic chanting from the banks of the Nile . . . the deep tones of Big Ben striking the hour in London . . . all this and more . . . yes, the whole world is at your fingertips through short-wave radio.

It's easy—and it's thrilling!

Under normal conditions, with patience and practice, it's possible to log *all continents* in a single evening—at times even within a few minutes! All you need to begin is a short-wave radio receiver, a simple antenna, a knowledge of *where* and *when* to listen—plus *persistence*.

International short-wave radio is glamorous as well as educational. It provides a satisfying hobby. To some, perhaps, it's the feeling of "power" to reach out to the farthestmost corners of the earth at the flick of a switch and the twirl of a knob! To many, it fills a desire to be on the ground floor . . . to get the news ahead of the broadcast-band listener or the TV viewer. It's a boon to the shut-in, and it offers endless opportunities to promote good will among the nations.

Short-wave broadcasts enable you to learn first-hand what people in other countries have to say about current affairs, and what kinds of music and other entertainment they have. Many programs are radiated in *English* for those who know no foreign languages, and in the various local languages for those who want to study languages as they are actually spoken in their respective countries.

Some short-wave enthusiasts are interested in receiving QSL's (*verifications*) from the stations to which they have listened. Others tune and report their results to radio clubs; they get their big thrill from seeing their names in print credited with a fine "catch," perhaps, such as a "first-heard" on a new station. Still others try to build up a long list of stations heard, content that their logs show a great amount of reception from all over the world. Then, there are those who are merely "fugitives from the commercials of the broadcast band!"

Short-wave radio transmitters include land communications stations, maritime stations, aeronautical stations, amateur (ham) stations, and broadcasting stations. Of these, the broadcasting and amateur (ham) stations are of most interest to the short-wave listener (SWL). However, there are many other "specialties" to listen to—such as code (c.w.—often referred to as "Morse"); commercial phones (international telephone and point-to-point communications—standard or inverted—or scrambled—speech); shipping and coastal radio; police, fire, and other local governmental agencies; plane and ground communications; weather station reports and contacts; special expeditions, and other unusual events.

Too, there's "freak" reception—such as v.h.f. (*very high frequency*) skip of 30- to 50-mc. (*megacycles*) taxicab, telephone relay, and others. And some SWL's like to listen for DX (*distant reception*) "the long way around"—which is another form of "freak" reception which is not normally heard.

Any type of radio which will tune to the short-wave bands will suffice as a start—such as an all-wave broadcast receiver, a home-built short-wave set, or a low-priced communications-type receiver like those advertised by leading kit manufacturers. Examine your present radio. A surprise may be in store for you—for it may include at least the "popular" short-wave bands. If not, perhaps there's an amateur (ham) radio operator in your vicinity who would help you build a simple short-wave set. One can be put together at small cost. In any case, get the best equipment you can afford.

By international agreement, each type of station is assigned certain bands for operations.

(NOTE: Unless otherwise stated, all time herein is expressed in Greenwich Mean Time—GMT—subtract 5 hours for EST, 6 for CST, 7 for MST, 8 for PST. This is on a 24-hour clock basis in which midnight is 2400 (or 0000). 3 a.m. is 0300, 10 a.m. is 1000, and noon is 1200, for example; instead of starting again at 1 p.m., as the 12-hour system does, the 24-hour system continues to increase the number of each hour until 2359 (11:59 p.m.) is reached, thus 1 p.m. is 1300, 5 p.m. is 1700, 10 p.m. is 2200.)

You'll find that the short-wave portions of the dial on your receiver are calibrated (*marked off*) in megacycles (*mc.*); a megacycle is 1000 kilocycles (*kc.*).

The short-wave broadcasting stations operate chiefly in these megacycle bands—5.95 to 6.20 mc.; 7.10 to 7.30 mc.; 9.50 to 9.80 mc.; 11.70 to 12.00 mc.; 15.10 to 15.45 mc.; 17.70 to 17.90 mc.; 21.45 to 21.75 mc. Some receivers indicate these bands in meters (*m.*)—such as the 49-, 41-, 31-, 25-, 19-, 16-, and 13-meter bands respectively. Thus, *megacycles* refer to *frequency*; *meters* refer to *wavelength*. To change *megacycles* to *meters*, divide the *frequency* in *mc.* into 300. For example, 6,000 mc. (*frequency*) divided into 300 gives you 50 m. (*wavelength*); conversely, 50 m. (*wavelength*) divided into 300 gives you 6,000 mc. (*frequency*).

Many short-wave stations lie outside the principal bands referred to. For example, the 60- and 80-m. bands are used for local (*domestic*) broadcasting over relatively short distances by many South and Central American stations, and by stations in Central Africa, Australia, India, and elsewhere. These bands are often referred to as the "*Tropical*" bands.

Reception conditions on each of the short-wave broadcast bands vary a lot at different times of the day and night, and also at different seasons of the year. It's highly important that you learn when to listen on each band.

In general, for SWL's in North America, the best reception on each of these bands during the fall and spring months should be:

The 6 mc. band—*Evening* for Latin America and Europe.

The 7 mc. band—*Late afternoon* and *evening* for Europe.

The 9 mc. band—*Morning* (6 to 8 a.m. *your local time*) for Asia and Australia; *afternoon* for Europe and Africa; *evening* for Europe and Latin America.

The 11 mc. band—*Morning* (6 to 9 a.m. *your local time*) for Asia and Australia; *afternoon* for Europe and Africa; *evening* for Latin America.

The 15 mc. band—*Morning* and *afternoon* for Europe and North America; *evening* for North and South America.

The 17 mc. band—*Morning* and *early afternoon* for Europe and North America.

The 21 mc. band—*Late morning* for Europe.

During the winter months, the best bands for evening reception are lower than during the fall and spring. For instance, the 9 mc. band becomes poor for reception from Europe during the evening hours, and the 6 mc. band becomes the best band for European reception.

In the summer months, the best evening reception shifts to the higher bands. Evening reception from Europe becomes good in the 11 mc. band, although the 9 mc. band remains good for reception from that area.

Year-around DX (distant reception) bands are the 9 mc. and 11 mc. bands, although consideration there must be given to receiving different parts of the world best in summer or winter.

The expected reception just outlined is for normal conditions. The factors which affect long-distance radio transmissions vary from day to day. On some days, for instance, reception will be quite good, but at times, generally for periods of several consecutive days, transmission conditions will be "disturbed" and only the more powerful stations can be heard.

But don't get discouraged because not—  
(Continued on page 96)

PCJ, "The Happy Station," Hilversum, Holland, is not only one of the oldest short-wave broadcasters in the world but it boasts the only rotating beam antenna of its kind, as shown below. Note that the entire installation can be rotated on rails. The prewar antenna was destroyed by the Dutch rather than permit it to fall into the hands of the German invaders in World War II. PCJ has English for North America at 2145-2225A GMT (except Sundays) over 11.730, 6.025, and at 0230-0310 GMT (except Mondays) over 9.590 and 6.025. On Mondays at 0230-0400 the "Happy Station Program," emceed by Eddie Startz for the past 25 years, is on 9.590, 6.025.

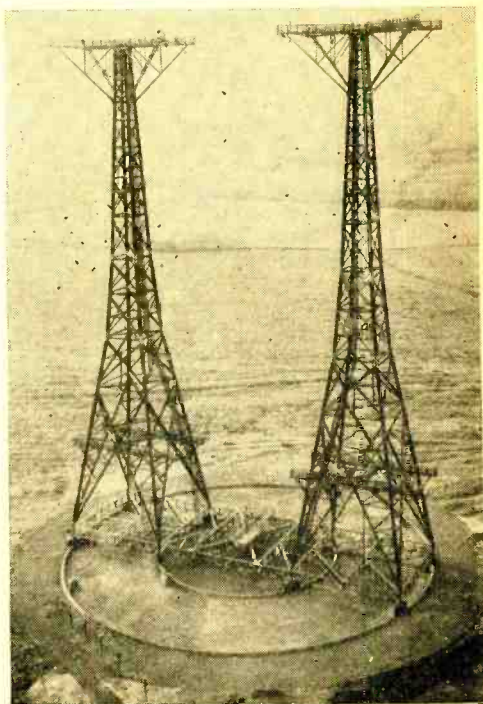

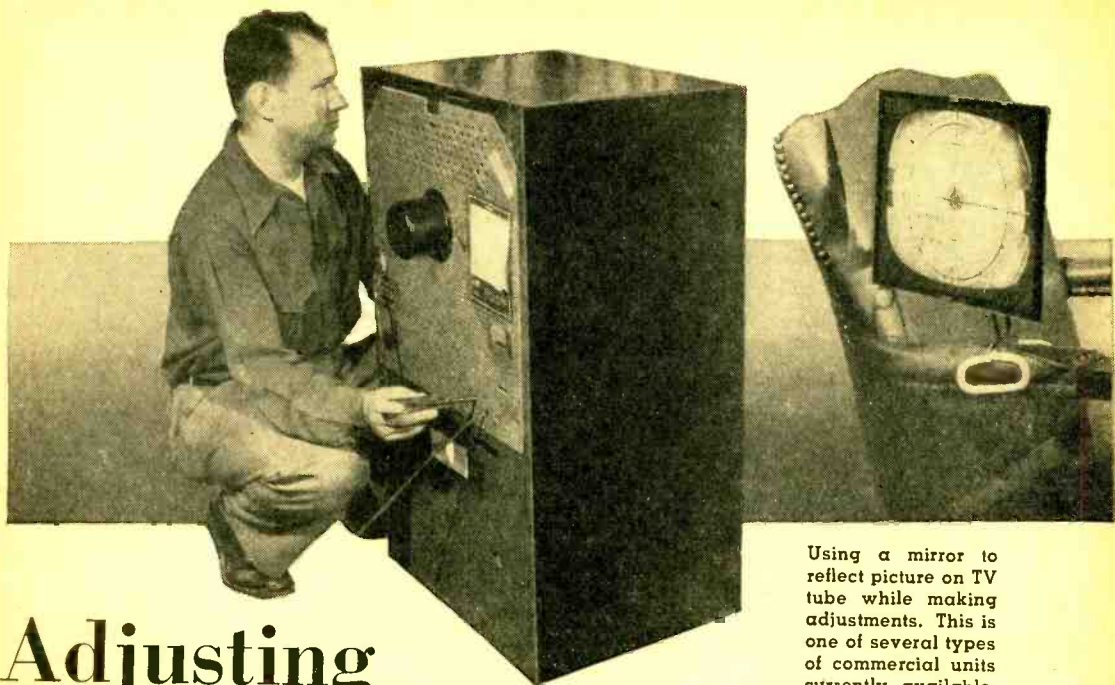

Using a mirror to reflect picture on TV tube while making adjustments. This is one of several types of commercial units currently available.

## Adjusting

# Your TV Height Control

**I**N a properly adjusted, normally operating television receiver the full transmitted picture should be completely visible on the screen and in no way extend beyond the visible area or be short in either height or width.

It does happen, from time to time, that a picture shrinks so that it is either not wide enough or high enough. Usually, this shrinkage occurs so slowly that, in the beginning, it is scarcely noticeable and not until some time later are you aware of the fact that the picture does not cover the entire screen.

When this situation occurs it does not require a major overhaul of the receiver. Any individual who is electrically inclined can at least try to bring the set back to normal.

Every television receiver has a height control and a width control. This is just as true for the first sets made in 1946 as it is for the present 27-inch receivers. Furthermore, the names height and width for the respective controls are universal, that is, every manufacturer uses the same terms.

The height control, of course, varies the size of the picture vertically. By the same token, the width control adjusts the size

of the picture horizontally. Both controls are independent of each other and either one may be adjusted first.

The receiver manufacturer has generally divided his operating controls into two or three groups. The first group, consisting of "station selector," "fine tuning control," "volume control," "on-off switch," and "contrast control," are used every time the receiver is turned on. They are placed prominently in view on the front panel or, on more recent models, they may be found on either the side or top of the cabinet.

A second group of controls is frequently placed on the front panel, but hidden from view by a hinged metallic plate or cover. The height and width controls may or may not be found among this group. If the latter is the case, then it will be necessary to seek further among the third group of controls. These are found on the back panel of the receiver. This is at the rear of the receiver and whatever controls are needed are available without removing the back cover of the receiver. If the manufacturer has a control which is not accessible until the back cover of the set is removed, then it indicates that he wants no one but a professional service technician to touch this control.



As a further precaution, removal of the back cover almost always cuts the power off to the set by opening the interlock connection. With 12,000 to 15,000 volts being applied to the picture tube, there is a very good reason for these precautions. While this high voltage may not prove fatal (because of the limited current drain), it can give you quite a jolt.

Once the controls are located, the next step is to determine from the picture which control needs adjusting. We will consider only the height control in this article, since it is the simpler of the two to adjust.

The only equipment required for making this adjustment is a fairly large mirror and possibly, in some cases, a screwdriver. The purpose of the mirror is to enable you to see the front screen when making adjustments on the controls mounted on the rear of the cabinet. Simply position the mirror in front of the screen so that you can see the reflection and proceed to make the necessary adjustments while keeping your eye on the screen.

Assume that the picture does not quite cover the screen vertically and that you can see a narrow black bar (actually this is the screen) at the top and bottom of the picture. With your fingers on the height control and your eye (via the mirror) on the picture, slowly rotate the control in a clockwise direction. When the picture fills the screen vertically, stop.

Now, several things can happen in this process. First, as you rotate the height control the picture may suddenly start moving up (or down). This means that the picture has dropped out of lock-in or synchronization. If this happens, leave the height control and move to the vertical hold control. Rotate this back and forth until the picture returns to its stationary position again and locks-in. Then the height adjusting may be continued until the picture is spread out sufficiently to fill the screen top and bottom.

Another thing that may happen is that when the picture has attained its full height, the resulting image is not evenly spaced, for example, a person's head may be too small or too large for the body or the feet may be compressed or elongated too much. If this should happen, then further adjustment will have to be made with another control called the "vertical linearity" control. This is rotated until the picture is spread out evenly from top to bottom. You may have to juggle back and forth between these two controls before you obtain the best combination of picture height and picture linearity. The job, however, requires more patience

than skill and should not be too difficult for anyone to do.

There is one remaining situation that may arise and that is you may reach the end of the control rotation before the picture is made large enough to fill the screen. Whether or not you can handle this problem will depend on how much you know about television receivers and how much equipment you have on hand. For example, an a.c. line voltage lower than normal can cause the foregoing situation to occur. If you have an a.c. voltmeter and you find the line voltage is less than 110 volts, then here is probably the reason for the narrow picture. The only sure solution to this situation (aside from moving out of the neighborhood) is to use a line voltage regulator. This can be purchased at any electronic parts jobber and will keep the output voltage steady at around 117 volts for line voltage variations anywhere from 95 to 130 volts. This is a very handy gadget to have, particularly in areas where the a.c. power line voltage is subject to fairly wide fluctuation. Cost is nominal, ranging from a few dollars up to 30. The higher-priced units generally offer more constant output voltage with wider input voltage fluctuation.

If the line voltage is OK yet you cannot fully fill the screen, then the problem most likely lies within the set itself, possibly a weak power tube or a weak tube in the vertical deflection system of the receiver. Since there are a variety of tubes that can be used in the vertical stages of a receiver, location and adequate testing of these tubes is best performed by a professional technician. Most of the time; adjusting the height control will do the job and do it nicely.

In this article we have covered the adjustment of the height control. Since the width control is a little more complicated we will discuss its adjustment in a later issue of this magazine. END



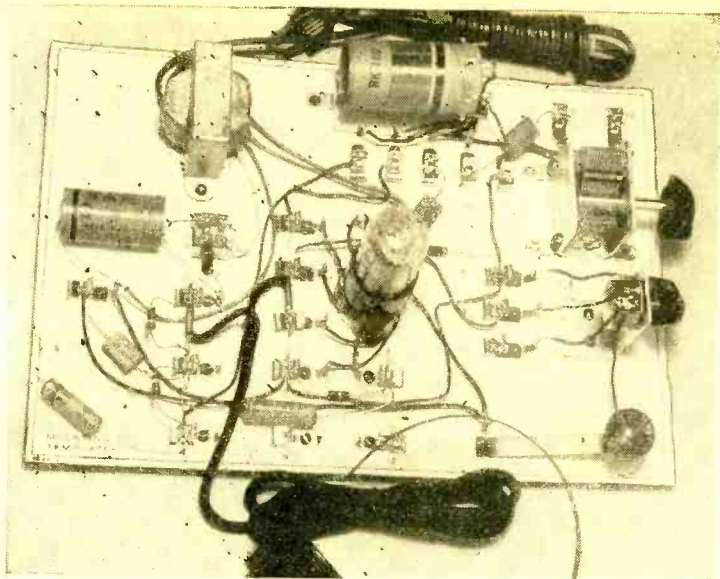

Fig. 1. Knight kit uses clips to facilitate changing the circuitry.

# Learn Electronics with

**WE CAN LEARN** something about electronic devices by building and using them. We may not be able to learn very much that way about how they work; we can't see what goes on inside the parts or the wires connecting them. On the other hand, if we build and use many different electronic devices, we will learn two things: first, that the same general function can be performed by different combinations of parts and, second, that the same parts connected in different ways can do different jobs. Thus we can get some idea of the operation of each part. A convenient way to learn this much is to experiment with a multiple-use kit. Two such kits are the *Progressive* radio "Edu-Kit" manufactured by *Progressive "Edu-Kits" Inc.* of Brooklyn, N. Y. and the *Knight "6 in 1"* radio lab kit manufactured by *Allied Radio Corp.* of Chicago, Ill.

The *Progressive* kit can be used to wire two one-tube receivers (a triode grid leak detector and a pentode grid leak detector); five two-tube receivers (an r.f. amplifier and triode grid leak detector, an r.f. amplifier and plate detector, an r.f. amplifier and diode detector, a pentode grid leak detector and audio amplifier, and a plate detector and audio amplifier); five three-tube receivers (a pentode grid leak detector and two audio amplifiers, an

r.f. amplifier, plate detector, and audio amplifier, a plate detector and two audio amplifiers, an r.f. amplifier, pentode grid leak detector, and audio amplifier, and two r.f. amplifiers and triode grid leak detector); a code oscillator; a transmitter; and a signal tracer.

The *Knight* kit can be used to wire a broadcast receiver, a phono oscillator-home broadcaster, a code practice oscillator, a wireless code practice oscillator, a signal tracer, and an audio sine-wave generator. The *Knight* kit includes one 6SN7GT twin-triode tube; the *Progressive* kit has one 6J5GT triode and two 6SJ7GT pentodes.

All of the circuits wired from both kits incorporate heater and plate voltage supplies which operate from 117-volt power lines. The *Knight* circuit includes a power transformer and must be connected to an a.c. power line. The *Progressive* circuit will operate on either a.c. or d.c. (On d.c. the power plug must be inserted in the wall outlet in one of the two possible ways; if the plug is inserted incorrectly, no harm will be done, but the circuit will not operate.)

A small metal chassis is used to mount the major parts in the *Progressive* kit and all connections are made by soldering, as in most manufactured electronic equipment. The *Knight* kit uses a wooden

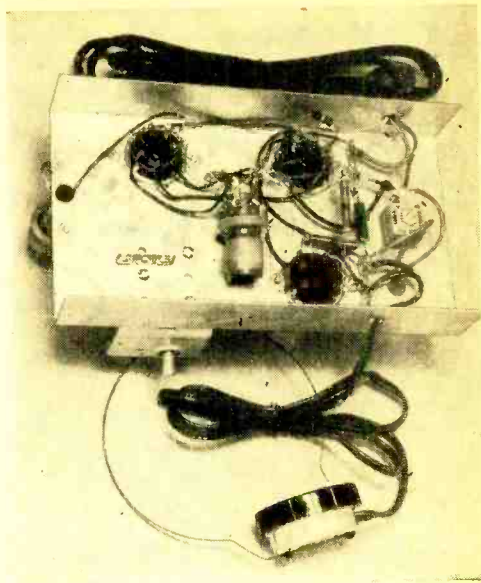
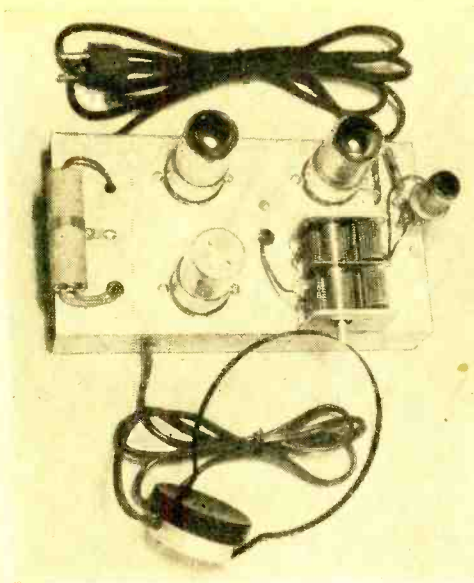

Fig. 2. Top and bottom views of the Progressive metal-chassis kit.

## Multi Use Kits

By JOHN K. FRIEBORN

"breadboard" to mount the major parts. The connections common to all circuits are soldered, but those which change from one circuit to another are made by simply slipping wires into *Fahnestock* clips. A paper template is provided to indicate the proper positions for all mounting holes in the breadboard.

The *Knight* kit includes an antenna for use with the receiver. The *Progressive* kit has no antenna, but does include a neon-tube radio and electrical tester. Both of the kits include single headphones and instruction books which give, for each circuit, a brief description of the intended function, detailed instructions for building including schematic and pictorial wiring diagrams, and a brief explanation of the theory of operation. Construction of the kits requires pliers, screwdriver, hookup wire, and solder, which are not included. A soldering iron is also required and one is included in the *Progressive* kit.

In the *Progressive* kit, some of the parts must be unsoldered to change from one circuit to another. Repeated soldering and unsoldering may damage some parts so that they cannot be used again. The *Progressive* kit therefore includes several of each type of part which must be used over. Some extra hardware is also included.

Actual use of the kits showed minor defects in both of them. The mounting holes indicated on the paper template for some of the major components of the *Knight* kit are incorrect. Before punching the wood for these holes, their alignment with the actual holes in the components should be checked. The *Knight* kit also was short one wood screw and one machine screw. On the other hand, the directions for connecting the three-wire line cord in the *Progressive* kit are inadequate. There is only one right way to connect the cord; if it is connected otherwise, the tube heaters either will have no voltage applied to them or will have the entire line voltage applied and will burn out. The wires themselves are color-coded, but all of the references to the wires in the wiring diagrams and in the instructions are by numbers 1, 2, and 3. Both manufacturers state that the defects will be corrected as soon as possible.

The neon-tube tester included with the *Progressive* kit can be used to determine the proper line cord connections. Carefully separate the ends of the three wires, then insert the plug into a wall outlet. Connect the tester between each pair of wires in turn. The bulb will light in two of the three possible cases. The wire which is not connected in the one case when the bulb does not light (the wire

which is connected both times when the bulb does light) is the common or grounded wire, designated as "Wire 3" in the instruction book. The heavier of the two remaining wires is the resistance wire for the heater circuit, designated as "Wire 1."

Although the main purpose of these kits is to make it possible to observe various electronic circuits in operation, the various circuits actually perform well enough to be of practical use. The receiver circuits are a good example. Fig. 1 shows the *Knight* kit with the basic circuit wired and with additional parts and wires inserted between clips to make the broadcast receiver. Fig. 2 shows top and bottom views of the *Progressive* chassis

wired to make the three-tube receiver with pentode r.f. amplifier, pentode grid-leak detector, and triode a.f. amplifier. The *Progressive* circuit provided reception of local stations with only a roll of hookup wire as an antenna. The *Knight* circuit, since it is regenerative, may radiate a signal to produce whistles in neighbors' receivers and it is more difficult to tune than the *Progressive* circuit, but when carefully adjusted the *Knight* provided reception of local stations with no antenna at all.

Either of these kits, or both of them, can be used to introduce a beginner to one phase of electronics. Both companies also manufacture more advanced multi-use kits. END

## WORLD'S MOST POWERFUL AIRBORNE RADAR UNIT

**T**HE most powerful airborne search radar yet developed is being built by *General Electric Company* for the U. S. Navy's Bureau of Aeronautics.

The unit is being installed in a number of Navy and Air Force planes, including new flying radar stations being built by *Lockheed*, patterned on the "Super Constellation" transport.

The Navy will use the high-altitude, four-engine planes as radar stations to fly off our Atlantic and Pacific coasts. The planes will fly from shore bases and are capable of patrolling for long periods of

time far at sea without returning to base.

The radar antennas are housed in bubble-like structures, called "radomes," atop and below the aircraft's fuselage. Each of the flying radar stations will carry about six tons of electronic equipment. The search radar and indicator system weighs about two tons—the weight and size having been kept down by the use of printed circuitry. Nearly all of the electronic chassis are printed wiring sub-assemblies which are easily maintained and individually replaceable, if necessary, according to the *G-E* engineers.

A "Flying Radar Station" which will be carried aloft in this Lockheed scout plane.

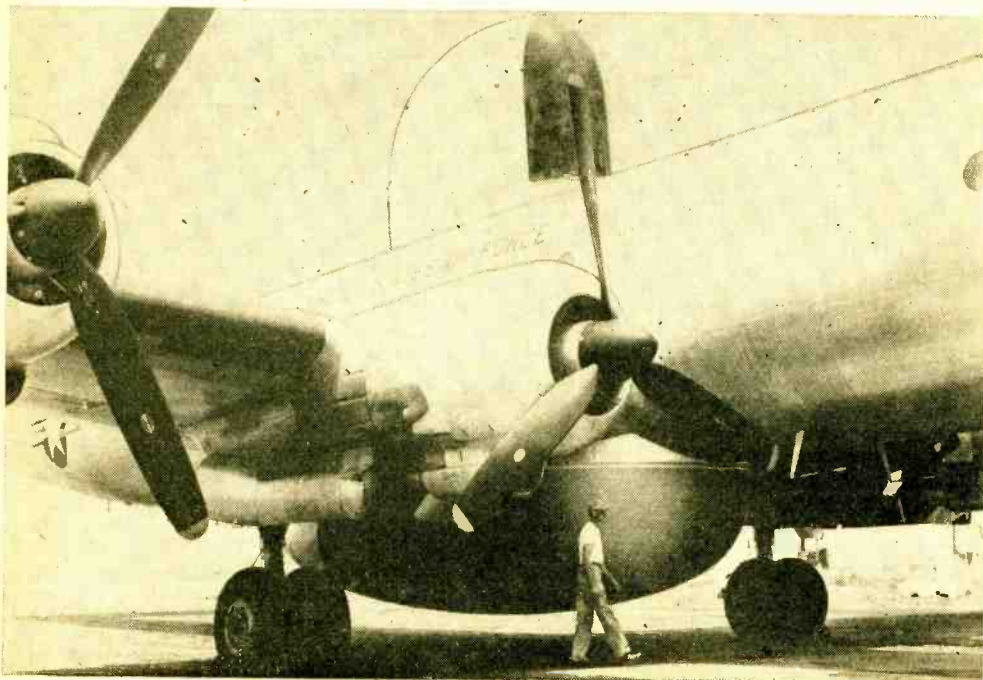

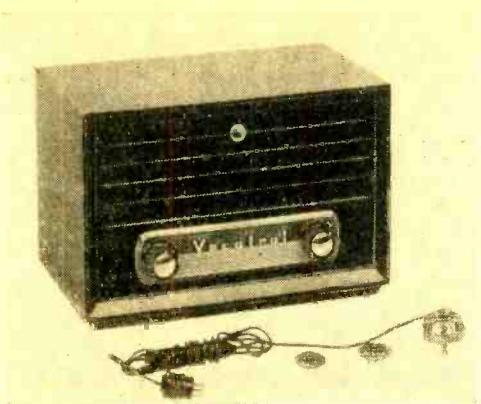

## TV COMMERCIAL "ELIMINATOR"

FOR those who like their radio and TV programs sans commercials, *Vocatrol Corp.*, P.O. Box 108, Cambridge, Mass. has come to their aid with an automatic "eliminator" which completely suppresses unwanted speech while allowing the musical portion to be heard without interruption.

The unit plugs into any radio or TV set and is so adjusted that the "vocal" portion of the musical program is permitted to come through. When the musical portion stops and the commercial begins, the unit stops the performance until the music resumes.

## SIX HOURS OF TV ON ONE GALLON OF GAS

RESIDENTS of Hayfork, a tiny California community 60 miles west of Redding, get six hours of television reception in exchange for one gallon of gasoline. This is how it works.

Robert Baird, a self-taught TV technician, figured that the folks of Hayfork could have TV if he could devise some way of feeding the signal from station KHSL-TV (Chico) into the town.

He located a suitable mountain top by means of an 8-inch set which he converted to battery operation. About 3½ miles from Hayfork he located his antenna site. Fellow citizens helped to form Cinco Television Co. and the antenna was erected and 20,000 feet of wire was strung.

The system is powered by a gasoline generator which holds exactly one gallon of gasoline. Whenever the three sets in Hayfork are to be turned on, someone in a jeep dashes up the mountain and fills the gas tank—which provides six hours of programming. If they want only three hours

of program they fill the tank half full and when the gas runs out, the system is automatically shut off. . . . K. R. MacDonald

## FUSE SAVER

IF YOU keep blowing fuses even after "repairing" short-circuited appliances or lamps, here is a handy hint. Insert a 100-watt (or larger) bulb in the fuse receptacle before plugging the "repaired" device into the power line.

If the repair job is OK, the bulb will light at less than full brilliance or not at all when the appliance is plugged in. If the appliance is still shorting the lamp will glow at full intensity.

Remember that high-wattage devices like toasters and broilers will make the lamp glow quite brightly even when no short is present because of the greater power consumption. A little practice will enable you to spot "full" and "partial" intensities.

## PORTABLE DIRECTION FINDER

A NEW portable radio which also serves as a marine direction finder to help yachtsmen determine their positions at sea is now being marketed by *Raytheon*. The set receives the regular AM broadcast band as well as the marine and beacon bands.

The new Model GM-114A looks very much like an ordinary portable receiver but doesn't have the loop projecting from the top—a feature of most direction finders. Instead a flat, knob-like antenna projects only two inches above the case. The whole radio weighs only 13 pounds, including batteries, and measures 12 inches wide and 7 inches deep and high.

When listening to a broadcast station, the user rotates the antenna until it points directly at the radio station and can thus obtain his "fix" showing his position at sea.



# Build YOUR OWN HEATHKITS

INTERESTING—EDUCATIONAL

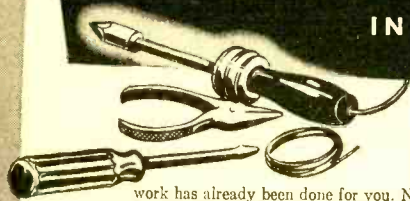

work has already been done for you. No cutting, drilling, or painting required. All parts furnished including tubes. Knowledge of electronics, circuits, etc., not required to successfully build Heathkits.

Heathkits are fun to build with the simplified easy-to-follow Construction Manual furnished with every kit. Only basic tools are required, such as soldering iron, long-nosed pliers, diagonal cutting pliers, and screwdriver. All sheet metal

## New PRINTED CIRCUIT VACUUM TUBE VOLTMETER KIT

The VTVM is the standard basic voltage measuring instrument for radio and TV servicemen, engineers, laboratory technicians, experimenters, and hobbyists. Because of its extremely high input resistance (11 megohms) the loading effect on the circuit being measured, is virtually negligible. The entire instrument is easy to build from a complete kit, with a detailed step-by-step Construction Manual. Featured in this instrument is an easy-to-wire fool-proof printed circuit board which cuts assembly time in half.

**CIRCUIT AND RANGES:** Full wave AC input rectifier permits 7 peak-to-peak voltage ranges with upper limits of 4000 volts peak-to-peak. Just the ticket for you TV servicemen. Seven voltage ranges, 1.5, 5, 15, 50, 150, 500 and 1500 volts DC and AC RMS. Peak-to-peak ranges 4, 14, 40, 140, 400, 1400, and 4000 volts. Ohmmeter ranges X1, X10, X100, X1000, X10K, X100K, X1 meg. Additional features are a db scale, center scale zero position, and a polarity reversal switch.

**IMPORTANT DESIGN FEATURES:** Transformer operated—1% precision resistors—6AL5 and 12AU7 tubes—selenium power rectifier—individual AC and DC calibrations—smoother improved zero adjust control action—new panel styling and color—new placement of pilot light—new positive contact battery mounting—new knobs—test leads included. Easily the best buy in kit instruments.

New peak-to-peak meter scale—new color harmony—new control knobs.

New easy-to-read open panel layout. Off-on switch incorporated in selector switch.

New charcoal gray baked enamel panel with highly readable white lettering.

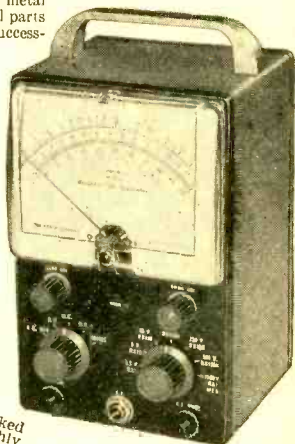

Model V-7

**\$24.50**

Shpg. Wt. 7 lbs.

New printed circuit board for faster, easier construction—exact duplication of Laboratory development model.

## Heathkit HANDITESTER KIT



MODEL M-1  
**\$14.50**

Shpg. Wt. 3 lbs.

The Heathkit Model M-1 Handitester readily fulfills all requirements for a compact, portable volt-ohm-milliammeter. Its small size permits the instrument to be tucked into your coat pocket, tool box or glove compartment of your car. Always the "handitester" for those simple repair jobs. Packed with every desirable feature required in an instrument of this type. AC or DC voltage ranges, full scale 10, 30, 300, 1000 and 5000 volts. Ohmmeter ranges 0-3000 ohms and 0-300,000 ohms. DC milliammeter ranges 0-10 milliamperes and 0-100 milliamperes. Uses 400 microampere meter—1% precision resistors—hearing aid type ohms adjust control—high quality Bradley rectifier. Test leads are included.

## Heathkit MULTIMETER KIT



MODEL MM-1

**\$26.50** Shpg. Wt. 6 lbs.

Here is an instrument packed with every desirable service feature and all of the measurement ranges you need or want. High sensitivity 20,000 ohms per volt DC, 5000 ohms per volt AC. Has the advantage of complete portability through freedom from AC line—provides service ranges of direct current measurements from 150 microamperes up to 15 amperes—can be safely operated in RF fields without impairing accuracy of measurement.

Full scale AC and DC voltage ranges of 1.5, 5, 50, 150, 500, 1500, and 5000 volts. Direct current ranges are 150 microamperes, 15, 150, and 500 milliamperes and 15 amperes. Resistances are measured from .2 ohms to 20 megohms in three ranges and db range from -10 to +65 db. Ohmmeter batteries and necessary test leads are furnished with the kit.

**HEATH COMPANY**  
BENTON HARBOR 10, MICHIGAN



**New**  
PRINTED  
CIRCUIT

# Heathkit 3" OSCILLOSCOPE KIT

Ideal for individual home work shop, ham shack, or as extra instrument for outside servicing.

Compact size, light weight, portable - perfect for service work or field operation.

New, modern styling, gray panel with white lettering, light gray knobs and red and black terminal posts.

**USE:** This brand new Utility Scope was designed especially for servicemen and radio amateurs, and is adaptable for use in all general Scope applications. Perfect for modulation monitoring, etc. Use it to tackle alignment or adjustment problems. Equally valuable in breadboard work. A must for ham shack or for outside servicing.

**DESCRIPTION:** Front panel controls of the Model OL-1 are "bench tested" for ease of operation and convenience. Sharp focusing 3" CRT. Printed circuit for ease of assembly and constant performance. Assembly time cut in half! High quality electronic components used. Sensitive hor. and vert. amplifiers with broad freq. response; cathode follower for isolation. Push-pull hor. and vert. output to deflection plates. Int. 60 cycle, or ext. sync. Sweep freq. range 10-100,000 cycles. Direct connection to deflection plates. Provision for Z axis input. Uses 3GP1 CRT, 4-12AU7 hor. and vert. amplifiers, 1-12AX7 sweep gen., 1-6X4 LV rect., and 1-1V2 HV rect. The Heathkit Model OL-1 is a real standout value at only \$29.50, and is another example of the famous Heathkit combination: quality plus economy.

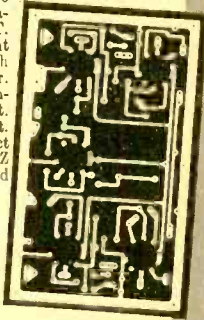

Model OL-1

**\$29.50** Shpg. Wt. 15 lbs.

Measures only 11 3/4" x 6 3/4" x 10 1/2" and weighs only 11 pounds.

New printed circuit for constant performance, rugged component mounting - assembly time cut in half!

# Heathkit SIGNAL GENERATOR KIT

**USE:** This instrument is "serviceman engineered" to fill the requirement for a reliable basic service instrument at moderate cost. Frequency coverage extends in five bands from 160 Kc to 110 Mc on fundamentals, and dial is calibrated to 220 Mc for harmonics. Pre-wound and pre-aligned coils make calibration unnecessary for service applications.

**DESCRIPTION:** The Heathkit Model SG-8 Signal Generator provides a stable modulated or unmodulated RF output of at least 100,000 microvolts which can be controlled by both a continuously variable and a fixed step attenuator. Internal modulation is at 400 cycles, or can be externally modulated. AF output of 2-3 volts is also available for audio testing. Uses dual purpose 12AU7 as Colpitts RF oscillator and cathode follower for stable, isolated, low impedance output, and type 6C4 tube for 400 cycle oscillator. Operation of the SG-8 is well within the frequency limits normally required for service work. Modern styling features high definition white letters on charcoal gray panel with re-designed control knobs. Modern professional appearance and Heathkit engineering know-how combine to place this instrument in the "best buy" category. Only \$19.50 complete.

New, modern panel and knob styling - professional appearance and professional performance.

Cathode follower output for good isolation - fixed step and continuously variable attenuation.



Output selection - internal modulation, pure r.f., or audio output.

Broad frequency coverage - fundamentals from 160 KC to 110 MC in 5 bands - up to 220 MC on calibrated harmonics.

MODEL SG-8

**\$19.50** Shpg. Wt. 8 lbs.



MODEL AM-1

**\$14.50** Shpg. Wt. 2 lbs.

# Heathkit ANTENNA IMPEDANCE METER KIT

The Model AM-1 Antenna Impedance Meter makes an ideal companion unit for the GD-1B Grid Dip Meter or a valuable instrument in its own right. Perfect for checking antenna and receiver impedance and match for optimum system operation. Use on transmission lines, halfwave, folded dipole, or beam antennas. Will double as monitor or relative field strength meter. Covers freq. range of 0-600 ohms. Uses 100 microampere meter and special calibrated potentiometer. A real buy at only \$14.50 complete.

# Heathkit GRID DIP METER KIT

Amateurs and servicemen have proven the value of this grid dip meter many times over. Indispensable for locating parasitics, neutralizing, and aligning filters and traps in TV or Radio and for interference problems. The Model GD-1B covers from 2 Mc to 250 Mc with 5 pre-wound coils. Featuring a sensitive 500 microampere meter and phone jack, the GD-1B uses a 6AF4 or 6T4 tube. An essential tool for the ham or serviceman.



MODEL GD-1B

**\$19.50** Shpg. Wt. 4 lbs.

**ACCESSORIES:** Low freq. coverage to 355 KC with two extra coils and calibration curve. Set No. 341A for GD-1B and set No. 341 for GD-1A. Shipping weight 1 lb. Only \$3.00.

**HEATH COMPANY**  
BENTON HARBOR 10, MICHIGAN

# New

# Heathkit VFO KIT



MODEL VF-1

**\$1950**

Ship. Wt. 7 lbs.

- Smooth acting illuminated and precalibrated dial.
- 6AU6 electron coupled Clapp oscillator and OA2 voltage regulator.
- 7 Band coverage, 160 through 10 meters—10 Volt RF output.
- Copper plated chassis—aluminum cabinet—easy to build—direct keying.

Here is the new Heathkit VFO you have been waiting for. The perfect companion to the Heathkit Model AT-1 Transmitter. It has sufficient output to drive any multi-stage transmitter of modern design. A terrific combination of outstanding features at a low kit price. Good mechanical

and electrical design insures operating stability. Coils are wound on heavy duty ceramic forms, using Litz or double cellulose wire coated with polystyrene cement. Variable capacitor is of differential type construction, especially designed for maximum bandspread and features ceramic insulation and double bearings.

This kit is furnished with a carefully precalibrated dial which provides well over two feet of calibrated dial scale. Smooth acting vernier reduction drive insures easy tuning and zero beating. Power requirements 6.3 volts AC at .45 amperes and 250 volts DC at 15 mills. Just plug it into the power receptacle provided on the rear of the AT-1 Transmitter Kit. The VFO coaxial output cable terminates in plastic plug to fit standard 1/4" crystal holder. Construction is simple and wiring is easy.

Open layout—easy to build—simplified wiring.

Smooth acting illuminated dial drive.

Clean appearance—rugged construction—accessible calibrating adjustments.

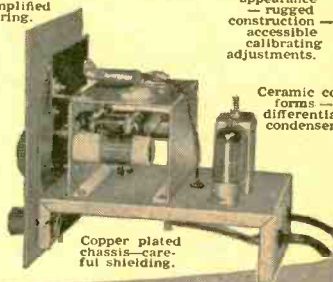

Ceramic coil forms—differential condenser.

Copper plated chassis—careful shielding.

# Heathkit AMATEUR TRANSMITTER KIT



MODEL AT-1

**\$2950**

Ship. Wt. 16 lbs.

### SPECIFICATIONS:

Range 80, 40, 20, 15, 11, 10 meters.  
 6AC7 ..... Oscillator-multiplier.  
 6L6 ..... Amplifier-doubler.  
 5U4G ..... Rectifier.  
 105-125 Volt A.C. 50-60 cycles 100 watts. Size: 8 1/2 inch high x 13 1/2 inch wide x 7 inch deep.

Here is a major Heathkit addition to the Ham radio field, the AT-1 Transmitter Kit, incorporating many desirable design features at the lowest possible dollar-per-watts price. Panel mounted crystal socket, stand-by switch, key click filter, A. C. line filtering, good shielding, etc. VFO or crystal excitation—up to 35 watts input. Built-in power supply provides 425 volts at 100 MA. Amazingly low kit price includes all circuit components, tubes, cabinet, punched chassis, and detailed construction manual.

Rugged, clean construction.

Crystal or VFO excitation.

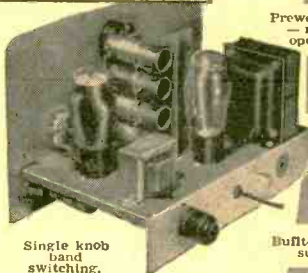

Prewound coils—metered operation.

52 ohm coaxial output.

Single knob band switching.

Built-in power supply.

# Heathkit COMMUNICATIONS RECEIVER KIT

Four band operation 535 to 35 Mc.

Stable BFO oscillator circuit.

RF gain control with AVC or MVC.

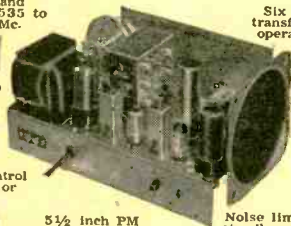

5 1/2 inch PM Speaker-Headphone Jack.

Six tube transformer operation.

Electrical bandspread and scale.

Noise limiter—standby switch.

### SPECIFICATIONS:

Range.....535 Kc to 35 Mc  
 12BE6 .....Mixer-oscillator  
 12BA6 .....I. F. Amplifier  
 12AV6 .....Detector—AVC—audio  
 12BA6 .....B. F. O. oscillator  
 12A6.....Beam power output  
 5Y3GT.....Rectifier  
 105-125 volts A.C. 50-60 cycles, 45 watts.

A new Heathkit AR-2 communications receiver. The ideal companion piece for the AT-1 Transmitter. Electrical bandspread scale for tuning and logging convenience. High gain miniature tubes and IF transformers for high sensitivity and good signal to noise ratio. Construct your own Communications Receiver at a very substantial saving. Supplied with all tubes, punched and formed sheet metal parts, speaker, circuit components, and detailed step-by-step construction manual.



MODEL AR-2

**\$2550**

Ship. Wt. 12 lbs.

### CABINET:

Proxylon impregnated fabric covered plywood cabinet. Shipp. weight 5 lbs. Number 91-10, \$4.50.

**HEATH COMPANY**  
 BENTON HARBOR 10, MICHIGAN



# Heathkit ECONOMY SIX-WATT AMPLIFIER KIT



**MODEL A-7B**

**\$15.50** Shpg. Wt. 10 lbs.

Here is an outstanding amplifier value. This economically priced amplifier is capable of performance usually associated only with far more expensive units. Can be nicely used as the heart of an inexpensive high quality home music system. Features inputs for tuner and phono (Model A-7C accommodates a microphone by using an additional pre-amplifier stage). Separate bass and treble boost and cut tone controls for just the degree of tonal balance you want. The entire kit can be built in a few pleasant hours for years of enjoyment.

Technical features, frequency response  $\pm 1\frac{1}{2}$  db 20-20,000 cycles. Full 6 watts output. Push-pull beam power output stage. Output transformer impedances 4, 8, and 15 ohms. Tube lineup, 12J5GT, 12SL7, 2-12A6, 5Y3GT, and 12SJ7 (A-7C only).

All parts including tubes are supplied along with a prefabricated and painted chassis. Detailed step-by-step Construction Manual eliminates necessity for specialized knowledge.

**MODEL A-7C** incorporates a preamplifier stage with special compensated network to provide necessary gain for operation with variable reluctance cartridge or microphone. \$17.50

BROADCAST BAND

# NEW Heathkit RECEIVER KIT

Here is the ideal radio kit for the student, beginner, or hobbyist. If you have ever had the urge to build your own radio receiver, this kit deserves your attention. Circuit is transformer operated, eliminating shock hazard usually associated with "economy" AC-DC circuits. New high gain miniature tubes and IF transformers—powerful ferrite core built-in rod type antenna—chassis mounted  $5\frac{1}{2}$ " PM speaker—optional operation either as receiver or tuner and phono input. Covers broadcast band 550-1600 Kc. Uses 12BE6, 12BA6, 12AV6, 12A6, and 5Y3 tubes.



**MODEL BR-2**

**\$17.50** Shpg. Wt. 10 lbs.  
less Cabinet

**CABINET:** Proxylon impregnated fabric covered plywood cabinet available. Includes aluminum panel, flocced re-inforced speaker grill and protective rubber feet. 91-0, Shpg. Wt. 5 lbs. \$4.50



**MODEL FM-2**  
**\$22.50**

Shpg. Wt. 8 lbs.

# Heathkit FM TUNER KIT

Here is an FM tuner kit designed for simplified construction to operate either through the "phono" section of your radio former operated—8 tube circuit—slide coverage—three double tuned IF stages—factory adjusted front end. Experience the thrill of building your own FM tuner and of true FM reception.

## HEATH COMPANY • BENTON HARBOR, MICH.

**MAIL YOUR ORDER TODAY TO THE HEATH COMPANY BENTON HARBOR 10, MICHIGAN**

# ORDER BLANK

From \_\_\_\_\_

SHIP VIA

- Parcel Post
- Express
- Freight
- Best Way

(PLEASE PRINT)

QUANTITY	ITEM	MODEL NO.	PRICE

Enclosed find ( ) check ( ) money order for \_\_\_\_\_ pounds.  
Please ship C.O.D. ( ) postage enclosed for \_\_\_\_\_

On Express orders do not include transportation charges—they will be collected by the express agency at time of delivery.

**ON PARCEL POST ORDERS**  
insure postage for weight shown.

**ORDERS FROM CANADA and APO's**  
must include full remittance.

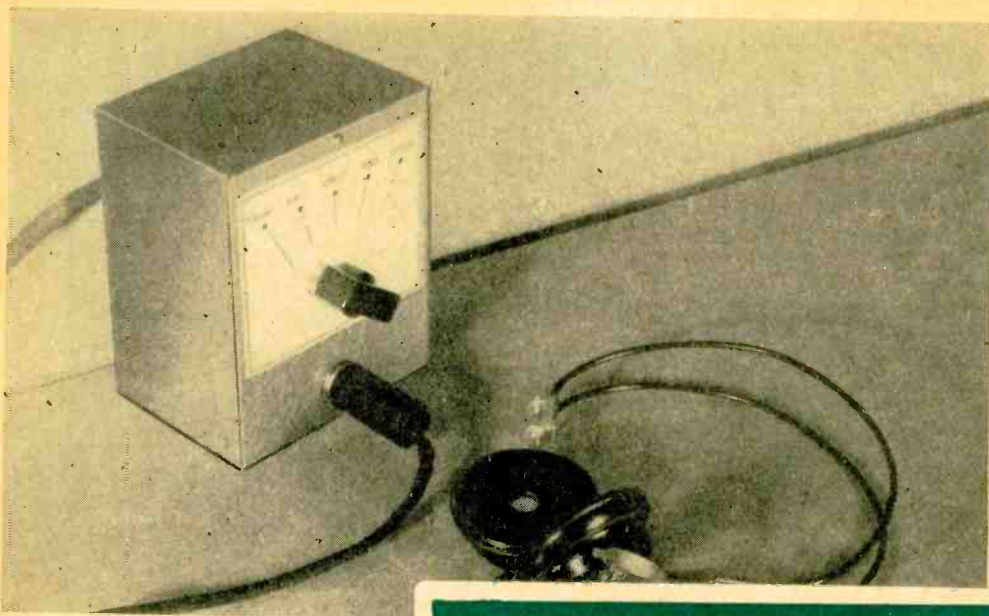

# CRYSTAL-TYPE

C1 TO C5 ARE SCREW-ADJUSTED MICA TRIMMER CAPACITORS

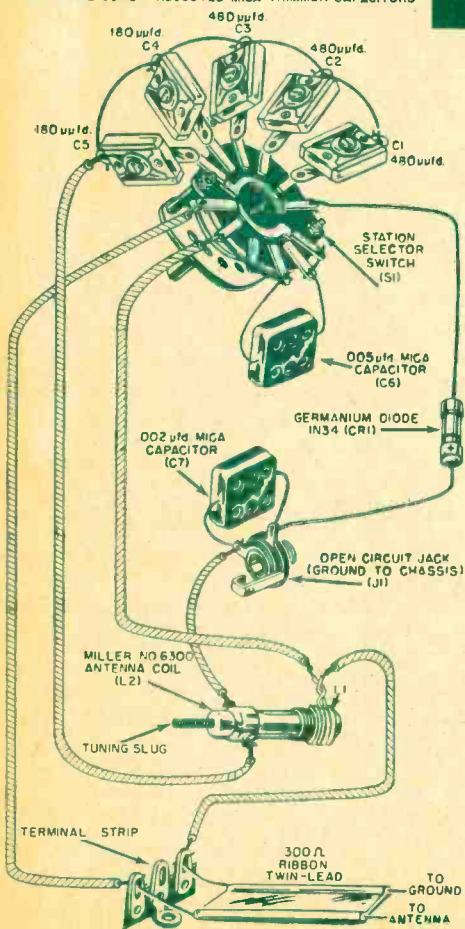

CRYSTAL radio receivers have been with us for more than 50 years. Thirty-three years ago more people owned crystal sets than tube sets. Although the crystal set can never produce the volume of a tube receiver nor pick up stations more than 25 miles away with any consistency, it still is a popular circuit because it needs no batteries or electricity for operation.

The crystal set shown on these pages is a little different from the usual circuit of this type because it incorporates a switch. In this way you can switch to your favorite stations instead of slowly tuning them in. With this arrangement you can be sure that a station is tuned "on the nose" because the tuning has been pre-set.

A glance at the circuit diagram will show how this pre-tuning is accomplished. The input coil,  $L_1-L_2$ , is connected to a two-pole rotary switch  $S_{1A}$ . Switch  $S_{1A}$  selects any one of the five screw-adjusted mica trimmers,  $C_1$  to  $C_5$ , and connects it across the coil,  $L_2$ . In the beginning, each trimmer is set with a screwdriver to tune in a particular station.

The input coil,  $L_2$ , is a Miller No. 6300 ferrite-tuned antenna coil. The tuning slug of this coil may be moved in and out of the coil (for adjustment) by turning it with a screwdriver. Before installation, screw the slug all the way into the coil. A length of insulated wire comes soldered to one terminal of this coil. Cut this wire off before installing  $L_2$  in the set. Using this

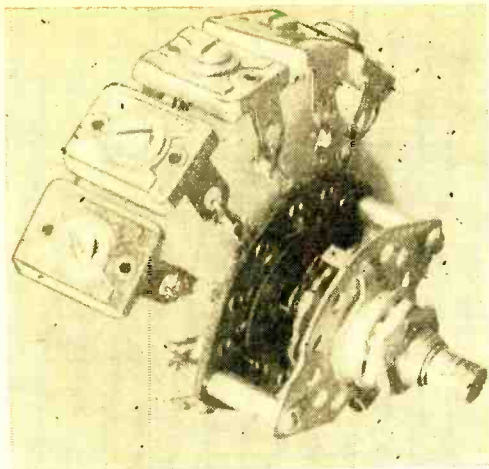

All of the trimmer capacitors are soldered directly to the station selector switch. Check also the schematic and pictorial diagrams for further wiring information.

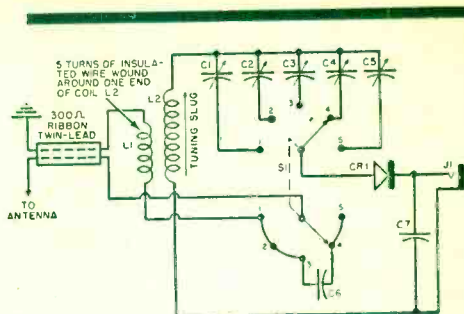

- $C_1, C_2, C_3$ —480  $\mu\text{fd.}$  mica trimmer (Arco Type 466)
- $C_4, C_5$ —180  $\mu\text{fd.}$  mica trimmer (Arco Type 463)
- $C_6$ —.005  $\mu\text{fd.}$  mica capacitor
- $C_7$ —.002  $\mu\text{fd.}$  mica capacitor
- $CR_1$ —1N34 germanium diode (see text)
- $S_1$ —D.p. 5-pos., non-shorting, rotary selector switch, single gang
- $J_1$ —Open-circuit phone jack
- $L_1$ —See text
- $L_2$ —Ferrite-tuned broadcast antenna coil (Miller No. 6300. See text for modifications)

## BROADCAST RECEIVER

piece of wire, wrap it tightly into 5 turns around the bottom of coil  $L_2$ , twisting the ends to prevent unraveling. This forms the input coil,  $L_1$ .

In the first three positions of the switch (1, 2, and 3), the large trimmers are used. In these three positions, stations having frequencies between 500 and 1000 kc. are selected. In the remaining two positions (4 and 5) of the switch, the small-size trimmers are used. In these two positions, stations on frequencies higher than 1000 kc. are selected.

In positions 1, 2, and 3 of the switch, the lower pole ( $S_{1B}$ ) connects the antenna and ground leads directly to coil  $L_1$ . In positions 4 and 5, capacitor  $C_6$  is switched automatically in series with the coil. This helps to improve separation of the high stations.

The crystal detector,  $CR_1$ , is an inexpensive 1N34 germanium diode. Other types of germanium diodes or silicon diodes can be used.

Capacitor  $C_7$  is a small .002  $\mu\text{fd.}$  mica unit for the headphone circuit. Magnetic headphones rated at 2000 to 3000 ohms will give best results.

A strip of television-type 300-ohm antenna ribbon is used to connect the crystal set to the antenna and ground. For greatest volume, a good outside antenna and ground connection are needed. The antenna should be erected as high in the air as possible and can be a single wire, but

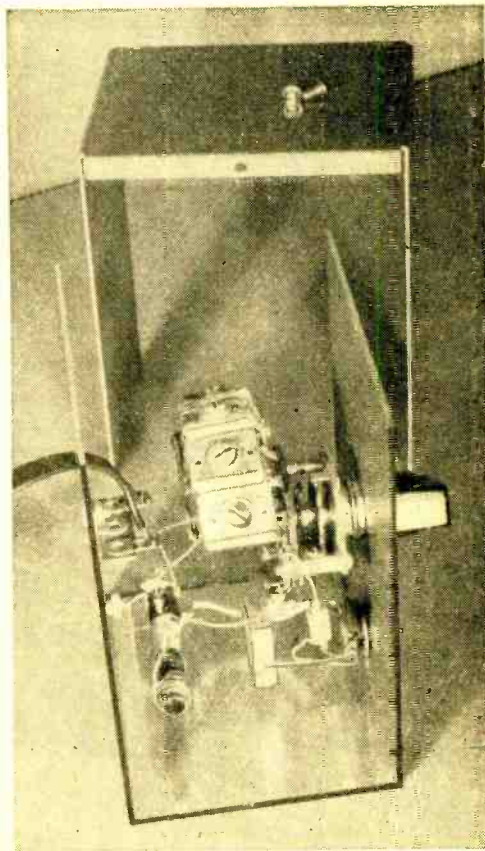

must be at least 25 feet long. The ground must be a good earth connection, such as a cold-water pipe or a 3-foot pipe driven into moist earth. Do not use gas pipes.

Begin the construction by soldering one lug of each trimmer to a switch contact in the top section ( $S_{1A}$ ) of the switch. This construction is shown in one of the photographs. Arrange the trimmers around the switch so that the three 480  $\mu\text{fd}$ . trimmers will be selected when the switch is set to its left-hand positions and the two 180  $\mu\text{fd}$ . trimmers when the switch is set to its right-hand positions. Connect the free lugs of the trimmers together with a length of No. 18 bare copper wire soldered to the lugs.

The receiver is built into a standard enamelled-aluminum radio chassis box, 5" high, 4" wide, and 3" deep. The antenna coil assembly,  $L_1-L_2$ , is mounted to the back wall of the box by means of a short piece of No. 14 wire twisted around the neck of the coil form to make a bracket. Complete the balance of the assembly and wiring as shown in the illustrations.

After the wiring has been completed and inspected for correctness, the crystal set may be pre-tuned to the desired stations

in the following manner: 1. With the box opened, screw each of the trimmers tightly closed; 2. Connect the antenna and ground; 3. Plug in the headphones; 4. Set the switch to position 1; 5. Unscrew trimmer  $C_1$ , slowly until the first desired low-frequency station is tuned in sharply. Use an insulated screwdriver to keep your hand from detuning the set; 6. Advance the switch to position 2; 7. Unscrew trimmer  $C_2$  until the second desired low-frequency station is tuned in sharply; 8. Repeat this procedure at each of the other settings of the switch, adjusting the corresponding trimmer to tune in the desired station. In positions 4 and 5 of the switch, adjust the corresponding trimmer ( $C_4$  and  $C_5$ ) to tune in the desired high-frequency stations; 9. Inscribe the station call letters on the card under each setting of the pointer knob of the switch; finally 10. Close the box.

Tuning may be inspected from time to time and the trimmers re-adjusted with a screwdriver if necessary. The set usually will stay in tune for months without needing any touching up. When moving to another town, or when stations are changed, the trimmer screws may be re-set to bring in different stations. END

## VERSATILE LOAD FOR YOUR HAM TRANSMITTER

**U**SING an incandescent bulb for low-power transmitter testing is a well-established practice, however, the usual method of sol-

dering leads to the bulb base has a number of disadvantages including the fact that a number of different bulbs must be processed to obtain loads of the desired amount.

An adapter to solve this problem consists of a plug-in type socket to which is soldered a short length of feedline terminated in alligator clips.

Such a unit facilitates quick interchangeability and does not mutilate the bulbs. . . . . Otto L. Woolley, WØSGG.

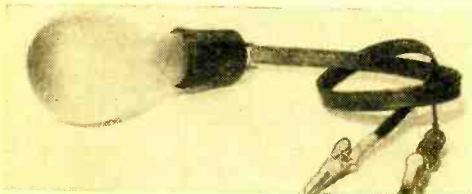

## RUNNING TV LEAD-IN THROUGH WINDOW PANES

**A** LITTLE patience, an electric drill, and a good valve-grinding compound will enable you to drill a hole in a window pane in order to accommodate the low-loss lead-in line from your television antenna. Here is how it is done.

Chuck a short piece of square-cut  $\frac{1}{4}$ " copper tubing in your power drill, dope the end liberally with valve-grinding compound (or carborundum-oil mix) and start pressing. Take care to hold the point on one spot until a groove is worn—use your left hand as a cradle to steady the drill. Use plenty of abrasive and just a little pressure. When close to the other side, press very lightly to avoid pushing a jagged patch on the

outside of the window pane being drilled.

After the hole is drilled a  $\frac{1}{4}$ " brass bolt with lead washers on each side may be installed as a through connection.



## "HANDBOOK OF TELEVISION REPAIR"

by Robert Hertzberg. *Arco Publishing Co.*, New York. 140 pages. Price \$2.00.

As the author of this book points out, there are many things that a television set owner can do to keep his receiver in top operating condition.

Simple rules for cleaning the safety glass and the tube face, steps for preventing antenna breakage, and line cord safety measures are covered pictorially and in the text.

For those of a technical bent, the book covers TV receiver circuitry, explains the function of the various circuits, and diagrams typical commercial receivers. The test equipment used in TV servicing is described and explained along with its function.

A comprehensive section on antennas helps to explain why one type of antenna works in one location but won't produce satisfactory pictures in another area.

Set owners who like to know the "why's and whyfore's" of their TV receivers will find this book interesting and instructive.

\* \* \*

"THE MAGIC OF ELECTRONICS" by Edward J. Bukstein. Published by *Frederick Ungar Publishing Co.*, New York. 251 pages. Price \$3.95.

There is something magical about the science of electronics which fascinates young and old alike. The never-ending parade of miraculous devices coming from the laboratories is a constant source of amazement to those old enough to remember the era of gas lights and horse-driven vehicles.

This book is a survey of some of the many developments that have taken place during a single generation—the vacuum tube, electronic heating, x-rays, medical electronic equipment, detectors of various types, FM and AM broadcasting, television, radar, sonar, loran, transistors, printed circuits, etc.

Each subject is discussed succinctly with either a photograph or diagram to illustrate the text material.

\* \* \*

"MODEL CONTROL BY RADIO" by Edward L. Safford, Jr. Published by *Gernsback Publications, Inc.*, New York. 112 pages. Price \$1.00. Paper bound.

The tremendous boom in the building and operating of models of all types has given rise to a corresponding surge in interest in radio control.

This book is a simple, easy-to-understand description of the various types of equipment which can be used for model control. So clearly and concisely is the subject matter presented that those without formal radio training can derive as much benefit from the text as the "old hand."

# BOOK REVIEWS

Construction details for the various systems are presented in thoroughly usable form, along with the circuit diagrams and photographs required for such projects.

Here is a "natural" for the hobbyist and those who like to experiment with miniature equipment of all types.

\* \* \*

"HOW TO BECOME A RADIO AMATEUR" by ARRL Staff. Published by the *American Radio Relay League*, West Hartford, Conn. 58 pages plus catalogue section. Price 50 cents. Paper bound.

Offhand we can think of no better introduction to the amateur radio hobby than this little handbook published by the "League."

Not only does it describe the rules and regulations, requirements and prerogatives of "hams" but it outlines the procedures for obtaining an amateur license.

Simple receivers and transmitters that the amateur can build, code practice equipment, code techniques, and a summary of license exam questions are all included in this compact manual.

Anyone considering amateur radio as a hobby as well as those who already hold their "tickets" should get a copy of this handbook as a reference source and self-instruction manual *par excellence*.

\* \* \*

"REMOTE CONTROL BY RADIO" by A. H. Bruinsma. Published by *Philips Technical Library*, Eindhoven, Holland. Available in the U.S. from *Elsevier Press Inc.*, 402 Lovett Blvd., Houston 6, Texas. 96 pages. Price \$1.50. Paper bound.

This is a practical handbook covering two systems for controlling small models by radio; an AM system with two independent channels, and a pulse-modulation system with eight channels.

The only prerequisite to an understanding of this text is a general knowledge of radio and low voltage techniques. Complete circuit diagrams of the transmitters and receivers used in the systems are included along with a detailed parts list. The parts included in the construction are standard and no difficulty should be encountered in purchasing them in the U. S.

For a practical, how-to-do-it book covering a fascinating project, this text meets all of the requirements. END

# Make **YOUR** Picture Taking **PAY!**

- ✓ —in a high-paid job
- ✓ —your own studio
- ✓ —as a free lance
- ✓ —for extra income



## **NYI'S** BIG FREE BOOK SHOWS YOU HOW SEND FOR IT TODAY!

Find out why today's money-making opportunities are the biggest ever. NYI's big FREE illustrated book takes you behind the scenes in professional photography, shows what the tremendous opportunities are in every major branch. It shows how NYI's famous low-cost LEARN-BY-DOING method and PERSONALIZED guidance train you quickly, easily AT HOME in spare time—how you can EARN AS YOU LEARN to make money 90 ways for extra income or a lifetime career. Get started NOW! Send for FREE book. Our 45th year. Resident Training also available. G.I. Approved.

NEW YORK INSTITUTE OF PHOTOGRAPHY  
Dept. 13, 10 W. 33 St., N. Y. 1, N. Y.

Please send me complete information regarding

Correspondence Course       Resident Training

Name \_\_\_\_\_

Address \_\_\_\_\_

City \_\_\_\_\_ Zone \_\_\_\_\_ State \_\_\_\_\_

Check if eligible under G.I. Bill.

# LEARN ELECTRICAL APPLIANCE

## START YOUR **Repairing & Installation** OWN BUSINESS

Revolutionary NEW TRAINING METHOD. trains you AT HOME... in just a few short weeks!

You receive big "ON-THE-JOB" home training kits, test equipment, audio instructions and practical service training lessons. You learn how to Service, Repair and Install all types of ELECTRICAL Appliances and Equipment. How to build and operate your own business, etc.

### You EARN As You Learn

You charge on basis of \$3.00 to \$5.00 per hour for spare time work! Write now for your Free Book, full details about this amazing opportunity for you in modern Electric Servicing.

**Big Book FREE!**

**ADVANCE TRAINING** 5944 NORTH NEWARK AVENUE Dept. 7410, CHICAGO 31, ILL.

## **ATTENTION** • Hobbyists • Club Members • Study Groups

Subscriptions to POPULAR ELECTRONICS at special bulk rates are available to club members, study groups, employee groups, schools, etc.

### For information, write to:

POPULAR ELECTRONICS, Dept. 1016  
366 Madison Ave., New York 17, N. Y.

## The World at a Twirl

(Continued from page 81)

mal conditions will return after the disturbance has ended, and reception will again be good.

Here's an especial caution: Short-wave broadcasting stations often change their schedules and/or frequencies with little or no prior notice. Always be on the alert for announcements of such changes.

Overseas broadcasters heard best in North America are the high-powered transmitters which radiate programs over directional antennas and which are intended especially for this area. Here are some "Current Best Bets for Beginners" from stations which broadcast sessions in *English* which are generally heard well; most of those listed are beamed to the North American continent. (Remember times are in GMT on a 24-hour system; subtract 5 hours for EST, 6 for CST, 7 for MST, 8 for PST.)

*Africa*—OTC, 9.655, Leopoldville, Belgian Congo, 0100-0300, relays ORU, Brussels, Belgium. Radio Brazzaville, 9.440, 11.970, French Equatorial Africa, with news 2245-2300. Radio Dakar, 9.560A, French West Africa, has *English* 2215-2230 closedown on Mon., Wed., Fri., Sat.

*Asia*—TAT, 9.515, Ankara, Turkey, 2315-2400, has typical Turkish music and news; Radio Teheran, EPB, 15.100, Iran, has news 2015; Tel Aviv, 9.008A ("A" means approximate frequency), Israel, has "Voice of Zion" session 2100-2145. Western listeners should try for Radio Japan, Tokyo, at 0500-0600 on 15.135, 11.780; and for BED4, 11.920, Taipei, Taiwan (Formosa) at 0300-0330, 0430-0500.

*Australia-Oceania*—Eastern SWL's should tune for Radio Australia, Melbourne, 9.615, at 1200-1345; western SWL's on same frequency at 1500-1615, and on 15.200 at 225-0415; has helpful DX session Sundays 1330 on 9.615 when tips for current listening are presented. For Radio New Zealand, Wellington, try ZL18, 9.520, or ZL2, 9.540, around 0700-1000. VLT6, 6.130, Port Moresby, British New Guinea, has a complete weather broadcast 0855, followed at 0900 by ABC news relayed from Radio Australia.

*Europe*—Try HER4, 9.535, Berne, Switzerland, 0130-0400, has delightful folk music; OZF, 9.520, Copenhagen, Denmark, 0200-0230, 0330-0400; Radio Athens, 11.718, Greece, has news 1745; Rome, 9.570A, 11.905A, has news 0015AV ("A" means approximate time news begins, which may vary—V—slightly) and 0230; Bucharest, 9.570, Roumania, 0300-0330A, 0430-0500;

Radio Sweden, 9.620, Stockholm, has news 0030, and (for western SWL's) on 11.705 at 0500; Madrid, 9.363AV, Spain, at 2300-2340A, and (for western SWL's), same channel, 0310A-0350A.

For the old standby, the BBC, London, try GSP, 15.310, at 1500-2215; GRH, 9.825, at 2215-0300; GRN, 6.195, at 0430-0615. Try Paris on 11.700 at 2000-2100, and Hilversum, Holland, on 11.730 at 2145-2225A. Radio Moscow, USSR, beams to North America 2300-0100 (or later) on many frequencies—including 9.480A, 9.530A, 9.595A, 9.640A, 9.680A—with portions being relayed by such satellites as Prague, 9.550, Czechoslovakia; Bucharest, 9.570, Roumania; Sofia, 9.700, Bulgaria; Budapest, 9.833, Hungary, and others. Prague, 9.550, parallel (*has same program*) on 11.760, has its own (English) session for North America 0030-0100 and 0400A-0430A; Sofia, 9.700, at 0100-0130; Budapest, 9.833, 6.248A, 2230-2300 and at other times.

*Latin America*—"Brazil Calling" is an entertaining feature weekdays 0105-0130A and Sundays 2130-2155A over ZYK3, 9.565, Recife, Pernambuco, Brazil; HCJB, Quito, Ecuador, can be heard well 0200-0500 on 9.743A, 11.915, 15.115, with religious broadcasts; try TGNB, 9.668, and TGNC, 11.850, Guatemala City, for further religious programs in English at 0300-0445; YVLK, 4.970, Caracas, Venezuela, has a "Supper Club" session 2300-2400.

*North America*—Try WRUL, Boston, around 2315 on 9.585, 11.780, or 15.285. The "Voice of America" (VOA) and the "Armed Forces Radio Service" (AFRS) have transmitters on both the East and West Coasts of USA which operate almost continuously in the various "popular" short-wave broadcasting bands. Try CHNX, 6.130, Halifax, Nova Scotia, Canada, 1030-0415; western SWL's may hear CKRX, 6.080, or CBRX, 6.160, Vancouver, British Columbia, around 0700. The *Canadian Broadcasting Corporation* (CBC) has a strong signal at 0230 with news in *English* in its Latin American beam over CKLO, 9.630, and CHOL, 11.720.

To get off to a good start, by all means buy a copy of the 1954 edition of "World Radio Handbook" which costs \$1.50, post-paid, direct from Ben E. Wilbur, 47 Mount-haven Drive, Livingston, New Jersey. It has a wealth of information of extreme value to all short-wave listeners.

Next month I'll discuss some of the world's leading short-wave broadcasting organizations and their use of directional beams; antennas; and how to tune your short-wave receiver for best results. In the meantime, good listening, as you "*twirl to tune the world!*" (Continued next month)

October, 1954

## Get New FREE PUBLIC ADDRESS HANDBOOK



### Valuable Facts Help You Install Better PA Systems

- Shows how to make sound surveys and recommendations for factories, arenas, etc. Gives typical examples and results.
- Discusses public address requirements in relation to characteristics of auditoriums, stadiums, large rooms, etc.
- Explains operational factors of importance in public address speaker systems for all types of applications, indoors and outdoors.
- Tells what the CDP Compound Diffraction Projector is—what it does—and how it provides a PA speaker system of much greater range, efficiency and dispersion.
- Includes illustrations, diagrams, charts, formulas, engineering data, technical and architectural specifications.

Send for your **FREE** copy now

# Electro-Voice®

ELECTRO-VOICE, INC., BUCHANAN, MICHIGAN

Without obligation, send **FREE** copy of the CDP Public Address Handbook.

NAME \_\_\_\_\_

ADDRESS \_\_\_\_\_

CITY \_\_\_\_\_ ZONE \_\_\_\_\_ STATE \_\_\_\_\_

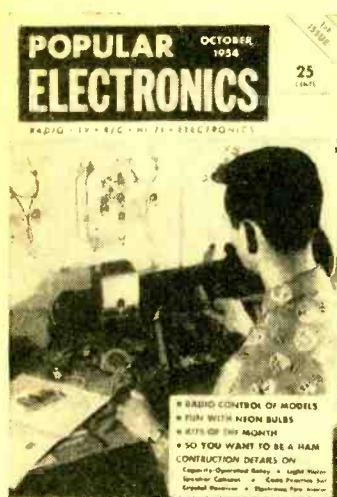

# THIS IS THE FIRST ISSUE OF POPULAR ELECTRONICS

If you like it . . .

If it answers just a few of the questions you've asked . . .

If it helps you in your hobby or experimentation . . .

. . . then you'll want to make sure you don't miss a single one of the information-packed issues during the coming months.

And you will make sure if you take advantage of this Special Money-Saving Subscription Rate.

## 5 issues of POPULAR ELECTRONICS FOR ONLY \$1.00

At this low price you not only won't risk missing any copies but you'll save money over the regular newsstand price of 25c per copy.

**Remember** — POPULAR ELECTRONICS is the first and only how-to-build-it, how-to-use-it, how-it-works magazine ever published.

Every month POPULAR ELECTRONICS will bring you more and more vital, easy-to-understand information on electronic components, construction, instruments and systems.

POPULAR ELECTRONICS is *the* magazine for the hobbyist and experimenter.

**SUBSCRIBE TODAY! ORDER GIFT SUBSCRIPTIONS FOR YOUR FRIENDS!**

Use the handy post-free envelope facing this page!

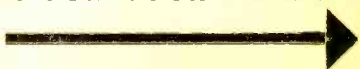





## The Mighty Midget Converter

THE popularity of miniature converters for providing household current in cars, boats, or planes is growing by leaps and bounds. By merely plugging the cord into the cigarette lighter, electric shavers, record players, radios, wire and tape recorders, etc. can be operated from the automotive system. *Terado Company* of 1051 Raymond Ave., St. Paul 14, Minn. for example, puts out a line of converters which vary in size from 10 to 75 (shown above) watts. With this type of equipment it is becoming commonplace for the family car to be a rolling "sound studio" or business office on wheels. Salesmen and business executives can dictate reports to their home offices or enjoy their short-wave radios while on the road. **END**

Six of the standard applications for converters. Hundreds of other uses are possible.



AT PICNICS - OUTINGS



IN THE CAR - IN THE TRUCK

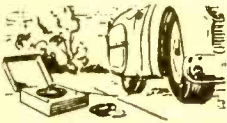

PORTABLE PHONOGRAPH



DICTATING MACHINE



IN BOATS



ELECTRIC SHAVER

October, 1954

# At Last!

## a complete TUBE TESTER

for only **\$24.90**



### New EMC Model 208\*

\*Pat. Pending tests all tube types quickly, easily... accurately in the field or shop.

The sensational new EMC Model 208\* gives you for the first time a complete precision tube tester for less than \$25.00.

With it you can quickly and accurately test all tube types for quality as well as shorts, leakages, filament continuity and opens.

MODEL 208 TUBE TESTER (COMPLETELY WIRED AND TESTED) Only \$24.90

MODEL CRA (PICTURE TUBE ADAPTOR OF MODEL 208) \$4.50

### CHECK THIS EXCLUSIVE COMBINATION OF FEATURES:

- Lowest market price
- Completely portable
- Checks all popular octal, loctal, miniature and noval base tubes
- Flexible switching system assures complete testing of all present and future tubes types

- Elements numbered according to RTMA base system
- Individual sockets for each tube type

- Checks completely for quality as well as shorts, leakages, filament continuity or opens between any two tube elements

- Visual line voltage check with adjustable control assures accurate quality testing

- Matches and checks HI-FI tubes such as 1614, KT 66, and 5881

- Space saving high impact case, 5 1/4 x 6 3/4 x 2 7/8"
- Comes complete with detailed instruction book and tube listings

An invaluable tool for: Servicemen, radio fans, HI-FI fans, students, hobbyists.

Write to Dept. PE-10 today for complete catalog of precision test equipment.

REPORT DEPT. 136 LIBERTY ST. N. Y. 6, N. Y.

# EMC

ELECTRONIC MEASUREMENT CORPORATION  
200 LAFAYETTE STREET  
NEW YORK 12, N. Y.

# TRICKS of the TRADE

## REMOVING BRAID

**S**HIELDED cable, whether used in audio or r.f. work, always presents a problem to the experimenter as stripping and removing parts of the braid are not easy. A good technique is as follows:

If an outer layer of insulation is used, remove a portion by running a sharp knife

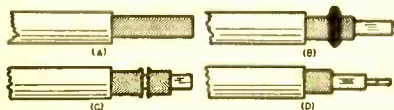

around the cable, flexing it slightly to break the insulation loose as shown in (A). Too much pressure on the knife may nick the braid.

Loosen the braid with the fingers and push it back so that a flat ring is formed as shown in (B). Using diagonal cutters, clip the outer edges of the flat ring (C) thus separating the braid. Remove the excess braid and strip a portion of the insulation from the inner conductor as shown in (D) . . . . . L.G.

## STRAIGHTENING BUS BAR

**B**ARE, tinned copper wire or "bus bar" is often used in commercially-built test equipment. Unfortunately, this bus bar develops kinks and wrinkles if left around the workshop bench and should be straightened before being used in home wiring projects.

To straighten any sized bus bar, from 22 gauge to 12 gauge, clamp one end in a heavy bench vise and grasp the other end tightly with a pair of pliers. Now apply a strong, steady pull on the wire. Use plenty of strength, but don't pull too hard or jerk the wire as it may break. The wire will straighten out nicely and may even stretch slightly. If this happens, the wire diameter will be reduced and the wire will tend to be stiffer and hold its shape better.

## TERMINATING CABLES

**S**MALL diameter shielded cables, such as microphone cable, as well as small sizes of r.f. coaxial cable, may be terminated in a professional way by using the method shown in the diagram.

If the cable has an outer insulator, remove about 3" of this material as shown

in (A) thus exposing the braid. Next, push the braid back to loosen it and bend the cable slightly. With a soldering aid, a scribe, or a small nail start working the strands of the braid apart to form a small hole as shown in (B). Keep working on the opening and bending the cable until you can get the tool under the inner conductor (C). Now slip your tool under the inner conductor and pull the free end out of the braid (D). Hold the edges of the braid back with the fingernail, if necessary, while performing the operation.

With the inner conductor free of the braid, stretch the braid out until the opening is closed tightly around the inner conductor (E). Finally, finish the job by

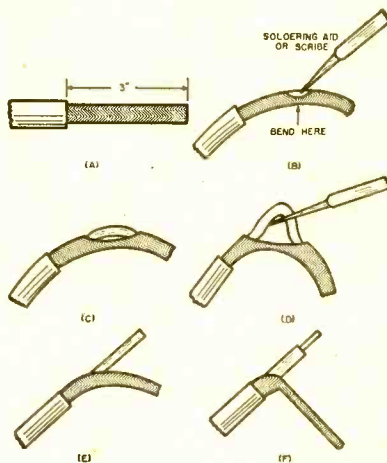

stripping insulation from the inner conductor and flatten the extra length of braid to form a ground strap as shown in (F) . . . . . L.G.

## SELF-TAPPING SCREW

**A** SELF-TAPPING screw, suitable for use in aluminum, as well as Bakelite, lucite, polystyrene, and other plastics, may be made in a few minutes from a conventional machine screw.

Using a steel machine screw of the desired size and length, run a nut up on the screw, almost to the head, as shown in (A). Next clamp the screw and nut in a vise and taper the end (B) using a flat file. Then, using a triangular file, file three or four tapered notches along the

screw. The notches should run the length of the screw as shown in (C) and be deepest at the end farthest from the head.

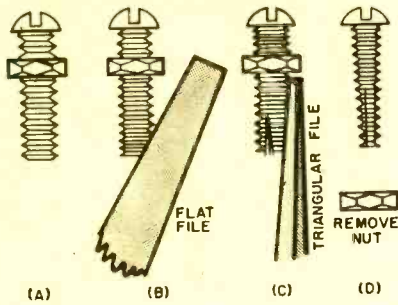

Finally, remove the nut, as shown in (D), thus restoring any damaged threads . . . . . L.G.

### SHORTENING SCREWS

**T**OO-LONG machine screws may be shortened by following a few simple steps. First select a steel nut to fit the screw, then run it up on the screw past the part to be cut off.

Clamp the screw and nut in a vise, cut off the unwanted portion, using either bolt cutters or a hack saw. Remove sharp burrs with a few passes of the file and then remove the nut. As the nut is run off the screw, the damaged threads will be restored . . . . . L.G.

### FOIL SHIELDING

**A**LUMINUM foil is a handy accessory to have in the home workshop for troubleshooting chirps and whistles in superhets due to insufficient shielding. Every "new-born" home-constructed superhet receiver seems to have at least a couple of these hard-to-clean-up bugs.

Place the set on a sheet of foil and fold up the ends to determine whether shielding the entire chassis will help. Form the foil into temporary tube and coil shields and put barriers of the foil between any components suspected of feedback.

This is much faster than the usual procedure of setting up permanent shields and then removing them when they don't seem to help. When components feeding back are found, isolate them entirely with conventional shielding. Always be sure to ground all shields—permanent or temporary. . . . . D. McM.

### MINIATURE SHIELDS

**R**ECENTLY I found it necessary to shield a small superheterodyne oscillator coil. Since none small enough for the purpose was on hand, I used the zinc can from a flashlight cell.

Simply cut the can with a hacksaw

# BIGGEST BARGAINS FOR BEGINNERS!

from

## WORLD RADIO LABS

**WRL'S FAMOUS BANDSWITCHING GLOBE SCOUT TRANSMITTER**



**Only \$7.95 per Mo.**  
\$10 DOWN AND 12 MOS. TO PAY

**COMPLETE AMATEUR RADIO KITS FOR THE NOVICE!**

**RECEIVER**  
\$14.70 Complete  
Stock No. 75A008

**TRANSMITTER**  
\$29.40 Complete  
Stock No. 81A052



This 65 watt, complete bandswitching Globe Scout is ideal for beginners. Compact: 8"x16"x8" case and operating 160 thru 10M. Fone and CW. PI Network antenna tuner. Fully TVI screened cabinet. Send for complete information today!

Stock No. 1000A020W

Build your own transmitter and receiver and "go on the air" with this complete kit and simple instructions. Complete kit only \$43.22. Designed for single wire antenna. Power supply included with transmitter. Units may be purchased separately. Write for full details.

**FREE!**  
**1955 CATALOG**  
Your Permanent Guide To Over 15,000 Top-Value Items!

**SEND FOR IT!**

- ★ Only 10% down payment
- ★ "10 Day Free Trial" Plan
- ★ More Money-Value for Trade-ins
- ★ Over 600 Bargains in reconditioned transmitters, receivers, etc.

**WORLD'S MOST PERSONALIZED RADIO SUPPLY HOUSE**

## World Radio

**LABORATORIES**



**WRITE - WIRE - PHONE 2-0277 COUNCIL BLUFFS, IOWA**

**Address To: WRL—BOX 811—CO. BLUFFS, IA. (PE-10)**

Please Quote Trade-In Value of My: \_\_\_\_\_

(Make and Model of Equipment) \_\_\_\_\_

On Your \_\_\_\_\_ (Make, Model Equipment Desired)

Send Free Catalog!  3'x4' Radio Map (25c). Full Information on  Globe Scout,  Amateur Radio Kits,  Reconditioned Equipment,  Globe King,  E-Z Pay Plan, to:

NAME \_\_\_\_\_ ADDRESS \_\_\_\_\_

close to the positive end of the cell, grasp the cloth lining with pliers, tear out, and clean the inside of the can. Cut holes for the leads and lugs for screw fastening.

Penlight cells make good subminiature shields for portable radios. . . . D. McM.

### SMALL STORAGE "BINS"

**S**MALL metal boxes, of the type used for certain types of sliced pipe tobacco, for



expensive cigarettes, and for cough lozenges, make excellent containers for small screws, nuts, soldering lugs, mica and ceramic capacitors, and small carbon resistors. The boxes are quite sturdy.

Labels may be attached quite easily either by using *Scotch* tape or by cementing the paper label directly to the metal. Use *Duco* cement or its equivalent. If the boxes are to be stacked on a shelf, labels should be placed on the edge of the box as well as on the top.

### LOW COST COIL FORMS

**S**MALL plastic vials or "pill boxes" make excellent low cost experimental coil

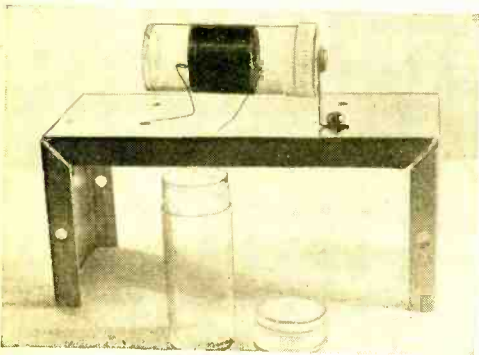

forms. Small holes may be drilled in the side of the box for fastening the coil wire. Two holes are used at each end of the winding and the wire looped through them.

The completed coil may be fastened in a vertical position by using a single screw through the bottom of the vial. If horizontal mounting is preferred, a single "L" bracket may be used.

Where an easily removable coil is desired, the cap may be used for mounting, as shown in the photograph. The mounting

bracket and cap are left permanently mounted on the chassis and different coils may be quickly slipped into place.

\* \* \*

### IMPROVING DIAGONAL PLIERS

**C**ONVENTIONAL diagonal cutting pliers, as supplied by *Klein* or *Peck-Stow* are suitable for most purposes. When it comes to fine cable work, or snipping extensive runs of lacing in a remodeling job, the cutter noses often prove to be too bulky.

A few minutes at the power grinder will correct this situation. Grind off excess jaw material as shown in the photograph (top),

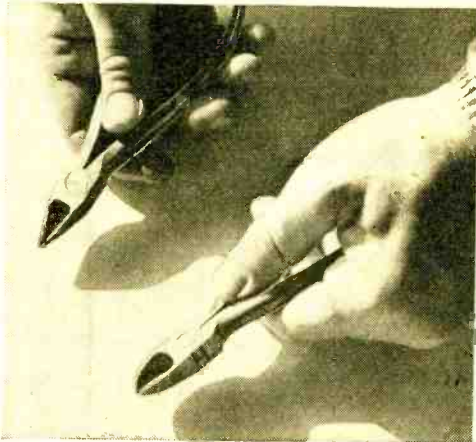

dousing frequently in water to prevent loss of temper. While the modified tool should not be used for cutting No. 9 steel wire, it is a natural for fine cable work. . . . F.R.

\* \* \*

### WIRING SMALL CHASSIS

**O**NE TUBE circuits, such as code practice oscillators, preamplifiers, and similar items are generally wired on very small chassis bases. Such chassis are quite difficult to handle and have a bad habit of sliding across the work bench at the wrong time.

A standard drill press vise, available at most hardware stores, makes an excellent mounting base to hold a subminiature chassis during wiring. Clamp the chassis



by its edges, as shown in the photograph. Tighten the vise sufficiently to get a good grip on the chassis but do not use too

much pressure lest you bend or distort the chassis.

The drill press vise has a number of other uses around the shop. It may be used for holding small brackets when drilling, to hold a coil form while winding a coil, to clamp a small loudspeaker in an upright position for temporary use, and in other applications . . . . . L. G.

\* \* \*

### MAKING "L" BRACKETS

**T**HE experimenter and home builder frequently needs "L" brackets for mounting shield plates, trimmer capacitors, and similar components. These may be made easily by cutting them from a piece of aluminum angle, available in the "do-it-yourself" section of most hardware stores.

Clamp the angle bar in a vise, as shown

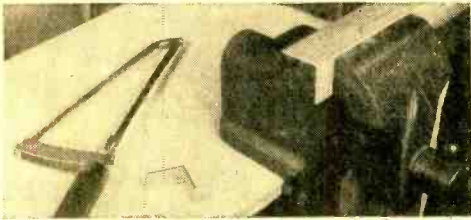

in the photograph, and cut off brackets of the desired size with an ordinary hacksaw.

Rough edges are then smoothed with a file or a pocket knife.

If screw holes are needed in the final bracket, drill these before cutting it off the angle bar.

\* \* \*

### TEST-PROD AID

**FIND** that an ordinary power-tip-jack comes in handy for holding a test-prod

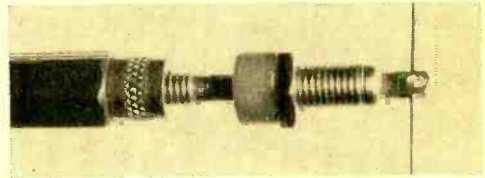

to a wire or lug. Simply push the tip of the prod into the tip-jack, and then clamp the dual lugs of the jack onto the wire, as shown in the photo.

If desired, you can remove the nut from the tip-jack and wrap a couple of turns of tape around the threaded shank of the jack, this helps to prevent shorts when working in crowded places. . . . A. T.

\* \* \*

### REPAIRING COIL STUDS

**M**ANY of the small coils used in radio and electronics work have powdered iron

**NEW STOCK OF FIRST QUALITY**

# TELTRON TUBES

**SPECIAL! . . . till NOV. 1st**

**Guaranteed! Lowest Prices Ever!**

**GIFT OFFER!**  
One 6BG6G tube will be shipped FREE with any order accompanying this ad.

All tubes individually boxed . . . unconditionally guaranteed for one year.

TYPE PRICE

0Z4	.39
1E3GT	.55
1S5	.35
5U4G	.39
6AU6	.33
6BA6	.38
6BQ6GT	.75
6SN7GT	.48
6W4GT	.35
12A7	.53
12B7	.59
12SA7	.43
12SK7	.43
12SQ7	.35
25W4GT	.39
35L6GT	.39
50L6GT	.47
117L7GT	.99

Watch for our Monthly Specials of key radio and TV tubes. Each month new key types will appear. Take advantage and order your requirements now.

**EXTRA Bonus of Radio & TV Parts**

3 lbs. of parts including resistors, controls, coils, IF cans, etc. Easilly worth \$10.00.

1A7GT	.53
1H5GT	.51
1L4	.51
1L6	.51
1LC6	.49
1N5GT	.51
1T4	.51
1U4	.51
1U5	.43
2A3	.35
2A7	.35
3Q4	.53
3Q5GT	.61
3S4	.48
3V4	.48
5Y4G	.49
5Y3GT	.30
5Y4G	.40
6A8	.40
6K7	.40
6Q7	.40

6AC7	.65
6AG5	.52
6AH4GT	.65
6AJ5	.96
6AK5	.96
6AL5	.43
6AQ5	.48
6AR5	.48
6AU5GT	.60
6AV5GT	.60
6AV6	.37
6AX4GT	.60
6AX5GT	.60
6BA7	.58
6BE6	.46
6BF5	.48
6BF6	.48
6BG6G	1.18
6BH6	.51
6BK6	.51
6BK5	.75

6BK7	.78
6BL7GT	.78
6BN6	.90
6BQ7	.85
6BY5G	.60
6BZ7	.95
6C4	.41
6CB6	.51
6CD6G	1.63
6CU6	.95
6F6	.42
6F5GT	.44
6H6	.50
6J6	.61
6J5GT	.49
6K6GT	.39
6L6	.78
6S4	.41
6S8GT	.65
6SA7GT	.45
6SK7GT	.45
6SL7GT	.60

6SQ7GT	.38
6T8	.71
6U8	.76
6V3	.80
6V6GT	.48
6W6GT	.53
6X4	.37
6X5GT	.38
6X8	.80
7F8	.49
7N7	.49
12AL5	.43
12AT6	.37
12AU6	.43
12AU7	.58
12AV7	.73
12AX4GT	.60
12AX7	.61
12AZ7	.65
12B4	.72
12BA6	.46

12BA7	.58
12BE6	.46
12BZ7	.63
12K7	.40
12SL7GT	.60
19T8	.71
25BQ6GT	.82
25L6GT	.41
25Z5	.55
25Z6GT	.36
35B5	.48
35C5	.48
35W4	.33
35Y4	.42
35Z5GT	.33
50A5	.49
50B5	.48
50C5	.48
TYPE 80	.40
11Z3	.33
11Z6GT	.65

**SAME DAY SERVICE**  
48 Hour Postal Delivery  
To West Coast

**TERMS:** Save all freight and postage charges. All orders accompanied by full remittance will be shipped POSTAGE PAID anywhere in the continental U.S.A. 25% deposit required on C.O.D.'s. Minimum order \$10.00. Open accounts to rated firms only.

Send for Free complete tube listing and monthly specials! Get on our mailing list.

## TELTRON ELECTRIC COMPANY

428 HARRISON AVE.

DEPT. PE10  
Phone Humboldt 4-9848

HARRISON, N. J.

there's always something new  
being developed by *Perma-Power*

**TV VOLTAGE  
REGULATOR**

10 Volt Line Adjustor • Normal  
Line Volts • 10 Volts Increase  
• 10 Volts Decrease. 300 Watts  
Returns full height &  
width of picture.  
Eliminates intermit-  
tent sync.

**\$675**



**UNIVERSAL  
TV TUBE  
BRITENER**



**\$445**

Isolation type transformer gives 6.3 V  
for cathode — filament short or 7.8 V  
to increase emission. • It's parallel  
• It's series • It's isolation • It's  
electrostatic • It's universal.

Available through recognized electronic parts suppliers

**Perma-Power** COMPANY 4727 N. DAMEN AVE.  
CHICAGO 25, ILL.  
Manufacturers of electronic equipment since 1928

NOW AT LAST  
A REAL SUBMINIATURE  
**OSCILLATOR-RADIO  
KIT**

ONLY  
**\$5.95**

Complete kit includes all parts and a real subminiature tube with easy-to-read instructions. Can be used as a phonograph oscillator. Allowing your records to be heard through your big radio without any connections whatsoever to your set. More power than any kit in the low-priced field. Tunes the broadcast band. Weighs only 4 oz. Complete kit less batteries and phone—\$5.95—postpaid in U. S. A.

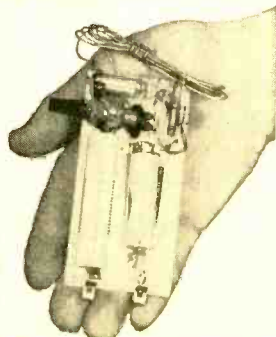

Single phone—\$1.25—double—\$2.00. Batteries available at your hearing-aid store.

ALSO  
**SUBMINIATURE RADIO PLANS** 50¢  
FOUR BAND 6,000 MILE RANGE  
**SENSATIONAL NEW!** \$1  
**F-M POCKET RADIO & TUNER PLANS**  
Anyone can build with these easy-to-follow plans  
Send self-addressed envelope

THE **EKERADIO** 2 BAND SUBMINIATURE SET.  
TUNES BROADCAST BANDS AND SHORT WAVE \$24.95  
160 TO 75 METERS. COMPLETE WITH BATTERIES, EARBUTTON AND PICK-UP WIRE. READY TO PLAY. Allow 10 days delivery—20% on C.O.D. orders

**EKERADIO** 646 N. Fair Oaks Avenue  
PASADENA 3, CALIF.

cores which are adjusted by means of a brass stud having a narrow screwdriver slot. This slot so weakens the stud that frequent breakage occurs during adjustment, especially when the stud is tight or when



too large a screwdriver is used for adjustment. A typical broken stud is shown on the coil to the left in the photograph.

An effective and permanent repair may be made by soldering a small nut on the end of the stud. Select a hex nut of the right size and having the proper number of threads. Spread a thin film of rosin base soldering flux on the tip of the stud, then screw on the nut until flush with the end of the stud. Hold a hot soldering iron against the nut, being careful not to touch its edges, and flow a small amount of solder into the joint.

A coil prepared using this technique is shown to the right in the photograph. After the repair is completed, a hollow "hex" type alignment tool is used for adjusting the coil. . . . . L. G.

\* \* \*

**TEST LEAD RACK**

IF YOU find that your clip and test leads are constantly getting tangled, make a small rack to hold them. Here's one you can make in a few minutes' time at almost zero cost.

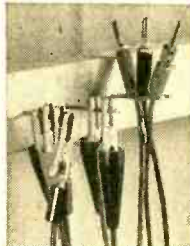

Drive 8 penny (or larger) finishing nails into a piece of 1 x 3 or 1 x 2 board. For leads having clips, space the nails about one to two inches apart. For leads without clips (phone tips or banana plugs)

use two nails at each position, spaced slightly greater than the diameter of the test lead wire and drive them in at a slight angle.

\* \* \*

**SOLDERING SMALL PARTS**

WHEN you have to solder a screw, bracket, or other small part, don't clamp it in a vise. You'll find that the heavy metal of the vise conducts the heat away too rapidly for you to do a good job.

Instead, cut a small hole in a cardboard box large enough to hold the part.

Next, use the box as a support while soldering. Cardboard is a poor conductor of heat and will serve to insulate the part while you do the job. If the box chars slightly, don't worry—they are cheap.

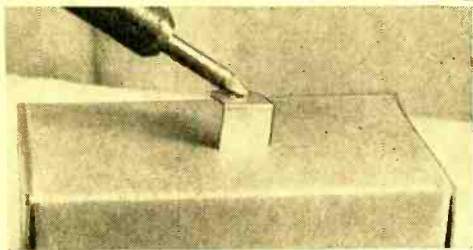

Since cardboard tends to char rather than to burn actively there is little danger of setting your workshop alight with this idea if you don't use the box as a soldering iron rest instead of your regular metal one.

### SANDPAPER PAD

**Y**OU'LL find that those small sandpaper pads artists and draftsmen use to sharpen their pencils are pretty handy to have around the home lab. In addition to keeping your pencils pointed, you can use them in place of a fine file for smoothing brackets and other small parts, and for removing



the "burrs" from volume controls and switch shafts.

Use them for smoothing Bakelite and plastic parts, too. A clogged file is hard to clean, but the small strip of sandpaper is cheap enough to discard. You will also find that the sandpaper is just right for removing the enamel from magnet and coil wire.

### "SPINNER KNOBS" FOR RADIOS

**H**ERE is an easy way to make a spinner knob out of almost any tuning knob. Probably you can use the tuning knob you have on your broadcast or communications set now. This trick comes in handy when you want to make a quick change from a station on the low-frequency end of the dial to a station on the high-frequency end of the dial, or vice versa.



October, 1954



## DON'T THROW OLD RADIOS AWAY!

This giant book shows exactly how to fix them . . . without a lot of previous experience!

There's a "secret" to repairing old radios fast and profitably . . . and this big RADIO TROUBLESHOOTER'S HANDBOOK is it!

Just look up the old make and model you want to fix. This manual-size, 3½ pound, 744-page Ghirardi handbook tells what the trouble is likely to be . . . AND SHOWS YOU EXACTLY HOW TO FIX IT. No useless testing! No wasted time! Even beginners can handle jobs "slick as a whistle." The only guide of its kind . . . cuts repair time in half!

Included are common trouble symptoms and remedies for over 4,800 models of home and auto radios and record changers. Actual case histories cover practically every model made by 202 manufacturers between 1925 and 1942—Airline, Apex, Arvin, Atwater Kent, Belmont, Bosch, Brunswick, Clarion, Crosley, Emerson, Fada, G-E, Kolster, Majestic, Motorola, Philco, Pilot, RCA, Silvertone, Sparton, Stromberg AND DOZENS MORE. Gives how-to-do-it data on SPECIFIC jobs—NOT general theory. Includes hundreds of pages of invaluable tube and component data, service short cuts, etc. Price \$6.50. 10-day free trial.

## HERE'S HOW TO GET YOUR START IN

### RADIO-ELECTRONICS!

More experts got their basic training from this book than any other of its type!

Here's basic training you can really understand . . . training that can help fit you for a good paying radio-television-electronic career! No matter what part of the work you want to do, this is the kind of training you need **FIRST!**

Ghirardi's RADIO PHYSICS COURSE is the oldest book of its kind . . . and still a best seller BECAUSE IT IS SO AMAZINGLY CLEAR AND COMPLETE. Thousands now in electronics got their start from this great book—**AND THEY'LL RECOMMEND IT TO YOU TODAY!**

Starts with Basic Electricity (over 300 pages) then takes you step by step through the entire radio-electronics field. Covers principles, theories and practices that are basic to even the most modern equipment. 972 pages; 508 pictures; 856 helpful self-review test questions. Price only \$6.50.

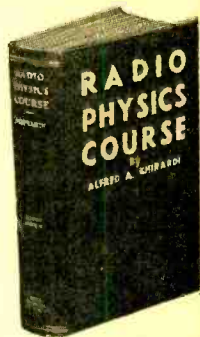

**10 DAYS FREE TRIAL**

Dept. PE-104, RINEHART & CO., INC.,  
232 Madison Ave., New York 16, N. Y.

Send book(s) checked for free examination. In 10 days, I will either send price shown (plus postage) or return books postpaid and owe nothing.

Ghirardi's RADIO TROUBLESHOOTER'S HANDBOOK, \$6.50.  
 Ghirardi's RADIO PHYSICS COURSE, \$6.50.

Name .....

Address .....

City, Zone, State.....

(OUTSIDE U.S.A.—\$7.25 each, cash only. Money back if books are returned in 10 days.)

**Created by Popular Demand...**

the  
**University**  
**MIGHTY MIDGET**  
Model EN-8



Hit of every Audio Fair in the nation, University now makes available this special speaker enclosure which was originally designed to demonstrate the remarkable model Diffusicone—8 coaxial speaker. In combination rear horn loading for unexcelled power handling and distortion control, and tuned horn mouth for phase inverter action for increased bass efficiency. EN-8 also has cut-out for University model 4401 tweeter and C8W 8" woofer combination, if desired. Order EN-8C for cherry mahogany finish, EN-8B for blond or no extra cost. Model EN-8U available in unfinished mahogany. Front grill material removable in all models.

The MIGHTY MIDGET . . . a GIANT in PERFORMANCE AND BEAUTY  
SEE YOUR HI-FI DEALER TODAY!

Write Desk No. 6 for full descriptive literature.

**UNIVERSITY LOUDSPEAKERS INC.**  
80 South Kensico Ave., White Plains, New York



- **ESSCO—The number one supplier in radio control materials extends a hearty welcome to "Popular Electronics." We hope that you too have the same healthy and prosperous growth experienced by "ESSCO" in this field.**
- **The ESSCO-Mini PWR PAC.** A miniature size 2 volt vibrator power supply that delivers 180 volts at 40 ma. It uses a new power transformer made to our exclusive design specifications. A built-in charger system is provided to recharge the external 2 volt wet cell from 110 VAC or from the 6 volt DC auto battery. With this latter connection it is then possible to "float" the 2 volt cell off the 6 volt auto battery and the transmitter then operates either as a fixed or portable unit. The power pack weighs less than 4 lbs. and comes in a case 4 x 5 x 3" high. Which is about the same dimensions as a large size 45 volt B battery. With this unit it becomes very easy for anyone to change over from dry B battery supply to power pack and not have to rework the transmitter case. The voltage and current output is ideal for almost every requirement. . . . **\$17.95**
- **Improved ESSCO WAG Audio Tone Receiver.** Only **\$19.95** version uses 3 high efficiency sub-miniature hard tubes, resulting in improved performance, smaller size, lighter weight. Will fit 1/2 A size models. Only 100 ma. total filament drain.
- **Complete tested receiver w/relay ready to operate. . . . \$24.95**
- **In kit form. . . . \$19.95**
- **The new ESSCO Piggy-Back Mini-Mac.** Use this novel unit to convert your Mini-Mac or the ESSCO M-M-M receiver to a dual hard tube receiver. Results in a very reliable and sensitive receiver at low cost with extraordinary long tube life. Many satisfied users advise us of their extremely fine results.
- **Complete unit ready to attach to existing sets. . . . \$6.45**
- **In kit form, includes all parts, tube and drilled base with full instructions. . . . \$4.95**
- **The improved new ESSCO Lorenz MOPA Transmitter.** Complete parts kit of highest grade components to build your own per August M.A.N. Includes wound coils, drilled chassis, tubes, case and crystal. . . . **\$17.95**
- **A completed unit ready for use, nothing else to buy (butcher's excepted). . . . \$34.95**
- **The Deluxe ESSCO-Lorenz.** A completed unit with built-in vibrator power pack, 2 volt rechargeable cell, with 110 volt AC and 12 VDC charger. Complete set ready to go. . . . **\$49.50**
- **The Lorenz 2 Tube.** The old reliable and most popular dual tube job. Complete ESSCO PARTS PKG. w/RR-61 and XFG-1. . . . **\$9.95**
- **The ESSCO M-M-M Receiver.** Our improved version of the Mini-Mac supplied as a completed set, ready for installation at a kit price. Size 1 1/4 x 2 1/2. wt. 2 1/2 oz. w/ Kurman relay. . . . **\$14.95**
- **The ESSCO DHT, a dual Hard Tube.** ESSCO's improved version with 1000 hour tube life. A super-sensitive 2 tube receiver for installation, less relay and batteries. . . . **\$19.95**
- **With choice of Kurman, Neomatic or ED relay. . . . \$19.95**
- **Special Free Bonus.** Lorenz pkg. high grade rosin core solder.
- **MONEY BACK GUARANTEE ON ALL ITEMS.** Send for free catalog.
- **FOR FAST, INTELLIGENT, FRIENDLY SERVICE ON YOUR R/C ORDERS "CALL ON ESSCO!"**
- **Serving The West Coast** | **Serving The Entire R/C Field**
- **ESSCO-WEST COAST** | **ESSCO-NEW YORK**
- 670 Bell Street, Palo Alto, Calif. | 56 Walker St., New York City 13, N. Y.

Using a #46 drill, drill a hole into one side of the tuning knob and drive a length of #12 bare copper wire into the hole. Cut the wire off so about 3/4" projects from the knob and file the end smooth and round so it cannot injure the fingers. The photograph at left below shows the completed knob.

In use simply place the forefinger along one side of the wire stem and spin the knob. The stem acts as a lever and keeps the finger from slipping off the knob.

If desired, use a longer piece of wire and make a right-angle bend near the end to form a crank. If the wire stem fits the hole in the knob too loosely, use a little Duco cement . . . . . A. T.

\* \* \*

**AMPLIFIER CONNECTORS**

WHEN experimenting with audio amplifiers, preamplifiers, modulators, etc., it is often desired to make quick temporary

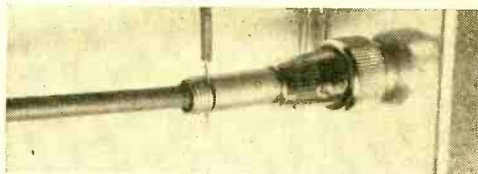

connections from other equipment to "ground" or chassis of the amplifier.

I find it handy to use the cable-protecting-spring in the female mike cable connector, as shown in the photo. Simply bend the spring a little and slip the wires in between the coils of the spring, or push the wires in with a fingernail. The spring holds the wires securely and the wires can be quickly removed when desired. . . . A. T.

\* \* \*

**INTERMITTENT CHECKER**

LAMINATED fiber fuse pullers of the type used by electricians are convenient in "wiggling" or moving radio or TV capacitors or resistors which fail intermittently.

Such fuse pullers are available at electrical supply stores in over-all lengths



from 5 to 7 1/2 inches with jaws at both ends which fit cartridge fuses.

The fiber handles are insulated and with care permit grasping a capacitor or resistor and moving it slightly, while set is operating, to note results. . . . END



# Make this Handy Sorting Tray

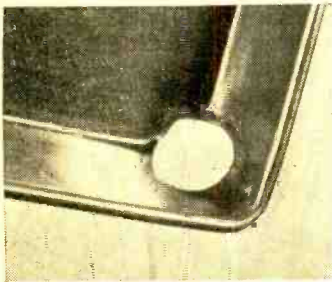

Punch 1" or 1 1/4" hole in corner of flat pan to make a sorting tray.

**A**LMOST every electronics lab has one or more "hell" boxes—those jars or boxes in which are kept an assortment of screws, nuts, washers, brackets, and what-have-you. They're mighty handy except when you try to find a special part—then the name seems quite appropriate.

Here's a sorting tray that you can make in a few minutes from an aluminum "coffee cake" pan and may save you many hours time. Use it as shown in the pictures below and you can rename your "hell" box. There will be no pricked fingers, broken fingernails, or frayed tempers with this slick system for restoring parts to their storage places after you have found that elusive part you want. **END**

Need a special part? Just dump your "hell box" in this tray.

Spread out the parts, select the special items you need.

Dump remaining parts through corner hole back into the jar.



DESIGNED FOR

## Radio Control

\* All parts die-cut or shaped for simple construction and easy assembly!  
\* Complete, easy-to-read step-by-step plans and instructions included! At your local hobby shop now!



**R.C. PIPER TRI-PACER**  
KIT FS-1—SPAN 58 3/4"  
Length 39 1/2"

**\$1095**

for Class A, B, or C engines

... and a Cinch To Build

Actual photographs of models built from kits.

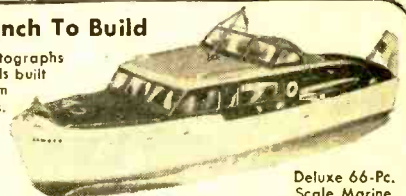

**CHRIS-CRAFT 50' CATALINA**  
Kit B-7M—Length 31 1/4" Beam 8 3/8"

**\$1195**

(less scale marine fittings)

Deluxe 66-Pc. Scale Marine Fittings—Kit B-7F  
**\$495**

## STERLING MODELS

Write for new '54 catalog featuring a complete line of model boats and planes—many designed for radio control. Send 10c in coin to Dept. PE-10

1530-34 N. Hancock St.  
Philadelphia 22, Pa.

## EASY! BUILD your own Professional Electronic Instruments with EICO KITS! SAVE 50%

• Complete easy-to-follow instructions

• Fully guaranteed

5" PUSH-PULL OSCILLOSCOPE



KIT \$44.95 WIRED \$79.95

VACUUM TUBE VOLTMETER



KIT \$25.95 WIRED \$39.95

1,000 Ohms/Volt MULTIMETER



KIT \$12.90 WIRED \$14.90

6V & 12V BATTERY ELIMINATOR & CHARGER



KIT \$29.95 WIRED \$38.95

Write now for FREE Catalog PE-10 describing 38 EICO KITS.

**EICO**

ELECTRONIC INSTRUMENT CO., INC.  
84 Withers St., Brooklyn 11, N. Y.

© 54

# ELECTRONIC SUPPLIES

## FOR EXPERIMENTERS—SERVICE ORGANIZATIONS—AMATEURS—AND INDUSTRY

CLEAN, USEFUL, ITEMS AT LOW COST ALWAYS—  
WHOLESALE AND RETAIL  
ALL MERCHANDISE SOLD ON A SATISFACTION  
GUARANTEED BASIS

### ELECTRONIC REMOTE CONTROL UNIT

Contains a multitude of new, valuable, useful parts. Including 3000 ohm sensitive plate relay—transformer, switch, tube sockets, panel lamp, condensers, resistors, potentiometer, etc.  
Including schematic instruction sheet. Ridiculous sale price of 79¢ complete while they last. . . . 4 for \$3.00  
Same chassis less relay and transformer. New with sheet . . . . . 3 for \$1.00  
HOW CAN YOU GO WRONG?

### LINE FILTER

To eliminate interference from line sources. No P.O.T.s or chokes, oil condensers—100 Watts housed on chassis 2 1/2 x 2 1/2. With diagram. Packed 2 in a box. 2 for \$1.50  
HOW CAN YOU GO WRONG?

### \$28.00 VALUE EXTREMELY SENSITIVE MICROAMMETER

0-20 Microamps condensed scale. Weston 301—3 1/2" round bakelite. Now advertised price before this special sale was \$10.00—Now to close out remaining few \$5.95 in original Weston boxes. Brand new.

All Items Shipped FOB New York

## REX RADIO SUPPLY

88 CORTLANDT STREET, NEW YORK 7, N. Y., CO 7-1617

### U. S. NAVY SOUND POWER HEAD AND CHEST SET

The tiny voltages created by the sound of your voice carried for great distances (miles) over wire with no external power source. All Guaranteed Operating—Used condition.  
Fair shape . . . . . \$1.95  
Good shape . . . . . 2.95  
New or near new . . . . . 3.95  
These are currently being advertised at \$20.00.  
HOW CAN YOU GO WRONG?

### GERMANIUM CRYSTAL DIODE

General purpose—1N60—Prepared for production. 4 for \$1.00  
Worth 65¢ each. HOW CAN YOU GO WRONG?

### RETRACTABLE PHONE CORD

Worth \$4.00 each—Special. New. Over 6' long—4 conductors. . . . . 3 for \$4.00

### 4 FOR THE PRICE OF 1 ELECTROLYTIC CONDENSER—DUAL 20 MFD

450 VDC Can Plug in. Brand new. Sprague Manufacturing. 4 for \$2.25—69¢ each.

## Guest Editorial

(Continued from page 15)

formed of the crisis, and within a few hours a supply of the vital drug was enroute to Venezuela by air.

In the U.S.A. many of the hams are organized into nets which meet regularly over the air to relay messages, perhaps from servicemen overseas to their families, or from a college student to his sweetheart at home. A larger number have registered their equipment, and themselves, with their local Emergency Coordinator, as members of the Amateur Radio Emergency Corps, to be available when emergency communications are needed in their community. Some are active in the government-sponsored Radio Amateur Civil Defense Emergency Corps, a part of the Civil Defense organization. Both groups (in many places membership is simultaneous) hold regular drills, build portable self-powered equipment for public use, and develop smooth-working plans that can be put into operation on very short notice.

"Where do these people get their equipment?"

Most hams build their own transmitters, although nowadays most of them buy their receivers. The maximum power allowed is 1000 watts, but many amateurs operate with far lower power—50 or 25 watts, or even less. A useful comparison here is with photography—you can spend a few dollars for a *Brownie*, or several hundred for an elaborate camera, but under good conditions the *Brownie* can hold its own. So it is in amateur radio. One commercially-built amateur transmitter sells for \$3850.00 and another sells for \$17.31. A good operator can make contacts thousands of miles away with an inexpensive transmitter, but the fancy job is much less limited by poor conditions. Ideas of what is necessary in a transmitter vary widely, however, so the average ham builds his own, incorporating the features he wants and can afford. He may spend several hundred dollars, or less than twenty-five dollars, according to his tastes and his pocketbook.

"Are most hams radio engineers, then?"

A good many are; more than half of the hams are employed in the electronics field. Some are industry leaders, like Arthur Collins, president of *Collins Radio*, William J. Halligan, president of *Hallcrafters*, and Ross Siragusa, president of *Admiral*. But a technical radio background is not at all necessary, and people of many other occupations are also hams. Among them are

## KITS by ELECTRONIC CRAFTS

### For The Finest Equipment in Kit Form

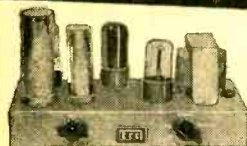

RLS

controlled by switch, same as used to turn amplifier "off."

#### Some important features:

- 117 Volts, 50-60 cycles
- Chassis made of heavy gauge steel fully enclosed, beautiful gold baked enamel hammer-tone finish
- All jacks, connections and controls clearly imprinted on chassis
- Tubes: 1/6X5, 1/6V6GT, 1/6SL7

Kit includes only matched parts, each carefully engineered for long service and peak performance. Completely wired, ready for use. . . . . **\$29.95** KIT **\$2495**

**Deduct \$5)** If your dealer doesn't have these kits in stock, send us his name & address and SAVE \$5 on the cost.



#### 5-TUBE, AC/DC SUPERHET. RADIO KIT

With step-by-step assembly and wiring instructions. Build this wonderful radio and learn the secrets of radio receivers. Complete instruction manual gives you radio theory, easy to follow directions. Fun-to-build! Includes built-in loop antenna and matched parts for maximum sensitivity and finest tone qualities.

LIST: (less cabinet) **\$19.95**

Glistening bakelite cabinet for radio. . . . . \$2.25  
We manufacture kits of all types—tell us your needs—satisfaction guaranteed—big savings assured. **SCHOOLS & COLLEGES, DISTRIBUTORS—write for special discounts.**  
Terms: F.O.B.—N.Y.C. Include 20% deposit with order, balance C.O.D. WRITE FOR FREE CATALOG.

## Electronic Crafts Co.

74 Cortlandt St. New York 7, N.Y.

REctor 2-4352

Herbert Hoover, Jr., son of the former President; Commissioner George Sterling, of the Federal Communications Commission; Tex Beneke, the well-known band leader, and his wife, Marguerite; Martin Block, famous radio personality; Freeman F. Gosden, "Amos" of "Amos 'n' Andy;" Captain Hendrik Kurt Carlsen, "Captain Stay-Put" of the "Flying Enterprise;" and even six princes of Saudi Arabia. There are storekeepers, writers, doctors, college professors, auto mechanics, policemen, executives, military men, and school children as young as seven!

"You mentioned that several industry leaders are hams. Have hams had any effect on the developments of all our modern electronic miracles?"

Yes, definitely. Radiotelephone, modern receivers, even the use of short-waves themselves were explored and developed by amateurs. The very-high and ultra-high frequencies, now used for television, FM broadcasting, air/ground voice communications, radar, and a host of other special uses were pioneered by amateurs. Speaking of radar, one of the basic circuits which made radar possible, was developed by a radio amateur back in the year 1935!

The majority of the active amateurs of this country and Canada belong to the American Radio Relay League, the clearing house for ham radio information and activities, not only in this country but world-wide. Governed by a board of directors elected by the membership, the League conducts contests, organizes message-handling circuits, develops and presents new equipment designs, coordinates emergency communications activities, and acts as headquarters society for the International Amateur Radio Union. It publishes a monthly magazine, *QST*, which is read by professional engineers as well as by hams. Its yearly *Radio Amateur's Handbook* has become the "bible" of the radio world. It publishes special booklets to help newcomers join the ranks of licensed amateurs. If you will write the Headquarters office at 38 LaSalle Road, West Hartford, Conn., it will be glad to send you background information on how to get started.

Think of it! Your own private two-way radio . . . friends in far countries . . . the thrill of helping during disasters . . . of serving your country in the Civil Defense program as a radio operator . . . of relaying a message from a homesick serviceman . . . perhaps of developing some new equipment . . . or of just talking across the state. You can be in on the fun—you, too, can be a ham! **END**

October, 1954

## Experimenters' Specials TACHOMETERS



Stewart Warner direct indicating. Supplied with two interchangeable rubber tips. 0-2000 rpm Stock #P-388 and 0-4000 rpm Stock #P-389.

Price P-388 \$6.25 ea.  
Price P-389 \$7.25 ea.



P-397  
P-398

**UNIVERSAL AC/DC MOTORS**  
115 VOLTS. DELCO No. 68008. 1/40 horsepower. 7,000 rpm loaded. Dual shaft extension. Has two hole mounting base for bench mounting. Ideal for high speed grinder-polisher in home shop. Stock #P-397.

Price \$5.00 ea.



P-396

**DELCO No. 84567**  
Identical to 68008 described above, but is 4 wire reversible. Ideal for power, high speed reversible applications. Stock #P-398.

Price \$5.50 ea.

### DELCO TYPE 5047140

1/50 horsepower motor. 7,000 rpm. Dual shaft extension. No mounting base. Ideal for hand model type grinders and polishers. Make your own hand held tool for buffing, reaming, etc. May be used for sewing machine motor conversion. Stock #P-396.

Price \$4.25 ea.

### ELECTRONIC MOTOR SPEED CONTROL KIT AND MOTOR

Industrial electronic motor speed control—1/20 hp. 1750 rpm dual shaft motor. Thyatron tube, transformer, chassis, all parts, tubes and instructions. Similar to Thyrotrol and Mototrol. Build and learn. Stock #P-1001. . . . Complete price \$49.50 each. Mercury switch—light to activate. . . . Special, four for \$2.00. Mailory D.P.D.T. momentary switch. Panel mt. . . . 3 for \$1.00. Pushbutton. . . .

Send for big catalogue of electronic, electric, hydraulic and aircraft bargains. Above prices are all F.O.B. destination for your convenience. No C.O.D. shipments. Send payment in full with order. Satisfaction guaranteed—money refunded.

*Electro Devices*

4-6 Godwin Ave.  
Paterson, N. J.  
DEPT. P-10

IT'S BIGGER AND BETTER THAN EVER!

B-A's NEW 1955

**FREE CATALOG!**

164  
PAGES

LOADED WITH  
SAVINGS AND  
NEW ITEMS  
IN RADIO,  
TV AND  
ELECTRONICS!

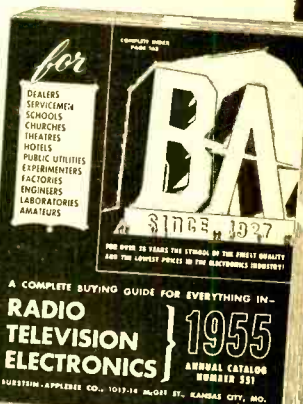

**SEND  
FOR IT  
TODAY!**

A COMPLETE BUYING GUIDE FOR EVERYTHING IN—  
**RADIO  
TELEVISION  
ELECTRONICS** } **1955**  
A BUREAU CATALOG  
NUMBER 551  
BURSTEIN-APPLEBEE CO., 1013-14 McGEE ST., KANSAS CITY, MO.

**BURSTEIN-APPLEBEE CO.**

Dept. PE, 1012-14 McGee St., Kansas City 6, Mo.  
 Send Free B-A Catalog No. 551.

Name \_\_\_\_\_  
Address \_\_\_\_\_  
City \_\_\_\_\_ State \_\_\_\_\_

# TOOLS

# & GADGETS

## ELECTRICIAN'S KNIFE

An all-purpose electrician's knife for cutting, stripping insulation, scraping wire, and performing light screwdriving is available from *Xcelite, Inc.* of Orchard Park, N. Y.

It has a breakproof handle of black, shockproof plastic. The blades are of high-grade steel, chrome plated, while the frame is steel with brass inserts. One blade is of the general purpose spear type while the screwdriver blade has scraper and cutting edges and is rigidly self-locking when open. The self-locking blade is readily closed by first depressing a spring-loaded stop.

## SMALL PARTS STORAGE BIN

Your home workshop-laboratory can have a neat and professional appearance if small parts used in your construction projects are neatly and accessibly stored. One way of being sure that you can always locate the part you want is to store such components in a cabinet such as the "Swing-Bins" offered by *Akro-Mils, Inc.*, of Akron 9, Ohio.

Each cabinet has six generous-sized drawers, 2½" wide by 1½" deep by 9½" long which swing from a sturdy bracket. Two screws mount the bracket securely to



the wall, table top, underneath shelves or bench, etc. The drawers are of crystal-clear, super-strength plastic. Dividers are furnished so that each drawer may be divided into as many as four separate compartments. Pressure-seal labels may be

fastened to each drawer. Drawers are removable for cleaning.

## PROBE-INSPECTION LIGHT

A combination tool which incorporates a mirror, plastic probe, and a flashlight has been introduced by *Moore Manufacturing Company* of Swedesboro, N. J.

When the probe is inserted the light is beamed to the probe tip which offers a flood of light at the tip end. When the mirror is slipped on the probe, an illu-

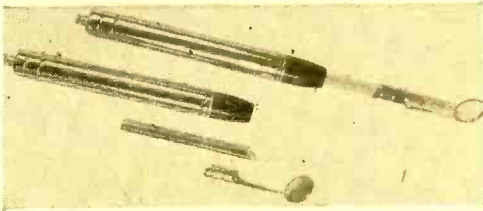

minated reflection permits inspection of tight wiring. The instrument is small enough to be carried in a pocket and light enough to be held for prolonged inspection sessions.

## TORQUE SCREWDRIVER

A torque screwdriver which may be pre-set at any desired torque between 0 and 6 inch pounds is being marketed by *Airdraulics Engineering Sales Co.* of Allendale, N. J. as its Model SD6 "Trutorq."

Once set, screws may be turned with a guaranteed tightness and an assurance that there will be no marring of screw slots or working surfaces nor will screws shear or threads strip.

This model has an aluminum handle, is 3¾" long, and weighs 5 ounces. It is designed to accommodate a standard screwdriver blade, hex bits, *Phillips* bits, a ¼" square drive, or special blades.



## HATCHET SOLDERING IRON

A 3 ounce soldering iron with miniature tips is being manufactured by *Hexacon Electric Company*, 213 W. Clay Ave., Roselle Park, N. J.

Designed for all types of electrical work, the new iron is available in two sizes: 25 watts with ⅛" tip or 30 watts with ⅜" tip. The iron operates on a.c. or d.c., any cycle, and is available in either 110 or 220 volt ratings.

## CIRCULAR SLIDE RULE

A handy laminated plastic slide rule which performs the functions of multiplication, division, proportions, finding squares

or square roots, cubes or cube roots, reciprocals and logarithms, is now available from *Allegheny Plastics, Inc.*, 96 Thorn Run Road, Coraopolis, Pa.

Complete instructions are permanently printed on the reverse side of this 8" diameter rule. These simply written instructions are intended to be easily understood by anyone having a slight knowledge of mathematics.

#### POCKET TESTER

A subminiature pocket tester that can measure voltage and perform a number of test functions is being offered by *Eby Sales Co.* of New York as its Model A1001.

Mounted in a metal case measuring 3"x4"x 1 1/4", this low-cost tester will measure a.c. and d.c. from 0 to 1000 volts, high voltage to 50 kv., will function as a signal tracer, audio oscillator, condenser tester, and a.g.c. substitution voltage supply, as a visual output meter, and a continuity tester.

The Model A1001 comes complete with operating instructions.



#### NOISE "STOPPER"

*Electronic Chemical Corp.* of Jersey City 4, N. J. is now packaging its "No Noise" in a handy spillproof, easy-to-use, 6 ounce spray can.

The can contains the company's well-known formula for cleaning, lubricating, and protecting volume controls. The product removes dirt and oxidation from contacts, eliminates scratch, hum, and noise, and offers protection against a repetition of such volume control and switch troubles in the future.

#### ELECTRONIC SOLDERING GUN

*Wen Products, Inc.* of Chicago is marketing a lightweight, high-speed soldering gun which is especially suited for all types of electronic construction work.

The new gun weighs only 1 1/2 pounds and comes up to operating temperature in just 2 1/2 seconds. It has a new type, extra-long reach and long-life tips. The gun sells in the moderate price class.



#### HANDY SOLDER DISPENSER

A one-hand-operated solder dispenser that does away with haywire coils of solder

# free!

VALUE-PACKED PAGES

308



## 1955 ALLIED TV & RADIO CATALOG

### SAVE ON EVERYTHING IN ELECTRONICS

World's Largest Stocks... Everything for Experimenters, Builders, Amateurs, Servicemen, Engineers & High Fidelity Specialists.

Send for ALLIED's big 308-page value-packed buying guide to *everything* in TV, Radio and Electronics! Largest selections of custom TV chassis, antennas and accessories; FM and AM tuners; High Fidelity systems and components; Amateur supplies; recorders and phono equipment; test instruments; builders' kits; industrial electronic supplies—plus the world's largest stocks of electronic parts, tubes, tools and books. Get *everything*—get more for your money—send today for your FREE 1955 ALLIED Electronic Supply Catalog.

**BUILDERS' KIT Headquarters**

Featuring Famous Knight Kits



ultra-modern facilities

TO SERVE YOU BEST!

Send for FREE Catalog

**ALLIED RADIO**

ALLIED RADIO CORP., Dept. 79-J-4  
100 N. Western Ave., Chicago 80, Ill.

Rush FREE 1955 ALLIED 308-Page Catalog

Name \_\_\_\_\_

Address \_\_\_\_\_

City \_\_\_\_\_ Zone \_\_\_\_\_ State \_\_\_\_\_

# ORDER BY MAIL AND SAVE!!!

**DUMONT 3GP1 CATHODE RAY TUBES**  
\$1.79-3 for \$5

With schematic so you can build your own scope. Same as used in Dumont 224A scope.

**ARC-4 VHF TRANSCIEVER** with schematic **\$24.50**

For 2-meter CD or CAP including tubes, less dynamotor & xtals.

**CERAMIC CONDENSERS**  
Kit of 100 ..... **\$1** ppd.

With condenser chart, Asst. std. brands. \$10 value.

**APS 13 Makes a Complete 420 MC Radiophone**

When converted with our schematics. Range in most cases equal to 2 meters. Fine for communications, ranches, farms, etc. Complete with RF sections, conversion booklet and 30 MC I.F. strip, less tubes, dynamotor and minor parts not needed for conversion. **\$14.95** value. Shipping wt. 13 lbs.



- T-21/ARC-5 5.3-7 MC XMTR ..... \$6.95
- R-27/ARC-5 6-9.1 MC RCVR ..... 6.95
- 24V FILAMENT TRANSFORMER FOR ABOVE ..... 1.49
- COMMAND SET TUNING KNOBS FOR ABOVE ..... .59

**SIGNAL CORPS TELEPHONES**  
Complete with batteries and aluminum case. Powerful, long range—makes a terrific phone patch. PAIR **\$14.95**

**WESTERN ELECTRIC HANDSET** with F-1 unit and cord. For mobile & home phone systems. **\$2.95**

**TELESCOPIC ANTENNA** 7' long, 11 sections for portable or mobile use. **95c**  
New each

**TV TUNERS**. Standard coil. CVC code with 6BQ7, 6J6. **\$13.95**  
Brand new

1000's of Items Not Listed  
Write for FREE CATALOG!

**24 V. TRANSFORMER & RECTIFIER COMB.**

Worth At Least \$8.95! **\$2.95**

A basic 24 V. DC power supply consisting of 110 V. AC primary, 24 V. secondary, and a Rectox Rectifier. Will operate intermittently up to 3 or 4 amps. Xint for operating DC relays, command equipment, model railroad accessories, etc.

Please send check or MO with orders (no COD'S please—credit to rated firms only).

**Harjo Sales Co.**

Dept. PE, 4109 Burbank Blvd., Burbank, Calif.  
Phone: Victoria 9-2411  
Retail Showroom Open 'Til 9 P.M. Fridays

is now being offered by **CBS-Hytron** through its regular distributor channels.

The operator's thumb on the knurled wheel of the solder dispenser feeds solder and retracts it neatly when the job is done—without waste or fuss. Holding 72 inches



of solder, the dispenser is compact, light, convenient, and pencil-like with a handy pocket clip. The dispenser comes ready to use, loaded with 20 refills. Additional dispenser refills, 80 lengths of solder, are also available, packaged in plastic cases.

## WORKSHOP SANDER

A sander-polisher that incorporates a unique, new-type, small motor which runs quieter, smoother, and cooler and with a minimum of vibration is now available from **Wen Products, Inc.** of Chicago.

The Model No. 303 can be plugged into

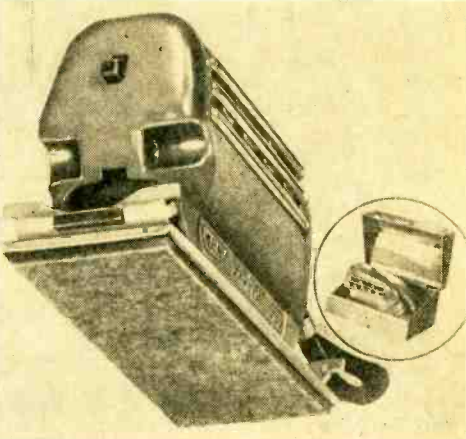

ordinary 110-120 volt a.c., 60 cycle lines. It delivers 14,400 strokes per minute. The throw is approximately 1/8" under load and the working area is 1 3/4 square inches. The unit weighs only 2 1/2 pounds so it can be used on vertical and overhead work as well as the usual bench projects.

The complete kit includes a storage box, six sheets each of assorted garnet and aluminum oxide papers, two fine polishing cloths, plus the sander-polisher. **END**

**GO PLACES**

LEARN ANOTHER  
**LANGUAGE**  
EASILY - QUICKLY  
by **LINGUAPHONE** **IN 20 MINUTES A DAY**

World's-Standard CONVERSATIONAL METHOD

Are interesting job, travel, cultural, armed services' opportunities passing you by because you speak only one tongue?

Learn AT HOME the same natural, easy way you learned English as a young child. **YOU LISTEN—you hear native men and women speak—you understand—YOU SPEAK.** Over a million home-study students of all ages. **FREE BOOK, "Passport to a New World of Opportunity,"** gives facts. **WRITE TODAY!**

**LINGUAPHONE INSTITUTE**  
—any of 29 Languages **8910 RCA Building New York 20, N. Y.**

# PARTS

Xfmr, rectifier, 120 v 60 cys pri, 9, 10, 11, 12, or 13 v @ 1.6 amps sec.	\$2.50
Selenium for above, 1 amp	2.00
Both units, ideal for Batt. Charger	4.00
Willard 6 V storage Batt. 20 Amp hrs. New, dry charged. In wooden carrying case, (less electrolyte).	4.00
Timer. Switch opens after Pre-set time, adj up to 4 hrs. 10 amp 125 v contacts.	3.00
Relay, Advance #1605 DPST 5VDC	1.00
6 V Vibrator xfmr, 460 v out @ 150 ma with 6 volt vibrator—both	3.00
Selenium bridge rectifier 36 v rms @ 140 ma.	2.00
Coke 1 hy 100 ma 82 ohm. Cased.	2.00

ALL ORDERS F.O.B. LA. 25% DEPOSIT, BAL. C.O.D. MONEY BACK GUARANTEE.

**DRILLICK ELECTRONIC SALES CO.**  
5279 W. PICO BLVD. L. A. 19, CALIF.  
Webster 1-9202

# NEW AIRBORNE RADAR SYSTEM

**A** NEW technique of "scope" presentation now enables an airline pilot to see the position, intensity, and scope of an approaching storm. The special "Iso-Echo" circuitry of Bendix's new RDR-1 radar unit will outline a storm center with its high precipitation and winds as well as its outer edges of lesser turbulence. In a region of great weather activity the radarscope will depict a series of dark centers surrounded by light rings.

This new radar unit, designed primarily for commercial airliners, has a nose-mounted, gyro-stabilized antenna which utilizes a pencil beam to scan an angle up to 120 degrees on either side of an aircraft's heading, depending on the configuration of the plane's leading edges.

Maximum range of the radar sweep is 150 miles. A switch on the indicator permits the display of ranges 0-20, 0-50, or 0-150 miles. The special range markers provide calibration at 5, 10, and 25 mile intervals respectively. An antenna tilt control provides adjustment of the beam elevation angle over a 30 degree range.

An additional feature of the unit is a special switch on the control panel which permits the operation of the unit in conjunction with the airport's ground radar beacon "Racon System," thus providing an added safety factor. When the beam is directed downward, ground mapping is also available to the pilot. **END**

The new Bendix RDR-1 radar unit in operation. By means of this device, pilots can detect range, scope of storms ahead.



October, 1954

the TV world is yours with

## WARD TV ANTENNAS

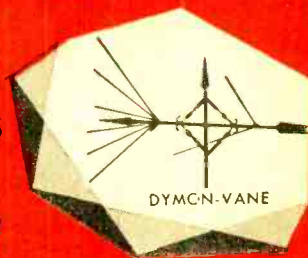

## WARD ANTENNA RAMA

Only Ward presents such an outstanding array of precision-engineered TV antennas. Among them is "Dymcn-Vane", the first to combine distinguished beauty with superb reception. Consult your local TV dealer about WARD antennas or mail coupon below.

**WARD PRODUCTS CORP.**  
**DIV. OF THE GABRIEL CO.**

1148 Euclid Avenue, Cleveland 15, Ohio

WARD PRODUCTS CORP., DIV. THE GABRIEL CO.  
Dept. PE 1054, 1148 Euclid Avenue, Cleveland 15, Ohio  
Send me free additional information on  
Ward's complete line of TV antennas.

Name \_\_\_\_\_  
Address \_\_\_\_\_  
City \_\_\_\_\_ State \_\_\_\_\_

# Learn ELECTRIC APPLIANCE REPAIR IN YOUR SPARE TIME AT HOME



**ONE  
BUSINESS  
THAT IS  
NOT AFFECTED  
by  
STRIKES,  
DEPRESSIONS OR  
POLITICS**

**OWN BUSINESS**  
**WITH A POTENTIAL MARKET**  
**OF 50,000,000 CUSTOMERS**

New shop-method, home-training system gives you electrical know-how that used to take years to learn. Learn at home by building valuable testing kits, repairing your own and neighbors' appliances. It is not unusual for appliance repairmen to charge on the basis of \$5.00-\$6.00 an hour.

**FREE ILLUSTRATED BOOK**  
Shows you how you learn every phase of electrical appliance. How to make money while you learn. Write today for your **FREE** copy.

**CHRISTY TRADES SCHOOL**

Dept. D-132  
4804 North Kedzie Ave., Chicago 25

# AFTER CLASS

## Series and Parallel Operation of Resistors

AS ITS name implies, a resistor is a component which *resists* or *limits* the flow of electric current. The greater the resistance, the greater the limiting effect and the smaller the current flow. To accurately designate the value of a resistor requires a unit of measurement. This unit is the "ohm." One ohm is the amount of resistance which will limit the current flow to one ampere when one volt is applied. A kilohm (designated "K") is equal to 1000 ohms while a megohm ("M") is equal to one-million ohms. A 5M resistor, then, is equal to 5000K or 5,000,000 ohms.

The two most popular types of resistors are the carbon and the wire-wound. Of these, the carbon is used more often because it generally can be made smaller for a given ohmic value and can be manufactured at a lower cost. The carbon is usually in the form of a rod which is encased in an insulating material. A lead at each end makes contact with the carbon rod. A wire-wound resistor, on the other hand, consists of a length of wire, having the required resistance, wound on an insulating form.

The value of a resistor changes with a change in temperature. The direction of this change depends on the type of resistor. The carbon resistor has a "negative coefficient," that is, its resistance will *decrease* as the temperature is raised. The wire-wound resistor has a "positive coefficient." Its resistance *increases* with an increase of temperature.

When any number of resistors are connected in series, the total resistance of the combination is equal to the sum of the individual resistor values. For example, a series circuit made up of one each of 100, 500, 1000, and 3000 ohm resistors will have a total resistance of 4600 ohms. This relationship is usually expressed as a formula:  $R_t = R_1 + R_2 + R_3$ , etc.

When two resistors are connected in parallel, the total resistance is less than the value of the smaller resistor. If the two resistors are equal in value, the total will be one-half of this value. When the two resistors are not equal in value, the total may be found by the formula:

$$R_t = \frac{R_1 R_2}{R_1 + R_2}$$

As an example, a 70 ohm resistor is connected in parallel with a 30 ohm resistor. The total resistance of this combination is calculated as follows:

$$R_t = \frac{R_1 R_2}{R_1 + R_2} = \frac{70 \times 30}{70 + 30} = \frac{2100}{100} = 21 \text{ ohms}$$

When three or more resistors are connected in parallel, the total resistance may be found by using the formula:

$$R_t = \frac{1}{\frac{1}{R_1} + \frac{1}{R_2} + \frac{1}{R_3} + \text{etc.}}$$

The following quiz is intended as a self-check. You should be able to answer all the questions correctly if you have analyzed the foregoing text correctly. The answers appear on page 127.

1. A 2500 ohm resistor is equal to:  
a. 2.5 M; b. 250 K; c. 2.5 K; d. .025 M
2. A resistor is to be constructed from a wire having a resistance of 5 ohms per inch of length. What length of wire should be used if the desired resistance is 300 ohms?  
a. 1500 inches; b. 60 inches; c. 800 inches; d. 300 inches
3. If the temperature of a carbon resistor decreases, the resistance will:  
a. increase; b. decrease; c. remain the same
4. If two 270 ohm resistors are connected in series, the total resistance will be:  
a. 135 ohms; b. 540 ohms; c. 270 ohms; d. 72,900 ohms
5. If a 40 ohm resistor is connected in parallel with a 60 ohm resistor, the total resistance will be:  
a. 24 ohms; b. 100 ohms; c. 2400 ohms; d. 20 ohms

## ELECTRONIC "TRAFFIC CONTROL"

THE familiar road signs that say "Trucks Keep Right" and "Through Traffic Keep Left" have a close parallel in electronics except, of course, that it is not done with signs.

High-fidelity audio systems use at least two loudspeakers, sometimes more. In a two-speaker system, a large reproducer, called the "woofer" is supposed to handle the low-frequency audio components of the sound while a smaller unit, the "tweeter," is responsible for the reproduction of the shriller tones. To realize the greatest degree of faithfulness, the lows must be kept away from the tweeter and, likewise,



the highs must be prevented from reaching the woofer. This is where the need for "traffic control" arises. The controlling components comprise a so-called crossover network, a rather elegant name for a simple combination of parts.

There are just about as many crossover network circuits as there are audio engineers; each designer has his own pet arrangement which he feels does a thorough job. For the simplest circuit of all, use is made of the basic properties of a single capacitor and a single inductor. A capacitor offers little opposition (low reactance) to high frequencies but tends to buck the passage of low frequencies; an inductor, on the other hand, encourages the flow of

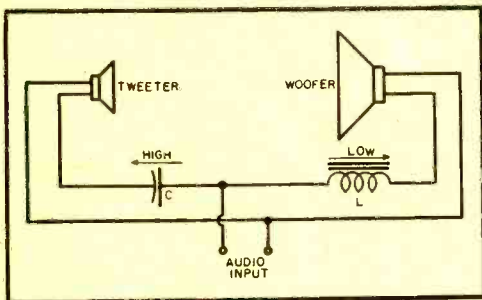

low frequency currents while it tends to attenuate the higher frequencies.

The circuit shown in the diagram is a fundamental one and, if the component values are correctly chosen, will control both the high and low "traffic" satisfactorily. Commercial crossover networks are generally more complex since they are designed to match the specific speakers used in the audio system.

Typical examples of component values include a capacitance of 100 microfarads and inductance of 300 microhenrys for a crossover network at 1000 cycles. If, however, the crossover frequency is to be at 5000 cycles, the component values must be changed accordingly and, in this case, the capacitor would have to be 20 microfarads while the inductance,  $L$  in the diagram, would become 500 microhenrys.

### "UN-VACUUM" TUBES

MUCH of our current technical literature creates the false impression that there is some subtle difference between radio tubes, television tubes, vacuum tubes, and industrial tubes. To be sure, certain differences do exist yet all of these tubes may properly be lumped in a single category—they are all vacuum tubes.

The term "vacuum tube", when applied to all electron tubes, is definitely erroneous because many small types that look

October, 1954

# 8 MASTERPIECES

LONG-PLAYING 33 1/3 R.P.M. HIGH-FIDELITY

No Strings Attached! Without obligating yourself to buy another record, you can enjoy all advantages of trial membership.

**\$1.00**

Long  
Playing

ALL 8 masterpieces for only \$1. Performed by world-famous artists. Custom-recorded on purest vinyl. Reproduced with a tonal fidelity encompassing the entire range of human hearing (50 to 15,000 cycles.) This amazing offer is made only to demonstrate superb quality of our recordings; and to show you advantages of trial membership.

**HOW CLUB OPERATES:** As a trial member, you are not obligated to ever buy another record from us. You do, however, have the right to try—free of charge—any of the Society's monthly selections which interest you. You receive prior notice of these. You pay nothing in advance. And you are not obligated to keep those you try . . . even after you have played them and read the interesting music notes which accompany each selection. You pay only for those which—after having tried them—you decide you really want to own. And for these, you pay only the low member's price of \$1.50 per long-playing disc, embodying on the average about 40 minutes of music by the great masters. A saving of about 2/3 off the usual retail price! This "give-away" offer can obviously not be kept open indefinitely. **MAIL COUPON NOW** while supply lasts. Full money-back guarantee. *The Musical Masterpiece Society, Inc., Dept. 6010, 43 West 61st Street, New York 23, N. Y.*

Not \$1 each, but \$1 for all 8!

#### SCHUBERT

Symphony No. 8  
("Unfinished")  
Zurich Tonhalle Orch.  
Otto Ackermann, Cond.

#### BETHOVEN

The Ruins of Athens  
(March and Choir)  
Netherlands Phil.  
Walter Goehr, Cond.

#### BRAHMS

Academic Festival  
Overture  
Utrecht Symphony  
Paul Hupperts, Cond.

#### MOZART

Piano Concerto in E Flat.  
Artur Balsam, piano,  
Winterthur Symphony  
Otto Ackermann, Cond.

#### BACH

Tocatta and Fugue in  
D Minor  
A. Schreiner; Organ of  
the Tabernacle,  
Salt Lake City

#### WAGNER

Die Meistersinger,  
Prelude, Act 1  
Zurich Tonhalle Orch.  
Otto Ackermann, Cond.

#### DUKAS

Sorcerer's Apprentice  
Utrecht Symphony  
Paul Hupperts, Cond.

#### MOUSSORGSKY

Night on Bald Mountain  
Netherlands Phil.  
Walter Goehr, Cond.

**FREE "Music in Your Home"**  
by Olin Downes

Mail coupon at once to receive. **FREE**, fascinating brochure by dean of American music critics. A guide to the valuable program notes and musical annotations which come free with every selection.



**The Musical Masterpiece Society, Inc., Dept. 6010  
43 West 61st Street, New York 23, N. Y.**

Enclosed is \$1 in full payment for the recordings of 8 masterpieces listed. Enroll me as trial member. Privileges: No purchase obligation ever! Advance notice of releases. 5 day free trial on any discs. I may reject records before or after receipt; may cancel membership at any time. For future I.P. discs I keep, I'll pay only \$1.50 each plus shipping.

Name . . . . .

Address . . . . .

City . . . . . State . . . . .

Canada, address: 686 Bathurst St., Toronto 4, Ont.

**START YOUR HI-FI  
RIGHT!**

**Karlson Handyman  
KIT**

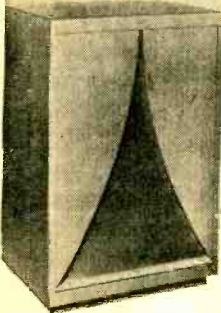

**WITH  
KARLSON  
ULTRA-FIDELITY  
ENCLOSURES**

The performance of a speaker, like a violin, largely depends upon the cabinet.

The Ultra-Fidelity Karlson is completely NEW and has amazed thousands at every audio show. "A new standard of performance," ... "un-surpassed" ... HI-FI Manual. Send today for information on this exciting new scientific discovery.

Available in kit or finished form from \$45 to \$117.60

If not yet available from your Hi-Fi dealer, order direct

Immediate Delivery

**only \$45.00**

51 Intricately cut pieces  
... 3/4" plywood ...  
34 1/2" x 22 1/2" x 18" overall.

Send for  
Complete Literature

**KARLSON ASSOCIATES, INC.**

DEPT. M

1483 Coney Island Ave., Brooklyn 30, N. Y.

## HEAVY-DUTY TOWERS

**USED TO HOLD T.V. ANTENNAS  
FLOODLIGHTS, SIGNS, ETC.**

10 Foot Section Only \$13.95  
(Top 10 Foot Same Price)

Includes All Hardware

Made of high tensile .065 gauge 1 1/4 in. O.D. tubular steel.

Wash primed and vinyl aluminum-coated salt spray resistant.

Self supporting to 50 ft.

Adjustable house brace.....\$4.95

Heavy duty top mast—10 ft. ....\$3.98

Special Prices on T.V. Antennas

\$19.95 Dbl. Aluminum Lazy X...\$9.95

**FINCO** 400A—UHF-VHF ....\$32.50

400SA—UHF-VHF ....\$39.95

5 Element (2-13) Dbl. Phoenix Inline...\$14.95

\$48.95 Heavy Duty TR4 Rotor.....\$34.50

Rotor cable (4 cond.)—5c ft. for above rotor

300 ohm UHF-VHF Tubular Leadin.. 4 1/2 c ft.

Write for circular. All price F.O.B. You pay delivery charges. All C.O.D. orders must have 25% deposit.

**RICHVILLE T.V. SUPPLY**

5666 NAVARRE RD., R. D. 1, CANTON, OHIO

very much like the ones you find in a radio or television set are intentionally filled with gas after the air has been pumped out. Adding a gas like neon or argon produces startling effects under certain conditions, many of which are extremely useful.

In diagram form, a thyratron, for example, appears to be the same as any other triode or tetrode except for the presence of a black dot just inside the circle that represents the glass envelope. This dot means that gas has been purposely introduced during manufacture to obtain certain desirable characteristics. In an ordinary triode, the control grid exercises a smooth, gradual influence on the plate current, causing the latter to rise and fall as its voltage changes. But when gas is present in the proper quantity, the control grid prevents any plate current from flowing as long as it is negative enough, but once plate current does begin to flow, the grid loses all control and cannot affect the electron stream from cathode-to-plate irrespective of its "negativeness". This "all or nothing" behavior of a thyratron makes it very useful in applications where sudden, heavy surges of plate current are wanted.

But how does one stop the flow of plate current when it is no longer desired? Removal of plate voltage does the trick, then the tube is ready to act once again. When employed in this manner, thyratrons make admirable relay tubes because the quick rise of plate current from zero to some relatively high value is just what's needed to operate a relay without chatter.

Other gas-filled electron tubes now finding wide application are: voltage regulators used to maintain power supply output voltages at some predetermined fixed level; mercury vapor rectifiers in high voltage power supplies, often preferred because of their smaller internal voltage drop; and stroboscopy, comparative newcomers to electronics, used to produce short-lived flashes of light of sufficient intensity to be used in commercial stroboscopes, instruments which make moving machinery appear to stand still.

## TUBE TERMINOLOGY

**T**WO terms often used in vacuum tube discussions are "thermionic emission" and "unilateral conductivity".

When materials are heated, the free electrons in the materials move faster. If the temperature is raised sufficiently, some of the electrons acquire sufficient velocity to overcome the "surface barrier" and fly off the surface. It is this release of electrons which is known as "thermionic emission".

When a positive voltage is applied to the plate of the tube it will attract the electrons given off by the cathode. By basic law, unlike charges attract. If, however, a negative voltage is applied to the plate, it will repel the electrons back toward the cathode—like charges repel.

This action is shown in the diagram. When the polarity of the a.c. line voltage is as shown in Fig. A, the plate of the tube is positive and electrons flow as indicated by the arrows. When the line voltage reverses, Fig. B, the plate is negative and no electrons flow.

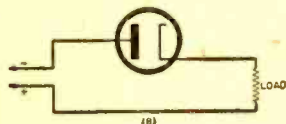
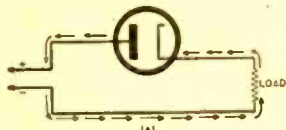

Thus the tube acts as a one-way valve and current flows in one direction but not the other. This property of a tube is known as "unilateral conductivity". . . . . E.B.

### CAPACITOR ACTION

ONE of the questions most frequently asked by the radio student is how can current flow through a capacitor when one of the essential parts of this component is its insulator or "dielectric".

Actually, current *doesn't* flow through the dielectric but flows through the wires leading to and from the capacitor.

We all know that for every complete cycle of alternating current there are two half cycles. During the half cycle when the polarity of the voltage is as shown in Fig. A, electrons flow from the negative power line to the lower plate of the capacitor. Since they cannot pass through the dielectric, they pile up on the lower plate.

At the same time, the positive power line attracts electrons from the upper plate of the capacitor. Note that the electrons move



through the wires even though they do not pass through the dielectric. When the polarity of the power line reverses (Fig. B) the electrons reverse themselves and flow in the opposite direction as indicated by the arrows. Electrons now accumulate on the upper plate of the capacitor. As long as the polarity of the power line keeps reversing,

# BUILD 15 RADIOS

AT HOME ONLY

With the New Improved 1955 Progressive Radio "EDU-KIT" **\$19.95**

NOW INCLUDES

HIGH FIDELITY, SIGNAL TRACER, CODE OSCILLATOR



- Attractively Gift Packed
- Free Soldering Iron
- Absolutely No Knowledge of Radio Necessary
- No Additional Parts Needed
- Excellent Background For Television
- 10-Day Money-Back Guarantee
- School Inquiries Invited
- Sold in 79 Countries

### WHAT THE PROGRESSIVE RADIO "EDU-KIT" OFFERS YOU

The Edu-Kit offers you a Home Radio Technician Course at a rock-bottom price. You will learn how to identify Radio Symbols and Diagrams; how to build radios, using regular radio schematics; how to wire and solder in a professional manner. You will learn how to operate Receivers, Transmitters, and Audio Amplifiers. You will learn how to service and trouble-shoot radios. You will learn code. You will receive training for F.C.C. license. In brief, you will receive a practical basic education in Radio, worth many times the small price you pay.

#### THE KIT FOR EVERYONE

It is not necessary that you have even the slightest background in science or radio. The "Edu-Kit" is used by young and old; by radio schools and clubs; by Armed Forces personnel and Veterans for training and rehabilitation. No instructor is required. Instructions are complete, simple and clear. You cannot make a mistake.

#### PROGRESSIVE TEACHING METHOD

The "Edu-Kit" uses the principle of "Learn by Doing." Therefore you will build radios, perform jobs, and conduct experiments to illustrate the principles which you learn. You begin by learning the function and theory of each of the radio parts. Then you build a simple radio. Gradually, in a progressive manner, you will find yourself constructing more advanced multi-tube radio sets, and doing work like a professional Radio Technician. The "Edu-Kit" now contains lessons for servicing with the Progressive Signal Tracer, F. C. C. instructions, quizzes. The "Edu-Kit" is a complete radio course down to the smallest detail.

#### The Progressive Radio "EDU-KIT" Is Complete

You will receive every part necessary to build fifteen different radio sets. Our kits contain tubes, tube sockets, chassis, variable condensers, electrolytic condensers, mica condensers, paper condensers, resistors, line cords, selenium rectifiers, tie strips, coils, hardware, tubing, Instruction Manuals, etc. A soldering iron is included, as well as an Electrical and Radio Tester. Complete, easy-to-follow instructions are provided. In addition, the "Edu-Kit" now contains lessons for servicing with the Progressive Signal Tracer, F. C. C. instructions, quizzes. The "Edu-Kit" is a complete radio course down to the smallest detail.

#### TROUBLE-SHOOTING LESSONS

Trouble-shooting and servicing are included. You will be taught to recognize and repair troubles. You will build and learn to operate a professional Signal Tracer. You receive an Electrical and Radio Tester, and learn to use it for radio repairs. While you are learning in this practical way, you will be able to do many a repair job for your neighbors and friends and charge fees which will far exceed the cost of the "Edu-Kit." Our Consultation Service will help you with any technical problems which you may have.

#### FREE EXTRAS

- Electrical & Radio Tester • Electric Soldering Iron • TV Book
- Radio Trouble-Shooting Guide • Consultation Service • Quizzes
- F. C. C. Training

#### PROGRESSIVE "EDU-KITS" INC.

497 Union Ave., Dept. PE-501, Brooklyn 11, N. Y.  
MAIL TODAY—Order shipped same day received.  
10-Day Money-Back Guarantee. INCLUDE ALL FREE EXTRAS.

- RUSH ME the following—Include all Free Extras:
- "EDU-KIT" Postpaid. I enclose full payment of \$19.95
  - "EDU-KIT" COD—I will pay \$19.95 plus postage
  - Outside USA: "Edu-Kit" Postpaid. Enclose full payment \$20.95
  - Outside USA: 210-250V. AC/DC Adapter. Enclose \$2.50
  - More details on "EDU-KIT" Free—No Obligation
  - FREE Radio-TV Servicing Literature. No Obligation

NAME \_\_\_\_\_  
ADDRESS \_\_\_\_\_

#### PROGRESSIVE "EDU-KITS" INC.

497 Union Ave. Dept. PE-501 Brooklyn 11, N. Y.

**The New Model 70 UTILITY TESTER  
FOR REPAIRING ALL  
ELECTRICAL APPLIANCES  
MOTORS • AUTOMOBILES • TV TUBES**

As an electrical trouble shooter the Model 70:

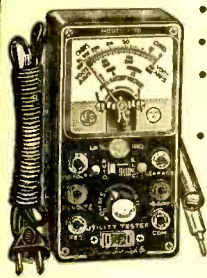

- Measures A.C. and D.C. Voltages, A.C. and D.C. Current, Resistances, Leakage, etc.
- Will measure current consumption *while the appliance under test is in operation.*
- Incorporates a sensitive direct-reading resistance range which will measure all resistances commonly used in electrical appliances, motors, etc.
- Leakage detecting circuit will indicate continuity from zero ohms to 5 megohms (5,000,000 ohms).
- Will test toasters, toasts, Broilers, Heating Pads, Clocks, Fans, Vacuum Cleaners, Refrigerators, Lamps, Fluorescents, Fans, Switches, Thermostats, etc.
- Will test all TV tubes for open filaments, inter-element shorts, burned out tubes, etc.

As an Automotive Tester the Model 70 will test:

- Both 6 Volt and 12 Volt Storage Batteries
- Generators
- Starters
- Distributors
- Ignition Coils
- Regulators
- Relays
- Circuit Breakers
- Cigarette Lighters
- Stop Lights
- Condensers
- Directional Signal Systems
- All Lamps and Bulbs
- Fuses
- Heating Systems
- Horns
- Also will locate poor grounds, breaks in wiring, poor connections, etc.

Handsome round-cornered molded bakelite case, 3 1/8" x 5 7/8" x 2 1/4". Complete with all test leads. Also included is a 64 page book giving detailed instructions for testing all electrical appliances, automotive equipment, TV tubes, etc. Only **15 85**

**SHIPPED ON APPROVAL  
NO MONEY WITH ORDER — NO C. O. D.**

Try it for 10 days before you buy. If completely satisfied then send \$3.85 and pay balance at rate of \$4.00 per month for 3 months — No Interest or Carrying Charges Added. If not completely satisfied, return to us, no explanation necessary.

MOSS ELECTRONIC DIST. CO., Dept. D-72  
3849 Tenth Ave., New York 34, N. Y.

Please rush Model 70 if agree to pay \$3.85 within 10 days after receipt and \$4.00 per month thereafter.

Name \_\_\_\_\_  
Address \_\_\_\_\_  
City \_\_\_\_\_ Zone \_\_\_\_\_ State \_\_\_\_\_

**SUPER POCKET RADIO**

Smaller than many hearing aids. Powerful, portable and can be assembled by anyone in one hour. Uses two inexpensive cells that fit within case. Owners report 1,500 mile reception. No antenna or ground required for local use. Complete kit of hearing-aid parts only



**\$3.99 POST-PAID**

\$3.99. Batteries extra at \$1.45. Use any regular headphone with Micro or tiny hearing-aid earset, shown in photo, available from us at low cost. Micro is guaranteed to please or return in 10 days for full refund.

SEND ONLY \$1.00  
BALANCE C.O.D.

**TRANSI-MITE RADIO LAB**

MANTEO (1) NO. CAR.

current will flow through the circuit, first in one direction—then the other.

This is how alternating current flows in a circuit even when a capacitor is used.

E. B.

**HOW SMART ARE YOU?**

This quiz will test your knowledge of vacuum tubes. Each correct answer is worth 10 points. A score of 60 or less—poor, 70—fair, 80—good, 90—very good. 100—excellent. (Answers on page 127)

1. If the bias of a variable mu tube is increased, the gain will:
  - a. increase; b. decrease
  - c. remain the same
2. In a tetrode, the grid closest to the plate is a:
  - a. suppressor grid
  - b. screen grid
  - c. control grid
3. The transconductance of a tube is the ratio of:
  - a. change of plate voltage to change of grid voltage
  - b. change of plate voltage to change of plate current
  - c. change of plate current to change of grid voltage
4. A class C amplifier is biased:
  - a. at cut-off; b. beyond cut-off
  - c. at saturation
5. A pentode has:
  - a. one grid; b. two grids
  - c. three grids
6. The purpose of a screen grid is to:
  - a. decrease capacity between control grid and plate
  - b. increase capacity between control grid and plate
  - c. attract electrons and thereby reduce plate current
7. If the first stage of a two-stage amplifier has a voltage gain of 20 and the second stage a voltage gain of 10, the total voltage gain is:
  - a. 200; b. 30
8. In the type designation 5U4G, the letter G indicates:
  - a. gas-filled tube
  - b. glass envelope
  - c. grid-cap type construction
9. What value of cathode resistor should be used to bias a triode if the required bias is 5 volts and the plate current is 4 ma.?
  - a. 20,000 ohms; b. 800 ohms
  - c. 1250 ohms
10. If a negative voltage is applied to the grid of tube in diagram right, the plate voltage will:
  - a. increase; b. decrease
  - c. remain the same

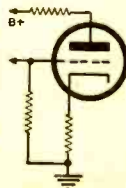

## MULTICHANNEL R/C WINS MEET

**M**ULTICHANNEL radio control came out so far ahead of single channel at the 1954 National Model Airplane Contest at Chicago recently that talk is that at the next meet the two will not compete against each other as they have up until now. The first four places in the radio control events of the meet were taken by multichannel jobs.

This year's meet, held at the Glenview Naval Air Station in Chicago during the week of July 25, saw first place in the R/C event going to Alex Schneider of California, using *Rockwood* multichannel control in a 7-foot "Piper Cub" model. Second place was captured by Howard Bonner, also of California, who used his own 2-channel radio control with a compound escapement. The model was a *Beam* kit. George Swank of Buffalo used a 5-channel *Schmidt* control in a "Super Buccaneer" model airplane to take third place in the Nationals.

### COMING NEXT MONTH POPULAR ELECTRONICS

How Television Works

How to Use an Oscilloscope

Learning the Code

Hints on Reading Diagrams

An Easily-Built Black Light Source

Photoelectric Control

Plus More On

High-Fidelity Audio • Kits • Radio

Control • Short-Wave Listening •

What's New • How it Works • How to

Make It • How to Use It • Carl and Jerry

### IN THIS MONTH'S RADIO & TELEVISION NEWS

(October)

A Regenerative Short-Wave Receiver

A Low-Powered Phono Amplifier

Fundamentals of Color TV

The "Mark 12"

Economy Model TV Sets

A Photoelectric Contrast Control

Economy Model Grid Dipper

A Tone-Compensating Preamp

Two-Tube Square-Wave Generator

"Bootstrap" Interval Timer

Communication Set—The Easy Way

How Good Are Your TV Installations?

# RIDER BOOKS MAKE ELECTRONICS EASY!...

## RADAR, WHAT IT IS

Complete, non-technical explanation of radar . . . what it is, how it works, how it's used. Covers types of gear used by ground, sea, and air forces. Illustrated. 8 1/2" x 11", soft cover, only \$1.00.

## HOW TO USE METERS

Explains everything about using all kinds of meters! Shows what to use, how to use it, where to use it! For everyone interested in electronics, this book is a must! 160 (5 1/2" x 8 1/2") pages, soft cover, only \$2.40.

## HIGH FIDELITY SIMPLIFIED

The complete Hi Fi story! How to get concert hall reception in your own home! Answers all questions about Hi Fi tuners, amplifiers, speakers, tape recorders, record players and changers. 224 (5 1/2" x 8 1/2") pages, soft cover, only \$2.50.

## GUIDE TO AUDIO REPRODUCTION

Covers design, construction, assembly, and testing of sound reproduction systems, and includes circuits for home construction of these units. Explains circuitry of pre-amps and amplifiers, pick-up devices, loud speakers and enclosures. 250 (5 1/2" x 8 1/2") pages, soft cover, only \$3.50.

## HOW TO TROUBLESHOOT A TV RECEIVER

A step-by-step guide to systematic troubleshooting. Tells how to service your own set quickly, easily, economically! 128 (5 1/2" x 8 1/2") pages, soft cover, only \$1.80.

## FUNDAMENTALS OF TRANSISTORS

An expert explains, in easy-to-understand terms, the basis operation, characteristics, and performance of transistors. This book is for every hobbyist, student, experimenter! 144 (5 1/2" x 8 1/2") pages, soft cover, only \$2.70.

## HOW TO SERVICE TAPE RECORDERS

Everything you need to know about what's inside a tape recorder . . . recording heads, drive mechanisms, circuits. Practical suggestions for troubleshooting. 176 (5 1/2" x 8 1/2") pages, soft cover, only \$2.90.

## TV AND ELECTRONICS AS A CAREER

Written by 5 prominent electronics experts, this book is crammed full of solid facts about the field . . . what the different jobs are, what training each one requires, what salaries they pay, how to get the job. If you're thinking about a career in TV and electronics, you **MUST** read this book! 5 1/2" x 8 1/2", cloth bound only \$2.50.

Write for free catalog

All Rider books are available through electronics parts jobbers and book stores throughout the country. If unavailable in your area, write to:

**JOHN F. RIDER PUBLISHER, INC.**  
480 Canal Street, New York 13, N. Y.

## MINIATURE RADIO

1000 mils reception. Regenerative circuit covers 540 to 1600 KC. All parts, hearing aid batteries, fit in case. FULLY GUARANTEED. PRECISION BUILT PARTS AND TUBE. Kit includes photodiagram for easy assembling. Batteries \$1.15 per set. Uses any radio earphone. BARGAIN DIAL. Regular \$2.50. ALNICO MAGNET EARPHONE at only \$1.45. SUPER DEAL. 1900 OHM MINIATURE HEARING AID, PHONE CORD AND EARMOULD INCLUDED (\$10.00 VALUE) at \$4.95 - you can't beat these prices! Enclose \$1.00 if C.O.D. order.



**\$599**

postpaid  
Factory assembled  
(set only) \$8.95

PRECISION ELECTRONICS, Dept. 4, Placerville, Calif.

## SCIENTIFIC CRIME DETECTION



There's a Thrill in Bringing a Crook to Justice.

A Steady Pay Profession Good Times or Bad.

We have taught thousands this exciting, profitable, pleasant profession. Let us

teach you, too, in your own home. Learn

Finger Printing, Firearms Identification, Police Photography and Criminal Investigation thoroughly, quickly and at small cost.

Over 800 of All U. S. Bureaus

of Identification employ students or graduates of I. A. S. You, too, can fit yourself to fill a responsible crime detection job with good pay and steady employment. But don't delay - get the details now. Let us show you how easily and completely I can

prepare you for this fascinating work, during spare time, in your own home. You may pay as you learn. Write today, stating age. No salesman will call.

(A Correspondence School Since 1916)

Be A  
FINGER  
PRINT  
Expert

FREE!!!

Send for Thrilling  
BLUE BOOK  
OF CRIME

INSTITUTE OF APPLIED SCIENCE

1920 Sunnyside Ave., Dept. 6547, Chicago 40, Ill.

## INVENTORS

Send for  
PATENT INFORMATION  
Book and  
INVENTOR'S RECORD  
without obligation

GUSTAVE MILLER  
104-PE WARNER BUILDING  
WASHINGTON 4, D.C.

REGISTERED PATENT  
ATTORNEY  
ASSOCIATE EXAMINER  
U.S. PAT. OFF. 1922-1929

Patent Attorney & Advisor  
U. S. NAVY DEPT. 1930-1947  
PATENT LAWYER

## Catalog of 3000 Novelties 10c



Send 10c for amazing catalog of novelties, live animals, scientific supplies, hobbies, funmakers, planes & boats, looms, magic tricks, joke articles, unusual seeds, gadgets, time-savers, cameras, optical goods, projectors, movies, lucky jewelry, religious novelties, disguises, musical instruments, stamps, coins, puzzles, fortune tellers, radios, auto & bike accessories, telescopes, magnifiers, compasses, banks, smokers' gadgets, artists' supplies, printing sets, engines, motors, shockers, knives, billfolds, fireworks, guns, rifles, sports, books, games, plants, etc. Send name, address & 10c to:

JOHNSON SMITH & CO., Dept. 858, Detroit 7, Michigan

## MAKE EXTRA MONEY!!

Spare time work at home. Big mail-order firm needs men and women to send out postcards. Easy! No experience necessary. Just address and mail. Steady work every month. Act now - write at once.

BUSINESS INFORMATION CORPORATION

143 Belmont Street, Belmont, Mass.

## Carl and Jerry

(Continued from page 39)

our lingo. Now let's try this thing. Leave the needle off the record and keep listening at different positions of the gain control. I'll dash over and turn on the rig and put out a test."

As he said the last word he was already halfway up the steps. Soon Jerry could hear his voice coming faintly through the basement window; but no setting of the amplifier gain control caused the voice to be heard in the speaker.

"The operation is a success, Doctor," he yelled out the window. "Come on back.

"Say," he remarked as Carl came back into the basement and perched himself on the workbench, "what was that you were saying about seeing if your transmitter would 'load up' your new antenna?"

"That's right. This antenna is cut for 3950 kilocycles, according to my figuring, and I wanted to make sure it would take energy from the transmitter."

"What would keep it from it?"

"Being the wrong length. A transmitting antenna has to be the proper length so that it will resonate at the frequency of the transmitter before it will accept power from the transmitter."

"How do you calculate the proper length?"

"There's a formula for it, but I just use a table in the *Radio Amateur's Handbook*. It says the proper length is 118 feet and six inches."

"Don't you wonder about the reasons behind those tables?" Jerry asked curiously.

"Not me. I just want to know *how* things work, not *why*. All I know is that an antenna should be roughly a half wavelength long for good transmission or reception of a given frequency."

"H-m-m," Jerry reflected, "that reminds me of sound waves. I remember in physics class we found that if an open-ended tube was to be resonant at the frequency of a tuning fork, it had to be a half wavelength long at the fork's frequency. Just for kicks, let's see if radio and sound waves can be handled the same way. First off, if we divide the speed of a wave motion by the frequency of the waves, we get the length of each wave; right?"

Carl wrinkled his brow in deep concentration. "I guess so," he finally agreed hesitatingly. "If we knew how many feet a minute a freight train was moving and divided that by the number of identical cars that passed in a minute, we'd get the length of each car. I guess it would be the same with waves."

"Exactly. We also know that light and radio waves scamper along at a speed of 300,000,000 meters-per-second, and we have the frequency you are shooting at as being 3950 kilocycles or 3,950,000 cycles-per-second. Check?"

"Double check," Carl agreed. "We can lop those three ciphers off each number and divide 300,000 by 3950. You got a pencil and piece of paper?"

Without answering Jerry dug down in the litter of papers and books piled on the end of the couch and came up with a cheap and battered slide rule which he began to manipulate with a few extra flourishes strictly for the benefit of his guest.

"The answer," he finally announced with all the importance of a Supreme Court Judge handing down a fateful decision, "is very close to seventy-six meters."

"We're getting warm!" Carl said excitedly. "This band I'm working is called the Seventy-Five Meter Phone Band."

"Since your antenna is going to be a half wavelength long, we chop seventy-six in two and get thirty-eight meters," Jerry continued. "A foot equals .3048 meter; so we divide 38 by .3048, and the good old slip-stick says—" he paused to work the slide rule again, "exactly 124.5 feet," he finished weakly.

"The good old slip-stick or the guy slipping it too far have slipped," Carl jeered. "That's too far off 118.5 feet to be right—say!" he suddenly broke off as he struck his forehead with a clenched fist, "I remember reading somewhere that a half wavelength resonant conductor is always somewhat shorter than an actual half wavelength in free space. It's shorter by about 5%. Try taking 5% off that and see what you get."

"Five per-cent of 124.5 is close to six feet, and 124.5 feet minus 6 gives us precisely 118.5 feet," Jerry announced triumphantly.

"Whew! I'm glad that's over," Carl said as he bent forward and mopped his face with the slack in the front of his sweat shirt. "This brain wrestling is harder on me than playing in a double overtime game."

He and Jerry grinned at each other with the mutual satisfaction that comes from having joined in a successful operation.

"Say," Carl began hesitantly, "I've got an idea, but if you don't like it, just say so. My feelings won't be hurt. Here's the way I look at it: both of us are interested in electronics. You like to read and think about it; I like to experiment and build things. You've got a dandy place to work but not much equipment. I've got a ham station, a volt ohmmeter, and a whole box

## precise TRANSISTOR KIT

Here is the unique **PRECISE TRANSISTOR KIT** that supplies you with all the components necessary to perform innumerable experiments . . . along with many prepared experiments including audio one stage amplifiers through transformer-coupled amplifiers . . . and into special circuits. Instruction book teaches you the theory of transistors in simple non-mathematical terms.

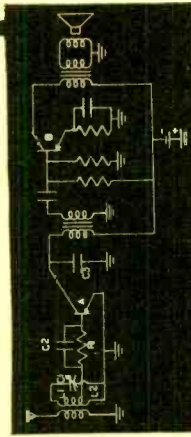

- ★ Audio oscillator
- ★ RF oscillator
- ★ Signal tracer
- ★ Tuned signal tracer (TRF type receiver), etc.

**TI...Kit \$17.95**

WRITE FOR  
1954 CATALOG  
INCLUDING  
New Test Equipment  
Instruments In  
Kit & Wired Form

**PRECISE DEVELOPMENT CORP.**  
Oceanside, New York

**FREE!**

GET ALL THESE  
5 PICTURE-PACKED  
COURSES  
Plus "Amazing secrets"  
PHOTO BOOK  
If you mail coupon NOW!  
Millions have been sold  
at \$1.



Quit being a **BAG OF BONES**  
Weakling Like I Was →  
IN **10** MINUTES OF  
FUN A DAY  
**YOU Can DO ALL I did!**

I gained 25 Terrific Lbs. of  
**HANDSOME POWER-PACKED  
MUSCLES** all over!

I Improved My **HE-MAN**  
Looks 1000%

I Won **NEW STRENGTH-POPULARITY**

**NO!** I don't care how skinny or flabby you  
are. I'll make you **OVER** by the SAME  
method I turned myself from a wreck to the  
strongest of the strong. **DEVELOP YOUR  
520 MUSCLES.**

**YES!** You'll see **INCHES** of  
mighty muscles added.  
From head to heels you'll  
gain **SIZE, POWER, SPEED.**  
**HOW YOU CAN WIN A BIG**  
**15" TALL SILVER CUP and \$100 or I just did**

**EAST CHANCE COUPON — 5 COURSES FREE!**

1 SWEET'S INSTITUTE, Dept. PE-410

220 Fifth Avenue, New York 1, N. Y.

Dear George: Please mail to the prepaid name Jonett's Photo  
Book of Strong Men & Muscle Men, plus all 5 Muscle Building  
Courses, "How to Become a Mighty He-Man." ENCLOSED FIND 10c for  
postage and handling (no C.O.D.).

NAME \_\_\_\_\_ (Please print plainly, include Zone Number) AGE \_\_\_\_\_  
ADDRESS \_\_\_\_\_  
CITY \_\_\_\_\_ ZONE & STATE \_\_\_\_\_

# BUILD your own TV Set

YES, build a fine TV Set at home. ALSO learn all about Installing, Repairing, Servicing. Get ready for a Big-Pay Job in America's fastest-growing Industry. The CTI TV Train-at-Home Plan is preparing hundreds for bigger pay TODAY—a brighter Future TOMORROW. No experience needed. We supply easy-to-understand instructions—plus TWENTY KITS of Parts, Professional Equipment and Tools. Get a TV Set to ENJOY. Get set to ENJOY a TV Future. Make money in spare time while taking Course. THOUSANDS SUCCEEDING! Send today for big FREE Book, "Succeed in Television." Commercial Trades Institute, Dept. T-59-9, 1400 Greenleaf Ave., Chicago 26, Ill.

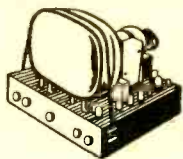

## CORONA RADIO KITS

EASY TO BUILD • EDUCATIONAL • EXCELLENT RECEPTION

**BROADCAST  
SUPERHET  
KIT**

**\$14.75**

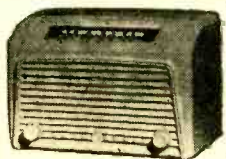

**ROCKET 115K**—Latest Single Band superhet circuit for ultimate in sensitive reception and tonal quality. Kit includes all necessary parts, punched chassis, attractive bakelite mahogany cabinet, built-in loop antenna, iron core IFs, big Alnico V spkr.; tubes: 12SK7, 12SA7, 12XQ7, 50L6, 35Z5. Automatic vol. control, beam power output. Tunes 540 to 1700 kc. Simple step-by-step instructions included.

**Prize 812K 2-Band AC-DC Super Kit**..... net \$20.75  
**Globe-master 814K 3-Band Super Kit**..... net \$24.75  
 All kits supplied less wire and solder. Please include 25% deposit with C.O.D. orders. Dept. P-7

**CORONA RADIO & TV CO.**  
 370 Broadway New York 13, N.Y.

## BRAND NEW

### SOUND POWERED PHONES!

● REQUIRES NO BATTERIES OR EXTERNAL POWER! OPERATED BY POWERFUL, PERMANENT INTERNAL MAGNETS.  
 UNCONDITIONALLY GUARANTEED!

Original government cost \$58.00  
 — new, specially priced ..... **\$9.95 each**

**SEMLER INDUSTRIES INC.** 6853 LANKERSHIM BLVD.  
 NO. HOLLYWOOD, CALIF.

of radio parts, but no place to work except my bedroom. You're good on math and theory where I am weak, but you do not seem to be too good with tools—"

"Let's face it: I'm about as clever as a cow with a crutch with tools," Jerry admitted without shame.

"I like tools and like to work with them," Carl went on. "To cut it short, how's about our sort of joining forces and working together? Maybe I'm wrong, but I think it would be a lot of fun. But if you don't like the idea—"

"I'm with you!" Jerry exclaimed. "A hobby is twice as much fun when you've got someone to work and argue with. As far as I'm concerned, we're in business. What'll we call ourselves? It's got to be something that sounds serious and imposing."

"Natch," Carl agreed. "How about 'Electronic Experimenters, Inc.'?"

"Let's change that 'Inc.' to 'Ltd.'" Jerry suggested. "Somehow it sounds more swanky."

"Fine! I'll get out my mechanical drawing set and make up a sign for over the basement door tonight," Carl said with mounting enthusiasm.

For a minute the two stood looking at each other, half serious, half joking. Then Jerry stuck out his hand. "Want to shake on it, Pardner?"

Instantly his plump hand was grasped by Carl's sinewy fingers.

"Here's to 'Electronic Experimenters, Ltd.'"

*(Continued next month)*

## SAFETY FIRST!

**B**EFORE removing radio and TV tubes, with the line plug disconnected from the wall outlet, it is good practice to short out the exposed tube terminal to the metal chassis, to avoid possible shock. See the photo below.

A screwdriver with an insulated handle should be used, permitting the metal blade of the screwdriver to serve as the shorting agent .....

H. L.

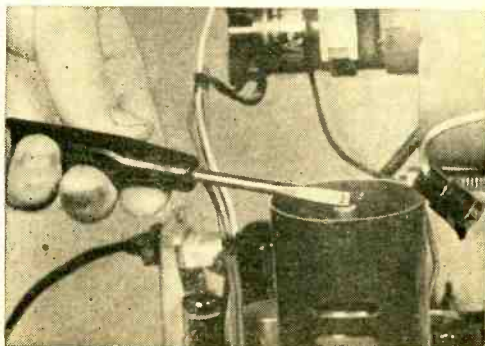

## 6 V. WESTINGHOUSE HIGHWAY SAFETY KIT **\$3.00**

Hi or low beam emergency light for camp, reading road signs, roadside repairs, garage light, spare headlamp etc. Each kit packed in sturdy box includes Westinghouse Sealed Beam headlamp, 12 ft. rubber cord which plugs into cigar lighter, 16 inch scotchlite "caution" sign and snap on bkt. for headlamp. All new & boxed. Order today! Postpaid Anywhere in U.S.A.

**DRILLICK ELECTRONIC SALES CO.**  
 5279 W. Pico Blvd., Los Angeles 19, Calif.



## How to Align Receivers

(Continued from page 59)

capacitors for the two sections are frequently mounted on one side of the *stator* plates (the stationary plates . . . the movable plate section is called the *rotor*), but, in some cases, these adjustments may be on the bottom of the tuning capacitor frame.

If the tuning capacitor is like the one shown to the left, the smaller rotor plates belong to the local oscillator section. If the capacitor is like the one shown to the right, you'll have to identify the oscillator and r.f. sections before alignment.

If you are able to pick up a station with the receiver, bring one finger close to one set of stator plates, then close to the second set. As you approach the r.f. stator section, you may find that the signal becomes weaker, but will not disappear; as you bring your finger close to the oscillator section, however, the station may disappear entirely, and you may even find that a different station is picked up.

Should the receiver be so far out of alignment that it is impossible to tune in a station, you can identify the oscillator section either by tracing out the circuit or by referring to a service manual.

Referring back to Fig. 1, the i.f. transformer adjustments correspond to trimmer capacitors  $C_6$ ,  $C_7$ ,  $C_8$ , and  $C_9$ . In some receivers, i.f. tuning "slugs" (movable iron cores) may be used instead of trimmer capacitors. This is usually the case where adjustments are provided on both the top and the bottom of the i.f. can.

The r.f. trimmer capacitor (on the side of the tuning capacitor) corresponds to  $C_3$ , while the local oscillator trimmer capacitor corresponds to  $C_1$ .

In many receivers, a low-frequency adjustment for the local oscillator will be provided. This may be either an adjustable local oscillator coil, using a movable powdered iron core, or a small "padder" in series with the tuning capacitor ( $C_1$  in Fig. 1). Where especially cut plates are employed on the tuning capacitor, like the one shown to the left in Fig. 6, the chances are that no low-frequency adjustment is provided. In any case, if a low-frequency adjustment is available, you should be able to identify it by checking the connections to the oscillator coil.

With the signal generator connected to the grid of the mixer tube, as previously outlined, set the instrument controls to deliver a modulated r.f. signal at the i.f. value for the set. For most receivers this will be either 455 or 456 kc. Set the output level controls (the *course* and *fine at-*

Become an

# Electrical Engineer

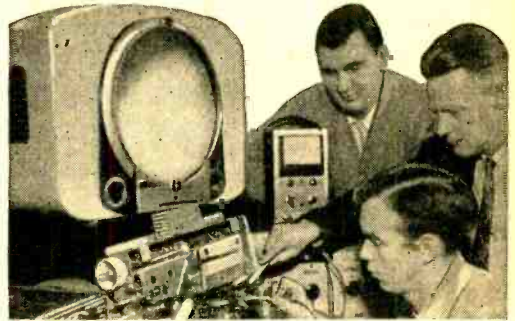

## Major in Electronics or Power BS Degree in 36 months

Prepare now for a career as an electrical engineer or engineering technician—and take advantage of the many opportunities in these expanding fields.

You can save a year by optional year 'round study. At MSOE previous military, academic, or practical training may be evaluated for advanced credit.

## Enter Radio and Television — courses 12 to 18 months

You can be a radio technician in 12 months. In an additional 6-months you can become a radio-television technician with Associate in Applied Science degree. Color television instruction is included in this program.

These technician courses may form the first third of the program leading to a degree in Electrical Engineering. Twenty-one subjects in electronics, electronic engineering and electronic design are included in these courses.

Courses also offered: radio-television service (12 mos.); electrical service (6 mos.); general preparatory (3 mos.).

## Terms — January, April, July, Sept.

Faculty of specialists. 50,000 former students — annual enrollment from 48 states, 23 foreign countries. Non-profit institution. 51st year. Courses approved for veterans. Residence courses only.

MS-68



## MILWAUKEE SCHOOL OF ENGINEERING

MILWAUKEE SCHOOL OF ENGINEERING  
Dept. PE-1054, 1025 N. Milwaukee Street  
Milwaukee 1, Wisconsin

Send FREE illustrated booklets

- Career in Electrical Engineering,  
 Career in Radio-Television.

I am interested in \_\_\_\_\_  
(name of course)

Name \_\_\_\_\_ Age \_\_\_\_\_

Address \_\_\_\_\_

City \_\_\_\_\_ Zone \_\_\_\_\_ State \_\_\_\_\_

If veteran, indicate date of discharge \_\_\_\_\_

ONLY  
**\$4.95**  
1 Ppd.  
or C.O.D.  
+ Chgs.



## THE NEW TV DYNATRACER

- TRACES TV SIGNALS AND VOLTAGES
- LOCATES DEFECTIVE COMPONENTS
- REQUIRES NO ADDITIONAL EQUIPMENT

This sensationally new piece of test equipment is ideal for trouble-shooting television sets in the home or in the shop. The "DYNATRACER" will out-perform more expensive testers and should pay for itself on the very first repair.

### A Must for Every TV Technician

**SPECIFICATIONS:** The "DYNATRACER" is a self-powered quality test instrument designed to trace TV signals through any Video, Sound, Sync, AFC, Horizontal or Vertical Sweep Circuit—will isolate trouble to a stage or component.

**ADDED FEATURE:** The "DYNATRACER" will also trace voltages (50/500 V. AC/DC) and instantly locate open, shorted, intermittent or leaky (up to 20 MCGOHMS) condensers, resistors, coils, XFormers, etc.

**Instruction and Trouble-Shooting Book Enclosed 10 DAY MONEY-BACK GUARANTEE**

Cut out advertisement, attach name and address with \$5.00 bill, check or money order and mail to

**Century ELECTRONICS CO.**

211-04 99th Ave., Dept. 601, Queens Village 29, N. Y.

## RADIO CONTROL EQUIPMENT

TRANSMITTER & RECEIVER KIT—27.255 Mc. Band. **\$9.95**  
License Free

All parts & diagrams (less tubes & crystal) to build 5 Watt Transmitter Unit & 2-Tube Lightweight Receiver, including SIGMA 10,000 ohm Relay.

- SIGMA 4F RELAY, 8,000 ohm, 1 Ma., 4.95-9,000 ohm. \$5.95
- STORAGE BATTERIES—2 Volt, 3"x4"x5 1/2"—27 A. Hr. 2.75
- MINIATURE 6 Volt—Willard NT6—2 1/2"x1 3/4"x1 1/2" 2.45
- 1 1/2 VOLT TINY MOTOR, 8,000 RPM with double shaft. 1.95
- ABOVE MOTOR with VARIABLE SPEED GEARBOX 3.95
- GEARBOX, 800/1, 2 1/2"x2", 5,000 RPM 1.45
- TOY ELECTRIC MOTOR KIT.....Special! .30

GROUND PLANE ANTENNAS, 10-20-40 Meters: easily made with our patented copper-plated WHIPS—threaded tapered sections: 16 ft. \$3.95; 32 ft. \$6.95

METERS: 2" 0-1 Ma. \$3.75; 0-3 Ma. 2.95

MULTIMETER KIT: Basic parts to build (less case) 3 Ma., 6, 60, 600 Volts Continuity. Includes meter 3.15

RF PROBE KIT: For Scope, Six, Tracer, VTVM 2.45

ELECTRONIC TOY TRAIN whistle unit—less tube, as is. .95

G.E. BLNKY CONTR UNIT—with sons, 10,000 ohm relay 1.25

6 VOLT DYNAMOTOR—300 V. @ 100 Ma. 7.95

PARTS FOR ALL KITS—FREE CATALOG "P"

### GYRO ELECTRONICS

325 Canal Street New York 13, New York

## Get Your F. C. C. LICENSE Quickly!

Correspondence or residence preparation for F.C.C. examinations. Results guaranteed.

An FCC commercial operator license means greater opportunities and higher pay. We are specialists in preparing you, in a MINIMUM OF TIME, to pass FCC examinations for all classes of licenses. Beginners get 2nd class license in 5 weeks and 1st class in 3 additional weeks. Write for free booklet.

### GRANTHAM School of Electronics

Dept. 104A, 6064 Hollywood Blvd., Hollywood 28, Calif.

## EASY TO LEARN CODE

Learn or increase speed with an Instructograph—the Radio-Telegraph Code Teacher that takes the place of an operator-instructor and enables anyone to master code without further assistance. Available tapes from beginners alphabet to typical messages on all subjects. Speed range 5 to 40 WPM. Always ready—no QRM. Thousands have "acquired the code" with the Instructograph System. Write today for convenient rental and purchase plans.



INSTRUCTOGRAPH COMPANY  
4713-P Sheridan Road, Chicago 40, Illinois

## HI-FI OUTPUTS \$13.95

Aerotron hi fi output transformer for PP 6L6s, 807s, etc. in regular Williamson or ultra linear circuit. 100-100,000 cycles. Fully guaranteed. Write for free bulletin.

### EMPIRE ELECTRONICS COMPANY

409P Avenue L Brooklyn 30, N. Y.

tenuators) to the minimum signal required to obtain an indication on the output meter used (or so that a faint tone can be heard in the loudspeaker, the receiver volume control should be turned up full). Turn the tuning control of the receiver until the tuning capacitor plates are fully meshed.

Short out the local oscillator temporarily. Do this by connecting a short piece of wire between the lug for the stator plates of the local oscillator section of the tuning capacitor and ground.

Now, using an insulated screwdriver or alignment tool, adjust the i.f. transformers for maximum output indication on the output meter (or maximum sound from the loudspeaker). The proper technique to use is shown in Fig 5. The output meter and signal generator are not shown in this photo.

Go through the adjustment steps at least twice, for the setting of one i.f. transformer may affect the adjustment of the other.

The mixer stage and local oscillator are generally called the "front end" of the receiver. This section is aligned after the i.f. transformers are properly adjusted.

With the outer shield of the signal generator lead still connected to chassis ground, remove the .001 mfd. capacitor used when adjusting the i.f. transformers, and clip the "hot" lead to the loop antenna of the receiver, as shown in Fig. 2. A direct electrical connection is not usually necessary. Remove the temporary shorting wire used on the local oscillator in the previous steps.

Next, set the signal generator to 1550 or 1600 kc. and tune the receiver to the same frequency, as indicated by the dial setting. Adjust the local oscillator trimmer (C<sub>1</sub> in Fig. 1) for maximum output. The proper technique to use is shown in Fig. 7.

Shift the signal generator and the receiver tuning to 1400 kc. and adjust the r.f. trimmer (C<sub>2</sub> in Fig. 1) for maximum output.

Finally, if a "padder" (C<sub>3</sub> in Fig. 1) or an adjustable local oscillator coil is provided in the receiver, tune both the signal generator and the receiver to 600 kc. Make the low-frequency adjustment (coil or padder) for maximum output while rocking the tuning capacitor plates back and forth (by adjusting the tuning knob). Use the adjustment and dial setting that gives maximum output, irrespective of the actual reading of the receiver dial.

Finally, go back to the high-frequency settings of the signal generator and receiver and repeat the adjustments of the local oscillator and r.f. trimmers. You may then wish to repeat the adjustment at the

low-frequency end of the dial, for, if best receiver performance is to be obtained, the alignment procedure should be carried out as a back-and-forth process. One adjustment affects the other, so you have to make slight changes in both to get the best possible setting of all trimmers. **END**

## Meet "Popular Electronics"

(Continued from page 13)

with new developments at an ever-increasing rate.

Circuitry has become more complicated through the years. Television and industrial electronics, telemetering and computing, and now color TV have necessitated a higher level of approach for technical magazines. This, unfortunately, has deprived thousands of people interested in electronics of a regular source of information written in simple, understandable terms. POPULAR ELECTRONICS is the answer to the demand for a monthly publication devoted entirely to electronics at a practical and hobby level.

POPULAR ELECTRONICS is, as its title implies, devoted to the science of electronics at How-It-Works, Why-It-Works, How-To-Do-It and How-To-Use-It level.

Its writers and editors have all grown up with electronics. They have all cut their eyeteeth in radio, TV, and communications as experimenters and hobbyists. They appreciate, from long experience, that "practical know-how" is all-important and essential to success in the fascinating science of electronics. They include experimenters, hams, short-wave experts, radio-control enthusiasts, instructors, technicians, editors, and engineers.

We think you will like POPULAR ELECTRONICS. We believe this to be a magazine designed to give you the best possible understanding of electronics. We will welcome all suggestions, ideas, and criticisms.

From our readers will come hundreds of features, gadgets, hints, and kinks. These will be carefully read and studied. If these are well illustrated (4 x 5 or 8 x 10 glossies) they will be considered for publication. Those accepted will be paid for at attractive rates, on acceptance.

And, among our readers will be found many experienced color photographers who are electronic hobbyists. Color transparencies (4 x 5 verticals) accompanied by a tie-in feature article will be considered. These will bring special rates of payment.

We will appreciate your help in telling your friends about POPULAR ELECTRONICS. Perhaps they too will be interested in this leading science of our times. And, finally, won't you please tell us how YOU like POPULAR ELECTRONICS? . . . Oliver Read

October, 1954

# LEARN TV

## FOR HIGH PAID JOBS

### BEST HOME RECEPTION

**NOW** you can easily learn from these books how to construct and service TV sets—plus the math so important in television today.

Complete course including color for only \$5.75

## Mandl's TV SERVICING

*Matthew Mandl.* Complete with a new chapter on NTSC color television, this famous service guide shows you exactly how color TV operates and gives practical instruction on servicing color sets. Contains a Master Trouble Index listing in clear, easily understood terms just how to locate and correct every flaw in both UHF and VHF receivers—plus up-to-the-minute data on all modern advances. \$5.75

Theory and math needed for the best jobs

## TELEVISION for RADIOMEN

*E. M. Noll.* One of the most widely used books on TV theory now brought up-to-date with new chapters on UHF, NTSC color television, and transistors. Offers practical explanations of the functions of all TV elements, techniques of installation, alignment, and adjustment. \$10.00

## RADIO AND TV MATH

*Bernhard Fischer.* A handbook of over 700 problems conveniently arranged so you can easily find the step-by-step solution to any math problem needed for getting best results in radio and TV servicing and construction. \$6.75

## Elements of Math for Radio, TV and Electronics

*Bernhard Fischer and Herbert Jacobs.* Illustrated with over 3000 practical examples and problems, this book makes crystal clear every procedure in the arithmetic, algebra, and geometry used every day by radio and TV men. \$7.20

### SEND THEM ON APPROVAL

The Macmillan Company, 60 Fifth Ave., N. Y. 11

Please send me books checked below. I will either remit the full price plus small delivery charge, or return the books in ten days. (SAVE: Send check or money order and we pay delivery charge.)

- |   |  |
|---|--|
| <input type="checkbox"/> Mandl's TV Servicing, \$5.75 | <input type="checkbox"/> Radio and TV Math, \$6.75 |
| <input type="checkbox"/> TV for Radiomen, \$10.00     | <input type="checkbox"/> Elements of Math, \$7.20  |

Name .....

Address .....

City..... State.....

(This offer good only within continental limits of U.S.A.)

# Classified

## FOR SALE

**BRASS**, stainless, aluminum, steel rods. Nepco, 366 Oakland St., Brooklyn 23, N. Y.

**RADIO** Diagrams \$1.00; Television \$2.00; Give make, model. Diagram Service, 672-PE, Hartford 1, Conn.

**GOLDEN** Grabbag 30 cts. Big lot \$1. Extra special \$2. Persil, 436 N. Y. Ave., Brooklyn 25, N. Y.

**HIGH Fidelity** 10 watt Amplifier. Regular \$85.00 value for only \$34.00. Storm Electronics, 89-47 198th Street, Hollis, N. Y.

**MILLION** products wholesale. List of sources 50c. Fitzpatrick, 1842 Jeanette, Abilene, Texas.

**T-30-S THROAT** type microphone, Special 50c, Tubes 19c up. Free Lists. Potter, 1314 McGee, Kansas City 6, Mo.

## INSTRUCTION

**U. S. CIVIL Service Jobs!** Men-Women, 18-55. Qualify Now! Start high as \$80.00 week. 23,000 jobs open. Experience often unnecessary. Get Free 36-page book showing jobs, salaries, requirements, sample tests. Write: Franklin Institute, Dept. T-23, Rochester, N. Y.

**MIDLAND** Linotype School, Charles City, Iowa. Civilian and Veteran Courses. Free placement. Established 1909.

**HIGH School**—No Classes. Study at home. Spare time. Diploma awarded. Write for Free Catalog HET-1. Wayne School, 2527 Sheffield, Chicago 14, Ill.

**SIMPLIFIED** analytics teach algebra clearly; guaranteed, \$1. Ziembra, E-6123 Orchard, Dearborn, Mich.

**ACTIONEERING** Home Study Course. Diploma granted. Auction School, Ft. Smith, Ark.

**BECOME** a Radio Amateur. Free information on how to pass Code and Theory FCC examinations. American Electronics, 1205½ Bryant Ave., New York 59, N. Y.

## BUSINESS OPPORTUNITIES

**CAN** You Earn \$40 weekly addressing Display Folders? Enclose stamped, addressed envelope; write Allen Co., Warsaw, Indiana.

**\$26,500 SALES** in two weeks! Amazing Radio-Mail Order method. Free details. Broadcast Service, 1412-ES Great Northern Building, Chicago 4, Ill.

**SPLENDID** opportunity mail order. Kester, 1028-P, Lancaster, Bryn Mawr, Pa.

**MONEYMAKING** opportunities galore! Free copy. Popular Mechanics Classified, 205-EP, East Ontario, Chicago 11.

**TRADE** Magazines. See late copies through our easy to get acquainted service. Choose from 4,387, covering all fields. Current List Free. Commercial Engraving Publishing Company, 34BW North Ritter, Indianapolis 19, Indiana.

**NEW** giveaway business stimulator. \$4.55 profit each sale. Sample 25c. Weigand, Graham, Florida.

**EARN** extra money in cartooning, free trial lesson tests your ability. Write Kaydee, 1412PE Great Northern Bldg., Chicago 4, Ill.

**A BUSINESS** of your own financed entirely by mail. Can be started during spare time. McCann, 1612 Johnson, Amarillo, Texas.

## INVENTIONS WANTED

**INVENTIONS** wanted. Patented; unpatented. Global Marketing Service, 1404 Mitchell, Oakland 1, Calif.

**PATENTED** and unpatented inventions wanted. Free particulars, invention recording and advice. America's foremost promotion service. Superior Inventions Agency, 340-342 North Rodeo, Beverly Hills, Calif.

## MISCELLANEOUS

**MEXICAN** Law. General Practice Attorney, 1203 Arizona St., El Paso, Texas.

**DETECTIVES**—Experience unnecessary. Detective Particulars free. Write, Wargner, 125 W. 86th, N. Y.

**"X-RAY Mind."** Dangerous power over others. (Details—10c.) Krishnar Institute, Box 842-S8, Escondido, Calif.

**FOAM** Rubber furniture cushions. Factory seconds. 50% discount. Free catalog. Perma-Foam, 140-E, Main Street, East Orange, New Jersey.

**MAGNET** wire insulation varnish. Electric Motor Service, 308 Delaware, Mason City, Iowa.

**KNOW** your Plastic's. "Plexiglas Craftsman's Handbook" with material catalog, postpaid, \$1.00. Plastic's. Box 1812, Salt Lake City 10, Utah.

**FREE** "Do-It-Yourself" Leathercraft Catalog. Tandy Leather Company, Box 791-J6, Fort Worth, Texas.

**AMAZING** only \$24.50 Troubleshoots every television and radio. Write for free information. Tele-Diagnosis, 155 W. 72, New York.

**FREE** Estimate: Industrial process control problems, Amplifier specifications, or, anything to be solved by Electronics, Transistors, Magnetic amplifiers. Box 345, Grand Rapids, Michigan.

**GEIGER** Counter and Metal Detector Kits. Inexpensive. Educational. Free Literature. Electronic Applications, Dept. B, 5024 Lee Highway, Arlington 7, Va.

**OBTAIN** Patents yourself and save hundreds. Most precise, practical, complete, easy guide ever published, \$5.00; refunded if unsatisfied. Superior Inventions, 340-342 North Rodeo, Beverly Hills, Calif.

**EXPERIMENTERS!** SWL's! October "Radio Science" 25c. 52 Backmen, Westfield, N. Y.

**LACHAPELLE'S** Treatment. (Patented.) Makes any car motor better, even a brand new one. Write Ferns. Box 71827-L, Los Angeles 1, Calif., for information.

POTTER & BRUMFIELD 2500 OHM RELAY	\$2.25
CAPACITY RELAY ALL BUILT READY TO USE	\$19.50
PHOTO ELECTRONIC KIT WITH SELF GENERATING CELL AND METER RELAY	\$9.95
SMALLEST MOTOR IN THE WORLD	\$2.50
4-NEON LAMPS 1/25 W-1/4 W-1 W-3 WATT	\$1.00
4-MICRO SWITCHES ASSORTED	\$1.00
GENERAL ELECTRIC BLANKET CONTROL CONTAINS SIGMA, 8,000 OHM RELAY AND OTHER PARTS	\$1.25

ALL PRICES F.O.B. NEW YORK

**BLAN**

ELECTRONICS SINCE 1923

64 DEY STREET

NEW YORK 7, N. Y.

## IT WILL PAY YOU

to read and answer the ads in this section or to place your own ad at these thrifty rates.

35c per word—minimum 10 words

# INDEX OF Advertisers

## INDEX OF

ADVERTISER	PAGE NO.
Advance Training	96
Allied Radio Corp.	111
Ashe Radio Co., Walter	SECOND COVER
Blan	129
Burstein-Applebee Co.	109
Century Electronics	124
Christy Trades School	113
Commercial Trades Institute	122
Corona Radio & TV Co.	122
Coyne Electrical School	5
Drillick Electronic Sales Co.	112, 122
Ekeradio	104
Electro Devices	109
Electronic Crafts Co.	108
Electronic Instrument Co., Inc. (EICO)	107
Electronic Measurements Corporation	99
ESSCO	106
Electro-Voice	97
Empire Electronics Company	124
G & H Wood Products Company	10
Grantham School of Electronics	124
Gyro Electronics	124
Harjo Sales Co.	112
Heath Company	88, 89, 90, and 91
International Correspondence Schools	7
Institute of Applied Science	120
Instructograph Company	124
Jowett Institute	121
Karlson Associates, Inc.	116
Linguaphone Institute	112
Macmillan Company, The	125
Miller, Gustave	120
Milwaukee School of Engineering	123
Moss Electronics Dist. Co.	118
Musical Masterpiece Society, Inc., The	115
McGraw-Hill Book Co., Inc.	16
National Company	THIRD COVER
National Engraving Co.	120
National Radio Institute	3
National Schools	11
New York Institute of Photography	96
Perma Power Company	104
Popular Electronics	98
Precise Development Co.	121
Precision Electronics	120
Progressive "Edu-Kits," Inc.	117
Rad-Tel Tube Co.	8
Radio Shack Corporation	127
Radio-Television Training Association	9
Raytheon Mfg. Co.	6
Richville TV Supply	116
Rex Radio Supply	108
John F. Rider Publisher, Inc.	119
Rinehart & Co., Inc.	105
Semler Industries, Inc.	122
Sleeper, Milton B., Publisher	14
Smith Johnson & Co.	120
Sprayberry Academy of Radio	FOURTH COVER
Sprague Products Co.	12
Sterling Models	107
Teltron Electric Company	103
Transmire Radio Lab.	118
University Loudspeakers	106
Ward Products Corp.	113
World Radio Laboratories	101

### RESISTOR QUIZ

(Answers to quiz on page 114)

1. c    2. b    3. a    4. b    5. a

### HOW SMART ARE YOU?

(Answers to Quiz on page 118)

1. b    3. c    5. c    7. a    9. c  
2. b    4. b    6. a    8. b    10. b

## FREE! 224-PAGE HOBBY CATALOG!

★ RADIO ★ TV ★ HI-FI ★ BOOKS  
★ TOOLS ★ KITS ★ AUDIO

Write for your Radio Shack's  
mail-order catalog today!



a



b



c



d

### 4 RADIO SHACK CATALOG SPECIALS!

(A) Fairchild 1/4" electric drill, regularly \$18.50 so you save \$8.65 or 47%. Die cast aluminum pistol grip and gear case, side lock, 6 1/2 ft. rubber cord. World famous Fairchild 1/10 hp 110-120V AC-DC motor, 1200 rpm no load, 700 rpm full load. Triple spring collet chuck. Add postage for 3 lbs. Order No. R-5170-PE. Only \$9.95. Same drill with geared Jacobs chuck: 3 lbs., Order No. R-5270-PE, only \$13.44. Famous-make circular saw for electric drill, 1 1/4 lbs., Order No. 17-569-PE, way off price at \$6.20.

(B) Drake 80-watt pistol grip solder set, regularly \$4.95 so you save almost \$3 at Radio Shack! Includes tip rest, rosin core solder, instructions. UL approved. 6 ft. cord. Replaceable 3/8" pyramid copper tip. Add postage for 1 1/4 lbs. Order No. R-7015-PE, only \$1.98.

(C) Transistor circuit kit — for building 12 fundamental circuits using transistors! Completely wired basic unit plus all parts and instructions to build circuits. Includes manual and reg. \$1.50 book on transistors. A kit of professional quality, yet easily built without previous knowledge. Have fun while you learn about these tiny components that are revolutionizing electronics! Add postage for 3 lbs. Order No. 36-775-PE, only \$17.15 at Radio Shack.

(D) Multi-drawer metal cabinets for small parts, hardware, stamps. Styrene drawers 5 3/4 x 2 7/8 x 1 1/4", each with metal dividers for 3 compartments! 16-drawer cabinet, 7 1/2 lbs., Order No. 37-550-PE, just \$5.41. 24-drawer, 10 1/4 lbs., Order No. 37-551-PE, only \$7.50. 32-drawer, 12 3/4 lbs., Order No. 37-552-PE, \$9.75.

## RADIO SHACK

167 WASHINGTON ST., BOSTON 8, MASS.

NAME \_\_\_\_\_  
STREET \_\_\_\_\_  
TOWN \_\_\_\_\_  
STATE \_\_\_\_\_

## RESISTOR COLOR CODE

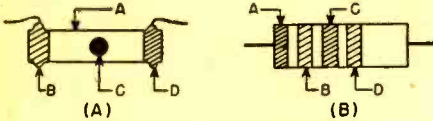

RETMA COLOR CODE CHART

COLOR	VALUE	MULTIPLIER
Black	0	1
Brown	1	10
Red	2	100
Orange	3	1000
Yellow	4	10,000
Green	5	100,000
Blue	6	1,000,000
Violet	7	10,000,000
Grey	8	100,000,000
White	9	1,000,000,000

**TOLERANCE CODE**

Gold—±5%	Silver—±10%
No Color—±20%	

The ohmic value of a resistor can be determined by means of the color code. There are two standard methods of indicating this value.

In Fig. A, the body (A) and end (B) indicate the first and second digits of the value while the dot (C) indicates the multiplier to be used. The tolerance of the unit is indicated by the end color (D). For example, if the body (A) is green the number is 5; if the end (B) is grey the second number is 8. If the dot (C) is red the multiplier is 100 or two zeros should be added. The resistor is then a 5800 ohm unit. If the end (D) has no color, the tolerance is ±20%.

In Fig. B, the first two stripes indicate the first two digits; the third stripe the multiplier; the fourth stripe the tolerance. Thus, if stripe (A) is green, (B) is grey, (C) is red, and (D) is silver, the resistor is a 5800 ohm, ±10% unit.

## CAPACITOR COLOR CODE

Color	MOLDED PAPER		MOLDED MICA		CERAMIC	
	Multiplier	Tolerance	Multiplier	Tolerance	Multiplier	Tolerance
Black	1	20%	1	20%	1	20% or 2.0μfd.*
Brown	10		10		10	1%
Red	100		100	2%	100	2%
Orange	1000		1000	3% (RETMA)	1000	2.5% (RETMA)
Yellow	10,000	5%	10,000		10,000	
Green				5% (RETMA)		5% or 0.5μfd.*
Blue						
Violet						
Gray					0.01	0.25μfd.*
White		100%			0.1	10% or 1.0μfd.*
Gold	0.1	5%	0.1	5% (JAN)		
Silver		100%	0.01	10%		
None		20%				*Capacitance less than 10μfd.

Capacitance is given in μfd. Colors have same values as on resistors, except as indicated in tables. Colors (A) and (B) are for first two digits; (C) is for multiplier. (D) is for tolerance. (E) and (F) give voltage rating in hundreds of volts; (E) is used only for ratings less than 1000 volts, (E) and (F) for first two digits of ratings 1000 volts or more. Values of colors for (E) and (F) are same as in resistance values. (G) is class or characteristic of capacitor, (H), (I), and (J) give temperature coefficient. (G), (H), (I), and (J) are not listed in the tables, since this information is seldom needed by the average home builder.

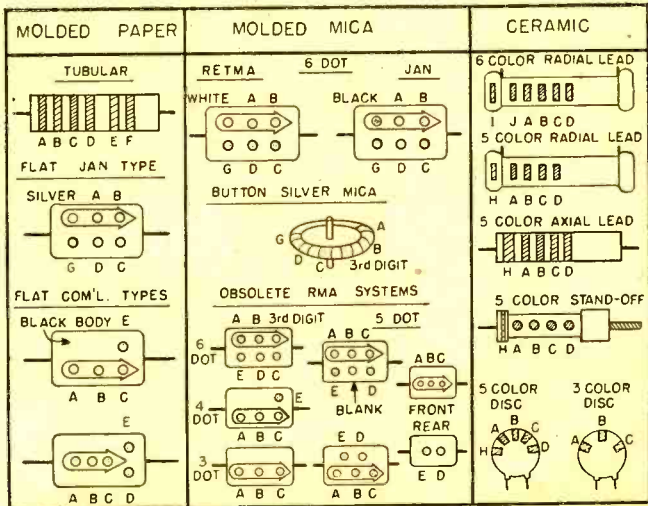

# STANDARDIZED WIRING DIAGRAM SYMBOLS

<b>ANTENNAS</b>		<b>MICROPHONE</b>			<b>TELEGRAPH KEY</b>			
 GENERAL	 DIPOLE	 LOOP	 FERRITE TYPE			 SINGLE BUTTON		
<b>BATTERIES</b>		<b>NEON BULB</b>			<b>PILOT LIGHT</b>			
 SINGLE-CELL		 MULTI-CELL			 DYNAMIC			
<b>CAPACITORS</b>		<b>PHONO PICKUPS</b>			<b>PLUG OR SOCKET</b>			
 FIXED MICA OR PAPER		 CRYSTAL			 MAGNETIC			
 ELECTROLYTIC		 RECEPTACLE 117V.			 RECORDING HEAD			
 VARIABLE CAPACITORS GANGED		 SELENIUM TYPE			 IRON CORE			
 STATOCOUPLER		<b>RELAYS</b>			<b>TRANSFORMERS</b>			
 STATOCOUPLER		 S.P.S.T. NORMALLY OPEN			 IRON CORE			
 STATOCOUPLER		 S.P.S.T. NORMALLY CLOSED			 IRON CORE			
 STATOCOUPLER		 S.P.S.T.			 AIR CORE			
<b>RESISTORS</b>		<b>SHIELDING</b>			<b>TUBES</b>			
 GENERAL		 DOTTED LINES INDICATE SHIELDING COULD BE AROUND ANY COMPONENT OR GROUPS			 DIODE			
 TAPPED OR ADJUSTABLE		<b>SPEAKERS</b>			 TRIODE			
 POTENTIOMETER OR RHEOSTAT		 P.M.			 TETRODE			
 CONTINUOUSLY VARIABLE		<b>SWITCHES</b>			 PENTODE			
<b>RECTIFIER</b>		 S.P.S.T.			 SUPPRESSOR SCREEN CONTROL			
<b>RECEPTACLE 117V.</b>		 S.P.S.T.			 GRID CAP			
<b>RECORDING HEAD</b>		 D.P.S.T.			 DIODE PLATE			
<b>MAGNETIC</b>		 D.P.D.T.			 PHOTO-ELECTRIC			
<b>RECTIFIER</b>		 PUSH-BUTTON			 DUO TRIODE			
<b>SELENIUM TYPE</b>		 BOTH TYPES GANGED			 COLD CATHODE			
<b>RELAYS</b>		<b>TRANSISTOR (JUNCTION)</b>			<b>VIBRATOR</b>			
 S.P.S.T.		 P-N-P TYPE N-P-N TYPE SAME SYMBOL EXCEPT ARROW IS REVERSED			 VIBRATOR			
 S.P.S.T.		 WAFER			 CONNECTION			
 S.P.S.T.		 NO CONNECTION			 NO CONNECTION			
<b>METER</b>		<b>MOTOR</b>			<b>WIRES</b>			
 METER		 MOTOR			 CONNECTION			
 PHONE PLUG		 WAFER			 NO CONNECTION			

3.50  
 0.20  
 5.75  
 1000-2700  
 3000-4000  
 550  
 9.50  
 1.00  
 11.00  
 90°

# GLOSSARY

**a.g.c.**—Automatic gain control, control of the amplification of an amplifier so that its output is approximately constant in spite of variations in the input signal; especially such control in television receivers to reduce variations in picture contrast produced by variations in r.f. signal strength.

**a.v.c.**—Automatic volume control (a.g.c. used in radio receivers to reduce variations in sound volume produced by variations in r.f. signal strength).

**crystal**—1. Rectifying crystal, one which passes electric current more easily in one direction than in the other and thus can be used to change alternating current to pulsating direct current; made of such materials as germanium, silicon, copper oxide, galena, and carborundum. 2. Piezo-electric crystal, one which transforms mechanical energy to electrical and vice versa. Such crystals, made of Rochelle salt or barium titanate, are used in microphones and phonograph pickups. When cut to a certain size and shape, a piezo-electric crystal, usually made of quartz, can be used as a resonant circuit, to control the frequency of an oscillator or as a frequency-selective filter.

**decibel**—A measure of the ratio between two power levels or of a power level with respect to a designated reference level. Basically, the number of decibels is ten times the logarithm of a power ratio. One decibel is approximately the smallest difference in sound power which can be detected by the average human ear.

**db of feedback**—The number of decibels by which inverse feedback in an amplifier reduces its over-all gain and distortion.

**detector**—A circuit used to recover an audio or video signal from a modulated radio signal.

**elevator**—Control surface of an aircraft which regulates its pitch attitude (level, climbing, or diving).

**feedback**—Returning part of the output of an amplifier stage to the input of the same or a previous stage. Negative or inverse (out-of-phase) feedback decreases the gain and distortion of the amplifier; positive (in-phase) feedback increases gain and distortion and may produce oscillation.

**frequency response**—The relative ability of an amplifier, loudspeaker, or other device to respond to different frequencies.

**glow plug**—A type of internal-combustion engine used in models, in which starting is assisted by a filament in the combustion chamber, which is energized by an external battery.

**harmonic distortion**—Distortion consisting of addition of components to the signal whose frequencies are multiples (harmonics) of the original signal frequency. It is produced by an amplifier or other device which is nonlinear (does not give the same ratio of output to input for all input amplitudes).

**heterodyne**—A difference frequency (beat) produced by combining two frequencies.

**Immelmann turn**—A maneuver in which an airplane is made to complete half of a loop and then rolled half of a complete turn. (Named after Max Immelmann, World War I German aviator.)

**microammeter**—A meter for the measurement of current flow, which is calibrated in microamperes, or millionths of an ampere.

**milliampere**—One-thousandth of an ampere.

**modulated**—Varied in amplitude, frequency, or some other quality. Radio-frequency signals are modulated in order to carry signals of lower frequency, such as sound or picture signals.

**multitester**—A meter which is a combination of a voltmeter, an ohmmeter, and (often) an ammeter.

**oscillator**—A vacuum-tube or transistor circuit or other device which produces an alternating-current power output without mechanical rotation.

**plate dissipation**—The part of the power applied to the plate circuit of a vacuum tube which does not appear as signal output, but is dissipated as heat in the plate of the tube.

**push-pull**—An arrangement of two vacuum tubes in an amplifier so that the input signal is applied in opposite phases to the two tubes and the signal outputs are combined in phase. This arrangement reduces even-harmonic distortion.

**regeneration**—Positive feedback in detectors and amplifiers. Increases gain and distortion and may produce oscillation.

**saturate**—To reach the maximum possible value of some quantity, such as magnetization in the core of an inductor or current flow in a vacuum tube from cathode to plate.

**servo-motor**—A special electric, hydraulic, or other type of motor used in control apparatus to convert a small movement into one of greater amplitude or greater force.

**superheterodyne**—A receiver in which all incoming radio-frequency signals are mixed with the output of an oscillator to produce a heterodyne or beat frequency. The oscillator frequency is variable so that the beat produced with any desired signal can be adjusted to a certain frequency. The beat-frequency signal is fed to a fixed-frequency (intermediate-frequency) amplifier, where greater and more uniform gain and selectivity can be obtained than at the original radio frequency.

**superregenerative**—A type of regenerative detector in which the tendency to oscillation is controlled by a quenching voltage of ultrasonic frequency which periodically allows the gain to increase, then reduces it. The quenching voltage can be produced by the detector tube itself or by a separate oscillator. This type of detector has great sensitivity, but poor selectivity.

**transconductance**—A characteristic of a vacuum tube which indicates the effectiveness of the grid in controlling the plate current and the all-around effectiveness of the tube as an amplifier.

**v.t.v.m.**—Vacuum-tube voltmeter, a voltmeter using one or more vacuum tubes to increase the sensitivity of the basic meter movement, so that measurements can be made in a circuit without drawing much current and without disturbing very much the normal operating conditions of the circuit. May also be a combination voltmeter, ohmmeter, and ammeter.



**It's New! 3 Years in Development  
-NOW READY FOR YOU!**

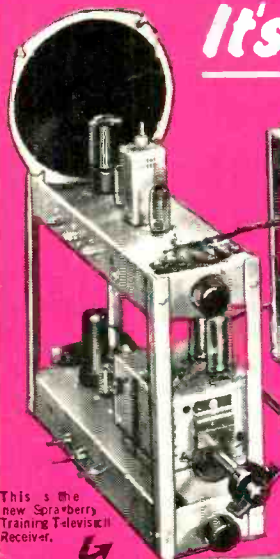

This is the new Sprayberry Training Television Receiver.

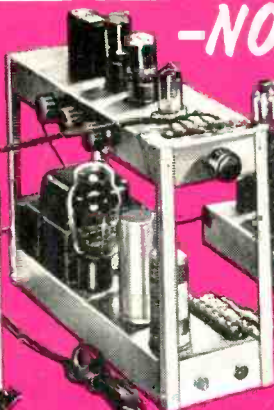

You build the new Sprayberry Tester... 18-range Volt-Ohm-Milliammeter readings.

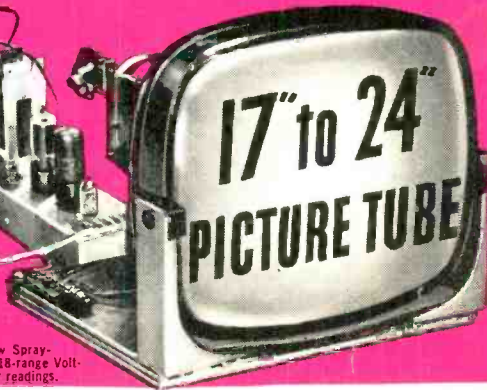

**New Equipment! New Lessons! Enlarged Course!  
SPRAYBERRY PRACTICAL TRAINING IN**

# RADIO-TELEVISION

**3 NO OBLIGATION TRAINING PLANS**



You will build this powerful short wave and broadcast superhet radio receiver.



F. L. SPRAYBERRY  
Pres.

**You have NO MONTHLY PAYMENT CONTRACT to sign... pay for this outstanding training as you learn!**

Mail the coupon at once for my big all-new 56 page FREE CATALOG and FREE Sample Lesson. Get the full story of this remarkable new Training Plan. Read about my 3 NO OBLIGATION PLANS of "packaged unit" instruction. I can prepare you in as little as 10 MONTHS to take your place as a Trained Radio-Television Technician. You take no risk in enrolling for my Training because you DO NOT SIGN A BINDING TIME PAYMENT CONTRACT. I have been training successful Radio-TV technicians for 22 years... I can prepare you, too, to get into your own profitable Service Shop or a good paying job. Full information FREE and without any obligation. No salesman will call.

## NEWEST DEVELOPMENTS

Your training covers U H F, Color Television, F.M., Oscilloscope Servicing, High Fidelity Sound and Transistors.

## PRACTICE AND TRAIN AT HOME WITH 25 NEW KITS of EQUIPMENT

You get valuable practical experience in construction, testing and shop practice. You build a powerful 2 band superhet radio, the all-new 18 range Sprayberry multimeter, the new Sprayberry Training Television receiver, signal tracer and many other projects. All equipment is yours to use and keep. All your training is IN YOUR HOME in spare hours. I help you earn extra spare time money while you learn. Rush coupon below for all the facts—FREE!

**SPRAYBERRY ACADEMY OF RADIO**  
111 NORTH CANAL STREET, DEPT. 105-P  
CHICAGO 6, ILLINOIS

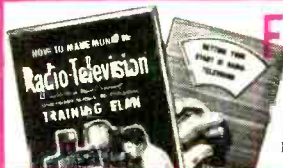
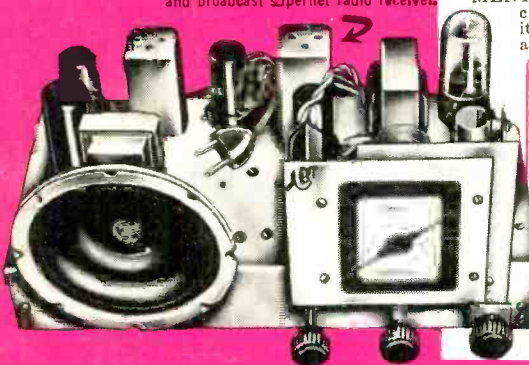

## FREE CATALOG AND SAMPLE LESSON

Just coupon for my catalog "How to Make Money in Radio-Television". PLUS an actual sample Sprayberry Lesson without obligation—ALL FREE. Mail coupon NOW!

SPRAYBERRY ACADEMY OF RADIO MAIL THIS COUPON FOR FREE  
Dept. 105-P 111 N. Canal St., Chicago 6, Ill. FACTS AND SAMPLE LESSON  
Please rush New Catalog and Sample Lesson FREE. I understand that no salesman will call.

Name \_\_\_\_\_ Age \_\_\_\_\_  
Address \_\_\_\_\_  
City \_\_\_\_\_ Zone \_\_\_\_\_ State \_\_\_\_\_

# hottest value in ham radio

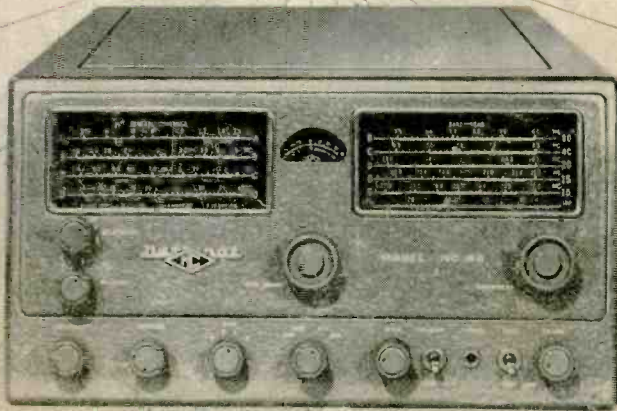

## The New NC-98

**\$149<sup>95</sup>**

Feature for feature, dollar for dollar, nothing on the market even comes close to the new NC-98! Compare and prove it! Complete with crystal filter and an S-meter at this modest price. No other offers this, plus these additional performance features:

550 kcs to 40 mcs range · calibrated amateur bandsread (or SWL bandsread for short-wave listening) · new miniature tubes · an RF stage · two IF stages · edge-lighted dial scales · noise limiter · separate high-frequency oscillator · 3-position selectivity · antenna trimmer · phasing control · sensitivity control · accessory socket ·

*tuned to tomorrow*

**National** 

*Electronics for the 40's*  
*the new* **HORIZON** *in high fidelity*



For the ultimate in high-fidelity reproduction, be sure to see and hear the new National HORIZON line of AM FM Binaural tuner and integrated amplifiers. For complete specifications on ham receivers and high-fidelity, write Dept. 1054.