

L. Ron Hubbard

Understanding the E-Meter

A Book on the Basics of How the
E-Meter Works

Eine Publikation der Freien Zone

First Printing 1982

Copyright © 1982 by L. Ron Hubbard.

ALL RIGHTS RESERVED

No part of this book may be reproduced without permission of the copyright owner.

"By itself, this meter does nothing. It is solely for the guide of Ministers of the Church in Confessionals and Pastoral Counselling. The Electrometer is not medically or scientifically useful for the diagnosis, treatment or prevention of any disease. It is not medically or scientifically capable of improving the health or bodily function of anyone and is for religious use by students and Ministers of the Church of Scientology only."

Scientology™ is an Applied Religious Philosophy.

This book has been compiled from the researches and notes of L. Ron Hubbard. The theory has been taken from parts of the film written by L. Ron Hubbard, How the E-Meter Works, which is scheduled for Academy showing. Grateful acknowledgment is made by L. Ron Hubbard for the editorial assistance of Norman F. Starkey. Also to Arthur Hubbard for the cover painting and to Melanie Seidler Murray, Pat Brice, Barbara de Celle, Andre Clavel, Jessica Rockweil Waldmann and Gerry Grant.

Library of Congress Catalog Card No.: 81-70129

ISBN 0-88404-078-X (United States of America)

ISBN 87-6336-103-8 (All other countries)

Printed in the United States of America

Important Note

One of the biggest barriers to learning a new subject is its nomenclature, meaning the set of terms used to describe the things it deals with. A subject must have accurate labels which have exact meanings before it can be understood and communicated.

If I were to describe parts of the body as "thingamabobs" and "whatsernames," we would all be in a confusion, so the accurate naming of something is a very important part of any field.

A student comes along and starts to study something and has a terrible time of it. Why? Because he or she not only has a lot of new principles and methods to learn, but a whole new language as well. Unless the student understands this, unless he or she realizes that one has to "know the words before one can sing the tune," he or she is not going to get very far in any field of study or endeavor.

Now I am going to give you an important datum:

The only reason a person gives up a study or becomes confused or unable to learn is because he or she has gone past a word that was not understood.

The confusion or inability to grasp or learn comes AFTER a word that the person did not have defined and understood.

Have you ever had the experience of coming to the end of a page and realizing you didn't know what you had read? Well, somewhere earlier on that page you went past a word that you had no definition for.

Here's an example. "It was found that when the crepuscule arrived the children were quieter and when it was not present, they were much livelier." You see what happens. You think you don't understand the whole idea, but the inability to understand came entirely from the one word you could not define, crepuscule which means twilight or darkness.

This datum about not going past an undefined word is the most important fact in the whole subject of study. Every subject you have taken up and abandoned had its words which you failed to get defined.

Therefore, in studying Dianetics and Scientology be very, very certain you never go past a word you do not fully understand. If the material becomes confusing or you can't seem to grasp it, there will be a word just earlier that you have not understood. Don't go any further, but go back to BEFORE you got into trouble, find the misunderstood word and get it defined.

Many of the Dianetics and Scientology terms in this book are defined in the text when they are used. Where the definitions were too lengthy, these together with a number of non-Dianetics and Scientology terms, have been included in the glossary at the end of the text. You are urged to make good use of the glossary while reading this book.

It will not only be the new and unusual words that you will have to look up. Some commonly used words can be misdefined and so cause confusion. So don't depend on our glossary alone. Use a general English language dictionary as well for any nonspecialized word you do not understand when you are reading or studying.

Dianetics and Scientology words and their definitions are the gateway to a new look and understanding of life. Understanding them will help you live better.

Contents

Foreword	5
Introduction.....	6
The Composition of the Physical Universe.....	7
The Thetan and the Physical Universe.....	25
How the E-Meter Really Works.....	40
About the Author.....	61
Glossary.....	62
Subject Index.....	72
Bibliography.....	75

Mark V E-Meter

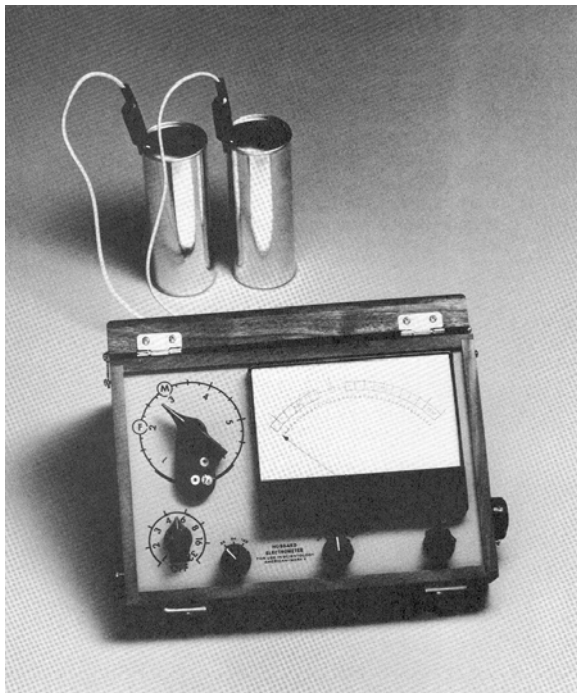

Mark VI E-Meter



Foreword

One lives better with Scientology since life, understood and controlled, becomes liveable.

A civilization could fare better with Scientology since that would not be pock-marked with unknowns and rendered null with chaos.

The only richness there is is understanding. That is all that Scientology has to give.

L. Ron Hubbard

- Scientology 8-8008

Introduction

The measurement of thought with a meter is not new; the understanding and accuracy of measurement is new. It has been known to a variety of beings for a very long time that thought and electrical manifestations were closely associated.

Einstein is reported to have said that all an observer should be permitted to do is to read a meter and report the message of the meter. This is true enough. But the observer of a human mind can read it with a meter only if the meter is an accurate and constant meter, and only if he knows what questions to ask.

The invention of the Hubbard Electrometer indubitably ranks as another Scientology "first." For here we have the first truly accurate and constant meter ever employed in the field of the mind.

If the truth be known, the E-Meter utterly dwarfs such inventions as that of the microscope. Leeuwenhoek found the way only to find bacteria; the E-Meter provides the way for Man to find his freedom and to rise to social and constructive levels of which Man has never dreamed, and to avoid perils in that route which Man, in going, would have found more deadly than any bacteria ever evolved or invented.

The first E-Meter was built in 1950 and there have been many refinements made over the years to improve its workability and accuracy. However, the basic principle of the operation of the meter has not changed. The very first E-Meter successfully put into operation, the most recent refinement called the Mark VI OT E-Meter, the Mark V and its predecessor the Mark IV and all other models before, all worked on the same basic principles.

The E-Meter is an instrument which measures emotional reaction by tiny electrical impulses generated by thought. This book contains exact descriptions with illustrations of how the E-Meter works to achieve this purpose.

The first thing one should know to understand and operate an E-Meter is the concept of a "facsimile." To this end the book also provides basic and fundamental data concerning the thetan and his relationship with the physical universe and the nature of facsimiles.

A complete chapter deals with essential points of the make-up of the physical universe, but it is also recommended that you study *Scientology: 8-80* and *Scientology 8-8008* by L. Ron Hubbard to enhance your knowledge of this subject.

The E-Meter is a religious artifact developed for the exclusive use of ordained ministers and theological students who are trained in its use in Church ministrations. Its purpose is to assist the minister to locate in his parishioners areas of travail so that he may then bring about relief from spiritual suffering.

Your skilled use of the E-Meter is a trust. Learn its operation well and observe the rewards in the results you will obtain with it. Good luck.

The Composition of the Physical Universe

If Life - or theta, as it is called in Scientology - is a mirror and creator of motion which can be mirrored, it follows then that mirror-wise, the whole of the laws of motion-magnetism, energy, matter, space and time - can be found in thought and behavior, and even thinking partakes of the physical universe laws regarding matter, energy, space and time.

The physical universe as we know it consists of just four parts:

Matter

Energy

Space

Time

We know these as a coined word, *MEST*. We would not include theta as an integral portion although theta obviously impinges on it as Life.

Space

The workable definition of space is "viewpoint of dimension": there is no space without viewpoint, there is no space without points to view.

Space is not nothingness. Space is the viewpoint of dimension, and that is what space is. It is how far we look. If you didn't look you wouldn't have any space. Space is caused by looking out from a point. The only actuality of space is the agreed upon consideration that one perceives through something, and this we call space.

Space is nothing more than what exists between a viewpoint and a dimension point.

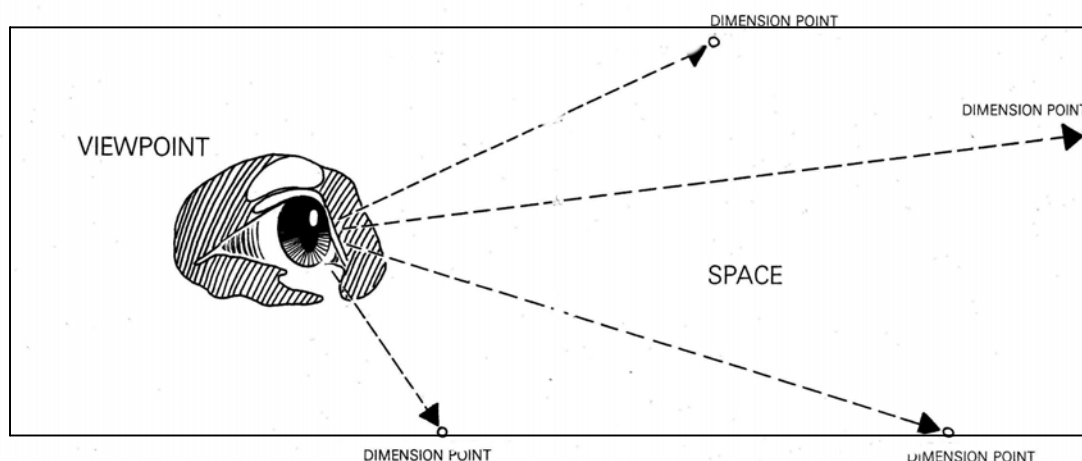

A dimension point is any point in a space or at the boundaries of space. As a specialized case, those points which demark the outmost boundaries of the space or its corners are called in Scientology "anchor points". Dimension is the distance from the point of view to the anchor point that is in space.

In order to have space, it is necessary to have a viewpoint and the potential in the viewpoint of creating anchor points. Viewpoints are not visible, but viewpoints can have dimension points which are themselves visible. Space is creatable by a thetan and he may also conserve, alter or destroy space.

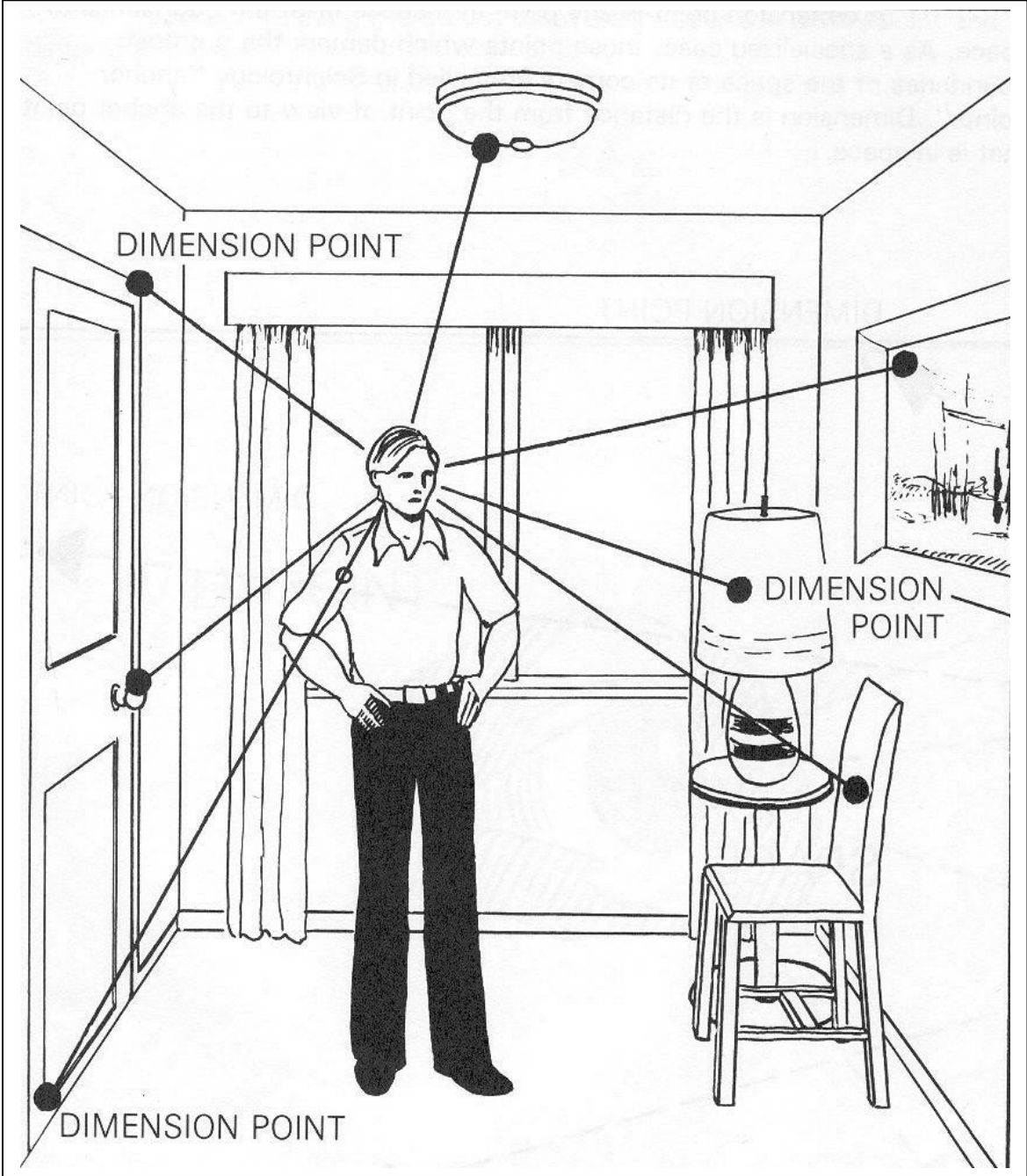

A material of the universe cannot exist in any universe without something in which to exist. The something in which it exists is space, and this is made by the attitude of a viewpoint which demarks an area with anchor points.

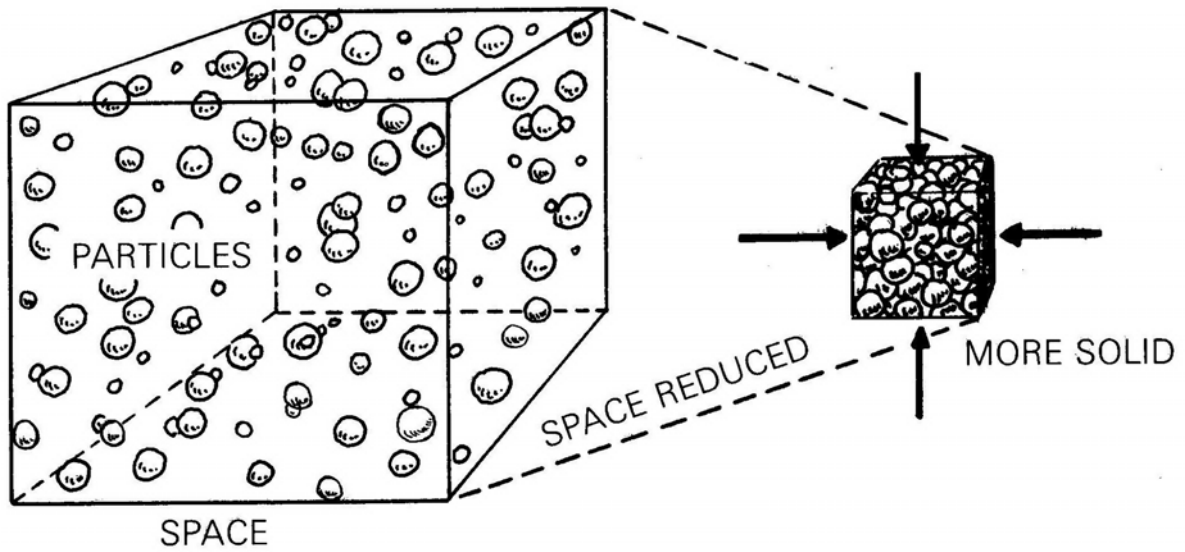

Solidity both in the physical universe and in the theta universe is concerned with space. Matter is a condensation of energy. The more energy condenses, the less space it occupies and the greater its endurance becomes. A being can become solidified by a collapse of space through a withdrawal of dimension points or an inability to occupy a viewpoint.

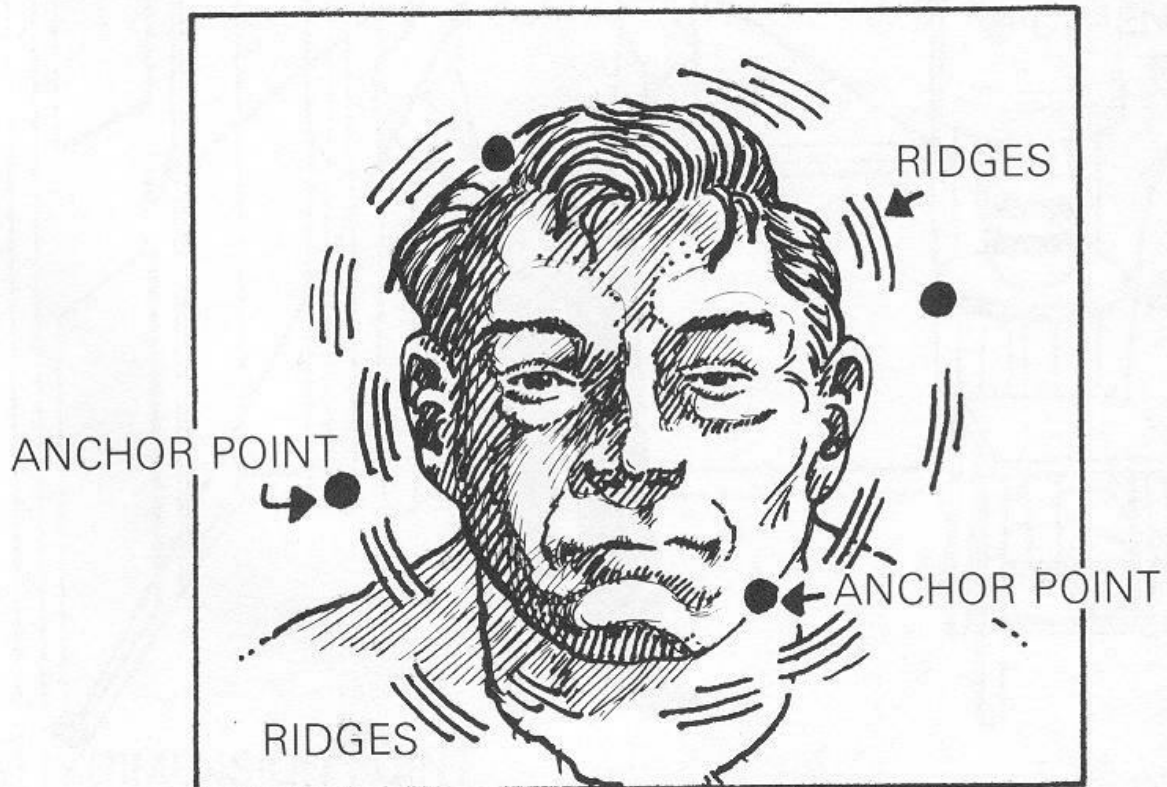

A Scientologist can gain great reality on the ability to conserve, alter or destroy space. His reality increases through confronting incidents which have caused him to pull in his anchor points and reduce his viewpoint of dimension and thus his space. He well knows the results of a successfully delivered standard auditing session wherein he is able to extend his dimension points and create more space for himself once again.

After many long hours at work in a small office, space seems to have collapsed and in fact it has for the being who has reduced his dimension points to close proximity to the viewpoint. A brief walk in the park soon remedies this and gives an abundance of points to view which are dimension points and an opportunity to expand the distance between viewpoint and dimension point and thus create space by the viewpoint. Any being (thetan) is a viewpoint; he is as much a being as he is able to assume viewpoints.

The rehabilitation of the viewpoint' s ability to act as a viewpoint and to extend points to view, or to put out dimension points, increases that viewpoint' s ability to create space and so destroy matter.

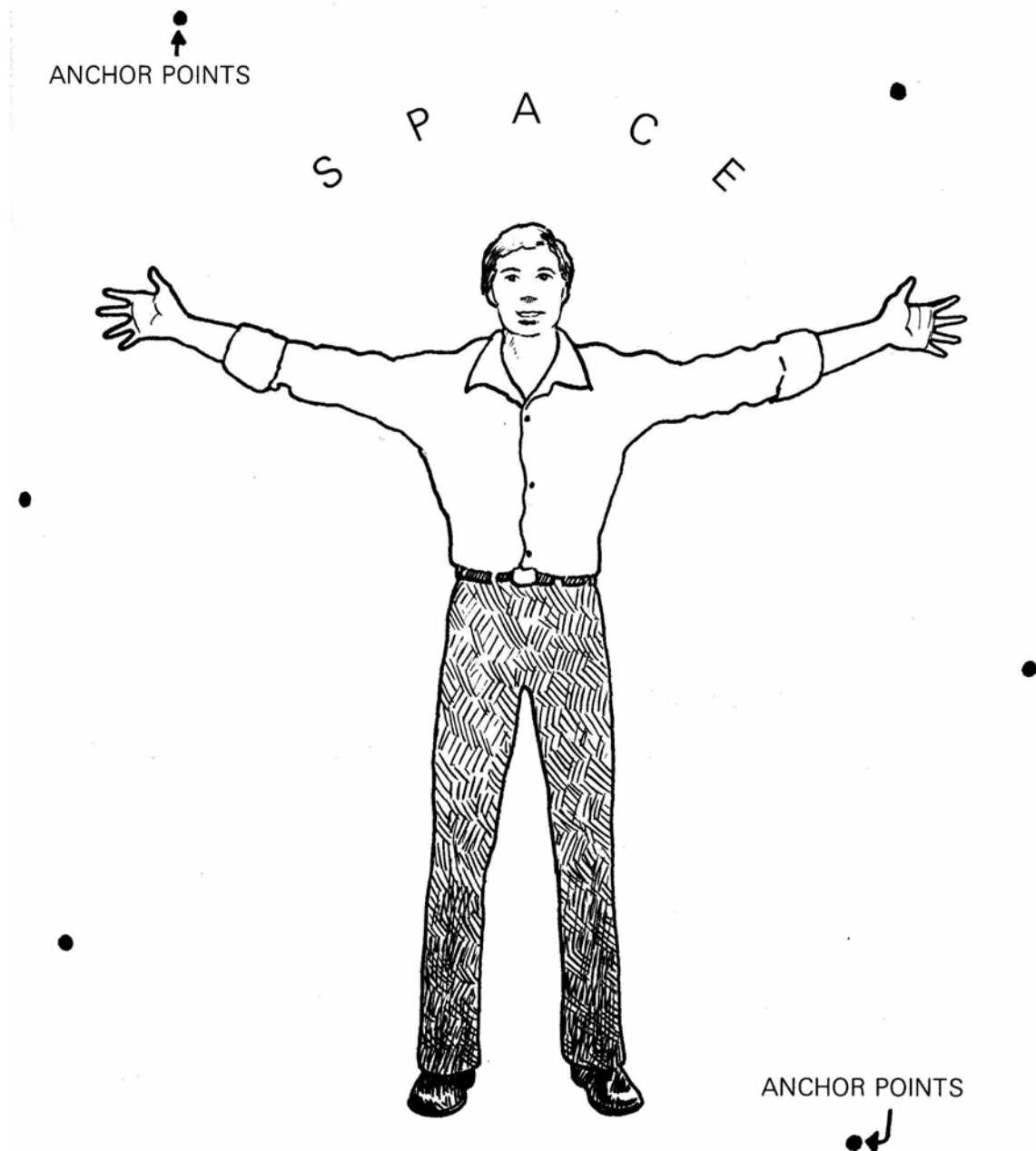

Matter

Energy becomes matter if condensed, and conversely matter becomes energy if dispersed

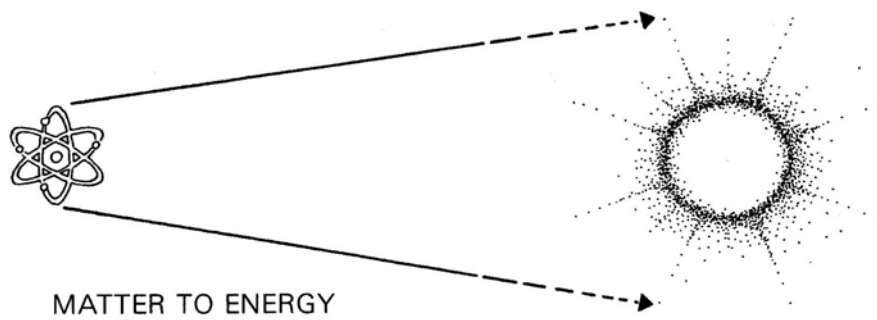
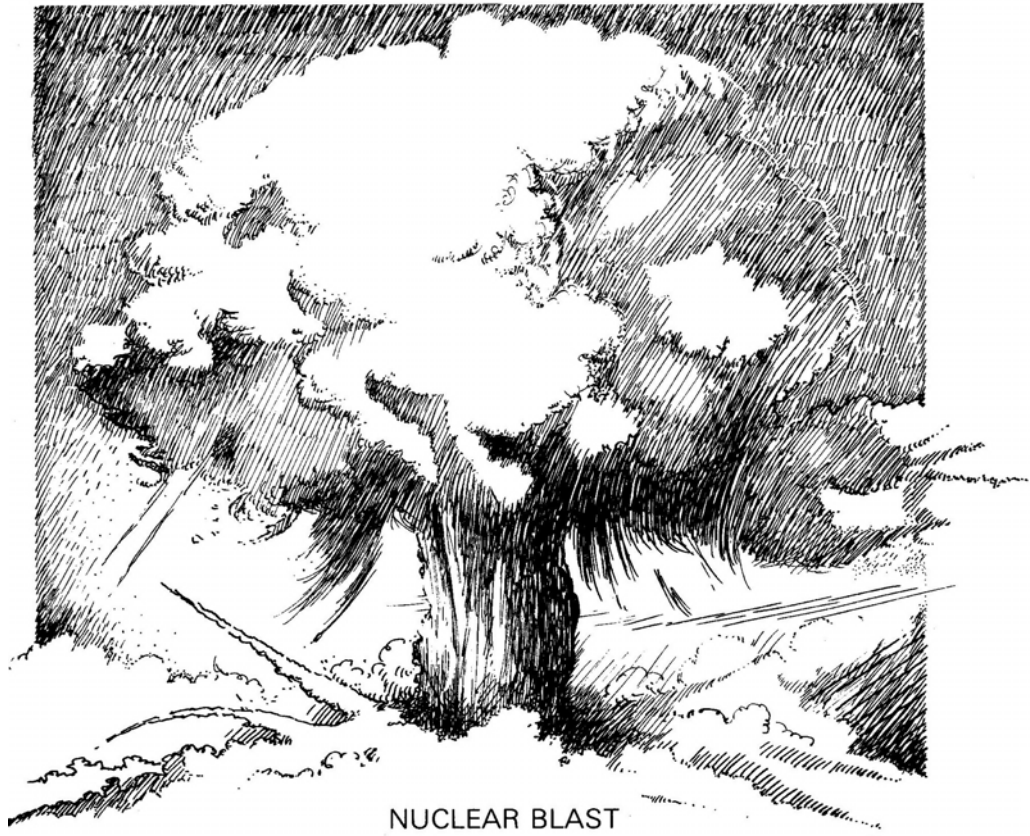
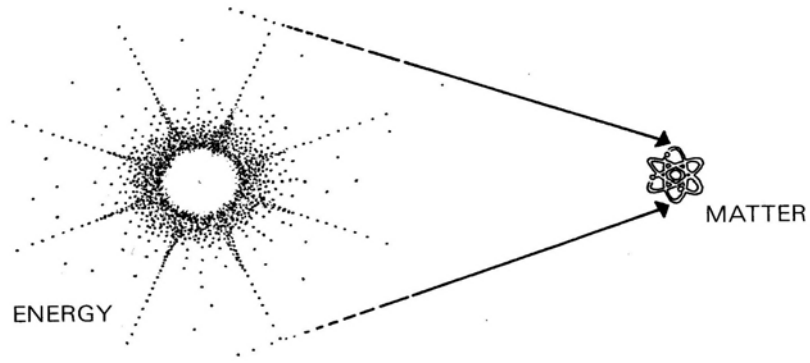

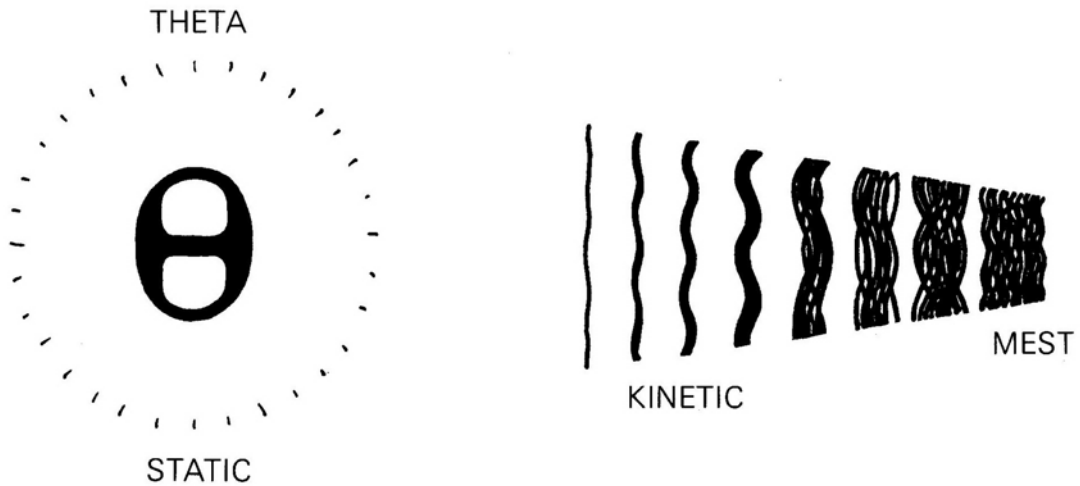

The January, 1979 issue of *Omni* magazine published a short article on the behavior of atoms together with a photograph of the first color films of the atom. The picture showed a blowup of some uranium atoms magnified 15 million times by an electron microscope, yet what was seen, baffled the scientists who had done the filming. Instead of seeing a bunch of static particles, what they saw, in their own words, looked "more like liquids than metals." They found that atoms just weren't sitting still but were shuttling back and forth, leaping in and out of the carbon depressions that supported them. They were completely astonished and had no way of explaining the phenomenon. They did not know the simple fact that matter is composed of condensed energy.

In the physical universe, the only true static is the thetan. The thetan has no mass, no motion, no wavelength, no location in space or in time.

At the opposite end of the spectrum, we have the ultimate in motion, or to be more technical, kinetic, and that is mest.

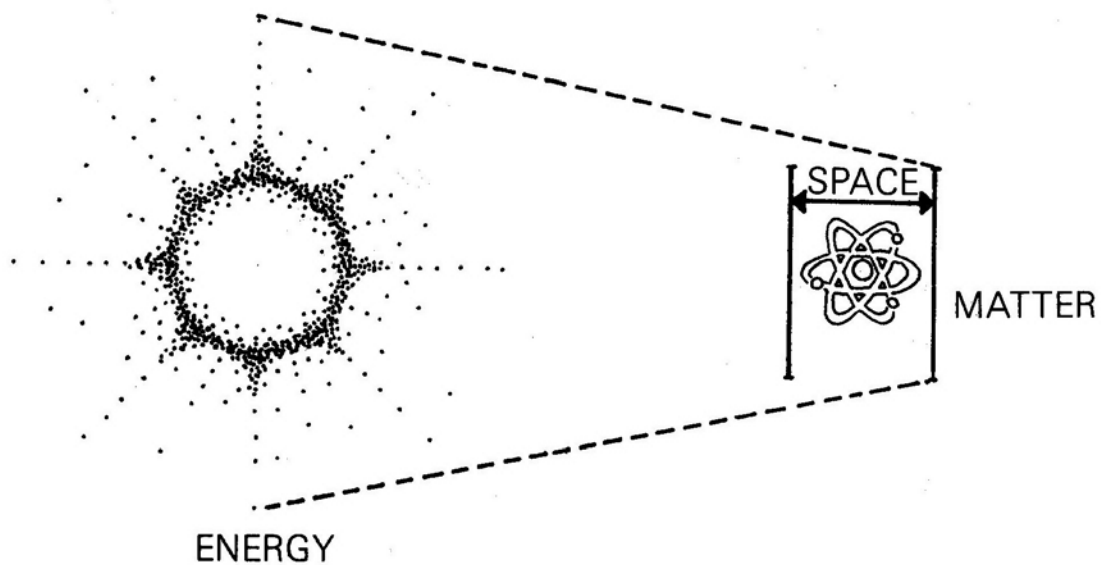

Formerly a static was defined only as a motionless object. This definition is not adequate, since an object - or a state of rest for an object - is attained only by an equilibrium of forces, and all objects have in themselves, if only on a molecular level, motion, and exist in space, which is itself an integral portion of motion. Hence we see we are dealing with a higher level static.

The word is from Latin *sto*, meaning *stand*. No part of mest can be static, but theta is static. Theta has no motion. Even when the mest it controls is moving in space and time, theta is not moving, since theta is not in space or time.

In Scientology, the static is represented by the mathematical symbol theta (θ); the kinetic is called mest. The static interacts with the kinetic, which is considered to be the ultimate of motion.

One cannot consider matter without also considering energy. In order to have matter, one must have space and must have had energy.

Time

"Viewpoint of dimension" is of course the definition of space; when we have dimension we can mark the dimension by dimension points, and when we get dimension points in there we get our first entrance into TIME. Time would be marked by the co-action of these particles which the person was using for dimension points. Time is the co-motion of particles.

It's a funny thing about this definition of time, the "co-motion of particles," particles moving with particles in relationship to particles. It determines then that you must have same kind of a unit viewpoint to have time, because you wouldn't get particles co-moving which were in entirely disrelated spaces. They wouldn't be moving in relationship to each other.

So the keynote of time is "relationship." In order to have time at all something must be related to something. We must have particles relating to particles in order to have time. If you have particles which are in no way capable of being related to some other particles, we wouldn't get a time which embraces both of those particles.

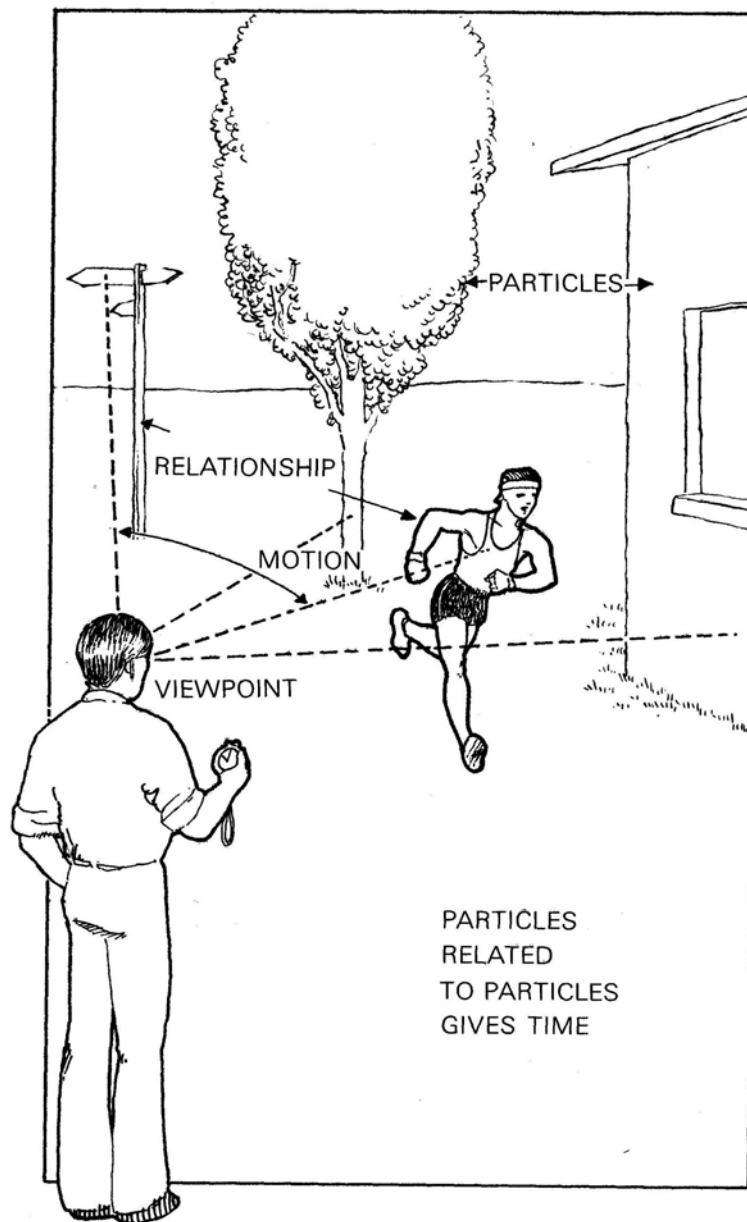

Time depends upon the capability of particles to Game into collision or contact, no matter how long it might take or impossible it might seem to get these particles to do this. The capability of contact is our sole condition as to a unit time. Any set of particles which have the capability of contacting one another, no matter at what distance or anything else, just the capability of contacting one another, can have a unit time.

Time is basically a postulate that space and particles will persist. (The rate of their persistence is what we measure with clocks and the motion of heavenly bodies.) Time exists in those things a thetan creates. It is a shift of particles, always making new space, always at an agreed upon rate.

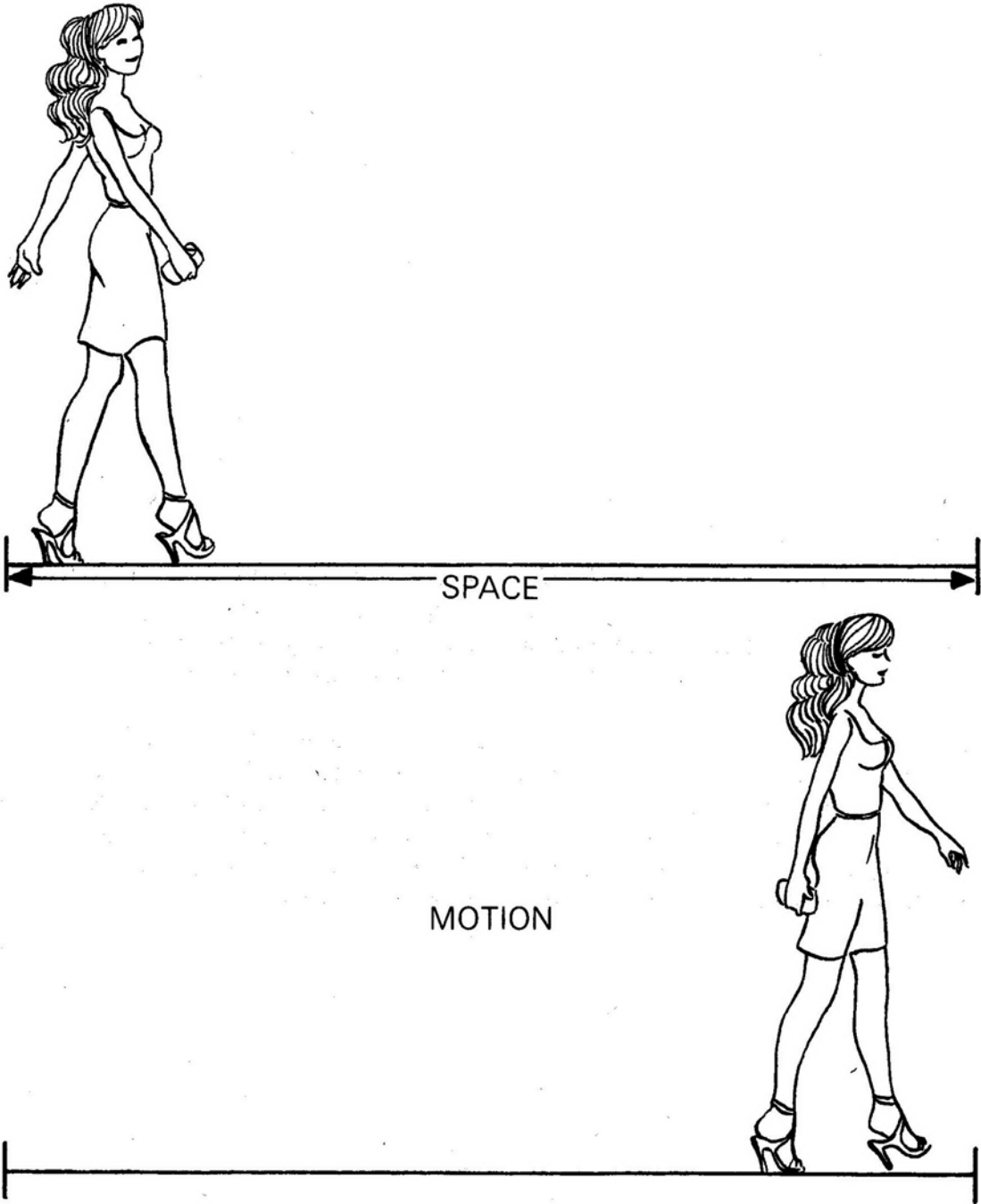

Time is actually a consideration, but there is the experience of time. There is a distance, there is a velocity of particle travel - and the movement of that particle in relationship to its starting point and in relationship to its ending point, itself is the consideration of time.

In order to have time one has to have space and same energy or matter in that space and some motion. Time is measured by motion. Motion is matter with energy in space. Thus a person can conceive of time as only matter and energy in space, such as a clock or a planetary rotation. Time is actual. But the person has become so dependent on matter moving in space to tell time that his time sense has become dependent on matter, energy and space.

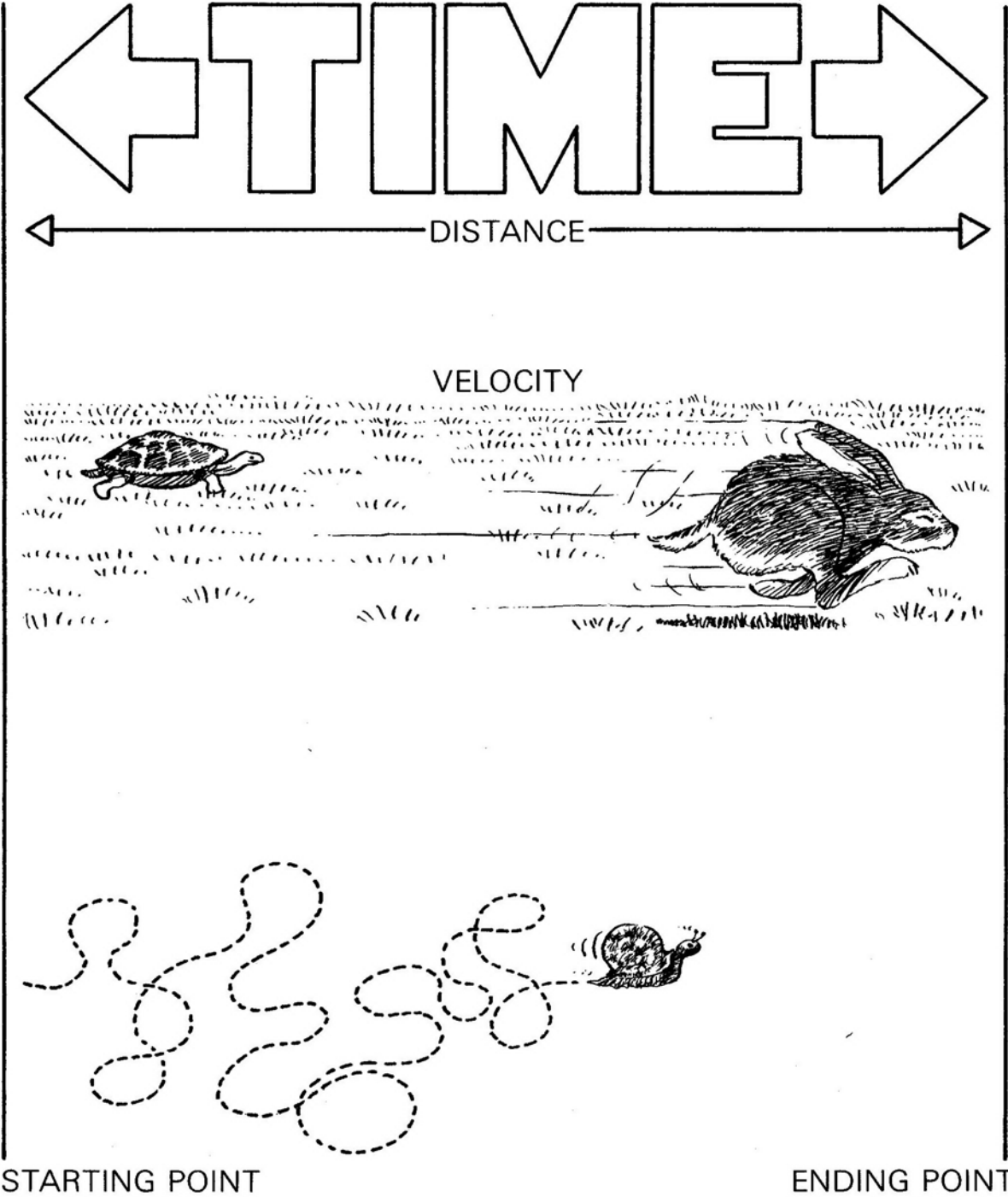

Let us assume that you were in a location that did not have a gun but there was a constant source of light, and there were no watches or clocks. How would the time appear to you? Remember those days when you were very busy and there was a lot of motion going on and things getting done? Remember how the time just seemed to fly along and you could hardly believe your eyes when you looked at your watch?

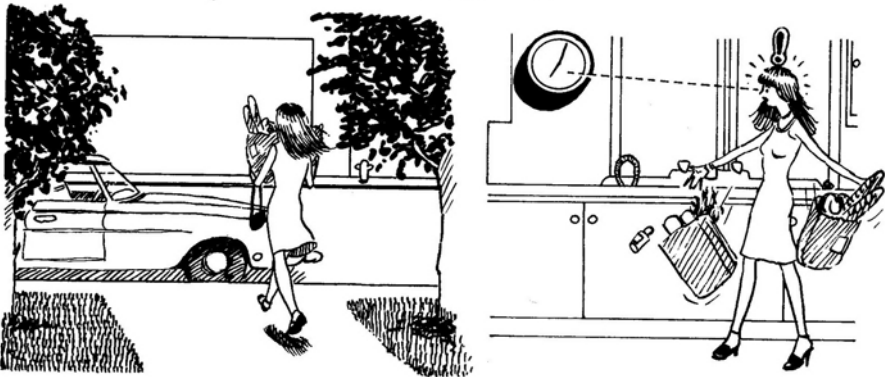
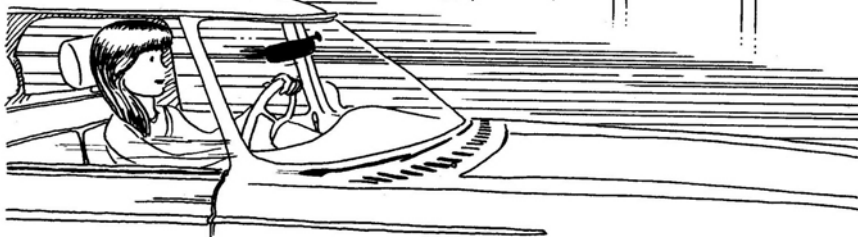
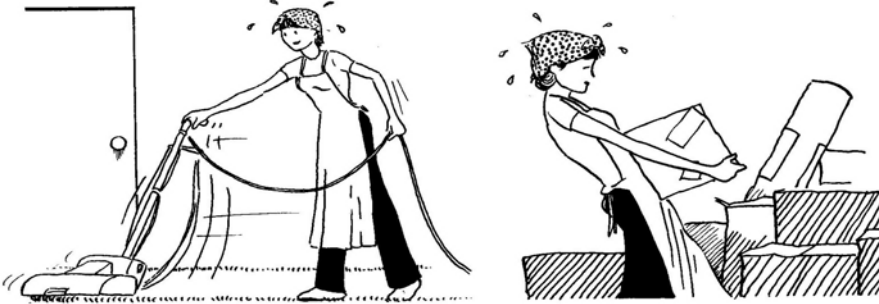
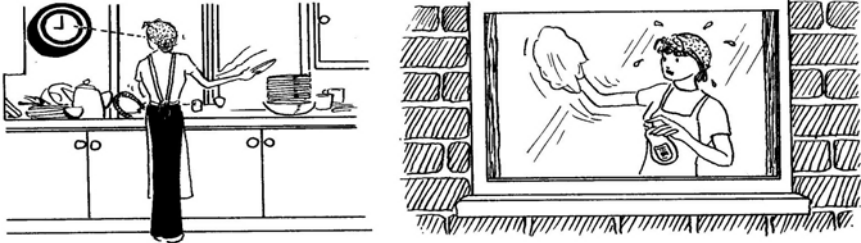

Then there are those days when time just seems to drag on. This is especially evident when you are waiting for something to happen or someone to arrive or waiting for a store to open or for the weekend to come along. Notice how slow the motion seemed and constant glances at your watch made you feel sure that your timepiece had stopped? You may even have gone so far as to rewind the thing or give it a few shakes and listen to it tick, so sure were you that the timepiece was wrong.

If something seems to move very slowly, it looks like a lot of time has gone by. If it moves very fast, only a little time appears to have gone by. Very little happening-time seems to drag. Lots of things happening-time flies.

In the most universe however, we have a constant of change most manifest in light and dark, in the change in position of the planets and the sun, and we have set a constant of time and relate all our motions to that arbitrary of motion called day and night and have subdivided that change up into segments called hours, minutes and seconds, days, weeks, months and years. These time periods are all made manifest by the constant in change of position in space of the planets and sun. In other words, we are constantly relating the speed of particle flow to the arbitrary we measure with a watch or clock or sandglass. Each of these measure change, and change is the primary manifestation of time.

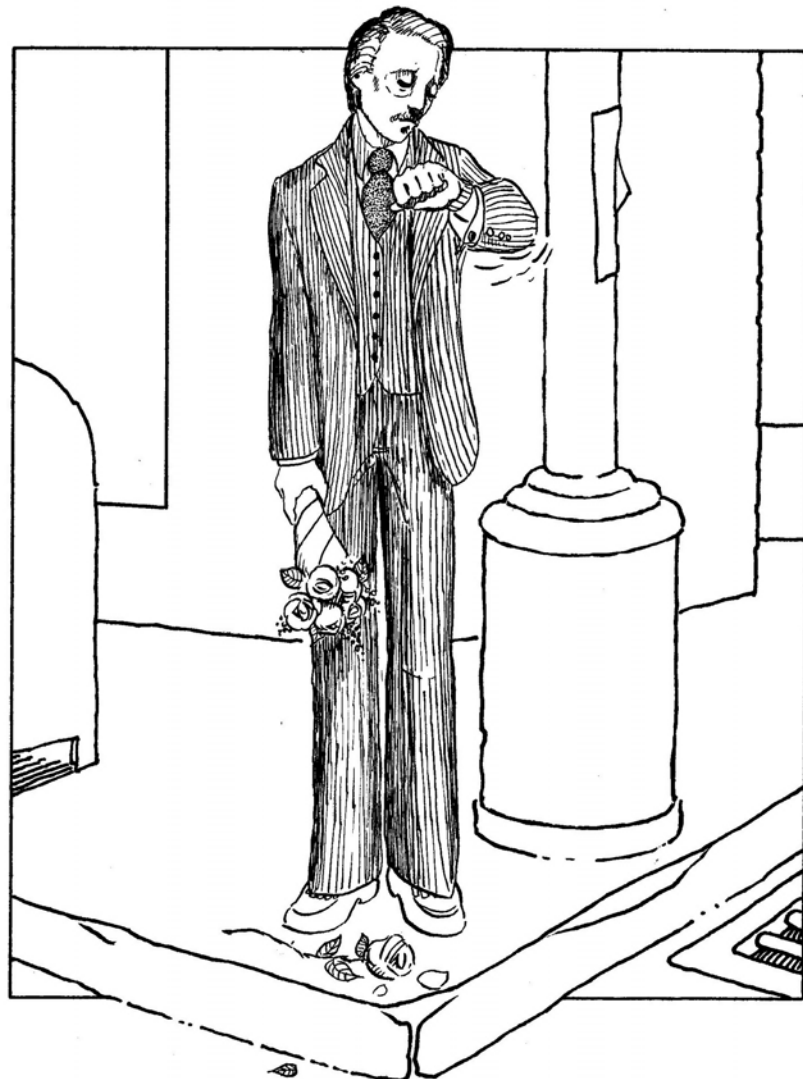

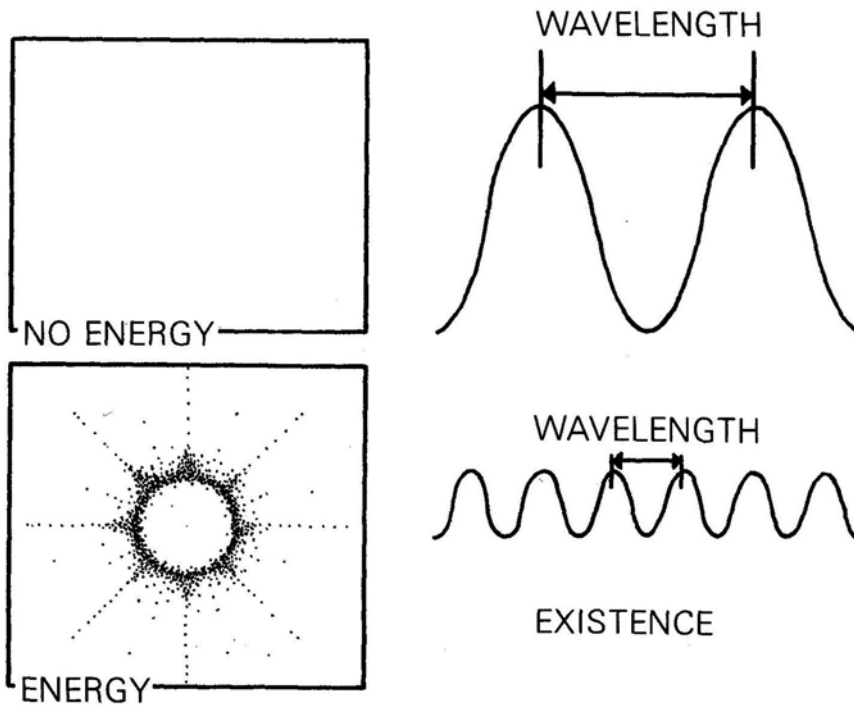

Energy

Energy consists of postulated particles in space - *Axiom 5*.

In Scientology, the word postulate means to cause a thinkingness or consideration. It is a specially applied word and is defined as causative thinkingness. (The static is capable of considerations, postulates, and opinions - *Axiom 2*.)

One considers that energy exists and that he can perceive energy. He also considers that energy behaves according to certain agreed upon laws. These assumptions or considerations are the totality of energy.

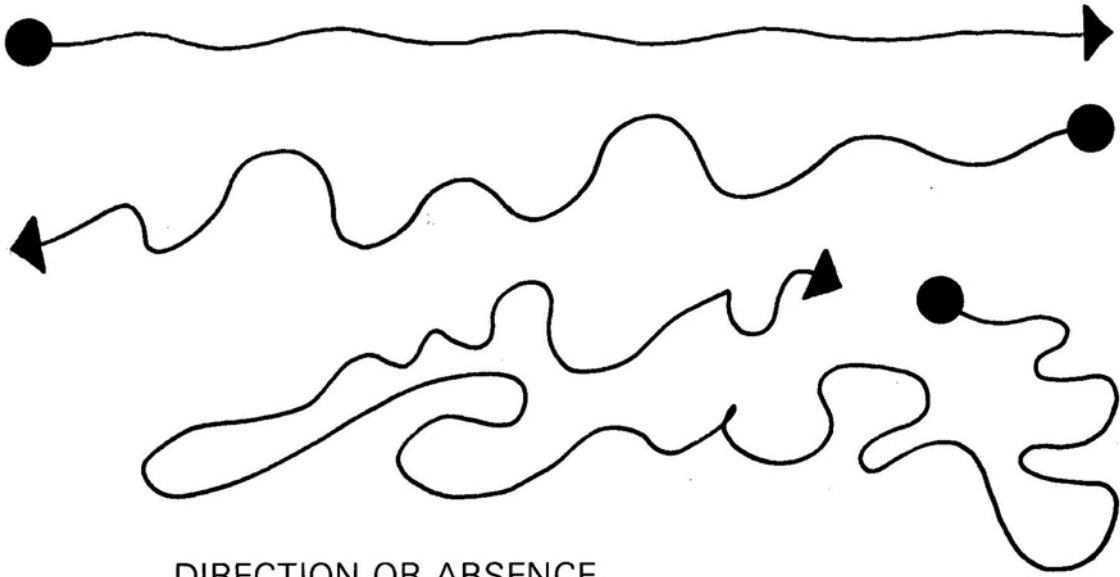

DIRECTION OR ABSENCE
OF DIRECTION

Space, energy, objects, form, and time are the result of considerations made and/or agreed upon or not by the static, and are perceived solely the static considers that it can perceive them - *Axiom 3*.

The qualities of energy are three in number: the first is its existing characteristics; the second is its wavelength; the third is its direction of flow or absence of direction of flow.

The characteristics can be divided into three classes in their turn. These are flows, dispersals and ridges. The flow is a transfer of energy from one point to another, and the energy in a flow can have any type of wave. Flowingness is simply the characteristic of transferringness.

A dispersal is a series of outflows from a common point. A dispersal is, primarily, a number of flows extending from a common center. The best example of a dispersal is an explosion. There is such a thing as an in-dispersal. This would be where the flows are all traveling towards a common center. One might call this an implosion. Outflow and inflow from a common center are classified alike under the word "dispersal" for handy classification.

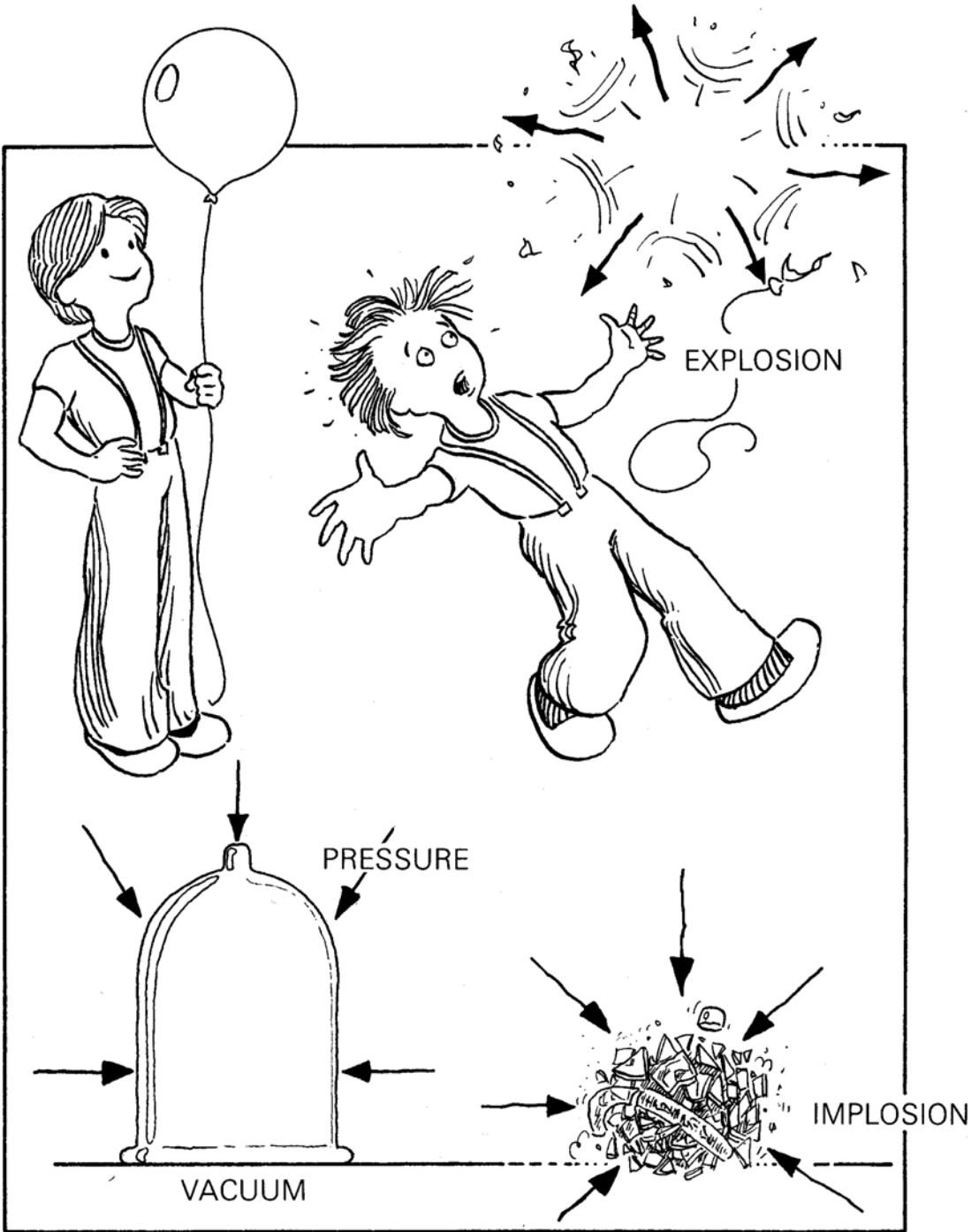

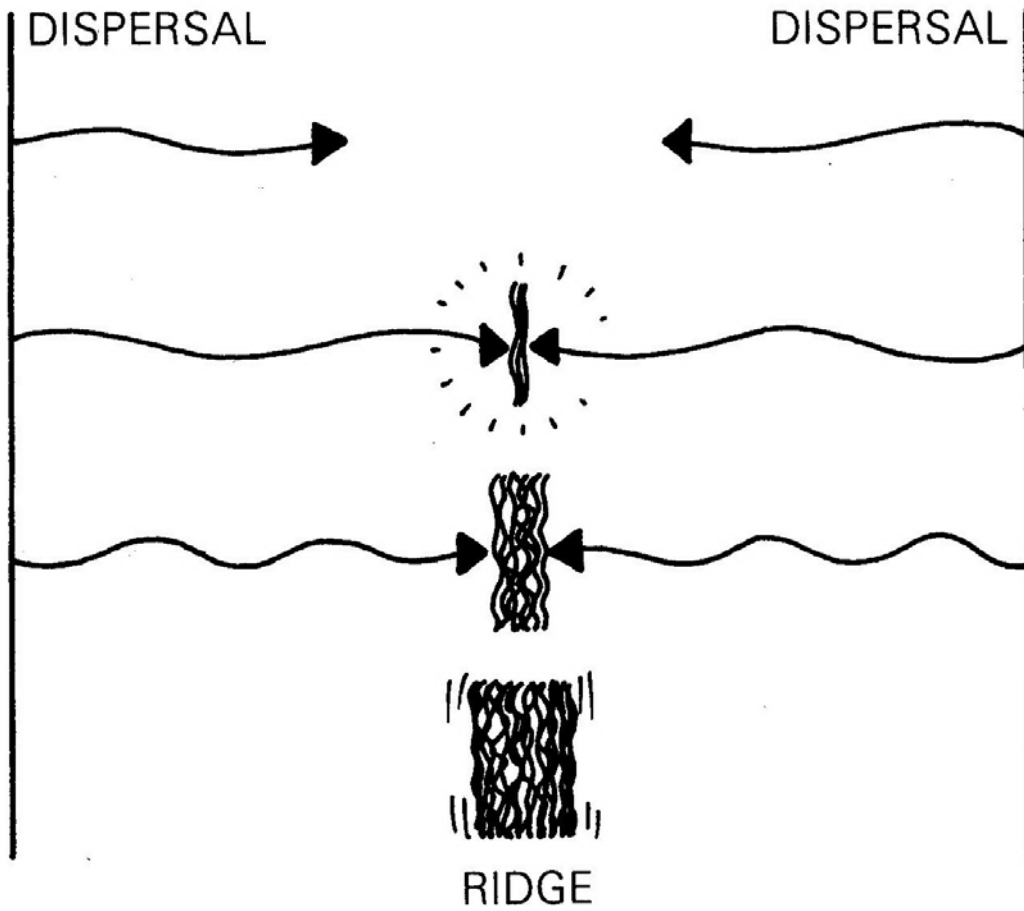

The third type of energy characteristic is the ridge. A ridge is essentially suspended energy in space. It comes about by flows, dispersals or ridges impinging against one another with a sufficient solidity to cause an enduring state of energy. A dispersal from the right and a dispersal from the left colliding in space with sufficient volume create a ridge which then exists after the flow itself has ceased. The duration of ridges is quite long.

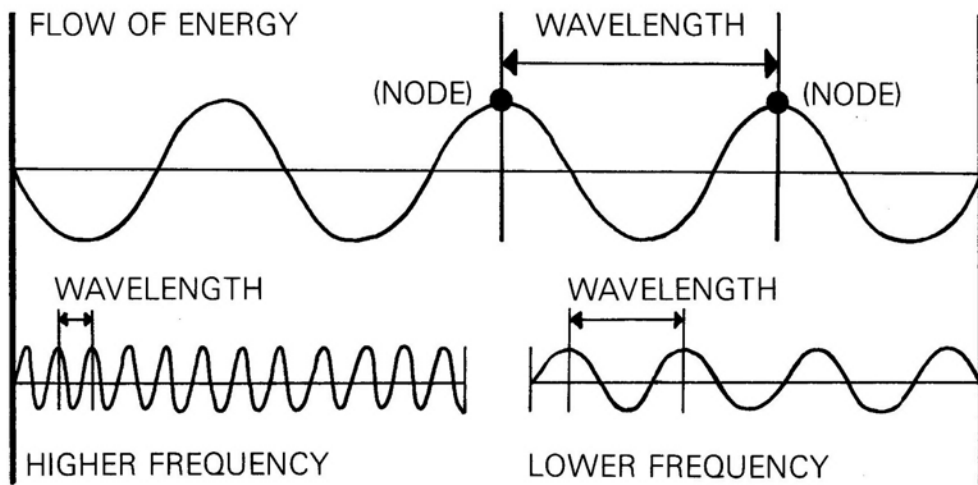

A wavelength is a characteristic of motion. Many motions are too random, too chaotic to have orderly wavelengths. An orderly wavelength is a flow of motion. It has a regular repeated distance between its crests. Take a rope or a garden hose and give it a flip. You will see a wave travel along it. Energy, whether electrical, light or sound, has same such pattern.

Wavelength is the relative distance from node to node (see diagram above) in any flow of energy. In the most universe, wavelength is commonly measured in centimeters or meters. The higher the frequency, the shorter the wavelength is considered to be on the gradient scale of wavelengths. The lower the frequency, the longer the wavelength is considered to be on a gradient scale.

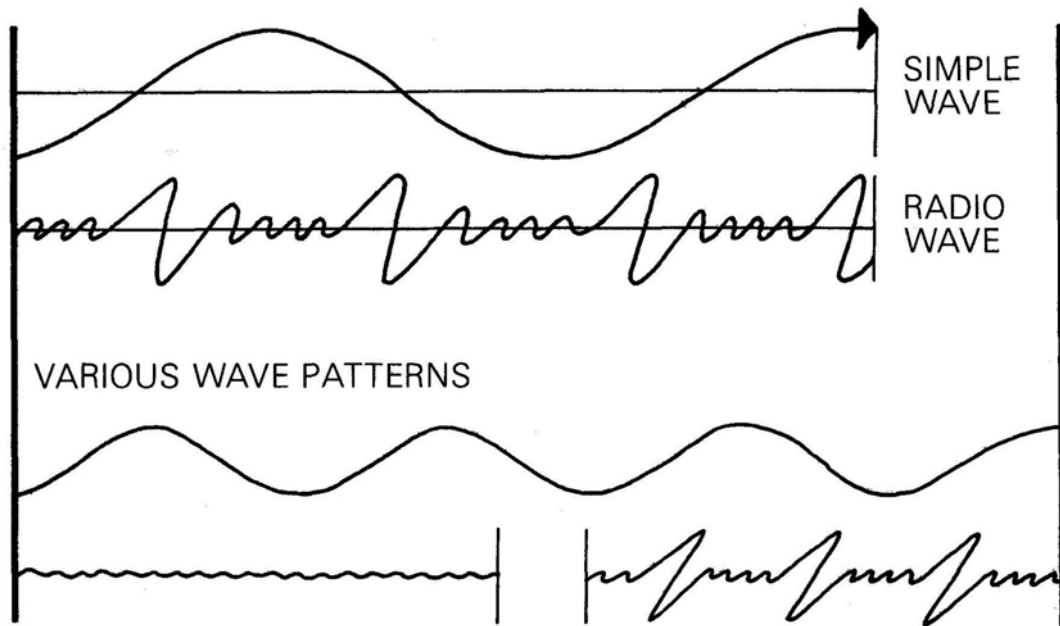

Some examples of wavelengths are:

Radio waves range from several hundred meters, to centimeters and smaller for high frequency radio waves. Light waves range between 3800 and 7600 X 10 millionths of a millimeter. Emotion waves are about .024 centimeters, analytical thought about .0000002 centimeters and aesthetics in the band of about .00000000000000000000000002 centimeters! At the top of the scale is theta itself, which has no wavelength.

Radio, sound, light and other manifestations each has its place on the gradient scale of wavelengths. Wavelength has no bearing upon wave characteristic, but applies to the flow or potential flow. A ridge has potential flow which, when released, may be supposed to have a wavelength.

The various perceptions of the body and the thetan, each one is established by a position on the gradient scale of wavelengths. They are each one an energy flow.

The Thetan and the Physical Universe

The tendency of the physical universe is condensation and solidification. At least this is the effect produced on the thetan. Continued dwelling in it without rehabilitation causes the thetan to become less reaching ("smaller") and more solid. A thetan, being a static, may become convinced he cannot duplicate matter, energy, space, or time or certain intentions and so succumbs to the influence of this universe. This influence in itself would be negligible unless recorded by the thetan, stored and made reactive upon the thetan as a "time track," and then maliciously used to trap the thetan.

Actually, the origin of mest lies with theta itself, and mest, as we know the physical universe, is a product of theta. The physicist has adequately demonstrated that matter seems to be composed of energy which has become condensed in certain patterns. It can also be adequately demonstrated in Scientology that energy is produced by and does emanate from theta.

Thus it is that theta, producing energy, condenses the space in which the energy is contained, which then becomes matter. The static has the peculiarity of acting as a "mirror." It records and holds the images of motion. It can even create motion and record and hold the image of that. It records also space and time in order to record motion, which is, after all, only "change in space through time."

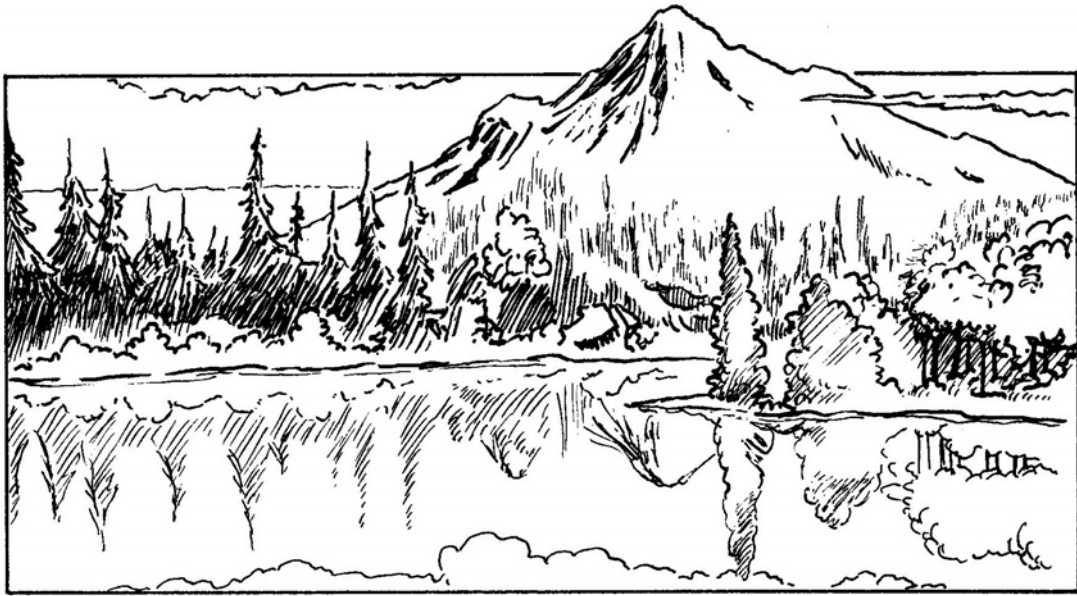

This leads us to memory. A memory is defined as "a recording of the physical universe." Any memory contains a time index (when it happened) and a pattern of motion. As a lake reflects the trees and moving clouds, so does a memory reflect the physical universe. Sight, sound, pain, emotion, effort, conclusions and many other things are recorded in this static for any given instant of observation.

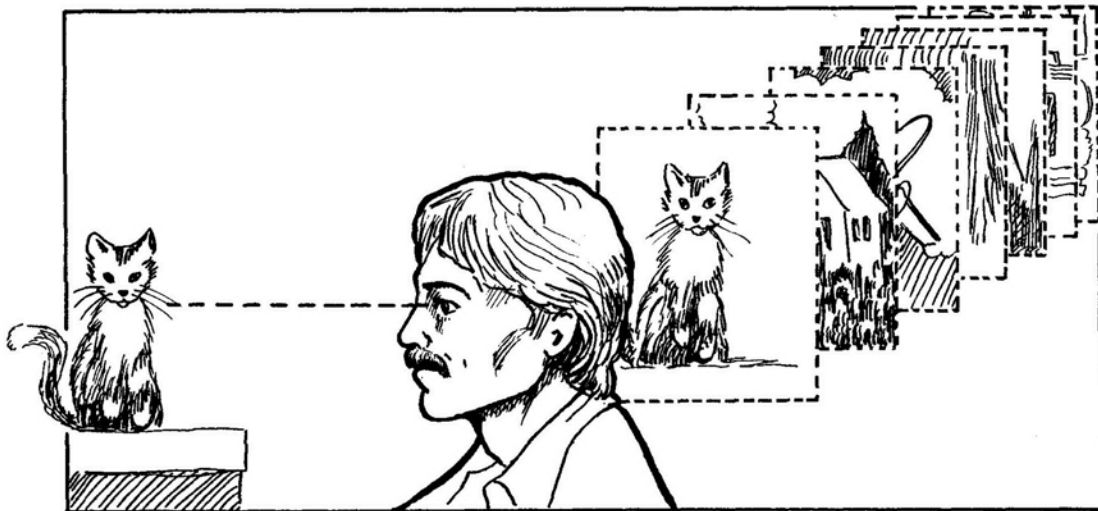

Such a memory we call a facsimile. A facsimile is "made" by the mind's ability to duplicate the wave or motion patterns of the physical universe. The mind, examining a facsimile it has made, can see it, feel it, hear it, re-experience the pain in it, the effort, the emotion.

Now we see that a facsimile can have a mirrored set of wavelengths which match any wave in the physical universe. Actually, theta can create waves. Thus the facsimile can contain heavy effort or emotion and throw that back at the preclear. A facsimile, restimulated by the preclear's attention units, can contain enough force to bow his back out of shape, scar his flesh, give him actual electrical shocks, or make him hot enough to run a fever, to say nothing of changing his ideas.

Theta can be forced to have facsimiles it did not create. Hit a man, operate on him, beat him, give him a shock - he then will have a facsimile which can reactivate when his attention units, later on, accidentally sweep over it.

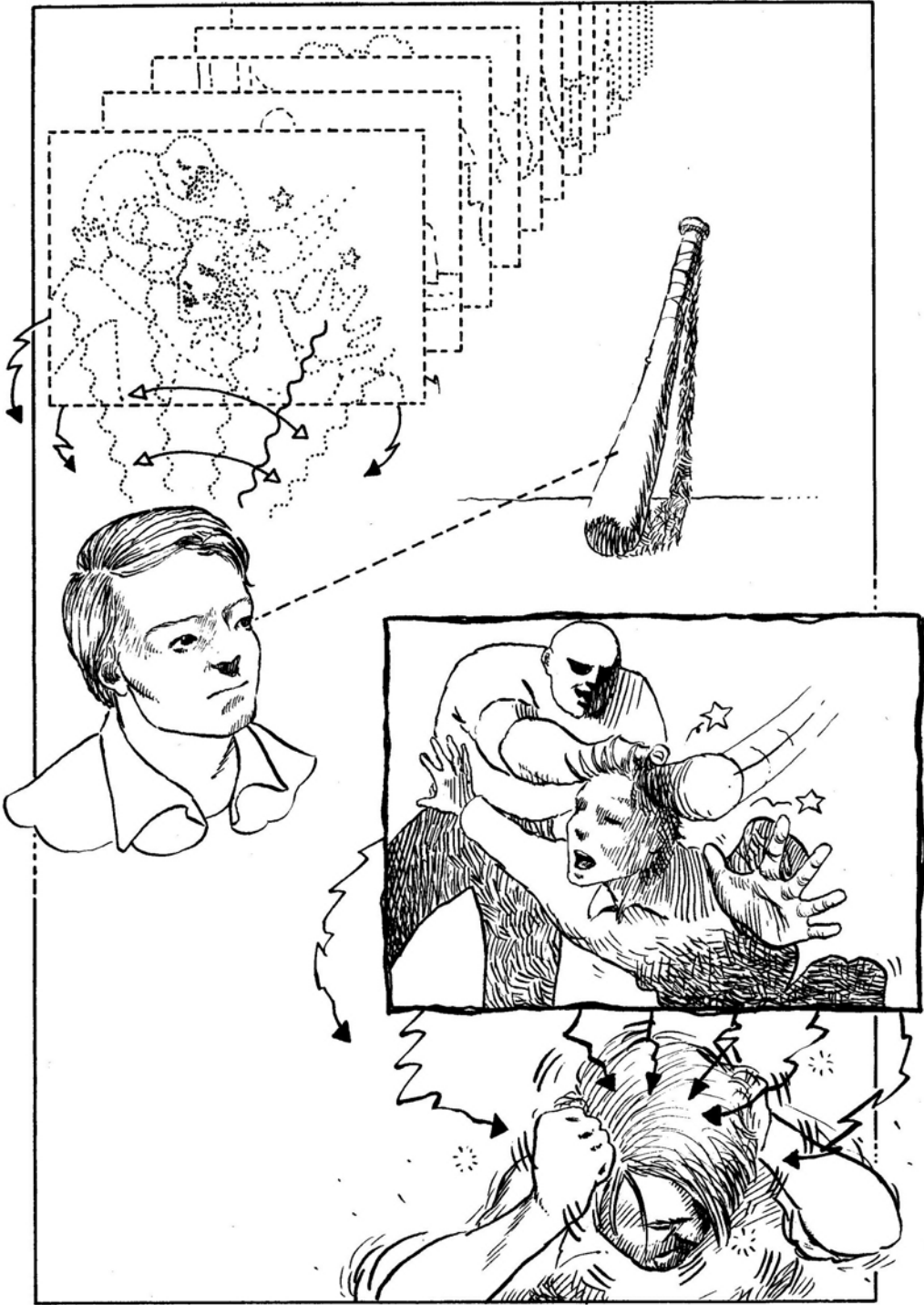

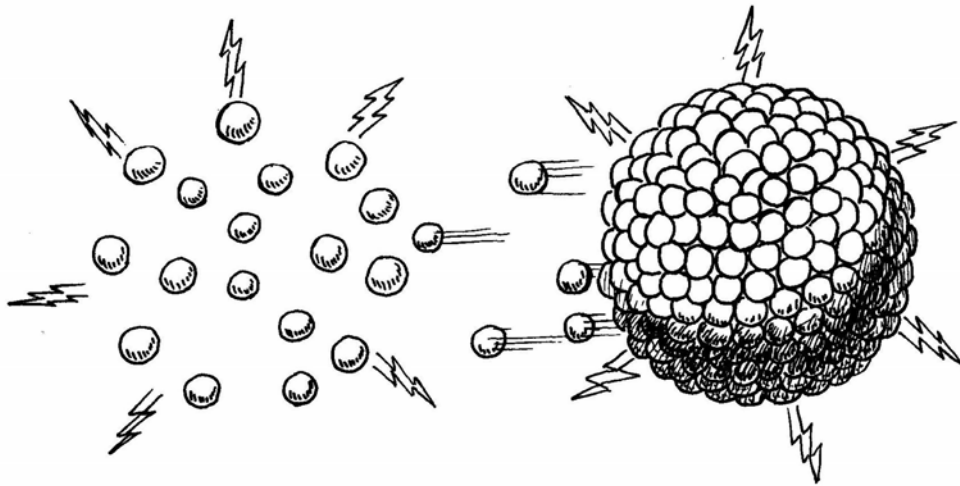

DIFFERENCE IN POTENTIAL

Theta and Energy

The basic principle of energy production by a being has been copied in electronics. It is very simple. A difference of potential of two areas can establish an energy flow of themselves. Carbon batteries, electric generators and other producers of electrical flows act on the principle that a difference of energy potential in two or more areas can cause an electrical impulse to flow between or amongst them. Relative speeds determine potential.

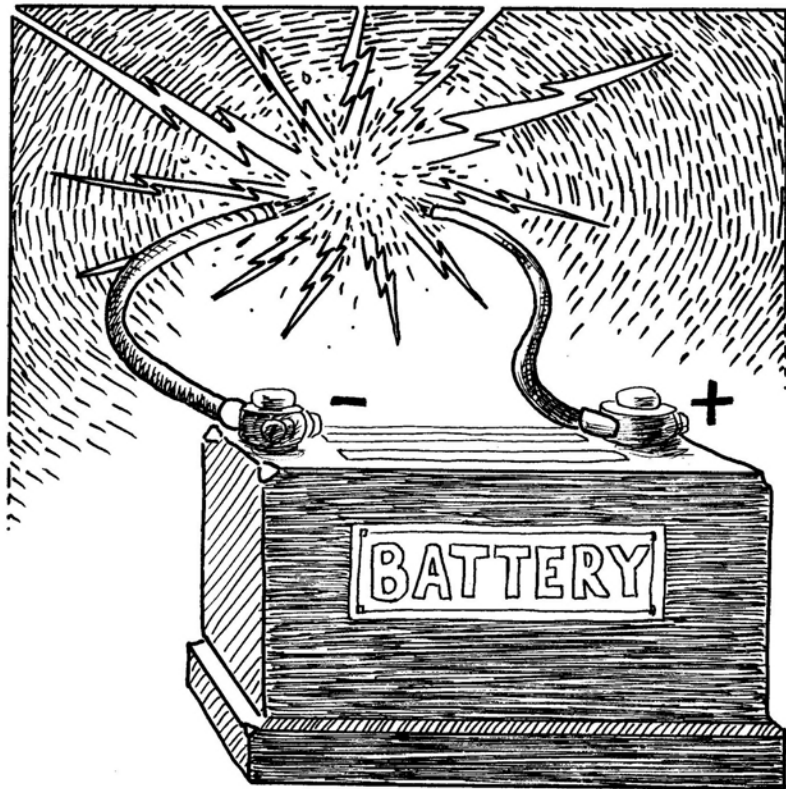

DIFFERENCE IN POTENTIAL
OF THE TERMINALS
IN A MOTOR CAR BATTERY

Actually, *any* difference of potential played one against the other creates energy. Aesthetic waves against a static produce energy. Aesthetic waves against analytical waves produce energy. Analytical waves against emotional waves produce energy. Emotional waves against effort waves produce energy. Effort against matter produces energy. The last, by the way, is the method used on Earth in generating electrical current for power. The others are equally valid and produce even higher flows.

With the thetan, there occurs an interplay of static against motion or between two classes of motion, one relatively static to the other, and this can and does produce active electrical energy in beings of different characteristics and potentials. The preclear is static and kinetic, meaning he is no-motion and motion. These, interplaying, produce electrical flow.

This makes a living being an electrical field more capable of high potentials and varieties of waves than are known to nuclear physics, of which Scientology is a basic.

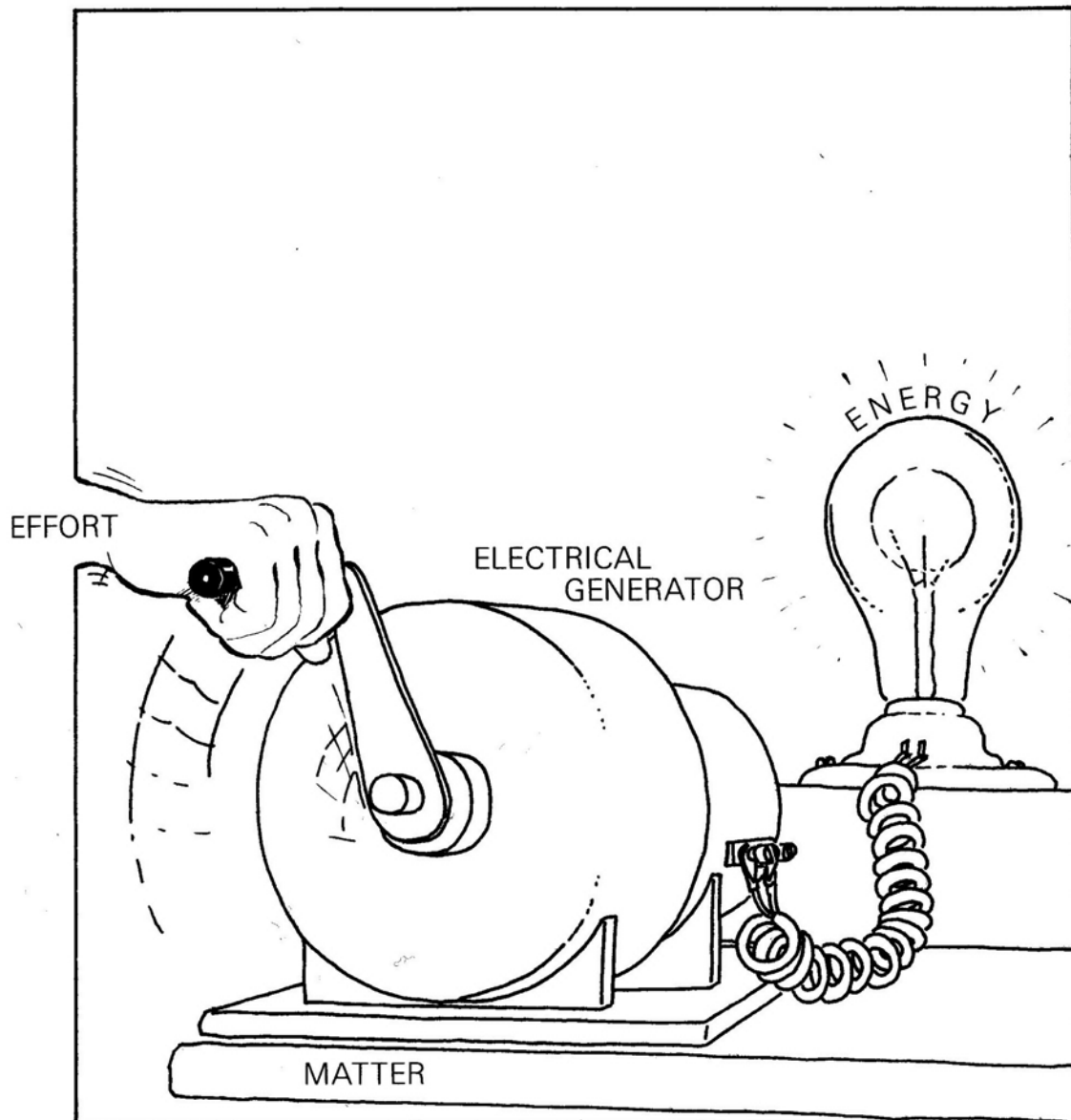

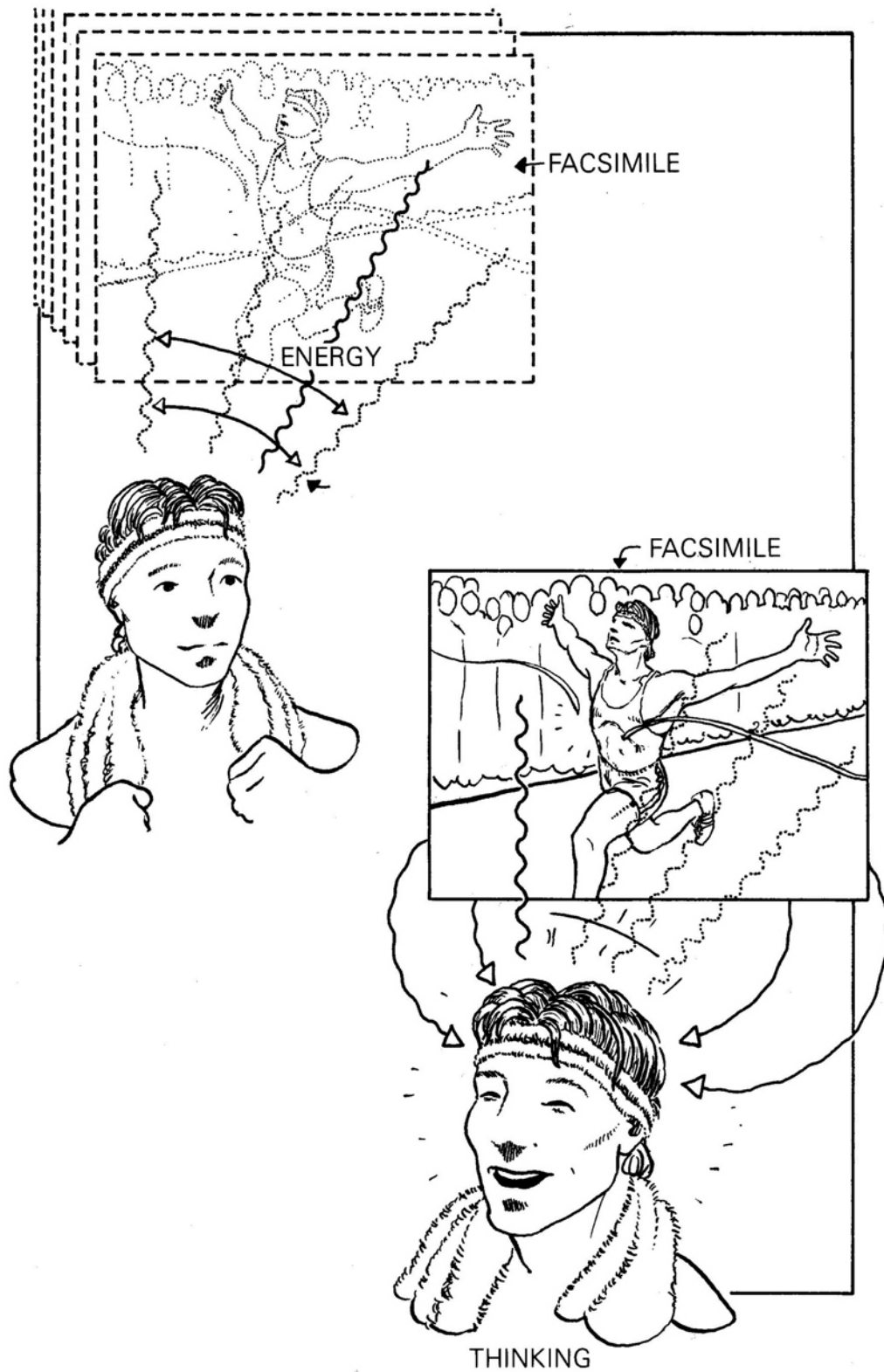

Attention units are actually flows of small wavelengths and definite frequency. These are measurable on specially designed oscilloscopes and meters. This created energy played lightly over a facsimile reactivates it and causes it to bear upon a being once more.

This is an activity of thinking.

A facsimile brought into play by a moment of intense activity may afterwards, when the being is again producing only normal energy output, "refuse" to be handled by the lower energy. This facsimile can then trap the energy of a being and turn upon him the pain, emotion and other things recorded in the facsimile. The facsimile thus can absorb energy and give pain, especially when the being holding it has forgotten it or does not perceive it.

This is restimulation.

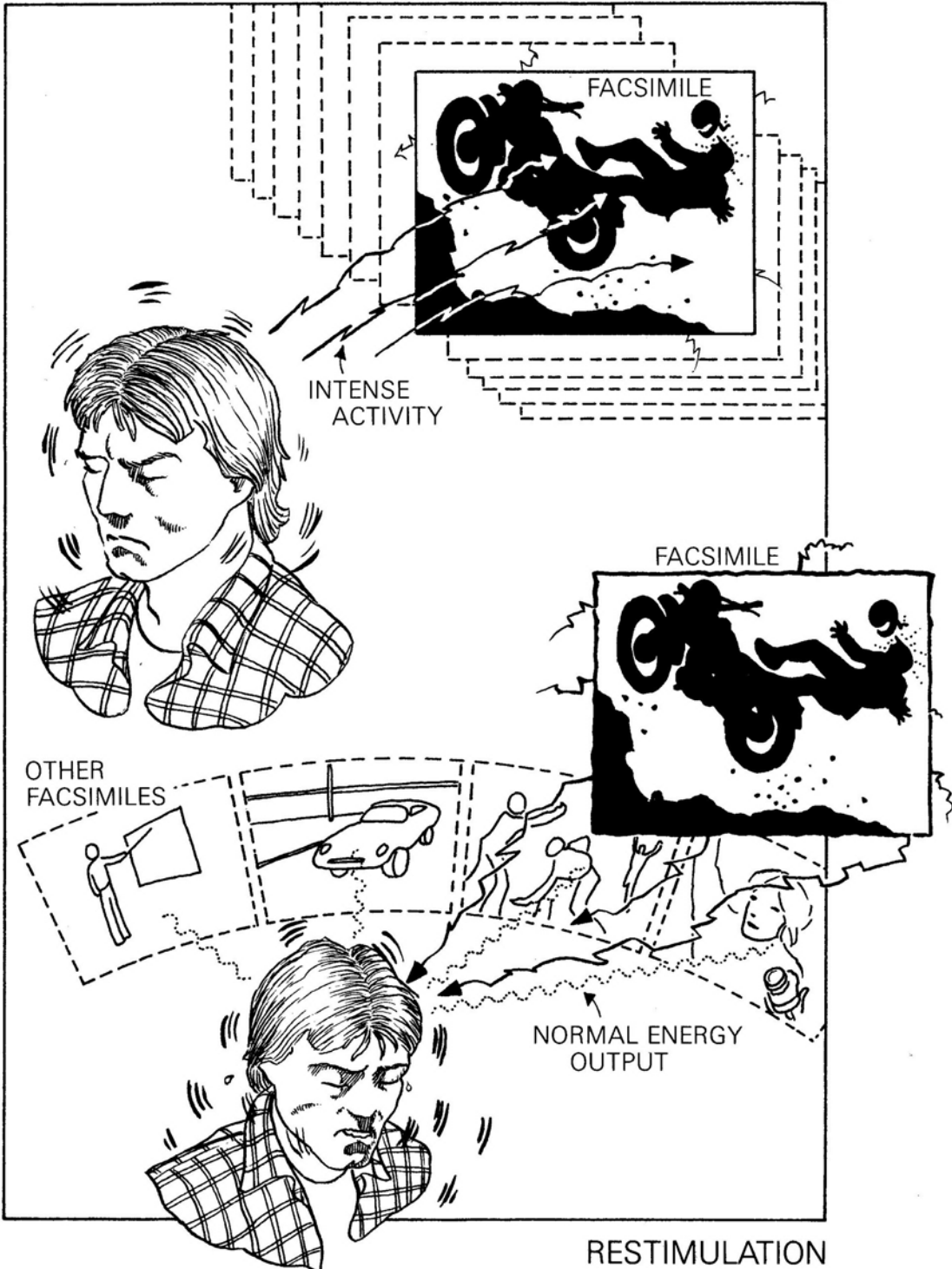

Facsimiles can disperse or flow when addressed by new energy, either exterior to the thetan or from the thetan. Thus the environment can set a facsimile into action or the thetan can set it into action.

By concentrating a live energy flow upon a facsimile directly, the being can erase, disintegrate, or explode or implode it.

As heavy facsimiles are the hidden source of human aberration and psychosomatic illness, their erasure or better handling by the being is intensely desirable.

We can rehabilitate the being by raising his ability to create energy, and thus bring him to a point where he has sufficient output to overcome facsimiles. We do this by erasing or reducing certain facsimiles, and, in doing so, retrain the being to produce a higher energy potential.

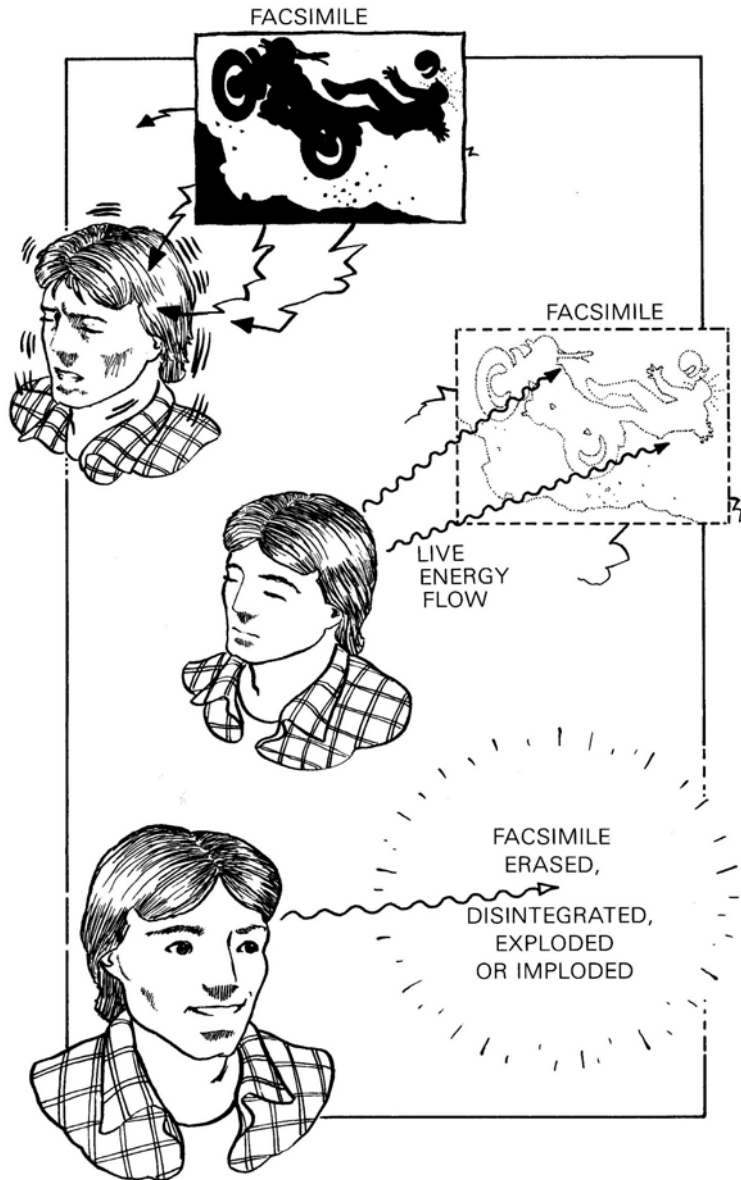

Theta and the Mest Body

The thetan is both outside and inside the mest body. It is not just inside. The only reason it is inside at all is that any field would penetrate the mest body. The mest body should not be thought of as a harbor or vessel for the theta being. A better example would be a sliver inserted unwantedly in the thumb where the thumb would be the theta being, the mest body the sliver.

The thetan flows electrical currents of command at the body. These hit pre-established ridges (areas of dense waves) and cause the body to perceive or act. The preclear takes from the body perception with tractor beams. He holds the body still or holds himself against it by wrapping a tractor (pulling) beam around it while placing a pressor (pushing) beam at his back to command himself into action.

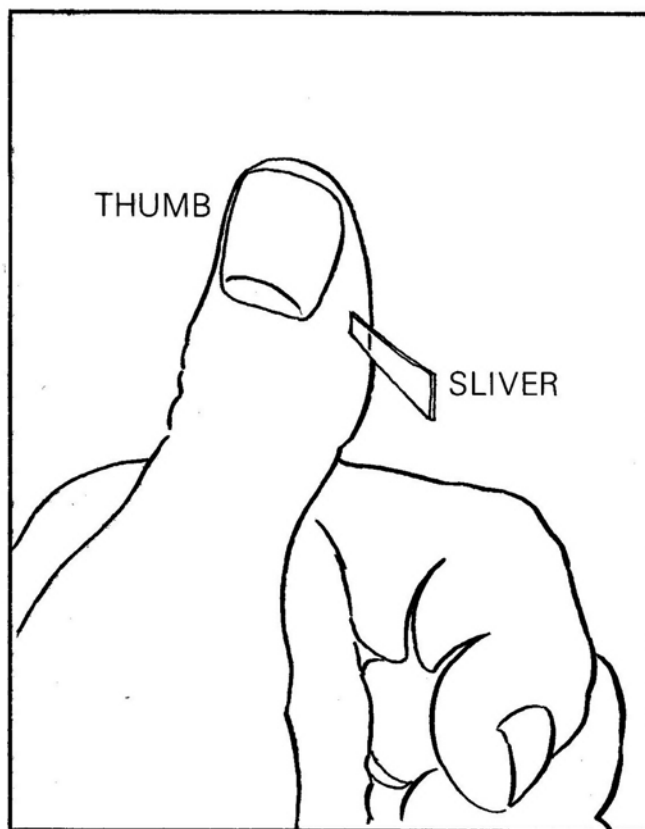

It was discovered in Scientology that a fixed electrical field existed surrounding a body entirely independent of, but influencable by, the human mind. The body exists in its own space. That space is created by "anchor points" (points which are anchored in a space different to the, physical universe around the body). The complexity of these anchor points, can cause an independent series of electronic flows which can occasion much discomfort to the individual. The balance structure of the body and even its joint action and physical characteristics can be changed by changing this electrical field which exists at a distance from, or within, the body.

This electrical field is paramount and monitors the actual physical structure of the body. Now, mental image pictures also influence the body, and they influence the body basically by influencing these anchor points. A facsimile evidently imposes itself by magnetic fields and currents and other things upon the anchor point system.

The body is then held together by electronic structure which is easily influencable, and that electronic structure has much more command upon the body than the mest around it.

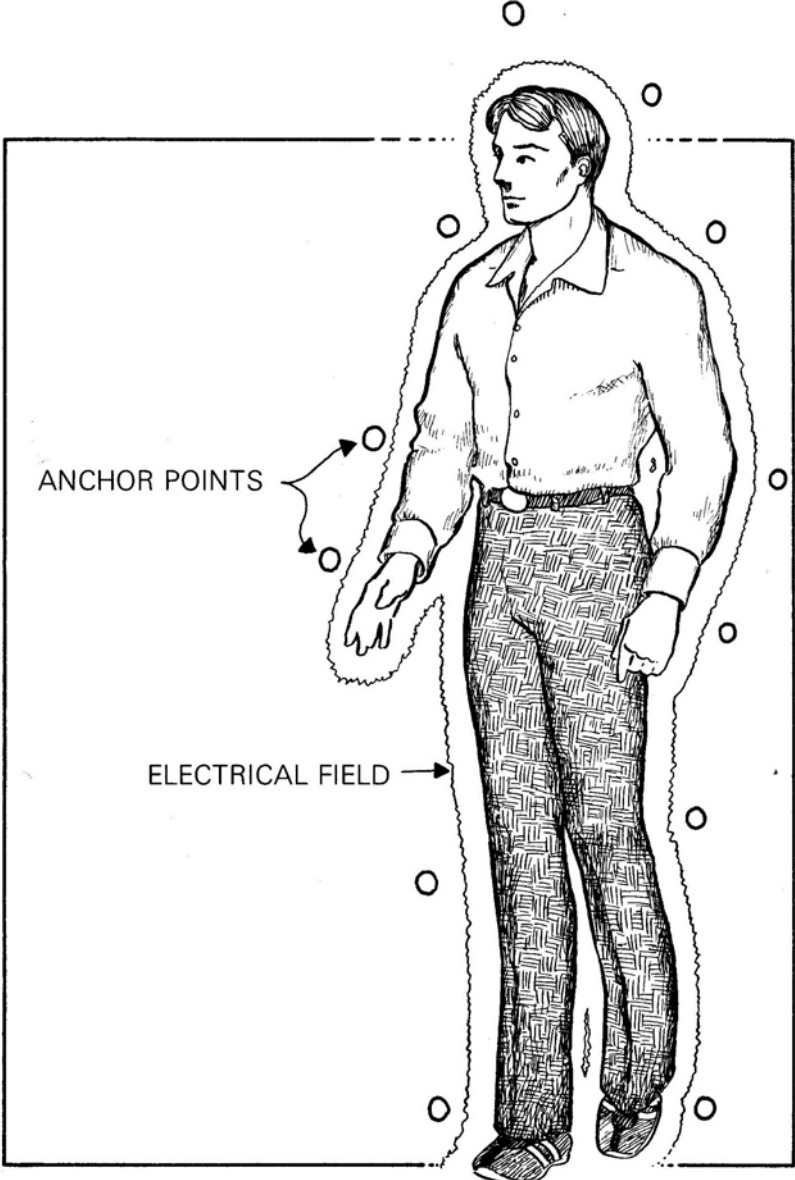

In Scientology it has been discovered that mental energy is simply a finer, higher level physical energy. The test of this is conclusive in that a thetan "mocking up" (creating) mental image pictures and thrusting them into the body can increase the body mass and by casting them away again can decrease the body mass. This test has actually been made and an increase of as much as thirty pounds, actually measured on scales, has been added to, and subtracted from, a body by creating "mental energy". Energy is energy. Matter is condensed energy.

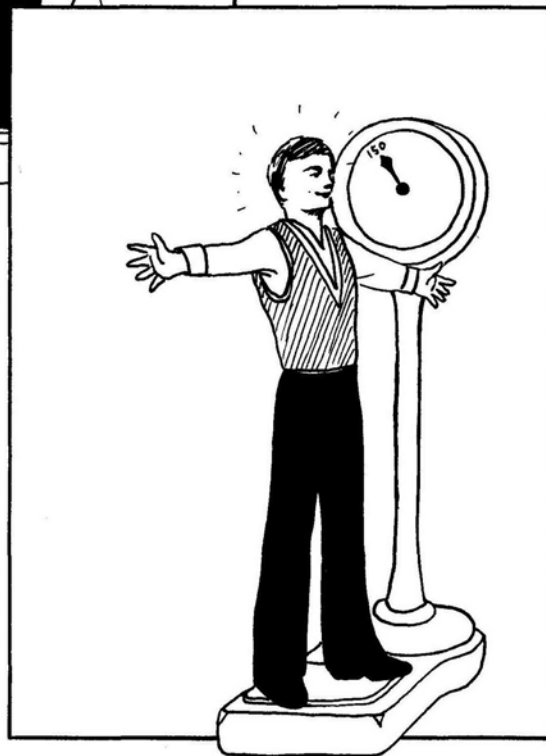
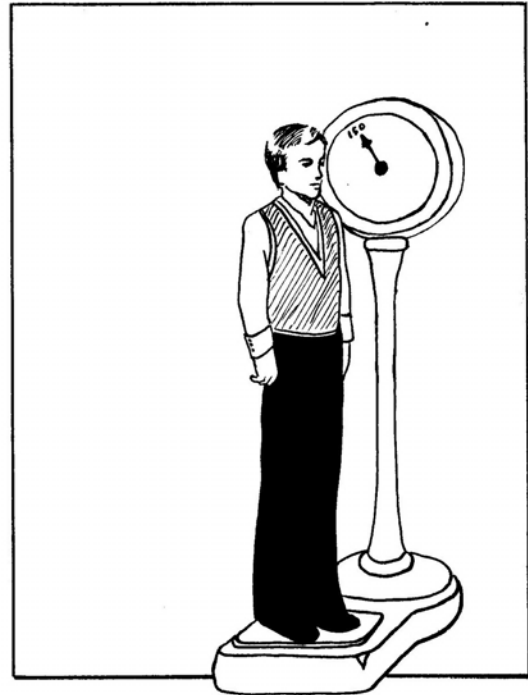
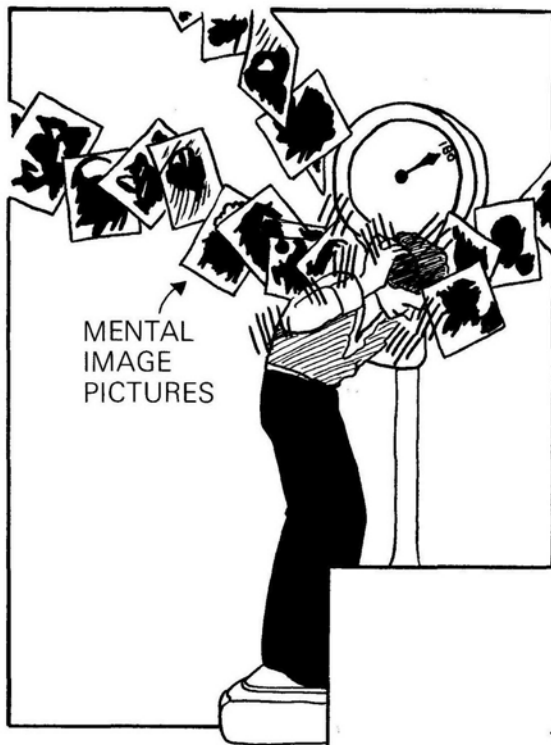

Charge and the Time Track

Charge, the stored quantities of energy in the time track, is the sole thing that is being relieved or removed by the auditor from the time track.

When this charge is present in huge amounts, the time track overwhelms the preclear and the preclear is thrust below observation of the actual track.

In response to the rhythm of the physical universe, undoubtedly assisted by overts and implants and convictions of the need of recording, the thetan began to respond to the physical universe in his creations and eventually obsessively created (by means of restimulatable involuntary intentions) the passing moments of the physical universe. But only when he began to consider these pictures important could they be used to aberrate him.

These are only partly permanently created. Other moments of the past become re-created only when the thetan's intention is directed to them, on which these parts spontaneously appear, the thetan not voluntarily creating them.

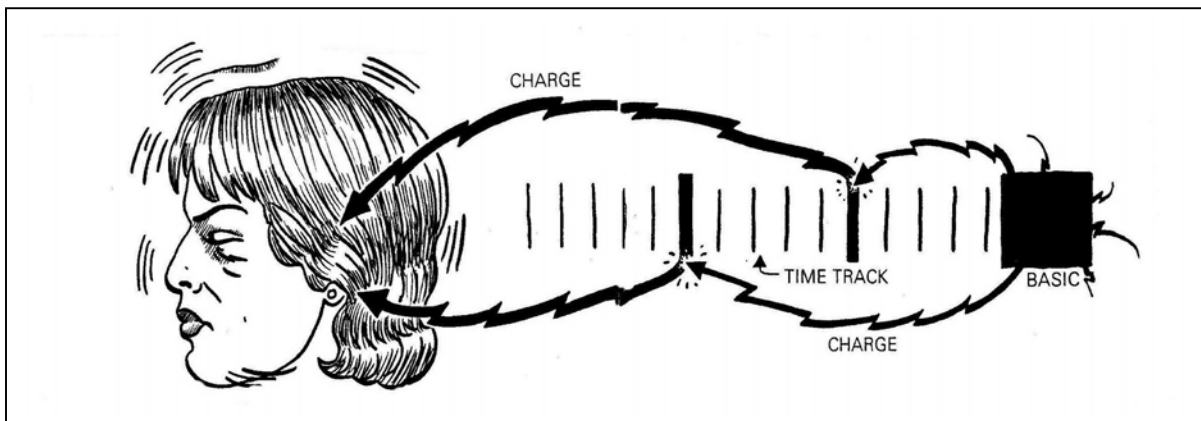

This forms the time track. Some parts of it, then, are "permanently" in a state of creation and the majority of it becoming created when the thetan's attention is directed to them.

The "permanently created" portions are those times of overwhelm and indecision which almost entirely submerged the thetan's own will and awareness.

Such parts are found in implants and great stresses. These parts are in permanent restimulation.

The mechanism of permanent restimulation consists of opposing forces of comparable magnitude which cause a balance which does not respond to current time and remains "timeless."

Such phenomena as the overt act-motivator sequence, the problem (postulate-counterpostulate), tend to hold certain portions of the time track in "permanent creation" and cause them to continue to exist in present time as unresolved masses, energies, spaces, times and significances.

All these things add up to charge, an impulse to withdraw from that which can't be withdrawn from or to approach that which can't be approached, and this, like a two-pole battery, generates current. This constantly generated current is chronic charge. The principal actions are:

a When the attention of the thetan is directed broadly in the direction of such a track record, the current increases

b When the attention is more closely (but not forcefully) and accurately directed, the current is discharged.

c When the basic on the chain is found and erased, that which composes the poles themselves is erased and later incidents erased, for no further generation is possible by that chain and it becomes incapable of producing further charge to be restimulated. The above are the actions which occur during auditing. If these actions do not occur despite auditing, then there is no case betterment, so it is the auditor's responsibility to make sure they do occur.

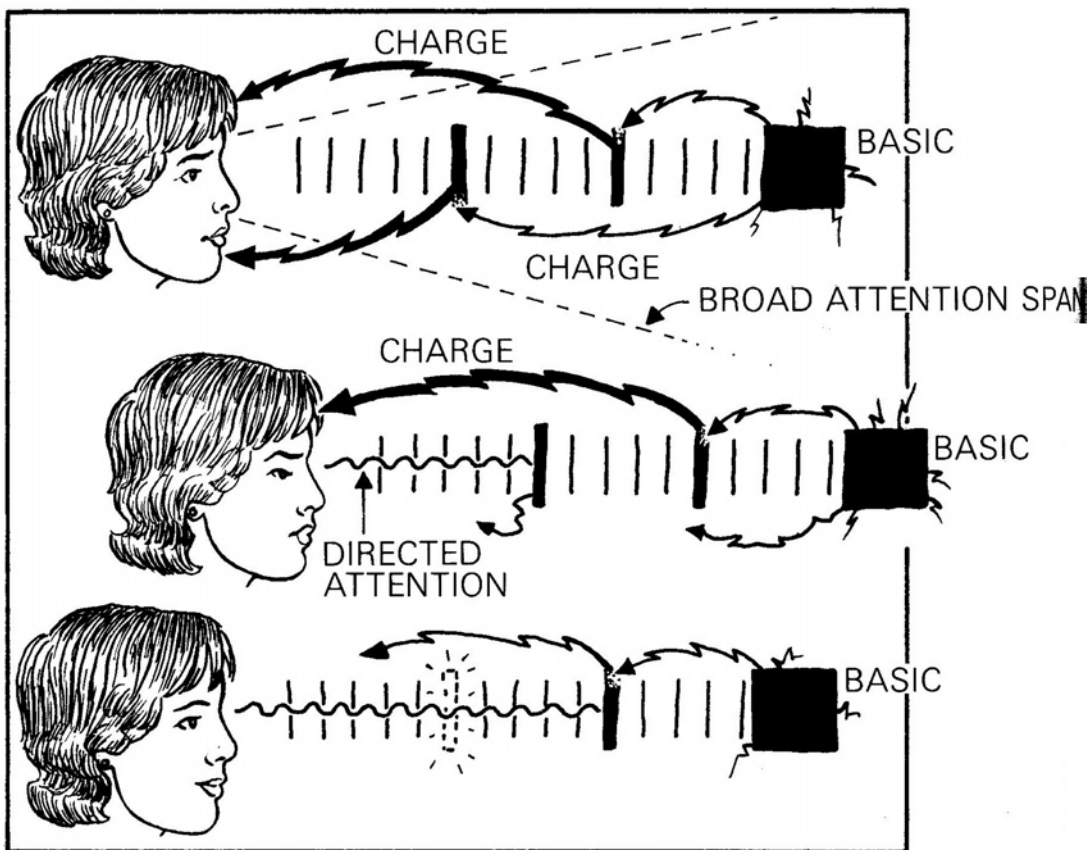

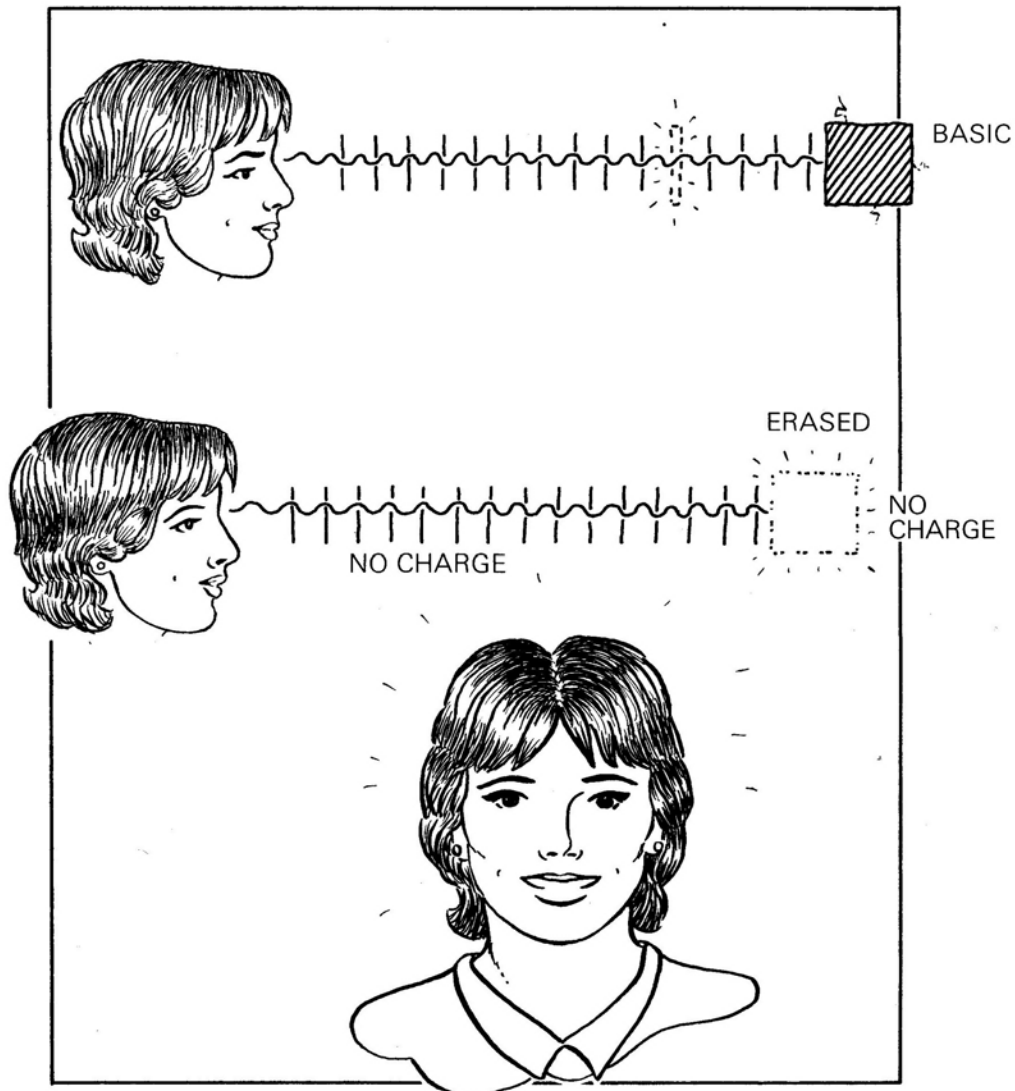

The mechanism of the time track can then be said to be the primary action in making a thetan solid, immobile and decisionless. For without a record of the past accumulating and forming a gradient of solidification of the thetan, the entrapment potential of the physical universe would be negligible and the havingness which it offers might be quite therapeutic. It probably requires more than just living in the physical universe to become aberrated. The main method of causing aberration and entrapment is therefore found in actions which create or confuse the time track.

A thetan has things beyond matter, energy, space and time which can deteriorate. His power of choice, his ability to keep two locations separate, his belief in self and his ethical standards are independent of material things. But these can be recorded in the time track as well and one sees them recover when no longer influenced by the time track.

As the thetan himself makes his own time track, even if under compulsion, and commits his own overts, even on provocation, it can be said, then, that the thetan aberrates himself. But he is assisted by mammoth betrayals and his necessity to combat them. And he is guilty of aberrating his fellows.

Aberration itself must be calculated to occur. The existence of a time track only makes it possible for it to occur and be retained. Thus a thetan's first real mistake is to consider his own pictures and their recorded events important, and his second mistake is in not obliterating entrapment activities in such a way as not to become entrapped or aberrated in doing so, all of which can be done and should be.

How the E-Meter Really Works

For many years auditors have had various concepts of how the meter works. Those who have had some electrical or electronics experience, have little difficulty in grasping the basic principle of its operation, but the majority who are not familiar with this field have sometimes had difficulties. They have tended to shy away from the technical aspects of meter operation as well as its associated terminology.

It is true that you don't have to know how the meter works to make it work. An auditor does not have to be an electronics technician (fortunately) and understand the circuitry of the E-Meter in order to flawlessly operate one and get standard technical results from using one. Many auditors, however, have requested a deeper understanding of just what the meter really operates on and how it works. This is understandable; after all, an auditor uses his meter constantly every day. Why shouldn't he know more about how it works?

The E-Meter works on a very easily understood principle. It "floats" a tiny electrical current through the preclear and uses this electrical current as a carrier wave to pick up the shifts in electrical energy that occur within or in close proximity to the preclear's body. These tiny electrical disturbances are carried into the E-Meter where they are amplified and made manifest in needle reads.

The truth of the matter is the E-Meter is an interlocking device along with the electronics of the bank.

In the bank, you have a sheet of energy made out of electricity and when you pass a current of electricity near the thing, it will monitor the current of electricity.

Life has the ability to register an impingement and to retain it or duplicate it. Life has that ability, and that is all that the meter measures.

The meter is simply measuring reactions to impingements in life.

For the benefit of those who wish a deeper understanding of the actual principles of operation of the E-Meter, this chapter covers the basics of electrical phenomena and how the E-Meter works in relationship to the preclear's bank and what makes the meter read.

Before going into the details of the operation of the E-Meter, there are a few simple basics which should be grasped in the field of electricity. They are actually quite simple but explain much.

What exactly is electricity? Very simple, we covered this in a previous chapter under energy and that is all electricity is, a flow of energy. There is nothing more complex to it than that. *

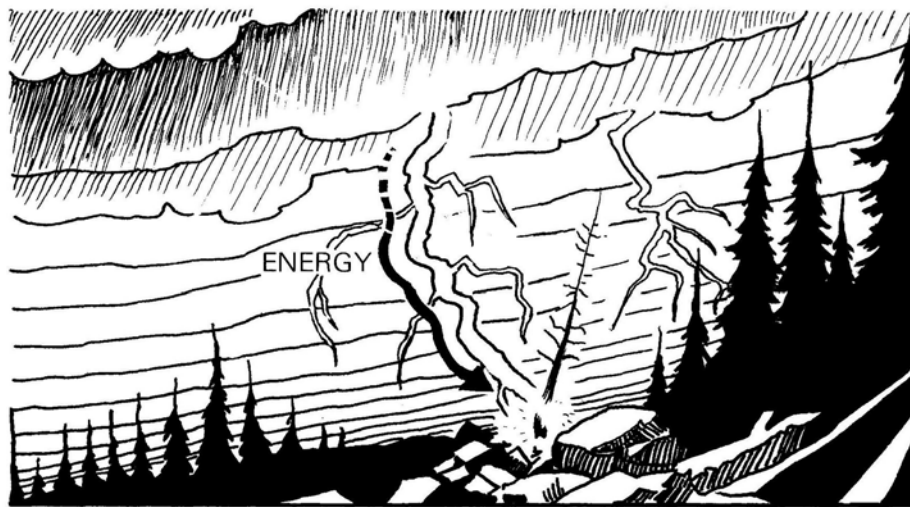

LIGHTNING = ENERGY FLOW

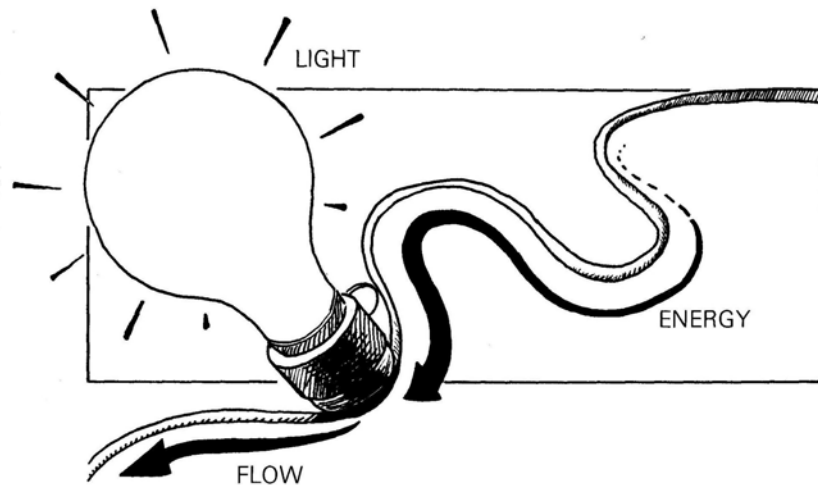

* For a further study on the simplicity and basic data on electricity listen to the PHILADELPHIA DOCTORATE COURSE LECTURE 5212C10D PDC-32 FLOWS: DISPERSALS AND RIDGES.

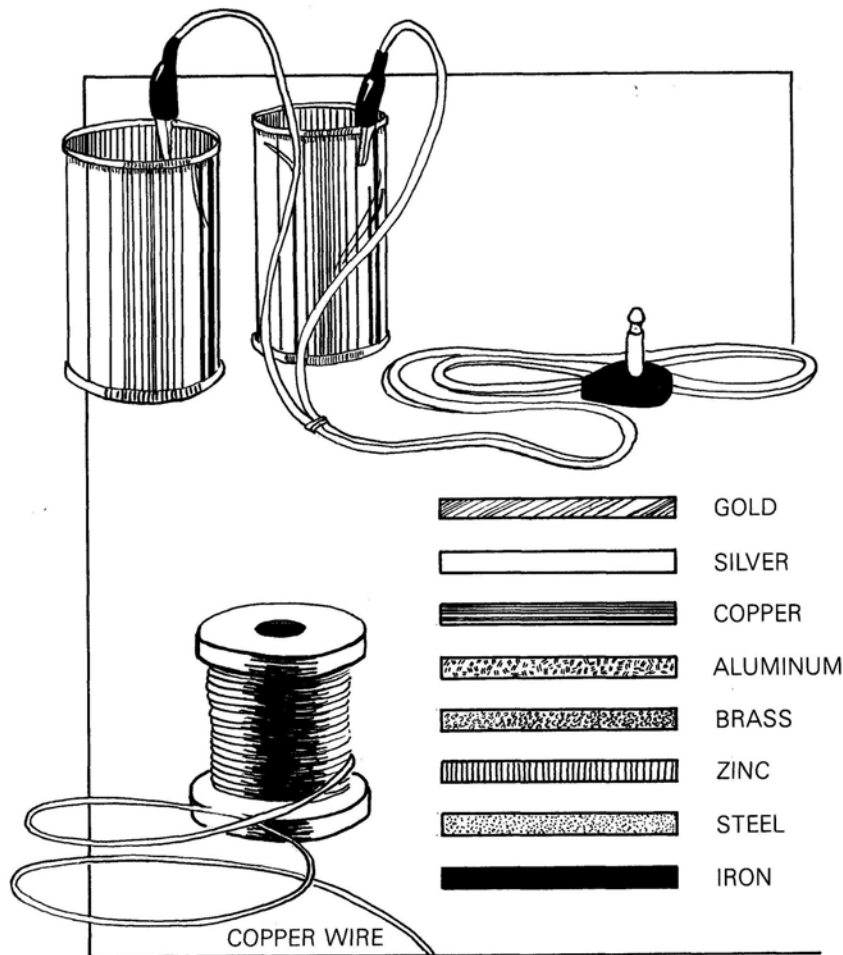

Electrical energy can be stored or made to flow in a given direction. It can be channeled. It flows best through metals, and these are called conductors. You have seen this in your home, in the office, and in fact even in the E-Meter itself where the electrical energy from a battery is channeled along copper wires. This is the same substance of which your E-Meter leads are made.

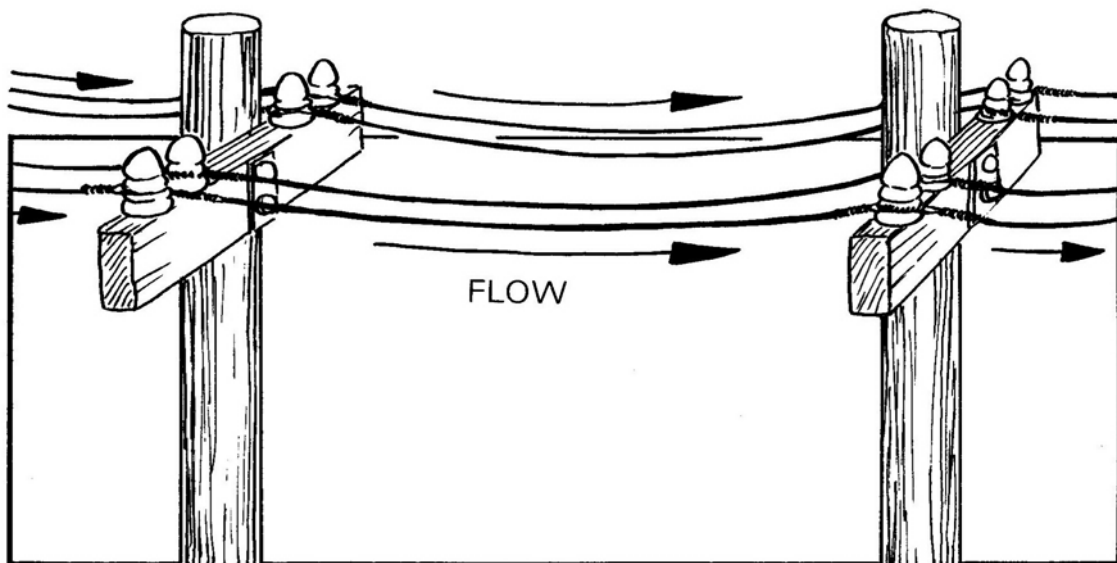

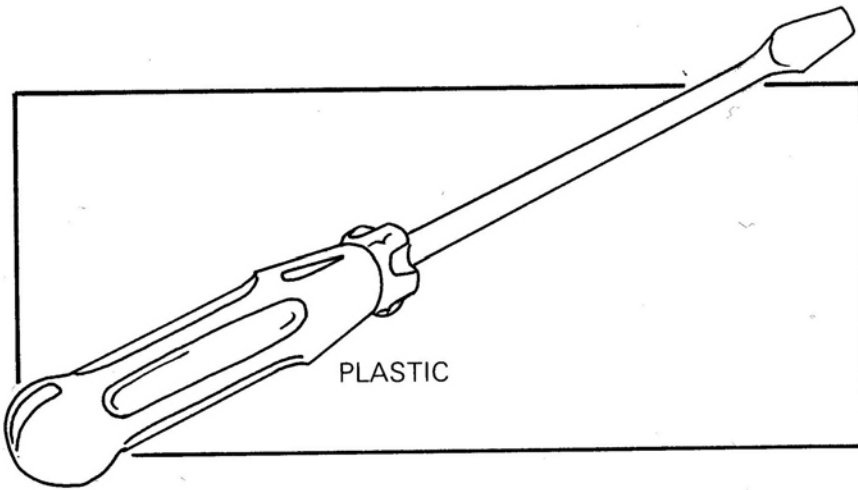

There are substances through which electrical energy does not flow, and these are called insulators. Some good insulators are glass, rubber, plastic, wood, and porcelain or ceramics. The E-Meter leads are covered with an insulator of vinyl plastic. Many tools such as pliers and screwdrivers have plastic or rubber coated handles to prevent electrical contact.

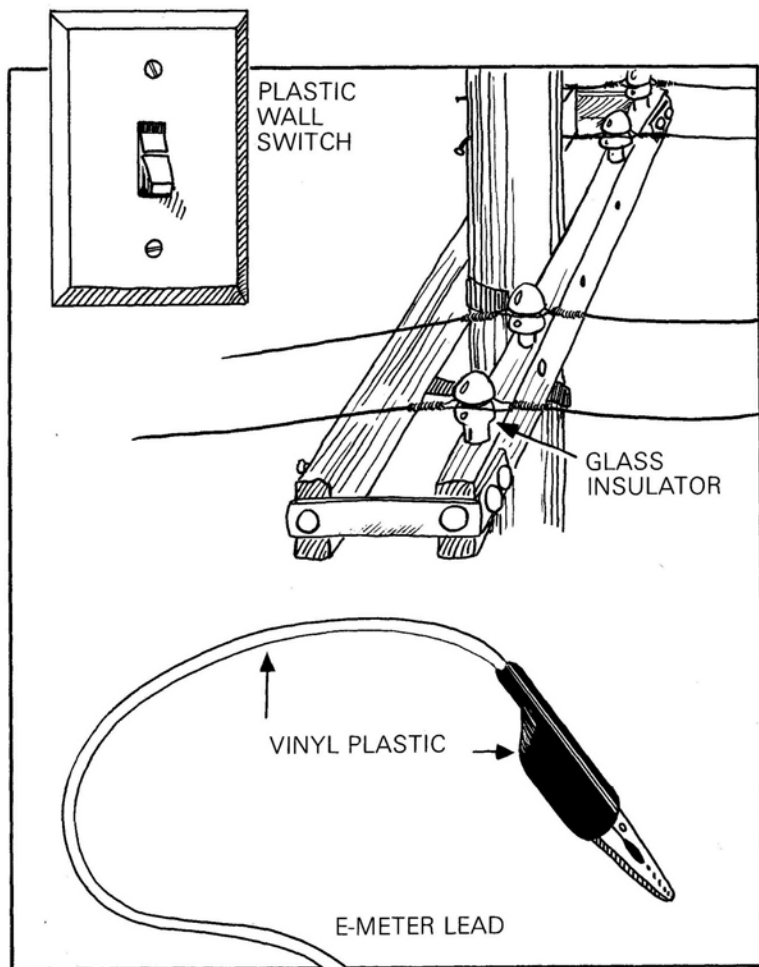

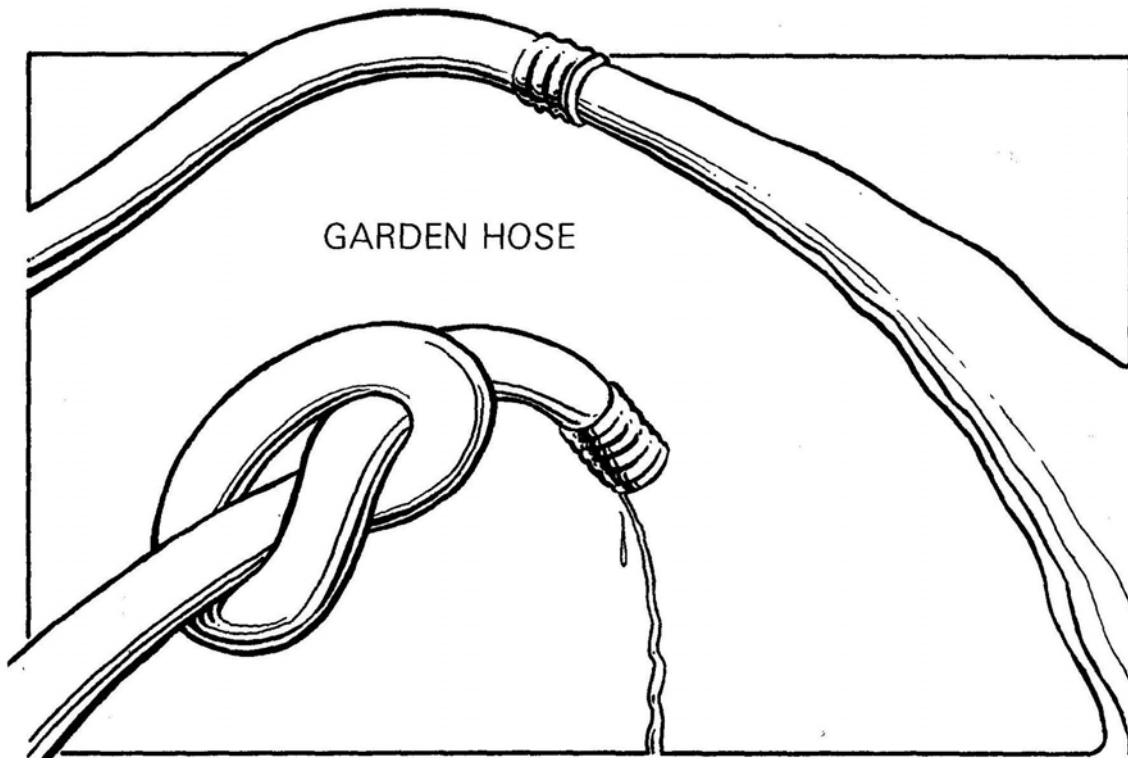

There are devices through which electrical energy can flow but has difficulty doing, and the flow becomes restricted. These are called resistors. Resistors are like barriers to a flow. Take a garden hose and flow water through it, then restrict the flow by squeezing the hose and making it smaller at any point; you have created a resistance, and the flow of water will be impeded. Take the same hose and plug up the end of it with some sponges. You have introduced a barrier into the flow and the velocity and quantity of water coming out of the nozzle will be reduced as a result. The same applies to electrical energy flow: it can be reduced and impeded by means of resistance.

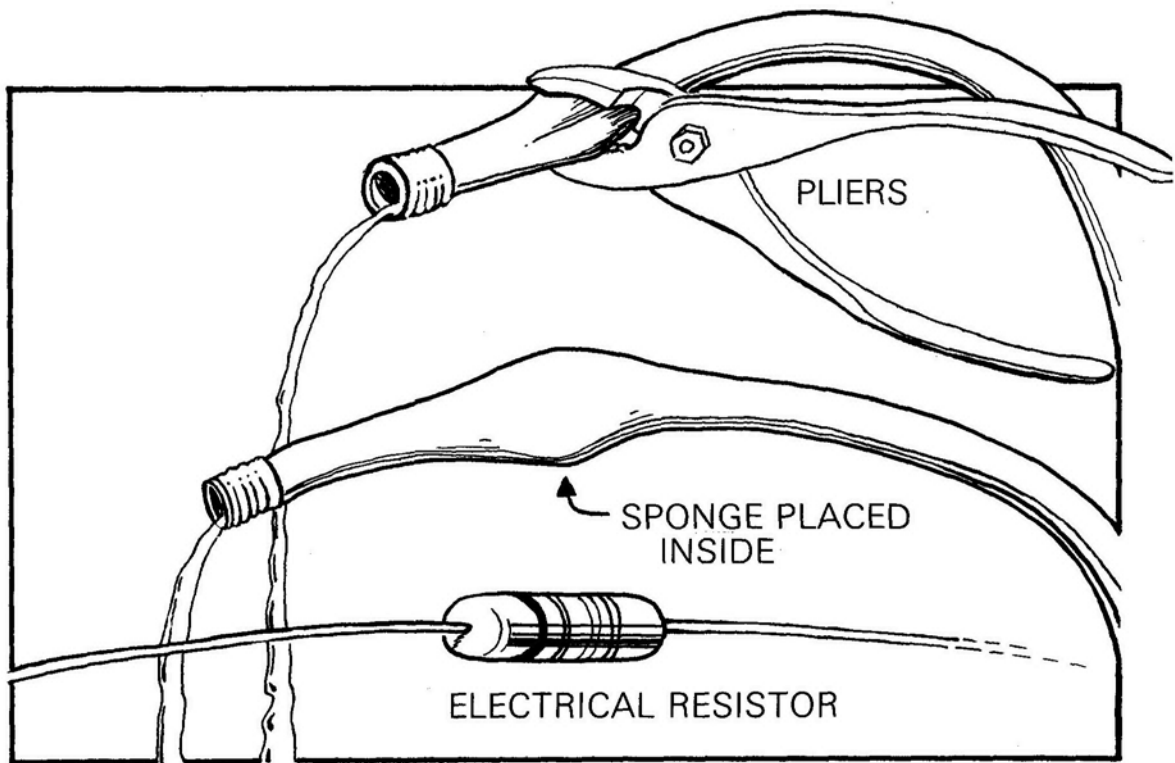

A common electrical resistor consists of plain old carbon. Electrical energy can flow through carbon, but not as well as it does through a metal. Introduce impurities into the carbon or extend the length of carbon and you have a greater resistance to the flow. The amount of the electrical current can be reduced by forcing it to flow through a carbon resistor.

Another commonly used electrical resistor consists of very thin wire. As with the restricted garden hose, the electrical energy has difficulty traveling through a very thin wire and so is reduced by the restriction. Some resistors are made by adding impurities into a wire.

Electrical energy can travel through the human body. It does not do so easily as the body cells are not good conductors, but they do conduct electrical energy, and electricity can be made flow through these cells.

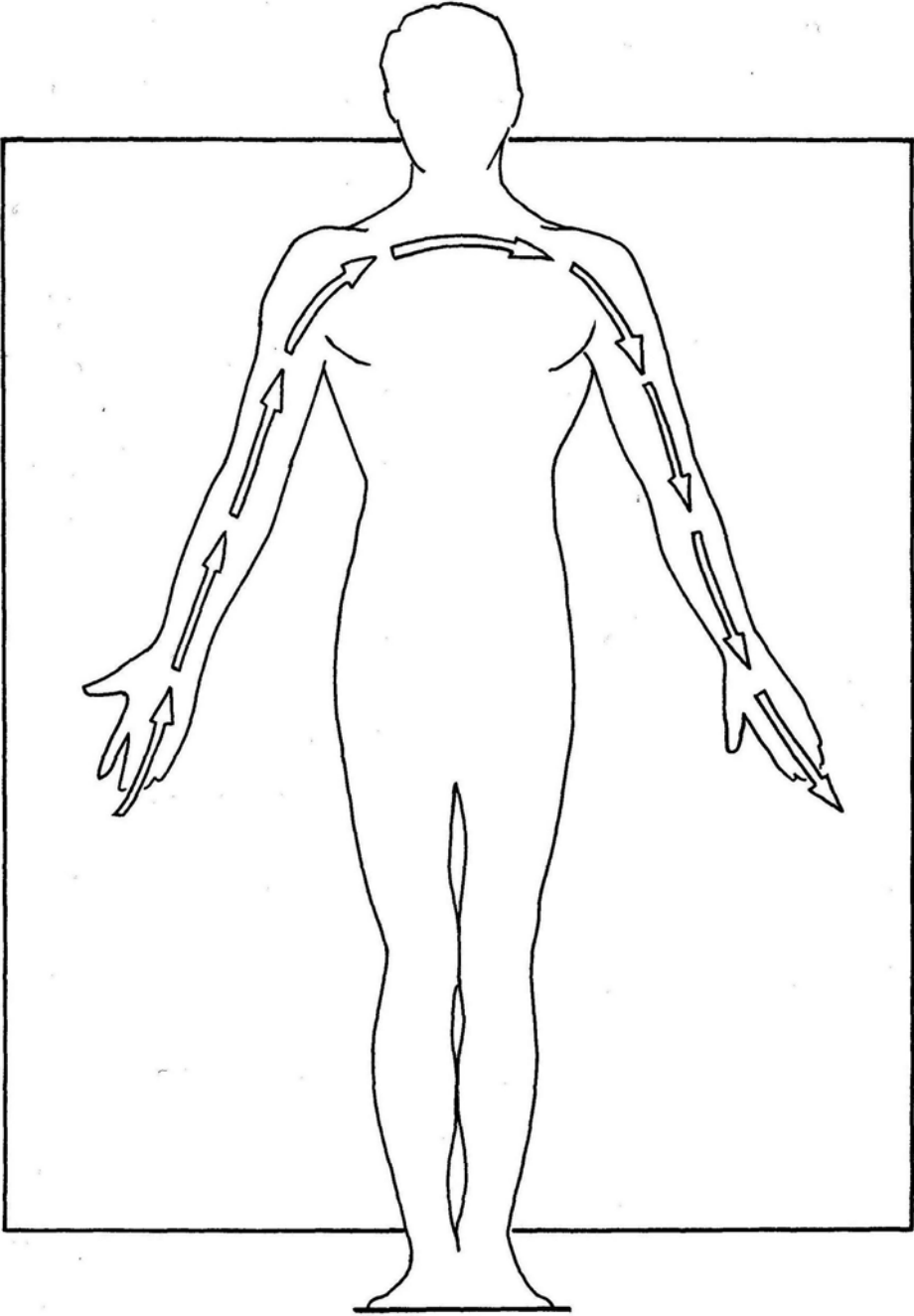

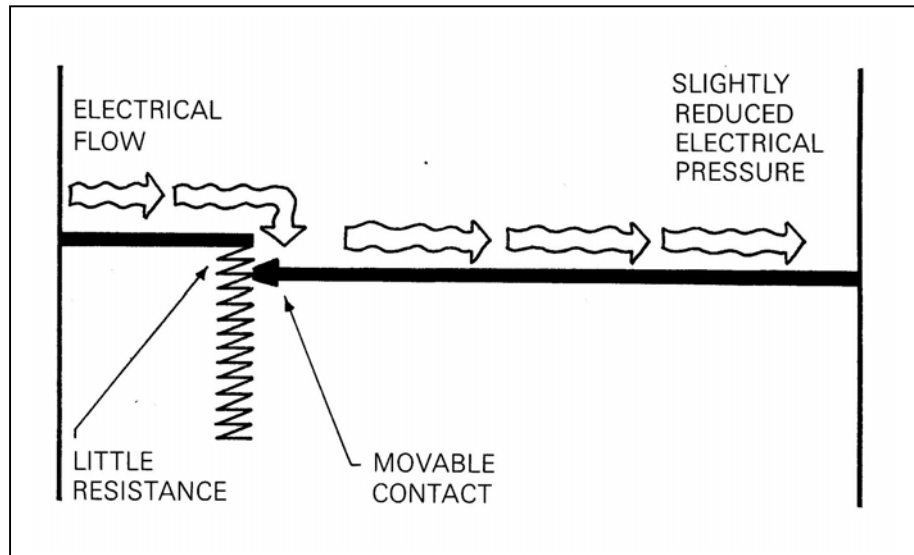
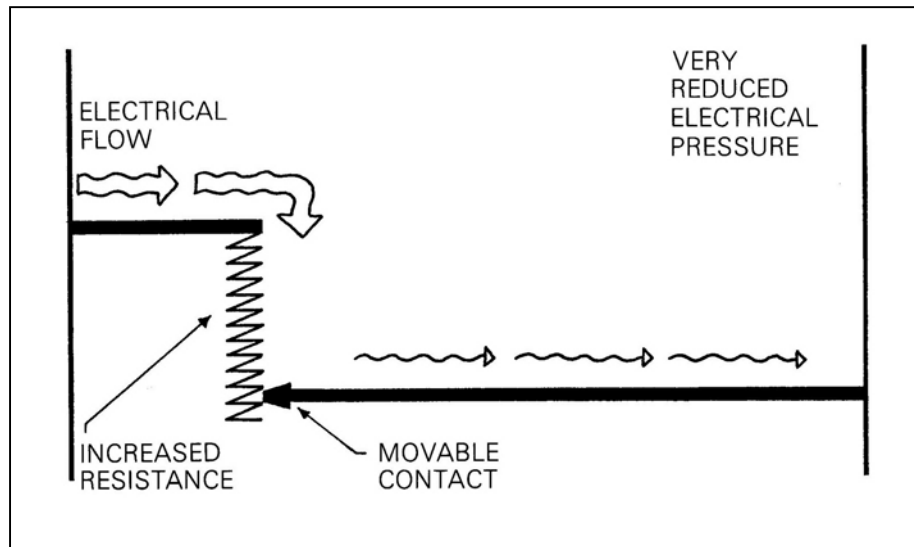
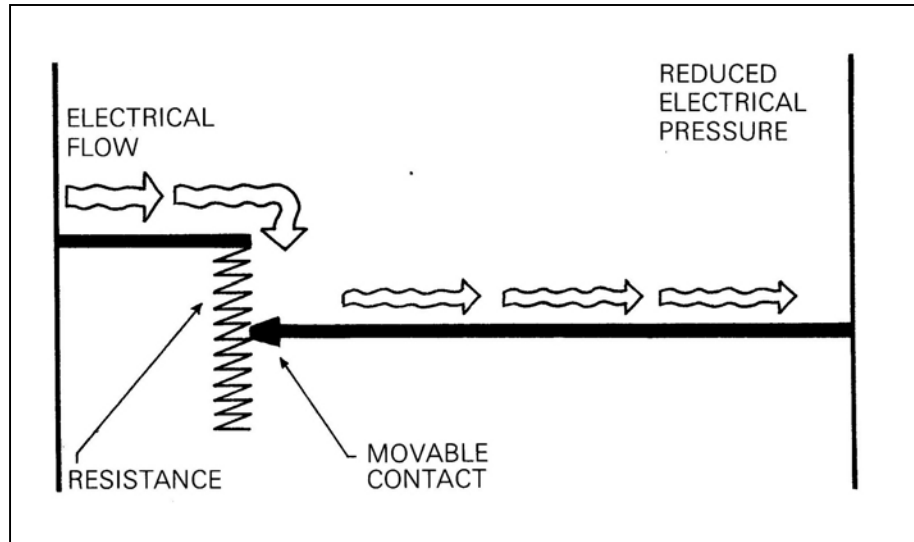

Resistance can be measured very exactly, and the amount of resistance to an electrical flow is measured in what is called ohms. These are simply the units of measurement of electrical resistance. Something which has a high resistance to electrical flow has a high ohm rating.

A variable resistor is simply a device used to vary the amount of resistance in an electrical conductor. Such a device consists of some resistance material and a movable contact. One can set the contact at various positions and control the amount of resistance. As you add more resistance to an electrical energy flow, the volume and pressure of that flow is reduced.

VARIABLE RESISTOR

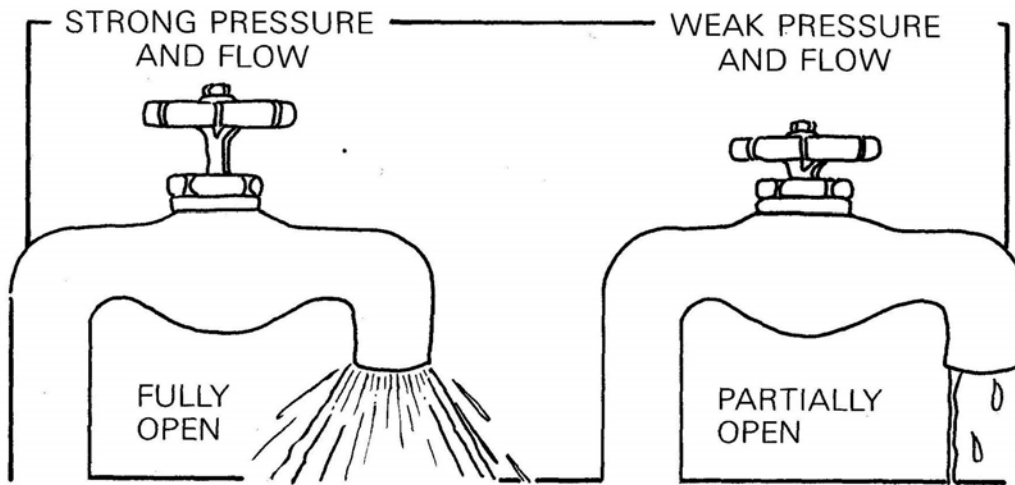

This can be paralleled to a valve or faucet on a water line. Open the faucet, and the volume and pressure of water is increased. Close the faucet a few turns, and the volume and pressure are reduced.

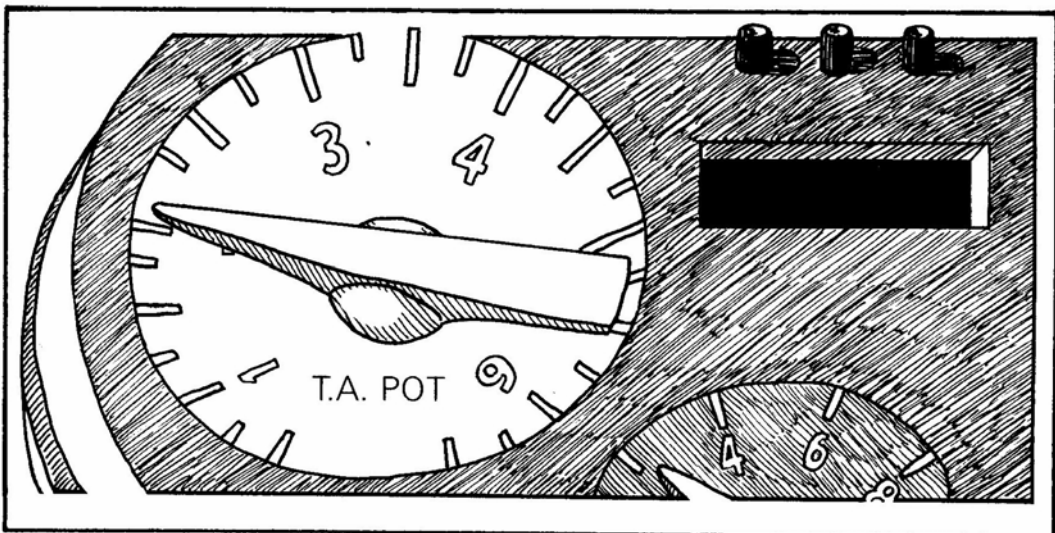

A potentiometer is simply a type of variable resistor. A potentiometer is sometimes called a pot as an abbreviation. The tone arm of your E-Meter is a type of variable resistor and is sometimes referred to as a pot. A potentiometer can be used to increase or decrease the pressure (voltage) behind a flow of electrical energy and to change the volume of the flow.

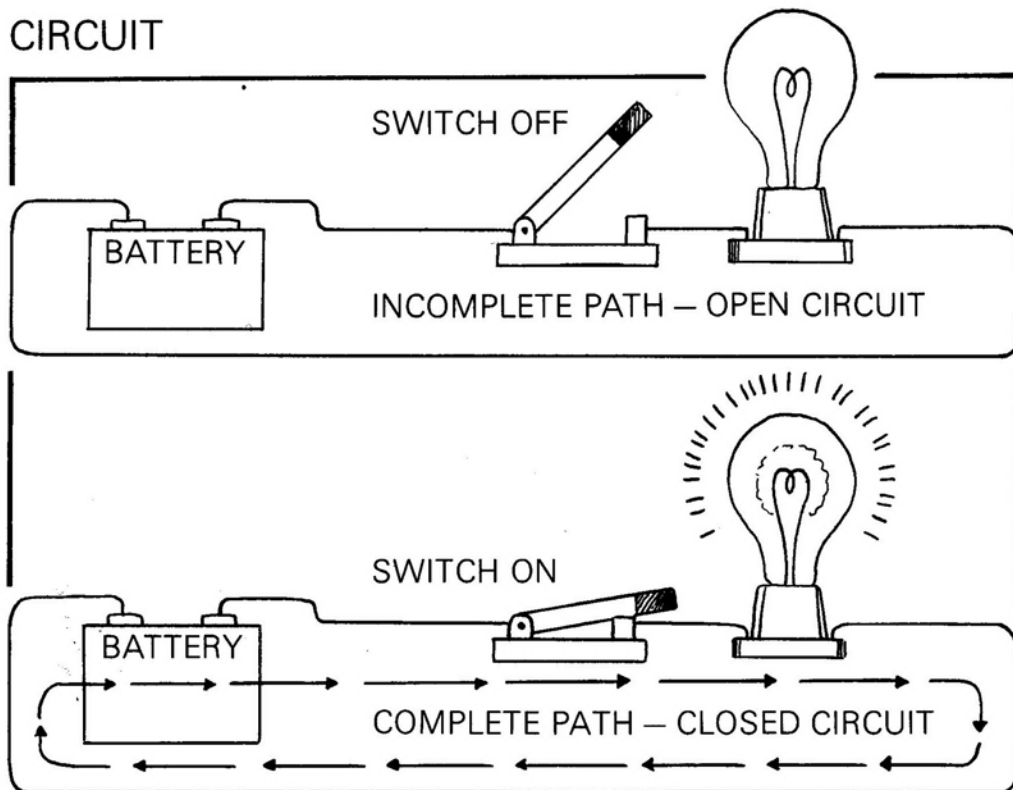

A circuit is a complete path along which an electrical current can flow. In the illustration above, you see a simple circuit. In the first example, the switch is on the 'off' position and the circuit is 'open.' No electrical current will flow as the circuit has not been completed. In the second example, the switch is in the 'on' position and the circuit is 'closed.' A tiny flow of electric energy is seen flowing out of the battery, along the wire, through the switch, through the light bulb, down the wire and back into the battery. The battery can be considered to be a bag full of energy to supply the flow.

SIMPLE DIAGRAM OF AN E-METER

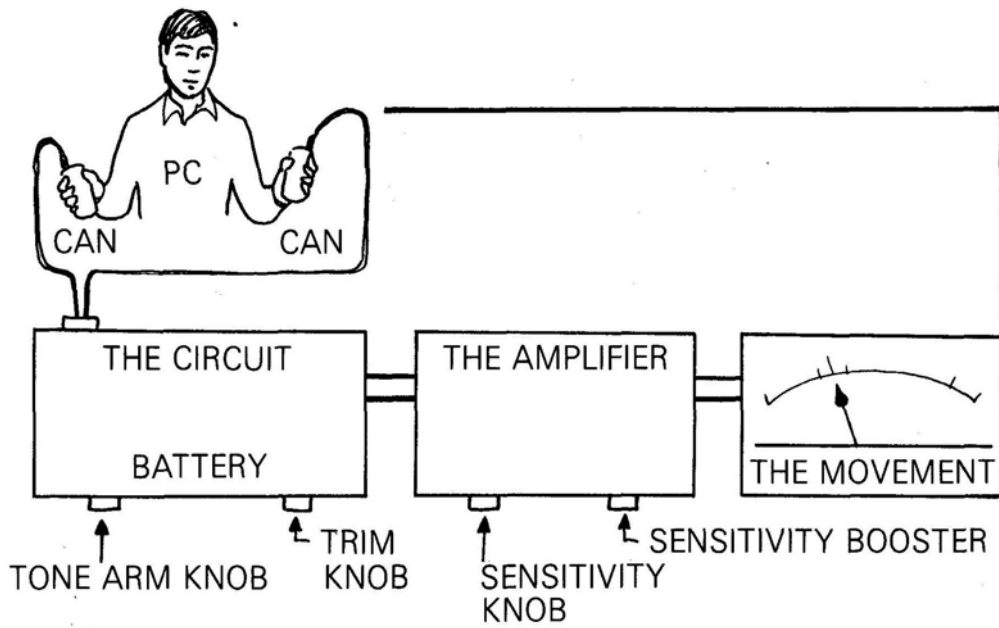

The E-Meter

The E-Meter, in its simplicity, consists of three separate parts which are: a) the circuit of the preclear, battery and tone arm, b) the amplifier, and c) the movement.

In the circuit part of the E-Meter is a small battery, similar to the battery in your flashlight or transistor radio. This battery is used to pass a very tiny flow of electrical energy down the wires of the E-Meter leads, through the body of the preclear and back up into the E-Meter.

This flow (which is very small indeed) acts as a carrier wave. In other words, it is a flow of current that can be influenced by other things and can carry other things.

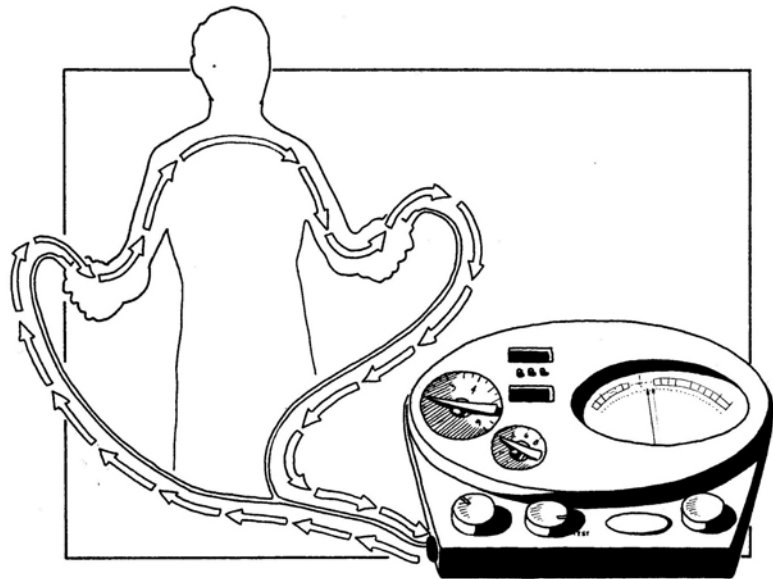

For the meter to be read, the tiny flow of electrical energy through the preclear has to remain constant. When this tiny flow is reduced due to increased resistance, the needle of the E-Meter movement moves off the dial to the left. This happens because the preclear pulls in mass. This is actual mental mass (condensed energy), and this mass acts as a resistance to the flow of electrical energy from the E-Meter. The tiny carrier wave becomes partially blocked.

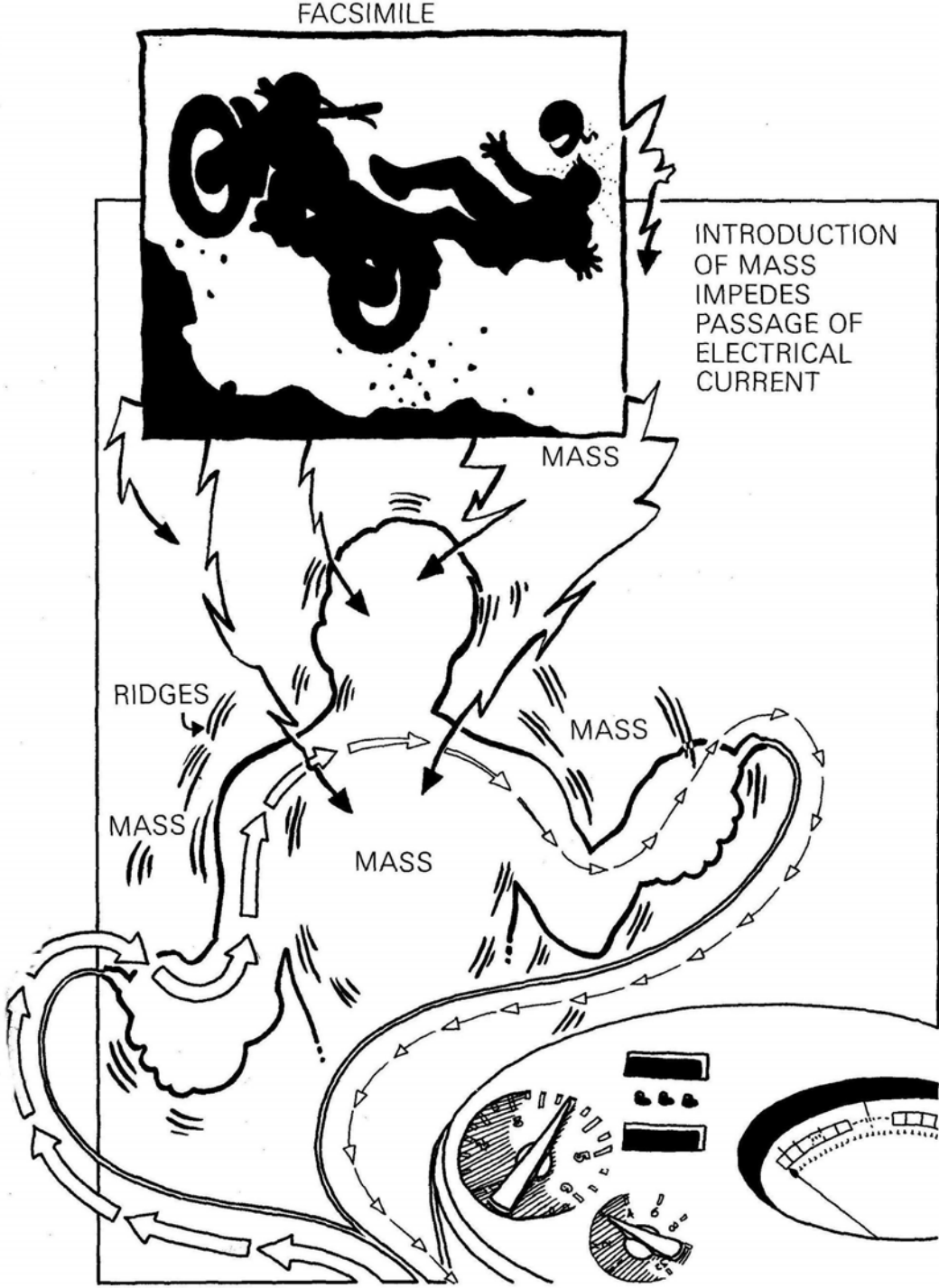

To overcome this blockage and maintain the same current flow, the pressure behind the tiny flow has to be increased. In the E-Meter the pressure of the little carrier wave is increased by turning the tone arm to the right-raising it. As the tone arm is moved to the right, the pressure (voltage) is increased slightly until the carrier wave is strong enough to pass through the mass which the preclear has pulled in, and the same volume of current is now flowing through the preclear and back into the meter. This increase in electrical pressure (voltage) is very small. In actual fact the potential pressure or voltage produced by the battery of the E-Meter is constant.

The tone arm simply regulates how much of the battery's pressure or voltage is required to push the carrier wave through the preclear. The required pressure or voltage is determined by the amount of mental mass or resistance present in the preclear.

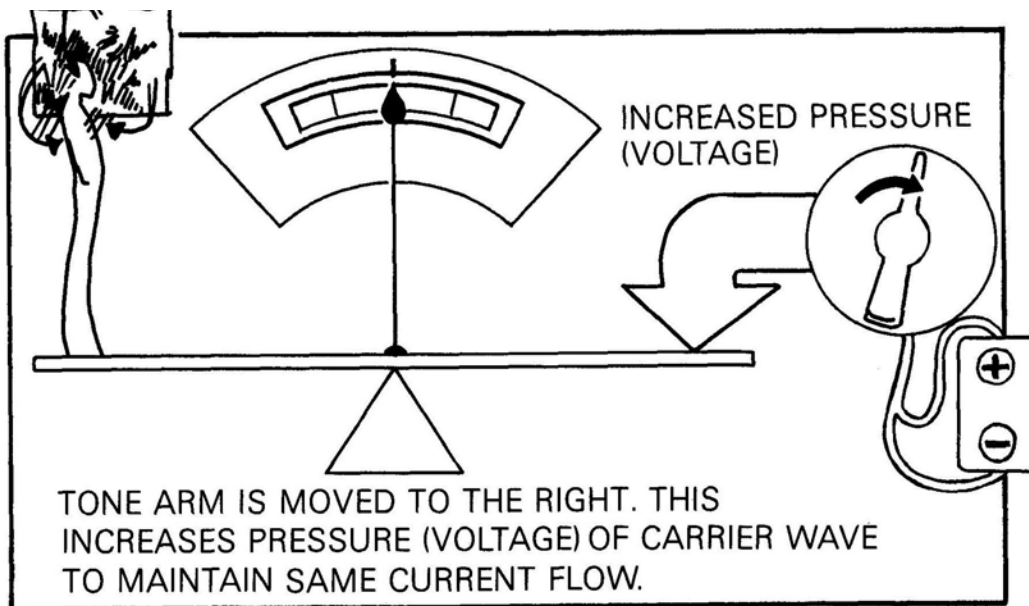
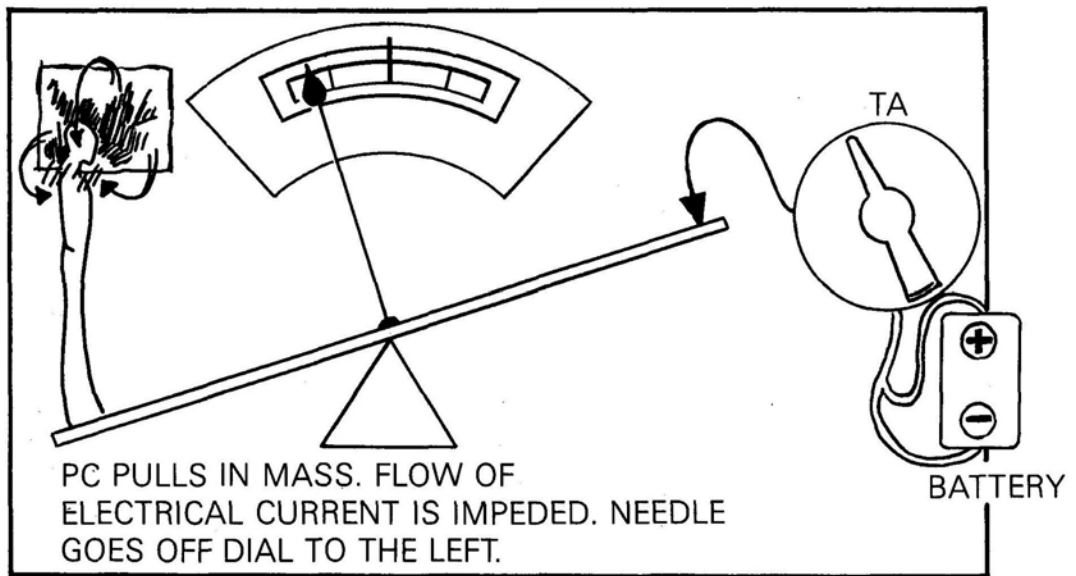

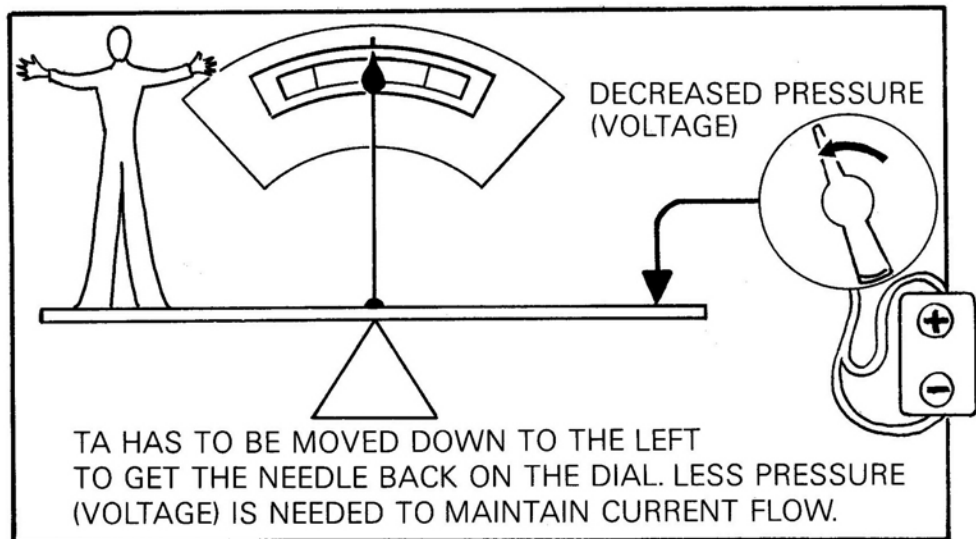
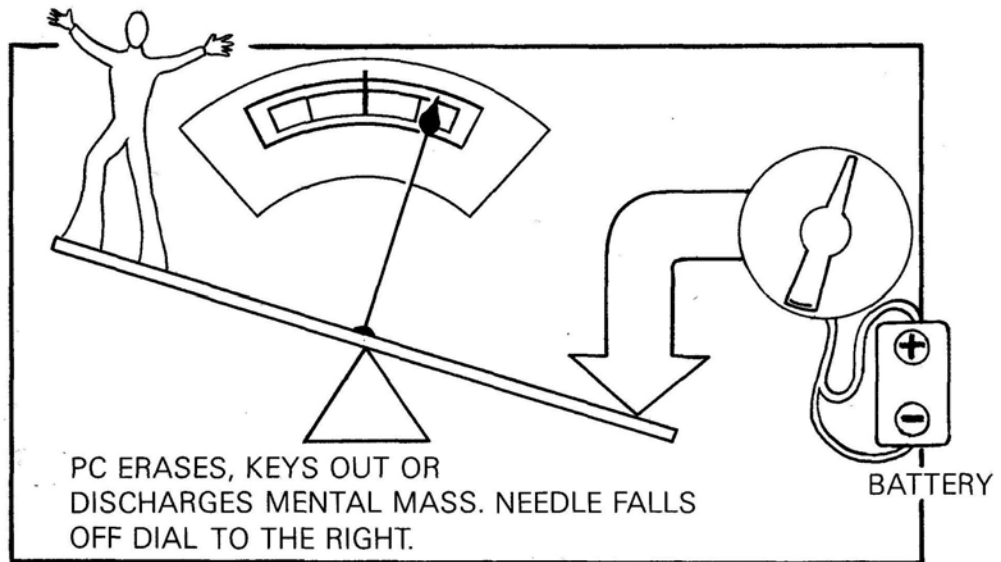

When the preclear as-ises or blows the mass that he pulled in, the resistance to the tiny flow of electrical energy through the preclear is lessened. The little carrier wave can flow through the preclear more easily, and less pressure (voltage) is needed to maintain the same volume of electrical energy flowing through him. The tone arm hag to be adjusted to the left (down) to decrease the pressure behind the tiny electrical carrier wave and bring the needle back onto the dial.

We see then that the tone arm measures density of mass (ridges, pictures, machines, circuits) in the mind of the preclear. This is actual mass, not imaginary, and can be weighed, measured by resistance, etc. Therefore the tone arm registers state of case at any given time in processing.

The tone arm also measures the advancement of the case during processing as, by moving up and down, it shows that an adequate amount of charge is being restimulated in session (tone arm going up) and that it is being adequately dispelled by the preclear (tone arm going down).

Before starting an auditing session, the E-Meter has to be set up correctly. It has to be adjusted so that it will flow the correct amount of electrical energy through the preclear and give correct readings on the tone arm dial. This is done by setting up the meter but leaving the preclear leads disconnected.

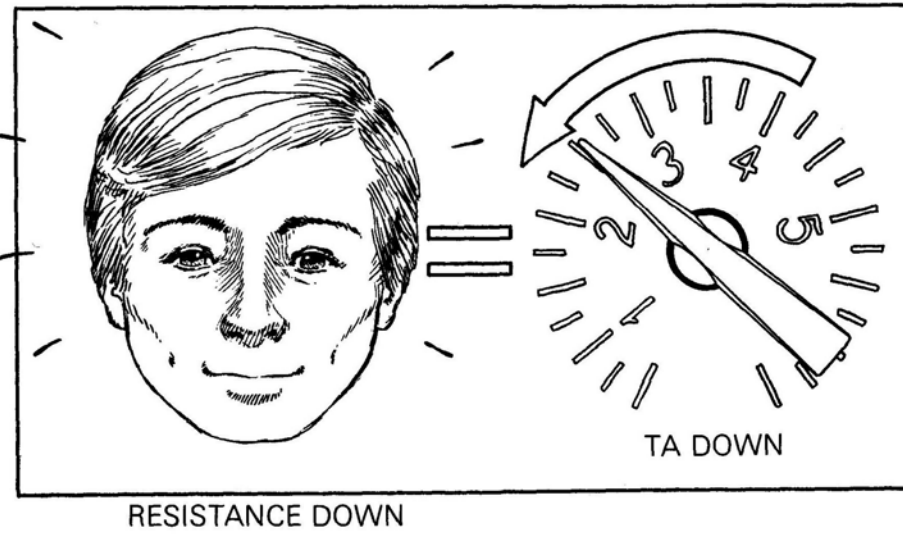
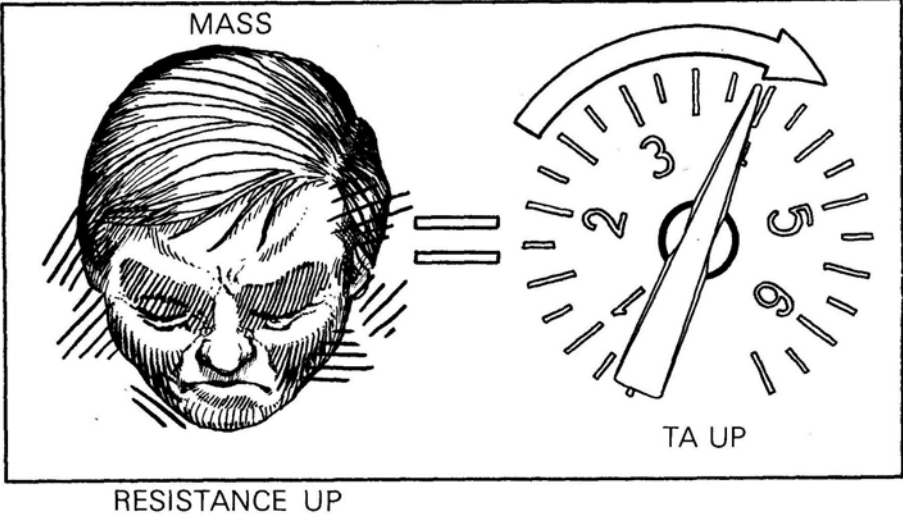

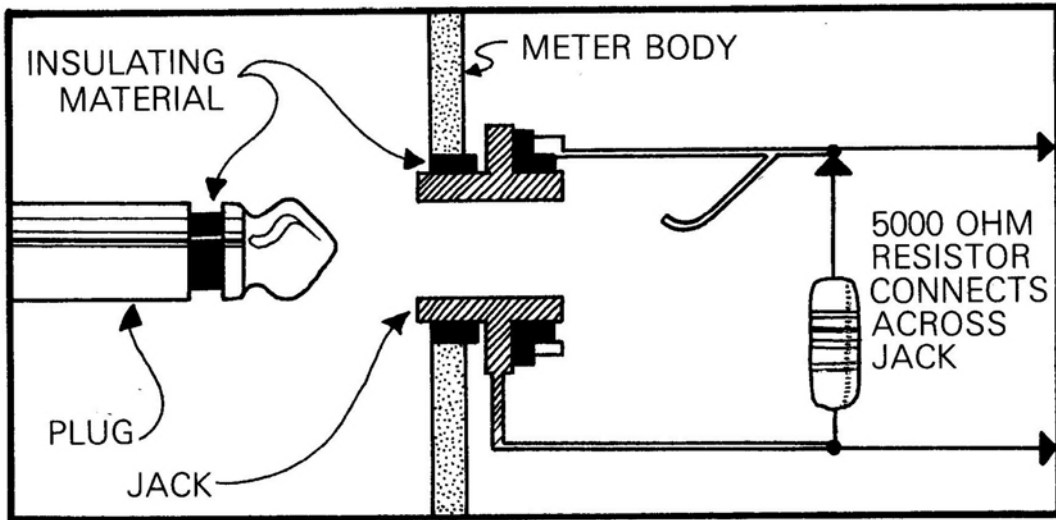

When the E-Meter is switched on without the jack plug being inserted, a 5,000 ohm resistor is connected across the lines of the meter outlet. This resistor is situated inside the meter itself, just inside the jack.

With this known resistance of 5,000 ohms connected across the jack in the E-Meter, the trim knob is adjusted until the needle is at set on the movement dial with the tone arm knob set at 2.0 on the tone arm dial. The meter is now set up to pass the correct current flow and is adjusted so that the meter will give the correct standard tone arm readings.

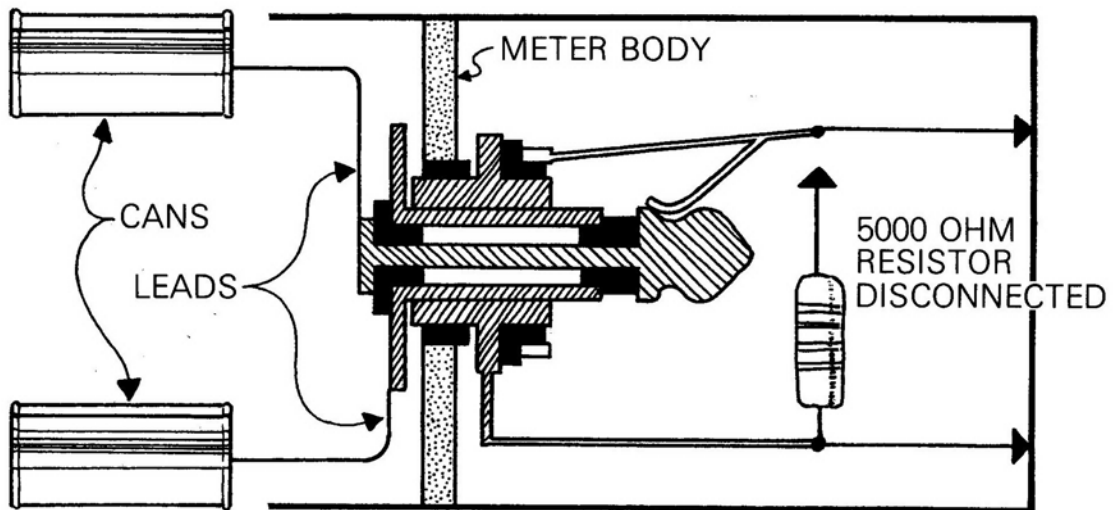

When the jack plug is inserted into the E-Meter, the little 5,000 ohm resistor is disconnected, and you are ready to have the preclear pick up the cans. Then you adjust the tone arm until the needle appears on the movement dial.

What Makes the E-Meter Read

With the preclear holding the two electrodes and the tone arm set so that the needle appears on the movement dial, we have a complete circuit with a constant flow of electrical energy flowing through the preclear.

This tiny flow through the preclear acts as a carrier wave. This means that the electrical flow going through the preclear can be influenced by other things. It can be influenced by an electrical disturbance that occurs in close proximity to it, and the carrier wave will pick up this disturbance and duplicate the wave pattern.

This is rather like the action of taking a piano and opening the lid, then depressing the damper pedal and singing a note into the inside of the instrument where the strings are. The strings of the piano are influenced by the sound vibrations of your voice and they duplicate the vibrations and you can actually hear the thing sort of sing back at you. The strings could be considered to be like carrier waves, influenced by the sound vibrations you make. You could do this with any stringed instrument including a guitar or violin.

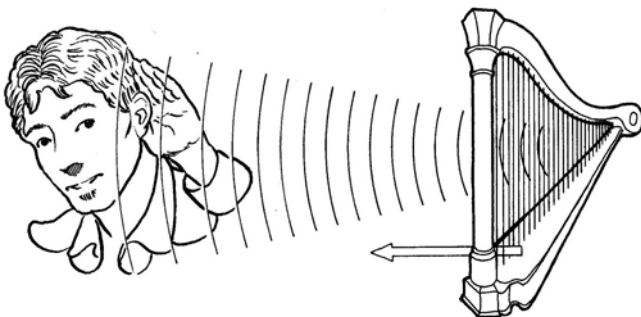
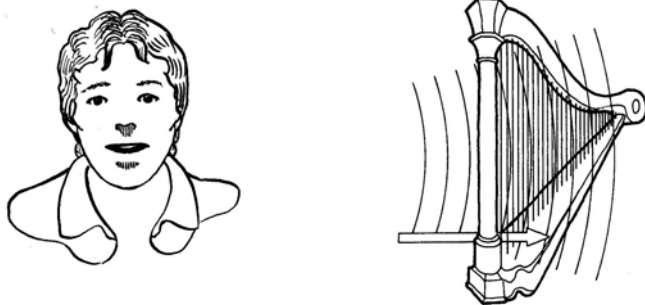

With the E-Meter, we are using a small current of electrical energy as the carrier wave. When any new and different source of energy comes near the carrier wave, the carrier wave picks it up.

An electrical field exists at a distance from, or within, the body of the preclear. The tiny electrical flow from the E-Meter, acting as a carrier wave, which is passed through the body of the preclear, is influenced by electrical shifts and disturbances which occur in this 'field'.

The preclear is also surrounded by such things as masses, pictures and ridges and an entire record of the past which we call a time track.

What are these pictures composed of? It has been established that this mental energy, such as is contained in a picture, and the energy of Earth or of the electric light company, are different only in wave length. Mental energy is simply a finer, higher level physical energy.

Thus, when the preclear thinks a thought, looks at a picture, re-experiences an Incident or shifts some part of the bank, he is using electrical energy to do so, and an electrical disturbance occurs within the electrical field surrounding, or within the preclear's body.

This electrical shift in the field is picked up by the tiny carrier wave and is transported along the wire from the electrode and back into the E-Meter.

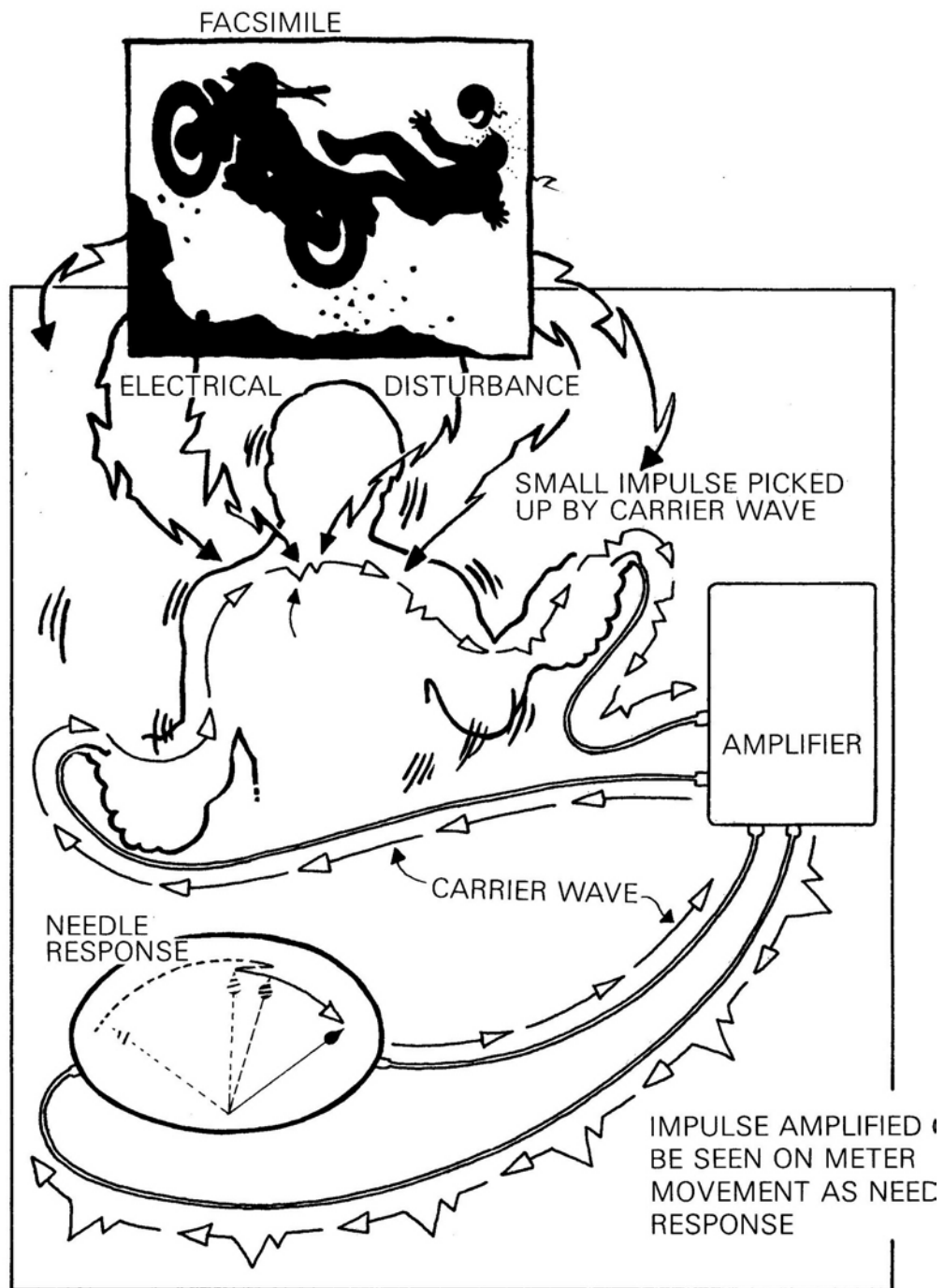

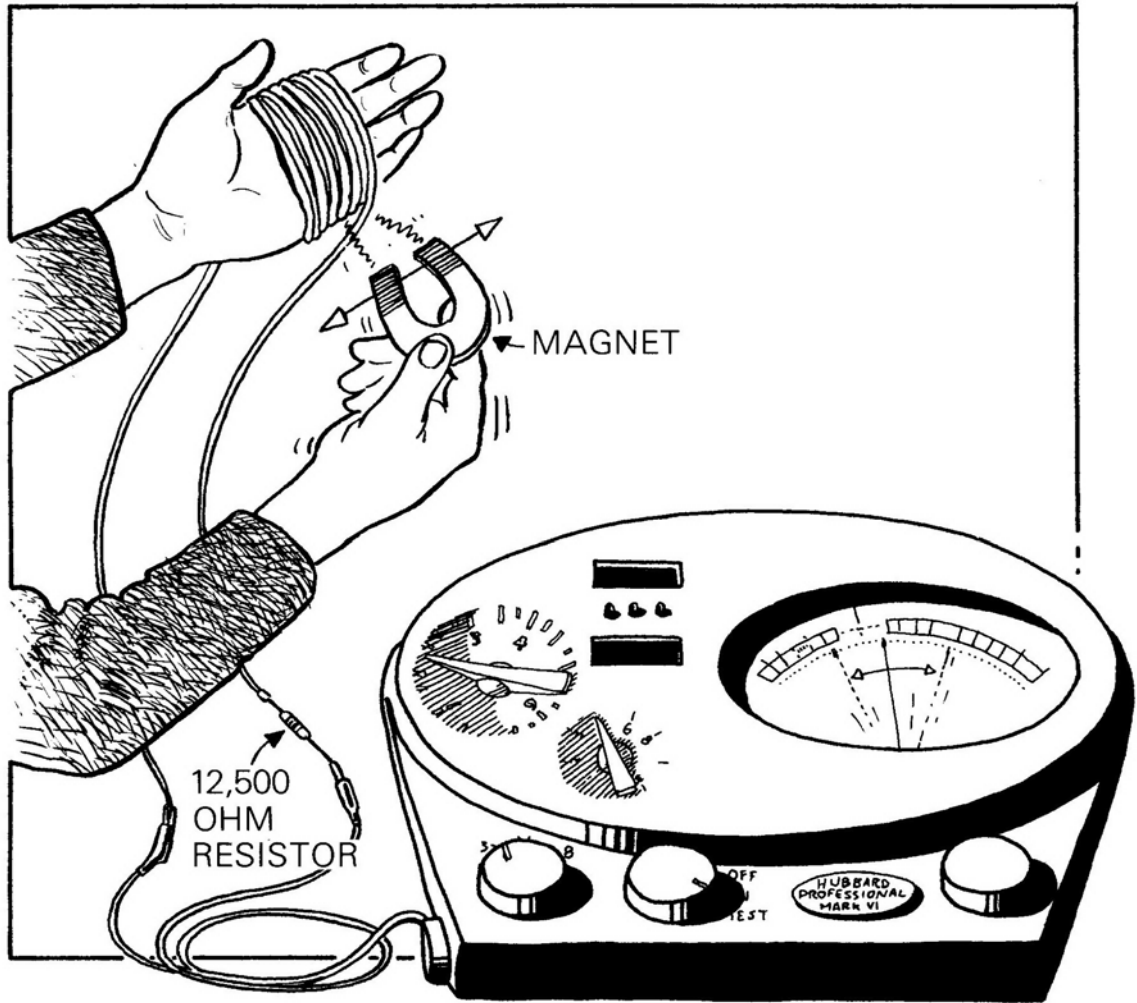

There is a little practical demonstration that you can do with your E-Meter to get some reality on this. To do this demonstration, you will need a strong magnet (flat bar magnet or horse shoe shaped magnet) and a 6 foot length of insulated electrical wire.

Connect one end of the electrical wire to one of the clips at the end of one of the E-Meter leads. At the other end connect a 12,500 ohm resistor used for calibrating the meter tone arm to 3.00. Now connect the other end of the resistor to the remaining E-Meter lead and turn the meter on. Notice that you have now completed a circuit and the 6 foot length of wire with the resistor could be likened to the body of a preclear with the carrier wave passing through him.

Crank up the sensitivity to maximum and set the sensitivity booster to 128. Now adjust the Tone Arm until the needle is at set. Let it settle down.

Make a coil of the 6 foot length of wire by wrapping it around one hand. Now take the magnet and move it about close to the wire, up and down, back and forth. You will see the needle kick and dip as the energy created by the motion of the magnet close to the wire, is picked up by the little carrier wave in the wire and is shown on the meter dial. Notice that you did not have to touch the wire to make the needle dip.

Now do a "pinch test" on somebody. Set up the meter and get someone to hold the cans. Tell the person that you are going to do a pinch test and then with the person holding the electrodes and the sensitivity set at normal for that person, with the needle visible on the meter dial, give a strong pinch on the person's arm. Notice that there is a reaction on the meter and the needle moves. This is often accompanied by a rise in tone arm position.

You just saw life's NOW reaction to applied force. It generated energy. If the TA also rose, it was because the added mass caused the carrier wave to be impeded so the tone arm had to be moved higher.

Now ask the person to, "Recall the moment of the pinch."

Notice the surge of the needle on the E-Meter dial.

Acknowledge the person and ask for the moment to be recalled again.

Each time the person recalls the pinch, you will see the needle react. But it will become less and less as the charge of the incident is as-ised, and with the mass blowing off, you will see that the blockage to the carrier wave is reduced and the tone arm moves down.

The reads you see on your E-Meter dial in the movement of the needle are visual manifestations of the shifts of masses, ridges and pictures in the mind of the preclear or actual mental energy which is generated or discharged by the preclear.

The idle uninfluenced movement of the needle on the dial without any patterns or reactions in it, is called a Floating Needle. It is simply an expression of interaction of mental current and meter current and expresses an absence of ridges or flows.

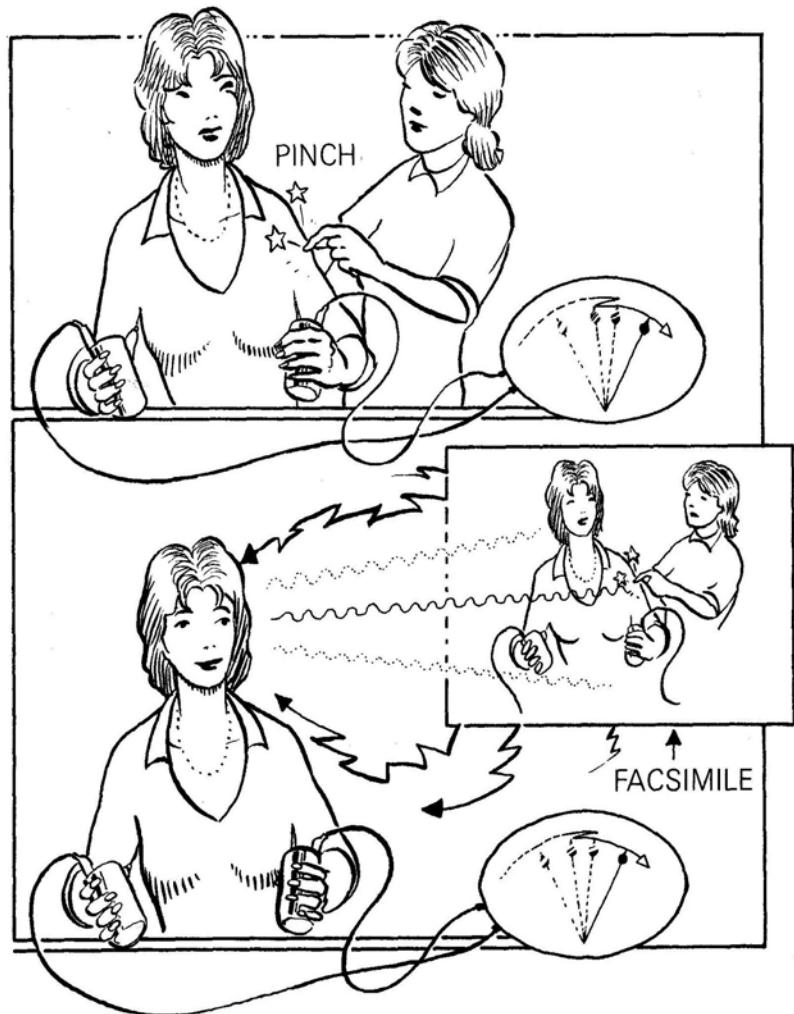

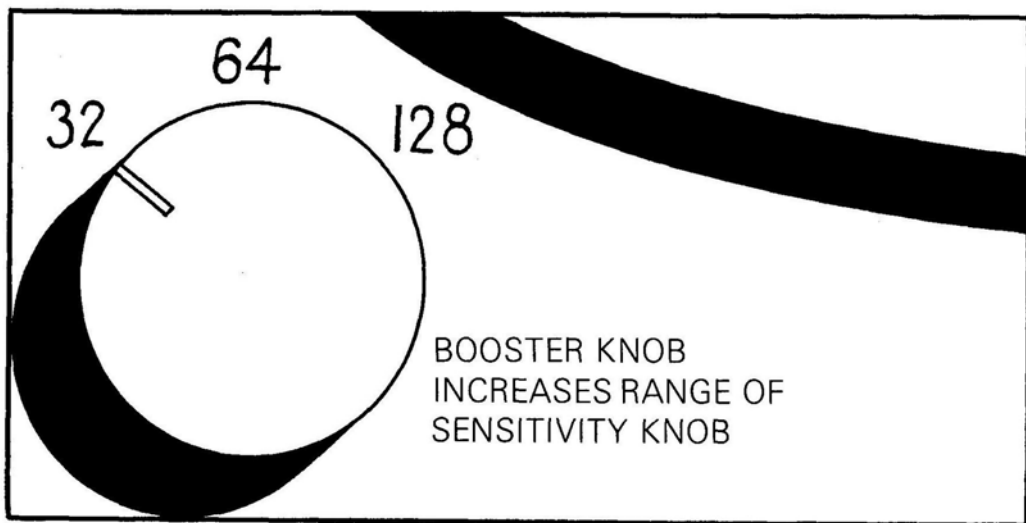
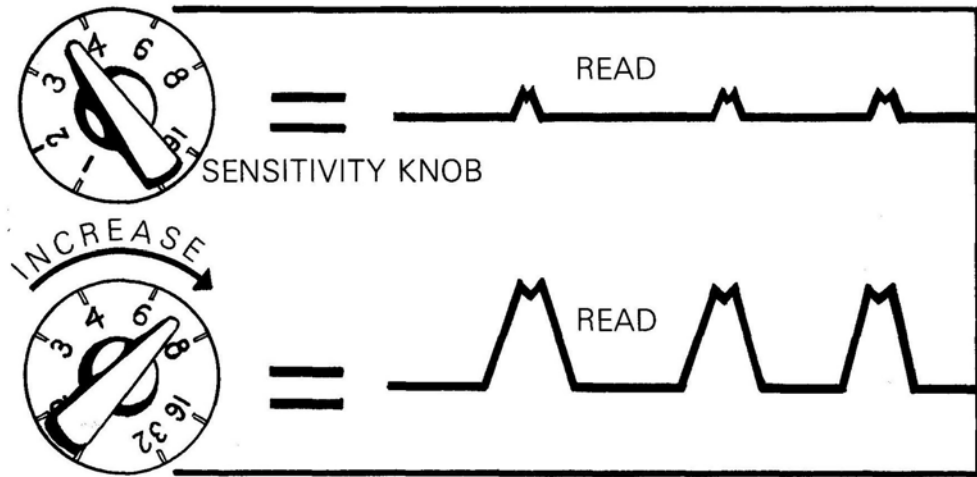

The electrical changes in the preclear can be very small. The tiny shifts and electrical disturbances which are picked up by the carrier wave have to be amplified. This means to be expanded or made to look bigger.

The tiny patterns picked up by the carrier wave are enlarged by an amplifier built into the E-Meter, which is similar to the amplifier in your radio or record player.

In a radio or record player, the sound impulses are amplified and are transmitted to a speaker where they can be heard. In the E-Meter, the tiny impulses picked up by the carrier wave are amplified so that they can be seen on the needle dial.

The sensitivity knob in the E-Meter acts as a sort of volume control for the amplifier similar to the volume control on a radio or television set. As you turn the sensitivity up, the degree of amplification or magnification of the needle reads is increased.

Setting the E-Meter to the correct amplification (sensitivity) is very important. An auditor must set the sensitivity of an E-Meter exactly right for each preclear and each session. The setting is different for almost every preclear and can change, session to session, even for one pc.

A sensitivity setting which is too low or too high for that particular preclear in the particular session will obscure reads and F/Ns, thus upsetting the preclear's case. The sensitivity booster knob in

the E-Meter simply increases the range of the E-Meter amplifier. The sensitivity booster works in conjunction with the sensitivity knob to increase the range of sensitivity and clarity of the reads picked up by the carrier wave passing through the body of the preclear. Tiny reads become clearer and easier to detect. Too high a sensitivity setting will make the E-Meter pick up body reads, heartbeat, etc.

The tiny shifts in the electrical field of the preclear, picked up by the carrier wave, amplified, and manifested by needle movements, are important. They are used as indicators of underlying areas of greater charge in the mind of the preclear and tell the trained auditor whether in fact an item or incident is charged or not and should be pursued or abandoned. They also indicate when the preclear has been released from or has erased charged incidents or pictures.

The identification and significance of the various types of E-Meter reads are not the subject of this work and are indeed covered fully in the following:

The E-Meter training films

E-Meter Essentials

The Book of E-Meter Drills

The Book Introducing the E-Meter

The Technical Bulletins of Dianetics and Scientology (12 volumes)

I have also more than amply covered the technology on E-Meter reads, their significance and their handling in my tape recorded lectures. All of this is available and for use.

The rehabilitation of the self-determinism and inherent capabilities of the being is therefore contingent upon:

- a** A well-trained Dianetics or Scientology auditor who insists upon the exact standard application of the technology of Dianetics and Scientology.
- b** An understanding of the mind and the mechanics of guiding the preclear toward and helping him to erase charged incidents and pictures in his mind.
- c** An understanding of and an ability to flawlessly operate the E-Meter.
- d** Actual charge off the case of the preclear through the flawless application of Dianetics and Scientology processes in Dianetics and Scientology auditing sessions.

Conclusion

This text and the E-Meter series films for Academy viewing, together with *E-Meter Essentials*, *The Book of E-Meter Drills* and *The Book Introducing the E-Meter* form the basic library on the subject of the E-Meter.

E-Metering is a science and an art. A thorough understanding of the E-Meter films, the above texts and familiarity with the E-Meter through E-Meter drills will make you a master of this precision instrument.

About the Author

L. Ron Hubbard's development of the E-meter is yet another unique contribution of one who many consider one of the remarkable men of the age.

As a renowned author, explorer and, most importantly, philosopher, he has spent the better part of his lifetime researching the fundamentals of life and making the findings available to Mankind through his considerable writings and recorded lectures.

In a career as an author spanning more than 50 years, he has written dozens of books, hundreds of stories and articles on a wide variety of subjects and sold many millions of copies of his works.

His fiction served to subsidize his more profound efforts in the humanities and his original researches into the mind and life. His objective, in these areas was, as he put it, "to find from nuclear physics and a knowledge of the physical universe, things entirely lacking in Asian philosophy".

Paramount in his successes along this line was demonstrable proof {much to the dismay of the materialists} that the human soul did indeed exist as a timeless and immortal entity and could exist separate from the body.

Oriental wisdom, having stagnated from centuries of idol worship, was bent to the exactitudes of Hubbard's Occidental scientific background. Fired by his dynamism and rare genius, there resulted the subjects of Dianetics and Scientology, which bring the technology for achieving the ancient dreams of liberation for the spirit and accord amongst men. It is out of this application of Western scientific thinking to the "mysteries" of the East that Hubbard developed the first E-meter in 1951 .

He had discovered that the animating principle in a human being, which he termed the "thetan", was connected closely with phenomena classified in the field of electronics. That the spirit {thetan} was the primary source of energy and activity which monitored the body and its functions, was something strongly suspected though not completely articulated in Dianetics.

Ron measured these effects through assessment of pulse rate, skin tone, breathing, pupil dilation and other means in Dianetics. Such mensuration proved unworkable when he bridged over into the realm of the spirit, Scientology, in late 1950.

Work began, to develop a device that would detect the more subtle changes in life energy and the mind. He presented the problem during a lecture in Los Angeles in November 1950. An inventor present, named Volney Mathison, soon breadboarded up the first version of what we now know as the E-meter. Mathison's meter was a significant advance and Ron has graciously acknowledged Mathison's contribution to the solution of the problem.

Amidst his colossal outpouring of books, writings and lectures, amidst the carrying forward of his researches into the mind and the nature of Man, amidst the burdens of establishing and directing organizations to disseminate his discoveries into a not-always-accepting society, Ron redesigned and refined the E-meter many times, creating at last the highly precise instrument it is today.

Ron remains a man of immense vitality. His writing continues at a prolific pace, even faster than in his heyday as a fiction writer in the 1930s. That he appears to be on the threshold of yet another wave of popularity as a fiction writer is testimony to his discoveries about life and to the workability of the subjects which occasioned the development of the E-meter, Dianetics and Scientology.

Glossary

aberrate: See aberration

aberrated: See aberration

aberration: A departure from rational thought or behavior. From the Latin, aberrare, to wander from; Latin, ab, away, errare, to wander. It means basically to err, to make mistakes, or more specifically to have fixed ideas which are not true. The word is also used in its scientific sense. It means departure from a straight line. If a line should go from A to B, then if it is "aberrated" it would go from A to some other point, to some other point, to some other point, to some other point, to some other point and finally arrive at B. Taken in its scientific sense, it would also mean a lack of straightness or to see crookedly as, in example, a man sees a horse but thinks he sees an elephant. Aberrated conduct would be wrong conduct, or conduct not supported by reason. When a person has engrams, these tend to deflect what would be his normal ability to perceive truth and bring about an aberrated view of situations which then would cause an aberrated reaction to them. Aberration is opposed to sanity, which would be its opposite.

aesthetics: The study of ideal form and beauty - it is the philosophy of art, which itself is the quality of communication.

affinity: Degree of liking or affection or lack of it. Affinity is a tolerance of distance. A great affinity would be a tolerance of or liking of close proximity. A lack of affinity would be an intolerance of or dislike of close proximity.

analytical: Capable of resolving, such as problems, situations. The word analytical is from the Greek analysis meaning resolve, undo, loosen, which is to say take something to pieces to see what it is made of. This is one of those examples of the shortcomings of the English language since no dictionary gives the word analytical any connection with thinking, reasoning, perceiving, which in essence is what it would have to mean, even in English.

anchor points: 1. Assigned or agreed upon points of boundary, which are conceived to be motionless by the individual. 2. The points which mark an area of space are called anchor points, and these, with the viewpoint, alone are responsible for space. 3. An anchor point is a specialized kind of dimension point. 4. Points which are anchored in a space different to the physical universe space around a body.

as-is: To view anything exactly as it is without any distortions or lies, at which moment it will vanish and cease to exist.

attention unit: A theta energy quantity of awareness existing in the mind in varying quantity from person to person.

auditing: See processing.

auditing command: A certain, exact command which the preclear can follow and perform. See also **processing**.

auditing session: A period in which an auditor and preclear are in a quiet place where they will not be disturbed. The auditor gives the preclear certain and exact commands which the preclear can follow.

auditor: Scientology processing is done on the principle of making an individual look at his own existence, and improve his ability to confront what he is and where he is. An auditor is the person trained in the technology and whose job it is to ask the person to look, and get him to do so. The ward auditor is used because it means one who listens, and a Scientology auditor does listen.

awareness: The ability to perceive the existence of.

axioms: Statements of natural laws on the order of those of the physical sciences.

bank: See reactive mind.

basic: The first experience recorded in mental image pictures of that type of pain, sensation, discomfort, etc. Every chain has its basic. It is a peculiarity and a fact that when one gets down to the basic on a chain, (a) it erases and (b) the whole chain vanishes for good. Basic is simply earliest.

being: 1. One who lives or exists, or is assumed to do so (a human being, a divine being).
2. An energy production source. See also **thetan**.

blow: The sudden dissipation of mass in the mind with an accompanying feeling of relief.

case: The way a person responds to the world around him by reason of his aberrations.

case betterment: See **case gain**.

case gain: The improvements and resurgences a person experiences from auditing.

chain: 1. A series of recordings of similar experiences. A chain has engrams, secondaries and lacks. 2. A series of incidents of similar nature or similar subject matter.

charge: The stored quantities of energy in the time track. It is the sole thing that is being relieved or removed by the auditor from the time track.

checkout: The action of verifying a student's knowledge of an item given on a checksheet.

checksheet: A list of materials, often divided into sections, that give the theory and practical steps which, when completed, give one a study completion. The items are selected to add up to the required knowledge of the subject. They are arranged in the sequence necessary to a gradient of increasing knowledge on the subject. After each item there is a place for the initial of the student or the person checking the student out. When the checksheet is fully initialed, it is complete, meaning the student may now take an exam and be granted the award for completion.

circuit: *Electricity.* 1. A complete or partial path over which current may flow. 2. Any hookup, wiring, etc., that is connected into this path, as for radio, television, sound reproduction, etc. 3. *Scientology.* A art of an individual's bank that behaves as though it were someone or something separate from him and that either talks to him or goes into action of its own accord, and may even, if severe enough, take control of him while it operates.

circuitry: 1. The detailed plan of an electric circuit or network (as of a radio or television receiver). 2. The components of an electric circuit or network such as wiring, tubes, transistors, etc.

clear: The name of a button on an adding machine. When you push it, all the hidden answers in the machine clear and the machine can be used for a proper computation. So long as the button is not pressed, the machine adds all old answers to all new efforts to compute and wrong

answers result. Really, that's all a Clear is. Clears are beings who have been cleared of wrong answers or useless answers which keep them from living or thinking. *-verb*. To clear: to release all the physical pain and painful emotion from the life of an individual.

command: See **auditing command**.

conductor: A substance or body capable of transmitting electricity, heat, or sound.

confront: 1. The ability to be there comfortably and perceive. 2. The ability to front up to.

consideration: A continuing postulate.

dial: 1. E-Meter dial. 2. A marked surface on which a moving pointer shows how much there is of something.

Dianetics: Dianetics is *not* psychiatry. It is *not* psycho-analysis. It is *not* psychology. It is *not* personal relations. It is *not* hypnotism. Dianetics is defined as DIA (Greek) through, NOUS (Greek) soul. It is further defined as WHAT THE SOUL IS DOING TO THE BODY. Dianetics is a system of analysis, control and development of human thought which also provides techniques for increased ability, rationality and freedom from the discovered source of irrational behavior stemming from the mind.

dimension: 1. Any measurable extent, as length, width, depth, etc. 2. The distance from the point of view to the anchor point that is in space.

dimension point: Any point in a space or at the boundaries of space. As a specialized case, those points which demark the outermost boundaries of the space or its corners are called in Scientology anchor points.

dispersal: A series of outflows tram a common point. A dispersal is, primarily a number of flows extending tram a common center. The best example of a dispersal is an explosion. There is such a thing as an in-dispersal. This would be where the flows are all traveling toward a common center. One might call this an implosion. Outflow and inflow tram a common center are classified under the ward dispersal.

drop: A falling needle. See also **fall**.

duplicate: To make an exact copy of; repeat exactly.

élan vital: Theta, life force, life energy, divine energy, the energy peculiar to life.

electric field: A field of force surrounding a charged object or a moving magnet.

electrode: 1. A conductor (as metallic substance or carbon) used to establish electrical contact with a nonmetallic portion of a circuit. 2. Either of the two metal cans which the preclear holds and which are connected to the wire leads which connect to the E-Meter.

electron: Any of the negatively charged particles that form a part of all atoms.

electron microscope: An instrument for focusing a beam of electrons, using electric or magnetic fields, to form an enlarged image of an object on a fluorescent screen or photographic plate. It is much more powerful than any optical microscope.

electropsychometer: It's an electrical means of measuring the spirit. It's exactly what its name says, electropsychometer. It's called for short, E-Meter. See also E-Meter.

E-Meter: 1. Means an *electro-psychometer*, an instrument which measures emotional reaction by tiny electrical impulses generated by thought. 2. Hubbard Electrometer. An electronic instrument for measuring mental state and change of state in individuals, as an aid to precision and speed in auditing. The E-Meter is not intended or effective for the diagnosis, treatment or prevention of any disease

emotion: 1. A response by wavelength affecting an individual or another which produces a sensation and a state of mind. 2. The intention to exert effort bridges into the body by emotion. In other words, the physical-mental bridge is emotion. Emotion is motion.

energy: 1. Energy would simply mean a potential of motion or power. It is potential or actual motion or force. 2. Energy is subdivisible into a large motion, such as a flow, a dispersal, or a ridge, and a small motion which is itself commonly called a "particle" in nuclear physics. Agitation within agitation is the basic formation of particles of energy, such as electrons, protons and others.

engram: A mental image picture which is a recording of a time of physical pain and unconsciousness. It must by definition have impact or injury as part of its content.

erasure: The action of erasing, rubbing out, lacks, secondaries or engrams. It occurs when the postulate made during the basic incident on the chain is gotten off.

facsimile: 1. A facsimile is an energy picture which can be reviewed again. A facsimile contains more than fifty easily identified perceptions. It also contains emotion and thought. 2. The pictures contained in the reactive mind.

fall: 1. A type of E-Meter read. 2. A movement of the needle to your right as you face the meter. It can take place anywhere on the dial. It can be a short movement or a long movement even necessitating adjustment of the tone arm. The movement can be either fast or slow.

firsts: See **Scientology Firsts**.

floating needle: A floating needle is a rhythmic sweep of the dial at a slow, even pace of the needle. That's what an F/N is.

flow: The progress of particles or impulses or waves from point A to point B. Flow has the connotation of being somewhat directional.

F/N: Floating needle.

frequency: The number of times that any regularly repeated event, as a vibration, occurs in a given unit of time.

havingness: 1. The feeling that one owns or possesses. 2. The ability to duplicate that which one perceives, or create a duplication of what one perceives, or to be willing to create a duplication of it. But it's duplication. 3. Havingness is the concept of being able to reach or not being prevented from reaching.

Hubbard electrometer: See **E-Meter**

implant: An unwilling and unknowing receipt of a thought. An intentional installation of fixed ideas, contra-survival to the thetan.

implosion: Something that could be likened to the collapse of a field of energy such as a sphere toward a common center point, making an inflow. It can happen with the same violence as an explosion; but does not necessarily do so.

incident: An experience, simple or complex, related by the same subject, location, perception or people that takes place in a short and finite time period such as minutes, hours or days; also, mental image pictures of such experiences.

intention: An intention is something that one wishes to do. He intends to do it; it's an impulse toward something; it's an idea that one is going to accomplish something. It's intentional, which means he meant to do it, he means to do it.

jack: A socket that accepts a plug at one end and attaches to electric circuitry at the other.

lead(s): 1. An insulated conductor conveying electricity. 2. A wire carrying current from one point to another in a circuit, or to or from a piece of apparatus.

locks: Mental image pictures of non painful but disturbing experiences the person has experienced. They depend for their force on secondaries and engrams.

machine: An actual machine in the mind, (like ordinary machinery) constructed out of mental mass and energy, that has been made by the individual to do work for him, usually having been set up so as to come into operation automatically under certain predetermined circumstances.

mass(es): Energy masses in the mind. And mental mass is mass. There's no doubt about that. It has weight. Very tiny, but it has weight. And it actually has size and shape.

matter: A group of particles located in a relatively stable relationship to each other.

mental image picture: By *mental image picture* is meant a visual, emotional, pictorial or obscured scene envisioned by a person as appearing in his mind or trauma said to be responsible for neurosis, psychosis and psychosomatic illness.

mental mass: See **mass(es)**.

mest: A coined word, meaning matter, energy, space and time, the physical universe. All physical phenomena may be considered as energy operating in space and time. The movement of matter or energy in time is the measure of space. All things are mest except theta.

meter: See **E-Meter**.

mind: A control system between the thetan and the physical universe. It is not the brain. The mind is the accumulated recordings of thoughts, conclusions, decisions, observations and perceptions of a thetan throughout his entire existence. The thetan can and does use the mind in handling life and the physical universe.

mock-up: *n.* 1. *Mock-up* is derived from the World War II phrase which indicated a symbolized weapon or area of attack. Here, it means in essence, something which a person makes up himself. 2. Any knowingly created mental picture that is not part of a time track. *-v.* (mock-up) To get an imaginary picture of.

motivator: An overt act against oneself by another. In other words, a motivator is a harmful action performed by somebody else against oneself.

movement: A particular arrangement of related moving parts. In the E-Meter it is the mechanism just behind the needle and dial and includes these.

needle: 1. E-Meter needle. 2. Any slender pointer or indicator on a dial, scale, or similar part of a mechanical device.

needle reactions: E-Meter needle reactions. There are specific and distinct reactions of an E-Meter needle which can occur during auditing of a preclear. These are fully described in *E-Meter Essentials* by L. Ron Hubbard.

node: The point, line, or surface of a vibrating object, as a string, where there is comparatively no vibration.

ohm: A unit for measuring the amount of resistance or opposition an electrical conductor has to the flow of an electric current.

Operating Thetan: This state of being is attained by drills and familiarity after the state of Clear has been obtained. A real OT has no reactive bank, is cause over matter, energy, space, time, and thought and is completely free.

oscilloscope(s): Any of various electronic instruments for projecting the forms of electromagnetic waves on a fluorescent screen.

OT: Operating Thetan.

overt act: 1. An intentionally committed harmful act committed in an effort to resolve a problem. 2. That thing which you do which you aren't willing to have happen to you.

overt act-motivator sequence: The sequence wherein someone who has committed an overt act has to claim the existence of motivators. The motivators are then likely to be used to justify committing further overt acts.

PC: Preclear.

picture: See facsimile and mental image picture.

pin: (as in the E-Meter) A small piece of wood, metal or other solid substance as part of a mechanism to check motion.

pinch test: For demonstrations you can do a "pinch test" where you explain to the pc that to show him how the meter registers mental mass-you will give him a pinch as part of the demonstration. Then get him to think of the pinch (while he is holding the cans) showing him the meter reaction and explaining how it registers mental mass.

plug: A usually two-pronged device attached to the end of a wire or cable and inserted in a socket or jack to make a connection.

postulate: *n.* 1. A self-created truth would be simply the consideration generated by self. Well, we just borrow the word which is in seldom use in the English language, we call that postulate. And we mean by postulate, self-created truth. He posts something. He puts something up and that's what a postulate is. 2. A postulate is, of course, that thing which is a directed desire or order, or inhibition, or enforcement, on the part of the individual in the form of an idea.

pot: See **potentiometer**.

potential: 1. The amount of energy held by a body as compared to another point or body. Usually measured in volts. 2. The relative voltage, amount of electrical energy, or degree of electrification at a point in an electric circuit or field compared to some other point in the same circuit or field.

potentiometer: A type of variable resistor. A potentiometer is sometimes called a pot as an abbreviation. The tone arm on your E-Meter is a type of variable resistor and is sometimes referred to as a pot. A potentiometer can be used to increase or decrease the pressure (voltage) behind a flow of electrical energy and change the volume of the flow at will.

preclear: A spiritual being who is now on the road to becoming Clear, hence *preclear*.

present time: The time which is now and which becomes the past almost as rapidly as it is observed. It is a term loosely applied to the environment existing in now, as in "The preclear came up to present time," meaning the preclear became aware of the existing matter, energy, space, and time of now. The point on anyone's time track where his physical body (if alive) may be found. *Now*.

pressor beam: The pressor is a beam which can be put out by a thetan which acts as a stick and with which one can thrust oneself away or thrust things away. The pressor beam can be lengthened, and in lengthening, pushes away. Pressor beams are used to direct action.

problem: A conflict arising from two opposing intentions. It's one thing vs. another thing; an intention-counter-intention that worries the preclear.

process: A set of questions asked by an auditor to help a person find out things about himself or life. More fully, a process is a patterned action, done by the auditor and preclear under the auditor's direction, which is invariable and unchanging, composed of certain steps or actions calculated to release or free a thetan.

processing: Called auditing by which the auditor (practitioner) "listens and commands." The auditor and the preclear (patient) are together out of doors or in a quiet place where they will not be disturbed or where they are not being subjected to interrupting influences. The purpose of the auditor is to give the preclear certain and exact commands which the preclear can follow and perform. The purpose of the auditor is to increase the ability of the preclear.

psychosomatic: Psycho of course refers to mind and somatic refers to body; the term psychosomatic means the mind making the body ill or illnesses which have been created physically within the body by derangement of the mind.

reactions: E-Meter needle reactions.

reactivate(d): An engram is reactivated when an individual with an engram receives something in his environment similar to the perceptions in the engram. The engram puts everything it contains into greater or lesser operation. See also restimulation.

reactive bank: See **reactive mind**.

reactive mind: Reactive bank. The portion of the mind which works on a stimulus-response basis (given a certain stimulus it will automatically give a certain response) which is not under a person's volitional control and which exerts force and power over a person's awareness, purposes, thoughts, body and actions. It consists of lacks, secondaries, engrams and chains of them and is the single source of human aberration and psychomatic ills.

reads: 1. E-Meter needle reactions. 2. Needle reactions which occur at the exact end of the full question asked by the auditor.

recall: Present time remembering something that happened in the past. It is not re-experiencing it, reliving it or rerunning it. Recall does not mean going back to when it happened. It simply means that you are in present time, thinking of, remembering, putting your attention on something that happened in the past-all done from present time.

resistor: 1. A conducting body or device to control voltage in an electrical circuit, especially of a radio or television set, or other electronic equipment, because of its resistance: *A resistor is simply a poor conductor of electricity.* 2. Is a device placed along an electrical line to reduce the flow of current.

ridge: A solid body of energy caused by various flows and dispersals which has a duration longer than the duration of flow. Any piece of matter could be considered to be a ridge in its last stage. Ridges, however, exist in suspension around a person and are the foundation upon which facsimiles are built.

Saint Hill: The name of LRH's home in East Grinstead, Sussex, England, and location of the world-wide headquarters of Scientology, and the UK Advanced Organization and SH (AOSH UK). LRH taught the original Saint Hill Special Briefing Course at Saint Hill from 1961 to 1965.

Saint Hill Special Briefing Course: The Saint Hill Special Briefing Course has certain distinct purposes. The course was begun to do two things: (1) to study and resolve training and education (2) to assist people who wanted to perfect their Scientology. There has been no change in these purposes.

Scientologist: One who betters the conditions of himself and the conditions of others by using Scientology technology.

Scientology: 1. An applied religious philosophy dealing with the study of knowledge, which through the application of its technology can bring about desirable changes in the conditions of life. 2. Scientology addresses the spirit. It is used to increase spiritual freedom, intelligence, ability and produce immortality. Scientology is further defined as THE STUDY AND HANDLING OF THE SPIRIT IN RELATIONSHIP TO ITSELF, UNIVERSES AND OTHER LIFE.

Scientology Firsts: The discoveries, developments and advances in the field of the human mind, the spirit of Man, the humanities and many others, first achieved in Scientology - and nowhere else. A list of these "firsts" can be found in Chapter 1 of the book *What is Scientology?*

secondary: A mental image picture of a moment of severe and shocking loss or threat of loss which contains unpleasant emotion such as anger, fear, grief, apathy or *deathfulness*. It is a mental image recording of a time of severe mental stress. A secondary is called a secondary because it itself depends upon an earlier engram with similar data but real pain, etc.

self-determinism: Means the ability to direct himself.

sensitivity booster: The meter can be made more sensitive by turning the sensitivity booster to 64 or 128. This device acts as a booster to increase the range of sensitivity of the meter.

sensitivity knob: On the E-Meter the sensitivity knob is used to magnify the size of the needle reactions.

session: See **auditing session**.

set position (set): 1. To put into a desired position, adjustment, or condition (*set a thermostat at 700*). 2. To adjust in conformity with same standard (*set his watch by the radio time*)

signal) - Set position is clearly shown on the dial of the E-Meter, and is that position in which the needle must be positioned in order to ensure that the meter is correctly adjusted and ready for use.

static: An actuality of no mass, no wavelength, no position in space or relation in time, but with the quality of creating or destroying mass or energy, locating itself or creating space, and of relating time. See also **thetan**.

TA: Tone arm.

theta: The life force, life energy, divine energy, *élan vital* or by any other name, the energy peculiar to life which acts upon material in the physical universe and animates it, mobilizes it and changes it.

thetan: 1. The living unit we call, in Scientology, a thetan, that being from the Greek letter *theta* (**Θ**), the mathematic symbol used in Scientology to indicate the source of life and life itself. 2. (Spirit) is described in Scientology as having no mass, no wavelength, no energy and no time or location in space except by consideration or postulate. The spirit is not a thing. It is the creator of things. 3. The person himself - not his body or his name, the physical universe, his mind, or anything else; that which is aware of being aware; the identity which is the individual. The thetan is most familiar to one and all as *you*.

thinking: The combination of past observations to derive a future observation.

thought: The perception of the present and the comparison of it to the perceptions and conclusions of the past in order to direct action in the immediate or distant future.

time: 1. Time is basically a postulate that space and particles will persist. (The rate of their persistence is what we measure with clocks and the motion of heavenly bodies.)

time track: The consecutive record of mental image pictures which accumulates through the preclear's life or lives. It is very exactly dated.

tone: See **tone scale**.

tone arm: 1. E-Meter control lever. 2. Registers density of mass (ridges, pictures, machines, circuits) in the mind of the preclear. This is actual mass, not imaginary and can be weighed, measured by resistance, etc. Therefore the tone arm registers state of case at any given time in processing. The tone arm also registers advance of case during processing by moving. See also **potentiometer**.

tone scale: 1. The main gradient scale of Scientology. One of the most important observations which led to the formulation of this scale was the change in emotional manifestation exhibited by a person who was being processed. The progress from painful emotions to pleasant emotions was so reliable and evident on indication of success, that it became the main measuring stick of the progress of a case. 2. Under affinity we have the various emotional tones ranged from the highest to the lowest and these are, in part, serenity (the highest level), enthusiasm (as we proceed downward toward the baser affinities), conservatism, boredom, antagonism, anger, covert hostility, fear, grief, apathy. This in Scientology is called the tone scale.

tractor beam: An energy flow which the thetan shortens. If one placed a flash light beam upon a wall and then, by manipulating the beam, brought the wall closer to him by it, he would have the action of a tractor beam.

track: See **time track**

transistor: A small device that amplifies electricity by controlling the flow of electrons.

trim knob: Trim; to adjust (as a sail) to a desired position. The trim knob on the E-Meter is used as needed to bring the needle to the set position on the E-Meter dial.

twin: The study partner with whom one is paired. Two students studying the same subject who are paired to check out or help each other are said to be twinned.

viewpoint: A point of awareness from which one can perceive. The place from which the individual is himself looking, we call a viewpoint.

wave: A path of flow or a pattern of flow.

wavelength: The relative distance from node to node in any flow of energy. In the most universe wavelength is commonly measured by centimeters or meters.

Subject Index

Aberration,

- Entrapment and, 38
- facsimiles and, 32
- must be calculated to occur, 38

Activity,

- facsimiles and, 31

Anchor Points, 7-8, 34

- space and, 7, 34

Attention units,

- definition, 30
- Flows and, 30

Auditors,

- concept of how the E-Meter works, 39
- you don't have to know how the E-Meter works to make it work, 39

Battery,

- E-Meter, 49-51

Body.

- electrical energy and, 45
- electrical field and, 35-35
- mass and, 35
- mental image pictures and, 34
- space and, 34
- tethan and, 33-35

Charge,

- chronic, 37
- principals actions, 37
- stored quantities of energy, 36
- time track and, 36

Choice,

- power of, 38

Circuit,

- definition, 48

Condensed Energy, 9

Conductors,

- electrical energy and, 41

Definition,

- attention units, 30
- circuit, 48
- dimension points, 7
- energy, 19
- mest, 7
- postulate, 19
- potentiometer, 47
- sensitivity knob, 59
- space, 7
- static, 13
- time, 14
- wavelength, 23

Dimension point,

- definition, 7
- space and, 7

Dispersal, 21

Electric Energy,

- body and, 45
- conductors and, 41
- E-Meter and, 51
- insulators and, 42
- preclear and, 52
- resistor and, 43-44

Electrical Field,

- body and, 34

Electricity,

- as energy, 40
- E-Meter and, 39-56

Electrodes,

- E-Meter, 55

Electronics,

- basic principle of energy production, 28

E-Meter,

- amplifying reads, 59
- auditor's concepts of how the meter works, 39
- battery, 49-51
- electrical energy and, 52
- electricity and, 39-56
- electrodes, 55
- measures – reactions to impingements in life, 40
- pinch test, 58
- reads, 58
- resistor, 54
- sensitivity knob, 59
- sensitivity booster knob, 59
- three separate parts, 48
- tone arm and, 52
- tone arm measures density, 53
- trim knob, 54
- what makes it read, 55-57
- you don't have to know how the meter works to make it work, 39

Energy,

- ability to create, 32
- basic principle of energy production, 28
- body mass and, 35
- characteristics of, 21
- charge and, 36

Energy (continue)

- condensed, 9
- definition, 19
- facsimile and, 32
- matter and, 7-11
- mental, 35
- particles and, 19
- postulate and, 19
- potential, 29
- qualities of, 20
- static and, 20
- theta producing, 25
- time and, 16
- wavelength and, 23

Energy Flow, 21-23**Energy Ridge, 22****Entrapment,**

- aberration and, 38

Facsimile,

- aberration and, 32
- activity and, 31
- energy and, 32
- memory and, 26
- restimulation and, 36

In-Dispersal, 21**Insulators,**

- electrical energy and, 42

Kinetic, 13

- is called mest, 13

Life,

- creator of motion, 7
- meter measures reactions to impingements in, 40

Mass,

- body, 35

Matter,

- energy and, 7, 11-13
- time and, 16

Memory,

- definition, 26
- facsimile and, 26

Mental Image pictures,

- body and, 34

Mest,

- is kinetic, 13
- matter, energy, space and time, 7-12
- origin of mest, 25
- theta and, 16

Mest universe, 7

- time and, 18

Motion,

- static and static interplay against, 25

Particles,

- energy and, 19
- time and, 15-16

Physical Universe,

- parts of, 7
- tendency of, 25
- thetan and, 25

Pinch Test, 58**Postulate(s),**

- definition, 19
- energy and, 19
- static and, 19

Potentiometer,

- definition, 47
- tone arm and, 47
- type of variable resistor, 47

Preclar,

- electrical energy, 51
- sensitivity and, 59-60

Resistors,

- electrical energy and, 43-44
- E-meter, 54
- potentiometer is a type of variable, 47

Restimulation, 31

- implants and, 36
- permanent, 36

Ridge, 22

- wavelength and, 24

Sensitivity Booster Knob,

- E-Meter and, 59

Sensitivity Knob,

- Definition, 59

Space, 7-10

- anchor points and, 7-8, 34
- body and, 34
- definition, 7
- dimension point and, 7
- expanded, 10
- how it's created, 7
- time and, 14, 16
- viewpoint and, 7

Static, 13

- definition, 13
- interplay against motion, 29
- motion and, 25
- postulates and, 19
- thetan – the only true, 12

Thinking,

- the activity of, 30

Theta, 7

- energy and, 25

Theta (contiuue)

- mest and, 13
- origin of mest, 25
- producing energy, 25
- wavelength and, 27

Thetan,

- body and, 33
- physical universe and, 25
- power of choice and, 38
- time track and, 25, 38

Time, 14-18

- consideration of, 16
- defintion, 14
- energy and, 16
- keynote of, 14
- matter and, 16
- mest universe and, 18
- particles and, 15-16
- quickly moving, 18
- slowly moving, 18
- space and, 14, 16

Time Track,

- aberration must be calculated to occur, 38
- charge and, 36
- mechanism of, 38
- thetan and, 25, 38

Tone Arm,

- E-Meter and, 52
- Potentiometer, 47
- measures density, 53

Trim Knob,

- E-Meter, 54

Viewpoint, 7

- space and, 7

Wavelength,

- definition, 23
- energy and, 23
- ridge and, 24
- theta and, 27

What makes the E-Meter read, 55-57**Withdraw,**

- impulses to, 37

Bibliography

Purchase these Books by L. Ron Hubbard

Dianetics: The Original Thesis A scholarly treatise, written by L. Ron Hubbard in early 1948, to present the basic causes of human behavior and the resolution of mental aberration and psychosomatic illness to the medical and psychiatric societies. It is a fascinating account, but more importantly, in this text Ron makes his original and perhaps most basic statement of those timeless truths which dispel Man's ignorance.

Dianetics: The Evolution of a Science Is Man, as most psychologists hold, a primitive animal whose basic savage nature is held in check only by rigid social conditioning, or is his basic nature good, creative and constructive? The answer was looked for and found! With this book, follow the research track of how Ron evolved Dianetics.

Dianetics: The Modern Science of Mental Health Published in May, 1950, Dianetics shot to the top of the best seller lists across the country and stayed there week after week and month after month - and has been a continuing bestseller of international importance ever since. World response to *Dianetics* was typically expressed in terms like those of the *New York Times* review. "As with all great books, the impact of Dianetics means the world will never be the same again. History has become a race between Dianetics and catastrophe. Dianetics will win if enough people are challenged, in time, to understand it."

Notes on the Lectures Taken from the 1950 Los Angeles and Oakland lecture series - this book explains the relationship between the physical universe and the universe of thought. Two different universes. If you want to know more about people, and why they are what they are, then study this book.

Child Dianetics Have you all but given up on handling children? Parents who read Child Dianetics and give its simple exercises to their children, will find out that something can be done!

Science of Survival Written about a remarkable chart: The Hubbard Chart of Human Evaluation. With this chart you will be able to predict human behavior.

Self Analysis Contains simple exercises which can be used by anyone to better his life. Included also is an explanation of the principles involved, and a set of tests which the reader can administer to himself. It's not necessary for you to take anyone's word for it. Try it and experience the results for yourself.

Advanced Procedure and Axioms Advanced Dianetic discoveries and techniques comprising a research breakthrough by L. Ron Hubbard beyond the field of the mind into codification of the basic principles of existence. Contains over 200 definitions, logics and axioms of Dianetics, and short highly interesting writeups on postulates, responsibility, cause and effect, computations, self-determinism and other subjects.

Handbook for Preclears Written by Ron in 1951 to meet the demand for a personal workbook, a good sound text that anyone could pick up, learn, and follow in easily done steps to gain changes in the conditions of their lives. Designed for use as a self-help volume, and for use by the trained auditor and intelligent layman.

A History of Man A list and description of the principal incidents to be found on the time track of a human being. "This is a cold-blooded and factual account of your last sixty trillion years."

Scientology 8-80 The discovery and isolation of life energy has been an ambition older than Man himself. This is the book of a major research breakthrough, and contains the factors necessary to rehabilitate life energy and thereby giving its control back to the individual.

Scientology 8-8008 The complete treatise of the anatomy of universes and the role played in them by a spiritual being-the beingness of Man in relation to the universe of matter, energy, space and time, subjective and objective.

How to Live Though an Executive The problems of the modern business executive are many. The solution is fully summarized by Ron in this book. It is based on years of research into many different types of organizations. L. Ron Hubbard's earliest work on the subject of organization is *How to Live Though an Executive*.

The Creation of Human Ability A huge number of processes for use by Scientology auditors, with full elucidation of the major philosophical and technical breakthroughs by L. Ron Hubbard.

Dianetics 55! In this book, L. Ron Hubbard deals with the problems and fundamental principles of communication between Man and Man, and between Man and his environment.

The Fundamentals of Thought A brief but broad summation of the basic principles of Scientology. It is of inestimable value to the beginner or advanced student of the mind and life. Some of L. Ron Hubbard's most loved essays are in this book.

The Problems of Work This book is addressed to the doer, rather than the individual. It shows any person how to become more competent, able and secure in his job. It presents life and work as a game, shows the importance and use of ARC in work relationships, and gives the key to handling exhaustion.

All About Radiation This book gives a fascinating summary of facts and figures concerning the effects of radiation mentally and physically. It clears up for the caring individual the world wide controversy and mystery on the subject.

Control and the Mechanics of S. C. S. It gives simple exercises designed to handle bad reactions to control and raise a person's ability to handle control on his own determinism. An excellent manual for parents, teachers and all involved in handling people.

Scientology: Clear Procedure The early breakthroughs into Clearing technology were written up in this booklet in 1957.

Have You Lived Before This Life? This book presents the original discoveries on past lives that started it all 41 personal accounts of what it's really like to recall a past life and how this awareness has changed people's lives.

Axioms and Logics A concise booklet containing the Axioms of Scientology, the Prelogics, the Logics and the Axioms of Dianetics.

E-Meter Essentials A standard text for all Dianetics and Scientology training on the use of the E-Meter. Written in an easy style, this book is loaded with solid know-how every student needs to master.

The Book of Case Remedies The trained auditor's and student's manual covering pre-clear difficulties and their remedies. Loaded with brilliant case resolutions by L. Ron Hubbard and technical notes, the book is as fascinating as it is important.

The Book of E-Meter Drills This booklet contains all the standard E-Meter drills used in training in Scientology. These drills have been of the greatest possible value.

New Slant on Life All-time favorite essays by the Founder of Scientology. Scientology brings new knowledge of life and happiness to Man and the first successful technology for increasing Man's abilities.

The Book Introducing the E-Meter A book of basic drills by L. Ron Hubbard which gives the beginner his first familiarization with the use of the Hubbard Electrometer. Fully photo illustrated throughout.

The Phoenix Lectures Knowledge and wisdom are gained by reading The Phoenix Lectures, where Ron traces the philosophical roots of Scientology from the Vedic writings of ancient India, through Middle Eastern and Western thought, to present day.

Magazine Articles on Level 0 Checksheet A collection of technical articles originally published in Ability magazine in the '50s and '60s containing some of the most basic technical material for auditor training at Level 0.

Magazine Articles on Level II Checksheet A course textbook containing articles essential to Level II which were written by L. Ron Hubbard in the '50s and '60s.

Basic Study Manual An illustrated easy-to-read manual presenting the fundamental discoveries on how to study as discovered by L. Ron Hubbard.

Primary Rundown Glossary A collection of clear, concise definitions for those specialized terms and uncommonly used words contained in L. Ron Hubbard's famous study lectures.

Introduction to Scientology Ethics How to make a safe environment in which the individual and organizations can continue to succeed in his or their lives and jobs.

Scientology 0-8 Every subject has a hard core set of facts, laws, axioms upon which it is based. These form the philosophical basis for the practical and technical developments of Dianetics and Scientology. Through this data one can discover ways and means of formulating new ways of life and evaluating or creating standards of living and being.

Background and Ceremonies of the Church of Scientology The background and religious antecedents of the Church of Scientology, the Creed of the Church, instructions for service, general sermon outlines, many ceremonies as originally given in person by the Founder of Scientology.

The Basic Scientology Picture Book Volume 1 A visual aid to a better understanding of Man and the material universe. Basic Scientology described through pictures, drawings, simple diagrams and text in a large, easy-to-read format.

The Basic Dianetics Picture Book A visual aid for a quicker understanding and dissemination of Standard Dianetics and Dianetics pastoral counseling.

Mission into Time In 1968, L. Ron Hubbard led an unusual expedition into the past, with a crew to check his recall of incidents occurring several thousand years ago.

Dianetics Today The book which gives the technical breakthroughs in Dianetics since 1950, a follow-up to *Dianetics: The Modern Science of Mental Health*.

The Management Series 1970-1974 Comprising the highest management technology written by L. Ron Hubbard from 1970-1974, this volume contains the Data Series, Public Relations Series, Personnel Series, Organizing Series, Finance Series, Executive Series and Establishment Officer Series. This volume can be used by any management body.

Hymn of Asia Ron's famous poetic address to the world. Destined to be among the greatest of religious classics of mankind, it contains colorful and splendid art work and photography.

The Organizational Executive Course - An Encyclopedia of Scientology Policy An eight-volume set containing the collected works of organizational policy researched and developed by L. Ron Hubbard. This is the management technology and Scientology administrative training material of the Organization Executive Course.

Dianetics and Scientology Technical Dictionary Released in 1975, this book is the key to greater awareness and a fuller understanding of the technology of Dianetics and Scientology.

Hubbard Communications Office Policy Subject Index Compiled using the volumes of the Organization Executive Course and additional policies published up to August 1975. This volume is subject indexed under the titles of the policy letters and provides easier, taster location of administrative and organizational policy.

The Volunteer Minister's Handbook Compiled from the materials of L. Ron Hubbard with a magnificent introductory photo series by him, showing religion through the ages. The fundamentals of how to help one's fellow man.

The Technical Bulletins of Dianetics and Scientology (10 Volumes) The first 8 volumes of this ten-volume set contain all of L. Ron Hubbard's technical bulletins from 1950 to 1976. The ninth volume has in it the Basic Auditing Series, Expanded Dianetics Series, Cramming Series, among others, and the tenth volume contains the CIS Series plus a master subject index for the entire set.

Modern Management Technology Defined Hubbard Dictionary of Administration and Management A comprehensive dictionary covering the entire range of business terminology, including such areas as personnel management, communication within the group, financial management and data evaluation. This book provides the key to new clarity and understanding in the field of management.

Group Auditor's Handbook (Volume 1 and Volume 2) A two-volume set with twenty Group Processing sessions, printed in large type and complete with instructions and codes for the group auditor to follow and use.

What is Scientology This most recent publication contains an extensive collection of information about Scientology and Scientologists never before published. Here, at last, is a definite collection of facts and figures on and about what millions consider to be the most extraordinary phenomenon of our time. What is it all about, this Scientology? Where is it headed? What makes it the fastest growing self-betterment and reform group in the world today? The answers to these and many other questions on the subject are contained in this new book.

Technical Bulletins of Dianetics and Scientology- Volume XI An additional volume to the existing ten-volume set of The Technical Bulletins of Dianetics and Scientology. It presents the many technical breakthroughs made by L. Ron Hubbard during 1976-1978, including New Era Dianetics.

Technical/ Bulletins of Dianetics and Scientology Volume XII Another beautiful addition to this set of technical bulletins by L. Ron Hubbard, this volume contains the latest technical data issued since the latter part of 1978 up to the end of 1979. Included are the technical bulletins of the incredible 1979 breakthrough by L. Ron Hubbard, *The Purification Rundown!*

The Research and Discovery Series - Volume 1 First of a 75-100 volume set, this book begins the Running Record of Research in Dianetics and Scientology. This first volume contains the transcribed taped lectures given by L. Ron Hubbard between 10 June 1950 and 29 June 1950, 27 lectures in all. The volume is big and beautiful, with 832 pages of an incredible wealth of data, some of it never before published! The volume and the succeeding volumes of the set are an absolute must for anyone who wants to really know about life and living.

The Research and Discovery Series - Volume 2 The second volume in the Research and Discovery series. This volume covers the taped lectures of L. Ron Hubbard from July 1950 through August 1950. As big and beautiful as Volume 1, it also covers material never before published in tape lecture form.