

G U R P S

HIGH-TECH

WEAPONS AND EQUIPMENT THROUGH THE AGES

THIRD EDITION

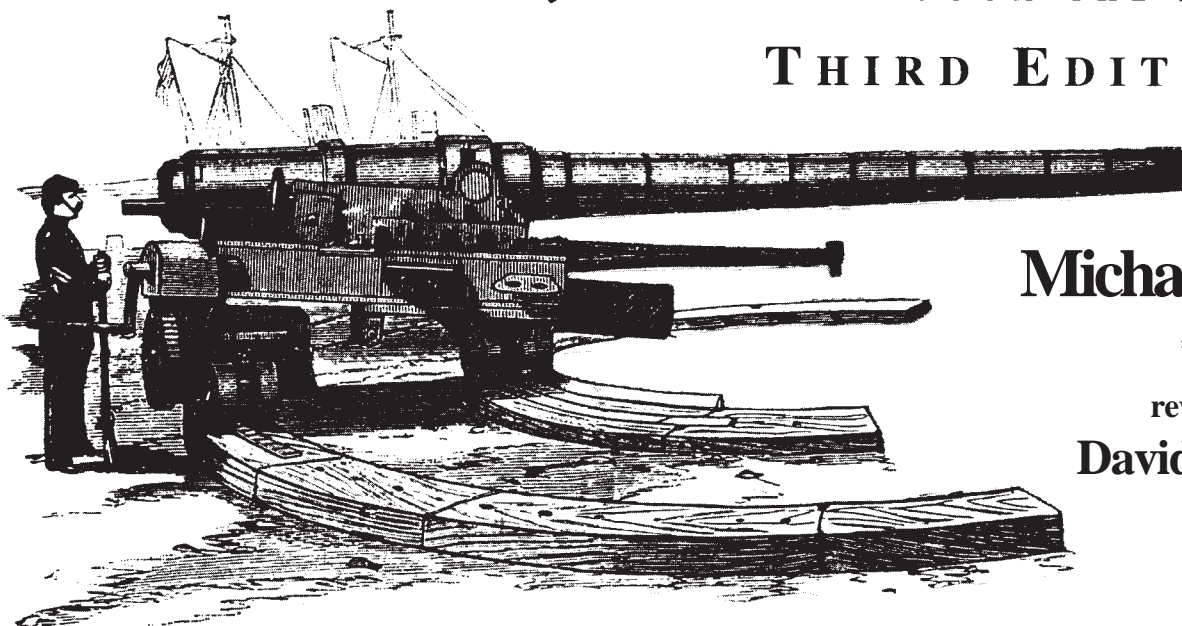

Michael Hurst

revised by
David Pulver

Edited by Steve Jackson

Additional Material by Steve Jackson and Ravi Rai

Cover by W.A. Dodge

Technical Illustrations by Laura Eisenhour

Illustrations and additional art by **Tim Bradstreet,
Guy Burchak, Rick Hardin, Michael Scott and
Dan Smith**

Additional Input: Scott Nickell, Bill Oliver, Mark Reynolds,
T. Carter Ross and Emily Smirle

GURPS System Design * Steve Jackson

Chief Operations Officer * Gene Seabolt

GURPS Line Editor * Scan Punch

Design, Production and Typography * Jack Elmy

Print Buying * Melissa Brunson

Art Direction * Alain Dawson

Production Assistance * S. John Ross

Playtesters: Bob Askelin, Walt Barber, Bill Barton, Chuck Bikle, Drew Bittner, Tim Carroll, James P. Clark, Joe Hollingshead, Matthew Huff, Ben V. Kloepper, Alex Kopponen, Brian L. Melcher, David T. Melcher, Walter Milliken, John Oliver, Steffan O'Sullivan, David Pulver, Ravi Rai, Brian Seely, Craig Sheeley, Mike White and The Wrecking Crew (Ray Carter, Dean Kenady, Dan Ormiston, Kelli Ormiston, Tim Ray, Steve Shepperson, Larry Stohr, Bill Williams and Michael Vragel).

GURPS and the all-seeing pyramid are registered trademarks of Steve Jackson Games Incorporated. *GURPS High-Tech*, *Pyramid* and *Illuminati Online* and the names of all products published by Steve Jackson Games Incorporated are registered trademarks or trademarks of Steve Jackson Games Incorporated, or used under license.

GURPS High-Tech is copyright © 1988, 1992, 1994, 1998 by Steve Jackson Games Incorporated. All rights reserved.

Some art copyright www.arttoday.com. Some art sourced from National Archives and Records Administration.

ISBN 1-55634-358-2

1 2 3 4 5 6 7 8 9 10

STEVE JACKSON GAMES

CONTENTS



Introduction	4	3. Explosives	22	<i>Lead, Iron and Stone</i>	41
ABOUT THE AUTHOR	4	CONCUSSION DAMAGE	22	<i>Pre-Gunpowder</i>	
<i>About GURPS</i>	4	<i>Flammables</i>	23	<i>Weapons at TLA</i>	42
1. Guns and Bullets	5	Fragmentation Damage	24	Firing Flintlocks	43
PENETRATE	5	EXPLOSIVES AND FIRE	24	AIR GUNS (1610 AND LATER)	43
WOUND	6	<i>Making Gunpowder</i>	24	<i>Combination Weapons</i>	43
WOUNDING MODIFIERS	6	RELATIVE EXPLOSIVE FORCE	25	GRENADES	44
Bullet Type	6	FUSES	25	<i>Bayonets</i>	44
<i>Flinch, Buck Fever and</i>		EXPLOSIVE DESTRUCTION OF		Throwing a Grenade	45
<i>Bullet Shyness</i>	6	MATERIAL	26	Grenade Damage	45
Bullet Size	7	<i>Fuel-Air Explosives</i>	26	Hand Mortars	45
Hit Location	8	GUNPOWDER	27	<i>Grenadiers</i>	45
APPLYING BULLET DAMAGE		SMOKELESS POWDER	27	HEAVY WEAPONS	46
MODIFIERS	8	<i>Napalm</i>	27	Bombards (pre-1500)	46
<i>Disabling a Gun</i>	9	DYNAMITE AND		<i>Iron and Bronze</i>	46
FIREARMS RANGE	10	NITROGLYCERINE	28	Cannon	47
RECOIL	10	<i>Explosive Artillery Shells</i>	28	<i>Engineer and Master Gunner</i>	47
Rcl Statistic (Felt Recoil)	10	Nuclear Devices	29	Artillery Cartridges	48
<i>Bursting Guns</i>	10	<i>Building a Nuclear Device</i>	29	<i>Ribaudequins</i>	48
MALFUNCTIONS	11	4. Guns, Sails and		<i>Moving Cannon</i>	48
<i>Improvised Guns</i>	11	Empires: Tech Level 4	31	<i>Starting Fires</i>	49
Immediate Action	12	PRODUCTION	31	Shipboard Artillery	50
<i>Bore Size to Inch/Millimeter</i>		BLACK POWDER WEAPONS	32	<i>TLA Starting Wealth</i>	50
<i>Conversion</i>	12	Types of Black Powder Gun	32	<i>TLA Tool Kit</i>	50
BUYING AND SELLING GUNS	13	CANNON-LOCK HANDGONNES		Howitzers	51
Metallic Cartridge Ammunition		(PRE-1450)	32	Mortars	51
Weights and Costs	14	<i>Black Powder Weapon Skill</i>	32	Unloading a Cannon	51
<i>Firearms Specialization and</i>		<i>Casting Your Own Bullets</i>	32	EXPLOSIVES AND PYROTECHNICS	51
<i>Familiarity</i>	14	MATCHLOCK GUNS		Shells	51
<i>Loose Cartridges Weight and</i>		(c. 1400-1700)	33	Fuse Action	52
<i>Cost Table</i>	15	Types of Matchlock	33	Petards	53
<i>Maintenance Specializations</i>	16	<i>Black Powder Ammunition</i>	33	Mines	53
2. Multiple Projectiles	17	<i>Match and Fuse</i>	35	<i>Draft Animals</i>	53
MULTIPLE PROJECTILES FOR		<i>Wet Guns</i>	35	Carcases	54
SMALLARMS	17	<i>Black Powder Fouling</i>	36	ARMOR	54
Smallarms Loads	17	<i>Backflash</i>	36	COVER	54
<i>Shotgun Combat Example</i>	18	Multi-Barrel Matchlocks	37	<i>Medicine</i>	54
Making Smoothbore Multiple		WHEELLOCK GUNS	37	DETECTION	55
Projectile Loads	20	<i>Drawing a Charge</i>	37	Watch Animals	55
MULTIPLE PROJECTILES FOR		How Wheellocks Work	38	Inanimate Alarms	55
ARTILLERY	20	<i>Carrying a Pistol</i>	38	<i>Communications</i>	55
<i>Play of the Engagement</i>	20	<i>Black Powder Smoke</i>	39	TRANSPORT	56
<i>Multiple Projectile Hit Table</i>	21	<i>Careful Loading</i>	39	Land	56
<i>Cannister Damage Table</i>	21	FLINTLOCK GUNS	40	Water	56
<i>Moving Targets for Artillery</i>	21	Varying the Load	40	<i>Building a Ship</i>	57
		Muzzle-Loading Flintlocks	41	<i>Piracy at TLA</i>	57
				<i>Printing</i>	58

5. The Triumph of Reason:

Tech level 5	59
PERSONAL WEAPONS	59
IMPROVED FLINTLOCK GUNS	59
<i>Ferguson, Crespi and Hall</i>	60
CAPLOCK (PERCUSSION) GUNS	61
<i>Why Weren't the Breech-Loaders</i>	
<i>Successful?</i>	61
<i>Minie Balls</i>	61
<i>The Rollin White Patents</i>	62
<i>Needle-Guns</i>	63
METALLIC CARTRIDGES	64
<i>Paradox Guns</i>	64
<i>The Volcanic Rifle</i>	64
<i>Mass Production, Price and</i>	
<i>Quality in Firearms</i>	65
<i>Single-Action and</i>	
<i>Double-Action</i>	66
<i>Metallic Cartridge Repeaters</i>	67
<i>Fast Firing: Fanning and</i>	
<i>Slipping the Hammer</i>	67
<i>Revolver Prices</i>	68
<i>Revolver Conversions</i>	68
<i>Deringer and Derringers</i>	69
<i>Cartridge Revolvers</i>	70
<i>Naval Artillery</i>	70
<i>Armor</i>	70
<i>Working on the Railroad</i>	71
HEAVY WEAPONS	72
<i>Cannon</i>	72
<i>Jumping a Train</i>	72
<i>TL5 Starting Wealth</i>	72
<i>TL5 Tool Kit</i>	73
DETECTION	74
TRANSPORT	74
<i>Land</i>	74
<i>Communications</i>	74
<i>Medicine</i>	75
<i>Water Transport</i>	76
<i>Air Transport</i>	76
<i>Tetanus</i>	76
6. The Wars to End Wars:	
Tech Level 6	77
PERSONAL WEAPONS	77
MACHINE GUNS	78
<i>Walking the Burst</i>	78
<i>Example of an SMG</i>	
<i>Engagement</i>	78
FLAMETHROWERS	79
HEAVY WEAPONS	80
<i>Artillery</i>	80
<i>The Cone of Fire and the</i>	
<i>Beaten Zone</i>	80
<i>Very High RoF</i>	80
<i>Guns, Mortars and Howitzers</i>	81
<i>Normal Vision Conditions</i>	81
<i>Fire Direction and</i>	
<i>Artillery Survey</i>	81
<i>New Skill: Forward Observer</i>	82
<i>Pre-Planned Artillery Fire</i>	82

<i>Types of Ammunition</i>	83
<i>Types of Fuses</i>	84
<i>Observed Fire for Other Weapons</i> ..	85
<i>Incoming!</i>	86
<i>Armored Vehicle Crew</i>	87
AFVs (ARMORED FIGHTING	
VEHICLES)	88
<i>Anti-Tank Weapons</i>	88
<i>Availability of AFVs</i>	88
INFANTRY DIRECT FIRE	
SUPPORT WEAPONS	89
<i>TL6 Ground Attack Aircraft</i>	89
AIRCRAFT AND AIR SUPPORT	90
<i>TL6 Body Armor</i>	90
<i>Alarm Systems</i>	91
<i>And-Aircraft</i>	92
ARMOR	92
<i>Working Underwater</i>	92
DETECTION	93
<i>Computers, Codes and Ciphers</i> ..	94
<i>TL6 Starting Wealth</i>	94
TRANSPORT	95
<i>Land</i>	95
<i>TL6 Tool Kit</i>	95
<i>Medicine at TL6</i>	96
<i>Water</i>	97
<i>TL6 Power</i>	97
<i>Air</i>	98
<i>TL6 Communications</i>	98

7. To the Edge of Space:

Tech Level 7	99
PERSONAL WEAPONS	99
<i>Assault Rifles, Submachine Guns</i>	
<i>and GPMGs</i>	100
<i>Electric Stun Weapons</i>	100
<i>Small Heavy Weapons</i>	101
<i>Silencers</i>	101
<i>Grenade Launchers</i>	102
<i>Augmented Sights (Scopes)</i>	102
HEAVY WEAPONS	103
<i>AFVs and Vehicular Weapons</i> ..	103
<i>Laser Sights</i>	103
<i>Anti-Tank Measures</i>	104
<i>Artillery</i>	104
<i>TL7 Body Armor</i>	104
<i>Air Defense Artillery</i>	105
ARMOR	105
<i>TL7 Starting Wealth</i>	105
<i>TL7 Tool Kit</i>	105
COMPUTERS	106
LASERS	106
COMMUNICATIONS	107
TRANSPORTATION	107
<i>Land</i>	107
<i>Water</i>	107
<i>Air</i>	107
<i>Space</i>	107
<i>Automotive Price and Quality</i> ..	107
<i>Medicine</i>	107

Weapon Descriptions

AUTO-LOADING PISTOLS	108
REVOLVERS	109
NON-REPEATING PISTOLS	110
SHOTGUNS	111
MUSKETS AND RIFLES	112
SUBMACHINE GUNS	115
GRENADES	117
MACHINE GUNS	117
MORTARS	120
GRENADE LAUNCHERS	121
FLAMETHROWERS	121
ANTI-TANK WEAPONS	122
CANNON	122



Weapon Tables

Abbreviations	123
AUTOMATIC PISTOLS	123
REVOLVERS	124
NON-REPEATING PISTOLS	124
SHOTGUNS	124
MUSKETS AND RIFLES	124
SUBMACHINE GUNS	125
GRENADES	125
MORTARS	125
MACHINE GUNS AND	
AUTOCANNON	126
GRENADE LAUNCHERS	126
FLAMETHROWERS	126
ANTI-TANK WEAPONS	126
ANTI-TANK GUIDED MISSILES	127
CANNON	127

Bibliography

Index	128
-------------	-----

ABOUT GURPS

Steve Jackson Games is committed to full support of the *GURPS* system. Our address is SJ Games, Box 18957, Austin, TX 78760. Please include a self-addressed, stamped envelope (SASE) any time you write us! Resources now available include:

Pyramid (www.sjgames.com/pyramid). Our online magazine includes new rules and articles for *GURPS*. It also covers all the hobby's top games - *AD&D*, *Traveller*, *World of Darkness*, *Call of Cthulhu*, *Shadowrun* and many more - and other SJ Games releases like *In Nomine*, *INWO*, *Car Wars*, *Toon*, *Ogre Miniatures* and more. And *Pyramid* subscribers also have access to playtest files online, to see (and comment on) new books before they're released.

New supplements and adventures. *GURPS* continues to grow, and we'll be happy to let you know what's new. A current catalog is available for an SASE. Or check out our Web site (below).

Errata. Everyone makes mistakes, including us - but we do our best to fix our errors. Up-to-date errata sheets for all *GURPS* releases, including this book, are always available from SJ Games; be sure to include an SASE with your request. Or download them from the Web - see below.

Q&A. We do our best to answer any game question accompanied by an SASE.

Gamer input. We value your comments. We will consider them, not only for new products, but also when we update this book on later printings!

Internet. Visit us on the World Wide Web at www.sjgames.com for an online catalog, errata and updates, and hundreds of pages of information. We also have conferences on CompuServe and America Online. *GURPS* has its own Usenet group, too: rec.games.frp.gurps.

GURPSnet. Much of the online discussion of *GURPS* happens on this e-mail list. To join, send mail to majordomo@io.com with "subscribe GURPSnet-L" in the body, or point your World Wide Web browser to: www.io.com/~ftp/GURPSnet/www/.

Page References

See *GURPS Compendium I*, p. 181, for a full list of abbreviations for *GURPS* titles. Any page reference that begins with a B refers to *GURPS Basic Set, Third Edition Revised*; e.g., p. B144 refers to page 144 of *Basic Set*. CI refers to *Compendium I*, CII to *Compendium II*, and V to *Vehicles*.

INTRODUCTION

GURPS is the universal roleplaying system. As such, it must cover any imaginable genre. Our main purpose in this book is to support and encourage an especially neglected species . . . the historical roleplayer. Earth's history has as much wonder and adventure to offer as any fantasy or science fiction . . . yet gamers often neglect this richest of all possible game-worlds.

This is the technical resource book for any historical campaign set after the Middle Ages. *GURPS High-Tech* starts with Tech Level 4 - the period at which gunpowder weapons begin to dominate the battlefield - and goes from there to the weaponry of today and tomorrow. *GURPS Ultra-Tech* describes the devices of science fiction.

Tech Levels, therefore, are described here in terms of the history of our own Earth. But GMs of fantasy and science fiction campaigns will, we think, find this book useful as well. The rules and descriptions apply to any similar technology, on Yrth, or Krishna, or H. Beam Piper's Aryan-Transpacific.

Tech Levels 4 through 7 (our present day) each are covered in a chapter. The main focus is on guns, from the first primitive *handgonne* to the laser-sighted machine-guns of the very near future. But we have tried not to slight other important technology. Each chapter also covers travel, communications, medicine and a Tool Kit of useful, typical items for the period.

It should be emphasized that history can't really be divided into neat Tech Levels. In many cases, a device is invented, and even available in a limited fashion, long before the man in the street has heard of it. In other cases, a device may literally seem to appear before its time! We have tried to keep a general historical perspective rather than a strict chronology when assigning devices to the different TLs, but especially anomalous situations are noted where they occur.

High-Tech has rules for a wide range of tools, weapons and devices. But it can't possibly be exhaustive. We hope that this book will encourage historical research as well as roleplaying, as both players and GMs investigate the technology of day-to-day life in our past.

Therefore, we have tried to make it easy to adapt gadgets from other sources to the game world. Much of the bibliography (p. 127) is devoted to sourcebooks for equipment information. Any item that is adequately described with real-world information can be converted to game terms. See p. 106 for information about the terminology used; this will be especially helpful if you are translating a new weapon into game terms.

About the Author

Mike Hurst served as an artilleryman in Viet Nam. He has also been a security officer (both uniformed and undercover); a tank commander in the Texas National Guard; and Captain of the Guard of the Barony of Bryn Gwlad. He is an NRA-certified firearms instructor and holds a Texas Reserve Police Officer certification. He possesses two dogs, an undetermined number of cats, and several thousand books, mostly history and science fiction.

He has been a wargamer and miniatures gamer for nearly 20 years, and shows no sign of reforming. On the other hand, his beloved wife Brenda, who shoots ambidextrously, insists he had better quit playing and commence writing.

CHAPTER ONE

GUNS AND BULLETS



Though the benefits and curses of technology are manifold, one invention stands out: the gun. This is as true in roleplaying as it is in history. The adventurers' first questions as they enter new territory are likely to be, "What weapons do they have here?" and "What can we carry without getting in trouble?"

This chapter will survey the *GURPS* rules for guns and bullets.

The basic damage for a gun is the damage done by its bullet; few guns are really effective as clubs. Basic damage for gun/cartridge combinations is in the *Weapon Tables* (pp. 123-127) and *Weapon Descriptions* (pp. 108-122). Unlike muscle-powered weapons, bullets do not base damage on the strength of the firearm's wielder. Basic damage is determined by "dice plus adds" (see *Basic Weapon Damage*, p. B73) and expressed as "hits" or "points of damage." Bullets always do at least 1 point of basic damage. A roll of 2 for a bullet that does 1d-4 basic damage is 1 hit. Bullets do two things, *penetrate* and *wound*.

Penetrate

This is a measure of how far the bullet will go into a given material. For *GURPS*, it is determined by a comparison of points of damage (as modified by bullet type) to Damage Resistance (also modified by bullet type). Subtract the DR from the damage at the time of impact; the points left are how much damage the bullet can still do on the far side of whatever it hit. Penetration applies equally to living or non-living things. Since a bullet (or shaped charge; see p. 27) makes a small hole, the hit points of an inanimate object (see p. B125) can be disregarded. Of course, a lot of little holes make one big one; GMs decide when enough small holes begin to take away hit points.

A bullet's dice of damage in *GURPS* are largely based on penetration - each 1d is the ability to penetrate about one-twentieth of an inch (1.25 millimeters) of hard steel. With enough damage, a bullet can shoot clear through one living thing, wounding it (see below) and continue with enough power to damage something else.

FLINCH, BUCK FEVER AND BULLET SHYNESS

The standard for accuracy of firearms in *GURPS* is that estimated for the weapon, in the hands of a shooter of the given skill, when he is calm, relaxed, in good physical shape and under no particular stress.

Combat seldom offers any of these conditions.

Even the stress of an important match or a trophy buck or a critical (or attractive) audience can seriously degrade the ability to hit a target. The variety of possible conditions, especially since they change for the same person under varying kinds of stress, is too great for a hard and fast rule. It is up to the GM to determine what the accuracy penalty is for each shooter under the given conditions. The GM applies the accuracy penalty after the player rolls for his character's shot. (If any gunman knew exactly what he was doing to foul up his shots, he would stop doing it!)

Flinch

Flinching is responding to the kick of the gun before it is fired. In *GURPS*, it is a recoil penalty applied to the *first* shot, or *added* to the normal recoil penalty of the first group of shots in automatic fire. It is most common for inexperienced shooters, but even veterans can pick up a flinch. GMs decide if the shooter is flinching, and to what degree.

Suppose a hoplophobe (see p. B36), totally unfamiliar with weapons, is attacked by a berserk biker. He might "flinch" to the extent that he closes his eyes, jerks the trigger and moves the muzzle two feet. For *GURPS*, this means no aim or accuracy bonus, twice Rcl penalty on the first shot - cumulative with each successive shot - full snap-shot penalty, and all this applied to default skill, if he first made a Will roll at -2 to allow him to touch the nasty thing at all.

Continued on next page . . .

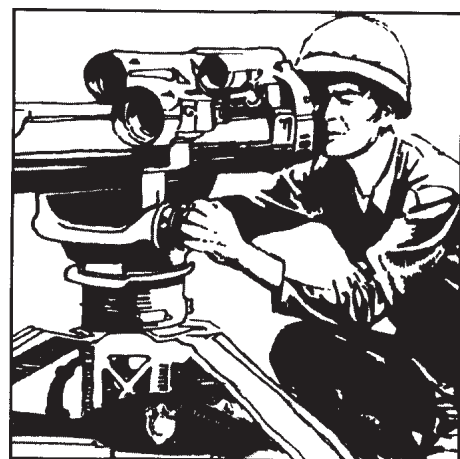

A bullet may, after injuring one person, pass right through and injure someone else. Only bother checking if something important is in the line of fire. If so, note the original damage roll. Then, after applying damage to the first target, if the original damage roll exceeded the cover DR that person's body provided, the bullet overpenetrated. Cover DR is the sum of any target armor (add front and back!) and his HT (for a head, torso or vitals hit), HT/2 (limb) or HT/3 (hand or foot), modified by armor divisors. Use *Hitting the Wrong Target*, p. B1 17 to check for a hit; if so, the damage that overpenetrated is applied to the new target (their own DR will protect).

Example: A sniper shoots a HT 10 terrorist in the chest. A hostage is behind him, so the GM checks for overpenetration. The rifle's basic damage roll on the terrorist was 19. He had a DR 1 jacket which gives DR 2 (front and back) added to his HT 10 = DR 12. Seven hits of damage "overpenetrates." The GM rolls to see if the hostage is hit, and he is. He'll take 7 damage (adjusted by any wounding modifiers for where he was hit).

Passive Defense Limitation

PD is the ability of armor to cause attacks to glance off harmlessly, but high-momentum projectiles are less likely to be deflected than melee weapons. For every *full* (Armor DR)/2 dice of damage a bullet would inflict, effective armor PD drops by one (minimum PD 0). Apply any armor divisor to DR before calculating PD reduction. *Example:* A man in plate armor (PD 4, DR 6) is shot. His PD is -1 for every (DR 6)/2 = 3 dice of damage, so a 7d bullet gives -2 PD, reducing his PD to 2.

Wound

The second thing bullets do is wound. A bullet's dice of damage is mostly a reflection of its size and kinetic energy - ideally, it needs enough energy to punch deep into flesh or shatter bone, while the larger it is, the more tissue is destroyed in its path. The damage roll models the variables of where the shot hit within a particular hit location and the highly unpredictable human reaction to trauma. For *GURPS* this is a comparison of points of damage (as modified) to hit points.

Any bullet that gets through armor and hits meat does at least 1 point of damage, which will be modified by various *Wounding Modifiers* (see below). Next, subtract the points of damage (as modified) from the target's current hit points (this may be a negative number). If the target is wounded enough, it may be incapacitated or killed; see p. B126.

Wounding Modifiers

Wounding modifiers are for bullet type, bullet size and hit location. They reflect additional variables beyond simply kinetic energy.

Bullet Type

There are three main bullet types: *expanding*, *solid* and *armor-piercing*.

Solid Bullets

Solid bullets give no modifier to either penetration or wounding. DR is subtracted from points of damage to determine penetration; points of damage are subtracted from hit points to determine wounding effect.

Before TL6, all bullets can be treated as solids. Velocities were low enough that significant expansion of any bullet was unlikely. At TL6 and above, solids are the default for all bullets. For simplified gaming, the GM can rule that all bullets are treated as solids.

Expanding Bullets

These are what the *Basic Set* calls “hollow points.” They are constructed (whether hollow point, soft point, pre-fragmented, etc.) to massively deform, making a larger wound cavity in living tissue. They do greater wounding damage but lack penetrating power. Expanding bullets have an armor divisor of (0.5), meaning DR is doubled against their damage. If no DR, an object lacking DR (save eyes, soap bubbles, single sheets of paper, etc.) gets DR 1 against them. If any points of damage remain after subtracting DR, damage is multiplied by 1.5.

Damage multiplication depends on actually getting expansion; at handgun and submachine-gun velocities this is difficult. There is only a 50% chance that a pistol or submachine-gun expanding bullet will get the multiplier. Roll a die, high/low or even/odd, or flip a coin to see if it expands. (This is realistic, but may be an unnecessary complication. It is required only at the GM’s discretion. For bursts, the GM can just assume half the rounds expand.) An expanding bullet that does not expand is treated as a solid bullet (see above).

Expanding bullets give -1 to the Malf of any semi-automatic fire and -2 to the Malf of any full-automatic fire.

Expanding bullets pay for their larger wound channel with decreased penetration. In addition to increasing armor DR, sometimes this means they cannot reach vital organs even with good shot placement. A shot to the vitals counts only as an ordinary torso hit if remaining damage (*after* DR but *before* wounding modifiers for bullet type or hit location) is less than HT/4 from in front or back or HT/2 from the side.

Historically, expanding bullets for rifles were commonly available from about 1890. Expanding bullets for revolvers were available from about the same time, but only common after about 1960. Expanding bullets for submachine guns and auto-loading pistols became widely available after 1970. It’s not enough that a bullet have exposed lead for expansion - it needs a high-enough velocity to actually expand in animal tissue.

Armor-Piercing Bullets

Armor-piercing bullets are specifically designed to penetrate. They are made of dense, hard materials that are very difficult to deform. They have an armor divisor of (2): DR protects at half value against them, but damage that penetrates DR is also halved.

Historically, armor-piercing bullets were first commonly available about the time of WWI (early in TL6).

Bullet Size

The greater a bullet’s diameter, the more tissue damage it does. Bullet-size modifiers affect only wounding; they have no effect on penetration.

Under .34 caliber (8.5mm) at low velocities (pistol and black powder) - This does not affect high-velocity weapons, such as most center-fire rifles; it does affect .22 Rimfire rifles. *Halve* remaining damage after DR is subtracted. This is an added complication, like the 50% chance for pistol-bullet expansion, that may not be worth the trouble. It models the behavior of rounds like .32 ACP, .25 ACP and .22 Rimfire, which are much more likely to wound than kill on targets larger than a rat. Weapons in this book that qualify have a “-” sign next to their damage. This rule is at the GM’s discretion.

.34 (8.5mm) to less than .40 (10mm) pistol, and rifle or shotgun less than .40 (10mm) - This is the default; there is no size modifier for bullet damage.

.40 to .60 (10-15mm) — Wounding damage, after DR is subtracted, is multiplied by 1.5. Weapons have a “+” sign after damage.

Over .60 (15mm) - Wounding damage after DR is doubled. Weapons have a “++” sign after damage.

FLINCH, BUCK FEVER AND BULLET SHYNESS (Continued)

On the other hand, an experienced hunter, used to shooting a .223 (Rcl -1), has to fire a .600 Nitro Express (Rcl -6). He knows that the recoil is much greater. (It is actually over 90 foot-pounds compared to about 3.5 foot-pounds for a .223.) The GM decides that a reasonable flinch penalty for a shooter going from varmint rifle to elephant gun is full Rcl on the first shot, and double Rcl for a second shot in the same second. He requires a Will roll (see p. B93) to control the flinch. On a success, subtract the number by which the Will roll was made from the Rcl penalty and apply this to the first shot as a flinch penalty. On a critical success, there is no Rcl penalty on the first shot, and normal penalty for a second shot (see *Felt Recoil*, p. 10). (The Will roll can’t give a bonus to Guns; if the flinch penalty becomes greater than 0, it is still 0.)

The flinch penalty is only used to determine if a shot is a hit; it has no effect on Malf, nor will it change an ordinary failure to a critical failure.

Buck Fever

Buck fever is the colloquial name for the sharp decrease in accuracy that mental stress can induce. It is most common for inexperienced shooters, but can affect anyone. The GM must determine if the stress on a character is such that a Will roll is required to resist buck fever. Modifiers to the Will roll should be based on how important success or failure is to the character; -1 to win or lose an important match, -3 for the only likely shot at a trophy elk, -5 to finish a hostage taker before he can kill (-10 or more if the hostage is the firer’s beloved child!). Advantages and disadvantages, such as Strong Will and Overconfidence, should also be taken into account; Combat Reflexes gives a bonus of +2 to resist buck fever. If the Will roll is a success, the shot is taken as normal. If failed, the shooter can still fire, but the shot is, at best, at the same penalty that was assessed to the Will roll.

The GM assesses the buck-fever penalty, but he does not have to announce it simply as, “You get a -5 to Guns.” This is a good time to tell the character what is happening and let him roleplay his decision.

“I’m taking aim with my Lee-Enfield at the IRA terrorist,” says the player.

“You have trouble focusing; somehow the sights and the target won’t align, sweat stings your eyes and the faces of the hostages keep sweeping across your vision. The rifle quivers in your hands. Somehow, the old, familiar feel from hours on the range is gone; your trigger finger seems to be on someone else’s hand,” says the GM.

Continued on next page . . .

FLINCH, BUCK FEVER AND BULLET SHYNESS (Continued)

The player says, "Is this a subtle indication that my skill is being negatively affected by stress?"

Bullet Shyness

Very few people want to get shot. Hence, the sight or sound of bullets in the immediate vicinity should make the complicated balancing of forces involved in aiming and firing much more difficult. (One reason snipers have such a good kill-to-shot ratio is that they usually get to shoot first.) GMs should reduce the accuracy of NPCs whose positions are being swept with fire, even if none are being hit. PCs should be restrained from overexposure by the traditional system ("Stick it up; lose it!"). Modifiers to any to-hit roll for a firer who is being shot at might go from -1 for an occasional stray round to -10 for a concentrated blast of auto-fire which is whipping dust and splinters like a hurricane.

Other Problems

With Accurate Shooting

Anything that disturbs a shooter's ability to hold steady while aiming can degrade accuracy. Physical exercise (a hard chase, a run up a staircase, a scuffle with a suspect) should take away some accuracy. The amount should depend on the amount of exercise as compared to the HT (endurance is more important than strength for this) of the shooter. Illness, especially fever and shakes, also make shooting harder. Distraction at the moment of aim can be disastrous. Anything that hurts vision - dripping sweat, blowing sand, badly fitted goggles (especially gas masks, -3 at least!) - hurts accuracy.

Hit Location

Hit Location effects are on p. B203; a Hit Location diagram for humans is on p. B211. Hits to the torso and extremities have no modifier. Hits to the vital organs of the torso do triple damage. Hits to the brain do quadruple damage.

Applying Bullet Damage Modifiers

Bullet damage modifiers are cumulative. The sequence of application is:

- (1) Roll for bullet damage.
- (2) Apply bullet-type modifier to DR; round *up* to the next whole number.
- (3) Subtract modified DR from points of damage. If damage fails to penetrate, see *Flexible Armor and Blunt Trauma*, below.
- (4) Apply bullet-type modifier to remaining damage; round *down*.
- (5) Apply bullet-size modifier to remaining damage; round down.
- (6) Apply Hit Location modifier; round up.
- (7) Adjust damage for blow-through (see below). Subtract modified points of damage from hit points.

Flexible Armor and Blunt Trauma

Flexible armor, such as Kevlar or mail, flexes with the blow and allows some damage to get through. Firearms literature calls this "blunt trauma." In *GURPS* it is crushing damage. Any "6" rolled on a bullet attack that does not penetrate flexible armor does 1 point of crushing damage to the target. Bullet type and size modifiers do not apply to blunt-trauma damage; Hit Location modifiers apply, but it's normal crushing (not bullet) attack, so damage to vitals isn't tripled.

Blow-Through

Bullets have a lot more energy than can usually be translated directly into killing or "stopping power." Some energy may be literally "lost downrange" if the bullet goes on through. More is "lost" because it doesn't take the target out of action. Waste heat, stretching of tissue below its elastic limit, transitory wave effect and other non-lethal actions use up much of the bullet's energy without necessarily "stopping" the victim from breathing, or even moving and fighting. In game terms, damage is limited by the "blow-through" rule (see p. B109).

Not every bullet is handled identically for blow through. Attacks that do more than 15d basic damage never blow through.

Any one bullet can do a maximum of HT/3 to hands and feet; HT/2 to arms and legs; HT to torso; HTx3 to head or vitals. There is no limit to the amount of damage a single bullet can do on a hit to the brain (except that the most it can do is kill instantly; it can't actually disintegrate the target). Use hit points, not HT, when calculating blow through on targets with split HT.

For armor-piercing bullets and expanding bullets that actually expand, apply the bullet type modifier to the maximum damage that can blow through. Thus, no more than HTx0.5 (5 hits for an average HT 10 person) can be inflicted from an AP bullet torso hit, or HTx1.5 (15 hits for a HT 10 victim) for a vitals hit.

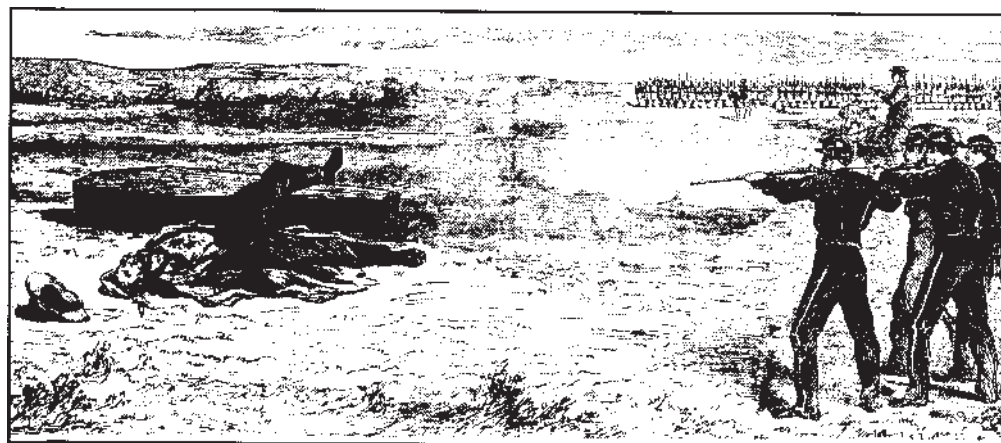

Bullet Knockback

Bullets don't push people around very well. Pushing is mostly a matter of momentum. While bullets have a lot of kinetic energy; they have comparatively little momentum. A man shot in the chest with an elephant gun is as likely to fall toward the shot as away from it; even a rifle shot stopped by armor is unlikely to knock the subject over. Bullets that wound give very little knockback; they rip and tear flesh rather than pushing it.

For *GURPS*, bullets that wound do no knockback. A bullet that does not penetrate DR moves the foe one hex directly away along the line of the shot if the unmodified damage rolled is more than 3 x ST of the target.

Examples of Bullet Damage

9mm solid from a Glock 17 pistol, torso hit on a HT 10 human wearing a Second Chance Standard Kevlar vest (DR 14):

- (1) 2d+2 damage, roll is $8 + 2 = 10$, one die is a 6.
- (2) Armor protects at full DR.
- (3) $14 - 10 = -4$ damage. One 6 was rolled, so 1 hit crushing damage from blunt trauma is inflicted.
- (4), (5) No bullet-type or bullet-size modifiers (neither would apply anyway, since the only damage is blunt trauma).
- (6) No Hit Location modifier.
- (7) 1 hit damage; HT 10 drops to HT 9.

.44 Magnum expanding round from a Desert Eagle pistol, torso hit on an unarmored HT 10 human:

- (1) 3d damage, roll is 11, no 6 is rolled.
- (2) No armor, but target gets automatic DR 1 from clothing and skin.
- (3) Damage is 11 points of damage minus 1 DR = 10 hits.
- (4) It's a pistol, so the GM decides to check for bullet expansion, 4-6 on 1d. He rolls high, so expansion occurs, giving a bullet-type modifier of 1.5, increasing damage to 15 hits.
- (5) Bullet-size modifier is also 1.5; $15 \times 1.5 = 22$ hits.
- (6) No Hit Location modifier.
- (7) 22 hits damage is modified by the blow-through rule to no greater than basic HT x bullet-type modifier, so 15 hits are taken. HT drops from HT 10 to HT -5; victim must roll each turn to avoid passing out.

.50 BMG armor-piercing from Barret Model 82 sniper rifle, brain hit, on HT 15/50 elephant with DR 2 hide:

- (1) 13d damage, roll is 44 with three 6s.
- (2) Target has DR 2 (hide) + DR 2 (skull) = DR 4; vs. AP bullets this is halved to DR 2.
- (3) $44 - DR 2 = 42$ hits. . (4) Bullet-type modifier for AP halves this to 21 hits.
- (5) Bullet-size multiplier for .50 caliber is 1.5, increasing damage to 30 hits.
- (6) Damage to brain is x 4, so 120 hits.
- (7) The blow-through rule has no effect on brain hits, so all 120 hits are taken. HT 15/50 minus 120 leaves HT -70. The elephant is unconscious, will need to roll vs. HT several times to avoid death and is 5 hits away from automatically dying.

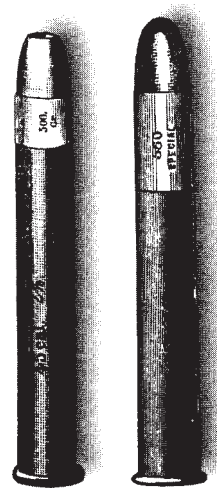

DISABLING A GUN

Guns may be intentionally disabled. It is easy to destroy a hand weapon. Any sort of long arm or pre-TL6 pistol will be wrecked if you swing it against a tree with both hands! A modern pistol may survive this treatment, but its accuracy and reliability will be severely hurt.

Disabling the big guns - that is, cannon - is more of a challenge. There are two basic methods: bursting and spiking. Bursting is done by deliberately overcharging the piece and touching it off. A truly heroic death is to stand with the guns until they are overrun, then touch them off and take the enemy with you. Most gunners, however, leave a slow match in the touch-hole and withdraw. The problem with this is that the enemy may get there in time to douse the fuse. A really heroic infantry action is to volunteer to be first into the battery so you can try for the fuse.

Spiking the gun means blocking the touch-hole. This is a reversible method of disabling, and is especially valuable if you expect to get the guns back. Improvised methods with ordinary nails or bayonets will have a temporary success. For really effective spiking, the military issues special spikes. They are in sizes that approximate that of the usual touch-hole and are somewhat longer than the length of the vent. The regulation spiking method is to ram a ball in under the vent and drive in a spike until the point bends over on the ball. To return the gun to service, you have to both drill out the spike and draw the ball. Drilling the spike (given a brace and bit or breast drill) takes 2d minutes. A properly equipped artillery unit has spikes, mallets and drill. The necessary tools would also be issued to a regular military assault force. A pirate crew, brigand band or the usual party of adventurers is a lot less likely to have the right tools.

Disabling Artillery at TL6+

These systems of disabling a gun lasted until the development of modern artillery at the very end of the 19th century. Dropping an incendiary thermite grenade into the breech is a neat solution. The breech will be welded to the barrel; at the same time, the structural strength of the steel will be so degraded that even if the breech could be removed, the gun would likely burst if fired. The modern equivalent to spiking the guns is to carry off the breech-blocks and sights; if you retake the guns, they can be reinstalled. A measure of the discipline and morale of an artillery unit is if they remember to disable their guns if they are forced to withdraw without them. Of course, abandoning the guns is a last desperate measure; "redlegs" have often died around their guns rather than leave them to the enemy.



Firearms Range

Ranges of ranged weapons are described in the following terms: $1/2D$ expresses two things: the distance at which damage is halved and the distance at which the *Accuracy bonus* (Acc) is lost.

Max. (Maximum) range is the farthest distance that the projectile will carry when the gun is fired at the most effective elevation. Maximum range for smallarms, and for artillery before TL6, ignores the curvature of the planet. Above TL6, artillery computation must account not only for a curved planet, but also for the distance that the planet turns under the projectile while it is in flight.

Recoil

Guns recoil because of the Newtonian laws of motion. Technically, recoil is a consequence of conservation of momentum; the mass x velocity of the ejecta (bullets, powder gases, anything that goes out the muzzle) going in one direction must equal the mass x velocity of the gun going in the opposite direction.

Rcl Statistic (Felt Recoil)

Felt recoil or *kick* is more significant for gaming (at least in a 1-G field for more or less human firers). Felt recoil is a matter not only of the momentum of the gun but of its controllability. Controllability is affected by stock and grip design, action type, compensators and the size, strength and position of the firer. This is simulated by the *Rcl* number, expressed as a negative, in the stats for each weapon in the weapon tables.

This number makes some assumptions about the variables affecting felt recoil; that this is the weapon as normally sold or issued, and that it is being fired from a steady position, with both hands holding the gun, by a human within the usual norms for size and strength (the 8 to 14 ST range in *GURPS*). The GM can choose to increase Rcl for different conditions.

As a guide: (1) double Rcl for any weapon except a TL5+ pistol fired one-handed; (2) add 50% to Rcl for any musket, rifle, shotgun or SMG with the butt-stock removed or folded during firing; (3) double Rcl for any strained, unbalanced or peculiar firing position; (4) double Rcl for each point of ST below the minimum ST listed on the *Weapon Tables*. These penalties are cumulative.

Non-Automatic Weapons Recoil

The Rcl penalty is applied to a *second* or subsequent shot from the same gun, unless there is a minimum one-second pause between shots to reestablish shooting position. If the ST of the firer is less than the minimum for the weapon, apply the Rcl penalty unless there is a two-second pause.

Light Automatic Weapons Recoil

For automatic fire, the Rcl penalty applies to the *first* group of up to four shots of a burst (each shot moves the weapon some). Each subsequent group of up to four rounds causes the Rcl penalty to increase by itself (1 becomes 2 becomes 3; 2 becomes 4 becomes 6; etc.) For an example of a submachine gun action, see the sidebar on pp. 78-79.

Heavy Automatic Weapons Recoil

Heavy automatic weapons (machine guns and autocannon) are designed to be fired from a mount, such as a tripod or pintle. The Rcl listed is for the gun fired from a correct mount, with the mount solidly placed and the gunner in a proper position. Firing such a gun when it is not solidly mounted can be really difficult! As a guide, quadruple Rcl penalties for any heavy or medium MG (see p. 79) that is not properly

BURSTING GUNS

Guns burst in one of two places: at the breech or at the barrel. Bursting at the breech is usually more serious. The explosion is a lot closer to the firer.

Guns can burst for many reasons. The most common are overcharge for the strength of the gun, or a plugged barrel.

Before the mid-19th century it was not too uncommon for either smallarms or cannon to burst. The metallurgical knowledge of the time was simply not good enough to design guns that could predictably stand up to the stress of firing. Iron guns, especially, were notorious for bursting without warning. One King of Scotland, and unnumbered commoners, were killed by the failure of their weapons.

After about 1850, burst guns became increasingly rare. By the 20th century, it is fairly safe to say that guns don't burst unless they are helped. The usual causes are overloads or bore obstructions.

Handloaders frequently stretch the safe limits of loading data. Handloaders also manage an occasional squib load, and leave a bullet stuck in the bore. If they then fire another round, they can manage some spectacular effects.

Even the worst efforts of the cartridge-stuffers can seldom manage to burst a modern gun. Usually the bolt will give way before the breech. A bolt in the face is not fun, but it is rarely fatal. It may require extensive plastic surgery, and it usually takes out the aiming eye.

mounted; double Rcl for LMGs and GPMGs that are not at least sitting firmly on their bipods. Multiply Rcl by 8 for such monster cartridges as the .50 BMG and 14.5mm Russian.

Malfunctions

Any gun can fail to work because of a mechanical malfunction or operator mistake. Operator mistakes are covered by the Critical Miss rules. A critical miss on a firing attempt happens only on a natural roll of 17, 18 or 10 more than adjusted skill.

A *malfunction* is a mechanical failure of the weapon or ammunition. A simple malfunction, unlike a critical failure, does not endanger the user.

All weapons have a *malfunction number*, or “Malf” number. For instance, a matchlock malfunctions, or misfires, on a 14+. This means that any roll of 14 or more, *unless* it is a critical failure, will be a malfunction. In other words, for a shooter of average skill, a roll of 14, 15 or 16 is a malfunction, while a 17 or 18 is a critical miss. Malfunction is based on the number rolled, with modifiers for weapon reliability and conditions. It is not affected by modifiers for target size, speed and range, accuracy, aiming, bracing or sights.

The better the weapon, the higher the malfunction number; most weapons of TL6+ have a malfunction number of *crit*, because they are reliable enough that, treated properly, they almost always fire when the trigger is pulled. Some have a higher “Ver.” malfunction - any malfunction must be verified by rolling a second failure. A critical failure with any weapon can turn out to be a malfunction, though! All “dud,” “jam” and “weapon breaks” results on the *Firearms Critical Miss Table* (p. B202) should be treated as malfunctions. The GM rolls; the player does not know whether his weapon’s problem is one that can be fixed or not until he tries Immediate Action (see below).

Malfunctions are far likelier for an untrained shooter. Any shooter with a skill of 10 or less has his weapon’s Malf number decreased by 1. (Remember, a decrease in Malf number makes a malfunction *more* likely.) Malfunction rates are also affected by the mechanical state and surrounding conditions of the weapon and ammunition, as determined by the GM.

For early weapons, including all black powder weapons, the only likely malfunction is a simple misfire . . . the gun does not go off. When automatic weapons are invented, a second common malfunction appears: *stoppage*. The weapon fires one or more shots, then stops. Usually a stoppage is a jam - the next round in sequence for a repeating weapon cannot reach the firing chamber. For single-shots, a stoppage means that the gun cannot be reloaded without repair. A misfire is a worse result than a stoppage in most circumstances; a stoppage at least gets one round off.

The relative likelihood of misfires or stoppages varies with different kinds of weapon. For a flintlock muzzle-loader, the most likely malfunction is a misfire. Many things can keep a flintlock from going off; if it fires, there are few things that can keep it from being reloaded. For a Thompson SMG, the most likely malfunction is a stoppage. The ammunition and action are both very reliable, but the ejection and feed sequence have many possibilities for failure. The type of weapon determines which malfunctions are misfires and which are stoppages.

The description of each type of weapon will give a general malfunction number for such weapons. Specific malf numbers are given in the *Weapon Tables*.

Mistreated Weapons

Abuse will make any weapon less reliable. The GM determines the penalty, if any, for using the gun snatched from the mud, or found abandoned for 40 years in a closet or rolled on by a collapsing horse. This may be a lowered malfunction number, a decrease in the weapon’s Acc or some other penalty. Rolls against Guns, Gunner or Armoury can attempt to detect and correct the mechanical flaws of a weapon.

IMPROVISED GUNS

A gun is a tube, closed at one end and open at the other. The only operational necessity is that it be strong enough to resist the force of the propellant for one shot. Propellant, ignition and projectile can all be improvised from commonly available materials.

Marsh Williams made his first short-stroke, gas-operated, semi-automatic rifle while he was a prison inmate. The barrel was a discarded axle. His most complex tool was a file.

The Israelis made hundreds of working submachine guns during the British mandate. Old Turkish rifles were the source for parts; each rifle yielded enough for two submachine guns. The only power tool used was a converted dentist’s drill.

Zip-guns were a prominent part of street-gang armament in the 1950s. They were single-shot .22 pistols. One common design used a piece of car-radio antenna, wire-reinforced, as the barrel. The grip was scrap wood. The firing pin was a nail, and the mainspring was a rubber band. Accuracy and reliability were both poor, and power was low, but they could kill a man as dead as he could get.

Given materials, anyone with Armoury or Mechanic skill can make some kind of a working gun. Two that can be improvised quickly are:

Zip-Gun

Fires .22 Rimfire ammunition; treat it as a cheap .22 single-shot. Malfunctions on 12+. Can be made any time after 1857. Base time to complete is 8 hours. Three hours and a successful Scrounging roll will be required to find the materials. Use the *Long Tasks* rules (p. B93) to see how long it really takes to finish, rolling against Armoury skill or Mechanic-2. A critical failure makes a gun that will explode on first use, doing 2d damage to the user.

Cannon-Lock Muzzle-Loader

Fires any available scrap, using black powder, smokeless powder or other propellant. Treat as a cheap smoothbore of the appropriate caliber. Essentially nothing more than a heavy pipe with one end closed off except for a touchhole; materials are available in any TL5+ area. Roll as above to make, rolling at either Armoury or Mechanic skill. If it explodes, it does 3d damage to the user.

If necessary, propellant can be improvised as well; this is a 24-hour task for Chemistry skill, unless a well-supplied laboratory is handy. In that case, only an hour is required! A critical failure during the process means the explosive won’t work. A natural 18 blows up in the chemist’s face (3d damage).

BORE SIZE TO INCH/MILLIMETER CONVERSION

Before the 19th century, the size of projectile fired by a gun was more often given in terms of *weight of ball* than diameter in inches or millimeters. For artillery, this was the weight in pounds of a cast-iron ball; for smallarms, the number of lead balls of bore diameter that would make one pound. Neither of these measurements was ever exactly equivalent to bore size. There had to be an allowance for “windage” (balls had to be smaller than the bore in order to load muzzle-loaders) and the density of lead and cast iron was not firmly standardized. They were close enough that balls “14 to the pound” or “1-pounder” would usually fit any gun so described. The system survived in England until well into the 20th century, and is still used for shotguns.

The following table gives equivalents in bore/inch/millimeter that are close enough for those *GURPS* rules where projectile or bore diameter is needed. *Gauge* is in nominal lead balls of bore diameter to make one pound. *Inch* is caliber in hundredths of an inch for smallarms, and tenths of an inch for artillery, as usually measured in U.S. arms. *Millimeter* is usually simply an arithmetical conversion rounded to the nearest millimeter; the exceptions are for rounds that have a common designation to tenths or hundredths of a millimeter; .45 ACP is usually listed as 11.43mm, for instance. *Pounder* is the weight of a nominal cast-iron ball of bore diameter.

These dimensions are often somewhat different from the same name as used in current practice; 20th-century 12 gauge shotguns, for instance, are about .73 caliber.

Gauge	Inch	Millimeter
4	1.05	27
8	.84	21
10	.79	20
12	.75	19
16	.66	17
20	.63	16
24	.58	15
32	.53	13
38	.50	12.7
50	.45	11.43
54	.44	10.2
72	.40	10
100	.36	9
120	.32	7.65
173	.30	7.62
285	.25	6.35

Continued on next page . . .

Immediate Action

For every kind of gun, some failures are more likely than others. There is a procedure for every kind of gun, which can be applied as soon as it fails, that will give the best chance of correcting the problem and returning the gun to service. This is called *Immediate Action*.

All malfunctions, as distinct from critical misses, are subject to Immediate Action. Immediate action is different for every weapon; it represents the standard “try this first” procedure for that weapon. For a flintlock, for instance, the most likely cause of failure is bad priming. Immediate action is to clear the pan, prick the vent and reprime. All this takes about five seconds. For an M1 carbine, the most likely fault is a failure to feed from the magazine. Immediate action is to clear the chamber and let the bolt fly home to chamber another round; this takes about one second.

Immediate action is represented by a roll against Black Powder Weapons, Guns, Beam Weapons (for ultra-tech devices), Gunner or Armoury, as applicable. The player announces that his character is trying Immediate Action. The roll is made by the GM, in secret.

An immediate-action roll is at -1 for any weapon that is not commonly used by the firer, -2 for an unfamiliar weapon of a familiar type, -5 for an unfamiliar type of weapon, -6 plus the difference in TL for a weapon from another TL and -10 for some completely off-the-wall weapon totally unlike anything the shooter has ever seen.

When a weapon malfunctions, the firer decides whether to attempt Immediate Action to resolve the problem. The weapon-user does *not* have to take Immediate Action, but the alternative is an unfirable weapon. The time required for Immediate Action is different for different weapons. It is usually variable (e.g., 2d seconds), though it may be fixed for some weapons. For most weapons, a critical success means that the weapon is restored to service *immediately*. On anything but a critical success, the GM rolls again to determine how long the attempt will take. He does not tell the player this. On every turn, the player must say, “I’m still working on the gun.” When the time is up, the GM will tell the player whether he succeeded. A success restores the weapon to service.

A failed Immediate Action roll leaves the weapon in non-firing condition. Another attempt can be made, in just the same way.

A critical failure puts the weapon out of action until repaired by an armorer at the appropriate TL.

The character can abandon Immediate Action at any time. The player announces at the beginning of his turn whether he is continuing Immediate Action or not. If he continues, the GM tells him whether or not the gun can be fired that turn. If Immediate Action is abandoned, it can be started again later; the restart requires another roll for time.

Immediate Action For Revolvers and Multi-Barrels

If a revolver malfunctions, the user can always hope the problem was with the ammunition and pull the trigger again, rather than taking Immediate Action to fix the gun. Similarly, the user of a multi-barrel gun can try to fire another barrel.

If the malf was the result of a critical failure, the GM already knows what is wrong with the gun, and can play it accordingly. Otherwise, the GM should immediately roll against the weapon’s Malf number, *minus* 2. For weapons with no Malf number, roll against a 15. A “failed” roll (greater than the Malf number) indicates a true malfunction; the next bullet or barrel won’t work, either. A successful roll means the next shot can be fired normally.



Buying and Selling Guns

The prices given in the *Weapon Tables* assume weapons purchased in new condition, from a reputable dealer, while they are state-of-the-art devices. Weapons may remain in service for generations after they are first designed, and inflation can push their prices far past original levels.

Since many campaigns are set in the present, *Weapon Tables* for late TL5 to early TL7 weapons list both an original price and a second 1990s-era contemporary price. If a campaign isn't present-day, you can still estimate the price of an out-of-period item by comparing the starting wealths given in the sidebars in each Tech Level chapter. For a rough idea how much a gun or other device costs after inflation, multiply the original price by the starting wealth of the era in which the item is being purchased and divide by the starting wealth of the era it was first introduced. E.g., if a gun cost \$10 when introduced in 1935 (starting wealth \$1,000) but is bought in 1942 (wealth \$3,000) its price is $\$10 \times 3,000$ divided by $1,000 = \$30$.

Of course, these prices apply to new guns. Used gun dealers are common in nations where guns are easy to come by (like the United States). Used guns in good condition, not spectacularly obsolete, sell for 50-80% of their current price - more if rare collectables. Weapons in poor condition (-1 Malf.) are likely 20- 50% price if the seller is honest. A successful Armoury roll will tell the would-be buyer whether he's getting a good deal: failure leaves the GM free to surprise the buyer with interesting malfunctions if the dealer is dishonest or incompetent.

Weapons of special quality (p. 65) are more costly.

Pawnshops

Pawnshops have existed since long before guns did; they were common in Renaissance times. A reputable pawnbroker will lend you perhaps 10% of a weapon's true resale value (and have a very good idea what that value is). If you do not redeem your ticket in a month or so, he'll keep the gun and sell it to someone else for as much as he can get. Or you can pay accrued interest - 10% to 50% per *month*, and he will keep the gun for you.

War Surplus

When the Pilgrim Fathers emigrated to America in 1620 they bought inexpensive matchlocks from the Dutch forces who were converting to flintlocks. After the American Civil War, the U.S. government sold cheap Spencer rifles to any veteran who wanted one. Each major war or army equipment upgrade sees military surplus gear dumped on the market. Still, most governments like to know where arms are going; shady or unofficial buyers may need Fast-Talk or a substantial bribe to get a chance to bid. On the other hand, if buyers can convince the government the deal is in its best interest, they may get favorable terms. It was in the Dutch government's interest to have Calvinist settlers in America in 1620, and the U.S.'s to have armed Americans out West in the 1860s - terms were *very* favorable.

Salvage

Armies on the move leave huge amounts of material behind. Rations, blankets, uniforms, even weapons that are too much trouble to carry home - these could mean survival for desperate adventurers. It is, however, unwise to be caught looting, as armies have no sense of humor about such things. Time-travelers are in a better position: they can pick places and times when things won't be missed. For instance, the smallarms magazine of *U.S.S. Hornet* just before she went down would yield several Thompsons and BARs. They can also buy low and sell high. Scrap-metal flintlocks in 1830 are mint-condition antiques in 1998.

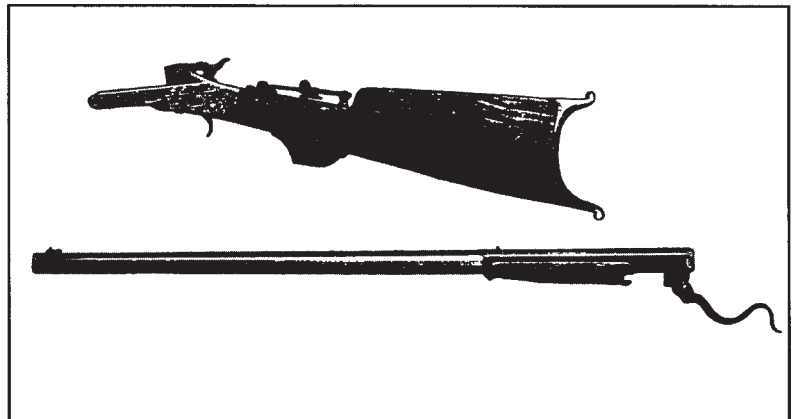

BORE SIZE TO INCH/MILLIMETER CONVERSION (Continued)

Gauge	Inch	Millimeter
1	2.0	50
2	2.5	65
3	2.9	74
4	3.2	81
6	3.7	94
8	4.0	100
9	4.2	107
12	4.6	117
18	5.3	135
24	5.8	147
32	6.4	163
42	7.0	178

Notes of Interest

(1) 54 gauge was the English equivalent of an American black-powder .44 revolver; modern American .44s actually fire .43-caliber bullets.

(2) Modern American .38 pistols and revolvers are actually .36s (.357 Magnum uses the same bullets as .38 Special, but in a longer case); the bullets are only a few thousandths of an inch larger than those for 9mm.

(3) .32, 7.65mm, 7.63mm and 7.62mm pistols all fire bullets of about .30 caliber, which are very nearly the same diameter as black-powder .31s.

(4) .410 "gauge" shotguns are actually .410 caliber.

(5) A rough formula for "pounder" from bore diameter for cannon is: [(bore diameter in inches - 0.1") cubed] x 0.13268 = "pounder" name. To convert the other way, use [cube root of (lbr./0.13268)] + 0.1.

(6) Bullet weights are usually given in *grains* or *grams*. 7,000 grains = 1 pound avoirdupois. 1 grain = 0.0648 grams; 1 gram = 15.432 grains. Powder charges are usually in grains; black powder is sometimes in *drams*. 1 dram = 27.4 grains.

FIREARMS SPECIALIZATION AND FAMILIARITY

Specialties are for types of weapons that are enough different that use of each type is a separate Physical/Easy skill. Specialties sometimes default to each other. Familiarity is the degree to which a shooter knows how to use a particular firearm.

Shooting firearms and *maintaining* firearms use slightly different interpretations of the same skill.

Black Powder Weapons Specializations

Handgonne - Firing a cannon-lock small arm.

(Lock-type) Musket - Firing a smooth-bore, shoulder-stocked gun designed primarily to fire a single bullet, but easily capable of firing multiple bullets.

(Lock-type) Rifle - Firing a rifled, sighted, shoulder-stocked gun designed to fire a single bullet.

(Lock-type) Shotgun - Firing a smoothbore, shoulder-stocked gun designed primarily to fire multiple shot.

(Lock-type) Pistol - Firing a gun that has no shoulder stock.

(Lock-type) Hand Mortar - Firing a true hand mortar or a grenade discharged from a gun.

(Lock-type) Special Weapon - Firing a gun of peculiar design . . . built into a shield boss, permanently swiveled to a saddle pommel, concealed in a codpiece and fired by a string braided into the beard (select for a tall assassin and short victim and multiply recoil penalties by 5), anything else that can be dreamed up. Each special weapon is a separate skill.

Defaults: *Lock-type* is the ignition system of the gun; cannon lock, matchlock, wheellock, flintlock or caplock. Going from a more advanced to a more primitive ignition system is hard. Handgonne defaults from any other Black Powder Weapons specialty at -7 (and is DX-6). Matchlock defaults from wheellock or flintlock at -3, from caplock at -5. Wheellock/flintlock defaults from caplock at -2. Going up the scale is easier. Wheellock/flintlock defaults from matchlock at -2; caplock from wheellock/flintlock at -1.

Specializations default by the type of use. Smoothbore, shoulder-stocked weapons default to each other at -1, to rifles at -2. Long guns default to pistols at -4.



Gun Control and the Black Market

Gun control laws vary dramatically from region to region and from era to era, with restrictions governing everything from the type of weapon to the kind of bullet and capacity of magazines.

In 1990s America, guns are common but some federal and state regulations apply. Shotguns, antique firearms (TL4-5) and non-automatic rifles (up to RoF 3~) and their ammunition are easy to buy over the counter. Handguns are subject to a background check and multiday waiting period. Purely military weapons are unavailable to anyone but licensed dealers; this includes weapons that are full-automatic, cannon-size or have explosive warheads, or “destructive devices” such as grenades and flamethrowers.

Circumventing gun-control regulations, a wide array of weapons are available on the black market. Illegal firearms are often 2 to 10 times price, depending on whether they're good as new or old military-surplus. Stolen *legal* guns can be very cheap, half price or less and the more identifiable, the cheaper.

Metallic Cartridge Ammunition Weights and Costs

This table gives weight and cost of loose rounds of metal-cartridge ammunition for modern (late TL5+) firearms. For TL4-5 ammo prior to metallic cartridges, see chapters 4 and 5.

“Weight per Shot (WPS).” The approximate weight of a complete round of loose ammunition including bullet and cartridge. Weights of loaded magazines, belts, etc. are found on the weapon tables. Weights of *empty* magazines vary, but SMG and rifle magazines are about 1/2 pound, handgun magazines about 1/4 pound and clips (Mauser or Mannlicher) 0.01 pound. Machine-gun belts are 0.4 pounds per 100 rounds for rifle calibers, one per 100 for heavy machine guns. Disintegrating belt links are 200 per pound.

“Cost per shot (CPS).” Reduce total cost by 5% if 500 or more rounds are purchased at once, by 15% if 5,000 or more rounds are purchased at once. Ammo is normally sold in lots of 20, 50, 100, 500, 1,000 and 5,000. The GM may charge up to 15% *more* for odd-sized lots! An Area Knowledge roll for the area where you're shopping (including Area Knowledge (Net) for purchases made over the Internet) will find someone selling ammo at a 5% discount. A critical success finds a 15% discount.

LOOSE CARTRIDGES WEIGHT AND COST TABLE

Cartridge	WPS	CPS
<i>Pistol</i>		
.22 Short	0.005	\$0.03
.25 ACP	0.011	\$0.35.
7x28mm	0.014	\$0.3
.32 ACP	0.0175	\$0.3
.380 ACP	0.021	\$0.3
7.62mm Nagant	0.021	\$0.3
9x19mm	0.023	\$0.3
7.62x25mm	0.024	\$0.3
7.63x25mm	0.024	\$0.3
.38 Special	0.033	\$0.3
.40 S&W	0.024	\$0.4
.357 Magnum	0.0357	\$0.5
10mm	0.04	\$0.4
.45 ACP	0.048	\$0.4
.455 Webley	0.05	\$0.4
.44 Magnum	0.053	\$0.8
.50 AE	0.055	\$1
<i>Shotgun</i>		
8-gauge	0.125	\$0.125
10-gauge	0.1	\$0.1
12-gauge	0.14	\$0.07
<i>Rifle</i>		
.22 Long Rifle	0.077	\$0.05
5.56x45mm	0.026	\$0.6
.30-30	0.05	\$0.6
7.5x54mm		
7.62x39mm	0.037	\$0.6
.45 Henry	0.043	\$0.6
.44-40 WCF	0.047	\$0.6
.303	0.055	\$0.6
7.62x51mm	0.055	\$0.6
.30-06	0.058	\$0.6
7.62x54mmR	0.058	\$0.6
7.92x57mm	0.058	\$0.6
8mmx50mmR	0.0625	\$0.6
8mmR Krag	0.0625	\$0.6
.44-90, .45-70	0.11	\$1 .45
MH, .50-90	0.11	\$1
.600 NitroExp	0.2	\$1
.50 BMG	0.33	\$1
12.7x108mm	0.33	\$1

Special Ammo: AP is 3 x cost, expanding 2 x cost. All prices assume late TL7. Modify by relative starting wealths for lower TLs.

FIREARMS SPECIALIZATION AND FAMILIARITY (Continued)

Familiarity penalties (see p. B43) apply to weapons that the firer doesn't normally use, even within his skill specialty. Common penalties are -2 for an unfamiliar weapon of a familiar type or -4 for an unfamiliar type of weapon. Familiarity penalties can be wiped out by eight hours of practice with the gun. Eight hours of practice means eight hours on the range, not eight hours of carrying the piece around!

Example 1: "Bloody Bob" Coleman, Quantrill's meanest guerrilla, has Black Powder Weapons (Caplock Pistol)-16. Unfortunately, the hyperspatial flux that dropped him in 16th-century Italy did not bring his Navy Colts. With his liberated arquebus, which requires Black Powder Weapons (Matchlock Musket), his adjusted skill is 16, minus 5 for change of lock-type, minus 4 for pistol to long gun, for a miserable 7. (Actually, it's even worse; there is a -4 *Familiarity* penalty, see above.)

Example 2: Bloody Bob skulks the hills of the Abruzzi, picking up a bare living as a brigand. He finds the broken body of a man, in clothing familiar to him, though it would be strange to anyone else of this time. With bated breath he searches the corpse . . . Yes! The blessed sight of civilized weapons! Unfortunately, the revolvers are 54-bore Adams self-cockers, not the .36 Colt single-actions with which he had terrorized Kansas. Bloody Bob has a -4 familiarity penalty for an unfamiliar type of weapon. With eight hours of practice, he can shed the penalty. However, he is not likely to *get* eight hours, unless he can find someone in Renaissance Italy who can make percussion caps.

Guns Specializations

Rifle - Firing a rifled, sighted, shoulder-stocked weapon with one shot for each pull of the trigger.

Shotgun - Firing a smoothbore, shoulder-stocked weapon with multiple-projectile loads with one shot for each pull of the trigger.

Light Automatic - Firing a shoulder-stocked weapon (SMG/assault rifle/machine carbine/light machine gun) in bursts of automatic fire.

Pistol - Firing a stockless gun with one shot for each pull of the trigger.

Machine Pistol - Firing a stockless gun in bursts.

Grenade Launcher - Firing grenades from guns, either specialized grenade launchers or attachments to other guns.

Light Antitank Weapon - Firing unguided projectiles from shoulder-mounted weapons such as rocket launchers and recoil less rifles.

FIREARMS SPECIALIZATION AND FAMILIARITY (Continued)

Flamethrower - Firing portable flamethrowers.

Special Weapon - Firing any peculiar firearm; glove guns, walking stick guns, belt buckle guns, shoe guns, briefcase guns, etc. A separate skill is required for each special weapon.

Defaults: Rifle and Shotgun default to each other at -2, to Pistol at -4. Defaults between auto and non-auto (Rifle/Shotgun to Light Automatic; Pistol to Machine Pistol) are -4; Long Gun (shotgun, rifle, submachine gun, etc.) to Machine Pistol is -5. Long guns default to LAWs and Grenade Launchers at -3; Light Automatics and Pistols default at -5. *Firing* rolls usually default to similar Black Powder Weapons skills - Guns (Rifle) to Black Powder Weapons (Caplock Rifle), for instance - at -2 plus the lock-type difference *from* caplock. Guns (Rifle) defaults to Black Powder Weapons (Caplock Rifle) at -2; to flintlock rifles at -4; to matchlock rifles at -7.

MAINTENANCE SPECIALIZATIONS

Guns are a lot more alike in shooting than they are in loading or maintenance. A soldier trained to aim and fire an M16 can *shoot* a flintlock Kentucky rifle effectively with a little practice. Getting used to the slow lock-time, pan fizzle, curved trajectory and drooping stock just takes a little getting used to. *Loading* the muzzle-loader, and *immediate action* (p. 12) are not as easy. GMs are the final authority on penalties to skill for such activities. The penalty should be at least -10 to go from loading a metallic-cartridge gun to loading a matchlock, perhaps only -8 for someone who has actually seen a muzzle-loader charged at a Bucksinner show or on television. Other lock-types should not be quite as hard; burning match and powder are an especially tricky combination.

Immediate action should have the same sort of penalties. Familiarity with loading and maintenance of muzzle loaders is not as easy to acquire as familiarity with shooting; usually it requires 48 hours to acquire full familiarity. (That's *48 hours of practice*; say, a week of rigid, eight hours per day drill under a good drill master.) Cartridge guns are simpler; the usual eight hours should be enough.

Ammunition Reliability

Before about 1830, and the general adoption of the percussion cap, average firearms could be expected to misfire about once in 10 tries, even under perfect conditions. Almost all misfires were the result of ammunition failures. In rain, blowing spray or heavy snow the failure rate could easily go up to two out of three.

The percussion cap was far more reliable, with perhaps one failure in 50 shots. It was also nearly impervious to weather.

The first self-contained cartridges were actually a bit less reliable than percussion caps, with about 1 misfire in 25 tries. (Cartridges had enough other advantages to offset the problem, and reliability rapidly improved.) As a general rule, the reliability of new factory cartridges can be rated as follows:

Cartridge Failure Rates

1850-1880:	1 in 25
1880-1910:	1 in 50
1910-1940:	1 in 200
1940-1970:	1 in 1,000
Post-1970:	1 in 10,000

Ammunition deteriorates in storage. Even stored in dry, temperature-controlled conditions, smokeless powder ammunition produced before 1940 lowers the weapon's Malf number by 1 for each 10 years since the date of manufacture. (For black powder ammunition, every five years.) After 1940, lower the Malf number by 1 for every 30 years since manufacture; if the weapon had no Malf number, assume it started at 17. Deterioration for storage in less-than-ideal conditions is up to the GM.

Large lots (cases of 500-5,000 rounds) of surplus ammo of dubious quality can usually be acquired at 20-30% list price, for popular issue military weapons. In the 1990s, rounds in this category include 9x19mm, 5.45mm Russian, 5.56mm NATO, 7.62mm NATO and 7.62mmx39mm Russian. Such ammo will give a -1 to Malf if used. One day (per 1,000 rounds) carefully cleaning and inspecting cartridges and a successful Armory roll negates this penalty, at a price of 1-6% of rounds rejected or test-fired.

Destroying Ammunition

The traditional way to destroy ammunition is to ruin the powder. There's not much that can be done to shot, and wadding is easily replaced.

The easiest way to destroy powder is to lay a long slow-match, and leave. If you can't do that, a *very* long powder train will suffice. Or a lone hero can call for the enemy guards, wait until he is surrounded, and then touch off the powder personally.



Subtler ways of destroying the powder would include wetting it (which would require that it be re-caked and re-ground . . . often not worth the trouble) or contaminating it with oil (which would ruin it utterly).

Paper cartridges can be burned or contaminated just like loose powder. Metal cartridges will cook off in a fire, and can be destroyed by prolonged immersion, but it's not nearly as easy as setting off a powder dump . . . which is one of the advantages of modern ammunition. Good TL6 and TL7 ammunition can stay underwater for a *long* time and remain usable. The smallarms ammunition from the *U.S.S. Maine* still fired after 13 years under Havana's harbor!

CHAPTER TWO

MULTIPLE PROJECTILES

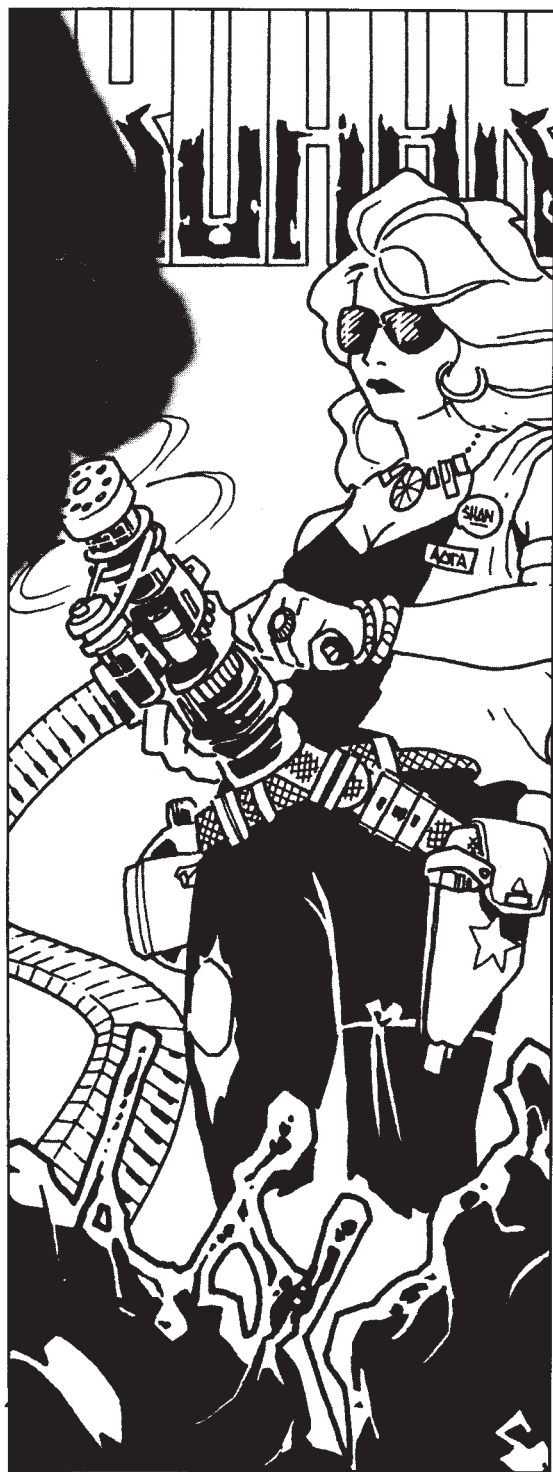

Any smoothbore weapon, and many rifled weapons, can be loaded with multiple projectiles. At one time all projectiles were called shot (including arrows and sling stones). By about the beginning of the 19th century, the term was reserved for projectiles that were less than bore size and normally loaded in multiples. A gun usually loaded this way was distinguished as a “shotgun.”

Multiple Projectiles for Smallarms

Use these rules for multiple projectile in smallarms, i.e., shotguns, pistols, rifles, muskets, submachine and machine guns.

At a range of 1 yard or less, any number of small projectiles do the same damage as one normal bullet, as long as the weight of the shot is the same. (Because the shot has not had time to disperse, all of the load hits, or misses, just as a single bullet would.) Roll once to hit, just as with a single bullet.

At greater than 1-yard range, the projectiles begin to disperse. The effectiveness of the shot depends on the type of multiple projectiles and the *density* of the shot pattern; that is, the number of projectiles that would strike within a circle of given radius (18 inches is the usual measure).

Smallarms Loads

Smallarm multiple-projectile loads come in one of four categories:

1. Multi-bullet - two or more bullets of bore size
2. Buck-and-ball - a single bore-size bullet and two or more smaller bullets.
3. Shot - a large number (half a dozen to several hundred) of less than bore-size bullets.
4. Flechettes - (literally, small arrows) from two to hundreds of small metal darts.

Any gun that will fire one projectile can fire more than one, if suitable ammunition is made for it. Handloaders frequently make shot loads for their weapons.

Multi-Bullet Loads

Multi-bullet loads are uncommon, especially for modern (post-TL5) cartridge firing guns. Special ammo loads are needed and are rarely made after TL5. At least one was adopted and issued by the U.S. military (in 7.62 NATO) in the Vietnam war.

SHOTGUN COMBAT EXAMPLE

A wiry man, with sandy hair and moustache, lay prone in a blackberry thicket. The thicket was at the crest of a 10-foot high cutbank on a dry creek-bed running down to the South Fork of the Canadian River. Perhaps a hundred yards away, a big, muscular Indian in faded denims stood examining a rifle. About five feet from him, a short, blond man with a long moustache held a pair of stag-handled revolvers.

"Damn," said the sandy-haired man. "They've got my guns!"

Deputy Marshal Rufus Kingsland was not a deep thinker, but most of the time he was careful. This time he had been careless.

Five days of corn dodgers and badly cured bacon had been enough to convince him that he deserved an afternoon's hunting. Leaving rifle and handguns in camp, he had taken his 12-gauge double and a pocketful of Number 6s down into the Canadian bottoms. Hunting had been good.

As he walked back to camp, he decided that a pair of berry-fed prairie chickens and a fat doe rabbit, an afternoon of peace, and a refreshing nap on the river bank were just the proper reward for a conscientious officer of the court. Only an old Indian-fighter's caution kept him from stumbling onto his unexpected visitors.

Kingsland snaked six inches forward and looked down toward his camp. He kept his head low, peering around the base of a foot-thick cottonwood.

"Yep, I know 'em," he thought. "The big Cherokee in the prison slops must be Sam Jay, 'cause the runt with the waterfall moustache is Cotton Longmont, and there ain't nobody in the Nation but Jay that's no-account enough to ride with him. Besides, Jay is just out of Huntsville, and that's Texas Guvmint denim. Got to be him."

Continued on next page . . .



Multiple bullets increase the chance of a hit with *something* by throwing more bullets at the target. Each small bullet does less damage than one large one.

For game purposes, a multibullet load may contain up to four bullets. In modern ammunition, a two-bullet load is called a "duplex" cartridge, a three-bullet a "triplex," etc.

If firing single shots, a separate roll to hit is made for each bullet. The first roll is at an additional -1 to hit, the second at -2, and so on. If using multi-bullet loads in automatic weapons, simply multiply RoF by the number of bullets in the load. Roll separately for damage for each hit. Damage for each hit is the basic damage for the gun divided by the number of bullets in the load; damage is rounded down.

Buck-and-Ball

Buck-and-ball is a cheap way to increase both the power and the hit probability of a smoothbore weapon. Buck-and-ball was a frequently used option all through the muzzle-loading era, but not in modern cartridge firearms. Buck-and-ball damage equals that of one full-size bullet for the bore size, and two buckshot hits that each do 1d damage. At 5 yards or less roll once to hit: a hit is with all the balls and a miss is a complete miss. At more than 5 yards, roll twice to hit. Once is at the normal Acc of the weapon, for the full-caliber ball, and once is at -2 to Acc for the buckshot. Maximum range for the buckshot is 150; 1/2D is 25. Maximum range for the full-bore bullet is 100 yards less than normal, and 1/2D is 10 yards less than normal.

Shotshell

Any smoothbore gun can effectively fire shot loads; this is the standard load of a shotgun. Shot comes in many sizes. 20th-century loadings run from *dust shot*, at 4,665 pellets to the *ounce*, to 000 ("*triple-ought*") *buckshot* at 100 pellets to the *pound*. For **GURPS**, all shot can be assigned to one of three categories:

Buckshot has 0.25-inch to slightly over 0.33-inch pellets. It is used for combat and big game.

Birdshot has 0.1-inch to less than 0.25-inch pellets. It is used for birds and small game.

Smallshot has less than 0.1-inch pellets. It is used for target shooting, pest control and non-lethal riot loads.

A load of shot begins to spread as soon as it leaves the muzzle. No two pellets have quite the same initial energy, mass or ballistic coefficient. This increases the likelihood that something will hit the target, but decreases the amount of energy that will be delivered. The amount of damage depends on how much of the shot hits the target and the retained energy of each pellet at that time. Retained energy decreases faster with shot than with single bullets. Smaller projectiles lose energy to atmospheric resistance faster than larger ones.

Shot loads give +1 to the base skill of the firer, but the maximum Acc bonus is 5 (with a smoothbore) and may be less, depending on the weapon. The 1/2D for buckshot is 25 yards; Max is 150 yards. Birdshot and smallshot have both 1/2D and 1/4D. The 1/2D for birdshot is 5 yards; 1/4D is 10 yards; Max is 50 yards. The 1/2D for smallshot is 3 yards; 1/4D is 6 yards; Max is 20 yards. The 1/4D is the same as 1/2D, except that damage is halved again, and most materials get a +1 to DR at 1/4D range and greater. (The GM is the authority on what materials - soap bubbles, glass Christmas tree ornaments, typing paper - do not get this bonus. Human flesh does, except for the eyes.)

Shot Damage: Use the gun's basic damage as for a single bullet, but roll each die separately for penetration against DR. Bonuses and penalties are applied to any damage that gets through the armor.

Example: A smoothbore with damage 2d-1 hits, with a load of shot, a man in leather armor (DR 2). Each damage die is rolled separately, giving two 1-die attacks. The first roll is a 3. One point of this damage gets through to tissue. The second roll is a 4; two points penetrate the armor. Now the -1 to damage (because the gun did 2d-1 basic damage) is applied. Total damage is only two points.

SHOTGUN COMBAT EXAMPLE (Continued)



Rifled Guns and Shot: Rifled guns, which include all TL6-7 guns except shotguns, are not effective with shot loads. The spin imparted by the rifling opens the patterns and makes them very irregular. After the smokeless powder revolution (about 1890), most rifled guns also have too small a bore and chamber for an effective load of shot. Nevertheless, some shot cartridges are made, e.g., for revolvers. Shot damage from a rifled gun depends on bore capacity. Use this table:

Caliber - damage

- Up to .25 - small shot only, damage 1d-5
- .25 to .35 - small shot or birdshot, damage 1d-2
- .35 to .45 - small shot or birdshot, damage 1d
- .45 to .65 - small shot, birdshot or buckshot, damage 2d-5

The greatest possible Acc with a rifled gun firing shot is 3; the greatest Aim bonus is 1. Malf of rifled guns firing shot normally decreases by one (e.g., crit becomes 16, 16 becomes 15).

Flechettes

Smallarm flechette loadings are still largely experimental, but some were made after circa 1970 (TL7) for shotguns. They might be available to special forces, etc.

Treat as buckshot, except that 1/2D and Max ranges drop by 10 yards, damage becomes impaling and the rounds cannot penetrate DR of rigid armor (anything DR 3+ except Kevlar, monocrys or chainmail). If available, they cost twice as much as normal.

Kingsland examined the possibilities. "Sam Jay can shoot, and he's got my .45-75 and prob'ly a belly-gun. Cotton could about hit himself in the foot, but he's got ten tries just with my Smith & Wessons. He most likely still has that Jim Fisk Colt in his over-alls; that's four more. Two horses, no saddle guns, no sign or sound of anyone else. If I can get close enough, I can take them both."

Kingsland slipped down the bank and into the creek bed. Ten minutes of stalking brought him to the edge of a stand of cotton-woods, within 20 yards of the pair of outlaws. Here was the last of the cover . . . there was only open ground to where they stood.

Sam Jay still held the big Winchester. His right hand was at the small of the stock and his left absently stroked the walnut foreend.

From his stand Kingsland could see that the hammer was at half-cock, which almost certainly meant a round in the chamber. Only a twitch of the thumb would be needed to prepare the weapon to fire.

Longmont had stuffed the short-barreled Schofields into the front pockets of his bib overalls. His free hands gestured widely. Whatever he was saying to his partner seemed to need a lot of emphasis. Longmont was no shootist; he would need time to get the revolvers into action. That made the Cherokee the dangerous man, the first target if bluff didn't work.

Kingsland charged from the cover of the trees, shotgun ready, shouting at his loudest.

"Hands up! Drop 'em! Federal Marshall!" The words didn't matter as much as the noise.

For two precious seconds the outlaws were frozen.

Sam Jay was the first to recover. With a strangled Cherokee curse, he thumbed the hammer to full-cock and jerked the rifle toward his shoulder.

Kingsland fired the left barrel at Jay's midsection, trying for a killing hit with the birdshot. Without waiting to check the effect, he swung the gun to cover Longmont.

"Don't," said Kingsland.

Longmont needed no directions on what not to do. He moved his hands wide of the stag-handled Smith and Wessons.

Kingsland risked one side glance at the Cherokee. One was enough.

"Easy, Cotton. You don't want to join Sam in Hell."

PLAY OF THE ENGAGEMENT

This is a contest of shotgun against rifle and pistol. The first problem for the shot-gunner is to get within range. #6 shells are birdshot, with a Max range of 50 yards. The .45-75 rifle has a 1/2D range of 600!

Kingsland stalks (Stealth vs. the senses of Jay and Longmont) to 20 yards. The GM determines how close terrain and cover will let him go.

Kingsland's roaring charge to close the range is good roleplaying; one of the character's disadvantages is Overconfidence. Surprise works. For two turns Sam and Cotton are mentally stunned; rolling for them, the GM fails the IQ roll that would allow them to recover.

At the beginning of the third turn, the GM says, "You see Sam Jay cocking the rifle and starting to raise it." Jay's IQ roll has finally worked; he is taking one turn to ready the weapon. "What is Longmont doing?" the player asks. "Standing there with his mouth open," replies the GM.

Kingsland fires at Jay, trying for the vitals. His sprint has brought him to five yards range. This is just at 1/2D range; he will roll 4d and halve the result. If he tries for a brain hit, the skull's DR of 2 might stop him. Penetration against DR applies to the result on each die separately.

Kingsland has Guns (Shotgun)-17, and is using a familiar weapon. There is a +1 to base skill for using shot with a smooth-bore gun. Range is 5 yards, giving -3. The target is standing still; no modifier. Aiming at the vitals is -3. SS is 12; adjusted skill is also 12, so there is no -4 penalty for the unaimed shot. The player rolls 9 and hits.

The 12-gauge's damage is 4d, halved because of range. Since the vitals are covered only by denim and flesh, and Rufus is well inside 1/4D, the target has no DR. Jay fails his Dodge roll. The die rolls are 4 and 6 for a total of 10. Since this is a hit to the vitals, damage is tripled. Jay takes 30 points of damage. He falls, stunned. Jay went from HT 12 to HT -18 at one stroke. This requires two rolls against basic HT to live (for -HT and 5 less than -HT) and one roll to stay conscious. As it happens, he failed one of the rolls vs. dying making the consciousness roll irrelevant.

Continued on next page . . .

Making Smoothbore Multiple Projectile Loads

Anyone with Black Powder Weapons at the right TL can load a loose-ammunition smoothbore weapon with multiple projectiles.

Given components and tools, anyone with Armoury skill for the appropriate TL can make multiple-bullet loads for any self-contained-cartridge gun (see sidebar, p. 64). An established ammunition company can make anything you can describe, but most companies will not even consider a special load for orders of less than 100,000 rounds.

Multiple-bullet components are not off-the-shelf items; an IQ-4, Scrounging, or Streetwise-2 roll is necessary to find the materials. Flechettes require precision machining and aren't easily manufactured outside of an ammunition factory.

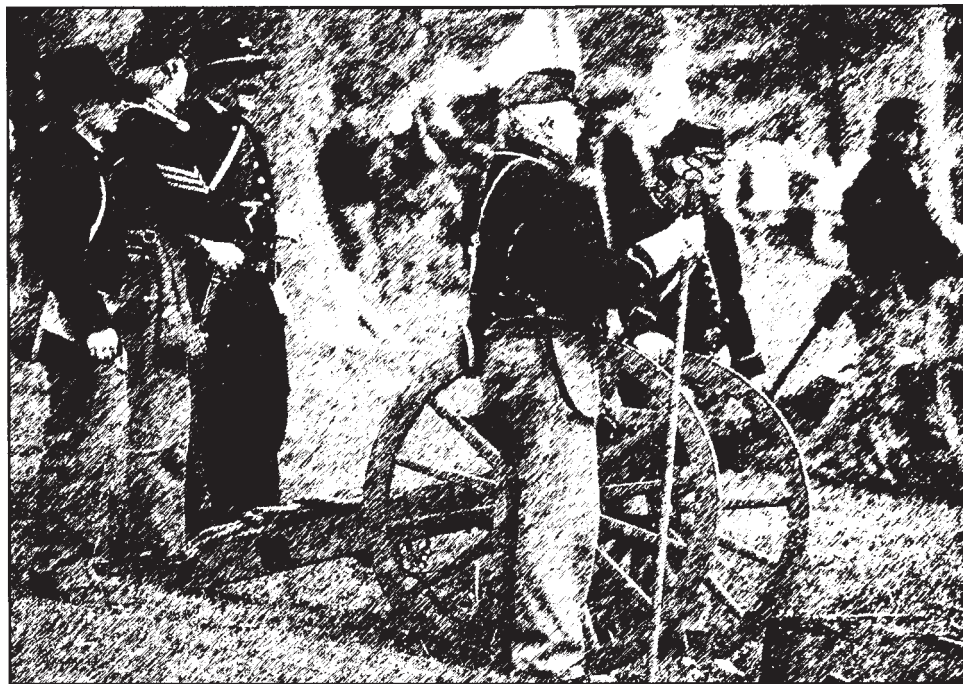

Multiple Projectiles for Artillery

Pellets, by various names, have always been the most common element of multiple-projectile loads.

Canister (TL4): Also known as *langrage* or *grapeshot*, a canister load is multiple pellets or bullets, very much like a giant shotgun blast in an expanding cone for which the apex was the muzzle of the gun. (It was *not* miscellaneous loads of scrap; that has a tendency to jam, and burst bores or breeches.) Bullets for canister are larger than for smallarms.

Shrapnel (TL5): A thin-cased shell filled with bullets with a small bursting charge. It was first issued for service by the British in 1804. By the 1830s, it was a standard load for artillery; it went out of use about 1916. In 19th-century shrapnel, the charge was just enough to split the case; the damage of the bullets was from the velocity imparted by the gun. In 20th-century shrapnel, the bursting charge was enough to actually give a little extra velocity to the bullets. Shrapnel mostly went out of service after WWI in favor of H.E. shells.

Beehive (TL7): Beehive was developed late in the 20th century as a replacement for canister. It was first available in 1965 and used by the United States in Vietnam. Each shell is filled with thousands of flechettes. Each flechette has more penetration effect than a canister ball, and more can be packed in a case.

Multiple Projectile Artillery Attacks

To resolve cannister, shrapnel or beehive attacks, use this system:

First, determine the point of dispersion (POD); everything in a cone in front of this point will be attacked. For cannister, the POD is the muzzle of the firing weapon, and projectiles are sprayed in the direction the cannon is pointing out to 1/6 Max range. For shrapnel or beehive, the POD is the hex where the shell landed, and projectiles are sprayed in a direction determined by drawing a straight line between the muzzle of the firing weapon and the POD. This effect spreads out along that line out to 1/10 Max range of the weapon.

Next, determine which hexes are in the area of effect. The cone is 1 yard wide at the POD; it increases in width by 1 yard for every 10 yards range, out to its maximum range. Anything in that cone is attacked unless behind solid cover.

Finally, roll to hit every target in the cone. The attack roll is $9 + (\text{weapon's bore size in inches} \times 1.25^*)$ plus the target's Size Modifier, minus the range modifier to the target. Always count range from the POD. Add +6 to hit if beehive rounds.

* If bore size is listed in mm, use bore/20 instead.

The number of hits is determined by this table:

MULTIPLE PROJECTILE HIT TABLE

Success By	#Hits	Success By	# Hits
0-1	1	6	10
2	2	7	15
3	3	8	20
4	4	9	30
5	7	10	45

... and so on, following the same progression.

There is no active defense against multiple projectile attacks; PD and DR are that of armor or cover. Damage from cannister, beehive or shrapnel is given on the weapon tables.

CANNISTER DAMAGE TABLE

Weapon	Damage
600-pounder (TL4)	2d cr.
3 to 6-pounder (TL4)	1d cr.
12-pounder(TL4)	3d cr.
16-pounder (TL4-5)	3d cr.
33-pounder (TL4-5)	4d cr.
75mm cannon (TL6-7)	1d cr.
105mm cannon (TL6-7)	2d cr.
155mm cannon (TL6-7)	2d cr.
203mm cannon (TL6-7)	3d cr.

All shrapnel does 1d cr., all beehive 2d imp. - larger bore weapons just get a higher "to hit" number.

Cannister Example: A Napoleonic brass 12-pounder (117mm) fires cannister at a line of infantry skirmishers. The POD is the gun's muzzle. Everyone in the cone out to one-sixth range is attacked. Suppose one soldier is 10 yards away: the chance he'll be hit is base $9 + 6$ ($117\text{mm}/20 = 5.85$, rounded up) - 4 for range = 11 or less. We roll a 10, success by one, so he is hit by one attack for 3d.

PLAY OF THE ENGAGEMENT (Continued)

Longmont recovers from surprise at the beginning of the third turn. The GM decides that he will surrender. This is a realistic view; few petty criminals will risk bad odds of death to avoid arrest. Longmont has no way to know that the gun is loaded with birdshot; he only knows that one blast dropped his partner.

What if Kingsland had fired from cover, 20 yards away? This would have been a -6 to hit; with an aim bonus of 3 and +1 for shot, the vitals would be a possible target. (Acc is zero at past 1/2D.) Damage is 1/4 at this range; 1/4 of 6 is not enough to get any damage through the DR of 1 for being past 1/4D. A shot at the eyes, a -9, could do significant damage. This would require a 6 or less to hit. A miss would leave Kingsland with two alerted enemies with longer-ranged weapons.

MOVING TARGETS FOR ARTILLERY

Want to fire a 12-pounder cannon at a sea monster, or drop a 155mm shell on a moving tank? The hard thing is to get the target to hold still for the shot long enough for the cannon to be slewed around to cover it. The traverse and elevation of guns is measured in degrees per second. At the bottom of the scale at TL4 and 5 are swivel guns, no heavier than 2-pounders. They can turn up to 60 degrees (one hex side) per turn. Heavier guns are very limited, and the limitation is not a constant factor. They can be moved a few degrees on carriage; to move them more, the entire carriage and trail must be moved. Ships' guns cannot be shifted more than the few on-carriage degrees; they have to run back out the ports to fire. Guns heavier than swivels take 10 seconds minimum to traverse 60 degrees. This time may be longer if conditions are not perfect. Part of this time is time to get the gun crew out of the way before firing. Any aiming time is over and above the moving time.

TL' 6 and 7 artillery have more on-carriage traverse. Some light weapons, up to 105mm, and some self-propelled 155mm have 360 degrees traverse. They can traverse 60 degrees per turn. Most other guns are even harder to shift that much than TL5 artillery; they are heavier. They depend on not being directly attacked.

EXPLOSIVES



Since the introduction of gunpowder at TL3, mankind has continued to develop more and better ways to blow up things (and his fellow man). But all explosives behave alike in many ways - enough so that they warrant their own chapter. All explosions from a firecracker to a matter-antimatter collision do three kinds of damage: concussion (which also subsumes heat damage), fragmentation and (for nuclear bombs) radiation. Each of these is dealt with separately.

Concussion Damage

Concussion damage is the damage done by the shock wave and expanding gases of the explosion. It is *crushing* damage. It is applied to all the body, not to a specific part. The blow-through rule (see p. B109) does not apply.

Radius of Concussion Damage

Concussion damage degrades very quickly with distance. For small explosions, up to 10 pounds of TNT (6dx20), concussion damage is quartered for each *two yards* from the center of the explosion. One pound of TNT does 6dx2 in the hex of the explosion and the six adjacent hexes. At two and three yards (the circle of 12 hexes and the circle of 18 hexes concentric to this) damage is 3d. At four and five yards, damage is 1d-2 (round down). At six and seven yards, damage is 1d-5. Beyond seven yards,

there is no significant concussion damage.

These are rules for Earth-normal air pressure; in thicker or thinner atmospheres the blast effect is different. Under Earth-normal conditions, the range at which damage is quartered is *tripled* in water. In a vacuum, with no matter to carry the shock wave, concussion damage is limited to that actually caused by the expanding gases. For 10 pounds or less of TNT exploding in vacuum, concussion damage is 1/8 per two yards from the explosion.

Larger explosions cannot be treated in the same way. The mathematical considerations of any model of explosive damage, especially in an atmosphere, defy simple arithmetical progressions. The following rule is reasonably accurate, compared to empirically derived information, but not an absolute: for each tenfold increase in amount of concussion damage, double the increment at which damage is quartered. This means 100 pounds of TNT does 6dx200 damage from the center of the explosion to three yards; 6dx50 to four to seven yards; 6dx12 at eight to 11 yards and so on. 1,000 pounds does 6dx2,000 at the center; 6dx500 at eight to 15 yards; 6dx125 at 16 to 23 yards, and so on.

Body armor won't protect against concussion damage unless it's rigid, sealed and covers the full body with no openings. Toughness and natural DR protect normally. The DR of rigid, sealed body armor and non-living objects such as structures, robots or vehicles is *squared* against concussion damage. PD has no effect on concussion damage and there is no active defense against it.

Contact Damage

Anyone actually touching the explosive device takes double concussion (and fragmentation) damage; someone covering it with his body takes triple damage. A person covering the explosion can take all the damage up to 20 x HT, heroically saving others. An explosion *inside* a living body does five times damage. (Grenades are hard on a dragon, if he can be persuaded to swallow one.)

Explosions in Enclosed Spaces

In a room or vehicle, the blast from an explosion is “contained”: the shockwave reflects off the walls and delivers all of its energy to anyone inside. This can be *very* deadly! When an explosive goes off in an enclosed space, calculate how much concussion damage would reach the area’s walls. If it’s more than 2 points at the walls, but not enough to burst the walls, the blast is contained. Anyone in that area takes *double* concussion damage. Reduce this to 1.5 times normal damage if there are doors and windows that can be blown out to relieve some of the pressure in the room. Anyone behind a door or window when it ruptures automatically takes fragmentation damage.

Concussion Damage and the Advanced Armor Rules

When a character has different amounts of sealed DR on various parts of his body, apply damage to *each* hit location: head, torso, each arm, each hand, each leg and each foot. The DR of that location protects normally. Sum all damage that penetrates, then divide by 10 to get the actual damage sustained.

Example: Trooper Jones has a close encounter with a TL8 concussion grenade while wearing Combat Infantry Dress. The GM rolls 42 points of damage. His DR 18 helmet lets 24 points in, his DR 40 torso armor lets 2 points in, the DR 12 arms, gloves and legs let 30 points each in, and his DR 15 boots let 27 points in. The total is 24 (head) + 2 (torso) + 2x30 (arms) + 2x30 (hands) + 2x30 (legs) + 2x27 (feet) = 260. This is divided by 10. Jones takes 26 points of damage from the blast.

Concussion & Deafness

Except in a vacuum, explosives damage things at a distance via a wave of high-pressure air. This is potentially damaging to hearing; anyone who receives damage from an explosion must roll vs. HT.

Modifiers: -1 per 5 points of damage taken *after* considering the DR of a vehicle or sealed armor; +1 for ordinary earplugs, +3 for high-quality ear-muffs.

If this roll fails, the victim has -1 to hearing rolls per point of failure (due to tinnitus). Failure by 10 or more — or any critical failure - results in total deafness. Any failure also stuns the victim; roll vs. HT each turn to recover. Hearing effects last for (20-HT) minutes (minimum 1 minute), after which a HT roll is made to recover. Use the *Recovering from Crippling Injuries* rule (p. B129). A permanent injury gives Hard of Hearing if the penalty was -1 to -9, or Deafness if total deafness occurred.

Flash & Blindness

Explosives release some of their energy in a blinding flash of visible light. This can be dangerous to look at; anyone looking toward a blast must roll vs. HT if concussion damage was rolled against them, *even if no damage penetrated DR*.

Modifiers: -1 per full 10 points of damage received, even if it doesn’t penetrate DR; +1 for sunglasses or a tinted windshield, +3 for welding goggles, +5 for ultra-tech anti-glare goggles, the bonus from the *Size* column on p. B201.

If this roll fails, the victim is dazzled, and has -1 to vision rolls per point of failure. Failure by 10 or more, or any critical failure, results in blindness. Any failure also stuns the victim; roll vs. HT each turn to recover. Vision effects last for (20-HT) minutes (minimum 1 minute), after which a HT roll is made to recover. Use the *Recovering from Crippling Injuries* rule (p. B129). A permanent injury gives Bad Sight if the penalty was -1 to -9, or Blindness if total blindness occurred.



FLAMMABLES

Fire is a problem for adventurers just as it is for more peaceable folk. Things burn, or won’t burn, at the most inopportune times. The GM is the final authority on whether or not something is on fire. Usually that decision is easy.

“Yes, the gasoline-soaked rag lights when you hold the match to it.”

“No, the granite block does not catch fire from the Molotov cocktail.”

Sometimes the result is of gaming importance, and is not self-evident. Most such decisions are skill rolls: against Survival to start a fire in the rain, against Engineer to set fire to a building, against Shipbuilding to extinguish a fire-ship.

Sometimes the fire (or lack of a fire) is a more random event. Any explosion, for instance, is likely to start fires. Heat radiation, burning gases and hot, sometimes burning material are thrown off. Guns frequently start fires. All bullets are heated by firing; iron or steel projectiles throw off sparks; tracer bullets and incendiaries actually contain burning material. Even the muzzle-flash of a gun can start a fire.

On the other hand, it can be very difficult to get a flame when it is needed. Liquid gasoline will extinguish a match. Diesel fuel is almost impossible to ignite unless it is vaporized. Damp black powder simply fizzes and stinks at the touch of a flame. Materials can be roughly classified in terms of ignition as:

Class A: very easy - vaporized gasoline, gunpowder, C4.

Class B: easy - dry grass, tinder, grease, cotton waste, oily rags.

Class C: average - dry wood, baled newspaper, coal lumps, cloth.

Class D: hard - damp wood, damp black powder, rubber.

Class E: very hard - wet wood, woolen cloth, green jungle foliage.

Class F: won’t burn under normal conditions - rock, concrete, dirt.

Plastics may fall into any category from A to F, depending on the particular composition. In general, hard plastics are harder to ignite than soft ones.

MAKING GUNPOWDER

Time travelers take note: the information in this sidebar can make your fortune.

Gunpowder is easy to make, once the secret is known. But there is no particular reason why anyone would mix the ingredients and touch a match to them. So a society could go hundreds of years without discovering this basic explosive. (H. Beam Piper's classic *Lord Kalvan of Otherwhen* stories explored just this possibility. Calvin Morrison, thrust into an alternate world, knew how to make gunpowder, and his life soon became very interesting indeed.)

Gunpowder consists of a mixture of *saltpeter* (potassium nitrate), *charcoal* and *sulfur*. A typical mixture is 75% saltpeter, 15% charcoal and 10% sulfur. In general, older gunpowder has less saltpeter and therefore less power.

Saltpeter is a white, crystalline substance, found under well-aged manure piles, of which no medieval society has a shortage. Charcoal is easily gotten by burning wood. Sulfur may be found as deposits of pale-yellow crystals, and can also be obtained by evaporating the water from foul-smelling sulfur springs.

When the finely ground ingredients are combined in the right proportions, they yield *meal powder*, or *serpentine*, which is less powerful than later powder and tends to separate in storage or travel. Layering sulfur, charcoal and saltpeter *does not* make an explosive! Meal powder was used for artillery until late in the 16th century. To keep meal powder from separating, it was frequently hauled to the battlefield as ingredients and mixed on site. Having to mix an unstable explosive under enemy fire, surrounded by burning matches or lit braziers, may explain the devotion of gunners to Saint Barbara, their patron saint.

Continued on next page . . .

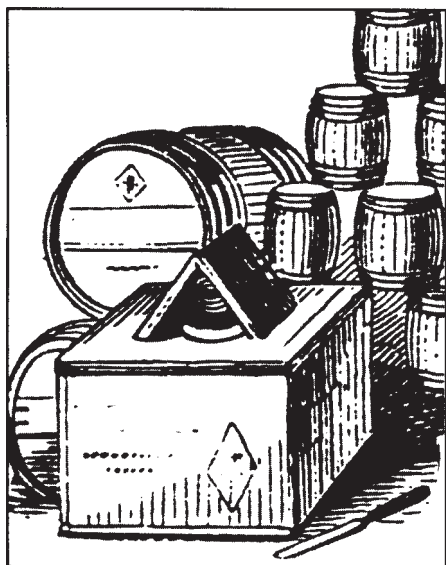

Fragmentation Damage

This is the damage produced by fast-moving fragments of whatever blew up: the metal casing of the explosive (if any) along with flying debris from objects shattered by the blast.

Fragments do cutting damage in an expanding sphere around the explosion center. "Blowthrough" does not apply. The dice of fragmentation damage depend on the nature of the fragments.

Ordinary explosives like a stick of dynamite, a wad of plastic explosive or a soft-casing "concussion grenade" do 1d-4 fragmentation damage if set off on normal soil; on rocks or timber, or in a typical indoor room, 1d-2; in a scrap yard 1d; if detonated in mid-air or in water, no fragments.

Explosive cannon shells, bombs and fragmentation grenades are designed to produce lots of metal fragments: if so, use their own listed fragmentation damage. It will be listed in square brackets following concussion damage, e.g., 6d[2d] is 6d concussion damage and 2d fragmentation. As a rule of thumb, fragmentation damage is 2d for hand grenades and 20-34mm rounds, 4d for 35-59mm rounds, 6d for 60-94mm rounds, 10d for 95-160mm rounds and 12d to as much as the GM thinks suitable for larger rounds (the explosion from a 16-inch shell can pick up a telephone pole and toss it like a javelin!)

Radius of Fragmentation Damage: Explosions project fragments to a distance of 5 yards times the dice of explosive damage, to a maximum of 250 yards. Fragmentation is random; anything within this radius may be hit. The farther from the explosion, the lower the chance of being hit as the fragments disperse over a greater volume.

Fragmentation Vs. Large Targets: Large targets may be hit with multiple fragments. An object will be attacked once for each +1 Size Modifier (see p. B201) over 0. Thus, for an object with a Size Modifier of +4 (a linear measurement of 10 yards), four fragment attacks are made against it - roll individually for each attack. DR of armor protects normally; cover protects if between victim and the explosion.

Chance of a Fragment Hit: A hit is automatic in the hex of the explosion. In every hex adjacent to the explosion, a hit occurs on a roll of 17 or less. One hex farther away, the roll is 16 or less, and so on. When this roll reaches 3, it stays at 3 to the limit of fragment range (see above).

In any hex outside the hex of the explosion, the cover and concealment modifiers on p. B118 apply to this roll, if the explosion is at ground level. Cover from air bursts must be overhead cover. Varying positions does not provide protection; lying prone under an air burst isn't any better than standing.

If using the hit location chart, roll randomly for the location of each attack that hits.

Defense Against Fragmentation Hits: PD has no effect on fragmentation and there is no active defense against it.

DR and Fragmentation Damage: DR protects normally against fragmentation damage, as does the DR of any cover between the explosion and the victim.

Contact Damage: If an explosive goes off in *direct* contact with flesh, fragmentation damage is doubled.

Explosives and Fire

Explosives produce high temperatures and scatter hot, burning residue over the blast area. When an explosion occurs, any class A to E flammable (see *Flammables*, p. 23) may ignite. Roll 3d vs. damage taken for any object in the area (treat "all furniture" and "all walls" as one object each). On a "success," the object catches fire. Modifiers: +4 for class A, +2 for class B, 0 for class C, -2 for class D, -4 for class E.

Relative Explosive Force

The concussive power of explosives is measured in relation to the explosive force of TNT (trinitrotoluene), an explosive invented in 1876. TNT has an arbitrary explosive force of 1.

Chemical explosives work by releasing energy held in stressed chemical bonds. Most common chemical explosives have Relative Explosive Force values between .3 and 2. So, for instance, black powder (REF of .5) does just half the damage that TNT does. A pound of TNT does 6dx2 damage, so a pound of black powder does 6d damage. (Explosion damage should be based on 6 dice where possible; this gives an appropriate spread of probable damage).

The following figures are a ballpark guide to relative power, pound for pound, of explosives, where TNT is rated 1.

Serpentine Powder (pre-1600)	0.3
Ammonium Nitrate	0.4
Corned Powder (pre-1850)	0.4
Black Powder (post-1850)	0.5
Diesel fuel/nitrate fertilizer mix	0.5
Dynamite (80%)	0.8
PETN (det cord)	1.0
TNT	1.0
Amatol	1.2
Gasoline	1.2
Tetryl	1.3
Composition B	1.4
C3	1.4
C4	1.4
Liquid hydrogen/liquid oxygen	1.5
Nitroglycerine	1.5
FAE munition (see p. 27)	5.0
Nuclear devices	see below
Antimatter	1.135x10 ¹⁰

Fuses

A fuse is a way of predetermining the time of an explosion. It can be anything from a powder-train to an elaborate mechanical or electronic gadget. Fuses are either for projectiles or for emplaced charges. Designing a fuse that will fire at the selected time requires Demolition/TL. Setting an already prepared fuse is a Gunner skill for artillery rounds, and a Demolition skill for most other purposes. Under ordinary circumstances, no skill roll is required to *light* a fuse or powder train *set* by someone else.

Correct fuse setting is not an intuitive process, and there are a lot of ways to foul it up. GMs roll for fuse action against the Demolition skill of the one who set the fuse, and do not inform the user of the result until time for the explosion. GMs are encouraged to be sneaky; explosives are a tricky business and should be accompanied by mystery and catastrophe.

TL affects the predictability of a fuse. At TL4, predictability is 10% (1 second for a 10-second fuse, 1 minute for a 10-minute fuse, etc.). At TL5, 5%. At TL6, 1%. At TL7 and above, predictability is so good that, within human perception, it is effectively without error. See the sidebar on p. 35 for burning times of slow-match, quick-match and powder trains.

MAKING GUNPOWDER (Continued)

Early in the 16th century, *corned powder* was invented. To make this, meal powder is dampened and pressed into cakes. The cakes are dried and ground (carefully - don't strike a spark!) into grains of various sizes. Corned powder does not separate in storage or transport. In 1588 the Duke of Medina Sidonia was happy that the powder for the Spanish Armada was corned and not meal powder.



Another benefit of corned powder is that varying the grain size changes the burning rate. Fine-grained powder was used for small-bore and short-barreled weapons, and for priming, which need a fast rate. Coarse powder was used for large-bore weapons, and as a blasting explosive. (Black powder is graded by a system introduced in France in the 18th century in which FG is the coarsest grade, FFG is one grade finer and so on.)

Though by no means the ultimate in chemical explosive, corned black powder, carefully made, gives very satisfactory results, and can be produced - as indeed it was - even with medieval technology.

FUEL-AIR EXPLOSIVES

Fuel-air explosive, or FAE, munitions were developed in the late 1960s as a method of generating large, non-nuclear explosions. The principle had been known for a long time. The Germans considered a fuel-air explosive (finely powdered coal dust) as a weapon against Allied bomber formations in WWII, but difficulties in spreading and igniting the fuel were never solved. The principle is simple. A volatile mixture of fuels, such as ethylene oxide, propylene oxide and methylacetylene, is maintained under pressure and then released. Within fractions of a second, the gases disperse over the desired area and are then ignited. In general, FAE munitions are five times as powerful as an equivalent weight of TNT.

Some military theorists have warned against the battlefield use of large FAE munitions, because their explosive power is so great that the opposing force might believe that nuclear devices had been used and reply in kind! FAEs have been used in combat, and were used to clear mine fields during the operations in Kuwait and Iraq in 1991.

Constructing a homemade FAE requires appropriate materials, at least 8 hours of time, and a successful roll vs. Chemistry-3, followed by a successful roll against Demolitions-4. A failure means that the device will not function; a critical failure is a life-threatening catastrophe. Success can be devastating. The fuel-enhanced truck bomb used against the U.S. Marine Headquarters in Beirut was equivalent to 12,000 pounds of TNT (6dx24,000).



Explosive Destruction of Materiel

One use of explosives is the destruction of materiel. The skill of knowing how to blow things up is Demolition/TL.

The guidelines below show the weight of explosive (in pounds of TNT, unless stated otherwise) required to destroy various objects. Well-tamped explosive has about twice the shattering power of explosive that is untamped; if you can bore a hole in the object to be destroyed, and pack the explosive in, you need only half as much explosive, unless tamping is specified in the description.

This section will guide the GM as to the amount of explosives that PCs must carry to accomplish demolition missions. To use an explosive other than the one named in the examples below, refer to the Relative Explosive Force table and use an amount sufficient to get the same explosive force.

Charges that meet these specifications will have the desired effect if the user makes his skill roll, and the fuse action roll is successful. Improvised materials can give a penalty to the roll. A failure always does some damage to the object. A critical failure usually does not explode, but the things a failed explosive charge *might* do are numberless!

To breach a wall with a mine or blow a crater: The explosive *must* be tightly packed in a hole in the ground. To breach a wall, a tunnel is driven under the wall; this is the original meaning of "mine." Later the name was transferred to the explosive charge. The usual rule of thumb is: 300 times the distance in feet to the surface equals the required weight of (post-1850) gunpowder in pounds. This will make a crater as deep as the distance to the surface and six times that distance in diameter.

To shatter timbers, such as bridge timbers, gates or trees: There are two methods. If the explosive can be placed in holes bored in the timbers, the weight of the charge in pounds (TNT) is about half the square of the thickness of the timber in feet. If the explosive is looped like a necklace around the timber (det cord works best for this) the weight of TNT is about three times the product of the width in feet and the square of the thickness in feet.

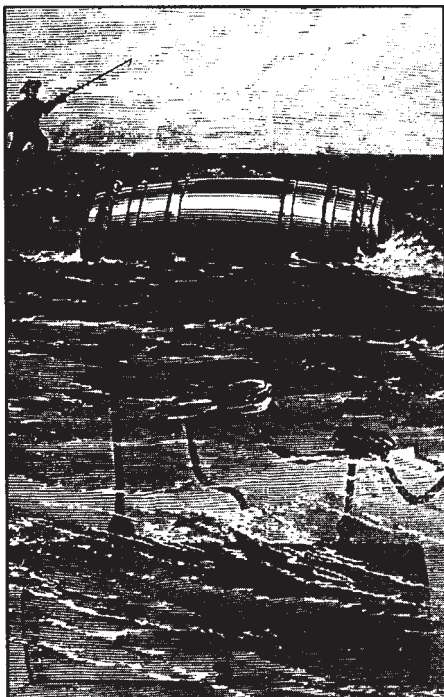

NAPALM

To break iron girders, such as bridge girders: Wrap the charges completely around the girder. Use half a pound of TNT per square inch of cross-sectional area of the girder.

To blow a hole in a wall: For a brick wall, the weight of the charge in pounds of TNT equals half the product of the diameter of the desired hole and the square of the thickness of the wall in feet. For reinforced concrete, use twice as much explosive. For iron plates, use the same formula but measure the thickness in inches; the weight of explosive is *twice* the product. Steel armor requires slightly more: 2.5 times the product.

Shaped charges: The Monroe effect was first demonstrated in the 1890s, but remained a scientific curiosity until the late 1930s. It increases the breaching power of an explosion by concentrating power at the apex of a conical cavity in the charge.

Before 1940, a TL6 Demolition expert must make a skill roll at -4 to remember this effect, and another at -5 to make such a charge that works. A home-made shaped charge of this kind will blow a hole in a wall (as described above) with half the amount of explosive (the same effect as tamping, but *not* cumulative with tamping). A failed charge simply doesn't do the job.

A shaped charge with a liner of metal can be made to produce a very narrow (less than one inch) hole in armor. Properly fused for time and stand-off distance, such a charge divides the DR of the armor it is used against by 10. These are used as anti-tank weapons.

After 1940, any demolition worker knows how to set shaped charges.

Gunpowder

Until the late 19th century, the only explosive and propellant in general use was what in the 20th century is called black powder. Since it was the only powder used in guns, it was then called simply *gunpowder*. All gunpowder was a mixture of *saltpeter* (potassium nitrate), charcoal and sulfur (see sidebar, pp. 24-25).

Exactly when it was invented is unknown. Roger Bacon, an English Franciscan monk, described how to make it and that it would explode, in a manuscript dated to about 1240. But Bacon wrote in a cipher that was not broken for more than 600 years! He did not claim to have invented gunpowder; he merely described it. A Chinese manuscript says that *The Spear of Vehement Fire* - by the description a sort of Roman-candle incendiary - was first used in 1259. An Arab manuscript of 1304 shows a picture of something that *might* be a cannon: an arrow, surrounded by smoke and flames, appears to be coming from a sort of tube.

By the mid-14th century, both artillery guns and handguns were used in battle in Europe. By the end of the 14th century, guns were available anywhere in the Old World, and common in Europe and the Mediterranean area.

The first type of black powder was *meal powder*, or *serpentine*; this was soon supplanted by *corned powder* (see sidebar, pp. 24-25). In the 1850s, Rodman, in the United States, developed *giant powder*. This was black powder cast in very big grains that were perforated with holes to control the burning rate. It was used mostly as a propellant for very heavy artillery. In the 1870s, *brown powder*, also called *cocoa powder*, was invented. This used a different charcoaling process and gave somewhat better combustion. It was used as a propellant in large naval guns.

Smokeless Powder

Nitroglycerine and nitrocellulose are the basis of all conventional smokeless powders. Nitrocellulose was developed in Switzerland by Schoenbein in 1845 and nitroglycerin in Italy by Sobrero in 1846. Both were useful as blasting explosives. There were attempts to use them as propellants, but both were too violent and sudden in effect.

Napalm, commonly known as jellied gasoline, is a mixture of 25% gasoline, 25% benzene and 50% aluminum or polystyrene. In its typical use as an incendiary bomb, it is enclosed with phosphorous as an igniter. When the casing is cracked, the phosphorous ignites spontaneously on contact with air, and then ignites the napalm. The napalm mixture spreads out evenly and is capable of penetrating into earthworks and bunkers.

Napalm sticks to whatever it hits, and continues to burn for at least a minute. It cannot be extinguished by anything less than complete immersion in water or burial under lots of earth (which won't help the victim). Treat as normal flame damage with the addition that it also burns up the oxygen in its immediate area, threatening even those protected against the flame with asphyxiation. Napalm is a relatively easy munition to manufacture, requiring a Chemistry+3 or Demolition+3 roll. The material required is gasoline and something to gel it; packing peanuts, liquid soap, melted animal fat or many other commonly available commodities will suffice.

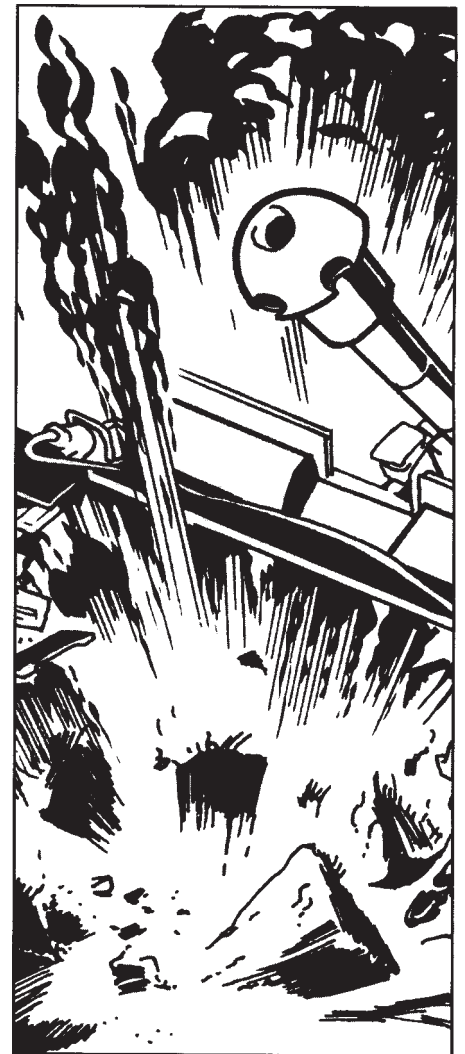

EXPLOSIVE ARTILLERY SHELLS

Explosive shells are *high explosive* if they are filled with one of the post-1846 explosives or *low explosive* if they are filled with black powder. HE is the principal artillery shell in use after 1916. It is effective against both materiel and personnel. The damage is explosive, based on the weight of the filler, which is usually about 10% of the total weight of the shell. Fragmentation damage is 2d to 12d+ (see p. 28) cutting per hex for any target within the fragmentation radius; multi-hex targets can take damage for each hex. Shells can throw additional fragments depending on the material on which they explode. This adds 1d-4 for ordinary soil conditions, 1d-2 for rock or timber and 1d for scrap metal or glass.

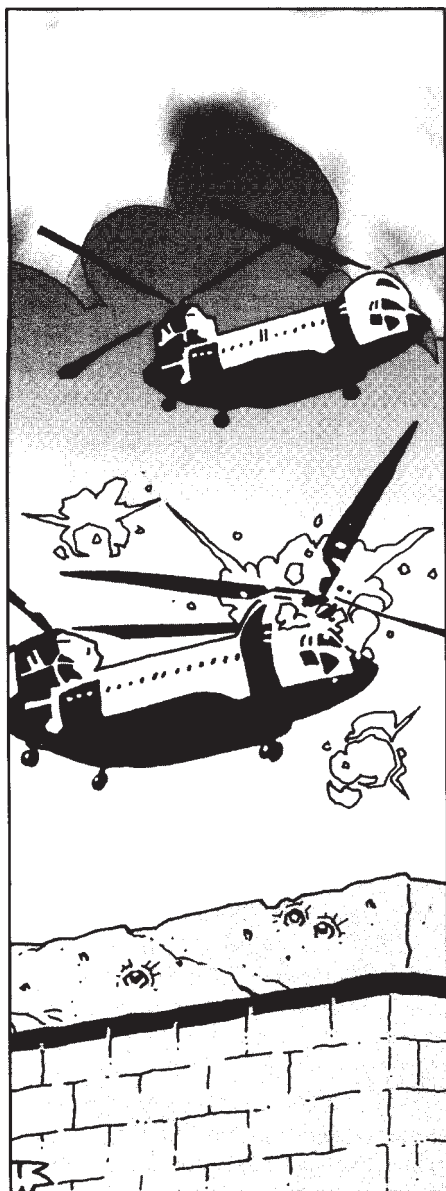

In 1885 a French chemist, Vielle, managed to produce the first *single-base powder*, it combined nitrocellulose with moderators so that it burned more slowly. This was the first successful smokeless powder; the French adopted a rifle with smokeless powder ammunition in 1886. In 1887, Nobel, in Sweden, developed the first *double-base powder* - one that combined nitrocellulose and nitroglycerine. Almost all smokeless powders developed since have been of one of these two types.

Smokeless powders are not truly smokeless, but they produce so much less than black powder that the name has stuck. Snobbishly precisionist gun nuts prefer the term *nitro powder*; characters with that Quirk may develop the *Odious Personal Habit* of insisting on the term. British and American writers tend to refer to all nitro powders as *cordite*. In fact, cordite was a particular kind of double-base powder used for English sporting and military ammunition from the 1890s to about the 1960s. It came in long strings rather than grains. Another *Odious Personal Habit* is correcting people for misusing the term.

Nitro powders are made to many different formulae for specific purposes. One cannot simply be substituted by weight or bulk for another. The results could be embarrassing or disastrous. Smokeless powder almost never fills the case of a cartridge; for instance, with some powders, enough to fill a .38 Special case would shatter the gun! Nitro powders are not normally explosive; emptying cartridge cases would not give you something with which to blow a bridge. They *will* burn fiercely; they can be used to start fires (see p. 23) even on wet wood.

Dynamite and Nitroglycerine

Nitroglycerine is still the most powerful, widely available commercial explosive. Nobel, in Sweden, perfected the process of making it in the 1860s. Under the name *Swedish Blasting Oil*, it was exported all over the world. Nobel insisted it was so safe that the routine precautions developed for gunpowder were unnecessary. But this proved not to be the case. Any sharp shock can detonate nitroglycerine! The result was a series of spectacular accidents, and a rash of explosives-control regulations. The GM may simulate this by rolling 3 dice whenever nitro is dropped or shocked; on a 13 or higher, it explodes. Impure nitro can be even more dangerous; some compounds explode on a 12 or higher.

Nobel solved most of the accident problems with the development of dynamite. This was nitroglycerine soaked into some neutralizing material, such as *kieselguhr* (a diatomaceous earth) or sawdust, to make it more difficult to ignite. Dynamite was so safe that it could be set on fire without exploding. (It burned beautifully, too.) But the regulations, some of which amounted to prohibitions on shipping nitroglycerine at all, still stood. This was complicated in the United States by a lack of any domestic manufacture of dynamite, and an active dislike of the substance by the American explosives industry.

The demand was still there. Dynamite could move more rock than black powder and was safer to handle. For a while in the 1860s and 1870s, there was an active black market in dynamite. Armed men with bulging suitcases roamed the mining and quarrying districts, at odds with the law, the explosives trust and each other. By the mid-1870s, dynamite was domestically produced in America, and the regulations had been modified to allow legal transportation. But it was lively while it lasted.

Using Dynamite

Dynamite is sold for blasting purposes in *sticks*. It is rated by the percentage of nitroglycerine it contains, from 20% (REF 0.2) to 80% (REF 0.8). One stick weighs half a pound and is 1.25" in diameter and 8" long. A stick of 80% would do 5d-2 damage. Half-sticks and quarter-sticks are also commonly used.

Dynamite won't explode in a fire; it burns nicely. It must be detonated by the shock of an explosion. For this purpose, *blasting caps* or *detonators* - small explosive charges - are used. Some blasting caps use ordinary fuses. At TL5+, blasting

caps can be set off electrically (see sidebar, p. 73). A blasting cap is itself a dangerous explosive, doing 1d-2 damage (minimum 1) . . . enough to mangle a hand.

One other problem enlivens any use of dynamite, especially illegal use or transportation. Old dynamite “sweats” - that is, the nitroglycerine oozes out of the carrier. Thus, old dynamite is just as dangerous as nitro. If the PCs encounter old dynamite, the GM should decide how risky it is . . . that is, what number, on 3 dice, will set it off. A successful Demolitions roll will give an observer a good guess what this number might be.

Yeggs and Nitro

Nitroglycerine had been on the market about one full day when someone figured out how to blow a safe with it. About one day after that, the police realized that anyone buying nitro was a suspect. The underworld soon learned that nitro could be extracted from dynamite by boiling the dynamite and skimming the nitro off the top - hence *soup* as the slang term for nitroglycerine. This operation is dangerous, requiring a Chemistry-2 or Demolitions-2 roll; a failure by 1 point simply ruins the dynamite, a failure by 2 blows up half its weight, and any greater failure blows it all up. The worse the failure, though, the closer the “expert” was to the explosion.

Safe-blowers were called *yeggs*. The classic way to blow a safe door was to put putty around the door-crack, pour the nitro in, and hit the safe with a sledgehammer. Yeggs usually had bad hearing and shaky nerves.

They were unpopular company, possibly because of their habit of carrying around impure and very unstable explosives. One method was to inject the nitro into a rubber ball (about the size of a baseball) and sling the ball by a string under the shirt. It was not safe to body-punch a yegg! A typical safe could be blown by 8 ounces of nitro, so this would be the normal amount for a yegg to carry. This much nitro would do 3dx3 damage.

Anyone carrying nitro in such a fashion must roll vs. DX any time he falls, is hit, is in a car accident and so on. A successful roll means he cushioned the explosive safely. A failure . . . R.I.P.! Nitro might also be carried in much larger quantities for some purposes . . . or a cache of old dynamite might be the equivalent of many pounds of nitroglycerine. Such an explosion could level a building or turn a vehicle to confetti.

Nuclear Devices

Nuclear explosives are not shown on the table on p. 25, because most of the weight of a nuclear device is in the detonator rather than the explosive. It's *hard* to set off a nuclear explosion. A nuclear device is rated in kilotons (1,000 tons of TNT) or megatons (1,000,000 tons of TNT) according to its design.

Nuclear weapons first appeared at the end of TL6. The first atomic bomb used in war was of the U-235 variety, named Little Boy. Released over the Japanese city of Hiroshima on August 6, 1945, it devastated the city with the equivalent of 12,500 tons of TNT. (This was equivalent to 300 million dice of damage.)

The first hydrogen bomb refined the art of destruction even further. A hydrogen bomb, properly known as a thermonuclear device, is a two-stage weapon, with a fission bomb providing the incredible heat necessary to fuse the hydrogen.

The smallest nuclear device that could be built with currently known technology would be a fission bomb. It would weigh between 30 and 40 pounds, and yield about a kiloton. It would fit in a large suitcase (13.5 cubic feet). It would devastate an area of approximately 1,100-yards radius.

BUILDING A NUCLEAR DEVICE

Contrary to some popular fiction, building a nuclear weapon is not so simple that anybody could do it; but most university faculties could manage it.

Obtaining the materials to build a nuclear device is the most difficult part of the task. Precision timers, beryllium, shielding materials and other unusual items are required. The actual fissile materials may not be that hard to obtain. Some 400 lbs. go unaccounted for every year in the United States alone. Of course, plutonium is *highly poisonous*, which adds to the difficulty of working with it.

Assuming that one has all the requisite materials at hand, assembling a nuclear device is still difficult. Although the theory is quite well known, the actual details of manufacture are still closely guarded secrets. Building a simple Hiroshima-type bomb is a task (see p. B119) requiring 500 hours of labor at Nuclear Physics-4, Engineer (Nuclear Powerplant)-2, Demolitions-6 or the specialized professional skill of Engineer (Nuclear Weapons). Also required are 1,000 hours of labor at Machinist (a professional skill), and 1,000 hours of ordinary labor, rolling vs. IQ. Note also that any time a critical failure is rolled, the GM should roll again; on a second critical failure, an accident has occurred with the radioactive materials. The gory details are left to the GM's discretion.

Continued on next page . . .

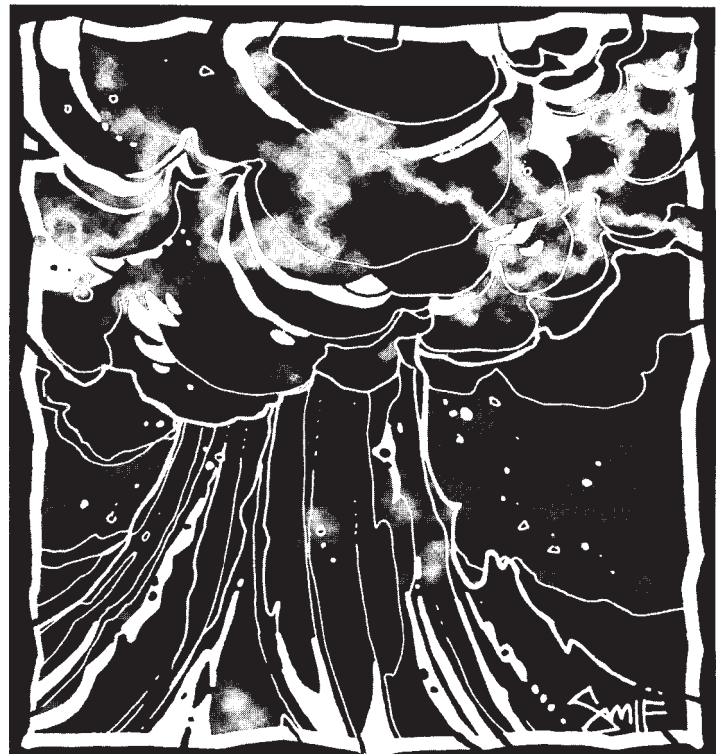



BUILDING A NUCLEAR DEVICE (Continued)

Note that very few freelance personnel will have Engineer (Nuclear Weapons) skill. Before 1990, any such mercenary was probably being pursued by his former employers! The thought of out-of-work Soviet nuclear weaponeers peddling their skills to the highest bidder became a nightmare for intelligence services in the 1990s. Very few insurance companies would be prepared to write a policy for one with such skills who tried to put them on the open market. After all, Dr. Gerald Bull, who just designed conventional artillery for unpopular clients, was found dead in a Belgian hotel with too many .32 bullets in him for his health!

Once the nuclear device is assembled, a successful Demolitions skill roll is required to ensure the functioning of the high-explosive detonator. A critical failure at this stage is inconvenient, since a premature detonation will at the very least scatter radioactive material around an appreciable area. U-235 is dangerous and embarrassing. Plutonium will kill everyone nearby, rather quickly.

A final Nuclear Physics-4 roll is required to see if the device works at all.

Depending on the intended use for the device, some means of transport and delivery will probably be necessary.

The process of rendering a nuclear device harmless is easier. A successful Demolitions roll will render the high-explosive trigger harmless and the nuclear device proper can then be disassembled at leisure. Alternatively, one without Demolitions skill may simply start pulling wires or bashing components. Anything but a critical failure will disable the bomb; a critical failure triggers it. Component-bashing is the best way to make sure nobody will fix the bomb, but if plutonium is involved, the saboteur is probably signing his own death warrant.

Damage from Nuclear Explosions

The energy release from a nuclear explosion consists of a thermal pulse (heat), concussion, hard radiation and - depending on the height of the burst - residual radiation. Heat is subsumed into basic explosive concussion damage; be sure to use the rules for *Flash and Blindness*, above.

If a detonation occurs in vacuum, concussion is not a factor but the blast produces high-energy X-rays (normally absorbed by atmosphere) that transmit enough energy to do similar damage. Instead of using the normal rules for explosive radius (p. 22), though, damage declines as the *square* of the distance: 1/4 at 2 yards, 1/9 at 3 yards, etc.

EMP or electromagnetic pulse, is a side effect of the weapon. Any unshielded electronic equipment within the visual horizon of the explosion risks a surge effect that will incapacitate it. As an example, a 10-megaton nuclear detonation 200 miles above the center of the continental United States would blanket the entire country with its pulse. In case of EMP, roll for each affected piece of equipment. The larger or more numerous the bombs, the greater the EMP.

A "generic" roll, for line-of-sight from a medium-sized bomb: simple electronic circuitry would "die" on a roll of 15 or greater. Transistor radios with whip antennas would die on a roll of 5 or greater. Integrated circuits would be blanked on a 6 or greater. A variety of military systems are shielded against EMP, and most civilian items of equipment can also be shielded by surrounding them with metal that is in turn grounded. Fiber-optic equipment is also wholly resistant. Most solid state technology affected by EMP would be permanently damaged: all repair rolls are at -10. Other items of equipment would be subject to a -4 on repair attempts.

Residual radiation, commonly known as fallout, produces radiation damage, measured in *rads*. (Radiation is measured in *roentgens*; *one rad* is the damage done to one organism by *one roentgen*.) Residual radiation is generally only a factor when ground bursts are used; the material picked up and spread by the blast has been irradiated. A dose of 450 rads is considered likely to cause a 50% fatality rate among human beings.

Fallout radiation decreases relatively quickly. Every sevenfold passage of hours from the initial burst results in a 90% decrease in the radiation damage. If the initial damage is 1,000 rads/hour (a very high dosage, only likely downwind from multiple ground bursts), it will be 100 rads/hour after seven hours, 10 rads/hour after about two days and 1 rad/hour after two weeks. A healthy human can take up to 6 rads per *day* for two months with no incapacitating symptoms. For more rules on radiation, see *GURPS Compendium II*.



CHAPTER FOUR

GUNS, SAILS AND EMPIRES

Tech Level 4

Tech Level 4 takes in the period from 1450-1700 in Earth's history. This was the time at which technology came into its own. By 1450, at least in Europe, it was possible to make a living by inventing, especially by inventing and improving weapons.

Carlo Cipolla called his classic monograph on the spread of European hegemony *Guns, Sails and Empires*. These were the dominant factors of TL4. Ships got bigger and longer ranged. Gunpowder, which had been known for one hundred years, came into its own; guns, by sea and land, supplanted almost all earlier weapons. The cultures that best used gun and sail soon dominated the Earth. By 1450, every fighting man in (at least) the Mediterranean-centered world had become accustomed to the roar and stink of firearms. Guns could tumble walls and bring down armored knights.

So, of course, could the older weapons. Mangonel, trebuchet and mine could defeat any wall, given time. Bows, long or composite or cross, could and did fell knights. Gunpowder replaced none of the older weapons; it only supplemented them. But gunpowder had already demonstrated its great virtue. Its power was not in the strength of the user, but in the art of the maker. A longbow, however cunningly crafted, depended on the muscle and skill of the bowman. When the archer's strength flagged, the arrow's flight shortened. And to train a bowman, the old saw went, begin by training his grandfather. But powder sent the ball just as far, regardless of the health of the gunner. Any peasant could learn to use a gun, or at least to aim it in the right general direction and fire, with a few hours practice.

Production

Less dramatic than cannon, but equally important, were improvements in production. Deeper mines produced more ore, with the help of explosives. Better ships and better wagons moved the ore faster and farther. Water-powered mills and hammers made the raw ore into finished weapons and tools. Scientific research was applied to the problems of business and warfare.

Better weapons and armor equipped larger armies, which campaigned more effectively, to get possession of the mines and rivers and harbors needed to produce and transport more ore and weapons and tools! The great Western rat race was on its first lap.

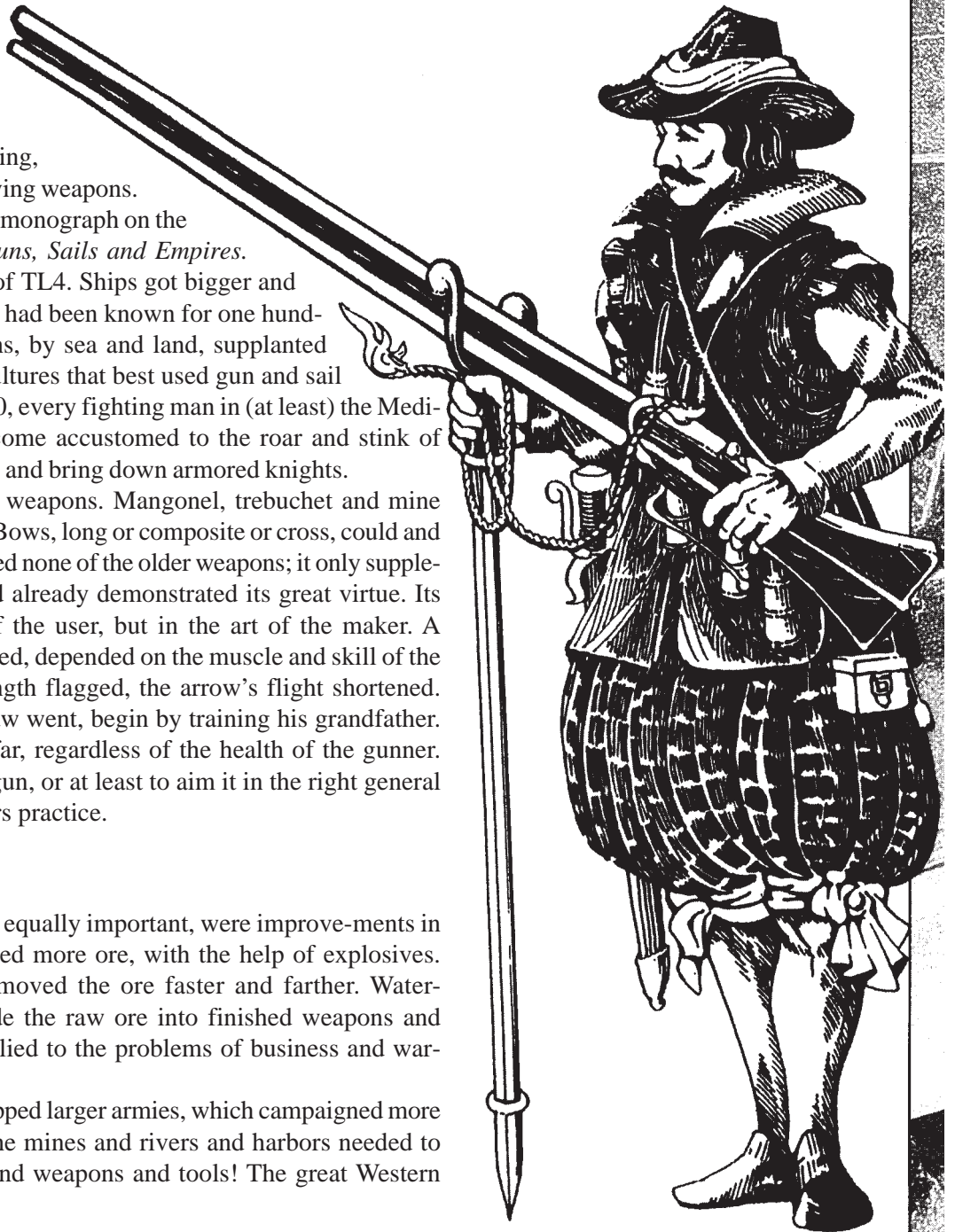

Black Powder Weapons

BLACK POWDER WEAPON SKILL

All black-powder guns are covered by the same skill (though it has many specializations). Black Powder Weapon skill is the basic knowledge of how to use - and care for - weapons of this type. This is a Physical/Easy skill. Thus, for one who has never studied it, it defaults to DX -4.

Because intelligence is important in the proper use of handguns, anyone with an IQ of 10 or 11 gets a +1 bonus to this skill. Anyone with an IQ of 12 or better gets a +2 bonus.

Black-powder shooters are also well advised to learn another weapon skill - both because they may need a backup weapon, and because, to save their lives, they may have to parry (or strike) with their gun! A gun used like this is essentially a club or mace of the appropriate weight, and is used with the Broadsword or Ax/Mace skill. (A long rifle would be more like a quarterstaff!) Such a treatment is not good for the gun . . .

CASTING YOUR OWN BULLETS

It was very common for hunters and explorers to economize by buying lead ingots, rather than prepared shot, and casting their own bullets at need. Black-powder muskets get between 10 and 20 shots to a pound of lead. A good, hot campfire is enough to melt lead. Bullet-molding equipment would weigh only a few pounds for a melting pot, tongs and mold, and the whole kit would cost perhaps \$3.

Soldiers might be issued shot, but it was also common for a unit to carry lead supplies and molding equipment. Running out of lead could be disastrous! Fortunately, lead is usually locally available and easily recognized. Dinnerware, roof gutters, clock weights, toy soldiers, plumbing and window leading are only a few sources for bullet material. In any urban area, an hour's looking, and a Scrounging roll, will turn up one pound, plus one more for every extra point by which the roll is made.

Bullets can be made quickly, too. Even with a single-cavity mold, a bullet per minute is a leisurely pace. And it is an easy job; a black-powder bullet is either good or it's not, and anyone can tell the difference.

"Put your faith in God, but keep your powder dry. "

- Oliver Cromwell

In this period, guns in every grade from cheap to very fine were commonly available in Europe and the Mediterranean, and could be found in India and anywhere else that Europeans traveled.

Guns got better and better for the whole era. By 1700, muscle-powered weapons had become secondary to firearms both on land and sea. Sword, knife, spear and axe (as both tool and weapon) were still used all through this period, but armor almost disappeared. What was still worn (see p. 54) was usually worn concealed.

Until 1886, the only type of gunpowder available was black powder. This is a less efficient propellant than the modern "smokeless" powders, but it was simple to make. For details about black powder and its manufacture, see Chapter 3, *Explosives*.

Black-powder guns were the first firearms used on the battlefield. The earliest such weapons date to the 14th century, and were nothing more than miniature cannon. They developed continually for more than 500 years, until the introduction of cartridge-type weapons and smokeless powder in the mid-1800s.

All black-powder weapons work in fundamentally the same way. The gun itself is a tube of brass, iron or steel, with a *barrel* and a *chamber*. The gunner loads the chamber with the *charge*, the *shot* and the *wadding*. The charge is loose gunpowder. The shot is a projectile or projectiles. The wadding is cloth, paper or leather. There is wadding over the charge to provide a gas seal, and over the shot to hold it in the barrel. A small quantity of gunpowder, the *priming*, is sprinkled into the touchhole to make igniting the charge easier and more certain. Priming powder is finer, and often of better quality, than the charge.

TL3 handgonnes (see below) were ignited by a match, like cannons. Later weapons used more sophisticated means of ignition. The igniting method is the gun's *lock*.

All black-powder guns are *slow*. Skilled musketeers of the Napoleonic period could load and fire four times a minute - once every 15 seconds. Less skilled men, with less advanced weapons, were much slower. Loading times are shown on the *Weapon Tables*, (pp. 123-127).

Types of Black-Powder Gun

A black-powder gun is made up of three parts - lock, stock and barrel. (Thus, the old expression "lock, stock and barrel" - meaning "the whole thing.") The "lock" is the device that ignites the powder; the stock and barrel determine the weapon's size. To describe a black-powder gun, therefore, we must describe its three parts.

The lock is the most important part, because it determines the gun's reliability and reloading time, and has a great effect on accuracy. In many cases, an existing gun (flintlock, for instance) was upgraded and modernized simply by changing to a better lock as technology improved.

Cannon-lock Handgonnes (Pre-1450)

This was the first type of gun. We will deal with it only briefly, because it is a TL3 development; still, cannon-lock handgonnes might be encountered in the hands of brigands in the mid-1400s.

There is no mechanism at all - just a touchhole like a cannon's. The charge is ignited with a match, or by passing a heated wire through the touchhole. Any can-

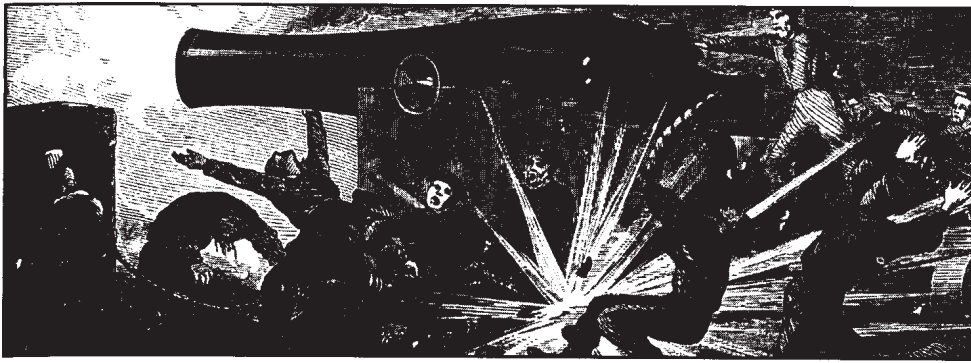

BLACK POWDER AMMUNITION

The term “ammunition” includes everything required to load a gun. Until the development of self-contained metallic cartridges (TL6), ammunition was stored and shipped as loose ammunition, in three separate components. Loose ammunition includes the *charge* (that is, the powder), the *shot* and the *wadding*. Ammunition for early guns was bulky, heavy and dangerous.

Whether his motives are patriotic or basely commercial, the ammunition smuggler of the black-powder era has an easier job than his higher-tech successor. Six or eight mule loads will supply a battalion for a day of battle. Ammo consumption in the muzzle-loader wars was not high; 40 rounds per man was usually considered enough for a battle. A fair amount of banditry, or a small revolution, can be equipped with one smuggler’s cargo. Artillery takes much more powder; charge weights run from equal to the shot in the 14th century to about 25% of shot weight in the 19th. A battery of four 12-pounders can run through a lot of powder and shot very quickly!

Powder

The charge for black-powder weapons was loose gunpowder. TL4 shooters carried two powder flasks, usually of horn: fine powder for priming and coarse powder for the charge. Sometime before 1550, the *bandolier* was developed. This is a wide leather belt, worn across the body from shoulder to hip. On the bandolier are wooden bottles, each containing one charge of powder. The traditional number is twelve; a musketeer calls them his “Twelve Apostles.”

Two powder flasks are carried - fine powder to prime, and coarse powder to refill the Twelve Apostles. A small quantity of fine gunpowder, the *priming*, was sprinkled on the touchhole to make igniting the charge easier and more certain.

An empty bandolier weighs five pounds and costs \$25. Loading with a bandolier is five seconds faster than loading from a powder flask.

Larger amounts of powder were normally carried in a waterproof leather bag, empty weight negligible, of one or two pounds capacity. More than two pounds of gunpowder was a danger to the whole neighborhood; a grenade usually held about a quarter-pound.

Every nation encouraged a native gunpowder industry. It was too dangerous to leave the ammunition supply in the hands of foreigners. Powder mills were normally located on a river, for water power. If the river was navigable, that helped to transport raw materials and finished product. Few people liked living near a powder mill; they had a tendency to blow up.

Continued on next page . . .

non-lock weapon will be useless after even a few minutes of rain, unless both barrel and touchhole are plugged until just before firing.

The cannon-lock weapon was not very accurate; since the gunner had to use one hand to steady the unwieldy weapon and the other to light it, while keeping his eye on the touchhole, any hits were largely a matter of luck. It’s possible that their greatest effect was frightening the enemy’s horses, but even unaimed fire could be deadly against a mass formation, and they outreached a sword or axe.

Cannon-lock weapons are loaded with loose ammunition, as described above. Loading a cannon-lock weapon is a Long Action, requiring 60 seconds.

Firing a cannon-lock weapon takes a roll against Black Powder Weapons/TL3 or 4. Such weapons malfunction (see p. 11) on a roll of 13 or more. A malfunction is always a misfire; most misfires can be corrected by *Immediate Action* (p. 12). Immediate Action to find and correct the problem requires 2d seconds and a successful Black Powder Weapons or Armoury roll.

A critical miss requires a roll on the appropriate *Critical Miss Table*. An ordinary failure on the Immediate Action attempt requires that the charge be drawn and the weapon be repaired by an armorer. In a battle, this usually means down gun, draw sword and have at them.

Matchlock Guns (c. 1400-1700)

Matchlock was the first mechanical gunlock, and directly supplanted the cannon lock. Matchlocks were in general use after 1500. The earliest matchlock pictured is in a manuscript from 1411, and is simply a hand cannon with an S-shaped *serpentine*. Pulling the serpentine (a crude trigger) brought a lit “match” or slow-burning fuse (see p. 35) in contact with the touchhole, which in turn ignited the gun. This was a tremendous advance because it allowed aiming! This is the sort of weapon that was common in the day of Dumas’ *The Three Musketeers*.

Combining the matchlock with the true shoulder-mountable stock (which appeared on some cannon-lock guns toward the end of TL3), and adding a separate *pan* to hold the priming, with a *pan cover* to protect the priming, produced the weapon of decision for infantry combat for two centuries.

Types of Matchlock

Matchlocks can be had as both pistols and long guns; as breech- or muzzle-loading single shots; as repeaters of several types; and, after 1475, as rifles. Nomenclature of matchlock guns is as confused and illogical as that of any other firearm system. Any statement about names will have exceptions, but these are common.

Arquebus is a comparatively short and light gun first adopted at the end of the 15th century.

Musket is a long, heavy gun of large caliber, fired from a rest. Muskets are first used in the early 16th century and stay in use until the late 17th century.

BLACK POWDER AMMUNITION (Continued)

From very early in history, a standard powder keg weighed about 100 pounds. This has a volume of only 1.25 cubic feet. Such a keg would do 6dx100 damage if it exploded - see *Explosives*, pp. 22-25.

Three or four kegs make a convenient load for a mule or pack horse. The usual charge for a flintlock musket is between 100 and 200 grains. One mule load of powder is enough for 12,000 to 24,000 musket shots!

Shot

The shot was a projectile or projectiles. Shot could be of stone, lead or iron. Shot was normally carried in a bag, of whatever capacity the gunner preferred.

Shot is the heaviest of the components, but hardly bulky - a cubic foot of pure lead weighs 712.5 pounds. Many gunners carried pigs of lead to make up into shot as needed - see sidebar, p. 32.

Wadding and Cartridge Paper

The wadding was cloth, paper or leather. Wadding was placed over the charge to provide a gas seal, and over the shot to hold it in the barrel.

When paper cartridges were developed (see p. 34), enough high-quality paper to make 16,000 cartridges weighed about 40 lbs. and occupied about a cubic foot. It could be tossed in wherever it fit with the rest of a load.

Igniters

Not considered "ammunition," but nevertheless vital, are the igniters . . . the devices that bring the fire to the powder. Match (see sidebar, p. 35) is the heaviest and bulkiest of the ignition systems. Since it is consumed steadily, lots of it has to be supplied. Even so, at 4" per hour, a pound of match gives 45 hours of continuous readiness to fire.

Flint and pyrites are better. A keg of 70 lbs. loaded weight holds about 10,000 flints. Each one is good for at least 10 shots, on the average. Pyrites is a little heavier, and a little less durable. Still, 100 lbs. is enough for at least 50,000 firings.

Percussion caps are even more efficient. The standard shipping quantity of 10,000 weighs only 12.5 pounds packed. The expected misfire rate would be only about 200 out of that number.

Caliver is an intermediate size, between musket and arquebus. It is first used about the first quarter of the 17th century. (Calivers are just about the size of a *flintlock* musket, to add a little more confusion.)

Pistol is a weapon designed to be fired from the hand, rather than the shoulder. They likely were originally intended for mounted combat.

Carbine and *Petronel* are both comparatively short and light shoulder weapons for horsemen.

Loading Matchlocks

In standing position, loading a matchlock muzzle-loading long-gun takes 60 seconds. A pistol or separate chamber takes 44 seconds. Loading the weapon does not normally require a skill roll, just the amount of time listed. Under special circumstances (such as a charging dinosaur) the GM can require a skill roll at the end of the loading time. On a failure, add the number of seconds by which the roll was failed to loading time.

At any time after half the normal loading time, the loader can try *hurried loading*. A roll against Black Powder Weapons, minus the number of seconds remaining until full loading time, is required. A failure adds the number of seconds by which the roll was failed to normal loading time. A critical failure requires that loading be started over. A success loads the gun immediately. A critical success loads the gun and gives +1 to Accuracy for the shot with that load.

Loading in other than the standing position is very difficult with a muzzle-loading long-gun. Loading in kneeling or sitting position takes 76 seconds; prone position takes 90 seconds. Loading pistols and separate chambers takes the same time in kneeling or prone position as in standing.

Loading on horseback takes the same time as sitting position, on an unmoving horse. If the horse is in motion, or is just skittish and restless, make a Riding roll. On a successful roll, loading time is the same as sitting. On a failed roll, the *best* result is that loading time is double the time for sitting; the rider may fall off his horse, drop the gun or have any of the accidents that result from mixing match and powder, as the GM decides. Trained war horses are worth the money; they don't skitter around while the rider is concentrating on loading.

Loading may be necessary under even more restrictive conditions. The firer may be on the heaving deck of a ship, balanced in the rigging, curled up in a chest, sliding down a bannister or clutched in the crushing tentacles of the Great Kraken. In such circumstances the GM should either increase loading time or require one or more "fumble" rolls (vs. weapon skill) during the loading time.

Firing Matchlocks

Firing a matchlock requires a roll against Black Powder Weapons/TL4. A critical success goes to the *Critical Hit Table*. A success is a hit. A non-critical failure is a miss or a misfire. A critical failure requires a roll on the *Critical Miss Table*.

Matchlocks malfunction (misfire) on 14+. Most misfires can be cleared by Immediate Action. The Immediate Action roll is against Black Powder Weapons/TL4 or Armoury/TL4 +2, and takes 3d+12 seconds. The GM makes the roll.

A success clears and readies the weapon. An ordinary failure requires that the charge be drawn before the weapon can be fired again.

A critical failure requires that the gun be repaired by an armorer.

Matchlock Quality

Matchlocks are available in various grades. The cost of an unadorned weapon is a measure of its reliability and accuracy.

A cheap matchlock costs 40% of the listed price, but is less accurate (1/2 Acc) and more likely to malfunction (misfires on 13+).

A good matchlock is the grade listed. A fine matchlock costs four times list price, is 1.5 x Acc and is more reliable. It misfires on a 15+.

A very fine matchlock costs 10 times the listed price. It is 1.5 x Acc. It misfires on a 15+, and is +1 to Immediate Action.

In addition to the basic cost, many guns are heavily decorated. The decoration adds nothing to effectiveness, but does boost the resale value.

Rifling Matchlocks

Any matchlock can be rifled. (Rifled weapons were generally available in Europe after 1475.) A weapon that has been rifled, compared to the same weapon as a smoothbore, has a lower velocity but greater accuracy. It takes more energy to force the same weight of shot through a rifled bore than it does for a smooth bore. (This is why 20th-century hyper-velocity tank guns tend to be smooth bored.) Anyone with Armoury/TL4 at 16 or more can rifle a barrel in one day and exchange barrels on a matchlock in one day, or two days to rifle *and* change barrels. A fair price to rifle and change barrels is \$50. Rifling a smoothbore weapon reduces damage by 1 point for every die of damage it does, and doubles its Accuracy and 1/2D range.

Required Tools

Muzzle-loading guns required a tool kit for efficient operation. The price of a gun in the *Weapon Tables* (pp. 124-125) includes the necessary tools. The most basic tool was the *rammer*, *ramrod* or *wiping stick*. This was a wooden rod, somewhat longer than the distance from breech to muzzle. It was used to ram charge, shot and wadding firmly in place when loading. It was also used as a cleaning rod. The ramrod is carried under the barrel, in metal loops called *pipes*.

The *worm* was a sort of corkscrew that fastened to the wiping stick. It was used to pull out wadding and bullets when drawing a charge (see p. 37). Other tools that could be fastened to the wiping stick were: a *scower*, to remove caked fouling from the bore and chamber; and a *jag*, to hold cloth patches for cleaning the bore and chamber. The *vent pick*, or *pricker*, was a piece of stiff wire set into a handle. It was used to clear any obstruction from the vent. Useful, but not absolutely necessary, items included a knife to cut patches and wadding; a mallet to drive home bullets in a fouled bore; and a flask of oil, applied to the metal to prevent rust.

Worm, scower and jag are usually in a separate compartment of the bullet bag.

Faster Loading with Paper Cartridges

Sometime about 1630, paper cartridges were developed; after that date, they were available for all smallarms. A paper cartridge was a paper tube containing one charge of powder and one load of shot. Loading with paper cartridges takes only half as long as with loose powder and ball. This reduces the normal loading time for a matchlock long gun to 30 seconds, and allows *hurried* loading after 15 seconds.

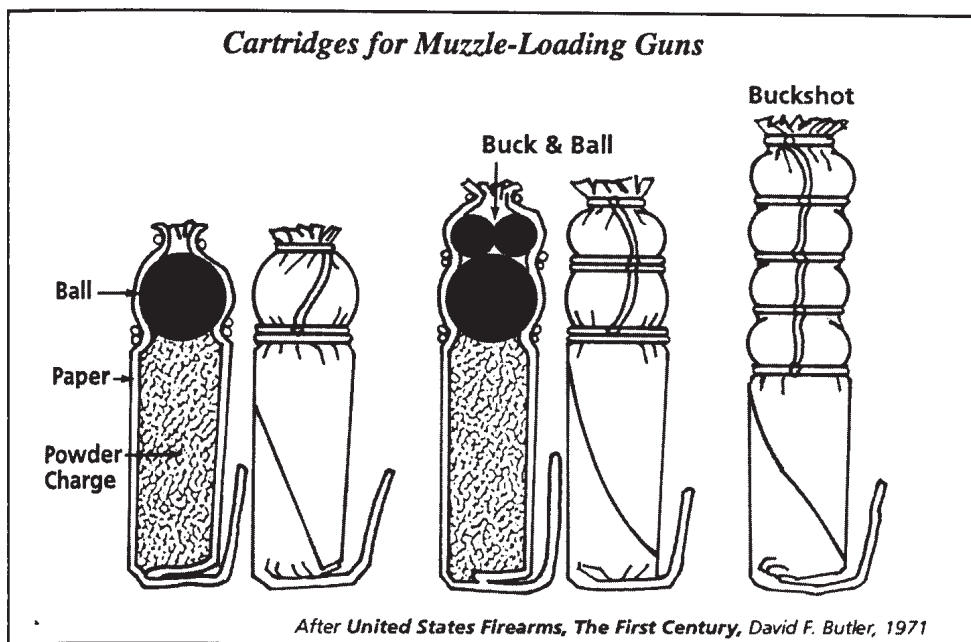

MATCH AND FUSE

From the 14th to the 19th centuries, *match* meant a cord impregnated with flammable material - usually a nitrate solution or spirits of wine (alcohol distilled from wine). The first self-igniting wooden match, usually called a *lucifer*, appeared in the 1830s.

Match came in two varieties, quick and slow. Quick-match was principally for fuses. Various formulas burned at from 1 foot per minute to 4 yards per minute. (An open powder train - that is, a line of powder laid on the ground - also burns at about 4 yards per minute.) Armoury/TL or Demolition/TL skill rolls are necessary to manufacture, evaluate and set a fuse to go off at a predetermined time.

Slow-match was used to carry fire until it was needed. It burned at 4 inches per hour. Match was used to fire matchlock guns, of course, but also to light grenades, to fire cannon, and to be the slow element in a fuse train.

Both varieties of match weigh one pound per five yards. A pound of match costs \$10.

Matchlocks and Slow-Match

To prepare a matchlock gun, a few inches of burning slow-match was clipped into the lock. When the trigger was pulled, the lit coal contacted the *touchhole* in the side or top of the gun barrel. From the touchhole, a *vent* led to the chamber. If the match was good, and the gun properly prepared, it fired.

WET GUNS

Cannonlocks and matchlocks were both extremely sensitive to water. In light rain, reduce the malfunction number by 2. In heavy rain or blowing spray, reduce it by 4. In driving gale or heavy surf, the guns will probably not fire at all; reduce the malfunction number by 6.

BLACK POWDER FOULING

Black powder produced an enormous amount of *fouling*, unburned solid waste. The barrel needed to be swabbed out with a wet patch after every shot to remove as much of the fouling as possible. (Saliva worked well; most shooters would hold a patch in their mouth until it was saturated. Any kind of water, including urine, would work.)

If the bore was not cleaned, loading became progressively more difficult. Normal loading time includes the time necessary to swab the bore. This hasty swabbing could not remove all the fouling. One necessary after-battle chore was cleaning and oiling the gun. Black powder is both corrosive and very attractive to moisture. A few hours in a damp climate can ruin an uncleaned gun.

In a long fight, the buildup of carbon and lead in the bore could immediately affect both loading and accuracy. After every five shots, the firer must take a 2-minute break and thoroughly clean the gun, or accuracy, loading speed and reliability will all suffer. For each five shots without cleaning, increase normal loading time by 10% (round up to the whole second), decrease the user's effective skill by 1 and decrease the Malf number by 1.

BACKFLASH

All guns, before the development of the self-contained cartridge case in the mid-19th century, were prone to backflash. When the powder in the chamber burned, some of the burning gases shot back out the vent.

For muzzle-loading weapons, this was disconcerting. But it was seldom dangerous, except with a worn or badly overloaded gun. With any pre-cartridge breech-loader, the problem was worse and more dangerous. Hot gas spurting through the join of breech and barrel eroded away the metal of the gun, increasing the amount of loss with each shot. Fouling from the unburned powder caked the breech mechanism. This made reloading more and more difficult, since the parts of the breech would not fit together. With each shot more metal was eroded from the breech, allowing more gas and fouling to escape. The blast of gas and fouling was, at best, hard on the nerves and the aim of the firer. At worst, it could permanently blind him.

No entirely satisfactory solution to the problem was reached until the metallic cartridge case, but many were tried. The advantage to breech-loading was obvious to both shooter and designer. The way to make it work eluded them all.

To load a paper cartridge, the shooter tore off the bottom, poured the powder down the bore and rammed the paper and shot down with the rammer. The paper acted as wadding.

This enormously speeded up loading, and also made the act of loading safer. The technique lasted as long as muzzle loading.

The paper of the cartridge was never completely consumed by firing. It formed part of the fouling that had to be wiped from the gun.

Even after the near-universal adoption of the paper cartridge by the military, most ammunition was transported in bulk as loose components. Soldiers normally carried a *cartridge former* (essentially just a specially sized and shaped stick) and made up cartridges for themselves. Bibles and hymn books were a favored source of high-quality cartridge paper.



Breech-Loading Matchlocks

Breech-loading matchlocks, with replaceable chambers, were available from the very beginning of matchlock design. Some had wedge-locked chambers, some had threaded chambers that screwed into the breech.

Some breech-loaders had non-replaceable chambers. They were faster to load than muzzle-loaders, but still had to have the chamber reloaded for every shot.

All had problems with gas loss and backflash. All suffered severely from erosion and fouling of the chamber join when fired.

Breech-loaders were also much more costly than the muzzle loaders, especially after the military-style gun became a standard product. A breech-loading matchlock costs at least three times as much as a comparable muzzle-loader. Extra chambers weigh 10% as much, and cost 10% as much as the whole gun. Any number of extra loaded chambers can be carried for a breech-loader; they count as part of encumbrance.

Exchanging chambers and repriming is a Long Action, taking 10 seconds. The GM can require a skill roll under any stressful circumstances. Loading takes the same time standing, kneeling, sitting or prone. Loading on horseback requires a Riding roll and a Black Powder Weapons roll, both at -1.

Breech-loading matchlocks malfunction on a roll of 13 or above. Any Immediate Action attempt is at -2.

Repeating Matchlocks

Repeaters also came in several types. Revolvers were the most common, but several kinds of magazine guns were available. All repeaters had the same problems as breech-loaders. Additionally, sometimes all the charges fired at once. And sometimes all the charges exploded.

Revolvers came in two categories: cylinder and multi-barrel. Multi-barrel guns were much heavier. If they chain-fired, however, the firer did not have his hand in front of the bullets, as with cylinder long-guns.

A repeating matchlock costs at least 10 times as much as a single-shot of the same type. Only an armorer with prior experience with repeating matchlocks can repair one. An armorer with such skill is only likely to be found in a large and prosperous city. He will gouge every penny he can, in advance, for the work. He will finish when he feels like it, and, if rushed, will recommend colorful and painful ways for the owner to use his (unrepaired) gun.

Repeaters malfunction on 13+. Immediate Action is at -2. On 15 or above, revolvers chain-fire. All the remaining shots go off at once. Magazine guns explode the magazine. The firer takes damage equivalent to a TL4 grenade. On any burst gun result, all the charges in the gun burst and damage the firer.

Unless specified differently, the RoF for matchlock repeaters is 1/4. The cock must be reset each time, usually the match must be adjusted, and the cylinder or breech-mechanism must be moved by hand.

Repeaters can be made for any number of shots. Multi-barrel repeaters weigh 1/3 more per barrel. Revolvers and magazine guns weigh 10% more per additional shot.

Super-Imposed Loads

Some matchlocks are made for *super-imposed loads*, that is, one load on top of another. They are loaded with a heavy wad and a tight ball between charges. They are supposed to fire in sequence, the front-most load first. Some are designed to *roman-candle*, firing all the loads in succession with one pull of the trigger. Most are designed with separate vents and are intended to fire one load at a time. The problem with superimposed loads is the practical impossibility of sealing the charges from each other with the technology of the time. Sooner or later, flash-over fires the wrong charge at the wrong time.

Super-imposed loads malfunction on 12+. Immediate Action is at -3. On a 15 or above, all the charges go off. Anything in front of the firer is attacked at 9 or the required to-hit number, whichever is worse. On a 16, the gun bursts. On any burst gun result, all the charges explode and damage the firer.

RoF in one second for super-imposed loads is 1/1 if there is a separate lock for each shot. If the same lock must be reprimed for each shot, RoF is 1/5. Roman-candle guns fire all the shots, in succession, in the same turn.

The limitation on super-imposed loads is the length of the barrel. One shot needs a minimum of 3 inches of barrel.

Multi-Barrel Matchlocks

A matchlock can, of course, be built as a multi-barrel gun. The barrel and lock make up about 2/3 of the weight of a matchlock, so each additional barrel increases the weight of the gun by 2/3. Each barrel also adds 50% of the cost of the original gun. Guns with up to 10 barrels were known, and more were possible. Loading time for each barrel is the same as for a separate gun.

Some guns are designed as “volley guns,” with a single lock and trigger that fires all the barrels at once. Roll to hit separately with each barrel. On a matchlock “repeating gun,” there is also a single lock and trigger, but barrels fire one at a time. After one is fired, it takes 2 seconds to rotate the next one into place, plus 5 seconds to prime the pan. Cost of both types is the same. For a repeating gun that can also be used as a volley gun, triple the cost.

Others have a separate lock and trigger for each barrel; treat each barrel as a separate gun (though the firer may still pull all the triggers at once). RoF for guns with a separate lock for each barrel is 1/1.

Volley guns have the full recoil for each barrel fired. Roll against HT minus total recoil to avoid being stunned.

Wheellock Guns

Sometime about the beginning of the 16th century, the first self-igniting firearm, the wheellock, was developed. Leonardo da Vinci drew something that no one ever built, but that might have worked, in 1508. In 1517 Emperor Maximilian outlawed guns that made their own fire, and could be carried under cloaks. On January 6, 1515, Laux Pfister was fooling with a gun, described as of a kind that makes its own fire. He accidentally shot a prostitute of the city of Constance, non-fatally, and thus became the first recorded “I didn’t know it was loaded” story. He had to pay 40 florins immediately and 20 florins a year for life as damages.

The wheellock made pistols more practical. A matchlock could not be stowed away in a sash or holster. A wheellock could; thus, it was a favored weapon of assassins, pirates and highwaymen.

DRAWING A CHARGE

The easy way to unload a muzzle-loading gun is to fire it, but the easy way is not always the best way. Firing a gun does at least two things that may not be desirable. The first is make a distinctive noise. Stray gunshots can attract a lot of unwanted attention. Military encampments especially do not want unexplained shooting - it disturbs the equanimity of sentinels and the peace of mind of commanders. The regulations of the Presidio of San Antonio in the 18th century specified that before anyone could fire a gun just to unload it, he had to have the permission of the *commandante*.

The other undesirable side effect is a bullet. All moving bullets go somewhere, whether fired at a target or fired at random. Fired in the air, the usual choice of the promiscuous shooter, the bullet comes back to earth, still carrying enough energy to kill. In the late 20th century, the city of San Antonio, Texas, usually has at least one fatality every New Year’s Eve from the ancient Hispanic custom of firing guns into the air to celebrate the New Year.

Sometimes the gun simply will not fire. If the charge is wet or contaminated with oil it will not ignite. If the vent is completely blocked, the flash cannot go from the pan to the charge. In any case where the gun cannot be unloaded the easy way, the charge must be drawn.

Drawing the charge requires some of the tools listed in the basic tool kit for each weapon. The rammer and worm are the minimum necessities. It takes four times normal loading time and a success roll against Black Powder Weapons, Gunner or Armoury to draw a charge. Normal failure adds 1 normal loading time to the time to draw the charge. A critical failure damages the gun. An Armoury roll can repair the gun in 1d hours.



CARRYING A PISTOL

Before about 1855, the most common way to carry a handgun was in a pocket or thrust through the belt. Holsters were an item of horse furniture, not of human dress; cavalry swung a pair of holsters across the pommel of the saddle. Large pistols, notably those issued by the Royal Navy of England and those carried by Highland infantry, had flat, spring hooks on one side to hold them in the belt. Small pistols fit neatly in the side or tail pockets of a gentleman's coat, or in a ladies muff. Small pistols could also be tucked in the crown of a hat; a courtly doffing of the hat might be an assassin drawing his weapon! High-quality duelling or target pistols were usually kept in a wooden case, with all accessories including a mold for the exactly sized ball.

Before the percussion cap, guns had to be loaded shortly before firing if they were to fire reliably. (One reason for the long survival of the sword; it never misfires.) The percussion cap and, even more, the metallic cartridge made it possible to load and carry for days.



How Wheellocks Work

By modern standards the wheellock was a “Rube Goldberg” device. A clockwork spring in the lock powered, with a chain, an axle attached to a serrated steel wheel. As the spring unwound, it spun the wheel against a chunk of iron pyrites; this threw sparks into the priming pan, igniting the gun. The earliest wheellocks may have been built by clockmakers; the mechanisms are similar.

The wheellock is the only type of black-powder gun that is not commonly fired by hobbyists today. The few surviving specimens are too valuable to fire, and few have the skill or time to build new ones!

Nevertheless, it was a great step forward. For the first time, a gun could be made ready to fire and then set aside until needed! There was no burning slow-match to go out - or to reveal the gunner's position. In fact, wheellock guns were illegal in some areas (France, Austria) for nearly 100 years, since they made banditry and assassination too easy.

Spanning the Lock

A complete wheellock also required a *spanner* - a lever, slotted to fit the end of the axle, which was used to *span the lock*. Spanning the lock was winding the spring to prepare the gun to fire. With the spring wound and the gun loaded and primed, all that was needed to fire was to lower the *cock*, which held the pyrites, onto the pan. (Older or cheaper guns had to have the pan cover opened for firing; later or more expensive guns automatically opened the pan cover when the trigger was pulled.) The gun could be carried safely, loaded and spanned, as long as the cock was lifted off the pan. Careful shooters (the kind that lived to write memoirs) carried their spanner on a string around the neck. It was possible to improvise some method of spanning the lock without the spanner, but it was not something to bet your life on. Roll vs. Guns -6, Mechanic -4 or IQ -6; if you fail, you may look frantically around for 5 minutes and then roll again. Availability of lots of possible tools would give a bonus to the roll. A critical failure, of course, ruins your gun.

Loading Wheellocks

Loading a wheellock is a Long Action. Muzzle-loading long-guns take 60 seconds to load, with loose powder and ball, while standing still. Muzzle-loading pistols take 44 seconds.

Each barrel of a multi-barrel gun must be loaded separately.

Each load of a super-imposed loading takes as long as loading a single shot.

Loading a muzzle-loading long-gun takes 76 seconds kneeling or sitting, 90 seconds prone. Loading on horseback requires a roll against Riding skill.

Each chamber of a revolver or detachable chamber gun takes 44 seconds to load. Exchanging chambers for a breechloader takes 10 seconds.

Breech-loaders and pistols take no extra time to load in positions other than standing.

Paper cartridges, available after 1630, *halve* the normal loading time, to 30 seconds for long guns and 22 seconds for pistols.

Firing Wheellocks

Firing a wheellock takes a roll against Black Powder Weapons. A success fires the gun and hits the target. A critical success goes to the *Critical Hit Table*.

A non-critical failure is either a miss or a misfire. A critical failure requires a roll on the *Critical Miss Table*.

A good wheellock malfunctions on 14+. A cheap wheellock malfunctions on 12+. Fine wheellocks malfunction on 15+, very fine wheellocks on 16+.

A misfire can usually be cleared by Immediate Action, requiring 2d seconds. On any misfire result, the GM rolls against Black Powder Weapons/TL4 or Armoury/TL4 -1.

An ordinary failure on Immediate Action requires that the charge be drawn before the weapon can be fired again. A critical failure damages the gun so much that it requires repair by an armourer.

Price of Wheellocks

For wheellocks, even more than for other types of gun, the difference between fine and cheap might be the difference between life and death. Any wheellock is expensive. It has to be made by a highly skilled craftsman. The delicate relationship among spring, axle, chain, wheel, sear and trigger cannot be achieved by unskilled labor. Higher price hopefully guarantees that care is taken with spring temper, chain strength, strain limits and the other details that ensure reliable operation. A fine wheellock is more reliable than a flintlock, especially in the rain. Fine wheellocks survived in use until the 19th century. Cheap wheellocks are disastrously unreliable.

Cheap wheellocks cost 40% of the listed price. They are 1/2 Acc and malfunction on 12+. Good wheellocks sell for the listed price. Fine wheellocks are four times the listed price. They are 1.5 x Acc and malfunction on 15+.

Very fine wheellocks are 20 times the listed price, and are also 1.5 x Acc. They are available only in the most technically advanced areas, or from the most exclusive merchants. They malfunction on 16+.

Even more than matchlocks, wheellocks are liable to be embellished with decoration. The cash value of the decoration may be many times the cost of the gun unadorned.

Wheellock Problems

Wheellocks have several weak points. The pyrites that produce the spark is soft and friable. One piece of pyrites will seldom spark for more than 10 shots. Pyrites might burst at any time and have to be replaced. The pyrites have to be carefully adjusted in the cock or the wheel will not make sparks.

The springs and the chain are vulnerable to damage. If the spring is kept in tension too long, it will take a set, and not turn the wheel fast enough to raise sparks. The chain is delicate and prone to breaking, especially if the trigger is pulled without the cock on the pan.

A damaged spring or chain is a repair job requiring an Armoury roll at -4, and eight hours. A gunsmith will charge at least \$50.

Multi-Shot Wheellocks

Several kinds of multi-shot wheellocks were available. Any multi-shot gun was even more expensive than a single-shot, and more prone to failure. There was more to go wrong. There were multi-barrel guns, with or without a separate lock for each barrel. There were revolvers. (As with matchlock revolvers, the cylinder usually had to be manually turned for each shot. Wheellock revolvers were slower to operate than matchlock revolvers, since the lock had to be spanned for each shot.) Wheellocks were also made for super-imposed loads. Wheellock magazine guns had the same problem as all loose ammunition repeaters; too often the entire magazine exploded. On any "burst gun" critical failure, all remaining charges explode and do normal damage to the firer.

Wheellocks and Water

Wheellocks were not as vulnerable to water as earlier guns. The pan cover protected the priming until the actual moment of firing. The wheel would strike sparks from the pyrites even in a heavy rain.

Cheap wheellocks reduce the malfunction roll by 3 in heavy rain or spray and 2 in light.

Good and fine wheellocks reduce the malfunction roll by 2 in heavy rain or spray and by 1 in light rain or spray.

Some very fine wheellocks are made with very tight tolerances, and with a box over the action, so that they are almost completely impervious to rain or spray. Such a weapon has no decrease in the likelihood of firing in rain or spray, and will even fire when completely submerged on a critical success. It costs 30 times the listed price.

BLACK POWDER SMOKE

Burning black powder produces clouds of greasy, gray-white smoke. It is heavily sulphurated, and the smell is never forgotten. The smell and taste cling to the mucous membranes of throat, mouth and nose for hours after firing. It causes intense thirst. The smoke hangs like a fog, sometimes remaining in sheltered areas for hours before dispersing. The sight and smell and taste are as integral a part of the black-powder battlefield as engine-exhaust fumes are of the 20th-century battle.

The smoke has two tactical effects. First, it gives away the position of the firer. In the light, the cloud of smoke is highly visible. In the dark, there is a tremendous flash of light because the powder is still burning as it leaves the gun. The second effect, paradoxically, is concealment. The cloud of smoke obscures both the firer and his target. In the open, this is not so bad. Indoors, for instance in the crowded quarters of a ship, or a fort under siege, or a barroom, a few shots can produce a fair approximation of hell.

The volume of smoke depends on how much powder was burned. The cloud of smoke is created directly in front of the muzzle of the gun. That produced by one smallarms shot is not very significant; a lot of smallarms, or a little artillery, is like setting off smoke grenades. That produced by a black powder machine-gun is like using a smoke generator. The early Maxim guns (pp. 78-79) had to be sited with a crosswind, or they completely blinded their own crews with a few seconds' firing.

CAREFUL LOADING

Taking time to load very carefully has a marked effect on the accuracy and reliability of muzzle-loading guns. Smoothbores, especially, are very much more accurate when firing a well-fitted, tightly patched ball from a clean barrel. Such things as a perfectly smooth ram of the load, an exactly measured amount of priming, and even a symmetrically burned end on the match, can affect the likelihood of the gun firing and scoring a hit. One reason that military commanders liked to save the first volley as long as possible was that it was the one that was most carefully loaded.

All matchlock guns are +1 to effective skill if the firer has spent three times the required loading time in carefully preparing the gun.

VARYING THE LOAD

Theoretically, the load of a loose powder gun was entirely at the option of the loader. He could always choose to load more or less powder and/or shot. In fact, most shooters settled on an accurate and reliable charge for their gun and then stayed with it. Soldiers loaded their cartridges according to regulation, not whim. Only the most highly skilled precisionists, and the ones who mistakenly thought of themselves as highly skilled, played with varied loads.

The actual effect on a particular gun of varying the load could only be determined by experiment. Given the number of variables in powder and shot quality, and the uncertain gunmaking of TL4 and 5, predicting the behavior of a new load was practically impossible. Some things were fairly safe guides. Increasing the charge gave more power and more recoil; increasing it too much could burst the gun. Increasing the weight of shot gave more power and more recoil and could also burst the gun if overdone, but it took a much greater change. Decreasing the charge lowered power and recoil, which made it easier for the shooter to hold steady but sometimes made the ball fly less true. Dedicated shooters would set up on the range with accurate measures, scales and a lot of targets to try to work up the best possible load for different conditions. Then they would have to hope that they could predict the future well enough to have the right load in the gun when the circumstances demanded. (Stark necessity sometimes required reducing loads. If there was a shortage of powder, reduced loads could give more shots, though each one was of less power.)

The game mechanics of varying the load approach reality in this; for a great deal of trouble, they can give a very small advantage.

By adding -1 to Rcl, any black-powder small arm can get a 10% (round down) increase in damage and a 5% (round down) increase in 1/2D and Max. The greatest possible increase in damage is 50%. Accuracy is reduced by 10% (round up) for each 10% increase in damage.

Reducing damage by 20% (round up) reduces the Rcl by 1 (but never to less than -1). A 20% reduction in damage allows a 10% (round down, less than 1 is 0) increase in Acc; 1/2D and Max are reduced by 20% (round up). A 20% reduction in damage is a 10% increase in the number of shots from a given quantity of ammunition. (That is, 10 loads at full damage would give you 11 loads at -20%.)

Flintlock Guns

The wheellock was only “state of the art” for about 50 years before gunsmiths improved on it. In the flintlock, a piece of flint was attached to the S-shaped serpentine. The gun was readied by pulling back the “cock” (hence, “cocking” the gun). A pull of the trigger released the flint to strike against a piece of steel and throw sparks into the priming pan. The flintlock was faster, more reliable and *much* cheaper than the wheellock. A skilled gunner with a simple smoothbore flintlock could easily manage three shots per minute. Both sides in the American Revolution used flintlocks.

Flintlocks took a long time to become popular, much to the surprise of later generations gifted with acute hindsight. By about 1580, the *snaphaunce* variety of flintlock was well known in Europe. The true flintlock was in use by 1620. But matchlocks and wheellocks remained in military use until after 1700. The first military issue of the flintlock was to the guards of the artillery train. Lighted match and gunpowder in quantity were not the best combination.

By the early 1700s, the flintlock had replaced every other ignition system for firearms. (Except in Japan, where the matchlock remained in use until Perry, and Germany, where fine wheellock sporting guns were made until the early 1800s.)

The Flintlock Mechanism

Collectors distinguish several different kinds of flintlock, but all had some common features.

Flintlocks had a *cock* with *jaws* that held a piece of flint. The cock was drawn back and held against spring tension. (Some flintlocks had a safety position called *half-cock*; if the gun went off while in the safe position, it went off half-cocked.) When the trigger was pulled, the flint struck against the *steel*, or *frizzen*, and a shower of sparks ignited the priming in the pan. Flintlocks were easier to use than matchlocks, while simpler to make and maintain than wheellocks. The very fine ones were as reliable as any gun built until the mid-19th century. Even the cheap ones worked considerably more often than not.

If the best advertisement is a satisfied customer, the flintlock sounds wonderful. Every primitive society that learned of flintlocks preferred them to their native weapons, for both war and hunting.

Nomenclature of Flintlocks

Nomenclature of flintlocks is no more logical than that of other weapons. Guns get called all sorts of things, but the following are the most common usage. *Musket* usually means a smooth-bore, military long-arm.

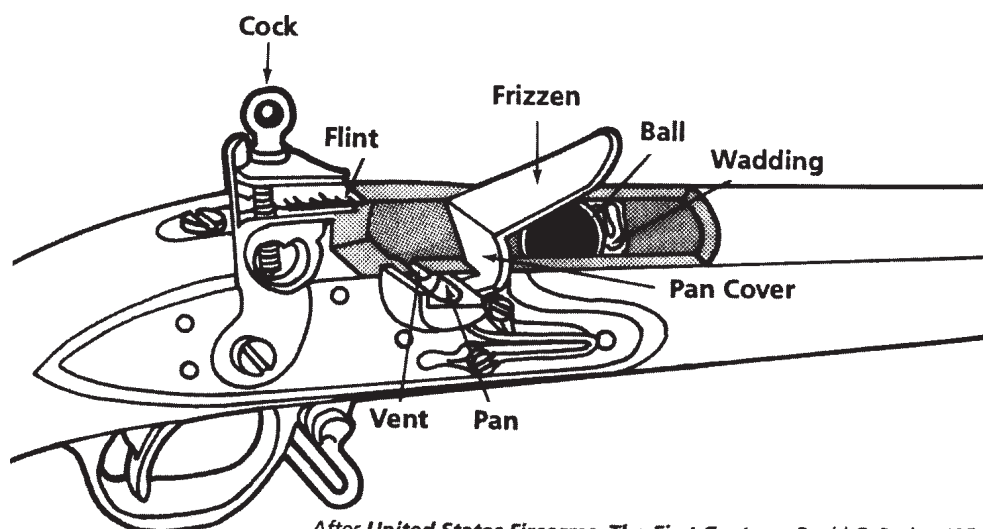

After *United States Firearms, The First Century*, David C. Butler, 1971

Rifle means that the weapon is rifled. The term is frequently compounded with another name: *rifled-pistol*, *rifled-gun* (colloquially in America *rifle-gun*), *rifled-musket*.

Carbine is a short-barrelled, shoulder arm for cavalry. Carbines are frequently, but not always, rifled.

Musketo is also a short-barrelled, cavalry weapon, but always smoothbored.

Pistol is a gun designed for convenient carry, and easily fired with with one hand. Pistols are a primary cavalry weapon. They are also a major naval weapon and the personal defense arm of everyone.

Fowling-piece is a smoothbore, usually a single-shot, intended for bird hunting. *Long-fowler* is a long-barreled, frequently big-bore fowling piece.

Shotgun or just *gun* begins to be used for a sporting arm principally intended to fire many small balls instead of one large ball. The faster lock-time and better balance of flintlocks allowed the development of the sport of shooting birds on the wing, instead of stalking and shooting them sitting.

Blunderbuss is a bell-mouthed gun much used at sea, and by coach guards. The bell doesn't actually spread the shot, but it looks menacing. It is also easier to load with loose powder and shot. (Important if the loader is sitting on a moving coach, or in the crossrees of a ship!)

Wall-piece is a very big musket or blunderbuss, one inch or more in the bore, fired from a wall mount rather than from the shoulder. The same kind of gun, called a *punt-gun*, is used for water fowling. In this case, it is mounted on a small, flat-bottomed boat.

Flintlock Rifles

Rifling was more common with flintlocks than with earlier ignition systems. Two parts of the world were especially partial to rifles: Germany (including Austria and Switzerland) and the North American frontier.

A rifle was slower to load, and had a lower velocity than a comparable smoothbore, but it had three to four times the effective range.

Most rifles were built as sporting arms and thus had weaknesses for military use. They were not as ruggedly built, and so were more prone to damage in the field. They were not made in standard calibers, which complicated the ammunition supply problem. They did not mount a bayonet, and that could be more than embarrassing in a melee. European hunters carried a shortsword for backup. American frontiersmen carried a knife or tomahawk (or both). These weapons were good for individual fighting, but could not stand against a bayonet charge. To use them effectively required putting down the rifle, which was likely to result in its loss. Rifles issued to regular military formations, such as the Ferguson (p. 60) and the Baker (p. 113), were equipped with bayonets.

Flintlock Quality

Flintlocks are available at the usual grades.

Cheap flintlocks cost 40% of the listed price. Their malfunction number is reduced by 1 and they are -1 to Accuracy. Good flintlocks are as listed. Fine flintlocks cost four times the listed price. They are +1 to Accuracy.

Very fine flintlocks cost 10 times the listed price, minimum. Each one is the custom product of a master gunsmith. They are +1 to Accuracy skill and +1 to the malfunction number.

Flintlocks are also often heavily and elaborately decorated.

Muzzle-Loading Flintlocks

Most flintlocks, probably more than 99% of all the flintlocks ever made, were muzzle-loaders. The muzzle-loader was efficient, effective and economical to make. But it was slow to load, and very difficult to load in the prone position, long recognized as the safest under fire and the steadiest for shooting.

LEAD, IRON AND STONE

Lead, iron and stone were the principal materials for gun projectiles.

Lead was probably one of the first known metals. It was used for projectiles at TL2. (Lead bullets for slings are one of the most common Roman archaeological remains.) Lead has a low melting point and is easy to cast to any desired shape. The soft metal deforms readily, so it expands to fill the grooves of a rifled gun. The high density gives a good ballistic coefficient and good wounding effect. At a high enough velocity, it "mushrooms" for even greater wounding effect. Lead was used almost exclusively in smallarms but seldom in artillery applications.

Stone was almost never used in smallarms, but was common in artillery until the 17th century. Stone was lighter than iron or lead, so could be driven to the same velocity by a smaller charge of powder. This was both cheaper and less likely to burst the gun. If you are firing a stone cannonball and get a "burst gun" result, there is a 50% chance (roll one die) that the gun did not really burst; roll again for the critical failure result.

Stonecutting, however, was a skilled trade, and one not aided much by advances in technology. By 1550, gunstones cost 3 to 12 times as much as comparable iron cannonballs; the prices on the *Weapon Tables* are for iron shot. In general, assume that iron shot sells for \$1 per pound, and stone shot sells for \$2 per pound.

Iron is not as dense as lead, but is considerably harder. It gave better penetration, and better range on a ricochet. Iron could be heated red-hot to give an incendiary effect, or cast hollow to be filled with powder as a shell.

The comparative weight of lead, iron and stone is in the proportion 4, 3, 1. Occasionally other metals, including brass, bronze and copper, were used as projectiles. They can be considered to have the same weight as iron. Silver comes between iron and lead; werewolf hunters could use a figure of 3.5.



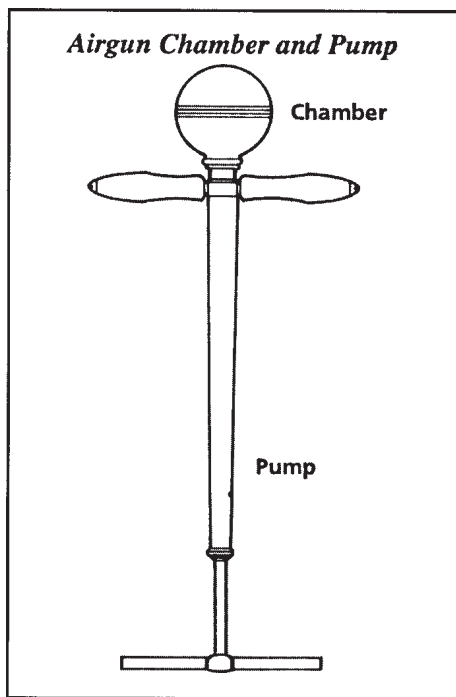

PRE-GUNPOWDER WEAPONS AT TL4

All of the low-tech weapons in the *GURPS Basic Set* are available at TL4. Late in the period, after about 1620, it will be hard to locate a mace or a battle-axe, and a full suit of plate will be close to impossible to find. (It might be possible to get a bargain from someone renovating the castle.)

Because of improved production and transportation, metal weapons and armor are cheaper and more widely available than they were earlier. Good weapons and armor cost only 80% of the listed price. The price of fine and very fine weapons has not changed. There are more master craftsmen and they have more materials to work with, but there are also more customers with money, so the masters can keep up prices.

Bows and crossbows cost the listed *GURPS Basic Set* price, modified by geography. Yew longbows were common in England, and composite bows in Turkey, but not vice-versa. Game Masters determine the likelihood of a particular type being in the adventure area, and adjust the price accordingly. Bows were as effective as ever. They were faster firing than any gun of the period, and more accurate than most. But they required great strength and continual practice to be effective.

Slings, javelins and throwing spears are available at the listed price. Slings can be used to throw gunpowder grenades after 1500, at halved range and -4 to skill due to the extra weight of grenades and the need to light and throw quickly.

All of this period is an age of war. Great bargains in slightly used gear can occasionally be found (see *War Surplus*, p. 13).

Loading Muzzle-Loading Flintlocks

Loading a flintlock muzzle-loader is a Long Action. Loading a smoothbore long gun with loose powder and ball takes 40 seconds, standing. Loading with paper cartridges halves this, to 20 seconds. In prone position, time is 60 seconds loose, and 30 seconds with cartridges. Sitting and kneeling are 60 seconds and 30 seconds, respectively. Loading on horseback requires an additional roll against Riding -3; time is as for sitting.

Loading time for a rifled weapon, with loose powder and ball, is 40 seconds, if greased patches to wrap the ball are used. If the load is without patching, time is 60 seconds. Rifles can be loaded with cartridges in 30 seconds, but at 2/3 Acc (round down).

Hurried loading, careful loading and loading in non-standing positions are as with other muzzle-loading smallarms.

Muzzle-loading pistols take 40 seconds to load standing, sitting or prone. Cartridges halve this time. Really cramped or uncertain positions, such as clinging to the rigging in a storm, add time and skill penalties at the discretion of the GM.

Flintlock Ammunition

Prepared cartridges were just about the exclusive choice for the military. Cartridges were carried in a *cartridge box*. This was a leather bag with a flap closure. In the bag was a wooden block, drilled with vertical holes; each hole was big enough for one cartridge. Usually more cartridges were carried stored horizontally in a compartment under the block. Capacity varied from two to as many as 50.

Spare parts and tools were also carried in the cartridge box. These might include worm, sower, vent pick, screwdriver, flints, patches, grease and a *cartridge former*. This last was a stick of the proper diameter, with a recess to hold the bullet. With a bullet in place, paper was wrapped around the stick, the bullet tied off with string, a powder charge poured in, and the flap closed and glued or tied shut.

Given all the materials, cartridges could be made at the rate of one every 60 seconds, with a roll against Black Powder Weapons or Armoury at the appropriate TL. A failure is obvious; start over. A critical failure means you have made a cartridge that won't fire! Usually, of course, cartridge preparation will be an offstage activity. In the military it is assigned as a detail, like KP.

Loading With Loose Powder and Shot

Any muzzle-loader can be loaded with loose powder and shot. Riflemen prefer to load this way, since it is more precise. Powder is carried in a flask or a powder horn, bullets usually in a bag, along with wadding, patches and tools. "American," or "Kentucky," rifles usually had a small brass box with a spring-loaded lid inset into the stock to hold patches.

The self-measuring powder flask, with a nozzle that accepts one charge of powder and then shuts off the rest of the flask, is a common accessory for sporting guns. A self-measuring powder flask subtracts five seconds from loose-ammunition loading time. It is included in the price of any fine or very fine sporting gun. One can be made for any gun, by an armorer, in three days. Cost must be negotiated, but will never be less than \$10.

Super-Imposed Loads

Flintlocks were also made for super-imposed loads (see p. 37). Some were intended to roman-candle; others were designed with multiple locks and intended for successive fire. As with other such systems, occasionally the wrong load fired. On any "burst gun" result, all the charges explode.

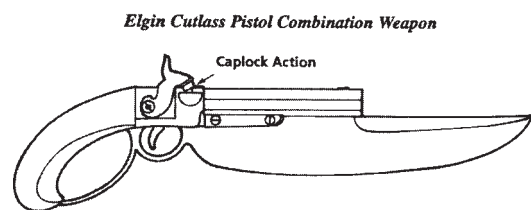

After *Weapons Through the Ages*, William Reid, 1976

Firing Flintlocks

The firing action is a roll against Black Powder Weapons. A critical success goes to the *Critical Hit Table*. An ordinary success is a hit.

A non-critical failure is a miss or a misfire. A critical failure requires a roll on the *Critical Miss Table*.

Flintlocks misfire on a roll of 14 or more. The Immediate Action roll is against Black Powder Weapons/TL5 or Armoury/TL5 +2. It takes 2d seconds.

A failure on Immediate Action leaves the gun unable to fire; another attempt can be made. A critical failure disables it until it is repaired by an armorer.

Flintlock Mechanical Problems

Flintlocks were less complex than wheellocks. Despite that, a lot of things had to work just so if one was to go off as desired. The flint had to be correctly *knapped*, shaped to produce sparks when it hit the steel. The steel had to be shaped and hardened properly. The sparks were actually bits of metal scraped from the steel and heated by the friction of the blow. The face of the steel was damaged a little by each firing and had to be repaired by a gunsmith regularly. Even the very best flint was good for no more than 50 shots and then had to be replaced. (Trying to knap used flints almost never worked. Good flint-producing areas exported dressed flints by the barrel; flint mining is the oldest of all industries.) All the parts of the lock, especially the springs, were subject to wear and damage.

Stick Airgun With Pump

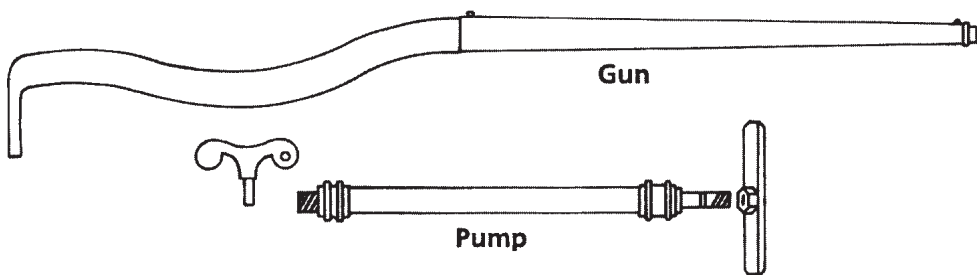

After *The Gun and Its Development*, W. W. Greener, 1910

Air Guns (1610 and Later)

Compressed air was used to power guns from as early as 1610. It was much easier to make a repeating air gun than it was to make a repeater using loose powder and ball.

The two great problems with air guns were: (1) achieving an airtight seal on the mechanism and (2) making a reservoir that would not burst when fully inflated. A lesser problem was that each successive shot from a charged reservoir was at a lower velocity.

There was no standard model airgun at TL4, or until near the end of the 18th century in TL5. After the Napoleonic Wars, the industrialized West could and did produce powerful air guns at relatively low prices. The development of the metallic-cartridge repeater eliminated the air gun's superiority as a multi-shot weapon. Its other advantage, comparatively quiet and flashless firing, remained. At TL6 and TL7 the air gun was mostly a toy, whether for children or target shooters.

COMBINATION WEAPONS

Weapon designers have a mad urge to combine. In the history of combination weapons, sanity is represented by the swordcane and raving psychosis by the pike-longbow. The invention of gunpowder seemed to give a particular impetus to the proclivity for combination weapons.

A simple combination is the bayoneted gun; see sidebar, p. 44.

Boar spears with a gun built into the shaft were fairly common in 17th-century Germany. It was hard to miss if the target was spitted on the point.

Combination knife-pistols were fairly common. The most effective were those, such as the Elgin cutlass-pistol, that combined a substantial blade and a heavy single-shot pistol. Any such weapon should be at least -1 for *either* of its combat uses.

Detachable shoulder-stocks, to convert pistols to carbines, were one of the more practical combinations. The only real objection is that they are about as bulky as, and much less effective than, a real rifle.

Grenade launchers attached to guns date to the 17th century. They achieved real success only with the development of precise fuses after 1914.

Walking-stick guns had a certain amount of popularity until the custom of carrying a cane ended.

Pistols combined with brass knuckles were not unusual in the 19th century, but seldom seen afterward. Just hitting someone with the gun is usually enough.

Henry VIII equipped his bodyguard with shield-guns. Each shield had an aiming port, protected by a steel grille, in the top center, and a breech-loading gun firing through the boss. Other combination guns included an axe with a barrel instead of a spike at the tip, and a mace with several barrels in the head.

Such a weapon cannot be fired immediately after use as a hand-weapon. The vent will be clogged with blood and brains, or the charge and shot will have fallen out, or some such accident. Preparing the gun to fire after using it thus will take 30 seconds and a roll against Black Powder Weapons skill. A failed roll requires that the gun be reloaded. A critical failure means that the gun is no longer fireable until it has been repaired by an armorer.

Just about any two (or more) weapons can be combined. Usually the result is not as good at any one thing as two specialized weapons, and more prone to mechanical failure. GMs may invent unusual combination weapons and make them available to the PCs, for better or worse. Or inventive players may come up with their own ideas for combination weapons. In any city there will be at least one armorer mad enough to try to build *anything*, for a price.

BAYONETS

Even as swords and spears declined in importance, a new piece of military cutlery appeared. Hunters in the Pyrenees Mountains may have been the first people to attach a knife to the muzzle of a gun. This was a comforting backup if the game sought was boar or bear. By 1700 the bayonet had completely replaced the pike in first-line military service in Europe.

Bayonet attacks use Spear-1 skill (for a longarm bayonet) or Knife-1 (for a bayoneted pistol). A bayonet is clumsy . . . but sometimes a lifesaver, nevertheless.

Plug Bayonet

The first bayonet was simply a knife with the handle jammed into the muzzle of the gun. The gun can be neither loaded nor fired with the bayonet in place.

If the bayonet is used as a spear, there is a 50% chance that the bayonet will either fall off or get stuck in the target. A plug bayonet off the gun is just a large knife.

Socket Bayonets

In 1687, the great French military engineer, Vauban, invented the socket bayonet. This had a sleeve, which fit over the muzzle. The bayonet locked to the gun by engaging a slot on the sleeve to a lug on the barrel. The blade was offset to permit firing and loading with the bayonet in place. By 1700 the socket bayonet had replaced both the pike and the plug bayonet in Europe.

The socket bayonet is an ordinary spear when fixed, and a large knife when unfixed. Most socket bayonets have no cutting edge and can be used only for thrusting attacks, but this is not a universal rule. A gun with a socket bayonet fixed can be loaded and fired normally. A socket bayonet also makes a handy candle holder.

Fixing bayonets is a Long Action that takes four seconds. Loading with the bayonet in place takes 10% longer (round up). Effective skill is at -1 if the weapon is fired with the bayonet in place.

Sword Bayonets

A sword bayonet is a shortsword or large knife, attached by a socket to the muzzle of a gun. They were not nearly as common in the 17th, 18th and 19th centuries as socket bayonets. They were most commonly issued to specialist troops such as riflemen and pioneers (combat engineers).

Sword bayonets take the same time to fix as socket bayonets, and have the same loading and firing penalties.

At TL4 air guns are expensive - 10 times the cost of a comparable wheellock. They can only be made by a highly skilled armourer (Skill 16 or above) and take 4d weeks to construct. This is the same for most of TL5. Air guns were used by those who could afford them. Royalist exiles bought a seven-shot repeater for an attempted assassination of Oliver Cromwell, but were arrested before they could get off a shot.

About 1750, on Earth (or at a comparable level of development elsewhere), air guns can be made for about five times the price of a flintlock musket, if there is enough demand to manufacture them *en masse*. In Austria, about that time, units of snipers with repeating air rifles were actually used in combat. The Lewis and Clark expedition of 1803 carried an air gun.

After 1850, air guns at about the same price as black powder guns are available in commercial centers such as Berlin, London or New York. Custom builders can still make a better product, but will charge exorbitantly. Colonel Sebastian Moran's air gun was such a custom piece; Dr. Watson never specified the price, but a fair estimate would be about \$500.

After 1900, very few serious-weapon air guns can be found. The repeating-cartridge gun, with a silencer, can do the same jobs better. Children's toys are widely available, at a 1900-price of \$2. They are spring-piston guns, charged and cocked by a lever on the gun and with no separate reservoir. They do 1d-4 damage and have a 1/2D of 10 and Max of 50. They are available as long-guns and pistols.

After 1950, high-quality target and sporting air guns are available. They have damage less than a .22, but Acc and 1/2D are much greater than for toys. Generically, give pistols 1d-2 damage, 1/2D 30, Max 200, SS 10 and Acc 3. Air rifles get 1d-1 damage, 1/2D 60, Max 300, SS 13 and Acc 9.

Any air gun can be used to fire poisoned ammunition. See p. B132 for poison effects.

Loading and Firing Air Guns

Loading an air gun requires two activities. The first is to pump up the reservoir and attach it to the gun. (Some air guns have reservoir, pump and gun combined, but all the powerful military and hunting guns of TL4 and 5 had separate reservoirs.) The second is to put bullets in. Most repeating air guns had tubular magazines for five to 20 lead bullets; single shots carried only one.

The price of an air gun includes one pump and reservoir. Extra reservoirs cost half the cost of the gun. (They are one of the hardest parts to make.)

Charging reservoirs takes 2d+3 seconds. Loading bullets takes one turn for any quantity (they are simply poured into a tube).

Charging a reservoir takes 2d+10 seconds per shot. Pumping up the reservoir always has the risk that the reservoir will crack or burst. When the reservoir is charged, roll against Guns (Air Gun) skill. Any success charges the reservoir. On a failure, it loses pressure and the gunner must start over. On a critical failure, roll again. This time, on a success, the reservoir merely splits; it can be repaired by an air-gun armourer in one day. On a failure the reservoir *bursts* and does one point of explosive damage for each shot in the reservoir. (TL6 and above air guns do not burst; on a critical failure they merely split.)

Charged reservoirs can be pre-loaded for sustained fire. With the material of TL4 and 5, they will not hold air for long. After one hour, roll against the Armoury skill of the fabricator, at -1 for each hour. On any failure the reservoir is discharged; on a critical failure the reservoir must be repaired.

Grenades

The hand grenade was invented around 1500. All grenades at TL4 and TL5 are similar. They have a shell of cast iron, pottery or heavy glass, containing about a quarter-pound of gunpowder. Overall grenade weight is about two pounds, so a

grenade can be thrown 2.5 x ST yards. The grenade has a screw-plug, that can be removed to load the powder. The plug holds the fuse. The fuse is a short length of match, usually cut to ignite the charge in about five seconds. Grenadiers normally prepare their own grenades just before going into action. The operational technique is simple: light the fuse and throw.

Grenades were a favorite naval weapon. They had a devastating effect on the crowded decks of a warship. A grenade in the powder magazine could sink a ship that might stand up to hours of pounding by cannon.

Throwing a Grenade

Damage with grenades depends ultimately on fuse action. If the grenade does not explode, it might as well be a rock. If it explodes too soon, it would have been better if it were a rock!

Throwing a TL4/5 grenade takes two rolls. First, roll against Black Powder Weapons. A successful roll prepares the grenade for throwing, fuse lit, in one second. A failure is simply an unlit fuse - try again.

On a critical failure, the fuse must first be replaced, which takes 2d+2 seconds and a success roll against Black Powder Weapons at the appropriate TL.

With the fuse lit, roll against Throwing skill (or DX-3) to determine if the grenade hits the target.

A critical failure requires a roll on the *Critical Miss Table*. A failure is just a miss.

Unless the grenadier has specified another fuse length, the grenade will go off five seconds from the time the fuse was lit. Flight time from the grenadier to the target is not usually an issue. If it is, divide distance in yards by ST for time of flight in seconds. Any answer less than 1 is effectively 0 - the grenade lands in the same turn it is thrown. A result of 1 to 2 means it lands in the next second; anything greater means in the second after that.

TL4 hand grenades cost \$5.

Grenade Damage

All TL4 grenades, however launched, do explosive damage as per the chapter on *Explosives*. Fragmentation damage is enhanced because the grenade body is a source of fragments. Usual damage is 1d+2 concussion; fragments do 2d cutting damage to each hex-worth of target (see p. 24).



Unexploded Grenades

An unexploded grenade can be dealt with. With a successful DX roll, the grenade can be picked up and thrown away by anyone who can reach it. With a Throwing roll the grenade can be thrown back at the original thrower. A Black Powder Weapons or Armoury roll allows the fuse to be extinguished.

Hand Mortars

About 1600 the *hand mortar* was invented. This was a firearm, wheellock or flintlock, that fired grenades. Those designed purely as grenade launchers were usually fired from the ground, rather than from the shoulder, because of the heavy recoil. There were also combination gun/launchers. These had a conventional gun barrel, and a hollow butt that doubled as a launcher.

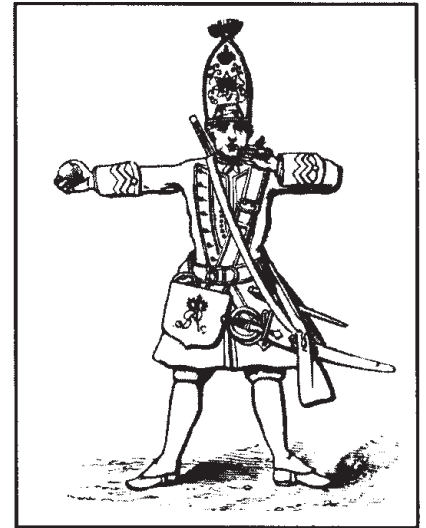

GRENADIERS

The grenade was considered a weapon for specialists. Grenadiers were selected for size and strength, so they could carry more and throw farther. They wore tall, brimless caps, instead of wide-brimmed hats, so that the throwing arm would not be impeded. They carried a length of slow match to light fuses, a sack of grenades, a sword or hatchet, and a flintlock or wheellock gun.

Because they were elite troops, grenadiers were regularly selected for special missions, even if the operation did not require grenading. Gradually, "grenadier" came to be a title of honor given to elite formations, even if they were not armed with grenades. The Grenadier Guards are the premier regiment of the British Army, for instance. The French Foreign Legion uses a flaming grenade as a badge: the privilege of using it was a recognition of elite status.

Grenades were not very prominent on the battlefield after about 1730. They were uncertain weapons and relatively short-ranged. They were still used extensively at sea and in sieges for another century.

When armies adopted the rifle, and navies the long-range gun, it really seemed that the grenade had been driven to obsolescence. In the late 19th century, the grenade was seen as the weapon of bearded and comically sinister anarchist assassins.

The siege of Port Arthur, in the Russo-Japanese war of 1904-05, brought a revival of grenading. By 1914, all modern armies had some form of grenade, with either time or impact fuse. After 1914, grenades were issued widely. In the French army, they were much more the standard infantry weapon than was the rifle. French soldiers were more likely to hurl a grenade than to shoot. Grenading had lost its specialist character.

IRON AND BRONZE

For all of the black-powder era, the big guns, such as cannons and bombards, were made of iron or bronze. (Bronze is an alloy principally of copper and tin; bronze guns were often called "brass," which is actually an alloy principally of copper and zinc.) Bronze was softer than iron, but tougher. Bronze guns were considerably less likely to burst. Bronze turns green with *verdigris*, an oxide, as it ages, but does not rust. Bronze costs from 3 to 10 times as much as iron, and the disparity increased all through this period, as iron became cheaper.

Iron is harder than bronze, but more brittle. Iron rusts as it ages, and loses elasticity with firing. All iron guns burst, if fired long enough. They let go with no visible sign of the aging process. Mons Meg survived for centuries, and then burst while firing a blank charge for a salute.

Regular armies, and even more, navies, wanted brass whenever possible. Merchant ships and irregular forces were liable to have iron because it was cheaper.

After about 1840, metallurgical techniques had improved enough to make iron guns considerably more reliable. Iron and bronze cannon were about equally common through the rest of the time of black powder.

Guns are classified according to projectile weight; a four-pounder cannon throws a four-pound ball. For iron or brass, the weight of the gun is usually between 80 and 150 times the weight of the projectile. (Some very heavy naval guns went to as much as 400 times the weight of the projectile at the very end of this period.) The weight of the carriage runs from about equal to the gun's weight, to twice as much. One of the steady improvements in artillery was the progressive lightening and strengthening of carriages.



Firing Hand Mortars

The firer must light the fuse before loading the grenade. Firing is the same as for any other muzzle-loader. Fuse time is as with hand grenades. Time of flight is always less than one second. An additional problem with grenade launchers is that in the event of a misfire, the firer has a live grenade - *with the fuse burning* - stuck in his weapon.

The firer can unload the launcher by turning it upside down and dumping the grenade, if it does not explode first. This requires a DX roll. If successful, it leaves a live grenade on the ground beside the firer. He can attempt to extinguish the fuse by submerging the grenade or the entire weapon in water, if enough water is handy. Roll against Black Powder Weapons skill to determine success. The firer can throw the whole weapon as far as strength will permit. Add 1 point to concussion damage (because the propelling charge also explodes) and 2 points to fragmentation damage (for the fragments of the gun) for a bore explosion.

Grenade Launcher Cups

Cup grenade launchers are attached to the muzzle of an ordinary gun. Most are made for military muskets. They have a notch that mates to a lug on the barrel to keep the launcher in place when the gun is fired. Ordinary hand grenades are launched from the cup, using a blank charge. A grenade launcher cup for a military-issue weapon weighs one pound and costs \$1. A grenade launcher for a non-issue weapon is a specially commissioned item. Only an armourer with the Black Powder Weapons specialization can make one. It takes one day, and the price must be negotiated. Fast-Talk will help.

Rodded Grenades

Another kind of explosive is a *rodded grenade*. It can be fired from any smooth-bore shoulder gun. The rod is hollow, and filled with an incendiary compound to serve as a fuse. The rod is fitted down the barrel, and the gun fired - with a blank charge, of course! If all goes well, the powder charge both propels and ignites the grenade. Rodded grenades cost \$10 apiece.

Firing Rodded or Cup-Launched Grenades

Weapon stats for rodded or cup-launched grenades are different than for the same weapon with ball. Damage, as a projectile, is 1d. Explosive damage is normal for a TL4/5 grenade.

Half-damage range is meaningless for a launched grenade; maximum range is 100. Accuracy is 2; Snap Shot is 10. For hand-mortars, Snap Shot is 15.

A critical failure of a grenade firing attempt requires a roll on the *Critical Miss Table*.

A rodded grenade can be picked up and thrown, if it does not explode - but the fuse cannot be extinguished. On a misfire of the launching weapon, the fuse of a rodded grenade does not ignite.

Grenades for a cup launcher must be lit before firing, as with a hand mortar. In the event of a misfire, a grenade in a cup launcher is not stuck in the barrel. It is just resting on the cup.

Heavy Weapons Bombards (pre-1500)

One common name for early (TL3) gunpowder artillery weapons was *bombard*. They varied in size from city-smashing monsters that fired half-ton stone balls, to pieces little bigger than handgonnes. For most purposes they can be treated as cannon (see below), but there were some significant differences.

Bombards were not provided with proper field carriages; the invention of the carriage was the major change from bombard to cannon. Heavy defensive guns were

permanently mounted on fortifications; siege guns were dragged into position, then mounted on timber sleds. A big gun in position was basically immobile and could make only the smallest changes in aim. It can fire only at targets that are already in front of the muzzle. Big siege guns take at least a full day to emplace. They are moved by dragging (see p. B89 for dragging rules).

Light bombards were frequently mounted on improvised carriages; the guns were simply tied, nailed or bolted to something like a farmer's cart. This worked only for light guns with light recoil. Maximum is a 3-inch bore (firing a cast-iron ball of 3 pounds or a stone ball of 1 pound) doing 6dx3 damage.

Bombards did not come in standardized types and sizes; each was a law unto itself. They may be either breech- or muzzle-loading. Breech-loaders are faster to load and cheaper to make, but burst more often. The gunners and armourers who dealt with these weapons were widely believed to be agents of the Devil. GMs should treat them and their dreadful tools as barely controllable forces of nature, not as ordinary weapons. The gunners themselves had only the shakiest understanding of what they were doing. Any bombard has a 50% chance of misfiring with every shot (10 or better on three dice). On any 16 it has a 1/6 chance of bursting and a 5/6 chance of being permanently put out of action. Breech loaders have a 1/3 chance of bursting. A burst bombard does damage according to the weight of the charge, which is 1/2 the weight of the (cast-iron) shot. See *Explosives* pp. 22-25, and *Lead, Iron and Stone*, p. 41, to compute this.

Cannon

The great change from TL3 *bombard* to TL4 *cannon* was the provision of functional field carriages. A field carriage consisted of wheels, for the gun to roll on; a trail, the solid stock for the rear of the gun to rest on; and a limber, two wheels and an axle with harness. The limber was fastened to the horses and the gun was attached to the limber. (Limbering up, in the artillery, had nothing to do with stretching the muscles. It meant hooking up the guns to move.) Artillery with proper field carriages could move with the armies, and be prepared to fire in minutes rather than in days.

The second most visible change was the almost complete disappearance of the breech-loading cannon. Breech-loading guns had never been very satisfactory. They were inefficient at best and positively dangerous at worst. With the development and wide spread of casting techniques, breech-loaders almost vanished. After about 1575, most gunners could spend a lifetime at their trade and never have to serve a breech-loader.

Artillery Recoil

Field carriages bring the recoil problem more to the fore than was the case with bombards. A field gun recoils 6 to 12 feet every time it is fired. Firing positions have to be selected to allow for recoil. The crew has to reposition and relay the gun after each shot. The choice is to move the gun forward after each recoil or to move the crew back after each shot. Careless gunners frequently get themselves crushed by their own gun.

Fortifications have to be designed with firing platforms that allow for the guns to recoil. Military engineers are busy for this whole period. Designing and building, redesigning and rebuilding of fortifications take up a major share of the budget of every state. Characters with Engineer skill may find lucrative employment. On the other hand, anyone in the wrong place at the wrong time may be press-ganged into construction crews.

Gun Crews

Cannon are crew-served weapons. Only a highly trained and disciplined crew can manage the complex series of actions necessary to load and fire a muzzle-loading gun. All of the activities of the crew have to be done at high speed, and in exactly the correct sequence. Any deviation from procedure is at least costly in time. At worst it can blow up the piece and the men serving it.

ENGINEER AND MASTER GUNNER

The years from 1450 to 1700 were profitable ones for the military expert. The weapons, tactics and fortifications of the entire world changed. New walls, new guns and new armies needed training and talents of a new kind. Until after 1600, engineer and gunner were more often than not the same man.

A good engineer or gunner was welcome anywhere. The guns that Mohammed the Second used against Constantinople were cast by a Hungarian master gunner. The coastal fortifications built by Henry the Eighth of England were designed by an Italian; the guns that armed them were cast by Flemings. Before 1600, most military engineers and gunners were hired civilian specialists.

A military engineer was expected to design and boss the construction of fortifications, cast cannon, manufacture powder, plan and dig mines, conduct sieges, organize logistics and put on a good fireworks display for the royal birthday party. (Or paint portraits, write biblical concordances, distill brandy and teach chess; it was not an age for over-specialization!) In return, he was well-paid, given high status (Status 2, equivalent to a knight or great captain) and allowed certain perquisites. Usually he had a legal monopoly on gunpowder production and sales. He had a right to any captured guns, and to the bells of any captured town (for use in casting new bronze cannon). Gunners of the Austrian Army got bell-money, a bonus for any town captured, until the mid-19th century.

The job is excellent for adventurers. It gives a reason to go almost anywhere, meet almost anyone, and carry almost any piece of equipment. It does have its hazards: combat, political intrigue, faulty machinery. But without danger, there is no adventure.

For TL4, Military Engineer/Master Gunner is a free-lance Comfortable Job. The prerequisites, all TL4, are Engineer (Military)-15, Gunner-15, Armoury-15, Demolition-15. Monthly salary is equal to that of a high-ranking captain. On a critical failure of his job success roll, he is dismissed from his job and must make a Fast-Talk roll to avoid prison. (Monarchs were reluctant to turn loose a good engineer/gunner; he might go to work for the enemy.) On a critical success, he gets a big share of loot, collects a profitable bribe for army contracts, or sells gunpowder and writes it off as weather-spoiled. This gives him five times his standard monthly pay.

RIBAUDEQUINS

A special type of “heavy weapon” was the *ribaudequin* or *ribauld*. This consisted of up to 50 handgones mounted on a cart and arranged to fire with one application of a match or iron. The ribaudequin was excellent for the defense of bridges and gates, and would be effective against large monsters as well, if one could get them to hold still.

Roll against Black Powder Weapons skill to see if the ribaudequin fires. On a critical success, *one* of the shots is a critical hit. Roll to hit separately for each barrel if the ribaudequin fires; a malfunction or critical failure then applies only to that barrel. All the barrels of a ribaudequin simply fire straight forward into the hex to their front. Anything in the line of fire is attacked at 9 or at the number that a single unaimed shot into that hex would require to hit, whichever is worse.



MOVING CANNON

Guns or howitzers on field carriages were horse-drawn. The usual team for a field-piece was six horses. A six-horse team and gun is about 20 hexes long.

A marching gun team, at the walk, moves two hexes per turn. At a trot, gun and team move five hexes per turn. At the gallop, movement is 10 hexes per turn. To turn completely around, at a walk, the gun and team has a turn radius of 10 hexes.

A gun team can move at a gallop, but this is very dangerous, requiring the driver to make a Teamster skill roll. A failure - a stumbling horse or an irregularity in the ground - can spill the gun. This results in crippled or dead horses and men, and probably a damaged gun. The gallop is also enormously fatiguing. A team can gallop for only 5 minutes, for each minute longer than that, roll against the HT-1 of each horse. On a failure, the horse falls, dead or crippled, and spills the gun.

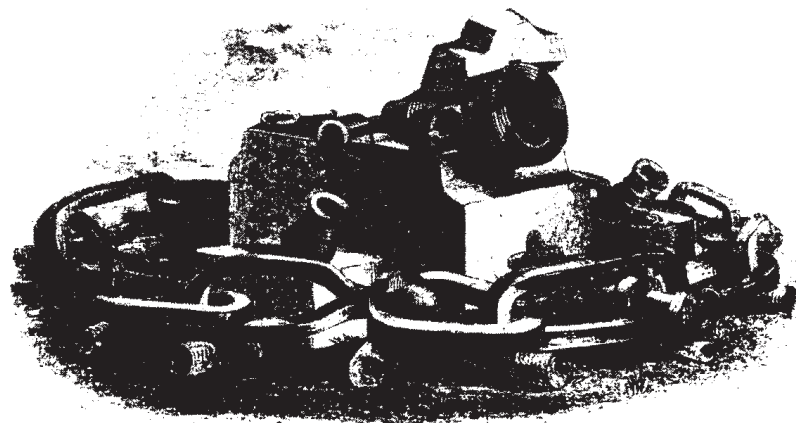

The critical members of the crew are the Gun Captain and the Gun Layer.

The Gun Captain is in overall charge of the gun. He is responsible for training the crew and organizing the operation of the gun in battle. He needs Leadership and Gunner skills.

The Gun Layer actually points the gun at the enemy. In an age of naked eye and very crude sights, the ability of the Gun Layer is the most important factor in accurate shooting. He needs Gunner skill.

Artillery Cartridges

Some time around the 1630s, cartridges for artillery came into general use. The cartridge is a cloth bag containing one round of powder and shot. Cartridges make loading both faster and safer, but add one chore to the loading process. In addition to wiping the gun down with water between shots, to quench any sparks and clean the fouling, the crew must use a worm to pull the unburned pieces of cartridge bag from the chamber.

Artillery Rate of Fire

Rate of fire for a particular weapon will be found in the appropriate *Weapon Table*. (RoF is for a full strength, fresh, trained crew.)

Loading

The success rolls for loading a cannon are usually against the Gunner skill of the Gun Captain. (Regardless of title, the Gun Captain is the one who gives the orders on a particular gun.) The Gun Captain's skill is modified by the number, state of training and fatigue of his crew. Full crew strength required for each cannon is found in the *Weapon Table*. The modifiers are cumulative.

Given enough time, success is effectively assured. Each complete multiple of RoF, from 2 to 4, is +2 to a loading attempt. Each additional multiple is +1 to loading, up to a maximum effective skill of 16. (If the chance of not loading successfully is of no game importance, the GM should just allow the gun to be loaded when it needs to be fired.)

At the end of whatever time the Gun Captain has chosen to allow for loading, roll against his Gunner skill with all modifiers. A critical success is an exceptionally good load: +3 to hit with that load for a natural 3, +1 to hit for any other critical success. A success is a loaded cannon. A failure requires more loading time: 5 seconds x number by which the roll was missed. (Roll again at that time.) A critical failure puts the gun out of action until it is repaired by an armourer.

Fast loading is an option. At any time after 1/2 RoF, roll against Gunner skill minus the number of seconds remaining until RoF time. Any failure at a fast loading attempt is a critical failure.

Cannon Crew Skill Modifiers TL4/5

The modifiers on this table affect both the Gun Captain's skill in loading the gun, and the Gun Layer's skill in firing it.

Gun Crew Strength	Modifier
Full Strength (3/4 to equal/greater than full crew)	0
Half Strength (1/2 to 3/4 full crew)	-2
Below Half (but more than one man)	-4
One Man	-8
Crew Training (Gunner skill)	Modifier
Superbly Trained (crew average 16+)	+4
Well Trained (crew average 14+)	+1
Trained (crew average 11+)	0
Poorly Trained (crew average 8+)	-2
Untrained (crew average 7-)	-6
Crew Fatigue	Modifier
Fresh Crew (average modified ST 10+)	0
Tired Crew (average modified ST 9-)	-2

Key Crew Familiarity

If either the Gun Captain or the Gun Layer is not familiar with the individual weapon being fired, -2. If both are unfamiliar, -3.

Laying the Gun

Actually pointing the gun so as to hit the target is the job of the Gun Layer. Through all of TL4 and most of TL5, his options are severely limited. The movement of the gun, on carriage, either laterally (traverse), or vertically (elevation), is limited to a few degrees. Even those few degrees require that the crew pry the gun around with levers called *handspikes*. (Handspikes can also be used as hand weapons, counting as a small mace.) Any larger movement requires shifting the entire carriage. Moving the gun to point it at the target is called *training the gun*, not to be confused with training the crew.

Moving a gun on its carriage is the same as moving a load on a 2-wheeled cart. The most that can be moved, on hard, reasonably level ground, is 300 lbs. per ST point of the crew with maximum, fatiguing effort, or 200 lbs. per ST point with normal hard work. See p. B134.

RoF includes time to lay the gun on target with a full, trained and fresh crew. It does take a minimum amount of simple brute strength to train a cannon. Check the combined ST of the crew on the following table. The modifier is applied to the Gunner skill of whoever fires.

Alternatively, a crew of low ST can take more time to lay the gun, and fire without a skill penalty.

ST to Train a Gun

Gun size	Combined ST	Skill penalty	Time penalty
12-pounder or less	less than 20	-1	50% more time
Over 12, to 24-pounder	less than 30	-1	50% more time
Over 24, to 32-pounder	less than 50	-2	100% more time
Over 32, to 64-pounder	less than 100	-4	100% more time
Over 64-pounder	less than 150	-6	100% more time

The above modifiers are cumulative: add them together. For example, a 32-pounder trained by a crew with a ST of less than 30 is -3, or 150% more time. If the crew has ST less than 20, it is -4 to skill, or 200% more time.

STARTING FIRES

The most common method for TL4 and most of TL5 is to use flint and steel and a tinderbox. Cost is \$2. Roll against DX to strike a light in one second in dry conditions. A failure just means no light, try again; a critical failure means you drop one or more of the components and have to pick them up before trying again. DX is -1 in light rain or snow, -2 in moderate rain, -4 in heavy rain or blowing spray. This should only be rolled out if the presence or absence of fire is critical to the game situation; in most cases just let it burn. Rolls can be against Survival skill rather than DX; one part of almost any survival-training course is fire-starting.

The first successful strike-anywhere friction matches (called "lucifers") became available about 1830. Starting a fire with a match is usually automatic. GMs may require a roll against DX, Survival, Demolition or a professional skill in certain critical circumstances (lighting the fuse to the mine with the last match, starting the life-saving fire in a blizzard, lighting the signal fire before the plane is out of sight, as examples).

A fire-starting method that could have been available as early as TL3, but was *not* developed (on this Earth) was the piston fire-starter. This is a chamber with space for tinder and a tightly fitted piston. Compressing the air in the chamber with the piston produces enough heat to ignite the tinder, which is dumped on the fuel to start the fire. Alien planets and alternate worlds at TL4 may well have piston fire-starters. For game purposes, treat them as matches.

Anyone with a gun can start a fire even with wet wood. Sprinkle some powder on the wood, then fire a shot or a blank charge through it. Firing the gun takes the same roll as any other shot, but only a critical miss counts as a miss.

Higher-Tech Firestarting

At TL6 and TL7 there are several almost infallible ways to start a fire. Igniting a magnesium flare, exploding a thermite grenade or applying a match to a gasoline-soaked rag will work almost every time. The GM should only require any kind of fire-starting roll in exceptional circumstances; survival or demolition scenarios, for instance.

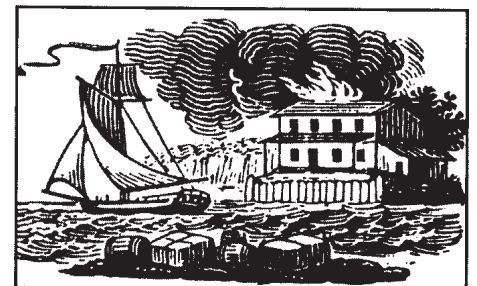

TL4 STARTING WEALTH

For campaigns set on Earth during the TL4 period, starting wealth is \$1,000. This represents 1,000 British shillings, that is, 50 pounds sterling. This is about 2,000% inflation compared to the TL3 era. All through this age, from 1450 to 1700, the amount of precious metal in Europe increased. Some came from deeper mines, some from increased trade; a lot came from the Americas. The overall effect was massive inflation.

TL4 TOOL KIT

Candles

Candles are available at TL2 and above. At TL4 and 5 they are available in two styles (taper and pillar) and two qualities (tallow and wax). Tapers are one inch or less in diameter and weigh 1/4 pound for a 12-inch length. Pillars are three or more inches in diameter. They weigh 10 times as much as a taper of equivalent length, and cost 30 times as much. (They are more expensive to make since they have to be molded rather than dipped.) Wax candles cost 10 times as much as tallow. Tallow candles produce more smoke than wax and they stink and sputter loudly as they burn. The sputtering of a tallow candle is audible within 10 yards with a Hearing roll, the smell at 20 with a Smell roll. Wax candles are -3 to either roll unless perfumed. (Either smell or sound can be overwhelmed by ambient noise or odor, of course.)

One candle produces enough light to read a map or document, or to light a three-yard by three-yard room well enough to distinguish colors.

The burning rate of candles varies. In still air, a wax taper burns one inch in three hours. A pillar candle burns one inch in six hours. Tallow burns twice as fast as wax. Burning rate is doubled in a wind; a wax taper burns one inch in 1.5 hours. A high-enough wind (GM's decision) blows the candle out. A candle-lantern allows still air burning rates even in the wind.

At TL4, a 6-inch-long tallow taper costs \$1. At TL5, six similar candles cost \$1. At TL6 and TL7, only wax candles are available; the 1900 price is six tapers for \$1. At TL6 and TL7, an additional type of candle, the cake candle, is for sale. It is less than 1/4 inch in diameter, burns at 1 inch in 10 minutes and lights only 1/2 the area of a full-sized candle. A dozen cost \$1 in 1900.

Continued on next page . . .

Firing

Once the cannon is loaded and laid, one man can fire it. Usually the roll will be against the Gunner skill of the Gun Layer. Modifiers for an exceptionally successful load, and for training or unfamiliarity (as given in the table above), apply to the skill of the firer.

A success fires the gun and hits; a critical success hits more precisely or does more damage at the GM's option.

The malfunction number for TL4 cannon is 14+. The Immediate Action roll is against the Gunner skill of the Gun Captain, and takes 3d seconds. A success returns the gun to service. A critical success returns the gun to service in two seconds. A failure allows another try. A critical failure puts the gun out of service until repaired by an armorer.

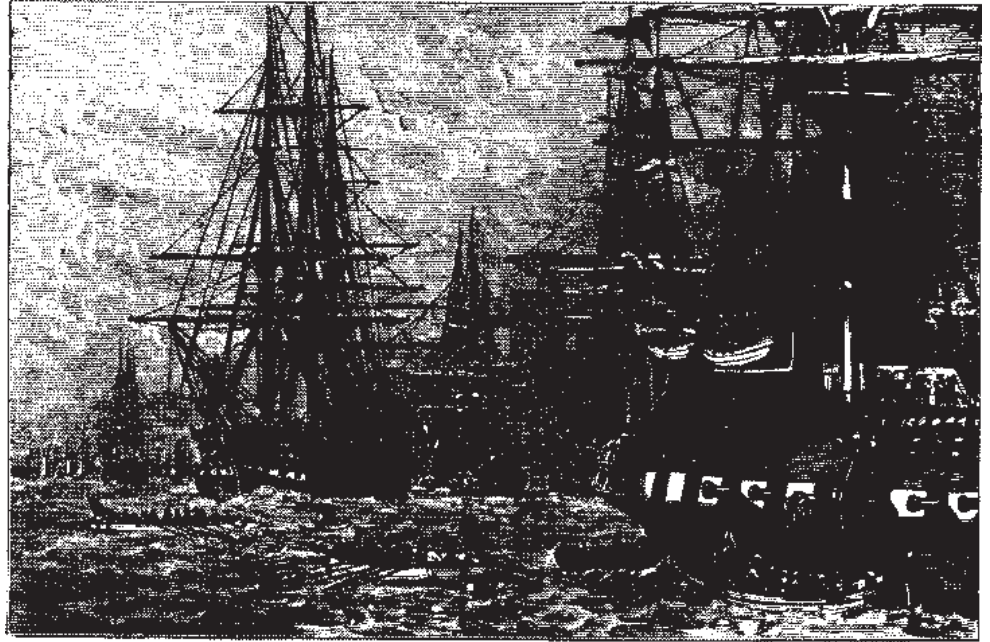

Shipboard Artillery

After 1450, guns on shipboard became common. The first used were relatively small anti-personnel weapons, called at the time *murthering pieces* and later *swivel-guns*. They were usually mounted in high superstructures, called *castles*, at the bow and stern. From there they could sweep the deck of an enemy before boarding, or the deck of their own ship if it was boarded. As artillery improved, bigger guns, designed to attack the fabric of the ship as well as the bodies of the crew, were mounted. By 1600, the normal armament of a warship was a mix of big guns for ship-smashing, and small pieces to directly attack people. After about 1575 almost all naval guns were muzzle-loaders. Any breech-loader found at sea was a dangerous antique.

The first naval guns were rigidly mounted. Heavy guns were on the deck; lighter ones were on swivels, usually on the rail. Recoil was absorbed directly by the ship. This worked well enough for breech-loaders, but made it very difficult to load muzzle-loaders. After 1520, heavy naval guns were on *truck carriages* - heavy timber frames with small wheels. Recoil was controlled by *breeching tackle*, heavy ropes that permitted only limited travel. Guns were *run out*, through ports or over the *gun-wales*, for each shot. Recoil drove the gun back for reloading; when it was loaded the ropes were used to run it up again for firing. Running out the guns was recognized as a sign of readiness to fight, almost the equivalent of opening fire.

Howitzers

Howitzers were a special form of cannon, with a short barrel, a chamber of less than bore diameter, and a thinner-walled barrel. Howitzers weighed less than guns of comparable bore. Artillery batteries were frequently mixed, with guns of one size, and howitzers of a larger size. For instance, a battery might have four six-pounder guns and two twelve-pounder howitzers. Howitzers were particularly well adapted for shell firing because of their lower muzzle velocity.

Mortars

Mortars were high-angle weapons intended to throw an explosive shell over an intervening obstacle, such as a wall. Mortars varied from hand-grenade size to big-bore siege weapons. Normally, they were of fixed elevation and traverse, and were not mounted on field carriages. Like bombardiers, they were transported to the battlefield on wagons and set up so that the recoil was directed into the ground. Range was changed on mortars by adjusting the powder charge.

Unloading a Cannon

Unloading a muzzle-loading cannon is drawing a charge, just as with a handgun (see sidebar, p. 37). A wire loop rather than a worm is used to withdraw the projectile. Worms don't bite very well on stone or cast iron.

Unloading a muzzle-loader takes a Gunner -1 or Armoury -2 roll. A non-critical failure adds 3d seconds to unloading time. A critical failure disables the gun for 3d hours. For muzzle-loaders up to five-inch bore, time required to draw the charge is two minutes. Add 10 seconds for each inch of bore above five inches.

For breech-loaders, unloading is much simpler. Loosen and withdraw the wedge and lift out the chamber. This takes three seconds.

Explosives and Pyrotechnics

The only explosive used at TL4 was gunpowder. Throughout this period, experimenters were so busy learning to use it, few other possibilities were explored.

Several varieties of incendiary were known. Compositions including pitch, sulfur, naphtha and nitrates were used in warfare. Preparing an incendiary requires a roll against Demolition/TL4. Time is up to the GM. It depends on availability of materials, weather conditions and so on. Igniting an incendiary at the right time and place takes a Gunner/TL4 or Demolition/TL4 roll. Incendiary effect depends on the flammability of the target (see sidebar, p. 23).

Shells

Shells, hollow projectiles filled with gunpowder and fused, were first tried at TL3. By TL4, they were relatively reliable. Any cannon can fire a shell instead of solid shot.

Preparing a shell requires Demolition skill. First, a hollow bronze or iron sphere, with a hole for loading and to take the fuse, must be available. (Originally, all shells were called *granadoes*, because they looked like pomegranates. A TL4 development was a shell thrown by hand, hence *hand granadoe*, hence hand grenade.)

An empty shell costs \$2 per pound. Weight, of course, depends on size. A filled shell weighs about 10% less than a ball for the same gun. The powder charge is 10% of the weight of the entire shell. The artificer fills the shell with gunpowder, and fuses it with a length of match. This takes five minutes and a successful Gunner or Demolition skill roll. Then the shell must be loaded into the cannon. Loading is as for any other shot.

TL4 TOOL KIT (Continued)

Surveying Instruments

A set typically includes compass, transit, chains, flags, plotting boards and drawing instruments. Cost is \$300; weight is 300 lbs. (most of this is the weight of the surveying chains). A surveying crew is usually three or four men. Starting from a known point, in one day, a crew can locate any point within five miles to an accuracy of one inch. Surveyors are in constant demand for road, bridge and fortress construction. In the new empires they are needed to survey land grants.

Surveying parties are an excellent cover for espionage. On the other hand, one of a spy's jobs is frequently surveying. Best is to make the cover and the mission the same, by surveying for the enemy!

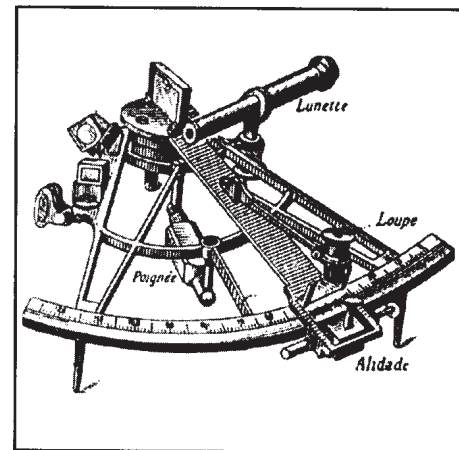

Navigating Instruments

These include compass, sextant (or its precursors, cross-staff and astrolabe), dividers, lead line, log (to toss overboard to figure speed), and sand-glass (to measure time). An attempt to navigate without proper instruments is at a -4; you can do without everything except lead-line and log, and those can be improvised.

The cost of a set of ordinary navigating instruments, *without* telescope (see below) is \$100; weight is 30 lbs., including chart books. \$500 will buy a set of fine, extra-precise instruments, suitable for wide-ranging nautical survey. These give +1 to any Navigation roll.

Continued on next page . . .

TL4 TOOL KIT (Continued)

Surgical Kit

Lancets, bone saw, scalpels, arrowhead/bullet remover, cautery, needles and gut, tooth-drawing pincers, all in a leather case. Cost \$100. Weight 2 lbs., +1 to a Surgery/TL4 roll or a First Aid roll if simple surgery is required.

Telescope

A typical telescope weighs five pounds, and is three feet long when extended. Magnification is eight power - it increases the apparent size of objects by 8. It costs \$100. It can be used as a light club, and is fairly well balanced as a weapon, but will never again be useful as a telescope.

A telescope is a symbol of authority for military officers; portraits of officers of the period, especially naval officers, usually show the "spyglass." (As, in the World Wars, the officers had the binoculars.)

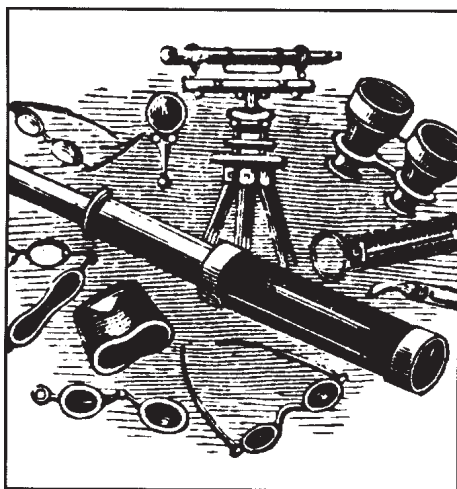

Logarithmic Table

Napier developed the first "log tables" in the mid-17th century; they were on sale by the end of the century. Use of such tables halves the time required to perform complex arithmetical procedures. A book of logarithms might cost \$50 in 1700 (far more than an ordinary book), and weigh a half-pound.

Lighting the Fuse

Now comes the tricky part. There are two methods of lighting the fuse. The first is to load the shell with the fuse toward the muzzle, reach down the barrel with a match, and light it.

Lighting the fuse takes one second and a successful Gunner roll. A failure is an unlit fuse. Another attempt to light the fuse takes another second and another roll. A critical failure has a 1/6 chance of exploding immediately. If the fuse lights, *quickly* fire the cannon. This requires another Gunner roll. In the event of a misfire, run away *very fast*, because the fuse on the shell is still burning. Shortly the shell will go off, also detonating the charge in the gun. This bursts the gun and does twice normal shell damage.

How long is shortly? TL4 fuses are somewhat uncertain. Since practical time of flight for any TL4 shell cannot be much over 10 seconds, roll against the Armoury skill of the one who prepared the shell each second after the misfire until 10 seconds elapse or an explosion occurs (an explosion occurs only on a critical miss). If no explosion happens in 10 seconds, give thanks to Saint Barbara, the patron saint of gunners, and face the problem of unloading.

There is a second method of igniting the fuse. Load the shell, fire the gun and hope that the blast of flame from the propellant will light it. (It is not necessary to load the shell fuse-down; the wash of flame around the shell is enough to ignite the fuse.) Firing the gun requires a successful Gunner roll. To determine if the fuse lights, roll against Armoury -3 for the one who prepared the shell. A critical failure has a 1/6 chance of bursting immediately. A misfire does not light the fuse on the shell.

Fuse Action

Most of the time the cannon fires and the shell heads toward the target - unless it prematurely ignites in the tube! But the fuse is still uncertain. There are three possibilities. The first is that the fuse will act too soon, a *premature detonation*. The second is that the fuse will not act at all, a *dud*. The third is that the fuse will act late, a *delayed detonation*.

Premature Detonation

When the cannon fires, roll against the Armoury/TL4 skill of the one who prepared the shell. On a successful roll, the shell does not premature. On a critical failure, the shell detonates in the firing hex. On any other failure, the shell detonates in flight on the way to the target.

Dud

If the shell does not premature, roll once more against Armoury/TL4. A failure is a dud. The shell does damage as a ball, but does not explode when it hits the target.

Delayed Detonation

In the event of a dud, roll one more time, against Armoury -3. A failure is a real dud, no explosion. A success is an explosion 2d-1 seconds after impact (GM rolls). An unexploded shell can be defused, with an Armoury -3 or Gunner -4 roll, by anyone who can reach it in time.

Unloading a Shell

If the cannon is not fired (or fails to fire), but the shell's own fuse was lit, unloading the shell is a hazardous job. As soon as the shell is in fresh air, the fuse may flare up and start burning again.

Roll 1 die. A 6 is an immediate explosion of the shell. On a 3 or below, the fuse does not flare. On a 4 or 5, the fuse begins to burn, and the shell explodes in 1d seconds. A successful roll against Armoury-3 or Gunner-4 allows the fuse to be put out. A failed roll is an explosion.

Pouring 1 gallon of water per inch of bore size down the bore, and waiting 30 minutes, will deactivate the shell and allow safe unloading.

Petards

A petard was a very brave engineer's way of opening a gate. It consisted of a charge of powder attached to a heavy spike. The engineer ran up to the gate, spiked the petard to it and lit the fuse. A premature burst resulted in an engineer "hoist by his own petard," probably fatally.

A successful Demolition roll is necessary to make a petard; the GM makes the roll. A failure will not be apparent until it is ignited. A critical failure means it explodes as soon as ignited! On any other failure, roll one die:

1 or 2: Petard fails to ignite.

3 or 4: Petard is too weak to do the job properly.

5 or 6: Petard is too strong. Depending on circumstances, this may be no problem at all, or it may be fatal.

To place and ignite a petard takes a successful Demolition roll at -2. On a failed roll (assuming the petard was good) the petard goes off in only 2d-1 seconds (GM rolls). On a critical failure it explodes immediately, or is ruined and will not explode at all; the GM may flip a coin.

Mines

Gunpowder seems to have first been used in mines in the Turkish wars, sometime in the early 16th century. The technique is to drive a tunnel under the enemy wall. In a chamber under the wall a large quantity of gunpowder is placed. The gunpowder is ignited and hopefully blows a breach in the wall. A successful Engineer (Combat or Mining) roll is necessary to plan a mine. Treat a failed roll as for a petard (above.) The amount of explosive necessary is covered in *Explosive Destruction of Material* on p. 26.

Placing and igniting the charge takes a successful Demolition roll. On a failed roll, the mine goes off early (GM decides how early). On a critical failure, the mine goes off with the engineer in it.

Fougasses

Fougasses were pots, or simply pits in the earth, filled with powder, and with scrap for projectiles. They were usually used for the defense of breaches in a fortification. The fougasses were fused to explode when the attackers were in the breach. Placing and igniting fougasses uses Demolition skill. A pot fougasse is treated as a ground-bursting explosion throwing extra fragments (see *Explosives*, pp. 22-25). The amount of extra damage depends on what was available when the fougasse was built . . . at least 2 dice of fragment damage for every die of concussion damage and between +1 and +3 damage to each die of fragment damage for extraordinarily ingenious fillings.

A pit fougasse also throws extra fragments, but the explosion is directed in an upward cone, and will have little effect except on those unlucky enough to be standing in or adjacent to the fougasse hex.

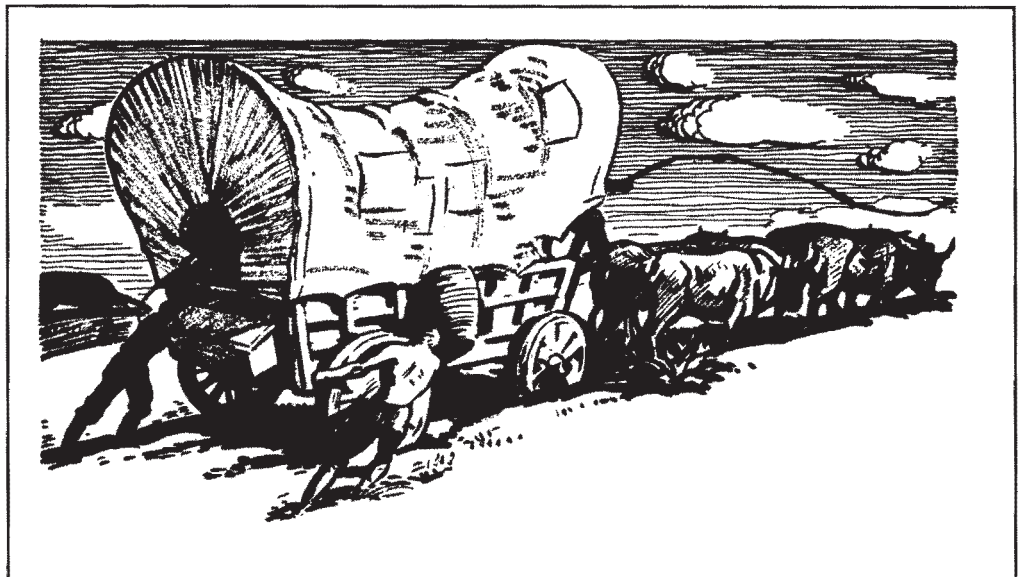

DRAFT ANIMALS

In addition to horses (see p. B144), several other draft animals were important at some times and places during Earth's TL4. GMs creating relatively primitive new worlds should invent interesting beasts of burden; the PCs will spend a lot of time with them!

Oxen

Oxen are found any place cattle are; an ox is a bull, gelded young. Basic ox stats are on p. B140. Oxen are patient and strong, but even slower for a long haul than the Speed of 8 suggests. They can only work eight hours a day; they need to spend eight grazing and eight digesting. One ox needs 100 lbs. of fodder and six gallons of water per day. Oxen work well in harness; Teamster rolls are at +2 when driving an ox team.

Reindeer

Reindeer are native to Arctic Eurasia and North America. They have been domesticated from prehistoric times in Eurasia and since the late 19th century in America. They can subsist in territory far too cold and sparse of forage for horses. They can be ridden, driven or packed. They are not handicapped by movement in snow, and not as much as horses in mud. Reindeer have normal movement in snow and -10% in mud.

Dogs

Dogs are found wherever man goes. Basic dog stats are on p. B142. Dogs can be trained to carry a backpack or to draw a cart, but their most effective transport use is as sled dogs. Dogs do not work well as a draft team; Teamster rolls are at -2 always, and achieving *familiarity* with dog-driving takes two weeks, not the usual eight hours.

MEDICINE

The First Aid and Medical Care rules on p. B127-128 give the chances for recovering from wounds or illness. Medicine was still primitive. There was no known treatment for disease or infection.

Surgery was limited to amputation, bonesetting, removing missiles from limbs and cauterizing wounds - that is, pressing a red-hot iron to the severed blood vessels to stop the bleeding. There were no surgical procedures available for the brain or for the body cavity.

There was still no concept of antisepsis, and no anesthesia. Opium was known, but only as an analgesic (painkiller). Most of the "medicines" available were ineffective; some were poisonous.

The best thing to do at TL4 is not get sick or hurt. Rapid Healing, Immunity to Disease and High Pain Threshold are excellent advantages for an adventurer.

Carcases

Carcases were incendiary projectiles. The most common were cageworks of iron straps filled with pitch and sulfur. They were loaded in guns or mortars and fired in the hope of setting fire to the enemy works. By the mid-17th century carcasses were pretty much out of use. They didn't set fires any better than gunpowder-filled shells, and they were harder to make and transport. Theoretically, they could be used for illumination, but usually it was easier just to fire a few shells and set something on fire to illuminate the area. Until the very end of muzzle-loading artillery, one of the marks of a trained officer was a knowledge of how to make carcasses. Every once in a while someone would employ one, out of respect for tradition. Making a carcass that works uses Demolition skill (at -2 difficulty). Loading and firing one uses Gunner skill, again at -2.

Armor

All of the medieval-style armor available at TL3 (p. B210) can still be found at TL4. But armor tends to be worn less and less, especially by foot soldiers, as the period passes. This is not because armor is ineffective - protection against the smallarms of the period is always possible. It's because armor is expensive and encumbering. Armies spend most of their time marching, not fighting, and don't like to wear armor. Governments have always found it cheaper to raise more soldiers than to keep the ones they have alive.

Cover

The best armor for a firefight is cover. The heaviest musket ball will be stopped by three feet of dirt, one foot of hard wood or a half-foot of stone.

The second choice is concealment; a target that can't be seen is hard to hit.

The third choice is to reduce the size of the target by crouching, kneeling or lying down.

Best is to combine all three . . . lie down and hide behind something solid.

Cover Value of Some Common Materials

Material	PD	DR per inch
Loose Dirt	0	1/7
Hard-Packed Dirt	0	1/4
Moist Sand	0	1/4
Gravel	1	1/3
Soft Wood	0	1/3
Hard Wood	1	1/2
Brick	3/4	
Stone	2	1

To determine DR of a fortification, multiply the cover value per inch times the *square* of the thickness in inches and round up (benefit to the defense). If the damage, modified by bullet-type for penetration, is half or less of the DR, the bullet glances off of hard materials, or is buried in soft materials, and does no damage to the fortification.



Detection

Early TL4 was still low-tech in detection systems. Nothing had fundamentally improved since the Romans were warned of Etruscan infiltrators by geese cackling in the night. (Geese are still used in the 20th century. The U.S. Army uses them as an alarm system on nuclear-weapons storage sites.)

This period saw the development of the science of optics. The telescope was invented about 1600 and the microscope about 1630. By 1700, the telescope was in common use on both land and sea. See sidebar, p. 52, for costs.

Magnifying lenses had been known since classical times. Any time traveler, even one without Engineer skill, can probably contrive a telescope even before TL4, if he can find or make lenses.

Watch Animals

Any farm and most city houses would have some animals in residence. Most pets and livestock make noise, which can alert the residents, if they detect a stranger. Anyone attempting to come within 20 yards of any strange domestic animal must make a Stealth or Animal Handling roll. A critical success allows free passage with no alert by the animal, at any distance from the animal. A success allows approach up to 1 yard, at which point another roll must be made. A failure causes the animal to give an alarm, as loudly as it can. On a critical failure the animal both gives the alarm and attacks the stranger.

Watch Geese

A flock of watch geese numbers six to 12. More important than their attack is their alert. Any stranger coming within 20 yards will cause the entire flock to hiss and cackle very noisily. Stealth against six or more geese is at -6, at -3 against 2-5 geese and at -1 against one goose. Geese cannot be bribed or distracted by food. In three days, with a roll against Animal Handling, geese can be trained to accompany a patrol around a site. Geese travel well on shipboard or wagon, or even pack animal, but not on their own feet. A flock of domestic geese travels only about one mile per hour and a maximum of five miles per day.

Watchdogs

For basic dog information, see p. B142. Watchdogs operate well either alone or in groups. They can readily be trained to give either vocal or silent alarms. Animal training is covered on p. B143. Common skills taught to watch dogs include: take food only from the handler, obey commands only from the handler, attack, hold, or kill on command, and silence on command. A fully trained watchdog costs at least 10% of starting wealth in any TL4 to 7 background. A watchdog will alert if any stranger comes within 20 yards downwind or 100 yards upwind. Stealth is at -2 against a trained watchdog.

Canaries

A canary has ST 0, DX 15, IQ 2, HT 1/10. What they do well is die. In any situation involving slowly increasing levels of toxic air, the canary goes unconscious before a human can even detect the presence of the toxin. The most common use is in mines. A canary with cage costs \$10.

Inanimate Alarms

A string hung with bells, at tripping height, will give warning of anyone who does not make a Traps, or Vision-4, roll to notice it. One cow bell costs \$10; one copper hawk's bell \$15; one silver hawk's bell \$50. String costs \$1 per 100 feet.

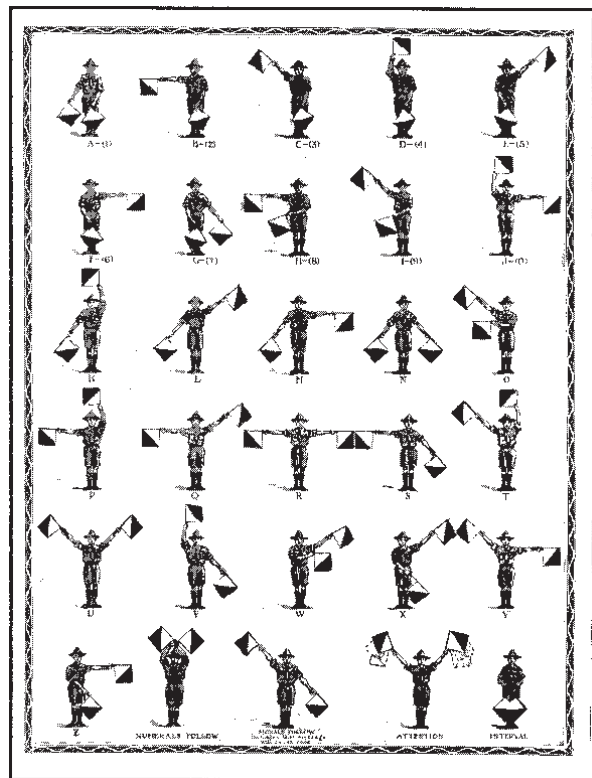

COMMUNICATIONS

At TL4, communication usually still means sending a messenger. Most postal service is still a government monopoly, reserved for official business. Big businesses have their own courier services. Ordinary citizens rely on finding someone reliable who is going that way anyhow. Printing (p. 58) is just beginning to make mass communication possible.

Semaphore and Signal Hoists

Visual signals of many kinds have a long history. The amount of information in any visual signal was limited as long as the signal had to be large enough to be distinguished by the naked eye. Telescopes increased both the range of signaling and the number of elements possible to the signaling system.

Flag Signals

A system of flag signals can be the secret of a small group, or widely distributed (to a whole army, for instance). Hand flags can be read at up to three miles with a telescope, terrain and weather permitting. At night lanterns or torches can be used.

Range can be extended by hoisting flags (lanterns by night) in the rigging of a ship, or on prepared rigging ashore. The flags can be bigger and farther off the ground, so such signals are readable at up to six miles, weather and terrain permitting.

A simple, prearranged signal ("One if by land, and two if by sea . . .") takes no skill to read. It might take a Vision roll to see.

Continued on next page . . .

COMMUNICATIONS

(Continued)

More complex messages require the Semaphore skill. This is a Mental/Easy skill, and is similar to the Telegraphy skill (p. B55). It is slower; it takes more time to manipulate flags than to tap a key. Maximum rate is 1 word per minute per point of skill; absolute maximum is 20 words per minute. Halve the rate for night messages; lanterns and torches are harder to handle and easier to destroy. The determinant in communication is the receiver's speed; if he is sent messages too fast for his skill, the GM should creatively garble the message. ("7 French ships" becomes "70 rented sheep.") Semaphore signals have never been as standardized as International Morse; sender and receiver *must* be operating from the same book!



Carrier Pigeons

Using pigeons as messengers is another technique that may have prehistoric roots. It came into more prominence at TL4 for several reasons. There were more domesticated pigeons. More people could read. Lightweight paper, better inks and pens, and handwriting techniques allowed more words per message (maximum about 100 words in English). Larger political and economic networks demanded messages over greater distance in less time.

Homing pigeons do not have to be trained; returning to their cote is instinctive. A homing pigeon costs \$35 (by contrast, a pigeon to eat costs \$1). Such a pigeon can carry a message 50 miles in a day. Once the bird is released, he is on his own. Roll 3 dice when the bird has had time enough to reach its destination. On a roll below 16, the message arrives. On 16 or above, the message disappears.

Anyone who knows pigeons are being used to carry messages can attempt to intercept them. A successful Falconry roll, if the bird is sighted, can bring it down. He could also try to shoot it down, but it's not an easy target: effectively 6" in size, and moving erratically at up to 60 mph.

Creaking floorboards or stair-treads can be built in by anyone with Carpentry skill. A successful Carpentry roll can make one board or one tread creak, with a noise audible at 10 yards. To identify and bypass such a warning board requires a Traps-2 roll.

Punji pits are holes full of sharp (and sometimes poisoned) stakes. Making a punji pit to trap a normal human foot takes one hour. Detecting and bypassing a punji pit requires a Contest of Skill between the trapper's Traps skill and the victim's Traps skill or Vision. The alarm of a punji pit is the scream of the victim. Roll against Will to avoid screaming; High Pain Threshold gives +3 to this roll. Each punji stake does 1d-3 impaling damage. Stepping in the pit hits 1d stakes. The victim is in danger of tetanus (see sidebar, p. 76).

Transport

There are few innovations in transport at TL4. Most of the changes are improvements in the systems that already exist. The exception is in ocean transport; TL4 sailing ships represent a great advance over earlier ones.

Land

Land transportation at TL4 is powered by the muscles of men or other animals. For most of the world, there is no real improvement over the methods of a thousand years before. Pack animals carry vastly more of the world's cargo than wheels. In Western Europe, roads gradually improve, until by 1700 some are actually as good as those of the Roman Empire . . . "average" roads as described on p. B188.

Wheeled Vehicles

Wheeled vehicles of TL4 are usually better made, more durable and perhaps more comfortable than earlier ones. Partly this is improved design, but mostly it is due to better materials. There is more seasoned wood, more well-tanned leather, and above all, more iron for the builders to work with.

Carriage-making emerges as a trade in its own right, rather than just a form of carpentry. It takes a team of workers to go from raw materials to finished vehicle. Anyone with Engineer (Primitive Machines) can design a carriage that will at least roll. Building it takes Carpenter, Blacksmith and Leatherworking skill. At least 100 man-hours of skilled labor goes into the construction of a four-wheeled carriage, over and above the labor of preparing the materials from raw wood, hides and ore. This is definitely a minimum; a fine coach might have a hundred times as many hours of work invested.

Luxury Transportation

The transportation of the very wealthy and powerful is the *glass coach* . . . that is, a carriage with glass windows. These are almost always custom-built for the owner. They will seat four to six persons inside. Outside will be the driver and one to three servants.

Such a coach can carry six persons and 1,000 pounds of baggage. A team of six horses can draw it at 30 miles an hour for 10 minutes, or for 30 miles in one 10-hour day. Relays of teams can keep it going at 30 miles a day indefinitely.

This is just the vehicle to take a party of adventurers from Paris to Warsaw. (East of Warsaw, sell the coach and ride the horses.)

Water

Improved charts and navigation instruments, and better-trained pilots, made sea travel faster and more reliable. Better sailing rigs allowed ships to sail closer to the wind. For all of this period, the major sea-traveling and sea-fighting machine was



BUILDING A SHIP

A successful roll against Shipbuilding is required to plan a sailing vessel. Construction of a 50- to 100-ton vessel is a task requiring about 2,000 man-hours of labor (see p. B93), at least 500 of which must be by laborers with Carpenter and Blacksmith skill; a Shipbuilder of skill 12 or better must supervise. Another 1,500 hours of unskilled labor, and 500 hours of Carpentry, are required if the timber for construction must be felled. A final roll against Shipbuilding skill will give the GM an idea of just how good the finished ship is. (Full shipyard facilities would give a +3 or so to Shipbuilding rolls.)

This means that a crew of a dozen men, shipwrecked on an island with timber, could build a seaworthy vessel in only *two months* - provided they had the necessary skills and tools, and could salvage the metal fittings and sails from their old ship.

the three-masted, square-rigged ship. The sailing ship could carry more artillery, and carry it farther, than any galley. In commerce the sailing ship could carry more cargo, and carry it without the expense of a shipload of oarsmen.

In narrow waters, the galley survived, for certain applications, until replaced by steam power. For general use, the ability of the sailing ship to travel long distances and carry heavy artillery made it the decisive instrument at sea.

Exploration

The dates for TL4 just about encompass the great age of European exploration. Improved guns, improved ships and improved navigation meant that Europeans could go anywhere in the world that the sea went, and usually they could come back home.

The usual exploratory vessel is considerably smaller than a ship of the line. She will displace less than 100 tons, and possibly less than 50. Crew size will be under 50 and probably under 30. She can be coned into small harbors, over reefs and even well up rivers - anywhere in the world where there is water under her keel. She can be repaired, or if need be rebuilt, with local timber and the supplies carried aboard. She can carry food and water for three to four months, and easily mount four 9-pounder guns - enough firepower to get out of most trouble with a native population. Such a ship - very like Columbus' *Nina* and *Pinta*, for instance - could normally be had for some \$25,000 or be scratch-built (see sidebar). The *Santa Maria* was the next size up . . . a 100-tonner.

Navigation

In 1450, Prince Henry of Portugal established the first formal institution for the study and teaching of navigation, so that fleets could be raised to free Jerusalem from the infidel - not the last time that new technology would be applied to old objectives.

Navigation rolls are required to con a ship across the ocean, and to sail safely in any coastal region. Failures will get the ship lost; critical failures near shoreline can put it aground. Rolls without charts (see below) are at -3 or worse, depending on the difficulty and danger of the ocean in the area.

GMs should make most Navigation rolls; on a failure they have the option of telling the navigator that he is lost, or letting him think (incorrectly) that he knows where he is.

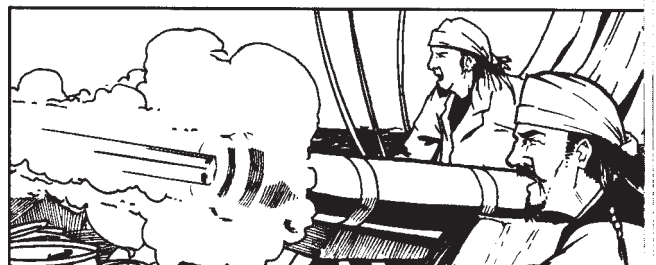

PIRACY AT TL4

This was a great age for piracy. The technology of the time gave an almost indefinite range to ships. A fairly small vessel could mount enormous comparative fire-power. The weapons of the time were more likely to kill opposing crewmen than to sink the ship or spoil the cargo. Speed of communication was no faster than ship speed; a pirate was unlikely to be ambushed. Repairs and resupply did not require a very sophisticated infrastructure; pirates could establish their own bases.

The politics of the time also encouraged piracy. Warring states were usually ready to turn a blind eye to "privateering" attacks on an enemy. An economy that was legally strongly controlled, but in fact very nearly free market, meant very little question as to the origin of goods. Civil servants were expected to augment their salaries by bribery and peculation; business with pirates was only another supplement. Guns and powder were widely available - no questions or end-user certificates to fret about.

Anyone with a ship can turn pirate. Pirate skippers in almost any port are ready to take on a likely hand.

For more about pirates, see *GURPS Swashbucklers*.

PRINTING

The printing press was one of the pivotal developments of TL4. Sometime about the mid-15th century someone, possibly Johann Gutenberg, developed the technique of making multiple copies using movable type. With a hand screw-press of this type one man could turn out 250 impressions, which might be many pages of book or newspaper, in one hour. This meant that one man, with less than a half ton of equipment, could transmit a point of view to thousands of people, if they could read. Before printing, literacy was a luxury. After printing, literacy became a necessity.

The press changed very little for all the period before the mid-19th century. This limited the amount that any one printer could produce, and encouraged diversity of production. Any city and most towns could support at least one printer. As literacy increased, there was a continually increasing demand for newspapers and for job printing (posters, handbills, waybills, pamphlets, flyers, etc.).

One possible job for any adventurer is tramp printer. Anyone who could compose and set up type could find employment; it is an excuse to travel without being branded as a vagrant or ne'er-do-well. The trade lasts well into the opening years of the 20th century.

In familiar waters, a Navigation roll can locate the ship within 10 miles. The seaman uses landmarks, winds, currents, bottom conditions, even the color, smell and taste of the water, to find his way. Even without instruments, a seaman familiar with the area will know the direction and distance to land, on a successful Navigation roll, if he is within 30 miles of the coast. Navigation in unfamiliar waters is more difficult, and dependent on instruments and charts.

A successful Navigation roll at TL4 can locate a ship's *latitude* (position north or south of the equator) within 100 miles anywhere in the world, if the navigator has normal instruments (see sidebar, pp. 51-52). For each point by which the roll is made, the location is more precise by 10 miles, to a minimum uncertainty of 10 miles. A critical success fixes the latitude within 10 miles. A failure means that the navigator does not know his latitude within 100 miles; a critical failure is 300 miles or more wrong.

Longitude (position east or west of an arbitrary line between the poles) is harder to find. Before about 1700, the only method of determining longitude was *dead reckoning*. This meant keeping an accurate, continuous record of how far, and in what direction, the ship traveled. Since the navigator had no accurate gauges for time, speed or direction, it was a little imprecise. The Navigation roll to find longitude by dead reckoning is against the *average* of the skills of all ship's personnel involved in navigation (captain, mates, pilot, master, quartermasters, etc.). There is a -1 penalty for each week since the last landfall at a known and charted point. (This penalty can be increased by the GM for storms, drunken parties and sea battles.) When adjusted skill drops to 3, it stays at 3. A success fixes the longitude within 300 miles; accuracy is 10 miles closer for each point by which the roll was made. A critical success fixes it within 30 miles. A failure is more than 300 miles off; a critical failure is more than 600 miles off.

A critical success on *both* navigation rolls locates the ship within a box 10 miles north-south by 30 miles east-west. A lesser success, or a failure, increases the size of the box. Once located this precisely, the captain then "feels his way," by lead and lookout, if he thinks he is close to shore. The longest practicable lead line is probably 100 fathoms (600 feet). Anything deeper than that is not an immediate problem. A lookout at the highest point of the mast tries to see anything solid before the ship runs into it. Visibility depends on the height of both observer and observed above the water, modified by light and atmospheric conditions. For a very rough calculation, the square root of the sum of the heights of both observer and object above the sea *in feet* is the *farthest* that the object is visible *in miles*. An observer 100 feet above the water could see a 10,000 foot mountain from 100 miles, in perfect light and clear air. GMs penalize the Vision roll for darkness, fog, storm and the condition of the observer.

Charts

Charts showing shorelines, reefs, landmarks, and so on are required to safely navigate any coastal region. Charts of mid-ocean regions are useful because they show prevailing winds and currents.

The cost of a set of charts is \$100 for one geographical area (Great Britain, Scandinavia, North American East Coast, etc.). This assumes that the charts are commercially available at all; often, charts are concealed for commercial or military advantage. A *rutter*, or chartbook, of such secret information is priceless.

Making new charts requires a successful Navigation roll, or series of rolls, and a good deal of time (GM's decision) spent in careful exploration of the area charted. Charts can be sold or traded. An expedition to chart a new area can be an adventure on its own - especially if the area is claimed by a foreign power whose warships will gleefully sink interloping chartmakers.



THE TRIUMPH OF REASON

Tech Level 5

During this period, between 1700 and 1900, man gained enormous understanding and control of the physical universe. By 1900, only the remotest parts of the Earth remained unvisited. Both aerial and undersea vehicles existed. Hard-surfaced, all-weather roads were common in Europe and America. Improved medicine and nutrition had enormously extended the average life span. Industrial developments had made more goods of every kind available at lower prices. Everything was better than it had ever been, and possibly better than it would ever be again.

Personal Weapons

At TL5, edged weapons were better and cheaper than ever before. Good swords, knives, daggers, spears and axes cost half the *Basic Set* listed price. (In developed areas! Remember how the Indians cheated the Dutch - trading a worthless island, to which they had no valid title, for a cargo of steel hatchets, guns and powder, genuine glass beads and distilled alcohol. Absolutely unobtainable, on *their* side of the Atlantic!) The price of bows and arrows does not change; scarcity of bowyers and fletchers balances improvements in production and availability of materials.

Guns

For TL5, weapon mostly meant "gun." Still, until after 1845 (when reliable repeaters became widely available), almost everyone wanted steel for a backup. Even then, officers carried swords, infantry carried bayonets, and ordinary citizens carried something that would cut, until long after 1900.

Improved Flintlock Guns

The flintlock system was a good one, and continued to be used and developed throughout TL5. This was the period in which the military finally discovered the flintlock.

Breech-Loading Flintlocks

Every kind of breech-loading system that was tried with matchlock and wheellock was tried again with flintlock. All had the problems that all loose ammunition breech-loaders displayed. Improvements in metallurgy and precision fitting made some flintlock breech-loaders more operationally effective than their predecessors. At least three were actually used in combat by regular armies: the Ferguson, the Crespi and the Hall (see sidebar, p. 60).

Loading a breech-loading flintlock is a Long Action, taking 10 seconds. Breech-loaders take the same time to load in prone or sitting position that they take when standing. Breech-loaders require a Riding roll at -3 before they can be loaded on horseback.



FERGUSON, CRESPI AND HALL

Most flintlock breech-loaders were sporting guns, but a few saw military service. Three were actually adopted by the armies of major nations.

The Ferguson

Patrick Ferguson was an officer of the British Army, a keen sportsman and an amateur inventor. He designed and manufactured a breech-loading flintlock, and persuaded the British government to organize an experimental rifle company, armed with the weapon, for use against the American rebels.

There are no reliable reports of how well the rifles performed. Ferguson himself was wounded, and his company disbanded. When he recovered, he was sent to the Carolinas to organize partisan warfare among the Loyalist population. Ferguson was killed in action at King's Mountain in 1780 - ironically, with a muzzle-loader. The Ferguson is described in the *Weapon Tables*.

The Crespi

At about that time, the Austrian Empire adopted the Crespi breech-loading smoothbore as a cavalry weapon. It was much easier to load a breech-loader than a muzzle-loader on horseback. In their alternate role as dismounted skirmishers, cavalry needed a higher rate of fire than was possible with muzzle-loading long-guns, and more range and accuracy than was possible with pistols.

The Crespi was not a success in the field, and the empire soon reverted to muzzle-loaders. Use stats as for the Musketoon, p. 124, except RoF 1/10 and Malf 13. Any critical failure includes a blinding backflash; blindness lasts 3d seconds.

The Hall

The United States officially adopted the Hall breechloader in 1816. Some were issued and used in the Mexican and Indian wars, but it never replaced the muzzle-loader in service. Halls were easily convertible to percussion firing. As late as 1862 some Hall carbines were issued, in the desperate weapons shortage of the early Civil War.

The Hall's entire breech mechanism, including trigger and hammer, could be removed as a unit. It could then be fired. Since there was no grip, no sights and no barrel, it was terribly inaccurate.

As a rifle, use the stats for the Ferguson rifle, p. 125. Carbine damage is reduced to 4d and weight to 6 pounds. Stats for the breech mechanism removed and used as a pistol: DMG 1d+2 (but with a bullet size multiplier of 1.5), Malf 13, SS 14, Acc 0, 1/2D 40, Max 300, Wt 1, RoF 1/10, Shots 1, ST 12, Rcl -5, TL5.

Ferguson Action

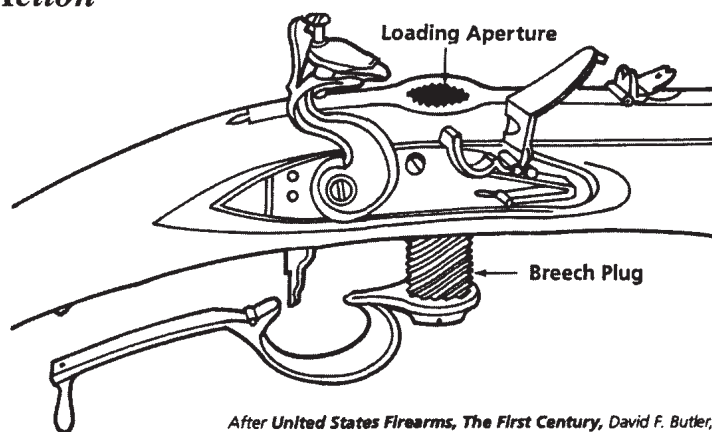

After *United States Firearms, The First Century*, David F. Butler, 1971

Flintlock Repeaters

Many kinds of flintlock repeaters were available. Probably the most practical were the revolvers (either cylinder or multi-barrel), and the rotating breech-block magazine guns.

Most revolvers required that the cylinder be manually turned for each shot. Turning and aligning the cylinder takes two seconds. RoF is 1/3; two seconds to align the chamber and one to cock the weapon.

Some revolvers were designed that did not require separate manual turning of the cylinder for each shot. Pulling back the cock both cocked the action and aligned the next chamber for firing.

Some revolvers had a separate pan for each chamber, that could be primed and carried closed until firing. Some had one pan and steel, with a priming magazine. This, either manually or automatically, primed the pan for each shot. Naturally, the most complex features were both the most expensive and the most delicate. Revolvers of this type have a RoF of 1/1.

Most of the magazine guns had tubes of powder and bullets in the stock. Operating the breech-block and turning the gun muzzle-down charged the gun. Most also had a priming magazine, which automatically re-primed the pan for each shot. RoF is 1/4.

As with other repeaters before the metallic cartridge, sometimes all the loads fired at once and sometimes all the loads exploded.

Hall Action

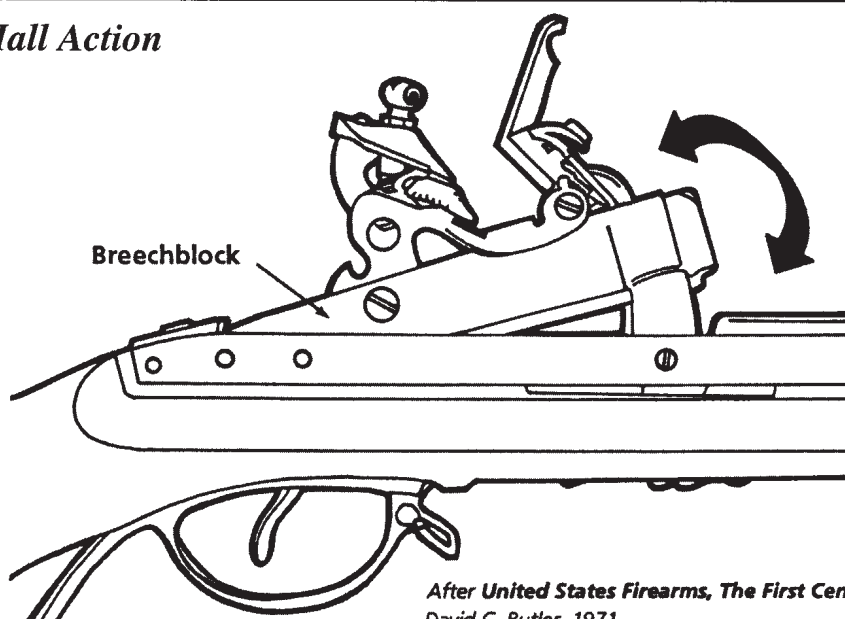

After *United States Firearms, The First Century*, David C. Butler, 1971

Loading Repeaters

It is hard to generalize a loading time for flintlock repeaters; they were made in too many different styles. Loading time for a tube repeater is obviously much less than loading time for a multi-barrel revolver. (One reason for the long reign of the muzzle-loading single-shot was that in sustained fire it was as fast as the repeaters. The single-shot closed up the race during the tedious reloading of the repeater's magazine.)

Revolvers take 40 seconds per barrel or chamber (60 seconds for rifled barrels).

Magazine guns take 60 seconds to load regardless of the number of rounds. (Most of the time is spent getting the gun apart and back together.)

Repeaters can attempt hurried loading in the same way as muzzle-loaders (see p. 34).

Firing Improved Flintlocks

The firing action is a roll against Black Powder Weapons. A critical success goes to the *Critical Hit Table*. An ordinary success is a hit.

A non-critical failure is a miss or a misfire. A critical failure is a critical miss.

Flintlocks misfire on a roll of 14 or more. The Immediate Action roll is against Black Powder Weapons/TL5 or Armoury/TL5-2.

Mechanical Problems

TL5 flintlocks share the mechanical problems described for TL4 flintlocks (p. 43). Breech-loaders add one more: backflash. This is a blast of burning and unburned powder, like a combination of a blowtorch and sandblaster, caused by a loose or worn breech. A breech-loading flintlock backflashes on a 17 or 18 (or a 16 or less for a worn gun!). Roll normally if it is a critical failure, and apply the back-flash as well. In addition to other damage, backflash does 1d burn damage to the user's face. If the damage is 4 or more, the user is blinded for 2d minutes.

Caplock (Percussion) Guns

17th-century chemists had discovered explosive substances called *fulminates*. These were metallic compounds that would detonate if heated, or if struck a sharp blow (percussed). They were too volatile and unstable to be much more than a scientific curiosity, but obviously had potential if they could be controlled.

Percussion Caps

Several fulminate ignition systems were tried in the early years of the 19th century. By the mid-1820s the percussion cap was the overwhelming choice. This was a copper cap containing the detonating compound, usually a half-grain or so of mercury fulminate. The caps were varnished for water-and air-tightness. A bag of 10,000 common caps weighed only 12.5 lbs.

The cap was fitted over a *nipple* on the breech of the gun. It exploded when struck by a *hammer*. Percussion caps were more reliable than any previous system of ignition, almost impervious to rain, and allowed for a simpler action with fewer parts to go wrong. By about 1840, percussion replaced flint all over the developed world. Percussion remained the most common system of ignition for only about 30 years; after 1870 it was quickly replaced by the metallic cartridge.

Converted Flintlocks

The first percussion-cap weapons were hardly radical; they were flint weapons converted by removing the pan and screwing in a nipple. After 1825, a TL5 armorer can convert a flintlock in one working day (10 hours of work). Price should be about \$10 - if he feels like converting flintlocks that day.

WHY WEREN'T THE BREECH-LOADERS SUCCESSFUL?

The Ferguson, Crespi and Hall, and other breech-loaders of the time, shared the same faults. They could not seal the breech; they were expensive to make; they were easy to break and hard to fix in the field.

The Hall was the best of the three, not because it was a better design, but because it came along a generation later. It was made of better metal and fitted more precisely.

Other, later breech-loaders, such as the Sharps, were even more successful than the Hall for the same reason. They came along later and thus fit together better.

MINIE BALLS

The principal difficulty of the muzzle-loading rifle for military service was its slow loading speed. The bullet had to fit the bore tightly in order to take the rifling - but a tight-fitting ball is hard to load, especially in a bore fouled by firing.

Several systems were tried that loaded an undersized bullet and "upset" it. This meant hammering out the malleable lead after loading so that it would be big enough to take the rifling. Unfortunately, bullets that have been hammered out of shape are not very accurate.

Minie, a French army officer, developed a hollow-based, conoidal bullet. The bullet was smaller than the bore for easy loading. In the hollow base was a plug of clay or iron. The pressure of firing forced the plug into the hollow base, expanding the lead to take the rifling. Later experimenters proved that the plug was unnecessary; the propellant gases expanded the hollow base enough to work.

Minie bullets were the standard load of the great mid-19th century wars: Crimea, Franco-Austria, the American Civil War and the Indian Mutiny. In fact, the Minie bullet was in one sense the cause of the Indian Mutiny. The new Enfield rifle used Minie bullets in a greased-paper cartridge. Rumors started among the native soldiers of the East India Company that the grease was made of pig fat (forbidden to Muslims) and cow fat (forbidden to Hindus). The company insisted that only mutton fat was used. The troops mutinied rather than use the ammunition. (There were, of course, other reasons for the mutiny, but that was the cause of the first great outbreak, at Meerut.)

The battlefield reign of what Americans called the "minny ball" was short. It was first adopted in the 1850s, and by the 1870s had been replaced by cartridge breech-loaders.

THE ROLLIN WHITE PATENTS

Rollin White was a rather obscure gun designer. In 1855 he patented a revolver that was apparently never built. As a sort of afterthought to the patent, he claimed the invention of a cylinder bored through so it could be loaded from the rear. The claim was nonsense - such cylinders were already available commercially in pinfire revolvers - but that's patent law.

In 1857, Horace Smith and D.B. Wesson were just about ready to sell their new rimfire .22 revolver, when they were informed of the Rollin White patents. They could have ignored the claim; a good case could be made for prior invention negating it. Instead they chose to pay White a royalty on each revolver sold, if he would agree to defend the patent in court. White agreed, and in 1863, the federal court upheld his claim. Until 1869, Smith & Wesson was the only company in America that could legally make a revolver with bored-through cylinders.

A lot of ingenuity went into attempts to make some kind of cylinder that would work with cartridges, and that did not have a hole all the way through. Colt, for instance, tried to sell the Thuer conversion. This used special front-loading, tapered cartridges. It could very cheaply be used to convert percussion guns to metallic-cartridge firing. It was not particularly successful.

For one thing, it was easy for any competent gunsmith to convert any percussion revolver to cartridge firing. This was illegal, but as long as it wasn't done on a big scale, Rollin White was too involved with major legal action to notice. (White spent most, if not all, of his royalty money on lawyers; his contract required that he, not Smith & Wesson, defend the patent claims.) For another, the Civil War was over, and the market was flooded with good, cheap percussion guns.

In 1869 the patents expired. Rollin White tried for an extension, but it was turned down. Everyone began making cartridge revolvers; even the Army got them. Some of the more interesting oddities in American gun design went out of production.

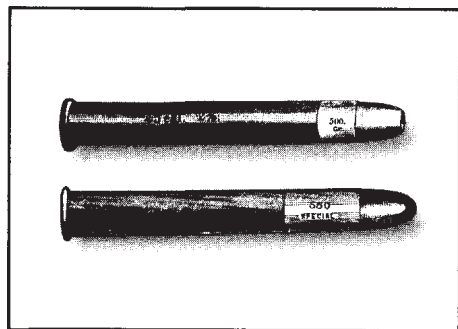

Loading Caplock Muzzle-Loaders

Loading is basically the same as with flintlocks, with *capping* taking the time that was previously used for priming the pan.

Smoothbore muzzle-loading long-guns take 20 seconds to load with cartridges, 40 seconds to load with loose powder and ball. Pistols take five seconds less in either case.

Rifled muzzle-loading long-guns take 30 seconds with cartridges and 60 with loose powder and ball, before 1855. After the general adoption of the Minie bullet in 1855 (see sidebar, p. 61), loading time for rifled muzzle-loaders is the same as for smoothbores. Pistols take five seconds less.

Careful loading, hurried loading, and loading in other than the standing position are the same as with flintlock muzzle-loaders.

Pistols take the same amount of time to load in any normal position.

Firing Caplock Muzzle-Loaders

The firing action is a roll against Black Powder Weapons/TL5.

A success is a hit. A critical success goes to the *Critical Hit Table*.

A non-critical failure is either a miss or a misfire. Caplocks misfire on 16. Immediate Action, Black Powder Weapons or Armoury/TL5-2, usually clears the problem in 1d seconds. A critical failure is a critical miss.

Caplock Breech-Loaders

Caplock breech-loaders were notably more successful than were flintlock breech-loaders. This was largely due to the overall improvement in metallurgy and machine tools in the 19th century. Better-fitting parts of higher-grade metal simply took the strain of loading and firing better. Several breech-loading caplocks had military success, notably the Sharps in the American Civil War.

Caplock breech-loaders still had the fundamental problems of fouling, erosion and backflash. These were unavoidable with a loose-ammunition breech-loader with outside ignition.

Caplock breech-loaders were rare before 1845 (except for the Hall - see sidebar, p. 60). They cost five times as much as a comparable muzzle-loader. After 1845 they were generally available and cost only three times as much.

Loading Caplock Breech-Loaders

Loading is a Long Action. A caplock breech-loader can be loaded and capped, using loose powder and ball, in 10 seconds. It can be loaded with *combustible cartridges* (fabric, burns as fired) in five seconds.

Loading time prone, sitting or kneeling is the same as standing. Loading on horseback requires a roll against Riding-3 with loose powder or against Riding with combustible cartridges.

Firing Caplock Breech-Loaders

The firing action is the same as for a caplock muzzle-loader. Breech-loaders also malfunction on 16+.

Caplock breech-loaders also backflash, though not as often as flintlocks. On any natural 18, if it fires at all, the weapon backflashes as described above.

Caplock Repeaters

There were comparatively few varieties of repeating action with caplock ignition. The most successful and common were the revolver and the harmonica action.

The revolver used the familiar rotating cylinder or barrels that had been relatively successful as far back as the 16th century. (Rotating barrel guns are usually called *pepperboxes*.)

The harmonica action used a horizontal block bored with separate chambers. A lever on the gun moved the block across, aligned it with the breech and usually cocked the action.

These actions had a couple of special problems.

The first problem is that fragments of the exploded cap have a nasty tendency to jam the action. Experienced revolver shooters flipped the gun hard in the hand after every shot to throw any fragment clear. (Some revolver shooters did this even with cartridge revolvers; shooters are a conservative lot and hate to change an established procedure even when the need for it is gone.)

The second problem was chain-fire. Sometimes the flash of one chamber going off would ignite others. This was at the very least disconcerting. With a long-gun, it usually meant damage to the supporting hand. (A little-used repeating action was the *turret revolver*, with a flat, horizontally mounted magazine. Its extra chambers pointed directly at the firer!)

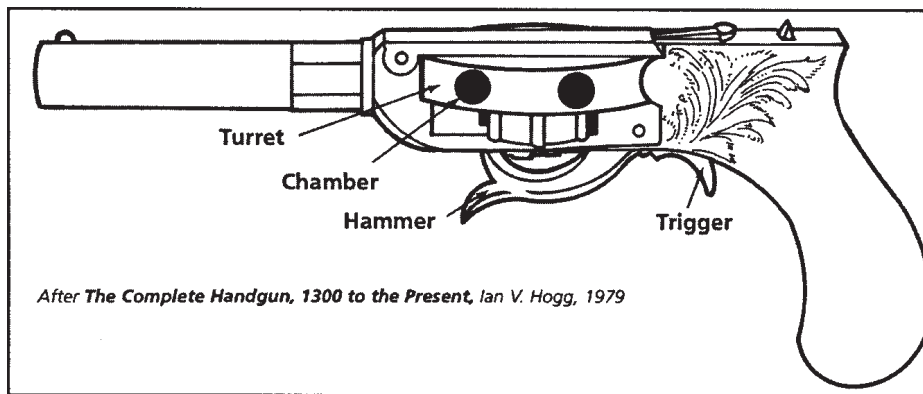

After *The Complete Handgun, 1300 to the Present*, Ian V. Hogg, 1979

Loading Revolvers and Harmonica-Action Repeaters

Each chamber takes 15 seconds to load with a cartridge or 30 seconds to load with loose powder and ball.

The cylinder of a revolver can be removed from the gun for loading, and extra preloaded cylinders can be carried. Disassembly and reassembly takes 30 seconds, sitting still. On the back of a running horse it takes the same time, but requires a Riding skill roll at -3 before it can be started. The Pony Express was reputed to be able to do this.

The magazine of a harmonica action is designed to be removed for loading. Removing the magazine takes one second.

Firing Revolvers and Harmonica-Action Repeaters

Firing requires a roll against Black Powder Weapons/TL5.

These repeaters misfire on 16+. On 18, they chain-fire all loaded chambers in addition to any other damage.

Harmonica-action guns have an RoF of 1/1 for all the shots in the magazine. Changing magazines takes five seconds and a roll against Black Powder Weapons/TL5.

Revolvers have a normal RoF of 1/1. A double-action revolver (see sidebar, p. 66) can be fired twice in one second. The second shot is at full recoil penalty. *Single-action* revolvers (see sidebar, p. 66) can be Fanned or Slip-hammered (see p. 67).

Price of Caplock Repeaters

Revolvers are rare before 1845. Price is usually less than \$50, but they are very hard to find. After 1845 they are common and inexpensive; a good revolver costs about \$20.

Harmonica-action repeaters cost \$50. They are always rare and expensive.

Other types of repeaters were very rare, and price was high but variable. Most were produced in very small quantity, and reliability was questionable. GMs are encouraged to be creatively nasty with anyone who wants a peculiar repeating caplock. None of them was as good as the revolver or harmonica action.

Self-Contained Cartridges

At the same time that designers were trying to perfect the caplock, other designers were trying to transcend it. Through the first half of the 19th century inventors tried to develop a *self-contained cartridge*.

Several designs combined a percussion cap with a *combustible* cartridge case. The *Dreyse Zundnadelgewehr* or needle-gun (see sidebar, right) is typical. It got the Prussians successfully through three wars. It was first issued in 1848 and continued in service until the early 1870s.

NEEDLE-GUNS

A prime source of possible confusion is the term needle-gun. It is a favorite term in science fiction, and already has a place in the *GURPS Basic Set* and *GURPS Space* as a futuristic weapon. It also has a historic existence as not one, but two different weapons.

The Dreyse Zundnadelgewehr was the Prussian standard service weapon from 1848 to 1871. (The concept was actually developed in 1838, and production began in 1841, but the first were not issued until 1848.) The gun got its name from the long firing pin. The Dreyse fired combustible-case ammunition. The firing pin penetrated completely through the case to strike a percussion cap at the base of the bullet.

The Prussians used the gun successfully in three wars: against the Danes in 1864, the Austrians in 1866 and the French in 1870. These wars were among the first to be heavily covered by newspaper correspondents. The correspondents loved colorful phrases such as “the deadly hail of the needle-guns.” By the end of the wars, needle-gun had become almost a synonym for breech-loader in the public mind. In much the same way, a generation later, “tommy-gun” became almost a synonym for submachine gun.

Among the early cartridge breech-loaders was the “trap-door” Springfield. This originated as the Allin conversion in 1866. Allin, a civilian employee of Springfield Armory, developed it as a system for converting the thousands of Civil War surplus muzzle-loading Springfields to breech-loading. Part of the conversion was a long, thin firing pin. This made the nickname of needle-gun almost inevitable.

The original conversions were in .50-70. In 1873, the U.S. Army kept the Springfield design, but adopted a new caliber, the .45-70. Thousands of the .50-70s were sold as surplus, very cheaply. Others were issued to militia units, prison guards, reservation police and other government gun-packers. They were popular all over the country, especially among buffalo hunters.

PARADOX GUNS

These were English-made double-barreled shotguns. They had rifle sights, and the barrels were partially or very shallowly rifled. They could use shot loads, or special slugs. Performance with their special ammunition is the same as with rifled slugs, and they can use rifled slugs of the appropriate size. They were available in England from about 1890.

True Paradox guns were based on the patents of Colonel Fosberry, VC, who also invented the automatic revolver that bears his name. Many others were made with slight design changes to avoid the patent. They all work about the same.

THE VOLCANIC RIFLE

The Volcanic was not a very good gun, even for 1854, the year it went on sale. It was laughably inaccurate, underpowered and clumsy to handle. The cartridge was a curious hybrid; it was self-contained but completely caseless. The propellant and percussion-cap were in a hollow in the base of the bullet. The cartridges were in a tubular magazine under the barrel; the action used a trigger-guard lever to move one round at a time into the chamber.

The whole thing was the concept of a couple of Yankee tinkers, who had sense enough to ditch the idea. They sold out to a shirt-maker, with a gift for hyperbolic publicity. Despite his inflated claims, the guns were out of production before 1860. (The guns were badly designed, but well-made; at least one was still being shot regularly, with hand loads, in the 1940s.)

This might be just another tale of small-business failure, except for the names involved. The two Yankee tinkers were Horace Smith and Daniel Baird Wesson. They took the buy-out money and their experience into the handgun business. In 1857 they began the sale of their Number One revolver, the first to carry the name Smith & Wesson.

The publicity conscious shirt manufacturer was Oliver Fisher Winchester. He soon realized that even the best salesmanship works better with a good product. Winchester hired an engineer, Benjamin Tyler Henry, to work with the patents bought from Smith & Wesson. Henry combined the lever and magazine of the Volcanic with the rimfire cartridge, made all the parts stronger and better fitting, rationalized the production machinery, and gave Winchester the Henry rifle, arguably the best repeater of the Civil War. The Henry was slightly improved in 1866 (a wooden fore-end and an improved loading system for the magazine) to become the first gun sold under the Winchester name.

The needle-gun was a single-shot, bolt-action rifle. It was faster firing than a muzzle-loader and it could easily be loaded in the prone position. Soldiers with the needle-gun could load and fire from cover much more effectively than troops with muzzle-loaders.

The combustible case still had the same problems of gas loss, backflash and fouling of the breech. The needle-gun added one more problem. It had a long, thin firing pin - thus the name needle-gun. On firing, the pin went *through* the charge and exploded a percussion cap attached to the base of the bullet. The pin was in the center of the black powder explosion, and soon corroded and crystallized. It would break at an unpredictable time. Changing firing pins in the middle of a firefight is not a soldier's idea of joy!

Loading and Firing Needle-Guns

Loading and firing the Dreyse and similar guns is much the same as with metallic-cartridge single-shots (see p. 66). RoF is 1/6. For each three shots without a two minute break to clean the action, RoF is one second slower.

The firing action is a roll against Black Powder Weapons/TL5.

Needle-guns misfire on 16+. On 15 they fire, but there is a 1/3 chance that the firing pin breaks. Replacing firing pins takes 30 seconds and a successful Armoury/TL5-3 roll. On a failure, start over. On a critical failure, the replacement pin breaks.

The Prussians won their wars and it is always a temptation to other armies to! copy the winner. Several countries adopted combustible cartridge rifles even after metallic cartridges were available. The Prussians, however, went to metallic cartridges as soon after the Franco-Prussian War (1870-71) as possible.

In the late 1870s, needle-guns are available at very cheap prices as war surplus in Europe. For three more decades they are liable to show up in the hands of low-grade bandits and impecunious revolutionaries.

Metallic Cartridges

It was apparent to many designers that a metallic cartridge would overcome almost all the problems of the combustible cartridge. It would hold the propellant and igniter until needed. It would provide the necessary protection from the elements. The ductility of the metal would provide *obturation* (sealing the breech against gas loss, see p. 80), and yet would allow easy extraction after firing. The theory was sound, but the practice took a while to perfect.

The Flobert Cap

In 1835, Flobert, in France, developed a cartridge directly from the percussion cap. He made a cap slightly extended in length, and with a swelling at the base. A bullet or a charge of shot was at the front, and the fulminate at the base. The bulge at the base held the *Flobert cap*, against the breech. The hammer fall ignited the fulminate, which also served as propellant. There was no separate charge. The copper case provided obturation; it sealed the breech against gas loss. The copper was *ductile*; it swelled on firing to seal the breech, but returned to pre-fired size so it could be easily extracted. But Flobert's design was suitable only for low-powered rounds. They were fine for indoor target shooting, or game on the order of mice and sparrows, but not for serious killing.

Flobert-type cartridge guns are available in France any time after 1836, in the rest of the developed world any time after 1837. Single-shot, breech-loading rifles and pistols are common and inexpensive. They come only in good, cheap and very cheap quality. Cost of a good rifle is \$50 and of a good pistol is \$25. (The common name is *saloon pistol/rifle*, which only means that they were intended for indoor target practice.)

The most powerful Flobert cartridge has no more power than a .22 Short (1d-1 damage).

Pinfire Cartridges

Lefauchaux, also in France, introduced the *pinfire cartridge* for shotguns in 1836. The cartridge had a metal base and a cardboard body, in the way that some shotgun shells are still made. Inside the metal base was a percussion cap. A pin protruded through the metal. The falling hammer drove the pin against the cap to ignite the charge. The metal base provided obturation.

Lefauchaux's original system did not seal the breech very well. Another French inventor, Houiller, improved the design in 1846. Houiller also made pinfire cartridges with cases entirely of metal, for rifles and pistols.

The pinfire system worked; pinfire guns and ammunition were manufactured in Europe until the 1930s. But the system had some problems. The cartridges had to be loaded in only one way, so that the pin stuck up through a slot in the breech to be struck by the hammer. Pinfire cartridges were more prone to accidental discharge in storage or shipment than other types because of the protruding pin. Pinfire cartridges saw very little military use, but millions were used by civilians for sport and self-defense. One reason for their popularity was that they were easily reloadable. The only things required were a simple, plier-like tool and something to measure the charge.

Breech-loading pinfire shotguns are available after 1837. Pinfire rifles and revolvers are available after 1847. The only form of repeating pinfire is the revolver. Most pinfire shotguns and many rifles are double-barreled.

Most of the details of operation of pinfire weapons are identical to the same type of centerfire cartridge gun. Pinfires have a Malf number 1 lower than a comparable centerfire. Cheap and very cheap pinfires are half the price of cheap and very cheap centerfires. They are very likely to be the weapon of unsuccessful criminals and low-rate hirelings.

Rimfire Cartridges

In the late 1850s, Smith & Wesson and B. Tyler Henry, in the United States, developed the *rimfire* cartridge from the Flobert cap. The rimfire had both an igniter and a charge. The priming compound was in the hollow rim of the cartridge case, and the propellant, black powder, was inside the case.

Horace Smith and Daniel B. Wesson brought out a cartridge revolver in 1857. The gun was not particularly distinguished, but the cartridge was possibly the most successful ever designed - the first .22 rimfire.

B. Tyler Henry, in 1860, brought out a successful cartridge, the .44 Henry. He also brought out the first of the lever-action rifles that were the characteristic American weapon of the late 19th and early 20th centuries. The Henry of 1860 was the direct ancestor of the Winchester lever-actions.

There were basic design limitations to the rimfire cartridge. It was not suited to high-pressure loads. The hollow rim was relatively vulnerable to damage in storage and shipment. Difficulty in distributing the fulminate evenly around the rim sometimes caused uncertain ignition. (Henry put a two-pronged firing pin on his rifles to increase the likelihood of firing.) There is no convenient method of reloading rimfire cartridges. Nevertheless, rimfires were the first metallic cartridges used in war, continued in use long after they were supposedly obsolete, and, in the .22-caliber format, are still the most used ammunition of the 20th century. They are much cheaper and easier to manufacture in quantity than center-fire cartridges.

Guns for the Rimfire Cartridge

Guns for the rimfire cartridge are not basically different than for the centerfire. The operational descriptions will be given in the same place. By the end of the 19th century, few new weapons were being designed for rimfires, with the exception of designs for the .22.

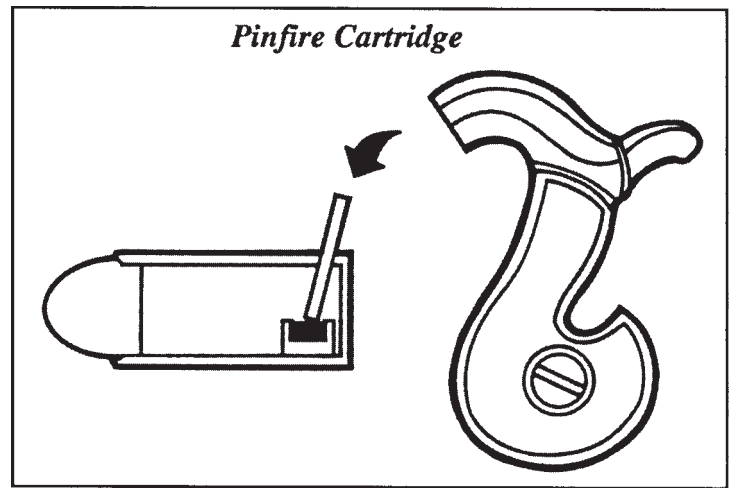

MASS PRODUCTION, PRICE AND QUALITY IN FIREARMS

Before about 1840 guns were mostly made one at a time by hand labor. The finest guns were marvels of art and craftsmanship; the cheapest were ugly and very unreliable.

Mass production, the making of standardized guns by machinery, was a long-sought military goal. In the 1840s the Colt system of machine tools and gauges finally made this possible. For the civilian market, this meant that most weapons were now in the good range, cheap weapons were very cheap indeed, and fine and very fine weapons were rare and even more expensive. After 1840, the "fine" and "very fine" classifications usually have more to do with decoration than with utility.

Really expensive weapons are usually intended for special jobs. Superaccurate target rifles can be built by hand-fitting parts on a standard action. Combat pistols of practically unerring reliability can be built on commercial frames. These jobs require enormous effort and expenditure for a very small gain. They are worth the expense if, and only if, the difference is life or death.

After 1840, fine and very fine guns cost, respectively, five times and 30 times the listed price. They can be specifically described as fine (decorated), fine (reliable) or fine (accurate). They can be very fine (decorated or accurate), but not very fine (reliable). They can be decorated *and* reliable, or decorated *and* accurate, but not both accurate and reliable. The extremely precise fitting necessary for exceptional accuracy means that the gun is more prone to malfunction.

Fine and very fine decorated guns have a higher resale or pawn value, as much as 90% of the new cost. Most guns can be pawned or resold for only 10% to 50% of new value - often much less. Fine (accurate) guns have +1 Accuracy; very fine ones have a +2.

Fine (reliable) guns get a second roll on any malfunction result; only a second malfunction counts.

SINGLE-ACTION AND DOUBLE-ACTION

There are two kinds of revolver action, single and double. A single-action revolver must have the hammer cocked by a separate action before the trigger can be used to fire the gun. A double-action revolver can be fired by trigger action alone; pressing the trigger both cocks the hammer and allows it to drop and fire the round. (Most double-action revolvers can also be fired single-action, but a few are trigger-action only). This gives a -2 penalty to hit - see p. 72.

Single-action firing allows a lighter trigger pull and is therefore easier to shoot accurately, especially at long range. Single-actions have a RoF of 1 per second, except with fanning or slipping the hammer - see p. 67. Double-actions can be fired three times per second; the second and third rounds are at full recoil penalty. Double-action is faster to fire (for most people) and does not require that the grip be changed during firing.

Double-Action Autos

Some automatic pistols can be fired double action on the first shot. On subsequent shots, the recoil of the gun cocks the action. The first shot for such a gun is at the same -2 penalty as double-action revolver shooting. Such a gun can be cocked for the first shot, but this takes an additional second to ready the gun.

Single-Action Autos

Most automatic pistols produced before 1960 are single-action only. The hammer must be manually cocked before the first shot can be fired. Most can be carried cocked-and-locked - that is, with the hammer cocked and the safety on. If they are not, it takes an extra second to ready the weapon to fire.

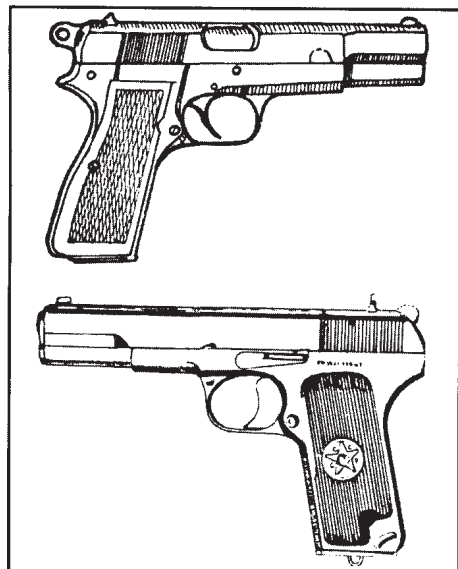

Cochran Turret Revolver

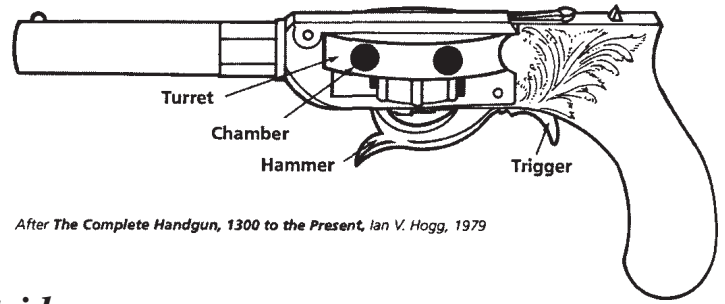

After *The Complete Handgun, 1300 to the Present*, Ian V. Hogg, 1979

Centerfire Cartridges

Centerfire cartridges were under development at the same time as rimfire. The Pottet centerfire cartridge was patented in France in 1857. The centerfire case was more adaptable to high-pressure loads than the rimfire, and soon replaced it as a military and big-game round.

Two types of centerfire system were developed, *inside-primed* and *outside-primed*. Inside-primed ammunition put the percussion cap inside the case. The firing pin crushed in a segment of the case head to explode the cap. This required a weak case head, which was already a problem with rimfires. It was also difficult to reload the case. By about 1880, inside priming had been abandoned. Since the only difference is in the primer location, inside- and outside-primed ammunition of the same caliber will work in the same gun.

Two outside-priming systems were developed. The *Berdan* system has a *cup*, a depression in the center of the base of the cartridge case. The *anvil*, a hard metal surface for the priming compound to be crushed against, is formed as part of the cup. Two or more *flash holes*, in the sides of the cup, communicate with the powder chamber in the cartridge case. The Berdan system was almost universally adopted in Europe for both military and sporting ammunition.

The *Boxer* system also has a primer cup, but it is a simple, cylindrical depression, with one large, centrally-located flash hole. The anvil is formed as part of the primer, rather than as part of the cartridge case. The Boxer system is almost always used for ammunition loaded in the United States.

Boxer-primed cartridges are easily reloaded with hand tools; Berdan-primed cases are difficult to reload. This may explain the survival of the pinfire cartridge, also easily reloaded with hand tools, in Europe. Berdan-primed cartridges are somewhat easier to make with machinery than Boxer-primed cartridges. ("Boxer-primed" cartridges are not the same thing as "Boxer" cartridges. Boxer cartridges are built up from brass sheet and soldered to a base, rather than being drawn from solid brass.)

Single-Shot Cartridge Guns

By 1900 every sort of action, including muzzle-loading, had been tried with metallic-cartridge guns.

Single-shot and multi-barrel guns were not a lot different than the same kinds of action before cartridges. Single-shots could handle the longest and most powerful cartridges and still be built with relatively unsophisticated metallurgy and machining techniques.

Some single-shot breech-loaders (notably the Sharps) carried over actions directly from the caplock, managing a great saving in design and tooling costs.

Other single-shots were developed by armies to salvage a huge investment in muzzle-loading rifles. The Snider was British issue in the 1860s and '70s. The trap-door Springfield was U.S. issue from 1866 until after 1900. Both began as methods of converting muzzle-loading caplocks to cartridge breech-loaders.

The easiest way to increase the power of black-powder cartridges was simply to lengthen the case so it would hold more powder. Single-shots have the breech-block behind the cartridge. There is an unobstructed line from breech to barrel, and no problem of magazine feeding. Therefore, they were easy to adapt to each more powerful round as it came along.

Most military rifles of the latter part of TL5 were single-shot, because the repeater actions then available could not handle rounds with the range and power that were wanted. For the same reason, most big-game guns were single-shot or multi-barrel. They were still significantly faster to operate than any gun of the pre-cartridge period.

Loading Cartridge Single-Shots

Loading is a Long Action. Loading time for a single-shot is three seconds: one second to open the action, one second to secure the cartridge and one second to put the cartridge in the action and close it. Loading time is the same standing, kneeling, sitting or prone. Loading on horseback requires a Riding roll at -1.

Multi-Barrel Cartridge Guns

Multi-barrel guns can be made on any action, and some very ingenious ones have been. A fairly common conversion of the Spencer repeater is to attach a shotgun barrel and action under the rifle barrel. The overwhelming majority of multi-barrels, however, are on the simple, hinged-breech, break-barrel action first used with separate-chamber breech-loaders in the 17th century.

Side-by-side double barrels are the most common; but over-unders; three-, four- or more barrel guns; and other variations are not unknown. In Germany and Austria, *drillings*, three-barrel break-barrels combining two shotgun and one rifle tube (or vice versa), are very popular.

Multi-barrel cartridge guns load in the same way as single-shots. They take an additional second per barrel.

Hinged-breech multi-barrel guns, such as most shotguns of the period, English Express rifles and European drillings, have a particular problem. There must be enough room for the barrels to be swung down to eject and load. Side-by-side guns do not have to be swung down as far as over-unders or drillings.

Side-by-sides need at least one inch of clear space under the horizontal line of the weapon for each three inches of barrel length to be successfully opened. Over-unders or drillings need one inch for each two inches of barrel length. Of course, the weapon can be turned sidewise or even upside down to open. But this adds one second per barrel to loading time because of the awkward position.

Firing Cartridge Single-Shots and Multi-Barrels

The success roll is against Guns. A success is a hit; a critical success goes to the *Critical Hit* table. A non-critical failure is a miss.

A critical failure may be a critical miss or a malfunction. Any jam result (9, 10 or 11) is a stoppage; the shot fired but the gun must have Immediate Action before it will fire again. Roll once more to see if the shot hit or missed; any failure or critical failure is a miss. Any dud result (8 or 12) is a misfire. With a multi-barrel, try firing the other barrel. Up to three attempts can be made in one second, if there are that many barrels. Before the misfiring barrel can be fired again, the firer must either make an Immediate Action roll, or have it repaired by an armorer.

With a single-shot, Immediate Action is necessary for a stoppage. (Immediate Action for a misfire is to load another cartridge and try again.) A critical success restores the weapon to action in 1 second. A non-critical success takes 2d seconds. A failure needs repair by an armorer. A critical failure doubles the repair time.

Metallic Cartridge Repeaters

The first repeating guns for metallic cartridges were revolvers. The Smith & Wesson .22 Short single-action was on sale in 1857, but they did not build a big-bore revolver until 1869. For legal reasons, S&W had a monopoly on cartridge revolvers in America until after the Civil War. The first militarily successful repeaters were, therefore, lever-action rifles, the Spencer and the Henry. Both were commercially available in 1863 and saw some military use in the Civil War.

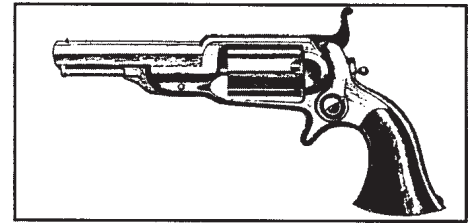

FAST FIRING: FANNING AND SLIPPING THE HAMMER

Single-action (but not double-action) revolvers can also be fired *by fanning* or by *slipping the hammer*.

To fan a revolver, the weapon is held in one hand, with the trigger pressed and held all the way in fire position. The other hand repeatedly strikes the hammer, pulling it to full cock and releasing it to fire the weapon. Some experts have achieved fair close-range accuracy with the technique; for most shooters it is a good way to bruise the hand and make lots of noise.

Fanning is a Physical/Easy skill, defaulting to Guns-4 or DX-6. Acc is halved while fanning and Snap-Shot penalty is doubled.

A shooter must have two free and working hands to fan. Only shooters with four or more arms can fan two revolvers at the same time.

A revolver can be fired three times per second by fanning. Roll to hit separately for each shot. The second and third shots are at Rcl penalty.

Slipping the hammer is a one-handed technique for increasing the rate of fire. The weapon is held with the trigger pressed back as in fanning. The thumb pulls the hammer back to full cock, then releases it to fire.

A good slip-hammer shooter can fire twice per second. Slipping the Hammer is also a Physical/Easy skill and defaults to Guns-2 or DX-5. A shooter with this skill can aim and brace on the first shot in a series of slip-hammer shots; shooters without the skill cannot aim or brace. Roll to hit separately for each shot.

A revolver can be temporarily modified for fanning or slipping the hammer by tying the trigger back. Wet rawhide is the usual material for trigger tying. A gun so modified can only be used for fanning or slipping, unless the tie is removed.

The gun can be permanently modified by removing the trigger. Only a gunsmith can remove the trigger; anyone can tie it back.

Fast Firing Double-Actions

A double-action revolver cannot be fanned or slip-hammered, but it does not need to be. A double-action can be fired as fast by trigger pressure as a single-action can be by the more complicated techniques. The shooter may fire up to three shots in one second using double-action.

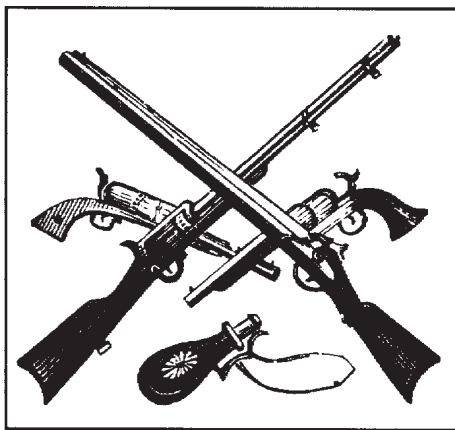

REVOLVER PRICES

Revolvers were made in an incredible range of size, price and quality. Any revolver listed has a copy or a near copy that is cheaper. Neither England nor the United States had any significant restrictive laws on weapons possession, and there was a revolver to fit the price and pocket of just about everyone. What British and American industry could not provide, Europe could. Even those countries that did not want their own people armed had no objection to exporting guns. It was normal in the United States to make a man's suit with a leather- or canvas-lined pistol pocket until long after 1900. The revolver-toting American was a stock figure in European fiction, and not at all unknown in fact.

A good revolver costs \$20. Very cheap revolvers cost 20% of list, and are -2 to Acc and Malf. Cheap revolvers are 40% of list and -1 to Acc and Malf. Revolvers are not available from the factory in fine or very fine grades. Gunsmiths can custom-build them, at incredible prices.

Revolvers are available with every imaginable kind of decoration, including gem-set, solid-gold grips. These add to the cost but not to the utility of the gun.

REVOLVER CONVERSIONS

Even before the major American revolver manufacturers began producing cartridge revolvers, they were available. An armourer can convert a percussion revolver to fire any existing cartridge that is not too long for the cylinder and has a bullet that will fit the bore. This takes three days of work with a success roll against Armoury-2 each day. (A failure is, "Just a little mistake, friend, I'll have that bent barrel as good as new." Add one day to the conversion time for each failed roll.)

Topping Up

A magazine or multi-barrel gun does not have to be completely reloaded before it can be fired again. Loading less than the maximum number of rounds gets the weapon back in action faster, but with fewer rounds available before reloading is again necessary. Nor does the weapon have to be fired empty before it can be reloaded. A competent gunman will take advantage of any pause in the shooting to *top up* his weapon. (This is how Roy Rogers' six-shooter can fire 18 times; he reloads whenever he is off-camera.)

Lever Actions

The first successful repeating rifles using metallic cartridges were *lever action*, with *tubular magazines*. A lever action has a lever pivoted around a fulcrum. Moving the lever ejects a fired round from the weapon and, in the case of lever-action repeaters, moves a round from the magazine to the chamber.

Tubular Magazines

A tubular magazine carries the ammunition nose to tail in a tube. A spring in the magazine forces each successive round into place to be fed into the action. The first military bolt-action repeaters (such as the French Lebel, see *Weapon Descriptions*, p. 114) had tubular magazines, as did the lever actions. But the tubular magazine has certain inherent difficulties. In the tube, the bullet of one cartridge rests directly on the base of the cartridge in front. With rimfire cartridges this does not matter. But with center fire, the bullet is directly against the primer of the round in front. With round or flat-nosed bullets, in relatively low-powered cartridges, this is still no real problem. With pointed bullets in high-powered cartridges the problem is very real. A cartridge ignited in the magazine usually at least ruins the rifle.

Tubular magazines have other problems for military use. The tube is easily damaged, each successive shot changes the balance of the weapon and tubular magazines are relatively slow to load.

Loading Tubular Magazines

Loading is a Long Action. Time required is two seconds to open and close the action plus one second for each round loaded.

The magazine can be topped up with a round in the chamber. *Gate-loading* guns can be topped up without taking the weapon down from the ready to fire position.

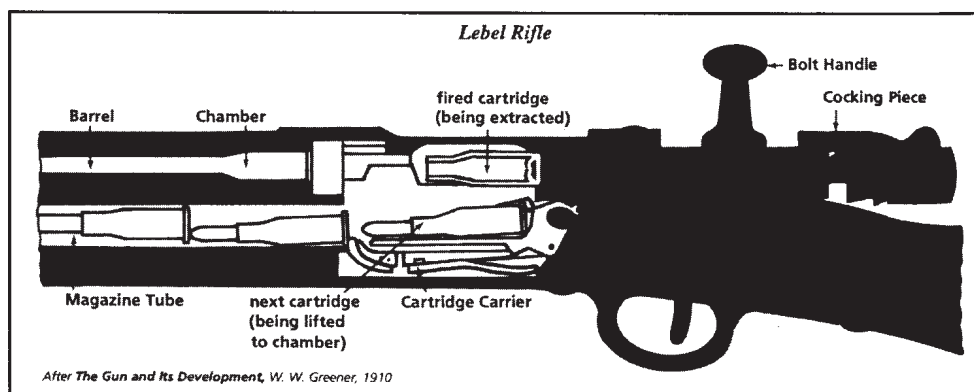

Bolt Actions

The *bolt action* takes its name from its resemblance to a common door bolt. Bolt actions were made as both single-shots and repeaters.

Bolt-action guns are usually divided into two types, *turn bolt* and *straight pull*. On turn-bolt guns, the firer grasps a handle, turns the bolt, and then draws it back to unlock the action and eject the fired round. Pushing forward and turning the bolt handle down chambers another round and locks the action for firing.

On straight-pull bolt actions, the firer pulls straight back on the bolt handle, then pushes it straight forward. A cam mechanism unlocks and locks the action.

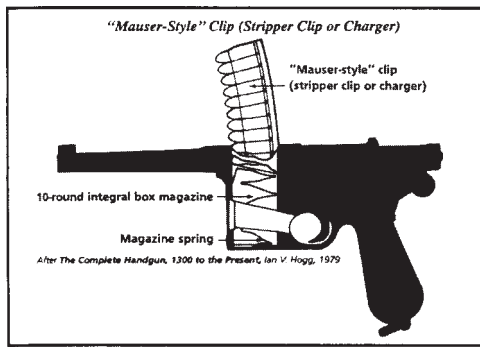

Theoretically, a straight-pull bolt action should be faster than a turn-bolt. In practice, either could be operated faster than it could be aimed. Turn-bolts were simpler to make and maintain, and were more reliable in the field. Straight-pull bolt actions give -1 to the malfunction number.

Box Magazines

The vertical *box magazine* stacked the rounds one atop the other. It was particularly suited to the back-and-forth action of the bolt gun. Some other magazines, such as the rotary Savage and Mannlicher-Schoenauer, and the horizontal-box Krag, were adopted, but the vertical-box magazine was the overwhelming choice for both military and sporting use. At least one lever action was built with a box magazine, the Winchester Model 1895. This saw

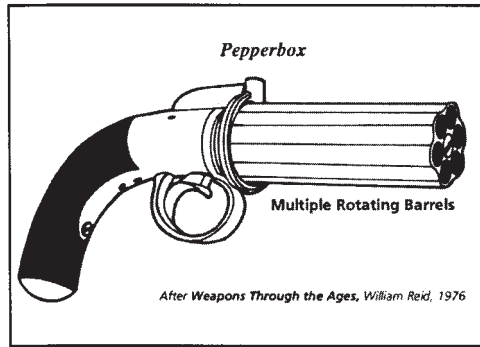

some military use, and was a favorite sporting gun. It was the chosen long arm of the Texas Rangers.

Loading single rounds into a box magazine takes two seconds (to open and close the action at the beginning and end) plus one second for each round loaded. Single-loading a bolt action magazine rifle takes two seconds; one to open the action and insert a round, and one to close and lock the action.

Clip Loading

Two kinds of clips were developed to speed loading in box magazines.

The Mauser-style clip (which the British call a “charger”) held the rounds, most commonly five to a clip, but was not loaded into the weapon. The clip was placed in feed guides above the magazine, and the rounds stripped into the magazine by thumb pressure. The clip would then be knocked away from the gun by the bolt as it was moved forward to chamber a round.

The Mannlicher clip was loaded into the action with the rounds and was ejected when the last round was ejected.

With either type of clip, the entire clip-load can be loaded in two seconds - one to grab the clip and one to load the magazine (plus two seconds to open and close the action).

A Mauser-style magazine can be topped up at any time by loading rounds into the action. Since the Mannlicher clip stays with the rounds, the magazine cannot be topped up this way. The clip, and whatever rounds are in it, must be ejected from the magazine and a new clip inserted. Mannlicher box magazines cannot be loaded with single rounds, only with clipped rounds.

Detachable Box Magazines

James Paris Lee invented the *detachable* box magazine. It can be removed from the gun and loaded. Spare loaded magazines can be carried and loaded all at once. (Loading a detachable magazine into the weapon takes three seconds.) The magazine can be placed in the weapon while a round is in the chamber.

Slide Actions

The *slide action*, or *pump action*, was developed in the 1880s. It was more widely used on shotguns than on rifles. Most slide action guns had tubular magazines. The slide action is the fastest manually worked action. Slide action guns can be fired three times per turn. The second and third shots are at full recoil penalty.

DERINGER AND DERRINGERS

Henry Deringer (with a capital D and one r) was a successful early 19th-century gunsmith in Philadelphia. He made fine sporting guns and bid successfully for government arms contracts. One of his specialties was the powerful pocket-pistol. This kind of piece was the gentleman’s best companion of the percussion era. It was small enough to be unobtrusive in evening dress, powerful enough to be a life-saver. Most of Deringer’s guns were about .44 caliber, with a three-inch or less barrel. They were usually sold cased, in matched pairs. They were a fairly expensive representative of their type; Deringer was a master gunmaker with an established reputation.

Deringer’s reputation was so good that it was a boast to say that your guns were real Deringers. The name became a generic term for pocket pistol; first for the same kind of high-powered gun as the original, then for any small pistol.

The Rollin White patents (see sidebar, p. 62) did not cover *barrels* bored through from the rear. This left a solid market for small, multi-shot cartridge guns. One of the most successful, and the image that most people have of derringer (the accepted spelling for the generic term), is the Remington Double-Derringer. This two-shot, tip-up gun was first on the market in 1866, and continued in production until 1935. Copies and derivatives are still made and marketed in 1998, and will probably still be in a hundred years.

The original Remington guns were chambered for the .41 Rimfire Short, a very anemic round. (But one of the few rimfire rounds still in production in the late 20th century.) The copies have been made in anything from .22 Short to .45-70. The most useful are probably the .357 Magnums. Anything with much more power than the original .41 has a devastating kick.

The great advantage to the derringer, especially the Remington, is small size. The Remington and its derivatives also have a very flat profile, and are thus even easier to conceal (+2 to Holdout skill) in a sleeve or boot-top. They have been a comfort to many people who could not be conspicuously armed.



NAVAL ARTILLERY

Guns at sea were much the same through the first part of TL5 as they had been at TL4. About 1830, a real revolution in naval armament began. Guns got bigger and bigger, culminating in things like the giant British 17.7-inch gun of the 1890s. The technology of shells improved, dooming the wooden warship - it was too easy to set wood on fire. Steam power not only propelled the ships, it powered the machinery to load and train the guns. Guns on land were restrained in size by the problem of recoil, but at sea the recoil could be taken by the ship.

Up to 1870, the cannon loading and firing rules on pp. 46-51 apply. Misfire numbers change as do those for land guns (see *Canon*, pp. 72-73). After 1870, use the rules for TL6 artillery on pp. 80-85.

ARMOR

All the armor on p. B210 is available at TL5. It is for the most part cheaper and of better quality. In Europe, most people do not wear armor openly after about 1700, except for certain kinds of heavy cavalry. In Asia and Africa, the wearing of both mail and plate is common until the 20th century.

Concealed armor is always available to those who can pay.

Breastplate

A common choice, concealed under the coat. PD 4, DR 10, weight 12 lbs. Protects only the torso (17, 18, 9-11), and only from in front. Many military officers wore one of these, right through the American Civil War. They stopped many a sniper's bullet, and even an occasional blast of canister. \$180 in 1862.

Mail Vest

This is worn without padding. It has PD 3 and DR 3, weighs 8 lbs., and protects both front and back (17, 18, 9, 10). It has PD 0 and DR 1 against impaling attacks. These vests were rare in the U.S.; they were made in China and Persia. Tong enforcers in San Francisco's Chinatown would wear them; they could be hidden completely under 19th-century clothing. They cost \$10 when available.

Steel Skullcap

The most common concealed head defense. It has PD 2 and DR 4, but protects only the top of the head (3, 4). \$5, 3 lbs.

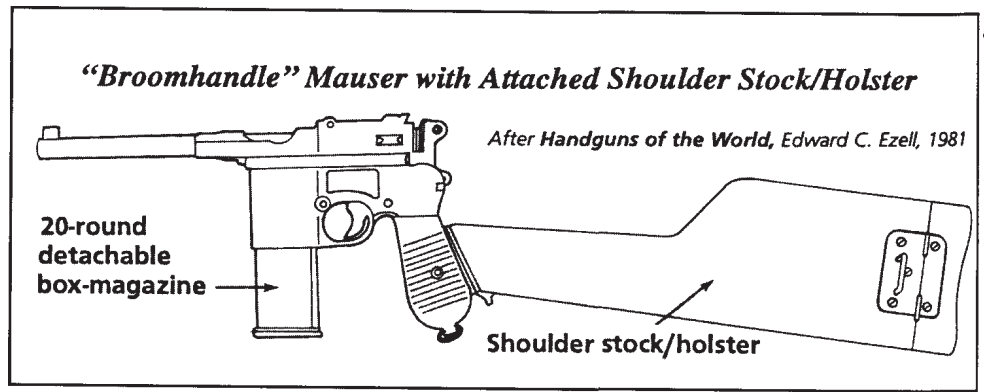

Firing Cartridge Repeaters

The success roll is against Guns. A success is a hit; a critical success is a Critical Hit. A non-critical failure is a miss.

Critical failures may be critical misses or malfunctions. All dud or jam results (8-12) are malfunctions. Duds are misfires; jams are stoppages. On a stoppage, roll once to see if the fired round was a hit. Immediate Action for a misfire is to work the action and chamber another round; time is the RoF time. Immediate Action for a stoppage requires a roll against Guns or Armoury-3. On a success the gun will be ready for service in 2d seconds. As with other Immediate Action, the GM determines both success and time. The character knows only that he is attempting Immediate Action, not whether it has worked. A critical failure on the Immediate Action roll puts the gun out of service until it is repaired by an armorer; the GM does tell the firer that he recognizes that much. On a critical success the gun is back in service on the next turn.

Cartridge Revolvers

Cartridge revolvers were very little different from caplock, or for that matter, flintlock revolvers. In the United States there was a brief period of very strange cartridge revolver actions in the 1860s and '70s. This design aberration was the result of legal, not technical concerns (see sidebar, p. 62).

Revolver Actions

Action types for cartridge revolvers were the same as for percussion revolvers - double-action and single-action. America tended to favor single-action for military use, and England double-action. Civilian buyers showed little preference at first, but mostly switched to double-action toward the end of the period.

Firing Condition and Safe Condition

Firing condition is with the hammer at full cock for single-action weapons, at full cock or fully forward for double-actions.

Until the development of positive revolver safeties (about 1890), the only safe way to carry a revolver is with the hammer down on an empty chamber. If the hammer is down on a live round, the gun has a chance (5 or less on 3 dice) of firing if it is dropped or struck sharply on the hammer. The development of the positive safeties was important enough to be a sales and advertising point, hence such names as Police Positive and Safety Hammerless. Originally these safety devices were only put on double-action revolvers; single-actions that were safe to carry fully-loaded did not appear until the late 1960s.

Loading Cartridge Revolvers

Most revolvers can be classified as *fixed-cylinder*, *break-open* or *swing-out-cylinder*. Fixed-cylinder guns were available from the beginning of the cartridge era; most of the percussion conversions were fixed-cylinder. The first break-open guns in wide use were the Smith & Wessons, starting with the American Model of 1869. Swing-out-cylinder guns did not become available until the late 1880s.

Fixed-cylinder guns have to be unloaded and reloaded one round at a time. Break open and swing-out-cylinder guns usually simultaneously eject all the empties. In the late 1880s, speed-loaders were developed for some simultaneous-ejecting guns, allowing simultaneous reloading of all chambers.

It is not necessary to empty all the chambers of a revolver before reloading, or to load all the chambers before firing. One, some or all can be loaded or empty, and the chamber under the hammer-fall will still fire.

Loading Fixed-Cylinder Revolvers

Loading is considered one Long Action.

Most fixed-cylinder guns have a built-in ejector rod with which to punch out the empties one at a time. Some cheap guns, and some expensive ones built for minimum bulk, have no ejector. The shooter has to use a stick or rod to empty the weapon.

Unloading a fixed-cylinder revolver takes one second to ready for unloading (usually by opening the loading gate and setting the hammer on half-cock) and one second per chamber to eject the empties. If the gun does not have an ejector rod, add the time necessary to pick up something to use as one. (A pencil, screwdriver or cleaning rod will work.)

To load an empty gun takes one second to prepare (if it has been “prepared” to unload, it is already “prepared” to reload); one second per chamber to reload (if the ammunition is readily available, in cartridge loops on the belt for instance); and one second to place in firing or carrying condition.

Loading Break-Open Revolvers

Most break-open revolvers are *self-ejecting*. The action of opening the weapon automatically ejects all the cartridges.

It takes one second to open and eject all the cartridges (note that any unfired ammo will be ejected as well).

If the cylinder is loaded with individual rounds, loading takes one second per round (if the ammunition is readily available). It then takes one second to close the weapon and put it in carrying or firing condition.

A successful roll against Speed-Load takes 1/3 second off the time for each cartridge - two seconds off the time for the usual six-shot cylinder.

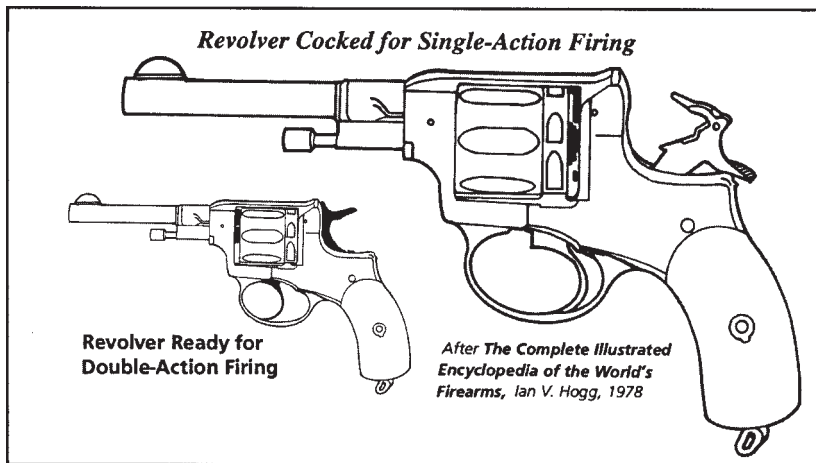

WORKING ON THE RAILROAD

Very few characters will have the capital and time to build their own railroad. They are more likely to be employed in construction or operation. Trouble-shooting for the railroad is a classic occupation for adventurers. Robbing trains is another.

In the United States, before about 1955, a railroad is a powerful Patron. For black PCs, railroad work is comparatively highly paid, and has travel advantages. Blacks were usually limited to porter, fireman or the track-gang. Engineer, brakeman and conductor were white-only jobs.

Traveling by Rail, Legally

Railroad rates vary enormously. The cheapest is about 10 miles for a dollar, to sit up in a crowded carriage. The ultimate luxury is to have your own private car, which you pay to have hooked on any train going in your direction. This costs \$1,000 a day. After 1870, sleeping cars are available on all major trains; cost of a sleeper berth is three times that for a seat.

One of the frequent perquisites of working on the railroad is free transportation. Even if the company won't issue a pass, a worker can usually talk the crew into letting him deadhead.

Traveling by Rail, Illegally

Riding the rods is the cheapest way to travel. (It is also travel without record; important if the Cabal, or the Illuminati, or the Pinkertons are after you.) Getting on a stationary train is easy; hiding on it is a contest between the hider's Stealth and the searcher's Vision roll. Train crews don't like tramps on the train; not only are they robbing the company of a fare, they will steal anything they can, especially the brass from the journal boxes - which can wreck the train. If discovered, bribery or a Fast-Talk or Sex Appeal roll might help. Otherwise, the would-be passenger will be ejected, probably with lumps for a souvenir.

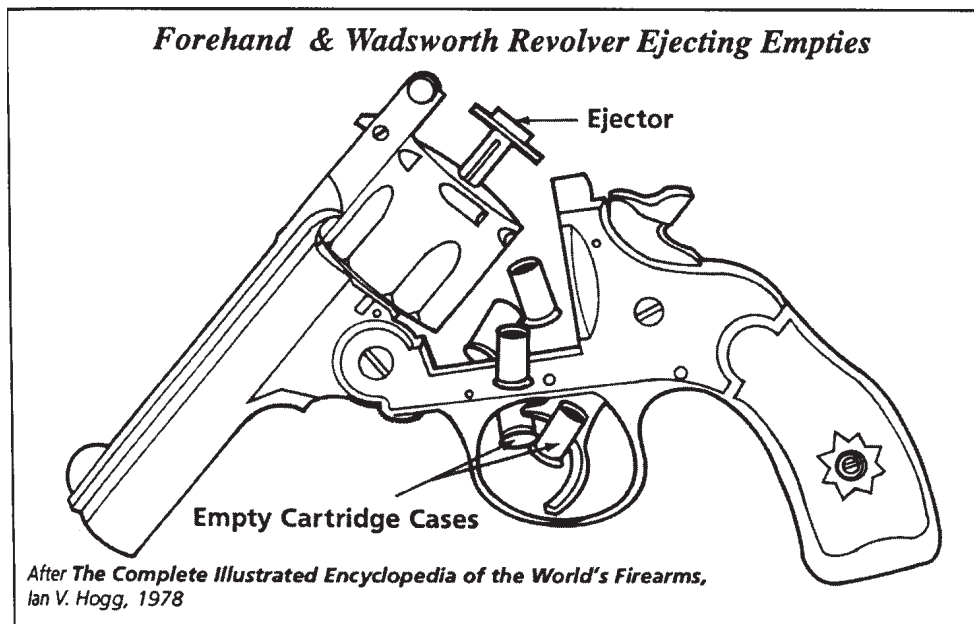

JUMPING A TRAIN

Boarding a moving train is dangerous at best, but it's sometimes the only way to get a ride. There are five ways to get on: from in front, behind, above, below and from the side.

Front and behind are usually too visible to the crew; boarding from the front has other obvious problems. If an attempt is made, it is a roll against Acrobatics (or DX-6) and is -1 for each mph that the train is moving.

Boarding from below is a frequent choice; that's what *riding the rods* means. It is not a very practical way of getting on a moving train. When the train is moving slowly, it is possible to get under it, or to lie and let it roll over. Then an attempt can be made to grab the undercarriage and swing aboard. This requires a roll against Acrobatics, at -1 for each mph the train is moving.

The top of the train is a good choice for both boarding and riding. The jump must be made from no more than half the jumper's height below the top of the car. The roll is against Acrobatics. It is -1 for each 5 mph up to 25, and another -1 for each additional mph above 25 - plus a further -1 for each 5 feet down that the would-be rider dropped.

The side is a good choice for boarding, but not much good for riding. Cars have a lot of projections that make good boarding handles; they have very few places to rest on for a long ride. The usual technique is to board from the side, then get on top or inside. Climbing or moving along the side requires a roll against Acrobatics. Boarding from the side is a roll against Acrobatics, -1 for each 5 mph up to 15, -1 for each additional 2 mph up to 25, and -1 for each additional mph above 25.

A critical failure on a boarding attempt, or any failure on an attempt from the front or underneath, is a fall under the wheels of the train. Roll randomly for damage location. Injury to the head or torso means the victim is cut in two; injury to any other location is an immediate neat amputation.

A special variation of Speed-Load is the skill of loading multiple rounds simultaneously. The human hand can, with some difficulty, manipulate two or even three rounds at the same time. Roll against Speed-Load-3 for two rounds and -5 for three rounds. On a success, two rounds can be loaded in one second; three rounds in 1.5 seconds (round up). On a failure, all the rounds are dropped. On a critical failure, they are dropped and roll completely out of reach, are stepped on or otherwise are made useless.

The first speed-loaders for break-open revolvers were for the Webley models, available in 1889. Normal loading time for a six-shot, break-open revolver is eight seconds. A speed-loader can reduce this to five seconds, and requires only a roll against Speed-Load.

Loading Swing-Out Cylinder Revolvers

Most swing-out-cylinder revolvers are *hand-ejecting*. An ejector rod attached to the cylinder removes all the empty cases with one push. It takes two seconds to prepare a swing-out-cylinder revolver for reloading: one to open the action and one to push out the empties. After that time is as for break-open revolvers (see above).

Firing Cartridge Revolvers

The normal method of firing a revolver is by pulling the trigger for each shot. RoF is 1.

Double-action revolvers can be fired either by straight trigger pressure or by thumbing the hammer back and then pulling the trigger. Trigger-pressure shooting is harder to do accurately: -2 to effective skill to hit, unless the hammer is thumb-cocked.

In a contest of Fast-Draw, a double-action revolver, which is fired double-action, is +2 to the effective skill of the shooter, if he is competing with a single-action shooter. This is just for the contest to see who shoots first.

The success roll for firing is against Guns. A success is a hit; a critical success goes to the *Critical Hit Table*. A non-critical failure is simply a miss.

A critical miss may be a malfunction. Any dud is a misfire; any jam is a stoppage. On a misfire, try to fire the next chamber. Up to three attempts to fire can be made in one second, if there are that many loaded chambers. A successful Immediate Action roll or armourer repair roll must be made before a malfunctioned chamber can be fired again. A stoppage with a revolver is a cylinder that will not turn; no shot fires without successful Immediate Action or repair.

Any other critical failure is a critical miss.

There were also two special techniques for firing revolvers quickly: see the sidebar on p. 67.

TL5 STARTING WEALTH

Starting wealth for an Earth campaign during the TL5 period is \$750. This is 150 pounds sterling, or 1,500 pieces of eight, or 750 Austrian thalers or U.S. dollars. An able seaman's pay in the 18th century, considered good for the time, was not quite 20 pounds a year (plus bed and board). A U.S. Army private in the 19th century made \$13 a month; a first lieutenant made \$90, but paid for food and quarters. A new musket cost about five pounds in 1750; a new Winchester .44 rifle cost \$40 in 1870.

Heavy Weapons

Cannon

For most of TL5, cannon were not significantly different than those of TL4. A gunner of Marlborough's army would have been equally at home with Gustavus Adolphus at Breitenfeld, or with Meade at Gettysburg. After 1870, artillery was in a wild stage of development. TL4 mixed with the beginning of TL6, and nothing really settled down until the First World War.

From about 1860 until after 1900, the critical tactical consideration was that riflemen could shoot as far as artillerymen could see to adjust fire. Until this was solved, field (but not siege or naval) artillery was eclipsed. The solutions moved cannon loading and firing out of the arena of personal combat (see pp. 80-85).

See pp. 46-51 for loading and firing cannon. About 1800, however, the ignition systems of artillery were greatly improved. Instead of firing the powder in the touch-hole directly, a quill of powder was inserted to pierce the cartridge, and then lit.

Later flintlocks, and then percussion primers (usually friction tubes of one sort or another) were employed.

After 1800 the malfunction number for cannon is 15+. After 1840, it is 16+. After 1890, only a critical miss is a malfunction.

Mechanical Machine Guns

Several attempts at machine guns were made at TL5. The American Civil War produced some that worked. But it was not until the development of the metallic cartridge, with a really sturdy case, that the problems of obturation and extraction were solved enough to allow field reliability. From 1870 until the early 1900s, mechanically operated machine guns were available and widely used. They were especially popular as anti-torpedo boat armament on warships, but saw extensive land service. (Custer could have had a battery of Gatling guns at the Little Big Horn, but turned them down because they would have slowed his approach march.)

Operating Mechanical Machine Guns

All mechanical machine guns are medium or heavy machine guns. Even medium guns are -8 to fire if they are operated off the mount. (The mount provides the necessary resistance to the torque of the operating mechanism.)

Mechanical machine guns require skilled operators. Unless the operation is smooth and even, they can jam in a variety of unpleasant ways. The familiarity modifier for a mechanical machine gun is -5. Immediate Action rolls are at a further -1 for anyone without experience with that particular model of gun.

Rate of Fire

For mechanical MGs, rate of fire is $(\text{skill} + \text{DX})/2$ up to 60mm, $(\text{skill} + \text{DX})/3$ for larger calibers.

Firing a Mechanical Machine Gun

The success roll is against the Gunner skill of the firer. A success is a hit; roll for damage for the appropriate ammunition. A critical success for one round of the group (see p. B120) goes to the *Critical Hit Table*.

A non-critical failure is either a miss or a malfunction. Mechanical machine guns malfunction on 16+. See *Immediate Action for Automatic Weapons* (p. 12) for stoppage and misfire rules. A misfire skips one shot; eliminate one shot of the group. A stoppage requires a roll against Gunner/TL5-1 for Immediate Action. (Guns using ammunition manufactured before 1880 malfunction on 15+.) Immediate Action takes 2d-1 seconds.

A critical failure is a critical miss. Duds are misfires and jams are stoppages, as above.

Burst Fire and Special Ammunition

Mechanical machine guns can be used for single-fire, but are usually fired in bursts. (See p. B120 for burst fire.)

Mechanical machine guns with a bore size of one inch or larger can use both multiple-bullet and explosive ammunition.

Multiple-bullet ammunition uses buckshot rules (p. 18).

Explosive ammunition fires like single-bullet, but explodes as a small grenade when it hits (if the fuse works). The shells are contact fused; that is, they are supposed to go off when they hit something solid. Pre-WWI fuses were not all that reliable. On a hit, roll 3 dice for fuse function. On 15 or below the fuse works and the shell explodes. It does 1d explosive damage. If the shell explodes inside a living body, damage is increased. If the explosion is in the torso or head, damage is tripled. If the explosion is inside a limb, the damage is doubled. This is in addition to any other increases to damage.

If the fuse does not function, treat as bullet damage for the appropriate caliber.

TLS TOOL KIT

Telegraph Key

Includes all that is necessary to tap into an existing telegraph line and send and receive messages. Available after 1840. Cost \$50. Weight 3 lbs.

Exploder

A hand generator that will ignite up to 12 blasting caps at once (see *Using Dynamite*, p. 28). Available after 1870. Cost \$100. Weight 10 lbs.

Marine Chronometer

An extremely accurate clock, mounted in gimbals so as not to be affected by the motion of a ship. Accurate to within three seconds per day before 1800, one second per day after 1800. Valuable for Navigation (+1 to any Navigation roll). Available after 1760. Cost \$500. Weight 20 lbs. Provided by navies or big shipping companies.

Slide Rule

An early version of the slide rule was available early in the 18th century; the modern log-log variety was developed in the 1880s. A good slide rule can speed arithmetical operations by a factor of 10! Cost \$50 and up (small ones would be cheaper at TL6, obsolete at TL7). Weight ranged from negligible for a small one, to a couple of pounds for a large one. A big one, made of hardwood, could be used as a baton if the mathematician found himself in dire straits. It would probably not be accurate thereafter.

Typewriter

The first practical typewriter was available commercially in the United States in 1874. It typed only in capitals. In 1878 the shift key for lower case was perfected. The first typewriters did not type a visible line; the carriage had to be lifted for the typist to see what had been typed. Visible-line typing came into use in the 1880s.

Typing is a Physical/Easy Professional skill. Typing speed is Skillx3 words per minute on a manual, Skillx5 on a TL7 electric. After 1880, skill at typing is always salable. After 1900 it is practically a necessity for office employment. Journalism, law and many other crafts and professions require at least a hunt-and-peck familiarity with the typewriter. (Members of these professions can assume a default Typing skill 3 less than their Professional skill.)

The typewriter provided new techniques for unauthorized access to records. Used carbons, discarded drafts and even the piece of paper most typists roll around the platen can yield information. Every typed document can be linked to the machine that typed it by a skilled analyst.

COMMUNICATIONS

All prior systems of communication were still in use at TL5. In the 1790s, a semaphore telegraph system was built in France. Flag systems were common by sea and land.

The mirror signal system was refined into the heliograph. In sunny conditions, two men with 50 pounds of apparatus apiece can communicate across 30 miles, terrain permitting. Anyone might see the signals; they can of course be coded or enciphered. Heliographs are generally available after 1850.

Electric Telegraph

The first electric telegraph systems were established in the 1840s. By 1860, the major eastern U.S. cities and part of Europe were linked by telegraph. In 1861, California was linked to the Atlantic Coast. In 1866 the first successful trans-Atlantic cable was laid. By the century's end, only a few remote locations were not part of the telegraph network.

Sending and receiving telegraph messages requires Telegrapher skill (see p. B55). On a successful roll, the message is sent or read correctly. On a failure, it is not understood. On a critical failure, the message is critically misunderstood. GMs may exercise their ingenuity when garbling messages.

A Telegrapher can tap into a line and intercept messages, or send false messages. Every telegrapher has a distinct *fist* - his way of sending. Recognizing another operator by his fist, or realizing that a message is sent by other than the expected person, requires a Telegrapher roll; Alertness helps.

Most messages are sent in International Morse Code. Of course, messages can be further enciphered or encoded. Enciphered messages are harder to send and receive accurately, since spelling can't be corrected from context ("hte" is not obviously "the.") Sending or receiving an enciphered message is at -4 to Telegrapher skill.

Telephone

The first practical telephone instrument was developed by Alexander Graham Bell in 1876. In 1878 the first commercial switchboard system was started in New Haven, Conn. By 1890 every major U.S. city had a phone system (some cities had two or more competing systems). In Europe most major cities had a telephone network, run as a government monopoly. Quality was variable; in France, there was a good network in Paris but a poor one anyplace else. An indication of how fast the telephone system spread is the number of phones in the United States. In 1877 there were less than 3,000. In 1900 there were almost a million and a half.

Continued on next page . . .

Detection

At most of TL5, detection is about the same as at TL4. Optical instruments get better and cheaper, but are still refracting telescopes. They don't show the image upside down, and don't have quite as much distortion and rainbowing at the edges, but weight and bulk are unchanged. But about 1830, binoculars come into use. Except for special applications, they replace the telescope as a field instrument.

Alarms

After 1857, the electric burglar alarm is available. It can be either a local alarm or a central station alarm - or it can do both. Installing or circumventing such a system is a Traps/TL5 skill. Note two things: such a trap is elementary to anyone of a higher TL, at least +3 to circumvent, but it is bewildering to a lower TL intruder, at least -6 to circumvent.

Transport

The great revolution in transport is steam power. Less important in the short run, but not less thrilling, are the first ventures into flight. Adventurers can go farther and faster, with more gear, and get into more trouble, than ever before.

Land

The Steam Engine

The first steam engines in wide use were the Newcomen atmospheric engines of the 1690s. These were low-powered stationary installations, used mostly to power mine pumps. From about 1770 to 1800, James Watt's patents controlled steam-engine manufacture in England. Watt favored low-pressure installations, also mostly suited to stationary application. The firm of Boulton and Watt built more than 400 engines in those years. They were used to power pumps, machine tools and industrial machinery and as traction engines. After 1800 began the real development of the steam engine for transport.

Design and operation of a steam engine is an Engineer skill. Between 1690 and 1770 any Engineer (Steam Machinery) roll is at a -6. From 1770 to 1820, rolls are at a -3. After 1820, rolls to operate steam machinery are at unmodified Engineer skill, but rolls to design or troubleshoot it are still at -3.

Railroads

Soon after the invention of the wheel, someone discovered that it was easier to pull and guide if it was rolling in its own rut. Quite a bit later, someone thought of inverting the rut, and invented the rail. By the early 19th century, horse-drawn railcars were common in mines.

Mines were already a major user of steam-engines. It was not a long step to hooking a steam engine to the rail cars. The period from 1800 to 1830 might be called the "infancy" of railroading. Anyone with engineering or mining background will certainly know of the railroading experiments; most people in Europe and the United States will have heard rumors at least.

1830 to 1860 is an age of railroad expansion and speculation. In Europe and America, major population centers get rail connections. The presence or absence of rail makes a great difference in speed and load. In 1855, a man with several tons of cargo can go by rail from New York to St. Joseph, Missouri, in a week. It will then take a month to go to San Francisco by stagecoach - if the coaches are running and the Apaches don't object too much. Any con-man may be peddling phony railroad stock (or genuine - sometimes it's hard to find a difference).

From 1860 to the end of the century the railroads spread all over the world. South America, India and China get extensive rail networks. By 1890 adventurers

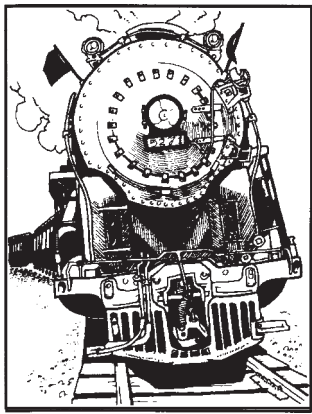

can at least get to the jumping-off place for any adventure by rail. Many plots can center around the railroad: The Steel Must Go Through/ I'll Die Before I'll Let You Put Them Rails Across My Land/ The Injuns Are Attacking The Train/ Destroy The White Man's Iron Road Or We Lose Our Hunting Grounds/ We'll Show Them Land-Grabbin' Yankee Railroads What Stealin' Is/ Nobody Robs My Express Car.

Speed of Railroads

By 1900, steam trains had managed speeds of well over 100 mph. Except in a locomotive chase, this will seldom matter to adventurers nearly as much as how far the train can go in a day. This is a variable based not only on the speed of the train, but on how often it has to stop. There are three classes of train: *Express*, running at high speed with very few or no stops; *Long-Haul*, carrying freight and passengers between major cities; and *Local*, running at low speed and stopping frequently. Speed also varies with time; trains get faster all through the 19th century. The following is a rough guide for planning the number of miles per day a train can travel. It assumes that connections get made on time and with no delay.

<i>Before 1830:</i> 400 miles per day max. (and very few 400-mile-long routes).		
<i>1830-1860:</i> Express - 800	Long-Haul - 500	Local-200
<i>1860-1875:</i> Express - 1,000	Long-Haul - 700	Local - 300
<i>1875-1900:</i> Express - 1,200	Long-haul - 900	Local - 300

Off Rail

Road-vehicles powered by steam were always possible. Trevithick, who also pioneered railroad engines, built steam carriages. The problems of suspension, steering and road-bed were so much greater off rail that practical steam cars were not developed before TL6.

Steam-powered agricultural and construction machinery, which has no requirement for high speed, was developed much earlier. Steam tractors were in use in agriculture about 1850. The first steam roller was in use about 1860. Steam shovels were in use about 1870. Anyone who needs to move, dig or squash can make use of these developments. Operation is an Engineer or Mechanic skill.

Bicycles

One form of widely used land transport was not steam powered. The first practical bicycles, called *velocipedes*, are available by 1865. They have solid wheels, one speed and are very heavy.

By 1875, the first *penny-farthing* bicycles are available; they have one enormous wheel for power and one small one for balance. Riding such a machine is at -1 to Bicycling; any spill is at least a two-yard fall.

The first safety bicycles, with equal-sized wheels, are available by 1885. By 1890, the pneumatic tire is for sale. About 1900, the modern gear system becomes available.

Bicycle speed is a function of the ability of the rider, the design of the machine, and the nature of the route. For TL5, both design and road change rapidly. In fact, a large part of the impetus for the rapid improvement of roads was the demand of cyclists.

On a level, well-paved road, maximum speed in miles per hour is the cyclist's Move, times a modifier for bicycle design: 2 for velocipedes, 3 for penny-farthings, 4 for safety bicycles and 5 for safety bicycles with pneumatic tires.

Fatigue rolls must be made more often as speed increases. At up to 1/2 maximum speed, roll every mile. At over 1/2 to 3/4, roll every 500 yards. At 3/4 to maximum, roll every 100 yards. Fatigue costs are the same as for running.

COMMUNICATIONS (Continued)

All calls were by operator connection. For adventurers, this can have several effects. In small towns, the local operator is likely to know an inordinate amount about everyone's business. This may be an excellent source of information, a serious leak of secrets or a channel for planting disinformation. In larger cities, the intimate knowledge of the operator may be less, but there is a chance that any call was noted or listened to. A friend at the telephone company is the easiest way to bug a call. The log of calls is an actual log-book; accessing it demands only a chance for a quick look.

Long-distance lines linked the local networks, but seldom extended past the major cities. In the United States, long-distance connections spread from the Eastern seaboard. Boston and New York were linked in 1884. The lines reached Chicago in 1892, but not much further until after the turn of the century. Calls were difficult to set up and involved several operator. Transmission and reception were variable; misunderstandings were common. GMs may demand IQ rolls at penalties up to -4 to ungarble hasty or easily confused messages.

MEDICINE

The years of TL5 saw more changes in medical technology than in all previous history. Most of this came between 1850 and 1900. Operations that were usually fatal in 1840 were routinely successful in 1900.

Anesthesia

After 1850, anesthesia for surgery is commonly available in the United States, Great Britain and Europe. It normally takes up to a minute to put a cooperative patient under, and three to five minutes for an uncooperative one. Inhalant anesthetics are volatile; they must be stored in airtight containers until shortly before use.

After 1885, local anesthetics for minor surgery are available. By 1850, morphine injections for pain were common.

Note: There were no laws controlling the sale, purchase or use of narcotic drugs at this time. Any drugstore in America had morphine, cocaine and heroin for sale. The only drugs that were smuggled were alcohol and tobacco, to avoid the taxes.

Antisepsis

After 1870, the use of antiseptic on wounds greatly reduced mortality. There was no direct treatment for a contaminated wound except to flush it with antiseptic.

Strong emphasis on cleanliness did not develop until the acceptance of the germ theory of disease.

TETANUS

Tetanus was one of the great killers before the modern era. The bacillus that carries the disease is found in horse manure, so was common around just about any human-occupied area until the development of the automobile. Any impaling or cutting wound received around a stable or farm-yard is likely to carry the disease. The bacillus is anaerobic, so a deep wound such as that from a punji stake is particularly dangerous.

The infection usually takes time to set in, and the longer it takes the less serious is the disease. Onset within a week is almost always fatal; onset after three weeks has a better than 30% recovery rate. After 1890 tetanus anti-toxin is available. Given any time before the actual onset of the disease it has an excellent prevention rate. Preventive treatment before that is to clean the wound well and, if possible, leave it open to the air.

Allowing a PC to get tetanus is a very serious decision. It might be a spur to action to the rest of the party, as they race the Grim Reaper for the potion/spell/serum that can save their comrade.

The symptoms of tetanus begin with headaches and a stiff neck. As the disease advances, all the muscles lock into a rigid contraction. The mouth locks in a hideous grin, the *risus sardonicus*. Any disturbance may throw the victim into convulsive contractions that can break bones and tear muscles. The only treatment for an advanced case is to keep the victim quiet and unexcited, give anesthetics for the pain and feed a liquid diet or intravenously.

If a character must be placed at risk of tetanus, use this procedure. Any time up to 21 days after a wound that could have become infected, the symptoms may appear. Roll against HT once per game day; on a failure the symptoms appear. Roll at +1 for each three days since the wound.

If the infection appears, the victim loses 1 HT per day until he is at 2/3 HT. For this period he is in pain but still able to move. At % HT he goes into contractions - "lock-jaw." If treatment including liquid diet or IV feeding is available, he continues to lose 1 HT per day. Without such treatment, he loses 2 per day. Every third day he rolls against HT (HT+1 if the initial onset was more than one week after the wound; HT+2 if the onset was over two weeks later). A success regains 1 HT; a critical success regains 3. A failure means normal loss for that day; critical failure costs an additional point. If HT is restored to 2/3, the victim remains in contractions but loses only 1 HT a day, even if HT subsequently drops below 2/3. If HT returns to normal, the victim recovers. If HT drops below full negative, use the dying rules on p. B126. Roll against HT modified for time of onset as above.

A bicycle that is being pushed counts as a two-wheeled cart for reducing encumbrance.

Water Transport

The steam engine was at work in boats at about the same time it was first used to move a land vehicle. Robert Fulton operated the first scheduled steamboat service, on the Hudson River, in 1801.

Steamboats were not faster than sailing ships, but they were not dependent on the wind. By 1825, they dominated the river trade. They were also widely used as tugs. For instance, sailing warships were frequently towed into action during the Crimean and American Civil Wars.

Operating a Steamboat

Operating the boat, of course, requires Seamanship and possibly Navigation skill. Operating the engine requires Engineer/TL5 (Marine Engines). Engines of the period were notoriously and violently unreliable. (Among other reasons, steam engines date from the 1690s, but an accurate, reliable steam-pressure gauge was not available until the 1880s!) Steamers used high-pressure engines because they were more economical with fuel. Profit, and the rivalry of owners and commanders, meant that boats tried for all the power the engines could produce. This means that any trip by steamer may be punctuated by explosion and fire. (One Temperance parade of the 1850s compared the serene progress of the Barque Temperance to the doomed race of the Steamer Alcohol.)

Piloting a river steamboat was one of the most prestigious and envied careers of the period. Steamboat Piloting was a Mental/Hard professional skill, requiring specialization in a particular river! The pilot had to memorize every single landmark and hazard of his entire route, both ways, by daylight and dark.

Air Transport

Balloons

In 1783 the Montgolfier brothers made the first ascent in a hot-air balloon. From then until 1900, adventurers have the option of going up in the air. They can't go very high, or very fast, but they can come down very hard. (The parachute was developed in the same years, but not to a real state of reliability.)

The skill necessary to fly a balloon is Piloting (Hot-Air Balloon)/TL5 or (Gas Balloon)/TL5. The skill to build one is an Engineer specialization.

Balloons have to be big to lift a significant amount. They have to lift the structure of the airship plus crew, passengers and cargo. Lift is the difference in weight between air (about 81 pounds per 1,000 cubic feet at sea level) and the gas used for lift. Hot air has a useful lift of about 30 pounds per 1,000 cubic feet, hydrogen about 68 pounds and illuminating gas (coal gas used for city lighting, the most available lifting agent in the 19th century) about 40 pounds. (Absolutely pure hydrogen would have slightly better lift, but any available at TL5 would have some contamination.) The deadweight structure (envelope and rigging) must weigh at least 20 pounds per 1,000 cubic feet. The rest of the lift is available for crew, cargo and structures to hold them.

Gliders

From about 1870, enough is known about airfoil design to produce a gliding wing that can lift one man. Both the strengths of materials and the technical knowledge of the time are such that any glider has only a slim chance of flying. Roll against the designer's Engineer skill at a -3 penalty. For every 10 seconds that the glider is airborne, another roll must be made; anything over 10 is a crash, and the pilot suffers falling damage. Nobody piloted a glider long enough to develop Piloting skill.

THE WARS TO END WARS

Tech Level 6

The beginning date for TL6, 1900, is even more arbitrary than those given for other tech levels. The technology of the early 20th century was almost all prefigured in the late 19th. In many ways, the five decades of TL6 were a playing out of themes presented at the end of TL5.

Personal Weapons

In 1886, France became the first country to adopt *smokeless powder* (see Chapter 3, *Explosives*). By 1900, every major army (and most of the minor ones) was fully equipped with smokeless powder smallarms. Many weapons of the black-powder era survived, with ammunition converted to the new propellant.

The action types developed at the beginning of the cartridge era all continued to be used.

The biggest new development was the application of auto-loading to smallarms. *Auto-loading*, *self-loading* or *semi-automatic* guns use the energy of firing to load successive rounds from the magazine, but fire only one shot for each pull of the trigger. By the end of TL6, everything from vest-pocket pistols to heavy artillery had been made as an auto-loader.

Personal automatic weapons are discussed in detail on p. B119.

Magazines and Loading

Most automatic weapons use magazines - spring-loaded boxes that feed ammunition, a round at a time, into the chamber. Loading a magazine with loose rounds takes one second per round. Many magazines can be loaded with Mauser-style *stripper clips* or *chargers* of five or 10 rounds; stripping a clip into a magazine takes two seconds.

The other common style of magazine is the drum, such as that made famous on the tommy-gun. These come in several types. All take one second per round to load with loose ammunition. Only those for which clip loading is listed as an option in the *Weapon Descriptions* (pp. 123-127) can be clip-loaded.

Loading a magazine into an empty weapon takes one second. Changing magazines takes three seconds - one to remove the old one, one to grab the new one, one to install it. Fast-Draw is available for magazines.

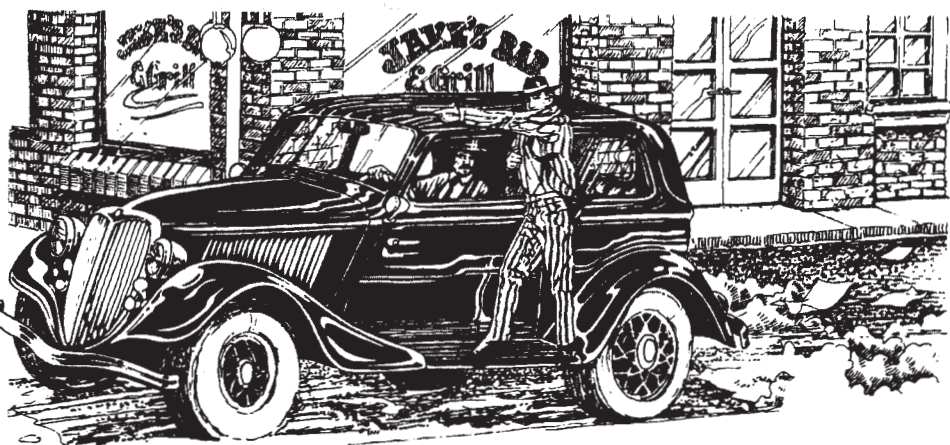

WALKING THE BURST

A burst is a stream of bullets, like the stream of water from a garden hose. The stream of bullets can be moved, which is very useful in combat. This is called *walking the burst* onto the target. This first requires *acquiring the burst*, either by seeing the bullet impacts or by observing the tracer flight. Bullet impacts can only be observed in the light; tracer can only be observed in the dark. It might be possible to observe both, e.g., by firing tracer from the dark at a man illuminated by a searchlight.

If the GM isn't sure if a character had a good view of bullet impacts, he can require a Vision roll to acquire the burst. In the dark, there is a +1 for using a tracer mix of at least one in five. There is a +2 for using all tracer in the dark. Firing tracer gives away the firer's position, of course.

Any burst of more than four rounds can be walked. On the fifth (or any subsequent) round of a single acquired burst, the firer can roll to hit on the same target. After the initial four-round group, the next group is at +1 plus half the Accuracy bonus of the weapon; that is, visually acquiring the burst has an effect not quite as good as having aimed for one second, but still better than nothing. (On a firing range, the firer can get the full Acc.) Each subsequent group is at an additional +1, to a maximum of +3, as long as fire is continuous, at the same target, and visually observable by the firer.

After each four rounds of any one burst, the firer rolls again to try and hit that target, at the skill increase for walking the burst.

Each successive four-round group does have the recoil penalty for automatic fire - the gun's regular recoil penalty, increased by itself for each group fired.

EXAMPLE OF AN SMG ENGAGEMENT

Obergefreiter Hugo Elting skulks through the Normandy bocage, MP40 ready at the hip. Suddenly he hears the crackle of brush to his left rear. With the snake-quick reflexes that have kept him alive from Leningrad to Palermo, from the Kuban to the Loire, Hugo spins left, eyes and gun-muzzle tracking. His battle-trained eyes scan the bushes - there, that patch is the wrong shade of green, not the dark of summer leaves but the olive drab of Ami uniforms.

Fifty yards, maybe 70. No time to drop or aim. Fire now! The SMG is chattering before the thoughts are even fully formed.

Dirt kicks up, low and left. Hugo holds the trigger down and lifts the burst onto target.

Red splotches blossom on the OD. Garand rifle half-way from high-port to shoulder, the U.S. soldier slumps to the ground. Another second of the war is done.

Luger with 32-Round "Snail Drum" Magazine and Shoulder Stock/Holster

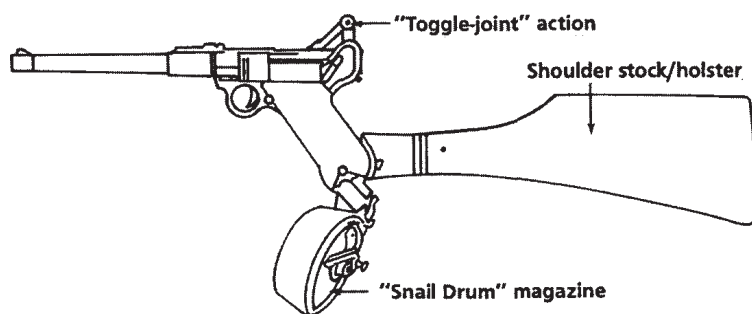

After Weapons Through the Ages, William Reid, 1976

Rifled Slugs

Rifled slugs are a TL6 development to increase the range and power of smoothbores, while retaining the option of shot-loads. The first ones were available in Germany around 1900. They were uncommon in America before WWII. England used the similar Paradox system (see sidebar, p. 64.)

Rifled slugs have three times the 1/2D and five times the Max range of a load of buckshot from the same shotgun. If fired from a shotgun equipped with rifle sights, they have +2 to Accuracy; otherwise they don't affect the weapon's accuracy.

These are very big solid bullets (see *Bullet Size Modifier*, p. 0). A 10 gauge is about .77 caliber, a 12 gauge about .73 and a 20 gauge about .61 caliber. They all get double wounding damage for damage that penetrates armor. (.410 shotguns are actually .410 caliber, an inexplicable exception to the gauge system of measurement.)

Rifle Grenades

An old weapon was revived during WWI - the grenade launched from a gun. There were models for every infantry rifle; all had about the same performance. Rifle Grenade: SS 18, Acc 5, 1/2D 75, Max 150, damage as a projectile 1d. Grenade damage is typical of period hand grenades. After 1942, there are shaped-charge rifle grenades; damage is that of the M72 LAW, p. 0.

Submachine Guns and Assault Rifles

Two new types of personal weapon appear at TL6. *Submachine guns* fire pistol ammunition. Some are autofire only; others are capable of selective fire. *Assault rifles* fire rifle ammunition and are capable of selective fire. Both use Guns skill.

Immediate Action for Automatic Weapons

Most automatic weapons malfunction on a roll of 17. Roll 2 dice; on a 2 or 3 it is a misfire (no shots are fired). The firer may begin Immediate Action.

Otherwise, it is a stoppage (some rounds were fired and *then* it jammed). Roll to hit again, at -3; the result indicates how many shots, if any, hit the target. A hit with all the rounds means the gun jammed at the end of the group.

For any malfunction, Immediate Action (see p. 12) takes 1d seconds. A success puts the gun back in service; a failure does nothing; a critical failure means the weapon must be repaired by an armorer - though, since the GM is rolling, the firer does not know that!

Machine Guns

It was not impossible to build an automatic gun using black-powder cartridges. The first models of the Maxim machine-gun were made for the British .450 Martini-Henry cartridge, and worked quite well. But the massive fouling required frequent and intensive cleaning, and the black powder produced such huge clouds of smoke

as to completely blind the crew in seconds. It was also difficult to conceal the gun, except, of course, behind its own smoke. As smokeless powder became available, heavy rapid-fire weapons became truly practical.

Heavy Machine Guns (HMG) are vehicle or tripod-mounted guns that fire big (e.g., .50-cal./12.7mm/14.5mm) rounds. Usually a team of two or three will carry weapon, tripod and ammo belts.

Medium Machine Guns (MMG) fire rifle-caliber ammunition (around .30-cal/7-8mm) but are otherwise similar to HMGs. Unless listed above, all tripod-equipped MGs are MMGs.

Light Machine Guns (LMG) fire rifle-caliber rounds like MMGs, but use a bipod and stock rather than tripod, making them light enough to be easily carried by a single gunner. Unless noted below, assume all bipod-equipped MGs are LMGs.

General Purpose Machine Guns (GPMG) are hybrid weapons such as MG34/42, Bren, M60, RPD and FN MAG. They use a bipod, like LMGs, but can be fitted with a tripod for better accuracy (3 turns to attach/detach, see *Weapon Descriptions* for weight). When so fitted, add +2 to Acc and ignore ST minimums.

Belt-Fed Guns

Most HMGs, MMGs and GPMGs are belt-fed. Loading a belt-fed gun is a Long Action requiring three seconds, or longer (GM's decision) if the ammo is anywhere except right beside the gun.

Belts come in two types: disintegrating and non-disintegrating. With a disintegrating belt, the links that hold the cartridges together separate after firing; with a non-disintegrating belt, they stay together. Disintegrating belts can be made up in any length; non-disintegrating belts are in fixed lengths. Non-disintegrating belts were the first in use; disintegrating-link belts were first developed, for aircraft guns, toward the end of WWI. Non-disintegrating belts remained standard for ground guns until the end of TL6. See the *Weapon Descriptions* for the type of belt used by any particular gun.

Flamethrowers

Portable flamethrowers date to at least the 9th-century Byzantine Empire, when bronze syphons were used to launch Greek fire. After the fall of Byzantium to the Latins in 1204, they went out of use until 1901, when the Germans introduced the first modern *Flammenwerfer*.

Using flamethrowers is a Guns specialization: Guns/TL (Flamethrower). It is enough different that it does not default from another Guns specialty. RoF is one shot per second; each shot is a one second burst of flame treated as a four-round burst of automatic fire. Use the Automatic Weapon rules (p. B120); as with lasers, add damage from multiple hits together for penetrating DR. Unsealed armor gets only 1/5 DR vs. flame. A hit burns for 10d seconds doing 1d extra damage per second (armor protects as above). Damage is to the entire body, not one location, and isn't limited by blowthrough. Flamethrowers are awkward, taking two seconds to ready.



PLAY OF THE ENGAGEMENT

Hugo has Combat Reflexes, Acute Vision +4 and Guns/TL6 (Light Automatic)-16. The reflexes bring him around and the acute vision adds enough to the Quick Contest of Skills (Hugo's IQ against the American's Stealth), for him to spot the target.

"How far off is he?" says Hugo's player.

"Over 50 yards, but way less than 100," says the GM. In this tight corner, time to aim might be time to die. Hugo's player chooses to fire all eight rounds possible at the RoF of the MP40, without aiming. He rolls against Hugo's skill with the weapon. The roll for the first four-round group is 10.

"Miss," says the GM. (Hugo's skill is 16. The speed/range modifier is 9, for a 7. The Snap Shot number of the MP40 is 10, so there is a further -4 penalty, and another -1 for recoil. Hugo could have hit only on a critical success.

"Can I see the rounds?" the player says. The GM makes a Vision roll for Hugo. "Yes, you can." "I'm walking the rest of the burst and trying for the body," says Hugo's player.

The GM determines whether the character can visually acquire the burst in order to move it onto target. The shooter must be able to see both the burst and the target. An experienced auto-weapons man, such as Hugo, will deliberately fire low and short, so that the dirt kicked up by the bullets will give him the visual index of the burst. In special cases, the GM can rule the burst is not visible at all. A burst fired into the air kicks up no dust!

With the second four-round group, Hugo suffers a recoil penalty of -2. But he now gets half the Accuracy bonus of 6 for his weapon, or 3, +1 for a total of 4. Speed/range is still -9. This gives a net penalty of only -7. With Hugo's skill of 16, he will hit on a 9 or less. He rolls an 8.

The GM rolls Dodge, the only available defense for the target. (OD wool has neither PD nor DR.) Not surprisingly, he fails.

"Hit to the body," says the GM. "Roll for damage."

Hugo's player made his roll by one. This means a hit with two bullets from the burst of four. Damage for one 9mm Parabellum solid is 3d-2. The damage rolls are a gratifyingly huge 15, and a respectable 8. Total damage is 23.

This is enough damage to put the unfortunate American on the ground, rolling against HT to avoid death. Hugo is free to concentrate on the other perils of war-torn Europe.

THE CONE OF FIRE AND THE BEATEN ZONE

As the bullets of a burst travel toward the target, they are dispersed around the line between the gun and the target. The pattern of dispersal is called the *cone of fire*. The bullets strike the ground in an oval pattern, with the long axis parallel to the gun-target line. This pattern of bullet strikes is called the *beaten zone*.

The goal of automatic weapons fire is to maximize the possibility of hits by centering the cone of fire or the beaten zone on the center of the target.

Grazing fire is such that the center of the cone of fire is never above half the height of a standing man. All 20th-century rifle-caliber MGs have grazing fire out to at least 500 yards. Grazing fire and beaten zones can be used as barricades of fire even when no target is visible. The burst is fired, and any man-sized target on the line of fire, or in the beaten zone, is attacked by all the rounds of the burst at an effective skill of 6.

VERY HIGH ROF

Some automatic weapons have RoF so high that figuring hits and damage in four-round groups takes too long. This is especially true of aircraft and anti-aircraft weapons. The American quad-.50 mounts four guns which are aimed and fired as one. RoF is 32 (4,000 per minute). A German mount of WWII simultaneously fired six MG42s at each target. RoF is 120!

It is both difficult and unrealistic to use four-round groups in such a case. Instead, use groups of 20 for any weapon with an RoF of 20 or more. The recoil penalties given in the Weapon Tables assume that all such weapons will be fired in groups of 20 rounds.

Most of the figuring is simply multiplication by 5. Rolling the exact number needed, or +1, is a hit with ten bullets. Rolling 2 to 4 more is a hit with 15 bullets. 5+ is a hit with all 20.

There is a slightly better chance to hit on a near miss. A roll failed by 1 is a hit with five bullets; a failure by 2 is a hit with one bullet.

Figuring by groups of 20 can be done for any group of 20 or larger. Any group of less than 20 must be computed in groups of four. This includes rounds left over from a burst computed in groups of 20.

Most backpack flamethrowers have a maximum range of less than 40 yards. Within that range it is easy to hit a target, since the stream of fire can be moved like the stream of water from a hose.

On a critical failure with a flamethrower, roll 3 dice. 5 or less means a simple non-ignition; the target is sprayed, but there is no flame unless the jet strikes a flame at the target. 5-17 means no fuel is sprayed. An 18 is a backfire; the weapon explodes and does the equivalent of one second's damage to the firer's hex and all adjacent hexes.

On any malfunction result except the last, Immediate Action can be attempted; this requires 10 seconds. A success returns the weapon to action; a failure lets the firer try again; a critical failure explodes, as above.

Flamethrowers can also explode if struck by a bullet or fragment. A firer can deliberately target a flamethrower; the modifier is 0 for a shot at a completely exposed flamethrower and -4 if the thrower is a backpack model and the carrier is facing the firer. The flamethrower has a PD of 1 and a DR of 2. If it takes damage above DR, roll one die. On a 1 the thrower explodes as above. On any other result, the thrower is put out of action.

Flame damage has almost no penetrating power on cover. Even a sheet of plywood will deflect the stream of burning fuel. If the stream is kept on the cover, it may catch fire, but the target behind it has time to attack or retreat.

Vehicular Flamethrowers

Flamethrowers are also mounted as vehicle weapons. Firing one is a Gunner skill. Specifications are in the *Weapon Tables*. Critical failures are as for portable flamethrowers, except that the vehicle's DR protects the crew from damage. The flamethrower is normally within the armor envelope of the vehicle, but can be an add-on mounted outside. Outside-mounted flamethrowers have the same PD and DR as portable flamethrowers.

Heavy Weapons

After 1900, artillery had to move back of the battle-line to survive. Gun crews within range of rifle or machine-gun could not live. Heavy weapons were divided into two categories. Some accompanied the maneuvering troops; others remained at a distance and supported the maneuver only by firing at the enemy. For convenience, these can be called *Artillery* and *Infantry Heavy Weapons*.

Artillery

Three things made it possible for the artillery to support the battle while remaining out of reach of the weapons of the opposing troops. These were obturation, recuperation and forward observation.

Obturation is sealing the chamber against loss of gas on firing. It allows a given charge of propellant to send the projectile much farther. In the late 1890s, several systems of breech-sealing were developed that actually worked. Most of the designs were things that had been tried, unsuccessfully, as far back as the 15th century; precision fitting and modern materials made them workable.

Recuperation is the fitting of hydraulic or mechanical devices to the gun to absorb recoil and keep it in position. Instead of the gun recoiling six to twelve feet each shot, and thus having to be re-laid each time, it stays in the same place.

Forward observation added to the utility of guns out of line of sight. There are three ways to use artillery: *direct fire*, at targets visible from the gun; *predicted fire*, at targets located on a map; and *observed fire*, at targets which can be seen by someone not at the gun who sends corrections to the gunner. This last method relies on forward observation.

Predicted and observed fire are collectively referred to as *indirect fire*. Direct

fire is too costly in casualties; predicted fire is often imprecise. Observed fire had been used in special cases for centuries, but it took reliable communications (first telephone, then radio) to make it practical at the ranges of TL6 guns. See sidebar, p. 98, for communications equipment.

Observing Fire

The Forward Observer (FO) must be able to observe both the target and the incoming rounds. (Observe does not necessarily mean *see*; artillery can be directed by sound or by radar.) He directs the guns by telling the gunners where a round hits in relation to the target. The gunners then correct fire until they are impacting near enough to the target to do the damage that the observer wants.

He must be able to locate the target on a map common to the observer and the guns. This is usually done by imposing a numbered grid on the map, and identifying points by coordinates. Other methods will work; artillery fire can be directed from no more than a road map, if both guns and observer can find the same reference points. The observer does not have to know where the guns are; the guns do not have to know where the observer is. If the observer can tell the Fire Direction Center (FDC) where the rounds land in relation to the target, that will do. If he can send distances as well, he can home in very quickly.

Very seldom does the first round of an artillery mission hit the target; usually it takes at least two adjustments (“one over, one short and split the bracket”). It may take many more.

Forward Observation as a skill is defined in the sidebar on p. 82. Any attempt to direct artillery fire (including naval gunfire and air-strikes) requires a roll against Forward Observation.

Adjusting Fire

The usual FO procedure is to *adjust fire* from one gun until the rounds are close enough to the target, then *fire for effect* with enough rounds to achieve the desired effect on the target.

The first part of the FO's job is to get within observing range of the target. This may be a major part of the adventure if the target is behind enemy lines.

Locating the target requires a roll against FO skill or Navigation by the GM. A critical success locates the target to a particular hex. An ordinary success locates the target within 100 yards, minus five yards for every point by which the roll was made. A failure is an error in location of 100 yards times the number by which the roll was failed. The GM picks this point; this is the target that the guns will shoot at with the first round. A critical failure sends the FO's location as the target (or is some other embarrassing and hazardous error if the GM chooses). Modifiers are for the FO's equipment. Basic equipment is a map and binoculars. There is a -1 to skill for no binoculars, -3 for no map and -5 for having neither. Some types of equipment, especially at higher tech levels, can give bonuses.

With the target located the FO can call for fire. In certain circumstances this might demand a skill roll - to communicate with a firing unit of another language or to operate unfamiliar electronic equipment, for instance. If the FO establishes communication, transmitting his call for fire takes 2d+5 seconds. (This can be ignored unless the time it takes to engage is of game importance.)

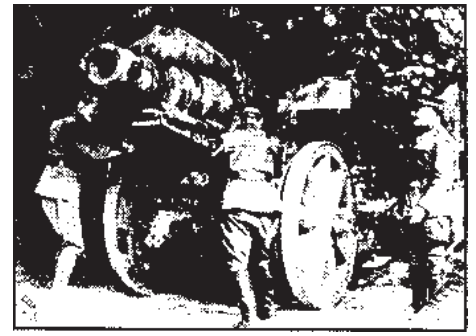
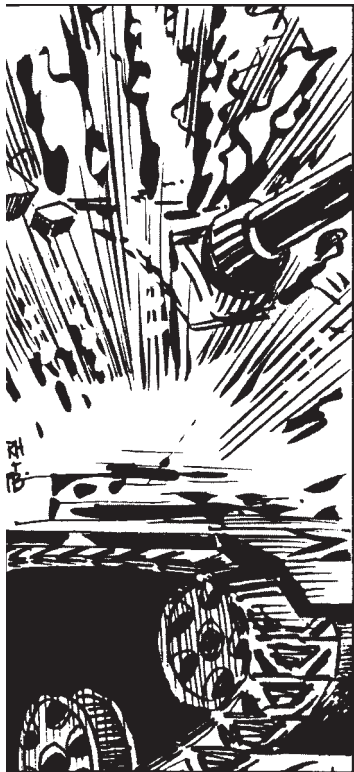

GUNS, MORTARS AND HOWITZERS

The definitions of artillery names changed with the change in technology. For TL6, *gun* means a long-barreled high-velocity piece intended for low-trajectory fire. Naval, anti-aircraft, anti-tank and long range applications use guns.

Howitzer is a shorter-barreled piece, intended for high-angle fire. It has higher on-carriage elevation, greater on-carriage traverse and a wider range of possible charges than a gun. It is principally used for support of the maneuver arms. It can reach over hills to search the reverse slopes with fire; but it can also be used for direct fire if necessary.

Mortars are even shorter-barreled and can fire only at a high angle. Most mortars of TL6 are relatively small weapons that directly accompany the maneuver units; there are some huge siege weapons.

NORMAL VISION CONDITIONS

Naked-eye vision can be reduced by light conditions, atmospheric conditions, terrain and vegetation. In unobstructed daylight, an observer can see to adjust fire at 2,000 yards. Proper binoculars (at least 7 power) extend this to 10,000 yards.

FIRE DIRECTION AND ARTILLERY SURVEY

Fire direction is the process of converting target location and observer corrections into a direction and elevation to point the guns. *Artillery survey* is the process of locating the gun position so that the Fire Direction Center will know how far and in what direction the guns are from the target. These directly affect the observer's ability to bring fire on the target.

The problem for naval gunnery is a little different; the gun position keeps changing. On the other hand, naval gunners can use the most sophisticated computers of the time. Land FDCs at TL6 are limited to the slide rule, graphic plotting, tabulated firing tables and paper-and-pencil arithmetic.

NEW SKILL: FORWARD OBSERVER

This Mental/Average skill defaults to IQ-5. This is the skill of directing fire from artillery or aircraft onto a target. It is taught only by the military. It includes the use of map, compass and terrain features to locate targets and the tactical skill of matching ordnance to the target for best effect.

PRE-PLANNED ARTILLERY FIRE

Response time to a request for artillery support can be reduced greatly if the target data can be computed ahead of time. Guns can be *registered* - fired and corrected for accuracy - on pre-planned targets. Near a contested area, artillery is likely to register hill-tops and crossroads in advance, so that an observer needs only say "Drop one on Point Orange" to get an accurate response in a short time.

Response time for a registered target is only the time necessary to lay the gun on the data, load and fire. Time is half that for a correction. Guns can even be laid and loaded on the data, prepared to fire as soon as a command is given. Response time then can be as little as one second plus flight time, if the crews are alert. Since the guns involved would be available for no other mission while laid and loaded on one target, this can only be done for the very highest priority operation. But the victims of such fire would find themselves in the center of a rain of high explosive, with no warning except the whistle of the shells.

Whole batteries and battalions of artillery can be involved in pre-planned fires. A *barrage* is a pre-planned fire operation that is intended to put a wall of friendly fire between hostile and friendly forces. A rolling barrage is actually moved in front of the attack to pin down the enemy; a box barrage is fired on the front and flanks of a raiding party to prevent a counter-attack, or around a defensive position to prevent the enemy from reinforcing his attack. A *TOT (time on target)* mission is planned so that all the rounds (possibly dozens) impact at once on the same target. These missions can all be arranged in advance so that the observer only has to give a single message to start the firing. Thousands of rounds could be fired without a further message from the observer.

Once the firing unit has received the order, they must compute firing data, select and fuse the ammunition, load and lay the piece, and fire. All this plus the time of flight of the projectile makes up the response time . . . from when the FO finds a target to the time something hits (or misses) it.

Response time varies with the strength, equipment, state of training, physical condition and position of the firing unit. A battery of dead-tired, green troops humping 200-pound, 8-inch projectiles in the Italian winter mud will not be as prompt as a battery of fresh, crack veterans handling 20-pound, 75mm shells on the range at Fort Sill on a bright May morning. Speed of response also improved with the development of artillery technique as the new weapons and tactics were absorbed. Figure response time to compute and fire as follows:

First rounds on a new target:

Before 1915 - Five minutes.

1915-1940 - Four minutes.

1940-1950 - Three minutes.

Add 1d seconds for projectiles that weigh over 100 pounds (above 155mm). Add or subtract 2dxmodifier seconds for troop quality. Modifiers: Elite -2; Crack -1; Seasoned 1; Average 2; Green 3; Raw 4.

Add 1d seconds for bad weather; 2d seconds for very bad weather.

Subsequent rounds on a target:

Before 1915 - Two minutes.

1915-1940 - A minute and a half.

1940-1950 - One minute.

Modifiers are as above. It is assumed that crews are of at least minimal training, adequate numbers, reasonable health and strength, with all the essential equipment and able to concentrate on the fire mission. GMs should consider penalties to both time and accuracy for short-handed crews, debilitating disease, fatigue, faulty or missing tools and the effects of enemy action.

Flight Time

Flight time is subject to an enormous number of variables: powder charge, temperature and pressure of the propellant, trajectory, air temperature and pressure, barrel length and wear. Two types of mission, high- and low-angle, enormously affect flight time. High-angle missions are fired to a high midpoint of trajectory in order to clear intervening obstacles. Low-angle missions fire at a more shallow trajectory, and get there sooner with fewer variables in the flight. For gaming purposes, it is reasonable to use a flight time of 500 yards per second for low-angle missions and 200 yards per second for high-angle missions. (These are not muzzle velocities; they are the times an FO has to wait for a round to impact in an indirect fire mission.)

Accuracy of Fire

Artillery accuracy is defined as the percentage of rounds that will land within a given distance of the target point under standard conditions. This varies from weapon to weapon. Since all modern artillery can fire explosive shells, a direct hit is not necessary for target damage. Once one gun has been adjusted close enough for target damage, other guns fire on the same data to saturate the target area with fire.

For gaming purposes, the inaccuracy of the firing weapon is part of the passive defense of the target. (The target is the location that the FO sent to the FDC, whether that is the true position of what he wants to hit or not.) The GM rolls 3d x thousands of yards from the guns to the target. This is the number of yards the rounds land from the target. (On a 3 roll again; a second 3 is a hit within one yard of the target.) For multi-hex targets, measure from the center of the target. Figure direction of miss as on p. B119; treat north as direction #1.

Some specific artillery weapons may be either more or less accurate; this will be noted in the weapon descriptions.

This is the inherent accuracy of the weapon, properly used by at least Average troops. Green troops miss by twice that, Raw troops by three times.

For the first round fired, this will be the accuracy against the target that the FO sent to the guns (see target location above) regardless of whether it is really where he wants to shoot. Accuracy can be plotted for every round if only a few rounds are being fired and there is a real chance that a miss might spare the target significant damage. If the target area is being saturated with fire, it is safe to assume that the errors will cancel out.

Correcting Fire

The first shot gives an invaluable piece of information to both the FO and the FDC. They know where the rounds are actually hitting in relation to the target under the actual prevailing conditions. (That is, if the FO actually observed the rounds. If he is crouching in a hole with head down, or locked in hand-to-hand combat, he is not likely to have made a good observation.) Even if the battery, target and observer are all mislocated, observational data can be converted into fire orders that will hit. The number of corrections depends on how close the first round was, how skilled the observer is, how big the target is and how far away the rounds can hit and damage the target.

The first shot locates the rounds in relationship to the target. The second refines that location and defines what changes move the rounds how far and in what direction. The third should be very close. A final correction ought to bring the rounds close enough to deal with any ordinary target. The observer can continue to send corrections and refine data as long as he is observing.

Observer correction rolls are against FO skill, made by the GM. Modifiers are for distance to the observed event, visibility, equipment and distraction. A success means that the round was observed and a valid correction sent to the guns (time to send is 2d seconds, if time is important). The correction changes the position to which the FDC is computing data. On a success that point is half as far from the actual target as was the first round. A critical success means that the point is actually on the target. A failure either puts the point 100 yards times the number by which the roll was missed farther away from the target, or is lost to observation and no correction is possible (GM's option). A critical failure is a serious error; the new point is the FO's position, a friendly unit location or some other dangerous or embarrassing location.

The modifier to FO skill for distance is -1 for each 500 yards from the target (tripled if he does not have binoculars). The GM must rule on whether or not the target is visible from any given position.

Hitting a moving target is a more complex problem than with direct fire weapons. The FO must predict both the target's speed and the time it will take for the rounds to impact. The penalty is -1 for each 10 mph of target speed, and -1 for each 30 seconds of flight time. The GM makes the roll and does not have to say if it worked until the shells fall.

Artillery Damage

Artillery shells can damage in three ways:

Kinetic energy damage - The damage caused by the mass and energy of the projectile can be enormous. The muzzle energy of a 105mm howitzer shell is 1.25 million foot-pounds (compared to 3,000 foot-pounds for a .30-06 rifle). All this energy is expended in a very small space; a 105mm shell is only four inches in diameter. A human being hit by a 105mm won't even slow it down (and probably won't activate the fuse). Some artillery pieces, such as tank and anti-tank guns, have non-explosive kinetic energy ammunition. KE damage is expressed in dice just as for bullet damage. Except for the smallest artillery shells, about the 1-inch range, the damage is so enormous that not even dinosaurs have any significant resistance. For examples: KE of a 1-inch Catling = 3dx5; KE of a 20mm Oerlikon = 3dx7; KE of a 40mm Bofors = 6dx6; KE of a 105mm M101A1 = 6dx23.

TYPES OF AMMUNITION

Shrapnel - Antipersonnel shell; see pp. 20-21.

High-Explosive (HE) - The most common artillery shell after 1916. See *Explosives*, pp. 22-25.

Illuminating - Filled with something that provides light, usually magnesium, and a parachute. One or two shells hanging above a battle give a very distinctive light. It is day-bright, white and very sharp-edged. Shadows look as though they had been stamped out with a cookie-cutter. Illum rounds last for 30-180 seconds, depending on size, altitude, wind and several other variables. Navies call this star-shell. Should an illuminating round strike a flammable target, it will perform as an incendiary round (below).

Selecting and directing illuminating rounds is part of FO skill. A success lights up the area the FO selects to the limit of the materiel. A failure illuminates the wrong area, or puts the shell too high or low for adequate illumination.

Incendiary - Designed to set things on fire. White phosphorus shell (WP) is also used for smoke and target marking, but it is a very effective incendiary. Anything that will burn at all (see p. 23) will ignite if hit with "Willie Pete."

Smoke - Used to produce smoke screens; the amount depends on the shell (see the *Weapon Tables*). Properly placing a smoke screen is an FO skill. It depends on wind, weather and terrain.

Gas - Dispenses poison gas; no one yet has filled artillery shells with riot gases. The amount of gas depends on the caliber of shell. It is never as great for artillery shells as for ground-mounted or rocket-propelled dispensers. So much of a shell's weight is made up of structural metal to resist the stress of firing that there is not much room for gas. See the *Weapon Tables* for details.

Canister - An antipersonnel round. See pp. 20-21.

Armor Piercing (AP) - Generic term for projectiles designed to punch through armor by kinetic energy. Often modified by another letter: APX (Armor Piercing Explosive), API (Armor Piercing Incendiary), APT (Armor Piercing Tracer). Such shells are high-velocity, very massive or both. It takes very high gun-weight to projectile-weight ratios to stand the stress.

Shaped Charge - Uses the Monroe effect (see p. 27) to crack armor with a low-velocity, low-firing-stress round. The United States calls this HEAT (High Explosive Anti-Tank). It can be used as an HE shell but with effect reduced by 50% for the same weight of explosive. Not available before 1940, and sporadically after that. After 1945 it is the standard AT round for low-velocity guns.

TYPES OF FUSES

The fuse for a shell is selected by the FDC and installed by the gun crew. The forward observer can request a particular kind of fuse, and unless there are pressing reasons (e.g., the gun crew is out of them!) he will get what he asks for.

Knowing what fuse to select is part of Forward Observer skill. If a player does not know what he wants, he may roll against skill to see if his character knows!

Quick - Detonates about 1/100 of a second after impact. Designed to burst the shell just at ground level for blast and fragmentation effect against troops and light fortifications.

Delay - Detonates about 1/10 of a second after impact. Designed to burrow into earthworks and bunkers and give the effect of a tamped explosion (see p. 26).

Concrete-piercing - Also a delay fuse, but hardened to go through heavy resistance before detonating. The 8-inch, for instance, will go through 12 feet of reinforced concrete.

Time - Set to go off at a predetermined time in the flight of the projectile. This type of fuse is used to give airbursts for troop-killing, illumination and marking missions and for anti-aircraft fire. For best result, antipersonnel airbursts should be about 20 yards in the air. The first attempt will usually be off, but the FO can give time corrections along with his distance adjustments.

Proximity - The fuse is a tiny radar set that detonates the charge at a predetermined distance from the first solid thing in its path. It is used as is a time fuse. Heavy rain can set off a TL6 proximity fuse early. Proximity fuse is available to U.S. anti-aircraft units in 1943, to field artillery in 1944, and to the rest of the world after 1945. In WWII, the details of the proximity fuse had a security classification only slightly lower than the atomic bomb.

Explosive damage - Most TL6 artillery projectiles were HE, that is, filled with high-explosive and fused to explode. (See sidebar, left, for fuses.) They do explosive damage, concussion and fragmentation; see Chapter 3, *Explosives*. Since most of the weight of an artillery shell is in the structural strength necessary to withstand firing, the explosive filling is small. It seldom amounts to more than 10% of the weight of the projectile. Fragmentation is very irregular. It consists of splinters from the casing of the shell plus any junk that happens to be around the site of the explosion. Naturally, ground bursts pick up more such junk than air bursts. A rough guide to concussion damage is below. HE fragments do 2d to 12d+ cutting damage to each hex-worth of target that is hit. (See p. 24 for details on fragmentation damage.)

<i>Gun Caliber</i>	<i>Explosive</i>
1-inch (23mm, 25mm, 27mm, etc.)	1d
1.5-inch (35mm, 37mm, 40mm, 2-pounder, etc.)	3d
2-inch (50mm, 57mm, 6-pounder, etc.)	6d
3-inch (75mm, 76mm, 17-pounder, etc.)	6dx3
3.5-inch (85mm, 88mm, 90mm, 20-pounder, etc.)	6dx6
4-inch (100mm, 105mm, etc.)	6dx9
5-inch (120mm, 122mm, 125mm, 128mm, etc.)	6dx15
6-inch (152mm, 155mm, 95-pounder, etc.)	6dx29
8-inch (203mm)	6dx65
11-inch (280mm)	6dx172
16-inch (400mm)	6dx500

(Assumes TL6: multiply by 1/2 at TL5 - and by 4/3 at TL7.)

Multiple projectile - Shrapnel was actually a development of TL5. It consisted of a fused shell filled with bullets. The charge in the shell was only enough to split open the case; the damage of the bullets was based on the velocity of the gun. It worked like an enormous shotgun, with very large shot, fired downward. It could be devastating to infantry in close formation, but had little effect on fortifications. It required fuse action at just the right time. If it burst too early, the bullets had lost force and were too scattered by the time of impact. If it burst too late, the bullets had insufficient time to disperse. Shrapnel was a very common shell until 1916. After that, it was only used if HE was not available. By 1920, only the most backward nations, and France, still used shrapnel.

Canister did not differ in kind from that used with the earliest artillery. It was still a load of bullets (usually steel ball bearings at TL6) that began to disperse at the muzzle. Some loads were packed in resin to slow dispersal and increase effective range. Canister was widely used by tank and anti-tank guns as an anti-personnel load. It was not commonly available for other kinds of gun. See Chapter 2, *Multiple Projectiles*, for details.

Normal Dispersion

When a group of guns fires at a target, they do not all attempt to hit the same point. The impacts are distributed in a rough oval, called a *sheaf*. The impacts are supposed to be close enough that unprotected troops in the area will find no gaps of safety. The usual planned distribution is about 25 yards between 3-inch to 5-inch bursts; 50 yards between 6-inch and larger bursts.

To simulate this, the first round of a unit's fire is at the target. (A battery usually adjusts with one of its center pieces.) The next round is aimed at a point to the right of the target, the next at a point to the left, the next at a point farther right and so on. Sticklers for accountancy can work out the point of impact of every round; usually it is enough to say that the impacts are 25 or 50 yards apart.

Direct Fire

Direct fire is fire that is observed from the gun. It was the standard method for anti-tank and anti-aircraft guns at TL6. Artillery units usually resorted to it only if



they were about to be overrun. Accuracy of TL6 artillery was good; it had excellent sights and, of course, every shot was braced. Accuracies of 12 to 15 are normal; exact Acc is in the weapon descriptions. Rolls are against Gunner skill with range and size/speed modifiers as for other missile weapons.

Artillery Range

The maximum ranges of artillery as a point-target weapon and as an area-target weapon are very different. At point targets, artillery is not a lot more accurate than a rifle. At area targets it only needs to get within the distance that will let the explosive filler damage the target. With an entire battery firing at normal dispersion of the shells, this does not have to be very close in smallarms terms. As a rough guide for planning; at TL6 any three-inch or larger artillery can fire indirect to 6,000 yards or more; the heaviest mobile land-based guns can fire no more than 30,000 yards. There were longer-ranged guns, but they were at best rail-mobile and often completely fixed in position.

Guns were usually positioned so that about 2/3 of their range was in front of the friendly front line. An 8-inch howitzer battery (range 18,000 yards) would be about 6,000 yards behind the lines. In frontless situations, artillery was emplaced as near to the center of operations as possible. Ranges for specific weapons are in the weapons descriptions.

Artillery Rate of Fire

The number of rounds that an artillery piece can put out is highly variable. It depends on design of the gun, weight of the shell, training and condition of the crew and many other factors. Artillery pieces cannot maintain their maximum rate of fire for more than a few minutes at a time without serious damage to the barrels of the guns from overheating. Rates of Fire for specific weapons are in the weapon descriptions. As a guide, the maximum rates for TL6 are:

3-inch - 10 rounds/minute.

4-inch - 8 rounds/minute.

6-inch - 2 rounds/minute.

8-inch - 1 round/minute.

above 8-inch - 1 round/2 minutes.

These are maximum rates with average crews for data that has already been computed and set out. This is the time it takes the crews to handle the ammunition and lay the guns.

Naval Gunfire

Naval gunfire can be directed in the same way as land artillery fire. Naval guns cannot fire high-angle missions. (Many of the guns can be elevated to high angles, but the high velocity and maximum ordinate make them too inaccurate in high-angle fire for ground support. Some specialty ships have been armed with howitzers for ground-support fire.) Ships can put out a huge volume of very heavy fire, but only if they are at the right place at the right time. They have a tendency to sail off about their own business just when you could use them the most. The GM is the final arbiter as to what naval support is available.

OBSERVED FIRE FOR OTHER WEAPONS

Mortars are observed as is artillery. The range is usually short, and high-angle is the only kind of fire. Details of mortars are in the *Weapon Tables*. Light mortars have such a short range that the observations are frequently made from the firing position; sometimes the firer does his own observing and corrects by eye instead of by calculation. This speeds response time.

Machine-guns and auto-cannon can be observed. The object is to move the beaten zone over the target. The beaten zone is one yard x the range/speed modifier in length and one yard wide; 1/3 of all the rounds are in the center hex of the beaten zone and 2/3 are divided among all the others. The observer can walk the burst toward the target as if he were firing a small-arm. The observer can send one correction to the fall of shot every second. The center of the beaten zone can be moved up to 10 yards per second for every 100 yards of range. Sweeping the gun distributes the rounds over even more area than the normal dispersion. The length of the beaten zone times the number of yards that the zone is moved gives the square yards over which the fire moves. Divide the number of shots fired by the number of square yards, to determine what the chance is of one round falling in a hex. If a given hex is attacked, each round falling in that hex has a flat roll of 9 to hit it.

Shifting the burst without walking it requires a roll against FO skill. A critical success moves the beaten zone directly over the target with one correction. A success moves the burst closer to the target; the better the roll the closer it should go. A second successful correction should move the burst onto target. A failed roll moves the burst away from the target; a critical failure has some bad result. It should only hit the observer's position if that is reasonable given the respective locations of observer, target and gun. Range/speed and size modifiers are as for other weapons.

Bursts of small-caliber projectiles are harder to see than the explosion of an artillery shell. A Vision roll is required to observe the burst. It is at -1 for each 100 yards the observer is from the target; this is tripled if the observer does not have binoculars.

Automatic weapons can be fired blind. The gunners shoot at a map reference, or just at a given elevation and direction. Usually this can be handled as an abstraction. The player simply tells the GM that he is firing blind into a given area, and the GM tells him if anything happens. This is done to harass an enemy, to establish a barrier to movement or to recon by fire. It demands a big supply of ammunition. All the shots are blind shots.

Fire from aircraft can also be observed and directed by ground units; see pp. 90-92.



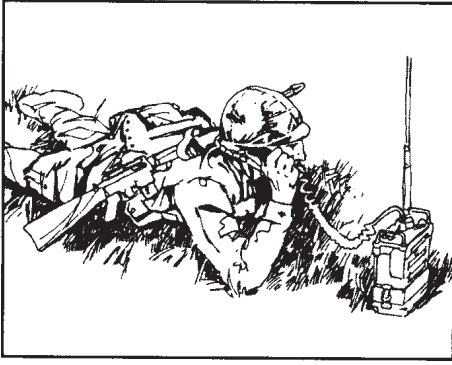

INCOMING!

To the infantryman, the warning cry of “*Incoming!*” is one of the most terrifying sounds of battle . . . next only to the whistle of the shells themselves.

Mortar fire is subsonic, and can be heard before it hits. The targets of a mortar attack have only 1 to 3 seconds to take cover from the time the shells are heard to the time they explode. Artillery fire, on the other hand, is *supersonic*. The first warning of incoming artillery fire is the explosion of the first shell, followed by the scream of that shell’s passage through the air, and the explosion of the *next* shell.

A veteran can tell whether artillery fire is getting closer by listening to the sounds of the explosions. Distant explosions are booms; close ones are *cracks*. The ground shakes, and the vibrations of the explosion jar the bodies of the troops hugging the ground.

The warning of artillery fire is “*Incoming!*” shouted by the first person to hear an explosion, hear the whistle or (possibly) pick up radio warning of an incoming fire mission. When a soldier hears the cry “*Incoming!*” he drops. Immediately. Don’t look for cover more than two steps away; you’ll never make it. A green troop yells “*Incoming!*” and drops. A veteran, on the other hand, drops *first*.

Against groundbursts, a man on the ground has a much better chance of surviving. Against an airburst, only a foxhole offers real protection . . . but you drop anyway. One of the real tests of duty is found when a soldier persists with a necessary task *instead* of hitting the dirt.

The only exceptions occur when troops are assaulting, or when they are ambushed by artillery fire. In that case, dropping is suicide - it traps you in the killing zone. But it is hard to stand up and run in those circumstances, and even harder to lead troops to do so.

Locating a target is the same as with artillery. First round data is the same; corrections are essentially the same but time of flight is liable to be longer than with artillery. Some naval guns have very impressive ranges. Naval 3-inch guns can shoot 10,000 to 12,000 yards; 5-, 6- and 8-inch guns reach to 20,000 to 30,000 yards. The main battery 12-inch to 18-inch guns of a capital ship can fire over 40,000 yards, or 22 miles! A shell as heavy as a Volkswagen, stuffed with more than 200 pounds of HE, and arriving at supersonic speed from more than 20 miles away, can be quite a *deus ex machina*.

Example of Observed Engagement

It was a crisp October morning in 1925. Corporal Calvin Knox, Arkansas National Guard, peered cautiously around a boulder. He lifted the old Zeiss 7x50 binoculars to his eyes.

About 500 yards away, in what had been Martha Johnson’s kitchen garden, sat a smooth cone of gray, rubbery matter. It was perhaps 30 feet high and 60 feet across the base. A fringe of 100-foot-long tentacles circled its midsection; they coiled and shifted with no obvious pattern.

Knox could see no other creature in the little valley. Hog-pen and chicken-run were empty; through the open barn door the stalls of the milk cow and of Colley Johnson’s prized mule team, Price and McCulloch, showed vacant. Not even an insect hum gave evidence of other life than the gray thing.

Knox moved back behind the boulder to the field telephone. It had taken most of the morning to stealthily run that line two miles from the battery position. “Redlaig, this is Blue Four. I’m on Splinter Ridge, less’n a quarter-mile from the Johnson place. The gray thing is still there, just about touchin’ the south side of the house.”

“Blue Four, this is Redleg.” The answer was in a Little Rock voice, crisper and faster than Knox’s Ozark drawl. “Can you adjust fire?”

“This is Blue Four,” Knox said. “Target is 300 yards due north of McCall’s Ford on Sow Creek. You got that on your map?”

“We have it, Blue Four. Stand by.”

Corporal Knox lifted himself back to a position from which he could see the creature, keeping the field phone at his ear.

The night before, he had seen the putrescent but still-living hulk that had been Colley Johnson, and heard Johnson’s bubbling, agonized voice.

“Hit took Martha. First it took the animals, then it took Martha, and it would’ve took me, but I ran. I thought I was clear, so I turned to look — and, oh God, its arms, its arms was on me and me a mile from the house! Hit touched me and I begun to burn, and now I’ll burn forever for my sins. I was a mile from the house but it touched me! I cut it with my knife and it let loose but now I’m burning and it talked to me in my head in Martha’s voice but Martha was gone, it took her.”

After four long minutes, Knox heard the whistle of the incoming shell and then the bang of the high explosive. The impact was south of the creature, more than halfway from its gray bulk to the silver-blue thread of the creek.

“This is Blue Four, you’re 200 yards south of the target. Fire all you’ve got on the correction. That thing’s reachin’ for me! Its arms - they’re growing toward me - and my God, it’s talkin’ to me, it’s in my head, oh God, shoot quick!”

The shaken battery commander fired until his caissons were empty. Two hours later, a patrol into the cratered ruin of the Johnson farm found rags of gray flesh, and an obscene green ooze that might have been the creature’s blood. They found no trace of Calvin Zwingli Knox, Corporal, Arkansas National Guard.

Play of the Engagement

Corporal Knox is not a very impressive character, except for his FO skill of 16. He is not, for instance, bright enough to avoid tangling with a Thing Man Was Not Meant To Know. His attack is with the heaviest weapon available; a battery (four tubes) of 75mm guns from the Arkansas National Guard.

ARMORED VEHICLE CREW

Corporal Knox locates his target; the GM rolls 16, making his roll exactly. This means that the location Knox sends is 100 yards from the actual target.

His first round for adjustment takes 271 seconds to arrive (the game is at quick time for that interval). The GM rules that the National Guard are green troops and rolls 2d for increased response time, multiplying by 3 for green troops. He rolls an 8, times 3 is 24, added to the four minutes for 1915-1940 response time. Flight time is seven seconds; the guns are 3,500 yards away.

The round lands a bit over 200 yards south of the center of the gray thing. Corporal Knox's location was 100 yards south, and the GM's accuracy roll was 15, times 3.5 for range, doubled for the green National Guardsmen equals 106 yards. The roll for direction was 4, so the hit location is another 106 yards to the south.

A 75mm shell does 6dx4 of concussion damage, quartered for every two yards. At over 200 yards the creature barely feels the shock. Fragmentation also has no effect. Fragmentation reaches to 5 yards times the dice of concussion damage (5 times 24 equals only 120 yards). But even a thing from the void between the stars is liable to notice when two pounds of TNT goes off nearby.

The creature is alerted and reaches for Knox. He makes his Fright Check and is not stunned; thus, he is able to shriek out a correction. In the interests of keeping the game moving, and because fright is a wonderful spur, no roll is required for time to send the correction. The GM rolls a 5. Knox's skill, at -1 for being 500 to 1,000 yards from the target, is 15, so the roll is a critical success. The new aiming point is the center of the creature.

Knox has staked everything on this correction, calling for fire for effect without adjusting until the rounds were hitting the target. The battery responds, slamming out four shots in only 105 seconds (again the play is in quick time). The GM rolls accuracy only for the base piece, and distributes the others at 25 yards at 90 degrees to the line of fire. (The GM should keep track of battery positions, lines of fire and other such data on his own map.) This time the National Guard is on the ball. The base piece round is 42 yards west of the target ($4 \times 3.5 \times 3 = 42$). At 25 yards east of that round, another 75mm slams into the 20-yard diameter of the thing. The direct hit does five times normal concussion and fragmentation damage since it actually explodes inside the creature. The other three rounds add their fragmentation damage, for what it is worth. The GM rules that the damage is so much that the monster cannot withdraw from this plane.

The battery commander failed his Fright Check on hearing the shrieks of his corporal. He acquires the permanent quirk of going to great lengths not to talk on the telephone. He will also have to explain to the Arkansas Adjutant General what happened to his 288 rounds of 75mm HE. The GM does not roll out the dispersion and damage of all the rounds. He has already said that the creature cannot withdraw; he assumes that there is enough damage to (at least) end the corporeal existence of this manifestation of evil.

Other Observed Fires

What if Corporal Knox had been from something besides an artillery unit? Infantry could have engaged with either mortars or machine guns. Mortar fire would be observed as was artillery.

Observed machine gun fire is somewhat different. The damage of each hit is less, but the response time is faster. Suppose that the scenario begins the same way, but the fire comes not from 75mm guns but from four .30-caliber Browning water-cooled machine guns dug in 2,000 yards down the draw from the Johnson farm.

"You're 200 yards south, shift and fire all you've got."

Five seconds later (one second to shift and four seconds flight time) the bullets begin to fall in the new beaten zone. The intervening area has been lightly peppered with bullets, but there's nothing there to hit, so the GM doesn't work out the effects. Calvin Knox is screaming frantically into the handset as he futilely empties his .45 into the tentacles that clutch him. He hangs onto the telephone as though it was a lifeline to sanity. "Fire, fire, you're on, it's still moving, Oh, please God, hurry!"

TL6 tanks are cramped, hot, dirty and noisy. Merely riding in one costs 1 Fatigue per hour, unless you are the commander, riding with your head outside - which has its own risks! Combat adds 1 Fatigue every 10 minutes. APCs are miserable, but not actually fatiguing.

The tank's main gun is operated by a gunner (requisite skill: Gunner/TL). Generally he is assisted by a loader, who is also a backup gunner. A driver - requisite skill: Driving (Tracked Vehicle)/TL - controls the vehicle. All these are overseen by the tank commander, who could also operate a turret-roof-mounted machine gun. In many tanks there was a fifth crewman who operated a bow-mounted machine gun and the radio.

Armored vehicle guns are mounted weapons unless otherwise stated. Main guns have augmented sight and fire-control systems. This varies from simple magnifying sights and gun-mounts to laser rangefinders, computer-augmented thermal-imaging viewers and fully stabilized turrets. Specific numbers are in the descriptions of individual vehicles.

Driving a tracked vehicle is very different from driving any other ground vehicle. A driver or gunner from one AFV could generally operate another AFV with some penalty for unfamiliarity (-2 or GM's ruling). A driver with no AFV experience would be at a -6, and would have to acquire Driving (Tracked Vehicle)/TL as a new skill.

Maintenance of armored vehicles is also difficult. The parts are bigger and more awkward, the strain on components is more severe and the location of components is dictated by the demands of the armor envelope. Mechanic rolls are at -2 for those without armored-vehicle-repair experience, and at -1 for those without familiarity with the specific vehicle being repaired.

AFVs are *noisy*. There is a -10 to hear anything on the exterior of the vehicle while it is operating, a -3 if it is not. AFV crewmen may be either *buttoned-up* or *opened-up*. While buttoned-up, they are incapable of visually observing anything within a 10-yard radius, and are at a -2 penalty to observe anything else. While buttoned-up, the driver may only observe things in the forward 90° arc. The gunner may only observe things in the forward 60° arc of the turret. The loader and tank commander may search throughout a 360° arc, but if the loader does so, he may not perform his primary function.

If a tank is opened, the commander normally rides outside the vehicle. He can observe without penalty, but he is vulnerable to enemy fire and a prime target for snipers.

AVAILABILITY OF AFVS

The earliest availability date for armored vehicles is the date of entry into service of the first type of that particular vehicle. It normally takes some time (less than a year in wartime, often several years in peace-time) for new vehicles to actually reach the troops in strength. Older vehicles can continue in service for many years; in the 1980s thousands of 1940s-era vehicles were still in active service. Over this time, many alterations can be made in a basic vehicle. A multi-billion-dollar international business flourishes by upgrading old armored vehicles with improved engines, suspensions, weapons, armor and fire-control.

Any nation that controls weapons at all will control AFVs tightly. Except, perhaps, in South America, private (or even corporate) ownership of any sort of AFV would be highly illegal and unusual. In a banana republic in the 1950s, it might still be illegal, but perhaps not unusual, for a private army to include APCs and a tank or two. Today . . . *quien sabe?*

Despite the restrictions, any revolutionary movement with any support at all will come into possession of AFVs, either supplied by outside sympathizers or stolen/captured from the government!

Four guns, firing at their ultimate water-boiling RoF of 8, drop 32 .30-caliber bullets into the beaten zone. The massive size of the Thing is not to its advantage here; since its bulk fills the whole area of the beaten zone all the bullets hit. That's 32 hits times 3d+1 - but don't bother working it out. The GM rules that since the damage is cumulative over the whole second, the Thing has time to withdraw to its own mysterious universe, perhaps forever, perhaps to strike again. With it has gone all that was mortal of the unfortunate Corporal Knox.

AFVs (Armored Fighting Vehicles)

The battlefields of the 20th century have been dominated by armored fighting vehicles of one sort or another since 1939. AFVs are essentially of three types. *Tanks* are direct-fire battlefield weapons intended to find, fix upon and destroy enemy forces through shock action. *Armored personnel carriers* (APCs) allow the infantry to keep up with the tanks, thus enabling the infantry to protect and support them. A sub-class of APCs is the mechanized infantry combat vehicle (MICV), which is intended to allow the infantry to participate in the shock action of the mechanized battlefield. *Support AFVs* are cross-country transport for the supporting arms, such as artillery, air defense and recovery vehicles.

The first tanks were committed to action by the British Army on the Somme battlefield on Sept. 20, 1915, at Flers. By late 1917, the essentials of armored warfare were manifested at Cambrai, as 400 tanks in a surprise offensive allowed the British to conduct the largest single-day advance on the Western front since the Marne campaign.

By 1939, the tank had standardized into its now-familiar form: an armored box, crawling on treads, with a large gun in a revolving turret and (usually) one or two machine-guns providing close anti-personnel and/or anti-aircraft defense.

Anti-Tank Weapons

The prevalence of AFVs led, naturally enough, to a proliferation of weapons designed to destroy them. The first specialized ATW was the armor-piercing "K" bullet issued to machine-gunners and selected riflemen in the Imperial German Army in 1917. By the end of the Great War, the race between armor and anti-tank weapons was already on.

The simplest method of attacking an AFV is a kinetic-energy weapon. If sufficient pressure is generated by a projectile, the armor will deform or rupture. The armor will also spall and contribute its share of bouncing fragments. These kill crew, and may also detonate any ready ammunition, setting off secondary explosions. They may also ignite fuel or lubricants, starting a fire which can also result in a "brew-up" - a flaming explosion that destroys the tank.

If the engine compartment is penetrated, the risks of fire are even greater. Most TL6 AFVs used gasoline engines, with a high chance of a catastrophic hit. The few diesel-powered variants enjoyed better odds.

High-explosive warheads attempt to penetrate armor by blasting power alone, and are not very efficient penetrators. As a rule of thumb, vehicular armor DR is squared against the concussion damage of an explosion. If the concussion damage does penetrate the armor, the chance of causing catastrophic damage is high; anything flammable will be ignited.

Another HE warhead is the High Explosive Anti-Tank warhead, a Monroe-effect weapon. HEAT warheads are good penetrators, and penetrate well at long ranges. They can be fired from relatively light weapons, so they are popular as the anti-tank armament of the infantry.

There are three different means of incapacitating AFVs. *M-kills*, or mobility kills, incapacitate the motive systems of the vehicles. Destruction of the engine, transmission, suspension or track will accomplish this. Many TL6 main battle tanks



can be put out of action by a grenade hit on the tracks. An *F-kill*, or firepower kill, is one that incapacitates the offensive system of the AFV, usually by destroying the main armament. A *K-kill* is one that destroys or incapacitates the vehicle as a whole.

As armored vehicles became more common and more effective, it was obvious that the normal battlefield weapons were not effective against them. Special rifles and heavy machine guns were a temporary answer, but for TL6 the real tank killer was a dedicated high-velocity gun firing a kinetic projectile. Anti-tank guns increased steadily in size and power. The anti-tank rifles and heavy machine guns topped out at just over 100 pounds; more was simply not feasible. In the 1920s anti-tank guns were about 20 to 25mm and weighed below 1/4 ton. By the late 1930s the standard was about 40mm at a weight of about 1/2 ton. The next step was to pieces of 50 to 60mm weighing about a ton, then to 75mm at about 3 tons. By the end of WWII the effective guns were mostly converted anti-aircraft guns of about 90mm, weighing over 5 tons.

Anti-tank guns were frequently mounted on some sort of self-propelled carriage. The most common were redundant tanks; as a generation of tanks became obsolete it was tied to a high-velocity gun and sent out to kill the new generation.

Hitting with an anti-tank gun requires a roll against the Gunner skill of the one pointing it. This is not usually the Gun Captain; his responsibility is to position and fight the gun. The gunner's sole responsibility is to hit targets. Fire is direct; most stats are the same as for other direct fire weapons. The *1/2D* is comparatively short. These guns' shells have very high velocity at the muzzle, but because of their comparatively small mass relative to cross-section, they lose velocity rapidly.

Infantry Direct-Fire Support Weapons

Troops in contact with the enemy frequently had a use for a direct-fire weapon with more range and power than rifle grenades (see p. 78). The first attempts at this were small, light conventional artillery pieces such as the French 37mm. They weighed just over 100 lbs. and broke down into components for moving, so they could accompany marching infantry. The Japanese used a very similar gun all through WWII. Such weapons fired a one-pound shell at low velocity to an effective range of about 1,000 yards. They were useful against machine-gun nests and soft-skinned vehicles.

Firing such a gun requires Gunner skill. They are mounted weapons, usually on a tripod, and cannot be fired off-mount. Usually they are disassembled into at least three component groups for transport. Assembly takes a trained crew 2d+3 seconds. Stats and specifications are in the *Weapon Tables*.

Near the end of this period, the recoilless gun was developed. It balances the recoil of the shell going out the front with a blast of high-velocity gas at the back. This allows for a very light weapon without the bother and expense of a recoil absorption and recuperation system. The drawbacks are a backflash that is itself a lethal weapon and a propellant consumption three times that of a conventional gun. Recoilless guns of up to a ton weight have been built, but the majority are much lighter. They come in two general categories: shoulder-fired guns of 15 to 30 pounds and mounted guns of up to about 300 pounds. The smaller guns are usually handled by a two-man team - one to carry and fire the gun, one to carry the ammunition and load. Heavier weapons are usually carried, mounted on or towed by a small vehicle.

Firing any recoilless gun requires Gunner skill. Stats are in the *Weapon Tables*. Most recoilless ammunition is HEAT (see *Monroe effect*, p. 27).

At about the same time as the recoilless guns, the portable rocket-launcher was developed. The classic representative is the American "bazooka" of WWII. Again, these were mostly Monroe-effect anti-armor weapons, or HEAT. They also have a lethal back-blast. Firing them is like firing a recoilless gun. Neither can be fired inside a closed room without major damage to the room and probably to the firer.

TL6 GROUND ATTACK AIRCRAFT

Some representative ground-attack air-craft of the period:

Fokker Triplane

First used in combat in August of 1917. Armed with two 7.92mm machine-guns (stats as for Maxim 7.92mm, p. 126). Usual ground attack speed 35 to 40 yards per second. No capacity for bombs.

De Havilland DH-4

First used in combat March 1917 and still in service in the early 1930s. Armed with two fixed .30-06 machine guns (stats as for the air-cooled Browning, p. 126, except RoF is 10 per gun) fired by the pilot and two flexible .30-06 machine-guns (stats as for the Lewis, p. 126, except RoF is 10 per gun). Carries up to 460 pounds of bombs (no one bomb heavier than 100 pounds). Usual ground-attack speed 35 to 45 yards per second.

Hawker Hurricane IIB

First used in combat in 1941. Armed with 12 .303 Browning machine-guns (stats as for .30-06 Browning except that damage is 6d+1 and RoF is 12 per gun). Can carry two bombs, 250-pound or 500-pound or one of each. Usual ground-attack speed 90 to 120 yards per second.

B25H Mitchell

First used in combat late in 1943. Armed with eight fixed and six flexible .50 Browning machine-guns (stats as listed except that RoF is 18 per gun) and a 75mm cannon (RoF 1/6, direct fire only). Eight of the machine-guns and the cannon are fired by the pilot. Two machine-guns are in single pintle-mounts and four are in two unstabilized power turrets. The single mounts can only fire to the sides; one turret can only fire to the rear and the other can only fire above and to the sides. Carries 3,200 pounds of bombs; its heaviest single bomb weighs 1,000 pounds. Usual ground-attack speed 80 to 100 yards per second.

F80 Shooting Star

First available for combat January 1945. Armed with six .50 machine-guns (stats as for B25). Can also carry up to 12 rockets with 25-pound warheads or two 250-lb. bombs or napalm tanks. Usual ground-attack speed 150 to 200 yards per second.

TL6 BODY ARMOR

Cuirassier's Dress Helmet

Every major European government before WWI had at least one regiment of heavy cavalry - big men on big horses, trained to charge home with the sword. Coverage is 3-4 and the back of 5, from the line of the ears rearward. PD 3, DR 4, 5 lbs., \$50. (This is the amount that would be taken from a trooper's pay if he lost one; these were government issue and not for sale on the legal market.) They were stainless steel or nickel-plated, and polished to mirror finish (+4 to any Vision roll to see one), so a cloth cover was provided for field use. Available after 1880.

Steel Skullcap

These could still be found at TL6, with improved steel. The French army issued these in 1915, and they were relatively common on the civilian market. Coverage 3-4, PD 2, DR 3, 2 lbs., \$20 for all of TL6.

Pickelhaube and Stahlhelm

The Germans went to war in 1914 with the *Pickelhaube*, a stiff, shiny leather cap with a short spike on top (PD 1, DR 1, covers 3-4, 2 lbs., \$10). By 1916 this was replaced by the first "coalscuttle" helmet, or *stahlhelm*. Covers areas 3-4 and the back of 5. PD 4, DR 4, 5 lbs., \$20.

Casque Adrian

The French issue helmet from 1916 until after WWII, and used later than that by police and reservists. PD 2, DR 3, 4 lbs., \$20. Covers 3-4 and the back of 5.

Cuirass

The body armor of a heavy cavalryman. Covers 17-18, 9-10 front and back. PD 4, DR 7, 30 lbs., \$200. Like the cavalry helmet, this was polished (traditionally cuirassiers used them as mirrors). They had a cloth cover for field duty.

Bulletproof Vest

Actually bullet-resistant would be a better name; no wearable armor will stop every bullet at TL6. It consists of small steel plates riveted between layers of fabric. It is normally worn under clothing; detecting it is a contest of Vision against Holdout-1. Covers 17-18, 9-10 front and back, PD 4, DR6, 25 lbs, \$100.

Aircraft and Air Support

Very shortly after the first powered flight, people began dropping and shooting things from aircraft. By 1918, hundreds of aircraft might be committed to a single mission against ground targets. For the FO, air support has its own problems. In some ways it is easier. The pilots of the aircraft are actually attacking a target they can see (except for high-altitude bombers, a special case). On the other hand, they are going very fast and a close miss for them may well hit the observer. Planes can carry a great variety of ordnance, but they can't change it nearly as

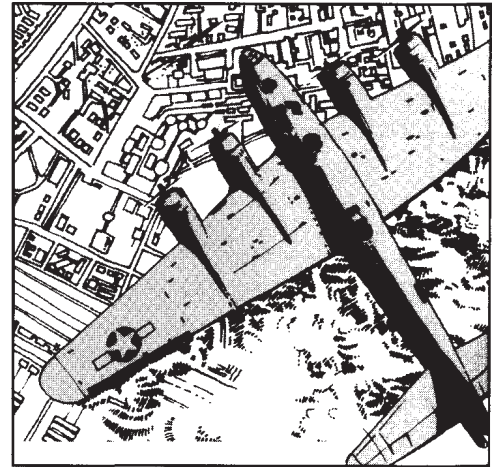

readily as an artillery unit; except for pre-planned missions, the observer is limited to whatever the aircraft he contacts happens to be carrying.

Aircraft ordnance can be classified as bombs, rockets, bullets and shells. Bombs and bullets were the first aerial weapons. The first bombs were hand grenades; the first air-launched bullets were from rifles and pistols. By 1916, the normal armament was machine guns and bombs of 5 to 250 pounds; this remained standard until about 1940. After 1940, it was common for some ground-attack aircraft to mount 20mm automatic cannon, and bombs were from 100 to 1,000 pounds. After 1942, ground-attack aircraft frequently mounted cannon of 37mm to 75mm. Rockets were first widely used in action in 1942; they usually have warheads of 5 to 25 pounds. Half the weight of a rocket warhead is high explosive. Rockets almost completely replace the heavy cannon (above 40mm) as aircraft armament before 1945.

Heavy bombing aircraft were in service from about 1916. They were not normally assigned to observed ground-attacks. When heavy bombers were sent against field targets they bombed a map-reference, just as they did in a strategic attack. The weapons involved before 1940 were bombs of up to 2,000 pounds. After 1940, bomb weight steadily increased. By 1945, bombs of up to 22,000 pounds were available for special missions. Because aerial bombs do not have to withstand firing stresses, a larger percentage of the weight can be explosive. Roughly, an aerial bomb has five times the explosive effect of a shell of the same weight. Special purpose bombs, such as incendiaries, gas-bombs, leaflet-bombs and deep-penetration bombs, were also available. After 1945, fission bombs are available, but are unlikely to be used for observed close support.

The normal observer technique for an aerial attack is to locate the target as a map-reference, mark his own position with smoke or marker panels or some other method visible from the air, then direct the aircraft by reference to his own position. Locating the target is the same as for artillery. Marking your own position is a matter for the GM's judgment. A fully equipped military FO will have smoke grenades and marker panels. An improviser will have to use his ingenuity. The GM normally determines what the success of an air strike is, but PCs on the air crew can roll against their own skills to hit a target. FO corrections are rolls against FO skill. A critical success puts the next pass directly on target; a success puts the strike closer to the target. A failure puts the next strike farther from the target; a critical failure is embarrassing or dangerous, and could be a strike on the observer's position. The skill of the pilots is expressed as a modifier to the FO's skill: Elite +2; Veteran +1; Seasoned 0; Average -1; Green -2; Raw -3. Most ground-attack pilots and crew rank as seasoned; average pilots aren't assigned to close support missions if there is any choice.

The damage of the attack depends on the type of aircraft, the type of ordnance, the skill of the aircrew and the flying conditions.

Machine guns and cannon do damage as in any other circumstances; accuracy of aircraft-mounted guns is not great but they fire a lot of rounds at once. Their fire is usually spread over an area of many yards, depending on the speed and altitude of the aircraft as it fires. An aircraft can spend several turns in a single gun attack, but, of course, has to be moving for the whole time. Aircraft, depending on type, may have fixed or flexible guns. Aiming fixed guns requires pointing the whole plane. (See pp. B135-136 for vehicular combat.) Note that planes cannot carry many rounds of ammunition, and are reluctant to use them all up on a ground target. Guns are the pilots' self-defense weapons; they hate to be jumped on the way home with no way to shoot back.

All guns firing under the control of a single firer hit in a single beaten zone (see sidebar, p. 80). The center of the zone is what is aimed at the target. On a critical success, the center of the beaten zone is the target hex. On a success the center is displaced from the target hex by the number of hundreds of yards per second that the plane is flying. On a failure, the center of the beaten zone is at least 5 yards x the speed/range modifier from the target hex. Roll 1d for direction, as per p. B119.

On a critical failure, no round from the aircraft takes effect on the target hex, and some may hit the observer or friendly forces.

The beaten zone's length is one yard times the speed/range modifier, plus the speed of the aircraft in hundreds of yards per second (round up). It is one yard wide (two yards for planes with wing-mounted guns).

Of the total rounds fired, 1/3 hit the center of the beaten zone. The remaining 2/3 is divided by the number of hexes in the rest of the beaten zone and an equal number of rounds hit each hex. Use the automatic fire rules with a to-hit number of 9; there is no recoil penalty and the burst cannot be walked. Any rounds left over impact in the center hex of the beaten zone. If there are fewer rounds than hexes, any other hex has a 50% chance of attack until all the rounds have attacked.

Example: A Grumman F8F Bearcat of the French Navy makes a gun pass at a Viet Minh machine-gun position near Haiphong. Armament is four 20mm cannon in the wings; speed is 250mph (125 yards per second). Range (the altitude of the plane as it fires) is 100 yards (the hot pilot is making his pass at a ground-hugging altitude). The 100-yard range plus 125 yards/second speed equals 225, yielding a speed/range modifier of 13. Adding 2 for the aircraft's speed over the ground yields a beaten zone of 15 yards by two yards (for the wing-mounted guns), or 30 square yards. Since the beaten zone is two yards wide, the two center hexes equally divide 1/3 of the rounds; all the other hexes divide the remainder. The RoF of each cannon is 10; four guns fire at 40. One-third of 40 is 13 and a fraction; the extra round also goes to the center for 14. This is seven hits in each of the two center hexes. 14 from 40 leaves 26 rounds that can hit any target in the remaining 28 hexes of the beaten zone. Since there are fewer rounds than hexes, the GM decides which hexes are hit. Realistically, those clustered around the center are at the greatest risk. A human-sized target in any of the hit hexes will be hit one time on a 9+.

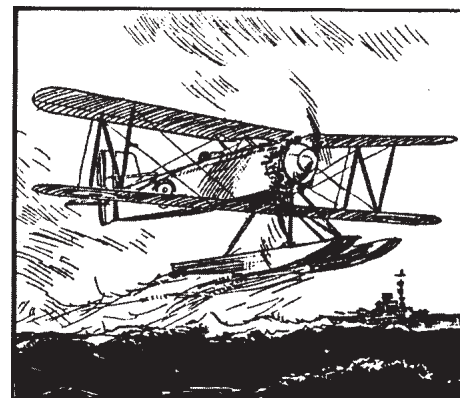

ALARM SYSTEMS

The principal alarm systems of TL6 are all electrical in nature. They depend on breaking or (more rarely) making an electrical circuit to send the alarm signal. They can be local, central-station or both. Installing, repairing or circumventing such a system uses Traps/TL6 skill. Circumventing the system is a Contest of Skill between intruder and installer.

A TL6 alarm system costs \$10 per skill level of the installer, at a minimum. Price above that depends on the nature of the premises. In general, each alarmed entrance, each alarmed room and each 100 yards of perimeter cost as much more as the minimum cost. Note that a skill-15 trapper can install a skill-10 system; it is easy to work below your skill level with alarms.

An intruder can roll against his own skill just to see if an alarm system is in place. A success means that he detects an alarm system; a critical success determines skill level of the installer. A failure means that the intruder does not know if an alarm system is present or not; a critical failure is -2 to any Contest of Skill if there is an alarm system. The GM should roll this and only tell the player "You have detected an alarm" or "You have not detected an alarm."

An intruder trying to disarm a trap is -1 to skill if he does not have the proper tools, -1 if he has less than a number of minutes equal to the skill level of the installer to work on the system, and -2 if he has to work without light. These modifiers are cumulative. The GM can assign other modifiers for adverse or favorable conditions.

Anyone entering an alarmed entrance without circumventing the alarms sets them off. Most systems guard only entrances, and once in, you are in, but some systems cover a large area or have internal trips, as well.

One critical point for alarm systems is response. An alarm that brings a platoon of Waffen SS in one minute is a different problem from one that brings one underpaid rent-a-cop in an hour. Some alarm systems incorporate lethal traps; these are illegal but not unknown in the United States, and may be common in other countries. Intruders need to do a thorough reconnaissance.



WORKING UNDERWATER

Prior to WWII, underwater work was part of one or more professional skills; e.g., Pearl Diver, Salvage Diver, Underwater Welder. The development of the SCUBA (Self-Contained Underwater Breathing Apparatus) system by Cousteau in 1946 made underwater work (and play) much more accessible. Scuba as a skill is covered on p. B48.

Free diving (without artificial apparatus) is a prehistoric skill. Success at it is measured by rolls against Swimming (p. B49) and holding your breath (p. B91). Underwater breathing apparatus is limited to variations on the snorkel, and depth to about 12 feet.

In 1819, Siebe perfected his "open" diving dress. This had a closed helmet supplied with air under pressure from a pump on the surface. Water was held out of the helmet by air pressure. This worked fairly well as long as the diver stayed vertical, but filled with water if he fell or even leaned too far. It was the best available for the time. Anyone in such a dress must roll against Professional Skill (Open Dress Diving) every five minutes, or whenever executing a difficult maneuver. On a failure, the dress fills with water and he must swim to the surface, at -2 to Swimming skill. On a critical failure of either the Diving or Swimming roll, he is tangled in his lines and cannot get up. Unless his handlers pull him up he is doomed. Open Dress Diving is a Mental/Average skill.

In 1830 Siebe perfected his "closed" dress. This hooked the helmet to a water-proof suit and provided it with controlled intake and outlet valves for air. This is still the basic equipment of the "hard-hat" as distinct from scuba diver. The hard-hat diver is tied to his air-lines, but has a long working time. Hard-hat equipment is about as safe as being underwater can be; the dangers of the job are not so much inherent in the equipment as in the environment. Most diving jobs are construction, salvage and rescue jobs that would be difficult and dangerous even on dry land. Hard-hat diving is a Mental/Average skill. In any difficult or dangerous activity performed underwater in diving dress, a diver can roll against his professional skill rather than an attribute or other skill. Failures include some sort of job-specific difficulty; e.g., a punctured hose or suit, a fouled line, a broken helmet, etc.

Continued on next page . . .

The roll to hit the target is against the skill of the observer (in this case 15 - he's had a lot of practice) modified by the skill of the pilot (+2 for an elite pilot) and for the observer's distance from the target (-2 for 700 yards). The roll is 11 which displaces the roll two yards (for the speed of the aircraft) north (1 on a roll of one die) of the target hex. Unfortunately, since the plane is flying east to west, the whole beaten zone is clear of the target. (The GM keeps track of target positions and flight paths on his map.) Since the shells don't hit anything, their KE damage (3dx7) is irrelevant. The shells explode at 2d damage each. Concussion damage is unlikely to hurt at two yards, but each explosion does 2d of fragmentation damage for a range of five yards. Unless the Communist gun is in solid cover, it is likely to be neutralized.

Aircraft bombs depend for accuracy on the skill of the crew, the equipment of the plane, the altitude of drop and the speed at the time of drop. Damage is based on weight of explosive; figure all bomb fillers as the equivalent of TNT. On a critical success, the bombs land (1d x the speed/range modifier) yards from the target hex; on a roll of 3, they land in the target hex. On a success, they land (2d x the speed/range modifier) yards from the target hex. On a failure, they land (5d x the speed/range modifier) yards or more away, always far enough away not to damage the target. On a critical failure, they do not harm the target in any way and may drop on the observer if the GM thinks it appropriate.

Rockets from aircraft at TL6 are unguided. They have a basic accuracy of 5 and are treated as are other missile weapons. They are usually fired in salvos rather than singly.

Anti-Aircraft

Anti-aircraft, or AA, weaponry was a natural response to the use of aircraft in a ground-attack role. The first AA weapons were machine guns on jury-rigged mounts with primitive sights that were nonetheless effective enough against the early, slow-flying aircraft. A Vickers weapon used by the Australian army was responsible for the death of Manfred von Richthofen, the Red Baron.

Further progress was made in the development of high-angle mounts, timed fuses and predictors, but AA fire continued to be inaccurate, relying largely on volume to compensate. The advent of radar fire control and proximity fuses, along with computers, changed all of this. AA fire became much more lethal. Of course, in the meantime, aircraft had become much tougher and faster, and the game continued.

During WWII, German researchers developed infrared and radar guidance techniques for missiles. After the war, further developments continued in the United States, resulting in heat-seeking and radar-homing missiles (p. 105).

The skill involved for any AA weapon is Gunner/TL for that system. For missiles, the firer's skill level is used solely to determine the proper setup and launch of the missile. Use the missile's to-hit number after that.

Armor

All of the armor from earlier TLs was still available in TL6, but hard to find. In a few out-of-the-way corners of the world, such as the Caucasus Mountains, the Sudan and Ethiopia, mail was still made and worn as it had been for perhaps 2,000 years. Chinese gangsters still wore their traditional mail vests, and more modern gangsters had become a market for "bulletproof vests."

WWI gave a sudden impetus to the development of armor. At the beginning of the war the only armor in common use was the cuirass and helmet of some heavy cavalry units. By the end of the war, every European army except the Russians had adopted a steel helmet, and some body armor had been issued.

Between the wars there was little development in personal armor, except for improvement and universal adoption of the helmet. In WWII body armor was devel-

oped for bomber crews; it was more efficient to armor the crews than the entire plane. These were the original flak jackets (flak is the abbreviation for *Fliegerabwehrkanone*, or anti-aircraft gun). By the end of the war there had been some issue of personal armor. The emphasis for the military was on flexible and fairly lightweight armor that would stop shell and grenade fragments.

The sidebar on p. 90 shows some representative types of armor. Another type, late in the period, was the flak jacket (p. B211).

For all of this period, any civilian purchasing or wearing armor would be an object of both official and unofficial curiosity. Those who just want a helmet, however, might be in luck. After each of the World Wars the surplus stores and pawnshops were full of excellent discarded "tin hats" for as little as a dime apiece. Anyone with money could have armor made. There are lots of good machinists and materials. Any armor within the limits of the materials can be built, but the work will probably provoke gossip.

Gas Masks

The use of gas in warfare after 1915 led to the development of the chemical protective mask. Different masks look very dissimilar, but are much the same in function. They take a little practice to get used to; eight hours is enough for familiarity with any given model. Time to put on a mask is 20 seconds minus DX for a familiar mask, 4 seconds longer for an unfamiliar one. GMs can consider other penalties for special cases; for instance, it is hard to put on a mask with one hand (double the time). The mask gives some protection against other attacks (PD 1, DR 2). Average weight with carrying case is five pounds. Sense rolls are at -4 in a mask, and it is very difficult to make anyone understand your speech (successful Hearing roll required to understand speech, and -4 to Language rolls if a different language is involved). Any fatigue penalties are tripled while the mask is worn, and it halves Ace with any weapon. After 1916 masks are standard issue to armies. After 1919 most police departments have them available (but a beat cop would be unlikely to carry one) and in the first part of WWII they were widely issued to civilians. Pawnshops and surplus stores had them for as little as a dollar. The filters for the mask degrade with use and must be renewed often; without the proper filters the mask still has PD and DR but is no use against chemical agents.

Detection

TL6 saw the development of many more items of detection apparatus. All the new resources of science were used to locate targets for the new weapons.

Sound Detectors

From the first part of the 20th century there were attempts to use sound to find targets. In WWI, sound detectors were used to find enemy artillery units by triangulating the sound of firing.

Sound detection equipment is available after 1910 in any industrially developed country. Cost for one set of equipment is \$1,000; weight is 400 pounds. Using such equipment requires Electronics Operation/TL (Sensors).

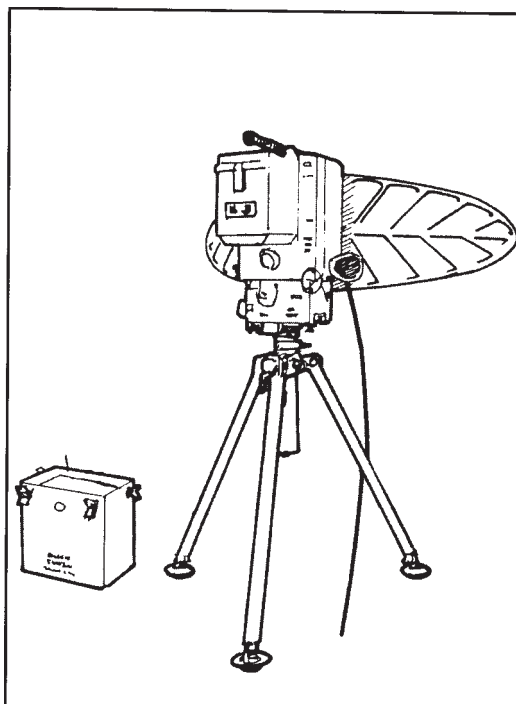

WORKING UNDERWATER (Continued)

Hard-hat diving is not a solo activity. It requires a trained crew of handlers on the surface. Before the 1940s, most air pumps were manually operated and required at least two pumpers. In addition the diver required at least one line-tender to keep air-hose and ropes from fouling. Paranoid adventurers should be encouraged to dwell on the thought of treachery by the topside crew.

Diving dress weighs 150 lbs. A two-man pump weighs 100. Lines and air-hose are 10 feet to the pound. Cost in 1830 is \$500 for an outfit to allow work at 100-foot depth.

Breathing an oxygen-nitrogen mixture at high pressure requires an extended time to depressurize on the way up. Not stopping can produce "bends." Decompression time is determined from the following table, where Depth is the *maximum* depth reached, Work Time is the time getting to the task and working (allow 1 minute descent time per 100 feet), and Ascent Time is the time spent returning to the surface (usually in several stages, stopping at different depths on the way up). Note that at 85 feet and below, maximum allowable Work Time is limited!

TL7 scuba divers would decompress in just the same way.

Depth	Work time	Ascent time
35	any	1
50	Under 1 hour	2
	1-3 hours	7
	Over 3 hours	12
67	0-14 minutes	2
	15-30 minutes	7
	31-45 minutes	13
	46-60 minutes	15
	61 minutes to 2 hours	22
85	Over 2 hours	32
	0-10 minutes	5
	11-20 minutes	7
	21-30 minutes	13
	31-45 minutes	22
100	46 minutes to 1 hour	30
	Up to 75 minutes	33
	0-10 minutes	7
	11-20 minutes	11
150	21-35 minutes	22
	36-55 minutes	32
	0-5 minutes	10
	6-12 minutes	16
200	13-20 minutes	26
	21-25 minutes	32
	0-10 minutes	34
230	0-10 minutes	40
275	0-10 minutes	76

Note that these tables have been greatly simplified, for game purposes, by the removal of columns showing the precise time to spend decompressing at different depths! If you're really going to dive, buy some real dive tables; using these could kill you.

COMPUTERS. CODES AND CIPHERS

In the 1940s the first electronic computers are built. They use tons of equipment, miles of wire and hundreds of vacuum tubes (which put out enormous amounts of heat). But they can solve complex mathematical problems faster and more accurately than humans. One of their first important tasks is breaking the complex ciphers used in radio and teletype communications.

A code is a series of prearranged secret meanings and a cipher is a mathematically-based substitution system for an alphabet. Code is frequently used casually to mean any system of disguising information (Morse "code" is really a cipher).

Since both radio and wire communication can be easily intercepted, encipherment and encoding became particularly important at TL6. In all the wars of the first half of the 20th century, communications intelligence was a major factor in success or failure.

Breaking a cipher is usually a team effort, not individual. It requires a significant sample of the enciphered text; it helps if the breakers have some idea what the message is about (military, diplomatic, industrial, etc.). Roll vs. IQ-8 or Mathematics-2. A critical success deciphers the message; a success deciphers some but not all (GM's decision).

Electronic computers give +2 to skill when they become available (1943), and then only to the very top echelon of U.S. code-breakers. Below 1,000 words of the cipher gives -1 for each 100 words less.

A failure is simply an untranslated message. A critical failure sends the cryptographer into a mental spin that allows no more successful breaking for 2d days. Roleplaying this as just about any mental symptom, from a phobia that will not allow the cryptographer to touch paper, to a delusion that Little Orphan Annie is trying to steal his decoder ring, is appropriate.

Breaking a true *code* is almost impossible. At best, you may deduce the meaning of a few code groups. And even if you know the code for "battleship," does this message say "Send three battleships," "Sighted three enemy battleships," or "Paint your aircraft battleship gray"? To acquire an enemy code, steal a codebook or bribe a clerk.

TL6 STARTING WEALTH

Starting wealth for TL6 varies with time. One of the phenomena of the modern world is rapid inflation. All amounts for this period represent U.S. dollars.

1900-1930 - Starting wealth is \$750. Detailed price lists for this period are given in *GURPS Horror*.

1931 -1940 - Starting wealth is \$1,000.

1941 -1950 - Starting wealth is \$3,000.

Successful rolls can locate any sound source of 100 decibels (the sound of an artillery piece firing) to within two yards at a distance of 10 miles. Add or subtract 1 to effective skill for each range change of one mile and each change of sound level by 10 decibels. One set of equipment is required at each observation site; three separate observations are necessary. The observations do not have to be made at the same time, but if they are not the target can move between observations. Three successful rolls, or one successful roll and one critical success, will locate the object. A failure is simply an observation that is obviously useless; a critical failure is a breakdown of the equipment that takes one day and a successful Electronics/TL roll to fix.

Naval sound detector systems are also available; an operator familiar with one could use the other at -4 if the manual or some quick training was available. Accuracy and failures are the same as for land systems.

One defense against sound detectors is to mask the critical sound with other noises, for instance by firing other artillery pieces at the same time. The GM can assign negative modifiers up to -10 for ambient noise, or simply rule that it is too noisy for sound detection to work.

Sonar

Sonar finds things by bouncing a beam of sound off the object and measuring the time it takes for the round trip. Sonar is available after 1920 to military personnel, after 1945 on the civilian market. Sonar equipment got better, smaller and more accurate all through TL6. As a rough guide, a ton of equipment at a cost of \$5,000 in 1920 is about equivalent to 100 pounds of equipment at \$2,000 in 1945.

Operating sonar is another Electronics Operation (Sensors) application, needed for several professions (fishing boat captain, naval officer/TL6-7). Sonar can be used to find objects, such as schools of fish, submarines or wrecks. It can also be used to chart a bottom, find a path through reefs or chart a course by finding known under-sea contours. Used for finding a way, sonar is +1 to all navigation rolls at sea. (For a navigator who can operate the sonar; it would be no use to Magellan.)

Many conditions, including inversion layers, temperature differentials, marine life and decoy noises can be used to spoof sonar. If there is a hunt situation, with a sonar operator in pursuit of a submarine, treat it as a Contest of Skills: Electronics Operation (Sensors) vs. the captain's Tactics.

For a full treatment of sonar, see *GURPS Vehicles*.

Radar

Radar was experimental in the early 1930s. The first equipment was both bulky and unreliable, with a tendency to identify targets that were not there and miss ones that were. Radar was a top military secret (for all the nations that were developing it) until well into WWII. Any civilian who tried to acquire or use radar before 1945 would fall under deep suspicion.

Operating radar is a military specialty until after 1945 (also extended to merchant seamen) and generally available to civilians after that date. It is another Electronics Operation (Sensors) application. Finding an object is a roll against the operator's skill, modified by the effectiveness of the equipment.

Before 1938 - Radar was purely experimental. A mad scientist or advanced researcher outside the military might have his own.

See *GURPS Vehicles* for a full treatment of radar.

Night Vision

After 1943, infrared (IR) sights and surveillance systems are available. The first are strictly limited to the military and are available only in the United States. Anyone except U.S. military personnel would have great difficulty in obtaining such equipment, and even more difficulty in explaining it. After 1945 this equipment began to appear on the police market. It would not be available to ordinary civilians until at least 1950, and cost would be very high . . . \$200 or more, which would be more than the rifle it was mounted on.

This is active IR, meaning that an IR light source at the sighting device illuminates what is observed. Out to 100 yards the effect is to convert darkness to daylight for Vision rolls. Beyond 100 yards, Vision is -1 for each 10 yards. Anyone with an IR viewer can see the illumination.

Many more night sights become available at TL7; see p. 103.

Conventional Optics

Binoculars and telescopes become cheaper and more available all through TL6. The usual power of magnification for binoculars for hunting and combat is about seven power. Ten-power binoculars are often used for artillery spotting and at sea. Astronomical telescopes have incredible powers of magnification.

Binoculars almost completely supplant the telescope for hunting, military and naval use. They can be had as cheap, good and fine. The effect of magnification is to make distant objects seem to be larger; whatever the price, all binoculars do this. Fine binoculars are +1 to any binocular-assisted Vision roll and cheap binoculars are -1. In addition, good and fine binoculars are less likely to be damaged in falls or by being used as a club. Cheap binoculars have a HT of 8, good of 10 and fine of 14 under such circumstances.

Transport

Transport is one of the great areas of change at TL6. In almost every case the change is to more, faster and farther.

Land

The key development in land transportation is the motor-car. By 1950, animal transport had been almost completely replaced by mechanical transport in the developed world. The railroads continued to be important bulk haulers of both people and goods, but the roads were major competition.

Automobiles

Automobiles changed drastically as TL6 progressed. They were expensive toys or rash experiments at the beginning of the period and everyday transportation at the end. There were constant increases in reliability and performance and a constant reduction in cost.

Automobile Reliability

Pre-1910 is the pioneer stage of automobiles. There were many manufacturers and even more designers. None of the things later to be standardized were yet inarguable. There were balloon and solid tires, electric and fire-tube ignitions, external and internal combustion engines. Knowing how to drive one car was no guarantee of knowing how to drive another. Road systems were *not* adapted to auto traffic. The infrastructure to support automobiles was not in place — for instance, the only reliable source of gasoline in the United States was drugstores. It was sold in quart bottles as a cleaning fluid.

Pre-1910 autos, whatever the type, break down frequently. (Fortunately they are easy to repair.) For every hour of driving, roll against Driving-3; a failed roll indicates a breakdown. Anything but a critical failure can be repaired by one hour's work and a successful Mechanic+2 roll. On a critical failure, the vehicle takes 3d eight-hour working days to repair.

1910-1925 is the coming of age of the automobile. Both luxury cars and workaday autos become available and fairly reliable. Garages, gas stations, and paved roads become common. Breakdown rolls are required only once a day and are at unmodified Driving skill. Mechanic rolls are also at unmodified skill; repairs take 1d hours, with critical repairs as above.

TL6 TOOL KIT

Adding Machine/Cash Register

The first adding machines were commercially available in 1820, but they were not common until TL6. Speeds simple math by a factor of 20 for a skilled operator. Early cash registers were often lavishly decorated! 1900 cost: \$50-100. Weight 10-50 pounds.

Oxyacetylene Torch

Actually developed in the late 1890s but only generally available after 1900. Cuts through metal, including hardened steel. Used in construction and burglary. Will cut 1/4-inch hardened steel at 1" a minute. 1900 cost: \$50. Weight variable: 50 to 200 lbs. A heavier one has more gas and operates longer without changing bottles.

Entrenching Tool

A combination pick and shovel that is standard issue in any TL6 army. Folds to an overall length of two feet, and normally comes with a case that can be fastened to a belt. Counts as an iron-bladed shovel (p. B90) for digging. In combat, treat it as a hatchet; it does swing-1 damage, and is used with Axe/Mace skill (-2 for poor balance); 3 lbs. and \$2 in 1900. Still extant, and almost identical, in 1988, at a cost of \$10.

Swiss Army Knife

Standard issue in the Swiss army since 1884; some other forces issue them to specialist troops. A multi-bladed pocketknife. *Standard* blades include knife, saw, screw-driver, bottle/can opener, file, fish-sealer, hook remover, wire-stripper, hoof-pick, awl and corkscrew. Separate slots hold a tooth-pick and tweezers.

A Swiss Army knife can substitute for most small tools, and help improvise larger ones. A toolless Mechanic rolls at only -3, instead of -5, if he has one. Treat as a dagger (non-throwable, doing -1 damage) in combat; it is not a fighting knife.

Weight negligible; \$5 in 1908. In 1988, identical knives are available at \$30 or so, and bulky, incredibly complex ones with dozens of blades can be had for \$100 and up. Blades on the elaborate (non-military) versions can include magnifying glass (for starting fires), Phillips screw-driver, regular and needle-nose pliers, hammer(!), fork and spoon, diamond scribe, and many more.

MEDICINE AT TL6

TL6 medicine is much more likely to keep the patient alive than at any earlier time. Antisepsis and anesthesia are in wide use. Most people who go to the hospital come back out.

Antibiotics

Sulfa in the mid-1930s and penicillin in the early 1940s were the first actual cures for disease in history. Until then medicine could treat symptoms or try to prevent infection, but not cure. Sulfa drugs are generally available in the industrialized world after 1935. Penicillin is available after 1943. At first it is available only to Allied military personnel and is in short supply. Until 1946 there is a thriving black market in penicillin, especially because it is a quick and relatively painless cure for the two common venereal diseases, syphilis and gonorrhea.

Treatment of open wounds with sulfa will prevent infection on any but a critical failure of the First Aid or Physician roll. Treatment of an ongoing infection with penicillin will cure it in 1d days except on a critical failure of the patient's HT roll. This is a relapse; the patient takes another 1d days to recover.

Plastic Surgery

After 1910 any surgeon with a specialization in cosmetic surgery can change a character's face so that it is unrecognizable. This takes a Surgery success roll and 3d+4 weeks to recuperate. On a critical failure, the surgery works but the patient now has Hideous appearance. On an ordinary failure the patient is changed but still recognizable. The 1910 price of a complete face-change from a reputable surgeon is \$ 1,000; from a criminal doctor, it would be a matter for negotiation. The criminal is less likely to tell the police afterward, unless they pay him more.

Prosthetics

Artificial limbs at TL6 are considerably better than at earlier periods. (See p. B22 for prosthetics and physical disadvantages.) One artificial limb costs \$50 in 1900. It reduces the effect of having one leg to that of having a merely crippled leg. With two artificial legs, a legless person can walk (speed 3 at best) but not run, and is -6 to any DX roll involving staying on his feet. Jumping is impossible.

1925-1950 is the maturity of the automobile. A well-maintained car is not expected to break down; no routine breakdown rolls are required. Old or abused vehicles may require breakdown rolls at the GM's discretion; any car will require one after unusual stress. Roll against Driving skill. A breakdown takes 2d hours to repair, with critical repairs as above.

Most Mechanics will not work night and day non-stop, nor will they work exclusively on one project. Eight hours of repair may take two or three days. Before 1910 finding a Mechanic (if there is not one with the car) always requires an Area Knowledge, Streetwise or Scrounging roll at -3 and 2d hours. After 1910 any town will probably have an auto mechanic; rolls are at base skill and time is 1d hours. After 1925 auto mechanics are common. Only in unusual circumstances, (e.g., primitive areas, wartime) will it be hard to find a mechanic.

Automobile Performance

Any driving maneuver is a roll against the Driving skill of the one actually at the controls. Hazards and bad conditions can add negative modifiers to this roll; exceptionally good vehicles can add positive modifiers. Losing control can be anything from an annoyance to a calamity, depending on circumstances.

Speed and payload of a vehicle are determined principally by two things: the horsepower-to-weight ratio and the suspension. A powerful engine can't give either speed or load-carrying ability if the body of the car shakes to pieces. At all stages of automobile development all sorts of vehicles, from motor-bicycles to trucks were available.

Pre-1910 autos had narrow tires, poor suspensions and low hp/wt ratios for even the best engines. They are mostly road-bound and have small payloads and low speed for any decent handling. Pushed above their very narrow operating envelope, their breakdown rate skyrockets. Roll every minute for breakdown.

1910-1925 vehicles have much better performance. Suspension, steering, tires, chassis and engines are all much better. Speed and payload are higher and vehicles are not as prone to breakage if stretched a little.

1925-1950 vehicles are still faster, stronger and tougher.

Travel by the Day

Daily rates of automobile travel depend on road conditions and weather. Even on the well-paved roads of late TL6, a blizzard can send every vehicle in search of cover. An estimate of travel rates under average conditions:

Pre-1910 - 100 miles in 12 hours of driving.

1910-1920 - 200 miles in 12 hours of driving.

1921 -1930 - 350 miles in 12 hours of driving.

1931 -1940 - 500 miles in 12 hours of driving.

1941-1950 - 600 miles in 12 hours of driving.

These times are for continuous driving, stopping only for fuel and a leg stretch. They do not include meal breaks, rest stops or breakdowns. They assume "good" roads (see p. B187). Average roads would give 75% of these distances. On poor roads, halve these distances. On no road, use 1/4 of these distances, if the vehicle can move at all, and make one breakdown roll every 15 minutes for a pre-1910 vehicle, one every 30 minutes for a 1910-1925 car, one every 2 hours for a later one.

Small Details

Standardized auto parts, lights, plugs, wiring, etc. did not become common until the 1940s. Until then each car was liable to require its own brand, which would very likely be unavailable in smaller towns. A Scrounging or Streetwise roll is necessary to find a part for the car.

Fuel consumption was enormously variable in automobiles, and until after 1925, gas stations were few and far between, outside the major cities. Carry full gas cans.

Finding gas takes a Scrounging or Streetwise roll before 1925. Figure an average of 10 miles per gallon before 1925; 15 MPG up to 1950.

Hand-cranking the engine was the normal starting method for many cars, and an option for most, until the mid-30s. Crank-starting a car takes a roll against Driving or Mechanic with penalties up to -4 for cold weather. Each attempt takes 10 seconds. A critical failure costs the cranker 1d damage to the cranking arm.

Controls were not nearly as standardized with early cars as with later ones. Before 1925 there is a -4 to driving any car of an unfamiliar make. Eight hours of driving is enough for familiarization.

Water

Water transport changed less at TL6 than did land. The steamship was the most common big vessel. Reciprocating steam engines were for the most part replaced by turbines before the end of the period. The difference is one of professional skill, and may make a difference in job-hunting. Small boats almost all can be propelled by outboard or inboard motors. Sailboats and ships usually have an auxiliary engine. Operating such engines is part of Seamanship/TL6. By the end of the period almost all large ships and many smaller ones are equipped with radar or sonar or both (see p. 97).



TL6 POWER

At TL6, electrical power became portable. The dry cell had been invented in 1888. By the late 1890s, dry-cell batteries were commercially available.

Hand-cranked and gas-powered generators appeared at the very beginning of the period; both were common in WWI. But such generators were either bulky or low-powered - the portable ones would power a few light bulbs or a shortwave radio, at best.

Almost as soon as cars become available, there are systems to draw electrical power from them for outside use. A power takeoff for a Model T might cost \$100 in 1910 (the car itself might be \$300 used or \$600 new). It would provide as much power as a portable generator. As time passed, a power takeoff from a cigarette lighter became an everyday item - perhaps \$10 by 1950.

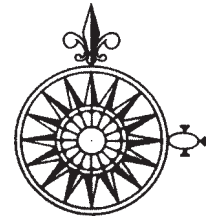

TL6 COMMUNICATIONS

The most apparent advance in TL6 communications was the radio. The first transmissions were after 1900; by 1950 the world was linked by radio. Transmitters and receivers came in all sizes, from handy-talkies with a range of a few hundred yards to multi-ton installations of intercontinental range.

Telegraph and Telephone

It was easier to send Morse code by radio than to send voice. Until the very end of TL6 long-range messages were most likely to go by code. As with electronic detection gear, the first radio installations were large and clumsy and went on ships or permanent land sites. As radio progressed, the size and weight got smaller. The biggest impetus for smaller transmitters was military demand.

1905-1910 - Radio telegraphy only. Limited to large ships and fixed shore stations. Range 100 miles from ships, 2,000 from shore stations.

Continued on next page . . .

TL6 COMMUNICATIONS (Continued)

1910-1915 - Ship range extends to 500 miles, shore station to 5,000. Portable transmitters are available: 50 pounds of equipment can send a signal 10 miles. Requires a generator (gas-powered or hand-cranked); available batteries won't give enough power.

1915-1940 - 20 pounds of equipment will send a signal 10 miles; a generator is needed. 50 lbs. and at least 20 feet of antenna will signal 100 miles. Transmissions can be sent 500 miles by ships and 5,000 miles by shore installations. Aircraft radio becomes common, with ranges up to 100 miles. Radio is used by police cars and taxi-cabs.

1940-1950 - Voice radio becomes more common than telegraphy. Battery-operated transmitters become common. Back-pack radios of 30 pounds with batteries have a range of 10 miles and a battery life of eight hours. Handy-talkies of five pounds have the same battery life and a range of one mile. Aircraft radios range 500 miles, ships 2,000.

Air

At the beginning of the period there is no scheduled airline service anywhere; by its end there is scheduled airline service almost everywhere. At the beginning of the period the only sustained flight is lighter-than-air; by its end lighter-than-air is only a tiny part of aviation.

Balloons

Both tethered and free balloons were used for various purposes all through this period. Controlling one is a Piloting (Balloons) skill. Free balloons can only run before the wind, but they can go hundreds of miles. Tethered balloons found their greatest use as artillery-observation platforms in WWI and the small wars around it. In war they were frequently attacked by planes, and so were usually heavily defended by aircraft and anti-aircraft guns. They disappeared from use in the late 1930s as fighter aircraft got too deadly for them. Balloons filled with hydrogen are almost instantly ignited by incendiary bullets.

Dirigible Balloons (Airships)

A dirigible balloon is a powered balloon capable of movement independent of the wind. They are divided into three types: non-rigid (also called blimps), semi-rigid and rigid. The first successful ones pre-dated the first powered airplanes by a few years. Between 1910 and 1914, there was actually a civil airline using Zeppelin rigid airships (named for the inventor, Count Ferdinand von Zeppelin) in Europe. Its schedules were chancy, but it did fly.

The World War of 1914-18 saw Zeppelins heavily involved. They were most successful at long-range reconnaissance, most spectacular at long-range bombing. The rate of advance in equipment was very fast. The first-line airships of 1914 were 170 yards long by 16 yards in diameter. They could carry a payload of 20,000 pounds for 800 miles and had a maximum speed of 50 mph. By 1918 the first-line ships had a maximum speed of 65 mph, a range of 3,000 miles and a payload of over 100,000 pounds. Over 100 of the airships were built during the war for the German army and navy. All were supposed to have been destroyed or turned over to the Allies, but the records are incomplete. Enterprising adventurers could have a lot of fun with a stolen Zeppelin.

After the war every major power built and flew large rigid airships. Almost uniformly they came to a bad end, usually in storms. On the other hand, Zeppelins remain the safest form of commercial transportation in terms of passenger miles flown compared to casualties. Hugo Eckener, the great German commercial airship master, explained his safety record very simply. He said that he was not foolish enough to fly into storms! With the Zeppelin's range and endurance he simply flew around them. After the spectacular Hindenburg disaster of 1936, big airships went completely out of service both commercially and militarily.

The smaller non-rigid airships called blimps were used in both world wars for convoy escort and anti-submarine work. After WWII blimps were fitted with radar and used as early-warning systems.

Handling Airships

Large airships are not controlled by one man; it is a crew job. Controlling any large airship takes at least four men: an engineer, two steersmen and a commander. Control rolls are against the Piloting or Leadership skill of the commander, whichever is worse.

Helium

Helium has less lift than hydrogen (62 lbs. per 1,000 cubic feet, as opposed to 68 for hydrogen), but it is not flammable. Throughout this period the United States controlled the world's entire supply of helium. It was declared a vital war material and exported only under stringent license. Private airships, or those of any other government, need diplomacy or bribery at a high level to obtain helium.



CHAPTER SEVEN

TO THE EDGE OF SPACE

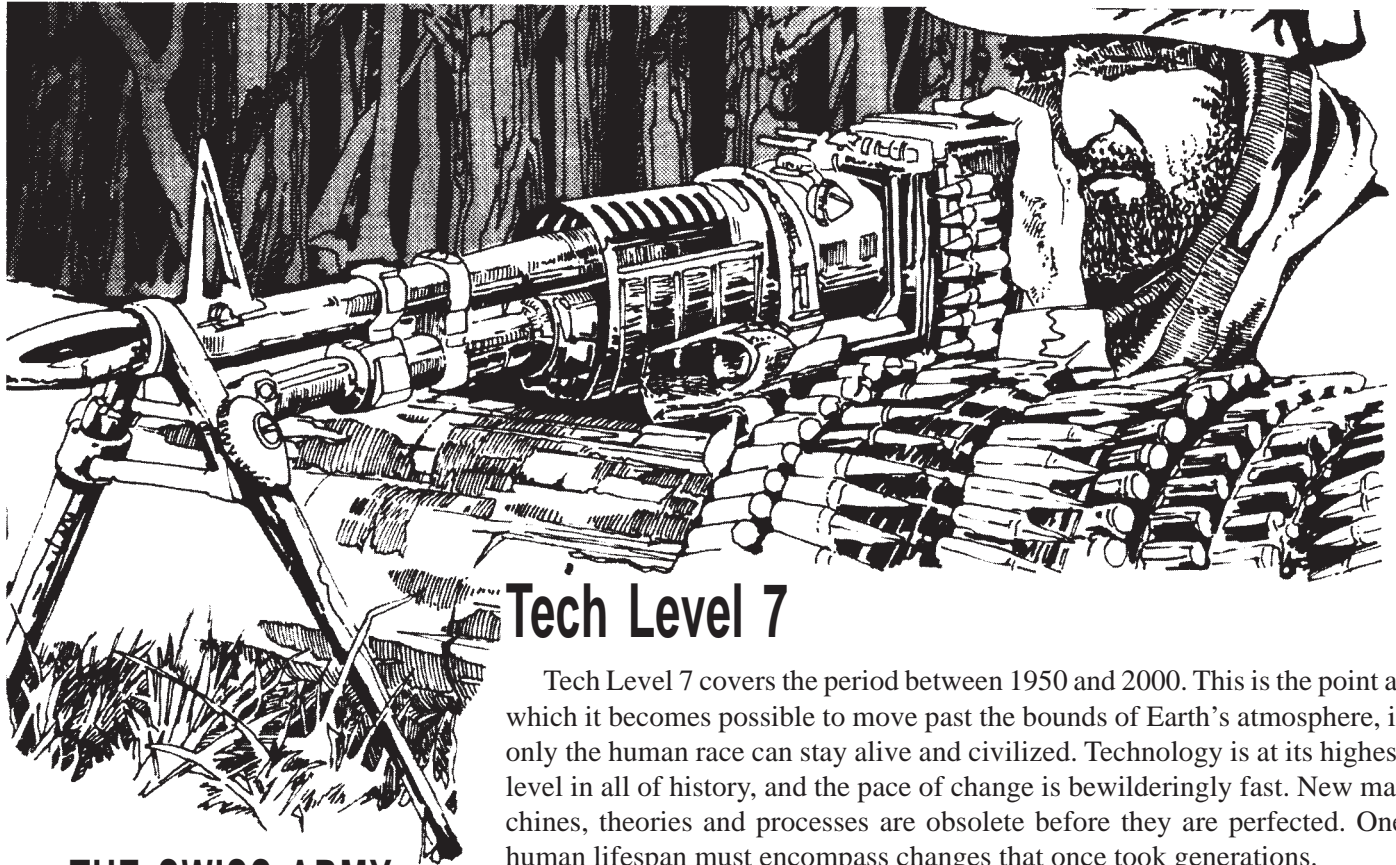

Tech Level 7

THE SWISS ARMY BAYONET

This is a nickname for the modern style of bayonet, inspired by the Swiss Army knife. Ironically, the Swiss haven't adopted it - but then, perhaps they don't need it.

Essentially, it applies the multipurpose concept to the large fixed-blade bayonet. The Israeli model is typical. The back of the blade is serrated for use as a saw. The pommel is heavy, so the bayonet can be used as a hammer. A slot in the bayonet clips to the sheath, for use as a wire cutter. There is even a bottle-opener!

In combat, such a weapon is still treated as a standard large knife. If a mechanic had it as his only tool, he would roll at -4 instead of -5 to skill.

1988 price: \$75 new.

Tech Level 7 covers the period between 1950 and 2000. This is the point at which it becomes possible to move past the bounds of Earth's atmosphere, if only the human race can stay alive and civilized. Technology is at its highest level in all of history, and the pace of change is bewilderingly fast. New machines, theories and processes are obsolete before they are perfected. One human lifespan must encompass changes that once took generations.

The destructive power of weapons moves most combat back to a level short of the total war that characterized TL6. The technology of war takes two directions. One is toward weapons of mass destruction, and the defenses against them. The other is toward combat by relatively small forces for limited objectives. For this kind of war, weapons are improved versions of those of TL6.

The cost and complexity of weapon systems is enormous, but governments produce and scatter them widely. Often the weapons issued to a peasant soldier cost more than the annual income of his whole village.

Personal Weapons

Personal weapons are the same in principle as the weapons of TL6. The same action types and frequently the same cartridges remain in use. For sporting use there is even a significant revival of single-shot rifles, much like those of TL5. There is also a flourishing market for flint- and percussion-ignition guns, both replicas of TL5 pieces and new designs. Time travelers are in an excellent position to procure quality equipment that will raise no eyebrows.

ELECTRIC STUN WEAPONS

At TL7 there are three kinds of electric stunners. All operate on batteries and depend on contact for effect. Each operates thousands of times on one set of batteries.

Prods

The earliest effective stunners were designed to move cattle. They put out an electric charge sufficient to burn the skin of a human being. There are two types; one is just a prod and the other is a combined prod and heavy flashlight. Either can also be used as a light club.

To use a prod, the attacker must hit with a *thrusting* attack, touching the contacts at the prod's end to the victim's skin. Damage is 1d-3 burning. The victim must make a Will roll to avoid being stunned for one turn and dropping anything in an affected limb. Armor protects normally; even heavy clothing is usually enough. Available for the whole TL. Weight 2 lbs; cost \$10 in 1950.

The cattle prod is not a legal antipersonnel weapon. They are available to citizens, with no controls, throughout the United States and most of Europe, wherever cattle are found.

Ranged Stunners

These were first sold under the trade name "Taser." They use compressed gas to fire darts connected to a battery by wires. The wires carry an electric current to the darts. The darts will penetrate normal clothing but not armor. A ranged stunner has SS 14, Acc 2. Reloading takes about 10 seconds, so RoF is 1/10.

To hit, the attacker rolls vs. Guns (Special Weapon, Taser) skill; this is an entirely separate type of gun. The victim must make a Will roll at -4 to avoid being stunned for as long as the darts are connected. A stunned victim cannot intentionally detach the darts. The darts do no significant damage; they might trigger a coronary attack in someone with a bad heart (on failure of a HT+4 roll by someone with a previous history of coronary trouble). First available in 1970; weighs 2 lbs.; cost is \$200.

These devices are controlled in some jurisdictions, ignored in others. Where they are controlled, they are treated like knives or firearms. Where they are not controlled, use of a taser might be an assault, but not a weapons violation!

Hand Stunners

Sold under the trade name "Stun Gun." They are held in the hand and use a very low-powered electric current to disorganize nerve function. The user attacks by attempting to touch the Stun Gun to his victim; it will work through ordinary clothing but not armor or heavy winter clothing.

Continued on next page . . .

Knives, too, have a renaissance. The best designed and built fighting knives in history become available, at reasonable to ridiculous prices, and almost every gunman wants steel for backup. All knife-type weapons from the *Basic Set* are available, but the prices given will buy "fine" quality rather than "average." The price for "fine" steel will buy "very fine," and so on.

One very old weapon appears in a new and improved format. The bow, heavily modified by 20th-century engineering, becomes the compound bow. This uses a system of pulleys and cables to make it more efficient at storing and transmitting energy. A compound bow has more range and requires less strength from the archer. Any of the bow types in the *Basic Set* can be made as a compound bow except the composite bow. The compound bow is -2 to the minimum ST required, +2 to effective ST for purposes of figuring 1/2D and Max range, and +1 to Damage. Cost in 1985 is \$150 for a short bow, \$250 for a regular bow and \$350 for a longbow. Compound crossbows cost \$300.

Bows frequently are fitted with sights, which increase the Accuracy bonus by 1 (for ordinary sights) or 2 (for magnifying sights). Crossbows can use any of the augmented sights available for rifles.

Wind-gauges, stabilizers and range-finders are also available for bows, at \$20 to \$100 each. Collectively, they improve Accuracy, but only in the hands of a skilled user. Any of these devices will add +1 to Acc; all of them together add +2. As for guns, Acc can never exceed the user's skill. (A user who is not accustomed to these devices will suffer -1 to skill for using a bow burdened with them.)

Another development of TL7 is the *speargun*, for use underwater. These may be powered either by elastic bands or by compressed gas. (A nice touch of underwater snobbery is to insist that spearguns are really harpoon guns, because the spear is attached to the gun by a line.) An elastic-powered speargun can be treated for most purposes as a ST 8 crossbow (damage 1d, SS 12, Acc 4, 1/2D 160, Max 200) with barbed arrows. The spear is usually fastened to the gun by a line of no more than 10 yards length. If the spear hits, the target must win a contest of ST to escape from the line. On a success by less than three, the barbed head of the spear tears out of the wound, doing damage equal to the original hit. Gas-powered guns have the same effect. A typical gas-powered gun has damage of 1d+1, SS 12, Acc 4, 1/2D 200, Max 250. In water the range for both types of guns is halved; Acc becomes 2, and the SS number is 14.

Either type of speargun uses Crossbow skill, but treat it as a new "type" of crossbow. A person experienced with crossbows would be at -4 to use a speargun until achieving familiarity (p. B43).

Assault Rifles, Submachine Guns and GPMGs

The characteristic infantry tactic of TL7 is the blast of poorly aimed automatic fire. Almost every infantry long-gun is capable of automatic fire, and is usually fired that way. The expected distance of engagement for smallarms is about 300 meters, and most guns are designed to be effective within that range.

The great advances are in the technology of weapon production and in the materials used for weapons. Light metal alloys and plastics give lighter guns without significant loss of strength. Stamping, pressing and molding for all non-precision parts speed and cheapen manufacture. Lighter weapons are accompanied by lighter ammunition - which is fortunate, since the rate of consumption in automatic fire is enormous. Standard military rifle caliber decreases from about .30 to about .22.

.30 is retained as the usual machine-gun caliber because of its superior penetration and retained energy at long range. Basic infantry tactics emphasize moving the machine guns to a good fire position and assaulting under cover of their fire. The water-cooled machine gun is almost completely replaced by the GPMG. Some water-cooled guns are retained for position defense. Their high sustained fire rate is useful and the heavy weight does not matter if the gun doesn't have to be moved.

The trend in SMGs is toward smaller and lighter weapons. They are seen as secondary weapons. SMGs are for troops who cannot carry a full-sized rifle or for situ-

ations, such as police confrontations, where the extra range and power of rifles is not desirable. Really effective SMGs small enough to be concealed in a standard brief-case are widely available.

Firing such weapons is a Guns skill; firing full-auto uses the automatic fire rules (see pp. 14-15, B119).

Small Heavy Weapons

Toward the end of TL6 (1943) the Germans pioneered a new kind of heavy weapon intended to be carried and used by the individual soldier. The *Faustpatronen* (fist cartridge) or *Panzerfaust* (armored fist) was a one-shot, disposable anti-armor or anti-fortification weapon using a Monroe-effect warhead. It was issued, not to a dedicated crew, but wherever it might be useful. It was small enough to be carried in addition to other equipment by an individual soldier. The *Raketenbuchse* was a rocket launcher, again using a Monroe-effect warhead. Recoilless guns also used Monroe-effect warheads for penetration; most also fired HE shells for anti-personnel effect. They countered recoil by firing a column of gas out the back to balance the projectile going out the front. Rocket launchers and recoilless rifles were normally issued as the firer's primary weapon, not as extra equipment.

In TL7 all these concepts became common. The American M72 LAW is a typical one-shot device. In fact, the Army does not classify it as a weapon, but as a round of ammunition. It is a fiberglass tube containing one rocket-propelled grenade. Once the rocket is fired, the tube is discarded. The loaded assembly weighs only five pounds and is only two feet long when closed. It will penetrate the side and rear armor of almost any tank, and the frontal armor of many. The warhead has enough explosive effect to be useful in clearing bunkers, but fragmentation is just what it can pick up from surroundings.

The Russian RPG7 is a typical reloadable rocket launcher. The launcher weighs 17 pounds and each rocket about five pounds, with some variation for different models of launcher and type of rocket. These weapons have a somewhat greater range and accuracy than the throw-away models. Penetration is about the same. HE as well as shaped-charge warheads are available.

The Swedish 84mm Carl Gustav is typical of the recoilless guns. It weighs just short of 30 pounds and each round weighs about five pounds. It is more accurate than the rocket launchers and fires several types of shell. Penetration with shaped charge is about the same as with the other two weapons listed.

Firing this type of weapon is a Guns skill. Range and accuracy stats are in the *Weapon Tables*. The principal destructive effect is the jet from the shaped charge, which penetrates armor and creates a very narrow (less than 2") hole. The hope is that the jet will kill personnel, damage vital components or, as a best result, ignite the fuel and ammunition in a tank. The fuse is point-initiating and base-detonating, and the penetration effect requires a proper stand-off distance. As range increases it is more and more difficult to get the proper angle of impact for correct fuse initiation at the right distance. Half-damage range for these weapons is the range at which it is likely that this complex series of events won't go off exactly right and penetration will be badly reduced.

The target also must be rigid enough to activate the fuse. Roll 3d against the DR+3 of the target. If the roll is equal to or less than the target's DR+3, the warhead explodes. If the roll exceeds DR, the warhead does not explode. It does 1/6 base damage as crushing damage, with no armor divisor.

Many launchers principally intended for shaped charges can also launch other types of warheads such as illuminating, high-explosive, white phosphorus or canister. The *Weapon Tables* list specific kinds of warheads for launchers. Pre-packed disposable launchers have only one kind of warhead.

Critical failures with such a weapon are of two possible types. One is a failure at the launcher: a misfire, a badly aimed shot or an error by the firer. (The most common is a failure to clear the back-blast area. This will do 4d damage to anyone in the way, and leave them on fire; see p. B130.)

ELECTRIC STUN WEAPONS (Continued)

The victim must make a HT-3 roll to avoid being stunned; if stunned, the victim remains stunned for as long as the weapon is in contact, and (20-HT) seconds longer, before any recovery rolls are permitted. If the victim makes the HT-3 roll, he is not stunned and can take any action against his opponent. The Stun Gun user can try another attack on his next turn.

The stun gun may trigger Berserk in anyone with that disadvantage (a successful HT-3 roll requires a Will roll to avoid going Berserk).

This weapon is less useful against drunks. Intoxication eliminates the -3; the roll then is against HT.

As of 1992, hand stunners are completely legal defensive weapons throughout the United States and the developed nations. In less-developed parts of Earth in the last half of the 20th century, they would be unheard of. There would be no law against them, but a policeman or judge might be very upset to encounter one!

Weight negligible. Available after 1980; cost \$100.

SILENCERS

A silencer is a device to muffle and disguise the sound of a gunshot. No system completely *silences* a gun. The noise is actually the sonic boom of the supersonic gases and (when applicable) the projectile. (The speed of sound is about 1,100 feet per second at sea level; 9mm pistol ammunition has a muzzle velocity of +1,200 fps; military rifles from 2,500 to 3,500 fps; powder gases of over 4,500 fps.) Any silencer works by confining and slowing one or both of these before they reach the exterior atmosphere.

A Hearing roll is required to hear a gunshot. The GM need not roll under circumstances where it is obvious the shot would be heard.

In the same room: +6!

In the next room: +4

Several rooms away, or in the next block outdoors: +2

Two blocks away: 0. Thus, the average man will notice a .38, fired two blocks away, about half the time.

A quarter-mile away: -2

A half-mile away: -4

Silencers give an additional penalty to any roll to hear the weapon, from -8 for the best commercial silencer to -5 for a good improvised silencer (see below) and -1 for a hasty improvisation.

Continued on next page . . .

SILENCERS (Continued)

The GM should add further Hearing penalties for background noise (-1 for conversation, up to -5 for a machine shop), or distraction (a man in the middle of a knife-fight is less likely to notice stray sounds). A further penalty of -2 may be exacted from those without the Guns skill; they are less likely to identify a gunshot if they hear it.

Weapon Choice

Silencers are more effective on certain types of gun. They are most effective with sealed breeches, such as bolt-actions or dropping blocks. Semi-automatics quiet the shot fairly well, but frequently leak high-velocity gas from the breech and always have the noise of the action working. Revolvers of conventional design are impossible to silence. It's *possible* to construct a revolver so tightly fitted that it can be silenced, but this is more an exercise in perverted ingenuity than in practical weapons design.

Silencers are big and awkward and wear out quickly; the more powerful the round they silence, the bigger they are. The U.S. Navy silencer, used on S&W 9mm pistols with special, subsonic ammunition, is one of the smallest. It is a bit less than 6 inches long and less than two inches in diameter. It is good for about 30 shots with subsonic ammunition, or about six with standard ammunition before it stops silencing. The British silencer for the 9mm Sterling submachine guns works much longer, sometimes for several hundred shots. It slows standard ammunition to subsonic and silences the gases. It is about 14 inches long, nearly three in diameter and surrounds and extends a special barrel with 72 holes drilled in it to bleed off gas. If the gun is fired at full auto, after three to five shots the silencer stops working.

Buying a Silencer

The first commercially available silencer was the Maxim, c. 1902, used widely for things like indoor target shooting. A typical modern silencer is \$200 and one pound. Silencers were generally legal until the gangster and subversive hysteria in the 1930s. After that, they were regulated: some U.S. states ban private sale. Elsewhere, registration and an extra \$200 Federal tax is required. In some noise-conscious European nations *rifle* silencers are legal and required for sport shooters. Military and espionage agencies have easy access to silencers. A machinist can make one in four hours.

Improvised silencers are somewhat effective: the classics are a pillow held tight between gun and target or the one-liter plastic bottle packed with Styrofoam peanuts (one shot per bottle!); both give a -1 to Hearing rolls to detect a shot.

The other critical failure is a failure of the fuse to initiate (see above). The GM can decide, for each critical failure, exactly what happens. Personnel errors are considerably more likely than fuse failures with well-made and maintained ammunition. With old, abused or improvised fuses the likelihood may be reversed.

Grenade Launchers

Another TL7 infantry weapon is the grenade launcher. This is not an attachment for firing grenades from a rifle, but a separate weapon that fires small explosive shells, like the hand mortars of the 17th century. It is intended to fill the gap in explosive delivery between the maximum distance of a hand grenade and the minimum safe range of a mortar.

The first in the field was the American 40mm M79, c. 1959. In the early 1970s, grenade launchers are developed that mount on a rifle, allowing both weapons to be fired. Desperate shooters can fire both at the same time, at a -6 to skill with each shot. Roll separately to hit for each.

The launchers can fire a full range of grenades including fragmentation, shaped charge, smoke, gas, illuminating and incendiary. After about 1980 the most common shell is a dual-purpose shaped-charge/fragmentation round. The shaped charge is too small to have much effect on a tank, but is effective against light armor. The fragmentation effect is not as great as that of a hand grenade, but can reach a much greater range. It is a nice ordnance compromise. See the *Weapon Tables*, pp. 123-127, for detailed information on specific weapons.

Augmented Sights (Scopes)

Augmentation of sights can be in several categories: magnification, increased visibility, range finding and predicting. All are intended to increase the accuracy or the speed of engagement of the firer.

Magnifying sights: These are usually called telescopic or scope sights. The first experiments with magnifying sights date to very near the invention of the telescope, in the early 17th century. By the 18th century they were in occasional use; they were long, heavy, expensive and fragile. A typical scope might be: 6-power magnification, four feet long, four pounds, \$100. Variations are enormous; each scope was a custom job.

By the mid-19th century scopes were common for target and long-range game shooting. They were still fragile, and often more expensive than the gun on which they were mounted. Scopes were used in war, by snipers and sharpshooters, from about 1850. Most were three to four feet long and weighed three to four pounds. Magnification was up to 30 power, for target shooting and long-range hunting.

By 1900 the size and expense of scopes was much less and they were in fairly common use by hunters in Europe and in colonized Africa and Asia. They were still rare in the Americas. Thousands of scoped sniper rifles were in use in WWI, by all participants. In the 1930s, scopes became much less expensive and much more common. After WWII they became the overwhelmingly common choice for hunting and the invariable choice for sniping and sharpshooting.

Scopes are rated by *power of magnification*. A four-power increases the apparent size of the target by four, a six-power by six. High-powered scopes make it easier to see the target. The narrower field of view, however, makes it harder to acquire the target in the first place. The magnification makes the target apparently bigger, but it also makes the apparent wobble of the sight picture larger. Aim can actually be harder, especially from an unbraced position. In *GURPS*, for each *doubling* of magnification, Acc is +1 for *aimed shots*. Scopes do not affect unaimed shots.

Scopes can be either *fixed-power* or *variable power*. Fixed power scopes have only one power of magnification; variables can have a range of powers but are limited to a three-fold increase in power (e.g., one to three, three to nine, six to eighteen). Variables cost more and are somewhat more fragile.

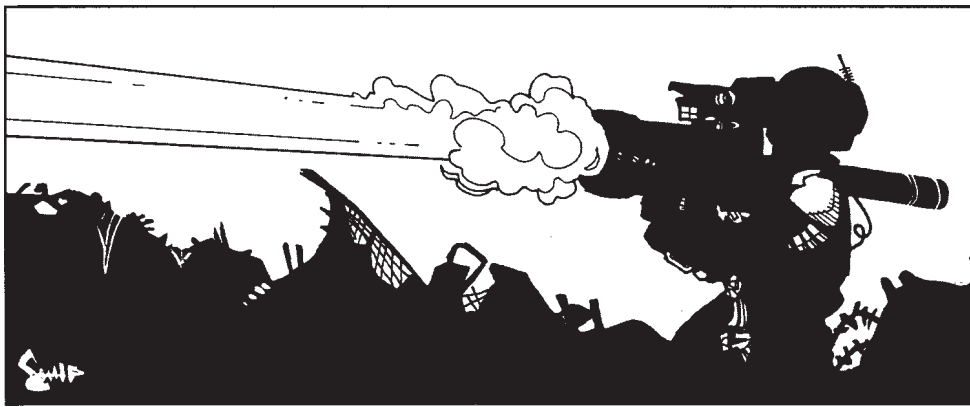

LASER SIGHTS

The laser sight was developed in the 1970s. Military research focused on laser range finders and sights for air and armor weapons. The smallarms laser sight was mostly a development of the sport of “practical shooting.” The first ones were cobbled together by enthusiastic amateurs in the early ’70s. By the end of the 1980s commercial laser sights were commonly available.

A laser sight takes a lot of the work out of aiming. The laser projects a dot on the target; if the gun is zeroed and the target is at the proper range (depending on the gun’s trajectory and dispersion), the bullet hits the dot. This is particularly valuable for quick shots at short range. The game effect is to add +2 to accuracy and decrease the snap shot penalty. At ranges up to 50 yards, the snap shot penalty is -1, at 50 to 100 yards -2, at over 100 yards -4.

Laser sights do have some problems. In very bright light, such as desert sunlight or movie-set lighting, it is hard to see the dot. Haze or smoke inhibit both the effectiveness of the laser and the visibility of the dot. All current smallarms lasers use a red dot, which does not show well against a red background. No current laser is visible beyond 200 yards in normal conditions.

The first laser sights were bulky. The smallest models were as big as a .45 pistol, which looked strange *mounted* on a .45. By the end of the 1980s this had changed by several orders of magnitude. A current laser smallarms sight, effective to 200 yards in proper light conditions, weighs less than two ounces and is no bigger than a man’s finger.

Laser sights are battery-powered. Early batteries were good for only a few activations, but usually would last longer than any one firefight. Current batteries will last for several thousand activations.

The laser is not powerful enough to do any damage on its own, or even to blind an opponent, unless he stares straight into it for several seconds.

Laser sights are considerably more fragile than a gun; current sights are more rugged than the first improvised models. If the laser sight (or the gun to which it is attached) is dropped, thrown, used as a club, etc., roll 3 dice. Pre-1980 lasers have a Malf of 12; 1980-1985 lasers have a Malf of 14; post-1985 lasers have a Malf of 16. Repairing laser sights is at -3 to Armoury skill. GMs can rule if a particular armorer has the special training and tools for lasers (they are not part of the normal gunsmithing curriculum).

Early, improvised laser sights were one-offs, made by gadgeteers for themselves or friends. Commercial laser sights first became available about 1980. A typical one weighs 2 lbs. and costs \$400 (1988 price). By 1992, \$200 would buy a two-ounce laser and mount adaptable to any weapon (including bows, crossbows and paint guns).

All scope sights are more fragile than the guns that mount them. Military rifles almost invariably and hunting rifles usually have an auxiliary set of *iron sights* in case the scope stops working. Anytime a scoped weapon is mistreated (dropped, clubbed, trampled, struck) in such a way that the scope could reasonably be expected to be damaged, roll 3 dice:

3-5 - The scope is undamaged.

6-8 - The scope takes minor damage; it can be repaired by an armorer in 1d hours. Until it is repaired it is at only 1/2 effectiveness as a sight.

9-13 - The scope takes significant damage; it must be replaced or repaired. Repair takes three successful Armoury rolls at 2d days intervals.

14+ - The scope is so damaged that it will no longer work as a sight and cannot be repaired.

These are the figures for TL7. For TL6, roll at +1; for TL5 at +2 and for TL4 and below at +4. More primitive equipment, in this case, is easier to fix!

There are several ways to improve sight performance in reduced light. The simplest is to make the sights more visible. This can be as simple as tying a white handkerchief around the muzzle or as complex as battery-powered lights mounted in the front blade. Improved visibility sights give a +1 to +3 to Accuracy (GM’s decision on those not specified in the *Weapon Tables*) for shooting in the dark, but have no effect in normal light.

A level up from this are systems to illuminate the target and the sights. A flash-light taped to the gun works, but it rather obviously gives away the firer’s position. Infra-red light works like white light, but is only visible to someone with IR-viewing capability. Either system eliminates the penalty for darkness.

TL7 IR systems have better definition at greater ranges, and more sensitivity, relative to those of TL6; in any contest of Vision skills between IR gear of the two tech levels, TL7 gets a +2 bonus.

Passive sensor systems don’t give away the firer’s position. These include light intensification and thermal-imaging systems. They also decrease the penalty for firing in reduced light. Both can be combined with magnifying sights. Such systems increase Accuracy by up to 10 (which would entirely eliminate the penalty for darkness).

Note that the Accuracy bonus for a night sight can never exceed the penalty for firing in reduced light!

Laser sights are also available; see the sidebar.

Heavy Weapons

AFVs and Vehicular Weapons

Armies became more and more vehicle-mounted in the course of the 20th century. Vehicular weapons became larger, more powerful and more accurate. At TL7 almost every weapon is available in a vehicle-mounted version.

TL7 BODY ARMOR

P. B211 describes several sorts of modern armor. A few others:

Armored Overcoat

Protection for everything but the head, hands and feet disguised as a heavy winter overcoat. PD 1, DR 12, 22 lbs., \$500. Bulky and awkward; it reduces Move by 1 and is -2 to any Acrobatics, Climbing or similar skill roll. Available after 1970.

Sap Gloves

A cross between armor and weapon - a pair of heavy leather gloves with lead stitched into the knuckles. PD 2, DR 4, 1 lb. (for the pair), \$50. They cover area 7 and count as brass knuckles in close combat. They give a -1 to any delicate work such as lockpicking. It takes one second to put on or take off each glove. Available any time at TL7.

Inserts

These are panels of resin-bonded Kevlar, ceramic, metal or a combination of materials. They are designed to reinforce other armor, or to be worn alone, as the wearer chooses. They give great flexibility to the choice of armor. They are usually designed to fit in pockets, but can be equipped with straps. Separate inserts usually are made to protect 17-18, 9-10 and 11 and for front and back (this is more comfortable to wear and allows greater freedom of movement). Inserts cost from \$50 to \$200 apiece and can add from 5 to 50 to DR. Cost is \$10 per point of DR for 17-18 plates or 11 plates; \$30 per point of DR for 17-18, 9-10 plates. Weight is 1/2 per point of DR.

Heavy Plate

A complete suit of medieval-styled armor: greathelm, heavy corselet, limbs and sollerets - made of the best TL7 materials. It has air-cushion padding and comes with an undersuit that helps wick away moisture from the skin. Greathelm, PD 4, DR 12, 10 lbs. Heavy Corselet PD 4, DR 12, 45 lbs. Arms PD 4, DR 10, 15 lbs. Legs PD 4, DR 11, 20 lbs. Sollerets PD 4, DR 10, 6 lbs. The whole outfit costs \$5,000 and takes one full year to make.



After 1950, many vehicles are outfitted with filtration and overpressure systems as a defense against chemical, bacteriological and radiological (CBR) weapons. Many different types of accessories for surveillance are also common fixtures. Various different types of rangefinding and computing devices are also now fitted.

TL7 AFVs use diesel fuel, and are much less likely to burn when hit. Armor continues to improve as well, with innovations such as Chobham (layered) armor, and reactive armor, which defeats shaped charges by instantly triggering a counter-explosion on the tank's hull to deflect the charge's force.

Anti-Tank Measures

Anti-Tank Guided Missiles (ATGM) were developed in the late 1950s as a means by which infantry or light vehicles could carry a weapon to defeat tanks at long ranges. They are also effective against thick-skinned targets such as dragons and dinosaurs.

An ATGM consists of a missile with a shaped-charge warhead (*Small Heavy Weapons*, p. 101) and launcher with guidance unit. The operator acquires a target, then fires and guides the missile toward it, with a very high probability of a hit.

Most ATGMs are wire-guided: flight commands are transmitted through a wire that reels off a spool at the back of the missile. Early missiles were manually guided via joysticks to the target, a method called MCLOS (Manual Command to Line Of Sight). This requires the firer to simultaneously track the missile and the target, which is difficult, especially if being shot at. Later Semi-Automatic Command to Line of Sight (SACLOS) systems require the gunner to simply keep the sight trained on the target. Whether a missile is MCLOS or SACLOS is shown on p. 122. All ATGMs are complex: unfamiliarity penalty is -8 rather than -4.

The skill to operate a wire-guided ATGM is Gunner/TL7 (ATGM). To fire, the gunner must be stationary and see the target. He rolls vs. Gunner (ATGM)+4 (or at ATGM-4 if the target is within the weapon's minimum range) to perform the proper firing sequence and launch; failure means the missile was incorrectly launched and will crash on its first turn of flight, missing its target. Success means it flies toward the target, closing the distance by a number of yards each second equal to its listed Speed. It can fly as many turns as its Endurance (End), after which it crashes if it hasn't reached its target.

To hold the missile on course, the gunner must take continuous Aim maneuvers - if he does anything else including Dodging the missile will crash - and make periodic Gunner (ATGM) skill rolls. Roll each turn for a MCLOS missile, every five turns (but at least once before the target is hit) for SACLOS. Failing means the ATGM goes off course; roll at -3 to avoid a crash on the next turn; success brings it back on track.

If the missile reaches its target, no actual attack roll is necessary, as it was guided all the way (the target can still Dodge). If not dodged, the missile explodes, doing damage using the shaped-charge warhead rules. Tank crews are taught that the proper way to counter ATGM attacks is to keep careful watch for launches, then hose down the ATGM gunner with machine gun fire while the missile is still in flight: if the gunner is shot or ducks for cover, the missile will go off course and miss.

The ATGM covered in this book are all wire-guided, but some missiles (especially vehicle-launched systems) use laser or infrared guidance. These are described in *GURPS Vehicles*.

Artillery

Artillery weapons for most of TL7 were little changed from TL6. The great change came with the computer and laser revolutions after 1970. Effective portable computers could give first round firing data more accurately and more speedily than manual computation. Lasers could give an actual distance from observer to target, rather than an estimate. Man-portable inertial navigation sets and battery survey by

satellite-contact positioning gave artillery positions to the fraction of an inch. Really accurate and current meteorological data could be applied to every calculation. After 1980, when all this materiel had been fielded, first-round hits with no adjustment became routinely possible. This widened the gap between the artillery of the technologically advanced (or simply wealthy) armies and the backward armies. Most of the world's artillery was not advanced over TL6, but a little was far ahead.

Response time for TL7 (after 1980) artillery:

First round - one minute

Subsequent rounds - 30 seconds

Modifiers for troop quality are as for TL6 (see p. 82).

FOs with post-1980 equipment are +3 to locate themselves and their target. If they have located the target and sent data to a TL7 firing unit, there is a 2/3 chance that the first round will be within the normal dispersion (see p. 84) of the rounds of the target. If the round is not within this distance, any success on a second round correction will be. A critical success will be a hit on the target hex.

Air Defense Artillery

Guided missiles are now used against aircraft: ground forces use SAMs (surface-to-air missiles) and warplanes carry AAMs (air-to-air missiles).

Big, long-range (10-100 mile) missiles are radar-guided. Most are "semi-active:" the launcher's radar illuminates the target, and the missile homes on this. As radar emissions can reveal one's position, late 1990s missiles like the U.S. AMRAAM carry their own small radars; until that's in range, they are guided to the target inertially, via preprogrammed coordinates that can come not only from the launching aircraft's radar but also from another plane's or from non-radar sensors.

Smaller, short-range (2-12 mile) missiles are infrared-homers, tracking the target's heat emissions. Early heatseekers weren't very sensitive: they had to be fired from behind a target to home in on the hot metal of its engine exhaust, and could be confused by the sun or decoy flares. Post-1980s "all-aspect" missiles detect heat contrast between the target and the sky; they're harder to fool, and can attack aircraft from any angle.

Armor

The development of synthetic materials at TL6 meant that by TL7 it was possible to build light and flexible body armor with considerable effectiveness. The first in the field were the *flak jackets* (imprecise nomenclature; they were not intended for aircrew) of woven nylon. These were widely available for the Korean War of 1950-53 and were the common military armor for another 20 years.

The development of para-aramid fiber (Kevlar) led to even more effective flexible armor. From the mid-1960s, most police and security people (and a lot of gas-station attendants, convenience-store clerks and politicians) wore Kevlar armor. Kevlar could be made up as garments that were indistinguishable on the surface from ordinary clothes. It could also be resin-bonded into rigid armor as protective as steel plate at 1/3 of the weight. Combined with light-metal alloys, ceramics and air-filled padding, this could make armor that was mobile and would stop most of the likely threats. Woven Kevlar is almost worthless against impaling weapons, such as icepicks, but resin-bonded Kevlar is effective.

In the late 20th century, any armor could be built for the right price. In addition, for the time traveler or participatory fantasist, there is a special resource: after 1960, the growth of historical and fantasy recreational groups created a whole subculture of armorers who could duplicate or improve on any Medieval or Renaissance armor in modern materials. The problem is to find one, and then to persuade him to do what the *customer* wants instead of what *he* wants.

See the sidebar on p. 104 for some specific armor examples.

TL7 STARTING WEALTH

Starting wealth for this period varies greatly. Most of the years from 1950 to the end of the century are inflationary.

1950-1960-\$5,000.

1960-1970-\$7,500.

1970-1980-\$10,000.

After 1980-\$15,000.

The price of a Colt Government Model .45 automatic pistol goes from \$87.50 in 1950 to \$600 in 1992. On the other hand, all the money in the world couldn't buy a home computer in 1950, and less than \$1,000 will buy one in 1985; the same price will buy a *much* better one in 1998. In 1950 the official U.S. price of gold is \$32 an ounce; the free market price is about \$100. In the 1990s the price is around \$400 with frequent fluctuations.

TL7 TOOL KIT

Transistor Radio Receivers

The portable radio is taken for granted today, but it made a revolutionary difference to travelers and campers. It would operate for several hours on a single battery. Its owner, no matter where in (at least) the Western Hemisphere he might be, could pull out the whip antenna and get current news, weather reports and so on.

Available after 1960. Weight 1/2 lb. at most; cost \$50 in 1960, rapidly dropping to as little as \$10.

Military Transmitter/Receivers

These radios would be issued to troops that needed them. Available to civilians as surplus or on the black market, at widely varying prices . . . but dirt cheap as soon as they were obsolete.

1950-1960. One frequency; battery life eight hours. Range two miles with short antenna, seven miles with long antenna. 25 lbs.

1961-1975. 20 frequencies; battery life 12 hours. Range five miles with short antenna, 30 miles with long antenna. 15 lbs.

1976-1990. 50 frequencies; battery life 20 hours. Range 10 miles with short antenna, 50 miles with long antenna, around the world with addition of small dish antenna and satellite relay. 10 lbs.

Hand Calculators

Within a space of a few years, the hand calculator totally outmoded the slide rule. In 1970, a hand calculator would (barely) fit in a shirt pocket. By 1985, they were credit-card-sized.

Continued on next page . . .

TL7 TOOL KIT (Continued)

The size of a calculator tells nothing about its functions. Some calculators do only simple arithmetic, but they do it at least 20 times as fast as hand calculation. Such units sell for \$50 when introduced, \$10 within a few years. "Engineering" calculators have trigonometric and other functions, and give +1 to +3 to any Mathematics roll. These sell for \$500 or more when first introduced, \$100 within a few years.

Early hand calculators use batteries (12 hours or more per battery) or house current. By 1980, photoelectric cells let calculators run indefinitely anywhere there is a light source.

Personal Computers

At the beginning of TL7, only government and big business owned computers, and they filled rooms. By the end of the period, any citizen of the developed nations could buy a *more powerful* computer for less than a month's pay, and it would fit on a desktop. For just a bit more, an equivalent system could go inside a briefcase, with room to spare.

Much of this computing capacity was used merely for entertainment. But word processors, spreadsheets and similar programs increased the productivity of writers, accountants and business planners many fold. And computerized databases made information much more accessible.

Miniature Generators

TL7 saw the availability of the first truly powerful portable generators. For \$400 to \$1,000, one could buy a gas-powered generator small enough to fit in the back seat of a car, and powerful enough to run a small household while the gas holds out.

Solar Cells

Photoelectric cells made "free" electrical power available . . . at least during daytime, and in small amounts. Though truly efficient and high-powered solar cells had not yet been developed, by the early 1980s solar cells were adequate for small applications (radios, calculators) or in very sunlight-rich environments (deserts, space). At TL7, anything that can be carried in the hand and powered by a battery can be adapted to solar cells, though for some devices (e.g., flash-lights) there's little point.

By the late 1980s and early 1990s, solar cells were efficient and cheap enough to be a real competitor to *long* power lines. They were used by the military, and anyone in remote locations, for such chores as charging vehicle and radio batteries. They were still dependent on weather, of course.

Computers

Electronic computers commercially debut in early TL7. The first systems required tons of wiring and vacuum tubes, squandered power and generated vast waste heat. The transistor, then microcircuitry reduced size, power demand and heat output. By the 1980s any small business had more computer power than the whole world had in 1950.

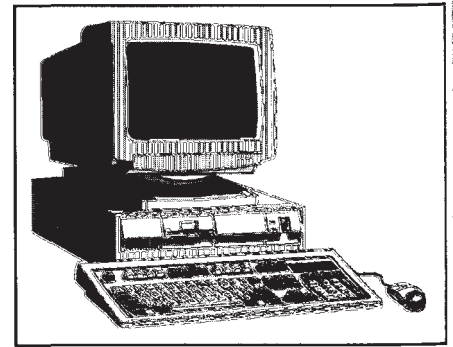

Computer Operation and Computer Programming depend heavily on timeframe. A 1955 master of punched-card programming would boggle at 1998's techniques - and vice versa. His skill would be about as relevant as flint-knapping. In general, assume a -1 to skill for each *two years* difference in time during this period.

Computer operators can get information, solve problems, access files and in general use familiar systems to the limits of system capabilities. Higher levels of skill mostly reflect familiarity with more varieties of software and hardware.

Computer programmers can design new software to perform new tasks. They can also invade and modify the software designed by other people. This is extremely useful in certain clandestine and even criminal operations (see *GURPS Cyberpunk*).

Designing and repairing computer hardware are, respectively, specializations of Electronics and Electronics Operation.

The penalties for unfamiliarity are very steep for any computer function. They can range from -1 for similar equipment to -10 for completely unfamiliar, e.g., a 1980s operator faced with UNIVAC.

Lasers

In 1960, a Bell Laboratories researcher discovered the principle of Light Amplification by Stimulated Emission of Radiation, or LASER. Since then, laser has become a generic term, and lasers have been applied to a host of new technologies. Precise measurements are now available instantly, making accurate rangefinding and CAD/CAM systems possible. Lasers are used for relay and switching systems, holographic projections, printing matrices, welding systems and information storage. Destruction of blood clots and other blockages is now commonplace, as is the use of lasers in cataract surgery. Military applications were also explored.

Laser rangefinding and guidance systems, allied to the microchip, have made a generation of "smart" weapons possible. Laser targeting systems are made for weapons as small as pistols (see sidebar, p. 103). Secure laser communication systems are installed on board U.S. Navy ships. Blue/green lasers are being investigated for their utility in detecting submarines.

A U.S. Army laser project was revealed in 1983. A low-powered, rapid pulse laser was to have been used on the battlefield to blind enemy personnel and optical systems, rather than killing them. Due to adverse publicity, this project was abandoned. The Soviet Union continued research on the technique. Relatively low-powered lasers onboard ships are capable of blinding the sensors and crew members of enemy or potentially enemy aircraft, and are apparently being used this way now.

Lasers are in their infancy as directed energy weapons. They suffer from tremendous power consumption and relative inefficiency compared to kinetic energy or chemical-explosive warheads, so current laser programs focus on ballistic missile defense. The USSR had various research ongoing; current status is unknown. The U.S. Strategic Defense Initiative and the SCUD missile attacks in the Gulf War spurred U.S. laser research. As of 1998, the USAF is testing airborne laser systems for defense against short-range ballistic missiles, and hopes to deploy a squadron of chemical laser-armed Boeing 747s by 2008.

Communications

Communications and intercept evolve alongside electronics at TL7. Portable radios vastly improve in range, reliability, frequency availability, durability and battery life. At the end of TL6, military radio networks generally terminated at company level. Ten years later, they extended to squad level. Twenty years later, it was not uncommon for every soldier to be in a radio net.

The ability to intercept and jam communications also increases enormously. By 1960 it was unsafe to assume any communication was private. By 1980 it was *necessary* to assume *every* conversation was monitored. Intercepting communications includes everything from fast-talking a messenger to translating the laser-monitored vibrations voices create on a window. Intercepting frequently boils down to a Contest of Skills between the ability to secure communications and the ability to snoop. This could involve Electronics, Stealth, Vision, Fast-Talk or any of several other skills.

TL7 communications technology is very specialized, interception even more so. In most countries the government monopolizes training and usage of the latter. U.S. and some European private intercept experts practice the trade. Underground and criminal groups also employ specialists, frequently ex-government.

Messages often are encrypted, requiring a Contest of Skill between encrypter and decrypter. Both can have considerable bonuses for technological assistance. A computer-generated one-time pad, for instance, is *impossible* to break on the basis of one short message. The usual method of breaking such a code is to bribe someone.

Transportation

TL7 is a high-speed culture. It is possible to go farther, faster in more comfort than ever before. The rate of increase in speed and capacity is also faster than ever.

Land

The railroad declines and automobiles reign in TL7. All of North America, most of Western Europe and some other areas are linked by heavy-duty all-weather roads. Motor vehicles that can reach or exceed 100 mph are widely available. Armored vehicles carrying heavy cannon reach 20 to 50 mph. All military forces of any stature possess them, as do many large rebel or opposition groups.

See p. 87 for specific armored vehicle driving and maintenance rules.

Water

Sails become a recreational and training sideline (though faster and stronger than ever) as powered vessels take over the waves. Nuclear power allows both surface and submarine craft effectively unlimited range at full speed. The U.S. ability to deploy a carrier battle-group - deploying more than 100 aircraft - at any trouble spot within days has been decisive in several touchy situations. The former Soviet navy, despite its sacrifices, remains on schedule to deploy its first nuclear carriers.

Air

TL7 air travel spans from hot-air balloons to multi-mach rocket craft. The highest-performance aircraft are especially complex. Unless the pilot is familiar with that *exact* model, he suffers a further penalty of at least -1. Fixed-wing and rotary-wing training especially defy translation; many excellent plane pilots cannot fly helicopters at all.

Space

TL7 space travel is in its infancy. For most of the period, any space mission is a separate large-scale engineering project. No one will be permitted to go into space without high IQ, excellent HT and a thorough background check. Sending objects into space costs millions per pound; only governments and large corporations can afford it.

AUTOMOTIVE PRICE AND QUALITY

Cars become more widespread and relatively affordable in TL7. They also become more mechanically reliable, but harder to fix when breakdowns do occur. After 1950 most U.S. adults own (or co-own with a lending institution) a car. After 1960, the same is true of England, Western Europe, Australia and Japan and the white population of South Africa. Credit systems are such that some kind of car is available for 25% or less of the monthly pay of just about any employed person in these countries. It is considerably more common to be paying on a car than to own one outright!

The full cost of automobiles varies enormously. Depending on time, place and circumstances it can be from several times normal beginning wealth to as little as 1% of normal beginning wealth.

Used cars commonly command 10% to 50% of new prices. Stolen cars are widely available; a Streetwise roll can usually find a car fence in one day in any moderate to large city. Stolen cars usually sell for 1% to 5% of new; they cost whatever the fence thinks he can get. Being found in possession of a stolen car makes a good *prima facie* case for a felony in every country. Penalties range from probation (for a U.S. first offender) to death (in many Moslem societies).

MEDICINE

Medicine advances so fast at TL7 that most doctors cannot keep up save in a very specialized field. Almost any trauma can be treated if the patient can be reached quickly. Antibiotics can treat most infections. Public hygiene and inoculation end most epidemic diseases, except for a stubborn few, in developed societies. Organs are regularly transplanted; severed limbs routinely reattached. Even battlefield injuries have a better than 95% chance of recovery if the patient can be in surgery within an hour. Public health is so much improved that a difficult-to-spread disease impacting less than 0.5 percent of the population is "a terrifying plague."

Treatments that approach "science fiction" are in (or past) the laboratory stage: electrical stimulation of broken bones' knitting, regrowth of lost digits, drugs to improve intelligence and memory. There are organizations which, for a fee, will freeze your corpse against the hope of a later cure. Of course, as of 1998, they can't even safely thaw it out, much less cure what was killing you. But the future holds such promise . . .

First Aid also improves. Cardiopulmonary resuscitation and rescue breathing, widely taught after 1960, are much more effective than earlier techniques. Allow a +2 on any (non-default) First Aid roll to revive a victim of drowning or asphyxiation.

WEAPON DESCRIPTIONS

Auto-loading Pistols

“Broomhandle” Mauser 7.63x25mm Mauser (Holdout -2) - This 1896 innovation was one of the first commercially and operationally successful automatic pistols. It was never the official sidearm of a major nation, but was used in just about every war of the 20th century. It was especially popular in China and South America. Copies and derivatives were produced in Spain and in China. German-made versions were produced in 7.63mm, 9mm Mauser (2d+2 damage) and 9mm Parabellum (2d+2 damage); Spanish and Chinese copies were made in these and also in .45 ACP (2d damage).

One accessory available with the broomhandle was a combination shoulder stock/holster. With the stock, use Guns (Rifle); the combination is +5 to Acc, if both hands can be used to hold it.

After 1923, fully automatic versions were available, at a cost of \$100. German ones were made only in 7.63, Spanish and Chinese copies were made in other calibers, but were rare (3 to 10 times normal cost) except in 7.63. Use Guns (Machine Pistol) without the shoulder stock, Guns (Light Automatic) with. The broomhandle is a very difficult SMG to operate. RoF is 20; Rcl is -5 with the shoulder stock and -7 without.

Mausers have two styles of magazine, integral and detachable. Integral-magazine guns load with stripper clips, like Mauser bolt-action rifles. They cannot have an extra round in the chamber because the bolt closes as the clip is withdrawn and strips the top round off the magazine. Detachable-magazine guns (available after 1930) can be loaded with stripper clips, or the magazine can be withdrawn and loaded as with other such guns. Detachable magazines are available holding 10- or 20-rounds. The 20-round magazine sticks far below the line of the trigger guard; the pistol won't fit in standard holsters with it in place and is -3 to holdout. Detachable-magazine guns can have an additional round in the chamber.

Browning .25, .25 ACP (Holdout +2) - In 1906, John Browning, working from FN in Belgium, introduced both the .25 ACP cartridge (6.35mm) and the first of the pistols chambered for it. These tiny, flat pistols are short on accuracy, killing power and reliability, but they are very easy to hide. They can be completely concealed under an average man's hand. German staff officers preferred them; they were small and light enough not to wrinkle a uniform and perfectly adequate for suicide, for a good shot. They have been the second (or third or fourth) gun of a lot of people who were more adequately armed. Colt produced this gun (as the Vest Pocket Model) in the United States from 1908 to 1946. Millions of copies and more millions of similar designs have been made worldwide. The gun is simple and operating stresses are low; many have been built with hand tools as a cottage industry, especially in Spain. Any U.S. pawnshop will have several, at half or less of new cost, after 1910.

Luger 9x19mm Parabellum (Holdout -1) - The first Lugers were available in 1900, in 7.65mm (called .30 Luger in the United States). The German armed forces felt that this was too small a caliber, so the Mauser company blew out the bottle-necked case to a near straight-wall. This turned out to be 9mm, and so the most widely distributed military-pistol round of the 20th century was developed. The 7.65mm and 9mm Lugers are very nearly identical; one can be converted to the other by changing barrel, recoil spring and magazine. 7.65mm Lugers have the same stats as 9mm except Damage 2d, 1/2D 120, Max 1,800. The German navy adopted the 9mm Luger in 1904 and the army in 1908. The United States tested a .45 caliber (2d damage) version in 1910, but did not adopt it and only a few were made. The Army destroyed its stock after test. They would be very rare anytime; modern value would probably be in six figures.

The Luger was adopted by several armies, and was made for commercial sale in several countries. Millions of Lugers were made in many versions (including a carbine).

A shoulder stock/holster combination was available for any of the pistols giving +4 to Acc using Guns (Rifle). Another accessory for the 9mm guns was a 32-round “snail-drum” magazine. Loaded weight of the magazine is two pounds; it is bigger and heavier than the pistol itself. It takes a special tool to load, at the rate of one round every two seconds.

The Luger is exceptionally easy to point and shoot; it has a SS of 9 and Acc of 4. Unfortunately it also has a poor performance record; it malfunctions on 16. Using the 32-round magazine, it jams on 15.

Colt .45 ACP (Holdout -1) - The first Colt Automatic Pistol in .45 ACP went on sale in 1905. A modified version was adopted as the U.S. service pistol in 1911, and remained standard until the 1980s (replaced by the

Beretta 92). It was also adopted by countries as diverse as Norway, Mexico, Argentina and China. Mexico and Argentina developed very similar guns firing the same cartridge.

The .45 is famous for reliability; any jam must be verified by a second roll. Any failure or critical failure is a jam; success means no jam.

The .45 has probably been more extensively customized and modified than any gun in history. Paying double the original cost of the gun in custom work can increase the Acc to 4; loading with high-powered ammunition, at three times standard cost per round, can increase damage to 2d+2. After 1970, scope sights and laser sights are available.

The Colt is also available in 9x19mm and .38 Super (Damage 2d+2, Rcl -1), .38 ACP (Damage 2d, Rcl -1) and 10mm (Damage 3d-2, Rcl -3). .38 ACP versions debut in 1900, .38 Super 1929, 9mm 1951 and 10mm 1990. .38 ACP will work in a .38 Super chamber; .38 Super in a .38 ACP chamber has a 1-in-6 chance with every shot of blowing the slide into the firer's face (1d of damage to the head, on a 6 damage is to the brain).

For an extra \$300, a modified frame that takes a 13-shot magazine of .45s is available. The magazine is not interchangeable with those for ordinary .45s. This makes the grip significantly larger. At the GM's discretion, shooters with small hands can be penalized up to -3 to Fast-Draw for the larger grip. The same problem can increase felt-recoil to -3.

Two smaller versions of the .45 are available. The Commander, from 1951, is Holdout 0 and the Officers Model, from 1980, is +1.

Walther PPK 7.65x17mm Browning (.32 ACP) (Holdout +1) - In 1929, Walther introduced a then-radical design, a double-action-first-shot auto-loading pistol. Walther called it the PP (Polizei Pistolen or Police Pistol). In 1931, a slightly modified version was introduced under the name PPK (Polizei Pistolen Kriminal, implying that it was for plain-clothes officers). The PP is very like the PPK; the only real difference in game terms is that the PP has an eight-shot magazine. Both the Walthers are also available in .22 LR (same shots) and .380 ACP (one shot less). They were favorites of the Nazi hierarchy and are often found in elaborately engraved and decorated versions with pearl or ivory stocks. In .380 ACP (also called 9mm Short, Kurz or Corto), Damage is 2d, 1/2D is 125, Max 1,500. In .22 LR Damage is 1d, 1/2D 75, Max 1,200.

Browning “Highpower” 9x19mm Parabellum (Holdout -1) - The Browning *Grand Puissance* (High-Power) was commercially introduced by the Fabrique Nationale organization in 1935. It was named for the late gun designer John Browning, who had done the original design work on which it was based. (In Europe, “browning” with a small b is synonymous with automatic pistol.) The pistol was the first of the high-capacity 9mm pistols that became the most popular sidearms of late TL7. The Browning was adopted as the official pistol of most of the NATO countries and of all the British Commonwealth. It was a favorite police and espionage weapon and one of the most popular among terrorists.

Ruger Standard Model .22 LR (Holdout -1) - Introduced in 1949, the Ruger was a low-cost .22 intended as a plinker and small-game gun. Later (post-1955) models included high-quality target guns considerably lower-priced than their competition. (Cost three times the Standard Model; Ace 8.) The Ruger was a favorite for conversion to a silenced assassination gun. One day's skilled gunsmith work can put a lock on the bolt to make it a selective single-shot. With a 12-inch silencer built integrally to the barrel, it makes considerably less noise than a bow-string twanging.

AMT Backup 9x17mm (.380 ACP) (Holdout +2) - First available in 1976. Chambered for the 9mm Short (.380 ACP), but no larger than some .25 automatics, it can be concealed completely under an average man's hand. Very popular as a second gun for police officers and drug dealers.

Beretta 92 9x19mm (Holdout -1) - This is a double-action automatic with a 15-round magazine. It is a well-made weapon, and spread around the world very rapidly after its 1976 debut. In 1986 it was adopted by the U.S. military as the M9. It was also the choice of many police agencies. It is made in a number of minor variants, but all have the same basic frame and action. Several European and South American countries forbid civilians and police from using the military caliber; for this market Beretta chambers the weapon in 7.65mm Parabellum (see *Luger*, above, for damage difference). In 1992 the Beretta was offered in .40 S&W (Damage 2d, Shots 13).

A very similar gun, the Beretta 93R in 9mm, has full-auto capability. It comes with a muzzle-brake, folding front hand-grip and detachable wire

shoulder-stock. Used as a pistol it has the same stats as the 92; used as an SMG or machine pistol, it has RoF 18, Shots 15+1 or 20+1, ST 12, Rcl -3 using the stock and -5 without, cost \$1,200.

Glock 17 9x19mm Parabellum (Holdout -1) - Developed in Austria in the late 1970s, and available for commercial sale worldwide by 1980. The Glock used the latest technology of the time to produce a pistol with a high-magazine capacity (17 rounds), controllable recoil and light weight. The frame and most non-stress parts are plastic. (The gun is not entirely plastic, and shows up very well on metal detectors and X-rays, so it is no easier to conceal than other, similar guns.) It has a curious action that is neither double nor single, but might best be described as trigger-activated; the manual safety is built into the trigger. Similar guns, with very minor differences in size and none in operation, are available: Glock 19 9mm, Shots 15+1, Holdout 0, from 1988; Glock 20 10mm (3d-2), Shots 15+1, Rcl -3, from 1990; Glock 22 .40 S&W (2d), Shots 15+1, also from 1990; Glock 21 .45, ACP (2d, Shots 12+1, Rcl -2) from 1991.

Desert Eagle .44 Magnum (Holdout -3) - An automatic pistol (c. 1984) designed to work with the most powerful, widely available revolver cartridge. This Israeli-designed gun is gas-operated (most auto-loading pistols are recoil-operated). It is extremely large and difficult to conceal, but has exceptional power and accuracy. The oversized grips can be (GM's discre-

Revolvers

Collier .50 (Holdout -2) - The Collier is a gun of somewhat mysterious parentage. It was patented in 1818 in France, England and the United States, by three different men, who were all former residents of the same New England town. Most examples were made in England, and it is usually known by the name of the English patentee, Elisha Collier.

The Colliers were well-made guns. They had self-priming magazines and a tight seal between cylinder and barrel that increased power and reduced fouling, backflashes, chain-firing and misfires. Well-maintained Colliers malfunction on 14+. GMs can assign penalties up to -4 for badly maintained or abused guns; they are delicate.

Colliers cannot be fanned or slip-hammered.

Colliers were available new only in the largest cities of England, the American Atlantic coast and Europe. Cost was not exorbitant, but availability was small and repairs demanded a highly skilled gunsmith. In the 20th century, Colliers are high-priced antiques; one in near-perfect shape will bring \$10,000 minimum.

After 1825, any gunsmith can easily convert one to caplock for \$25.

Colt "Texas Paterson" .36 (Holdout -1) - The largest version of Col. Samuel Colt's Paterson Revolver, the gun that made all men equal. This was intended to be carried in pairs in saddle holsters. Similar but smaller guns in .28, .31 and .34 caliber came on sale in 1836. The .28s use the same stats as the S&W No. 1 (see below); .31s have the same stats, except that damage is 1d; .34s have the same stats as .36s except that damage is 2d-2. These were the first mass-production revolvers. At a price any working man could pay, they were reliable and easy to repair. These first Colts were not widely available because Colt could not get his finances in order. GMs should allow them to be purchased only in the largest cities of the U.S. East and South, except in unusual circumstances.

Colt "Dragoon" .44 Caplock (Holdout -2) - In 1848, Colt introduced one of the company's most successful guns, the Dragoon. This was a massive weapon, 14 inches long and weighing four pounds. It was one of the most powerful of black-powder handguns, with a load of powder and lead that approached that of military rifles.

The Dragoon was preceded, in 1846, by the even more massive Walker, 1.5 inches longer, half a pound heavier and a little more powerful; use Dragoon stats but increase damage to 2d+2 and weight to 4.5, Holdout -3. Only a few Walkers were made and almost all went to the Army. Walkers were made of inferior steel and many burst in service; any natural 18 bursts a Walker for 1d damage to firer.

Some versions of the Dragoon were made with a detachable wooden shoulder-stock. Cost for this model is 50% greater. Acc is +2 when the stock is used; use Guns (Rifle).

The Dragoon was manufactured by Colt until 1860 and was widely imitated in Europe and in the Southern Confederacy.

Colt "Navy" .36 (Holdout -2) - In 1851, Colt began sales of one of its most popular guns, the Navy .36. The nickname came from the scene, engraved on the cylinder, of a battle between ships of the Texan and Mexican navies. The Navy was renowned for its balance and pointability. Combined with the light recoil, this made it a favorite for accurate shooting, but it was not notably powerful. The Navy was a favorite sidearm of the Civil War and early gunfighters. Robert E. Lee kept one in his saddlebags;

tion) up to -4 in a Fast-Draw contest or increase felt-recoil to -5 for small-handed shooters. The Desert Eagle is also available in .357 Magnum (3d-1, Rcl -2) and .50 AE (3d+2, Rcl -4, from 1991).

H&K P7M8 9mmx19mm (Holdout +1) - This is a small but full-powered 9mm handgun with a unique hand-grip cocking and locking system that lets it be carried safely with a round in chamber. Its gas-retarded blow-back action is extremely reliable, but the weapon has a price to match its workmanship. It is used by German police and is popular commercially and with U.S. lawmen.

SIG P229 .40 S&W (Holdout 0) - A 1992 entry in a series of medium-frame high-quality pistols from SIG, it is smaller than a Glock 17 or Beretta 92. These guns are popular with police detectives and FBI agents. Also comes in 9x19mm (2d+2, 13 shots) and .357 SiG (3d-1, Rcl -2, 12 shots).

Kahr Arms K40, .40 S&W (Holdout +1) - A double-action automatic as concealable as a Walther PPK but firing a "serious" round, this 1994 model is a popular backup or undercover cop gun. Polygonal rifled barrel is accurate despite short length.

H&K USP .45 ACP (Holdout -1) - H&K's first pistol designed for the U.S. shooter, this popular 1990s weapon mates a modified Browning action with a powerful recoil-reduction system. Also available: .40 S&W (2d+, 13 shots), 9x19mm (2d+2, 15 shots).

Wild Bill Hickok kept a brace in his sash. Colt favored this gun as a presentation piece. Elaborately engraved and stocked guns in plush-lined cases of the finest woods were sent as gifts. Usually they went to monarchs, ministers of war or senior officers who might slip a lucrative contract to Colt.

The Colt "Army" .44 of 1860 was a Navy frame with .44-caliber barrel and rebated cylinder. Use the same stats, except Rcl is -2.

Adams 54-bore (.442) (Holdout -1) - Available for sale in England in 1853. One of the first true *double-action* revolvers, that could be fired by trigger pressure alone *or* by cocking the hammer first. (Earlier Adams "self-cocking" revolvers, available from 1851, looked much the same but could fire only by trigger action.) This was the typical English revolver, as the single-action Colt was the typical American revolver.

The British tended to favor lighter loads than Americans for revolvers in the same caliber, hence the lesser damage. The Adams put 11 grains of powder behind a ball that the Colt Army launched with 28 grains. Similar revolvers were available in .36 (2d-3), .32 (1d-2) and .500 (2d). The British called .500 caliber 38 bore, .442 54 bore, .36 100 bore and .32 120 bore.

Basically similar Adams revolvers were made for cartridges from 1867. They were side-gate loading with rod ejectors. The .450 Adams was the British service revolver in the 1870s and '80s. (Dr. Watson's "old service revolver" was probably an Adams .450.) Cartridge .450s have the same stats as caplock .442s. .380s have the same stats as .36s and .320s have the same stats as .32s. A gunsmith can convert any Adams from caplock to the corresponding cartridge in one day at a price of \$5. Adams revolvers were license-built or copied in Belgium, the United States, Austria and Prussia. They could be found almost anywhere in the world.

S&W No. 1 .22 Short (Holdout +1) - A genuinely history-making gun on its introduction in 1854, it was the first rimfire revolver and it introduced the .22 rimfire cartridge, the most widely distributed cartridge of the 19th and 20th centuries. It was neither powerful nor accurate, and it took a long time to reload. (The cylinder had to be completely removed, and the empties punched out one by one.) It was easy to conceal and it could be loaded and bolstered with a betting chance that it could be drawn and fired a month later. It was also made, from 1857, in .32 Rimfire (1d).

S&W Russian Model .44 Russian (Holdout -2) - In 1869, S&W brought out their first big-bore revolver, the .44 American. It was the first S&W top-break, simultaneously extracting revolver. In 1871, the Russian Imperial Army adopted the S&W as their service revolver. S&W slightly redesigned the cartridge and gave it the name .44 Russian, but the dimensions are so similar that one round will usually work in a gun chambered for the other. .44 Russian will work perfectly in any gun chambered for .44 Special or .44 Magnum (also in the 11 mm revolvers that were German Imperial Army issue from 1879 to 1904; a few of these guns were still in use as late as WWII.)

The .44 Russian was the best production target pistol of its time and was used to set many world records. Copies, both licensed and unlicensed, of the .44 S&W were made in many countries, particularly Spain and Belgium. It was officially replaced in Russian service in 1895, but was still issued as late as WWII. Some were provided from Russian stocks to equip the Cuban militia in the 1960s. The same frame was used for .38 caliber guns (use range and damage stats for the .36 Colt Navy).

Colt "Peacemaker" .45 Colt (Holdout -2) - In 1873, the United States Army officially adopted the Colt to replace its hodgepodge of cartridge and caplock handguns. The Colt, with a 250-grain bullet over 40 grains of powder, was tremendously powerful for its time - and had a tremendous kick. To alleviate this, the Army standard load was 28 grains of powder in a slightly shorter case. This case would also fit the S&W Schofield top-break, self-extracting revolvers that the Army tested starting in 1875. (The Army soon discarded the Schofields, but they were popular among civilians; Jesse James robbed banks with one and Wells, Fargo issued them to guards and detectives.) This load is officially the .45 Army, but is sometimes called the .45 Short. Stats on the table are for the .45 Army; for the full-power load make Damage 3d-2 and Rcl -3. The big Colt was also chambered for loads from the .22 Short to the .476 Eley. Particularly common in the Americas were Colts chambered for the Winchester rifle cartridges, .44-40, .38-40 and .32-20. This allowed one kind of shell for both handgun and long-gun. For .44-40, use the damage and range stats for the Colt Dragoon. For .38-40, use stats for the .38 Special, but use the modifier for .40+ caliber bullets. For the .32-20, use stats for the Colt Navy. The Colt had many nicknames: SAA (Single-Action Army), Peacemaker, Frontier Colt, Army Colt, Thumb-buster and Hog-leg were among them.

Smith and Wesson Safety Hammerless .38 S&W (Holdout +1) - Introduced in 1887, this was the preeminent holdout gun of the late 19th and early 20th centuries. The gun was small, with a smooth profile and no protruding sights or hammer. (The hammer was inside the mechanism and the gun could only be fired double-action.) Its most common nickname was Lemon Squeezer; it had a grip safety and, unless the grip was held firmly in firing position, "squeezing" the safety, it would not fire. This, and the lack of an entangling hammer, made it the most suitable sort of gun to be carried in a pocket. It could even be fired from a pocket with little danger of jamming. Millions of this gun, copies of it and near-identical designs, were made in the United States and Europe. It was the least expensive and most commonly available quality handgun; after 1890, any pawnshop probably has one at 50% to 75% of new price. Criminals favored the gun because it was concealable, economical and anonymous; cops liked it as a second gun or off-duty gun. It was also made in .32 S&W (2d-3).

Single-action guns of much the same design and in the same calibers were available from 1875. Use the same stats, but they can only be fired single-action; if fired from a pocket, Malf is 16.

Webley No.1 .455 Webley (Holdout -2) - The British Army adopted this big top-break, self-extracting double-action in 1887 and continued issuing successive models of it until the Mk. VI of 1915. Some continued in service until the 1960s. It had been theoretically obsolete since the mid-1930s, but many troops preferred the reliability and stopping power of the old gun to its replacements. The .455 will also chamber any British service-revolver cartridge identified as .450 or .476. .476s have the same stats as .455s; .450s have the same stats as the Adams .442 caplock. Very similar revolvers in .450, .455, .476 and .442 (cartridge with the same stats as the caplock) were available commercially from 1880 under the names Webley-Kaufmann and Webley-Green. Use the same stats as for the Webley. The Webley-Green was made as a target pistol with precision sights; +2 to Acc at double the cost. Speed-loaders are available from 1889.

Nagant "Gas-Seal" (M1895) 7.62 Nagant (Holdout -1) - The Nagant was adopted in 1895, officially replaced in 1933, but still in use all through WWII in Russia. It was an unusual weapon. Though never very widely distributed in the West, millions were produced in Russia and distributed all over Asia and Eastern Europe. It has a seven-shot cylinder and is side-gate loading and rod-ejecting. The cartridges completely cover the bullet; when the gun is fired, the cylinder moves forward and the barrel and cartridge mate to seal the weapon against gas loss. This gives a significant edge in velocity and makes the Nagant one of the few revolvers that can be effectively silenced. (This only works if both gun and ammunition are in first-class condition.) The Nagant was manufactured both as a double-action and a single-action.

Smith and Wesson Military & Police .38 Special (Holdout -1) - In 1902, S&W introduced a swing-out cylinder, simultaneously ejecting revolver. Through a bewildering number of name changes and minor variations, it remained the most common police and security sidearm of America

in the 20th century. Since the 1950s, the most common version (four-inch barrel, fixed sights, square butt) has been called the Model 10. It was made in barrel lengths from two inches to eight inches, in round and square butts, with fixed or adjustable sights, in every finish from military gray to gold-plated. Through all the changes, it was basically the same gun. The essential design was so satisfactory that its competitors all worked in almost exactly the same way; anyone who can use the S&W can use well over 95% of the .38 Special revolvers made in the 20th century, with at most a -1 for familiarity. Adding adjustable target sights (10% to cost) is +1 to accuracy; dropping the barrel length to two inches makes Holdout 0 and changes recoil to -2. (Note: the .38 S&W and the .38 Special are *not* interchangeable.) Speed-loaders are available by 1900, common by 1960.

Smith & Wesson .357 Magnum (M27) .357 Magnum (Holdout -2) - In 1936, S&W began sales of what they billed as the "world's most powerful handgun." It was basically a beefed-up version of their .44 Special revolver, chambered for a lengthened and heavily loaded .38 Special cartridge. (The actual diameter of .38 bullets is about .357 inch; *magnum* is Latin for great and had been used by the British to describe an exceptionally powerful cartridge for some years.) The first guns were available only with eight-inch barrels, but by 1938, the factory was offering lengths down to four. The .357 rapidly became a favorite of police. It helped that the Magnum would also use .38 Special ammo, which was both cheaper and easier to handle for practice. Soon other manufacturers began producing guns for the same round; in practice one .357 Magnum is a lot like the others. Currently, S&W calls the .357 the Model 27 or 28, depending on style. As with the .38, target sights (+10% cost) increase accuracy, but by +2. Shortening the barrel to two inches changes recoil to -3. Speed-loaders are available by 1960.

Colt Python .357 Magnum (Holdout -2) - The Colt Python was probably the most prestigious handgun of its day. It was renowned for out-of-the-box accuracy and reliability. It also had an intimidating psychological effect, with its heavy, vent-ribbed barrel. It came standard with target sights but some shooters preferred the ruggedness of fixed sights (Acc 3). A two-inch Python has Rcl -3. Speed-loaders are available by 1960.

S&W M29 .44 Magnum (Holdout -2) - The M29 uses the same frame as the M27, but for an even more powerful cartridge. The .44 Magnum has the same relationship to the .44 Special that the .357 Magnum has to the .38 Special: a longer case and hotter load. Any .44 Magnum will chamber .44 Special ammo (use range, damage and recoil stats as for the .44 Russian). S&W had a monopoly on .44 Magnum double-actions until the mid-1960s. From about 1965 to 1975, M29s frequently sold for two or three times the list price, because demand outstripped supply. After 1975, Spanish-made double-actions and, after 1980, the Ruger Redhawk competed with S&W for the market and prices came down. In 1991 Colt finally produced a .44 Mag, the Anaconda. Single-action revolvers for the .44 Magnum were available as soon as the S&W appeared. The best and widest distributed was the Ruger Super Blackhawk, but Spanish and German guns and rechambered Colt SAAs were also on the market. These have the same stats as the S&W except RoF 1. Speed-loaders are available by 1960 for the double-action guns.

Charter Arms Undercover .38 Special (Holdout +1) - Charter Arms was founded in 1964 to fill a particular niche in the firearms world: the small, handy revolver of high quality. The Undercover, a five-shot .38, weighs an even pound. Charter also makes the Undercoverette, a six-shot .32 (2d-2) and the Pathfinder, a six-shot .22 (range and damage as for the Ruger Standard Model). In 1976, the Bulldog in .44 Special was added. It's slightly larger and bulkier, with considerably more power and recoil. It is 0 to Holdout, range and damage as for the .44 Russian, Rcl -2 and ST 11.

Essentially identical revolvers, generically called ".38 snub," have been available since the 1920s by many manufacturers; S&W probably made most of the high-quality ones before Charter Arms.

Speed-loaders are available by 1960.

Taurus M454, .454 Casull (Holdout -3) - This is a double-action gun firing the world's most powerful revolver cartridge. Other revolvers in .454 Casull have been available since c. 1980.

Taurus M608 .357 Magnum (Holdout -2) - This 1996 large frame revolver sports a revolutionary *eight-round* cylinder.

Non-Repeating Pistols

Handgonne .50 (Holdout -4) - About 1350, perhaps as much as 50 years earlier, weapons like this appeared as the earliest "pistols." This was an eight-inch-long bronze cylinder mounted on a two-foot shaft. Empty, it could be used as a small mace (see p. B206). The recoil was not actually heavy, but the awkward stock and one-handed hold made control difficult.

Axe-gonne .60 (Holdout -4) - A sophisticated weapon from the German States, c. 1400. The barrel took the place of a spike at the top of the axe blade. Loading had to be done carefully . . .

Japanese Pistol .60 (Holdout -3 or worse, with the match lit) - The Japanese began making matchlock pistols like this in the early 16th century

and were still making them in the late 19th. Europeans could make similar guns, but didn't make many. There were tactical and technical reasons to prefer the wheellock and flintlock, even though they were more expensive by far. The Japanese, as part of the official policy of shutting out foreign influence, did not copy the wheellock or flintlock.

Pocket Pistol .50 (Holdout 0) - By the time this gun was made in 1580, wheellocks had been in use for perhaps as long as 50 years. This was a holdout gun for its time, especially given the elaborate and bulky clothing of the period.

Belt Pistol .60 (Holdout -2) - This is one of a pair of wheellock pistols, intended to be carried on the person. Belt holsters were unknown; they would just be thrust through the belt or sash. They are typical of the guns that might very well have been owned by an affluent soldier or sailor circa 1600. The price is for a cased pair with all the accessories; a pistol alone would cost \$300. Anyone of less than Comfortable wealth with a pair of these probably looted them.

Horse Pistol .75 (Holdout -4) - This wheellock was the standard weapon of cavalry in the late 16th and early 17th centuries. Most cavalymen carried three; two in saddle holsters and one tucked into the right boot. Overall size is like that of a 20th-century sawed-off shotgun. Price listed is for a set of three with all accessories; one gun would cost \$400. Cavalry was the service of the wealthy and powerful; the captain of a troop would be expected to purchase his own and troops' guns, and reimburse himself from loot and the rental of his company.

Naval Pistol .51 (Holdout -3) - This is one of the Miquelet lock pistols common in the Mediterranean. This type of lock had been around since about 1550, but was not very common. It was more expensive than a matchlock and nearly as complex to make as a wheellock. (A flintlock is a simpler mechanism than a wheellock, but very dependent on good springs and well-fitted parts.) The tiny price compared to wheellocks is part of the economic revolution in manufacturing of the 18th century. All sorts of mechanical devices were suddenly within the pocketbook range of the common man. Price for a flintlock before 1700 should be the same as a comparable wheellock. This pistol has a belt-hook on the side opposite the lock to hold it and free the seaman's hands to hold cutlass and rigging. Boarders often carried six or more pistols for sustained firepower.

"Ducks-Foot" Pistol .40 (Holdout -2) - Four-barreled volley pistol of 1720 vintage. All the barrels are fired at once by one lock; the barrels are at a diverging angle so that the shots spread as they travel. No one in front of the gun can tell quite where it is pointing, which makes it great for intimidation. For the game, all four shots go off at once. In the first hex from the firer, all the bullets are in the same hex, and any target can be struck by one, some or all of them. Roll separately to hit for each bullet. At two hexes from the firer, there are two bullets in the hex in a straight line with the firer and one in each of the adjacent hexes to the line of fire. A target in any of these hexes is attacked, at an additional -1 to all other modifiers. Beyond two hexes, any target within the triangle formed by a line 10 hexes long at a distance of 30 hexes can be attacked at 9, or the number it would take to hit on purpose with a conventional pistol of similar characteristics, whichever is worse. The GM determines which targets, up to four, are attacked. A taste for reality would distribute the targets more or less equally across the frontage, but this is optional.

Highland Pistol .52 (Holdout -2) - This is one of the distinctive, all-steel pistols characteristic of the Highlands of Scotland. It has a belt-hook on the left side of the lock; in a matched set, its mate would have a hook on

the right side. Similar pistols were made from the early 17th century in Scotland (and in England and Europe for export to Scotland). Most were flintlock, but some wheellocks were made before 1700, and some caplocks in the 19th century. (In the mid-19th century, cheap copies of the Highland pistol, with caplocks, were popular as part of Highland dress. They were not practical weapons.) A highland fighter normally carried broadsword, shield, dirk (large knife), skean dubh (small knife), two pistols and musket. Part of his tactical problem was deciding what to use first.

Durs Egg Holster Pistol .65 (Holdout -2) - A high-quality pistol from Durs Egg, one of the most famous makers of all time, but otherwise similar to the guns carried by cavalry and all mounted officers. It is designed for power rather than accuracy; most shots in mounted combat are at arms-length. Similar guns, at prices down to \$5, are common both for land and sea service from 1700 to the end of the flintlock era. Figure anything cheaper as Malf 13, anything at \$ 10 Malf 12, anything at \$5 Malf 11.

The first military caplocks were similar except for the lock.

Wogdon Dueller .45 (Holdout -2) - A product of the famous London maker, Robert Wogdon. These guns are designed for accuracy (snap-shot or aimed fire) and certainty of fire; they have the most reliable of all flintlocks. RoF listed is the fastest loading time; by taking three times as long, accuracy can be increased to 4. Similar guns by other makers were used both for dueling and for target shooting. (Wagering on target shoots was a favorite form of gambling in England and America.) Price is for a cased set with accessories; all duelers and most target pistols were sold as cased pairs. Any time a single was available, it was probably stolen. Similar caplocks were available after 1820; Malf is crit.

Deringer .44 (Holdout +2) - This was a small, sleek gun of considerable power and accuracy. This is a single piece, but Deringer frequently sold the guns as cased pairs, or even sets of four. It was much faster to draw another gun than to reload. A pair of Deringers in the trouser pockets and a Bowie knife in the tail coat pocket completed the ensemble of the well-dressed gambler, lawyer or congressman of the 1840s. John Wilkes Booth assassinated Abraham Lincoln with a very similar piece.

Remington Double-Derringer .41 Remington (Holdout +2) - The gambler's companion from its introduction in 1866 to at least the end of the next century. Remington officially ended production in 1935, but imitations were still being made 50 years later. The .41 was a pretty anemic round, but it was better than nothing in a pinch; it remained in production a century and a half after its introduction. After about 1960, copies of the Remington appeared in an enormous number of calibers, from .22 Rimfire to .44 Magnum and beyond. Any cartridge more robust than the .32 has a fearful recoil in the small-gripped, light-weight derringer. Use stats for the cartridge involved, reduced by 10% for the short barrels and use a Rcl of -3, or -1 to the listed recoil, whichever is worse.

Lancaster "Howdah Pistol" .500 (Holdout -2) - This 1882 weapon was designed as a backup gun for elephant-mounted tiger hunters, but widely adopted by officers. The power is matched by the recoil, and the four-shot limitation can be embarrassing, but the multi-barrel, rotating-lock system is as nearly malfunction proof as a repeating firearm can get. On any jam or misfire, verify by rolling again.

Thompson Contender 5.56x45mm (Holdout -4) - A precisely manufactured target/hunting pistol firing rifle ammunition, the Contender is possibly the world's most accurate handgun. It's available in the 1990s in many different barrel lengths and chamberings besides 5.56mmx45mm (for example .44 Magnum with Acc 6, damage and range as S&W M29).

Shotguns

Blunderbuss 8g (Holdout -5) - This particular piece is a flintlock from c. 1700; similar guns were made in wheellock a hundred years earlier. The bell-mouth does not spread the shot any better, but it looks intimidating. It does make loading easier, especially on the seat of a bouncing coach or while perched on swaying crosstrees. The blunderbuss was official issue to mail-coach guards in England, and in all the European navies. It was also a favorite on merchant ships. (This was perhaps as much for its psychological effects as its practical; it has to be aimed like any gun, but it looks as though anything approximately in front of it is in danger.) The belled muzzle makes a precise aim impossible, but actually helps in quick pointing; if you keep the target above the bell there is less tendency to shoot high.

Manton 12g (Holdout -7) - This is an expensive weapon from one of the master makers of all time: the personal gunsmith of the Royal Family of England. This gun is fitted to the original owner; SS is +2 for anyone else except his identical twin. It is exceptionally light for a 12g flintlock, and the light weight is paid for with increased recoil. This gun has Manton's patent-

ed, elevated sighting rib, waterproof locks and rustproof platinum vents. It can be converted to percussion-cap firing very easily; the 1820 cost of conversion is \$10. This gun misfires on 15+.

Winchester Model 1887 10g (Holdout -7) - This gun was a favorite of market hunters and riot quellers in the late 19th and early 20th centuries. Its four-shot magazine, plus one in the chamber, gave more fumble-free fire power than a double-barreled gun, and the lever action was familiar to Americans from the long line of Winchester lever-action rifles. The company sold both long- and short-barreled guns; of course, anyone with a hack-saw can turn a long-barrel into a sawed-off. Difference in power and accuracy is negligible, unless the barrel is cut to below six inches (damage 4d, -1d for each inch less to a minimum of 1d, triple Rcl).

Winchester Model 1897 12g (Holdout -7) - The famous Winchester "trombone action" actually appeared in 1893. In 1897, Winchester made some improvements. The '97 was made in every grade from military plain to elaborately engraved and mounted. It was made as a long-barreled goose-

gun and as a take-down sawed-off that was less than two feet long when disassembled (Holdout -3, -5 when assembled). The '97 was distributed worldwide; it was used in both World Wars and in countless smaller conflicts. It epitomizes the pump shotgun. It was also available in 16, 20, 28 and .410 gauges (16g and 20g do 3d damage, 28 and .410 do 2d-1).

Ithaca Hammerless Double 10g (Holdout -7) - Typical of the heavy double-barreled shotguns standard for hunters, express messengers, prison guards and Mafia assassins in the late 19th and early 20th centuries. Hammer and hammerless doubles have the same RoF; sweeping the hammers to full cock takes only a fraction of a second. This gun is by a well-known manufacturer. Pieces that were similar in operation were manufactured by everything from fly-by-night mail-order companies to master gun-smiths, from 1860 on. The price ranged from \$2 to \$2,000 in 1900. The finer grades of shotgun fit their owner better (-1 SS number for the person to whom they are fitted) and lasted longer. Sawing off the barrels of a double makes Holdout -5; sawing stock and barrels gives Holdout -3.

Browning Auto-5 12g (Holdout -7) - In 1900, John Moses Browning patented his first auto-loading shotgun and, in 1903, it was first offered for U.S. sale in all the standard gauges. The auto has a lower felt-recoil because some of the energy involved is absorbed in the operation of the action. The Remington M11 is an exact copy of the Browning (no familiarity penalty). Millions of the two guns were made and they are likely to be found anywhere in the world. After WWII, when gas-operated guns became more popular than recoil-operated, pawnshops frequently had Brownings at half or more off. Sawing off changes Holdout as with doubles, above.

Remington 870 12g (Holdout -7) - In 1955, Remington brought out an improved pump shotgun that rapidly became the best-selling scattergun of

all time. It was the overwhelming choice of police and security agencies as well as hunters. It had an exceptionally smooth and reliable action, good handling and a moderate price. It is available in 12g, 20g, 28g and .410. Stats are for the standard commercial model.

As sold off the rack in a sporting goods store, the magazine is plugged to take only two rounds (a capacity of three shots with one in the chamber). The plug is easily removed (a successful Armoury roll and five minutes). Police shotguns, after 1965, usually have extended magazines holding seven or eight rounds. The same sort of magazine is available for civilians for \$50. Slings, folding stocks, short barrels, bayonet mounts and exotic sights are also after-market add-ons for the 870.

Short-barreled guns, with a folded stock, are Holdout -3.

Franchi SPAS 12 12g (Holdout -5) - The Franchi company designed this in 1975 as a purely combat shotgun, not a modification of a sporting piece. It features a folding stock, bayonet mount and sling swivels. It can be operated as either a gas-operated semi-auto or, at the touch of a button, as a pump. This allows it to use any 12g ammunition that will fit the chamber, even if it is not powerful enough to operate the action. This is a favored weapon of narcotics agents, since it is compact enough (stock folded, Holdout -3) to conceal or work from inside a car.

Striker 12g (Holdout -5) - In the 1980s, this shotgun was developed in South Africa as a riot and home-defense gun for the subjects of a government that preferred to keep assault rifles in its own hands.

This is a cylinder-fed gun. The cylinder is turned by a clock-work spring. Reloading is slow; two turns to put each round in its chamber, then two turns to wind the spring. Holdout can't be improved by chopping on it; it is already as compact as it can get.

Muskets and Rifles

Heavy Handgonne .90 (Holdout -9) - About the middle of the 14th century, cannon-lock guns like this began to appear all over Europe. Bohemia was already an armor-making center. It rapidly added handgonnes to its product line. This was still an inferior weapon to the bow or crossbow, but it was a lot easier to learn and the noise scared horses. From 1419 to 1436, the Hussite sect used handgonnes and artillery mounted on wagons to fight the armies of the Holy Roman Emperor. Their armies were mostly peasants without prior military experience, but they could learn to use guns in only a few weeks.

Arquebus .65 (Holdout -7, worse with the match lit) - The matchlock arquebus was the first firearm to combine accuracy, power, ease of training and reliability in one battle-winning package. It was introduced in the Mediterranean area, probably by the Spanish, probably in the last quarter of the 15th century. By the beginning of the 16th century, it was the predominant military firearm both on land and at sea. It was less common as a civilian weapon, since it was relatively bulky; most were three to four feet long.

Musket, with Rest .80 (Holdout -9 or worse) - One response to the power of the arquebus was to put on more armor. To counter this, the Spanish developed the matchlock musket toward the middle of the 16th century; a firearm that could pierce any practical personal armor at battle-field ranges. The musket was so long (five or six feet) and heavy (20 pounds or more) that it had to be fired from a *rest* (a three- or four-foot-long pole with a spike at one end and a fork for the musket at the other). A musket fired without resting it is Acc 1; resting it across a wall or log is Acc 2.) The rest can be used as a spear with one-hex reach.

Caliver .75 (Holdout -7 or worse) - The matchlock caliver was a compromise, heavier and more powerful than an arquebus, but lighter and less awkward than a musket. The caliver was the first firearm to be standardized for bore-diameter throughout a unit; the techniques of manufacture and measurement developed with the caliver were carried over to the production of flintlock military guns. A rough chronology of matchlock guns puts the arquebus first, then the musket, with the caliver as the final development. Heavy, rest-fired guns were available before the turn of the 16th century and lightweight guns of relatively low power were in use right to the opening of the 18th.

Target Rifle .85 (Holdout -9 or worse) - This is an early (1580) rifled gun; rifled matchlocks were always rare. This one is designed for the target competitions central to Swiss social life (a tradition that began with crossbows and continues in the 20th century; it is almost a given that any adult male *Schweizer* knows how to shoot). This is a long (four feet) and awkward gun, but its long-range accuracy might make it valuable to an adventurer.

Double-Barreled Carbine .60 (Holdout -6) - An expensive, custom-made wheellock gun for a wealthy hunter c. 1620, but also useful for a fighter. This gun has two barrels and two separate locks. The upper barrel is

rifled for long-range shooting; it takes 90 seconds to load. The lower barrel is smoothbored, for rapid loading (60 seconds) and efficiency with shot. Both barrels can be fired successively in one second. Both barrels can be fired simultaneously but the firer must roll against HT to avoid being stunned for one turn by the recoil.

Jager Rifle .85 (Holdout -6) - A wheellock hunting rifle c. 1600 for the most dangerous European animals, boar and bear. It is accurate and powerful, but short (three feet) and handy. It is equipped with a sling, used both to carry the weapon and as an additional brace in shooting. (1d seconds to get into a braced position with the sling; +1 to accuracy.) Guns like this, but in flintlock and caplock, were made and used in Germany, Austria and Switzerland until the 20th century. Jager (German for hunter) units armed with such rifles were an elite scout and sniper component of all German armies. As mercenaries, they served all over the world.

Fusil .65 (Holdout -7) - This was the first kind of flintlock to be widely used by the military, c. 1690. The artillery train needed guards, and the greater expense of the flintlocks was tolerable when compared to the likely results of guards with lit matches in the midst of tons of powder. These guard units were called "fusiliers" after their weapon. Later, fusilier units were incorporated as regiments of infantry, but some kept the name.

After the general adoption of the flintlock for all troops, lighter guns issued to sergeants and officers were called fusils. Fusils were popular with American Indians who liked the comparative light weight and recoil. They were made for the Indian trade, in England, Europe and the United States, until the middle of the 19th century.

Brown Bess .75 (Holdout -7) - Also called the Tower Musket, the Service-Pattern Musket and the Government Musket. This flintlock gun was in production from c. 1720 until c. 1838 as a British-issue weapon. Copies were manufactured all over the world. Guns not enough dissimilar to cause a familiarity penalty were the standard British service weapon from about 1690. They had probably replaced the matchlock at sea 20 years before (flintlocks worked much better in spray). The general revolution in manufacture of the 17th and 18th centuries had brought the price of a working gun down to the reach of almost anyone.

Charleville .69 (Holdout -7) - The French equivalent of the British Brown Bess. Like the Bess, roughly similar guns were probably in use for 50 years before it was officially adopted as standard. Also like the Bess, it had a long life. It was the common weapon of the French armies from the 1730s until the 1830s. Its percussion successor (identical stats except for the lock) remained in service until the 1850s. The Charleville was found around the world; it was popular in India and a copy was the U.S. service weapon until the 1850s (converted to caplock in 1842).

Surplus muskets were the most common gun of the poor and middle-class. They could not afford the prices of master gunsmiths.

Musketoons .69 (Holdout -6) - Cavalry needed a short, handy weapon that could be used on horseback but would give greater range and power than a pistol in dismounted combat. The easiest way to produce one was simply to cut down the barrel of the issue musket to a more manageable length. Weapons about three feet long were standard. They were usually called either musketoons or carbines; usage was inexact, and sometimes carbine was reserved for rifled weapons. The British used a carbine of smaller bore than the Brown Bess; it kicked less in the short carbine barrel, but meant that infantry and cavalry used different sizes of ammunition. Carbines were also issued to police and customs agents, and were the common equipment of brigands. Musketoons and carbines were normally carried slung.

"Kentucky" Rifle .45 (Holdout -9) - Modern collectors sometimes prefer "Pennsylvania" rifle, though similar guns were made all over the United States. In its own time, it was called just "rifle." The European hunting rifle evolved for killing dangerous game at fairly close range. It was intended for very skilled shooters who seldom needed more than one shot. The American rifle evolved on a continent where the only really dangerous game was human; range was variable but often as long as possible; the shooters ranged from bad to incredibly skilled; and a fast second shot was often life or death. The bore was made smaller (men are easier to kill than boar) and a .45 gets six times as many shots from a pound of lead as an .85. Barrels were lengthened; the longer sight radius made precise sighting at long range easier. The system of loading with a greased patch was adopted; it was less precise, but much faster than forcing the ball into the grooves with a mallet and rod. Guns of this type were made all over English-speaking North America from about the first quarter of the 18th century. (Manufacture never entirely ceased.) The flintlock was mostly superseded by the caplock in the 1830s, but a few stubborn shooters kept to flint. Sporting rifles like these are not designed for a bayonet, and are not sturdy enough to stand up to use as a club or staff. One used as such has a 1/3 chance of breaking.

Ferguson Rifle .60 (Holdout -7) - The 1770s-era Ferguson (see p. 60) was an excellent weapon in the skilled hands of its inventor, and when in tip-top condition. Like all breech-loaders of its time, it was delicate, easily put out of action, and prone to backflashes and fouled breeches. The Ferguson has a sliding bayonet permanently mounted under the barrel; it takes one turn to slide the bayonet out and lock it. Loading time in the table is for a new weapon, immaculately clean. GMs should consider increasing loading time if the gun is fired rapidly without stops of at least two minutes for cleaning. Any critical failure includes a blinding backflash; blindness lasts 2d seconds.

Baker Rifle .625 (Holdout -7) - European and American riflemen impressed the British as specialist scouts and snipers. With declining access to European mercenaries, they raised rifle regiments of their own. Birmingham gunsmith Ezekiel Baker designed the weapon chosen to arm them. It was a sound, orthodox design with few faults, used from 1790 to 1838. After the British regular service dropped it in the 1830s, it spread worldwide as surplus. In Asia and South and Central America, the Baker could be found until the 20th century. British rifle regiments call their bayonets swords. This is a tradition from the days of the Baker, because the bayonet issued with it was a formidable, full-knuckle-bow shortsword with a two-foot blade. It can be used as brass knuckles at close range. Cost of the bayonet is included in the cost of the rifle; separately it costs \$5.

Enfield 1853 .577 (Holdout -7) - The Enfield was Britain's standard rifle until the adoption of a cartridge breechloader. Most of the nations of Europe adopted a very similar weapon; the Enfield itself was sold all over the world. Both sides in the American Civil War used Enfields, and the Springfield 1858, standard U.S. issue, was so close a copy that ammunition was interchangeable. The Enfield is notorious in British history as the immediate instigator of the Indian Mutiny of 1857 (see sidebar, p. 61).

Both explosive bullets (1d-2 explosive damage, in addition to bullet damage, if it explodes; 50% chance of exploding; if it explodes, 50% chance that it explodes on the surface and 50% chance that it penetrates as a bullet first and then explodes for triple explosive damage) and multiple-bullet cartridges (three to hit rolls; each hit does 1d+2 damage; 1/2D and Max halved) were issued for the Enfield. Cost for either is 10 times the cost of ordinary ammunition, and they are available only from specialized manufacturers in the largest cities of England and the United States. The military issued such ammunition, but only in small lots and for special missions. An explosive bullet will set off any gunpowder it hits, if it explodes.

Martini-Henry .45 (Holdout -7) - The Martini-Henry was typical of the heavy, breech-loading single-shot cartridge rifles of the late 19th century. It was another very widespread gun; the British and Indian armies used it from 1871 until well into the 20th century and the action was still used for target and hunting rifles at the end of that century.

Remington "Creedmoor" .44-90 Remington Special (Holdout -7) - A target rifle of the highest quality for 1876, and very much the equipment of a specialist. It has fragile, but wonderfully precise, micrometer sights (or can be equipped with a scope). To achieve the listed accuracy, it is loaded with a mixture of breech and muzzle loading. An unbulleted cartridge with a precisely measured charge of powder is loaded in the breech. Then a bullet is loaded from the muzzle with a false muzzle and bullet starter, and rammed home, very carefully and precisely, with a rod, to pre-engage the rifling on the bullet. Loading from the breech with complete cartridges halves accuracy and changes RoF to 1/4.

Sharps "Big Fifty" .50-90 Sharps (Holdout-7) - The Sharps was one of the few guns to make a successful transition from caplock to cartridge. The strong, dropping-block action was equally well-suited to linen cartridges and to the long, straight-cased, black-powder rounds used for big game and long-range target shooting. The Sharps was the favorite rifle of affluent buffalo hunters. (Poor ones favored the Springfield .50-70, below.) The .50-90 cartridge (also called the .50-100 and .50-110 depending on the exact load) first appeared in 1875; it is the "Big Fifty" of buffalo hunting fame. .52 (or .54 or .56, different names for the same bullet) caplock Sharps guns were available from 1851. Stats are Damage 5d; 1/2D 500; Max 3,000, RoF 1/6, Rcl -2. Cartridge Sharps are available from 1867; stats are the same as for the .50-70 Springfield (see below). Ammunition is interchangeable with the Springfield. After 1880, Sharps rifles were made for the .50-140 cartridge on special order (cost twice normal) which has damage 6d+2. .50-90 ammunition will fire in a .50-140-chambered rifle, but not vice-versa.

Springfield Trapdoor .45-70 (Holdout -7) - This breechloader was adopted by the United States in 1873, and was the official weapon through all of the rest of the century. It was officially supplanted by the bolt-action Krag in 1895, but continued in reserve and militia service until well into the 20th century. The Springfield was sensitive to fouling and poor-quality ammunition; the extractor could slip off the expended cartridge and leave it stuck in the action. This was usually only a problem in rapid fire, and with soft-cased cartridges. (Unfortunately for a lot of soldiers, the U.S. Army issued soft, copper-cased ammunition until the late 1880s; it was cheaper and Congress demanded economy.) A stuck case had to be pried out (2d seconds on any jam result) with a knife or screwdriver.

An earlier version of the Springfield was adopted by the Army in .50-70. Use the same stats as the .45-70 except Acc 7, 1/2D 600, Max 1,900. .50-70 became a popular civilian caliber, especially because the government sold surplus .50-70 rifles at 10% of the cost of a new gun.

Stats are for the infantry rifle; for the cavalry carbine, damage is 5d-3, drop 1/2D by 100 and Max by 400; Holdout is -5.

Winchester '73 .44-40 WCF (Holdout -5) - This is the 20-inch-barreled carbine (rifle has Shots 15+1 and a 24-inch barrel) version of the Model 1873; the final development of the line of lever-action, tubular-magazine rifles that began with the Henry of 1863.

The '73 was available in several other calibers: .38-40 (3d-2 but use the modifier for .40+ bullets, after 1880) and .32-20 (2d, after 1882) were very common. The .44-40, .38-40 and .32-20 could also be used in handguns; for stats, see the Colt Peacemaker, p. 110.

The Henry and the Winchester Model 1866 use .44 Henry rimfire ammunition (Damage 2d+1; Acc 6; 1/2D 250; Max 1,900). Winchester '66s were available as rifle (Shots 17+1), carbine (Shots 13+1) and military musket (Shots 17+1, full-length stock, equipped to take a bayonet, weight 8 lbs.).

The Henry has the same RoF as the Winchester, but takes longer to reload; it did not have a side loading-gate. The magazine tube has to be pulled out and loaded from the front. This takes two seconds to pull out, one per round to load and one to close. The Henry capacity was 15+1. It was a relatively delicate weapon, especially the magazine. A Henry that is dropped or used as a club has a 1/3 chance of being so damaged that it will need repair by an armorer. The Winchester '66 was a stronger gun, and had a side loading-gate; reloading time is one second per round. The '66 can be topped up at any time, even with a round in the chamber. The '73 is loaded in the same way as the '66; it was made in many barrel lengths, with capacities from 17+1 to 6+1.

In 1876, Winchester began the sale of a larger version of the '73 for more powerful cartridges. Operationally the '76s are the same as the '73s. The calibers available were .45-75 (stats as for the .45-70) and, in 1879, the .50-95 (stats as for the .50-90 Sharps). The Royal Northwest Mounted Police used the .45-75 until after 1900. The '76 was available in several barrel lengths and in capacities from 13+1 to 6+1.

In 1886, Winchester brought out a new action, designed by John Browning, that used the .45-70 and several other large calibers. Operationally it was identical to the '76, but was stronger and easier to manufacture. In 1892, a similar Browning design was adopted for the .44-40, .38-40 and .32-20.

Lebel Models d'Ordonnance 1886 8mm Lebel (Holdout -7) - The first smokeless powder military rifle, and one of very wide distribution. The Foreign Legion and the Colonial Army used these in the French conquests in Africa and Asia. In accordance with French ideas, it was a better bayonet platform than it was a rifle. The standard bayonet was a two-foot blade that could only be used for thrusting; it had no effective cutting edge. (Treat as a spear, two-hex reach, impaling damage, thrust +1 when fixed.) Many variants existed; since the French hate to throw anything away, older models were in use to the very end of the Lebel's service, sometime in the late 1960s. (It was replaced as the Army issue rifle in 1936, but continued to be issued to police and reserve units for 30 years.)

The true "Lebel" has an eight-shot tubular magazine; it can have one round in the chamber and one more on the cartridge carrier between magazine and chamber, when fully loaded. Rifles were about four feet long and carbines about three feet. Carbine stats are: Damage 5d+1, 1/2D 800, Max 3,400, Weight 7 lbs., Shots 3+2.

In 1890, a commission redesigned the Lebel to use a Mannlicher-style clip of three rounds. The new rifles were called "Berthier," after the president of the commission; most French soldiers continued to call them Lebel. The first issued were carbines (stats as above except Shots 3; Mannlicher-style clips do not allow an extra round in the chamber). Rifles (as above except Shots 3) were first issued in 1902.

In 1916, another redesign increased shots to 5 for carbines and rifles. All three designs in both styles were in use at the same time.

SMLE (Short, Magazine, Lee-Enfield) .303 British (Holdout -6) - Adopted by the British in 1888, and still in use at the end of the 20th century, as a sniper rifle converted to 7.62 NATO. This was one of the fastest manual-action rifles to operate. Skilled shooters could get off 40 rounds in a minute, even allowing for reloading. The magazine was removable, but normally reloading was with five-shot, Mauser-type stripper clips.

The first versions of this rifle (called Lee-Metford) had an eight-shot magazine and could not be clip-loaded. The first 10-shot magazines were adopted in 1892 and the name was changed to Lee-Enfield in 1895. The first clip-loading versions appeared in 1900. Many variations of rifle and carbine on the same basic action were made during the Lee-Enfield's more than a century of use, but all were basically similar.

Winchester '94 .30-30 (Holdout -5) - The Model 1894 was Winchester's first smokeless-powder rifle, and the first smokeless-powder rifle commonly available in America. It was another triumph of the great designer, John Browning. It was never adopted as a military rifle by any major power, but was widely used in such wars as the Mexican Revolution of 1910. It was adopted by many police departments, especially in the South and Southwest, was the standard rifle of most prison systems and was the gun most likely to be found in closets or pickups all over North America. Any U.S. small-town grocery or hardware store was liable to have a few boxes of .30-30 ammo. Millions of Americans grew up thinking that rifle and .30-30 were synonymous. Operationally, it is identical to the long line of lever-action rifles going back to the Winchester '66. It was made in many barrel lengths, from 26 to 12 inches; capacity varies from 3+1 to 10+1.

Mauser 98 7.92x57mm (Holdout -6) - Adopted in this caliber by the German army in 1898. Very similar rifles have been in service since 1891, in many calibers. This cartridge is also called 7.9mm and 8mm Mauser; the British called it the .311 or .315 Mauser. Variations of this action, in many calibers, were used around the world for all of the 20th century. Many times, both sides in a given war were armed with Mausers. The action was also the basis for most 20th-century hunting and target bolt-actions. As a sporting rifle it was chambered in calibers from .22 rimfire to .505 Gibbs. Military rifles are normally clip-loaded; sporting rifles usually are not. Among the calibers for which Mausers were chambered: .303 British, 7.62 NATO, .30-06, .45-70 and .223 Remington. The action was even used for two-shot, bolt-action 12g shotguns.

Springfield M1903 .30-06 (Holdout -6) - Essentially just a variant of the Mauser, but exceptional for well-fitted actions, excellent sights and a very highly developed cartridge. This rifle was spread around the world both as a military weapon (the United States handed them out as military assistance during and after WWII) and as a sporting rifle.

Holland & Holland Double-Express .600 NE (Holdout -7) - The most powerful commercial hunting rifle, from its introduction in 1903 until the .460 Weatherby Magnum came on sale in 1958. The .600 was commercially available only in expensive English double-barreled rifles. They were normally sold only in three places: at the gunmakers in London, in the most exclusive and expensive sporting-goods stores in the major cities of the civilized world and in Africa. The \$200 price-tag is definitely the bottom of the scale. That is the price you would pay if you just happened to find one on the rack at the gunmakers to suit you. The markup by sporting goods deal-

ers was 200% or 300% at minimum. A custom-ordered weapon might cost only 100% over list, but the wait for delivery was a year at minimum. In Africa it was sometimes possible to get a bargain in used guns, frequently because the owner had made one mistake too many with elephant or rhino. More recent prices for a Holland & Holland .600 double ran between \$5,000 and \$10,000 for a used gun, and there weren't any new ones. When Holland & Holland made their last .600 double, in 1974, they guaranteed the buyer that his would be the last. Unless he sells it back to them, they will make no more. In 1989 they built a .700 Double-Express (11d, Rcl -7) for an undisclosed price for an American collector (the cartridge was specially designed).

The .600 can fire both barrels simultaneously, but the firer must roll against HT-5 to avoid being physically stunned for the next turn.

Garand .30-06 United States (Holdout -6) - Adopted by the United States in 1936. The most advanced combat weapon of its time, and still an effective one 50 years later. It fired a powerful and accurate cartridge, and its gas-operated action made control in rapid fire much easier than with manual actions. The Garand was distributed around the world after 1945 and might be encountered anywhere. It uses an 8-round, Mannlicher-style clip, but can be used as a single-shot if no clips are available. A few Garands were altered to use 20-shot box magazines; this was a custom job and required a very skilled gunsmith.

The U.S. Army adopted the M14 in 1959 to replace the Garand. It was essentially the same weapon, but rechambered for the 7.62 NATO (.308 Winchester) round, equipped with a 20-round detachable box magazine and fitted for selective fire. Use the stats for the FN-FAL, below. The Army adopted a modified M14, the M21, as their standard sniper rifle in 1968. This had a selected barrel and action (Acc 12) and was equipped with a 3-to-9 power variable scope. 1/2D is 1,200. The Garand was also produced by Beretta in Italy. A total of about 5.5 million Garands and 1.5 million M14s were made for military customers. After 1974, the M1A, a semi-automatic only M14, was produced for civilian sale as a hunting and target rifle. Cost is \$600. Versions of the Garand were available for the same price after 1980. Any .30-06 Garand can be converted to 7.62 NATO for \$20. This requires no gunsmith, just purchase of one part.

From 1936 to 1959, the Garand was not normally available to civilians.

M1 Carbine (Holdout -5) - The U.S. government bought more than 5 million of these carbines; no one knows how many more have been built. The U.S. military issued them from WWII until well into the 1960s and sold and gave them all over the world. Police and prison guards used them extensively. They are especially popular in Asia and South America. The German Police use a modified, accurized, custom-stocked version (Acc 12) as a short-range sharpshooter's weapon.

As of 1945, a selective semi-auto/full-auto version (M2; RoF 12*) was issued. This came with a 30-round magazine (nicknamed "banana clip") which also fits the M1; it rapidly became the more common. M1s are easy to convert; it takes only a few drop-in parts. With the parts, it requires only success on an Armoury roll at +2. Making the parts takes an Armoury roll and 1d days, with a complete shop. Carbines are not very reliable at full auto; Malf in auto fire is 16. Filing the sear on an M1 will allow full auto, but very unreliably (Malf is 14). (An M1 with a worn sear will sometimes burst fire unexpectedly; this can be very disconcerting to the firer.)

Kalashnikov Automatic Rifle 7.62x39mm Russian (Holdout -6) - The Kalashnikov, in its various models, is probably the most numerous weapon ever produced. Estimates of production since its 1949 debut run to more than 30 million. It was produced in Russia, China, most of the Warsaw pact countries, Egypt, Finland and probably other places. It was principally responsible for the elimination of the African elephant herds. It was adopted as part of the national flag of at least one country and as the insignia of numerous political factions and terrorist groups. Millions of people with minimal familiarity with weapons could recognize the silhouette of a Kalashnikov with a glance.

All the variants of the Kalashnikov are similar in operation; there is no familiarity penalty to go from one to another. In the mid-1970s, the Russian Army began replacing its 7.62mm Kalashnikovs (AK47s and AKMs) with 5.45mm weapons, the AK74s. Use the stats for the M16, below, except that Acc is 7 and Shots 30.

The Kalashnikov is also made as a light machine-gun, the RPK in 7.62mm and RPK-74 in 5.45mm. The RPK has a longer barrel and is fitted with a bipod (+1 when used to brace the gun). It normally uses a 40-round box magazine. The 7.62mm version also has a 75-round drum magazine. This is slow to load (two seconds per round) and weighs five pounds loaded. Any RPK magazine will work in an AK of the same caliber and vice-versa. The AK74 has a very effective muzzle-brake. This reduces recoil, especially in automatic fire (the AK74 adds recoil to itself only after

every *second* four-shot group of a continuous burst). It also gives increased muzzle-flash (+2 to any vision roll to locate an AK-74 that is firing in the dark).

The Russians did not begin exporting AKs until their own forces were completely equipped - about 1955. From that date on AKs begin to show up all over the world. By 1965, it would not be unusual to find an AK anywhere. Black-market prices for AKs depend on circumstances. The usual price on the American criminal market in the 1990s was about \$500.

FN-FAL 7.62x51mm NATO (.308 Winchester) (Holdout -6) - After WWII, most nations were still using the same bolt-action rifle that they had standardized about 1900. The exception was the United States, with the satisfactory Garand. The formation of the NATO alliance led to a program to standardize small-arms ammunition; the United States insisted that the round had to be their 7.62x51mm. The FN organization in Belgium had an excellent design already available, and it was adopted by most of the non-communist nations in the late 1950s. It was used by the British in Malaya, the Australians in Vietnam and by both sides in the Congo wars of the early 1960s and the Falklands war of 1982. Belgian-produced weapons are selective fire; most British and British Commonwealth guns are semi-automatic only.

Colt M16 5.56x45mm (.223 Remington) (Holdout -6) - The M16 was developed, as the AR15, by Eugene Stoner in the late 1950s. It was a response to the tactical theory that full-power military rifles were more powerful than necessary. Since most targets more than three hundred yards away were engaged with heavy weapons, it would be adequate if the personal weapon was effective to about that range. Lighter bullets could reduce the recoil, which allowed a lighter weapon, but one still controllable in automatic fire. Lighter ammunition meant that more rounds could be carried for the same weight. Using alloys, plastics and modern production methods, Stoner developed a six-pound automatic rifle with ammunition that weighed only about 2/3 as much as that for the M14. It was first adopted by the U.S. Air Force as the M16 in 1964. The Army made some modifications and called the result the M16A1. By 1970, it had replaced the M14 as the standard U.S. weapon and had been very widely adopted, both by military and police agencies. Colt sold both the M16A1 and the original AR15 around the world.

The AR15 can be converted to full-automatic. Conversion takes half a day, for any gunsmith with Armoury/TL7 at 12 or better, with a successful roll. A failure extends the time by a half-day. A critical failure ruins some vital component part, which must be replaced. This conversion is illegal; in the United States, it can result in 10 years imprisonment, but a Streetwise roll can probably find a gunsmith willing to attempt it. On the other hand, a crooked gunsmith is very likely to be a federal informant. The M16 was also made as a short-barreled gun, often called the CAR15. Damage for the CAR 15 is 5d-3, 1/2D 400, Max 3,000, Holdout -4.

The M16 has a lot of after-market add-ons. Magazines of 5, 10, 30, 45, 75 and 90 are available after 1970. (The Army officially switched to a 30-round magazine in 1975.)

For \$200, a gunsmith can convert it to fire from a disintegrating-link belt. This conversion drops the Malf to 16. The M16 is not really designed for sustained automatic fire. Stocks, sights, barrels and bipods are all available in non-standard models.

H&K G3 7.62x51mm NATO (.308 Winchester) (Holdout -6) - Most of the countries in the West that did not adopt the FN FAL adopted the G3. It is a roller-locked, recoil-operated rifle with a fluted chamber. Fired G3 ammunition is instantly recognizable by the striations on the case.

Submachine Guns

Bergmann MP18 9x19mm (Holdout -5) - This was the first submachine gun to see wide use, with the German army in 1918. The first models used the 32-round "snail-drum" magazine developed for the Luger (see p. 108). After the war, a more conventional box magazine was adopted, with the same capacity. Like most SMGs, the capacity of the magazine is the capacity of the gun; they fire from an open bolt. The only way to chamber a round is to fire it. The Bergmann continued in production and was used extensively in China, South America and Europe between the World Wars.

In 1939, the British needed SMGs in a hurry; they copied the Bergmann, naming it the Lanchester for the engineer who made a few changes in the design and set up production. The Lanchester was one of the handsomest SMGs ever made. For reasons of production economy, the magazine housing was made of brass, and it had a brass butt-plate like the Lee-Enfield rifle. The bluing on the steel was deep and lustrous, and the heavy rifle-type stocks were dark walnut. It also had a 50-round magazine and sights

Galil 5.56x45mm (.223 Remington) (Holdout -6) - One of Israel's sources of income is a flourishing small-arms industry. In the late 1960s, Israeli Military Industries adapted the basic Kalashnikov action into an excellent 5.56mm assault rifle. It was an orthodox design, very well made and with a better fitting stock than the Russian designs. The stock folds to make it handier in vehicles and house-to-house fighting. Standard magazines are 12, 35 and 50 rounds. One nice touch is that the integral bipod can be used to cut barbed wire without dismounting it from the rifle. This is handy; in the conditions in which Israel fights, massive wire obstacles are common. A sniper version of the Galil is made in 7.62 NATO (use the stats for the FN FAL, except Acc is 12 and 1/2D is 1,200). The sniper version can be equipped with a scope. It is semi-auto only.

SteyrAUG 5.56x45mm (.223 Remington) (Holdout -5) - Developed in Austria in the 1970s and widely distributed (Morocco and New Zealand are among the countries that have adopted it). It has a very distinctive silhouette; a bullpup action with the chamber and magazine behind the trigger, a trigger guard so big that the whole hand fits into it, and a back-raked carrying handle with a scope sight built in. The scope is non-magnifying; the purpose is to allow easier sight engagement since front and rear sights do not have to be aligned. This is reflected in the low Snapshot number. Barrels can be removed in less than a second. Factory-produced 14-, 16-, 20- and 24-inch barrels are available. Drop damage to 5d-2 for the 14 inch, 5d-1 for the 16 inch. Raise damage to 5d+1, Acc to 11 and Holdout to -6 for the 24 inch. A 42-shot magazine is available.

H&K PSG1 7.62x51mm NATO (.308 Winchester) (Holdout -7) - The *Prazisionschutzengewehr* (Precision Shooting Rifle) is a special-purpose sniping rifle based on the roller-locked action of the H&K G3. This 1982 model is much modified, with a longer and heavier barrel, adjustable stock and attached, 2.25-pound tripod. As issued, it is a semi-automatic single-shot; the action holds one round, but ejects the case and locks the action open after firing. Loading another round takes three turns. It is designed so that the bolt can be closed silently, rather than slamming shut as with most semi-autos. Specially selected and fitted barrels and actions are what provide the accuracy; abused rifles can lose accuracy easily. Dropping a PSG1, or using it as a club or pry bar, will drop the accuracy by -1 to -6 - GM's decision.

Optional magazines of five or 20 rounds are available. RoF is 3 and Shots 5+1 or 20+1. Accuracy as listed is for the standard issue 6x scope; a 10x scope (+3 Acc) is also common. It also includes the tripod; firing without the tripod (or an equivalent support) is -1 to Acc.

Barrett Model 82 .50 BMG (Holdout -12) - The Barrett is chambered for the .50 machine-gun cartridge. It is a heavy, recoil-operated gun; the weight, action and an excellent muzzle-brake tame the recoil to manageable proportions. The Barrett has an integral bipod; it can also be mounted on machine-gun tripods and pintle-mounts. It is intended for long-range sniping, destruction of soft-skinned vehicles and an occasional shot at dinosaur. The Barrett has no iron sights; it is intended to be equipped with a scope. Something on the order of an 8x24 variable seems appropriate. This would add +3 Acc. The U.S. Marines adopted the Barrett as a special-purpose sniper weapon in 1991 and used some in the Persian Gulf operation. A more compact bolt-action bullpup model, the Barrett M90, is available in the late 1990s: Wt. 26 lbs., RoF 1, Shots 5, Holdout -9.

SA-80 5.56x45mm NATO (.223 Remington) (Holdout -5) - A bullpup-style assault rifle used by the British army, also known as the L85. The weapon has a 4x telescopic sight (SUSAT) as standard (+2 Acc when used); price includes the sight.

graduated to 600 yards. Lanchesters have Acc 8 in semi-auto fire, using Guns (Rifle). The Lanchesters all went to the Royal Navy; most of them were chained in racks aboard ship and only removed to be lovingly cleaned and polished - especially the brass.

"Tommy-Gun" (Thompson Submachine Gun) .45 ACP (Holdout -5) - General John Talliaferro Thompson was already one of the most respected names in U.S. ordnance *before* he designed the tommy-gun. He conceived the gun during WWI, but did not have a practical working model until after the war; it was first available for commercial sale in 1922. The Thompson had only very limited military use before WWII; the U.S. Marines and Navy used a few in Central America and China and several countries (including Germany) tested them. But they were very widely used in less formal conflicts. The gangsters of Prohibition America and the terrorists/patriots of the IRA were the first to use them widely; they were followed by police, prison guards and prohibition agents. The FBI adopted

the tommy-gun as soon as they were officially allowed to carry guns, in 1932. Well over a million Thompsons were made, possibly twice that many. They were copied without license all over Asia.

In the 1970s, with the supply of Thompsons badly depleted, semi-automatic-only copies were manufactured in the United States. They sold for \$400 and were real Thompsons; the manufacturer purchased the patents.

The Thompson can use both box and drum magazines. The box magazines, normal for the military gun (late-model military Thompsons will use *only* the box magazine) are 20- and 30-shot; the drums come in 50- and 100-round versions. The 50-round drum weighs 5 pounds loaded; the 100-round weighs almost 8.5 pounds loaded. (This nearly doubles the weight of the gun; with a 100-round drum it weighs as much as a BAR.) Drum magazines take the same time to change as other magazines, but they take a lot longer to reload (three seconds to prepare the drum and one second per round to put in the ammunition). Drums are noisy to carry (-2 to Stealth) and prone to jam unless they are in perfect condition and very carefully loaded (Malf 15, at the GM's discretion, for abused or damaged drums).

Most Thompsons were the military version, the M1. The stats on the table are for that model. The commercial Thompsons were beautiful guns, blued-steel with polished walnut stocks. They had very precise adjustable sights (in semi-auto, use Guns (Rifle) for Ace 8). Culps compensator and vertical foregrip helped in control (Rcl -2). A Thompson with the vertical front-grip and compensator is Rcl -3 with the butt-stock removed; with no stock and foregrip *or* compensator missing, it is -4; without stock, foregrip *and* compensator, it is -6. Holdout is -4 with the stock removed.

"Schmeisser" (MP38; MP40) 9x19mm (Holdout -4) - The German Army was forbidden by the Treaty of Versailles to have SMGs. Nevertheless, design and manufacture went on, sometimes under the cover of Swiss or Swedish companies. In 1938, the Army officially adopted the MP38. Some minor manufacturing changes produced the MP40. It is operationally the same as the MP38. This is probably the most recognizable German weapon of WWII. Originally it was intended for parachutists and tank crews. It was such a satisfactory gun that by the end of the war, it sometimes was the major armament of an entire squad.

Americans usually call the MP40 a Schmeisser. No one quite knows why. Hugo Schmeisser had nothing to do with the design, which was from Erma (Erfurter Maschinenfabrik). Schmeisser worked for Haenel. (His father, Louis, had designed the SMGs that were called Bergmanns; maybe this was poetic justice.) In 1945, Hugo Schmeisser disappeared after the Russian occupation; maybe his name was too well-known.

PPSh 41 "Burr Gun" 7.62x25mm (Holdout -5) - If the "Schmeisser" was the signature of the German Army, the drum-magazine "peh peh shah," with its distinctive perforated barrel-jacket, was the distinguishing feature of Communist armies from 1941 to about 1960. The U.S.S.R. made millions of this SMG; almost any picture of an Eastern Bloc soldier from 1940 to 1960 was likely to show the "Russian burp gun." The PPSH was preceded by the similar PPD in 1934; the PPSH was simpler and cheaper to manufacture, but kept the PPD's 71-round drum magazine and had similar lines. In WWII, the Russians armed entire infantry battalions with nothing but PPSHs. They were assigned directly to tank units. The infantry rode on the outside of the tanks, clinging to handles welded to the armor. It must have been a truly delightful way to fight, especially in a Russian winter. The PPSH was distributed around the world. It has an outstanding reputation for ruggedness.

The ammunition is interchangeable with that of the Broomhandle Mauser 7.63mm. The drum magazine takes three seconds to prepare for loading and one second per round to load. Loaded weight is five pounds. A 35-round box magazine (from 1943) takes one second to prepare and one second per round to load. Loaded weight is two pounds.

Sten Gun 9x19mm (Holdout -4) - In 1941 the British were desperate for weapons. The losses of the first year of war had to be made up, and new weapons made for the troops just coming into service. Two engineers named Shepherd and Turpin at the Royal Small Arms Manufactory, Enfield, designed a submachine gun that could be produced rapidly with minimal investment in tooling. It was called the Sten from their initials and the first two letters of Enfield. That and the "cheap and nasty" appearance got it the nickname "stench gun." It was also called the "Woolworth gun," the "gas-pipe gun" and the "plumber's delight." The British manufactured a lot of Stens; so did quite a few other people. The simple design lent itself to production with few tools. Stens were being made at the height of production for less than \$10 apiece.

The Sten was always plagued with reliability problems; most could be traced to the magazine, which was both poorly designed and badly made. Experienced soldiers went through all the magazines available to select a few that worked well; GMs might raise Malf to crit for veterans who have had the opportunity to do this.

Uzi 9x19mm (Holdout -3) - The Uzi was really the foundation of the Israeli small-arms industry. There was nothing really new about it, but it was well-made and available at a good price at just the right time. It was adopted by armies and police organizations worldwide, and has been especially popular among Arab terrorists.

The Uzi is very compact, just over two feet long with the stock and less than 18 inches with the stock folded or removed. (Both folding-metal and fixed-wooden stocks are available.) The standard magazine is 25 rounds, but 32-round and 20-round versions are made. The magazine well is in the pistol grip, which keeps down length and helps protect the magazine.

There are two smaller versions of the Uzi, designed for extreme compactness. These are called the Mini-Uzi and Micro-Uzi; required skill is Guns (Machine Pistol). Stats are as in the table except as here noted. Mini-Uzi, length with stock folded 14 inches - stock open 24 inches, weight 6, RoF 16, Rcl -3. Micro-Uzi, length with stock folded 10 inches - stock open 18 inches, weight 4, RoF 20, Rcl -5. There is also an Uzi pistol; it is effectively the same size as the Micro-Uzi but is semi-auto only. Holdout for all these is -2.

The Uzi is also made in .45 ACP; damage is 2d+1 and Shots 16 or 20.

H&K MP5 9x19mm (Holdout -4) - The Heckler and Koch MP5 (first available in 1966) is unusual for an SMG; it fires from a closed bolt and can have one round more than the magazine capacity in the chamber. This makes it more accurate in semi-automatic fire but prone to overheating in full-auto. The MP5 was designed for police duties, on the theory that most shots will be aimed semi-auto with full-auto only for emergencies.

The standard version is just over two feet long with a fixed stock or the collapsible metal stock extended, about 19 inches with the stock retracted.

The silenced version has a permanently mounted silencer that also reduces the muzzle velocity of 9mm ammunition to subsonic. When fired, it makes less noise than a powerful air rifle. Damage is reduced to 2d-1. It is over 30" long with stock, 25" with stock collapsed and is made in a stockless variant only 22" long.

A special compact version is made with a very short barrel and no stock at all. Use Guns (Machine Pistol). These models have a front pistol grip to help control of recoil. Damage is reduced to 2d+2, recoil is increased to -3, but overall length is only 13 inches. With a 15-shot magazine, weight is only 5 lbs. and Holdout is -2.

MAC 10 (Ingram M10) .45 ACP (Holdout -3) - Gordon Ingram designed this gun in the late '60s as the first really compact American SMG (MAC is for Military Armaments Corporation, the first producer). It was first available in 1970. It has never been widely available, but its distinctive silhouette has made it a favorite cinematic weapon (the sour joke was that all the production went to Hollywood). The M10 is also available in 9x19mm (damage 3d-1). The slightly smaller Mil is in .380 ACP. The Mil has: Damage 2d, 1/2D 120, Max 1,100, Weight 7, RoF 16*, Shots 36, ST 11 — otherwise as with the M10. All Ingrams have a barrel threaded to take a silencer. The most common is the fine noise suppressor designed for it by "the Edison of silenced weapons," Colonel Mitch Werbell.

American 180 .22 LR (Holdout -6) - The American 180 unloads 1,800 rounds per minute from a 177-round top-mounted drum. It was introduced in the late 1970s and came with a clip-on laser sight. The gun itself was light (5.75 lbs. empty), but with a loaded drum (4 lbs.) and the bulky "Laser-Lok" (6 pounds) got hefty. It was also a very easy gun to shoot, with very little felt recoil even when blazing away at 30 rounds a second: recoil is -1 per 2 groups fired. Reloading is as with the Thompson. Malf is crit. when using high-quality, brand-name .22 rounds, but drops to 16 with ordinary rounds.

American Arms sold a few dozen to U.S. police forces. But the 180 was too bulky and specialized for most police work to be a commercial success. The 180 was in limbo until the 1980s when Ilarco reissued it with a modern laser sight, and several variants: a .22 Magnum version (1d+3 damage, Shots 168), a short barrel (SS 11, Ace 6, 1/2D 75, Max 1,500, Wt. 9, Holdout -4) and a semi-automatic version (RoF 3~). Also tested were prototype vehicular duplex-mounts (RoF 60) and quad-mounts (RoF 120!) intended for ultralight aircraft. Sales again failed to take off, but some collectors or police still have the guns. All listed prices and weights do not include the laser sight.

FN P90 S.7x28mm (Holdout -3) - Available from the early 1990s, this is a radical new "personal weapon" of compact and unusual shape firing a cartridge midway between pistol and rifle power. Its large magazine is horizontal rather than vertical and an ergonomic grip encloses the trigger hand.

Steyr Tactical Machine Pistol 9x19mm (Holdout -2) - Resembling an oversized pistol with a front foregrip, the TMP is a sleek, lightweight design molded from high-impact composites giving it smooth, rounded lines that help break up its outline when concealed under a jacket. A true machine *pistol*, it has no stock. It uses a delayed blowback closed-bolt action. Rcl is only -1 when fired at RoF 3~. A semi-automatic-only version, the Steyr Special Pistol, is available for civilian purchase at \$850.

Grenades

Steilhandgranate (“Potato Masher”) (Holdout -3) - Nobody had really effective grenades ready for the 1914 war. After a lot of fumbling and improvisation, most of the belligerents came up with a functional design by about the middle of 1915. The Germans adopted a style that remained standard issue until the close of WWII, the “potato masher.” The long handle gives good leverage for a throw, which compensates for the extra weight (+2 to Throwing skill to figure distance) but makes the grenade awkward to carry and hide. To activate the grenade, twist off the cap at the end of the handle and pull sharply on the string inside the handle. The time fuse has a five-second delay.

No. 36 Grenade (“Mills Bomb”) (Holdout 0) - The British started WWI with the complex and expensive “Rale’s Patent” grenade. It was not a success in the trenches; it frequently went off in the thrower’s hand. The troops preferred to simply fuse a chunk of HE and toss it. The Mills bomb debuted in May 1915 (the No. 5) with the final version, of 1918, the No. 36. It stayed in use until the 1960s. Most people called it simply “Mills bomb;” snobbish precisionists insisted on “36 grenade.”

The Mills bomb was the first grenade to have a deeply serrated cast-iron body. There is some dispute as to the reason for the serrations. They don’t control fragmentation (though Mills may not have known this). They do give a much better grip, especially in the slimy mud of a Flanders trench. Fragmentation with the Mills bomb is very uneven. Much of the cast iron is splintered, too small to cause serious injury beyond a yard or so from the explosion. An occasional large piece (especially the fuse) might fly for 200 yards with enough force to kill. Anywhere within 200 yards of the explosion, anything can be attacked with one 2d cutting attack, if the GM wants it so.

To activate a Mills bomb, pull out the pin with its attached ring and let the arming handle fly off. Until the handle is released, the fuse doesn’t begin to burn, but the handle only has to move a fraction of an inch. The pin can be reinserted. Fuse delay is five seconds.

Mk II (“Pineapple”) (Holdout 0) - The U.S. Army had no grenades at the beginning of U.S. involvement in WWI; Congress barely provided money for rifles, much less newfangled geegaws such as grenades. In the rush to get something now, they simply adopted the French-issue defensive

grenade. The Mk II had a serrated body, pin and arming handle like the Mills bomb, though the fuse mechanism was different. With its deeply serrated oval body, the nickname “pineapple” was obvious. Activation and delay are as with the Mills bomb; so is fragmentation. Charge is about 2 ounces of TNT.

M26 (“Frag”) (Holdout 0) - This was intended to replace the Mk II for WWII, but was not ready until after the war. It has served in all America’s subsequent wars, and has been very widely copied; M26s might be found anywhere. It has a smooth, sheet-metal body; inside, a tight coil of notched wire surrounds the explosive charge (about 1/3 pound of Composition B. The wire gives a lot of fragments, but they are small and have poor aerodynamic characteristics; they don’t travel far. At 15 yards from the explosion, fragmentation damage drops to 1d-3 (minimum 1 point). Activation and delay are as with the Mk II.

AN-M8 (“Smoke”) (Holdout -1) - This is a typical smoke grenade; most armies have something like it. It looks like a can of soup, with a grenade pin and arm attached. The fuse is two-second delay. Fuse action doesn’t burst the grenade; it just starts the filler burning. The grenade burns for 100 to 150 seconds (GM decides if the time is critical) and emits a cloud of thick, white smoke. This fills an area three yards around the hex where the grenade sits. The smoke is not harmful, though its aroma is a little unpleasant. The grenade is hot. It would burn unprotected flesh, and might set fire to dry grass or paper or similar flammables; otherwise it is harmless. It is used for signaling or concealment.

A similar grenade body can be filled with tear gas (CN or CS) as a non-lethal munition. It fills the same space with tear gas for the same time.

M59 (“Concussion Grenade”) (Holdout -1) - This is a half-pound block of TNT in a cardboard wrapper. It has a pin and arm like most American grenades, but no fragmentation material. If it lands in a pile of scrap metal, it might pick up some (see p. 24). The Army classifies this as an “offensive” grenade. Fragmentation grenades are “defensive” grenades; they throw fragments farther than they can be thrown, so the thrower needs to be protected by cover. Offensive grenades rely only on concussion damage (see pp. 22-23) so they can safely be thrown by troops in the open.

Machine Guns

Gatling .58 (uses reloadable, outside-capped cartridges) - The Gatling was one of the first successful machine guns, and the only one to make the transition from caplock to cartridge firing. As first sold it had reloadable steel chambers. Each one was separately primed with an external percussion cap, then the cases were dropped into a hopper on the top of the gun. The rotating barrels, turned by a hand crank, picked up a chamber in succession, fired it and then ejected it for reloading. The mechanism worked but was very susceptible to jamming. Gatlings with this firing system malfunction on any roll of 14 or more. There is an even chance of a misfire or stoppage.

Gatlings were available commercially at \$200 apiece from 1862 to 1865. A few were bought by the U.S. Army for test, but there is no evidence that they were used in action. In 1865, Gatling introduced a modified gun for a .58 caliber rimfire cartridge. Range and damage are as for the earlier gun, but malfunctions are on 15+. In 1866, Gatling chambered this gun for the .50-70 center-fire (range and damage as the Springfield .50-70 and malfunctions on a critical failure). After 1873, the most common chambering for American Gatlings was .45-70 - range and damage as for the .45-70 Springfield.

After the Civil War, Gatlings were manufactured and sold by the Colt company, and were available in many chamberings; one of the most common was the .450 Martini-Henry. The Russians bought many Gatlings from Colt for their .42 caliber rifle round (use the range and damage for the .45-70). They were called Gorloffs, for the Russian general who selected them. (The Gorloffs, like many later Gatlings, were 10-barreled.)

A one-inch Gatling was widely used as a fortress defense and naval weapon. It dated to the original 1862 caplock model, and had been converted to cartridge firing in 1866. The one-inch with solid bullets could punch through light armor and tear up the boilers of fast torpedo boats; with its alternate shot cartridge it could sweep away close-packed troops or boat’s crews at short range. Stats for the one-inch Gatling are: damage 10d, 1/2D 900, Max 2,500, weight 450 pounds, Rcl -2. The shot cartridge is a big buckshot round: damage 6d, 1/2D 50, Max 200, +1 to skill. At beyond 1/2D range, the damage is divided equally between two adjacent lines of hexes, one along the line of fire and one next to it (firer’s choice of the two possible adjacent lines).

The rate of fire of a Gatling gun is dependent on the skill and strength of the firer. The principal demand is that the rate of turn be smooth and steady; jerkiness tends to cause jams. It is not as easy as turning a coffee mill; the crank is well-gearred, but it is not just operating the bolts, it is also rotating the heavy barrels. The maximum RoF is (skill + DX)/2.

There were several feed devices for Gatlings. The one listed was very common — a gravity-fed drum.

Hotchkiss 1.5 inch (37mm) - The 1874 Hotchkiss looked a lot like the Gatling, but with only five barrels. Internally it is quite different, but operation is so similar that the familiarity modifier is only -1 for anyone familiar with the Gatling. The common version of the Hotchkiss was as a 1.5-inch (37mm) cannon, used by navies as an anti-torpedo boat gun. The most common ammunition was solid shot; an explosive round was available but it had low penetration and uncertain fuses. Penetration is 2d; on less than enough to penetrate the DR it either explodes or breaks up on the surface. There is 2/3 chance that the fuse will function; explosive damage is 1d. The French Navy alone bought over 10,000 Hotchkiss guns, and they were sold all over the world. They were well-made and lasted for years. They were uncommon, but not unknown, on ground mounts. RoF is as with the Gatling gun. The feed device is a gravity-fed drum.

Nordenfeldt .450 Martini-Henry - The Nordenfeldt was actually designed by an engineer named Helge Palmkrantz; Nordenfeldt was the banker who financed the 1880 product. It was a multi-barrel gun with fixed barrels; operation was by a back-and-forth handle rather than a crank. The model in the table is a comparatively light one, used as a boat and anti-boat gun and as a landing-force gun (it was standard issue for the British Royal Marines and the Dutch Royal Marines). This model has four barrels; they can be fired either simultaneously or in a ripple pattern. The normal landing mount is a two-wheeled cart that weighs 100 pounds. Rate of Fire is as with the Gatling gun. The feed device is a gravity-fed box.

Maxim .303 British - The Maxim gun was the product of the American-born English knight, Sir Hiram Maxim. It was the first really effective auto-loading machine gun, and introduced the belt-feed that became nearly universal. The first Maxims, on sale in 1884, were for the black-powder .450

Martini-Henry round. The problem was the huge clouds of smoke produced by the high rate of fire. As soon as smokeless powder cartridges were adopted the Maxim was chambered for them.

The Maxim was the dominant machine-gun of WWI. It was standard in the German (7.92x57mm, damage 7d) and Russian (7.62x54mmR, damage 6d+1) armies as well as the British. (The British used a slightly modified gun called the Vickers; familiarity is at no penalty from one Maxim model to another.) Maxim guns were manufactured, legally or illegally, in many countries and might be found in almost any military rifle caliber. With decent maintenance the guns will last for years; in the 1980s they were still in regular use by several small armies.

Maxims are water cooled; the water is in a metal jacket surrounding the barrel. Capacity of the jacket is about one gallon (seven or eight pounds). Any water-cooled Maxim will boil the water in the jacket by firing 250 rounds nonstop; this makes enough hot water for about a gallon of tea, soup or coffee.

Feed device is a 100-round or 250-round fabric belt. After 1918, British aircraft Vickers guns used disintegrating link belts, but the ground guns kept the fabric belt.

Schwarzlose 8x50mmR Austrian - The Schwarzlose is unusual as being probably the most powerful unlocked-breech blowback infantry weapon. It is proof that good mechanical detail can get a working gun out of bad engineering. The 1905 innovation has a powerful recoil spring; great care has to be used in disassembly or the spring can actually injure the disassembler. Any failed Armoury roll causes 1d damage to the armourer. It was used as an official weapon in both world wars; was used in Sweden (6.5x55mm, damage 6d), Italy, Holland and Czechoslovakia as well as Austria; and was sold to many guerrilla and liberation movements after WWII. The gun is water cooled; feed device is a 250-round fabric belt.

Browning M1917 .30-06 - This was the first of the long line of Browning recoil-operated machine guns. They were as ubiquitous in the era of WWII as the Maxim had been in the era of WWI. John Browning actually had the gun design ready in 1910, but the peacetime U.S. Army had no money to buy it. By the time tooling was ready for manufacture on a large scale, WWI was over. In the years between the world wars, the Army completely re-equipped with Brownings.

Stats on the table are for the water-cooled model in .30-06. The air-cooled model is covered below. Feed device for both was originally a 250-round fabric belt. In the 1920s, the aircraft and some tank guns were modified to use disintegrating-link belts. Most ground guns continued to use fabric belts for as long as the water-cooled Browning was in U.S. service (the middle '60s).

Lewis .303 British - This was the first machine gun to be fired from an airplane (in 1912) and was light enough to be carried and operated by one man instead of by a crew. Lewis offered the gun in the United States, but without success. FN in Belgium built the gun for sale; one of the customers was the Belgian army. In 1915 the British were desperate for machine guns. In addition to its tactical advantages, three Lewises cost about the same as one Vickers. The Lewis was used as both a ground and aircraft gun. It continued in use after WWI; it was used widely as a second-line weapon in WWII, and was likely to be found anywhere in the world between the wars. It was especially common as a light anti-aircraft gun on merchant ships and small naval vessels.

Its distinctive silhouette, with the aluminum cooling-jacket around the barrel and flat pan-drum above the action, was a favorite for cartoonists. The Lewis action is difficult to unload; removing the magazine does not remove the round in the feedway. When unloading a Lewis gun make a roll against Guns (Light Automatic) +2. Any failure is an accidental discharge.

The Lewis feeds from a drum mounted flat above the action. The usual infantry drum holds 47 rounds and weighs four pounds loaded. There is a 97-round drum, usually used for aircraft guns; it weighs seven pounds loaded.

Chauchat 8x50mmR Lebel - The Chauchat was probably the most hated gun of its time, at least by the people who had to use it. The design was bad and the manufacture was worse. This 1915 introduction was an ugly angular gun, and was not helped by the peculiar shape of the French service cartridge. The rimmed, tapered Lebel round took an actual crescent-shaped magazine to hold a mere 20 rounds. Loaded in the action, the magazine curved up enough to touch the fore-end of the gun. The Chauchat malfunctions on 14; few of the stoppages can be corrected by Immediate Action. The gun has to be disassembled, cleared and put back together. This takes 3d+10 seconds and a successful roll against Armoury-4. It has been estimated that half of all the Chauchats made were thrown away by disgusted soldiers.

Despite its miserable record, the Chauchat was widely used. It was the French issue until 1929, and many were still in use in WWII. The Belgians used the same gun, in 7.65mm.

In WWI it was U.S. issue, chambered for .30-06 and with a straight, 16-round magazine that sticks down far enough to make it very hard to take up a good, braced prone position. U.S. soldiers called them "Sho-shos," usually with some pejorative adjective attached. Some remained in U.S. service until replaced by the BAR in 1919.

Chauchats were available readily to the resistance movements of WWII; the Germans thought so little of the gun that they left it for occupation police use rather than confiscating it for their own army. It was used by the Viet Minh in the first years of their war against the French Union and in the civil war in Greece.

Maxim MG08/15 7.92x57mm - This 1915 weapon just barely qualifies as a light machine gun (39 pounds loaded). It is the only widely used LMG with water-cooling and is the only machine-gun to have been used as the title of a novel (08/15 by Hans Helmut Kirst). The Germans realized as soon as the British that they needed a machine gun that could be moved fast enough to keep up with infantry assaults. Instead of procuring a new gun, they modified the Maxim 08. They dropped the tripod mount, added a shoulder stock and integral bipod and cut down the amount of water in the jacket. This made an effective but very heavy gun. Maxim gunners had to be picked for strength and endurance and still needed to trade off on carrying the piece if they were to keep up with the riflemen. The Germans kept this gun in secondary use throughout WWII. An air-cooled version was used as a flexible gun in aircraft; the stream of air from the motion of the plane was enough for cooling.

Feed device is a 50-round fabric belt coiled inside a metal drum; weight is five pounds. It will also use the belts for the MG 08.

Hotchkiss 8x50mmR Lebel - The French Army adopted the Hotchkiss machine gun (it was actually designed by an Austrian officer named von Odokolek and modified by an American named Benet) in 1899. In 1907, it was replaced by the St. Etienne M1907, designed by a government committee. The St. Etienne was delicate and expensive to manufacture. One in good shape worked well, but in the field it was prone to breakdowns. (Malfunction number is 14 if the gun has been out of peacetime barracks conditions for more than a week.) The St. Etienne was replaced by the Hotchkiss M1914 (not significantly different from the 1899 model). The Hotchkiss remained the French service machine gun until the 1950s, and in reserve stocks after that. It was used by the United States in large numbers in WWI. It was used by the Spanish in 7mm Mauser (6d+1) and by the Chinese in 7.92mm Mauser (7d+1). The Japanese used the Hotchkiss as a standard gun all through WWII in 6.5mm (5d+1).

It was a massive gun on a tall tripod, usually equipped with a metal seat for the gunner. The Hotchkiss was air-cooled; one of the distinguishing characteristics was the five disc-shaped brass cooling fins around the barrel near the breech. The St. Etienne looked very much like the Hotchkiss and operated in much the same way (familiarity between them is -1). They shared the same feed system; 30-round metal or papier-mache strips fed in from the side. One of the marks of a French (or Japanese) battlefield was the piles of empty Hotchkiss strips.

Hotchkiss Mk 1.303 British - The British cavalry wanted a gun with a greater sustained fire rate than the Lewis. In 1916 they adopted a modified and lightened version of the French Hotchkiss. This was also the gun used on the first tanks and widely on armored cars between WWI and WWII. It uses feed strips of 9, 14 or 30 rounds. The French used it as an aircraft gun in 8mm Lebel; the first airplane shot down by a machine gun was the victim of a French light Hotchkiss.

BAR .30-06 - Upon its 1917 debut, the BAR was not intended to be a machine gun at all, but it was good enough to serve as a light machine gun, and the United States used it with satisfaction until 1959 (longer in the Reserve and National Guard.) Before 1934, there was no federal law forbidding the sale of automatic weapons in the states. (After 1934 it was not forbidden, but it was taxed at \$200 per sale and required record-keeping.) BARs were manufactured for civilian sale as the Colt Monitor. They were also manufactured in Belgium and sold in just about any caliber; for instance, they were Swedish issue in 6.5mm (6d) and Polish issue in 7.92mm Mauser (7d+1). It was a favorite gun of gangsters in America, since a burst was a lot more likely to disable a pursuing car than a burst from a tommy gun. On the other hand, it was a lot harder to conceal. Feed device is a 20-round box magazine mounted vertically below the action.

Browning 1919A4 .30-06 - This is the same action as the 1917 Browning but with a shorter barrel and no water jacket. It was originally developed for tanks, then as an aircraft gun and finally adopted by the cavalry and infantry as a light gun that could keep up with fast-moving troops. It did not have the sustained fire capacity of the water-cooled guns (which could fire 10,000 or more rounds without wearing out a barrel) but such long sustained fire was not necessary for small-unit support. Technically

there were several models of the gun: for aircraft, fixed and flexible mounts; as a tank coaxial gun; with a butt stock and pistol grip as the 1919A6 in the Korean War period. It was a standard gun in many countries and might be found in almost any caliber.

The original feed device was a 150-round fabric belt. Disintegrating-link belts became standard for aircraft in the 1920s. In the 1960s they became standard for all models.

Chatellerault 7.5mm M1929 - It was obvious even to the French that the Chauchat was simply not a good weapon. With the peace in 1918 they began a study of a possible replacement, starting with the cartridge. In 1924 they adopted the 7.5x54mm, which was ballistically very similar to the 7.92x57mm that had been shot at them for so long by the German army. The round was available in 1924 and so was a gun for it. The Chatellerault was an example of really intelligent arms design. The French wasted no time reinventing the wheel; they took elements already proved to work and combined them. The top-mounted box magazine was like that of the Madsen and the action was the Browning gas system of the successful BAR. The innovation was the two-trigger selector; pulling one trigger gave automatic fire and pulling the other gave semi-auto. The only difficulty with the early guns was that they blew up when fired! This was finally traced to a combination of ammunition and metallurgy difficulties, and in 1929 the new gun and the redesigned round were ready for service. This remained the standard French gun until the 1950s, and was one of the few French weapons that French troops preferred to foreign guns.

Feed device is a top-mounted box magazine of 25 rounds.

Degtyarev DP 7.62x54 Russian - The Degtyarev's nickname was "Russian guitar." The four-pound, 47-round drum magazine appeared to be even flatter and thinner than it really was compared to the long, thin barrel and club-like stock. The DP was a simple, orthodox weapon with an excellent reputation for reliability and ease of maintenance. It came into Russian service in 1926 and remained in service until the mid-50s. It could commonly be found in guerrilla use for another decade. Its most notable use outside Russia, prior to WWII, was in Spain; the Russians provided thousands to the Loyalists.

After WWII, the DP was modified to the RP46. It had an integral bipod and the capacity to use either drums or 250-round belts. With a 250-round belt, weight is 29 lbs.

Browning M2 .50 BMG - Two developments of WWI led to the same countermeasure - the heavy machine gun. Tanks were too well-armored, and aircraft flew too high for the rifle-caliber machine guns of WWI. A lot of experiments, and a few fielded weapons, addressed the problem. After WWI, John Browning's solution was to scale up his .30 caliber gun to .50 and to base the cartridge on an experimental German anti-tank round. The .50 Browning trickled into service all during the 1920s. It was the Army's anti-tank and anti-aircraft gun, and was rapidly adapted to aircraft. Through WWII, the .50 Browning was the usual armament of American aircraft, fighters and bombers. Part of the incredible firepower of American units was from the habit of sticking a .50 Browning on any vehicle that would take the firing stress. (A jeep will, but just barely; things shake loose as it is fired.) The .50 continued in service with no sign of withdrawal all through the century. The gun was manufactured in several countries, notably by FN in Belgium.

The original feed device was a 100-round fabric belt; loaded this weighed 31 pounds. Disintegrating-link belts came along in the 1920s, but fabric belts were standard for ground guns until after WWII.

MG34 7.92mm - The 1934-issue German MG34 was the first of the general purpose machine guns. It was intended to supply, in one gun, a light machine gun for the infantry squads, a tripod-mounted support gun, an anti-aircraft gun for ship and shore mounts, a flexible or fixed aircraft gun, a secondary and coaxial gun for tanks and a fortress gun. Instead of a heavy water jacket, the MG34 was issued with spare barrels that could be quickly changed to prevent burning one up in sustained fire.

Both belts and drums were provided for feed. The belts were metal, which was both lighter and less susceptible to water and mud than the canvas belts of the Maxim. The belts were in 50-round lengths and could be combined to any multiple of 50. For ease of use, they were usually coiled inside a steel drum, one belt to a drum, that clipped to the side of the gun. True, spring-powered drums held 75 rounds, and were saddle shaped for better balance on the gun and more reliable feeding. The selector system was simple and reliable; the trigger was pivoted in the middle so that a pull on the top gave semi-auto and a pull on the bottom gave full-auto. The gun was completely satisfactory in the field, but was expensive and slow to make.

In 1942, a new gun, the MG42, was adopted. It has the same stats as the MG34 except that it is one pound lighter, has no selective fire capability, has RoF of 20 and recoil -2. The MG42 continues in service in the 1990s in

Germany and several other countries. It is chambered for the 7.62x51mm NATO round (except in what used to be Yugoslavia, which still uses the 7.92x57mm). The rate of fire cannot be changed in the field, but can be changed by an armorer with the right parts. Slowing the RoF to 15 or less reduces the recoil to -1. The MG42 and MG34 use the same tripod, which is heavy and elaborate. It can be used as an anti-aircraft mount by extending the legs. A telescopic sight mounts on the tripod (not on the gun). It adds +1 to Acc.

Loaded 50-round belts weigh three pounds; in a drum, five pounds. Loaded 75-round drums weigh seven pounds.

Bren .303 British - In the middle 1920s the Czechoslovak arsenal at Brno developed a series of top-mounted-box-magazine light machine guns. In 7.92mm they were adopted by the Czech Army, by several South American countries and by China. In the 1930s, the British were looking for a replacement for their Lewis guns. They tested several, and decided on a modification of the Czech ZB26 chambered for the .303 British cartridge. Bren is a compound of Brno and Enfield. All of these guns have excellent field reliability and are simple to repair. Armoury rolls for anyone with the right training and tools are at +2. The Bren was converted to 7.62 NATO in the late 1950s and continues in service with several armies. It has also been made in .30-06 by the Chinese (7d+1). It is likely to be found anywhere in the world after 1926; familiarity from all the Czech ZB models to the Bren is -1. The Bren can be mounted on a tripod or on vehicle pintle mounts. It was mounted on the top of most British tank turrets so it could be dismount-ed and used by the crew if they had to fight on foot.

Type 11 Nambu Light 6.5mm Japanese - This was one of several standard Japanese machine guns in WWII. It was adopted in 1922 and was in use by the Japanese in the long war with China, beginning in 1931, and in the border war with the Russians in 1938 and 1939. It has a unique hopper magazine. Six stripper-clips for a rifle are dropped into the hopper and held down by a spring loaded arm. One at a time, the clips are fed to the action. This had the advantage that it used ammunition packaged in the same way that it was issued to riflemen, but was vulnerable to dirt and trash. Hopper-fed Nambus can be assigned a lower malfunction number in bad conditions, at the GM's discretion. In 1936, the Japanese adopted a very similar looking and operating gun called the Type 96. The biggest obvious difference is the 30-round, top-mounted box-magazine much like that of the Bren gun. One peculiarity of these guns is that the Japanese regularly mounted a bayonet, the same as that for the Arisaka rifle, on the gas cylinder under the barrel. A common accessory is a 2.5x scope sight (+1 to accuracy).

RPD 7.62x39mm - The Russians were among the first to develop a short-cased intermediate-sized cartridge as their standard issue. They adopted a light machine gun for it in 1946. This used a development of the Degtyarev action they had used for 20 years, but externally it was greatly changed. The RPD weighs only 19 pounds loaded with 100 rounds. It is belt-fed with a non-disintegrating metal belt, but the belt (50-round sections) is packed into a 100-round drum (eight pounds loaded) that fits under the breech, like a Thompson SMG. The gun is fitted with an integral bipod, but there is no provision for a tripod or pintle mount. This is a specialized gun, intended only to accompany the infantry squad. In 1964, the Russians adopted the RPK, essentially a heavy version of the AK rifle as their light machine gun. It is functionally very different from the RPD but operationally similar. See the Kalashnikov rifle, p. 114.

KPV 14.5mm - The 14.5mm cartridge was developed as an anti-tank rifle round in the 1930s; it is measurably more powerful than the .50 BMG. The 1947-issue KPV machine gun is used mostly as an anti-aircraft gun. It is used in single, double and quadruple powered, towed mounts and in single and double unpowered mounts on armored vehicles and boats. It is very unusual to find a single gun on a ground mount; the great weight of the weapon makes it unlikely that it will be found on the infantry line. Any attack on a Russian airfield or missile site, however, will probably face a hail of 14.5mm fire. Thousands of the guns were distributed in Asia, Africa and South and Central America in the 1960s and 1970s. Feed is from disintegrating-link belts.

M60 7.62x51mm - The M60 is a thoroughly undistinguished gun. It is neither better nor worse than a lot of other GPMGs, but it is very available. Anyone who served in U.S. or U.S.-equipped armed forces after its 1959 debut will probably know how to operate the M60 and it can be found around the world. It is used as a ground gun, on aircraft mounts, on ships and on vehicles. It is provided with a tripod for use as a medium machine gun. Feed is from disintegrating-link belts.

MI34 Minigun 7.62x51mm - The Minigun is a Galling gun tied to an external power source. As early as the 1890s it had been demonstrated that a Gatling gun could be motor-driven at over 2,000 rounds per minute. When the U.S. Air Force was in need of guns with a very high rate of fire for air-

craft armament in the late 1950s, someone resurrected that datum. Aircraft have plenty of reserve power for operating guns, and capacity to carry the huge amounts of ammunition that high-rate guns fire. The first such gun to be fielded was the 20mm Vulcan, which is still the normal armament of U.S. fighters and is used as an anti-aircraft gun. The demands of the Vietnam War for helicopter armament led to the development of the M134 by 1962.

The M134 can be ground mounted on a tripod (45 pounds), and motor and batteries are man-portable (50 pounds, good for 5,000 shots before recharging), but no one really wants to hump ammo for a gun that burns up 100 7.62mm rounds (six pounds) every second.

Feed device on most aircraft mounts is linkless feed, through a flexible chute from a magazine that may have several thousand rounds. For ground mounts, it uses 500+ round disintegrating-link belts.

PK 7.62x54mmR - In 1964, the Soviets adopted the PK as the company support weapon to replace the RP46. It is another modification of the Kalashnikov action. It is considerably lighter than the RP46, but can be used with a tripod (weight 16 pounds). Feed is from disintegrating-link belts, usually of 100, 200 or 250 rounds. The PK tripod can be adjusted for anti-aircraft fire. The PK is also used as a coaxial machine gun on armored vehicles.

FN MAG & M240 7.62x51mm - This is FN's companion to the FN FAL. Since 1968, it has been the standard LMG of most non-communist countries not using the MG42 or M60. It is very similar outwardly to the M60, though very different in technical operation. It will fit any tripod or pintle made for the M60. A version of it, the M240, became the standard U.S. Army tank coaxial gun in the early 1980s. In the 1990s the M240G replaced the M60 as the U.S. GPMG. It is liable to be found anywhere in the world, and could easily be made in just about any modern military rifle caliber. It has only been made in 7.62x51mm for sale.

NSV 12.7x108mm - Yet another gun designed around the basic Kalashnikov action. It is usually found as an anti-aircraft machine gun mounted on tank turrets, but would be adaptable to ground, light-vehicle and small-boat mountings. It is, in many ways, a Soviet equivalent of the .50 Browning. The round was called the .51 by American forces in Vietnam; it has been in use since the 1930s in the DShk series of machine guns. Stats for the DShk are as for the NSV except Weight 75/269. The mount is a two-wheeled cart with a gun shield (PD 1, DR 3) that can be towed behind a vehicle. The mount can be set up for anti-aircraft fire. The DShk series of guns are wide-spread, especially in South Asia, Africa and Central America.

FN Minimi 5.56x45mm NATO - Designed to provide a squad-level automatic weapon that fires the same round as the infantry rifle, this has logistical advantages and still provides fire support within the 300-yard expected engagement range. The Minimi (1974) is another widely sold weapon; in the 1980s it was adopted by the U.S. military as the M249 Squad Automatic Weapon. It can use either disintegrating-link belts (nor-

mally carried in a 200-round box that clamps to the gun, weight six pounds) or M16 magazines. The Minimi has an integral bipod.

HK21A1 7.62x51mm - In 1977, Heckler and Koch designed a system of light machine guns based on components of their automatic rifle, the G3. It will use most of the accessories, such as scope and night sights, that fit the G3. It fires from an open bolt in full auto and a closed bolt in semi-auto. Versions of this gun are available for the 7.62x39mm and 5.56x45mm; it could easily be made for others if there were demand. Portugal and Sweden adopted the HK, and it was sold commercially to anyone who would pay. Special operations units, including the U.S. Delta Force, like it as a light-weight, full-power gun; they can spend the time and ammunition to train troops to use it effectively.

Feed is normally from a non-disintegrating metal belt of 100 rounds, but with an adapter the gun can use 20-round box magazines or an 80-round saddle drum (seven pounds).

EX34 Chain Gun 7.62x51mm - The chain gun is a single-barreled weapon with an action that is powered not by the cartridge but by an external electric motor. The motor drives the action with a chain, hence the name. Since the operation of the action is independent of the ammunition, the chain gun is extremely unlikely to malfunction. Any critical miss that is a malfunction of the gun must be rolled again; only on a second critical failure is it an actual malfunction. The chain gun was developed to a U.S. Army requirement, but was available for commercial sale from its 1977 debut. It spread rapidly to affluent governments such as the Arab oil states. It is used mostly as helicopter armament, but can be used anywhere there is a power supply. (A portable battery and motor, good for 5,000 shots, weighs 50 pounds.)

Feed device can be linkless or disintegrating-link belts.

XM214 6Pak 5.56x45mm - The 6Pak is an orphan - a 1984-issue technical masterpiece looking for a tactical home. It is a 6-barreled Gatling gun, complete with electric motor and battery pack, that is light enough to be carried and operated by a small crew or even a single man. The 33-pound weight is including motor and battery good for 5,000 shots. A tripod would be another 15 pounds. The rate of fire can be set as high as 10,000 rounds per minute; burst control can be set to fire as few as three rounds for each firing. The problem is that a small crew can't carry enough ammunition to feed a gun that potentially fires more than 250 pounds of ammunition a minute! One suggested use is for small boats and light vehicles, which could provide both power and ammunition carriage. With that much transportation, however, the usual option is to go for more range and punch than 5.56mm.

The normal feed device is linkless through a flexible chute. Ammo for man-portable guns is in 500-round "cassettes" weighing 14 pounds. Two clamp to the gun at once, and it automatically switches when the first cassette is empty. The empty cassette can be removed and replaced without interrupting firing. Despite some frenzied rumors, the gun will not melt if fired at full rate; it does get much too hot to touch.

Mortars

Trennen Mortar 77mm - A German design from 1905. Most of the artillery available to the armies of WWI fired with a flat trajectory to ranges of over 6,000 yards. The Germans were almost alone in having a considerable supply of high-trajectory weapons. These were probably designed for the attack and defense of fortresses, but proved to be ideal for trench warfare. They fired a high-explosive bomb with 4dx2 explosive damage and 4d fragmentation damage. The rest of the armies had to rush to catch up. Weight per shot three pounds; cost per shot (1914) \$10.

Minenwerfer 170mm - The 170mm was a bigger mortar, also available to the Germans from the beginning of WWI. Its HE bomb did 6dx20 explosive damage and 10d fragmentation damage. It could also fire gas shells and illuminating shells. The gas shells have a coverage of three hexes and duration of 60 seconds; the illuminating shells will light a 100-yard circle for 60 seconds. Weight per shot 90 pounds; cost per shot (1914) \$30.

Stokes 2-inch - The Stokes was a simple weapon. It was a tube with a fixed firing pin. The tube rested on a base-plate (to keep recoil from sinking it into the ground) and was supported by a bipod. Most mortars since its 1915 debut have followed this basic design. The bomb of the 2-inch Stokes does 5d explosive damage and 2d fragmentation damage. It can also fire smoke (fills a 3-hex radius for 120 seconds) and illuminating (a 50-yard circle for 30 seconds). Weight per shot one pound; cost per shot (1915) \$10.

M36 82mm - This Russian 1936 mortar is typical of weapons that were in use from the mid-1930s to the end of the 20th century. The M36 was so

similar that it would use the 81mm ammunition used by most of its enemies. The HE bomb does 6dx2 explosive damage and 6d fragmentation damage. The smoke round will obscure a five-hex circle for 120 seconds. Weight per shot six pounds; cost per shot (1940) \$25.

M2 60mm - The U.S. M2 of 1938 is representative of the kind of light mortar fielded by every modern army after the mid-1930s. It disassembles into three parts for transport; the base-plate is about half the weight and the rest is about equally divided between tube and bipod. The tube can be braced against the ground and fired without the rest; Accuracy is 1. The HE bomb does 6d explosive and 4d fragmentation damage. This is a favorite weapon of guerrillas and terrorists because of the portability of gun and ammo; one round weighs only about three pounds. Cost per shot (1940) \$20.

M38 120mm - This Russian 1938 weapon is about as big as an infantry mortar can get and still be mobile. The Russians normally tow this on a two-wheeled carriage with a light truck as prime mover. It can be disassembled into several loads for man-portability, but the baseplate and tube each weigh about 200 pounds. The HE bomb does 6dx15 concussion damage and 10d fragmentation damage. It can also fire gas and smoke (8-yard circle, 120-second persistence), illuminating (100-yard circle for 30 seconds) and leaflet bombs. Later models of this mortar are all over the Communist (and ex-Communist) world. Weight per shot 34 pounds; cost per shot (1940) \$50.

M30 4.2-inch (107mm) - The United States organized a Chemical Corps during WWI. Between the wars, given the revulsion against gas warfare, the

Corps was always short on funds and personnel. Still, they managed some R&D, and one of their notable developments was the 4.2-inch mortar. It was designed to fire gas and smoke shells, but in WWII was quickly adapted to HE. Its big thin-skinned bombs actually carried more HE than a 105mm artillery shell, and its high-trajectory fire was ideal for close support. After the war the 4.2s were added to the infantry arsenal. The M30 is the improved, post-WWII (1951) model; performance is the same but it is a little lighter and cheaper to manufacture. They were the basis of bunker-line defense in Korea and of Special Forces camp defense in Vietnam. The HE bomb does 6dx15 concussion and 10d fragmentation damage; other shells are as for the M38 120mm above. Weight per shot 25 pounds; cost per shot (1960) \$200.

M29 81mm - Except for the lighter weight this is very similar to the M36 82mm. Its bombs do the same damage. It was the standard U.S. mortar in the infantry company from 1956 through the Vietnam War and beyond. It could be found anywhere in the world. Similar weapons were produced by almost any country with any sort of industrial base. It was another favorite guerrilla and terrorist weapon. Weight per shot 7 pounds; cost per shot (1960) \$100.

MO-120 120mm - This French design, from 1962, is a heavy mortar on a two-wheeled carriage. It is normally towed by vehicle, but can be broken down into three man-portable loads (barrel 90 lbs., bipod and baseplate 50 lbs. apiece). With the firing pin in one position, shells can simply be dropped down the muzzle; in the other position, they are dropped down but fired by a trigger when wanted. Damage is as for the 4.2-inch above, but with special rocket-assisted shells it can reach to 9,000 yards. Weight per shot 29 pounds; cost per shot (1970) \$300; rocket-assisted shells, \$500.

Commando 60mm - This is a French design (1966) at the other extreme from the MO-120 (above). It is an attempt to get the lightest possible 60mm

Grenade Launchers

M79 40mm - The hand mortar was an idea almost as old as gunpowder. After WWII the idea was revived, to provide a weapon more accurate than rifle grenades and able to cover the gap between the shortest range of mortars and the farthest range of thrown hand grenades. The result (adopted by the U.S. in 1960) was a very simple, hinged-breech gun like a big single-barreled shotgun. The small grenades have less concussion damage than most current hand-grenades (2d+2) but a lethal load of short-range fragments (3d, reduced to 1d-3 at 15 yards). The M79 can also fire illuminating, tear-gas, smoke and signal flares. A buckshot round (treat as 12 gauge) is available for self-defense. Each shot weighs 1/2 pound and costs (1960) \$10.

MK19 40x53mm - This was adopted in 1967 on small boats and armored vehicles, and as a ground gun on the same tripod as the M60. U.S. Marine units use it on the tripod as a battalion support weapon. Ammunition is *not* interchangeable with the M79. This is a full auto weapon. It feeds from a disintegrating-link belt, usually carried in a box clamped to the side of the gun which holds 20 rounds. The original load was HE; the usual modern load (after 1980) is HEDP. This combines concussion/fragmentation as on the table with a shaped-charge warhead - 2d (5) - effective against light armor. Each shot weighs 3/4 pound and costs (1980) \$40.

M203 40x46mm - Uses the same ammunition as the M79, which it began to replace in 1969. The launcher mounts under the barrel of an M16. (After 1984, a later model can be mounted on just about any rifle.) It does not interfere significantly with the use of the rifle. A firer using two hands can fire both rifle and grenade launcher at the same time; Rcl is for *both* weapons.

AGS-17 30mm - The Russian equivalent of the American MK19. It was first known in the West in 1975. Its issue has been limited to troops of the former Soviet Union, except for those captured in Afghanistan. It is widely used on helicopters and APCs. There may be an HEDP round for it; penetration would be 2d-2(10). Feed device is metallic link belt in a 29-round drum; each shot weighs .75 pounds and costs \$50.

Armscor MGL-6 40x46mm - The MGL-6 is a six-shot launcher of British design, first on sale in 1979. It has a cylinder like that of an oversize

Flamethrowers

Flammenwerfer M1912 - The first modern flamethrower (1912), it seems to have been designed to attack fortresses. It was ideal for taking out strongpoints in trenches, and gave the allies more propaganda fuel with its frightfulness. By 1915, all modern armies had flamethrowers much like it. It can fire one six-second stream of fire or two three-second bursts.

M2A1-7 - This style was standard for the United States and its allies from about 1940 until the 1970s. It can fire a 10-second continuous stream or five two-second bursts. After 1970, U.S. forces replaced it with the M9E1-7, which works the same but weighs only 48 lbs.

for fast-moving light infantry forces. The light weight decreases accuracy and range, but it is a support weapon that can go anywhere with the troops. It has no bipod and no sights. It has a sling, and a canvas hand-protector is wrapped around the barrel; the firer holds the tube with one hand and drops the bombs with the other. There is a white line painted around the muzzle to help estimate elevation. With a different baseplate, it can be lanyard fired. Damage and shot weight as for other 60mm; cost per shot (1970) \$75.

51mm Mortar - This is the latest version (1982) of an old British stand-by. It is a light support weapon intended to be carried and operated by one man. It has no bipod or sight, just a hand grip and a white line around the muzzle. It gives raiding parties, patrols and small advisory groups effective support without compromising their mobility. This mortar is trigger-fired rather than drop-fired. The British used a similar mortar - the 2" - from the 1920s until about 1980. Thousands of them are spread around the former British Empire. For the 2" use the same stats except that range is only 500 yards. Weight per shot one pound; cost per shot (1990) \$50.

FLY-K 52mm - This Belgian design (1983) is one of the most unusual of modern weapons. It uses the piston principle to fire without smoke, flash or noise. The propellant is consumed entirely within the case. It is an ideal choice for ambushers, assassins and deep-penetration patrols. Weight per shot one pound; cost per shot (1990) \$80.

BLM 120mm - This British tube from 1987 is mortar as artillery piece. The shells are the latest design, with enhanced explosive and fragmentation damage. Damage is 6dx20 concussion and 11d fragmentation. It loads from the breech and is trigger fired. It is intended for mounting in armored vehicle turrets; no ground mount has been designed. Weight per shot is 30 pounds; cost (1990) is \$500.

revolver, which is powered by a clock-spring. It comes standard with a collimating sight which also acts as a range finder. The ammunition is interchangeable with that of the M79.

HAFLA DM34 - This is a German pocket incendiary. It is a simple aluminum tube containing red phosphorus incendiary and a propellant. It has a folding handle and trigger. When fired, the incendiary is propelled about 80 yards. There it bursts and covers an area of 10 by 15 yards with burning phosphorus. Any exposed person is hit on a roll of 9 or less on 3d (roll randomly for hit location) and takes 1d of burn damage. The burning continues for 1 hit of damage each second for 120 seconds unless cut from the skin (1d-2 of surgical damage to remove). Armor or cover will stop the phosphorus; even heavy clothing will keep it away from flesh until it can be removed. Any normally flammable material will be ignited if it is hit. The phosphorus cannot be extinguished with water and burns at about 2,400°. It can be buried in earth. Otherwise, it keeps burning for 120 seconds.

MMI MGL 40x46mm - This 1979 U.S. civilian design, intended for police, is a repeating grenade launcher with a 12-shot cylinder. It is also made in 37mm for the police line of non-lethal munition (tear gas, rubber bullets, plastic shot, etc.) for civilian departments who are sensitive about their image.

HK79 40x46mm - This is the 1980 German equivalent of the U.S. M203. It can be adapted to any rifle. It is fired with the thumb of the non-firing hand, so there is no interference with the use of the rifle. The same launcher, fitted to a pistol grip and folding stock, makes the *Granatpistole* (Grenade Pistol).

This is the *Bundeswehr* issue grenade launcher. With the stock folded it can be conveniently carried in a belt holster; it is -4 to Holdout. It uses the same ammunition as the American M79.

Hilton MPG 40mm - The Hilton is a British weapon, offered for commercial sale in 1983. It has a folding stock and action that can be fitted with two different barrels for different applications. With a 37mm smoothbore barrel it is a tear-gas or flare gun for the normal range of civilian police munitions. With a 40mm rifled barrel, it is a grenade-launcher for the full range of M79 ammunition.

LPO-50 - This is the most recent Soviet flamethrower (1967). Earlier models had about the same range but usually fired eight to 10 one-second bursts instead of the LPO-50's three three-second bursts. The Soviet WWII flamethrower had a flame-gun that looked like a rifle and a rectangular tank that looked like a back-pack. This was apparently to deceive the enemy into letting the flamethrower within range. Unfortunately, most soldiers don't let any enemy within 50 yards, no matter his armament. The LPO-50 is also the type of flamethrower that is mounted in some Soviet tanks in place of the coaxial machine gun.

Anti-Tank Weapons

Bazooka 2.36-inch - In 1942, a U.S. ordnance officer cobbled up a simple anti-tank weapon, a tube that launched a rocket-propelled Monroe-effect warhead. It was nicknamed "bazooka" after the improvised musical instrument of a then-popular comedian. Explosive effect of the warhead is 6dx2; armor divisor is 10. This applies to all the shaped-charge warheads below. The penetration is a very narrow jet of gas that can ignite flammables or kill personnel behind the armor. Fragmentation effect depends on what the rocket can pick up wherever it explodes.

In 1944, the Germans deployed a larger rocket launcher, the 88mm Raketenbuchse. Stats are the same except Weight 10 and Damage 6dx4.

In 1945 the United States fielded a similar weapon, the 3.5" bazooka. Use the same stats as the German weapon. Any flammable up to 25 yards behind a bazooka has a 50% chance of being ignited; any person takes 1d damage. Cost is the launcher; rockets cost \$35 apiece.

Panzerfaust — The Germans' principal anti-tank weapon was the Panzerfaust, first issued in 1942. This was so light and simple that it was issued not to a special crew but to any soldier who might be faced with a tank. Cost is the launcher and one round. It can be reloaded, but normally was discarded after use. Reloads are \$25 apiece.

RPG-2 82mm 1952 - This was the basic Communist AT weapon from 1952 through the 1960s. It was basically an improved and elaborated Panzerfaust with better sights. Cost is for the launcher and one round; reloads are \$35 apiece.

M40 106mm 1959 - A heavy recoilless gun, in use since 1959. (An earlier 105mm RR was in use from 1945; damage is 6dx6, Acc is 10.) It is usually mounted on or towed by a jeep. This weapon is likely to be found anywhere in the world after 1960. Cost is for the gun and sighting device. Rounds cost \$90 apiece. The sighting device is a .50 semi-automatic rifle mounted on the 106mm. Range for the spotting rifle is the same as for the 106mm; capacity is 10 and damage is 10d. Rounds cost \$1 apiece.

SS11 1960 (MCLOS) - A French design, from 1960, and one of the very first of the wire-guided anti-tank missiles. This was very widely adopted, and was one of the first wire-guided missiles to be fired from a helicopter. The French used this as a bunker-buster in the Algerian War. Cost is for the launcher and one missile; reloads are \$2,500 apiece.

M47 Dragon (SACLOS) - The U.S. standard AT missile for small infantry units after 1961. Cost is for the launcher and one missile; reloads are \$3,000. This has been a disappointing weapon, with less performance than contemporary foreign ATGMs. An improved Dragon appeared in the mid-'80s with a warhead that does 6dx15 (10) damage; price doubles. Dragon's long-overdue replacement, the Javelin, is just now (1998) entering service.

RPG-7 85mm - Used extensively as an anti-tank and anti-bunker weapon by Communist forces since 1962. It has been widely supplied to terrorist groups by Soviet intelligence. Most U.S. soldiers in Vietnam called it simply the RPG and disliked it intensely. The NVA and VC seemed to have an infinite supply of them, and would shoot them off at anything, especially sleepy bunkers. U.S. positions were often surrounded by heavy-gauge chain-link fence (RPG screen) to detonate them early. Cost is for the launcher alone; rockets cost \$100 apiece.

TOW (SACLOS) - In its time the most advanced anti-tank weapon in the world, the TOW had a very impressive kill rate when first used in combat in Vietnam in 1969, and this was confirmed in the Persian Gulf operation. The name stands for Tube-Launched, Optically Tracked, Wire-Guided. Cost is for the launcher and sight; missiles cost an additional \$10,000 apiece.

Various improved versions are available. The 1990s version, TOW-2B, weighs 2 lbs. more but is programmed to overfly the target vehicle and fire two explosively forged fragment warheads down into the lightly armored top, each doing 6dx4 (5) damage.

AT-3 Sagger (MCLOS) - The Soviets first fielded this missile in 1964. It was infamous in the 1967 Arab-Israeli war as the "suitcase missile." It can be manhandled to forward firing positions by a single man. It is a good weapon, but the slow flight time makes it easier to avoid than some later missiles. Cost is for the launcher; missiles cost \$8,000 apiece.

M72 LAW 66mm - This came into service in 1960 in the United States as a completely disposable weapon; once the rocket is fired the launching tube is thrown away. LAW stands for Light Anti-Armor Weapon. Cost is for one complete disposable weapon.

Milan (SACLOS) - Standard in France, Britain and most European countries since 1966. The British used it extensively to knock out bunkers in the Falklands; this is expensive but effective. Cost is for the launcher and sight; missiles are an additional \$10,000 apiece. An improved model with double-damage warhead is available by the early 1980s.

Carl Gustav 84mm - An old (1958) but tried and true Swedish weapon, also in service in many other countries. Besides the shaped-charge warhead, it has a full range of HE, smoke, illuminating and incendiary shells. Cost is for the gun; ammunition is \$100 for shaped-charge, \$70 for HE, \$80 for smoke, illuminating and incendiary rounds. Each round weighs eight pounds. It has a couple of advantages over more advanced weapons. It has no minimum range, a comparatively fast flight time, and once it is launched there is very little the enemy can do about it. The United States has used a similar, 90mm RR since the early 1960s; use the same stats except Max 2,100 and Weight 35.

Cannon

Bombard 600-pounder - The kind of gun used for heavy siege work. This one was used at Constantinople in 1453. Moving and emplacing one of these guns was a major engineering feat. Loading one was hardly less. The separate, detachable chamber weighs 10,000 pounds and has to be completely removed for each shot. Each shot costs \$1,000.

Bombard 16-pounder — A light breech-loader from 1480. These were the first ship-killing naval guns. Each shot costs \$25.

Cannon Perrier 24-pounder — For its time (1530) a very heavy gun, at the limit of what could move in the field. Used mostly in sieges; in an open battle, it was immobile and likely to be overrun. Each shot costs \$40.

Culverin 16-pounder - c. 1600. The distinguishing mark of a culverin was the long barrel. It was neither more accurate nor harder-shooting (though both these were believed to be true). But it was less likely to burst, so crews had confidence in it. The best men tried to serve the culverins; they lasted longer as teams and got more skilled. In the end, culverins were likely to be more accurate, because they had better gunners. Each shot costs \$25.

Saker - The standard field gun from mid-17th to late-18th centuries was like this piece. Carriages and artillery organization improved much more than the guns for this period. Each shot costs \$15.

Cannon 33-pounder — A massive and heavy siege gun of the 18th century. These pieces only came up when a fortress had been invested. At that point they battered the walls to open a breach for assault. Each shot costs \$48.

Gallopier Gun 3-pounder - It is so called because it could keep up with cavalry. Frederick the Great pioneered this kind of horse artillery in the 1750s. The usual tactic was to move rapidly to a good position, then try to soften up the enemy ranks for a charge. Enthusiastic gunners sometimes limbered up and charged with the cavalry. Each shot costs \$5.

Napoleon 12-pounder 1855 — The standard gun of both sides in the American Civil War. The name was not honorary - the gun from which it

was copied had actually been designed by Louis Napoleon, Emperor of the French. Each shot costs \$10.

French 75mm 1897 — The first really modern gun, breech-loading and with full recuperation. From this point in the table, damage is high explosive. For the 75, multi-projectile damage is shrapnel (see p. 20-21). HE is \$12 per shot; shrapnel is \$16.

Big Bertha 420mm 1913 - One of the enormous howitzers used for fortress destruction. It has no direct fire capability. Each shot costs \$300.

Paris Gun 210mm 1918 - A one-of-a-kind gun used by the Germans to bombard Paris. It had pitifully little destructive power but the greatest range of its time: over 80 miles! Each shot costs \$1,700.

M101A1 105mm 1928 - Typical of the light artillery of the 20th century. Basically similar guns have been used in all the wars since WWII. Each shot costs \$35. The 1/2D is for a shaped charge (after 1942, armor divisor 10).

M114 155mm 1932 - A typical medium howitzer of the 20th century. This particular model was spread around the world by U.S. military assistance. Each shot costs \$70.

Multiple-projectile damage is beehive (after 1965, see pp. 20-21). The 1/2D is for a shaped-charge warhead (after 1942, armor divisor 10).

M115 8-inch 1942 - A standard U.S. heavy piece from its introduction, it is renowned for its accuracy in indirect fire. Its dispersion from point of aim is only half that of other artillery (see p. 84). Each shot costs \$140. Multiple-projectile damage is beehive (after 1965).

Katyusha 130mm 1941 - The *Katyusha*, or *Stalin Organ*, was one of the first of the multiple rocket launchers in service. It is short on range and accuracy but puts down a huge amount of HE. It can fire four rockets per second, and fire all its 16 rockets in four seconds. Then it takes one minute per rocket to reload. Each rocket costs \$100.

Weapons Tables

The weapons in the tables are given in the following format:

Weapon: Common name, caliber (or cartridge) and abbreviation for the skill used. Other information and variant weapons are in the following *Weapon Descriptions*. Cartridges may be given in bullet diameter in inches (e.g., .60) or (bullet diameter)x(case length)mm; an R suffix means "rimmed case." This shows which guns use interchangeable cartridges.

Malf: The die roll on which the weapon malfunctions. *Crit* means only on a critical failure described on the *Firearm Critical Miss Table* as a malfunction; other critical failures are as described. *Ver* means only a critical failure which is verified by rolling another failure.

Damage: The number of dice damage the weapon does. A (5) or (10) in parenthesis after damage indicates a shaped-charge warhead with an armor divisor: DR is divided by that number vs. the attack (see p. 27). Grenades, mortars and cannons may have a second number in square brackets: *fragmentation damage* (p. 24). For non-explosive weapons, a "+" or "-" after damage means a caliber-based *wounding modifier* (p. 7) applies to remaining damage after subtracting DR: "-" means halve damage; "+" means multiply by 1.5, "++" means double remaining damage.

All weapons do crushing damage except grenades, mortars, grenade launchers, anti-tank weapons and modern cannon (TL6+), which do explosive damage and flamethrowers (special, pp. 79-80).

Multi: This is the number of attacks/dice of damage for multiple-projectile rounds such as canister or shrapnel/beehive (pp. 20-21).

SS: This is the snap-shot number (see p. B1 15). If no SS modifier, the weapon can only be used if aimed.

Acc: The weapon's Accuracy (p. B115). Guided missiles do not have an Acc number. A "+" indicates weapon usually with telescopic sights that give that bonus when aiming.

Spd: The speed of a guided missile in yards/second.

End: The flight endurance of a missile in seconds.

Min: Indirect fire and guided missiles may have a minimum range.

1/2D: Range at which Acc drops to zero and damage is halved. If parenthesized, Acc is lost but damage is unaffected.

Max: The maximum range - the farthest distance the round can reach fired at the most efficient angle for a given combination of bullet and weapon under Earth-normal conditions.

Wt.: The *loaded* weight, in pounds. Guns with detachable tripods list without/with weights. Tripods take about 30 seconds to attach or detach.

AWt.: Weight of the listed amount of ammunition including any detachable magazine, belt, etc. *Wt.* minus *AWt.* is empty weight.

RoF: Rate of fire in shots per second. Fractional RoF means a single-shot weapon requiring multiple turns of loading; e.g., 1/3 means a loading time of three turns. RoF of 2~, 3~ or 4~ means a *semi-automatic* weapon capable of firing up to that many single shots per turn. A RoF of 4 or more with no ~ means a *fully automatic* weapon that fires the listed number of shots per turn; an asterisk (*) indicates a *selective fire* weapon that can either fire its full RoF on automatic or at RoF 3~ on semi-automatic.

Shots: Number of shots the weapon holds, either internally in cylinder, magazine or clip, or in a belt or hopper. Weapons with a separate magazine and chamber can have a full magazine and one more round in the chamber: they are listed as magazine capacity+1.

ST: The minimum ST to avoid recoil penalties (p. 10). "B" means a bipod is standard (if fired prone, +1 Acc, -2 ST). "T" means a tripod is used (if attached and weapon is fired from sitting or prone position, ignore ST minimum; if not, -2 Acc). An "n/a" means vehicle or carriage mounted; ST is non-applicable.

Rcl: The recoil penalty (see p. 10).

Cost: The price of the weapon when first introduced and a second, 1990s price where applicable. A "-" means replicas or kits may be available at 20-50 times original price, but originals are costly collector items. See *Buying Guns* (pp. 13-14) for more details. For ammo prices, see p. 15.

TL: The TL of the weapon's *technology*.

Abbreviations

ACP	Automatic Colt Pistol (ammunition)	IMI	Israeli Military Industries (manufacturer)	NE	Nitro Express (ammunition)
ATGM	Anti-Tank Guided Missile (specialization)	LAW	Light Anti-Tank Weapon (specialization)	Ptl	Pistol (specialization)
BMG	Browning Machine Gun (ammunition)	LtAu	Light Automatic (specialization)	Rem	Remington (manufacturer, ammo)
BPW	Black Powder Weapons (skill)	LR	Long Rifle (ammunition)	Rfl	Rifle (specialization)
CL	Caplock (lock type)	Mag	Magnum (ammunition)	RR	Recoilless Rifle (specialization)
FL	Flintlock (lock type)	McMG	Mechanical Machine Gun (specialization)	Sh	Short
FlnTh	Flamethrower (specialization)	ML	Matchlock (lock type)	Shg	Shotgun (specialization)
Gnr	Gunner (skill)	MG	Machine Gun (specialization)	Spc	Special
GmLa	Grenade Launcher (specialization)	MH	Martini Henry (manufacturer)	SpWpn	Special Weapon (specialization)
H&H	Holland and Holland (manufacturer)	MPtl	Machine Pistol (specialization)	S&W	Smith and Wesson (manufacturer, ammunition)
H&K	Heckler & Koch (manufacturer)	Msk	Musket (specialization)	WCF	Winchester Center Fire (ammunition)
HnG	Handgonne (specialization)			Win	Winchester (manufacturer)
				WL	Wheellock (lock type)

Automatic Pistols

Weapon	Malf	Damage	SS	Acc	1/2D	Max	Wt.	AWt.	RoF	Shots	ST	Rcl	Costs	TL
<i>Guns (Pistol)</i>														
Broomhandle Mauser, 7.63x25mm	crit.	2d+1	11	3	140	1,800	2.75	0.25	3~	10	10	-1	\$20/\$600	6
Browning Model 1906, .25 ACP	16	1d-	10	0	50	1,000	0.5	0.2	3~	6+1	7	-1	\$10/\$200	6
Luger, 9x19mm	16	2d+2	9	4	175	1,900	2	0.4	3~	8+1	9	-1	\$25/\$500	6
Colt Government Model, .45 ACP	ver.	2d+	10	2	175	1,700	2.75	0.5	3~	7+1	10	-2	\$30/\$500	6
Walter PPK, .32 ACP	crit.	2d-1	10	2	100	1,500	1.25	0.2	3~	7+1	8	-1	\$75/\$500	6
Browning High-Power, 9x19mm	crit.	2d+2	10	3	150	1,900	2.5	0.4	3~	13+1	9	-1	\$80/\$450	6
Ruger Standard Model, .22LR	crit.	1d+1-	9	4	75	1,200	2.5	0.3	3~	9+1	7	-1	\$25/\$250	6
AMT Backup, .380 ACP	crit.	2d	11	0	125	1,500	1	0.25	3~	5+1	8	-2	\$180/\$310	7
Beretta92, 9x19mm	crit.	2d+2	10	3	150	1,900	2.5	0.6	3~	15+1	9	-1	\$400	7
Clock 17, 9x19mm	crit.	2d+2	10	3	150	1,900	2	0.5	3~	17+1	9	-1	\$450	
Desert Eagle, .44 Mag.	crit.	3d+	12	3	230	2,500	4.5	0.6	3~	9+1	12	-3	\$750	7
H&K P7M8, 9x19mm	ver.	2d+1	10	2	140	1,800	2.1	0.36	3~	8+1	9	-1	\$900	7
SiG P229, .40 S&W	ver.	2d+	10	3	150	1,900	2.45	0.55	3~	12+1	9	-1	\$800	7
Kahr K40, .40 S&W	crit.	2d+	10	2	140	1,800	1.9	0.3	3~	6+1	10	-1	\$500	7
H&K USP, .45 ACP+	ver.	2d+1+	10	3	175	1,700	2.7	1	3~	12+1	10	-1	\$900	7

Anti-Tank Guided Missiles

Weapon	Malf.	Damage	Min	Max	Spd	End	Wt.	RoF	Shots	Cost	TL
Gunner (ATGM)											
SS11	crit.	6dx9(10)	500	3,000	120	25	25	1/10	1	\$12,000	7
M47 Dragon	crit.	6dx7(10)	65	1,100	100	11	31	1/6	1	\$10,000	7
BGM-71 TOW	crit.	6dx9(10)	65	4,000	300	15	260	1/7	1	\$40,000	7
AT-3 Sagger	crit.	6dx5(10)	300	3,000	120	25	26	1/10	1	\$20,000	7
Milan	crit.	6dx16(10)	25	2,000	200	10	57	1/7	1	\$30,000	7

Cannon

Weapon	Malf	Damage	Multi	Acc	1/2D	Max	Wt.	RoF	Costs	Crew	TL
Bombard, 600-lbr.	10	6dx24	2,000/2	0	1,000	2,600	60,000	1/7,200	\$30,000/-	200	4
Bombard, 16-lbr.	10	6dx7	120/2	2	400	2,000	8,000	1/45	\$4,000/-	14	4
Cannon Perrier, 24-lbr.	14	6dx8	140/2	3	450	2,500	6,000	1/45	\$3,000/-	8	5
Culverin, 16-lbr.	14	6dx9	120/2	4	400	2,100	5,500	1/60	\$3,000/-	10	5
Saker, 6-lbr.	14	6dx4	80/1	3	300	1,900	1,700	1/20	\$1,000/-	3	5
Cannon, 33-lbr.	14	6dx9	200/2	3	600	2,500	6,200	1/30	\$8,000/-	8	5
Galloper Gun, 3-lbr.	14	6dx3	40/2	2	250	1,800	600	1/20	\$500/-	4	5
Napoleon, 12-lbr.	16	6dx8	100/3	3	600	1,800	2,600	1/20	\$3,000/-	6	5
French 75, 75mm	crit.	6dx3[6d]	250/1	10	n/a	7,500	2,700	1/3	\$11,000/-	3	6
Big Bertha, 420mm	crit.	6dx578[16d]	n/a	n/a	n/a	10,300	85,000	1/600	\$75,000/-	200	6
Paris Gun, 210mm	crit.	6dx5[6d]	n/a	n/a	n/a	144,000	284,000	1/900	\$200,000/-	150	6
M101A1, 105mm	crit.	6dx9[10d]	5,000/2	12	900*	13,800	5,000	1/10	\$20,000/-	8	6
M1 14, 155mm	crit.	6dx29[11d]	8,000/2	11	900*	20,800	12,600	1/30	\$40,000/-	11	6
M1 15, 8-inch(203mm)	crit.	6dx65[12d]	n/a	11	n/a	21,000	31,800	1/60	\$60,000/-	14	6
Katyusha, 130mm	crit.	6dx23[10d]	n/a	n/a	n/a	6,500	4,000	4	\$8,000/-	6	6

Skill for all cannon is Gunner/TL (Cannon) except Katyusha, which is Gunner/TL6 (Rocket Launcher). * See weapon description.

Bibliography

African Rifles and Cartridges - by John Taylor. One of the best books ever written about guns.

American Ammo - by Edward Matunas. A study of the technical aspects of 20th-century ammunition.

Brassey's - These annual volumes tend to be about the higher levels of strategy and funding.

Cartridges of the World - by Frank C. Barnes. Covers most of the historic cartridges and nearly all modern ones.

Civil War Guns - by William B. Edwards. Examines almost every model of firearm known to have been used in the American Civil War.

History of Aviation - by John W.R. Taylor. Includes performance data, dates of availability and unequalled pictorial coverage.

How Weapons Work - edited by Christopher Chant. This gives one of the best surveys ever written of the actual working of weapons from catapults and Greek fire to nuclear weapons.

The Illustrated Encyclopedia of 19th Century Firearms - by Major Frederick C. Myatt, MC, one of the truly great arms historians.

Jane's - From the 1890s to the present, the *Jane's* publications have been the standard reference on military subjects.

Small Arms of the World - Not as relentlessly completist as *Jane's*, but often more rewarding. Includes more detail on operation of weapons.

Street Survival - by Ronald J. Adams, Thomas M. McTernan and Charles Remsberg. The best book ever written about police use of deadly force - how to do it and how to live through it.

Survival Guns - by Mel Tappan. This book examines the gun as a tool for individual survival in the event of societal collapse. It is a cold and common-sense look at most of the commonly available U.S. civilian weapons as of 1980.

The Complete Encyclopedia of Arms and Weapons - edited by Leonid Tarassuk and Claude Blair. A comprehensive, beautifully illustrated reference book.

The Complete Illustrated Encyclopedia of the World's Firearms - by Ian V. Hogg. This, and anything else by Ian Hogg, is detailed, concise, unflinchingly accurate and vastly entertaining.

The Encyclopedia of Military History - by R. Ernest Dupuy and Trevor N. Dupuy. A survey in brief of major wars and battles. Excellent as a picture of how technology changes and is changed by war.

The Gun and its Development - by W. W. Greener. Encyclopedic, covering everything from powder making to competition shooting.

The Handgun - by Geoffrey Boothroyd. A survey that covers the product and the means of production.

The Truth About Self-Protection - by Massad F. Ayoob. An invaluable book about taking care of yourself in the violence of modern America.

The Way Things Work - A two-volume illustrated guide to the most common and the most abstruse technology

United States Firearms, The First Century - by David F. Butler. A prime source of information on the actual performance of 18th- and 19th-century guns.

Weapons Through the Ages - by William Reid. An eclectic look at everything from flint-chipping to nuclear weapons. Illustrations are superb and concentrate on the unusual and little-known.

