

KROHNE

© KROHNE 07/2003

7.02337.22.00

GR

Fundamentals of Radar Technology for Level Gauging

4th edition (revised and expanded)
by Dr.-Ing. Detlef Brumbi

KROHNE Messtechnik GmbH & Co. KG



Foreword to the 4th edition

The first edition of "Fundamentals of Radar Technology for Level Gauging" in 1995 originated from the wish to write a concise account of the technical basis of the then still relatively young field of industrial radar technology. Although countless books and articles had already been published on radio frequency technology and radar methods, there was still a general lack of information on the special issues relating to level measurement.

Owing to popular demand, this booklet now appears in its 4th edition. Following the additions made to the 3rd edition, the contents of this new edition have again been updated, adapted to the latest state of the art and greatly expanded. Thus many aspects have been annotated by additional information, formulae of calculation and diagrams, and more space given to the subjects of TDR and signal evaluation.

This booklet is not a brochure for a particular industrial product but a well-grounded article on technical fundamentals to explain the processes taking place in radar and TDR level gauges. For some it may serve as a kind of textbook to provide a deeper understanding of level measurement technology, for others it may serve as a reference work to provide more details on specific matters.

Not included are subjects of a general nature, such as bus systems and power supply concepts (e.g. 2-wire technology), since they are generally applicable to process measurement technology and are dealt with extensively in many works.

Duisburg, January 2003

Detlef Brumbi

Content	page
1 Introduction	5
2.1 RADAR systems	5
2.2 Radar milestones	5
2 General	6
2.1 Frequency, wavelength and propagation rate	6
2.2 Electromagnetic frequency spectrum	6
2.3 Postal regulations	8
2.4 Hazards from microwaves	8
2.5 Fields of application	8
3 Radar level measurement systems	9
3.1 Overview of level measurement methods	9
3.2 Radar level measurement - General	10
3.3 Comparison of radar methods	10
3.4 Interferometer radar	11
3.5 Pulse radar	12
3.5.1 Bandwidth of an HF pulse	12
3.6 FMCW radar	13
3.6.1 Principle	13
3.6.2 Type model	13
3.6.3 Frequency control by PLL	14
3.7 Power balance ("radar equation")	15
4 Components for radar systems	16
4.1 Active devices	16
4.1.1 GaAs transistors	16
4.1.2 Active diodes	16
4.1.3 Silicon devices	17
4.1.4 Velocity-modulated tubes	17
4.2 Oscillators to generate microwave frequency oscillations	17
4.2.1 Fixed-frequency transmitters	17
4.2.2 DRO	17
4.2.3 VCO	17
4.3 Circuit stages for processing radar signals	18
4.3.1 Mixers	18
4.3.2 Receiver noise	18
4.4 Line transmission	19
4.4.1 Coaxial cable	19
4.4.2 Twin line	19
4.4.3 Planar lines	20
4.4.4 Wire in free space	20
4.4.5 Waveguide	20
4.4.6 Coupling into waveguides	21
4.4.7 Directional coupler	22
4.4.8 Reflections at junctions	22
4.4.9 Plug connectors	23
5 Antennas	24
5.1 Types of antenna	24
5.2 Antenna gain	24
5.3 Radiation angle	25
5.4 Polarization	25
5.5 Directional diagrams	26

Content	page
6 Wave propagation	28
6.1 Propagation rate	28
6.1.1 Influence of the carrier medium (atmosphere)	28
6.1.2 Propagation rate on lines	30
6.1.3 Propagation rate in stillwells/waveguides	31
6.2 Transmission through dielectric windows	31
6.3 Free-space attenuation	32
6.4 Atmospheric signal attenuation	32
6.5 Modified radar equation	34
6.6 Equivalent isotropic radiation power (EIRP)	36
6.7 Propagation along electric lines (TDR method)	37
7 Reflection	38
7.1 Reflection factor	38
7.2 Reflection at interfaces	39
7.3 Dielectric permittivity	40
7.3.1 Chemico-physical assessment	40
7.3.2 Frequency dependence	42
7.3.3 Temperature and viscosity dependence	42
7.3.4 Liquid mixes	42
7.3.5 Bulk (particulate) materials	43
7.4 Scattering from particulate materials	43
7.5 Reflected radar cross-section from limited targets	44
7.6 Angle of reflection	44
8 Evaluation methods	45
8.1 Object discrimination	45
8.2 Unambiguity	45
8.3 Measurement uncertainty	46
8.4 Interference	46
8.5 Sample calculation for received powers	48
8.5.1 Useful signal	48
8.5.2 Signal-to-noise ratio	48
8.5.3 Signal-to-interference ratio of an interference reflector	48
8.6 Signal evaluation in the pulse-radar system	49
8.7 Signal evaluation in FMCW radar	50
8.7.1 Counting method	50
8.7.2 Fourier transform	50
8.7.3 Phasegradient method	51
8.7.4 Tracking	52
8.8 Special methods	54
8.8.1 Empty-tank spectrum	54
8.8.2 Tank bottom tracing	55
8.8.3 Interface detection	56
Annex	58
A Table of dielectric permittivity	58
B System-theoretical comparison between interferometer and FMCW methods	60
C Bibliography	63

Symbols used

a	Distance, spacing	P	Power
Δa	Object discrimination; measuring error	P_E	Received power
A	Aperture area	P_S	Transmission power
A_E	Receive area	r	Voltage reflection factor
A_R	Reflection area	R	(Power) reflection factor
b	Width	R_S	Reflection scattering from a particulate material
B	Bandwidth	t	Time, transit time, delay
c	Speed of propagation, velocity of light	T	Temperature (in Kelvin); sweep time
c_0	Speed of light in vacuum ($\sim 3 \cdot 10^8$ m/s)	T_N	Normal temperature
d	Conductor diameter	v	Propagation rate in the medium; speed of target
D	Diameter (of waveguide, antenna)	Z_L	Natural impedance
D_1, D_2	Propagation loss	α	Propagation loss factor
D_{free}	Free-space attenuation	ϵ_0	Absolute dielectric permittivity in a vacuum ($8.854 \cdot 10^{-12}$ As/Vm)
E	Electric field strength	ϵ_r	Relative permittivity
E_{eff}	r.m.s. value of electric field strength	ϵ_r'	Real part of relative permittivity
E_p	Peak value of electric field strength	ϵ_r''	Imaginary part of relative permittivity
EIRP	Equivalent Isotropic Radiation Power	$\epsilon_{r,N}$	Relative permittivity of gas at normal conditions
f	Frequency	φ	Phase
Δf	Frequency difference; spectral line interval	$\Delta\varphi$	Phase difference
f_0	Fundamental frequency	λ	Wavelength
f_c	Cut-off frequency in the waveguide	λ_c	Cut-off wavelength in the waveguide
f_A	Sampling frequency	λ_0	Wavelength in free space
f_g	Cut-off frequency	η_1, η_2	Radiation (antenna) efficiency
f_D	Doppler frequency	σ	Radar cross-section
f_i	Repetition frequency	τ	Pulse duration
F	Sweep frequency; noise figure	ϑ	Temperature (in °C or °F)
ΔF	Linearity error		
G_1, G_2	Antenna gain		
h	Tank height		
h_v	Shifted tank height		
H	Magnetic field strength		
k	Boltzmann constant ($1.38 \cdot 10^{-23}$ J/K)		
K	Correction factor		
L	Filling level		
N	Integer; number of sampling points		
p	Pressure; power density		
p_N	Normal pressure		

1. Introduction

1.1 RADAR systems

The term “radar” is generally understood to mean a method by means of which short electromagnetic waves are used to detect distant objects and determine their location and movement. The term RADAR is an acronym from

RAdio **D**etection **A**nd **R**anging

A complete radar measuring system is comprised of a transmitter with antenna, a transmission path, the reflecting target, a further transmission path (usually identical with the first one), and a receiver with antenna. Two separate antennas may be used, but often just one is used for both transmitting and receiving the radar signal.

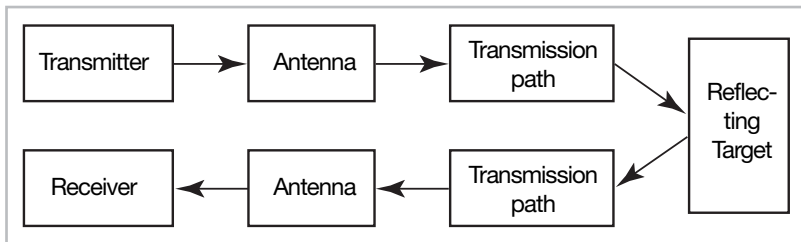

Fig. 1:
Basic structure
of a radar system

1.2 Radar milestones

Even though the existence of electromagnetic waves had been predicted by Maxwell in the 19th century and the theoretical principles laid down, the technical means for constructing a radar device was not available until 1922, when for the first time it was possible using a continuous-wave radar with 5 m wavelength to detect a wooden-hulled ship. Since then radar technology – for military, civil and industrial applications – has developed rapidly, as outlined below:

1865	Theoretical prediction of electromagnetic waves (Maxwell)
1887	Experimental verification of Maxwell's theory (Hertz)
1904	Patent: "method of signalling distant metallic objects to an observer by means of electric waves" (Hülsmeier)
1922	First radar device (Taylor & Young, USA)
1935	Used for locating aircraft (Watson-Watt, GB)
from 1939	Intensive research for military applications (GB, USA, D)
c. 1960	Radar devices to monitor the speed of road traffic
1976	First radar level gauge
1989	First compact radar level gauge

2. General

2.1 Frequency, wavelength and propagation rate

To characterize electromagnetic waves, the relevant factors in addition to intensity¹ are their frequency f and wavelength λ , that are linked by way of their propagation rate c . The following interrelationships exist:

$$c = \lambda \cdot f \quad \lambda = \frac{c}{f} \quad f = \frac{c}{\lambda}$$

The propagation rate c is equal to the velocity of light; in a vacuum it amounts to exactly² $c_0 = 299\,792\,458$ m/s, or approx. $3 \cdot 10^8$ m/s; in gases it is only negligibly lower.

2.2 Electromagnetic frequency spectrum

Microwaves are generally understood to be electromagnetic waves with frequencies above 2 GHz and wavelengths of less than 15 cm (6"). For technical purposes, microwave frequencies are used up to approx. 120 GHz – a limit that will extend upwards as technology advances. Far above this limit are to be found the infrared, visible light and ultraviolet ranges.

As shown in Figure 2 on the next page, microwave frequencies are used intensively for communications and locating purposes. The 4 to 120 GHz frequency range is divided into 7 bands³, whose commonly used letter code is also given in Figure 2.

¹ The power or power (flux) density (power/area) is normally used as the measure of intensity, or the electric or magnetic field strength.

² The speed of light c_0 is now defined as an absolute natural constant (since 1983). The unit "metre" is now derived from c_0 (previously vice versa).

³ However, there are different divisions and codings, e.g. bands upwards of 100 MHz with consecutive coding A, B, C, D, E, F, G (4-6 GHz), H (6-8 GHz), I (8-10 GHz), J (10-20 GHz), K (20-40 GHz).

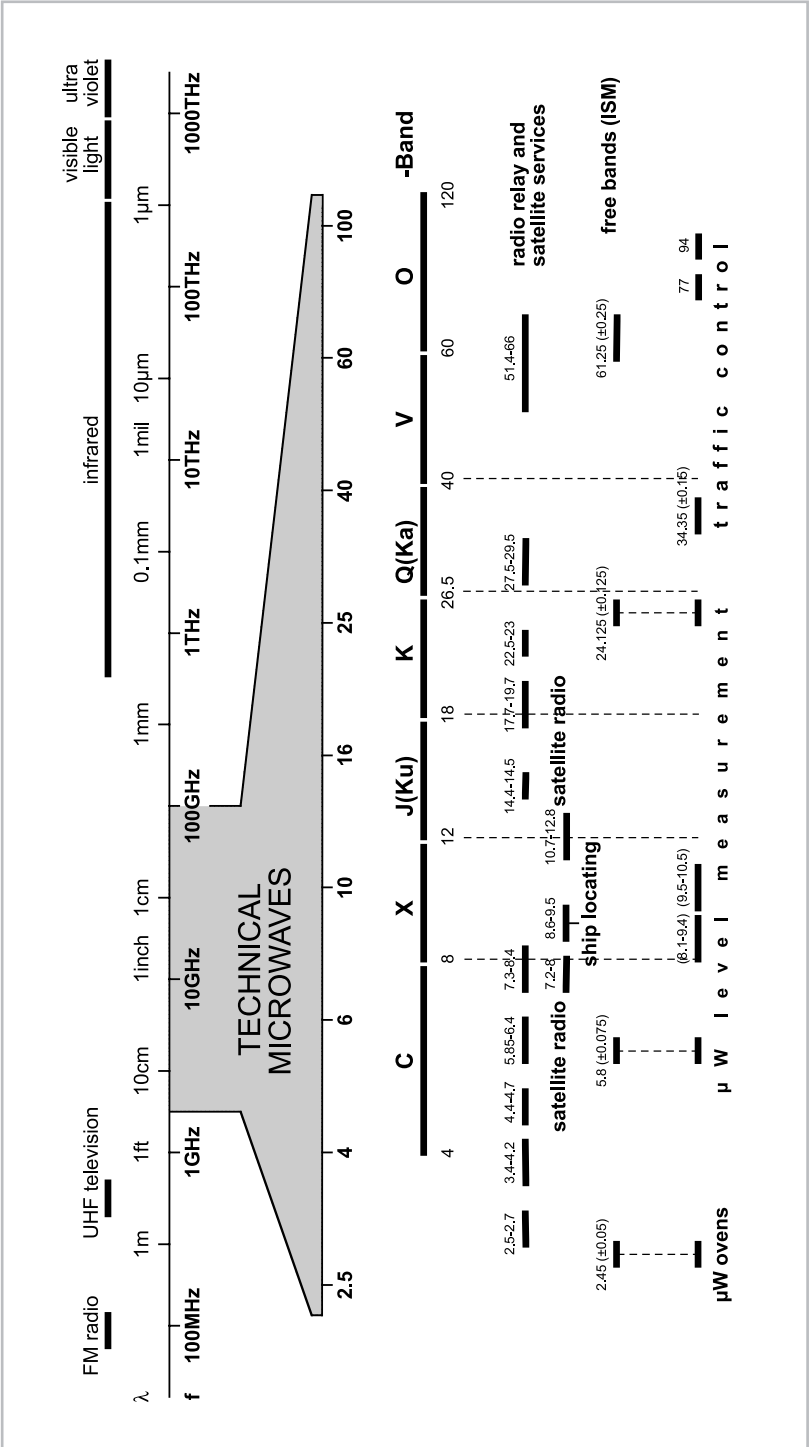

Fig. 2:
Electromagnetic frequency spectrum with typical applications in the microwave range

2.3 Postal regulations

To prevent mutual influence and interference, the use of microwaves is officially regulated. Most countries require an approval or licence from the postal or other authorities, while the European Union requires these to conform to the R&TTE (**R**adio and **T**elecommunications **T**erminal **E**quipment) directives. A post office licence often involves compliance with special conditions⁴.

There are, however, also internationally released⁵ frequency bands for industrial, scientific and medical purposes (so-called ISM bands). Currently these are the following 4 frequency ranges:

2.45 GHz	± 50 MHz	24.125 GHz	± 125 MHz
5.8 GHz	± 75 MHz	61.25 GHz	± 250 MHz

2.4 Hazards from microwaves

The health hazard potential of electromagnetic waves is a highly controversial subject. However, according to the present state of knowledge it can be assumed that persons are not at risk provided the 3 directives issued under DIN-VDE 0848 [DIN] and by the "Berufsgenossenschaft der Feinmechanik und Elektrotechnik" [BG] (German employers' liability insurance association in light engineering and electrical engineering) and ANSI are observed.

These define e.g. limits for the power density: 1 mW/cm² [DIN] and 6.7 mW/cm² [BG] and 5 mW/cm² (ANSI).

Taking, for example, typical transmission power levels of 0.1 ... 10 mW from microwave level measuring systems, the maximum power density at the aperture⁶ of an antenna with 100 mm (4") diameter is 130 µW/cm² (20 µW/in²). Even at this critical point this is far below the specified limit values.

2.5 Fields of application

Microwave techniques and radar systems have become established in many technical areas – for military, civil and industrial purposes. Some of these are shown in Figure 2.

The following brief overview demonstrates part of the large range of application:

- to locate and measure the movement of flying objects
- to locate aircraft and ships, for navigation, altimeters
- speed measurement in road traffic
- distance warning for vehicles
- meteorology
- materials analysis, chemical analysis
- humidity recorders,
- industrial level measurement systems

⁴ For example, notification of the location, limiting of the transmission power, provision of shielding equipment, restriction to certain local areas.

⁵ An approval or a licence is normally required, but the requirements are far less strict.

⁶ Homogeneous power distribution assumed

3. Radar level measurement systems

3.1 Overview of level measurement methods

Measuring the level of liquids or solids in vessels is a frequent requirement in industry. Many traditional and modern methods have been developed [Webster], of which the most important are described in brief:

<i>Hydrostatic:</i>	A pressure sensor is fitted to the tank bottom to measure the differential pressure relative to the environment. A term frequently used is "bottom pressure transmitter". Advantage: low cost. Drawbacks: dependent on the density of the medium; low accuracy.
<i>Buoyancy:</i>	<ol style="list-style-type: none"> The position of a float, whose density must be less than that of the liquid, is sensed; a float ("displacer") dips partially into the liquid and the change in weight is measured; a sensing plate is mechanically guided on the surface until uplift is detected. <p>Advantages: relatively low cost. Drawbacks: dependent on the density of the medium; heavy contamination causes failure.</p>
<i>Capacitive:</i>	Measures the level-dependent capacitance between an electrode dipped into the liquid and the tank wall. Given an electrically conductive liquid the electrode must be insulated, in which case the insulating capacitance in the wetted part is effective. Drawbacks: low accuracy; dependent on liquid.
<i>Conductive:</i>	Measures the current flowing through an electrode at the instant it comes into contact with the liquid. Normally only used as a liquid-level switch.
<i>Vibration:</i>	Measures the degree of damping of a vibrating fork when dipped into the liquid. Normally only used as a liquid-level switch.
<i>Thermal:</i>	Utilizes the greater heat dissipation when a current-carrying, temperature-dependent resistor is dipped into a liquid; the electrical resistance varies with the depth of immersion. Advantage: very simple. Drawbacks: dependent on the medium; low accuracy.
<i>Radiometric:</i>	Gamma rays are more greatly attenuated as they pass through the medium than in the atmosphere. Advantage: non-contact measurement. Drawbacks: radiation exposure; elaborate calibration.
<i>Laser:</i>	Deduces the transit time of a laser beam reflected from the surface of the liquid. Advantages: non-contact measurement; very good accuracy; narrow beam angle. Drawbacks: risk of contamination; fails in vapour atmospheres; expensive.
<i>Ultrasonic:</i>	An ultrasonic signal is emitted, reflected from the surface of the liquid and received. Measures the transit time of the signal. Advantage: non-contact measurement. Drawbacks: sound velocity heavily dependent on gas composition and temperature of the atmosphere; fails in vacuum conditions and vapour atmosphere.
<i>Microwave:</i>	Measures the transit time of a radar signal that is reflected from the surface of the liquid. Advantages: non-contact measurement; almost independent of carrier medium and surface of the liquid product; good accuracy.
<i>TDR:</i>	Also called "directed microwave". A method that also measures the transit time of radio-frequency signals which, however, travel along a conductor dipped into the liquid. Advantages: largely independent of tank internals, even very weak reflections detectable, good accuracy.

3.2 Radar level measurement - General

A radar signal is emitted via an antenna, reflected from the surface of the product and the echo received again after a time interval t .

The distance of the reflecting boundary layer – independent of the radar method used – is determined by way of the transit time t of the microwave signal: per metre target distance, the waves travel a distance of 2 m, for which they require approx. 6.7 ns (or approx. 2 ns for 1 ft distance). Generally the distance measured is $a = c \cdot t / 2$. The level is then calculated from the difference between tank height and distance.

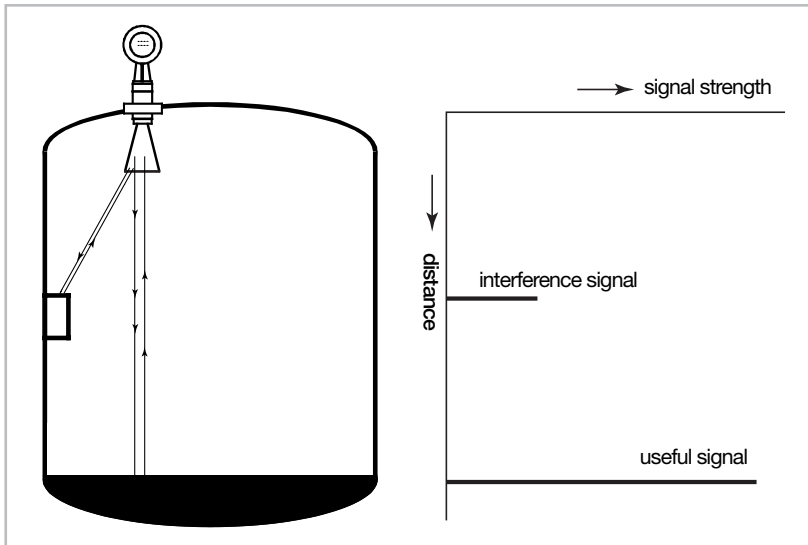

Fig. 3:
Geometric
configuration of
reflectors and
signal strength as a
function of distance

3.3 Comparison of radar methods

The following gives a brief description of the signal forms and properties of commonly used radar methods – keyed to specific application requirements:

- **CW radar** (continuous wave): this system transmits a continuous signal of constant frequency f . The velocity v of moving targets can be determined by the Doppler shift in the received signal. The Doppler frequency is: $f_D = 2 \cdot v \cdot f / c$. This is the method used for vehicle speed checks. Distances cannot be measured, however.
- **Interferometer radar**: the phase of the received signal relative to the transmission phase can be established in order to measure changes in distance with the aid of a non-modulated high frequency signal of constant frequency. The absolute distance information is, however, $\lambda/2$ -periodical (see chapter 3.4).
- **Pulse radar**: transmits a radar signal in short-duration pulses (carrier-modulated or non-modulated). The distance of the target is deduced from the transit times of the pulses from the transmitter via the reflecting target back to the receiver (see Section 3.5). At the same time, the speed can be calculated from the Doppler shift of the frequency.
- **FMCW radar** (frequency modulated continuous wave) the signal is continuously present but the frequency is modulated, usually in successive (linear) ramps. The distance of the target can be deduced from the received signal (see Section 3.6).

- **Reflectometer radar:** this method is used to measure the complex reflection coefficient of the target. From this material information can be deduced, e.g. the characteristics of absorber materials or the moisture content of products.
- **Combined methods:** a combination of reflectometer and pulse can, for example, also measure absolute distances. In another method, pulses are frequency-modulated („chirp“ radar).
- **TDR method** (time domain reflectometry): this is similar to pulse radar, but is normally conductor-bound and used with electrical pulses without carrier frequency.

The basic methods used for radar level measuring equipment are pulse radar or FMCW radar, sometimes supported by the interferometer method. Hence, these processes are described in greater detail in the following sections.

3.4 Interferometer radar

With this method, a microwave signal of constant frequency is transmitted for a certain period of time. This signal is reflected from a reflector (e.g. liquid surface), and the resultant phase difference $\Delta\varphi$ determined from the received signal:

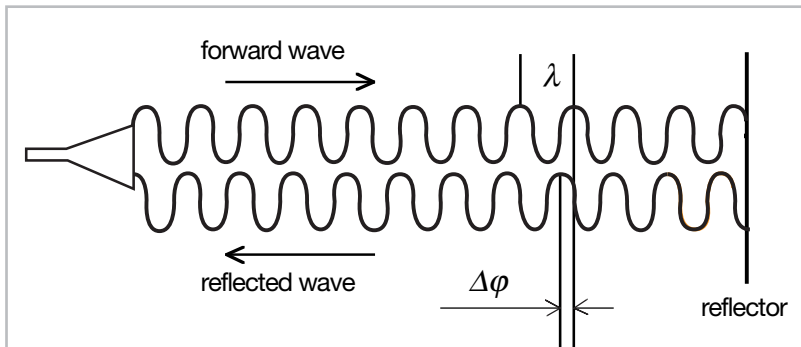

Fig. 4:
Principle of
interferometer
radar

For this purpose, phase evaluation is carried out between the transmitted signal and the received signal with a delay of $t = 2a/c$:

$$\frac{\Delta\varphi}{2\pi} = \frac{\varphi_E - \varphi_S}{2\pi} = f \cdot t = \frac{2f}{c} \cdot a = \frac{a}{\lambda/2}$$

The accuracy of the interferometer method is determined by the resolution of the phase measurement and can be very high. But the result is periodical with $N \cdot \lambda/2$ and therefore ambiguous.

3.5 Pulse radar

The principle is very simple: a short electrical pulse or wave package is transmitted, meets the reflector after time $t_1 = a/c$ and is received back after a total time $t_2 = 2a/c$.

The technical difficulty lies in obtaining accurate measurement of the time t_2 because for an accuracy of 1 mm (0.04") distance measurement, an accuracy of approx. 6 ps time measurement is needed. An extended time scale is normally used by sampling⁷ so that signal evaluation can be performed in the range of low frequencies (see chapter 8.6). Nevertheless, the requirement for a time accuracy of ps for the sampling procedure remains the same. Another requirement is a good repeatability of the reflection signals during a sampling sequence.

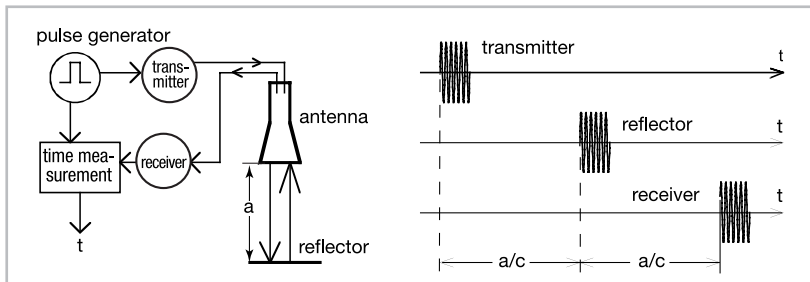

Fig. 5:
Pulse radar measuring system

3.5.1 Bandwidth of an HF pulse

Basically a frequency spectrum can be assigned to every time signal (Fourier transform). If a high-frequency signal of constant frequency f_0 is pulsed with duration τ , a spectrum is formed representing a sinc function ($\sin(x)/x$), see Fig. 6). The 3 dB bandwidth is approx. $B = 1/\tau$.

To be able to compare pulse radar systems with FMCW systems (see chapter 3.6), the signal bandwidth can be employed as a reference quantity: a pulse radar with 1 ns pulse duration has, for example, the same bandwidth as an FMCW radar with 1 GHz sweep.

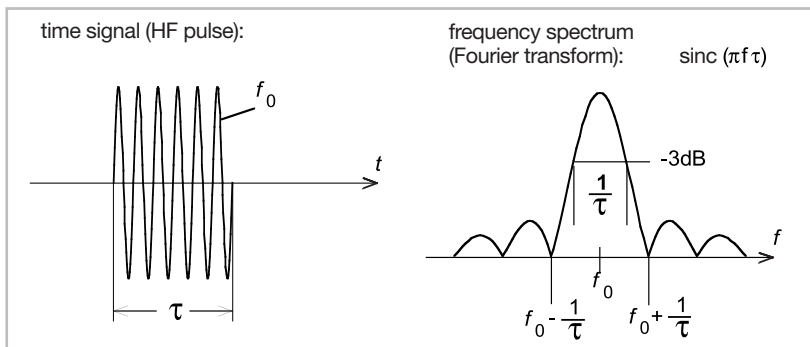

Fig. 6:
Time signal and spectrum of a radar pulse

The same diagram applies to an (ideal) squarewave pulse without carrier frequency when $f_0 = 0$.

⁷ Sequential sampling of a periodic signal at continuously delayed points of time, e.g. for a signal with 1 MHz repetition frequency at the points: 0.000 μ s; 1.001 μ s; 2.002 μ s; 3.003 μ s; 4.004 μ s etc.

3.6 FMCW radar

3.6.1 Principle

FMCW radar uses a linear frequency-modulated high-frequency signal; the transmission frequency rises e.g. linearly in a time interval (frequency sweep).

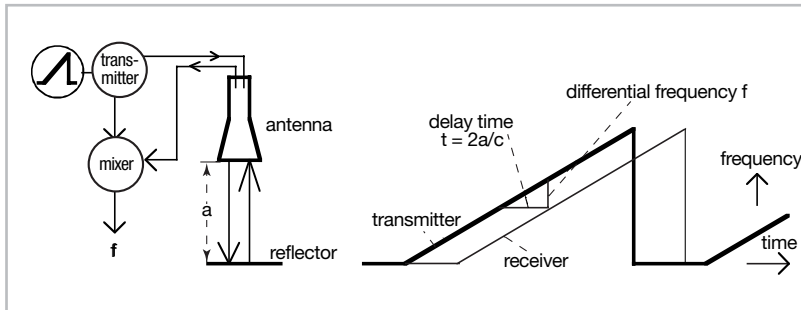

Fig. 7:
Functional principle
and signal trend in
FMCW radar

Due to the time delay during signal propagation, the transmitted frequency changes so that from the difference between the momentary transmitted frequency and the received frequency a low-frequency signal (typically up to a few kHz) is obtained. The frequency f of that signal is proportional to the reflector distance a ; in this method, therefore, the delay t is transformed into a frequency (df/dt is the sweep velocity):

$$f = df/dt \cdot t$$

Technically, the differential frequency is formed by mixing. If the frequency sweep is linear, the frequency of the low-frequency mixed signal remains constant during the sweep procedure. Because the resultant signal frequencies⁸ are low, further signal processing is technically simple and very accurate. Normally evaluation is by means of digital signal processing.

3.6.2 Type model

Fig. 8 shows an example of an FMCW radar system⁹. A variable oscillator VCO is controlled by a microprocessor so that the desired frequency sweep is obtained. This signal is amplified and fed via a pin coupler into the transmitting antenna.

The instantaneous frequency needs to be measured in order to ensure good sweep linearity. This is done by counting the frequency after it has been mixed with a known frequency (DRO).

The received signal is decoupled via a directional coupler, mixed with the transmission signal, and processed by the microprocessor.

⁸ As opposed to the pulse radar method

⁹ The individual electronic components are described in Section 4.

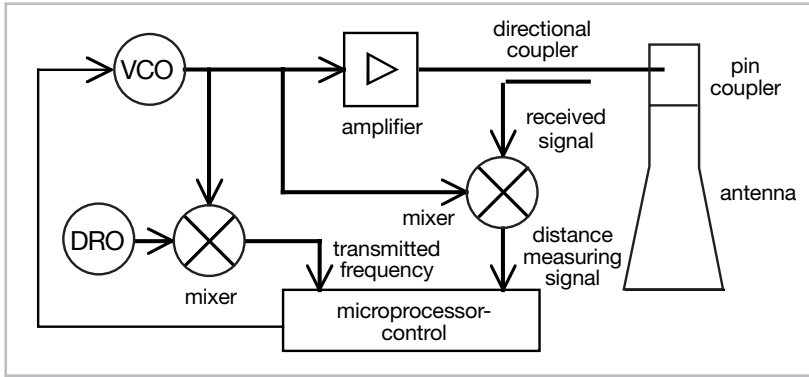

Fig. 8:
Basic circuit diagram
of an FMCW microwave
circuit

3.6.3 Frequency control by PLL

The measuring accuracy of an FMCW system depends on the non-linearity of the frequency sweep [Stolle.2]:

$$\Delta a/a < 8 \cdot \Delta F/F$$

To obtain measuring accuracy in the mm range at distances of 10 m and more, nonlinearity of the frequency must be in the order of 10^{-6} . This can only be accomplished by using active frequency control by means of a PLL circuit (phase locked loop) [Musch], which dynamically sets the required frequency precisely at every instant of the sweep.

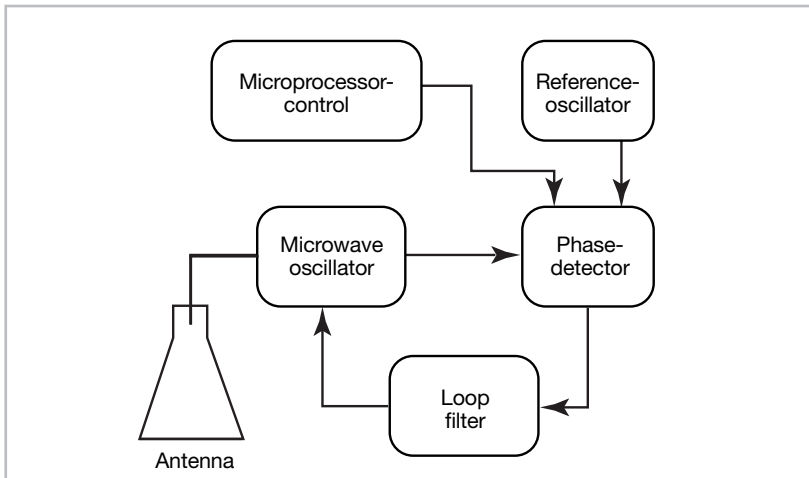

Fig. 9:
Structure of a PLL
frequency control

With such a system, the same measuring accuracy can be obtained as with a static interferometer radar system (see Annex B), but with the added benefit of gaining definitive information on distance.

3.7 Power balance (“radar equation”)

With reference to the basic system shown in Fig. 1 the following power balance quantities are assigned to the various component parts:

Transmitter:	transmission power P_S
Transmitting antenna:	antenna gain ¹⁰ G_1
Transmission paths:	propagation loss D_1, D_2
Reflecting object:	reflection factor R
Receiving antenna:	antenna gain G_2
Receiver:	received power P_E

Accordingly, the following system equation – often termed “radar equation” – is obtained:

$$P_E = \frac{P_S \cdot G_1 \cdot R \cdot G_2}{D_1 \cdot D_2}$$

¹⁰ An antenna can, of course, only emit as much power as is fed into it. The antenna gain describes the higher power density that is obtained with a directional antenna, when compared with an isotropic antenna. See also Section 5.2.

4. Components for radar systems

4.1 Active devices

4.1.1 GaAs transistors

Transistors made of **gallium arsenide** are amplifying semiconductor devices (usually in the form of MESFETs, i.e. field-effect transistors with metallic gate), that are used principally in the frequency ranges of 1 GHz to approx. 30 GHz for low-power applications (a few mW). For example, these devices are used in satellite receivers and other high-frequency circuitries for oscillators, mixers and amplifiers.

More recent developments are **hetero-bipolar transistors (HBT)** and **high electron mobility transistors (HEMT)**.

These types of transistor consist of various semiconducting layers, as shown schematically in Fig. 10.

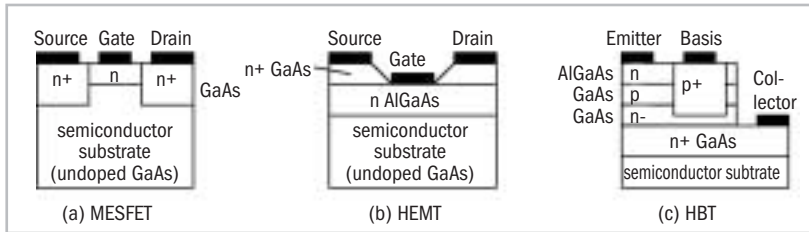

Fig. 10
Cross-section through
the structures of
MESFET (a), HEMT (b)
and HBT (c)
(after [Meinke])

4.1.2 Active diodes

Various bipolar semiconductor devices are available which have a negative differential resistance characteristic in certain operating conditions and so can be used for amplifier or oscillator purposes. For example, with very few components and a very small space requirement, they can be used to assemble low-power oscillators in the microwave range up to about 100 GHz.

Such active diodes include:

- the tunnel diode, also known as the Esaki diode (made of Ge, GaAs or GaSb)
- the IMPATT diode (**impact avalanche transit time**)
- the BARRITT diode (**barrier injection transit time**)
- the transferred electron device (TED) or Gunn diode¹¹
- the quantum effect diode, e.g. resonant tunnel diode (RTD)

Gunn diodes are relatively expensive and therefore not worthwhile for low frequencies < 20 GHz. Frequency modulation, as required for FMCW systems, would only be implementable with considerable outlay.

Gunn diodes are therefore used mainly for pulse oscillators in the range above 20 GHz, since here the GaAs MESFETs have currently reached the limit of their technical capabilities.

¹¹ Strictly speaking, this device is not a diode because it has no p-n junction, but it is nevertheless ranked among the active diodes because of similar physical transit time effects.

4.1.3 Silicon devices

The development of transistors made of silicon (Si) is continuing in the direction of higher cut-off frequencies. Considerable advances have been made in the last few years, e.g. with the SIEGET family¹² (**S**iemens **g**rounded **e**mitter **t**ransistor), which currently is available with transit frequencies¹³ of up to 45 GHz and achieves sufficient gain in the range up to about 15 GHz.

4.1.4 Velocity-modulated tubes

High microwave outputs (up to some kW) at high efficiency levels (80%) can be obtained with velocity-modulated tubes (e.g. magnetron, klystron). Magnetrons are used, for example, in microwave ovens (2.45 GHz). Special velocity-modulated tubes are available to generate frequencies up to some 100 GHz.

Velocity-modulated tubes are not suitable for radar level measuring systems because they are too large in size and such high power outputs are not required.

4.2 Oscillators to generate microwave frequency oscillations

4.2.1 Fixed-frequency transmitters

Oscillators for systems with a constant transmission frequency (CW radar) are usually equipped with GaAs-FET, SIEGET or Gunn diodes in known basic circuitries.

4.2.2 DRO

An oscillator for a stable fixed frequency can be made with the aid of a dielectric resonator (usually made of ceramic material) in conjunction with an amplifier element (e.g. GaAs-MESFET, SIEGET), when it is termed a DRO = **d**ielectric **r**esonance **o**scillator. Since the resonant frequency depends essentially on the geometric dimensions of the resonator, an extremely stable frequency is guaranteed with low temperature drift.

In measuring systems, a DRO is frequently used as a reference for the mixer to determine the transmission frequency (see Fig. 8).

4.2.3 VCO

A **v**oltage **c**ontrolled **o**scillator is required for transmitters transmitting frequency-modulated signals. By means of a control voltage, which e.g. acts on a variable capacitance diode (varactor diode) in a resonant circuit, the transmitted frequency can be varied - which is necessary for an FMCW radar system (see Figs 8 and 11).

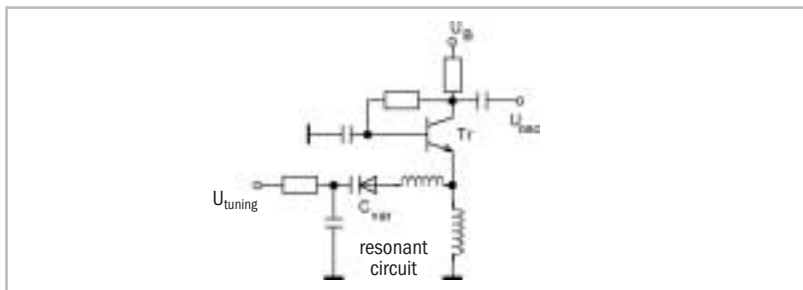

Fig. 11:
Schematic of an oscillator circuit with transistor Tr and varactor diode C_{var}

¹² Unlike the structure of a standard n-p-n or p-n-p bipolar transistor, the frequency-limiting parasitic effects are minimized in the SIEGET by short bonds, two metallization layers and a "buried" emitter area.

¹³ The transit frequency f_T is the frequency extrapolated from the decreasing frequency characteristic by -20 dB/decade, at which the gain is 1 (0 dB). Within this decreasing range the gain is approx.: $G = f_T/f$.

4.3 Circuit stages for processing radar signals

4.3.1 Mixers

Mixers are used to generate an output signal from two signals of different frequencies with the appropriate differential frequency. Multiplying two sine functions together produces sinusoidal signals with the differential and the cumulative frequency. The latter is generally eliminated by frequency filtering. Mixers can be made e.g. with the aid of transistors in various circuit configurations (as multipliers or non-linear amplifiers) or with diodes using their non-linear characteristic.

FMCW systems (see Fig. 8) generally feature two mixers:

- one to allow measurement of the VCO transmitted frequency after mixing with the DRO frequency (e.g. VCO = 10 GHz and DRO = 9 GHz, giving a mixture frequency of 1 GHz, which is easier to process metrologically than the considerably higher VCO frequency by the direct method);
- another to mix the signal received by the antenna with the transmission signal; the differential frequency is processed as a distance-proportional signal for level measurement.

4.3.2 Receiver noise

Natural thermal noise is calculated according to: $P_{\text{noise}} = k \cdot T \cdot B$, where k is the Boltzmann constant, T the absolute temperature, and B the receiving bandwidth. For a receiver, the input-related noise is increased by the noise figure F :

$$P'_{\text{noise}} = F \cdot k \cdot T \cdot B.$$

The signal-to-noise ratio should be as high as possible in order to obtain high detection reliability and a low error rate.

The required transmission power is determined from this, taking into account the total transfer function (see Section 6.5). With the relatively short ranges (up to some 10s of metres or 100s of feet) that are relevant for level measurements, powers of less than 1 mW to a few mW are sufficient to obtain a sufficiently large signal-to-noise ratio.

4.4 Line transmission

4.4.1 Coaxial cable

A coaxial cable generally consists of a wire as the internal conductor and an external conductor - wire mesh or tube - with synthetic material in between as the dielectric. Depending on quality, coaxial cables are capable of transmitting electrical signals from direct current up to high-frequency waves of approx. 20 GHz. The electromagnetic field is only formed inside the cable, so the coaxial cable is a low-radiation type.

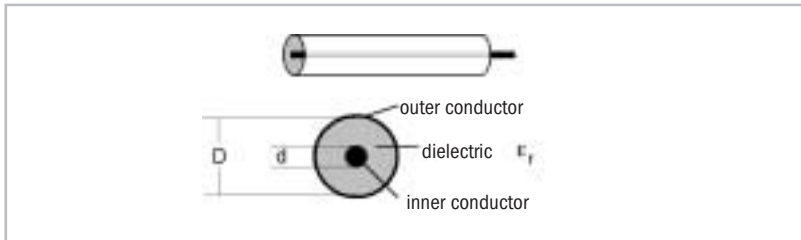

Fig. 12:
Coaxial cable

The natural impedance Z_L is an important parameter of a transmission line. It describes the ratio between voltages and currents in the individual waves on the line, and is calculated for the coaxial cable according to the equation¹⁴:

$$Z_L = \frac{60\Omega \cdot \ln(D/d)}{\sqrt{\epsilon_r}}$$

To design a "standard" line with $50\ \Omega$, the diameter ratio must be $D/d = 2.3$ with an air filling and $D/d = 3.35$ with a Teflon filling ($\epsilon_r = 2.1$).

4.4.2 Twin line

The twin line consists of two conductors routed in parallel by spacers or a dielectric jacket. The electromagnetic field surrounds the entire space around the twin line. It is suitable for signals from d.c. to a few GHz.

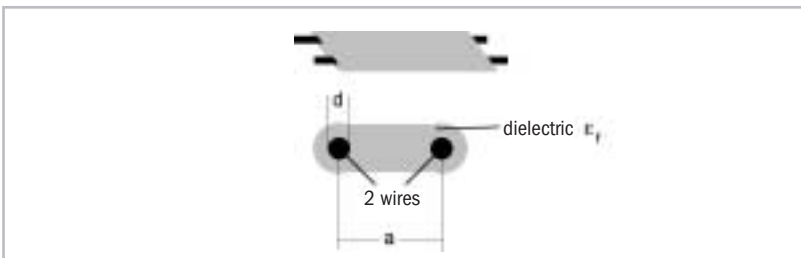

Fig. 13:
Twin line

Natural impedance is calculated according to the equation:

$$Z_L = \frac{120\Omega \cdot \ln(2a/d)}{\sqrt{\epsilon_r}}$$

¹⁴ Assuming a lossless line and non-magnetic environment ($\mu_r = 1$)

4.4.3 Planar lines

Planar lines (also called striplines or microstrip lines) consist of plane line structures applied to a dielectric substrate. An example is shown in Fig. 14. The advantage of this form of line is that other devices are also easy to mount.

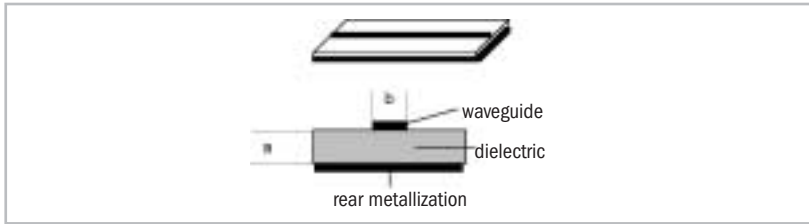

Fig. 14:
Planar line

In the structure shown in Fig. 14, for $b \geq a$ the natural impedance is approximately [Pehl.1]:

$$Z_L = \frac{1}{\sqrt{\frac{\epsilon_r + 1}{2} + \frac{\epsilon_r - 1}{2\sqrt{1 + 10a/b}}}} \cdot \frac{377\Omega}{\left[1.393 + \frac{b}{a} + 0.667 \cdot \ln\left(1.44 + \frac{b}{a}\right)\right]}$$

For example, for a commonly used Teflon substrate ($\epsilon_r = 2.2$) of thickness $a = 0.25$ mm, the line width must be $b = 0.75$ mm if the natural impedance is to be 50Ω .

4.4.4. Wire in free space

A single wire in free space also transmits electromagnetic waves – however with losses because of radiant emittance. This is roughly the same setup as that of a TDR system (see chapters 3.1 and 6.7) with a rod or wire rope. The natural impedance $Z_L = 377 \Omega / \sqrt{\epsilon_r}$ is approximately the same as that of free space (so-called characteristic impedance).

4.4.5 Waveguide

A waveguide consists of a metal tube with circular or rectangular cross-section in which high-frequency electromagnetic waves are propagated along its length. The waveguide can be filled with air or a dielectric.

In contrast to the coaxial cable or the twin line, the waveguide can only transmit signals with a defined minimum frequency f_c .

For the H_{11} fundamental wave in the circular waveguide with an inside diameter D , f_c is approx. 7 GHz at $D = 25$ mm (1"), for example. The following formula applies:

$$f_c = \frac{c}{\lambda_c} \approx \frac{c}{1.7D\sqrt{\epsilon_r}} = \frac{176 \text{ GHz}}{D[\text{mm}]\sqrt{\epsilon_r}} = \frac{7 \text{ GHz}}{D[\text{inch}]\sqrt{\epsilon_r}}$$

However, a situation to be avoided is for the operating frequency to be distinctly higher than the cut-off frequency f_c , since then higher modes can also be propagated at a different velocity:

$$c = c_0 \cdot \sqrt{1 - \left(\frac{\lambda_0}{\lambda_c}\right)^2}$$

which is slower than in free space. The cut-off wave length λ_c for individual modes in a circular waveguide is, for example:

Typ	H ₁₁	E ₀₁	H ₂₁	E ₁₁ /H ₀₁	E ₂₁	H ₁₂
λ_c/D	1.706	1.306	1.029	0.820	0.612	0.589

At GHz frequencies, the transmission losses of a waveguide are lower than those in coaxial cables or twin lines.

4.4.6 Coupling into waveguides

A coupling device is required for transition from the double-line transmission path (e.g. coaxial cable) to a waveguide, e.g. a so-called pin coupler.

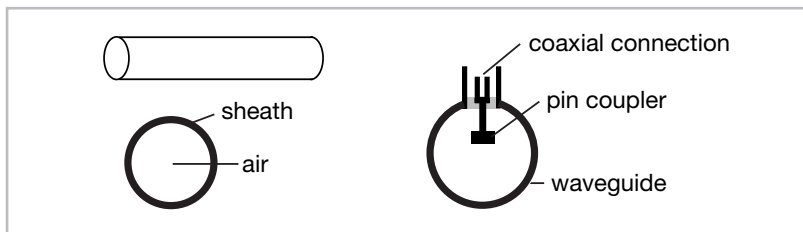

Fig. 15:
Waveguide (left) and
coupling into
waveguide (right)

In addition, there are various possibilities for planar coupling – directly from the PCB to the waveguide.

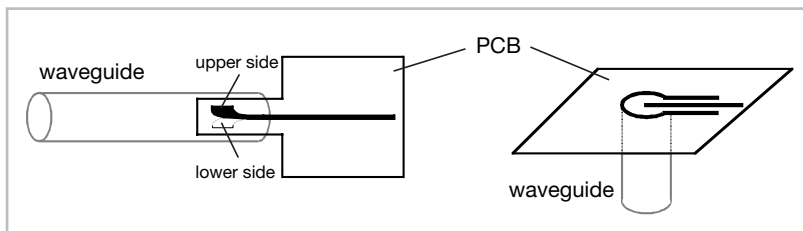
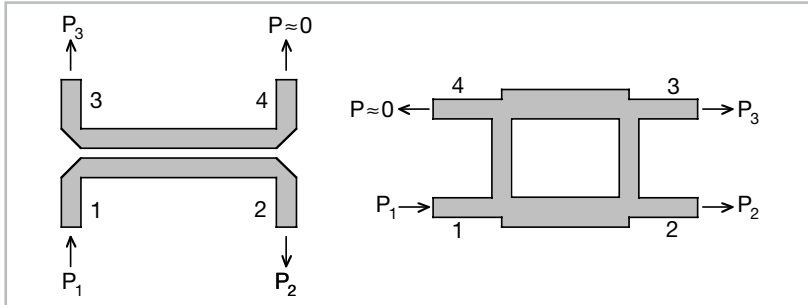

Fig. 16:
Planar waveguide
coupling with fin line
(left) or in radial
arrangement (right)

4.4.7 Directional coupler

A directional coupler transforms only such waves along a second line structure that are transmitted in a predetermined direction along the first line. For single-antenna systems it needs to be fitted in front of the antenna connection in order to decouple the received signal and separate it from the transmission signal, since both signals are present simultaneously at the coupling point.

Fig. 17:
Examples of planar
directional couplers
[Pehl.1]



The characteristic of the planar structures shown in Fig. 17 is that a wave (P_1 fed into a gate) is transmitted only to 2 gates (P_2 and P_3) while the 4th gate remains largely without power ($P \approx 0$). The same applies analogously when a wave is fed into another gate. For example, in the system shown in Fig. 8, the transmission amplifier could be connected to gate 1, the antenna to gate 2, and the receiver mixer to gate 4. Gate 3 is not used and must feature a non-reflecting termination. By this means the high-energy transmission signal is not transmitted to the sensitive mixer.

4.4.8 Reflections at junctions

At every junction in a conductor (particularly in waveguides) at which the cross-sectional geometry or the dielectric material changes, the natural impedance will also change, so that unwanted reflections can occur at these points. For that reason suitable design measures are necessary at junctions in order to keep reflections as small as possible.

Where there is a junction between one line structure with natural impedance Z_1 and another line with Z_2 we obtain the following voltage reflection factor r :

$$r = \frac{Z_2 - Z_1}{Z_2 + Z_1}$$

A negative value for r means that the polarity of the reflected pulse reverses.

Fig. 18 shows the value of r at the junction between a (standard) 50 Ω line and a line with natural impedance Z_2 :

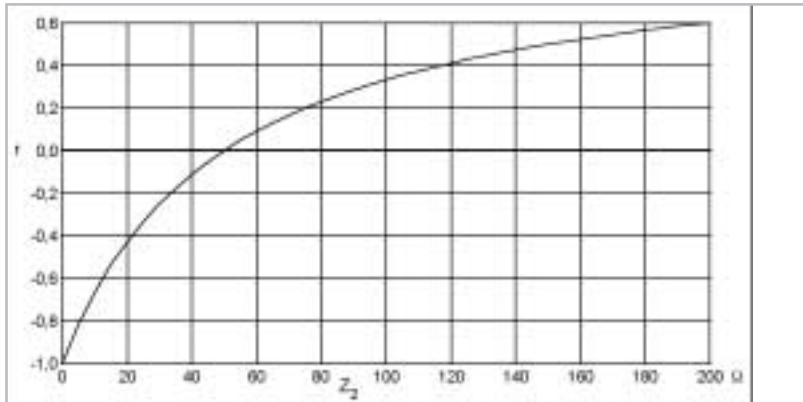

Fig. 18:
Voltage reflection factor at the junction of a 50 Ω line

In waveguide structures, when the waveguide is filled with materials having different dielectric constants ϵ_r , the challenge is to implement a junction that has the least possible reflections.

By combining different materials with matched ϵ_r and using special geometries¹⁵ an approximately reflection-free junction can be obtained which effects “impedance transformation” of the waves (Fig. 19).

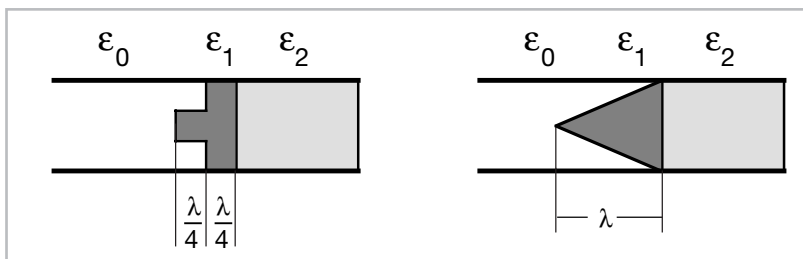

Fig. 19:
Examples of impedance transformers in waveguides

4.4.9 Plug connectors

Plug connectors are required to provide quick-connection facilities between coaxial cables or between such cables and circuit modules. So-called SMA connectors are the most commonly used for the maximum-frequency range up to 26 GHz. They exhibit low through-put losses and good active return losses.

¹⁵ Mostly dielectric bodies with gradually or abruptly changing cross-section or filling of the waveguide, the geometry being in a certain proportion to the wavelength in the dielectric.

5. Antennas

5.1 Types of antenna

The following figure shows some of the most commonly used antenna types. The spectrum of geometries is extremely varied¹⁶, but the forms shown represent the most practical versions for level measuring systems.

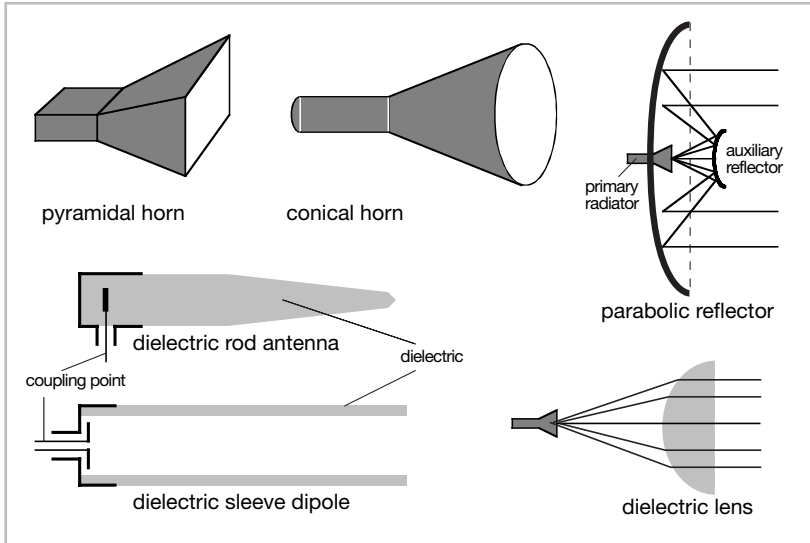

Fig. 20:
Various form
of antenna

5.2 Antenna gain

The antenna emits the waveguide wave into the free space below the antenna aperture. In addition to adjusting natural impedance, it also has a directional effect. The quantity “antenna gain” is closely connected to the directional effect: since the high-frequency power is emitted in a narrower spatial angle, power density in the lobe is higher; the antenna “amplifies”, as it were, the signal. The antenna gain is the better the larger is the aperture area A of the antenna and the smaller the wavelength λ .

The following relation exists between the antenna diameter D or aperture area A of a conical horn radiator and the antenna gain G_1 :

$$G_1 = \eta_1 \cdot \left(\frac{\pi \cdot D}{\lambda} \right)^2 = \eta_1 \cdot \frac{4\pi \cdot A}{\lambda^2}$$

¹⁶ Refer to the literature, e.g. [Pehl.2], [Philippow.3], [Meinke]

Typical values for antenna efficiency η_1 are approx. 0.5 - 0.8. Due to reciprocity¹⁷ a gain G_2 is imputed to a receiving antenna that is generally equal to the transmission G_1 :

$$G_2 = \frac{\text{received power of antenna in a planar wave field (optimally aligned)}}{\text{received power on an ideal isotropic radiator}}$$

The following correlation with the effective receiving area A_E is given by:

$$A_E = G_2 \cdot \frac{\lambda^2}{4\pi}$$

5.3 Radiation angle

A characteristic quantity for describing the directional effect is the radiation angle or half-value width. This is defined as the cone angle at whose edge the power density is 3 dB below the maximum power density (i.e. at the edge of this lobe the power density is half the size it is in the middle).

The smaller the radiation angle, the larger the aperture area, i.e. the higher the antenna gain. Fig. 21 gives a rough estimation of the half-value width of horn radiators with an aperture angle of approx. 40° . By approximation the following equation applies (D = antenna diameter):

$$\varphi \cong 70^\circ \cdot \frac{\lambda}{D}$$

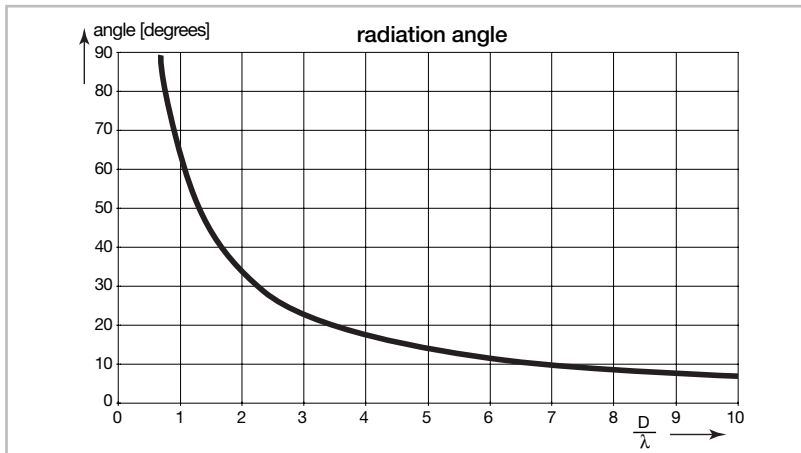

Fig. 21:
Radiation angle
of horn antennas
(approximative values
after [Pehl.2])

The radiation lobe is slightly asymmetrical (elliptical) due to polarization of the waves (see subsection below).

For level measuring systems, a small radiation angle, i.e. good focusing, is desirable in order to avoid interference reflections as much as possible from the tank wall or tank internals.

¹⁷ Reciprocity of characteristics for transmission and reception

5.4 Polarization

In the microwaves emitted by the antenna the vectors of electric field strength E and magnetic field strength H are constantly oriented (linear polarization), or the direction of polarization rotates in space and time (elliptical or circular polarization). Vectors E and H are always perpendicular to each other and perpendicular to the direction of propagation¹⁸.

In level measurement technology, the direction of the linearly polarized wave can be significant in the vicinity of metal surfaces (e.g. a tank wall), since there only such H vectors exist that run parallel to the conducting surface, and also E vectors that are vertical to the conducting surface. If the direction of polarization coincides with this, strong reflections are obtained from the wall and signals are cancelled due to wave interference.

5.5 Directional patterns

The radiation pattern of an antenna describes the distribution of power density over the solid angle. In a first approximation it can be assumed that the characteristic is rotationally symmetrical around the main radiation direction, so that the resultant directional pattern can be represented in a two-dimensional graph¹⁹.

From the examples given in Fig. 22, it can be seen that apart from the major lobe there are also side lobes which are particularly well developed for the dielectric rod antenna.

¹⁸ This applies to plane wave fronts and so, strictly speaking, only to the far-field region of the antenna.

¹⁹ Any asymmetry due to polarization, represented by different radiation patterns for the E and H field is not discussed here.

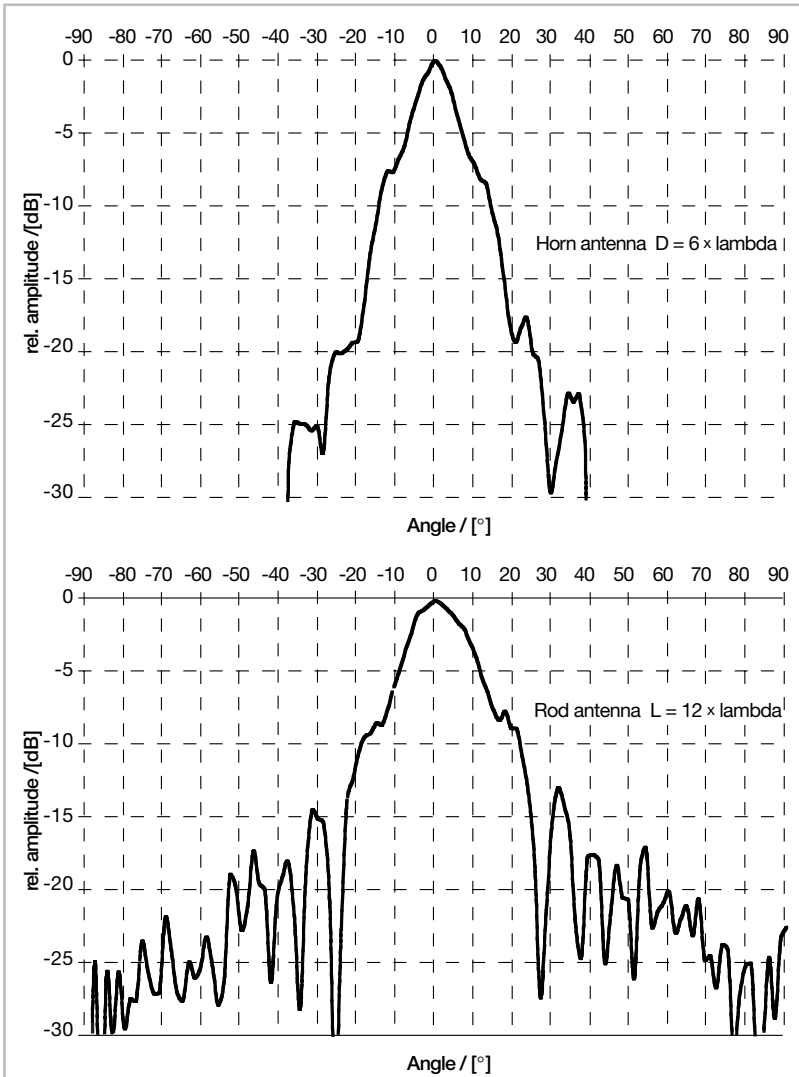

Fig. 22:
Measured
directional patterns
of a horn antenna
and a rod antenna

6. Wave propagation

6.1 Propagation rate

To calculate distance with the radar measuring system, the free-space speed of light in a vacuum or in air is generally taken as the basis. This method is normally adequate, but deviating propagation rates can occur in special application conditions. Correction is relevant under the following conditions:

- a) high pressures in the tank (with air, approx. 10 bar/145 psi and higher)
- b) waveguides used as stillwells.

Such a systematic error of the measured distance can be taken into account by using a correction factor K in signal evaluation. The corrected distance a is then:

$$a = a_0 \cdot K$$

The following subsections describe the correction factor $K = c/c_0$ obtained from theoretical calculations. Exact compensation, however, requires a calibration measurement.

It is important that only the desired fundamental mode be generated in the stillwell, since multi-modal propagation within the waveguide would lead to different transit times (see chapter 4.4.4) and thus to signal distortion. The greater the diameter of the stillwell, the greater is the risk that higher modes will be activated by interference, for example.

6.1.1 Influence of the carrier medium (atmosphere)

Microwaves are propagated almost independently of the carrier medium. Normally, the influence of the atmosphere on the speed of light need not be taken into account for the measuring accuracy of microwave level measuring systems. The relative permittivity ϵ_r of the gas in the atmosphere above the liquid determines the propagation rate of the microwaves. It is very close to unity but is dependent on medium, pressure and temperature:

$$\epsilon_r = 1 + (\epsilon_{r,N} - 1) \cdot \frac{T_N}{T} \cdot \frac{p}{p_N}$$

where:

$\epsilon_{r,N}$	rel. permittivity of gas at normal conditions
T_N	normal temperature (in Kelvin), generally 273.15 K (= 0°C/32°F)
p_N	normal pressure, generally 10 ⁵ Pa (= 1 bar = 14.5 psi)
T	temperature (in Kelvin)
p	pressure

Thus the correction factor as the ratio of propagation rate c to the speed of light in a vacuum c_0 is:

$$K = \frac{c}{c_0} = \frac{1}{\sqrt{1 + (\epsilon_{r,N} - 1) \frac{273.15 \cdot p[\text{bar}]}{\vartheta[^\circ\text{C}] + 273.15}}} = \frac{1}{\sqrt{1 + (\epsilon_{r,N} - 1) \frac{33.9 \cdot p[\text{psi}]}{\vartheta[^\circ\text{F}] + 459}}}$$

For air at normal conditions, the difference in the propagation rate compared to a vacuum is only 0.03%. For deviating pressures and temperatures the following graph is obtained:

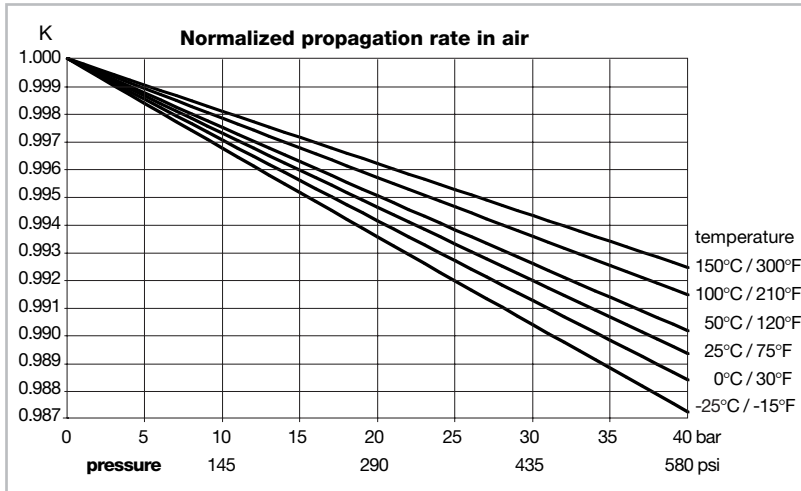

Fig. 23:
Change in
propagation rate
at pressure and
temperature

Significant deviations arise only when pressure levels exceed 10 bar (145 psi), the measuring error then exceeds 0.3%.

A correction will of course only make sense provided the pressure in particular remains approximately constant during measurements.

Oxygen, nitrogen and argon behave similarly to air; with other gaseous media the quantitative effect can, dependent on ϵ_{rN} be lower or even substantially higher:

<u>Medium</u>	$\epsilon_{rN} - 1$	<u>Medium</u>	$\epsilon_{rN} - 1$
Helium	$0.07 \cdot 10^{-3}$	Air	$0.59 \cdot 10^{-3}$
Hydrogen	$0.26 \cdot 10^{-3}$	Carbon dioxide	$1.00 \cdot 10^{-3}$
Oxygen	$0.52 \cdot 10^{-3}$	Hydrogen chloride	$4.60 \cdot 10^{-3}$
Argon	$0.55 \cdot 10^{-3}$	Ammonia	$7.20 \cdot 10^{-3}$
Nitrogen	$0.58 \cdot 10^{-3}$		

6.1.2 Propagation rate on lines

Electromagnetic waves are propagated at the speed of light along a loss-free line (sections 4.4.1 to 4.4.4). When the line is completely surrounded by a dielectric ϵ_r , or the coaxial cable is filled with a dielectric, the propagation rate is:

$$c = \frac{c_0}{\sqrt{\epsilon_r}}$$

Given a spatially restricted dielectric (e.g. planar line, section 4.4.3) or given ohmic and/or dielectric losses²⁰, value c/c_0 needs to be specially calculated.

6.1.3 Propagation rate in stillwells/waveguides

Another physical factor affecting the propagation rate is when microwaves are propagated not in free space but inside a pipe acting in the same way as a waveguide (see chapter 4.4.5). The liquid surface to be measured is located inside the stillwell.

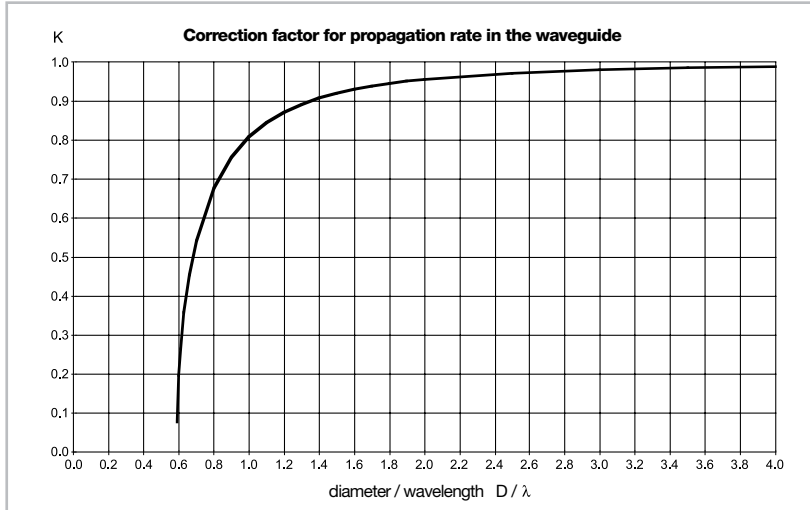

Fig. 24:
Change of propagation
rate in the waveguide
($K = c/c_0$)

²⁰ Heat loss in the conductor / dielectric material

The thinner the pipe, the slower are the waves propagated²¹. The propagation rate in the cylindrical waveguide (inside diameter D) is²²:

$$c = c_0 \cdot \sqrt{1 - \frac{\lambda^2}{(1.7 \cdot D)^2}}$$

The diagram in Fig. 24 shows the correction factor as a function of the inside pipe diameter. The minimum diameter is dependent on the wavelength, or frequency.

6.2 Transmission through dielectric windows

The practical application of radar level gauging systems requires that the tank interior be separated from the tank exterior in order to provide separation of pressure, temperature and product. To this end, "windows" of a dielectric material (plastics, glass, ceramics) are used which for the microwaves should preferably be transparent and low reflecting.

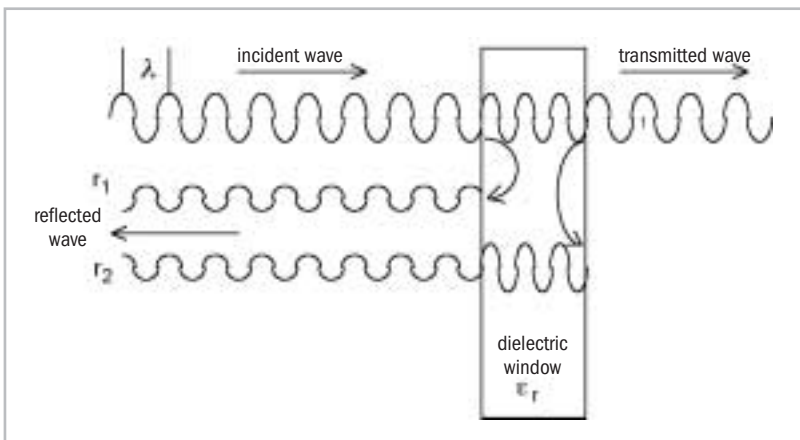

Fig. 25:
Reflection of waves
from a dielectric
window

The series of events can be imagined thus: a first (negative) reflection r_1 occurs at the left interface between air and dielectric and a second (positive) reflection r_2 at the right interface, which ideally cancel each other out (Fig. 25). It is reasonable to assume that the difference in the transit time of the waves must be a multiple of the wavelength inside the dielectric, divided up into incident wave and reflected wave. We therefore obtain the ideal thickness d of the window with material property ϵ_r as:

$$d = \frac{N \cdot \lambda}{2\sqrt{\epsilon_r}} \quad (N=1,2,3,\dots)$$

²¹ Relevant is the so-called group velocity, not the phase velocity of the waves

²² Group velocity; the formula applies to the fundamental mode of the H_{11} waves; for other modes the factor 1.7 will change according to the table in section 4.4.5.

6.3 Free-space attenuation

By this is meant the power density decreasing in step with increasing distance from the radiator in the loss-free medium. An isotropic (having the same physical properties in all directions) radiator distributes its transmission power at distance a on a spherical surface of size $4\pi a^2$. Including antenna gain G , the following is given for the power density p :

$$p = \frac{P_s \cdot G}{4\pi \cdot a^2}$$

There is no free-space attenuation in a stillwell; the power density is largely constant²³ (independent of a):

$$p = \frac{4 \cdot P_s \cdot \eta_1}{\pi \cdot D^2}$$

6.4 Atmospheric signal attenuation

Given transmission losses, power additionally decreases exponentially with distance a ; α is the relevant attenuation factor (unit m^{-1} or ft^{-1}):

$$P' = P \cdot e^{-\alpha \cdot a}$$

If the powers are given in dB and attenuation in dB/m or dB/ft, the equation is simplified to:

$$\begin{aligned} P'[\text{dB}] &= P[\text{dB}] - a[\text{m}] \cdot \alpha [\text{dB/m}] \\ P'[\text{dB}] &= P[\text{dB}] - a[\text{ft}] \cdot \alpha [\text{dB/ft}] \end{aligned}$$

Attenuation must be considered for both ways.

²³ However, slight attenuation does occur due to the resistance of the pipe wall; typical values for copper are about 0.02 ... 0.2 dB/m, for stainless steel waveguides about 0.2 ... 1.5 dB/m.

The attenuation factor is dependent on frequency. It is given in Fig. 26 for air at 20°C and 7.5 g/m² moisture content. The absorption maximum at approx. 20 GHz is due to water vapour, the maxima at 60 GHz and 120 GHz to oxygen. Attenuation performance is dependent on pressure, temperature and relative humidity.

However, in practical terms microwave attenuation in air is not significant for radar level measurement systems because at typical tank heights of up to 30 m (100 ft) it is at most only about $15 \text{ dB/km} \cdot 2 \cdot 30 \text{ m} = 1 \text{ dB}$.

The case is different with liquid ammonia (NH₃), which under pressure (approx. 10 bar/145 psi at 10°C/50°F) usually forms a dense gas phase above the liquid; in practice, it dampens microwave signals in the X-band (10 GHz) so much that no reflection is measurable.

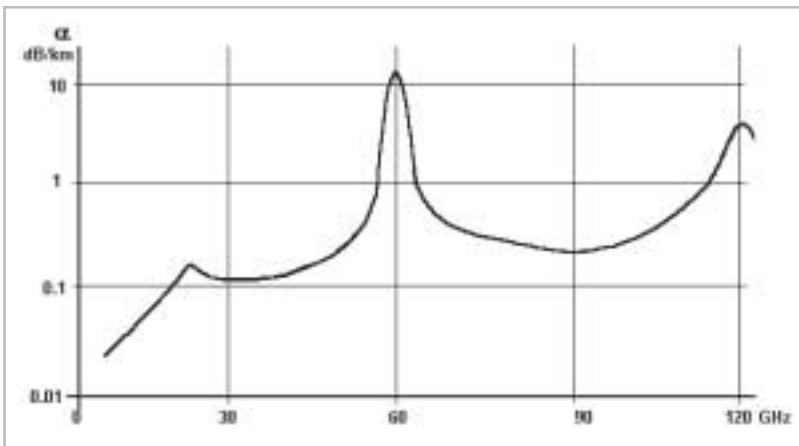

Fig. 26:
Attenuation of
microwaves in air.

²⁴ Reflection factor $R = 1$, see Section 7.1.

6.5 Modified radar equation

Based on the radar equation given in Section 3.7 the relations for antenna gain and propagation loss can now be included.

According to Section 6.3 the power density of the waves before reaching the reflector at distance a is given by:

$$p_1 = \frac{P_s \cdot G_1}{4\pi \cdot a^2}$$

The distinction now needs to be made between 2 cases, depending on the size of reflecting area A_R :

(a) The reflecting area is so large that it intersects the beam cross-section completely, so that in the ideal case²⁴ the transmission power is totally reflected. Therefore, the total path $a + a$ is travelled to the receiving antenna, and the power density is:

$$p_{2a} = \frac{P_s \cdot G_1}{4\pi \cdot (a + a)^2} = \frac{P_s \cdot G_1}{16\pi \cdot a^2}$$

(b) When A_R is smaller than the beam cross-section, the effective radar cross-section of the reflecting target σ is relevant. Area σ (see Section 7.5) then acts as an isotropic radiator with power $p_1 \cdot \sigma$, so that the power density at the receiving antenna, located at distance a from that reflector, is:

$$p_{2b} = \frac{P_s \cdot G_1}{4\pi \cdot a^2} \cdot \frac{\sigma}{4\pi \cdot a^2} = \frac{P_s \cdot G_1 \cdot \sigma}{16\pi^2 \cdot a^4}$$

By multiplying the power density with the effective antenna area and the receive efficiency η_2 , we obtain the received power:

$$P_E = p_2 \cdot \eta_2 \cdot A_E$$

²⁴ Reflection factor $R = 1$, see Section 7.1.

Also taking into account the equation for antenna gain G_1 (Section 5.2), and atmospheric attenuation α and a reflection factor R of the reflecting surface (see Section 7), we obtain the following interrelationships:

$$P_{Ea} = \frac{P_s}{16\pi \cdot a^2} \cdot \eta_1 \cdot \left(\frac{\pi \cdot D}{\lambda} \right)^2 \cdot \eta_2 \cdot \frac{\pi \cdot D^2}{4} \cdot R \cdot e^{-2\alpha a} = \frac{P_s \cdot \eta_1 \cdot \eta_2 \cdot R \cdot e^{-2\alpha a} \cdot \pi \cdot D^4}{64 \cdot \lambda^2 \cdot a^2}$$

$$P_{Eb} = \frac{P_s \cdot \sigma}{16\pi^2 \cdot a^4} \cdot \eta_1 \cdot \left(\frac{\pi \cdot D}{\lambda} \right)^2 \cdot \eta_2 \cdot \frac{\pi \cdot D^2}{4} \cdot R \cdot e^{-2\alpha a} = \frac{P_s \cdot \eta_1 \cdot \eta_2 \cdot \sigma \cdot R \cdot e^{-2\alpha a} \cdot \pi \cdot D^4}{64 \cdot \lambda^2 \cdot a^4}$$

A significant point is that the received power decreases with increasing distance a . Where a level measuring system is used in a large-area tank, equation (a) should be applied by approximation: the signal decreases to the square of a . Where extremely tall tanks or interference reflections from small internals are involved, it is better to use equation (b): decrease with the 4th power of a .

In both cases, however, there is the same proportional dependence²⁵ on antenna diameter D and wavelength λ or transmission frequency f :

$$P_E \cong \frac{D^4}{\lambda^2} \cong D^4 \cdot f^2$$

Fig. 27 gives a comparison of various radar systems using different antennas and transmission frequencies.

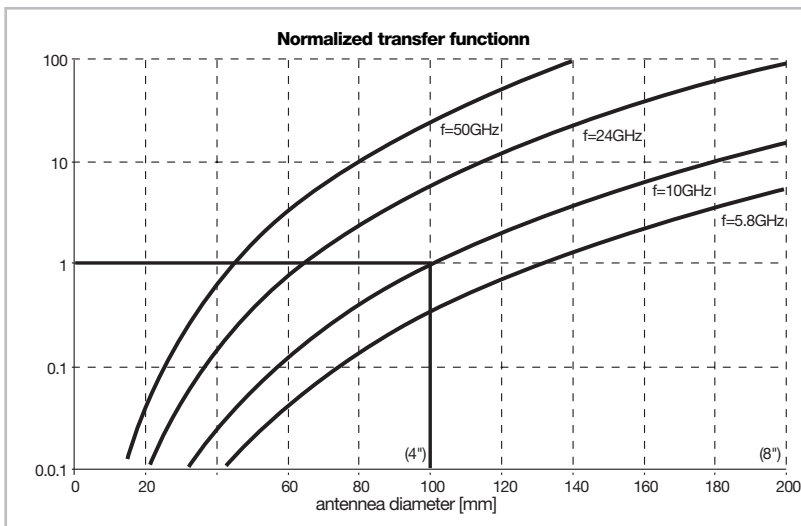

Fig. 27:
Transfer function of radar systems using different frequencies and antenna sizes (normalized to $D = 100 \text{ mm}$ (4") at 10 GHz)

The distinct increase in power due to higher frequencies and larger antennas is quite evident. A 50 GHz system with a 45 mm (1.8") dia. antenna would have the same power as a 5.8 GHz system with 130 mm (5") dia. or a 10 GHz system with 100 mm (4") dia. antenna.

²⁵ Assuming that efficiencies, reflection factor, atmospheric attenuation and effective reflector area are independent of frequency. This applies only up to a point to the cross-section of the reflected beam σ , since e.g. for a plane face it is proportional to f^2 (see Section 7.5).

6.6 Equivalent isotropic radiation power (EIRP)

The equivalent isotropic radiation power (EIRP) is calculated in order to allow assessment of the effective radiated power in the main-radiation direction. This is equal to the product of transmitted power P_S and antenna gain G_1 :

$$\text{EIRP} = P_S \cdot G_1.$$

In practice, the received power P_E is measured at a defined distance a by means of a reference antenna (gain G_2):

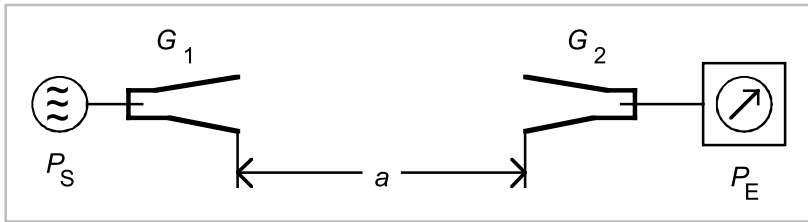

Fig. 28:
Arrangement to
measure the EIRP

When allowing for the loss in free space $D_{\text{free}} = (4\pi a/\lambda)^2$, the EIRP is then calculated by:

$$\text{EIRP} = \frac{P_E \cdot D_{\text{free}}}{G_2} = \frac{P_E \cdot (4\pi a)^2}{G_2 \cdot \lambda^2}$$

In turn, the electric field strength E , dependent on distance a , can be calculated as follows, whereby the distinction has to be made between the peak value E_p and the r.m.s. value E_{eff} of the field strength:

$$E_p = \frac{\sqrt{\text{EIRP} \cdot 60\Omega}}{a} \quad E_{\text{eff}} = \frac{\sqrt{\text{EIRP} \cdot 30\Omega}}{a}$$

For example, an EIRP = -45 dBm at a distance of 3 m (10 ft) corresponds to a field strength of approx. 460 $\mu\text{V}/\text{m}$ peak and 325 $\mu\text{V}/\text{m}$ r.m.s.

6.7 Propagation along electric lines (TDR method)

In the TDR method, waves are propagated not through the tank atmosphere but along an electric line (see chapters 4.4.1 to 4.4.4), shown in Fig. 29 by way of example with a rod or wire rope.

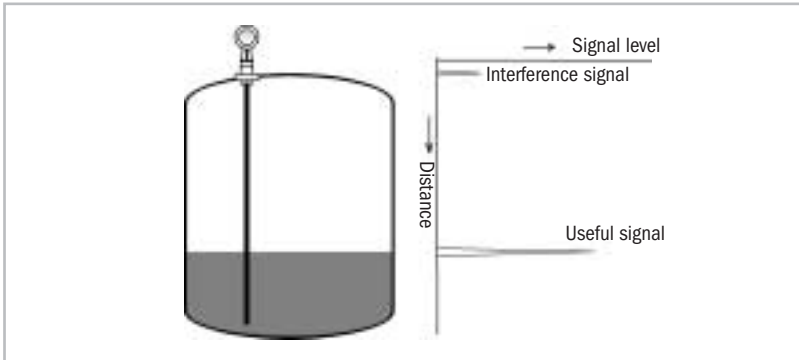

Fig. 29:
TDR arrangement
with a rod

An interference reflection is generally formed at the junction between measuring system and rod (see chapter 4.4.8).

The propagation rate along the line is equal to the speed of light, independent of the type and dimensions of the line (see chapter 6.1.2). Line attenuation occurs with the finite conductivity of the metallic material, but this only becomes apparent in steel lines of more than 10 m (32 ft) in length²⁶.

On the basis of the field patterns for single-wire, two-wire and coaxial cables shown in Fig. 30, it will be recognized that the possibility of interference from adjacent metal objects is the greatest with the single-wire system and non-existent with the coaxial system.

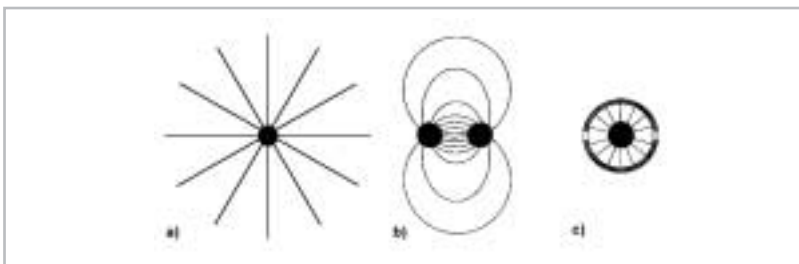

Fig. 30:
Pattern of electric field
lines in the plane
across the line:
a) single-wire,
b) two-wire,
c) coaxial cable.

²⁶ As the skin effect is heavily dependent on the magnetic property μ_r , a completely non-magnetic (austenitic) steel is to be favoured. If in doubt, copper or aluminium should be used, both of which, moreover, have a conductivity that is approximately 40 and 25 times, resp., higher than steel.

7. Reflection

7.1 Reflection factor

Significant operating parameters of a radar level measuring device are dependent upon the reflected useful signal of the microwaves, e.g. measurability, accuracy, repeatability, error probability and detectivity in the case of non-ideal surfaces or interference reflectors. The power reflection factor R is defined here as being the ratio of reflected power density to the power density of the incident beam $R = p_{\text{refl}} / p$.

Electromagnetic waves are reflected by electromagnetic interaction:

- a) from conductive surfaces (metals, and highly conductive liquids such as acids and saline solutions of sufficient concentration). In these cases, reflection is almost 100%: $R = 1$.
- b) from dielectric liquids (described by the relative permittivity ϵ_r , which describes the interaction with electric fields²⁷): the strength of reflection is a function of ϵ_r ²⁸:

$$R = \frac{(\sqrt{\epsilon_r} - 1)^2}{(\sqrt{\epsilon_r} + 1)^2}$$

At a relative permittivity $\epsilon_r = 3.5$ about 10% of the signal power (-10 dB), and at $\epsilon_r = 1.5$ only 1% of the signal power (-20 dB) is reflected, see Fig. 31.

Hence, the relative permittivity plays a central role in the evaluation of reflectivity and applicability of the microwave level measuring system.

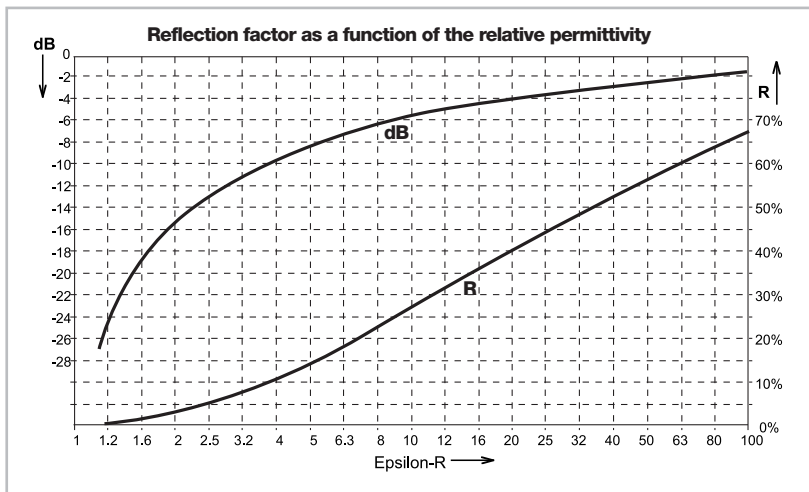

Fig. 31:
Reflection factors
of dielectric media

²⁷ There is an additional dependence on the relative permeability μ_r which describes the magnetic behaviour of the medium. For almost all materials, however μ_r is very close to unity, so that its influence is negligible.

²⁸ Generally speaking, the relative permittivity is a complex number $\epsilon_r = \epsilon_r' + j\epsilon_r''$, whose imaginary component ϵ_r'' quantifies the loss (damping) in the dielectric. In the frequency range > 1 GHz under consideration, the imaginary component is close to zero for most liquids. Exceptions are for instance water, alcohols, nitrobenzene; the absolute value of ϵ_r can by approximation then be taken for calculations.

7.2 Reflection at interfaces

When microwaves strike an interface between 2 media with relative permittivities of $\epsilon_{r,1}$ and $\epsilon_{r,2}$, the reflection factor is:

$$R' = \frac{(\sqrt{\epsilon_{r,2}} - \sqrt{\epsilon_{r,1}})^2}{(\sqrt{\epsilon_{r,2}} + \sqrt{\epsilon_{r,1}})^2}$$

If the power received from that point in relation to the transmitted power is to be calculated, it must be borne in mind that the waves still have to travel twice through the transition zone between the atmosphere and the upper layer with in each case a transmission factor of $(1-R)$. Therefore, the effective reflection factor R_2 at the interface is:

$$R_2 = \frac{(\sqrt{\epsilon_{r,2}} - \sqrt{\epsilon_{r,1}})^2}{(\sqrt{\epsilon_{r,2}} + \sqrt{\epsilon_{r,1}})^2} \cdot \left[1 - \frac{(\sqrt{\epsilon_{r,1}} - 1)^2}{(\sqrt{\epsilon_{r,1}} + 1)^2} \right]^2$$

provided that the waves are propagated loss-free through the upper layer.

The following diagram shows the reflection factor R_1 at the upper liquid layer as a function of $\epsilon_{r,1}$, and also the reflection factor R_2 at the interface for various parameters $\epsilon_{r,2}$. It will be seen that the interface reflection becomes stronger the greater is the difference in relative permittivity. Even where $\epsilon_{r,1} \gg \epsilon_{r,2}$ the interface can in theory be readily detected. In practice, however, problems often arise because some products with a high ϵ_r (e.g. water) absorb microwaves.

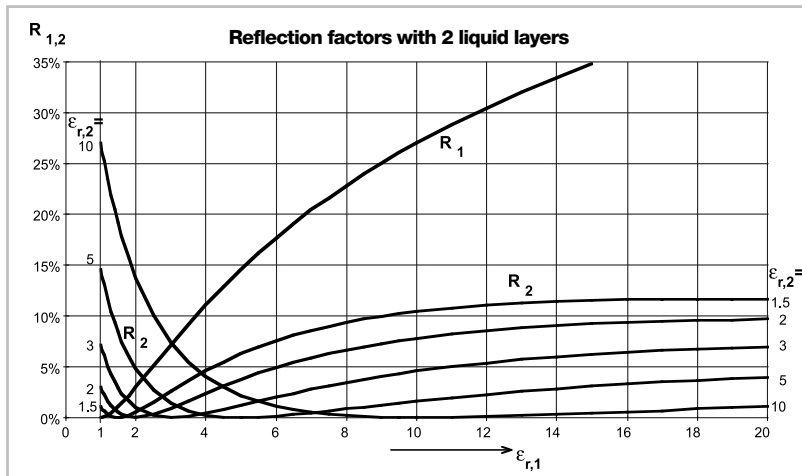

Fig. 32:
Reflection factors
at a liquid-liquid
interface

7.3 Dielectric permittivity

The (relative) dielectric permittivity²⁹ is a dimensionless quantity describing the physical behaviour of a material in an electric field. For vacuum conditions, $\epsilon_r = 1$, for gases only negligibly greater than 1, for liquids usually much higher (normally ≥ 2), for water very high, with $\epsilon_r = 80$.

The following describes the dependence of the permittivity on various influencing factors.

7.3.1 Chemico-physical assessment

The value of the dielectric permittivity is dependent on the electric dipole moment of the compound, which in turn depends on the molecular geometry and on the electron distribution.

- Noble gases (e.g. helium) which are monatomic, have an ϵ_r that is only slightly greater than unity.
- With diatomic elemental gases (e.g. oxygen, nitrogen, fluorine), the rotational symmetry is only slightly disturbed, ϵ_r being about 1.5.
- Inorganic compounds that feature atoms with different electron affinities (e.g. hydrogen and oxygen) and also an asymmetrical structure (e.g. water and ammonia) have a high ϵ_r . This also applies to the sulphur/oxygen compounds (sulphuric acid, sulphuric dioxide).
- Because of their slight asymmetries, the basic hydrocarbons (alkanes, alkenes) or mixes thereof (gasoline, oils) have an $\epsilon_r = 2$.
- On the other hand, alcohols, aldehydes and ketones, due to affine OH and O groups, have high ϵ_r values, but these probably decrease for long-chain compounds.
- Carbonic acids are strongly polarized only in short chains, and only then have a high ϵ_r .

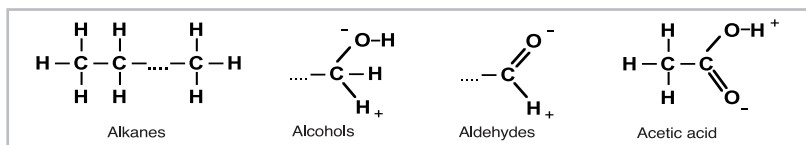

²⁹ The dimensionless quantity ϵ_r should be termed relative permittivity and not dielectric constant, even if this term is still often to be found in the literature for ϵ_r . The dielectric constant ϵ is the dimensional physical material constant with $\epsilon = \epsilon_r \cdot \epsilon_0$, the following applying to the free space: $\epsilon = \epsilon_0 = 8.85 \cdot 10^{-12} \text{ As/Vm}$.

- Cyclic compounds because of their high symmetry of faces have lower ϵ_r values.
- The dielectric characteristic of nitrogen or halogen derivatives varies considerably, and depends essentially on the symmetry in the molecule. Dichlorobenzene is a case in point, with the 3 positional isomers having ϵ_r values of between 2.5 and 10.

A table with ϵ_r values of different products can be found in Annex A.

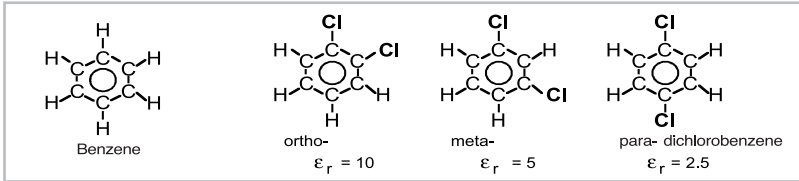

7.3.2 Frequency dependence

The permittivity ϵ_r decreases in step with increasing frequency f . Due to dielectric relaxation (i.e. the electrically polarized molecules cannot align themselves fast enough in the high-frequency field), there is a transitional frequency range³⁰ in which ϵ_r drops. For most liquids, these frequencies lie between a few 100 kHz and a few 100 GHz. Above this range, ϵ_r remains constant³¹. With a few media, this range is however located just inside the 5-100 GHz microwave range. A good example is water, which has at different temperatures the complex dielectric constant $\epsilon_r' + j\epsilon_r''$, shown in Fig. 33³².

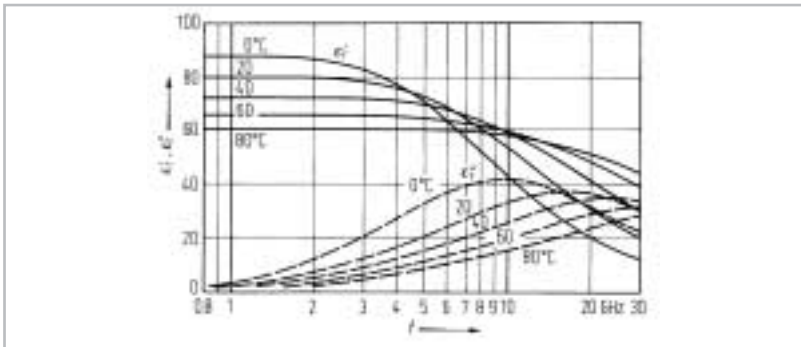

Fig. 33:
Dielectric constant of water as a function of frequency [Meinke]

³⁰ In this transitional range the imaginary component of ϵ_r is relatively high, i.e. wave attenuation would also occur in the medium. For surface reflection, however, this has no negative influence.

³¹ A further drop in the ϵ_r due to ion or electron resonance occurs only far above the microwave range, e.g. in the infrared or visible light range.

³² The imaginary part $j\epsilon_r''$ describes the dielectric losses in the dielectric.

Other media, which already have a low ϵ_r at low frequencies, maintain this value up to microwave frequencies and beyond.

Basically, with reference to their permittivity and frequency dependence, media can be divided roughly into four categories:

- A)** Media with high $\epsilon_r > 20$ (tabular data for low f), changing in the microwave range to $\epsilon_r > 9$ at 10 GHz.
- B)** Media with high $\epsilon_r > 20$ (tabular data for low f), changing below the micro-wave range so that ϵ_r (approx. 3-6) is constant at $f > 5$ GHz.
- C)** Media with relatively low $\epsilon_r = 3-6$, dropping only slightly in the microwave range.
- D)** Media with low $\epsilon_r < 3$, constant up to and into the microwave range.

7.3.3 Temperature and viscosity dependence

A definitive temperature dependence cannot be specified as behaviour differs from substance to substance. Examples:

Water:	ϵ_r drops at temperatures below 25°C
Organic liquids:	Mostly negative temperature coefficient, i.e. ϵ_r drops at higher temperatures (typical values are around approx. $-0.1\%/K$)

On transition from the liquid to the solid state of aggregation the ϵ_r generally drops abruptly (ice for example has an ϵ_r of only 3.2), and the transition frequency is usually lower.

Also, there are initial indications that the transition frequency is dependent upon the viscosity of the medium: the higher the viscosity, the lower the transition frequency.

7.3.4 Liquid mixes

Given a mixture of two or more liquids, it must be assumed that the ϵ_r is at least equal to the lowest ϵ_r of the constituents.

An approximation equation for a mix of two liquids with a_1 and a_2 parts by volume reads:

$$\ln(\epsilon_m) = a_1 \cdot \ln(\epsilon_1) + a_2 \cdot \ln(\epsilon_2)$$

Organic liquids with a low ϵ_r and an added low water content have practically the same ϵ_r as the pure organic substance.

On the other hand, aqueous solutions of acids, bases and salts, despite containing a large proportion of water, have an ϵ_r that is quite distinct from that of water ($\epsilon_r =$ approx. 20 ... 30 for solutions of ammonia, NaOH, NaCl, sulphuric acid or acetic acid).

7.3.5 Bulk (particulate) materials

The effective relative permittivity of particulate materials (with air in the interstices) can be much lower than that of the homogeneous solid body. For instance, a material with $\epsilon_r = 2$ and 50% air content has an effective $\epsilon_{r\text{eff}}$ of 1.5. The rule of thumb:

$$\epsilon_{r\text{eff}} = 1 + (\epsilon_r - 1) \cdot (1 - 0.01 \cdot L[\%]); \quad L = \text{volumetric air content in \%}.$$

Also to be borne in mind is the fact that with bulk materials having a particle size range in the order of the wavelength, the microwaves will disperse (see next chapter) and so greatly decrease reflectivity.

7.4 Scattering from particulate materials

Depending on the relationship between particle size (diameter D) and wavelength λ , the waves are reflected or scattered when meeting the surface of particulate materials³⁴:

- $D \gg \lambda$: The surfaces of the particles act like miniature reflectors that reflect the waves according to the cross-section of their reflected beam.
- $D \approx \lambda$: If the wavelength is in the same order of magnitude as the particle size of the bulk material (approx. $\lambda/4$ to 3λ) heavy scattering must be expected. Practically no reflection can be measured.
- $D \ll \lambda$: The very fine-sized surface acts in the same way as a liquid; by approximation the following applies to the diffuse reflection [Ries] (see Fig. 34):

$$R_s = e^{-16\pi^2 \cdot \frac{D^2}{\lambda^2}}$$

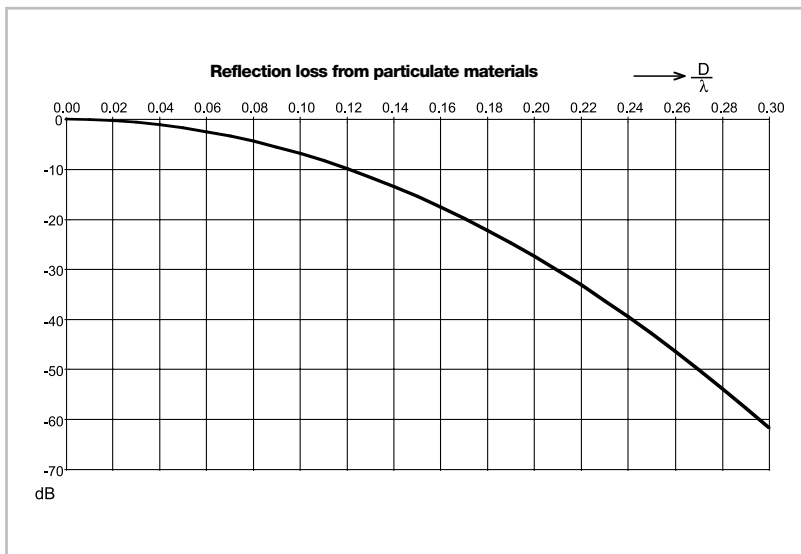

Fig. 34:
Loss of reflection from
particulate materials

³⁴ Also to be considered is the reflection factor due to the ϵ_r of the particulate material (incl. air).

7.5 Reflected radar cross-section from limited targets

If reflection does not take place over the entire beam cross-section, the radar cross-section σ must be considered as the effective reflection area. For some geometric bodies, that are large as compared with the wavelength λ , it can be calculated as [Baur],[Philippow.4]:

Large flat plate (any shape)	$\sigma = 4\pi \cdot A^2 / \lambda^2$	$A = \text{area}$
Triple reflector	$\sigma = 4\pi \cdot b^4 / 3\lambda^2$	$b = \text{side of triangle}$
Sphere	$\sigma = \pi \cdot r^2$	$r = \text{radius}$
Cylinder, exposed to radiant radiation (e.g. pipe)	$\sigma = 2\pi \cdot l^2 \cdot r / \lambda$	$r = \text{radius}; l = \text{length}$

The radar cross-section can be substantially larger than the actual reflection area, since the relevant radar equation (see Section 6.5) uses a sphere as reference for the secondary radiator.

7.6 Angle of reflection

The waves are reflected from a surface, whose dimensions are large in relation to the wavelength, at an angle opposed to the normal. This particularity can be significant if the antenna axis (assuming horizontal surface of the medium, e.g. a liquid) is not vertically aligned (Fig. 35 left), or the reflection area is oblique (Fig. 35 centre; in the case of particulate materials or due to a running agitator).

The optimum arrangement is orthogonal alignment of the antenna axis and reflection area. In general, as a rough estimate the maximum allowable angle of deviation between the direction of propagation (antenna axis) and the normal line of the surface is equal to half the lobe angle (Fig. 35 right).

Fig. 35:
Influence of the angle
of reflection in the
case of non-orthogonal
arrangements:
left:
inclined antenna
position;
centre:
inclined reflection area;
right:
still acceptable
angle of deviation

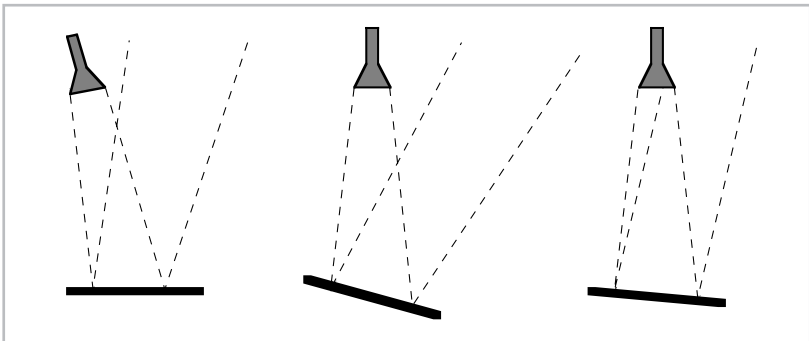

8. Evaluation methods

8.1 Object discrimination

If two or more objects reflect the radar signal, the system will also receive a corresponding number of pulses (Fig. 36, top). However, if the pulse length τ is too long, the two reflections will not be separable (Fig. 36, bottom).

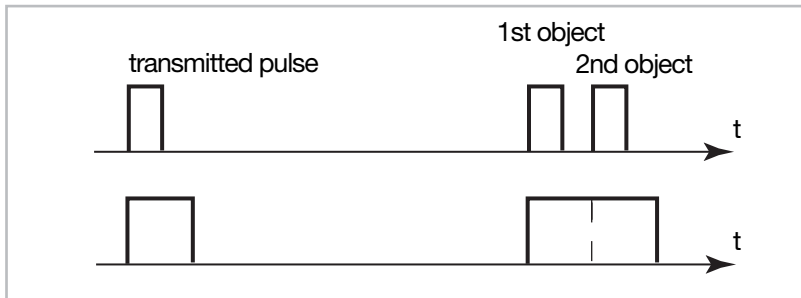

Fig. 36:
Reflected signal
at different pulse
lengths

Object discrimination, i.e. the minimum difference in distance allowing two objects to be distinguished, is given by:

$$\Delta a = c \cdot \tau / 2$$

By virtue of the analogy between pulse duration and bandwidth B (see Section 3.5.1) the following general “uncertainty relation” can be set up between B and the object discrimination Δa , which also applies to FMCW systems:

$$\Delta a = c / 2 \cdot B$$

8.2 Unambiguity

If another pulse is emitted before the reflected signal from the previous pulse has been received, the signals cannot be unambiguously assigned. Hence it is necessary to satisfy the following relation (f_i = pulse repetition rate):

$$f_i \leq c / 2 \cdot a_{\max}$$

For the relatively short distances involved in level measurements, however, this requirement is normally not important ($a_{\max} = 30 \text{ m} \rightarrow f_i \leq 5 \text{ MHz}$).

8.3 Measurement uncertainty

The measuring accuracy of a radar distance measurement is determined by the uncertainty of time measurement. For the pulse radar, the uncertainty of time Δt influences the result:

$$\Delta a = c \cdot \Delta t / 2$$

Neither is there any change when an extended time scale method is used (cf. section 8.6). In this case, Δt is the repeatability that is determined by the jitter³⁵ error of the sampling. In FMCW radar, the signal frequency can nearly always be accurately determined³⁶, but the relative measurement uncertainty is influenced by the linearity of the frequency sweep $\Delta F/F$. The error is [Stolle.2]:

$$\Delta a/a \leq 8 \cdot \Delta F/F$$

Independent of the radar method used, interference reflections influence the measuring accuracy because of interaction when they occur in the vicinity of the useful signal (see also section 8.8.1).

8.4 Interference

Various forms of interference can falsify the received radar signal in relation to the ideal reflection pattern. They need to be given consideration and if necessary included in the signal evaluation in order to avoid misinterpretation.

In regard to level measurement, significant interference factors are (see Fig. 37):

- Atmospheric effects:
Heavy damping or scattering from particles in the atmosphere (dust, vapour, foam, etc.)
→ If the surface of the medium is no longer detectable, no significant value can be determined for the level; an appropriate (error) message must be available.
- Interference reflections
Various internals (pipes, filling nozzles, agitator blades, other sensors, etc.) or medium-induced interference (e.g. condensation or deposits on the antenna) can also produce reflection signals. → If reproducible, they may be included in the signal evaluation (see Section 8.8.1 “empty-tank spectrum”). However, if the surface of the medium is at times obscured (e.g. level below agitator), measurements must be blanked out for such times.

³⁵ Irregular fluctuations of the sampling points of time.

³⁶ Even if digital evaluation by means of discrete frequency transformation (section 8.7.2) is applied, the signal frequency can be calculated exactly with interpolation techniques.

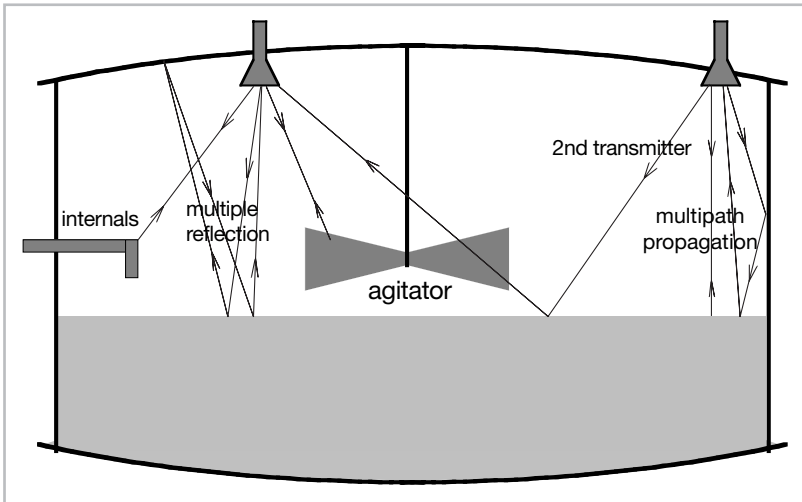

Fig. 37:
Possible sources of
interference in radar
level measurement

- **Multiple reflections:**
These occur, for example, when the signal is reflected from the surface of the medium, then strikes the tank cover or some other “good” reflector, and is again reflected from the medium before being received by the antenna → Since multiple reflections occur at periodic intervals, they can be detected and taken into account in the signal processing. A better solution is to change the mounting position so as to eliminate multiple reflections altogether.
- **Multipath propagation:**
If, for example, a signal is deflected from the tank wall, its propagation path is lengthened; the reflection signal is thus broadened in time and the measuring accuracy reduced → The antenna should be moved further away from the wall.
- **Other microwave transmitters:**
Several radar systems that are installed in one tank can mutually influence one other. With FMCW radar, however, this probability is normally very low because the systems would have to operate in synchronism down to fractions of μs in order to generate an additional differential frequency portion within the processing bandwidth of a few kHz. In pulse radar with a high pulse repetition rate, an interference can however easily occur when the signals from several transmitters are interpreted as being the total reflection pattern.

8.5 Sample calculation for received powers

An example is given below for calculating the received power of a radar system, and the signal-to-noise ratio and signal-to-interference ratio for an interference reflector.

Let a 10-GHz radar be used, so that the wavelength is $\lambda = 3$ cm (1.2"). Let the transmission power be $P_s = 1$ mW = 0 dBm.

Let a horn antenna with $D = 200$ mm (8") have an efficiency $\eta = 0.7$. Thus the antenna gain in accordance with Section 5.2 is:

$$G = \eta \cdot \left(\frac{\pi \cdot D}{\lambda} \right)^2 = 307 \hat{=} 25dB$$

Let the tank height be 20 m (60 ft). Atmospheric damping may be disregarded ($\alpha \approx 0$).

8.5.1 Useful signal

For 'worst case' estimation, let a tank contain a poorly reflecting medium (gasoline, $\epsilon_r = 2$) at a low level, i.e. $a = 20$ m (60 ft). Let the tank diameter be such that a large reflecting surface and case (a) from Section 6.5 can be assumed.

In accordance with the formula given in Section 7.1, the reflection factor of the medium is thus:

$$R = 0.03 = -15 \text{ dB.}$$

According to Section 6.5, the received power is given as:

$$P_{Ea} = P_s \cdot \frac{\eta^2 \cdot R \cdot \pi^2 \cdot D^4}{64 \cdot \lambda^2 \cdot a^2} = 1\text{mW} \cdot 10^{-5} = 10 \text{ nW} = -50 \text{ dBm}$$

8.5.2 Signal-to-noise ratio

The noise power of the receiver as given in Section 4.3.2:

$$P'_{\text{noise}} = FkTB.$$

The receiver bandwidth is used for the effective bandwidth B . In an FMCW system with 1 GHz sweep and 20 ms sweep time, signal frequency is $f = 6.7$ kHz. Therefore, $B = 10$ kHz and a noise figure $F = 10$ dB are assumed.

At $T = 300$ K, the receiver noise power thus amounts to:

$$P'_{\text{noise}} = 4 \cdot 10^{-16} \text{ W} = -124 \text{ dBm.}$$

The signal-to-noise ratio is: $\text{SNR} = 74$ dB. Normally noise is not a factor in radar level measuring equipment.

8.5.3 Signal-to-interference ratio of an interference reflector

By way of example it is assumed that a metal plate ($R = 1$) with an area $A = 10 \times 10$ cm² (4×4 in²) is located at distance $a = 10$ m (30 ft) below the antenna.

As given in Section 7.5, the radar cross-section of the reflector is:

$$\sigma = 4\pi \cdot A^2 / \lambda^2 = 1.4 \text{ m}^2$$

The received power is calculated according to Section 6.5, case (b):

$$P_{Eb} = P_s \cdot \frac{\eta^2 \cdot \sigma \cdot \pi \cdot D^4}{64 \cdot \lambda^2 \cdot a^4} = 1\text{mW} \cdot 6 \cdot 10^{-6} = 6 \text{ nW} = -52 \text{ dBm}$$

In this example, the signal-to-interference ratio amounts to only 2 dB.

8.6 Signal evaluation in the pulse-radar system

Both in pulse radar (see 3.5) and in the TDR method (see 3.3), which normally use pulse-shaped signals, the signal propagation time must be evaluated directly. This lies in the nanosecond range, and the necessary resolution in the picosecond range.

A so-called extended time scale method is used to be able to measure such short times.

Fig. 38 shows the elementary circuit arrangement consisting of two oscillators which oscillate with a slight frequency shift Δf , stabilized by a PLL. Accordingly, the signal received via a directional coupler is sampled at every following pulse with a time delay of:

$$\Delta t = \frac{1}{f_0 - \Delta f} - \frac{1}{f_0} \approx \frac{\Delta f}{f_0^2} \quad (\text{für } \Delta f \ll f_0)$$

The time scale factor is thus $f_0 / \Delta f$.

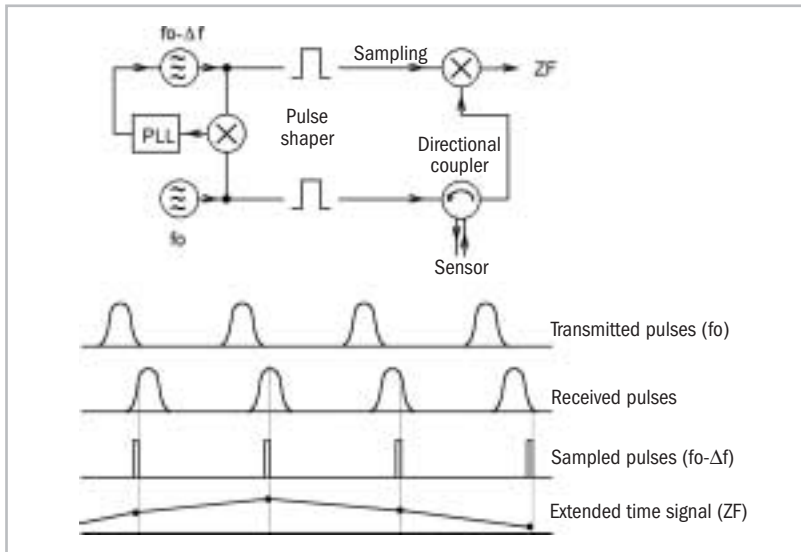

Fig. 38:
Block diagram of
an extended time
scale circuit and
signal diagram

The extended time signal can be evaluated by digitizing and subsequent valuation of the reflection characteristics (determination of maxima above an envelope).

8.7 Signal evaluation in FMCW radar

In FMCW radar, the information on the measured distance is contained in the frequency of the low-frequency signal obtained from the mixer. Accordingly, various methods can be applied to determine the frequency of analog signals, and these are outlined in the following subsections.

8.7.1 Counting method

The simplest evaluation method consists in measuring the time interval between two zero crossings of the oscillations (Fig. 39: e.g. $t_1-t_0, t_2-t_1\dots$). Results are more accurate when a greater number of cycles N are counted:

$$\Delta t = (t_n - t_0) / N.$$

The problem with this method lies in the fact that the signal-to-interference ratio must be reasonably good in order to avoid making errors when determining the zero crossings. Given large interference components, the method is no longer suitable.

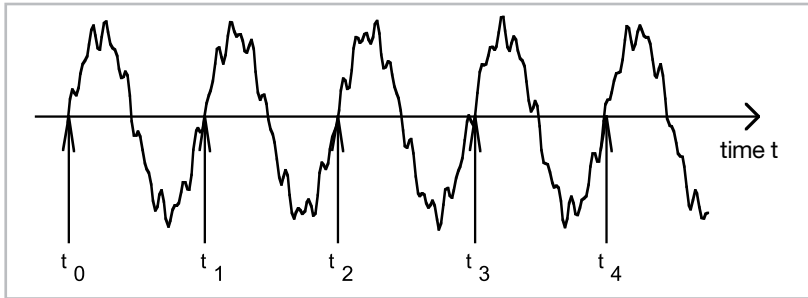

Fig. 39:
Counting method to
determine frequency

8.7.2 Fourier transform

The method commonly used for signal evaluation provides for a Fourier transform with the aid of digital signal processing. The signal is first digitized by being sampled at constant intervals. This is followed by discrete Fourier transformation (FFT³⁷) into the frequency range (Fig. 40). Generally several adjacent spectral lines occur³⁸.

The spectral lines formed by discrete Fourier transform of a signal (cf. Fig. 30) sampled at intervals T/N have a frequency spacing of:

$$\Delta f = 1/T.$$

In accordance with the relation for the mixed frequency:

$$f = \frac{F}{T} \cdot t = \frac{F}{T} \cdot \frac{2 \cdot a}{c} \Leftrightarrow a = \frac{f \cdot c}{2 \cdot F / T}$$

we obtain for the local spacing of two adjacent spectral lines:

$$\Delta a = \frac{\Delta f \cdot c}{2 \cdot F / T} = \frac{c}{2 \cdot F}$$

³⁷ Fast Fourier Transform

³⁸ Due to the finite scanning period and convolution with the time window, a sinc (= $\sin(x)/x$) function is obtained as the envelope of the spectral lines. And in general, the signal frequency is located between the discrete lines.

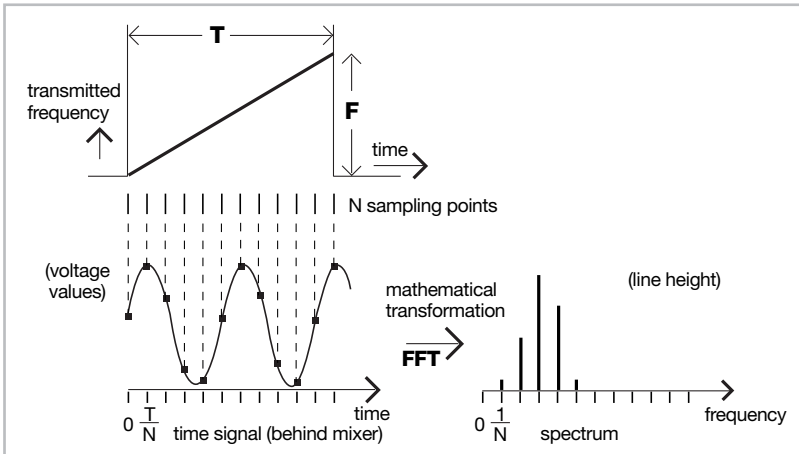

Fig. 40:
Digital signal-
processing in
FMCW radar

Example: at a frequency sweep $F = 1$ GHz, a line spacing in the FFT spectrum can be calculated of 15 cm (6") measuring distance.

Using a method to locate the "weighted average" in the spectrum by interpolating between the discrete lines, however, the measurement resolution can be significantly increased provided only one reflector is located within a distance of less than Δa .

It is important to know that line spacing Δa is **only** dependent on sweep F . It is not possible to improve object discrimination by changing the sampling frequency or the number of sampling points³⁹.

The above relationship is identical with the relation for the pulse radar system (see Section 8.1), if bandwidth B and sweep F are equated. The uncertainty relation formulated in 8.1 is universally valid.

A great advantage of FFT evaluation is that useful signals and interference signals, provided their frequencies are far enough apart, are distinctly separated – even when the interference amplitude is greater than the amplitude of the useful signal. However, through superposition of close-by interference frequencies, it is possible for measurement deviations to occur which become apparent by a locally periodic error function⁴⁰.

8.7.3 Phasegradient method

As described in Annex B, the individual sampling points in the FMCW method contain phase information on the reflection signal at different frequencies. The phase gradient function can be calculated with the aid of the so-called Hilbert transform from the time signal, and from that the distance value. The calculation is more time consuming than a simple Fourier transform, but the result is more accurate when there is only small signal interference⁴¹. However, the phase gradient method is not suitable when interference signals are greater than the useful signal.

³⁹ Even though there are methods of reducing the line spacing in the spectrum by adding further synthetic sampling values, they have no effect on the object discrimination.

⁴⁰ Caused by superposition with the "sidebands" of the interference spectrum, which in accordance with a sinc function are located around the main frequency.

⁴¹ For example, by near interference reflections or frequency-dependent amplitude modulation of the RF

8.7.4 Tracking

The objective of this method is to determine the frequency of a digitized signal. It is carried out in four steps: first the frequency is estimated, for which e.g. the FFT analysis can be used; in the second step, a signal is synthesized from the frequency and, in the third step, compared with the measuring signal. This comparison supplies an error value, from which in the fourth step the deviation of the estimated from the real value is calculated. The corrected frequency can then be used as the starting value for the next measurement. If the frequency value has not changed by too much between two measurements, the change in frequency – and thus the change in level – can be very accurately tracked. Hence the term “tracking”.

Appropriately, tracking is also carried out by means of digital signal processing, but the computational effort is substantially higher than when using the FFT.

8.7.5 Signal filtering

Since in FMCW radar the information on the target distance is to be found in the frequency of the down-converted received signal (see Fig. 8), it is possible by appropriately filtering the frequency to considerably increase the effective dynamic performance of measurement and thus improve signal quality. Owing to the low signal frequencies involved, such electronic filters are easy to set up and reproduce. Fig. 41 shows, by way of example, the circuit arrangement of a second-order high-pass filter with an operational amplifier. A point worth noting for all practical filters is that the signals cannot be completely suppressed in the rejection band, but that a finitely steep filter slope is obtained, see Fig. 41.

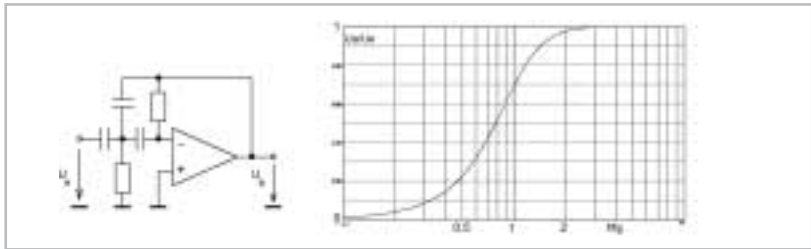

Fig. 41:
A high-pass filter
and its filtering
characteristics

In all, the following filters can be used:

Antialiasing filter

Due to time-discrete analog/digital conversion of the signal and because of Shannon's sampling theorem, the frequency spectrum f has to be limited to half the sampling frequency f_A : $f < f_A / 2$. If this is ignored, the higher signal frequencies will be reflected from half the sampling frequency and will produce spurious frequency contents after conversion and Fourier transform (Fig. 42): $f' = f_A - f$

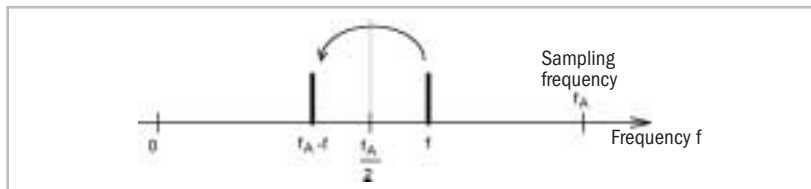

Fig. 42:
Visualization of
frequency reflection
when Shannon's
condition is ignored

The antialiasing filter must be a very steep-sloped low-pass filter (at least 4th order) and is usually dimensioned for a cut-off frequency of $0.8 \dots 0.95 \cdot f_A / 2$.

Spatial filter

As explained in chapter 6.4, signal amplitude diminishes with the square of the distance. Since in FMCW radar the frequency is proportional to the distance, and assuming the same reflection conditions on the surface of the liquid, the amplitude is inversely proportional to the frequency of the signal. This characteristic could simply be compensated by a double differentiator circuit which amplifies the higher frequencies accordingly. In practice, a second-order high-pass filter is used with an appropriately high cut-off frequency (Fig. 43).

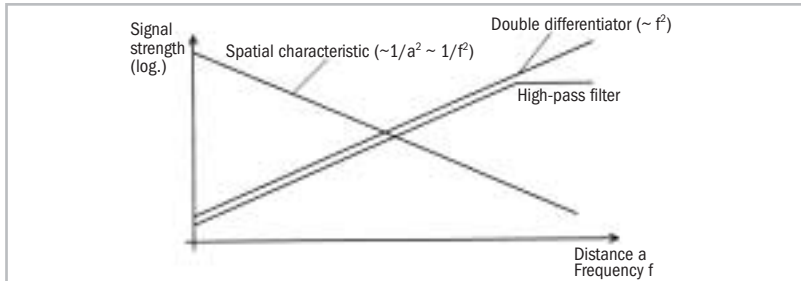

Fig. 43:
Characteristics
of the spatial filter

High-pass filter

In practice, a greater number of interference reflections occur in the case of short distances, and therefore low frequencies, which for instance stem from the mechanical tank separation system (see chapters 4.4.8 and 6.2) and the antenna.

Such interferences can largely be eliminated by high-pass filtering. Ideal is a circuit which allows changeover of the filter cut-off frequency (e.g. by means of selectable resistors in Fig. 43) or even continuous variation by switched-capacitor filters (SCF)⁴².

Low-pass filter

Similarly, undesirably strong signals will in some applications occur in the case of long distances, i.e. high frequencies, such as when multiple reflections occur (see 8.4). These interferences can be reduced by low-pass filters, which if necessary can also be of change-over design.

Adaptive filtering

The recommended variable high-pass and low-pass filters can be most effectively used when their cut-off frequencies are set as a function of the measuring distance. Thus, for example when the useful, or wanted, reflection is located farther away the high-pass frequency can be amplified in order to reject short-distance interference reflections even better. The filters are optimally adapted to the current measurement situation.

None of these filters can be used in the pulsed radar system. Where level measurement is carried out by means of pulse radar, not only is the RF signal performance restricted but the dynamic performance of the measuring system is also limited, so limiting the means of detecting very weak signals or very different amplitudes within a signal mix.

⁴² With the SCF, an equivalent resistance whose value is proportional to the clock frequency is synthesized by the periodic charging and discharging of a capacitor. Built into the negative-feedback branch of an operational amplifier, filters can thus be implemented with a controllable cut-off frequency. The variable clock frequency has to be substantially higher than the signal frequencies.

8.8 Special methods

8.8.1 Empty-tank spectrum

Reproducible interferences caused by reflection points in the transmitter (transmission lines, antenna) or in the tank (by fixed internals, tank fitting, tank bottom, etc.) can be suppressed if the reflection signal is measured and stored when the tank is empty. For current measurements, this “empty-tank spectrum” can then be subtracted from the established reflection spectrum; interferences are accordingly blanked out (Fig. 44).

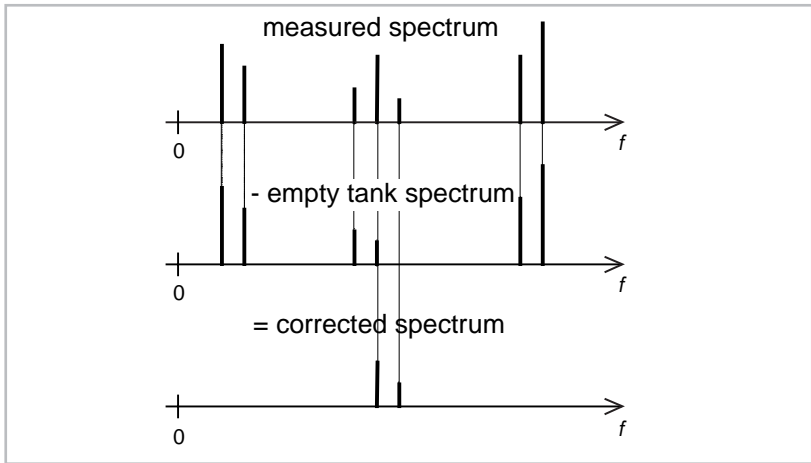
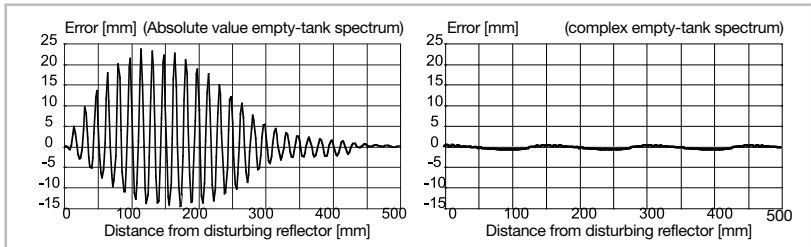

Fig. 44:
Subtraction of
empty-tank spectrum

In its simplest form, absolute values may be used for the empty-tank spectrum. Measuring errors occurring in the vicinity of interference reflectors, however, can be minimized by using the complex spectrum information (including phase) (Fig. 45).

Fig. 45:
Measuring errors
caused by an
interfering reflector:
evaluation with the
absolute-value empty-
tank spectrum (left)
and complex empty-
tank spectrum (right)



The term “empty-tank spectrum” originates from applying the described method to the signal spectrum of an FMCW system. The method can also be applied by analogy to pulse radar, in which case the “empty-tank time signal” needs to be subtracted.

8.8.2 Tank bottom tracing

In media with a low relative permittivity, only a small portion of the power is reflected from the surface, while the majority penetrates into the liquid or particulate material. Given low attenuation in the medium, the waves are propagated down to the tank bottom, where they are reflected and pass through the medium and the atmosphere before reaching the receiving antenna. The medium is “transparent”, so the tank bottom is practically “visible”. However, since the propagation rate in the medium is slower than in the atmosphere, the tank bottom appears to be shifted downwards.

Tank bottom tracing is a special evaluation method to allow measurements to be carried out in such application conditions. Here the reflection from the tank bottom, shifted in the spectrum (FMCW) or in the time signal (pulse), is evaluated and the true level established by way of the known reduced propagation rate of the microwaves in the medium:

- Whereas waves in the tank atmosphere of height a are propagated at the speed of light c , waves in the medium (rel. permittivity = ϵ_r , height L) are propagated at a slower velocity v .
- Hence, the reflection r_2 from the tank bottom appears on the time axis or in the spectrum to be shifted downwards, and the apparent tank height h_v greater than the true height h .

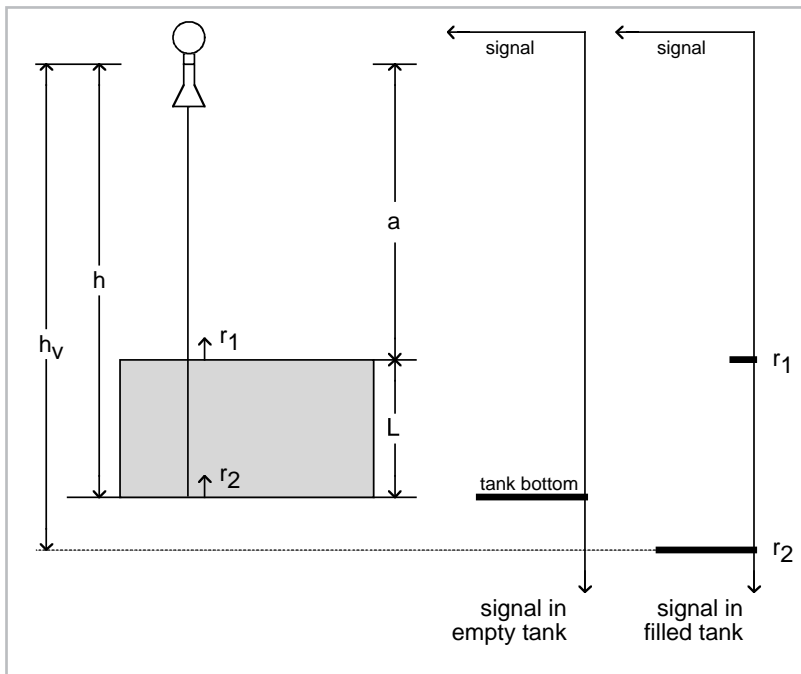

Fig. 46:
Mechanism of tank
bottom reflection and
tracing

- The transit time in the medium is $t_1 = L/v$, whereas for the same distance in an empty tank it would be $t_0 = L/c$. The ratio of apparent "layer thickness" ($h_v - a$) to true filling height ($h - a$) therefore corresponds to the ratio of the wave propagation rates:

$$\frac{h_v - a}{h - a} = \frac{c}{v} = \sqrt{\epsilon_r}$$

- Where ϵ_r , h and h_v are known, d and from that filling height L can accordingly be determined exactly:

$$L = h - a = \frac{h_v - h}{\sqrt{\epsilon_r - 1}}$$

The method can even be applied when signal from the surface of the medium is no longer measurable.

8.8.3 Interface detection

The requirements for interface detection are described here by way of example in connection with a TDR system (time domain reflectometry, see section 3.3). In principle, these measurement problems can be solved using a non-contacting radar system, but the advantage of guided waves is that signal weakening is not so great and interference from the tank geometry is largely avoided.

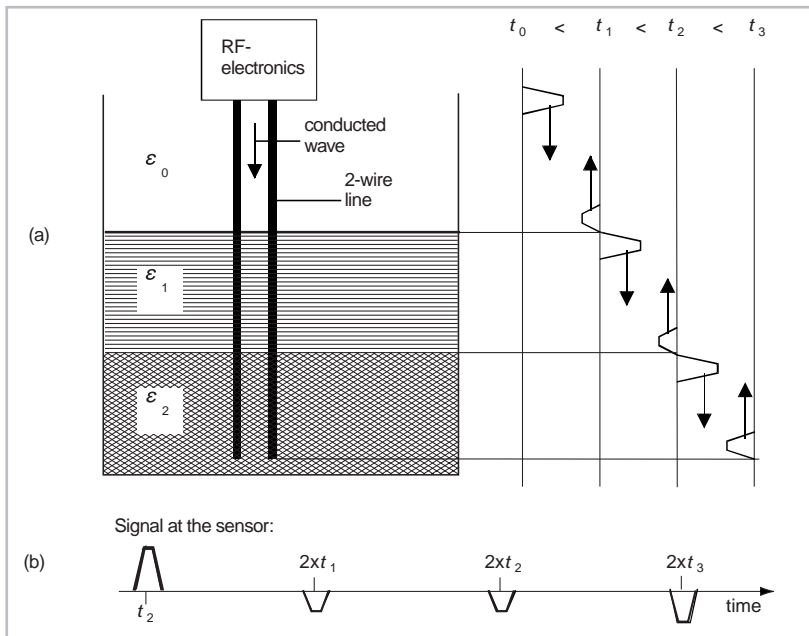

Fig. 47:
Principle of operation
of a wire-conducting
TDR level gauge

Fig. 47 shows that an electrical pulse is generated (time t_0) and guided via a 2-wire line as an electromagnetic wave. At each position at which the surrounding relative permittivity ϵ changes, part of the wave is reflected back to the sensor (time t_1). The wave is propagated along the entire line and is reflected a second time (t_2) at the interface between the two liquids and a third time (t_3) at the end of the line. The signal delay times ($2t_1$, $2t_2$ and $2t_3$) indicate the positions of the interfaces and the end of the line, which can serve as reference point. The polarity of the signal is reversed at each reflection from lower to higher relative permittivity. The reflected power in each case depends on the difference of the relative permittivities (see section 7.2).

For a reliable measuring system, the following situations need to be considered for signal processing:

- Changing ϵ_r values due to changes in temperature or composition of product.
- Pronounced attenuation or absorption of the microwaves in the liquid (e.g. water).
- No abrupt transition from one product to another (e.g. layer of emulsion).
- Inadequate object discrimination (see Section 8.1) when thickness of the interface is too small.
- Risk of product deposits on the lines, causing additional reflections.

Annex

A Table of dielectric permittivity

The following overview is based on data from the literature, tabular data [Weast], [Hippel], [VDI.1], application experience and laboratory measurements.

(ϵ_r values are rounded guide values for the media examples)

Group of liquids	low f^{43} ϵ_r	high f^{44} ϵ_r	Examples
INORGANIC	115	?	hydrogen cyanide HCN
	80	60 (tr)	water H ₂ O
	52	?	hydrazine N ₂ H ₄
	22	?	sulphuric acid H ₂ SO ₄
	17	?	ammonia NH ₃
	9	?	hydrogen sulphide H ₂ S
Tetrachlorides	2.4-2.9	c	Ge-, Pb-, Si-, Sn-, Ti-Cl ₄
Sulphur (liquid)	3.5	?	

Inorganic liquid gases (pressurized or at low temp.)

- elemental	1.05	c	helium
	1.23	c	hydrogen
	1.5	c	argon, nitrogen, oxygen, air
	1.5-2.1	c	chlorine, fluorine
- compounds	1.6	c	carbon dioxide CO ₂
	14	?	sulphur dioxide SO ₂

ORGANIC COMPOUNDS

Alkanes

- liquid gases	3	c	methane, ethane, propane, butane
- liquids	2	c	pentane, octane, decane, gasoline
- long-chain (>C ₁₆)	2	c	paraffins, vaseline
- oils	2.1-2.8	c	mineral, synth., silicon oil, triptene

Alkenes

2 c ethylene, propylene, pentene etc.

Alcohols

	30	2-9 (tr)	methanol, ethanol
	14-20	?	propanol, pentanol
- longer-chain	13-19	?	butanol, benzyl alcohol
- polyhydric	40	5	glycol, glycerol

Aldehydes

13-22 ? form-, acet-, propion-aldehyde

Ketones

20 ? acetone = propanone, butanone

Acids & derivatives

	58	?	formic acid
	6	?	acetic acid
	3	c	butyric acid
- long-chain	2.5	c	fatty acids
- ester	3-16	?	(various)
- anhydrides	20	?	acetic anhydride

⁴³ quasistatic, generally up to a few kHz

⁴⁴ in the microwave range (at approx. 10 GHz)

? = value not known

c = ϵ_r constant into the microwave range

tr = at 10 GHz still in the transition range, i.e. decreasing further at higher frequencies

(continued)

<i>Group of liquids</i>	<i>low. f^{45}</i> ϵ_r	<i>high f^{46}</i> ϵ_r	<i>Examples</i>
Ether	3-8	?	diethyl ether, dioxan
Cyclic compounds	2.3	c	benzene C ₆ H ₆
	2	c	cyclohexane C ₆ H ₁₂ , -hexene C ₆ H ₁₀
	2.4	c	toluene, xylene etc.
	10	?	phenols
Halogen derivatives	3.5	c	trichloroethylene
	2.2	c	carbon tetrachloride, tetrachloroethylene
	2.5-10	?	dichlorobenzene (o-,m-,p-)
	5-6	?	chlorobenzene, -phenol, chloroform
	5.1	c	chlorinated diphenyl = clophen
- acid halides	33	?	chloroacetic acid
	16	?	acetyl chloride
Nitrogen derivatives	10	?	methylamine
	3.5-5.5	?	isopropyl-, diethyl-, trimethyl-, benzyl-, amylamine
	35	30 (tr)	nitrobenzene
	28	?	nitroethane
	5-7	?	aniline
- amides	60	?	acetamide
Plastics (solid form)	1.9-2.5	c	PE, PP, PS, PTFE
	3-3.3	c	PC, PA, ABS
	3.5-5	3	PVC, cellulose acetate, nylon
	5-9	4-5	phenolic aldehyde, melamineformaldehyde, cellulose nitrate, PVDF
Solids	3.8-6.7	c	glass
	4.5-8.4	c	Al ₂ O ₃ ceramics
Particulate materials	1.4	c	PVC powder
	2	c	alumina
	2.5-3.5	c	bauxite

A comprehensive table with many other products can, for example, be found on the Internet under:

<http://www.asiinstr.com/dc1.html>

⁴⁵ quasistatic, generally up to a few kHz

⁴⁶ in the microwave range (at approx. 10 GHz)

? = value not known

c = ϵ_r constant into the microwave range

tr = at 10 GHz still in the transition range, i.e. decreasing further at higher frequencies

B System-theoretical comparison between interferometer and FMCW method

With the **interferometer** method, phase evaluation is made between the transmitted and the received signal, delayed with $\tau = 2a/c$:

$$\frac{\Delta\varphi}{2\pi} = \frac{\varphi_E - \varphi_S}{2\pi} = f \cdot \tau = \frac{2f}{c} \cdot a = \frac{a}{\lambda/2}$$

φ	phase	(A1)
φ_E	phase of the received signal	
φ_S	phase of the transmitted signal	
f	frequency	
τ	delay time of the wave	
c	propagation rate of the microwaves = speed of light	
a	distance of the reflector	
λ	$= c/f =$ wavelength	

A **sine or cosine signal** s can be described in general by:

$$s = A \cdot \cos \varphi = A \cdot \cos(2\pi ft + \varphi_0)$$

A	amplitude	(A2)
φ	phase	
f	frequency	
t	time	
φ_0	start phase	

With a **linear frequency-modulated signal** the modulation constant m is included in the cosine function:

$$s = A \cdot \cos(2\pi \cdot (f_0 + m \cdot t) \cdot t + \varphi_0)$$

(A3)

The instantaneous frequency of signals with a time-dependent frequency is generally calculated by the differential of the phase:

$$f = \frac{1}{2\pi} \cdot \frac{d\varphi}{dt}$$

(A4)

For the signal in Eq. (A3) with linear frequency modulation, the instantaneous (time-dependent) frequency is:

$$f = f_0 + 2mt = f_0 + \frac{F}{T} \cdot t$$

F frequency sweep (A5)

T sweep time

Hence, Eq. (A3) can also be expressed as:

$$s = A \cdot \cos \left[2\pi f_0 \cdot t + 2\pi \cdot \frac{F}{2T} \cdot t^2 + \varphi_0 \right] \quad (\text{A6})$$

For **evaluating the phase** of two signals s_1 and s_2 ideally a multiplication of the signals is performed (e.g. by a mixer). Then the high frequency part ($f_1 + f_2$) is eliminated (e.g. by a low-pass filter):

$$\begin{aligned} x &= s_1 \cdot s_2 = A_1 \cdot A_2 \cdot \cos(2\pi f_1 t + \varphi_1) \cdot \cos(2\pi f_2 t + \varphi_2) \\ &= \frac{1}{2} \cdot A_1 \cdot A_2 \cdot [\cos(2\pi(f_1 - f_2)t + \varphi_1 - \varphi_2) + \cos(2\pi(f_1 + f_2)t + \varphi_1 + \varphi_2)] \end{aligned}$$

Behind the low-pass filter: $\Rightarrow \frac{1}{2} \cdot A_1 \cdot A_2 \cdot [\cos(2\pi(f_1 - f_2)t + \varphi_1 - \varphi_2)]$ (A7)

The phase is: $\varphi = 2\pi(f_1 - f_2)t + \varphi_1 - \varphi_2$ (A8)

For the further considerations the signal amplitudes A_1, A_2 and the start phases φ_1, φ_2 are disregarded because they are constants and do not influence the results of the phase evaluation.

Signal-theoretical description of the **FMCW method**:

The phase difference of both signals (transmitted and received) is actually determined by the process of mixing two high-frequency voltages and subsequent digital sampling of the mixer output signal. The FMCW system therefore acts in exactly the same way as an interferometer which determines the phase with the many different frequencies that are present at the respective sampling times.

Except for a negligible error term (see Eq. (A11)), it is immaterial in signal theoretical terms whether the frequency ramp rises continuously or in N equidistant steps [Stolle].

The phase of the transmitted signal (see Eq. (A6)):

$$\varphi_S = 2\pi f_0 \cdot t + 2\pi \cdot \frac{F}{2T} \cdot t^2 \quad (\text{A9})$$

The phase of the received signal is:

$$\varphi_E = 2\pi f_0 \cdot (t - \tau) + 2\pi \cdot \frac{F}{2T} \cdot (t - \tau)^2 \quad (\text{A10})$$

Therefore, the phase difference is:

$$\begin{aligned} \frac{\varphi_S - \varphi_E}{2\pi} &= f_0 \cdot t + \frac{F}{2T} \cdot t^2 - f_0 \cdot (t - \tau) - \frac{F}{2T} \cdot (t - \tau)^2 \\ &= f_0 \cdot \tau + \frac{Ft\tau}{T} - \frac{F}{2T} \cdot \tau^2 = f \cdot \tau - \frac{F}{2T} \cdot \tau^2 \end{aligned} \quad (\text{A11})$$

where f is the instantaneous (time-dependent) transmission frequency, see Eq. (A5).

Except for the error term $F\tau^2/2T$ the result is identical with the interferometer method, see Eq. (A1).

To assess this error, a calculation is made by way of a practical example for an FMCW radar method:

$F = 1 \text{ GHz}$; $T = 20 \text{ ms}$; $\tau = 130 \text{ ns}$ (equal to a measuring distance of approx. 20 m) to give:

$$\frac{\Delta\varphi}{2\pi} = \frac{F\tau^2}{2T} = 4 \cdot 10^{-4}$$

At a half-wavelength $\lambda/2 = 15 \text{ mm}$ ($f = 10 \text{ GHz}$), the measuring error then amounts to:

$\Delta a = 4 \cdot 10^{-4} \cdot 15 \text{ mm} = 6 \text{ }\mu\text{m}$, and is thus negligible.

C. Bibliography

- [Baur] Baur, Erwin. *Einführung in die Radartechnik*. Teubner, Stuttgart, 1985
- [BG] Berufsgenossenschaft der Feinmechanik und Elektrotechnik. *Merkblatt für die Unfallverhütung*, Fassung 8.82 "Sicherheitsregeln für Arbeitsplätze mit Gefährdung durch elektromagnetische Felder". Köln, 1982
- [Bonfig] Bonfig, Karl Walter, et al. *Technische Füllstandsmessung und Grenzstandskontrolle*. Expert-Verlag, Ehningen, 1990
- [Brumbi.1] Brumbi, Detlef. Measuring Process and Storage Tank Level with Radar Technology. *The Record of the IEEE 1995 International Radar Conference*, pp. 256-260.
- [Brumbi.2] Brumbi, Detlef: Low Power FMCW Radar System for Level Gaging. 2000 IEEE MTT-S Symposium Digest, Volume 3, pp. 1559-1562
- [DIN0848-2] Deutsche Norm. *DIN-VDE 0848 Teil 2: Sicherheit in elektromagnetischen Feldern – Schutz von Personen im Frequenzbereich von 30 kHz bis 300 GHz*, Entwurf Januar 1991. Beuth Verlag, Berlin, 1991
- [EN300440] Draft EN 300 440: Electromagnetic compatibility and radio spectrum matters (ERM); Short range devices; Technical characteristics and test methods for radio equipment to be used in the 1 GHz to 40 GHz frequency range. April 1999
- [Hippel] Von Hippel, Arthur (Editor). *Dielectric Materials and Applications*. Artech House, Boston, London, 1995
- [Meinke] Meinke; Gundlach; Lange, Klaus (Hrsg.); Löcherer, Karl-Heinz (Hrsg.). *Taschenbuch der Hochfrequenztechnik*. Springer-Verlag, Berlin, Heidelberg, 1992
- [Musch] Musch, Thomas; Schiek, Burkhard: Erzeugung einer hochlinearen analogen Frequenzrampe mit Hilfe von Phasenregelkreisen, *Kleinheubacher Berichte*, Band 40 (1997)
- [Pehl.1] Pehl, Erich. *Mikrowellentechnik*, Band 1: Wellenleitungen und Leitungsbausteine. Hüthig Verlag, Heidelberg, 1984
- [Pehl.2] Pehl, Erich. *Mikrowellentechnik*, Band 2: Antennen und aktive Bauteile. Hüthig Verlag, Heidelberg, 1984
- [Philippow.3] Philippow, Eugen (Hrsg.). *Taschenbuch Elektrotechnik, Band 3: Bauelemente und Bausteine der Informationstechnik*. Verlag Technik, Berlin, 1978
- [Philippow.4] Philippow, Eugen (Hrsg.). *Taschenbuch Elektrotechnik, Band 4: Systeme der Informationstechnik*. Verlag Technik, Berlin, 1979
- [Ries] Ries, G. *Radarverfahren zur Füllstandsmessung in Großraumbehältern (Studie)*. Fachbereich Hochfrequenztechnik, Universität Siegen, April 1986.
- [Salema] Salema, Carlos; Fernandes, Carlos; Jha, Rama Kant. *Solid Dielectric Horn Antennas*. Artech House, Norwood, 1998

- [Schiek] Schiek, Burkhard: Grundlagen der Hochfrequenz-Messtechnik. Springer-Verlag, Berlin, Heidelberg, New York, 1999.
- [Skolnik] Skolnik, Merrill I.: Radar Handbook. McGraw-Hill Professional Publishing, New York, 1989.
- [Stolle.1] Stolle, Reinhard; Heuermann, Holger; Schiek, Burkhard. Auswertemethoden zur Präzisionsentfernungsmessung mit FMCW-Systemen und deren Anwendung im Mikrowellenbereich. *Technisches Messen* 62 (1995) 2.
- [Stolle.2] Stolle, Reinhard; Schiek, Burkhard. A General Approach to the Estimation of Measurement Errors in Microwave Range Finding. *25th EuMC Conference Proceedings* (1995).
- [Tietze] Tietze, Ulrich; Schenk, Christoph: Halbleiter-Schaltungstechnik. Springer-Verlag, Berlin, Heidelberg, New York, 10. Auflage, 1993.
- [VDI3519] Verein Deutscher Ingenieure, Verband Deutscher Elektrotechniker (VDI/VDE). Füllstandmessung von Flüssigkeiten und Feststoffen, VDI/VDE 3519, Teil 1 und Teil 2. Beuth-Verlag, Berlin, 2002.
- [Voges.1] Voges, Edgar. *Hochfrequenztechnik, Band 1: Bauelemente und Schaltungen*. Hüthig Verlag, Heidelberg, 1991.
- [Voges.2] Voges, Edgar. *Hochfrequenztechnik, Band 2: Leistungsröhren, Antennen und Funkübertragung, Funk- und Radartechnik*. Hüthig Verlag, Heidelberg, 1991.
- [Weast] Weast, Robert C. (Editor). Handbook of Chemistry and Physics, 55th Edition. CRC Press, Cleveland, 1974.
- [Webster] Webster, John G. (Editor). *Measurement, Instrumentation and Sensors Handbook*, CRC Press, Cleveland, 1999.