

Java™



HOW TO PROGRAM

NINTH EDITION

PAUL DEITEL
HARVEY DEITEL

DEITEL® HOW TO PROGRAM SERIES Cover Theme

The cover theme for the DEITEL® HOW TO PROGRAM SERIES emphasizes social consciousness issues such as going green, clean energy, recycling, sustainability and more. Within the text, in addition to conventional programming exercises, we've included our Making a Difference exercise set to raise awareness of issues such as global warming, population growth, affordable healthcare, accessibility, privacy of electronic records and more. In this book, you'll use Java to program applications that relate to these issues. We hope that what you learn in *Java How to Program, 9/e* will help you to make a difference.



Night at the Niagara Falls—Ontario and New York

The Niagara Falls waterfalls straddle the border between Ontario, Canada and upstate New York in the United States. Horseshoe Falls is located on the Canadian side, and American Falls and Bridal Veil Falls are on the U.S. side.

The Niagara Falls are an awe-inspiring, world-class tourist attraction, and a significant source of hydroelectric power. On average, nearly four million cubic feet of water falls over the crest line each minute. The U.S. and Canada harness the natural energy from Niagara Falls to generate clean, inexpensive electricity. The first hydroelectric generating station on the Niagara River was built in 1881. Its electricity powered local mills and street lights. The Niagara Redevelopment Act, passed by the U.S. Congress in 1957, gave the New York Power Authority the right to develop the U.S. Niagara River hydroelectric power plants. The Niagara Falls hydroelectric project began operating in 1961. Up to 375,000 gallons of water per second is diverted from the river through conduits to the power plants. The water spins turbines that power generators that convert the mechanical energy into electrical energy. Today, the project generates 2.4 million kilowatts, which can power 24 million 100-watt light bulbs simultaneously. For further information visit:

en.wikipedia.org/wiki/Niagra_falls

www.nypa.gov/facilities/niagara.htm

www.niagarafrontier.com/power.html

About Deitel & Associates, Inc.

Deitel & Associates, Inc., is an internationally recognized authoring and corporate training organization. The company offers instructor-led courses delivered at client sites worldwide on programming languages and other software topics such as Java™, C#®, Visual Basic®, Visual C++®, C++, C, Objective-C®, XML®, Python®, JavaScript, object technology, Internet and web programming, and Android and iPhone app development. The company's clients include many of the world's largest companies, as well as government agencies, branches of the military and academic institutions. To learn more about Deitel Pearson Higher Education publications and Dive Into® Series corporate training, e-mail deitel@deitel.com or visit www.deitel.com/training/. Follow Deitel on Facebook® at www.deitel.com/deitelFan/ and on Twitter® @deitel.

JavaTM

HOW TO PROGRAM

NINTH EDITION

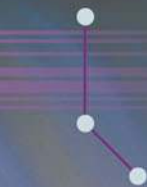

Deitel® Series Page

How To Program Series

Java™ How to Program, 9/E
Java™ How to Program, Late Objects Version, 8/E
C++ How to Program, 8/E
C How to Program, 6/E
Internet & World Wide Web How to Program, 4/E
Visual Basic® 2010 How to Program
Visual C#® 2010 How to Program, 3/E
Visual C++® 2008 How to Program, 2/E
Small Java™ How to Program, 6/E
Small C++ How to Program, 5/E

Simply Series

Simply C++: An App-Driven Tutorial Approach
Simply Java™ Programming: An App-Driven Tutorial Approach
Simply C#: An App-Driven Tutorial Approach
Simply Visual Basic® 2008, 3/E: An App-Driven Tutorial Approach

CourseSmart Web Books

www.deitel.com/books/CourseSmart/
C++ How to Program, 5/E, 6/E, 7/E & 8/E
Java™ How to Program, 6/E, 7/E, 8/E & 9/E
Simply C++: An App-Driven Tutorial Approach
(continued next column)

(continued)

Simply Visual Basic 2008: An App-Driven Tutorial Approach, 3/E
Visual Basic® 2010 How to Program
Visual Basic® 2008 How to Program
Visual C#® 2010 How to Program, 4/E
Visual C#® 2008 How to Program, 3/E

Deitel® Developer Series

AJAX, Rich Internet Applications and Web Development for Programmers
Android for Programmers: An App-Driven Approach
C++ for Programmers
C# 2010 for Programmers, 3/E
iPhone for Programmers: An App-Driven Approach
Java™ for Programmers
JavaScript for Programmers

LiveLessons Video Learning Products

www.deitel.com/books/LiveLessons/
Java™ Fundamentals
C# Fundamentals
C++ Fundamentals
iPhone® App Development Fundamentals
JavaScript Fundamentals
Visual Basic Fundamentals

To receive updates on Deitel publications, Resource Centers, training courses, partner offers and more, please register for the free *Deitel® Buzz Online* e-mail newsletter at:

www.deitel.com/newsletter/subscribe.html

follow us on Twitter®

@deitel

and become a Deitel & Associates fan on Facebook®

www.deitel.com/deitelfan/

To communicate with the authors, send e-mail to:

deitel@deitel.com

For information on government and corporate *Dive-Into® Series* on-site seminars offered by Deitel & Associates, Inc. worldwide, visit:

www.deitel.com/training/

or write to

deitel@deitel.com

For continuing updates on Prentice Hall/Deitel publications visit:

www.deitel.com
www.pearsonhighered.com/deitel/

Check out our Resource Centers for valuable web resources that will help you master Java, other important programming languages, software and, Internet- and web-related topics:

www.deitel.com/ResourceCenters.html

Java™

HOW TO PROGRAM

NINTH EDITION

Paul Deitel

Deitel & Associates, Inc.

Harvey Deitel

Deitel & Associates, Inc.



Prentice Hall

Boston Columbus Indianapolis New York San Francisco Upper Saddle River
Amsterdam Cape Town Dubai London Madrid Milan Munich Paris Montreal Toronto
Delhi Mexico City Sao Paulo Sydney Hong Kong Seoul Singapore Taipei Tokyo

Vice President and Editorial Director: *Marcia J. Horton*
Editor-in-Chief: *Michael Hirsch*
Associate Editor: *Carole Snyder*
Vice President, Marketing: *Patrice Jones*
Marketing Manager: *Yezan Alayan*
Senior Marketing Coordinator: *Kathryn Ferranti*
Vice President, Production: *Vince O'Brien*
Managing Editor: *Jeff Holcomb*
Associate Managing Editor: *Robert Engelhardt*
Operations Specialist: *Lisa McDowell*
Art Director: *Linda Knowle*
Cover Design: *Abbey S. Deitel, Harvey M. Deitel, Marta Samsel*
Cover Photo Credit: © *Gonzalo E. Brea/Flickr/Getty Images*
Media Editor: *Daniel Sandin*
Media Project Manager: *Wanda Rockwell*

Credits and acknowledgments borrowed from other sources and reproduced, with permission, in this textbook appear on page vi.

The authors and publisher of this book have used their best efforts in preparing this book. These efforts include the development, research, and testing of the theories and programs to determine their effectiveness. The authors and publisher make no warranty of any kind, expressed or implied, with regard to these programs or to the documentation contained in this book. The authors and publisher shall not be liable in any event for incidental or consequential damages in connection with, or arising out of, the furnishing, performance, or use of these programs.

Copyright © 2012, 2009, 2007, 2005, 2003 Pearson Education, Inc., publishing as Prentice Hall. All rights reserved. Manufactured in the United States of America. This publication is protected by Copyright, and permission should be obtained from the publisher prior to any prohibited reproduction, storage in a retrieval system, or transmission in any form or by any means, electronic, mechanical, photocopying, recording, or likewise. To obtain permission(s) to use material from this work, please submit a written request to Pearson Education, Inc., Permissions Department, 501 Boylston Street, Suite 900, Boston, Massachusetts 02116.

Many of the designations by manufacturers and sellers to distinguish their products are claimed as trademarks. Where those designations appear in this book, and the publisher was aware of a trademark claim, the designations have been printed in initial caps or all caps.

Library of Congress Cataloging-in-Publication Data

Deitel, Paul J.

Java : how to program / P.J. Deitel, H.M. Deitel. -- 9th ed.
p. cm.

H.M. Deitel's name appears on the earlier editions.

Includes index.

ISBN 978-0-13-257566-9

1. Java (Computer program language) I. Deitel, Paul J. II. Deitel, Harvey M. III. Title.

QA76.73.J38D45 2012

005.13'3--dc22

2011000244

10 9 8 7 6 5 4 3 2 1

ISBN-10: 0-13-257566-3

ISBN-13: 978-0-13-257566-9

Prentice Hall
is an imprint of



*In memory of Sargent Shriver,
The first director of the Peace Corps and
founder of numerous social organizations:*

For a lifetime of making a difference.

Paul and Harvey Deitel

Trademarks

DEITEL, the double-thumbs-up bug and DIVE INTO are registered trademarks of Deitel and Associates, Inc.

Oracle and Java are registered trademarks of Oracle and/or its affiliates. Other names may be trademarks of their respective owners.

Microsoft, Internet Explorer and the Windows logo are either registered trademarks or trademarks of Microsoft Corporation in the United States and/or other countries.

UNIX is a registered trademark of The Open Group.

Apache is a trademark of The Apache Software Foundation.

CSS, XHTML and XML are registered trademarks of the World Wide Web Consortium.

Firefox is a registered trademark of the Mozilla Foundation.

Google is a trademark of Google, Inc.

Web 2.0 is a service mark of CMP Media.

Throughout this book, trademarks are used. Rather than put a trademark symbol in every occurrence of a trademarked name, we state that we are using the names in an editorial fashion only and to the benefit of the trademark owner, with no intention of infringement of the trademark.



Contents

Appendices M–Q are PDF documents posted online at the book’s Companion Website (www.pearsonhighered.com/deitel/).

Preface **xxiii**

Before You Begin **xxxiii**

1 Introduction to Computers and Java **1**

1.1	Introduction	2
1.2	Computers: Hardware and Software	5
1.3	Data Hierarchy	6
1.4	Computer Organization	8
1.5	Machine Languages, Assembly Languages and High-Level Languages	10
1.6	Introduction to Object Technology	11
1.7	Operating Systems	13
1.8	Programming Languages	16
1.9	Java and a Typical Java Development Environment	18
1.10	Test-Driving a Java Application	22
1.11	Web 2.0: Going Social	26
1.12	Software Technologies	29
1.13	Keeping Up-to-Date with Information Technologies	31
1.14	Wrap-Up	32

2 Introduction to Java Applications **37**

2.1	Introduction	38
2.2	Your First Program in Java: Printing a Line of Text	38
2.3	Modifying Your First Java Program	44
2.4	Displaying Text with <code>printf</code>	46
2.5	Another Application: Adding Integers	47
2.6	Memory Concepts	52

2.7	Arithmetic	53
2.8	Decision Making: Equality and Relational Operators	56
2.9	Wrap-Up	60

3 Introduction to Classes, Objects, Methods and Strings 71

3.1	Introduction	72
3.2	Declaring a Class with a Method and Instantiating an Object of a Class	72
3.3	Declaring a Method with a Parameter	76
3.4	Instance Variables, <i>set</i> Methods and <i>get</i> Methods	79
3.5	Primitive Types vs. Reference Types	84
3.6	Initializing Objects with Constructors	85
3.7	Floating-Point Numbers and Type <code>double</code>	88
3.8	(Optional) GUI and Graphics Case Study: Using Dialog Boxes	92
3.9	Wrap-Up	95

4 Control Statements: Part I 102

4.1	Introduction	103
4.2	Algorithms	103
4.3	Pseudocode	104
4.4	Control Structures	104
4.5	<code>if</code> Single-Selection Statement	107
4.6	<code>if...else</code> Double-Selection Statement	107
4.7	<code>while</code> Repetition Statement	112
4.8	Formulating Algorithms: Counter-Controlled Repetition	113
4.9	Formulating Algorithms: Sentinel-Controlled Repetition	118
4.10	Formulating Algorithms: Nested Control Statements	125
4.11	Compound Assignment Operators	130
4.12	Increment and Decrement Operators	130
4.13	Primitive Types	134
4.14	(Optional) GUI and Graphics Case Study: Creating Simple Drawings	134
4.15	Wrap-Up	138

5 Control Statements: Part 2 151

5.1	Introduction	152
5.2	Essentials of Counter-Controlled Repetition	152
5.3	<code>for</code> Repetition Statement	154
5.4	Examples Using the <code>for</code> Statement	158
5.5	<code>do...while</code> Repetition Statement	162
5.6	<code>switch</code> Multiple-Selection Statement	164
5.7	<code>break</code> and <code>continue</code> Statements	172
5.8	Logical Operators	173
5.9	Structured Programming Summary	179

5.10	(Optional) GUI and Graphics Case Study: Drawing Rectangles and Ovals	184
5.11	Wrap-Up	187

6 Methods: A Deeper Look **197**

6.1	Introduction	198
6.2	Program Modules in Java	198
6.3	static Methods, static Fields and Class Math	200
6.4	Declaring Methods with Multiple Parameters	202
6.5	Notes on Declaring and Using Methods	205
6.6	Method-Call Stack and Activation Records	206
6.7	Argument Promotion and Casting	207
6.8	Java API Packages	208
6.9	Case Study: Random-Number Generation	210
6.9.1	Generalized Scaling and Shifting of Random Numbers	214
6.9.2	Random-Number Repeatability for Testing and Debugging	214
6.10	Case Study: A Game of Chance; Introducing Enumerations	215
6.11	Scope of Declarations	219
6.12	Method Overloading	222
6.13	(Optional) GUI and Graphics Case Study: Colors and Filled Shapes	224
6.14	Wrap-Up	227

7 Arrays and ArrayLists **240**

7.1	Introduction	241
7.2	Arrays	242
7.3	Declaring and Creating Arrays	243
7.4	Examples Using Arrays	244
7.5	Case Study: Card Shuffling and Dealing Simulation	254
7.6	Enhanced for Statement	258
7.7	Passing Arrays to Methods	259
7.8	Case Study: Class GradeBook Using an Array to Store Grades	262
7.9	Multidimensional Arrays	268
7.10	Case Study: Class GradeBook Using a Two-Dimensional Array	271
7.11	Variable-Length Argument Lists	278
7.12	Using Command-Line Arguments	279
7.13	Class Arrays	281
7.14	Introduction to Collections and Class ArrayList	284
7.15	(Optional) GUI and Graphics Case Study: Drawing Arcs	286
7.16	Wrap-Up	289

8 Classes and Objects: A Deeper Look **311**

8.1	Introduction	312
8.2	Time Class Case Study	312
8.3	Controlling Access to Members	316
8.4	Referring to the Current Object's Members with the this Reference	317
8.5	Time Class Case Study: Overloaded Constructors	320

8.6	Default and No-Argument Constructors	326
8.7	Notes on <i>Set</i> and <i>Get</i> Methods	326
8.8	Composition	328
8.9	Enumerations	331
8.10	Garbage Collection and Method <code>finalize</code>	333
8.11	<code>static</code> Class Members	334
8.12	<code>static</code> Import	338
8.13	<code>final</code> Instance Variables	339
8.14	Time Class Case Study: Creating Packages	340
8.15	Package Access	345
8.16	(Optional) GUI and Graphics Case Study: Using Objects with Graphics	347
8.17	Wrap-Up	351

9 Object-Oriented Programming: Inheritance 359

9.1	Introduction	360
9.2	Superclasses and Subclasses	361
9.3	<code>protected</code> Members	363
9.4	Relationship between Superclasses and Subclasses	364
9.4.1	Creating and Using a <code>CommissionEmployee</code> Class	364
9.4.2	Creating and Using a <code>BasePlusCommissionEmployee</code> Class	370
9.4.3	Creating a <code>CommissionEmployee–BasePlusCommissionEmployee</code> Inheritance Hierarchy	375
9.4.4	<code>CommissionEmployee–BasePlusCommissionEmployee</code> Inheritance Hierarchy Using <code>protected</code> Instance Variables	377
9.4.5	<code>CommissionEmployee–BasePlusCommissionEmployee</code> Inheritance Hierarchy Using <code>private</code> Instance Variables	380
9.5	Constructors in Subclasses	385
9.6	Software Engineering with Inheritance	386
9.7	Class Object	387
9.8	(Optional) GUI and Graphics Case Study: Displaying Text and Images Using Labels	388
9.9	Wrap-Up	391

10 Object-Oriented Programming: Polymorphism 394

10.1	Introduction	395
10.2	Polymorphism Examples	397
10.3	Demonstrating Polymorphic Behavior	398
10.4	Abstract Classes and Methods	400
10.5	Case Study: Payroll System Using Polymorphism	403
10.5.1	Abstract Superclass <code>Employee</code>	404
10.5.2	Concrete Subclass <code>SalariedEmployee</code>	407
10.5.3	Concrete Subclass <code>HourlyEmployee</code>	408
10.5.4	Concrete Subclass <code>CommissionEmployee</code>	410
10.5.5	Indirect Concrete Subclass <code>BasePlusCommissionEmployee</code>	412
10.5.6	Polymorphic Processing, Operator <code>instanceof</code> and Downcasting	413

10.5.7	Summary of the Allowed Assignments Between Superclass and Subclass Variables	418
10.6	final Methods and Classes	418
10.7	Case Study: Creating and Using Interfaces	419
10.7.1	Developing a Payable Hierarchy	421
10.7.2	Interface Payable	422
10.7.3	Class Invoice	422
10.7.4	Modifying Class Employee to Implement Interface Payable	425
10.7.5	Modifying Class SalariedEmployee for Use in the Payable Hierarchy	427
10.7.6	Using Interface Payable to Process Invoices and Employees Polymorphically	428
10.7.7	Common Interfaces of the Java API	430
10.8	(Optional) GUI and Graphics Case Study: Drawing with Polymorphism	431
10.9	Wrap-Up	433

11 Exception Handling: A Deeper Look **438**

11.1	Introduction	439
11.2	Example: Divide by Zero without Exception Handling	439
11.3	Example: Handling ArithmeticExceptions and InputMismatchExceptions	442
11.4	When to Use Exception Handling	447
11.5	Java Exception Hierarchy	447
11.6	finally Block	450
11.7	Stack Unwinding and Obtaining Information from an Exception Object	454
11.8	Chained Exceptions	457
11.9	Declaring New Exception Types	459
11.10	Preconditions and Postconditions	460
11.11	Assertions	461
11.12	(New in Java SE 7) Multi-catch: Handling Multiple Exceptions in One catch	462
11.13	(New in Java SE 7) try-with-Resources: Automatic Resource Deallocation	463
11.14	Wrap-Up	463

12 ATM Case Study, Part I: Object-Oriented Design with the UML **469**

12.1	Case Study Introduction	470
12.2	Examining the Requirements Document	470
12.3	Identifying the Classes in a Requirements Document	478
12.4	Identifying Class Attributes	484
12.5	Identifying Objects' States and Activities	489
12.6	Identifying Class Operations	493
12.7	Indicating Collaboration Among Objects	499
12.8	Wrap-Up	506

13	ATM Case Study Part 2: Implementing an Object-Oriented Design	510
13.1	Introduction	511
13.2	Starting to Program the Classes of the ATM System	511
13.3	Incorporating Inheritance and Polymorphism into the ATM System	516
13.4	ATM Case Study Implementation	522
13.4.1	Class ATM	523
13.4.2	Class Screen	528
13.4.3	Class Keypad	529
13.4.4	Class CashDispenser	530
13.4.5	Class DepositSlot	531
13.4.6	Class Account	532
13.4.7	Class BankDatabase	534
13.4.8	Class Transaction	537
13.4.9	Class BalanceInquiry	538
13.4.10	Class Withdrawal	539
13.4.11	Class Deposit	543
13.4.12	Class ATMCaseStudy	546
13.5	Wrap-Up	546
14	GUI Components: Part I	549
14.1	Introduction	550
14.2	Java's New Nimbus Look-and-Feel	551
14.3	Simple GUI-Based Input/Output with JOptionPane	552
14.4	Overview of Swing Components	555
14.5	Displaying Text and Images in a Window	557
14.6	Text Fields and an Introduction to Event Handling with Nested Classes	561
14.7	Common GUI Event Types and Listener Interfaces	567
14.8	How Event Handling Works	569
14.9	JButton	571
14.10	Buttons That Maintain State	574
14.10.1	JCheckBox	574
14.10.2	JRadioButton	577
14.11	JComboBox; Using an Anonymous Inner Class for Event Handling	580
14.12	JList	584
14.13	Multiple-Selection Lists	586
14.14	Mouse Event Handling	589
14.15	Adapter Classes	594
14.16	JPanel Subclass for Drawing with the Mouse	597
14.17	Key Event Handling	601
14.18	Introduction to Layout Managers	604
14.18.1	FlowLayout	605
14.18.2	BorderLayout	608
14.18.3	GridLayout	611
14.19	Using Panels to Manage More Complex Layouts	613

14.20	JTextArea	615
14.21	Wrap-Up	618

15 Graphics and Java 2D **631**

15.1	Introduction	632
15.2	Graphics Contexts and Graphics Objects	634
15.3	Color Control	635
15.4	Manipulating Fonts	642
15.5	Drawing Lines, Rectangles and Ovals	647
15.6	Drawing Arcs	651
15.7	Drawing Polygons and Polylines	654
15.8	Java 2D API	657
15.9	Wrap-Up	664

16 Strings, Characters and Regular Expressions **672**

16.1	Introduction	673
16.2	Fundamentals of Characters and Strings	673
16.3	Class <code>String</code>	674
16.3.1	String Constructors	674
16.3.2	String Methods <code>length</code> , <code>charAt</code> and <code>getChars</code>	675
16.3.3	Comparing Strings	676
16.3.4	Locating Characters and Substrings in Strings	681
16.3.5	Extracting Substrings from Strings	683
16.3.6	Concatenating Strings	684
16.3.7	Miscellaneous String Methods	684
16.3.8	String Method <code>valueOf</code>	686
16.4	Class <code>StringBuilder</code>	687
16.4.1	<code>StringBuilder</code> Constructors	688
16.4.2	<code>StringBuilder</code> Methods <code>length</code> , <code>capacity</code> , <code>setLength</code> and <code>ensureCapacity</code>	688
16.4.3	<code>StringBuilder</code> Methods <code>charAt</code> , <code>setCharAt</code> , <code>getChars</code> and <code>reverse</code>	690
16.4.4	<code>StringBuilder</code> append Methods	691
16.4.5	<code>StringBuilder</code> Insertion and Deletion Methods	693
16.5	Class <code>Character</code>	694
16.6	Tokenizing Strings	699
16.7	Regular Expressions, Class <code>Pattern</code> and Class <code>Matcher</code>	700
16.8	Wrap-Up	708

17 Files, Streams and Object Serialization **719**

17.1	Introduction	720
17.2	Files and Streams	720
17.3	Class <code>File</code>	722
17.4	Sequential-Access Text Files	726
17.4.1	Creating a Sequential-Access Text File	726

17.4.2	Reading Data from a Sequential-Access Text File	733
17.4.3	Case Study: A Credit-Inquiry Program	736
17.4.4	Updating Sequential-Access Files	741
17.5	Object Serialization	742
17.5.1	Creating a Sequential-Access File Using Object Serialization	743
17.5.2	Reading and Deserializing Data from a Sequential-Access File	749
17.6	Additional <code>java.io</code> Classes	751
17.6.1	Interfaces and Classes for Byte-Based Input and Output	751
17.6.2	Interfaces and Classes for Character-Based Input and Output	753
17.7	Opening Files with <code>JFileChooser</code>	754
17.8	Wrap-Up	757

18 Recursion **765**

18.1	Introduction	766
18.2	Recursion Concepts	767
18.3	Example Using Recursion: Factorials	768
18.4	Example Using Recursion: Fibonacci Series	771
18.5	Recursion and the Method-Call Stack	774
18.6	Recursion vs. Iteration	776
18.7	Towers of Hanoi	777
18.8	Fractals	779
18.9	Recursive Backtracking	790
18.10	Wrap-Up	790

19 Searching, Sorting and Big O **798**

19.1	Introduction	799
19.2	Searching Algorithms	800
19.2.1	Linear Search	800
19.2.2	Binary Search	804
19.3	Sorting Algorithms	809
19.3.1	Selection Sort	810
19.3.2	Insertion Sort	814
19.3.3	Merge Sort	817
19.4	Wrap-Up	824

20 Generic Collections **829**

20.1	Introduction	830
20.2	Collections Overview	830
20.3	Type-Wrapper Classes for Primitive Types	831
20.4	Autoboxing and Auto-Unboxing	832
20.5	Interface <code>Collection</code> and Class <code>Collections</code>	832
20.6	Lists	833
20.6.1	<code>ArrayList</code> and <code>Iterator</code>	834
20.6.2	<code>LinkedList</code>	836

20.7	Collections Methods	841
20.7.1	Method <code>sort</code>	842
20.7.2	Method <code>shuffle</code>	845
20.7.3	Methods <code>reverse</code> , <code>fill</code> , <code>copy</code> , <code>max</code> and <code>min</code>	847
20.7.4	Method <code>binarySearch</code>	849
20.7.5	Methods <code>addAll</code> , <code>frequency</code> and <code>disjoint</code>	851
20.8	Stack Class of Package <code>java.util</code>	853
20.9	Class <code>PriorityQueue</code> and Interface <code>Queue</code>	855
20.10	Sets	856
20.11	Maps	859
20.12	<code>Properties</code> Class	863
20.13	Synchronized Collections	866
20.14	Unmodifiable Collections	866
20.15	Abstract Implementations	867
20.16	Wrap-Up	867

21 Generic Classes and Methods **873**

21.1	Introduction	874
21.2	Motivation for Generic Methods	874
21.3	Generic Methods: Implementation and Compile-Time Translation	877
21.4	Additional Compile-Time Translation Issues: Methods That Use a Type Parameter as the Return Type	880
21.5	Overloading Generic Methods	883
21.6	Generic Classes	883
21.7	Raw Types	891
21.8	Wildcards in Methods That Accept Type Parameters	895
21.9	Generics and Inheritance: Notes	899
21.10	Wrap-Up	900

22 Custom Generic Data Structures **904**

22.1	Introduction	905
22.2	Self-Referential Classes	905
22.3	Dynamic Memory Allocation	906
22.4	Linked Lists	907
22.5	Stacks	917
22.6	Queues	921
22.7	Trees	924
22.8	Wrap-Up	930

23 Applets and Java Web Start **941**

23.1	Introduction	942
23.2	Sample Applets Provided with the JDK	943
23.3	Simple Java Applet: Drawing a String	947
23.3.1	Executing <code>WelcomeApplet</code> in the <code>appletviewer</code>	949
23.3.2	Executing an Applet in a Web Browser	951

26.11.1	Performing Computations in a Worker Thread	1096
26.11.2	Processing Intermediate Results with <code>SwingWorker</code>	1102
26.12	Interfaces <code>Callable</code> and <code>Future</code>	1109
26.13	Java SE 7: Fork/Join Framework	1109
26.14	Wrap-Up	1110

27 Networking **1118**

27.1	Introduction	1119
27.2	Manipulating URLs	1120
27.3	Reading a File on a Web Server	1125
27.4	Establishing a Simple Server Using Stream Sockets	1128
27.5	Establishing a Simple Client Using Stream Sockets	1130
27.6	Client/Server Interaction with Stream Socket Connections	1130
27.7	Datagrams: Connectionless Client/Server Interaction	1142
27.8	Client/Server Tic-Tac-Toe Using a Multithreaded Server	1150
27.9	[Web Bonus] Case Study: <code>DeitelMessenger</code>	1165
27.10	Wrap-Up	1165

28 Accessing Databases with JDBC **1171**

28.1	Introduction	1172
28.2	Relational Databases	1173
28.3	Relational Database Overview: The books Database	1174
28.4	SQL	1177
28.4.1	Basic <code>SELECT</code> Query	1178
28.4.2	<code>WHERE</code> Clause	1179
28.4.3	<code>ORDER BY</code> Clause	1181
28.4.4	Merging Data from Multiple Tables: <code>INNER JOIN</code>	1182
28.4.5	<code>INSERT</code> Statement	1184
28.4.6	<code>UPDATE</code> Statement	1185
28.4.7	<code>DELETE</code> Statement	1186
28.5	Instructions for Installing MySQL and MySQL Connector/J	1186
28.6	Instructions for Setting Up a MySQL User Account	1187
28.7	Creating Database books in MySQL	1188
28.8	Manipulating Databases with JDBC	1189
28.8.1	Connecting to and Querying a Database	1189
28.8.2	Querying the books Database	1194
28.9	<code>RowSet</code> Interface	1207
28.10	Java DB/Apache Derby	1209
28.11	<code>PreparedStatement</code> s	1211
28.12	Stored Procedures	1226
28.13	Transaction Processing	1227
28.14	Wrap-Up	1227
28.15	Web Resources	1228

29	JavaServer™ Faces Web Apps: Part 1	1235
29.1	Introduction	1236
29.2	HyperText Transfer Protocol (HTTP) Transactions	1237
29.3	Multitier Application Architecture	1240
29.4	Your First JSF Web App	1241
29.4.1	The Default <code>index.html</code> Document: Introducing Facelets	1242
29.4.2	Examining the <code>WebTimeBean</code> Class	1244
29.4.3	Building the <code>WebTime</code> JSF Web App in NetBeans	1246
29.5	Model-View-Controller Architecture of JSF Apps	1250
29.6	Common JSF Components	1250
29.7	Validation Using JSF Standard Validators	1254
29.8	Session Tracking	1261
29.8.1	Cookies	1262
29.8.2	Session Tracking with <code>@SessionScoped</code> Beans	1263
29.9	Wrap-Up	1269
30	JavaServer™ Faces Web Apps: Part 2	1276
30.1	Introduction	1277
30.2	Accessing Databases in Web Apps	1277
30.2.1	Setting Up the Database	1279
30.2.2	<code>@ManagedBean</code> Class <code>AddressBean</code>	1282
30.2.3	<code>index.html</code> Facelets Page	1286
30.2.4	<code>addentry.html</code> Facelets Page	1288
30.3	Ajax	1290
30.4	Adding Ajax Functionality to the Validation App	1292
30.5	Wrap-Up	1295
31	Web Services	1299
31.1	Introduction	1300
31.2	Web Service Basics	1302
31.3	Simple Object Access Protocol (SOAP)	1302
31.4	Representational State Transfer (REST)	1302
31.5	JavaScript Object Notation (JSON)	1303
31.6	Publishing and Consuming SOAP-Based Web Services	1303
31.6.1	Creating a Web Application Project and Adding a Web Service Class in NetBeans	1303
31.6.2	Defining the <code>WelcomeSOAP</code> Web Service in NetBeans	1304
31.6.3	Publishing the <code>WelcomeSOAP</code> Web Service from NetBeans	1307
31.6.4	Testing the <code>WelcomeSOAP</code> Web Service with GlassFish Application Server's Tester Web Page	1308
31.6.5	Describing a Web Service with the Web Service Description Language (WSDL)	1309
31.6.6	Creating a Client to Consume the <code>WelcomeSOAP</code> Web Service	1310
31.6.7	Consuming the <code>WelcomeSOAP</code> Web Service	1312

31.7	Publishing and Consuming REST-Based XML Web Services	1315
31.7.1	Creating a REST-Based XML Web Service	1315
31.7.2	Consuming a REST-Based XML Web Service	1318
31.8	Publishing and Consuming REST-Based JSON Web Services	1320
31.8.1	Creating a REST-Based JSON Web Service	1320
31.8.2	Consuming a REST-Based JSON Web Service	1322
31.9	Session Tracking in a SOAP Web Service	1324
31.9.1	Creating a Blackjack Web Service	1325
31.9.2	Consuming the Blackjack Web Service	1328
31.10	Consuming a Database-Driven SOAP Web Service	1339
31.10.1	Creating the Reservation Database	1340
31.10.2	Creating a Web Application to Interact with the Reservation Service	1343
31.11	Equation Generator: Returning User-Defined Types	1346
31.11.1	Creating the EquationGeneratorXML Web Service	1349
31.11.2	Consuming the EquationGeneratorXML Web Service	1350
31.11.3	Creating the EquationGeneratorJSON Web Service	1354
31.11.4	Consuming the EquationGeneratorJSON Web Service	1354
31.12	Wrap-Up	1357

A Operator Precedence Chart **1365**

B ASCII Character Set **1367**

C Keywords and Reserved Words **1368**

D Primitive Types **1369**

E Using the Java API Documentation **1370**

E.1	Introduction	1370
E.2	Navigating the Java API	1370

F Using the Debugger **1378**

F.1	Introduction	1379
F.2	Breakpoints and the run, stop, cont and print Commands	1379
F.3	The print and set Commands	1383
F.4	Controlling Execution Using the step, step up and next Commands	1385
F.5	The watch Command	1388
F.6	The clear Command	1391
F.7	Wrap-Up	1393

G Formatted Output **1395**

G.1	Introduction	1396
-----	--------------	------

G.2	Streams	1396
G.3	Formatting Output with <code>printf</code>	1396
G.4	Printing Integers	1397
G.5	Printing Floating-Point Numbers	1398
G.6	Printing Strings and Characters	1400
G.7	Printing Dates and Times	1401
G.8	Other Conversion Characters	1403
G.9	Printing with Field Widths and Precisions	1405
G.10	Using Flags in the <code>printf</code> Format String	1407
G.11	Printing with Argument Indices	1411
G.12	Printing Literals and Escape Sequences	1411
G.13	Formatting Output with Class <code>Formatter</code>	1412
G.14	Wrap-Up	1413

H Number Systems **1418**

H.1	Introduction	1419
H.2	Abbreviating Binary Numbers as Octal and Hexadecimal Numbers	1422
H.3	Converting Octal and Hexadecimal Numbers to Binary Numbers	1423
H.4	Converting from Binary, Octal or Hexadecimal to Decimal	1423
H.5	Converting from Decimal to Binary, Octal or Hexadecimal	1424
H.6	Negative Binary Numbers: Two's Complement Notation	1426

I GroupLayout **1431**

I.1	Introduction	1431
I.2	GroupLayout Basics	1431
I.3	Building a <code>ColorChooser</code>	1432
I.4	GroupLayout Web Resources	1442

J Java Desktop Integration Components **1443**

J.1	Introduction	1443
J.2	Splash Screens	1443
J.3	Desktop Class	1445
J.4	Tray Icons	1447

K Mashups **1449**

K.1	Introduction	1449
K.2	Popular Mashups	1449
K.3	APIs Commonly Used in Mashups	1450
K.4	Deitel Mashups Resource Center	1450
K.5	Deitel RSS Resource Center	1451
K.6	Mashup Performance and Reliability Issues	1451

L Unicode® **1452**

L.1	Introduction	1452
-----	--------------	------

L.2	Unicode Transformation Formats	1453
L.3	Characters and Glyphs	1454
L.4	Advantages/Disadvantages of Unicode	1454
L.5	Using Unicode	1455
L.6	Character Ranges	1457

Appendices on the Web **1459**

Index **1461**

Appendices M–Q are PDF documents posted online at the book’s Companion Website (www.pearsonhighered.com/deitel/).

M Creating Documentation with javadoc **M-1**

M.1	Introduction	M-1
M.2	Documentation Comments	M-1
M.3	Documenting Java Source Code	M-1
M.4	javadoc	M-8
M.5	Files Produced by javadoc	M-9

N Bit Manipulation **N-1**

N.1	Introduction	N-1
N.2	Bit Manipulation and the Bitwise Operators	N-1
N.3	BitSet Class	N-11

O Labeled break and continue Statements **O-1**

O.1	Introduction	O-1
O.2	Labeled break Statement	O-1
O.3	Labeled continue Statement	O-2

P UML 2: Additional Diagram Types **P-1**

P.1	Introduction	P-1
P.2	Additional Diagram Types	P-1

Q Design Patterns **Q-1**

Q.1	Introduction	Q-1
Q.2	Creational, Structural and Behavioral Design Patterns	Q-2
Q.2.1	Creational Design Patterns	Q-3
Q.2.2	Structural Design Patterns	Q-5

Q.2.3	Behavioral Design Patterns	Q-6
Q.2.4	Conclusion	Q-7
Q.3	Design Patterns in Packages <code>java.awt</code> and <code>javax.swing</code>	Q-7
Q.3.1	Creational Design Patterns	Q-7
Q.3.2	Structural Design Patterns	Q-8
Q.3.3	Behavioral Design Patterns	Q-10
Q.3.4	Conclusion	Q-13
Q.4	Concurrency Design Patterns	Q-14
Q.5	Design Patterns Used in Packages <code>java.io</code> and <code>java.net</code>	Q-15
Q.5.1	Creational Design Patterns	Q-15
Q.5.2	Structural Design Patterns	Q-15
Q.5.3	Architectural Patterns	Q-16
Q.5.4	Conclusion	Q-19
Q.6	Design Patterns Used in Package <code>java.util</code>	Q-19
Q.6.1	Creational Design Patterns	Q-19
Q.6.2	Behavioral Design Patterns	Q-19
Q.7	Wrap-Up	Q-20



Preface

Live in fragments no longer, only connect.
—Edgar Morgan Foster

Welcome to Java and *Java How to Program, Ninth Edition*! This book presents leading-edge computing technologies for students, instructors and software developers.

The new Chapter 1 engages students with intriguing facts and figures to get them excited about studying computers and programming. The chapter includes a table of some of the research made possible by computers; current technology trends and hardware discussion; the data hierarchy; a table of mobile and Internet app platforms; a new section on social networking; an introduction to Android; a table of popular web services; a table of business and technology publications and websites that will help you stay up to date with the latest technology news and trends; and updated exercises.

The book is appropriate for introductory course sequences based on the ACM/IEEE curriculum recommendations and for AP Computer Science exam preparation.

We focus on software engineering best practices. At the heart of the book is the Deitel signature “live-code approach”—concepts are presented in the context of complete working programs, rather than in code snippets. Each complete code example is accompanied by live sample executions. All the source code is available at www.deitel.com/books/jhtp9/ and at the book’s Companion Website www.pearsonhighered.com/deitel/.

As you read the book, if you have questions, send an e-mail to deitel@deitel.com; we’ll respond promptly. For updates on this book, visit www.deitel.com/books/jhtp9/, follow us on Facebook (www.deitel.com/deitelfan) and Twitter (@deitel), and subscribe to the *Deitel*[®] *Buzz Online* newsletter (www.deitel.com/newsletter/subscribe.html).

New and Updated Features

Here are the updates we’ve made for *Java How to Program, 9/e*:

Java Standard Edition (SE) 7

- *Easy to use as a Java SE 6 or Java SE 7 book.* There are a few Java Standard Edition (SE) 7 features that affect CS 1 and CS 2 courses. We cover those features in optional modular sections that are easy to include or omit. Here’s some of the new functionality: Strings in switch statements, the try-with-resources statement for managing AutoCloseable objects, multi-catch for defining a single exception handler to replace multiple exception handlers that perform the same task, the NIO filesystem APIs and inferring the types of generic objects from the variable they’re assigned to by using the <> notation. We also overview the new concurrency API features.

- *Java SE 7 filesystem APIs.* We provide an *alternate* online version of Chapter 17, Files, Streams and Object Serialization, that’s reimplemented with the new filesystem APIs from Java SE 7.
- *Java SE 7’s AutoClosable versions of Connection, Statement and ResultSet.* With the source code for Chapter 28, Accessing Databases with JDBC, we provide a version of the chapter’s first example that’s implemented using Java SE 7’s AutoClosable versions of Connection, Statement and ResultSet. AutoClosable objects reduce the likelihood of resource leaks when you use them with Java SE 7’s try-with-resources statement, which automatically closes the AutoClosable objects allocated in the parentheses following the try keyword.

Pedagogic Features

- *Enhanced Making a Difference exercises set.* We encourage you to use computers and the Internet to research and solve significant social problems. These exercises are meant to increase awareness and discussion of important issues the world is facing. We hope you’ll approach them with your own values, politics and beliefs. Check out our new Making a Difference Resource Center at www.deitel.com/MakingADifference for additional ideas you may want to investigate further.
- *Page numbers for key terms in chapter summaries.* For key terms that appear in the chapter summaries, we include the page number of the key term’s defining occurrence.
- *VideoNotes.* The Companion Website includes extensive VideoNotes in which co-author Paul Deitel explains in detail most of the programs in the core chapters. Instructors have told us that their students find the VideoNotes valuable.

Object Technology

- *Object-oriented programming and design.* We introduce the basic concepts and terminology of object technology in Chapter 1. Students develop their first customized classes and objects in Chapter 3. Presenting objects and classes early gets students “thinking about objects” immediately and mastering these concepts more thoroughly. [For courses that require a late-objects approach, consider *Java How to Program, Late Objects Version, 8/e*, which begins with six chapters on programming fundamentals (including two on control statements) and continues with seven chapters that gradually introduce object-oriented programming concepts.]
- *Exception handling.* We integrate basic exception handling earlier in the book and instructors can easily pull more material forward from Chapter 11, Exception Handling: A Deeper Look.
- *Class Arrays and ArrayList.* Chapter 7 covers class Arrays—which contains methods for performing common array manipulations—and class ArrayList—which implements a dynamically resizable array-like data structure. This follows our philosophy of getting lots of practice *using existing classes while learning how to define your own classes*.
- *OO case studies.* The early classes and objects presentation features Time, Employee and GradeBook class case studies that weave their way through multiple sections and chapters, gradually introducing deeper OO concepts.

- *Optional Case Study: Using the UML to Develop an Object-Oriented Design and Java Implementation of an ATM.* The UML™ (Unified Modeling Language™) is the industry-standard graphical language for modeling object-oriented systems. Chapters 12–13 include an *optional* case study on object-oriented design using the UML. We design and implement the software for a simple automated teller machine (ATM). We analyze a typical requirements document that specifies the system to be built. We determine the classes needed to implement that system, the attributes the classes need to have, the behaviors the classes need to exhibit and specify how the classes must interact with one another to meet the system requirements. From the design we produce a *complete* Java implementation. Students often report having a “light-bulb moment”—the case study helps them “tie it all together” and really understand object orientation.
- *Reordered data structures presentation.* We begin with generic class `ArrayList` in Chapter 7. Because *students will understand basic generics concepts early in the book*, our later data structures discussions provide a deeper treatment of generic collections—showing how to use the built-in collections of the Java API. We then show how to implement generic methods and classes. Finally, we show how to build custom generic data structures.

Database and Web Development

- *JDBC 4.* Chapter 28, Accessing Databases with JDBC, covers JDBC 4 and uses the Java DB/Apache Derby and MySQL database management systems. The chapter features an OO case study on developing a database-driven address book that demonstrates prepared statements and JDBC 4’s automatic driver discovery.
- *Java Server Faces (JSF) 2.0.* Chapters 29–30 have been updated to introduce JavaServer Faces (JSF) 2.0 technology, which greatly simplifies building JSF web applications. Chapter 29 includes examples on building web application GUIs, validating forms and session tracking. Chapter 30 discusses data-driven and Ajax-enabled JSF applications. The chapter features a database-driven multitier web address book that allows users to add and search for contacts. This Ajax-enabled application gives the reader a nice sense of Web 2.0 software development.
- *Web services.* Chapter 31, Web Services, demonstrates creating and consuming SOAP- and REST-based web services. Case studies include developing blackjack and airline reservation web services.
- *Java Web Start and the Java Network Launch Protocol (JNLP).* We introduce Java Web Start and JNLP, which enable applets *and* applications to be launched via a web browser. Users can install locally for later execution. Programs can also request the user’s permission to access local system resources such as files—enabling you to develop more robust applets and applications that execute safely using Java’s sandbox security model, which applies to downloaded code.

Multithreading

- *Multithreading.* We completely reworked Chapter 26, Multithreading [special thanks to the guidance of Brian Goetz and Joseph Bowbeer—two of the co-authors of *Java Concurrency in Practice*, Addison-Wesley, 2006].
- *SwingWorker class.* We use class `SwingWorker` to create *multithreaded user interfaces*.

GUI and Graphics

- *Scalable GUI and graphics presentation.* Instructors teaching introductory courses have a broad choice of the amount of GUI and graphics to cover—from none, to an optional 10-brief-sections introductory sequence woven in with the early chapters, to a deep treatment in Chapters 14, 15 and 25, and Appendix I.
- *GroupLayout layout manager.* We discuss the GroupLayout layout manager in the context of the GUI design tool in the NetBeans IDE.
- *JTable sorting and filtering capabilities.* Chapter 28 uses these capabilities to re-sort the data in a JTable and filter it by regular expressions.

Other Features

- *Android.* Because of the tremendous interest in Android-based smartphones and tablets, we've included a three-chapter introduction to Android app development on the Companion Website. These chapters are from our new Deitel Developer Series book *Android for Programmers: An App-Driven Approach*. After you learn Java, you'll find it straightforward to develop and run Android apps on the free Android emulator that you can download from developer.android.com.
- *Software engineering community concepts.* We discuss agile software development, refactoring, design patterns, LAMP, SaaS (Software as a Service), PaaS (Platform as a Service), cloud computing, open-source software and more.

Dependency Chart

The chart on the next page shows the dependencies among the chapters to help instructors plan their syllabi. *Java How to Program, 9/e*, is appropriate for a variety of programming courses at various levels, most notably CS 1 and CS 2 courses and introductory course sequences in related disciplines. The book has a clearly delineated, modular organization. Chapters 1–11 and 14–17 form an accessible elementary programming sequence with a solid introduction to object-oriented programming. *Optional* Chapters 12–13 form an accessible introduction to object-oriented design with the UML. The GUI and Graphics Track and Chapters 14, 15, 23, 24 and 25 form a substantial GUI, graphics and multimedia sequence. Chapters 18–22 form a nice data-structures sequence. Chapters 26–27 form a solid introduction to multithreading and Internet networking. Chapters 28–31 form a rich database-intensive web application development sequence.

Teaching Approach

Java How to Program, 9/e, contains hundreds of complete working examples. We stress program clarity and concentrate on building well-engineered software.

Syntax Coloring. For readability, we syntax color all the Java code, similar to the way most Java integrated-development environments and code editors syntax color code. Our syntax-coloring conventions are as follows:

```

comments appear in green
keywords appear in dark blue
errors appear in red
constants and literal values appear in light blue
all other code appears in black

```

Modules and Chapter Dependency Chart

[Note: Arrows pointing into a chapter indicate that chapter's dependencies. Some chapters have multiple dependencies.]

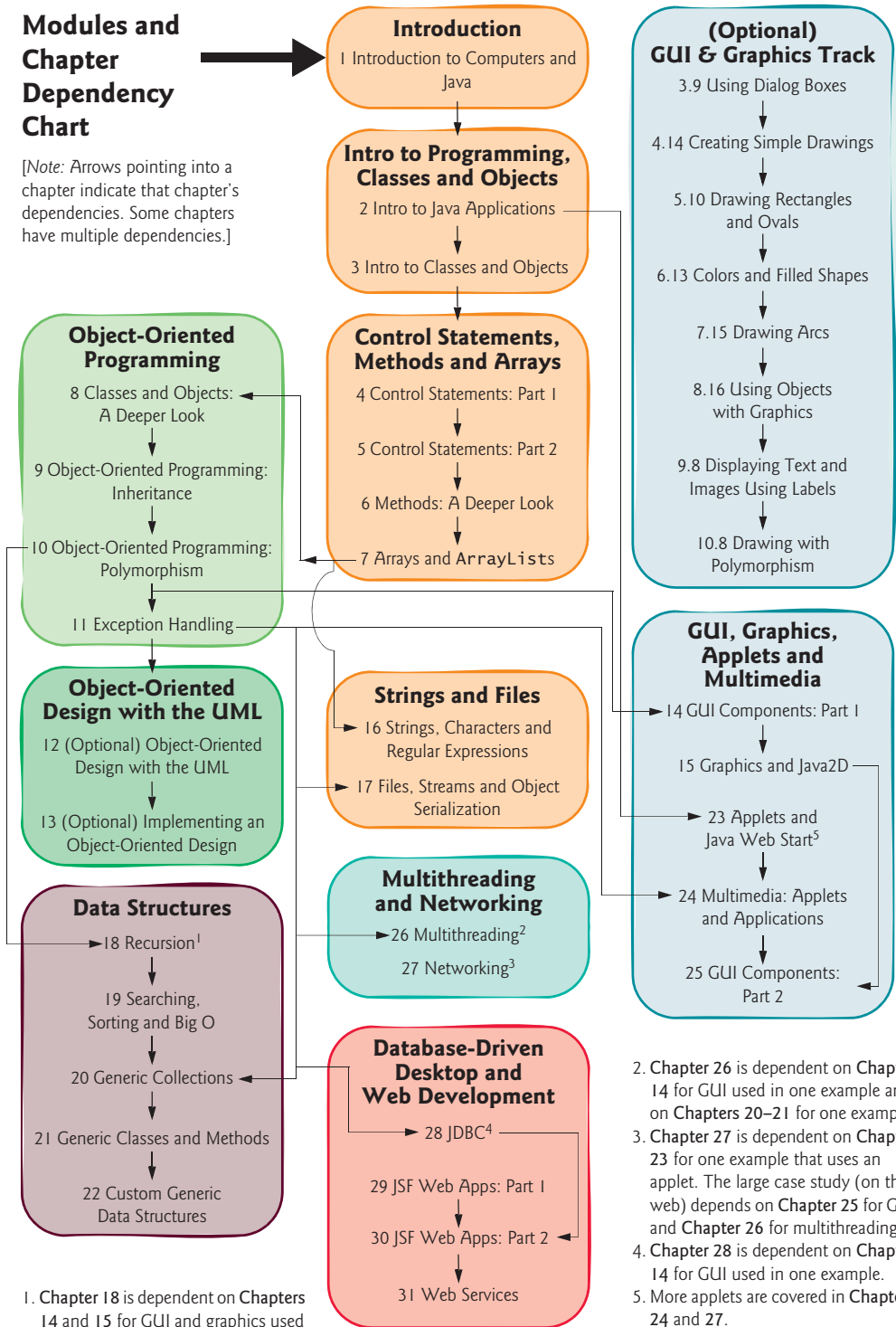

1. Chapter 18 is dependent on Chapters 14 and 15 for GUI and graphics used in one example.

2. Chapter 26 is dependent on Chapter 14 for GUI used in one example and on Chapters 20–21 for one example.
 3. Chapter 27 is dependent on Chapter 23 for one example that uses an applet. The large case study (on the web) depends on Chapter 25 for GUI and Chapter 26 for multithreading.
 4. Chapter 28 is dependent on Chapter 14 for GUI used in one example.
 5. More applets are covered in Chapters 24 and 27.

Code Highlighting. We place yellow rectangles around key code segments.

Using Fonts for Emphasis. We place the key terms and the index's page reference for each defining occurrence in **bold maroon** text for easier reference. We emphasize on-screen components in the **bold Helvetica** font (e.g., the **File** menu) and emphasize Java program text in the Lucida font (for example, `int x = 5;`).

Web Access. All of the source-code examples can be downloaded from:

www.deitel.com/books/jhttp9
www.pearsonhighered.com/deitel

Objectives. The opening quotes are followed by a list of chapter objectives.

Illustrations/Figures. Abundant tables, line drawings, UML diagrams, programs and program outputs are included.

Programming Tips. We include programming tips to help you focus on important aspects of program development. These tips and practices represent the best we've gleaned from a combined seven decades of programming and teaching experience.



Good Programming Practices

The Good Programming Practices call attention to techniques that will help you produce programs that are clearer, more understandable and more maintainable.



Common Programming Errors

Pointing out these Common Programming Errors reduces the likelihood that you'll make them.



Error-Prevention Tips

These tips contain suggestions for exposing bugs and removing them from your programs; many describe aspects of Java that prevent bugs from getting into programs in the first place.



Performance Tips

These tips highlight opportunities for making your programs run faster or minimizing the amount of memory that they occupy.



Portability Tips

The Portability Tips help you write code that will run on a variety of platforms.



Software Engineering Observations

The Software Engineering Observations highlight architectural and design issues that affect the construction of software systems, especially large-scale systems.



Look-and-Feel Observations

The Look-and-Feel Observations highlight graphical-user-interface conventions. These observations help you design attractive, user-friendly graphical user interfaces that conform to industry norms.

Summary Bullets. We present a section-by-section bullet-list summary of the chapter. For ease of reference, we include the page number of each key term's defining occurrence in the text.

Self-Review Exercises and Answers. Extensive self-review exercises *and* answers are included for self study. All of the exercises in the optional ATM case study are fully solved.

Exercises. The chapter exercises include:

- simple recall of important terminology and concepts
- What's wrong with this code?
- What does this code do?
- writing individual statements and small portions of methods and classes
- writing complete methods, classes and programs
- major projects
- in many chapters, Making a Difference exercises.

Index. We've included an extensive index. Defining occurrences of key terms are highlighted with a **bold maroon** page number.

Software Used in Java How to Program, 9/e

All the software you'll need for this book is available free for download from the web. See the Before You Begin section that follows this Preface for links to each download.

We wrote most of the examples in *Java How to Program, 9/e*, using the free Java Standard Edition Development Kit (JDK) 6. For the optional Java SE 7 modules, we used the OpenJDK's early access version of JDK 7. In Chapters 29–31, we also used the Netbeans IDE, and in Chapter 28, we used MySQL and MySQL Connector/J. You can find additional resources and software downloads in our Java Resource Centers at:

www.deitel.com/ResourceCenters.html

Java IDE Resource Kit

Your instructor may have ordered through your college bookstore a Value Pack edition of *Java How to Program, 9/e* that comes bundled with the Java IDE Resource Kit. This kit contains CD or DVD versions of Java™ SE Development Kit 6 for Windows®, Eclipse™ IDE for Windows®, NetBeans™ IDE, jGRASP™ IDE, DrJava IDE, BlueJ IDE and the TextPad® Text Editor for Windows®. Free versions of these IDEs also can be downloaded from the web. The Java IDE Resource Kit also includes access to a Companion Website containing step-by-step VideoNotes and written instructions to help you get started with each development environment. If your book did not come with the Java IDE Resource Kit, you can purchase access to the Resource Kit's Companion Website from www.pearsonhighered.com/javaidokit/. You'll still need to download the free software separately.

Discounts on Deitel Developer Series Books

If you'd like to receive information on professional *Deitel Developer Series* titles, including *Android for Programmers: An App-Driven Approach*, please register your copy of *Java How*

to Program, *9/e* at informit.com/register. You'll receive information on how to purchase *Android for Programmers* at a discount.

CourseSmart Web Books

Today's students and instructors have increasing demands on their time and money. Pearson has responded to that need by offering digital texts and course materials online through CourseSmart. CourseSmart allows faculty to review course materials online, saving time and costs. It offers students a high-quality digital version of the text for less than the cost of a print copy of the text. Students receive the same content offered in the print textbook enhanced by search, note-taking, and printing tools. For more information, visit www.coursesmart.com.

Instructor Supplements

The following supplements are available to qualified instructors only through Pearson Education's Instructor Resource Center (www.pearsonhighered.com/irc):

- *PowerPoint® slides* containing all the code and figures in the text, plus bulleted items that summarize key points.
- *Test Item File* of multiple-choice questions (approximately two per book section).
- *Solutions Manual* with solutions to the vast majority of the end-of-chapter exercises.

Please do not write to us requesting access to the Pearson Instructor's Resource Center which contains the book's instructor supplements, including the exercise solutions. Access is limited strictly to college instructors teaching from the book. Instructors may obtain access only through their Pearson representatives. Solutions are *not* provided for "project" exercises. Check out our Programming Projects Resource Center for lots of additional exercise and project possibilities (www.deitel.com/ProgrammingProjects/).

If you're not a registered faculty member, contact your Pearson representative or visit www.pearsonhighered.com/educator/replocator/.

Acknowledgments

We'd like to thank Abbey Deitel and Barbara Deitel for long hours devoted to this project. We're fortunate to have worked on this project with the dedicated team of publishing professionals at Pearson. We appreciate the guidance, savvy and energy of Michael Hirsch, Editor-in-Chief of Computer Science. Carole Snyder recruited the book's reviewers and managed the review process. Bob Engelhardt managed the book's production.

Reviewers

We wish to acknowledge the efforts of our eighth and ninth edition reviewers. They scrutinized the text and the programs and provided countless suggestions for improving the presentation: Lance Andersen (Oracle), Soundararajan Angusamy (Sun Microsystems), Joseph Bowbeer (Consultant), William E. Duncan (Louisiana State University), Diana Franklin (University of California, Santa Barbara), Edward F. Gehringer (North Carolina State University), Huiwei Guan (Northshore Community College), Ric Heishman (George Mason University), Dr. Heinz Kabutz (JavaSpecialists.eu), Patty Kraft (San Diego State University), Lawrence Premkumar (Sun Microsystems), Tim Margush (Univer-

sity of Akron), Sue McFarland Metzger (Villanova University), Shyamal Mitra (The University of Texas at Austin), Peter Pilgrim (Consultant), Manjeet Rege, Ph.D. (Rochester Institute of Technology), Manfred Riem (Java Champion, Consultant, Robert Half), Simon Ritter (Oracle), Susan Rodger (Duke University), Amr Sabry (Indiana University), José Antonio González Seco (Parliament of Andalusia), Sang Shin (Sun Microsystems), S. Sivakumar (Astra Infotech Private Limited), Raghavan “Rags” Srinivas (Intuit), Monica Sweat (Georgia Tech), Vinod Varma (Astra Infotech Private Limited) and Alexander Zuev (Sun Microsystems).

Well, there you have it! As you read the book, we’d appreciate your comments, criticisms, corrections and suggestions for improvement. Please address all correspondence to:

`deitel@deitel.com`

We’ll respond promptly. We hope you enjoy working with *Java How to Program, 9/e*. Good luck!

Paul and Harvey Deitel

About the Authors

Paul J. Deitel, CEO and Chief Technical Officer of Deitel & Associates, Inc., is a graduate of MIT, where he studied Information Technology. Through Deitel & Associates, Inc., he has delivered hundreds of Java, C++, C, C#, Visual Basic and Internet programming courses to industry clients, including Cisco, IBM, Siemens, Sun Microsystems, Dell, Lucent Technologies, Fidelity, NASA at the Kennedy Space Center, the National Severe Storm Laboratory, White Sands Missile Range, Rogue Wave Software, Boeing, SunGard Higher Education, Stratus, Cambridge Technology Partners, One Wave, Hyperion Software, Adra Systems, Entergy, CableData Systems, Nortel Networks, Puma, iRobot, Invensys and many more. He and his co-author, Dr. Harvey M. Deitel, are the world’s best-selling programming-language textbook authors.

Dr. Harvey M. Deitel, Chairman and Chief Strategy Officer of Deitel & Associates, Inc., has 50 years of experience in the computer field. Dr. Deitel earned B.S. and M.S. degrees from MIT and a Ph.D. from Boston University. He has extensive college teaching experience, including earning tenure and serving as the Chairman of the Computer Science Department at Boston College before founding Deitel & Associates, Inc., with his son, Paul J. Deitel. He and Paul are the co-authors of dozens of books and LiveLessons multimedia packages and they are writing many more. The Deitels’ texts have earned international recognition, with translations published in Japanese, German, Russian, Chinese, Spanish, Korean, French, Polish, Italian, Portuguese, Greek, Urdu and Turkish. Dr. Deitel has delivered hundreds of professional programming seminars to major corporations, academic institutions, government organizations and the military.

Corporate Training from Deitel & Associates, Inc.

Deitel & Associates, Inc., is an internationally recognized corporate training and authoring organization. The company provides instructor-led courses delivered at client sites worldwide on major programming languages and platforms, such as Java™, C++, Visual C++®, C, Visual C#®, Visual Basic®, XML®, Python®, object technology, Internet and web programming, Android™ and iPhone® app development, and a growing list of additional programming and software-development courses. The founders of Deitel & Associates,

Inc., are Paul J. Deitel and Dr. Harvey M. Deitel. The company's clients include many of the world's largest companies, government agencies, branches of the military, and academic institutions. Through its 35-year publishing partnership with Prentice Hall/Pearson, Deitel & Associates, Inc., publishes leading-edge programming textbooks, professional books and *LiveLessons* DVD-based and web-based video courses. Deitel & Associates, Inc., and the authors can be reached via e-mail at:

deitel@deitel.com

To learn more about Deitel & Associates, Inc., its publications and its *Dive Into*[®] *Series* Corporate Training curriculum delivered at client locations worldwide, visit:

www.deitel.com/training/

and subscribe to the free *Deitel*[®] *Buzz Online* e-mail newsletter at:

www.deitel.com/newsletter/subscribe.html

and follow the authors on Facebook (www.deitel.com/deitel/fan) and Twitter (@deitel).

Individuals wishing to purchase Deitel books, and *LiveLessons* DVD and web-based training courses can do so through www.deitel.com. Bulk orders by corporations, the government, the military and academic institutions should be placed directly with Pearson. For more information, visit

www.pearsonhighered.com



Before You Begin

This section contains information you should review before using this book and instructions to ensure that your computer is set up properly for use with this book. We'll post updates (if any) to the Before You Begin section on the book's website:

www.deitel.com/books/jhttp9/

Font and Naming Conventions

We use fonts to distinguish between on-screen components (such as menu names and menu items) and Java code or commands. Our convention is to emphasize on-screen components in a sans-serif bold **Helvetica** font (for example, **File** menu) and to emphasize Java code and commands in a sans-serif **Lucida** font (for example, `System.out.println()`).

Software Used in the Book

All the software you'll need for this book is available free for download from the web.

Java SE Software Development Kit (JDK) 6 and 7

We wrote most of the examples in *Java How to Program, 9/e*, using the free Java Standard Edition Development Kit (JDK) 6, which is available from:

www.oracle.com/technetwork/java/javase/downloads/index.html

For the optional Java SE 7 modules, we used the OpenJDK's early access version of JDK 7, which is available from:

dlc.sun.com.edgesuite.net/jdk7/binaries-/index.html

Java DB, MySQL and MySQL Connector/J

In Chapter 28, we use the Java DB and MySQL Community Edition database management systems. Java DB is part of the JDK installation. At the time of this writing, the JDK's 64-bit installer was not properly installing Java DB. If you are using the 64-bit version of Java, you may need to install Java DB separately. You can download Java DB from:

www.oracle.com/technetwork/java/javadb/downloads/index.html

At the time of this writing, the latest release of MySQL Community Edition was 5.5.8. To install MySQL Community Edition on Windows, Linux or Mac OS X, see the installation overview for your platform at:

- Windows: dev.mysql.com/doc/refman/5.5/en/windows-installation.html
- Linux: dev.mysql.com/doc/refman/5.5/en/linux-installation-rpm.html
- Mac OS X: dev.mysql.com/doc/refman/5.5/en/macosx-installation.html

Carefully follow the instructions for downloading and installing the software on your platform. The downloads are available from:

dev.mysql.com/downloads/mysql/

You also need to install **MySQL Connector/J** (the J stands for Java), which allows programs to use JDBC to interact with MySQL. MySQL Connector/J can be downloaded from

dev.mysql.com/downloads/connector/j/

At the time of this writing, the current generally available release of MySQL Connector/J is 5.1.14. The documentation for Connector/J is located at

dev.mysql.com/doc/refman/5.5/en/connector-j.html

To install MySQL Connector/J, carefully follow the installation instructions at:

dev.mysql.com/doc/refman/5.5/en/connector-j-installing.html

We *do not* recommend modifying your system's CLASSPATH environment variable, which is discussed in the installation instructions. Instead, we'll show you how use MySQL Connector/J by specifying it as a command-line option when you execute your applications.

Java IDE Resource Kit

Your instructor may have ordered through your college bookstore a Value Pack edition of *Java How to Program, 9/e* that comes bundled with the Java IDE Resource Kit. This kit contains CD or DVD versions of Java™ SE Development Kit 6 (JDK 6) for Windows®, Eclipse™ IDE for Windows®, NetBeans™ IDE, jGRASP™ IDE, DrJava IDE, BlueJ IDE and the TextPad® Text Editor for Windows®. Free versions of these IDEs also can be downloaded from the web at the following sites:

- JDK 6: www.oracle.com/technetwork/java/javase/downloads/
- Eclipse IDE: eclipse.org/downloads/
- NetBeans IDE: netbeans.org/downloads/
- jGRASP IDE: spider.eng.auburn.edu/user-cgi/grasp/grasp.pl?d1=download_jgrasp.html
- DrJava IDE: drjava.org
- BlueJ IDE: www.bluej.org/download/download.html
- TextPad Text Editor (evaluation version): www.textpad.com/download/

Obtaining the Code Examples

The examples for *Java How to Program, 9/e* are available for download at

www.deitel.com/books/jhttp9/

If you're not already registered at our website, go to www.deitel.com and click the **Register** link below our logo in the upper-left corner of the page. Fill in your information. There's no charge to register, and we do not share your information with anyone. We send you only account-management e-mails unless you register separately for our free *Deitel® Buzz Online* e-mail newsletter at www.deitel.com/newsletter/subscribe.html. After registering for

the site, you'll receive a confirmation e-mail with your verification code. *Click the link in the confirmation e-mail to complete your registration.* Configure your e-mail client to allow e-mails from `deitel.com` to ensure that the confirmation email is not filtered as junk mail.

Next, go to `www.deitel.com` and sign in using the **Login** link below our logo in the upper-left corner of the page. Go to `www.deitel.com/books/jhttp9/`. You'll find the link to download the examples under the heading **Download Code Examples and Other Premium Content for Registered Users**. Write down the location where you choose to save the ZIP file on your computer.

We assume the examples are located at `C:\Examples` on your computer. Extract the contents of `Examples.zip` using a tool such as WinZip (`www.winzip.com`) or the built-in capabilities of your operating system.

Setting the PATH Environment Variable

The PATH environment variable on your computer designates which directories the computer searches when looking for applications, such as the applications that enable you to compile and run your Java applications (called `javac` and `java`, respectively). *Carefully follow the installation instructions for Java on your platform to ensure that you set the PATH environment variable correctly.*

If you do not set the PATH variable correctly, when you use the JDK's tools, you'll receive a message like:

```
'java' is not recognized as an internal or external command,
operable program or batch file.
```

In this case, go back to the installation instructions for setting the PATH and recheck your steps. If you've downloaded a newer version of the JDK, you may need to change the name of the JDK's installation directory in the PATH variable.

Setting the CLASSPATH Environment Variable

If you attempt to run a Java program and receive a message like

```
Exception in thread "main" java.lang.NoClassDefFoundError: YourClass
```

then your system has a CLASSPATH environment variable that must be modified. To fix the preceding error, follow the steps in setting the PATH environment variable, to locate the CLASSPATH variable, then edit the variable's value to include the local directory—typically represented as a dot (`.`). On Windows add

```
.;
```

at the beginning of the CLASSPATH's value (with no spaces before or after these characters). On other platforms, replace the semicolon with the appropriate path separator characters—often a colon (`:`)

Java's Nimbus Look-and-Feel

Java comes bundled with an elegant, cross-platform look-and-feel known as Nimbus. For programs with graphical user interfaces, we've configured our systems to use Nimbus as the default look-and-feel.

To set Nimbus as the default for all Java applications, you must create a text file named `swing.properties` in the `lib` folder of both your JDK installation folder and your JRE installation folder. Place the following line of code in the file:

```
swing.defaultlaf=com.sun.java.swing.plaf.nimbus.NimbusLookAndFeel
```

For more information on locating these installation folders visit java.sun.com/javase/6/webnotes/install/index.html. [*Note:* In addition to the standalone JRE, there's a JRE nested in your JDK's installation folder. If you're using an IDE that depends on the JDK (e.g., NetBeans), you may also need to place the `swing.properties` file in the nested `jre` folder's `lib` folder.]

You're now ready to begin your Java studies with *Java How to Program, 9/e*. We hope you enjoy the book!

Introduction to Computers and Java

I

Man is still the most extraordinary computer of all.

—John F. Kennedy

Good design is good business.

—Thomas J. Watson, Founder of IBM

How wonderful it is that nobody need wait a single moment before starting to improve the world.

—Anne Frank

Objectives

In this chapter you'll learn:

- Exciting recent developments in the computer field.
- Computer hardware, software and networking basics.
- The data hierarchy.
- The different types of programming languages.
- Basic object-technology concepts.
- The importance of the Internet and the web.
- A typical Java program-development environment.
- To test-drive a Java application.
- Some key recent software technologies.
- How computers can help you make a difference.

- | | |
|---|--|
| 1.1 Introduction | 1.9 Java and a Typical Java Development Environment |
| 1.2 Computers: Hardware and Software | 1.10 Test-Driving a Java Application |
| 1.3 Data Hierarchy | 1.11 Web 2.0: Going Social |
| 1.4 Computer Organization | 1.12 Software Technologies |
| 1.5 Machine Languages, Assembly Languages and High-Level Languages | 1.13 Keeping Up-to-Date with Information Technologies |
| 1.6 Introduction to Object Technology | 1.14 Wrap-Up |
| 1.7 Operating Systems | |
| 1.8 Programming Languages | |

Self-Review Exercises | *Answers to Self-Review Exercises* | *Exercises* | *Making a Difference* | *Making a Difference Resources*

1.1 Introduction

Welcome to Java—the world’s most widely used computer programming language. You’re already familiar with the powerful tasks computers perform. Using this textbook, you’ll write instructions commanding computers to perform those kinds of tasks. *Software* (i.e., the instructions you write) controls *hardware* (i.e., computers).

You’ll learn *object-oriented programming*—today’s key programming methodology. You’ll create and work with many *software objects* in this text.

Java is the preferred language for meeting many organizations’ enterprise programming needs. Java has also become the language of choice for implementing Internet-based applications and software for devices that communicate over a network.

In use today are more than a billion general-purpose computers and billions more Java-enabled cell phones, smartphones and handheld devices (such as tablet computers). According to a study by eMarketer, the number of mobile Internet users will reach approximately 134 million by 2013.¹ Other studies have projected smartphone sales to surpass personal computer sales in 2011² and tablet sales to account for over 20% of all personal computer sales by 2015.³ By 2014, the smartphone applications market is expected to exceed \$40 billion,⁴ which is creating significant opportunities for programming mobile applications.

Java Editions: SE, EE and ME

Java has evolved so rapidly that this ninth edition of *Java How to Program*—based on **Java Standard Edition 6 (Java SE 6)** with optional modules on the new features of **Java SE 7**—was published just 14 years after the first edition. Java is used in such a broad spectrum of applications that it has two other editions. The **Java Enterprise Edition (Java EE)** is geared toward developing large-scale, distributed networking applications and web-based applications. In the past, most computer applications ran on “standalone” computers (comput-

1. www.circleid.com/posts/mobile_internet_users_to_reach_134_million_by_2013/.
 2. www.pcworld.com/article/171380/more_smartphones_than_desktop_pcs_by_2011.html.
 3. www.forrester.com/ER/Press/Release/0,1769,1340,00.html.
 4. *Inc.*, December 2010/January 2011, pages 116–123.

ers that were not networked together). Today's applications can be written with the aim of communicating among the world's computers via the Internet and the web. Later in this book we discuss how to build such web-based applications with Java.

The **Java Micro Edition (Java ME)** is geared toward developing applications for small, memory-constrained devices, such as BlackBerry smartphones. Google's Android operating system—used on numerous smartphones, tablets (small, lightweight mobile computers with touch screens), e-readers and other devices—uses a customized version of Java not based on Java ME.

Computing in Industry and Research

These are exciting times in the computer field. Many of the most influential and successful businesses of the last two decades are technology companies, including Apple, IBM, Hewlett Packard, Dell, Intel, Motorola, Cisco, Microsoft, Google, Amazon, Facebook, Twitter, Groupon, Foursquare, Yahoo!, eBay and many more—these are major employers of people who study computer science, information systems or related disciplines. At the time of this writing, Apple was the second most valuable company in the world and *the* most valuable technology company.⁵ Computers are also used extensively in academic and industrial research. Figure 1.1 provides just a few examples of exciting ways in which computers are used in research and industry.

Name	Description
Internet	The Internet—a global network of computers—was made possible by the <i>convergence of computing and communications</i> . It has its roots in the 1960s, when research funding was supplied by the U.S. Department of Defense. Originally designed to connect the main computer systems of about a dozen universities and research organizations, the Internet today is accessible by billions of computers and computer-controlled devices worldwide. Computers break lengthy transmissions into packets at the sending end, route the packets to their intended receivers and ensure that those packets are received in sequence and without error at the receiving end. According to a study by Forrester Research, the average U.S. online consumer now spends as much time online as watching television (forrester.com/rb/Research/understanding_changing_needs_of_us_online_consumer/q/id/57861/t/2).
Human Genome Project	The Human Genome Project was founded to identify and analyze the 20,000+ genes in human DNA. The project used computer programs to analyze complex genetic data, determine the sequences of the billions of chemical base pairs that make up human DNA and store the information in databases which have been made available to researchers in many fields. This research has led to tremendous innovation and growth in the biotechnology industry.

Fig. 1.1 | A few uses for computers. (Part 1 of 3.)

5. www.zdnet.com/blog/apple/apple-becomes-worlds-second-most-valuable-company/9047.

Name	Description
World Community Grid	World Community Grid (www.worldcommunitygrid.org) is a non-profit computing grid. People worldwide donate their unused computer processing power by installing a free secure software program that allows the World Community Grid to harness the excess power when the computers are idle. The computing power is used in place of supercomputers to conduct scientific research projects that are making a difference, including developing affordable solar energy, providing clean water to the developing world, fighting cancer, curing muscular dystrophy, finding influenza antiviral drugs, growing more nutritious rice for regions fighting hunger and more.
Medical imaging	X-ray computed tomography (CT) scans, also called CAT (computerized axial tomography) scans, take X-rays of the body from hundreds of different angles. Computers are used to adjust the intensity of the X-ray, optimizing the scan for each type of tissue, then to combine all of the information to create a 3D image.
GPS	Global Positioning System (GPS) devices use a network of satellites to retrieve location-based information. Multiple satellites send time-stamped signals to the device GPS device, which calculates the distance to each satellite based on the time the signal left the satellite and the time the signal was received. The location of each satellite and the distance to each are used to determine the exact location of the device. Based on your location, GPS devices can provide step-by-step directions, help you easily find nearby businesses (restaurants, gas stations, etc.) and points of interest, or help you find your friends.
Microsoft's SYNC [®]	Many Ford cars now feature Microsoft's SYNC technology, providing speech-synthesis (for reading text messages to you) and speech-recognition capabilities that allow you to use voice commands to browse music, request traffic alerts and more.
AMBER [™] Alert	The AMBER (America's Missing: Broadcast Emergency Response) Alert System is used to find abducted children. Law enforcement notifies TV and radio broadcasters and state transportation officials, who then broadcast alerts on TV, radio, computerized highway signs, the Internet and wireless devices. AMBER Alert recently partnered with Facebook. Facebook users can "Like" AMBER Alert pages by location to receive alerts in their news feeds.
Robots	Robots are computerized machines that can perform tasks (including physical tasks), respond to stimuli and more. They can be used for day-to-day tasks (e.g., iRobot's Roomba vacuum), entertainment (such as robotic pets), military combat, space and deep sea exploration, manufacturing and more. In 2004, NASA's remote-controlled Mars rover—which used Java technology—explored the surface to learn about the history of water on the planet.

Fig. 1.1 | A few uses for computers. (Part 2 of 3.)

Name	Description
One Laptop Per Child (OLPC)	One Laptop Per Child (OLPC) is providing low-power, inexpensive, Internet-enabled laptops to poor children worldwide—enabling learning and reducing the digital divide (one.laptop.org). By providing these educational resources, OLPC is increasing the opportunities for poor children to learn and make a difference in their communities.
Game programming	The computer game business is larger than the first-run movie business. The most sophisticated video games can cost as much as \$100 million to develop. Activision's <i>Call of Duty 2: Modern Warfare</i> , released in November 2009, earned \$310 million in just one day in North America and the U.K. (news.cnet.com/8301-13772_3-10396593-52.html?tag=mncol;text)! Online <i>social gaming</i> , which enables users worldwide to compete with one another, is growing rapidly. Zynga—creator of popular online games such as <i>Farmville</i> and <i>Mafia Wars</i> —was founded in 2007 and already has over 215 million monthly users. To accommodate the growth in traffic, Zynga is adding nearly 1,000 servers each week (techcrunch.com/2010/09/22/zynga-moves-1-petabyte-of-data-daily-adds-1000-servers-a-week/)! Video game consoles are also becoming increasingly sophisticated. The Wii Remote uses an <i>accelerometer</i> (to detect tilt and acceleration) and a sensor that determines where the device is pointing, allowing the device to respond to motion. By gesturing with the Wii Remote in hand, you can control the video game on the screen. With Microsoft's Kinect for Xbox 360, you—the player—become the controller. Kinect uses a camera, depth sensor and sophisticated software to follow your body movement, allowing you to control the game (en.wikipedia.org/wiki/Kinect). Kinect games include dancing, exercising, playing sports, training virtual animals and more.
Internet TV	Internet TV set-top boxes (such as Apple TV and Google TV) give you access to content—such as games, news, movies, television shows and more—allowing you to access an enormous amount of content on demand; you no longer need to rely on cable or satellite television providers to get content.

Fig. 1.1 | A few uses for computers. (Part 3 of 3.)

1.2 Computers: Hardware and Software

A computer is a device that can perform computations and make logical decisions phenomenally faster than human beings can. Many of today's personal computers can perform billions of calculations in one second—more than a human can perform in a lifetime. *Supercomputers* are already performing *thousands of trillions (quadrillions)* of instructions per second! To put that in perspective, a quadrillion-instruction-per-second computer can perform in one second more than 100,000 calculations *for every person on the planet!* And—these “upper limits” are growing quickly!

Computers process data under the control of sets of instructions called **computer programs**. These programs guide the computer through orderly sets of actions specified by people called computer **programmers**. The programs that run on a computer are referred to as **software**. In this book, you'll learn today's key programming methodology that's enhancing programmer productivity, thereby reducing software-development costs—*object-oriented programming*.

A computer consists of various devices referred to as **hardware** (e.g., the keyboard, screen, mouse, hard disks, memory, DVDs and processing units). Computing costs are *dropping dramatically*, owing to rapid developments in hardware and software technologies. Computers that might have filled large rooms and cost millions of dollars decades ago are now inscribed on silicon chips smaller than a fingernail, costing perhaps a few dollars each. Ironically, silicon is one of the most abundant materials—it's an ingredient in common sand. Silicon-chip technology has made computing so economical that more than a billion general-purpose computers are in use worldwide, and this is expected to *double* in the next few years.

Computer chips (*microprocessors*) control countless devices. These **embedded systems** include anti-lock brakes in cars, navigation systems, smart home appliances, home security systems, cell phones and smartphones, robots, intelligent traffic intersections, collision avoidance systems, video game controllers and more. The vast majority of the microprocessors produced each year are embedded in devices other than general-purpose computers.⁶

Moore's Law

Every year, you probably expect to pay at least a little more for most products and services. The opposite has been the case in the computer and communications fields, especially with regard to the costs of hardware supporting these technologies. For many decades, hardware costs have fallen rapidly. Every year or two, the capacities of computers have approximately *doubled* without any increase in price. This remarkable observation often is called **Moore's Law**, named for the person who identified the trend, Gordon Moore, co-founder of Intel—a leading manufacturer of the processors in today's computers and embedded systems. Moore's Law and related observations are especially true in relation to the amount of memory that computers have for programs, the amount of secondary storage (such as disk storage) they have to hold programs and data over longer periods of time, and their processor speeds—the speeds at which computers execute their programs (i.e., do their work). Similar growth has occurred in the communications field, in which costs have plummeted as enormous demand for communications bandwidth (i.e., information-carrying capacity) has attracted intense competition. We know of no other fields in which technology improves so quickly and costs fall so rapidly. Such phenomenal improvement is truly fostering the *Information Revolution*.

1.3 Data Hierarchy

Data items processed by computers form a **data hierarchy** that becomes larger and more complex in structure as we progress from bits to characters to fields, and so on. Figure 1.2 illustrates a portion of the data hierarchy. Figure 1.3 summarizes the data hierarchy's levels.

6. www.eetimes.com/electronics-blogs/industrial-control-designline-blog/4027479/Real-men-program-in-C?pageNumber=1.

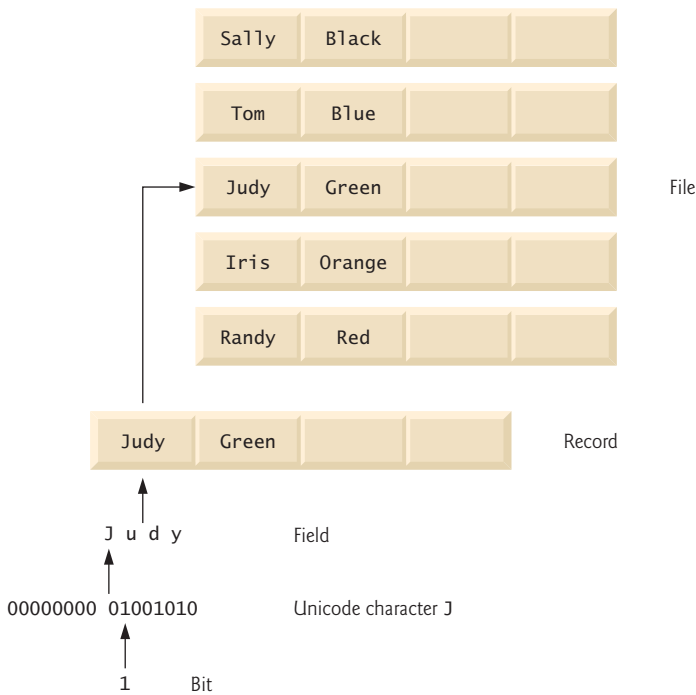

Fig. I.2 | Data hierarchy.

Level	Description
Bits	The smallest data item in a computer can assume the value 0 or the value 1. Such a data item is called a bit (short for “binary digit”—a digit that can assume one of two values). It’s remarkable that the impressive functions performed by computers involve only the simplest manipulations of 0s and 1s— <i>examining a bit’s value</i> , <i>setting a bit’s value</i> and <i>reversing a bit’s value</i> (from 1 to 0 or from 0 to 1).
Characters	It’s tedious for people to work with data in the low-level form of bits. Instead, they prefer to work with <i>decimal digits</i> (0–9), <i>letters</i> (A–Z and a–z), and <i>special symbols</i> (e.g., \$, @, %, &, *, (,), -, +, ", :, ? and /). Digits, letters and special symbols are known as characters . The computer’s character set is the set of all the characters used to write programs and represent data items. Computers process only 1s and 0s, so a computer’s character set represents every character as a pattern of 1s and 0s. Java uses Unicode [®] characters that are composed of two bytes , each composed of eight bits. Unicode contains characters for many of the world’s languages. See Appendix L for more information on Unicode. See Appendix B for more information on the ASCII (American Standard Code for Information Interchange) character set—the popular subset of Unicode that represents uppercase and lowercase letters, digits and some common special characters.

Fig. I.3 | Levels of the data hierarchy. (Part 1 of 2.)

Level	Description
Fields	Just as characters are composed of bits, fields are composed of characters or bytes. A field is a group of characters or bytes that conveys meaning. For example, a field consisting of uppercase and lowercase letters can be used to represent a person's name, and a field consisting of decimal digits could represent a person's age.
Records	Several related fields can be used to compose a record (implemented as a <code>class</code> in Java). In a payroll system, for example, the record for an employee might consist of the following fields (possible types for these fields are shown in parentheses): <ul style="list-style-type: none"> • Employee identification number (a whole number) • Name (a string of characters) • Address (a string of characters) • Hourly pay rate (a number with a decimal point) • Year-to-date earnings (a number with a decimal point) • Amount of taxes withheld (a number with a decimal point) <p>Thus, a record is a group of related fields. In the preceding example, all the fields belong to the same employee. A company might have many employees and a payroll record for each one.</p>
Files	A file is a group of related records. [<i>Note:</i> More generally, a file contains arbitrary data in arbitrary formats. In some operating systems, a file is viewed simply as a <i>sequence of bytes</i> —any organization of the bytes in a file, such as organizing the data into records, is a view created by the application programmer.] It's not unusual for an organization to have many files, some containing billions, or even trillions, of characters of information.

Fig. 1.3 | Levels of the data hierarchy. (Part 2 of 2.)

1.4 Computer Organization

Regardless of differences in physical appearance, computers can be envisioned as divided into various **logical units** or sections (Fig. 1.4).

Logical unit	Description
Input unit	This “receiving” section obtains information (data and computer programs) from input devices and places it at the disposal of the other units for processing. Most information is entered into computers through keyboards, touch screens and mouse devices. Other forms of input include speaking to your computer, scanning images and barcodes, reading from secondary storage devices (like hard drives, DVD drives, Blu-ray Disc™ drives and USB flash drives—also called “thumb drives” or “memory sticks”), receiving video from a webcam and having your computer receive information from the Internet (such as when you download videos from YouTube™ or e-books from Amazon). Newer forms of input include reading position data from a GPS device, and motion and orientation information from an accelerometer in a smartphone or game controller.

Fig. 1.4 | Logical units of a computer. (Part 1 of 2.)

Logical unit	Description
Output unit	This “shipping” section takes information that the computer has processed and places it on various output devices to make it available for use outside the computer. Most information that’s output from computers today is displayed on screens, printed on paper, played as audio or video on portable media players (such as Apple’s popular iPods) and giant screens in sports stadiums, transmitted over the Internet or used to control other devices, such as robots and “intelligent” appliances.
Memory unit	This rapid-access, relatively low-capacity “warehouse” section retains information that has been entered through the input unit, making it immediately available for processing when needed. The memory unit also retains processed information until it can be placed on output devices by the output unit. Information in the memory unit is <i>volatile</i> —it’s typically lost when the computer’s power is turned off. The memory unit is often called either memory or primary memory . Typical main memories on desktop and notebook computers contain between 1 GB and 8 GB (GB stands for gigabytes; a gigabyte is approximately one billion bytes).
Arithmetic and logic unit (ALU)	This “manufacturing” section performs <i>calculations</i> , such as addition, subtraction, multiplication and division. It also contains the <i>decision</i> mechanisms that allow the computer, for example, to compare two items from the memory unit to determine whether they’re equal. In today’s systems, the ALU is usually implemented as part of the next logical unit, the CPU.
Central processing unit (CPU)	This “administrative” section coordinates and supervises the operation of the other sections. The CPU tells the input unit when information should be read into the memory unit, tells the ALU when information from the memory unit should be used in calculations and tells the output unit when to send information from the memory unit to certain output devices. Many of today’s computers have multiple CPUs and, hence, can perform many operations simultaneously. A multi-core processor implements multiple processors on a single integrated-circuit chip—a <i>dual-core processor</i> has two CPUs and a <i>quad-core processor</i> has four CPUs. Today’s desktop computers have processors that can execute billions of instructions per second.
Secondary storage unit	This is the long-term, high-capacity “warehousing” section. Programs or data not actively being used by the other units normally are placed on secondary storage devices (e.g., your <i>hard drive</i>) until they’re again needed, possibly hours, days, months or even years later. Information on secondary storage devices is <i>persistent</i> —it’s preserved even when the computer’s power is turned off. Secondary storage information takes much longer to access than information in primary memory, but the cost per unit of secondary storage is much less than that of primary memory. Examples of secondary storage devices include CD drives, DVD drives and flash drives, some of which can hold up to 128 GB. Typical hard drives on desktop and notebook computers can hold up to 2 TB (TB stands for terabytes; a terabyte is approximately one trillion bytes).

Fig. I.4 | Logical units of a computer. (Part 2 of 2.)

1.5 Machine Languages, Assembly Languages and High-Level Languages

Programmers write instructions in various programming languages, some directly understandable by computers and others requiring intermediate *translation* steps. Hundreds of such languages are in use today. These may be divided into three general types:

1. Machine languages
2. Assembly languages
3. High-level languages

Any computer can directly understand only its own **machine language**, defined by its hardware design. Machine languages generally consist of strings of numbers (ultimately reduced to 1s and 0s) that instruct computers to perform their most elementary operations one at a time. Machine languages are *machine dependent* (a particular machine language can be used on only one type of computer). Such languages are cumbersome for humans. For example, here's a section of an early machine-language program that adds overtime pay to base pay and stores the result in gross pay:

```
+1300042774
+1400593419
+1200274027
```

Programming in machine language was simply too slow and tedious for most programmers. Instead of using the strings of numbers that computers could directly understand, programmers began using English-like abbreviations to represent elementary operations. These abbreviations formed the basis of **assembly languages**. *Translator programs* called **assemblers** were developed to convert early assembly-language programs to machine language at computer speeds. The following section of an assembly-language program also adds overtime pay to base pay and stores the result in gross pay:

```
load    basepay
add     overpay
store   grosspay
```

Although such code is clearer to humans, it's incomprehensible to computers until translated to machine language.

Computer usage increased rapidly with the advent of assembly languages, but programmers still had to use many instructions to accomplish even the simplest tasks. To speed the programming process, **high-level languages** were developed in which single statements could be written to accomplish substantial tasks. Translator programs called **compilers** convert high-level language programs into machine language. High-level languages allow you to write instructions that look almost like everyday English and contain commonly used mathematical notations. A payroll program written in a high-level language might contain a *single* statement such as

```
grossPay = basePay + overTimePay
```

From the programmer's standpoint, high-level languages are preferable to machine and assembly languages. Java is by far the most widely used high-level programming language.

Compiling a large high-level language program into machine language can take a considerable amount of computer time. *Interpreter* programs were developed to execute high-level language programs directly (without the delay of compilation), although slower than compiled programs run. We'll say more about how interpreters work in Section 1.9, where you'll learn that Java uses a clever performance-tuned mixture of compilation and interpretation to ultimately run programs. Exercises 7.35–7.37 (in the Special Section: Building Your Own Computer) guide you through the process of building an interpreter program.

1.6 Introduction to Object Technology

Building software quickly, correctly and economically remains an elusive goal at a time when demands for new and more powerful software are soaring. *Objects*, or more precisely—as we'll see in Chapter 3—the *classes* objects come from, are essentially *reusable* software components. There are date objects, time objects, audio objects, video objects, automobile objects, people objects, etc. Almost any *noun* can be reasonably represented as a software object in terms of *attributes* (e.g., name, color and size) and *behaviors* (e.g., calculating, moving and communicating). Software developers are discovering that using a modular, object-oriented design and implementation approach can make software-development groups much more productive than was possible with earlier popular techniques like “structured programming”—object-oriented programs are often easier to understand, correct and modify.

The Automobile as an Object

To help you understand objects and their contents, let's begin with a simple analogy. Suppose you want to *drive a car and make it go faster by pressing its accelerator pedal*. What must happen before you can do this? Well, before you can drive a car, someone has to *design* it. A car typically begins as engineering drawings, similar to the *blueprints* that describe the design of a house. These drawings include the design for an accelerator pedal. The pedal *hides* from the driver the complex mechanisms that actually make the car go faster, just as the brake pedal hides the mechanisms that slow the car, and the steering wheel “hides” the mechanisms that turn the car. This enables people with little or no knowledge of how engines, braking and steering mechanisms work to drive a car easily.

Just as you cannot cook meals in the kitchen of a blueprint, you cannot drive a car's engineering drawings. Before you can drive a car, it must be *built* from the engineering drawings that describe it. A completed car has an *actual* accelerator pedal to make the car go faster, but even that's not enough—the car won't accelerate on its own (hopefully!), so the driver must *press* the pedal to accelerate the car.

Methods and Classes

Let's use our car example to introduce some key object-oriented programming concepts. Performing a task in a program requires a **method**. The method houses the program statements that actually perform its tasks. The method hides these statements from its user, just as the accelerator pedal of a car hides from the driver the mechanisms of making the car go faster. In Java, we create a program unit called a **class** to house the set of methods that

perform the class's tasks. For example, a class that represents a bank account might contain one method to *deposit* money to an account, another to *withdraw* money from an account and a third to *inquire* what the account's current balance is. A class is similar in concept to a car's engineering drawings, which house the design of an accelerator pedal, steering wheel, and so on.

Instantiation

Just as someone has to *build a car* from its engineering drawings before you can actually drive a car, you must *build an object* of a class before a program can perform the tasks that the class's methods define. The process of doing this is called *instantiation*. An object is then referred to as an **instance** of its class.

Reuse

Just as a car's engineering drawings can be *reused* many times to build many cars, you can *reuse* a class many times to build many objects. Reuse of existing classes when building new classes and programs saves time and effort. Reuse also helps you build more reliable and effective systems, because existing classes and components often have gone through extensive *testing*, *debugging* and *performance* tuning. Just as the notion of *interchangeable parts* was crucial to the Industrial Revolution, reusable classes are crucial to the software revolution that has been spurred by object technology.



Software Engineering Observation 1.1

Use a building-block approach to creating your programs. Avoid reinventing the wheel—use existing pieces wherever possible. This software reuse is a key benefit of object-oriented programming.

Messages and Methods Calls

When you drive a car, pressing its gas pedal sends a *message* to the car to perform a task—that is, to go faster. Similarly, you *send messages to an object*. Each message is implemented as a **method call** that tells a method of the object to perform its task. For example, a program might call a particular bank account object's *deposit* method to increase the account's balance.

Attributes and Instance Variables

A car, besides having capabilities to accomplish tasks, also has *attributes*, such as its color, its number of doors, the amount of gas in its tank, its current speed and its record of total miles driven (i.e., its odometer reading). Like its capabilities, the car's attributes are represented as part of its design in its engineering diagrams (which, for example, include an odometer and a fuel gauge). As you drive an actual car, these attributes are carried along with the car. Every car maintains its *own* attributes. For example, each car knows how much gas is in its own gas tank, but *not* how much is in the tanks of *other* cars.

An object, similarly, has attributes that it carries along as it's used in a program. These attributes are specified as part of the object's class. For example, a bank account object has a *balance attribute* that represents the amount of money in the account. Each bank account object knows the balance in the account it represents, but *not* the balances of the *other* accounts in the bank. Attributes are specified by the class's **instance variables**.

Encapsulation

Classes **encapsulate** (i.e., wrap) attributes and methods into objects—an object’s attributes and methods are intimately related. Objects may communicate with one another, but they’re normally not allowed to know how other objects are implemented—implementation details are *hidden* within the objects themselves. This **information hiding**, as we’ll see, is crucial to good software engineering.

Inheritance

A new class of objects can be created quickly and conveniently by **inheritance**—the new class absorbs the characteristics of an existing class, possibly customizing them and adding unique characteristics of its own. In our car analogy, an object of class “convertible” certainly *is an* object of the more *general* class “automobile,” but more *specifically*, the roof can be raised or lowered.

Object-Oriented Analysis and Design (OOAD)

Soon you’ll be writing programs in Java. How will you create the **code** (i.e., the program instructions) for your programs? Perhaps, like many programmers, you’ll simply turn on your computer and start typing. This approach may work for small programs (like the ones we present in the early chapters of the book), but what if you were asked to create a software system to control thousands of automated teller machines for a major bank? Or suppose you were asked to work on a team of 1,000 software developers building the next U.S. air traffic control system? For projects so large and complex, you should not simply sit down and start writing programs.

To create the best solutions, you should follow a detailed **analysis** process for determining your project’s **requirements** (i.e., defining *what* the system is supposed to do) and developing a **design** that satisfies them (i.e., deciding *how* the system should do it). Ideally, you’d go through this process and carefully review the design (and have your design reviewed by other software professionals) before writing any code. If this process involves analyzing and designing your system from an object-oriented point of view, it’s called an **object-oriented analysis and design (OOAD) process**. Languages like Java are object oriented. Programming in such a language, called **object-oriented programming (OOP)**, allows you to implement an object-oriented design as a working system.

The UML (Unified Modeling Language)

Although many different OOAD processes exist, a single graphical language for communicating the results of *any* OOAD process has come into wide use. This language, known as the Unified Modeling Language (UML), is now the most widely used graphical scheme for modeling object-oriented systems. We present our first UML diagrams in Chapters 3 and 4, then use them in our deeper treatment of object-oriented programming through Chapter 11. In our *optional* ATM Software Engineering Case Study in Chapters 12–13 we present a simple subset of the UML’s features as we guide you through an object-oriented design experience.

1.7 Operating Systems

Operating systems are software systems that make using computers more convenient for users, application developers and system administrators. Operating systems provide services

that allow each application to execute safely, efficiently and *concurrently* (i.e., in parallel) with other applications. The software that contains the core components of the operating system is called the **kernel**. Popular desktop operating systems include Linux, Windows 7 and Mac OS X. Popular mobile operating systems used in smartphones and tablets include Google's Android, BlackBerry OS and Apple's iOS (for its iPhone, iPad and iPod Touch devices).

Windows—A Proprietary Operating System

In the mid-1980s, Microsoft developed the **Windows operating system**, consisting of a graphical user interface built on top of DOS—an enormously popular personal-computer operating system of the time that users interacted with by typing commands. Windows borrowed from many concepts (such as icons, menus and windows) popularized by early Apple Macintosh operating systems and originally developed by Xerox PARC. Windows 7 is Microsoft's latest operating system—its features include enhancements to the user interface, faster startup times, further refinement of security features, touch-screen and multi-touch support, and more. Windows is a *proprietary* operating system—it's controlled by one company exclusively. Windows is by far the world's most widely used operating system.

Linux—An Open-Source Operating System

The Linux operating system is perhaps the greatest success of the *open-source* movement. **Open-source software** is a software development style that departs from the *proprietary* development that dominated software's early years. With open-source development, individuals and companies contribute their efforts in developing, maintaining and evolving software in exchange for the right to use that software for their own purposes, typically at no charge. Open-source code is often scrutinized by a much larger audience than proprietary software, so errors often get removed faster. Open source also encourages more innovation. Sun open sourced its implementation of the Java Development Kit and many of its related Java technologies.

Some organizations in the open-source community are the Eclipse Foundation (the Eclipse Integrated Development Environment helps Java programmers conveniently develop software), the Mozilla Foundation (creators of the Firefox web browser), the Apache Software Foundation (creators of the Apache web server used to develop web-based applications) and SourceForge (which provides the tools for managing open source projects—it has over 260,000 of them under development). Rapid improvements to computing and communications, decreasing costs and open-source software have made it much easier and more economical to create a software-based business now than just a few decades ago. A great example is Facebook, which was launched from a college dorm room and built with open-source software.⁷

The **Linux** kernel is the core of the most popular open-source, freely distributed, full-featured operating system. It's developed by a loosely organized team of volunteers, and is popular in servers, personal computers and embedded systems. Unlike that of proprietary operating systems like Microsoft's Windows and Apple's Mac OS X, Linux source code (the program code) is available to the public for examination and modification and is free to download and install. As a result, users of the operating system benefit from a community of developers actively debugging and improving the kernel, an absence of licensing

7. developers.facebook.com/opensource/.

fees and restrictions, and the ability to completely customize the operating system to meet specific needs.

In 1991, Linus Torvalds, a 21-year-old student at the University of Helsinki, Finland, began developing the Linux kernel as a hobby. (The name Linux is derived from “Linus” and “UNIX”—an operating system developed by Bell Labs in 1969.) Torvalds wished to improve upon the design of Minix, an educational operating system created by Professor Andrew Tanenbaum of the Vrije Universiteit in Amsterdam. The Minix source code was publicly available to allow professors to demonstrate basic operating-system implementation concepts to their students.

Torvalds released the first version of Linux in 1991. The favorable response led to the creation of a community that has continued to develop and support Linux. Developers downloaded, tested, and modified the Linux code, submitting bug fixes and feedback to Torvalds, who reviewed them and applied the improvements to the code.

The 1994 release of Linux included many features commonly found in a mature operating system, making Linux a viable alternative to UNIX. Enterprise systems companies such as IBM and Oracle became increasingly interested in Linux as it continued to stabilize and spread to new platforms.

A variety of issues—such as Microsoft’s market power, the small number of user-friendly Linux applications and the diversity of Linux distributions, such as Red Hat Linux, Ubuntu Linux and many others—have prevented widespread Linux use on desktop computers. But Linux has become extremely popular on servers and in embedded systems, such as Google’s Android-based smartphones.

Android

Android—the fastest growing mobile and smartphone operating system—is based on the Linux kernel and Java. Experienced Java programmers can quickly dive into Android development. One benefit of developing Android apps is the openness of the platform. The operating system is open source and free.

The Android operating system was developed by Android, Inc., which was acquired by Google in 2005. In 2007, the Open Handset Alliance™—a consortium of 34 companies initially and 79 by 2010—was formed to continue developing Android. As of December 2010, more than 300,000 Android smartphones were being activated each day!⁸ Android smartphones are now outselling iPhones.⁹ The Android operating system is used in numerous smartphones (such as the Motorola Droid, HTC EVO™ 4G, Samsung Vibrant™ and many more), e-reader devices (such as the Barnes and Noble Nook™), tablet computers (such as the Dell Streak, the Samsung Galaxy Tab and more), in-store touch-screen kiosks, cars, robots and multimedia players.

Android smartphones include the functionality of a mobile phone, Internet client (for web browsing and Internet communication), MP3 player, gaming console, digital camera and more, wrapped into handheld devices with full-color *multitouch screens*—these allow you to control the device with *gestures* involving one touch or multiple simultaneous touches. You can download apps directly onto your Android device through Android Market and other app marketplaces. As of December 2010, there were over 200,000 apps in Google’s Android Market.

8. www.pcmag.com/article2/0,2817,2374076,00.asp.

9. mashable.com/2010/08/02/android-outselling-iphone-2/.

Android App-Development Chapters on the Companion Website

Because of the tremendous interest in Android-based devices and apps, we've included on the book's companion website a three-chapter introduction to Android app development from our new book, *Android for Programmers: An App-Driven Approach*. After you learn Java, you'll find it straightforward to begin developing and running Android apps. You can place your apps on the online Android Market (www.market.android.com) and if they're successful, you may even be able to launch a business. Just remember—Facebook, Microsoft and Dell were all launched from dorm rooms.

1.8 Programming Languages

In this section, we provide brief comments on several popular programming languages (Fig. 1.5). In the next section we introduce Java.

Programming language	Description
Fortran	Fortran (FORMula TRANslator) was developed by IBM Corporation in the mid-1950s to be used for scientific and engineering applications that require complex mathematical computations. It's still widely used and its latest versions are object oriented.
COBOL	COBOL (COMmon Business Oriented Language) was developed in the late 1950s by computer manufacturers, the U.S. government and industrial computer users based on a language developed by Grace Hopper, a career U.S. Navy officer and computer scientist. COBOL is still widely used for commercial applications that require precise and efficient manipulation of large amounts of data. Its latest version supports object-oriented programming.
Pascal	Research in the 1960s resulted in <i>structured programming</i> —a disciplined approach to writing programs that are clearer, easier to test and debug and easier to modify than large programs produced with previous techniques. One of the more tangible results of this research was the development of Pascal by Professor Niklaus Wirth in 1971. It was designed for teaching structured programming and was popular in college courses for several decades.
Ada	Ada, based on Pascal, was developed under the sponsorship of the U.S. Department of Defense (DOD) during the 1970s and early 1980s. The DOD wanted a single language that would fill most of its needs. The Pascal-based language was named after Lady Ada Lovelace, daughter of the poet Lord Byron. She's credited with writing the world's first computer program in the early 1800s (for the Analytical Engine mechanical computing device designed by Charles Babbage). Its latest version supports object-oriented programming.
Basic	Basic was developed in the 1960s at Dartmouth College to introduce novices to programming. Many of its latest versions are object oriented.
C	C was implemented in 1972 by Dennis Ritchie at Bell Laboratories. It initially became widely known as the UNIX operating system's development language. Today, most of the code for general-purpose operating systems is written in C or C++.

Fig. 1.5 | Other programming languages. (Part 1 of 2.)

Programming language	Description
C++	C++, an extension of C, was developed by Bjarne Stroustrup in the early 1980s at Bell Laboratories. C++ provides a number of features that “spruce up” the C language, but more important, it provides capabilities for object-oriented programming.
Objective-C	Objective-C is an object-oriented language based on C. It was developed in the early 1980s and later acquired by Next, which in turn was acquired by Apple. It has become the key programming language for the Mac OS X operating system and all iOS-powered devices (such as iPods, iPhones and iPads).
Visual Basic	Microsoft’s Visual Basic language was introduced in the early 1990s to simplify the development of Microsoft Windows applications. Its latest versions support object-oriented programming.
Visual C#	Microsoft’s three primary object-oriented programming languages are Visual Basic, Visual C++ (based on C++) and C# (based on C++ and Java, and developed for integrating the Internet and the web into computer applications).
PHP	PHP is an object-oriented, “open-source” (see Section 1.7) “scripting” language supported by a community of users and developers and is used by numerous websites including Wikipedia and Facebook. PHP is platform independent—implementations exist for all major UNIX, Linux, Mac and Windows operating systems. PHP also supports many databases, including MySQL.
Python	Python, another object-oriented scripting language, was released publicly in 1991. Developed by Guido van Rossum of the National Research Institute for Mathematics and Computer Science in Amsterdam (CWI), Python draws heavily from Modula-3—a systems programming language. Python is “extendible”—it can be extended through classes and programming interfaces.
JavaScript	JavaScript is the most widely used scripting language. It’s primarily used to add programmability to web pages—for example, animations and interactivity with the user. It’s provided with all major web browsers.
Ruby on Rails	Ruby—created in the mid-1990s by Yukihiro Matsumoto—is an open-source, object-oriented programming language with a simple syntax that’s similar to Python. Ruby on Rails combines the scripting language Ruby with the Rails web application framework developed by 37Signals. Their book, <i>Getting Real</i> (gettingreal.37signals.com/toc.php), is a must read for web developers. Many Ruby on Rails developers have reported productivity gains over other languages when developing database-intensive web applications. Ruby on Rails was used to build Twitter’s user interface.
Scala	Scala (www.scala-lang.org/node/273)—short for “scalable language”—was designed by Martin Odersky, a professor at École Polytechnique Fédérale de Lausanne (EPFL) in Switzerland. Released in 2003, Scala uses both the object-oriented and functional programming paradigms and is designed to integrate with Java. Programming in Scala can reduce the amount of code in your applications significantly. Twitter and Foursquare use Scala.

Fig. 1.5 | Other programming languages. (Part 2 of 2.)

1.9 Java and a Typical Java Development Environment

The microprocessor revolution's most important contribution to date is that it made possible the development of personal computers. Microprocessors are having a profound impact in intelligent consumer-electronic devices. Recognizing this, Sun Microsystems in 1991 funded an internal corporate research project led by James Gosling, which resulted in a C++-based object-oriented programming language Sun called Java.

A key goal of Java is to be able to write programs that will run on a great variety of computer systems and computer-control devices. This is sometimes called “write once, run anywhere.”

The web exploded in popularity in 1993, and Sun saw the potential of using Java to add *dynamic content*, such as interactivity and animations, to web pages. Java garnered the attention of the business community because of the phenomenal interest in the web. Java is now used to develop large-scale enterprise applications, to enhance the functionality of web servers (the computers that provide the content we see in our web browsers), to provide applications for consumer devices (e.g., cell phones, smartphones, television set-top boxes and more) and for many other purposes. Sun Microsystems was acquired by Oracle in 2009. At the JavaOne 2010 conference, Oracle announced that 97% of enterprise desktops, three billion handsets, and 80 million television devices run Java. There are currently over 9 million Java developers, up from 4.5 million in 2005.¹⁰ Java is now the most widely used software development language in the world.

Java Class Libraries

You can create each class and method you need to form your Java programs. However, most Java programmers take advantage of the rich collections of existing classes and methods in the **Java class libraries**, which are also known as the **Java APIs (Application Programming Interfaces)**.



Performance Tip 1.1

Using Java API classes and methods instead of writing your own versions can improve program performance, because they're carefully written to perform efficiently. This also shortens program development time.



Portability Tip 1.1

Although it's easier to write portable programs (i.e., programs that can run on many different types of computers) in Java than in most other programming languages, differences between compilers, JVMs and computers can make portability difficult to achieve. Simply writing programs in Java does not guarantee portability.

We now explain the commonly used steps in creating and executing a Java application using a Java development environment (illustrated in Figs. 1.6–1.10). Java programs normally go through five phases—edit, compile, load, verify and execute. We discuss these phases in the context of the Java SE Development Kit (JDK). You can download the most up-to-date JDK and its documentation from www.oracle.com/technetwork/java/

10. jaxenter.com/how-many-java-developers-are-there-10462.html.

javase/downloads/index.html. Read the *Before You Begin* section of this book to ensure that you set up your computer properly to compile and execute Java programs. You may also want to visit Oracle’s New to Java Center at:

www.oracle.com/technetwork/topics/newtojava/overview/index.html

[*Note:* This website provides installation instructions for Windows, Linux and Mac OS X. If you aren’t using one of these operating systems, refer to the documentation for your system’s Java environment or ask your instructor how to accomplish these tasks based on your computer’s operating system. If you encounter a problem with this link or any others referenced in this book, please check www.deitel.com/books/jhttp9/ for errata and please notify us by e-mail at deitel@deitel.com.]

Phase 1: Creating a Program

Phase 1 consists of editing a file with an *editor program*, normally known simply as an *editor* (Fig. 1.6). You type a Java program (typically referred to as **source code**) using the editor, make any necessary corrections and save the program on a secondary storage device, such as your hard drive. A file name ending with the **.java extension** indicates that the file contains Java source code.

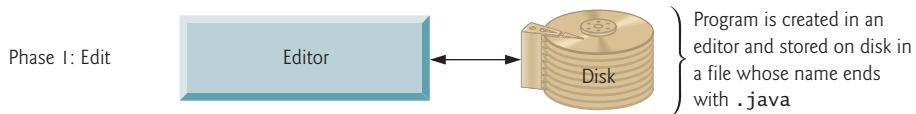

Fig. 1.6 | Typical Java development environment—editing phase.

Two editors widely used on Linux systems are *vi* and *emacs*. On Windows, Notepad will suffice. Many freeware and shareware editors are also available online, including Edit-Plus (www.ediplus.com), TextPad (www.textpad.com) and jEdit (www.jedit.org).

For organizations that develop substantial information systems, **integrated development environments (IDEs)** are available from many major software suppliers. IDEs provide tools that support the software development process, including editors for writing and editing programs and debuggers for locating **logic errors**—errors that cause programs to execute incorrectly. Popular IDEs include Eclipse (www.eclipse.org) and NetBeans (www.netbeans.org).

Phase 2: Compiling a Java Program into Bytecodes

In Phase 2, you use the command **javac** (the **Java compiler**) to **compile** a program (Fig. 1.7). For example, to compile a program called `Welcome.java`, you’d type

```
javac Welcome.java
```

in the command window of your system (i.e., the **Command Prompt** in Windows, the *shell prompt* in Linux or the Terminal application in Mac OS X). If the program compiles, the compiler produces a **.class** file called `Welcome.class` that contains the compiled version of the program.

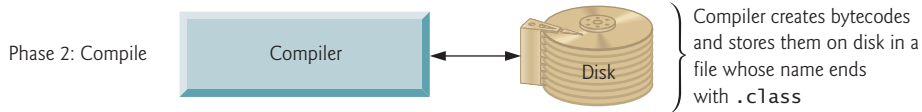

Fig. 1.7 | Typical Java development environment—compilation phase.

The Java compiler translates Java source code into **bytecodes** that represent the tasks to execute in the execution phase (Phase 5). Bytecodes are executed by the **Java Virtual Machine (JVM)**—a part of the JDK and the foundation of the Java platform. A **virtual machine (VM)** is a software application that simulates a computer but hides the underlying operating system and hardware from the programs that interact with it. If the same VM is implemented on many computer platforms, applications that it executes can be used on all those platforms. The JVM is one of the most widely used virtual machines. Microsoft's .NET uses a similar virtual-machine architecture.

Unlike machine language, which is dependent on specific computer hardware, bytecodes are platform independent—they do not depend on a particular hardware platform. So, Java's bytecodes are **portable**—without recompiling the source code, the same bytecodes can execute on any platform containing a JVM that understands the version of Java in which the bytecodes were compiled. The JVM is invoked by the **java** command. For example, to execute a Java application called `Welcome`, you'd type the command

```
java Welcome
```

in a command window to invoke the JVM, which would then initiate the steps necessary to execute the application. This begins Phase 3.

Phase 3: Loading a Program into Memory

In Phase 3, the JVM places the program in memory to execute it—this is known as **loading** (Fig. 1.8). The JVM's **class loader** takes the `.class` files containing the program's bytecodes and transfers them to primary memory. The class loader also loads any of the `.class` files provided by Java that your program uses. The `.class` files can be loaded from a disk on your system or over a network (e.g., your local college or company network, or the Internet).

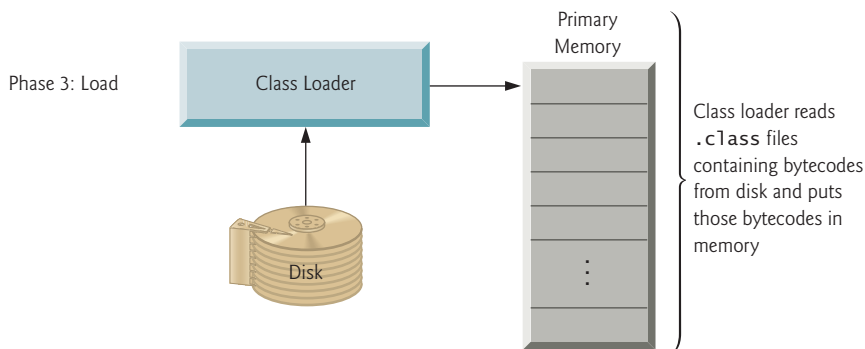

Fig. 1.8 | Typical Java development environment—loading phase.

Phase 4: Bytecode Verification

In Phase 4, as the classes are loaded, the **bytecode verifier** examines their bytecodes to ensure that they're valid and do not violate Java's security restrictions (Fig. 1.9). Java enforces strong security to make sure that Java programs arriving over the network do not damage your files or your system (as computer viruses and worms might).

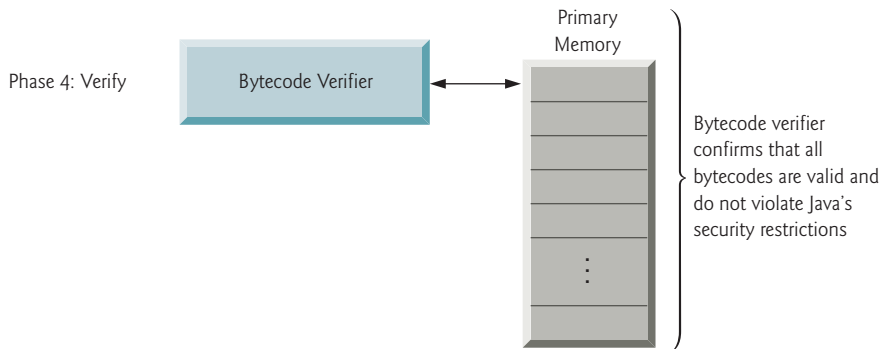

Fig. 1.9 | Typical Java development environment—verification phase.

Phase 5: Execution

In Phase 5, the JVM **executes** the program's bytecodes, thus performing the actions specified by the program (Fig. 1.10). In early Java versions, the JVM was simply an interpreter for Java bytecodes. This caused most Java programs to execute slowly, because the JVM would interpret and execute one bytecode at a time. Some modern computer architectures can execute several instructions in parallel. Today's JVMs typically execute bytecodes using a combination of interpretation and so-called **just-in-time (JIT) compilation**. In this process, the JVM analyzes the bytecodes as they're interpreted, searching for *hot spots*—parts of the bytecodes that execute frequently. For these parts, a **just-in-time (JIT) compiler**—known as the **Java HotSpot compiler**—translates the bytecodes into the underlying computer's machine language. When the JVM encounters these compiled parts again,

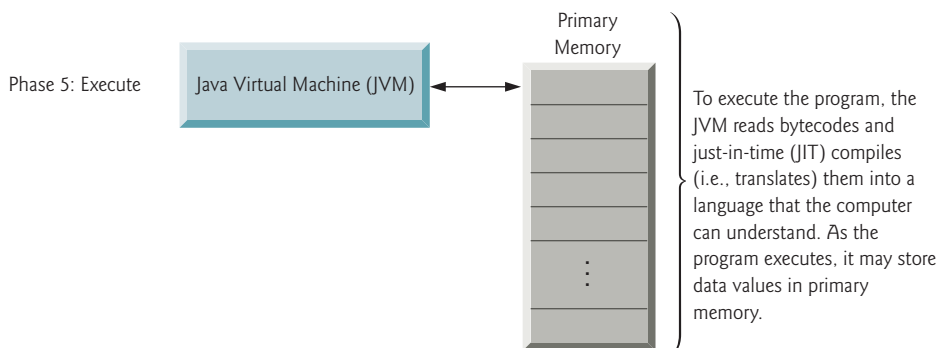

Fig. 1.10 | Typical Java development environment—execution phase.

the faster machine-language code executes. Thus Java programs actually go through *two* compilation phases—one in which source code is translated into bytecodes (for portability across JVMs on different computer platforms) and a second in which, during execution, the bytecodes are translated into machine language for the actual computer on which the program executes.

Problems That May Occur at Execution Time

Programs might not work on the first try. Each of the preceding phases can fail because of various errors that we'll discuss throughout this book. For example, an executing program might try to divide by zero (an illegal operation for whole-number arithmetic in Java). This would cause the Java program to display an error message. If this occurred, you'd have to return to the edit phase, make the necessary corrections and proceed through the remaining phases again to determine that the corrections fixed the problem(s). [*Note:* Most programs in Java input or output data. When we say that a program displays a message, we normally mean that it displays that message on your computer's screen. Messages and other data may be output to other devices, such as disks and hardcopy printers, or even to a network for transmission to other computers.]



Common Programming Error 1.1

*Errors such as division by zero occur as a program runs, so they're called **runtime errors** or **execution-time errors**. **Fatal runtime errors** cause programs to terminate immediately without having successfully performed their jobs. **Nonfatal runtime errors** allow programs to run to completion, often producing incorrect results.*

1.10 Test-Driving a Java Application

In this section, you'll run and interact with your first Java application. You'll begin by running an ATM application that simulates the transactions that take place when you use an ATM machine (e.g., withdrawing money, making deposits and checking your account balances). You'll learn how to build this application in the *optional*, object-oriented case study included in Chapters 12–13. For the purpose of this section, we assume you're running Microsoft Windows.¹¹

In the following steps, you'll run the application and perform various transactions. The elements and functionality you see here are typical of what you'll learn to program in this book. [*Note:* We use fonts to distinguish between features you see on a screen (e.g., the **Command Prompt**) and elements that are not directly related to a screen. Our convention is to emphasize screen features like titles and menus (e.g., the **File** menu) in a semibold **sans-serif Helvetica** font and to emphasize nonscreen elements, such as file names or input (e.g., `ProgramName.java`) in a sans-serif **Lucida** font. As you've already noticed, the defining occurrence of each key term in the text is set in **bold maroon**. In the figures in this section, we highlight in yellow the user input required by each step and point out sig-

11. At www.deitel.com/books/jhtp9/, we provide a Linux version of this test-drive. We also provide links to videos that help you get started with several popular integrated development environments (IDEs), including Java SE Development Kit 6 for Windows, Eclipse SDK for Windows, NetBeans, jGRASP, DrJava, BlueJ and TestPad Text Editor for Windows.

nificant parts of the application. To make these features more visible, we've changed the background color of the **Command Prompt** windows to white and the foreground color to black.] This is a simple text-only version. Later in the book, you'll learn the techniques to rework this using GUI (graphical user interface) techniques.

1. *Checking your setup.* Read the Before You Begin section of the book to confirm that you've set up Java properly on your computer and that you've copied the book's examples to your hard drive.
2. *Locating the completed application.* Open a **Command Prompt** window. This can be done by selecting **Start > All Programs > Accessories > Command Prompt**. Change to the ATM application directory by typing `cd C:\examples\ch01\ATM`, then press *Enter* (Fig. 1.11). The command `cd` is used to change directories.

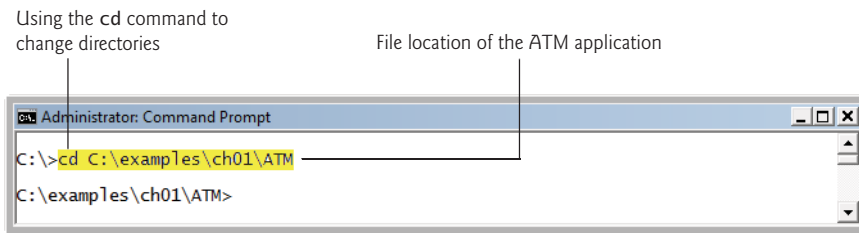

Fig. 1.11 | Opening a **Command Prompt** and changing directories.

3. *Running the ATM application.* Type the command `java ATMCaseStudy` and press *Enter* (Fig. 1.12). Recall that the `java` command, followed by the name of the application's `.class` file (in this case, `ATMCaseStudy`), executes the application. Specifying the `.class` extension when using the `java` command results in an error. [*Note:* Java commands are case sensitive. It's important to type the name of this application with a capital A, T and M in "ATM," a capital C in "Case" and a capital S in "Study." Otherwise, the application will not execute.] If you receive the error message, "Exception in thread "main" java.lang.NoClassDefFoundError: ATMCaseStudy," your system has a CLASSPATH problem. Please refer to the Before You Begin section of the book for instructions to help you fix this problem.

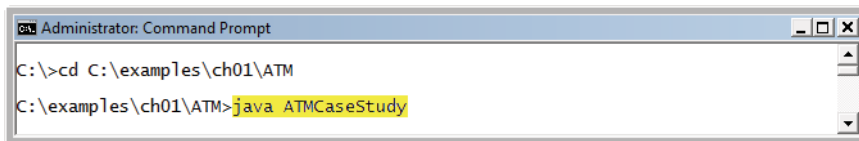

Fig. 1.12 | Using the `java` command to execute the ATM application.

4. *Entering an account number.* When the application first executes, it displays a "Welcome!" greeting and prompts you for an account number. Type 12345 at the "Please enter your account number:" prompt (Fig. 1.13) and press *Enter*.

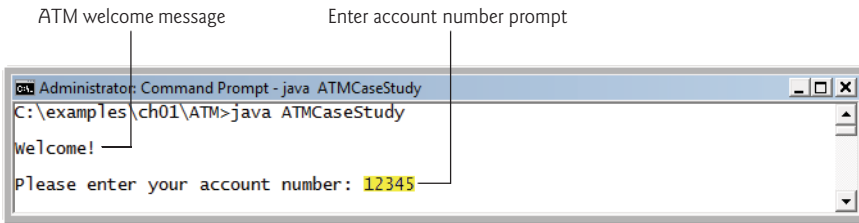

Fig. 1.13 | Prompting the user for an account number.

5. *Entering a PIN.* Once a valid account number is entered, the application displays the prompt "Enter your PIN:". Type "54321" as your valid PIN (Personal Identification Number) and press *Enter*. The ATM main menu containing a list of options will be displayed (Fig. 1.14). We'll show how you can enter a PIN privately using a `JPasswordField` in Chapter 14.

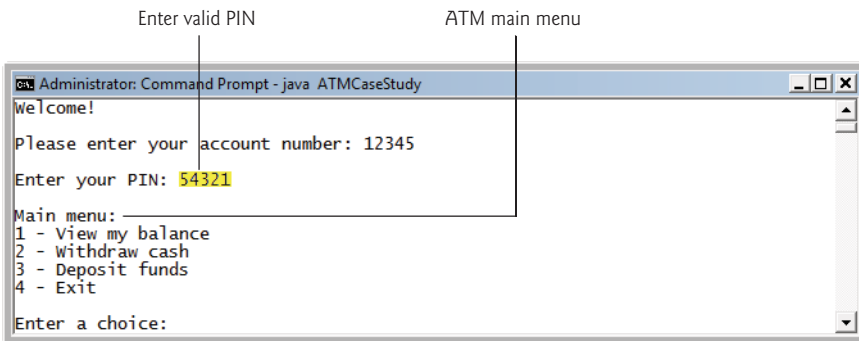

Fig. 1.14 | Entering a valid PIN number and displaying the ATM application's main menu.

6. *Viewing the account balance.* Select option 1, "View my balance", from the ATM menu (Fig. 1.15). The application then displays two numbers—the Available balance (\$1000.00) and the Total balance (\$1200.00). The available balance is the maximum amount of money in your account which is available for withdrawal at a given time. In some cases, certain funds, such as recent deposits, are not immediately available for the user to withdraw, so the available balance may be less than the total balance, as it is here. After the account-balance information is shown, the application's main menu is displayed again.
7. *Withdrawing money from the account.* Select option 2, "Withdraw cash", from the application menu. You're then presented (Fig. 1.16) with a list of dollar amounts (e.g., 20, 40, 60, 100 and 200). You're also given the option to cancel the transaction and return to the main menu. Withdraw \$100 by selecting option 4. The application displays "Please take your cash now." and returns to the main menu. [Note: Unfortunately, this application only *simulates* the behavior of a real ATM and thus does not actually dispense money.]

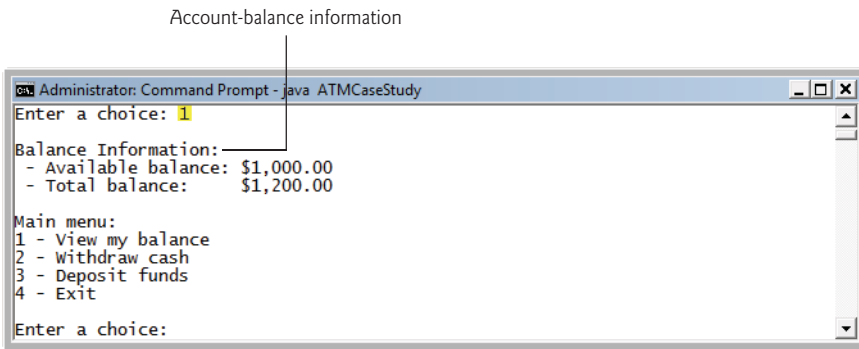

Fig. 1.15 | ATM application displaying user account-balance information.

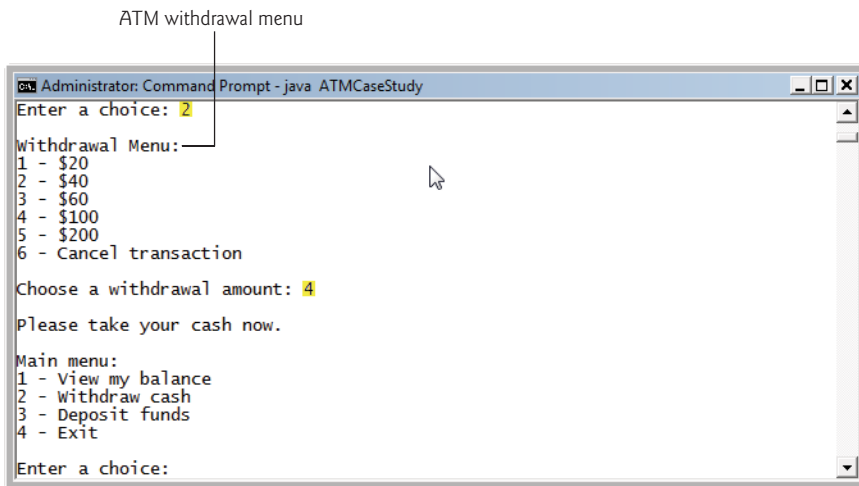
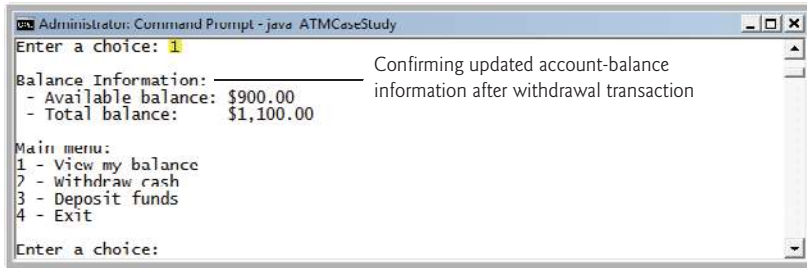

Fig. 1.16 | Withdrawing money from the account and returning to the main menu.

8. *Confirming that the account information has been updated.* From the main menu, select option 1 again to view your current account balance (Fig. 1.17). Both the available balance and the total balance have been updated to reflect your withdrawal transaction.
9. *Ending the transaction.* To end your current ATM session, select option 4, "Exit", from the main menu (Fig. 1.18). The ATM will exit the system and display a good-bye message to the user. The application will then return to its original prompt, asking for the next user's account number.
10. *Exiting the ATM and closing the Command Prompt window.* Most applications provide an option to exit and return to the **Command Prompt** directory from which the application was run. A real ATM does not provide a user with the option to turn off the ATM. Rather, when a user has completed all desired transactions and chosen



```
Administrator: Command Prompt - java ATMCaseStudy
Enter a choice: 1
Balance Information: _____ Confirming updated account-balance
- Available balance: $900.00      information after withdrawal transaction
- Total balance: $1,100.00
Main menu:
1 - View my balance
2 - Withdraw cash
3 - Deposit funds
4 - Exit
Enter a choice:
```

Fig. 1.17 | Checking the new balance.

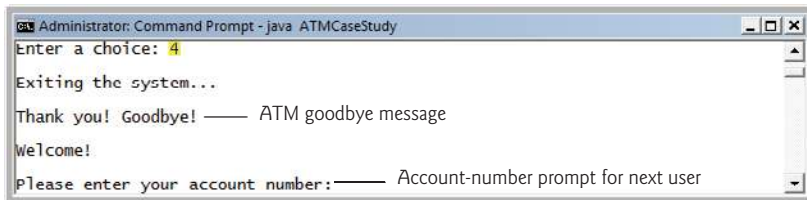

```
Administrator: Command Prompt - java ATMCaseStudy
Enter a choice: 4
Exiting the system...
Thank you! Goodbye! — ATM goodbye message
Welcome!
Please enter your account number: _____ Account-number prompt for next user
```

Fig. 1.18 | Ending an ATM transaction session.

the menu option to exit, the ATM resets itself and displays a prompt for the next user's account number. As Fig. 1.18 illustrates, the ATM application here behaves similarly. Choosing the menu option to exit ends only the current user's ATM session, not the entire ATM application. To actually exit the ATM application, click the close (x) button in the upper-right corner of the **Command Prompt** window. Closing the window causes the running application to terminate.

1.11 Web 2.0: Going Social

The web literally exploded in the mid-to-late 1990s, but the “dot com” economic bust brought hard times in the early 2000s. The resurgence that began in 2004 or so has been named **Web 2.0**. Google is widely regarded as the signature company of Web 2.0. Some other companies with “Web 2.0 characteristics” are YouTube (video sharing), FaceBook (social networking), Twitter (microblogging), Groupon (social commerce), Foursquare (mobile check-in), Salesforce (business software offered as online services), Craigslist (free classified listings), Flickr (photo sharing), Second Life (a virtual world), Skype (Internet telephony) and Wikipedia (a free online encyclopedia).

Google

In 1996, Stanford computer science Ph.D. candidates Larry Page and Sergey Brin began collaborating on a new search engine. In 1997, they changed the name to Google—a play on the mathematical term *googol*, a quantity represented by the number “one” followed by 100 “zeros” (or 10^{100})—a staggeringly large number. Google's ability to return extremely accurate search results quickly helped it become the most widely used search engine and one of the most popular websites in the world.

Google continues to be an innovator in search technologies. For example, Google Goggles is a fascinating mobile app (available on Android and iPhone) that allows you to perform a Google search using a photo rather than entering text. You simply take pictures of a landmarks, books (covers or barcodes), logos, art or wine bottle labels, and Google Goggles scans the photo and returns search results. You can also take a picture of text (for example, a restaurant menu or a sign) and Google Goggles will translate it for you.

Web Services and Mashups

We include in this book a substantial treatment of web services (Chapter 31) and introduce the applications-development methodology of *mashups* in which you can rapidly develop powerful and intriguing applications by combining (often free) complementary web services and other forms of information feeds (Fig. 1.19). One of the first mashups was www.housingmaps.com, which quickly combines the real estate listings provided by www.craigslist.org with the mapping capabilities of *Google Maps* to offer maps that show the locations of apartments for rent in a given area.

Web services source	How they're used
Google Maps	Mapping services
Facebook	Social networking
Foursquare	Mobile check-in
LinkedIn	Social networking for business
YouTube	Video search
Twitter	Microblogging
Groupon	Social commerce
Netflix	Movie rentals
eBay	Internet auctions
Wikipedia	Collaborative encyclopedia
PayPal	Payments
Last.fm	Internet radio
Amazon eCommerce	Shopping for books and more
Salesforce.com	Customer Relationship Management (CRM)
Skype	Internet telephony
Microsoft Bing	Search
Flickr	Photo sharing
Zillow	Real estate pricing
Yahoo Search	Search
WeatherBug	Weather

Fig. 1.19 | Some popular web services (www.programmableweb.com/apis/directory/1?sort=mashups).

Ajax

Ajax is one of the premier Web 2.0 software technologies. Ajax helps Internet-based applications perform like desktop applications—a difficult task, given that such applications

suffer transmission delays as data is shuttled back and forth between your computer and server computers on the Internet. Using Ajax, applications like Google Maps have achieved excellent performance and approach the look-and-feel of desktop applications. Although we don't discuss "raw" Ajax programming (which is quite complex) in this text, we do show in Chapter 30 how to build Ajax-enabled applications using JavaServer Faces (JSF) Ajax-enabled components.

Social Applications

Over the last several years, there's been a tremendous increase in the number of social applications on the web. Even though the computer industry is mature, these sites were still able to become phenomenally successful in a relatively short period of time. Figure 1.20 discusses a few of the social applications that are making an impact.

Company	Description
Facebook	Facebook was launched from a Harvard dorm room in 2004 by classmates Mark Zuckerberg, Chris Hughes, Dustin Moskovitz and Eduardo Saverin and is already worth an estimated \$70 billion. By January 2011, Facebook was the most active site on the Internet with more than 600 million users—nearly 9% of the Earth's population—who spend 700 billion minutes on Facebook per month (www.time.com/time/specials/packages/article/0,28804,2036683_2037183,00.html). At its current growth rate (about 5% per month), Facebook will reach one billion users in 2012, out of the two billion Internet users! The activity on the site makes it extremely attractive for application developers. Each day, over 20 million applications are installed by Facebook users (www.facebook.com/press/info.php?statistics).
Twitter	Twitter was founded in 2006 by Jack Dorsey, Evan Williams and Isaac "Biz" Stone—all from the podcast company, Odeo. Twitter has revolutionized <i>microblogging</i> . Users post tweets—messages of up to 140 characters long. Approximately 95 million tweets are posted per day (twitter.com/about). You can follow the tweets of friends, celebrities, businesses, government representatives (including the U.S. President, who has 6.3 million followers), etc., or you can follow tweets by subject to track news, trends and more. At the time of this writing, Lady Gaga had the most followers (over 7.7 million). Twitter has become the point of origin for many breaking news stories worldwide.
Groupon	Groupon, a <i>social commerce</i> site, was launched by Andrew Mason in 2008. By January 2011, the company was valued around \$15 billion, making it the fastest growing company ever! It's now available in hundreds of markets worldwide. Groupon offers one daily deal in each market for restaurants, retailers, services, attractions and more. Deals are activated only after a minimum number of people sign up to buy the product or service. If you sign up for a deal and it has yet to meet the minimum, you might be inclined to tell others about the deal by email, Facebook, Twitter, etc. If the deal does not meet the minimum sales, it's cancelled. One of the most successful national Groupon deals to date was a certificate for \$50 worth of merchandise from a major apparel company for \$25. Over 440,000 vouchers were sold in one day.

Fig. 1.20 | Social applications. (Part 1 of 2.)

Company	Description
Foursquare	Foursquare—launched in 2009 by Dennis Crowley and Naveen Selvadurai—is a mobile <i>check-in</i> application that allows you to notify your friends of your whereabouts. You can download the app to your smartphone and link it to your Facebook and Twitter accounts so your friends can follow you from multiple platforms. If you do not have a smartphone, you can check in by text message. Foursquare uses GPS to determine your exact location. Businesses use Foursquare to send offers to users in the area. Launched in March 2009, Foursquare already has over 5 million users worldwide.
Skype	Skype is a software product that allows you to make mostly free voice and video calls over the Internet using a technology called <i>Voice over IP</i> (IP stands for “Internet Protocol”). Skype was founded in 2003 by Niklas Zennström and Dane Janus Friis. Just two years later, the company was sold to eBay for \$2.6 billion.
YouTube	YouTube is a video-sharing site that was founded in 2005. Within one year, the company was purchased by Google for \$1.65 billion. YouTube now accounts for 10% of all Internet traffic (www.webpronews.com/topnews/2010/04/16/facebook-and-youtube-get-the-most-business-internet-traffic). Within one week of the release of Apple’s iPhone 3GS—the first iPhone model to offer video—mobile uploads to YouTube grew 400% (www.hypebot.com/hypebot/2009/06/youtube-reports-1700-jump-in-mobile-video.html).

Fig. 1.20 | Social applications. (Part 2 of 2.)

1.12 Software Technologies

Figure 1.21 lists a number of buzzwords that you’ll hear in the software development community. We’ve created Resource Centers on most of these topics, with more on the way.

Technology	Description
Agile software development	Agile software development is a set of methodologies that try to get software implemented faster and using fewer resources than previous methodologies. Check out the Agile Alliance (www.agilealliance.org) and the Agile Manifesto (www.agilemanifesto.org).
Refactoring	Refactoring involves reworking programs to make them clearer and easier to maintain while preserving their correctness and functionality. It’s widely employed with agile development methodologies. Many IDEs contain built-in <i>refactoring tools</i> to do major portions of the reworking automatically.
Design patterns	Design patterns are proven architectures for constructing flexible and maintainable object-oriented software. The field of design patterns tries to enumerate those recurring patterns, encouraging software designers to <i>reuse</i> them to develop better-quality software using less time, money and effort. We discuss Java design patterns in Appendix Q.

Fig. 1.21 | Software technologies. (Part 1 of 2.)

Technology	Description
LAMP	MySQL is an open-source database management system. PHP is the most popular open-source server-side “scripting” language for developing web applications. LAMP is an acronym for the open-source technologies that many developers use to build web applications—it stands for Linux, Apache, MySQL and PHP (or Perl or Python—two other scripting languages).
Software as a Service (SaaS)	Software has generally been viewed as a product; most software still is offered this way. To run an application, you buy it from a software vendor. You then install it on your computer and run it as needed. As new versions appear, you upgrade the software, often at considerable expense. This process can be cumbersome for organizations with tens of thousands of systems that must be maintained on a diverse array of computer equipment. With Software as a Service (SaaS) , the software runs on servers elsewhere on the Internet. When that server is updated, all clients worldwide see the new capabilities—no local installation is needed. You access the service through a browser. Browsers are quite portable, so you can run the same applications on a wide variety of computers from anywhere in the world. Salesforce.com, Google, and Microsoft’s Office Live and Windows Live all offer SaaS.
Platform as a Service (PaaS)	Platform as a Service (PaaS) provides a computing platform for developing and running applications as a service over the web, rather than installing the tools on your computer. PaaS providers include Google App Engine, Amazon EC2, Bungee Labs and more.
Cloud computing	SaaS and PaaS are examples of cloud computing in which software, platforms and infrastructure (e.g., processing power and storage) are hosted on demand over the Internet. This provides users with flexibility, scalability and cost savings. For example, consider a company’s data storage needs which can fluctuate significantly over the course of a year. Rather than investing in large-scale storage hardware—which can be costly to purchase, maintain and secure, and would most likely not be used to capacity at all times—the company could purchase cloud-based services (such as Amazon S3, Google Storage, Microsoft Windows Azure™, Nirvanix™ and others) dynamically as needed.
Software Development Kit (SDK)	Software Development Kits (SDKs) include the tools and documentation developers use to program applications. For example, you’ll use the Java Development Kit (JDK) to build and run Java applications.

Fig. 1.21 | Software technologies. (Part 2 of 2.)

Figure 1.22 describes software product release categories.

Version	Description
Alpha	<i>Alpha</i> software is the earliest release of a software product that’s still under active development. Alpha versions are often buggy, incomplete and unstable, and are released to a relatively small number of developers for testing new features, getting early feedback, etc.

Fig. 1.22 | Software product release terminology. (Part 1 of 2.)

Version	Description
Beta	<i>Beta</i> versions are released to a larger number of developers later in the development process after most major bugs have been fixed and new features are nearly complete. Beta software is more stable, but still subject to change.
Release candidates	<i>Release candidates</i> are generally <i>feature complete</i> and (supposedly) bug free, and ready for use by the community, which provides a diverse testing environment—the software is used on different systems, with varying constraints and for a variety of purposes. Any bugs that appear are corrected and eventually the final product is released to the general public. Software companies often distribute incremental updates over the Internet.
Continuous beta	Software that's developed using this approach generally does not have version numbers (for example, Google search or Gmail). The software, which is hosted in the cloud (not installed on your computer), is constantly evolving so that users always have the latest version.

Fig. 1.22 | Software product release terminology. (Part 2 of 2.)

1.13 Keeping Up-to-Date with Information Technologies

Figure 1.23 lists key technical and business publications that will help you stay up-to-date with the latest news and trends and technology. You can also find a growing list of Internet- and web-related Resource Centers at www.deitel.com/ResourceCenters.html.

Publication	URL
Bloomberg BusinessWeek	www.businessweek.com
CNET	news.cnet.com
Computer World	www.computerworld.com
Engadget	www.engadget.com
eWeek	www.eweek.com
Fast Company	www.fastcompany.com/
Fortune	money.cnn.com/magazines/fortune/
InfoWorld	www.infoworld.com
Mashable	mashable.com
PCWorld	www.pcworld.com
SD Times	www.sdtimes.com
Slashdot	slashdot.org/
Smarter Technology	www.smartertechnology.com
Technology Review	technologyreview.com
Techcrunch	techcrunch.com
Wired	www.wired.com

Fig. 1.23 | Technical and business publications.

1.14 Wrap-Up

In this chapter we discussed computer hardware, software, programming languages and operating systems. We overviewed a typical Java program development environment and you test-drove a Java application. We introduced the basics of object technology. You learned about some of the exciting recent developments in the computer field. We also discussed some key software development terminology.

In Chapter 2, you'll create your first Java applications. You'll see how programs display messages on the screen and obtain information from the user at the keyboard for processing. You'll use Java's primitive data types and arithmetic operators in calculations and use Java's equality and relational operators to write simple decision-making statements.

Self-Review Exercises

- 1.1** Fill in the blanks in each of the following statements:
- The company that popularized personal computing was _____.
 - The computer that made personal computing legitimate in business and industry was the _____.
 - Computers process data under the control of sets of instructions called _____.
 - The key logical units of the computer are the _____, _____, _____, _____, _____ and _____.
 - The three types of languages discussed in the chapter are _____, _____ and _____.
 - The programs that translate high-level language programs into machine language are called _____.
 - _____ is a smartphone operating system based on the Linux kernel and Java.
 - _____ software is generally feature complete and (supposedly) bug free, and ready for use by the community.
 - The Wii Remote, as well as many smartphones, use a(n) _____ which allows the device to respond to motion.
- 1.2** Fill in the blanks in each of the following sentences about the Java environment:
- The _____ command from the JDK executes a Java application.
 - The _____ command from the JDK compiles a Java program.
 - A Java program file must end with the _____ file extension.
 - When a Java program is compiled, the file produced by the compiler ends with the _____ file extension.
 - The file produced by the Java compiler contains _____ that are executed by the Java Virtual Machine.
- 1.3** Fill in the blanks in each of the following statements (based on Section 1.6):
- Objects have the property of _____—although objects may know how to communicate with one another across well-defined interfaces, they normally are not allowed to know how other objects are implemented.
 - Java programmers concentrate on creating _____, which contain fields and the set of methods that manipulate those fields and provide services to clients.
 - The process of analyzing and designing a system from an object-oriented point of view is called _____.
 - With _____, new classes of objects are derived by absorbing characteristics of existing classes, then adding unique characteristics of their own.

- e) _____ is a graphical language that allows people who design software systems to use an industry-standard notation to represent them.
- f) The size, shape, color and weight of an object are considered _____ of the object's class.

Answers to Self-Review Exercises

1.1 a) Apple. b) IBM Personal Computer. c) programs. d) input unit, output unit, memory unit, central processing unit, arithmetic and logic unit, secondary storage unit. e) machine languages, assembly languages, high-level languages. f) compilers. g) Android. h) Release candidate. i) accelerometer.

1.2 a) java. b) javac. c) .java. d) .class. e) bytecodes.

1.3 a) information hiding. b) classes. c) object-oriented analysis and design (OOAD). d) inheritance. e) The Unified Modeling Language (UML). f) attributes.

Exercises

1.4 Fill in the blanks in each of the following statements:

- a) The logical unit of the computer that receives information from outside the computer for use by the computer is the _____.
- b) The process of instructing the computer to solve a problem is called _____.
- c) _____ is a type of computer language that uses English-like abbreviations for machine-language instructions.
- d) _____ is a logical unit of the computer that sends information which has already been processed by the computer to various devices so that it may be used outside the computer.
- e) _____ and _____ are logical units of the computer that retain information.
- f) _____ is a logical unit of the computer that performs calculations.
- g) _____ is a logical unit of the computer that makes logical decisions.
- h) _____ languages are most convenient to the programmer for writing programs quickly and easily.
- i) The only language a computer can directly understand is that computer's _____.
- j) _____ is a logical unit of the computer that coordinates the activities of all the other logical units.

1.5 Fill in the blanks in each of the following statements:

- a) _____ is now used to develop large-scale enterprise applications, to enhance the functionality of web servers, to provide applications for consumer devices and for many other purposes.
- b) _____ initially became widely known as the development language of the Unix operating system.
- c) The Web 2.0 company _____ is the fastest growing company ever.
- d) The _____ programming language was developed by Bjarne Stroustrup in the early 1980s at Bell Laboratories.

1.6 Fill in the blanks in each of the following statements:

- a) Java programs normally go through five phases—_____, _____, _____, _____ and _____.
- b) A(n) _____ provides many tools that support the software development process, such as editors for writing and editing programs, debuggers for locating logic errors in programs, and many other features.

- c) The command `java` invokes the _____, which executes Java programs.
- d) A(n) _____ is a software application that simulates a computer, but hides the underlying operating system and hardware from the programs that interact with it.
- e) The _____ takes the `.class` files containing the program's bytecodes and transfers them to primary memory.
- f) The _____ examines bytecodes to ensure that they're valid.

1.7 Explain the two compilation phases of Java programs.

1.8 You're probably wearing on your wrist one of the world's most common types of objects—a watch. Discuss how each of the following terms and concepts applies to the notion of a watch: object, attributes, behaviors, class, inheritance (consider, for example, an alarm clock), abstraction, modeling, messages, encapsulation, interface and information hiding.

Making a Difference

Throughout the book we've included Making a Difference exercises in which you'll be asked to work on problems that really matter to individuals, communities, countries and the world. For more information about worldwide organizations working to make a difference, and for related programming project ideas, visit our Making a Difference Resource Center at www.deitel.com/makingadifference.

1.9 (*Test Drive: Carbon Footprint Calculator*) Some scientists believe that carbon emissions, especially from the burning of fossil fuels, contribute significantly to global warming and that this can be combatted if individuals take steps to limit their use of carbon-based fuels. Organizations and individuals are increasingly concerned about their “carbon footprints.” Websites such as TerraPass

www.terrapass.com/carbon-footprint-calculator/

and Carbon Footprint

www.carbonfootprint.com/calculator.aspx

provide carbon footprint calculators. Test-drive these calculators to determine your carbon footprint. Exercises in later chapters will ask you to program your own carbon footprint calculator. To prepare for this, research the formulas for calculating carbon footprints.

1.10 (*Test Drive: Body Mass Index Calculator*) By recent estimates, two-thirds of the people in the United States are overweight and about half of those are obese. This causes significant increases in illnesses such as diabetes and heart disease. To determine whether a person is overweight or obese, you can use a measure called the body mass index (BMI). The United States Department of Health and Human Services provides a BMI calculator at www.nhlbi.nih.gov/health/heart/bmi/. Use it to calculate your own BMI. An exercise in Chapter 2 will ask you to program your own BMI calculator. To prepare for this, research the formulas for calculating BMI.

1.11 (*Attributes of Hybrid Vehicles*) In this chapter you learned the basics of classes. Now you'll begin “fleshing out” aspects of a class called “Hybrid Vehicle.” Hybrid vehicles are becoming increasingly popular, because they often get much better mileage than purely gasoline-powered vehicles. Browse the web and study the features of four or five of today's popular hybrid cars, then list as many of their hybrid-related attributes as you can. For example, common attributes include city-miles-per-gallon and highway-miles-per-gallon. Also list the attributes of the batteries (type, weight, etc.).

1.12 (*Gender Neutrality*) Many people want to eliminate sexism in all forms of communication. You've been asked to create a program that can process a paragraph of text and replace gender-specific words with gender-neutral ones. Assuming that you've been given a list of gender-specific words and their gender-neutral replacements (e.g., replace “wife” by “spouse,” “man” by “person,” “daughter” by “child” and so on), explain the procedure you'd use to read through a paragraph of text and manually perform these replacements. How might your procedure generate a strange term

like “woperchild,” which is actually listed in the Urban Dictionary (www.urbandictionary.com)? In Chapter 4, you’ll learn that a more formal term for “procedure” is “algorithm,” and that an algorithm specifies the steps to be performed and the order in which to perform them.

1.13 (*Privacy*) Some online email services save all email correspondence for some period of time. Suppose a disgruntled employee of one of these online email services were to post all of the email correspondences for millions of people, including yours, on the Internet. Discuss the issues.

1.14 (*Programmer Responsibility and Liability*) As a programmer in industry, you may develop software that could affect people’s health or even their lives. Suppose a software bug in one of your programs were to cause a cancer patient to receive an excessive dose during radiation therapy and that the person is either severely injured or dies. Discuss the issues.

1.15 (*2010 “Flash Crash”*) An example of the consequences of our excessive dependency on computers was the so-called “flash crash” which occurred on May 6, 2010, when the U.S. stock market fell precipitously in a matter of minutes, wiping out trillions of dollars of investments, and then recovered within minutes. Use the Internet to investigate the causes of this crash and discuss the issues it raises.

Making a Difference Resources

The *Microsoft Image Cup* is a global competition in which students use technology to try to solve some of the world’s most difficult problems, such as environmental sustainability, ending hunger, emergency response, literacy, combating HIV/AIDS and more. Visit www.imaginecup.com/about for more information about the competition and to learn about the projects developed by previous winners. You can also find several project ideas submitted by worldwide charitable organizations at www.imaginecup.com/students/imagine-cup-solve-this. For additional ideas for programming projects that can make a difference, search the web for “making a difference” and visit the following websites:

www.un.org/millenniumgoals

The United Nations Millennium Project seeks solutions to major worldwide issues such as environmental sustainability, gender equality, child and maternal health, universal education and more.

www.ibm.com/smarterplanet/

The IBM® Smarter Planet website discusses how IBM is using technology to solve issues related to business, cloud computing, education, sustainability and more.

www.gatesfoundation.org/Pages/home.aspx

The Bill and Melinda Gates Foundation provides grants to organizations that work to alleviate hunger, poverty and disease in developing countries. In the United States, the foundation focusses on improving public education, particularly for people with few resources.

www.nethope.org/

NetHope is a collaboration of humanitarian organizations worldwide working to solve technology problems such as connectivity, emergency response and more.

www.rainforestfoundation.org/home

The Rainforest Foundation works to preserve rainforests and to protect the rights of the indigenous people who call the rainforests home. The site includes a list of things you can do to help.

www.undp.org/

The United Nations Development Programme (UNDP) seeks solutions to global challenges such as crisis prevention and recovery, energy and the environment, democratic governance and more.

www.unido.org

The United Nations Industrial Development Organization (UNIDO) seeks to reduce poverty, give developing countries the opportunity to participate in global trade, and promote energy efficiency and sustainability.

www.usaid.gov/

USAID promotes global democracy, health, economic growth, conflict prevention, humanitarian aid and more.

www.toyota.com/ideas-for-good/

Toyota's Ideas for Good website describes several Toyota technologies that are making a difference—including their Advanced Parking Guidance System, Hybrid Synergy Drive®, Solar Powered Ventilation System, T.H.U.M.S. (Total Human Model for Safety) and Touch Tracer Display. You can participate in the Ideas for Good challenge by submitting a short essay or video describing how these technologies can be used for other good purposes.

Introduction to Java Applications

2



*What's in a name?
That which we call a rose
By any other name would
smell as sweet.*

—William Shakespeare

*When faced with a decision,
I always ask, "What would be
the most fun?"*

—Peggy Walker

*The chief merit of language
is clearness.*

—Galen

*One person can make a
difference and every person
should try.*

—John F. Kennedy

Objectives

In this chapter you'll learn:

- To write simple Java applications.
- To use input and output statements.
- Java's primitive types.
- Basic memory concepts.
- To use arithmetic operators.
- The precedence of arithmetic operators.
- To write decision-making statements.
- To use relational and equality operators.

- | | |
|--|---|
| 2.1 Introduction | 2.6 Memory Concepts |
| 2.2 Your First Program in Java: Printing a Line of Text | 2.7 Arithmetic |
| 2.3 Modifying Your First Java Program | 2.8 Decision Making: Equality and Relational Operators |
| 2.4 Displaying Text with <code>printf</code> | 2.9 Wrap-Up |
| 2.5 Another Application: Adding Integers | |

Summary | Self-Review Exercises | Answers to Self-Review Exercises | Exercises | Making a Difference

2.1 Introduction

This chapter introduces Java application programming. We begin with examples of programs that display messages on the screen. We then present a program that obtains two numbers from a user, calculates their sum and displays the result. You'll learn how to instruct the computer to perform arithmetic calculations and save their results for later use. The last example demonstrates how to make decisions. The application compares numbers, then displays messages that show the comparison results.

This chapter uses tools from the JDK to compile and run programs. We've also posted Dive Into[®] videos at www.deitel.com/books/jhttp9/ to help you get started with the popular Eclipse and NetBeans integrated development environments.

2.2 Your First Program in Java: Printing a Line of Text

A Java **application** is a computer program that executes when you use the **java command** to launch the Java Virtual Machine (JVM). Later in this section we'll discuss how to compile and run a Java application. First we consider a simple application that displays a line of text. Figure 2.1 shows the program followed by a box that displays its output. The program includes line numbers. We've added these for instructional purposes—they're *not* part of a Java program. This example illustrates several important Java features. We'll see that line 9 does the real work—displaying the phrase Welcome to Java Programming! on the screen.

```

1 // Fig. 2.1: Welcome1.java
2 // Text-printing program.
3
4 public class Welcome1
5 {
6     // main method begins execution of Java application
7     public static void main( String[] args )
8     {
9         System.out.println( "Welcome to Java Programming!" );
10    } // end method main
11 } // end class Welcome1

```

```
Welcome to Java Programming!
```

Fig. 2.1 | Text-printing program.

Commenting Your Programs

We insert **comments** to **document programs** and improve their readability. The Java compiler ignores comments, so they do *not* cause the computer to perform any action when the program is run.

By convention, we begin every program with a comment indicating the figure number and file name. The comment in line 1

```
// Fig. 2.1: Welcome1.java
```

begins with `//`, indicating that it is an **end-of-line comment**—it terminates at the end of the line on which the `//` appears. An end-of-line comment need not begin a line; it also can begin in the middle of a line and continue until the end (as in lines 10 and 11). Line 2

```
// Text-printing program.
```

is a comment that describes the purpose of the program.

Java also has **traditional comments**, which can be spread over several lines as in

```
/* This is a traditional comment. It
   can be split over multiple lines */
```

These begin and end with delimiters, `/*` and `*/`. The compiler ignores all text between the delimiters. Java incorporated traditional comments and end-of-line comments from the C and C++ programming languages, respectively. In this book, we use only `//` comments.

Java provides comments of a third type, **Javadoc comments**. These are delimited by `/**` and `*/`. The compiler ignores all text between the delimiters. Javadoc comments enable you to embed program documentation directly in your programs. Such comments are the preferred Java documenting format in industry. The **javadoc utility program** (part of the Java SE Development Kit) reads Javadoc comments and uses them to prepare your program's documentation in HTML format. We demonstrate Javadoc comments and the javadoc utility in Appendix M, Creating Documentation with javadoc.



Common Programming Error 2.1

*Forgetting one of the delimiters of a traditional or Javadoc comment is a syntax error. A **syntax error** occurs when the compiler encounters code that violates Java's language rules (i.e., its syntax). These rules are similar to a natural language's grammar rules specifying sentence structure. Syntax errors are also called **compiler errors**, **compile-time errors** or **compilation errors**, because the compiler detects them during the compilation phase. The compiler responds by issuing an error message and preventing your program from compiling.*



Good Programming Practice 2.1

Some organizations require that every program begin with a comment that states the purpose of the program and the author, date and time when the program was last modified.

Using Blank Lines

Line 3 is a blank line. Blank lines, space characters and tabs make programs easier to read. Together, they're known as **white space** (or whitespace). The compiler ignores white space.



Good Programming Practice 2.2

Use blank lines and spaces to enhance program readability.

Declaring a Class

Line 4

```
public class Welcome1
```

begins a **class declaration** for class `Welcome1`. Every Java program consists of at least one class that you (the programmer) define. The **class keyword** introduces a class declaration and is immediately followed by the **class name** (`Welcome1`). **Keywords** (sometimes called **reserved words**) are reserved for use by Java and are always spelled with all lowercase letters. The complete list of keywords is shown in Appendix C.

Class Names and Identifiers

By convention, class names begin with a capital letter and capitalize the first letter of each word they include (e.g., `SampleClassName`). A class name is an **identifier**—a series of characters consisting of letters, digits, underscores (`_`) and dollar signs (`$`) that does not begin with a digit and does not contain spaces. Some valid identifiers are `Welcome1`, `$value`, `_value`, `m_inputField1` and `button7`. The name `7button` is not a valid identifier because it begins with a digit, and the name `input field` is not a valid identifier because it contains a space. Normally, an identifier that does not begin with a capital letter is not a class name. Java is **case sensitive**—uppercase and lowercase letters are distinct—so `value` and `Value` are different (but both valid) identifiers.

In Chapters 2–7, every class we define begins with the **public** keyword. For now, we simply require this keyword. For our application, the file name is `Welcome1.java`. You'll learn more about **public** and **non-public** classes in Chapter 8.



Common Programming Error 2.2

*A **public** class must be placed in a file that has the same name as the class (in terms of both spelling and capitalization) plus the `.java` extension; otherwise, a compilation error occurs. For example, `public class Welcome` must be placed in a file named `Welcome.java`.*

A **left brace** (as in line 5), `{`, begins the **body** of every class declaration. A corresponding **right brace** (at line 11), `}`, must end each class declaration. Lines 6–10 are indented.



Error-Prevention Tip 2.1

When you type an opening left brace, `{`, immediately type the closing right brace, `}`, then reposition the cursor between the braces and indent to begin typing the body. This practice helps prevent errors due to missing braces. Many IDEs insert the braces for you.



Common Programming Error 2.3

It's a syntax error if braces do not occur in matching pairs.



Good Programming Practice 2.3

Indent the entire body of each class declaration one “level” between the left brace and the right brace that delimit the body of the class. We recommend using three spaces to form a level of indent. This format emphasizes the class declaration's structure and makes it easier to read.



Good Programming Practice 2.4

Many IDEs insert indentation for you in all the right places. The Tab key may also be used to indent code, but tab stops vary among text editors. Most IDEs allow you to configure tabs such that a specified number of spaces is inserted each time you press the Tab key.

Declaring a Method

Line 6

```
// main method begins execution of Java application
```

is an end-of-line comment indicating the purpose of lines 7–10 of the program. Line 7

```
public static void main( String[] args )
```

is the starting point of every Java application. The **parentheses** after the identifier `main` indicate that it's a program building block called a **method**. Java class declarations normally contain one or more methods. For a Java application, one of the methods *must* be called `main` and must be defined as shown in line 7; otherwise, the Java Virtual Machine (JVM) will not execute the application. Methods perform tasks and can return information when they complete their tasks. Keyword **void** indicates that this method will *not* return any information. Later, we'll see how a method can return information. For now, simply mimic `main`'s first line in your Java applications. In line 7, the `String[] args` in parentheses is a required part of the method `main`'s declaration—we discuss this in Chapter 7.

The left brace in line 8 begins the **body of the method declaration**. A corresponding right brace must end it (line 10). Line 9 in the method body is indented between the braces.



Good Programming Practice 2.5

Indent the entire body of each method declaration one “level” between the braces that define the body of the method. This makes the structure of the method stand out and makes the method declaration easier to read.

Performing Output with `System.out.println`

Line 9

```
System.out.println( "Welcome to Java Programming!" );
```

instructs the computer to perform an action—namely, to print the **string** of characters contained between the double quotation marks (but not the quotation marks themselves). A string is sometimes called a **character string** or a **string literal**. White-space characters in strings are *not* ignored by the compiler. Strings cannot span multiple lines of code, but as you'll see later, this does not restrict you from using long strings in your code.

The **System.out** object is known as the **standard output object**. It allows a Java application to display information in the **command window** from which it executes. In recent versions of Microsoft Windows, the command window is the **Command Prompt**. In UNIX/Linux/Mac OS X, the command window is called a **terminal window** or a **shell**. Many programmers call it simply the **command line**.

Method **System.out.println** displays (or prints) a line of text in the command window. The string in the parentheses in line 9 is the **argument** to the method. When `System.out.println` completes its task, it positions the output cursor (the location where the next character will be displayed) at the beginning of the next line in the command

window. This is similar to what happens when you press the *Enter* key while typing in a text editor—the cursor appears at the beginning of the next line in the document.

The entire line 9, including `System.out.println`, the argument "Welcome to Java Programming!" in the parentheses and the **semicolon** (`;`), is called a **statement**. A method typically contains one or more statements that perform its task. Most statements end with a semicolon. When the statement in line 9 executes, it displays `Welcome to Java Programming!` in the command window.



Error-Prevention Tip 2.2

When learning how to program, sometimes it's helpful to "break" a working program so you can familiarize yourself with the compiler's syntax-error messages. These messages do not always state the exact problem in the code. When you encounter an error message, it will give you an idea of what caused the error. [Try removing a semicolon or brace from the program of Fig. 2.1, then recompile the program to see the error messages generated by the omission.]



Error-Prevention Tip 2.3

When the compiler reports a syntax error, it may not be on the line that the error message indicates. First, check the line for which the error was reported. If you don't find an error on that line,, check several preceding lines.

Using End-of-Line Comments on Right Braces for Readability

We include an end-of-line comment after a closing brace that ends a method declaration and after a closing brace that ends a class declaration. For example, line 10

```
} // end method main
```

indicates the closing brace of method `main`, and line 11

```
} // end class Welcome1
```

indicates the closing brace of class `Welcome1`. Each comment indicates the method or class that the right brace terminates.

Compiling and Executing Your First Java Application

We're now ready to compile and execute our program. We assume you're using the Java Development Kit's command-line tools, not an IDE. Our Java Resource Centers at www.deitel.com/ResourceCenters.html provide links to tutorials that help you get started with several popular Java development tools, including NetBeans™, Eclipse™ and others. We've also posted NetBeans and Eclipse videos at www.deitel.com/books/jhttp9/ to help you get started using these popular IDEs.

To prepare to compile the program, open a command window and change to the directory where the program is stored. Many operating systems use the command `cd` to change directories. On Windows, for example,

```
cd c:\examples\ch02\fig02_01
```

changes to the `fig02_01` directory. On UNIX/Linux/Mac OS X, the command

```
cd ~/examples/ch02/fig02_01
```

changes to the `fig02_01` directory.

To compile the program, type

```
javac Welcome1.java
```

If the program contains no syntax errors, this command creates a new file called `Welcome1.class` (known as the **class file** for `Welcome1`) containing the platform-independent Java bytecodes that represent our application. When we use the `java` command to execute the application on a given platform, the JVM will translate these bytecodes into instructions that are understood by the underlying operating system and hardware.



Error-Prevention Tip 2.4

When attempting to compile a program, if you receive a message such as “bad command or filename,” “javac: command not found” or “'javac' is not recognized as an internal or external command, operable program or batch file,” then your Java software installation was not completed properly. If you’re using the JDK, this indicates that the system’s `PATH` environment variable was not set properly. Please carefully review the installation instructions in the *Before You Begin* section of this book. On some systems, after correcting the `PATH`, you may need to reboot your computer or open a new command window for these settings to take effect.



Error-Prevention Tip 2.5

Each syntax-error message contains the file name and line number where the error occurred. For example, `Welcome1.java:6` indicates that an error occurred at line 6 in `Welcome1.java`. The rest of the message provides information about the syntax error.



Error-Prevention Tip 2.6

The compiler error message “class `Welcome1` is public, should be declared in a file named `Welcome1.java`” indicates that the file name does not match the name of the public class in the file or that you typed the class name incorrectly when compiling the class.

Figure 2.2 shows the program of Fig. 2.1 executing in a Microsoft® Windows® 7 Command Prompt window. To execute the program, type `java Welcome1`. This command launches the JVM, which loads the `.class` file for class `Welcome1`. The command omits the `.class` file-name extension; otherwise, the JVM will not execute the program. The JVM calls method `main`. Next, the statement at line 9 of `main` displays “Welcome to Java Programming!” [Note: Many environments show command prompts with black backgrounds and white text. We adjusted these settings in our environment to make our screen captures more readable.]

```
Select Command Prompt
C:\examples\ch02\fig02_01>javac Welcome1.java
C:\examples\ch02\fig02_01>java Welcome1
Welcome to Java Programming!
C:\examples\ch02\fig02_01>
```

You type this command to execute the application

The program outputs to the screen
Welcome to Java Programming!

Fig. 2.2 | Executing `Welcome1` from the Command Prompt.



Error-Prevention Tip 2.7

When attempting to run a Java program, if you receive a message such as “Exception in thread “main” java.lang.NoClassDefFoundError: Welcome1,” your CLASSPATH environment variable has not been set properly. Please carefully review the installation instructions in the *Before You Begin* section of this book. On some systems, you may need to reboot your computer or open a new command window after configuring the CLASSPATH.

2.3 Modifying Your First Java Program

In this section, we modify the example in Fig. 2.1 to print text on one line by using multiple statements and to print text on several lines by using a single statement.

Displaying a Single Line of Text with Multiple Statements

Welcome to Java Programming! can be displayed several ways. Class Welcome2, shown in Fig. 2.3, uses two statements (lines 9–10) to produce the output shown in Fig. 2.1. [Note: From this point forward, we highlight the new and key features in each code listing, as we’ve done for lines 9–10.]

```

1 // Fig. 2.3: Welcome2.java
2 // Printing a line of text with multiple statements.
3
4 public class Welcome2
5 {
6     // main method begins execution of Java application
7     public static void main( String[] args )
8     {
9         System.out.print( "Welcome to " );
10        System.out.println( "Java Programming!" );
11    } // end method main
12 } // end class Welcome2

```

```
Welcome to Java Programming!
```

Fig. 2.3 | Printing a line of text with multiple statements.

The program is similar to Fig. 2.1, so we discuss only the changes here. Line 2

```
// Printing a line of text with multiple statements.
```

is an end-of-line comment stating the purpose of the program. Line 4 begins the Welcome2 class declaration. Lines 9–10 of method main

```
System.out.print( "Welcome to " );
System.out.println( "Java Programming!" );
```

display one line of text. The first statement uses System.out’s method print to display a string. Each print or println statement resumes displaying characters from where the last print or println statement stopped displaying characters. Unlike println, after displaying its argument, print does *not* position the output cursor at the beginning of the next line in the command window—the next character the program displays will appear *immediately after* the last character that print displays. Thus, line 10 positions the first character

in its argument (the letter “J”) immediately after the last character that line 9 displays (the *space character* before the string’s closing double-quote character).

Displaying Multiple Lines of Text with a Single Statement

A single statement can display multiple lines by using **newline characters**, which indicate to `System.out`’s `print` and `println` methods when to position the output cursor at the beginning of the next line in the command window. Like blank lines, space characters and tab characters, newline characters are white-space characters. The program in Fig. 2.4 outputs four lines of text, using newline characters to determine when to begin each new line. Most of the program is identical to those in Fig. 2.1 and Fig. 2.3.

```

1 // Fig. 2.4: Welcome3.java
2 // Printing multiple lines of text with a single statement.
3
4 public class Welcome3
5 {
6     // main method begins execution of Java application
7     public static void main( String[] args )
8     {
9         System.out.println( "Welcome\n\tto\n\tJava\n\tProgramming!" );
10    } // end method main
11 } // end class Welcome3

```

```

Welcome
to
Java
Programming!

```

Fig. 2.4 | Printing multiple lines of text with a single statement.

Line 2

```
// Printing multiple lines of text with a single statement.
```

is a comment stating the program’s purpose. Line 4 begins the `Welcome3` class declaration.

Line 9

```
System.out.println( "Welcome\n\tto\n\tJava\n\tProgramming!" );
```

displays four separate lines of text in the command window. Normally, the characters in a string are displayed *exactly* as they appear in the double quotes. Note, however, that the paired characters `\` and `n` (repeated three times in the statement) do not appear on the screen. The **backslash** (`\`) is an **escape character**, which has special meaning to `System.out`’s `print` and `println` methods. When a backslash appears in a string, Java combines it with the next character to form an **escape sequence**. The escape sequence `\n` represents the newline character. When a newline character appears in a string being output with `System.out`, the newline character causes the screen’s output cursor to move to the beginning of the next line in the command window.

Figure 2.5 lists several common escape sequences and describes how they affect the display of characters in the command window. For the complete list of escape sequences, visit java.sun.com/docs/books/jls/third_edition/html/lexical.html#3.10.6.

Escape sequence	Description
<code>\n</code>	Newline. Position the screen cursor at the beginning of the next line.
<code>\t</code>	Horizontal tab. Move the screen cursor to the next tab stop.
<code>\r</code>	Carriage return. Position the screen cursor at the beginning of the current line—do <i>not</i> advance to the next line. Any characters output after the carriage return overwrite the characters previously output on that line.
<code>\\</code>	Backslash. Used to print a backslash character.
<code>\"</code>	Double quote. Used to print a double-quote character. For example, <code>System.out.println("\"in quotes\"");</code> displays "in quotes".

Fig. 2.5 | Some common escape sequences.

2.4 Displaying Text with `printf`

The `System.out.printf` method (f means “formatted”) displays formatted data. Figure 2.6 uses this method to output the strings “Welcome to” and “Java Programming!”. Lines 9–10

```
System.out.printf( "%s\n%s\n",
    "Welcome to", "Java Programming!" );
```

call method `System.out.printf` to display the program’s output. The method call specifies three arguments. When a method requires multiple arguments, they’re placed in a **comma-separated list**.



Good Programming Practice 2.6

Place a space after each comma (,) in an argument list to make programs more readable.

```
1 // Fig. 2.6: Welcome4.java
2 // Displaying multiple lines with method System.out.printf.
3
4 public class Welcome4
5 {
6     // main method begins execution of Java application
7     public static void main( String[] args )
8     {
9         System.out.printf( "%s\n%s\n",
10            "Welcome to", "Java Programming!" );
11     } // end method main
12 } // end class Welcome4
```

```
Welcome to
Java Programming!
```

Fig. 2.6 | Displaying multiple lines with method `System.out.printf`.

Lines 9–10 represent only *one* statement. Java allows large statements to be split over many lines. We indent line 10 to indicate that it's a *continuation* of line 9.



Common Programming Error 2.4

Splitting a statement in the middle of an identifier or a string is a syntax error.

Method `printf`'s first argument is a **format string** that may consist of **fixed text** and **format specifiers**. Fixed text is output by `printf` just as it would be by `print` or `println`. Each format specifier is a placeholder for a value and specifies the type of data to output. Format specifiers also may include optional formatting information.

Format specifiers begin with a percent sign (%) followed by a character that represents the data type. For example, the format specifier **%s** is a placeholder for a string. The format string in line 9 specifies that `printf` should output two strings, each followed by a newline character. At the first format specifier's position, `printf` substitutes the value of the first argument after the format string. At each subsequent format specifier's position, `printf` substitutes the value of the next argument. So this example substitutes "Welcome to" for the first %s and "Java Programming!" for the second %s. The output shows that two lines of text are displayed.

We introduce various formatting features as they're needed in our examples. Appendix G presents the details of formatting output with `printf`.

2.5 Another Application: Adding Integers

Our next application reads (or inputs) two **integers** (whole numbers, such as -22, 7, 0 and 1024) typed by a user at the keyboard, computes their sum and displays it. This program must keep track of the numbers supplied by the user for the calculation later in the program. Programs remember numbers and other data in the computer's memory and access that data through program elements called **variables**. The program of Fig. 2.7 demonstrates these concepts. In the sample output, we use bold text to identify the user's input (i.e., **45** and **72**).

```

1 // Fig. 2.7: Addition.java
2 // Addition program that displays the sum of two numbers.
3 import java.util.Scanner; // program uses class Scanner
4
5 public class Addition
6 {
7     // main method begins execution of Java application
8     public static void main( String[] args )
9     {
10        // create a Scanner to obtain input from the command window
11        Scanner input = new Scanner( System.in );
12
13        int number1; // first number to add
14        int number2; // second number to add
15        int sum; // sum of number1 and number2
16

```

Fig. 2.7 | Addition program that displays the sum of two numbers. (Part 1 of 2.)

```

17     System.out.print( "Enter first integer: " ); // prompt
18     number1 = input.nextInt(); // read first number from user
19
20     System.out.print( "Enter second integer: " ); // prompt
21     number2 = input.nextInt(); // read second number from user
22
23     sum = number1 + number2; // add numbers, then store total in sum
24
25     System.out.printf( "Sum is %d\n", sum ); // display sum
26 } // end method main
27 } // end class Addition

```

```

Enter first integer: 45
Enter second integer: 72
Sum is 117

```

Fig. 2.7 | Addition program that displays the sum of two numbers. (Part 2 of 2.)

Import Declarations

Lines 1–2

```

// Fig. 2.7: Addition.java
// Addition program that displays the sum of two numbers.

```

state the figure number, file name and purpose of the program.

A great strength of Java is its rich set of predefined classes that you can *reuse* rather than “reinventing the wheel.” These classes are grouped into **packages**—named groups of related classes—and are collectively referred to as the **Java class library**, or the **Java Application Programming Interface (Java API)**. Line 3

```
import java.util.Scanner; // program uses class Scanner

```

is an **import declaration** that helps the compiler locate a class that’s used in this program. It indicates that this example uses Java’s predefined Scanner class (discussed shortly) from package **java.util**.



Common Programming Error 2.5

All import declarations must appear before the first class declaration in the file. Placing an import declaration inside or after a class declaration is a syntax error.



Error-Prevention Tip 2.8

Forgetting to include an import declaration for a class used in your program typically results in a compilation error containing a message such as “cannot find symbol.” When this occurs, check that you provided the proper import declarations and that the names in them are correct, including proper capitalization.

Declaring Class Addition

Line 5

```
public class Addition

```

begins the declaration of class `Addition`. The file name for this `public` class must be `Addition.java`. Remember that the body of each class declaration starts with an opening left brace (line 6) and ends with a closing right brace (line 27).

The application begins execution with the `main` method (lines 8–26). The left brace (line 9) marks the beginning of method `main`'s body, and the corresponding right brace (line 26) marks its end. Method `main` is indented one level in the body of class `Addition`, and the code in the body of `main` is indented another level for readability.

Declaring and Creating a Scanner to Obtain User Input from the Keyboard

A **variable** is a location in the computer's memory where a value can be stored for use later in a program. All Java variables *must* be declared with a **name** and a **type** *before* they can be used. A variable's name enables the program to access the value of the variable in memory. A variable's name can be any valid identifier. A variable's type specifies what kind of information is stored at that location in memory. Like other statements, declaration statements end with a semicolon (;).

Line 11

```
Scanner input = new Scanner( System.in );
```

is a **variable declaration statement** that specifies the name (`input`) and type (`Scanner`) of a variable that's used in this program. A **Scanner** enables a program to read data (e.g., numbers and strings) for use in a program. The data can come from many sources, such as the user at the keyboard or a file on disk. Before using a `Scanner`, you must create it and specify the source of the data.

The `=` in line 11 indicates that `Scanner` variable `input` should be **initialized** (i.e., prepared for use in the program) in its declaration with the result of the expression to the right of the equals sign—`new Scanner(System.in)`. This expression uses the **new** keyword to create a `Scanner` object that reads characters typed by the user at the keyboard. The **standard input object, `System.in`**, enables applications to read bytes of information typed by the user. The `Scanner` translates these bytes into types (like `ints`) that can be used in a program.

Declaring Variables to Store Integers

The variable declaration statements in lines 13–15

```
int number1; // first number to add
int number2; // second number to add
int sum; // sum of number1 and number2
```

declare that variables `number1`, `number2` and `sum` hold data of type **int**—they can hold integer values (whole numbers such as 72, -1127 and 0). These variables are not yet initialized. The range of values for an `int` is -2,147,483,648 to +2,147,483,647. [*Note: Actual `int` values may not contain commas.*]

Other types of data include **float** and **double**, for holding real numbers, and **char**, for holding character data. Real numbers contain decimal points, such as 3.4, 0.0 and -11.19. Variables of type `char` represent individual characters, such as an uppercase letter (e.g., `A`), a digit (e.g., `7`), a special character (e.g., `*` or `%`) or an escape sequence (e.g., the newline character, `\n`). The types `int`, `float`, `double` and `char` are called **primitive types**. Primitive-type names are keywords and must appear in all lowercase letters. Appendix D summarizes the characteristics of the eight primitive types (`boolean`, `byte`, `char`, `short`, `int`, `long`, `float` and `double`).

Several variables of the same type may be declared in a single declaration with the variable names separated by commas (i.e., a comma-separated list of variable names). For example, lines 13–15 can also be written as:

```
int number1, // first number to add
    number2, // second number to add
    sum; // sum of number1 and number2
```



Good Programming Practice 2.7

Declare each variable on a separate line. This format allows a descriptive comment to be inserted next to each declaration.



Good Programming Practice 2.8

Choosing meaningful variable names helps a program to be self-documenting (i.e., one can understand the program simply by reading it rather than by reading manuals or viewing an excessive number of comments).



Good Programming Practice 2.9

By convention, variable-name identifiers begin with a lowercase letter, and every word in the name after the first word begins with a capital letter. For example, variable-name identifier `firstNumber` starts its second word, `Number`, with a capital `N`.

Prompting the User for Input

Line 17

```
System.out.print( "Enter first integer: " ); // prompt
```

uses `System.out.print` to display the message "Enter first integer: ". This message is called a **prompt** because it directs the user to take a specific action. We use method `print` here rather than `println` so that the user's input appears on the same line as the prompt. Recall from Section 2.2 that identifiers starting with capital letters typically represent class names. So, `System` is a class. Class `System` is part of package **java.lang**. Notice that class `System` is not imported with an `import` declaration at the beginning of the program.



Software Engineering Observation 2.1

By default, package `java.lang` is imported in every Java program; thus, classes in `java.lang` are the only ones in the Java API that do not require an `import` declaration.

Obtaining an `int` as Input from the User

Line 18

```
number1 = input.nextInt(); // read first number from user
```

uses `Scanner` object `input`'s `nextInt` method to obtain an integer from the user at the keyboard. At this point the program waits for the user to type the number and press the *Enter* key to submit the number to the program.

Our program assumes that the user enters a valid integer value. If not, a runtime logic error will occur and the program will terminate. Chapter 11, Exception Handling: A Deeper Look, discusses how to make your programs more robust by enabling them to handle such errors. This is also known as making your program *fault tolerant*.

In line 18, we place the result of the call to method `nextInt` (an `int` value) in variable `number1` by using the **assignment operator**, `=`. The statement is read as “`number1` gets the value of `input.nextInt()`.” Operator `=` is called a **binary operator**, because it has two **operands**—`number1` and the result of the method call `input.nextInt()`. This statement is called an assignment statement, because it assigns a value to a variable. Everything to the *right* of the assignment operator, `=`, is always evaluated *before* the assignment is performed.



Good Programming Practice 2.10

Placing spaces on either side of a binary operator makes the program more readable.

Prompting for and Inputting a Second `int`

Line 20

```
System.out.print( "Enter second integer: " ); // prompt
```

prompts the user to input the second integer. Line 21

```
number2 = input.nextInt(); // read second number from user
```

reads the second integer and assigns it to variable `number2`.

Using Variables in a Calculation

Line 23

```
sum = number1 + number2; // add numbers then store total in sum
```

is an assignment statement that calculates the sum of the variables `number1` and `number2` then assigns the result to variable `sum` by using the assignment operator, `=`. The statement is read as “`sum` gets the value of `number1 + number2`.” In general, calculations are performed in assignment statements. When the program encounters the addition operation, it performs the calculation using the values stored in the variables `number1` and `number2`. In the preceding statement, the addition operator is a *binary operator*—its *two* operands are the variables `number1` and `number2`. Portions of statements that contain calculations are called **expressions**. In fact, an expression is any portion of a statement that has a *value* associated with it. For example, the value of the expression `number1 + number2` is the *sum* of the numbers. Similarly, the value of the expression `input.nextInt()` is the integer typed by the user.

Displaying the Result of the Calculation

After the calculation has been performed, line 25

```
System.out.printf( "Sum is %d\n", sum ); // display sum
```

uses method `System.out.printf` to display the sum. The format specifier `%d` is a placeholder for an `int` value (in this case the value of `sum`)—the letter `d` stands for “decimal integer.” The remaining characters in the format string are all fixed text. So, method `printf` displays “Sum is ”, followed by the value of `sum` (in the position of the `%d` format specifier) and a newline.

Calculations can also be performed *inside* `printf` statements. We could have combined the statements at lines 23 and 25 into the statement

```
System.out.printf( "Sum is %d\n", ( number1 + number2 ) );
```

The parentheses around the expression `number1 + number2` are not required—they're included to emphasize that the value of the *entire* expression is output in the position of the `%d` format specifier.

Java API Documentation

For each new Java API class we use, we indicate the package in which it's located. This information helps you locate descriptions of each package and class in the Java API documentation. A web-based version of this documentation can be found at

```
download.oracle.com/javase/6/docs/api/
```

You can download it from

```
www.oracle.com/technetwork/java/javase/downloads/index.html
```

Appendix E shows how to use this documentation.

2.6 Memory Concepts

Variable names such as `number1`, `number2` and `sum` actually correspond to locations in the computer's memory. Every variable has a **name**, a **type**, a **size** (in bytes) and a **value**.

In the addition program of Fig. 2.7, when the following statement (line 18) executes:

```
number1 = input.nextInt(); // read first number from user
```

the number typed by the user is placed into a memory location corresponding to the name `number1`. Suppose that the user enters 45. The computer places that integer value into location `number1` (Fig. 2.8), replacing the previous value (if any) in that location. The previous value is lost.

number1	45
---------	----

Fig. 2.8 | Memory location showing the name and value of variable `number1`.

When the statement (line 21)

```
number2 = input.nextInt(); // read second number from user
```

executes, suppose that the user enters 72. The computer places that integer value into location `number2`. The memory now appears as shown in Fig. 2.9.

number1	45
number2	72

Fig. 2.9 | Memory locations after storing values for `number1` and `number2`.

After the program of Fig. 2.7 obtains values for `number1` and `number2`, it adds the values and places the total into variable `sum`. The statement (line 23)

```
sum = number1 + number2; // add numbers, then store total in sum
```

performs the addition, then replaces any previous value in `sum`. After `sum` has been calculated, memory appears as shown in Fig. 2.10. The values of `number1` and `number2` appear exactly as they did before they were used in the calculation of `sum`. These values were used, but not destroyed, as the computer performed the calculation. When a value is read from a memory location, the process is nondestructive.

number1	45
number2	72
sum	117

Fig. 2.10 | Memory locations after storing the sum of `number1` and `number2`.

2.7 Arithmetic

Most programs perform arithmetic calculations. The **arithmetic operators** are summarized in Fig. 2.11. Note the use of various special symbols not used in algebra. The **asterisk** (*) indicates multiplication, and the percent sign (%) is the **remainder operator**, which we'll discuss shortly. The arithmetic operators in Fig. 2.11 are *binary* operators, because each operates on *two* operands. For example, the expression `f + 7` contains the binary operator `+` and the two operands `f` and `7`.

Java operation	Operator	Algebraic expression	Java expression
Addition	<code>+</code>	$f + 7$	<code>f + 7</code>
Subtraction	<code>-</code>	$p - c$	<code>p - c</code>
Multiplication	<code>*</code>	bm	<code>b * m</code>
Division	<code>/</code>	x / y or $\frac{x}{y}$ or $x \div y$	<code>x / y</code>
Remainder	<code>%</code>	$r \bmod s$	<code>r % s</code>

Fig. 2.11 | Arithmetic operators.

Integer division yields an integer quotient. For example, the expression `7 / 4` evaluates to 1, and the expression `17 / 5` evaluates to 3. Any fractional part in integer division is simply *discarded* (i.e., *truncated*)—no rounding occurs. Java provides the remainder operator, `%`, which yields the remainder after division. The expression `x % y` yields the remainder after `x` is divided by `y`. Thus, `7 % 4` yields 3, and `17 % 5` yields 2. This operator is most commonly used with integer operands but can also be used with other arithmetic types. In this chapter's exercises and in later chapters, we consider several interesting applications of the remainder operator, such as determining whether one number is a multiple of another.

Arithmetic Expressions in Straight-Line Form

Arithmetic expressions in Java must be written in **straight-line form** to facilitate entering programs into the computer. Thus, expressions such as “a divided by b” must be written as `a / b`, so that all constants, variables and operators appear in a straight line. The following algebraic notation is generally not acceptable to compilers:

$$\frac{a}{b}$$

Parentheses for Grouping Subexpressions

Parentheses are used to group terms in Java expressions in the same manner as in algebraic expressions. For example, to multiply a times the quantity `b + c`, we write

$$a * (b + c)$$

If an expression contains **nested parentheses**, such as

$$((a + b) * c)$$

the expression in the innermost set of parentheses (`a + b` in this case) is evaluated first.

Rules of Operator Precedence

Java applies the operators in arithmetic expressions in a precise sequence determined by the **rules of operator precedence**, which are generally the same as those followed in algebra:

1. Multiplication, division and remainder operations are applied first. If an expression contains several such operations, they’re applied from left to right. Multiplication, division and remainder operators have the same level of precedence.
2. Addition and subtraction operations are applied next. If an expression contains several such operations, the operators are applied from left to right. Addition and subtraction operators have the same level of precedence.

These rules enable Java to apply operators in the correct order.¹ When we say that operators are applied from left to right, we’re referring to their **associativity**. Some operators associate from right to left. Figure 2.12 summarizes these rules of operator precedence. A complete precedence chart is included in Appendix A.

Operator(s)	Operation(s)	Order of evaluation (precedence)
* / %	Multiplication Division Remainder	Evaluated first. If there are several operators of this type, they’re evaluated from left to right.
+ -	Addition Subtraction	Evaluated next. If there are several operators of this type, they’re evaluated from left to right.
=	Assignment	Evaluated last.

Fig. 2.12 | Precedence of arithmetic operators.

1. We use simple examples to explain the order of evaluation of expressions. Subtle issues occur in the more complex expressions you’ll encounter later in the book. For more information on order of evaluation, see Chapter 15 of *The Java™ Language Specification* (java.sun.com/docs/books/jls/).

Sample Algebraic and Java Expressions

Now let's consider several expressions in light of the rules of operator precedence. Each example lists an algebraic expression and its Java equivalent. The following is an example of an arithmetic mean (average) of five terms:

$$\begin{array}{ll} \text{Algebra:} & m = \frac{a + b + c + d + e}{5} \\ \text{Java:} & m = (a + b + c + d + e) / 5; \end{array}$$

The parentheses are required because division has higher precedence than addition. The entire quantity $(a + b + c + d + e)$ is to be divided by 5. If the parentheses are erroneously omitted, we obtain $a + b + c + d + e / 5$, which evaluates as

$$a + b + c + d + \frac{e}{5}$$

Here's an example of the equation of a straight line:

$$\begin{array}{ll} \text{Algebra:} & y = mx + b \\ \text{Java:} & y = m * x + b; \end{array}$$

No parentheses are required. The multiplication operator is applied first because multiplication has a higher precedence than addition. The assignment occurs last because it has a lower precedence than multiplication or addition.

The following example contains remainder (%), multiplication, division, addition and subtraction operations:

$$\begin{array}{ll} \text{Algebra:} & z = pr \% q + w/x - y \\ \text{Java:} & z = p * r \% q + w / x - y; \end{array}$$

The circled numbers under the statement indicate the order in which Java applies the operators. The *, % and / operations are evaluated first in left-to-right order (i.e., they associate from left to right), because they have higher precedence than + and -. The + and - operations are evaluated next. These operations are also applied from left to right. The assignment (=) operator is evaluated last.

Evaluation of a Second-Degree Polynomial

To develop a better understanding of the rules of operator precedence, consider the evaluation of an assignment expression that includes a second-degree polynomial $ax^2 + bx + c$:

$$y = a * x * x + b * x + c;$$

The multiplication operations are evaluated first in left-to-right order (i.e., they associate from left to right), because they have higher precedence than addition. (Java has no arithmetic operator for exponentiation in Java, so x^2 is represented as $x * x$. Section 5.4 shows an alternative for performing exponentiation.) The addition operations are evaluated next from left to right. Suppose that a , b , c and x are initialized (given values) as follows: $a = 2$, $b = 3$, $c = 7$ and $x = 5$. Figure 2.13 illustrates the order in which the operators are applied.

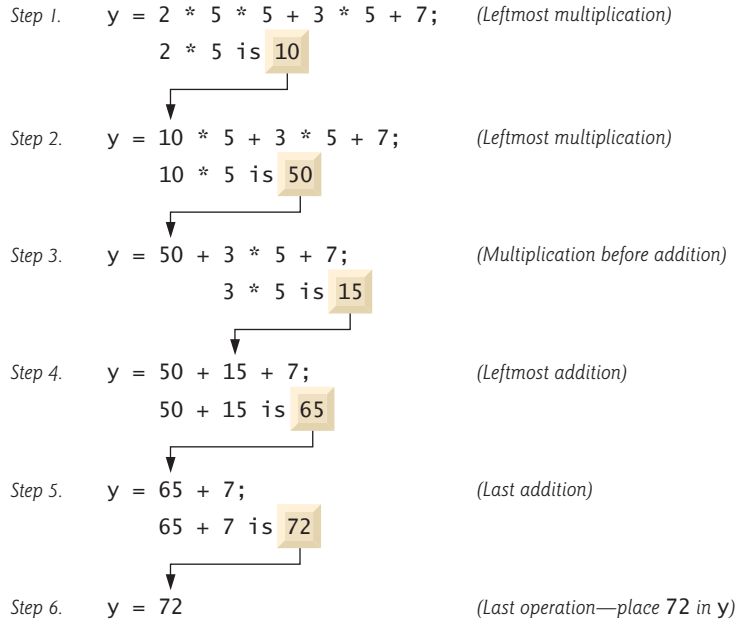

Fig. 2.13 | Order in which a second-degree polynomial is evaluated.

You can use **redundant parentheses** (unnecessary parentheses) to make an expression clearer. For example, the preceding statement might be parenthesized as follows:

```
y = ( a * x * x ) + ( b * x ) + c;
```

2.8 Decision Making: Equality and Relational Operators

A **condition** is an expression that can be **true** or **false**. This section introduces Java’s **if selection statement**, which allows a program to make a **decision** based on a condition’s value. For example, the condition “grade is greater than or equal to 60” determines whether a student passed a test. If the condition in an **if** statement is true, the body of the **if** statement executes. If the condition is false, the body does not execute. We’ll see an example shortly.

Conditions in **if** statements can be formed by using the **equality operators** (**==** and **!=**) and **relational operators** (**>**, **<**, **>=** and **<=**) summarized in Fig. 2.14. Both equality operators have the same level of precedence, which is *lower* than that of the relational operators. The equality operators associate from left to right. The relational operators all have the same level of precedence and also associate from left to right.

Figure 2.15 uses six **if** statements to compare two integers input by the user. If the condition in any of these **if** statements is true, the statement associated with that **if** statement executes; otherwise, the statement is skipped. We use a **Scanner** to input the integers from the user and store them in variables **number1** and **number2**. The program compares the numbers and displays the results of the comparisons that are true.

Standard algebraic equality or relational operator	Java equality or relational operator	Sample Java condition	Meaning of Java condition
<i>Equality operators</i>			
=	==	x == y	x is equal to y
≠	!=	x != y	x is not equal to y
<i>Relational operators</i>			
>	>	x > y	x is greater than y
<	<	x < y	x is less than y
≥	>=	x >= y	x is greater than or equal to y
≤	<=	x <= y	x is less than or equal to y

Fig. 2.14 | Equality and relational operators.

```

1 // Fig. 2.15: Comparison.java
2 // Compare integers using if statements, relational operators
3 // and equality operators.
4 import java.util.Scanner; // program uses class Scanner
5
6 public class Comparison
7 {
8     // main method begins execution of Java application
9     public static void main( String[] args )
10    {
11        // create Scanner to obtain input from command line
12        Scanner input = new Scanner( System.in );
13
14        int number1; // first number to compare
15        int number2; // second number to compare
16
17        System.out.print( "Enter first integer: " ); // prompt
18        number1 = input.nextInt(); // read first number from user
19
20        System.out.print( "Enter second integer: " ); // prompt
21        number2 = input.nextInt(); // read second number from user
22
23        if ( number1 == number2 )
24            System.out.printf( "%d == %d\n", number1, number2 );
25
26        if ( number1 != number2 )
27            System.out.printf( "%d != %d\n", number1, number2 );
28
29        if ( number1 < number2 )
30            System.out.printf( "%d < %d\n", number1, number2 );
31

```

Fig. 2.15 | Compare integers using if statements, relational operators and equality operators. (Part I of 2.)

```

32     if ( number1 > number2 )
33         System.out.printf( "%d > %d\n", number1, number2 );
34
35     if ( number1 <= number2 )
36         System.out.printf( "%d <= %d\n", number1, number2 );
37
38     if ( number1 >= number2 )
39         System.out.printf( "%d >= %d\n", number1, number2 );
40     } // end method main
41 } // end class Comparison

```

```

Enter first integer: 777
Enter second integer: 777
777 == 777
777 <= 777
777 >= 777

```

```

Enter first integer: 1000
Enter second integer: 2000
1000 != 2000
1000 < 2000
1000 <= 2000

```

```

Enter first integer: 2000
Enter second integer: 1000
2000 != 1000
2000 > 1000
2000 >= 1000

```

Fig. 2.15 | Compare integers using `if` statements, relational operators and equality operators. (Part 2 of 2.)

The declaration of class `Comparison` begins at line 6

```
public class Comparison
```

The class's main method (lines 9–40) begins the execution of the program. Line 12

```
Scanner input = new Scanner( System.in );
```

declares `Scanner` variable `input` and assigns it a `Scanner` that inputs data from the standard input (i.e., the keyboard).

Lines 14–15

```
int number1; // first number to compare
int number2; // second number to compare
```

declare the `int` variables used to store the values input from the user.

Lines 17–18

```
System.out.print( "Enter first integer: " ); // prompt
number1 = input.nextInt(); // read first number from user
```

prompt the user to enter the first integer and input the value, respectively. The input value is stored in variable `number1`.

Lines 20–21

```
System.out.print( "Enter second integer: " ); // prompt
number2 = input.nextInt(); // read second number from user
```

prompt the user to enter the second integer and input the value, respectively. The input value is stored in variable `number2`.

Lines 23–24

```
if ( number1 == number2 )
    System.out.printf( "%d == %d\n", number1, number2 );
```

compare the values of `number1` and `number2` to determine whether they're equal. An `if` statement always begins with keyword `if`, followed by a condition in parentheses. An `if` statement expects one statement in its body, but may contain multiple statements if they're enclosed in a set of braces (`{}`). The indentation of the body statement shown here is not required, but it improves the program's readability by emphasizing that the statement in line 24 *is part of* the `if` statement that begins at line 23. Line 24 executes only if the numbers stored in variables `number1` and `number2` are equal (i.e., the condition is true). The `if` statements in lines 26–27, 29–30, 32–33, 35–36 and 38–39 compare `number1` and `number2` using the operators `!=`, `<`, `>`, `<=` and `>=`, respectively. If the condition in one or more of the `if` statements is true, the corresponding body statement executes.



Common Programming Error 2.6

Confusing the equality operator, `==`, with the assignment operator, `=`, can cause a logic error or a syntax error. The equality operator should be read as “is equal to” and the assignment operator as “gets” or “gets the value of.” To avoid confusion, some people read the equality operator as “double equals” or “equals equals.”



Good Programming Practice 2.11

Placing only one statement per line in a program enhances program readability.

There's no semicolon (`;`) at the end of the first line of each `if` statement. Such a semicolon would result in a logic error at execution time. For example,

```
if ( number1 == number2 ); // logic error
    System.out.printf( "%d == %d\n", number1, number2 );
```

would actually be interpreted by Java as

```
if ( number1 == number2 )
    ; // empty statement
    System.out.printf( "%d == %d\n", number1, number2 );
```

where the semicolon on the line by itself—called the **empty statement**—is the statement to execute if the condition in the `if` statement is true. When the empty statement executes, no task is performed. The program then continues with the output statement, which always executes, regardless of whether the condition is true or false, because the output statement is not part of the `if` statement.



Common Programming Error 2.7

Placing a semicolon immediately after the right parenthesis of the condition in an `if` statement is normally a logic error.

Note the use of white space in Fig. 2.15. Recall that the compiler normally ignores white space. So, statements may be split over several lines and may be spaced according to your preferences without affecting a program's meaning. It's incorrect to split identifiers and strings. Ideally, statements should be kept small, but this is not always possible.



Error-Prevention Tip 2.9

A lengthy statement can be spread over several lines. If a single statement must be split across lines, choose breaking points that make sense, such as after a comma in a comma-separated list, or after an operator in a lengthy expression. If a statement is split across two or more lines, indent all subsequent lines until the end of the statement.

Figure 2.16 shows the operators discussed so far in decreasing order of precedence. All but the assignment operator, `=`, associate from left to right. The assignment operator, `=`, associates from right to left, so an expression like `x = y = 0` is evaluated as if it had been written as `x = (y = 0)`, which first assigns the value 0 to variable `y`, then assigns the result of that assignment, 0, to `x`.



Good Programming Practice 2.12

When writing expressions containing many operators, refer to the operator precedence chart (Appendix A). Confirm that the operations in the expression are performed in the order you expect. If, in a complex expression, you're uncertain about the order of evaluation, use parentheses to force the order, exactly as you'd do in algebraic expressions.

Operators	Associativity	Type
* / %	left to right	multiplicative
+ -	left to right	additive
< <= > >=	left to right	relational
== !=	left to right	equality
=	right to left	assignment

Fig. 2.16 | Precedence and associativity of operators discussed.

2.9 Wrap-Up

In this chapter, you learned many important features of Java, including displaying data on the screen in a **Command Prompt**, inputting data from the keyboard, performing calculations and making decisions. The applications presented here introduced you to basic programming concepts. As you'll see in Chapter 3, Java applications typically contain just a few lines of code in method `main`—these statements normally create the objects that perform the work of the application. In Chapter 3, you'll learn how to implement your own classes and use objects of those classes in applications.

Summary

Section 2.2 Your First Program in Java: Printing a Line of Text

- A Java application (p. 38) executes when you use the `java` command to launch the JVM.

- Comments (p. 39) document programs and improve their readability. The compiler ignores them.
- A comment that begins with `//` is an end-of-line comment—it terminates at the end of the line on which it appears.
- Traditional comments (p. 39) can be spread over several lines and are delimited by `/*` and `*/`.
- Javadoc comments (p. 39), delimited by `/**` and `*/`, enable you to embed program documentation in your code. The javadoc utility program generates HTML pages based on these comments.
- A syntax error (p. 39; also called a compiler error, compile-time error or compilation error) occurs when the compiler encounters code that violates Java’s language rules. It’s similar to a grammar error in a natural language.
- Blank lines, space characters and tab characters are known as white space (p. 39). White space makes programs easier to read and is ignored by the compiler.
- Keywords (p. 40) are reserved for use by Java and are always spelled with all lowercase letters.
- Keyword `class` (p. 40) introduces a class declaration.
- By convention, all class names in Java begin with a capital letter and capitalize the first letter of each word they include (e.g., `SampleClassName`).
- A Java class name is an identifier—a series of characters consisting of letters, digits, underscores (`_`) and dollar signs (`$`) that does not begin with a digit and does not contain spaces.
- Java is case sensitive (p. 40)—that is, uppercase and lowercase letters are distinct.
- The body of every class declaration (p. 40) is delimited by braces, `{` and `}`.
- A `public` (p. 40) class declaration must be saved in a file with the same name as the class followed by the “.java” file-name extension.
- Method `main` (p. 41) is the starting point of every Java application and must begin with

```
public static void main( String[] args )
```

 otherwise, the JVM will not execute the application.
- Methods perform tasks and return information when they complete them. Keyword `void` (p. 41) indicates that a method will perform a task but return no information.
- Statements instruct the computer to perform actions.
- A string (p. 41) in double quotes is sometimes called a character string or a string literal.
- The standard output object (`System.out`; p. 41) displays characters in the command window.
- Method `System.out.println` (p. 41) displays its argument (p. 41) in the command window followed by a newline character to position the output cursor to the beginning of the next line.
- You compile a program with the command `javac`. If the program contains no syntax errors, a class file (p. 43) containing the Java bytecodes that represent the application is created. These bytecodes are interpreted by the JVM when you execute the program.
- To run an application, type `java` (p. 38) followed by the name of the class that contains `main`.

Section 2.3 Modifying Your First Java Program

- `System.out.print` (p. 44) displays its argument and positions the output cursor immediately after the last character displayed.
- A backslash (`\`) in a string is an escape character (p. 45). Java combines it with the next character to form an escape sequence (p. 45). The escape sequence `\n` (p. 45) represents the newline character.

Section 2.4 Displaying Text with `printf`

- `System.out.printf` method (p. 46; `f` means “formatted”) displays formatted data.

- Method `printf`'s first argument is a format string (p. 47) containing fixed text and/or format specifiers. Each format specifier (p. 47) indicates the type of data to output and is a placeholder for a corresponding argument that appears after the format string.
- Format specifiers begin with a percent sign (%) and are followed by a character that represents the data type. The format specifier `%s` (p. 47) is a placeholder for a string.

Section 2.5 Another Application: Adding Integers

- An `import` declaration (p. 48) helps the compiler locate a class that's used in a program.
- Java's rich set of predefined classes are grouped into packages (p. 48)—named groups of classes. These are referred to as the Java class library (p. 48), or the Java Application Programming Interface (Java API).
- A variable (p. 49) is a location in the computer's memory where a value can be stored for use later in a program. All variables must be declared with a name and a type before they can be used.
- A variable's name enables the program to access the variable's value in memory.
- A `Scanner` (package `java.util`; p. 49) enables a program to read data that the program will use. Before a `Scanner` can be used, the program must create it and specify the source of the data.
- Variables should be initialized (p. 49) to prepare them for use in a program.
- The expression `new Scanner(System.in)` creates a `Scanner` that reads from the standard input object (`System.in`; p. 49)—normally the keyboard.
- Data type `int` (p. 49) is used to declare variables that will hold integer values. The range of values for an `int` is `-2,147,483,648` to `+2,147,483,647`.
- Types `float` and `double` (p. 49) specify real numbers with decimal points, such as `3.4` and `-11.19`.
- Variables of type `char` (p. 49) represent individual characters, such as an uppercase letter (e.g., `A`), a digit (e.g., `7`), a special character (e.g., `*` or `%`) or an escape sequence (e.g., `\n`, `\n`).
- Types such as `int`, `float`, `double` and `char` are primitive types (p. 49). Primitive-type names are keywords; thus, they must appear in all lowercase letters.
- A prompt (p. 50) directs the user to take a specific action.
- `Scanner` method `nextInt` obtains an integer for use in a program.
- The assignment operator, `=` (p. 51), enables the program to give a value to a variable. It's called a binary operator (p. 51) because it has two operands.
- Portions of statements that have values are called expressions (p. 51).
- The format specifier `%d` (p. 51) is a placeholder for an `int` value.

Section 2.6 Memory Concepts

- Variable names (p. 52) correspond to locations in the computer's memory. Every variable has a name, a type, a size and a value.
- A value that's placed in a memory location replaces the location's previous value, which is lost.

Section 2.7 Arithmetic

- The arithmetic operators (p. 53) are `+` (addition), `-` (subtraction), `*` (multiplication), `/` (division) and `%` (remainder).
- Integer division (p. 53) yields an integer quotient.
- The remainder operator, `%` (p. 53), yields the remainder after division.
- Arithmetic expressions must be written in straight-line form (p. 54).
- If an expression contains nested parentheses (p. 54), the innermost set is evaluated first.

- Java applies the operators in arithmetic expressions in a precise sequence determined by the rules of operator precedence (p. 54).
- When we say that operators are applied from left to right, we're referring to their associativity (p. 54). Some operators associate from right to left.
- Redundant parentheses (p. 56) can make an expression clearer.

Section 2.8 Decision Making: Equality and Relational Operators

- The `if` statement (p. 56) makes a decision based on a condition's value (true or false).
- Conditions in `if` statements can be formed by using the equality (`==` and `!=`) and relational (`>`, `<`, `>=` and `<=`) operators (p. 56).
- An `if` statement begins with keyword `if` followed by a condition in parentheses and expects one statement in its body.
- The empty statement (p. 59) is a statement that does not perform a task.

Self-Review Exercises

- 2.1** Fill in the blanks in each of the following statements:
- A(n) _____ begins the body of every method, and a(n) _____ ends the body of every method.
 - The _____ statement is used to make decisions.
 - _____ begins an end-of-line comment.
 - _____, _____ and _____ are called white space.
 - _____ are reserved for use by Java.
 - Java applications begin execution at method _____.
 - Methods _____, _____ and _____ display information in a command window.
- 2.2** State whether each of the following is *true* or *false*. If *false*, explain why.
- Comments cause the computer to print the text after the `//` on the screen when the program executes.
 - All variables must be given a type when they're declared.
 - Java considers the variables `number` and `NUMbER` to be identical.
 - The remainder operator (`%`) can be used only with integer operands.
 - The arithmetic operators `*`, `/`, `%`, `+` and `-` all have the same level of precedence.
- 2.3** Write statements to accomplish each of the following tasks:
- Declare variables `c`, `thisIsAVariable`, `q76354` and `number` to be of type `int`.
 - Prompt the user to enter an integer.
 - Input an integer and assign the result to `int` variable `value`. Assume `Scanner` variable `input` can be used to read a value from the keyboard.
 - Print "This is a Java program" on one line in the command window. Use method `System.out.println`.
 - Print "This is a Java program" on two lines in the command window. The first line should end with `Java`. Use method `System.out.println`.
 - Print "This is a Java program" on two lines in the command window. The first line should end with `Java`. Use method `System.out.printf` and two `%s` format specifiers.
 - If the variable `number` is not equal to 7, display "The variable number is not equal to 7".
- 2.4** Identify and correct the errors in each of the following statements:
- ```
if (c < 7);
 System.out.println("c is less than 7");
```
  - ```
if ( c => 7 )
    System.out.println( "c is equal to or greater than 7" );
```

2.5 Write declarations, statements or comments that accomplish each of the following tasks:

- a) State that a program will calculate the product of three integers.
- b) Create a Scanner called `input` that reads values from the standard input.
- c) Declare the variables `x`, `y`, `z` and `result` to be of type `int`.
- d) Prompt the user to enter the first integer.
- e) Read the first integer from the user and store it in the variable `x`.
- f) Prompt the user to enter the second integer.
- g) Read the second integer from the user and store it in the variable `y`.
- h) Prompt the user to enter the third integer.
- i) Read the third integer from the user and store it in the variable `z`.
- j) Compute the product of the three integers contained in variables `x`, `y` and `z`, and assign the result to the variable `result`.
- k) Display the message "Product is" followed by the value of the variable `result`.

2.6 Using the statements you wrote in Exercise 2.5, write a complete program that calculates and prints the product of three integers.

Answers to Self-Review Exercises

2.1 a) left brace (`{`), right brace (`}`). b) `if`. c) `//`. d) Space characters, newlines and tabs. e) Keywords. f) `main`. g) `System.out.print`, `System.out.println` and `System.out.printf`.

2.2 a) False. Comments do not cause any action to be performed when the program executes. They're used to document programs and improve their readability.
 b) True.
 c) False. Java is case sensitive, so these variables are distinct.
 d) False. The remainder operator can also be used with noninteger operands in Java.
 e) False. The operators `*`, `/` and `%` are higher precedence than operators `+` and `-`.

2.3 a)

```
int c, thisIsAVariable, q76354, number;
or
int c;
int thisIsAVariable;
int q76354;
int number;
```

 b)

```
System.out.print( "Enter an integer: " );
```

 c)

```
value = input.nextInt();
```

 d)

```
System.out.println( "This is a Java program" );
```

 e)

```
System.out.println( "This is a Java\nprogram" );
```

 f)

```
System.out.printf( "%s\n%s\n", "This is a Java", "program" );
```

 g)

```
if ( number != 7 )
    System.out.println( "The variable number is not equal to 7" );
```

2.4 a) Error: Semicolon after the right parenthesis of the condition (`c < 7`) in the `if`.
 Correction: Remove the semicolon after the right parenthesis. [Note: As a result, the output statement will execute regardless of whether the condition in the `if` is true.]

b) Error: The relational operator `=>` is incorrect. Correction: Change `=>` to `>=`.

2.5 a)

```
// Calculate the product of three integers
```

 b)

```
Scanner input = new Scanner( System.in );
```

 c)

```
int x, y, z, result;
```

 or

```

    int x;
    int y;
    int z;
    int result;
d) System.out.print( "Enter first integer: " );
e) x = input.nextInt();
f) System.out.print( "Enter second integer: " );
g) y = input.nextInt();
h) System.out.print( "Enter third integer: " );
i) z = input.nextInt();
j) result = x * y * z;
k) System.out.printf( "Product is %d\n", result );

```

2.6 The solution to Self-Review Exercise 2.6 is as follows:

```

1 // Ex. 2.6: Product.java
2 // Calculate the product of three integers.
3 import java.util.Scanner; // program uses Scanner
4
5 public class Product
6 {
7     public static void main( String[] args )
8     {
9         // create Scanner to obtain input from command window
10        Scanner input = new Scanner( System.in );
11
12        int x; // first number input by user
13        int y; // second number input by user
14        int z; // third number input by user
15        int result; // product of numbers
16
17        System.out.print( "Enter first integer: " ); // prompt for input
18        x = input.nextInt(); // read first integer
19
20        System.out.print( "Enter second integer: " ); // prompt for input
21        y = input.nextInt(); // read second integer
22
23        System.out.print( "Enter third integer: " ); // prompt for input
24        z = input.nextInt(); // read third integer
25
26        result = x * y * z; // calculate product of numbers
27
28        System.out.printf( "Product is %d\n", result );
29    } // end method main
30 } // end class Product

```

```

Enter first integer: 10
Enter second integer: 20
Enter third integer: 30
Product is 6000

```

Exercises

2.7 Fill in the blanks in each of the following statements:

- _____ are used to document a program and improve its readability.
- A decision can be made in a Java program with a(n) _____.

- c) Calculations are normally performed by _____ statements.
- d) The arithmetic operators with the same precedence as multiplication are _____ and _____.
- e) When parentheses in an arithmetic expression are nested, the _____ set of parentheses is evaluated first.
- f) A location in the computer's memory that may contain different values at various times throughout the execution of a program is called a(n) _____.

2.8 Write Java statements that accomplish each of the following tasks:

- a) Display the message "Enter an integer: ", leaving the cursor on the same line.
- b) Assign the product of variables b and c to variable a.
- c) Use a comment to state that a program performs a sample payroll calculation.

2.9 State whether each of the following is *true* or *false*. If *false*, explain why.

- a) Java operators are evaluated from left to right.
- b) The following are all valid variable names: `_under_bar_`, `m928134`, `t5`, `j7`, `her_sales$`, `his_$account_total`, `a`, `b$`, `c`, `z` and `z2`.
- c) A valid Java arithmetic expression with no parentheses is evaluated from left to right.
- d) The following are all invalid variable names: `3g`, `87`, `67h2`, `h22` and `2h`.

2.10 Assuming that $x = 2$ and $y = 3$, what does each of the following statements display?

- a) `System.out.printf("x = %d\n", x);`
- b) `System.out.printf("Value of %d + %d is %d\n", x, x, (x + x));`
- c) `System.out.printf("x = ");`
- d) `System.out.printf("%d = %d\n", (x + y), (y + x));`

2.11 Which of the following Java statements contain variables whose values are modified?

- a) `p = i + j + k + 7;`
- b) `System.out.println("variables whose values are modified");`
- c) `System.out.println("a = 5");`
- d) `value = input.nextInt();`

2.12 Given that $y = ax^3 + 7$, which of the following are correct Java statements for this equation?

- a) `y = a * x * x * x + 7;`
- b) `y = a * x * x * (x + 7);`
- c) `y = (a * x) * x * (x + 7);`
- d) `y = (a * x) * x * x + 7;`
- e) `y = a * (x * x * x) + 7;`
- f) `y = a * x * (x * x + 7);`

2.13 State the order of evaluation of the operators in each of the following Java statements, and show the value of x after each statement is performed:

- a) `x = 7 + 3 * 6 / 2 - 1;`
- b) `x = 2 % 2 + 2 * 2 - 2 / 2;`
- c) `x = (3 * 9 * (3 + (9 * 3 / (3))));`

2.14 Write an application that displays the numbers 1 to 4 on the same line, with each pair of adjacent numbers separated by one space. Use the following techniques:

- a) Use one `System.out.println` statement.
- b) Use four `System.out.print` statements.
- c) Use one `System.out.printf` statement.

2.15 (*Arithmetic*) Write an application that asks the user to enter two integers, obtains them from the user and prints their sum, product, difference and quotient (division). Use the techniques shown in Fig. 2.7.

2.16 (*Comparing Integers*) Write an application that asks the user to enter two integers, obtains them from the user and displays the larger number followed by the words "is larger". If the numbers are equal, print the message "These numbers are equal". Use the techniques shown in Fig. 2.15.

2.17 (*Arithmetic, Smallest and Largest*) Write an application that inputs three integers from the user and displays the sum, average, product, smallest and largest of the numbers. Use the techniques shown in Fig. 2.15. [Note: The calculation of the average in this exercise should result in an integer representation of the average. So, if the sum of the values is 7, the average should be 2, not 2.3333....]

2.18 (*Displaying Shapes with Asterisks*) Write an application that displays a box, an oval, an arrow and a diamond using asterisks (*), as follows:

```

*****      ***      *      *
*   *   *   *   *   *   *   *
*   *   *   *   *   *   *   *
*   *   *   *   *   *   *   *
*   *   *   *   *   *   *   *
*   *   *   *   *   *   *   *
*   *   *   *   *   *   *   *
*   *   *   *   *   *   *   *
*****      ***      *      *

```

2.19 What does the following code print?

```
System.out.println( "*" + "\n*" + "\n***" + "\n*****" );
```

2.20 What does the following code print?

```
System.out.println( "*" );
System.out.println( "****" );
System.out.println( "*****" );
System.out.println( "*****" );
System.out.println( "****" );
```

2.21 What does the following code print?

```
System.out.print( "*" );
System.out.print( "****" );
System.out.print( "*****" );
System.out.print( "*****" );
System.out.println( "****" );
```

2.22 What does the following code print?

```
System.out.print( "*" );
System.out.println( "****" );
System.out.println( "*****" );
System.out.print( "*****" );
System.out.println( "****" );
```

2.23 What does the following code print?

```
System.out.printf( "%s\n%s\n%s\n", "*", "****", "*****" );
```

2.24 (*Largest and Smallest Integers*) Write an application that reads five integers and determines and prints the largest and smallest integers in the group. Use only the programming techniques you learned in this chapter.

2.25 (*Odd or Even*) Write an application that reads an integer and determines and prints whether it's odd or even. [Hint: Use the remainder operator. An even number is a multiple of 2. Any multiple of 2 leaves a remainder of 0 when divided by 2.]

2.26 (*Multiples*) Write an application that reads two integers, determines whether the first is a multiple of the second and prints the result. [Hint: Use the remainder operator.]

2.27 (*Checkerboard Pattern of Asterisks*) Write an application that displays a checkerboard pattern, as follows:

```
* * * * *
 * * * * *
* * * * *
 * * * * *
* * * * *
 * * * * *
* * * * *
 * * * * *
* * * * *
```

2.28 (*Diameter, Circumference and Area of a Circle*) Here's a peek ahead. In this chapter, you learned about integers and the type `int`. Java can also represent floating-point numbers that contain decimal points, such as 3.14159. Write an application that inputs from the user the radius of a circle as an integer and prints the circle's diameter, circumference and area using the floating-point value 3.14159 for π . Use the techniques shown in Fig. 2.7. [Note: You may also use the predefined constant `Math.PI` for the value of π . This constant is more precise than the value 3.14159. Class `Math` is defined in package `java.lang`. Classes in that package are imported automatically, so you do not need to `import class Math` to use it.] Use the following formulas (r is the radius):

$$\begin{aligned} \text{diameter} &= 2r \\ \text{circumference} &= 2\pi r \\ \text{area} &= \pi r^2 \end{aligned}$$

Do not store the results of each calculation in a variable. Rather, specify each calculation as the value that will be output in a `System.out.printf` statement. The values produced by the circumference and area calculations are floating-point numbers. Such values can be output with the format specifier `%f` in a `System.out.printf` statement. You'll learn more about floating-point numbers in Chapter 3.

2.29 (*Integer Value of a Character*) Here's another peek ahead. In this chapter, you learned about integers and the type `int`. Java can also represent uppercase letters, lowercase letters and a considerable variety of special symbols. Every character has a corresponding integer representation. The set of characters a computer uses together with the corresponding integer representations for those characters is called that computer's character set. You can indicate a character value in a program simply by enclosing that character in single quotes, as in `'A'`.

You can determine a character's integer equivalent by preceding that character with `(int)`, as in

```
(int) 'A'
```

An operator of this form is called a cast operator. (You'll learn about cast operators in Chapter 4.) The following statement outputs a character and its integer equivalent:

```
System.out.printf(
    "The character %c has the value %d\n", 'A', (int) 'A' );
```

When the preceding statement executes, it displays the character `A` and the value 65 (from the Unicode® character set) as part of the string. The format specifier `%c` is a placeholder for a character (in this case, the character `'A'`).

Using statements similar to the one shown earlier in this exercise, write an application that displays the integer equivalents of some uppercase letters, lowercase letters, digits and special symbols. Display the integer equivalents of the following: `A B C a b c 0 1 2 $ * + /` and the blank character.

2.30 (*Separating the Digits in an Integer*) Write an application that inputs one number consisting of five digits from the user, separates the number into its individual digits and prints the digits separated from one another by three spaces each. For example, if the user types in the number 42339, the program should print

```
4 2 3 3 9
```

Assume that the user enters the correct number of digits. What happens when you execute the program and type a number with more than five digits? What happens when you execute the program and type a number with fewer than five digits? [*Hint:* It’s possible to do this exercise with the techniques you learned in this chapter. You’ll need to use both division and remainder operations to “pick off” each digit.]

2.31 (*Table of Squares and Cubes*) Using only the programming techniques you learned in this chapter, write an application that calculates the squares and cubes of the numbers from 0 to 10 and prints the resulting values in table format, as shown below. [*Note:* This program does not require any input from the user.]

number	square	cube
0	0	0
1	1	1
2	4	8
3	9	27
4	16	64
5	25	125
6	36	216
7	49	343
8	64	512
9	81	729
10	100	1000

2.32 (*Negative, Positive and Zero Values*) Write a program that inputs five numbers and determines and prints the number of negative numbers input, the number of positive numbers input and the number of zeros input.

Making a Difference

2.33 (*Body Mass Index Calculator*) We introduced the body mass index (BMI) calculator in Exercise 1.10. The formulas for calculating BMI are

$$BMI = \frac{weightInPounds \times 703}{heightInInches \times heightInInches}$$

or

$$BMI = \frac{weightInKilograms}{heightInMeters \times heightInMeters}$$

Create a BMI calculator that reads the user’s weight in pounds and height in inches (or, if you prefer, the user’s weight in kilograms and height in meters), then calculates and displays the user’s body mass index. Also, display the following information from the Department of Health and Human Services/National Institutes of Health so the user can evaluate his/her BMI:

BMI VALUES	
Underweight:	less than 18.5
Normal:	between 18.5 and 24.9
Overweight:	between 25 and 29.9
Obese:	30 or greater

[*Note:* In this chapter, you learned to use the `int` type to represent whole numbers. The BMI calculations when done with `int` values will both produce whole-number results. In Chapter 3 you'll learn to use the `double` type to represent numbers with decimal points. When the BMI calculations are performed with `doubles`, they'll both produce numbers with decimal points—these are called “floating-point” numbers.]

2.34 (*World Population Growth Calculator*) Use the web to determine the current world population and the annual world population growth rate. Write an application that inputs these values, then displays the estimated world population after one, two, three, four and five years.

2.35 (*Car-Pool Savings Calculator*) Research several car-pooling websites. Create an application that calculates your daily driving cost, so that you can estimate how much money could be saved by car pooling, which also has other advantages such as reducing carbon emissions and reducing traffic congestion. The application should input the following information and display the user's cost per day of driving to work:

- a) Total miles driven per day.
- b) Cost per gallon of gasoline.
- c) Average miles per gallon.
- d) Parking fees per day.
- e) Tolls per day.

Introduction to Classes, Objects, Methods and Strings

3

*Nothing can have value without
being an object of utility.*

—Karl Marx

*Your public servants serve you
right.*

—Adlai E. Stevenson

*You'll see something new.
Two things. And I call them
Thing One and Thing Two.*

—Dr. Theodor Seuss Geisel

Objectives

In this chapter you'll learn:

- How to declare a class and use it to create an object.
- How to implement a class's behaviors as methods.
- How to implement a class's attributes as instance variables and properties.
- How to call an object's methods to make them perform their tasks.
- What instance variables of a class and local variables of a method are.
- How to use a constructor to initialize an object's data.
- The differences between primitive and reference types.



- | | |
|---|---|
| 3.1 Introduction | 3.6 Initializing Objects with Constructors |
| 3.2 Declaring a Class with a Method and Instantiating an Object of a Class | 3.7 Floating-Point Numbers and Type <code>double</code> |
| 3.3 Declaring a Method with a Parameter | 3.8 (Optional) GUI and Graphics Case Study: Using Dialog Boxes |
| 3.4 Instance Variables, <i>set</i> Methods and <i>get</i> Methods | 3.9 Wrap-Up |
| 3.5 Primitive Types vs. Reference Types | |

Summary | Self-Review Exercises | Answers to Self-Review Exercises | Exercises | Making a Difference

3.1 Introduction

We introduced the basic terminology and concepts of object-oriented programming in Section 1.6. In this chapter, we present a simple framework for organizing object-oriented applications in Java. Typically, the applications you develop in this book will consist of two or more classes. If you become part of a development team in industry, you might work on applications that contain hundreds, or even thousands, of classes.

First, we motivate the notion of classes with a real-world example. Then we present five applications to demonstrate creating and using your own classes. The first four of these begin our case study on developing a grade book class that instructors can use to maintain student test scores. This case study is enhanced in Chapters 4, 5 and 7. The last example introduces floating-point numbers—that is, numbers containing decimal points—in a bank account class that maintains a customer’s balance.

3.2 Declaring a Class with a Method and Instantiating an Object of a Class

In Sections 2.5 and 2.8, you created an object of the *existing* class `Scanner`, then used that object to read data from the keyboard. In this section, you’ll create a *new* class, then use it to create an object. We begin by declaring classes `GradeBook` (Fig. 3.1) and `GradeBookTest` (Fig. 3.2). Class `GradeBook` (declared in the file `GradeBook.java`) will be used to display a message on the screen (Fig. 3.2) welcoming the instructor to the grade book application. Class `GradeBookTest` (declared in the file `GradeBookTest.java`) is an application class in which the `main` method will create and use an object of class `GradeBook`. *Each class declaration that begins with keyword `public` must be stored in a file having the same name as the class and ending with the `.java` file-name extension.* Thus, classes `GradeBook` and `GradeBookTest` must be declared in *separate* files, because each class is declared `public`.

Class `GradeBook`

The `GradeBook` class declaration (Fig. 3.1) contains a `displayMessage` method (lines 7–10) that displays a message on the screen. We’ll need to make an object of this class and call its method to execute line 9 and display the message.

The *class declaration* begins in line 4. The keyword `public` is an **access modifier**. For now, we’ll simply declare every class `public`. Every class declaration contains keyword

```
1 // Fig. 3.1: GradeBook.java
2 // Class declaration with one method.
3
4 public class GradeBook
5 {
6     // display a welcome message to the GradeBook user
7     public void displayMessage()
8     {
9         System.out.println( "Welcome to the Grade Book!" );
10    } // end method displayMessage
11 } // end class GradeBook
```

Fig. 3.1 | Class declaration with one method.

class followed immediately by the class's name. Every class's body is enclosed in a pair of left and right braces, as in lines 5 and 11 of class `GradeBook`.

In Chapter 2, each class we declared had one method named `main`. Class `GradeBook` also has one method—`displayMessage` (lines 7–10). Recall that `main` is a special method that's *always* called automatically by the Java Virtual Machine (JVM) when you execute an application. Most methods do not get called automatically. As you'll soon see, you must call method `displayMessage` explicitly to tell it to perform its task.

The method declaration begins with keyword `public` to indicate that the method is “available to the public”—it can be called from methods of other classes. Next is the method's **return type**, which specifies the type of data the method returns to its caller after performing its task. The return type `void` indicates that this method will perform a task but will *not* return (i.e., give back) any information to its **calling method**. You've used methods that return information—for example, in Chapter 2 you used `Scanner` method `nextInt` to input an integer typed by the user at the keyboard. When `nextInt` reads a value from the user, it returns that value for use in the program.

The name of the method, `displayMessage`, follows the return type. By convention, method names begin with a lowercase first letter and subsequent words in the name begin with a capital letter. The parentheses after the method name indicate that this is a method. Empty parentheses, as in line 7, indicate that this method does not require additional information to perform its task. Line 7 is commonly referred to as the **method header**. Every method's body is delimited by left and right braces, as in lines 8 and 10.

The body of a method contains one or more statements that perform the method's task. In this case, the method contains one statement (line 9) that displays the message “Welcome to the Grade Book!” followed by a newline (because of `println`) in the command window. After this statement executes, the method has completed its task.

Class GradeBookTest

Next, we'd like to use class `GradeBook` in an application. As you learned in Chapter 2, method `main` begins the execution of *every* application. A class that contains method `main` begins the execution of a Java application. Class `GradeBook` is *not* an application because it does *not* contain `main`. Therefore, if you try to execute `GradeBook` by typing `java GradeBook` in the command window, an error will occur. This was not a problem in Chapter 2, because every class you declared had a `main` method. To fix this problem, we must either declare a separate class that contains a `main` method or place a `main` method in class `Grade-`

Book. To help you prepare for the larger programs you'll encounter later in this book and in industry, we use a separate class (`GradeBookTest` in this example) containing method `main` to test each new class we create in this chapter. Some programmers refer to such a class as a *driver class*.

The `GradeBookTest` class declaration (Fig. 3.2) contains the `main` method that will control our application's execution. The `GradeBookTest` class declaration begins in line 4 and ends in line 15. The class, like many that begin an application's execution, contains *only* a `main` method.

```

1 // Fig. 3.2: GradeBookTest.java
2 // Creating a GradeBook object and calling its displayMessage method.
3
4 public class GradeBookTest
5 {
6     // main method begins program execution
7     public static void main( String[] args )
8     {
9         // create a GradeBook object and assign it to myGradeBook
10        GradeBook myGradeBook = new GradeBook();
11
12        // call myGradeBook's displayMessage method
13        myGradeBook.displayMessage();
14    } // end main
15 } // end class GradeBookTest

```

```
Welcome to the Grade Book!
```

Fig. 3.2 | Creating a `GradeBook` object and calling its `displayMessage` method.

Lines 7–14 declare method `main`. A key part of enabling the JVM to locate and call method `main` to begin the application's execution is the `static` keyword (line 7), which indicates that `main` is a static method. *A static method is special, because you can call it without first creating an object of the class in which the method is declared.* We discuss static methods in Chapter 6, *Methods: A Deeper Look*.

In this application, we'd like to call class `GradeBook`'s `displayMessage` method to display the welcome message in the command window. Typically, you cannot call a method that belongs to another class until you create an object of that class, as shown in line 10. We begin by declaring variable `myGradeBook`. The variable's type is `GradeBook`—the class we declared in Fig. 3.1. Each new *class* you create becomes a new *type* that can be used to declare variables and create objects. You can declare new class types as needed; this is one reason why Java is known as an **extensible language**.

Variable `myGradeBook` is initialized (line 10) with the result of the **class instance creation expression** `new GradeBook()`. Keyword **new** creates a new object of the class specified to the right of the keyword (i.e., `GradeBook`). The parentheses to the right of `GradeBook` are required. As you'll learn in Section 3.6, those parentheses in combination with a class name represent a call to a **constructor**, which is similar to a method but is used only at the time an object is *created* to *initialize* the object's data. You'll see that data can be placed in the parentheses to specify *initial values* for the object's data. For now, we simply leave the parentheses empty.

Just as we can use object `System.out` to call its methods `print`, `printf` and `println`, we can use object `myGradeBook` to call its method `displayMessage`. Line 13 calls the method `displayMessage` (lines 7–10 of Fig. 3.1) using `myGradeBook` followed by a **dot separator** (`.`), the method name `displayMessage` and an empty set of parentheses. This call causes the `displayMessage` method to perform its task. This method call differs from those in Chapter 2 that displayed information in a command window—each of those method calls provided arguments that specified the data to display. At the beginning of line 13, “`myGradeBook.`” indicates that `main` should use the `myGradeBook` object that was created in line 10. Line 7 of Fig. 3.1 indicates that method `displayMessage` has an *empty parameter list*—that is, `displayMessage` does *not* require additional information to perform its task. For this reason, the method call (line 13 of Fig. 3.2) specifies an empty set of parentheses after the method name to indicate that *no arguments* are being passed to method `displayMessage`. When method `displayMessage` completes its task, method `main` continues executing at line 14. This is the end of method `main`, so the program terminates.

Any class can contain a `main` method. The JVM invokes the `main` method *only* in the class used to execute the application. If an application has multiple classes that contain `main`, the one that’s invoked is the one in the class named in the `java` command.

Compiling an Application with Multiple Classes

You must compile the classes in Fig. 3.1 and Fig. 3.2 before you can execute the application. First, change to the directory that contains the application’s source-code files. Next, type the command

```
javac GradeBook.java GradeBookTest.java
```

to compile *both* classes at once. If the directory containing the application includes only this application’s files, you can compile *all* the classes in the directory with the command

```
javac *.java
```

The asterisk (`*`) in `*.java` indicates that *all* files in the current directory that end with the file-name extension “`.java`” should be compiled.

UML Class Diagram for Class `GradeBook`

Figure 3.3 presents a **UML class diagram** for class `GradeBook` of Fig. 3.1. In the UML, each class is modeled in a class diagram as a rectangle with three compartments. The top compartment contains the name of the class centered horizontally in boldface type. The middle compartment contains the class’s attributes, which correspond to instance variables (discussed in Section 3.4) in Java. In Fig. 3.3, the middle compartment is empty, because this `GradeBook` class does *not* have any attributes. The bottom compartment contains the

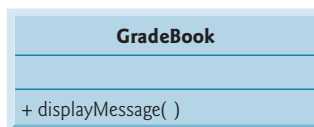

Fig. 3.3 | UML class diagram indicating that class `GradeBook` has a public `displayMessage` operation.

class's **operations**, which correspond to methods in Java. The UML models operations by listing the operation name preceded by an access modifier (in this case +) and followed by a set of parentheses. Class `GradeBook` has one method, `displayMessage`, so the bottom compartment of Fig. 3.3 lists one operation with this name. Method `displayMessage` does *not* require additional information to perform its tasks, so the parentheses following the method name in the class diagram are *empty*, just as they were in the method's declaration in line 7 of Fig. 3.1. The plus sign (+) in front of the operation name indicates that `displayMessage` is a public operation in the UML (i.e., a `public` method in Java). We'll often use UML class diagrams to summarize a class's attributes and operations.

3.3 Declaring a Method with a Parameter

In our car analogy from Section 1.6, we discussed the fact that pressing a car's gas pedal sends a *message* to the car to *perform a task*—to go faster. But *how fast* should the car accelerate? As you know, the farther down you press the pedal, the faster the car accelerates. So the message to the car actually includes the *task to perform* and *additional information* that helps the car perform the task. This additional information is known as a **parameter**—the value of the parameter helps the car determine how fast to accelerate. Similarly, a method can require one or more parameters that represent additional information it needs to perform its task. Parameters are defined in a comma-separated **parameter list**, which is located inside the parentheses that follow the method name. Each parameter must specify a *type* and a variable name. The parameter list may contain any number of parameters, including none at all. Empty parentheses following the method name (as in Fig. 3.1, line 7) indicate that a method does *not* require any parameters.

Arguments to a Method

A method call supplies values—called *arguments*—for each of the method's parameters. For example, the method `System.out.println` requires an argument that specifies the data to output in a command window. Similarly, to make a deposit into a bank account, a `deposit` method specifies a parameter that represents the deposit amount. When the `deposit` method is called, an argument value representing the deposit amount is assigned to the method's parameter. The method then makes a deposit of that amount.

Class Declaration with a Method That Has One Parameter

We now declare class `GradeBook` (Fig. 3.4) with a `displayMessage` method that displays the course name as part of the welcome message. (See the sample execution in Fig. 3.5.) The new method requires a parameter that represents the course name to output.

Before discussing the new features of class `GradeBook`, let's see how the new class is used from the `main` method of class `GradeBookTest` (Fig. 3.5). Line 12 creates a `Scanner` named `input` for reading the course name from the user. Line 15 creates the `GradeBook` object `myGradeBook`. Line 18 prompts the user to enter a course name. Line 19 reads the name from the user and assigns it to the `nameOfCourse` variable, using `Scanner` method `nextLine` to perform the input. The user types the course name and presses *Enter* to submit the course name to the program. Pressing *Enter* inserts a newline character at the end of the characters typed by the user. Method `nextLine` reads characters typed by the user until it encounters the newline character, then returns a `String` containing the characters up to, but *not* including, the newline. The newline character is *discarded*.

```

1 // Fig. 3.4: GradeBook.java
2 // Class declaration with one method that has a parameter.
3
4 public class GradeBook
5 {
6     // display a welcome message to the GradeBook user
7     public void displayMessage( String courseName )
8     {
9         System.out.printf( "Welcome to the grade book for\n%s!\n",
10             courseName );
11     } // end method displayMessage
12 } // end class GradeBook

```

Fig. 3.4 | Class declaration with one method that has a parameter.

```

1 // Fig. 3.5: GradeBookTest.java
2 // Create GradeBook object and pass a String to
3 // its displayMessage method.
4 import java.util.Scanner; // program uses Scanner
5
6 public class GradeBookTest
7 {
8     // main method begins program execution
9     public static void main( String[] args )
10    {
11        // create Scanner to obtain input from command window
12        Scanner input = new Scanner( System.in );
13
14        // create a GradeBook object and assign it to myGradeBook
15        GradeBook myGradeBook = new GradeBook();
16
17        // prompt for and input course name
18        System.out.println( "Please enter the course name:" );
19        String nameOfCourse = input.nextLine(); // read a line of text
20        System.out.println(); // outputs a blank line
21
22        // call myGradeBook's displayMessage method
23        // and pass nameOfCourse as an argument
24        myGradeBook.displayMessage( nameOfCourse );
25    } // end main
26 } // end class GradeBookTest

```

```

Please enter the course name:
CS101 Introduction to Java Programming

Welcome to the grade book for
CS101 Introduction to Java Programming!

```

Fig. 3.5 | Create a GradeBook object and pass a String to its displayMessage method.

Class Scanner also provides a similar method—**next**—that reads individual words. When the user presses *Enter* after typing input, method next reads characters until it encounters a *white-space character* (such as a space, tab or newline), then returns a String containing

the characters up to, but *not* including, the white-space character (which is discarded). All information after the first white-space character is not lost—it can be read by other statements that call the Scanner’s methods later in the program. Line 20 outputs a blank line.

Line 24 calls myGradeBooks’s `displayMessage` method. The variable `nameOfCourse` in parentheses is the *argument* that’s passed to method `displayMessage` so that the method can perform its task. The value of variable `nameOfCourse` in `main` becomes the value of method `displayMessage`’s *parameter* `courseName` in line 7 of Fig. 3.4. When you execute this application, notice that method `displayMessage` outputs the name you type as part of the welcome message (Fig. 3.5).

More on Arguments and Parameters

In Fig. 3.4, `displayMessage`’s parameter list (line 7) declares one parameter indicating that the method requires a `String` to perform its task. When the method is called, the argument value in the call is assigned to the corresponding parameter (`courseName`) in the method header. Then, the method body uses the value of the `courseName` parameter. Lines 9–10 of Fig. 3.4 display parameter `courseName`’s value, using the `%s` format specifier in `printf`’s format string. The parameter variable’s name (`courseName` in Fig. 3.4, line 7) can be the *same* or *different* from the argument variable’s name (`nameOfCourse` in Fig. 3.5, line 24).

The number of arguments in a method call *must* match the number of parameters in the parameter list of the method’s declaration. Also, the argument types in the method call must be “consistent with” the types of the corresponding parameters in the method’s declaration. (As you’ll learn in Chapter 6, an argument’s type and its corresponding parameter’s type are not always required to be *identical*.) In our example, the method call passes one argument of type `String` (`nameOfCourse` is declared as a `String` in line 19 of Fig. 3.5) and the method declaration specifies one parameter of type `String` (`courseName` is declared as a `String` in line 7 of Fig. 3.4). So in this example the type of the argument in the method call exactly matches the type of the parameter in the method header.

Updated UML Class Diagram for Class `GradeBook`

The UML class diagram of Fig. 3.6 models class `GradeBook` of Fig. 3.4. Like Fig. 3.1, this `GradeBook` class contains `public` operation `displayMessage`. However, this version of `displayMessage` has a parameter. The UML models a parameter a bit differently from Java by listing the parameter name, followed by a colon and the parameter type in the parentheses following the operation name. The UML has its own data types similar to those of Java (but, as you’ll see, not all the UML data types have the same names as the corresponding Java types). The UML type `String` does correspond to the Java type `String`. `GradeBook` method `displayMessage` (Fig. 3.4) has a `String` parameter named `courseName`, so Fig. 3.6 lists `courseName : String` between the parentheses following `displayMessage`.

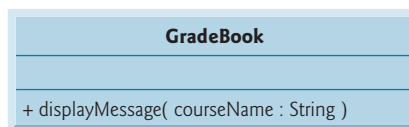

Fig. 3.6 | UML class diagram indicating that class `GradeBook` has a `displayMessage` operation with a `courseName` parameter of UML type `String`.

Notes on `import` Declarations

Notice the `import` declaration in Fig. 3.5 (line 4). This indicates to the compiler that the program uses class `Scanner`. Why do we need to import class `Scanner`, but not classes `System`, `String` or `GradeBook`? Classes `System` and `String` are in package `java.lang`, which is implicitly imported into *every* Java program, so all programs can use that package's classes *without* explicitly importing them. Most other classes you'll use in Java programs must be imported explicitly.

There's a special relationship between classes that are compiled in the same directory on disk, like classes `GradeBook` and `GradeBookTest`. By default, such classes are considered to be in the same package—known as the **default package**. Classes in the same package are *implicitly imported* into the source-code files of other classes in the same package. Thus, an `import` declaration is *not* required when one class in a package uses another in the same package—such as when class `GradeBookTest` uses class `GradeBook`.

The `import` declaration in line 4 is *not* required if we always refer to class `Scanner` as `java.util.Scanner`, which includes the *full package name and class name*. This is known as the class's **fully qualified class name**. For example, line 12 could be written as

```
java.util.Scanner input = new java.util.Scanner( System.in );
```



Software Engineering Observation 3.1

The Java compiler does not require `import` declarations in a Java source-code file if the fully qualified class name is specified every time a class name is used in the source code. Most Java programmers prefer to use `import` declarations.

3.4 Instance Variables, set Methods and get Methods

In Chapter 2, we declared all of an application's variables in the application's `main` method. Variables declared in the body of a particular method are known as **local variables** and can be used only in that method. When that method terminates, the values of its local variables are lost. Recall from Section 1.6 that an object has *attributes* that are carried with it as it's used in a program. Such attributes exist before a method is called on an object, while the method is executing and after the method completes execution.

A class normally consists of one or more methods that manipulate the attributes that belong to a particular object of the class. Attributes are represented as variables in a class declaration. Such variables are called **fields** and are declared *inside* a class declaration but *outside* the bodies of the class's method declarations. When each object of a class maintains its own copy of an attribute, the field that represents the attribute is also known as an **instance variable**—each object (instance) of the class has a separate instance of the variable in memory. The example in this section demonstrates a `GradeBook` class that contains a `courseName` instance variable to represent a particular `GradeBook` object's course name.

GradeBook Class with an Instance Variable, a set Method and a get Method

In our next application (Figs. 3.7–3.8), class `GradeBook` (Fig. 3.7) maintains the course name as an instance variable so that it can be used or modified at any time during an application's execution. The class contains three methods—`setCourseName`, `getCourseName` and `displayMessage`. Method `setCourseName` stores a course name in a `GradeBook`. Method `getCourseName` obtains a `GradeBook`'s course name. Method `displayMessage`,

which now specifies no parameters, still displays a welcome message that includes the course name; as you'll see, the method now obtains the course name by calling a method in the same class—`getCourseName`.

```

1 // Fig. 3.7: GradeBook.java
2 // GradeBook class that contains a courseName instance variable
3 // and methods to set and get its value.
4
5 public class GradeBook
6 {
7     private String courseName; // course name for this GradeBook
8
9     // method to set the course name
10    public void setCourseName( String name )
11    {
12        courseName = name; // store the course name
13    } // end method setCourseName
14
15    // method to retrieve the course name
16    public String getCourseName()
17    {
18        return courseName;
19    } // end method getCourseName
20
21    // display a welcome message to the GradeBook user
22    public void displayMessage()
23    {
24        // calls getCourseName to get the name of
25        // the course this GradeBook represents
26        System.out.printf( "Welcome to the grade book for\n%s!\n",
27            getCourseName() );
28    } // end method displayMessage
29 } // end class GradeBook

```

Fig. 3.7 | GradeBook class that contains a `courseName` instance variable and methods to set and get its value.

A typical instructor teaches more than one course, each with its own course name. Line 7 declares `courseName` as a variable of type `String`. Because the variable is declared *in* the body of the class but *outside* the bodies of the class's methods (lines 10–13, 16–19 and 22–28), line 7 is a declaration for an *instance variable*. Every instance (i.e., object) of class `GradeBook` contains one copy of each instance variable. For example, if there are two `GradeBook` objects, each object has its own copy of `courseName`. A benefit of making `courseName` an instance variable is that all the methods of the class (in this case, `GradeBook`) can manipulate any instance variables that appear in the class (in this case, `courseName`).

*Access Modifiers **public** and **private***

Most instance-variable declarations are preceded with the keyword `private` (as in line 7). Like `public`, keyword **private** is an *access modifier*. *Variables or methods declared with access modifier `private` are accessible only to methods of the class in which they're declared.* Thus,

variable `courseName` can be used only in methods `setCourseName`, `getCourseName` and `displayMessage` of (every object of) class `GradeBook`.

Declaring instance variables with access modifier `private` is known as **data hiding** or information hiding. When a program creates (instantiates) an object of class `GradeBook`, variable `courseName` is *encapsulated* (hidden) in the object and can be accessed only by methods of the object's class. This prevents `courseName` from being modified accidentally by a class in another part of the program. In class `GradeBook`, methods `setCourseName` and `getCourseName` manipulate the instance variable `courseName`.



Software Engineering Observation 3.2

Precede each field and method declaration with an access modifier. Generally, instance variables should be declared `private` and methods `public`. (It's appropriate to declare certain methods `private`, if they'll be accessed only by other methods of the class.)



Good Programming Practice 3.1

We prefer to list a class's fields first, so that, as you read the code, you see the names and types of the variables before they're used in the class's methods. You can list the class's fields anywhere in the class outside its method declarations, but scattering them can lead to hard-to-read code.

Methods `setCourseName` and `getCourseName`

Method `setCourseName` (lines 10–13) does not return any data when it completes its task, so its return type is `void`. The method receives one parameter—`name`—which represents the course name that will be passed to the method as an argument. Line 12 assigns `name` to instance variable `courseName`.

Method `getCourseName` (lines 16–19) returns a particular `GradeBook` object's `courseName`. The method has an empty parameter list, so it does not require additional information to perform its task. The method specifies that it returns a `String`—this is the method's return type. When a method that specifies a return type other than `void` is called and completes its task, the method returns a *result* to its calling method. For example, when you go to an automated teller machine (ATM) and request your account balance, you expect the ATM to give you back a value that represents your balance. Similarly, when a statement calls method `getCourseName` on a `GradeBook` object, the statement expects to receive the `GradeBook`'s course name (in this case, a `String`, as specified in the method declaration's return type).

The **return** statement in line 18 passes the value of instance variable `courseName` back to the statement that calls method `getCourseName`. Consider, method `displayMessage`'s line 27, which calls method `getCourseName`. When the value is returned, the statement in lines 26–27 uses that value to output the course name. Similarly, if you have a method `square` that returns the square of its argument, you'd expect the statement

```
int result = square( 2 );
```

to return 4 from method `square` and assign 4 to the variable `result`. If you have a method `maximum` that returns the largest of three integer arguments, you'd expect the statement

```
int biggest = maximum( 27, 114, 51 );
```

to return 114 from method `maximum` and assign 114 to variable `biggest`.

The statements in lines 12 and 18 each use `courseName` *even though it was not declared in any of the methods*. We can use `courseName` in `GradeBook`'s methods because `courseName` is an instance variable of the class.

Method `displayMessage`

Method `displayMessage` (lines 22–28) does *not* return any data when it completes its task, so its return type is `void`. The method does *not* receive parameters, so the parameter list is empty. Lines 26–27 output a welcome message that includes the value of instance variable `courseName`, which is returned by the call to method `getCourseName` in line 27. Notice that one method of a class (`displayMessage` in this case) can call another method of the *same* class by using just the method name (`getCourseName` in this case).

GradeBookTest Class That Demonstrates Class GradeBook

Class `GradeBookTest` (Fig. 3.8) creates one object of class `GradeBook` and demonstrates its methods. Line 14 creates a `GradeBook` object and assigns it to local variable `myGradeBook` of type `GradeBook`. Lines 17–18 display the initial course name calling the object's `getCourseName` method. The first line of the output shows the name “null.” *Unlike local variables, which are not automatically initialized, every field has a default initial value—a value provided by Java when you do not specify the field's initial value.* Thus, fields are *not* required to be explicitly initialized before they're used in a program—unless they must be initialized to values *other than* their default values. The default value for a field of type `String` (like `courseName` in this example) is `null`, which we say more about in Section 3.5.

Line 21 prompts the user to enter a course name. Local `String` variable `theName` (declared in line 22) is initialized with the course name entered by the user, which is returned by the call to the `nextLine` method of the `Scanner` object `input`. Line 23 calls object `myGradeBook`'s `setCourseName` method and supplies `theName` as the method's argument. When the method is called, the argument's value is assigned to parameter `name` (line 10, Fig. 3.7) of method `setCourseName` (lines 10–13, Fig. 3.7). Then the parameter's value is assigned to instance variable `courseName` (line 12, Fig. 3.7). Line 24 (Fig. 3.8) skips a line in the output, then line 27 calls object `myGradeBook`'s `displayMessage` method to display the welcome message containing the course name.

```

1 // Fig. 3.8: GradeBookTest.java
2 // Creating and manipulating a GradeBook object.
3 import java.util.Scanner; // program uses Scanner
4
5 public class GradeBookTest
6 {
7     // main method begins program execution
8     public static void main( String[] args )
9     {
10        // create Scanner to obtain input from command window
11        Scanner input = new Scanner( System.in );
12
13        // create a GradeBook object and assign it to myGradeBook
14        GradeBook myGradeBook = new GradeBook();
15

```

Fig. 3.8 | Creating and manipulating a `GradeBook` object. (Part 1 of 2.)

```

16     // display initial value of courseName
17     System.out.printf( "Initial course name is: %s\n\n",
18         myGradeBook.getCourseName() );
19
20     // prompt for and read course name
21     System.out.println( "Please enter the course name:" );
22     String theName = input.nextLine(); // read a line of text
23     myGradeBook.setCourseName( theName ); // set the course name
24     System.out.println(); // outputs a blank line
25
26     // display welcome message after specifying course name
27     myGradeBook.displayMessage();
28 } // end main
29 } // end class GradeBookTest

```

```

Initial course name is: null
Please enter the course name:
CS101 Introduction to Java Programming
Welcome to the grade book for
CS101 Introduction to Java Programming!

```

Fig. 3.8 | Creating and manipulating a GradeBook object. (Part 2 of 2.)

set and get Methods

A class's private fields can be manipulated *only* by the class's methods. So a **client of an object**—that is, any class that calls the object's methods—calls the class's public methods to manipulate the private fields of an object of the class. This is why the statements in method main (Fig. 3.8) call the `setCourseName`, `getCourseName` and `displayMessage` methods on a `GradeBook` object. Classes often provide public methods to allow clients to *set* (i.e., assign values to) or *get* (i.e., obtain the values of) private instance variables. The names of these methods need not begin with *set* or *get*, but this naming convention is recommended and is convention for special Java software components called JavaBeans, which can simplify programming in many Java integrated development environments (IDEs). The method that *sets* instance variable `courseName` in this example is called `setCourseName`, and the method that *gets* its value is called `getCourseName`.

GradeBook UML Class Diagram with an Instance Variable and set and get Methods

Figure 3.9 contains an updated UML class diagram for the version of class `GradeBook` in Fig. 3.7. This diagram models class `GradeBook`'s instance variable `courseName` as an attribute in the middle compartment of the class. The UML represents instance variables as attributes by listing the attribute name, followed by a colon and the attribute type. The UML type of attribute `courseName` is `String`. Instance variable `courseName` is private in Java, so the class diagram lists a minus sign (-) access modifier in front of the corresponding attribute's name. Class `GradeBook` contains three public methods, so the class diagram lists three operations in the third compartment. Recall that the plus sign (+) before each operation name indicates that the operation is public. Operation `setCourseName` has a `String` parameter called `name`. The UML indicates the return type of an operation by placing a colon and the return type after the parentheses following the operation name. Method `getCourseName` of class `GradeBook` (Fig. 3.7) has a `String` return type in Java, so the

class diagram shows a `String` return type in the UML. Operations `setCourseName` and `displayMessage` *do not* return values (i.e., they return `void` in Java), so the UML class diagram *does not* specify a return type after the parentheses of these operations.

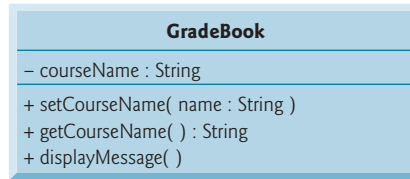

Fig. 3.9 | UML class diagram indicating that class `GradeBook` has a private `courseName` attribute of UML type `String` and three public operations—`setCourseName` (with a name parameter of UML type `String`), `getCourseName` (which returns UML type `String`) and `displayMessage`.

3.5 Primitive Types vs. Reference Types

Java’s types are divided into primitive types and **reference types**. The primitive types are `boolean`, `byte`, `char`, `short`, `int`, `long`, `float` and `double`. All nonprimitive types are reference types, so classes, which specify the types of objects, are reference types.

A primitive-type variable can store exactly one *value of its declared type* at a time. For example, an `int` variable can store one whole number (such as 7) at a time. When another value is assigned to that variable, its initial value is replaced. Primitive-type instance variables are *initialized by default*—variables of types `byte`, `char`, `short`, `int`, `long`, `float` and `double` are initialized to 0, and variables of type `boolean` are initialized to `false`. You can specify your own initial value for a primitive-type variable by assigning the variable a value in its declaration, as in

```
private int numberOfStudents = 10;
```

Recall that local variables are *not* initialized by default.



Error-Prevention Tip 3.1

An attempt to use an uninitialized local variable causes a compilation error.

Programs use variables of reference types (normally called **references**) to store the *locations* of objects in the computer’s memory. Such a variable is said to **refer to an object** in the program. Objects that are referenced may each contain many instance variables. Line 14 of Fig. 3.8 creates an object of class `GradeBook`, and the variable `myGradeBook` contains a reference to that `GradeBook` object. *Reference-type instance variables are initialized by default to the value `null`*—a reserved word that represents a “reference to nothing.” This is why the first call to `getCourseName` in line 18 of Fig. 3.8 returned `null`—the value of `courseName` had not been set, so the default initial value `null` was returned. The complete list of reserved words and keywords is listed in Appendix C.

When you use an object of another class, a reference to the object is required to **invoke** (i.e., call) its methods. In the application of Fig. 3.8, the statements in method `main` use

the variable `myGradeBook` to send messages to the `GradeBook` object. These messages are calls to methods (like `setCourseName` and `getCourseName`) that enable the program to interact with the `GradeBook` object. For example, the statement in line 23 uses `myGradeBook` to send the `setCourseName` message to the `GradeBook` object. The message includes the argument that `setCourseName` requires to perform its task. The `GradeBook` object uses this information to set the `courseName` instance variable. Primitive-type variables do not refer to objects, so such variables cannot be used to invoke methods.



Software Engineering Observation 3.3

A variable's declared type (e.g., `int`, `double` or `GradeBook`) indicates whether the variable is of a primitive or a reference type. If a variable is not of one of the eight primitive types, then it's of a reference type.

3.6 Initializing Objects with Constructors

As mentioned in Section 3.4, when an object of class `GradeBook` (Fig. 3.7) is created, its instance variable `courseName` is initialized to `null` by default. What if you want to provide a course name when you create a `GradeBook` object? Each class you declare can provide a special method called a constructor that can be used to initialize an object of a class when the object is created. In fact, Java *requires* a constructor call for *every* object that's created. Keyword `new` requests memory from the system to store an object, then calls the corresponding class's constructor to initialize the object. The call is indicated by the parentheses after the class name. A constructor *must* have the *same name* as the class. For example, line 14 of Fig. 3.8 first uses `new` to create a `GradeBook` object. The empty parentheses after “`new GradeBook`” indicate a call to the class's constructor without arguments. By default, the compiler provides a **default constructor** with *no parameters* in any class that does *not* explicitly include a constructor. When a class has only the default constructor, its instance variables are initialized to their *default values*.

When you declare a class, you can provide your own constructor to specify custom initialization for objects of your class. For example, you might want to specify a course name for a `GradeBook` object when the object is created, as in

```
GradeBook myGradeBook =
    new GradeBook( "CS101 Introduction to Java Programming" );
```

In this case, the argument “`CS101 Introduction to Java Programming`” is passed to the `GradeBook` object's constructor and used to initialize the `courseName`. The preceding statement requires that the class provide a constructor with a `String` parameter. Figure 3.10 contains a modified `GradeBook` class with such a constructor.

```
1 // Fig. 3.10: GradeBook.java
2 // GradeBook class with a constructor to initialize the course name.
3
4 public class GradeBook
5 {
6     private String courseName; // course name for this GradeBook
7 }
```

Fig. 3.10 | `GradeBook` class with a constructor to initialize the course name. (Part I of 2.)

```

8 // constructor initializes courseName with String argument
9 public GradeBook( String name ) // constructor name is class name
10 {
11     courseName = name; // initializes courseName
12 } // end constructor
13
14 // method to set the course name
15 public void setCourseName( String name )
16 {
17     courseName = name; // store the course name
18 } // end method setCourseName
19
20 // method to retrieve the course name
21 public String getCourseName()
22 {
23     return courseName;
24 } // end method getCourseName
25
26 // display a welcome message to the GradeBook user
27 public void displayMessage()
28 {
29     // this statement calls getCourseName to get the
30     // name of the course this GradeBook represents
31     System.out.printf( "Welcome to the grade book for\n%s!\n",
32         getCourseName() );
33 } // end method displayMessage
34 } // end class GradeBook

```

Fig. 3.10 | GradeBook class with a constructor to initialize the course name. (Part 2 of 2.)

Lines 9–12 declare GradeBook’s constructor. Like a method, a constructor’s parameter list specifies the data it requires to perform its task. When you create a new object (as we’ll do in Fig. 3.11), this data is placed in the *parentheses that follow the class name*. Line 9 of Fig. 3.10 indicates that the constructor has a String parameter called name. The name passed to the constructor is assigned to instance variable courseName in line 11.

Figure 3.11 initializes GradeBook objects using the constructor. Lines 11–12 create and initialize the GradeBook object gradeBook1. The GradeBook constructor is called with the argument "CS101 Introduction to Java Programming" to initialize the course name. The class instance creation expression in lines 11–12 returns a reference to the new object, which is assigned to the variable gradeBook1. Lines 13–14 repeat this process, this time passing the argument "CS102 Data Structures in Java" to initialize the course name for gradeBook2. Lines 17–20 use each object’s getCourseName method to obtain the course names and show that they were initialized when the objects were created. The output confirms that each GradeBook maintains its own copy of instance variable courseName.

An important difference between constructors and methods is that constructors cannot return values, so they cannot specify a return type (not even void). Normally, constructors are declared public. If a class does not include a constructor, the class’s instance variables are initialized to their default values. *If you declare any constructors for a class, the Java compiler will not create a default constructor for that class.* Thus, we can no longer create a GradeBook object with new GradeBook() as we did in the earlier examples.

```

1 // Fig. 3.11: GradeBookTest.java
2 // GradeBook constructor used to specify the course name at the
3 // time each GradeBook object is created.
4
5 public class GradeBookTest
6 {
7     // main method begins program execution
8     public static void main( String[] args )
9     {
10        // create GradeBook object
11        GradeBook gradeBook1 = new GradeBook(
12            "CS101 Introduction to Java Programming" );
13        GradeBook gradeBook2 = new GradeBook(
14            "CS102 Data Structures in Java" );
15
16        // display initial value of courseName for each GradeBook
17        System.out.printf( "gradeBook1 course name is: %s\n",
18            gradeBook1.getCourseName() );
19        System.out.printf( "gradeBook2 course name is: %s\n",
20            gradeBook2.getCourseName() );
21    } // end main
22 } // end class GradeBookTest

```

```

gradeBook1 course name is: CS101 Introduction to Java Programming
gradeBook2 course name is: CS102 Data Structures in Java

```

Fig. 3.11 | GradeBook constructor used to specify the course name at the time each GradeBook object is created.



Software Engineering Observation 3.4

Unless default initialization of your class's instance variables is acceptable, provide a constructor to ensure that they're properly initialized with meaningful values when each new object of your class is created.

Adding the Constructor to Class *GradeBook*'s UML Class Diagram

The UML class diagram of Fig. 3.12 models class *GradeBook* of Fig. 3.10, which has a constructor that has a name parameter of type *String*. Like operations, the UML models constructors in the third compartment of a class in a class diagram. To distinguish a

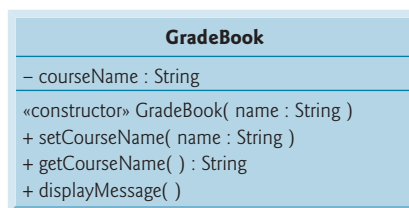

Fig. 3.12 | UML class diagram indicating that class *GradeBook* has a constructor that has a name parameter of UML type *String*.

constructor from a class’s operations, the UML requires that the word “constructor” be placed between **guillemets** (« and ») before the constructor’s name. It’s *customary* to list constructors *before* other operations in the third compartment.

Constructors with Multiple Parameters

Sometimes you’ll want to initialize objects with multiple data items. In Exercise 3.11, we ask you to store the course name *and* the instructor’s name in a `GradeBook` object. In this case, the `GradeBook`’s constructor would be modified to receive two `Strings`, as in

```
public GradeBook( String courseName, String instructorName )
```

and you’d call the `GradeBook` constructor as follows:

```
GradeBook gradeBook = new GradeBook(
    "CS101 Introduction to Java Programming", "Sue Green" );
```

3.7 Floating-Point Numbers and Type `double`

We now depart temporarily from our `GradeBook` case study to declare an `Account` class that maintains the balance of a bank account. Most account balances are not whole numbers (such as 0, -22 and 1024). For this reason, class `Account` represents the account balance as a **floating-point number** (i.e., a number with a decimal point, such as 7.33 , 0.0975 or 1000.12345). Java provides two primitive types for storing floating-point numbers in memory—`float` and `double`. They differ primarily in that `double` variables can store numbers with larger magnitude and finer detail (i.e., more digits to the right of the decimal point—also known as the number’s **precision**) than `float` variables.

Floating-Point Number Precision and Memory Requirements

Variables of type **float** represent **single-precision floating-point numbers** and can represent up to *seven significant digits*. Variables of type **double** represent **double-precision floating-point numbers**. These require twice as much memory as `float` variables and provide *15 significant digits*—approximately double the precision of `float` variables. For the range of values required by most programs, variables of type `float` should suffice, but you can use `double` to “play it safe.” In some applications, even `double` variables will be inadequate. Most programmers represent floating-point numbers with type `double`. In fact, Java treats all floating-point numbers you type in a program’s source code (such as 7.33 and 0.0975) as `double` values by default. Such values in the source code are known as **floating-point literals**. See Appendix D, Primitive Types, for the ranges of values for `floats` and `doubles`.

Although floating-point numbers are not always 100% precise, they have numerous applications. For example, when we speak of a “normal” body temperature of 98.6 , we do not need to be precise to a large number of digits. When we read the temperature on a thermometer as 98.6 , it may actually be 98.5999473210643 . Calling this number simply 98.6 is fine for most applications involving body temperatures. Owing to the imprecise nature of floating-point numbers, type `double` is preferred over type `float`, because `double` variables can represent floating-point numbers more accurately. For this reason, we primarily use type `double` throughout the book. For precise floating-point numbers, Java provides class `BigDecimal` (package `java.math`).

Floating-point numbers also arise as a result of division. In conventional arithmetic, when we divide 10 by 3 , the result is $3.3333333\dots$, with the sequence of 3 s repeating infi-

nity. The computer allocates only a fixed amount of space to hold such a value, so clearly the stored floating-point value can be only an approximation.

Account Class with an Instance Variable of Type `double`

Our next application (Figs. 3.13–3.14) contains a class named `Account` (Fig. 3.13) that maintains the balance of a bank account. A typical bank services many accounts, each with its own balance, so line 7 declares an instance variable named `balance` of type `double`. It’s an instance variable because it’s declared in the body of the class but outside the class’s method declarations (lines 10–16, 19–22 and 25–28). Every instance (i.e., object) of class `Account` contains its own copy of `balance`.

```

1 // Fig. 3.13: Account.java
2 // Account class with a constructor to validate and
3 // initialize instance variable balance of type double.
4
5 public class Account
6 {
7     private double balance; // instance variable that stores the balance
8
9     // constructor
10    public Account( double initialBalance )
11    {
12        // validate that initialBalance is greater than 0.0;
13        // if it is not, balance is initialized to the default value 0.0
14        if ( initialBalance > 0.0 )
15            balance = initialBalance;
16    } // end Account constructor
17
18    // credit (add) an amount to the account
19    public void credit( double amount )
20    {
21        balance = balance + amount; // add amount to balance
22    } // end method credit
23
24    // return the account balance
25    public double getBalance()
26    {
27        return balance; // gives the value of balance to the calling method
28    } // end method getBalance
29 } // end class Account

```

Fig. 3.13 | `Account` class with a constructor to validate and initialize instance variable `balance` of type `double`.

The class has a constructor and two methods. It’s common for someone opening an account to deposit money immediately, so the constructor (lines 10–16) receives a parameter `initialBalance` of type `double` that represents the *starting balance*. Lines 14–15 ensure that `initialBalance` is greater than 0.0. If so, `initialBalance`’s value is assigned to instance variable `balance`. Otherwise, `balance` remains at 0.0—its default initial value.

Method `credit` (lines 19–22) does *not* return any data when it completes its task, so its return type is `void`. The method receives one parameter named `amount`—a `double`

value that will be added to the balance. Line 21 adds amount to the current value of balance, then assigns the result to balance (thus replacing the prior balance amount).

Method getBalance (lines 25–28) allows clients of the class (i.e., other classes that use this class) to obtain the value of a particular Account object's balance. The method specifies return type double and an empty parameter list.

Once again, the statements in lines 15, 21 and 27 use instance variable balance even though it was *not* declared in any of the methods. We can use balance in these methods because it's an instance variable of the class.

AccountTest Class to Use Class Account

Class AccountTest (Fig. 3.14) creates two Account objects (lines 10–11) and initializes them with 50.00 and -7.53, respectively. Lines 14–17 output the balance in each Account by calling the Account's getBalance method. When method getBalance is called for account1 from line 15, the value of account1's balance is returned from line 27 of Fig. 3.13 and displayed by the System.out.printf statement (Fig. 3.14, lines 14–15). Similarly, when method getBalance is called for account2 from line 17, the value of the account2's balance is returned from line 27 of Fig. 3.13 and displayed by the System.out.printf statement (Fig. 3.14, lines 16–17). The balance of account2 is 0.00, because the constructor ensured that the account could *not* begin with a negative balance. The value is output by printf with the format specifier %.2f. The format specifier %f is used to output values of type float or double. The .2 between % and f represents the number of decimal places (2) that should be output to the right of the decimal point in the floating-point number—also known as the number's **precision**. Any floating-point value output with %.2f will be rounded to the hundredths position—for example, 123.457 would be rounded to 123.46, 27.333 would be rounded to 27.33 and 123.455 would be rounded to 123.46.

```

1 // Fig. 3.14: AccountTest.java
2 // Inputting and outputting floating-point numbers with Account objects.
3 import java.util.Scanner;
4
5 public class AccountTest
6 {
7     // main method begins execution of Java application
8     public static void main( String[] args )
9     {
10        Account account1 = new Account( 50.00 ); // create Account object
11        Account account2 = new Account( -7.53 ); // create Account object
12
13        // display initial balance of each object
14        System.out.printf( "account1 balance: %.2f\n",
15            account1.getBalance() );
16        System.out.printf( "account2 balance: %.2f\n\n",
17            account2.getBalance() );
18
19        // create Scanner to obtain input from command window
20        Scanner input = new Scanner( System.in );
21        double depositAmount; // deposit amount read from user

```

Fig. 3.14 | Inputting and outputting floating-point numbers with Account objects. (Part 1 of 2.)

```

22
23     System.out.print( "Enter deposit amount for account1: " ); // prompt
24     depositAmount = input.nextDouble(); // obtain user input
25     System.out.printf( "\nadding %.2f to account1 balance\n\n",
26         depositAmount );
27     account1.credit( depositAmount ); // add to account1 balance
28
29     // display balances
30     System.out.printf( "account1 balance: $%.2f\n",
31         account1.getBalance() );
32     System.out.printf( "account2 balance: $%.2f\n\n",
33         account2.getBalance() );
34
35     System.out.print( "Enter deposit amount for account2: " ); // prompt
36     depositAmount = input.nextDouble(); // obtain user input
37     System.out.printf( "\nadding %.2f to account2 balance\n\n",
38         depositAmount );
39     account2.credit( depositAmount ); // add to account2 balance
40
41     // display balances
42     System.out.printf( "account1 balance: $%.2f\n",
43         account1.getBalance() );
44     System.out.printf( "account2 balance: $%.2f\n",
45         account2.getBalance() );
46 } // end main
47 } // end class AccountTest

```

```

account1 balance: $50.00
account2 balance: $0.00

Enter deposit amount for account1: 25.53

adding 25.53 to account1 balance

account1 balance: $75.53
account2 balance: $0.00

Enter deposit amount for account2: 123.45

adding 123.45 to account2 balance

account1 balance: $75.53
account2 balance: $123.45

```

Fig. 3.14 | Inputting and outputting floating-point numbers with Account objects. (Part 2 of 2.)

Line 21 declares local variable `depositAmount` to store each deposit amount entered by the user. Unlike the instance variable `balance` in class `Account`, local variable `depositAmount` in `main` is *not* initialized to 0.0 by default. However, this variable does not need to be initialized here, because its value will be determined by the user's input.

Line 23 prompts the user to enter a deposit amount for account1. Line 24 obtains the input from the user by calling Scanner object `input`'s `nextDouble` method, which returns a `double` value entered by the user. Lines 25–26 display the deposit amount. Line 27 calls

object `account1`'s `credit` method and supplies `depositAmount` as the method's argument. When the method is called, the argument's value is assigned to parameter `amount` (line 19 of Fig. 3.13) of method `credit` (lines 19–22 of Fig. 3.13); then method `credit` adds that value to the `balance` (line 21 of Fig. 3.13). Lines 30–33 (Fig. 3.14) output the balances of both `Accounts` again to show that only `account1`'s balance changed.

Line 35 prompts the user to enter a deposit amount for `account2`. Line 36 obtains the input from the user by calling `Scanner` object `input`'s `nextDouble` method. Lines 37–38 display the deposit amount. Line 39 calls object `account2`'s `credit` method and supplies `depositAmount` as the method's argument; then method `credit` adds that value to the balance. Finally, lines 42–45 output the balances of both `Accounts` again to show that only `account2`'s balance changed.

UML Class Diagram for Class `Account`

The UML class diagram in Fig. 3.15 models class `Account` of Fig. 3.13. The diagram models the private attribute `balance` with UML type `Double` to correspond to the class's instance variable `balance` of Java type `double`. The diagram models class `Account`'s constructor with a parameter `initialBalance` of UML type `Double` in the third compartment of the class. The class's two public methods are modeled as operations in the third compartment as well. The diagram models operation `credit` with an `amount` parameter of UML type `Double` (because the corresponding method has an `amount` parameter of Java type `double`), and operation `getBalance` with a return type of `Double` (because the corresponding Java method returns a `double` value).

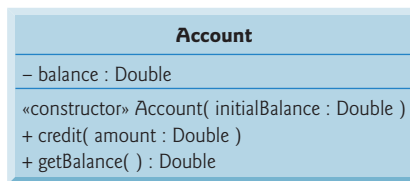

Fig. 3.15 | UML class diagram indicating that class `Account` has a private `balance` attribute of UML type `Double`, a constructor (with a parameter of UML type `Double`) and two public operations—`credit` (with an `amount` parameter of UML type `Double`) and `getBalance` (returns UML type `Double`).

3.8 (Optional) GUI and Graphics Case Study: Using Dialog Boxes

This optional case study is designed for those who want to begin learning Java's powerful capabilities for creating graphical user interfaces (GUIs) and graphics early in the book, before the main discussions of these topics in Chapter 14, GUI Components: Part 1, Chapter 15, Graphics and Java 2D, and Chapter 25, GUI Components: Part 2.

The GUI and Graphics Case Study appears in 10 brief sections (see Fig. 3.16). Each section introduces new concepts and provides examples with screen captures that show sample interactions and results. In the first few sections, you'll create your first graphical applications. In subsequent sections, you'll use object-oriented programming concepts to

create an application that draws a variety of shapes. When we formally introduce GUIs in Chapter 14, we use the mouse to choose exactly which shapes to draw and where to draw them. In Chapter 15, we add capabilities of the Java 2D graphics API to draw the shapes with different line thicknesses and fills. We hope you find this case study informative and entertaining.

Location	Title—Exercise(s)
Section 3.8	Using Dialog Boxes—Basic input and output with dialog boxes
Section 4.14	Creating Simple Drawings—Displaying and drawing lines on the screen
Section 5.10	Drawing Rectangles and Ovals—Using shapes to represent data
Section 6.13	Colors and Filled Shapes—Drawing a bull’s-eye and random graphics
Section 7.15	Drawing Arcs—Drawing spirals with arcs
Section 8.16	Using Objects with Graphics—Storing shapes as objects
Section 9.8	Displaying Text and Images Using Labels—Providing status information
Section 10.8	Drawing with Polymorphism—Identifying the similarities between shapes
Exercise 14.17	Expanding the Interface—Using GUI components and event handling
Exercise 15.31	Adding Java 2D—Using the Java 2D API to enhance drawings

Fig. 3.16 | Summary of the GUI and Graphics Case Study in each chapter.

Displaying Text in a Dialog Box

The programs presented thus far display output in the command window. Many applications use windows or **dialog boxes** (also called **dialogs**) to display output. Web browsers such as Firefox, Internet Explorer, Chrome and Safari display web pages in their own windows. E-mail programs allow you to type and read messages in a window. Typically, dialog boxes are windows in which programs display important messages to users. Class **JOptionPane** provides prebuilt dialog boxes that enable programs to display windows containing messages—such windows are called **message dialogs**. Figure 3.17 displays the String "Welcome\n\t\nJava" in a message dialog.

```

1 // Fig. 3.17: Dialog1.java
2 // Using JOptionPane to display multiple lines in a dialog box.
3 import javax.swing.JOptionPane; // import class JOptionPane
4
5 public class Dialog1
6 {
7     public static void main( String[] args )
8     {
9         // display a dialog with a message
10        JOptionPane.showMessageDialog( null, "Welcome\n\t\nJava" );
11    } // end main
12 } // end class Dialog1

```

Fig. 3.17 | Using JOptionPane to display multiple lines in a dialog box. (Part 1 of 2.)



Fig. 3.17 | Using `JOptionPane` to display multiple lines in a dialog box. (Part 2 of 2.)

Line 3 indicates that the program uses class `JOptionPane` from package `javax.swing`. This package contains many classes that help you create **graphical user interfaces (GUIs)**. **GUI components** facilitate data entry by a program’s user and presentation of outputs to the user. Line 10 calls `JOptionPane` method `showMessageDialog` to display a dialog box containing a message. The method requires two arguments. The first helps the Java application determine where to position the dialog box. A dialog is typically displayed from a GUI application with its own window. The first argument refers to that window (known as the parent window) and causes the dialog to appear centered over the application’s window. If the first argument is `null`, the dialog box is displayed at the center of your screen. The second argument is the `String` to display in the dialog box.

Introducing static Methods

`JOptionPane` method `showMessageDialog` is a so-called **static method**. Such methods often define frequently used tasks. For example, many programs display dialog boxes, and the code to do this is the same each time. Rather than requiring you to “reinvent the wheel” and create code to display a dialog, the designers of class `JOptionPane` declared a static method that performs this task for you. A static method is called by using its class name followed by a dot (`.`) and the method name, as in

```
ClassName.methodName( arguments )
```

Notice that you do *not* create an object of class `JOptionPane` to use its static method `showMessageDialog`. We discuss static methods in more detail in Chapter 6.

Entering Text in a Dialog

Figure 3.18 uses another predefined `JOptionPane` dialog called an **input dialog** that allows the user to enter data into a program. The program asks for the user’s name and responds with a message dialog containing a greeting and the name that the user entered.

Lines 10–11 use `JOptionPane` method `showInputDialog` to display an input dialog containing a prompt and a field (known as a **text field**) in which the user can enter text. Method `showInputDialog`’s argument is the prompt that indicates what the user should enter. The user types characters in the text field, then clicks the **OK** button or presses the *Enter* key to return the `String` to the program. Method `showInputDialog` (line 11) returns a `String` containing the characters typed by the user. We store the `String` in variable name (line 10). [*Note:* If you press the dialog’s **Cancel** button or press the *Esc* key, the method returns `null` and the program displays the word “null” as the name.]

Lines 14–15 use static `String` method `format` to return a `String` containing a greeting with the user’s name. Method `format` works like method `System.out.printf`, except that `format` returns the formatted `String` rather than displaying it in a command window. Line 18 displays the greeting in a message dialog, just as we did in Fig. 3.17.

```

1 // Fig. 3.18: NameDialog.java
2 // Basic input with a dialog box.
3 import javax.swing.JOptionPane;
4
5 public class NameDialog
6 {
7     public static void main( String[] args )
8     {
9         // prompt user to enter name
10        String name =
11            JOptionPane.showInputDialog( "What is your name?" );
12
13        // create the message
14        String message =
15            String.format( "Welcome, %s, to Java Programming!", name );
16
17        // display the message to welcome the user by name
18        JOptionPane.showMessageDialog( null, message );
19    } // end main
20 } // end class NameDialog

```

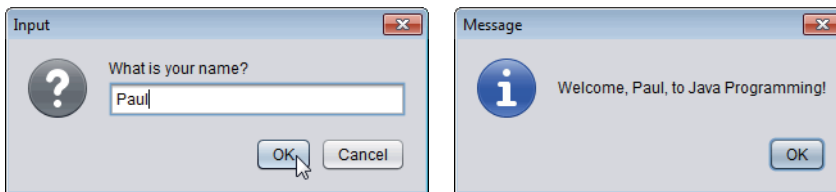

Fig. 3.18 | Obtaining user input from a dialog.

GUI and Graphics Case Study Exercise

3.1 Modify the addition program in Fig. 2.7 to use dialog-based input and output with the methods of class `JOptionPane`. Since method `showInputDialog` returns a `String`, you must convert the `String` the user enters to an `int` for use in calculations. The `Integer` class's static method `parseInt` takes a `String` argument representing an integer (e.g., the result of `JOptionPane.showInputDialog`) and returns the value as an `int`. Method `parseInt` is a static method of class `Integer` (from package `java.lang`). If the `String` does not contain a valid integer, the program will terminate with an error.

3.9 Wrap-Up

In this chapter, you learned how to declare instance variables of a class to maintain data for each object of the class, and how to declare methods that operate on that data. You learned how to call a method to tell it to perform its task and how to pass information to methods as arguments. You learned the difference between a local variable of a method and an instance variable of a class and that only instance variables are initialized automatically. You also learned how to use a class's constructor to specify the initial values for an object's instance variables. Throughout the chapter, you saw how the UML can be used to create class diagrams that model the constructors, methods and attributes of classes. Finally, you learned about floating-point numbers—how to store them with variables of primitive type `double`,

how to input them with a Scanner object and how to format them with `printf` and format specifier `%f` for display purposes. In the next chapter we begin our introduction to control statements, which specify the order in which a program's actions are performed. You'll use these in your methods to specify how they should perform their tasks.

Summary

Section 3.2 Declaring a Class with a Method and Instantiating an Object of a Class

- Each class declaration that begins with the access modifier (p. 72) `public` must be stored in a file that has exactly the same name as the class and ends with the `.java` file-name extension.
- Every class declaration contains keyword `class` followed immediately by the class's name.
- A method declaration that begins with keyword `public` indicates that the method can be called by other classes declared outside the class declaration.
- Keyword `void` indicates that a method will perform a task but will not return any information.
- By convention, method names begin with a lowercase first letter and all subsequent words in the name begin with a capital first letter.
- Empty parentheses following a method name indicate that the method does not require any parameters to perform its task.
- Every method's body is delimited by left and right braces (`{` and `}`).
- The method's body contains statements that perform the method's task. After the statements execute, the method has completed its task.
- When you attempt to execute a class, Java looks for the class's `main` method to begin execution.
- Typically, you cannot call a method of another class until you create an object of that class.
- A class instance creation expression (p. 74) begins with keyword `new` and creates a new object.
- To call a method of an object, follow the variable name with a dot separator (`.`; p. 75), the method name and a set of parentheses containing the method's arguments.
- In the UML, each class is modeled in a class diagram as a rectangle with three compartments. The top compartment contains the class's name centered horizontally in boldface. The middle one contains the class's attributes, which correspond to fields (p. 79) in Java. The bottom one contains the class's operations (p. 76), which correspond to methods and constructors in Java.
- The UML models operations by listing the operation name followed by a set of parentheses. A plus sign (+) in front of the operation name indicates that the operation is a `public` one in the UML (i.e., a `public` method in Java).

Section 3.3 Declaring a Method with a Parameter

- Methods often require parameters (p. 76) to perform their tasks. Such additional information is provided to methods via arguments in method calls.
- Scanner method `nextLine` (p. 76) reads characters until a newline character is encountered, then returns the characters as a `String`.
- Scanner method `next` (p. 77) reads characters until any white-space character is encountered, then returns the characters as a `String`.
- A method that requires data to perform its task must specify this in its declaration by placing additional information in the method's parameter list (p. 76).
- Each parameter must specify both a type and a variable name.

- At the time a method is called, its arguments are assigned to its parameters. Then the method body uses the parameter variables to access the argument values.
- A method specifies multiple parameters in a comma-separated list.
- The number of arguments in the method call must match the number of parameters in the method declaration's parameter list. Also, the argument types in the method call must be consistent with the types of the corresponding parameters in the method's declaration.
- Class `String` is in package `java.lang`, which is imported implicitly into all source-code files.
- By default, classes compiled into the same directory are in the same package. Classes in the same package are implicitly imported into the source-code files of other classes in the same package.
- `import` declarations are not required if you always use fully qualified class names (p. 79).
- The UML models a parameter of an operation by listing the parameter name, followed by a colon and the parameter type between the parentheses following the operation name.
- The UML has its own data types similar to those of Java. Not all the UML data types have the same names as the corresponding Java types.
- The UML type `String` corresponds to the Java type `String`.

Section 3.4 Instance Variables, set Methods and get Methods

- Variables declared in a method's body are local variables and can be used only in that method.
- A class normally consists of one or more methods that manipulate the attributes (data) that belong to a particular object of the class. Such variables are called fields and are declared inside a class declaration but outside the bodies of the class's method declarations.
- When each object of a class maintains its own copy of an attribute, the corresponding field is known as an instance variable.
- Variables or methods declared with access modifier `private` are accessible only to methods of the class in which they're declared.
- Declaring instance variables with access modifier `private` (p. 80) is known as data hiding.
- A benefit of fields is that all the methods of the class can use the fields. Another distinction between a field and a local variable is that a field has a default initial value (p. 82) provided by Java when you do not specify the field's initial value, but a local variable does not.
- The default value for a field of type `String` (or any other reference type) is `null`.
- When a method that specifies a return type (p. 73) is called and completes its task, the method returns a result to its calling method (p. 73).
- Classes often provide `public` methods to allow the class's clients to *set* or *get* `private` instance variables (p. 83). The names of these methods need not begin with *set* or *get*, but this naming convention is recommended and is required for special Java software components called JavaBeans.
- The UML represents instance variables as an attribute name, followed by a colon and the type.
- Private attributes are preceded by a minus sign (-) in the UML.
- The UML indicates an operation's return type by placing a colon and the return type after the parentheses following the operation name.
- UML class diagrams (p. 75) do not specify return types for operations that do not return values.

Section 3.5 Primitive Types vs. Reference Types

- Types in Java are divided into two categories—primitive types and reference types. The primitive types are `boolean`, `byte`, `char`, `short`, `int`, `long`, `float` and `double`. All other types are reference types, so classes, which specify the types of objects, are reference types.

- A primitive-type variable can store exactly one value of its declared type at a time.
- Primitive-type instance variables are initialized by default. Variables of types `byte`, `char`, `short`, `int`, `long`, `float` and `double` are initialized to 0. Variables of type `boolean` are initialized to `false`.
- Reference-type variables (called references; p. 84) store the location of an object in the computer's memory. Such variables refer to objects in the program. The object that's referenced may contain many instance variables and methods.
- Reference-type fields are initialized by default to the value `null`.
- A reference to an object (p. 84) is required to invoke an object's instance methods. A primitive-type variable does not refer to an object and therefore cannot be used to invoke a method.

Section 3.6 Initializing Objects with Constructors

- Keyword `new` requests memory from the system to store an object, then calls the corresponding class's constructor (p. 74) to initialize the object.
- A constructor can be used to initialize an object of a class when the object is created.
- Constructors can specify parameters but cannot specify return types.
- If a class does not define constructors, the compiler provides a default constructor (p. 85) with no parameters, and the class's instance variables are initialized to their default values.
- The UML models constructors in the third compartment of a class diagram. To distinguish a constructor from a class's operations, the UML places the word "constructor" between guillemets (« and »; p. 88) before the constructor's name.

Section 3.7 Floating-Point Numbers and Type `double`

- A floating-point number (p. 88) is a number with a decimal point. Java provides two primitive types for storing floating-point numbers (p. 88) in memory—`float` and `double`. The primary difference between these types is that `double` variables can store numbers with larger magnitude and finer detail (known as the number's precision; p. 88) than `float` variables.
- Variables of type `float` represent single-precision floating-point numbers and have seven significant digits. Variables of type `double` represent double-precision floating-point numbers. These require twice as much memory as `float` variables and provide 15 significant digits—approximately double the precision of `float` variables.
- Floating-point literals (p. 88) are of type `double` by default.
- Scanner method `nextDouble` (p. 91) returns a `double` value.
- The format specifier `%f` (p. 90) is used to output values of type `float` or `double`. The format specifier `%.2f` specifies that two digits of precision (p. 90) should be output to the right of the decimal point in the floating-point number.
- The default value for a field of type `double` is 0.0, and the default value for a field of type `int` is 0.

Self-Review Exercises

- 3.1** Fill in the blanks in each of the following:
- Each class declaration that begins with keyword _____ must be stored in a file that has exactly the same name as the class and ends with the `.java` file-name extension.
 - Keyword _____ in a class declaration is followed immediately by the class's name.
 - Keyword _____ requests memory from the system to store an object, then calls the corresponding class's constructor to initialize the object.
 - Each parameter must specify both a(n) _____ and a(n) _____.
 - By default, classes that are compiled in the same directory are considered to be in the same package, known as the _____.

- f) When each object of a class maintains its own copy of an attribute, the field that represents the attribute is also known as a(n) _____.
- g) Java provides two primitive types for storing floating-point numbers in memory: _____ and _____.
- h) Variables of type `double` represent _____ floating-point numbers.
- i) Scanner method _____ returns a `double` value.
- j) Keyword `public` is an access _____.
- k) Return type _____ indicates that a method will not return a value.
- l) Scanner method _____ reads characters until it encounters a newline character, then returns those characters as a `String`.
- m) Class `String` is in package _____.
- n) A(n) _____ is not required if you always refer to a class with its fully qualified class name.
- o) A(n) _____ is a number with a decimal point, such as 7.33, 0.0975 or 1000.12345.
- p) Variables of type `float` represent _____ floating-point numbers.
- q) The format specifier _____ is used to output values of type `float` or `double`.
- r) Types in Java are divided into two categories—_____ types and _____ types.

3.2 State whether each of the following is *true* or *false*. If *false*, explain why.

- a) By convention, method names begin with an uppercase first letter, and all subsequent words in the name begin with a capital first letter.
- b) An `import` declaration is not required when one class in a package uses another in the same package.
- c) Empty parentheses following a method name in a method declaration indicate that the method does not require any parameters to perform its task.
- d) Variables or methods declared with access modifier `private` are accessible only to methods of the class in which they're declared.
- e) A primitive-type variable can be used to invoke a method.
- f) Variables declared in the body of a particular method are known as instance variables and can be used in all methods of the class.
- g) Every method's body is delimited by left and right braces (`{` and `}`).
- h) Primitive-type local variables are initialized by default.
- i) Reference-type instance variables are initialized by default to the value `null`.
- j) Any class that contains `public static void main(String[] args)` can be used to execute an application.
- k) The number of arguments in the method call must match the number of parameters in the method declaration's parameter list.
- l) Floating-point values that appear in source code are known as floating-point literals and are type `float` by default.

3.3 What is the difference between a local variable and a field?

3.4 Explain the purpose of a method parameter. What is the difference between a parameter and an argument?

Answers to Self-Review Exercises

3.1 a) `public`. b) `class`. c) `new`. d) type, name. e) default package. f) instance variable. g) `float`, `double`. h) double-precision. i) `nextDouble`. j) modifier. k) `void`. l) `nextLine`. m) `java.lang`. n) `import` declaration. o) floating-point number. p) single-precision. q) `%f`. r) primitive, reference.

3.2 a) False. By convention, method names begin with a lowercase first letter and all subsequent words in the name begin with a capital first letter. b) True. c) True. d) True. e) False. A prim-

itive-type variable cannot be used to invoke a method—a reference to an object is required to invoke the object’s methods. f) False. Such variables are called local variables and can be used only in the method in which they’re declared. g) True. h) False. Primitive-type instance variables are initialized by default. Each local variable must explicitly be assigned a value. i) True. j) True. k) True. l) False. Such literals are of type `double` by default.

3.3 A local variable is declared in the body of a method and can be used only from the point at which it’s declared through the end of the method declaration. A field is declared in a class, but not in the body of any of the class’s methods. Also, fields are accessible to all methods of the class. (We’ll see an exception to this in Chapter 8, *Classes and Objects: A Deeper Look*.)

3.4 A parameter represents additional information that a method requires to perform its task. Each parameter required by a method is specified in the method’s declaration. An argument is the actual value for a method parameter. When a method is called, the argument values are passed to the corresponding parameters of the method so that it can perform its task.

Exercises

3.5 (*Keyword new*) What’s the purpose of keyword `new`? Explain what happens when you use it.

3.6 (*Default Constructors*) What is a default constructor? How are an object’s instance variables initialized if a class has only a default constructor?

3.7 (*Instance Variables*) Explain the purpose of an instance variable.

3.8 (*Using Classes Without Importing Them*) Most classes need to be imported before they can be used in an application. Why is every application allowed to use classes `System` and `String` without first importing them?

3.9 (*Using a Class Without Importing It*) Explain how a program could use class `Scanner` without importing it.

3.10 (*set and get Methods*) Explain why a class might provide a *set* method and a *get* method for an instance variable.

3.11 (*Modified GradeBook Class*) Modify class `GradeBook` (Fig. 3.10) as follows:

- Include a `String` instance variable that represents the name of the course’s instructor.
- Provide a *set* method to change the instructor’s name and a *get* method to retrieve it.
- Modify the constructor to specify two parameters—one for the course name and one for the instructor’s name.
- Modify method `displayMessage` to output the welcome message and course name, followed by "This course is presented by: " and the instructor’s name.

Use your modified class in a test application that demonstrates the class’s new capabilities.

3.12 (*Modified Account Class*) Modify class `Account` (Fig. 3.13) to provide a method called `debit` that withdraws money from an `Account`. Ensure that the debit amount does not exceed the `Account`’s balance. If it does, the balance should be left unchanged and the method should print a message indicating "Debit amount exceeded account balance." Modify class `AccountTest` (Fig. 3.14) to test method `debit`.

3.13 (*Invoice Class*) Create a class called `Invoice` that a hardware store might use to represent an invoice for an item sold at the store. An `Invoice` should include four pieces of information as instance variables—a part number (type `String`), a part description (type `String`), a quantity of the item being purchased (type `int`) and a price per item (type `double`). Your class should have a constructor that initializes the four instance variables. Provide a *set* and a *get* method for each instance variable. In addition, provide a method named `getInvoiceAmount` that calculates the invoice amount (i.e., multiplies the quantity by the price per item), then returns the amount as a `double` value. If the

quantity is not positive, it should be set to 0. If the price per item is not positive, it should be set to 0.0. Write a test application named `InvoiceTest` that demonstrates class `Invoice`'s capabilities.

3.14 (Employee Class) Create a class called `Employee` that includes three instance variables—a first name (type `String`), a last name (type `String`) and a monthly salary (double). Provide a constructor that initializes the three instance variables. Provide a *set* and a *get* method for each instance variable. If the monthly salary is not positive, do not set its value. Write a test application named `EmployeeTest` that demonstrates class `Employee`'s capabilities. Create two `Employee` objects and display each object's *yearly* salary. Then give each `Employee` a 10% raise and display each `Employee`'s yearly salary again.

3.15 (Date Class) Create a class called `Date` that includes three instance variables—a month (type `int`), a day (type `int`) and a year (type `int`). Provide a constructor that initializes the three instance variables and assumes that the values provided are correct. Provide a *set* and a *get* method for each instance variable. Provide a method `displayDate` that displays the month, day and year separated by forward slashes (/). Write a test application named `DateTest` that demonstrates class `Date`'s capabilities.

Making a Difference

3.16 (Target-Heart-Rate Calculator) While exercising, you can use a heart-rate monitor to see that your heart rate stays within a safe range suggested by your trainers and doctors. According to the American Heart Association (AHA) (www.americanheart.org/presenter.jhtml?identifier=4736), the formula for calculating your *maximum heart rate* in beats per minute is 220 minus your age in years. Your *target heart rate* is a range that's 50–85% of your maximum heart rate. [Note: These formulas are estimates provided by the AHA. Maximum and target heart rates may vary based on the health, fitness and gender of the individual. Always consult a physician or qualified health care professional before beginning or modifying an exercise program.] Create a class called `HeartRates`. The class attributes should include the person's first name, last name and date of birth (consisting of separate attributes for the month, day and year of birth). Your class should have a constructor that receives this data as parameters. For each attribute provide *set* and *get* methods. The class also should include a method that calculates and returns the person's age (in years), a method that calculates and returns the person's maximum heart rate and a method that calculates and returns the person's target heart rate. Write a Java application that prompts for the person's information, instantiates an object of class `HeartRates` and prints the information from that object—including the person's first name, last name and date of birth—then calculates and prints the person's age in (years), maximum heart rate and target-heart-rate range.

3.17 (Computerization of Health Records) A health care issue that has been in the news lately is the computerization of health records. This possibility is being approached cautiously because of sensitive privacy and security concerns, among others. [We address such concerns in later exercises.] Computerizing health records could make it easier for patients to share their health profiles and histories among their various health care professionals. This could improve the quality of health care, help avoid drug conflicts and erroneous drug prescriptions, reduce costs and, in emergencies, could save lives. In this exercise, you'll design a "starter" `HealthProfile` class for a person. The class attributes should include the person's first name, last name, gender, date of birth (consisting of separate attributes for the month, day and year of birth), height (in inches) and weight (in pounds). Your class should have a constructor that receives this data. For each attribute, provide *set* and *get* methods. The class also should include methods that calculate and return the user's age in years, maximum heart rate and target-heart-rate range (see Exercise 3.16), and body mass index (BMI; see Exercise 2.33). Write a Java application that prompts for the person's information, instantiates an object of class `HealthProfile` for that person and prints the information from that object—including the person's first name, last name, gender, date of birth, height and weight—then calculates and prints the person's age in years, BMI, maximum heart rate and target-heart-rate range. It should also display the BMI values chart from Exercise 2.33.

4

Control Statements: Part I

Let's all move one place on.

—Lewis Carroll

The wheel is come full circle.

—William Shakespeare

*How many apples fell on
Newton's head before he took the
hint!*

—Robert Frost

Objectives

In this chapter you'll learn:

- Basic problem-solving techniques.
- To develop algorithms through the process of top-down, stepwise refinement.
- To use the `if` and `if...else` selection statements to choose among alternative actions.
- To use the `while` repetition statement to execute statements in a program repeatedly.
- To use counter-controlled repetition and sentinel-controlled repetition.
- To use the compound assignment, increment and decrement operators.
- The portability of primitive data types.

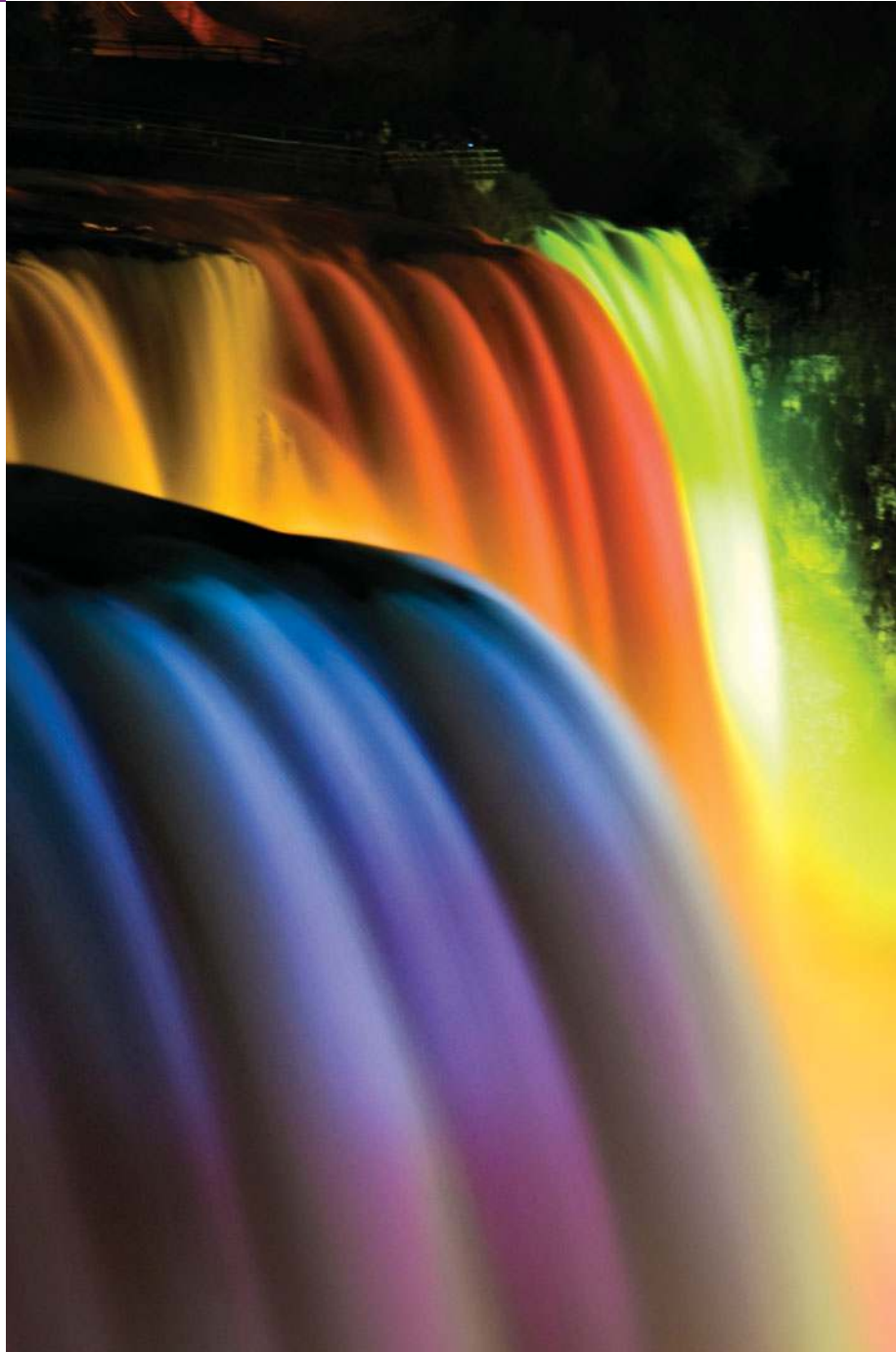

- | | |
|--|--|
| 4.1 Introduction | 4.9 Formulating Algorithms: Sentinel-Controlled Repetition |
| 4.2 Algorithms | 4.10 Formulating Algorithms: Nested Control Statements |
| 4.3 Pseudocode | 4.11 Compound Assignment Operators |
| 4.4 Control Structures | 4.12 Increment and Decrement Operators |
| 4.5 <code>if</code> Single-Selection Statement | 4.13 Primitive Types |
| 4.6 <code>if...else</code> Double-Selection Statement | 4.14 (Optional) GUI and Graphics Case Study: Creating Simple Drawings |
| 4.7 <code>while</code> Repetition Statement | 4.15 Wrap-Up |
| 4.8 Formulating Algorithms: Counter-Controlled Repetition | |

Summary | Self-Review Exercises | Answers to Self-Review Exercises | Exercises | Making a Difference

4.1 Introduction

Before writing a program to solve a problem, you should have a thorough understanding of the problem and a carefully planned approach to solving it. When writing a program, you also should understand the available building blocks and employ proven program-construction techniques. In this chapter and in Chapter 5, Control Statements: Part 2, we discuss these issues in our presentation of the theory and principles of structured programming. The concepts presented here are crucial in building classes and manipulating objects.

We introduce Java’s `if`, `if...else` and `while` statements, three of the building blocks that allow you to specify the logic required for methods to perform their tasks. We devote a portion of this chapter (and Chapters 5 and 7) to further developing the `GradeBook` class introduced in Chapter 3. In particular, we add a method to the `GradeBook` class that uses control statements to calculate the average of a set of student grades. Another example demonstrates additional ways to combine control statements to solve a similar problem. We introduce Java’s compound assignment, increment and decrement operators. Finally, we discuss the portability of Java’s primitive types.

4.2 Algorithms

Any computing problem can be solved by executing a series of actions in a specific order. A procedure for solving a problem in terms of

1. the **actions** to execute and
2. the **order** in which these actions execute

is called an **algorithm**. The following example demonstrates that correctly specifying the order in which the actions execute is important.

Consider the “rise-and-shine algorithm” followed by one executive for getting out of bed and going to work: (1) Get out of bed; (2) take off pajamas; (3) take a shower; (4) get dressed; (5) eat breakfast; (6) carpool to work. This routine gets the executive to work well prepared to make critical decisions. Suppose that the same steps are performed in a slightly different order: (1) Get out of bed; (2) take off pajamas; (3) get dressed; (4) take a shower; (5) eat breakfast; (6) carpool to work. In this case, our executive shows up for work soaking

wet. Specifying the order in which statements (actions) execute in a program is called **program control**. This chapter investigates program control using Java’s **control statements**.

4.3 Pseudocode

Pseudocode is an informal language that helps you develop algorithms without having to worry about the strict details of Java language syntax. The pseudocode we present is particularly useful for developing algorithms that will be converted to structured portions of Java programs. Pseudocode is similar to everyday English—it’s convenient and user friendly, but it’s not an actual computer programming language. You’ll see an algorithm written in pseudocode in Fig. 4.5.

Pseudocode does not execute on computers. Rather, it helps you “think out” a program before attempting to write it in a programming language, such as Java. This chapter provides several examples of using pseudocode to develop Java programs.

The style of pseudocode we present consists purely of characters, so you can type pseudocode conveniently, using any text-editor program. A carefully prepared pseudocode program can easily be converted to a corresponding Java program.

Pseudocode normally describes only statements representing the actions that occur after you convert a program from pseudocode to Java and the program is run on a computer. Such actions might include input, output or calculations. We typically do not include variable declarations in our pseudocode, but some programmers choose to list variables and mention their purposes at the beginning of their pseudocode.

4.4 Control Structures

Normally, statements in a program are executed one after the other in the order in which they’re written. This process is called **sequential execution**. Various Java statements, which we’ll soon discuss, enable you to specify that the next statement to execute is *not* necessarily the *next* one in sequence. This is called **transfer of control**.

During the 1960s, it became clear that the indiscriminate use of transfers of control was the root of much difficulty experienced by software development groups. The blame was pointed at the **goto statement** (used in most programming languages of the time), which allows you to specify a transfer of control to one of a wide range of destinations in a program. The term **structured programming** became almost synonymous with “goto elimination.” [Note: Java does *not* have a goto statement; however, the word goto is *reserved* by Java and should *not* be used as an identifier in programs.]

The research of Bohm and Jacopini¹ had demonstrated that programs could be written *without* any goto statements. The challenge of the era for programmers was to shift their styles to “goto-less programming.” Not until the 1970s did most programmers start taking structured programming seriously. The results were impressive. Software development groups reported shorter development times, more frequent on-time delivery of systems and more frequent within-budget completion of software projects. The key to these successes was that structured programs were clearer, easier to debug and modify, and more likely to be bug free in the first place.

1. Bohm, C., and G. Jacopini, “Flow Diagrams, Turing Machines, and Languages with Only Two Formation Rules,” *Communications of the ACM*, Vol. 9, No. 5, May 1966, pp. 336–371.

Bohm and Jacopini’s work demonstrated that all programs could be written in terms of only three control structures—the **sequence structure**, the **selection structure** and the **repetition structure**. When we introduce Java’s control structure implementations, we’ll refer to them in the terminology of the *Java Language Specification* as “control statements.”

Sequence Structure in Java

The sequence structure is built into Java. Unless directed otherwise, the computer executes Java statements one after the other in the order in which they’re written—that is, in sequence. The **activity diagram** in Fig. 4.1 illustrates a typical sequence structure in which two calculations are performed in order. Java lets you have as many actions as you want in a sequence structure. As we’ll soon see, anywhere a single action may be placed, we may place several actions in sequence.

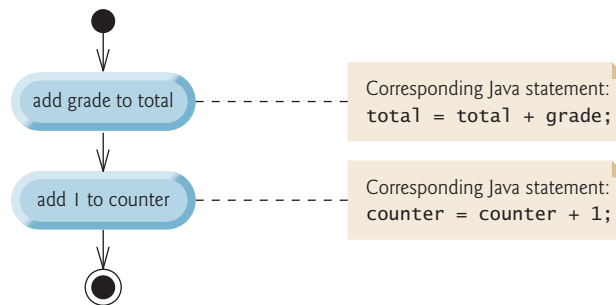

Fig. 4.1 | Sequence structure activity diagram.

A UML activity diagram models the **workflow** (also called the **activity**) of a portion of a software system. Such workflows may include a portion of an algorithm, like the sequence structure in Fig. 4.1. Activity diagrams are composed of symbols, such as **action-state symbols** (rectangles with their left and right sides replaced with outward arcs), **diamonds** and **small circles**. These symbols are connected by **transition arrows**, which represent the flow of the activity—that is, the order in which the actions should occur.

Like pseudocode, activity diagrams help you develop and represent algorithms, although many programmers prefer pseudocode. Activity diagrams clearly show how control structures operate. We use the UML in this chapter and Chapter 5 to show control flow in control statements. In Chapters 12–13, we use the UML in a real-world automated-teller machine case study.

Consider the sequence structure activity diagram in Fig. 4.1. It contains two **action states** that represent actions to perform. Each action state contains an **action expression**—for example, “add grade to total” or “add 1 to counter”—that specifies a particular action to perform. Other actions might include calculations or input/output operations. The arrows in the activity diagram represent **transitions**, which indicate the *order* in which the actions represented by the action states occur. The program that implements the activities illustrated by the diagram in Fig. 4.1 first adds grade to `total`, then adds 1 to counter.

The **solid circle** at the top of the activity diagram represents the **initial state**—the *beginning* of the workflow *before* the program performs the modeled actions. The **solid**

circle surrounded by a hollow circle that appears at the bottom of the diagram represents the **final state**—the *end* of the workflow *after* the program performs its actions.

Figure 4.1 also includes rectangles with the upper-right corners folded over. These are UML **notes** (like comments in Java)—explanatory remarks that describe the purpose of symbols in the diagram. Figure 4.1 uses UML notes to show the Java code associated with each action state. A **dotted line** connects each note with the element it describes. Activity diagrams normally do *not* show the Java code that implements the activity. We do this here to illustrate how the diagram relates to Java code. For more information on the UML, see our optional case study (Chapters 12–13) or visit www.uml.org.

Selection Statements in Java

Java has three types of **selection statements** (discussed in this chapter and Chapter 5). The `if` statement either performs (selects) an action, if a condition is true, or skips it, if the condition is false. The `if...else` statement performs an action if a condition is true and performs a different action if the condition is false. The `switch` statement (Chapter 5) performs one of many different actions, depending on the value of an expression.

The `if` statement is a **single-selection statement** because it selects or ignores a *single* action (or, as we'll soon see, a *single group of actions*). The `if...else` statement is called a **double-selection statement** because it selects between *two different actions* (or *groups of actions*). The `switch` statement is called a **multiple-selection statement** because it selects among *many different actions* (or *groups of actions*).

Repetition Statements in Java

Java provides three **repetition statements** (also called **looping statements**) that enable programs to perform statements repeatedly as long as a condition (called the **loop-continuation condition**) remains true. The repetition statements are the `while`, `do...while` and `for` statements. (Chapter 5 presents the `do...while` and `for` statements.) The `while` and `for` statements perform the action (or group of actions) in their bodies zero or more times—if the loop-continuation condition is initially false, the action (or group of actions) will not execute. The `do...while` statement performs the action (or group of actions) in its body *one or more* times. The words `if`, `else`, `switch`, `while`, `do` and `for` are Java keywords. A complete list of Java keywords appears in Appendix C.

Summary of Control Statements in Java

Java has only three kinds of control structures, which from this point forward we refer to as control statements: the sequence statement, selection statements (three types) and repetition statements (three types). Every program is formed by combining as many of these statements as is appropriate for the algorithm the program implements. We can model each control statement as an activity diagram. Like Fig. 4.1, each diagram contains an initial state and a final state that represent a control statement's entry point and exit point, respectively. **Single-entry/single-exit control statements** make it easy to build programs—we simply connect the exit point of one to the entry point of the next. We call this **control-statement stacking**. We'll learn that there's only one other way in which control statements may be connected—**control-statement nesting**—in which one control statement appears *inside* another. Thus, algorithms in Java programs are constructed from only three kinds of control statements, combined in only two ways. This is the essence of simplicity.

4.5 if Single-Selection Statement

Programs use selection statements to choose among alternative courses of action. For example, suppose that the passing grade on an exam is 60. The pseudocode statement

```
If student's grade is greater than or equal to 60
  Print "Passed"
```

determines whether the condition “student’s grade is greater than or equal to 60” is true. If so, “Passed” is printed, and the next pseudocode statement in order is “performed.” (Remember, pseudocode is not a real programming language.) If the condition is false, the *Print* statement is ignored, and the next pseudocode statement in order is performed. The indentation of the second line of this selection statement is optional, but recommended, because it emphasizes the inherent structure of structured programs.

The preceding pseudocode *If* statement may be written in Java as

```
if ( studentGrade >= 60 )
    System.out.println( "Passed" );
```

The Java code corresponds closely to the pseudocode. This is one of the properties of pseudocode that makes it such a useful program development tool.

Figure 4.2 illustrates the single-selection *if* statement. This figure contains the most important symbol in an activity diagram—the diamond, or **decision symbol**, which indicates that a decision is to be made. The workflow continues along a path determined by the symbol’s associated **guard conditions**, which can be true or false. Each transition arrow emerging from a decision symbol has a guard condition (specified in square brackets next to the arrow). If a guard condition is true, the workflow enters the action state to which the transition arrow points. In Fig. 4.2, if the grade is greater than or equal to 60, the program prints “Passed,” then transitions to the activity’s final state. If the grade is less than 60, the program immediately transitions to the final state without displaying a message.

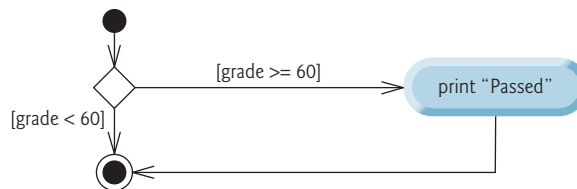

Fig. 4.2 | *if* single-selection statement UML activity diagram.

The *if* statement is a single-entry/single-exit control statement. We’ll see that the activity diagrams for the remaining control statements also contain initial states, transition arrows, action states that indicate actions to perform, decision symbols (with associated guard conditions) that indicate decisions to be made, and final states.

4.6 if...else Double-Selection Statement

The *if* single-selection statement performs an indicated action only when the condition is true; otherwise, the action is skipped. The **if...else double-selection statement** allows

you to specify an action to perform when the condition is true and a different action when the condition is false. For example, the pseudocode statement

```
If student's grade is greater than or equal to 60
    Print "Passed"
Else
    Print "Failed"
```

prints “Passed” if the student’s grade is greater than or equal to 60, but prints “Failed” if it’s less than 60. In either case, after printing occurs, the next pseudocode statement in sequence is “performed.”

The preceding *If...Else* pseudocode statement can be written in Java as

```
if ( grade >= 60 )
    System.out.println( "Passed" );
else
    System.out.println( "Failed" );
```

The body of the `else` is also indented. Whatever indentation convention you choose should be applied consistently throughout your programs.



Good Programming Practice 4.1

Indent both body statements of an `if...else` statement. Many IDEs do this for you.



Good Programming Practice 4.2

If there are several levels of indentation, each level should be indented the same additional amount of space.

Figure 4.3 illustrates the flow of control in the `if...else` statement. Once again, the symbols in the UML activity diagram (besides the initial state, transition arrows and final state) represent action states and decisions.

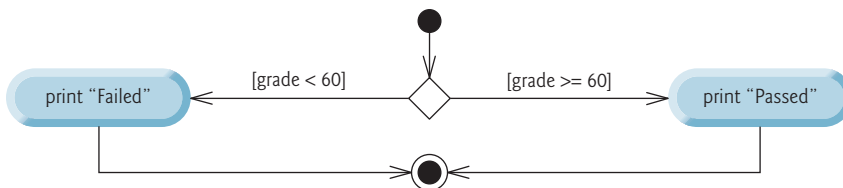

Fig. 4.3 | `if...else` double-selection statement UML activity diagram.

Conditional Operator (?:)

Java provides the **conditional operator** (`?:`) that can be used in place of an `if...else` statement. This is Java’s only **ternary operator** (operator that takes three operands). Together, the operands and the `?:` symbol form a **conditional expression**. The first operand (to the left of the `?`) is a **boolean expression** (i.e., a condition that evaluates to a boolean

value—**true** or **false**), the second operand (between the ? and :) is the value of the conditional expression if the boolean expression is true and the third operand (to the right of the :) is the value of the conditional expression if the boolean expression evaluates to false. For example, the statement

```
System.out.println( studentGrade >= 60 ? "Passed" : "Failed" );
```

prints the value of `println`'s conditional-expression argument. The conditional expression in this statement evaluates to the string "Passed" if the boolean expression `studentGrade >= 60` is true and to the string "Failed" if it's false. Thus, this statement with the conditional operator performs essentially the same function as the `if...else` statement shown earlier in this section. The precedence of the conditional operator is low, so the entire conditional expression is normally placed in parentheses. We'll see that conditional expressions can be used in some situations where `if...else` statements cannot.

Nested if...else Statements

A program can test multiple cases by placing `if...else` statements inside other `if...else` statements to create **nested if...else statements**. For example, the following pseudocode represents a nested `if...else` that prints A for exam grades greater than or equal to 90, B for grades 80 to 89, C for grades 70 to 79, D for grades 60 to 69 and F for all other grades:

```
If student's grade is greater than or equal to 90
  Print "A"
else
  If student's grade is greater than or equal to 80
    Print "B"
  else
    If student's grade is greater than or equal to 70
      Print "C"
    else
      If student's grade is greater than or equal to 60
        Print "D"
      else
        Print "F"
```

This pseudocode may be written in Java as

```
if ( studentGrade >= 90 )
    System.out.println( "A" );
else
    if ( studentGrade >= 80 )
        System.out.println( "B" );
    else
        if ( studentGrade >= 70 )
            System.out.println( "C" );
        else
            if ( studentGrade >= 60 )
                System.out.println( "D" );
            else
                System.out.println( "F" );
```

If variable `studentGrade` is greater than or equal to 90, the first four conditions in the nested `if...else` statement will be true, but only the statement in the `if` part of the first `if...else` statement will execute. After that statement executes, the `else` part of the “outermost” `if...else` statement is skipped. Many programmers prefer to write the preceding nested `if...else` statement as

```
if ( studentGrade >= 90 )
    System.out.println( "A" );
else if ( studentGrade >= 80 )
    System.out.println( "B" );
else if ( studentGrade >= 70 )
    System.out.println( "C" );
else if ( studentGrade >= 60 )
    System.out.println( "D" );
else
    System.out.println( "F" );
```

The two forms are identical except for the spacing and indentation, which the compiler ignores. The latter form avoids deep indentation of the code to the right. Such indentation often leaves little room on a line of source code, forcing lines to be split.

Dangling-else Problem

The Java compiler always associates an `else` with the immediately preceding `if` unless told to do otherwise by the placement of braces (`{` and `}`). This behavior can lead to what is referred to as the **dangling-else problem**. For example,

```
if ( x > 5 )
    if ( y > 5 )
        System.out.println( "x and y are > 5" );
else
    System.out.println( "x is <= 5" );
```

appears to indicate that if `x` is greater than 5, the nested `if` statement determines whether `y` is also greater than 5. If so, the string “`x and y are > 5`” is output. Otherwise, it appears that if `x` is not greater than 5, the `else` part of the `if...else` outputs the string “`x is <= 5`”. Beware! This nested `if...else` statement does not execute as it appears. The compiler actually interprets the statement as

```
if ( x > 5 )
    if ( y > 5 )
        System.out.println( "x and y are > 5" );
else
    System.out.println( "x is <= 5" );
```

in which the body of the first `if` is a nested `if...else`. The outer `if` statement tests whether `x` is greater than 5. If so, execution continues by testing whether `y` is also greater than 5. If the second condition is true, the proper string—“`x and y are > 5`”—is displayed. However, if the second condition is false, the string “`x is <= 5`” is displayed, even though we know that `x` is greater than 5. Equally bad, if the outer `if` statement’s condition is false, the inner `if...else` is skipped and nothing is displayed.

To force the nested `if...else` statement to execute as it was originally intended, we must write it as follows:

```

if ( x > 5 )
{
    if ( y > 5 )
        System.out.println( "x and y are > 5" );
}
else
    System.out.println( "x is <= 5" );

```

The braces indicate that the second `if` is in the body of the first and that the `else` is associated with the *first* `if`. Exercises 4.27–4.28 investigate the dangling-else problem further.

Blocks

The `if` statement normally expects only one statement in its body. To include several statements in the body of an `if` (or the body of an `else` for an `if...else` statement), enclose the statements in braces. Statements contained in a pair of braces form a **block**. A block can be placed anywhere in a program that a single statement can be placed.

The following example includes a block in the `else` part of an `if...else` statement:

```

if ( grade >= 60 )
    System.out.println( "Passed" );
else
{
    System.out.println( "Failed" );
    System.out.println( "You must take this course again." );
}

```

In this case, if grade is less than 60, the program executes *both* statements in the body of the `else` and prints

```

Failed
You must take this course again.

```

Note the braces surrounding the two statements in the `else` clause. These braces are important. Without the braces, the statement

```

System.out.println( "You must take this course again." );

```

would be outside the body of the `else` part of the `if...else` statement and would execute *regardless* of whether the grade was less than 60.

Syntax errors (e.g., when one brace in a block is left out of the program) are caught by the compiler. A **logic error** (e.g., when both braces in a block are left out of the program) has its effect at execution time. A **fatal logic error** causes a program to fail and terminate prematurely. A **nonfatal logic error** allows a program to continue executing but causes it to produce incorrect results.

Just as a block can be placed anywhere a single statement can be placed, it's also possible to have an empty statement. Recall from Section 2.8 that the empty statement is represented by placing a semicolon (;) where a statement would normally be.



Common Programming Error 4.1

Placing a semicolon after the condition in an `if` or `if...else` statement leads to a logic error in single-selection `if` statements and a syntax error in double-selection `if...else` statements (when the `if`-part contains an actual body statement).

4.7 while Repetition Statement

A **repetition** (or **looping**) **statement** allows you to specify that a program should repeat an action while some condition remains true. The pseudocode statement

*While there are more items on my shopping list
Purchase next item and cross it off my list*

describes the repetition that occurs during a shopping trip. The condition “there are more items on my shopping list” may be true or false. If it’s true, then the action “Purchase next item and cross it off my list” is performed. This action will be performed repeatedly while the condition remains true. The statement(s) contained in the *While* repetition statement constitute its body, which may be a single statement or a block. Eventually, the condition will become false (when the last item on the shopping list has been purchased and crossed off). At this point, the repetition terminates, and the first statement after the repetition statement executes.

As an example of Java’s **while repetition statement**, consider a program segment that finds the first power of 3 larger than 100. Suppose that the `int` variable `product` is initialized to 3. After the following `while` statement executes, `product` contains the result:

```
while ( product <= 100 )
    product = 3 * product;
```

When this `while` statement begins execution, the value of variable `product` is 3. Each iteration of the `while` statement multiplies `product` by 3, so `product` takes on the values 9, 27, 81 and 243 successively. When variable `product` becomes 243, the `while`-statement condition—`product <= 100`—becomes false. This terminates the repetition, so the final value of `product` is 243. At this point, program execution continues with the next statement after the `while` statement.



Common Programming Error 4.2

*Not providing in the body of a `while` statement an action that eventually causes the condition in the `while` to become false normally results in a logic error called an **infinite loop** (the loop never terminates).*

The UML activity diagram in Fig. 4.4 illustrates the flow of control in the preceding `while` statement. Once again, the symbols in the diagram (besides the initial state, transition arrows, a final state and three notes) represent an action state and a decision. This diagram introduces the UML’s **merge symbol**. The UML represents both the merge symbol and the decision symbol as diamonds. The merge symbol joins two flows of activity into one. In this diagram, the merge symbol joins the transitions from the initial state and from the action state, so they both flow into the decision that determines whether the loop should begin (or continue) executing. The decision and merge symbols can be distinguished by the number of “incoming” and “outgoing” transition arrows. A decision symbol has one transition arrow pointing to the diamond and two or more pointing out from it to indicate possible transitions from that point. In addition, each transition arrow pointing out of a decision symbol has a guard condition next to it. A merge symbol has two or more transition arrows pointing to the diamond and only one pointing from the diamond, to indicate multiple activity flows merging to continue the activity. *None* of the transition arrows associated with a merge symbol has a guard condition.

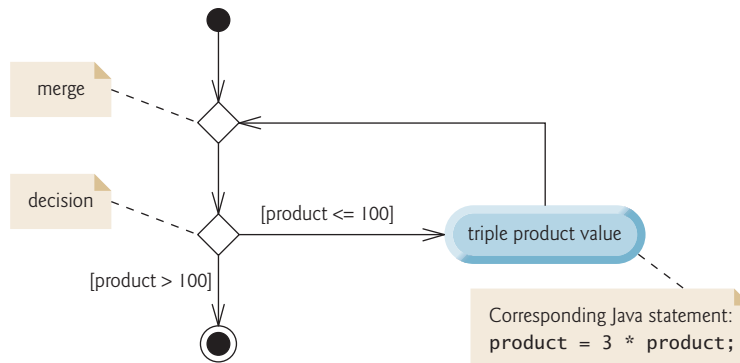

Fig. 4.4 | while repetition statement UML activity diagram.

Figure 4.4 clearly shows the repetition of the while statement discussed earlier in this section. The transition arrow emerging from the action state points back to the merge, from which program flow transitions back to the decision that's tested at the beginning of each iteration of the loop. The loop continues to execute until the guard condition `product > 100` becomes true. Then the while statement exits (reaches its final state), and control passes to the next statement in sequence in the program.

4.8 Formulating Algorithms: Counter-Controlled Repetition

To illustrate how algorithms are developed, we modify the GradeBook class of Chapter 3 to solve two variations of a problem that averages student grades. Consider the following problem statement:

A class of ten students took a quiz. The grades (integers in the range 0 to 100) for this quiz are available to you. Determine the class average on the quiz.

The class average is equal to the sum of the grades divided by the number of students. The algorithm for solving this problem on a computer must input each grade, keep track of the total of all grades input, perform the averaging calculation and print the result.

Pseudocode Algorithm with Counter-Controlled Repetition

Let's use pseudocode to list the actions to execute and specify the order in which they should execute. We use **counter-controlled repetition** to input the grades one at a time. This technique uses a variable called a **counter** (or **control variable**) to control the number of times a set of statements will execute. Counter-controlled repetition is often called **definite repetition**, because the number of repetitions is known *before* the loop begins executing. In this example, repetition terminates when the counter exceeds 10. This section presents a fully developed pseudocode algorithm (Fig. 4.5) and a version of class GradeBook (Fig. 4.6) that implements the algorithm in a Java method. We then present an application (Fig. 4.7) that demonstrates the algorithm in action. In Section 4.9, we demonstrate how to use pseudocode to develop such an algorithm from scratch.



Software Engineering Observation 4.1

Experience has shown that the most difficult part of solving a problem on a computer is developing the algorithm for the solution. Once a correct algorithm has been specified, producing a working Java program from the algorithm is usually straightforward.

Note the references in the algorithm of Fig. 4.5 to a total and a counter. A **total** is a variable used to accumulate the sum of several values. A counter is a variable used to count—in this case, the grade counter indicates which of the 10 grades is about to be entered by the user. Variables used to store totals are normally initialized to zero before being used in a program.

- 1 *Set total to zero*
- 2 *Set grade counter to one*
- 3
- 4 *While grade counter is less than or equal to ten*
- 5 *Prompt the user to enter the next grade*
- 6 *Input the next grade*
- 7 *Add the grade into the total*
- 8 *Add one to the grade counter*
- 9
- 10 *Set the class average to the total divided by ten*
- 11 *Print the class average*

Fig. 4.5 | Pseudocode algorithm that uses counter-controlled repetition to solve the class-average problem.

Implementing Counter-Controlled Repetition in Class `GradeBook`

Class `GradeBook` (Fig. 4.6) contains a constructor (lines 11–14) that assigns a value to the class's instance variable `courseName` (declared in line 8). Lines 17–20, 23–26 and 29–34 declare methods `setCourseName`, `getCourseName` and `displayMessage`, respectively. Lines 37–66 declare method `determineClassAverage`, which implements the class-averaging algorithm described by the pseudocode in Fig. 4.5.

Line 40 declares and initializes `Scanner` variable `input`, which is used to read values entered by the user. Lines 42–45 declare local variables `total`, `gradeCounter`, `grade` and `average` to be of type `int`. Variable `grade` stores the user input.

```

1 // Fig. 4.6: GradeBook.java
2 // GradeBook class that solves class-average problem using
3 // counter-controlled repetition.
4 import java.util.Scanner; // program uses class Scanner
5
6 public class GradeBook
7 {
8     private String courseName; // name of course this GradeBook represents

```

Fig. 4.6 | `GradeBook` class that solves class-average problem using counter-controlled repetition. (Part I of 3.)

```
9
10 // constructor initializes courseName
11 public GradeBook( String name )
12 {
13     courseName = name; // initializes courseName
14 } // end constructor
15
16 // method to set the course name
17 public void setCourseName( String name )
18 {
19     courseName = name; // store the course name
20 } // end method setCourseName
21
22 // method to retrieve the course name
23 public String getCourseName()
24 {
25     return courseName;
26 } // end method getCourseName
27
28 // display a welcome message to the GradeBook user
29 public void displayMessage()
30 {
31     // getCourseName gets the name of the course
32     System.out.printf( "Welcome to the grade book for\n%s!\n\n",
33         getCourseName() );
34 } // end method displayMessage
35
36 // determine class average based on 10 grades entered by user
37 public void determineClassAverage()
38 {
39     // create Scanner to obtain input from command window
40     Scanner input = new Scanner( System.in );
41
42     int total; // sum of grades entered by user
43     int gradeCounter; // number of the grade to be entered next
44     int grade; // grade value entered by user
45     int average; // average of grades
46
47     // initialization phase
48     total = 0; // initialize total
49     gradeCounter = 1; // initialize loop counter
50
51     // processing phase uses counter-controlled repetition
52     while ( gradeCounter <= 10 ) // loop 10 times
53     {
54         System.out.print( "Enter grade: " ); // prompt
55         grade = input.nextInt(); // input next grade
56         total = total + grade; // add grade to total
57         gradeCounter = gradeCounter + 1; // increment counter by 1
58     } // end while
59
```

Fig. 4.6 | GradeBook class that solves class-average problem using counter-controlled repetition. (Part 2 of 3.)

```

60     // termination phase
61     average = total / 10; // integer division yields integer result
62
63     // display total and average of grades
64     System.out.printf( "\nTotal of all 10 grades is %d\n", total );
65     System.out.printf( "Class average is %d\n", average );
66 } // end method determineClassAverage
67 } // end class GradeBook

```

Fig. 4.6 | GradeBook class that solves class-average problem using counter-controlled repetition. (Part 3 of 3.)

The declarations (in lines 42–45) appear in the body of method `determineClassAverage`. Recall that variables declared in a method body are local variables and can be used only from the line of their declaration to the closing right brace of the method declaration. A local variable’s declaration must appear before the variable is used in that method. A local variable cannot be accessed outside the method in which it’s declared.

In this chapter, class `GradeBook` simply reads and processes a set of grades. The averaging calculation is performed in method `determineClassAverage` using local variables—we do not preserve any information about student grades in instance variables of the class.

The assignments (in lines 48–49) initialize `total` to 0 and `gradeCounter` to 1. These initializations occur *before* the variables are used in calculations. Variables `grade` and `average` (for the user input and calculated average, respectively) need not be initialized here—their values will be assigned as they’re input or calculated later in the method.



Common Programming Error 4.3

Using the value of a local variable before it’s initialized results in a compilation error. All local variables must be initialized before their values are used in expressions.



Error-Prevention Tip 4.1

Initialize each counter and total, either in its declaration or in an assignment statement. Totals are normally initialized to 0. Counters are normally initialized to 0 or 1, depending on how they’re used (we’ll show examples of when to use 0 and when to use 1).

Line 52 indicates that the `while` statement should continue looping (also called **iterating**) as long as `gradeCounter`’s value is less than or equal to 10. While this condition remains true, the `while` statement repeatedly executes the statements between the braces that delimit its body (lines 54–57).

Line 54 displays the prompt "Enter grade: ". Line 55 reads the grade entered by the user and assigns it to variable `grade`. Then line 56 adds the new grade entered by the user to the `total` and assigns the result to `total`, which replaces its previous value.

Line 57 adds 1 to `gradeCounter` to indicate that the program has processed a grade and is ready to input the next grade from the user. Incrementing `gradeCounter` eventually causes it to exceed 10. Then the loop terminates, because its condition (line 52) becomes false.

When the loop terminates, line 61 performs the averaging calculation and assigns its result to the variable `average`. Line 64 uses `System.out.printf` method to display the

text "Total of all 10 grades is " followed by variable `total`'s value. Line 65 then uses `printf` to display the text "Class average is " followed by variable `average`'s value. After reaching line 66, method `determineClassAverage` returns control to the calling method (i.e., `main` in `GradeBookTest` of Fig. 4.7).

Class GradeBookTest

Class `GradeBookTest` (Fig. 4.7) creates an object of class `GradeBook` (Fig. 4.6) and demonstrates its capabilities. Lines 10–11 of Fig. 4.7 create a new `GradeBook` object and assign it to variable `myGradeBook`. The `String` in line 11 is passed to the `GradeBook` constructor (lines 11–14 of Fig. 4.6). Line 13 calls `myGradeBook`'s `displayMessage` method to display a welcome message to the user. Line 14 then calls `myGradeBook`'s `determineClassAverage` method to allow the user to enter 10 grades, for which the method then calculates and prints the average—the method performs the algorithm shown in Fig. 4.5.

```

1 // Fig. 4.7: GradeBookTest.java
2 // Create GradeBook object and invoke its determineClassAverage method.
3
4 public class GradeBookTest
5 {
6     public static void main( String[] args )
7     {
8         // create GradeBook object myGradeBook and
9         // pass course name to constructor
10        GradeBook myGradeBook = new GradeBook(
11            "CS101 Introduction to Java Programming" );
12
13        myGradeBook.displayMessage(); // display welcome message
14        myGradeBook.determineClassAverage(); // find average of 10 grades
15    } // end main
16 } // end class GradeBookTest

```

```

Welcome to the grade book for
CS101 Introduction to Java Programming!

```

```

Enter grade: 67
Enter grade: 78
Enter grade: 89
Enter grade: 67
Enter grade: 87
Enter grade: 98
Enter grade: 93
Enter grade: 85
Enter grade: 82
Enter grade: 100

```

```

Total of all 10 grades is 846
Class average is 84

```

Fig. 4.7 | `GradeBookTest` class creates an object of class `GradeBook` (Fig. 4.6) and invokes its `determineClassAverage` method.

Notes on Integer Division and Truncation

The averaging calculation performed by method `determineClassAverage` in response to the method call at line 14 in Fig. 4.7 produces an integer result. The program's output indicates that the sum of the grade values in the sample execution is 846, which, when divided by 10, should yield the floating-point number 84.6. However, the result of the calculation `total / 10` (line 61 of Fig. 4.6) is the integer 84, because `total` and 10 are both integers. Dividing two integers results in **integer division**—any fractional part of the calculation is lost (i.e., **truncated**). In the next section we'll see how to obtain a floating-point result from the averaging calculation.

**Common Programming Error 4.4**

Assuming that integer division rounds (rather than truncates) can lead to incorrect results. For example, $7 \div 4$, which yields 1.75 in conventional arithmetic, truncates to 1 in integer arithmetic, rather than rounding to 2.

4.9 Formulating Algorithms: Sentinel-Controlled Repetition

Let's generalize Section 4.8's class-average problem. Consider the following problem:

Develop a class-averaging program that processes grades for an arbitrary number of students each time it's run.

In the previous class-average example, the problem statement specified the number of students, so the number of grades (10) was known in advance. In this example, no indication is given of how many grades the user will enter during the program's execution. The program must process an arbitrary number of grades. How can it determine when to stop the input of grades? How will it know when to calculate and print the class average?

One way to solve this problem is to use a special value called a **sentinel value** (also called a **signal value**, a **dummy value** or a **flag value**) to indicate "end of data entry." The user enters grades until all legitimate grades have been entered. The user then types the sentinel value to indicate that no more grades will be entered. **Sentinel-controlled repetition** is often called **indefinite repetition** because the number of repetitions is *not* known before the loop begins executing.

Clearly, a sentinel value must be chosen that cannot be confused with an acceptable input value. Grades on a quiz are nonnegative integers, so -1 is an acceptable sentinel value for this problem. Thus, a run of the class-average program might process a stream of inputs such as 95, 96, 75, 74, 89 and -1 . The program would then compute and print the class average for the grades 95, 96, 75, 74 and 89; since -1 is the sentinel value, it should *not* enter into the averaging calculation.

Developing the Pseudocode Algorithm with Top-Down, Stepwise Refinement: The Top and First Refinement

We approach this class-average program with a technique called **top-down, stepwise refinement**, which is essential to the development of well-structured programs. We begin with a pseudocode representation of the **top**—a single statement that conveys the overall function of the program:

Determine the class average for the quiz

The top is, in effect, a *complete* representation of a program. Unfortunately, the top rarely conveys sufficient detail from which to write a Java program. So we now begin the refinement process. We divide the top into a series of smaller tasks and list these in the order in which they'll be performed. This results in the following **first refinement**:

Initialize variables
Input, sum and count the quiz grades
Calculate and print the class average

This refinement uses only the sequence structure—the steps listed should execute in order, one after the other.



Software Engineering Observation 4.2

Each refinement, as well as the top itself, is a complete specification of the algorithm—only the level of detail varies.



Software Engineering Observation 4.3

Many programs can be divided logically into three phases: an initialization phase that initializes the variables; a processing phase that inputs data values and adjusts program variables accordingly; and a termination phase that calculates and outputs the final results.

Proceeding to the Second Refinement

The preceding Software Engineering Observation is often all you need for the first refinement in the top-down process. To proceed to the next level of refinement—that is, the **second refinement**—we commit to specific variables. In this example, we need a running total of the numbers, a count of how many numbers have been processed, a variable to receive the value of each grade as it's input by the user and a variable to hold the calculated average. The pseudocode statement

Initialize variables

can be refined as follows:

Initialize total to zero
Initialize counter to zero

Only the variables *total* and *counter* need to be initialized before they're used. The variables *average* and *grade* (for the calculated average and the user input, respectively) need not be initialized, because their values will be replaced as they're calculated or input.

The pseudocode statement

Input, sum and count the quiz grades

requires a repetition structure (i.e., a loop) that successively inputs each grade. We do not know in advance how many grades are to be processed, so we'll use sentinel-controlled repetition. The user enters grades one at a time. After entering the last grade, the user enters the sentinel value. The program tests for the sentinel value after each grade is input and terminates the loop when the user enters the sentinel value. The second refinement of the preceding pseudocode statement is then

```

    Prompt the user to enter the first grade
    Input the first grade (possibly the sentinel)

    While the user has not yet entered the sentinel
        Add this grade into the running total
        Add one to the grade counter
        Prompt the user to enter the next grade
        Input the next grade (possibly the sentinel)

```

In pseudocode, we do not use braces around the statements that form the body of the *While* structure. We simply indent the statements under the *While* to show that they belong to the *While*. Again, pseudocode is only an informal program development aid.

The pseudocode statement

```

    Calculate and print the class average

```

can be refined as follows:

```

    If the counter is not equal to zero
        Set the average to the total divided by the counter
        Print the average
    else
        Print "No grades were entered"

```

We're careful here to test for the possibility of division by zero—a logic error that, if undetected, would cause the program to fail or produce invalid output. The complete second refinement of the pseudocode for the class-average problem is shown in Fig. 4.8.



Error-Prevention Tip 4.2

When performing division by an expression whose value could be zero, test for this and handle it (e.g., print an error message) rather than allow the error to occur.

```

1  Initialize total to zero
2  Initialize counter to zero
3
4  Prompt the user to enter the first grade
5  Input the first grade (possibly the sentinel)
6
7  While the user has not yet entered the sentinel
8      Add this grade into the running total
9      Add one to the grade counter
10     Prompt the user to enter the next grade
11     Input the next grade (possibly the sentinel)
12
13    If the counter is not equal to zero
14        Set the average to the total divided by the counter
15        Print the average
16    else
17        Print "No grades were entered"

```

Fig. 4.8 | Class-average problem pseudocode algorithm with sentinel-controlled repetition.

In Fig. 4.5 and Fig. 4.8, we included blank lines and indentation in the pseudocode to make it more readable. The blank lines separate the algorithms into their phases and set off control statements; the indentation emphasizes the bodies of the control statements.

The pseudocode algorithm in Fig. 4.8 solves the more general class-average problem. This algorithm was developed after two refinements. Sometimes more are needed.



Software Engineering Observation 4.4

Terminate the top-down, stepwise refinement process when you've specified the pseudocode algorithm in sufficient detail for you to convert the pseudocode to Java. Normally, implementing the Java program is then straightforward.



Software Engineering Observation 4.5

Some programmers do not use program development tools like pseudocode. They feel that their ultimate goal is to solve the problem on a computer and that writing pseudocode merely delays the production of final outputs. Although this may work for simple and familiar problems, it can lead to serious errors and delays in large, complex projects.

Implementing Sentinel-Controlled Repetition in Class `GradeBook`

Figure 4.9 shows the Java class `GradeBook` containing method `determineClassAverage` that implements the pseudocode algorithm of Fig. 4.8. Although each grade is an integer, the averaging calculation is likely to produce a number with a decimal point—in other words, a real (i.e., floating-point) number. The type `int` cannot represent such a number, so this class uses type `double` to do so.

```

1 // Fig. 4.9: GradeBook.java
2 // GradeBook class that solves the class-average problem using
3 // sentinel-controlled repetition.
4 import java.util.Scanner; // program uses class Scanner
5
6 public class GradeBook
7 {
8     private String courseName; // name of course this GradeBook represents
9
10    // constructor initializes courseName
11    public GradeBook( String name )
12    {
13        courseName = name; // initializes courseName
14    } // end constructor
15
16    // method to set the course name
17    public void setCourseName( String name )
18    {
19        courseName = name; // store the course name
20    } // end method setCourseName
21
22    // method to retrieve the course name
23    public String getCourseName()
24    {

```

Fig. 4.9 | `GradeBook` class that solves the class-average problem using sentinel-controlled repetition. (Part 1 of 3.)

```
25     return courseName;
26 } // end method getCourseName
27
28 // display a welcome message to the GradeBook user
29 public void displayMessage()
30 {
31     // getCourseName gets the name of the course
32     System.out.printf( "Welcome to the grade book for\n%s!\n\n",
33         getCourseName() );
34 } // end method displayMessage
35
36 // determine the average of an arbitrary number of grades
37 public void determineClassAverage()
38 {
39     // create Scanner to obtain input from command window
40     Scanner input = new Scanner( System.in );
41
42     int total; // sum of grades
43     int gradeCounter; // number of grades entered
44     int grade; // grade value
45     double average; // number with decimal point for average
46
47     // initialization phase
48     total = 0; // initialize total
49     gradeCounter = 0; // initialize loop counter
50
51     // processing phase
52     // prompt for input and read grade from user
53     System.out.print( "Enter grade or -1 to quit: " );
54     grade = input.nextInt();
55
56     // loop until sentinel value read from user
57     while ( grade != -1 )
58     {
59         total = total + grade; // add grade to total
60         gradeCounter = gradeCounter + 1; // increment counter
61
62         // prompt for input and read next grade from user
63         System.out.print( "Enter grade or -1 to quit: " );
64         grade = input.nextInt();
65     } // end while
66
67     // termination phase
68     // if user entered at least one grade...
69     if ( gradeCounter != 0 )
70     {
71         // calculate average of all grades entered
72         average = (double) total / gradeCounter;
73
74         // display total and average (with two digits of precision)
75         System.out.printf( "\nTotal of the %d grades entered is %d\n",
76             gradeCounter, total );
```

Fig. 4.9 | GradeBook class that solves the class-average problem using sentinel-controlled repetition. (Part 2 of 3.)

```
77     System.out.printf( "Class average is %.2f\n", average );
78     } // end if
79     else // no grades were entered, so output appropriate message
80         System.out.println( "No grades were entered" );
81     } // end method determineClassAverage
82 } // end class GradeBook
```

Fig. 4.9 | GradeBook class that solves the class-average problem using sentinel-controlled repetition. (Part 3 of 3.)

In this example, we see that control statements may be *stacked* on top of one another (in sequence). The `while` statement (lines 57–65) is followed in sequence by an `if...else` statement (lines 69–80). Much of the code in this program is identical to that in Fig. 4.6, so we concentrate on the new concepts.

Line 45 declares `double` variable `average`, which allows us to store the class average as a floating-point number. Line 49 initializes `gradeCounter` to 0, because no grades have been entered yet. Remember that this program uses sentinel-controlled repetition to input the grades. To keep an accurate record of the number of grades entered, the program increments `gradeCounter` only when the user enters a valid grade.

Program Logic for Sentinel-Controlled Repetition vs. Counter-Controlled Repetition

Compare the program logic for sentinel-controlled repetition in this application with that for counter-controlled repetition in Fig. 4.6. In counter-controlled repetition, each iteration of the `while` statement (e.g., lines 52–58 of Fig. 4.6) reads a value from the user, for the specified number of iterations. In sentinel-controlled repetition, the program reads the first value (lines 53–54 of Fig. 4.9) before reaching the `while`. This value determines whether the program's flow of control should enter the body of the `while`. If the condition of the `while` is false, the user entered the sentinel value, so the body of the `while` does not execute (i.e., no grades were entered). If, on the other hand, the condition is true, the body begins execution, and the loop adds the grade value to the `total` (line 59). Then lines 63–64 in the loop body input the next value from the user. Next, program control reaches the closing right brace of the loop body at line 65, so execution continues with the test of the `while`'s condition (line 57). The condition uses the most recent grade input by the user to determine whether the loop body should execute again. The value of variable `grade` is always input from the user immediately before the program tests the `while` condition. This allows the program to determine whether the value just input is the sentinel value *before* the program processes that value (i.e., adds it to the `total`). If the sentinel value is input, the loop terminates, and the program does not add `-1` to the `total`.



Good Programming Practice 4.3

In a sentinel-controlled loop, prompts should remind the user of the sentinel.

After the loop terminates, the `if...else` statement at lines 69–80 executes. The condition at line 69 determines whether any grades were input. If none were input, the `else` part (lines 79–80) of the `if...else` statement executes and displays the message "No grades were entered" and the method returns control to the calling method.

Notice the `while` statement's block in Fig. 4.9 (lines 58–65). Without the braces, the loop would consider its body to be only the first statement, which adds the grade to the

total. The last three statements in the block would fall outside the loop body, causing the computer to interpret the code incorrectly as follows:

```
while ( grade != -1 )
    total = total + grade; // add grade to total
    gradeCounter = gradeCounter + 1; // increment counter
// prompt for input and read next grade from user
System.out.print( "Enter grade or -1 to quit: " );
grade = input.nextInt();
```

The preceding code would cause an infinite loop in the program if the user did not input the sentinel -1 at line 54 (before the `while` statement).



Common Programming Error 4.5

Omitting the braces that delimit a block can lead to logic errors, such as infinite loops. To prevent this problem, some programmers enclose the body of every control statement in braces, even if the body contains only a single statement.

Explicitly and Implicitly Converting Between Primitive Types

If at least one grade was entered, line 72 of Fig. 4.9 calculates the average of the grades. Recall from Fig. 4.6 that integer division yields an integer result. Even though variable `average` is declared as a `double` (line 45), the calculation

```
average = total / gradeCounter;
```

loses the fractional part of the quotient *before* the result of the division is assigned to `average`. This occurs because `total` and `gradeCounter` are *both* integers, and integer division yields an integer result. To perform a floating-point calculation with integer values, we must temporarily treat these values as floating-point numbers for use in the calculation. Java provides the **unary cast operator** to accomplish this task. Line 72 uses the **(double)** cast operator—a unary operator—to create a *temporary* floating-point copy of its operand `total` (which appears to the right of the operator). Using a cast operator in this manner is called **explicit conversion** or **type casting**. The value stored in `total` is still an integer.

The calculation now consists of a floating-point value (the temporary `double` version of `total`) divided by the integer `gradeCounter`. Java knows how to evaluate only arithmetic expressions in which the operands' types are *identical*. To ensure that the operands are of the same type, Java performs an operation called **promotion** (or **implicit conversion**) on selected operands. For example, in an expression containing values of the types `int` and `double`, the `int` values are promoted to `double` values for use in the expression. In this example, the value of `gradeCounter` is promoted to type `double`, then the floating-point division is performed and the result of the calculation is assigned to `average`. As long as the **(double)** cast operator is applied to *any* variable in the calculation, the calculation will yield a `double` result. Later in this chapter, we discuss all the primitive types. You'll learn more about the promotion rules in Section 6.7.



Common Programming Error 4.6

A cast operator can be used to convert between primitive numeric types, such as `int` and `double`, and between related reference types (as we discuss in Chapter 10, *Object-Oriented Programming: Polymorphism*). Casting to the wrong type may cause compilation errors or runtime errors.

A cast operator is formed by placing parentheses around any type's name. The operator is a **unary operator** (i.e., an operator that takes only one operand). Java also supports unary versions of the plus (+) and minus (-) operators, so you can write expressions like -7 or +5. Cast operators associate from right to left and have the same precedence as other unary operators, such as unary + and unary -. This precedence is one level higher than that of the **multiplicative operators** *, / and %. (See the operator precedence chart in Appendix A.) We indicate the cast operator with the notation (*type*) in our precedence charts, to indicate that any type name can be used to form a cast operator.

Line 77 displays the class average. In this example, we display the class average rounded to the nearest hundredth. The format specifier %.2f in printf's format control string indicates that variable average's value should be displayed with two digits of precision to the right of the decimal point—indicated by .2 in the format specifier. The three grades entered during the sample execution of class GradeBookTest (Fig. 4.10) total 257, which yields the average 85.666666.... Method printf uses the precision in the format specifier to round the value to the specified number of digits. In this program, the average is rounded to the hundredths position and is displayed as 85.67.

```

1 // Fig. 4.10: GradeBookTest.java
2 // Create GradeBook object and invoke its determineClassAverage method.
3
4 public class GradeBookTest
5 {
6     public static void main( String[] args )
7     {
8         // create GradeBook object myGradeBook and
9         // pass course name to constructor
10        GradeBook myGradeBook = new GradeBook(
11            "CS101 Introduction to Java Programming" );
12
13        myGradeBook.displayMessage(); // display welcome message
14        myGradeBook.determineClassAverage(); // find average of grades
15    } // end main
16 } // end class GradeBookTest

```

```

Welcome to the grade book for
CS101 Introduction to Java Programming!

Enter grade or -1 to quit: 97
Enter grade or -1 to quit: 88
Enter grade or -1 to quit: 72
Enter grade or -1 to quit: -1

Total of the 3 grades entered is 257
Class average is 85.67

```

Fig. 4.10 | GradeBookTest class creates an object of class GradeBook (Fig. 4.9) and invokes its determineClassAverage method.

4.10 Formulating Algorithms: Nested Control Statements

For the next example, we once again formulate an algorithm by using pseudocode and top-down, stepwise refinement, and write a corresponding Java program. We've seen that con-

trol statements can be stacked on top of one another (in sequence). In this case study, we examine the only other structured way control statements can be connected—namely, by **nesting** one control statement within another.

Consider the following problem statement:

A college offers a course that prepares students for the state licensing exam for real estate brokers. Last year, ten of the students who completed this course took the exam. The college wants to know how well its students did on the exam. You've been asked to write a program to summarize the results. You've been given a list of these 10 students. Next to each name is written a 1 if the student passed the exam or a 2 if the student failed.

Your program should analyze the results of the exam as follows:

- 1. Input each test result (i.e., a 1 or a 2). Display the message "Enter result" on the screen each time the program requests another test result.*
- 2. Count the number of test results of each type.*
- 3. Display a summary of the test results, indicating the number of students who passed and the number who failed.*
- 4. If more than eight students passed the exam, print the message "Bonus to instructor!"*

After reading the problem statement carefully, we make the following observations:

- 1.** The program must process test results for 10 students. A counter-controlled loop can be used, because the number of test results is known in advance.
- 2.** Each test result has a numeric value—either a 1 or a 2. Each time it reads a test result, the program must determine whether it's a 1 or a 2. We test for a 1 in our algorithm. If the number is not a 1, we assume that it's a 2. (Exercise 4.24 considers the consequences of this assumption.)
- 3.** Two counters are used to keep track of the exam results—one to count the number of students who passed the exam and one to count the number who failed.
- 4.** After the program has processed all the results, it must decide whether more than eight students passed the exam.

Let's proceed with top-down, stepwise refinement. We begin with a pseudocode representation of the top:

Analyze exam results and decide whether a bonus should be paid

Once again, the top is a *complete* representation of the program, but several refinements are likely to be needed before the pseudocode can evolve naturally into a Java program.

Our first refinement is

Initialize variables

Input the 10 exam results, and count passes and failures

Print a summary of the exam results and decide whether a bonus should be paid

Here, too, even though we have a *complete* representation of the entire program, further refinement is necessary. We now commit to specific variables. Counters are needed to record the passes and failures, a counter will be used to control the looping process and a variable is needed to store the user input. The variable in which the user input will be

stored is *not* initialized at the start of the algorithm, because its value is read from the user during each iteration of the loop.

The pseudocode statement

```
Initialize variables
```

can be refined as follows:

```
Initialize passes to zero
Initialize failures to zero
Initialize student counter to one
```

Notice that only the counters are initialized at the start of the algorithm.

The pseudocode statement

```
Input the 10 exam results, and count passes and failures
```

requires a loop that successively inputs the result of each exam. We know in advance that there are precisely 10 exam results, so counter-controlled looping is appropriate. Inside the loop (i.e., *nested* within the loop), a double-selection structure will determine whether each exam result is a pass or a failure and will increment the appropriate counter. The refinement of the preceding pseudocode statement is then

```
While student counter is less than or equal to 10
  Prompt the user to enter the next exam result
  Input the next exam result
  If the student passed
    Add one to passes
  Else
    Add one to failures
  Add one to student counter
```

We use blank lines to isolate the *If...Else* control structure, which improves readability.

The pseudocode statement

```
Print a summary of the exam results and decide whether a bonus should be paid
```

can be refined as follows:

```
Print the number of passes
Print the number of failures
If more than eight students passed
  Print "Bonus to instructor!"
```

Complete Second Refinement of Pseudocode and Conversion to Class Analysis

The complete second refinement appears in Fig. 4.11. Notice that blank lines are also used to set off the *While* structure for program readability. This pseudocode is now sufficiently refined for conversion to Java.

The Java class that implements the pseudocode algorithm and two sample executions are shown in Fig. 4.12. Lines 13–16 of `main` declare the variables that method `processExamResults` of class `Analysis` uses to process the examination results. Several of these

```

1  Initialize passes to zero
2  Initialize failures to zero
3  Initialize student counter to one
4
5  While student counter is less than or equal to 10
6      Prompt the user to enter the next exam result
7      Input the next exam result
8
9      If the student passed
10         Add one to passes
11     Else
12         Add one to failures
13
14     Add one to student counter
15
16 Print the number of passes
17 Print the number of failures
18
19 If more than eight students passed
20     Print "Bonus to instructor!"

```

Fig. 4.11 | Pseudocode for examination-results problem.

declarations use Java's ability to incorporate variable initialization into declarations (`passes` is assigned 0, `failures` 0 and `studentCounter` 1). Looping programs may require initialization at the beginning of each repetition—normally performed by assignment statements rather than in declarations.



Error-Prevention Tip 4.3

Initializing local variables when they're declared helps you avoid any compilation errors that might arise from attempts to use uninitialized variables. While Java does not require that local-variable initializations be incorporated into declarations, it does require that local variables be initialized before their values are used in an expression.

The `while` statement (lines 19–33) loops 10 times. During each iteration, the loop inputs and processes one exam result. Notice that the `if...else` statement (lines 26–29) for processing each result is nested in the `while` statement. If the `result` is 1, the `if...else` statement increments `passes`; otherwise, it assumes the `result` is 2 and increments `failures`. Line 32 increments `studentCounter` before the loop condition is tested again at line 19. After 10 values have been input, the loop terminates and line 36 displays the number of `passes` and `failures`. The `if` statement at lines 39–40 determines whether more than eight students passed the exam and, if so, outputs the message "Bonus to instructor!".

```

1  // Fig. 4.12: Analysis.java
2  // Analysis of examination results using nested control statements.
3  import java.util.Scanner; // class uses class Scanner

```

Fig. 4.12 | Analysis of examination results using nested control statements. (Part I of 3.)

```
4
5 public class Analysis
6 {
7     public static void main( String[] args )
8     {
9         // create Scanner to obtain input from command window
10        Scanner input = new Scanner( System.in );
11
12        // initializing variables in declarations
13        int passes = 0; // number of passes
14        int failures = 0; // number of failures
15        int studentCounter = 1; // student counter
16        int result; // one exam result (obtains value from user)
17
18        // process 10 students using counter-controlled loop
19        while ( studentCounter <= 10 )
20        {
21            // prompt user for input and obtain value from user
22            System.out.print( "Enter result (1 = pass, 2 = fail): " );
23            result = input.nextInt();
24
25            // if...else is nested in the while statement
26            if ( result == 1 ) // if result 1,
27                passes = passes + 1; // increment passes;
28            else // else result is not 1, so
29                failures = failures + 1; // increment failures
30
31            // increment studentCounter so loop eventually terminates
32            studentCounter = studentCounter + 1;
33        } // end while
34
35        // termination phase; prepare and display results
36        System.out.printf( "Passed: %d\nFailed: %d\n", passes, failures );
37
38        // determine whether more than 8 students passed
39        if ( passes > 8 )
40            System.out.println( "Bonus to instructor!" );
41    } // end main
42 } // end class Analysis
```

```
Enter result (1 = pass, 2 = fail): 1
Enter result (1 = pass, 2 = fail): 2
Enter result (1 = pass, 2 = fail): 1
Enter result (1 = pass, 2 = fail): 1
Enter result (1 = pass, 2 = fail): 1
Enter result (1 = pass, 2 = fail): 1
Enter result (1 = pass, 2 = fail): 1
Enter result (1 = pass, 2 = fail): 1
Enter result (1 = pass, 2 = fail): 1
Enter result (1 = pass, 2 = fail): 1
Passed: 9
Failed: 1
Bonus to instructor!
```

Fig. 4.12 | Analysis of examination results using nested control statements. (Part 2 of 3.)

```

Enter result (1 = pass, 2 = fail): 1
Enter result (1 = pass, 2 = fail): 2
Enter result (1 = pass, 2 = fail): 1
Enter result (1 = pass, 2 = fail): 2
Enter result (1 = pass, 2 = fail): 1
Enter result (1 = pass, 2 = fail): 2
Enter result (1 = pass, 2 = fail): 2
Enter result (1 = pass, 2 = fail): 1
Enter result (1 = pass, 2 = fail): 1
Enter result (1 = pass, 2 = fail): 1
Passed: 6
Failed: 4

```

Fig. 4.12 | Analysis of examination results using nested control statements. (Part 3 of 3.)

Figure 4.12 shows the input and output from two sample executions of the program. During the first, the condition at line 39 of method `main` is `true`—more than eight students passed the exam, so the program outputs a message to bonus the instructor.

This example contains only one class, with method `main` performing all the class's work. In this chapter and in Chapter 3, you've seen examples consisting of two classes—one containing methods that perform useful tasks and one containing method `main`, which creates an object of the other class and calls its methods. Occasionally, when it does not make sense to try to create a reusable class to demonstrate a concept, we'll place the program's statements entirely within the `main` method of a single class.

4.11 Compound Assignment Operators

The **compound assignment operators** abbreviate assignment expressions. Statements like

```
variable = variable operator expression;
```

where *operator* is one of the binary operators `+`, `-`, `*`, `/` or `%` (or others we discuss later in the text) can be written in the form

```
variable operator= expression;
```

For example, you can abbreviate the statement

```
c = c + 3;
```

with the **addition compound assignment operator**, `+=`, as

```
c += 3;
```

The `+=` operator adds the value of the expression on its right to the value of the variable on its left and stores the result in the variable on the left of the operator. Thus, the assignment expression `c += 3` adds 3 to `c`. Figure 4.13 shows the arithmetic compound assignment operators, sample expressions using the operators and explanations of what the operators do.

4.12 Increment and Decrement Operators

Java provides two unary operators (summarized in Fig. 4.14) for adding 1 to or subtracting 1 from the value of a numeric variable. These are the unary **increment operator**, `++`, and the unary **decrement operator**, `--`. A program can increment by 1 the value of a variable

Assignment operator	Sample expression	Explanation	Assigns
<i>Assume: int c = 3, d = 5, e = 4, f = 6, g = 12;</i>			
+=	c += 7	c = c + 7	10 to c
-=	d -= 4	d = d - 4	1 to d
*=	e *= 5	e = e * 5	20 to e
/=	f /= 3	f = f / 3	2 to f
%=	g %= 9	g = g % 9	3 to g

Fig. 4.13 | Arithmetic compound assignment operators.

called `c` using the increment operator, `++`, rather than the expression `c = c + 1` or `c += 1`. An increment or decrement operator that's prefixed to (placed before) a variable is referred to as the **prefix increment** or **prefix decrement operator**, respectively. An increment or decrement operator that's postfix to (placed after) a variable is referred to as the **postfix increment** or **postfix decrement operator**, respectively.

Operator	Operator name	Sample expression	Explanation
++	prefix increment	++a	Increment <code>a</code> by 1, then use the new value of <code>a</code> in the expression in which <code>a</code> resides.
++	postfix increment	a++	Use the current value of <code>a</code> in the expression in which <code>a</code> resides, then increment <code>a</code> by 1.
--	prefix decrement	--b	Decrement <code>b</code> by 1, then use the new value of <code>b</code> in the expression in which <code>b</code> resides.
--	postfix decrement	b--	Use the current value of <code>b</code> in the expression in which <code>b</code> resides, then decrement <code>b</code> by 1.

Fig. 4.14 | Increment and decrement operators.

Using the prefix increment (or decrement) operator to add 1 to (or subtract 1 from) a variable is known as **preincrementing** (or **predecrementing**). This causes the variable to be incremented (decremented) by 1; then the new value of the variable is used in the expression in which it appears. Using the postfix increment (or decrement) operator to add 1 to (or subtract 1 from) a variable is known as **postincrementing** (or **postdecrementing**). This causes the current value of the variable to be used in the expression in which it appears; then the variable's value is incremented (decremented) by 1.



Good Programming Practice 4.4

Unlike binary operators, the unary increment and decrement operators should be placed next to their operands, with no intervening spaces.

Figure 4.15 demonstrates the difference between the prefix increment and postfix increment versions of the `++` increment operator. The decrement operator (`--`) works similarly.

```

1 // Fig. 4.15: Increment.java
2 // Prefix increment and postfix increment operators.
3
4 public class Increment
5 {
6     public static void main( String[] args )
7     {
8         int c;
9
10        // demonstrate postfix increment operator
11        c = 5; // assign 5 to c
12        System.out.println( c ); // prints 5
13        System.out.println( c++ ); // prints 5 then postincrements
14        System.out.println( c ); // prints 6
15
16        System.out.println(); // skip a line
17
18        // demonstrate prefix increment operator
19        c = 5; // assign 5 to c
20        System.out.println( c ); // prints 5
21        System.out.println( ++c ); // preincrements then prints 6
22        System.out.println( c ); // prints 6
23    } // end main
24 } // end class Increment

```

```

5
5
6

5
6
6

```

Fig. 4.15 | Preincrementing and postincrementing.

Line 11 initializes the variable `c` to 5, and line 12 outputs `c`'s initial value. Line 13 outputs the value of the expression `c++`. This expression postincrements the variable `c`, so `c`'s original value (5) is output, then `c`'s value is incremented (to 6). Thus, line 13 outputs `c`'s initial value (5) again. Line 14 outputs `c`'s new value (6) to prove that the variable's value was indeed incremented in line 13.

Line 19 resets `c`'s value to 5, and line 20 outputs `c`'s value. Line 21 outputs the value of the expression `++c`. This expression preincrements `c`, so its value is incremented; then the new value (6) is output. Line 22 outputs `c`'s value again to show that the value of `c` is still 6 after line 21 executes.

The arithmetic compound assignment operators and the increment and decrement operators can be used to simplify program statements. For example, the three assignment statements in Fig. 4.12 (lines 27, 29 and 32)

```

passes = passes + 1;
failures = failures + 1;
studentCounter = studentCounter + 1;

```

can be written more concisely with compound assignment operators as

```
passes += 1;
failures += 1;
studentCounter += 1;
```

with prefix increment operators as

```
++passes;
++failures;
++studentCounter;
```

or with postfix increment operators as

```
passes++;
failures++;
studentCounter++;
```

When incrementing or decrementing a variable in a statement by itself, the prefix increment and postfix increment forms have the same effect, and the prefix decrement and postfix decrement forms have the same effect. It's only when a variable appears in the context of a larger expression that preincrementing and postincrementing the variable have different effects (and similarly for predecrementing and postdecrementing).



Common Programming Error 4.7

Attempting to use the increment or decrement operator on an expression other than one to which a value can be assigned is a syntax error. For example, writing ++(x + 1) is a syntax error, because (x + 1) is not a variable.

Figure 4.16 shows the precedence and associativity of the operators we've introduced. They're shown from top to bottom in decreasing order of precedence. The second column describes the associativity of the operators at each level of precedence. The conditional operator (?:); the unary operators increment (++), decrement (--), plus (+) and minus (-); the cast operators and the assignment operators =, +=, -=, *=, /= and %= associate from right to left. All the other operators in the operator precedence chart in Fig. 4.16 associate from left to right. The third column lists the type of each group of operators.

Operators	Associativity	Type
++ --	right to left	unary postfix
++ -- + - (type)	right to left	unary prefix
* / %	left to right	multiplicative
+ -	left to right	additive
< <= > >=	left to right	relational
== !=	left to right	equality
?:	right to left	conditional
= += -= *= /= %=	right to left	assignment

Fig. 4.16 | Precedence and associativity of the operators discussed so far.

4.13 Primitive Types

The table in Appendix D lists the eight primitive types in Java. Like its predecessor languages C and C++, Java requires all variables to have a type. For this reason, Java is referred to as a **strongly typed language**.

In C and C++, programmers frequently have to write separate versions of programs to support different computer platforms, because the primitive types are not guaranteed to be identical from computer to computer. For example, an `int` value on one machine might be represented by 16 bits (2 bytes) of memory, on a second machine by 32 bits (4 bytes) of memory, and on another machine by 64 bits (8 bytes) of memory. In Java, `int` values are always 32 bits (4 bytes).



Portability Tip 4.1

The primitive types in Java are portable across all computer platforms that support Java.

Each type in Appendix D is listed with its size in bits (there are eight bits to a byte) and its range of values. Because the designers of Java want to ensure portability, they use internationally recognized standards for character formats (Unicode; for more information, visit www.unicode.org) and floating-point numbers (IEEE 754; for more information, visit grouper.ieee.org/groups/754/).

Recall from Section 3.4 that variables of primitive types declared outside of a method as fields of a class are automatically assigned default values unless explicitly initialized. Instance variables of types `char`, `byte`, `short`, `int`, `long`, `float` and `double` are all given the value 0 by default. Instance variables of type `boolean` are given the value `false` by default. Reference-type instance variables are initialized by default to the value `null`.

4.14 (Optional) GUI and Graphics Case Study: Creating Simple Drawings

An appealing feature of Java is its graphics support, which enables you to visually enhance your applications. We now introduce one of Java's graphical capabilities—drawing lines. It also covers the basics of creating a window to display a drawing on the computer screen.

Java's Coordinate System

To draw in Java, you must understand Java's **coordinate system** (Fig. 4.17), a scheme for identifying points on the screen. By default, the upper-left corner of a GUI component

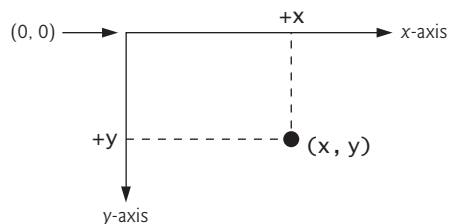

Fig. 4.17 | Java coordinate system. Units are measured in pixels.

has the coordinates (0, 0). A coordinate pair is composed of an *x-coordinate* (the **horizontal coordinate**) and a *y-coordinate* (the **vertical coordinate**). The *x-coordinate* is the horizontal location moving from left to right. The *y-coordinate* is the vertical location moving from top to bottom. The *x-axis* describes every horizontal coordinate, and the *y-axis* every vertical coordinate.

Coordinates indicate where graphics should be displayed on a screen. Coordinate units are measured in **pixels**. The term pixel stands for “picture element.” A pixel is a display monitor’s smallest unit of resolution.

First Drawing Application

Our first drawing application simply draws two lines. Class `DrawPanel` (Fig. 4.18) performs the actual drawing, while class `DrawPanelTest` (Fig. 4.19) creates a window to display the drawing. In class `DrawPanel`, the `import` statements in lines 3–4 allow us to use class **Graphics** (from package `java.awt`), which provides various methods for drawing text and shapes onto the screen, and class **JPanel** (from package `javax.swing`), which provides an area on which we can draw.

```

1 // Fig. 4.18: DrawPanel.java
2 // Using drawLine to connect the corners of a panel.
3 import java.awt.Graphics;
4 import javax.swing.JPanel;
5
6 public class DrawPanel extends JPanel
7 {
8     // draws an X from the corners of the panel
9     public void paintComponent( Graphics g )
10    {
11        // call paintComponent to ensure the panel displays correctly
12        super.paintComponent( g );
13
14        int width = getWidth(); // total width
15        int height = getHeight(); // total height
16
17        // draw a line from the upper-left to the lower-right
18        g.drawLine( 0, 0, width, height );
19
20        // draw a line from the lower-left to the upper-right
21        g.drawLine( 0, height, width, 0 );
22    } // end method paintComponent
23 } // end class DrawPanel

```

Fig. 4.18 | Using `drawLine` to connect the corners of a panel.

```

1 // Fig. 4.19: DrawPanelTest.java
2 // Application to display a DrawPanel.
3 import javax.swing.JFrame;
4
5 public class DrawPanelTest
6 {

```

Fig. 4.19 | Creating `JFrame` to display `DrawPanel`. (Part 1 of 2.)

```

7   public static void main( String[] args )
8   {
9       // create a panel that contains our drawing
10      DrawPanel panel = new DrawPanel();
11
12      // create a new frame to hold the panel
13      JFrame application = new JFrame();
14
15      // set the frame to exit when it is closed
16      application.setDefaultCloseOperation( JFrame.EXIT_ON_CLOSE );
17
18      application.add( panel ); // add the panel to the frame
19      application.setSize( 250, 250 ); // set the size of the frame
20      application.setVisible( true ); // make the frame visible
21  } // end main
22 } // end class DrawPanelTest

```

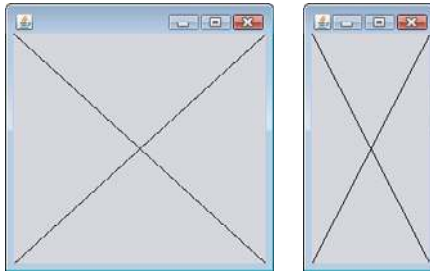

Fig. 4.19 | Creating JFrame to display DrawPanel. (Part 2 of 2.)

Line 6 uses the keyword **extends** to indicate that class `DrawPanel` is an enhanced type of `JPanel`. The keyword `extends` represents a so-called inheritance relationship in which our new class `DrawPanel` begins with the existing members (data and methods) from class `JPanel`. The class from which `DrawPanel` **inherits**, `JPanel`, appears to the right of keyword `extends`. In this inheritance relationship, `JPanel` is called the **superclass** and `DrawPanel` is called the **subclass**. This results in a `DrawPanel` class that has the attributes (data) and behaviors (methods) of class `JPanel` as well as the new features we're adding in our `DrawPanel` class declaration—specifically, the ability to draw two lines along the diagonals of the panel. Inheritance is explained in detail in Chapter 9. For now, you should mimic our `DrawPanel` class when creating your own graphics programs.

Method `paintComponent`

Every `JPanel`, including our `DrawPanel`, has a **`paintComponent`** method (lines 9–22), which the system automatically calls every time it needs to display the `JPanel`. Method `paintComponent` must be declared as shown in line 9—otherwise, the system will not call it. This method is called when a `JPanel` is first displayed on the screen, when it's covered then uncovered by a window on the screen and when the window in which it appears is resized. Method `paintComponent` requires one argument, a `Graphics` object, that's provided by the system when it calls `paintComponent`.

The first statement in every `paintComponent` method you create should always be

```
super.paintComponent( g );
```

which ensures that the panel is properly rendered before we begin drawing on it. Next, lines 14–15 call methods that class `DrawPanel` inherits from `JPanel`. Because `DrawPanel` extends `JPanel`, `DrawPanel` can use any public methods of `JPanel`. Methods `getWidth` and `getHeight` return the `JPanel`'s width and height, respectively. Lines 14–15 store these values in the local variables `width` and `height`. Finally, lines 18 and 21 use the `Graphics` variable `g` to call method `drawLine` to draw the two lines. Method `drawLine` draws a line between two points represented by its four arguments. The first two arguments are the x - and y -coordinates for one endpoint, and the last two arguments are the coordinates for the other endpoint. If you resize the window, the lines will scale accordingly, because the arguments are based on the width and height of the panel. Resizing the window in this application causes the system to call `paintComponent` to redraw the `DrawPanel`'s contents.

Class `DrawPanelTest`

To display the `DrawPanel` on the screen, you must place it in a window. You create a window with an object of class `JFrame`. In `DrawPanelTest.java` (Fig. 4.19), line 3 imports class `JFrame` from package `javax.swing`. Line 10 in `main` creates a `DrawPanel` object, which contains our drawing, and line 13 creates a new `JFrame` that can hold and display our panel. Line 16 calls `JFrame` method `setDefaultCloseOperation` with the argument `JFrame.EXIT_ON_CLOSE` to indicate that the application should terminate when the user closes the window. Line 18 uses class `JFrame`'s **add method** to attach the `DrawPanel` to the `JFrame`. Line 19 sets the size of the `JFrame`. Method `setSize` takes two parameters that represent the width and height of the `JFrame`, respectively. Finally, line 20 displays the `JFrame` by calling its **setVisible method** with the argument `true`. When the `JFrame` is displayed, the `DrawPanel`'s `paintComponent` method (lines 9–22 of Fig. 4.18) is implicitly called, and the two lines are drawn (see the sample outputs in Fig. 4.19). Try resizing the window to see that the lines always draw based on the window's current width and height.

GUI and Graphics Case Study Exercises

- 4.1** Using loops and control statements to draw lines can lead to many interesting designs.
- Create the design in the left screen capture of Fig. 4.20. This design draws lines from the top-left corner, fanning them out until they cover the upper-left half of the panel. One approach is to divide the width and height into an equal number of steps (we found 15 steps worked well). The first endpoint of a line will always be in the top-left corner (0, 0). The second endpoint can be found by starting at the bottom-left corner and moving up one vertical step and right one horizontal step. Draw a line between the two endpoints. Continue moving up and to the right one step to find each successive endpoint. The figure should scale accordingly as you resize the window.
 - Modify part (a) to have lines fan out from all four corners, as shown in the right screen capture of Fig. 4.20. Lines from opposite corners should intersect along the middle.
- 4.2** Figure 4.21 displays two additional designs created using `while` loops and `drawLine`.
- Create the design in the left screen capture of Fig. 4.21. Begin by dividing each edge into an equal number of increments (we chose 15 again). The first line starts in the top-left corner and ends one step right on the bottom edge. For each successive line, move down one increment on the left edge and right one increment on the bottom edge. Continue drawing lines until you reach the bottom-right corner. The figure should scale as you resize the window so that the endpoints always touch the edges.
 - Modify your answer in part (a) to mirror the design in all four corners, as shown in the right screen capture of Fig. 4.21.

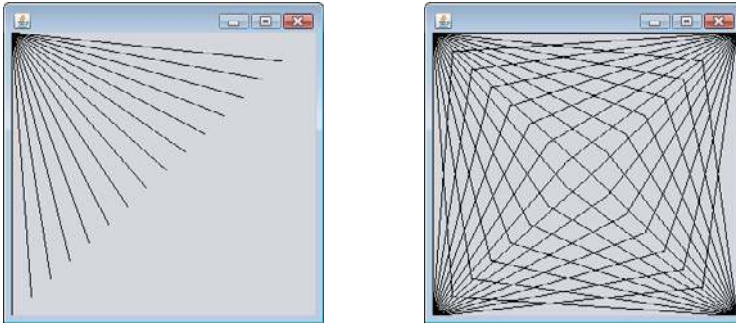

Fig. 4.20 | Lines fanning from a corner.

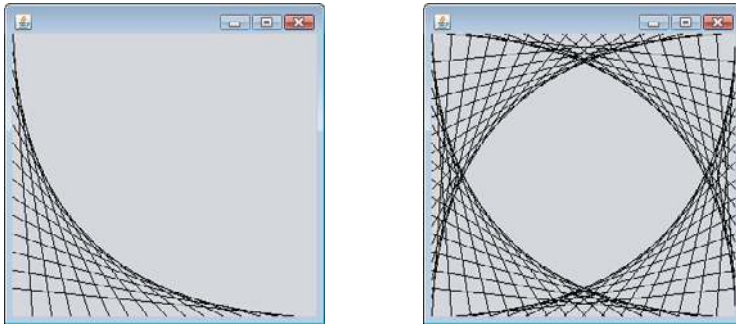

Fig. 4.21 | Line art with loops and drawLine.

4.15 Wrap-Up

This chapter presented basic problem solving for building classes and developing methods for these classes. We demonstrated how to construct an algorithm (i.e., an approach to solving a problem), then how to refine the algorithm through several phases of pseudocode development, resulting in Java code that can be executed as part of a method. The chapter showed how to use top-down, stepwise refinement to plan out the specific actions that a method must perform and the order in which the method must perform these actions.

Only three types of control structures—sequence, selection and repetition—are needed to develop any problem-solving algorithm. Specifically, this chapter demonstrated the `if` single-selection statement, the `if...else` double-selection statement and the `while` repetition statement. These are some of the building blocks used to construct solutions to many problems. We used control-statement stacking to total and compute the average of a set of student grades with counter- and sentinel-controlled repetition, and we used control-statement nesting to analyze and make decisions based on a set of exam results. We introduced Java's compound assignment operators and its increment and decrement operators. Finally, we discussed Java's primitive types. In Chapter 5, we continue our discussion of control statements, introducing the `for`, `do...while` and `switch` statements.

Summary

Section 4.1 Introduction

- Before writing a program to solve a problem, you must have a thorough understanding of the problem and a carefully planned approach to solving it. You must also understand the building blocks that are available and employ proven program-construction techniques.

Section 4.2 Algorithms

- Any computing problem can be solved by executing a series of actions (p. 103) in a specific order.
- A procedure for solving a problem in terms of the actions to execute and the order in which they execute is called an algorithm (p. 103).
- Specifying the order in which statements execute in a program is called program control (p. 104).

Section 4.3 Pseudocode

- Pseudocode (p. 104) is an informal language that helps you develop algorithms without having to worry about the strict details of Java language syntax.
- Pseudocode is similar to everyday English—it's convenient and user friendly, but it's not an actual computer programming language.
- Pseudocode helps you “think out” a program before attempting to write it in a programming language, such as Java.
- Carefully prepared pseudocode can easily be converted to a corresponding Java program.

Section 4.4 Control Structures

- Normally, statements in a program are executed one after the other in the order in which they're written. This process is called sequential execution (p. 104).
- Various Java statements enable you to specify that the next statement to execute is not necessarily the next one in sequence. This is called transfer of control (p. 104).
- Bohm and Jacopini demonstrated that all programs could be written in terms of only three control structures (p. 105)—the sequence structure, the selection structure and the repetition structure.
- The term “control structures” comes from the field of computer science. The *Java Language Specification* refers to “control structures” as “control statements” (p. 104).
- The sequence structure is built into Java. Unless directed otherwise, the computer executes Java statements one after the other in the order in which they're written—that is, in sequence.
- Anywhere a single action may be placed, several actions may be placed in sequence.
- Activity diagrams (p. 105) are part of the UML. An activity diagram models the workflow (p. 105; also called the activity) of a portion of a software system.
- Activity diagrams are composed of symbols (p. 105)—such as action-state symbols, diamonds and small circles—that are connected by transition arrows, which represent the flow of the activity.
- Action states (p. 105) contain action expressions that specify particular actions to perform.
- The arrows in an activity diagram represent transitions, which indicate the order in which the actions represented by the action states occur.
- The solid circle located at the top of an activity diagram represents the activity's initial state (p. 105)—the beginning of the workflow before the program performs the modeled actions.
- The solid circle surrounded by a hollow circle that appears at the bottom of the diagram represents the final state (p. 106)—the end of the workflow after the program performs its actions.
- Rectangles with their upper-right corners folded over are UML notes (p. 106)—explanatory remarks that describe the purpose of symbols in the diagram.

- Java has three types of selection statements (p. 106).
- The `if` single-selection statement (p. 106) selects or ignores one or more actions.
- The `if...else` double-selection statement selects between two actions or groups of actions.
- The `switch` statement is called a multiple-selection statement (p. 106) because it selects among many different actions or groups of actions.
- Java provides the `while`, `do...while` and `for` repetition (looping) statements that enable programs to perform statements repeatedly as long as a loop-continuation condition remains true.
- The `while` and `for` statements perform the action(s) in their bodies zero or more times—if the loop-continuation condition (p. 106) is initially false, the action(s) will not execute. The `do...while` statement performs the action(s) in its body one or more times.
- The words `if`, `else`, `switch`, `while`, `do` and `for` are Java keywords. Keywords cannot be used as identifiers, such as variable names.
- Every program is formed by combining as many sequence, selection and repetition statements (p. 106) as is appropriate for the algorithm the program implements.
- Single-entry/single-exit control statements (p. 106) are attached to one another by connecting the exit point of one to the entry point of the next. This is known as control-statement stacking.
- A control statement may also be nested (p. 106) inside another control statement.

Section 4.5 if Single-Selection Statement

- Programs use selection statements to choose among alternative courses of action.
- The single-selection `if` statement's activity diagram contains the diamond symbol, which indicates that a decision is to be made. The workflow follows a path determined by the symbol's associated guard conditions (p. 107). If a guard condition is true, the workflow enters the action state to which the corresponding transition arrow points.
- The `if` statement is a single-entry/single-exit control statement.

Section 4.6 if...else Double-Selection Statement

- The `if` single-selection statement performs an indicated action only when the condition is true.
- The `if...else` double-selection (p. 106) statement performs one action when the condition is true and a different action when the condition is false.
- The conditional operator (p. 108; `?:`) is Java's only ternary operator—it takes three operands. Together, the operands and the `?:` symbol form a conditional expression (p. 108).
- A program can test multiple cases with nested `if...else` statements (p. 109).
- The Java compiler associates an `else` with the immediately preceding `if` unless told to do otherwise by the placement of braces.
- The `if` statement expects one statement in its body. To include several statements in the body of an `if` (or the body of an `else` for an `if...else` statement), enclose the statements in braces.
- A block (p. 111) of statements can be placed anywhere that a single statement can be placed.
- A logic error (p. 111) has its effect at execution time. A fatal logic error (p. 111) causes a program to fail and terminate prematurely. A nonfatal logic error (p. 111) allows a program to continue executing, but causes the program to produce incorrect results.
- Just as a block can be placed anywhere a single statement can be placed, you can also use an empty statement, represented by placing a semicolon (`;`) where a statement would normally be.

Section 4.7 while Repetition Statement

- The `while` repetition statement (p. 112) allows you to specify that a program should repeat an action while some condition remains true.

- The UML’s merge (p. 112) symbol joins two flows of activity into one.
- The decision and merge symbols can be distinguished by the number of “incoming” and “outgoing” transition arrows. A decision symbol has (p. 107) one transition arrow pointing to the diamond and two or more transition arrows pointing out from the diamond to indicate possible transitions from that point. Each transition arrow pointing out of a decision symbol has a guard condition. A merge symbol has two or more transition arrows pointing to the diamond and only one transition arrow pointing from the diamond, to indicate multiple activity flows merging to continue the activity. None of the transition arrows associated with a merge symbol has a guard condition.

Section 4.8 Formulating Algorithms: Counter-Controlled Repetition

- Counter-controlled repetition (p. 113) uses a variable called a counter (or control variable) to control the number of times a set of statements execute.
- Counter-controlled repetition is often called definite repetition (p. 113), because the number of repetitions is known before the loop begins executing.
- A total (p. 114) is a variable used to accumulate the sum of several values. Variables used to store totals are normally initialized to zero before being used in a program.
- A local variable’s declaration must appear before the variable is used in that method. A local variable cannot be accessed outside the method in which it’s declared.
- Dividing two integers results in integer division (p. 118)—the calculation’s fractional part is truncated.

Section 4.9 Formulating Algorithms: Sentinel-Controlled Repetition

- In sentinel-controlled repetition (p. 118), a special value called a sentinel value (also called a signal value, a dummy value or a flag value) is used to indicate “end of data entry.”
- A sentinel value must be chosen that cannot be confused with an acceptable input value.
- Top-down, stepwise refinement (p. 118) is essential to the development of well-structured programs.
- Division by zero is a logic error.
- To perform a floating-point calculation with integer values, cast (p. 124) one of the integers to type `double`.
- Java knows how to evaluate only arithmetic expressions in which the operands’ types are identical. To ensure this, Java performs an operation called promotion (p. 124) on selected operands.
- The unary cast operator (p. 124) is formed by placing parentheses around the name of a type.

Section 4.11 Compound Assignment Operators

- The compound assignment operators (p. 130) abbreviate assignment expressions. Statements of the form

variable = *variable* *operator* *expression*;

where *operator* is one of the binary operators +, -, *, / or %, can be written in the form

variable *operator* = *expression*;

- The += operator adds the value of the expression on the right of the operator to the value of the variable on the left of the operator and stores the result in the variable on the left of the operator.

Section 4.12 Increment and Decrement Operators

- The unary increment operator, ++, and the unary decrement operator, --, add 1 to or subtract 1 from the value of a numeric variable (p. 130).

- An increment or decrement operator that's prefixed (p. 131) to a variable is the prefix increment or prefix decrement operator, respectively. An increment or decrement operator that's postfixed (p. 131) to a variable is the postfix increment or postfix decrement operator, respectively.
- Using the prefix increment or decrement operator to add or subtract 1 is known as preincrementing or predecrementing, respectively.
- Preincrementing or predecrementing a variable causes the variable to be incremented or decremented by 1; then the new value of the variable is used in the expression in which it appears.
- Using the postfix increment or decrement operator to add or subtract 1 is known as postincrementing or postdecrementing, respectively.
- Postincrementing or postdecrementing the variable causes its value to be used in the expression in which it appears; then the variable's value is incremented or decremented by 1.
- When incrementing or decrementing a variable in a statement by itself, the prefix and postfix increment have the same effect, and the prefix and postfix decrement have the same effect.

Section 4.13 Primitive Types

- Java requires all variables to have a type. Thus, Java is referred to as a strongly typed language (p. 134).
- Java uses Unicode characters and IEEE 754 floating-point numbers.

Self-Review Exercises

- 4.1** Fill in the blanks in each of the following statements:
- All programs can be written in terms of three types of control structures: _____, _____ and _____.
 - The _____ statement is used to execute one action when a condition is true and another when that condition is false.
 - Repeating a set of instructions a specific number of times is called _____ repetition.
 - When it's not known in advance how many times a set of statements will be repeated, a(n) _____ value can be used to terminate the repetition.
 - The _____ structure is built into Java; by default, statements execute in the order they appear.
 - Instance variables of types `char`, `byte`, `short`, `int`, `long`, `float` and `double` are all given the value _____ by default.
 - Java is a(n) _____ language; it requires all variables to have a type.
 - If the increment operator is _____ to a variable, first the variable is incremented by 1, then its new value is used in the expression.
- 4.2** State whether each of the following is *true* or *false*. If *false*, explain why.
- An algorithm is a procedure for solving a problem in terms of the actions to execute and the order in which they execute.
 - A set of statements contained within a pair of parentheses is called a block.
 - A selection statement specifies that an action is to be repeated while some condition remains true.
 - A nested control statement appears in the body of another control statement.
 - Java provides the arithmetic compound assignment operators `+=`, `-=`, `*=`, `/=` and `%=` for abbreviating assignment expressions.
 - The primitive types (`boolean`, `char`, `byte`, `short`, `int`, `long`, `float` and `double`) are portable across only Windows platforms.
 - Specifying the order in which statements execute in a program is called program control.
 - The unary cast operator (`double`) creates a temporary integer copy of its operand.

- i) Instance variables of type `boolean` are given the value `true` by default.
- j) Pseudocode helps you think out a program before attempting to write it in a programming language.

4.3 Write four different Java statements that each add 1 to integer variable `x`.

4.4 Write Java statements to accomplish each of the following tasks:

- a) Use one statement to assign the sum of `x` and `y` to `z`, then increment `x` by 1.
- b) Test whether variable `count` is greater than 10. If it is, print "Count is greater than 10".
- c) Use one statement to decrement the variable `x` by 1, then subtract it from variable `total` and store the result in variable `total`.
- d) Calculate the remainder after `q` is divided by `divisor`, and assign the result to `q`. Write this statement in two different ways.

4.5 Write a Java statement to accomplish each of the following tasks:

- a) Declare variables `sum` and `x` to be of type `int`.
- b) Assign 1 to variable `x`.
- c) Assign 0 to variable `sum`.
- d) Add variable `x` to variable `sum`, and assign the result to variable `sum`.
- e) Print "The sum is: ", followed by the value of variable `sum`.

4.6 Combine the statements that you wrote in Exercise 4.5 into a Java application that calculates and prints the sum of the integers from 1 to 10. Use a `while` statement to loop through the calculation and increment statements. The loop should terminate when the value of `x` becomes 11.

4.7 Determine the value of the variables in the statement `product *= x++`; after the calculation is performed. Assume that all variables are type `int` and initially have the value 5.

4.8 Identify and correct the errors in each of the following sets of code:

- a)

```
while ( c <= 5 )
{
    product *= c;
    ++c;
}
```
- b)

```
if ( gender == 1 )
    System.out.println( "Woman" );
else;
    System.out.println( "Man" );
```

4.9 What is wrong with the following `while` statement?

```
while ( z >= 0 )
    sum += z;
```

Answers to Self-Review Exercises

4.1 a) sequence, selection, repetition. b) `if...else`. c) counter-controlled (or definite). d) sentinel, signal, flag or dummy. e) sequence. f) 0 (zero). g) strongly typed. h) prefixed.

4.2 a) True. b) False. A set of statements contained within a pair of braces (`{` and `}`) is called a block. c) False. A repetition statement specifies that an action is to be repeated while some condition remains true. d) True. e) True. f) False. The primitive types (`boolean`, `char`, `byte`, `short`, `int`, `long`, `float` and `double`) are portable across all computer platforms that support Java. g) True. h) False. The unary cast operator (`double`) creates a temporary floating-point copy of its operand. i) False. Instance variables of type `boolean` are given the value `false` by default. j) True.

4.3

```
x = x + 1;
x += 1;
++x;
x++;
```

4.4 a) `z = x++ + y;`
 b) `if (count > 10)`
 `System.out.println("Count is greater than 10");`
 c) `total -= --x;`
 d) `q %= divisor;`
 `q = q % divisor;`

4.5 a) `int sum;`
 `int x;`
 b) `x = 1;`
 c) `sum = 0;`
 d) `sum += x; or sum = sum + x;`
 e) `System.out.printf("The sum is: %d\n", sum);`

4.6 The program is as follows:

```

1 // Exercise 4.6: Calculate.java
2 // Calculate the sum of the integers from 1 to 10
3 public class Calculate
4 {
5     public static void main( String[] args )
6     {
7         int sum;
8         int x;
9
10        x = 1; // initialize x to 1 for counting
11        sum = 0; // initialize sum to 0 for totaling
12
13        while ( x <= 10 ) // while x is less than or equal to 10
14        {
15            sum += x; // add x to sum
16            ++x; // increment x
17        } // end while
18
19        System.out.printf( "The sum is: %d\n", sum );
20    } // end main
21 } // end class Calculate

```

The sum is: 55

4.7 `product = 25, x = 6`

4.8 a) Error: The closing right brace of the `while` statement's body is missing.
 Correction: Add a closing right brace after the statement `++c;`.
 b) Error: The semicolon after `else` results in a logic error. The second output statement will always be executed.
 Correction: Remove the semicolon after `else`.

4.9 The value of the variable `z` is never changed in the `while` statement. Therefore, if the loop-continuation condition (`z >= 0`) is true, an infinite loop is created. To prevent an infinite loop from occurring, `z` must be decremented so that it eventually becomes less than 0.

Exercises

4.10 Compare and contrast the `if` single-selection statement and the `while` repetition statement. How are these two statements similar? How are they different?

4.11 Explain what happens when a Java program attempts to divide one integer by another. What happens to the fractional part of the calculation? How can you avoid that outcome?

4.12 Describe the two ways in which control statements can be combined.

4.13 What type of repetition would be appropriate for calculating the sum of the first 100 positive integers? What type would be appropriate for calculating the sum of an arbitrary number of positive integers? Briefly describe how each of these tasks could be performed.

4.14 What is the difference between preincrementing and postincrementing a variable?

4.15 Identify and correct the errors in each of the following pieces of code. [*Note:* There may be more than one error in each piece of code.]

- a) `if (age >= 65);`
 `System.out.println("Age is greater than or equal to 65");`
 `else`
 `System.out.println("Age is less than 65");`
- b) `int x = 1, total;`
 `while (x <= 10)`
 {
 `total += x;`
 `++x;`
 }
- c) `while (x <= 100)`
 `total += x;`
 `++x;`
- d) `while (y > 0)`
 {
 `System.out.println(y);`
 `++y;`
 }

4.16 What does the following program print?

```

1 // Exercise 4.16: Mystery.java
2 public class Mystery
3 {
4     public static void main( String[] args )
5     {
6         int y;
7         int x = 1;
8         int total = 0;
9
10        while ( x <= 10 )
11        {
12            y = x * x;
13            System.out.println( y );
14            total += y;
15            ++x;
16        } // end while
17
18        System.out.printf( "Total is %d\n", total );
19    } // end main
20 } // end class Mystery

```

For Exercise 4.17 through Exercise 4.20, perform each of the following steps:

- Read the problem statement.
- Formulate the algorithm using pseudocode and top-down, stepwise refinement.

- c) Write a Java program.
- d) Test, debug and execute the Java program.
- e) Process three complete sets of data.

4.17 (*Gas Mileage*) Drivers are concerned with the mileage their automobiles get. One driver has kept track of several trips by recording the miles driven and gallons used for each tankful. Develop a Java application that will input the miles driven and gallons used (both as integers) for each trip. The program should calculate and display the miles per gallon obtained for each trip and print the combined miles per gallon obtained for all trips up to this point. All averaging calculations should produce floating-point results. Use class `Scanner` and sentinel-controlled repetition to obtain the data from the user.

4.18 (*Credit Limit Calculator*) Develop a Java application that determines whether any of several department-store customers has exceeded the credit limit on a charge account. For each customer, the following facts are available:

- a) account number
- b) balance at the beginning of the month
- c) total of all items charged by the customer this month
- d) total of all credits applied to the customer's account this month
- e) allowed credit limit.

The program should input all these facts as integers, calculate the new balance ($= \textit{beginning balance} + \textit{charges} - \textit{credits}$), display the new balance and determine whether the new balance exceeds the customer's credit limit. For those customers whose credit limit is exceeded, the program should display the message "Credit limit exceeded".

4.19 (*Sales Commission Calculator*) A large company pays its salespeople on a commission basis. The salespeople receive \$200 per week plus 9% of their gross sales for that week. For example, a salesperson who sells \$5000 worth of merchandise in a week receives \$200 plus 9% of \$5000, or a total of \$650. You've been supplied with a list of the items sold by each salesperson. The values of these items are as follows:

Item	Value
1	239.99
2	129.75
3	99.95
4	350.89

Develop a Java application that inputs one salesperson's items sold for last week and calculates and displays that salesperson's earnings. There's no limit to the number of items that can be sold.

4.20 (*Salary Calculator*) Develop a Java application that determines the gross pay for each of three employees. The company pays straight time for the first 40 hours worked by each employee and time and a half for all hours worked in excess of 40. You're given a list of the employees, their number of hours worked last week and their hourly rates. Your program should input this information for each employee, then determine and display the employee's gross pay. Use class `Scanner` to input the data.

4.21 (*Find the Largest Number*) The process of finding the largest value is used frequently in computer applications. For example, a program that determines the winner of a sales contest would input the number of units sold by each salesperson. The salesperson who sells the most units wins the contest. Write a pseudocode program, then a Java application that inputs a series of 10 integers and determines and prints the largest integer. Your program should use at least the following three variables:

- a) counter: A counter to count to 10 (i.e., to keep track of how many numbers have been input and to determine when all 10 numbers have been processed).
- b) number: The integer most recently input by the user.
- c) largest: The largest number found so far.

4.22 (*Tabular Output*) Write a Java application that uses looping to print the following table of values:

N	10*N	100*N	1000*N
1	10	100	1000
2	20	200	2000
3	30	300	3000
4	40	400	4000
5	50	500	5000

4.23 (*Find the Two Largest Numbers*) Using an approach similar to that for Exercise 4.21, find the *two* largest values of the 10 values entered. [Note: You may input each number only once.]

4.24 (*Validating User Input*) Modify the program in Fig. 4.12 to validate its inputs. For any input, if the value entered is other than 1 or 2, keep looping until the user enters a correct value.

4.25 What does the following program print?

```

1 // Exercise 4.25: Mystery2.java
2 public class Mystery2
3 {
4     public static void main( String[] args )
5     {
6         int count = 1;
7
8         while ( count <= 10 )
9         {
10            System.out.println( count % 2 == 1 ? "****" : "+++++++" );
11            ++count;
12        } // end while
13    } // end main
14 } // end class Mystery2

```

4.26 What does the following program print?

```

1 // Exercise 4.26: Mystery3.java
2 public class Mystery3
3 {
4     public static void main( String[] args )
5     {
6         int row = 10;
7         int column;
8
9         while ( row >= 1 )
10        {
11            column = 1;
12
13            while ( column <= 10 )
14            {
15                System.out.print( row % 2 == 1 ? "<" : ">" );
16                ++column;
17            } // end while
18
19            --row;
20            System.out.println();
21        } // end while
22    } // end main
23 } // end class Mystery3

```

4.27 (*Dangling-else Problem*) Determine the output for each of the given sets of code when x is 9 and y is 11 and when x is 11 and y is 9. The compiler ignores the indentation in a Java program. Also, the Java compiler always associates an `else` with the immediately preceding `if` unless told to do otherwise by the placement of braces (`{}`). On first glance, you may not be sure which `if` a particular `else` matches—this situation is referred to as the “dangling-else problem.” We’ve eliminated the indentation from the following code to make the problem more challenging. [*Hint*: Apply the indentation conventions you’ve learned.]

- a)

```
if ( x < 10 )
    if ( y > 10 )
        System.out.println( "*****" );
    else
        System.out.println( "#####" );
        System.out.println( "$$$$" );
```
- b)

```
if ( x < 10 )
{
    if ( y > 10 )
        System.out.println( "*****" );
}
else
{
    System.out.println( "#####" );
    System.out.println( "$$$$" );
}
```

4.28 (*Another Dangling-else Problem*) Modify the given code to produce the output shown in each part of the problem. Use proper indentation techniques. Make no changes other than inserting braces and changing the indentation of the code. The compiler ignores indentation in a Java program. We’ve eliminated the indentation from the given code to make the problem more challenging. [*Note*: It’s possible that no modification is necessary for some of the parts.]

```
if ( y == 8 )
if ( x == 5 )
    System.out.println( "#####" );
else
    System.out.println( "#####" );
    System.out.println( "$$$$" );
    System.out.println( "#####" );
```

- a) Assuming that $x = 5$ and $y = 8$, the following output is produced:

```
#####
$$$$$
#####" ;
```

- b) Assuming that $x = 5$ and $y = 8$, the following output is produced:

```
#####" ;
```

- c) Assuming that $x = 5$ and $y = 8$, the following output is produced:

```
#####" ;
```

- d) Assuming that $x = 5$ and $y = 7$, the following output is produced. [*Note*: The last three output statements after the `else` are all part of a block.]

```
#####
$$$$$
#####" ;
```

4.29 (*Square of Asterisks*) Write an application that prompts the user to enter the size of the side of a square, then displays a hollow square of that size made of asterisks. Your program should work for squares of all side lengths between 1 and 20.

4.30 (*Palindromes*) A palindrome is a sequence of characters that reads the same backward as forward. For example, each of the following five-digit integers is a palindrome: 12321, 55555, 45554 and 11611. Write an application that reads in a five-digit integer and determines whether it's a palindrome. If the number is not five digits long, display an error message and allow the user to enter a new value.

4.31 (*Printing the Decimal Equivalent of a Binary Number*) Write an application that inputs an integer containing only 0s and 1s (i.e., a binary integer) and prints its decimal equivalent. [*Hint*: Use the remainder and division operators to pick off the binary number's digits one at a time, from right to left. In the decimal number system, the rightmost digit has a positional value of 1 and the next digit to the left a positional value of 10, then 100, then 1000, and so on. The decimal number 234 can be interpreted as $4 * 1 + 3 * 10 + 2 * 100$. In the binary number system, the rightmost digit has a positional value of 1, the next digit to the left a positional value of 2, then 4, then 8, and so on. The decimal equivalent of binary 1101 is $1 * 1 + 0 * 2 + 1 * 4 + 1 * 8$, or $1 + 0 + 4 + 8$ or, 13.]

4.32 (*Checkerboard Pattern of Asterisks*) Write an application that uses only the output statements

```
System.out.print( "* " );
System.out.print( " " );
System.out.println();
```

to display the checkerboard pattern that follows. A `System.out.println` method call with no arguments causes the program to output a single newline character. [*Hint*: Repetition statements are required.]

```
* * * * *
 * * * * *
* * * * *
 * * * * *
* * * * *
 * * * * *
* * * * *
 * * * * *
* * * * *
```

4.33 (*Multiples of 2 with an Infinite Loop*) Write an application that keeps displaying in the command window the multiples of the integer 2—namely, 2, 4, 8, 16, 32, 64, and so on. Your loop should not terminate (i.e., it should create an infinite loop). What happens when you run this program?

4.34 (*What's Wrong with This Code?*) What is wrong with the following statement? Provide the correct statement to add one to the sum of x and y .

```
System.out.println( ++(x + y) );
```

4.35 (*Sides of a Triangle*) Write an application that reads three nonzero values entered by the user and determines and prints whether they could represent the sides of a triangle.

4.36 (*Sides of a Right Triangle*) Write an application that reads three nonzero integers and determines and prints whether they could represent the sides of a right triangle.

4.37 (*Factorial*) The factorial of a nonnegative integer n is written as $n!$ (pronounced “ n factorial”) and is defined as follows:

$$n! = n \cdot (n - 1) \cdot (n - 2) \cdot \dots \cdot 1 \quad (\text{for values of } n \text{ greater than or equal to } 1)$$

and

$$n! = 1 \quad (\text{for } n = 0)$$

For example, $5! = 5 \cdot 4 \cdot 3 \cdot 2 \cdot 1$, which is 120.

- Write an application that reads a nonnegative integer and computes and prints its factorial.
- Write an application that estimates the value of the mathematical constant e by using the following formula. Allow the user to enter the number of terms to calculate.

$$e = 1 + \frac{1}{1!} + \frac{1}{2!} + \frac{1}{3!} + \dots$$

- Write an application that computes the value of e^x by using the following formula. Allow the user to enter the number of terms to calculate.

$$e^x = 1 + \frac{x}{1!} + \frac{x^2}{2!} + \frac{x^3}{3!} + \dots$$

Making a Difference

4.38 (*Enforcing Privacy with Cryptography*) The explosive growth of Internet communications and data storage on Internet-connected computers has greatly increased privacy concerns. The field of cryptography is concerned with coding data to make it difficult (and hopefully—with the most advanced schemes—impossible) for unauthorized users to read. In this exercise you'll investigate a simple scheme for encrypting and decrypting data. A company that wants to send data over the Internet has asked you to write a program that will encrypt it so that it may be transmitted more securely. All the data is transmitted as four-digit integers. Your application should read a four-digit integer entered by the user and encrypt it as follows: Replace each digit with the result of adding 7 to the digit and getting the remainder after dividing the new value by 10. Then swap the first digit with the third, and swap the second digit with the fourth. Then print the encrypted integer. Write a separate application that inputs an encrypted four-digit integer and decrypts it (by reversing the encryption scheme) to form the original number. [*Optional reading project:* Research “public key cryptography” in general and the PGP (Pretty Good Privacy) specific public key scheme. You may also want to investigate the RSA scheme, which is widely used in industrial-strength applications.]

4.39 (*World Population Growth*) World population has grown considerably over the centuries. Continued growth could eventually challenge the limits of breathable air, drinkable water, arable cropland and other limited resources. There's evidence that growth has been slowing in recent years and that world population could peak some time this century, then start to decline.

For this exercise, research world population growth issues online. *Be sure to investigate various viewpoints.* Get estimates for the current world population and its growth rate (the percentage by which it's likely to increase this year). Write a program that calculates world population growth each year for the next 75 years, *using the simplifying assumption that the current growth rate will stay constant.* Print the results in a table. The first column should display the year from year 1 to year 75. The second column should display the anticipated world population at the end of that year. The third column should display the numerical increase in the world population that would occur that year. Using your results, determine the year in which the population would be double what it is today, if this year's growth rate were to persist.

Control Statements: Part 2

5



The wheel is come full circle.

—William Shakespeare

—Robert Frost

*All the evolution we know of
proceeds from the vague to the
definite.*

—Charles Sanders Peirce

Objectives

In this chapter you'll learn:

- The essentials of counter-controlled repetition.
- To use the `for` and `do...while` repetition statements to execute statements in a program repeatedly.
- To understand multiple selection using the `switch` selection statement.
- To use the `break` and `continue` program control statements to alter the flow of control.
- To use the logical operators to form complex conditional expressions in control statements.

5.1 Introduction	5.7 <code>break</code> and <code>continue</code> Statements
5.2 Essentials of Counter-Controlled Repetition	5.8 Logical Operators
5.3 <code>for</code> Repetition Statement	5.9 Structured Programming Summary
5.4 Examples Using the <code>for</code> Statement	5.10 (Optional) GUI and Graphics Case Study: Drawing Rectangles and Ovals
5.5 <code>do...while</code> Repetition Statement	5.11 Wrap-Up
5.6 <code>switch</code> Multiple-Selection Statement	

Summary | Self-Review Exercises | Answers to Self-Review Exercises | Exercises | Making a Difference

5.1 Introduction

This chapter continues our presentation of structured programming theory and principles by introducing all but one of Java's remaining control statements. We demonstrate Java's `for`, `do...while` and `switch` statements. Through a series of short examples using `while` and `for`, we explore the essentials of counter-controlled repetition. We create a version of class `GradeBook` that uses a `switch` statement to count the number of A, B, C, D and F grade equivalents in a set of numeric grades entered by the user. We introduce the `break` and `continue` program-control statements. We discuss Java's logical operators, which enable you to use more complex conditional expressions in control statements. Finally, we summarize Java's control statements and the proven problem-solving techniques presented in this chapter and Chapter 4.

5.2 Essentials of Counter-Controlled Repetition

This section uses the `while` repetition statement introduced in Chapter 4 to formalize the elements required to perform counter-controlled repetition, which requires

1. a **control variable** (or loop counter)
2. the **initial value** of the control variable
3. the **increment** (or **decrement**) by which the control variable is modified each time through the loop (also known as **each iteration of the loop**)
4. the **loop-continuation condition** that determines if looping should continue.

To see these elements of counter-controlled repetition, consider the application of Fig. 5.1, which uses a loop to display the numbers from 1 through 10.

```

1 // Fig. 5.1: WhileCounter.java
2 // Counter-controlled repetition with the while repetition statement.
3
4 public class WhileCounter
5 {
6     public static void main( String[] args )
7     {

```

Fig. 5.1 | Counter-controlled repetition with the `while` repetition statement. (Part 1 of 2.)

```

8      int counter = 1; // declare and initialize control variable
9
10     while ( counter <= 10 ) // loop-continuation condition
11     {
12         System.out.printf( "%d ", counter );
13         ++counter; // increment control variable by 1
14     } // end while
15
16     System.out.println(); // output a newline
17 } // end main
18 } // end class WhileCounter

```

```
1 2 3 4 5 6 7 8 9 10
```

Fig. 5.1 | Counter-controlled repetition with the `while` repetition statement. (Part 2 of 2.)

In Fig. 5.1, the elements of counter-controlled repetition are defined in lines 8, 10 and 13. Line 8 declares the control variable (`counter`) as an `int`, reserves space for it in memory and sets its initial value to 1. Variable `counter` also could have been declared and initialized with the following local-variable declaration and assignment statements:

```

int counter; // declare counter
counter = 1; // initialize counter to 1

```

Line 12 displays control variable `counter`'s value during each iteration of the loop. Line 13 increments the control variable by 1 for each iteration of the loop. The loop-continuation condition in the `while` (line 10) tests whether the value of the control variable is less than or equal to 10 (the final value for which the condition is `true`). The program performs the body of this `while` even when the control variable is 10. The loop terminates when the control variable exceeds 10 (i.e., `counter` becomes 11).



Common Programming Error 5.1

Because floating-point values may be approximate, controlling loops with floating-point variables may result in imprecise counter values and inaccurate termination tests.



Error-Prevention Tip 5.1

Use integers to control counting loops.

The program in Fig. 5.1 can be made more concise by initializing `counter` to 0 in line 8 and preincrementing `counter` in the `while` condition as follows:

```

while ( ++counter <= 10 ) // loop-continuation condition
    System.out.printf( "%d ", counter );

```

This code saves a statement (and eliminates the need for braces around the loop's body), because the `while` condition performs the increment before testing the condition. (Recall from Section 4.12 that the precedence of `++` is higher than that of `<=`.) Coding in such a condensed fashion takes practice, might make code more difficult to read, debug, modify and maintain, and typically should be avoided.



Software Engineering Observation 5.1

“Keep it simple” is good advice for most of the code you’ll write.

5.3 for Repetition Statement

Section 5.2 presented the essentials of counter-controlled repetition. The `while` statement can be used to implement any counter-controlled loop. Java also provides the **for repetition statement**, which specifies the counter-controlled-repetition details in a single line of code. Figure 5.2 reimplements the application of Fig. 5.1 using `for`.

```

1 // Fig. 5.2: ForCounter.java
2 // Counter-controlled repetition with the for repetition statement.
3
4 public class ForCounter
5 {
6     public static void main( String[] args )
7     {
8         // for statement header includes initialization,
9         // loop-continuation condition and increment
10        for ( int counter = 1; counter <= 10; counter++ )
11            System.out.printf( "%d ", counter );
12
13        System.out.println(); // output a newline
14    } // end main
15 } // end class ForCounter

```

1 2 3 4 5 6 7 8 9 10

Fig. 5.2 | Counter-controlled repetition with the `for` repetition statement.

When the `for` statement (lines 10–11) begins executing, the control variable `counter` is declared and initialized to 1. (Recall from Section 5.2 that the first two elements of counter-controlled repetition are the control variable and its initial value.) Next, the program checks the loop-continuation condition, `counter <= 10`, which is between the two required semicolons. Because the initial value of `counter` is 1, the condition initially is true. Therefore, the body statement (line 11) displays control variable `counter`’s value, namely 1. After executing the loop’s body, the program increments `counter` in the expression `counter++`, which appears to the right of the second semicolon. Then the loop-continuation test is performed again to determine whether the program should continue with the next iteration of the loop. At this point, the control variable’s value is 2, so the condition is still true (the final value is not exceeded)—thus, the program performs the body statement again (i.e., the next iteration of the loop). This process continues until the numbers 1 through 10 have been displayed and the `counter`’s value becomes 11, causing the loop-continuation test to fail and repetition to terminate (after 10 repetitions of the loop body). Then the program performs the first statement after the `for`—in this case, line 13.

Figure 5.2 uses (in line 10) the loop-continuation condition `counter <= 10`. If you incorrectly specified `counter < 10` as the condition, the loop would iterate only nine times. This is a common logic error called an **off-by-one error**.



Common Programming Error 5.2

Using an incorrect relational operator or an incorrect final value of a loop counter in the loop-continuation condition of a repetition statement can cause an off-by-one error.



Error-Prevention Tip 5.2

Using the final value in the condition of a while or for statement and using the `<=` relational operator helps avoid off-by-one errors. For a loop that prints the values 1 to 10, the loop-continuation condition should be `counter <= 10` rather than `counter < 10` (which causes an off-by-one error) or `counter < 11` (which is correct). Many programmers prefer so-called zero-based counting, in which to count 10 times, `counter` would be initialized to zero and the loop-continuation test would be `counter < 10`.

A Closer Look at the for Statement's Header

Figure 5.3 takes a closer look at the for statement in Fig. 5.2. The for's first line (including the keyword `for` and everything in parentheses after `for`)—line 10 in Fig. 5.2—is sometimes called the **for statement header**. The for header “does it all”—it specifies each item needed for counter-controlled repetition with a control variable. If there's more than one statement in the body of the for, braces are required to define the body of the loop.

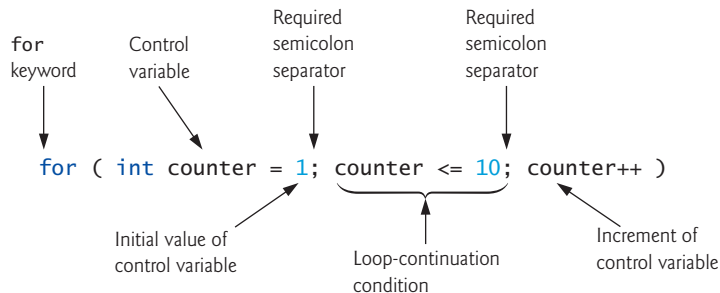

Fig. 5.3 | for statement header components.

General Format of a for Statement

The general format of the for statement is

```

for ( initialization; loopContinuationCondition; increment )
    statement
  
```

where the *initialization* expression names the loop's control variable and optionally provides its initial value, *loopContinuationCondition* determines whether the loop should continue executing and *increment* modifies the control variable's value (possibly an increment or decrement), so that the loop-continuation condition eventually becomes false. The two semicolons in the for header are required. If the loop-continuation condition is initially false, the program does *not* execute the for statement's body. Instead, execution proceeds with the statement following the for.

Representing a for Statement with an Equivalent while Statement

In most cases, the for statement can be represented with an equivalent while statement as follows:

```

initialization;
while ( loopContinuationCondition )
{
    statement
    increment;
}

```

In Section 5.7, we show a case in which a `for` statement cannot be represented with an equivalent `while` statement.

Typically, `for` statements are used for counter-controlled repetition and `while` statements for sentinel-controlled repetition. However, `while` and `for` can each be used for either repetition type.

Scope of a `for` Statement's Control Variable

If the *initialization* expression in the `for` header declares the control variable (i.e., the control variable's type is specified before the variable name, as in Fig. 5.2), the control variable can be used *only* in that `for` statement—it will not exist outside it. This restricted use is known as the variable's **scope**. The scope of a variable defines where it can be used in a program. For example, a local variable can be used *only* in the method that declares it and *only* from the point of declaration through the end of the method. Scope is discussed in detail in Chapter 6, *Methods: A Deeper Look*.



Common Programming Error 5.3

When a `for` statement's control variable is declared in the initialization section of the `for`'s header, using the control variable after the `for`'s body is a compilation error.

Expressions in a `for` Statement's Header Are Optional

All three expressions in a `for` header are optional. If the *loopContinuationCondition* is omitted, Java assumes that the loop-continuation condition is always true, thus creating an infinite loop. You might omit the *initialization* expression if the program initializes the control variable before the loop. You might omit the *increment* expression if the program calculates the increment with statements in the loop's body or if no increment is needed. The increment expression in a `for` acts as if it were a standalone statement at the end of the `for`'s body. Therefore, the expressions

```

counter = counter + 1
counter += 1
++counter
counter++

```

are equivalent increment expressions in a `for` statement. Many programmers prefer `counter++` because it's concise and because a `for` loop evaluates its increment expression *after* its body executes, so the postfix increment form seems more natural. In this case, the variable being incremented does not appear in a larger expression, so preincrementing and postincrementing actually have the same effect.



Common Programming Error 5.4

Placing a semicolon immediately to the right of the right parenthesis of a `for` header makes that `for`'s body an empty statement. This is normally a logic error.



Error-Prevention Tip 5.3

Infinite loops occur when the loop-continuation condition in a repetition statement never becomes false. To prevent this situation in a counter-controlled loop, ensure that the control variable is incremented (or decremented) during each iteration of the loop. In a sentinel-controlled loop, ensure that the sentinel value is able to be input.

Placing Arithmetic Expressions in a for Statement's Header

The initialization, loop-continuation condition and increment portions of a for statement can contain arithmetic expressions. For example, assume that $x = 2$ and $y = 10$. If x and y are not modified in the body of the loop, the statement

```
for ( int j = x; j <= 4 * x * y; j += y / x )
```

is equivalent to the statement

```
for ( int j = 2; j <= 80; j += 5 )
```

The increment of a for statement may also be *negative*, in which case it's really a *decrement*, and the loop counts *downward*.

Using a for Statement's Control Variable in the Statements's Body

Programs frequently display the control-variable value or use it in calculations in the loop body, but this use is not required. The control variable is commonly used to control repetition without being mentioned in the body of the for.



Error-Prevention Tip 5.4

Although the value of the control variable can be changed in the body of a for loop, avoid doing so, because this practice can lead to subtle errors.

UML Activity Diagram for the for Statement

The for statement's UML activity diagram is similar to that of the while statement (Fig. 4.4). Figure 5.4 shows the activity diagram of the for statement in Fig. 5.2. The

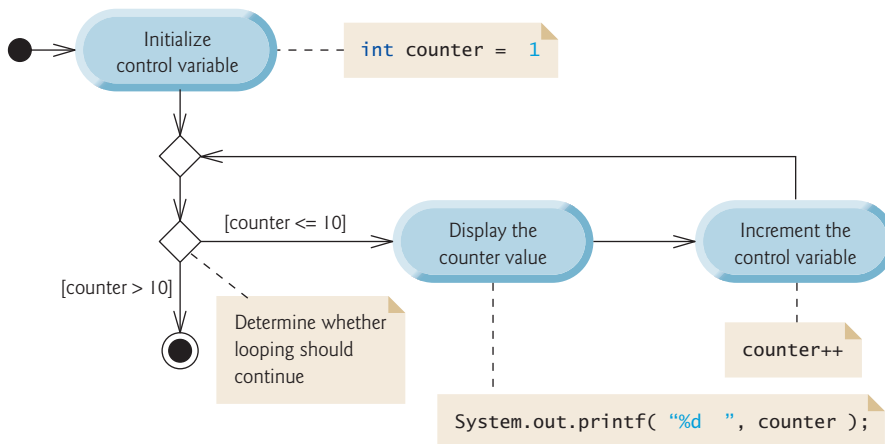

Fig. 5.4 | UML activity diagram for the for statement in Fig. 5.2.

diagram makes it clear that initialization occurs *once before* the loop-continuation test is evaluated the first time, and that incrementing occurs *each* time through the loop *after* the body statement executes.

5.4 Examples Using the for Statement

The following examples show techniques for varying the control variable in a for statement. In each case, we write the appropriate for header. Note the change in the relational operator for loops that decrement the control variable.

- a) Vary the control variable from 1 to 100 in increments of 1.

```
for ( int i = 1; i <= 100; i++ )
```

- b) Vary the control variable from 100 to 1 in decrements of 1.

```
for ( int i = 100; i >= 1; i-- )
```

- c) Vary the control variable from 7 to 77 in increments of 7.

```
for ( int i = 7; i <= 77; i += 7 )
```

- d) Vary the control variable from 20 to 2 in decrements of 2.

```
for ( int i = 20; i >= 2; i -= 2 )
```

- e) Vary the control variable over the values 2, 5, 8, 11, 14, 17, 20.

```
for ( int i = 2; i <= 20; i += 3 )
```

- f) Vary the control variable over the values 99, 88, 77, 66, 55, 44, 33, 22, 11, 0.

```
for ( int i = 99; i >= 0; i -= 11 )
```



Common Programming Error 5.5

Using an incorrect relational operator in the loop-continuation condition of a loop that counts downward (e.g., using $i \leq 1$ instead of $i \geq 1$ in a loop counting down to 1) is usually a logic error.

Application: Summing the Even Integers from 2 to 20

We now consider two sample applications that demonstrate simple uses of for. The application in Fig. 5.5 uses a for statement to sum the even integers from 2 to 20 and store the result in an int variable called total.

```
1 // Fig. 5.5: Sum.java
2 // Summing integers with the for statement.
3
4 public class Sum
5 {
6     public static void main( String[] args )
7     {
8         int total = 0; // initialize total
9     }
```

Fig. 5.5 | Summing integers with the for statement. (Part I of 2.)

```

10     // total even integers from 2 through 20
11     for ( int number = 2; number <= 20; number += 2 )
12         total += number;
13
14     System.out.printf( "Sum is %d\n", total ); // display results
15 } // end main
16 } // end class Sum

```

```
Sum is 110
```

Fig. 5.5 | Summing integers with the for statement. (Part 2 of 2.)

The *initialization* and *increment* expressions can be comma-separated lists that enable you to use multiple initialization expressions or multiple increment expressions. For example, *although this is discouraged*, you could merge the body of the for statement in lines 11–12 of Fig. 5.5 into the increment portion of the for header by using a comma as follows:

```

for ( int number = 2; number <= 20; total += number, number += 2 )
; // empty statement

```



Good Programming Practice 5.1

For readability limit the size of control-statement headers to a single line if possible.

Application: Compound-Interest Calculations

Let's use the for statement to compute compound interest. Consider the following problem:

A person invests \$1000 in a savings account yielding 5% interest. Assuming that all the interest is left on deposit, calculate and print the amount of money in the account at the end of each year for 10 years. Use the following formula to determine the amounts:

$$a = p(1 + r)^n$$

where

p is the original amount invested (i.e., the principal)

r is the annual interest rate (e.g., use 0.05 for 5%)

n is the number of years

a is the amount on deposit at the end of the n th year.

The solution to this problem (Fig. 5.6) involves a loop that performs the indicated calculation for each of the 10 years the money remains on deposit. Lines 8–10 in method `main` declare `double` variables `amount`, `principal` and `rate`, and initialize `principal` to 1000.0 and `rate` to 0.05. Java treats floating-point constants like 1000.0 and 0.05 as type `double`. Similarly, Java treats whole-number constants like 7 and -22 as type `int`.

```

1 // Fig. 5.6: Interest.java
2 // Compound-interest calculations with for.
3
4 public class Interest
5 {

```

Fig. 5.6 | Compound-interest calculations with for. (Part 1 of 2.)

```

6   public static void main( String[] args )
7   {
8       double amount; // amount on deposit at end of each year
9       double principal = 1000.0; // initial amount before interest
10      double rate = 0.05; // interest rate
11
12      // display headers
13      System.out.printf( "%s%20s\n", "Year", "Amount on deposit" );
14
15      // calculate amount on deposit for each of ten years
16      for ( int year = 1; year <= 10; year++ )
17      {
18          // calculate new amount for specified year
19          amount = principal * Math.pow( 1.0 + rate, year );
20
21          // display the year and the amount
22          System.out.printf( "%4d%,20.2f\n", year, amount );
23      } // end for
24  } // end main
25 } // end class Interest

```

Year	Amount on deposit
1	1,050.00
2	1,102.50
3	1,157.63
4	1,215.51
5	1,276.28
6	1,340.10
7	1,407.10
8	1,477.46
9	1,551.33
10	1,628.89

Fig. 5.6 | Compound-interest calculations with for. (Part 2 of 2.)

Formatting Strings with Field Widths and Justification

Line 13 outputs the headers for two columns of output. The first column displays the year and the second column the amount on deposit at the end of that year. We use the format specifier `%20s` to output the String "Amount on Deposit". The integer 20 between the `%` and the conversion character `s` indicates that the value should be displayed with a **field width** of 20—that is, `printf` displays the value with at least 20 character positions. If the value to be output is less than 20 character positions wide (17 characters in this example), the value is **right justified** in the field by default. If the year value to be output were more than four character positions wide, the field width would be extended to the right to accommodate the entire value—this would push the amount field to the right, upsetting the neat columns of our tabular output. To output values **left justified**, simply precede the field width with the **minus sign (-) formatting flag** (e.g., `%-20s`).

Performing the Interest Calculations

The for statement (lines 16–23) executes its body 10 times, varying control variable `year` from 1 to 10 in increments of 1. This loop terminates when `year` becomes 11. (Variable `year` represents n in the problem statement.)

Classes provide methods that perform common tasks on objects. In fact, most methods must be called on a specific object. For example, to output text in Fig. 5.6, line 13 calls method `printf` on the `System.out` object. Many classes also provide methods that perform common tasks and do *not* require objects. These are called *static* methods. For example, Java does not include an exponentiation operator, so the designers of Java's `Math` class defined *static* method `pow` for raising a value to a power. You can call a *static* method by specifying the class name followed by a dot (`.`) and the method name, as in

```
ClassName.methodName( arguments )
```

In Chapter 6, you'll learn how to implement *static* methods in your own classes.

We use *static* method `pow` of class `Math` to perform the compound-interest calculation in Fig. 5.6. `Math.pow(x, y)` calculates the value of x raised to the y^{th} power. The method receives two `double` arguments and returns a `double` value. Line 19 performs the calculation $a = p(1 + r)^n$, where a is amount, p is principal, r is rate and n is year. Class `Math` is defined in package `java.lang`, so you do *not* need to import class `Math` to use it.

The body of the `for` statement contains the calculation `1.0 + rate`, which appears as an argument to the `Math.pow` method. In fact, this calculation produces the same result each time through the loop, so repeating it every iteration of the loop is wasteful.



Performance Tip 5.1

In loops, avoid calculations for which the result never changes—such calculations should typically be placed before the loop. Many of today's sophisticated optimizing compilers will place such calculations outside loops in the compiled code.

Formatting Floating-Point Numbers

After each calculation, line 22 outputs the year and the amount on deposit at the end of that year. The year is output in a field width of four characters (as specified by `%4d`). The amount is output as a floating-point number with the format specifier `%,20.2f`. The **comma (,) formatting flag** indicates that the floating-point value should be output with a **grouping separator**. The actual separator used is specific to the user's locale (i.e., country). For example, in the United States, the number will be output using commas to separate every three digits and a decimal point to separate the fractional part of the number, as in 1,234.45. The number 20 in the format specification indicates that the value should be output right justified in a field width of 20 characters. The `.2` specifies the formatted number's precision—in this case, the number is rounded to the nearest hundredth and output with two digits to the right of the decimal point.

A Warning about Displaying Rounded Values

We declared variables `amount`, `principal` and `rate` to be of type `double` in this example. We're dealing with fractional parts of dollars and thus need a type that allows decimal points in its values. Unfortunately, floating-point numbers can cause trouble. Here's a simple explanation of what can go wrong when using `double` (or `float`) to represent dollar amounts (assuming that dollar amounts are displayed with two digits to the right of the decimal point): Two `double` dollar amounts stored in the machine could be 14.234 (which would normally be rounded to 14.23 for display purposes) and 18.673 (which would normally be rounded to 18.67 for display purposes). When these amounts are added, they produce the internal sum 32.907, which would normally be rounded to 32.91 for display purposes. Thus, your output could appear as

```

14.23
+ 18.67
-----
32.91

```

but a person adding the individual numbers as displayed would expect the sum to be 32.90. You've been warned!



Error-Prevention Tip 5.5

Do not use variables of type `double` (or `float`) to perform precise monetary calculations. The imprecision of floating-point numbers can cause errors. In the exercises, you'll learn how to use integers to perform precise monetary calculations. Java also provides class `java.math.BigDecimal` to perform precise monetary calculations. For more information, see download.oracle.com/javase/6/docs/api/java/math/BigDecimal.html.

5.5 do...while Repetition Statement

The **do...while repetition statement** is similar to the `while` statement. In the `while`, the program tests the loop-continuation condition at the beginning of the loop, before executing the loop's body; if the condition is false, the body *never* executes. The `do...while` statement tests the loop-continuation condition *after* executing the loop's body; therefore, *the body always executes at least once*. When a `do...while` statement terminates, execution continues with the next statement in sequence. Figure 5.7 uses a `do...while` (lines 10–14) to output the numbers 1–10.

```

1 // Fig. 5.7: DoWhileTest.java
2 // do...while repetition statement.
3
4 public class DoWhileTest
5 {
6     public static void main( String[] args )
7     {
8         int counter = 1; // initialize counter
9
10        do
11        {
12            System.out.printf( "%d ", counter );
13            ++counter;
14        } while ( counter <= 10 ); // end do...while
15
16        System.out.println(); // outputs a newline
17    } // end main
18 } // end class DoWhileTest

```

```
1 2 3 4 5 6 7 8 9 10
```

Fig. 5.7 | do...while repetition statement.

Line 8 declares and initializes control variable `counter`. Upon entering the `do...while` statement, line 12 outputs `counter`'s value and line 13 increments `counter`. Then the pro-

gram evaluates the loop-continuation test at the *bottom* of the loop (line 14). If the condition is true, the loop continues from the first body statement (line 12). If the condition is false, the loop terminates and the program continues with the next statement after the loop.

Figure 5.8 contains the UML activity diagram for the `do...while` statement. This diagram makes it clear that the loop-continuation condition is not evaluated until *after* the loop performs the action state at least once. Compare this activity diagram with that of the `while` statement (Fig. 4.4).

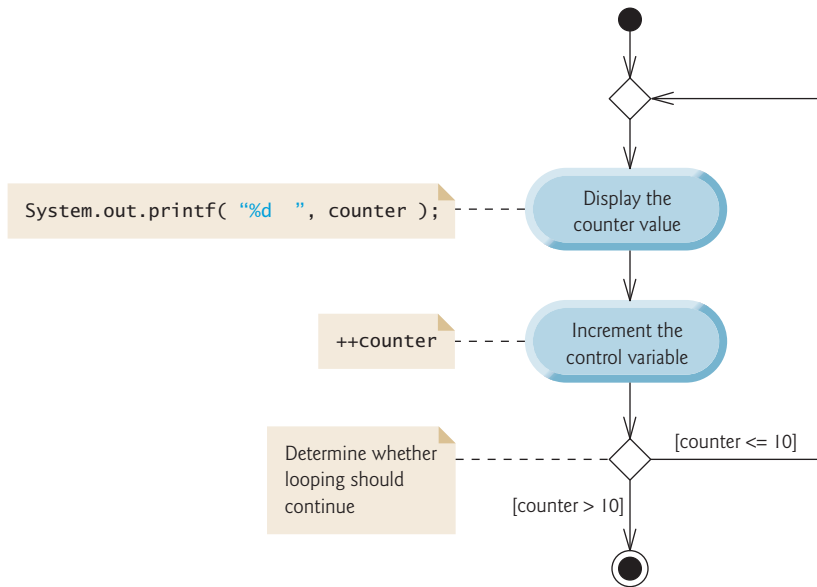

Fig. 5.8 | `do...while` repetition statement UML activity diagram.

It isn't necessary to use braces in the `do...while` repetition statement if there's only one statement in the body. However, many programmers include the braces, to avoid confusion between the `while` and `do...while` statements. For example,

```
while ( condition )
```

is normally the first line of a `while` statement. A `do...while` statement with no braces around a single-statement body appears as:

```
do
    statement
while ( condition );
```

which can be confusing. A reader may misinterpret the last line—`while(condition);`—as a `while` statement containing an empty statement (the semicolon by itself). Thus, the `do...while` statement with one body statement is usually written as follows:

```
do
{
    statement
} while ( condition );
```



Good Programming Practice 5.2

Always include braces in a `do...while` statement. This helps eliminate ambiguity between the `while` statement and a `do...while` statement containing only one statement.

5.6 switch Multiple-Selection Statement

Chapter 4 discussed the `if` single-selection statement and the `if...else` double-selection statement. The **switch multiple-selection statement** performs different actions based on the possible values of a **constant integral expression** of type `byte`, `short`, `int` or `char`.

GradeBook Class with switch Statement to Count A, B, C, D and F Grades

Figure 5.9 enhances class `GradeBook` from Chapters 3–4. The new version we now present not only calculates the average of a set of numeric grades entered by the user, but uses a `switch` statement to determine whether each grade is the equivalent of an A, B, C, D or F and to increment the appropriate grade counter. The class also displays a summary of the number of students who received each grade. Refer to Fig. 5.10 for sample inputs and outputs of the `GradeBookTest` application that uses class `GradeBook` to process a set of grades.

```

1 // Fig. 5.9: GradeBook.java
2 // GradeBook class uses switch statement to count letter grades.
3 import java.util.Scanner; // program uses class Scanner
4
5 public class GradeBook
6 {
7     private String courseName; // name of course this GradeBook represents
8     // int instance variables are initialized to 0 by default
9     private int total; // sum of grades
10    private int gradeCounter; // number of grades entered
11    private int aCount; // count of A grades
12    private int bCount; // count of B grades
13    private int cCount; // count of C grades
14    private int dCount; // count of D grades
15    private int fCount; // count of F grades
16
17    // constructor initializes courseName;
18    public GradeBook( String name )
19    {
20        courseName = name; // initializes courseName
21    } // end constructor
22
23    // method to set the course name
24    public void setCourseName( String name )
25    {
26        courseName = name; // store the course name
27    } // end method setCourseName
28
29    // method to retrieve the course name
30    public String getCourseName()
31    {

```

Fig. 5.9 | `GradeBook` class uses `switch` statement to count letter grades. (Part 1 of 3.)

```
32     return courseName;
33 } // end method getCourseName
34
35 // display a welcome message to the GradeBook user
36 public void displayMessage()
37 {
38     // getCourseName gets the name of the course
39     System.out.printf( "Welcome to the grade book for\n%s!\n\n",
40         getCourseName() );
41 } // end method displayMessage
42
43 // input arbitrary number of grades from user
44 public void inputGrades()
45 {
46     Scanner input = new Scanner( System.in );
47
48     int grade; // grade entered by user
49
50     System.out.printf( "%s\n%s\n  %s\n  %s\n",
51         "Enter the integer grades in the range 0-100.",
52         "Type the end-of-file indicator to terminate input:",
53         "On UNIX/Linux/Mac OS X type <Ctrl> d then press Enter",
54         "On Windows type <Ctrl> z then press Enter" );
55
56     // loop until user enters the end-of-file indicator
57     while ( input.hasNext() )
58     {
59         grade = input.nextInt(); // read grade
60         total += grade; // add grade to total
61         ++gradeCounter; // increment number of grades
62
63         // call method to increment appropriate counter
64         incrementLetterGradeCounter( grade );
65     } // end while
66 } // end method inputGrades
67
68 // add 1 to appropriate counter for specified grade
69 private void incrementLetterGradeCounter( int grade )
70 {
71     // determine which grade was entered
72     switch ( grade / 10 )
73     {
74         case 9: // grade was between 90
75             case 10: // and 100, inclusive
76                 ++aCount; // increment aCount
77                 break; // necessary to exit switch
78
79                 case 8: // grade was between 80 and 89
80                     ++bCount; // increment bCount
81                     break; // exit switch
82     }
```

Fig. 5.9 | GradeBook class uses switch statement to count letter grades. (Part 2 of 3.)

```

83     case 7: // grade was between 70 and 79
84         ++cCount; // increment cCount
85         break; // exit switch
86
87     case 6: // grade was between 60 and 69
88         ++dCount; // increment dCount
89         break; // exit switch
90
91     default: // grade was less than 60
92         ++fCount; // increment fCount
93         break; // optional; will exit switch anyway
94 } // end switch
95 } // end method incrementLetterGradeCounter
96
97 // display a report based on the grades entered by the user
98 public void displayGradeReport()
99 {
100     System.out.println( "\nGrade Report:" );
101
102     // if user entered at least one grade...
103     if ( gradeCounter != 0 )
104     {
105         // calculate average of all grades entered
106         double average = (double) total / gradeCounter;
107
108         // output summary of results
109         System.out.printf( "Total of the %d grades entered is %d\n",
110             gradeCounter, total );
111         System.out.printf( "Class average is %.2f\n", average );
112         System.out.printf( "%s\n%s%d\n%s%d\n%s%d\n%s%d\n%s%d\n",
113             "Number of students who received each grade:",
114             "A: ", aCount, // display number of A grades
115             "B: ", bCount, // display number of B grades
116             "C: ", cCount, // display number of C grades
117             "D: ", dCount, // display number of D grades
118             "F: ", fCount ); // display number of F grades
119     } // end if
120     else // no grades were entered, so output appropriate message
121         System.out.println( "No grades were entered" );
122 } // end method displayGradeReport
123 } // end class GradeBook

```

Fig. 5.9 | GradeBook class uses switch statement to count letter grades. (Part 3 of 3.)

Like earlier versions of the class, class `GradeBook` (Fig. 5.9) declares instance variable `courseName` (line 7) and contains methods `setCourseName` (lines 24–27), `getCourseName` (lines 30–33) and `displayMessage` (lines 36–41), which set the course name, store the course name and display a welcome message to the user, respectively. The class also contains a constructor (lines 18–21) that initializes the course name.

Class `GradeBook` also declares instance variables `total` (line 9) and `gradeCounter` (line 10), which keep track of the sum of the grades entered by the user and the number of grades entered, respectively. Lines 11–15 declare counter variables for each grade category. Class `GradeBook` maintains `total`, `gradeCounter` and the five letter-grade counters

as instance variables so that they can be used or modified in any of the class's methods. The class's constructor (lines 18–21) sets only the course name, because the remaining seven instance variables are `ints` and are initialized to 0 by default.

Class `GradeBook` (Fig. 5.9) contains three additional methods—`inputGrades`, `incrementLetterGradeCounter` and `displayGradeReport`. Method `inputGrades` (lines 44–66) reads an arbitrary number of integer grades from the user using sentinel-controlled repetition and updates instance variables `total` and `gradeCounter`. This method calls method `incrementLetterGradeCounter` (lines 69–95) to update the appropriate letter-grade counter for each grade entered. Method `displayGradeReport` (lines 98–122) outputs a report containing the total of all grades entered, the average of the grades and the number of students who received each letter grade. Let's examine these methods in more detail.

Method `inputGrades`

Line 48 in method `inputGrades` declares variable `grade`, which will store the user's input. Lines 50–54 prompt the user to enter integer grades and to type the end-of-file indicator to terminate the input. The **end-of-file indicator** is a system-dependent keystroke combination which the user enters to indicate that there's no more data to input. In Chapter 17, Files, Streams and Object Serialization, we'll see how the end-of-file indicator is used when a program reads its input from a file.

On UNIX/Linux/Mac OS X systems, end-of-file is entered by typing the sequence

```
<Ctrl> d
```

on a line by itself. This notation means to simultaneously press both the `Ctrl` key and the `d` key. On Windows systems, end-of-file can be entered by typing

```
<Ctrl> z
```

[*Note:* On some systems, you must press `Enter` after typing the end-of-file key sequence. Also, Windows typically displays the characters `^Z` on the screen when the end-of-file indicator is typed, as shown in the output of Fig. 5.10.]



Portability Tip 5.1

The keystroke combinations for entering end-of-file are system dependent.

The `while` statement (lines 57–65) obtains the user input. The condition at line 57 calls Scanner method `hasNext` to determine whether there's more data to input. This method returns the `boolean` value `true` if there's more data; otherwise, it returns `false`. The returned value is then used as the value of the condition in the `while` statement. Method `hasNext` returns `false` once the user types the end-of-file indicator.

Line 59 inputs a grade value from the user. Line 60 adds `grade` to `total`. Line 61 increments `gradeCounter`. The class's `displayGradeReport` method uses these variables to compute the average of the grades. Line 64 calls the class's `incrementLetterGradeCounter` method (declared in lines 69–95) to increment the appropriate letter-grade counter based on the numeric grade entered.

Method `incrementLetterGradeCounter`

Method `incrementLetterGradeCounter` contains a `switch` statement (lines 72–94) that determines which counter to increment. We assume that the user enters a valid grade in

the range 0–100. A grade in the range 90–100 represents A, 80–89 represents B, 70–79 represents C, 60–69 represents D and 0–59 represents F. The `switch` statement consists of a block that contains a sequence of **case labels** and an optional **default case**. These are used in this example to determine which counter to increment based on the grade.

When the flow of control reaches the `switch`, the program evaluates the expression in the parentheses (`grade / 10`) following keyword `switch`. This is the `switch`'s **controlling expression**. The program compares this expression's value (which must evaluate to an integral value of type `byte`, `char`, `short` or `int`) with each case label. The controlling expression in line 72 performs integer division, which *truncates the fractional part* of the result. Thus, when we divide a value from 0 to 100 by 10, the result is always a value from 0 to 10. We use several of these values in our case labels. For example, if the user enters the integer 85, the controlling expression evaluates to 8. The `switch` compares 8 with each case label. If a match occurs (case 8: at line 79), the program executes that case's statements. For the integer 8, line 80 increments `bCount`, because a grade in the 80s is a B. The **break statement** (line 81) causes program control to proceed with the first statement after the `switch`—in this program, we reach the end of method `incrementLetterGradeCounter`'s body, so the method terminates and control returns to line 65 in method `inputGrades` (the first line after the call to `incrementLetterGradeCounter`). Line 65 is the end of a `while` loop's body, so control flows to the `while`'s condition (line 57) to determine whether the loop should continue executing.

The cases in our `switch` explicitly test for the values 10, 9, 8, 7 and 6. Note the cases at lines 74–75 that test for the values 9 and 10 (both of which represent the grade A). Listing cases consecutively in this manner with no statements between them enables the cases to perform the same set of statements—when the controlling expression evaluates to 9 or 10, the statements in lines 76–77 will execute. The `switch` statement does not provide a mechanism for testing ranges of values, so every value you need to test must be listed in a separate case label. Each case can have multiple statements. The `switch` statement differs from other control statements in that it does *not* require braces around multiple statements in a case.

Without `break` statements, each time a match occurs in the `switch`, the statements for that case and subsequent cases execute until a `break` statement or the end of the `switch` is encountered. This is often referred to as “falling through” to the statements in subsequent cases. (This feature is perfect for writing a concise program that displays the iterative song “The Twelve Days of Christmas” in Exercise 5.29.)



Common Programming Error 5.6

Forgetting a break statement when one is needed in a switch is a logic error.

If no match occurs between the controlling expression's value and a case label, the `default` case (lines 91–93) executes. We use the `default` case in this example to process all controlling-expression values that are less than 6—that is, all failing grades. If no match occurs and the `switch` does not contain a `default` case, program control simply continues with the first statement after the `switch`.

GradeBookTest Class That Demonstrates Class GradeBook

Class `GradeBookTest` (Fig. 5.10) creates a `GradeBook` object (lines 10–11). Line 13 invokes the object's `displayMessage` method to output a welcome message to the user. Line 14 invokes the object's `inputGrades` method to read a set of grades from the user and keep

track of the sum of all the grades entered and the number of grades. Recall that method `inputGrades` also calls method `incrementLetterGradeCounter` to keep track of the number of students who received each letter grade. Line 15 invokes method `displayGradeReport` of class `GradeBook`, which outputs a report based on the grades entered (as in the input/output window in Fig. 5.10). Line 103 of class `GradeBook` (Fig. 5.9) determines whether the user entered at least one grade—this helps us avoid dividing by zero. If so, line 106 calculates the average of the grades. Lines 109–118 then output the total of all the grades, the class average and the number of students who received each letter grade. If no grades were entered, line 121 outputs an appropriate message. The output in Fig. 5.10 shows a sample grade report based on 10 grades.

```

1 // Fig. 5.10: GradeBookTest.java
2 // Create GradeBook object, input grades and display grade report.
3
4 public class GradeBookTest
5 {
6     public static void main( String[] args )
7     {
8         // create GradeBook object myGradeBook and
9         // pass course name to constructor
10        GradeBook myGradeBook = new GradeBook(
11            "CS101 Introduction to Java Programming" );
12
13        myGradeBook.displayMessage(); // display welcome message
14        myGradeBook.inputGrades(); // read grades from user
15        myGradeBook.displayGradeReport(); // display report based on grades
16    } // end main
17 } // end class GradeBookTest

```

```

Welcome to the grade book for
CS101 Introduction to Java Programming!

Enter the integer grades in the range 0-100.
Type the end-of-file indicator to terminate input:
    On UNIX/Linux/Mac OS X type <Ctrl> d then press Enter
    On Windows type <Ctrl> z then press Enter
99
92
45
57
63
71
76
85
90
100
^Z

Grade Report:
Total of the 10 grades entered is 778
Class average is 77.80

```

Fig. 5.10 | Create `GradeBook` object, input grades and display grade report. (Part 1 of 2.)

Number of students who received each grade:
 A: 4
 B: 1
 C: 2
 D: 1
 F: 2

Fig. 5.10 | Create GradeBook object, input grades and display grade report. (Part 2 of 2.)

Class GradeBookTest (Fig. 5.10) does not directly call GradeBook method `incrementLetterGradeCounter` (lines 69–95 of Fig. 5.9). This method is used exclusively by method `inputGrades` of class GradeBook to update the appropriate letter-grade counter as each new grade is entered by the user. Method `incrementLetterGradeCounter` exists solely to support the operations of GradeBook’s other methods, so it’s declared private.



Software Engineering Observation 5.2

Recall from Chapter 3 that methods declared with access modifier `private` can be called only by other methods of the class in which the private methods are declared. Such methods are commonly referred to as *utility methods* or *helper methods* because they’re typically used to support the operation of the class’s other methods.

switch Statement UML Activity Diagram

Figure 5.11 shows the UML activity diagram for the general switch statement. Most `switch` statements use a `break` in each case to terminate the `switch` statement after processing the case. Figure 5.11 emphasizes this by including `break` statements in the activity

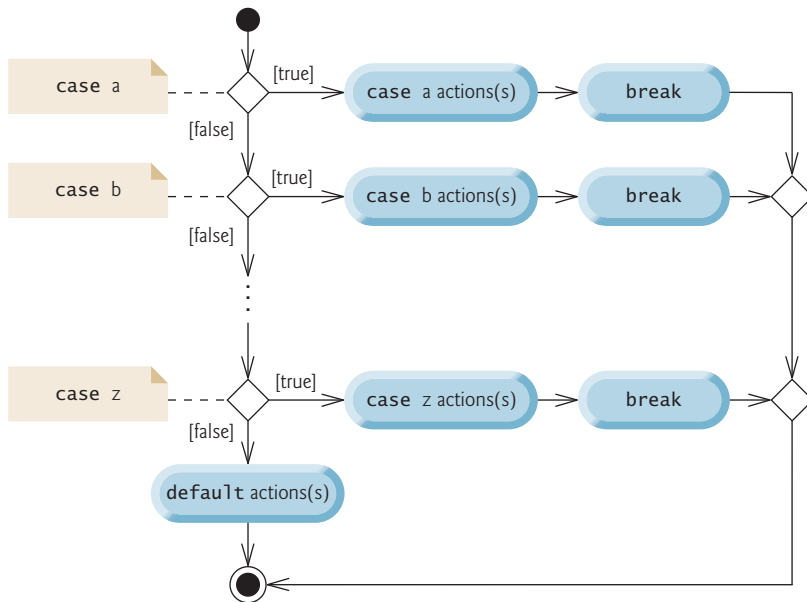

Fig. 5.11 | `switch` multiple-selection statement UML activity diagram with `break` statements.

diagram. The diagram makes it clear that the `break` statement at the end of a case causes control to exit the `switch` statement immediately.

The `break` statement is not required for the `switch`'s last case (or the optional default case, when it appears last), because execution continues with the next statement after the `switch`.



Software Engineering Observation 5.3

Provide a default case in `switch` statements. Including a default case focuses you on the need to process exceptional conditions.



Good Programming Practice 5.3

Although each case and the default case in a `switch` can occur in any order, place the default case last. When the default case is listed last, the `break` for that case is not required.

Notes on the Expression in Each case of a `switch`

When using the `switch` statement, remember that each case must contain a constant integral expression—that is, any combination of integer constants that evaluates to a constant integer value (e.g., `-7`, `0` or `221`). An integer constant is simply an integer value. In addition, you can use **character constants**—specific characters in single quotes, such as `'A'`, `'7'` or `'$'`—which represent the integer values of characters and enum constants (introduced in Section 6.10). (Appendix B shows the integer values of the characters in the ASCII character set, which is a subset of the Unicode character set used by Java.)

The expression in each case can also be a **constant variable**—a variable containing a value which does not change for the entire program. Such a variable is declared with keyword `final` (discussed in Chapter 6). Java has a feature called *enumerations*, which we also present in Chapter 6. Enumeration constants can also be used in case labels. In Chapter 10, Object-Oriented Programming: Polymorphism, we present a more elegant way to implement `switch` logic—we use a technique called *polymorphism* to create programs that are often clearer, easier to maintain and easier to extend than programs using `switch` logic.

Using Strings in `switch` Statements (New in Java SE 7)

As of Java SE 7, you can use `Strings` in a `switch` statement's controlling expression and in case labels. For example, you might want to use a city's name to obtain the corresponding ZIP code. Assuming that `city` and `zipCode` are `String` variables, the following `switch` statement performs this task for three cities:

```
switch( city )
{
    case "Maynard":
        zipCode = "01754";
        break;
    case "Marlborough":
        zipCode = "01752";
        break;
    case "Framingham":
        zipCode = "01701";
        break;
} // end switch
```

5.7 break and continue Statements

In addition to selection and repetition statements, Java provides statements `break` and `continue` (presented in this section and Appendix O) to alter the flow of control. The preceding section showed how `break` can be used to terminate a `switch` statement's execution. This section discusses how to use `break` in repetition statements.

break Statement

The `break` statement, when executed in a `while`, `for`, `do...while` or `switch`, causes immediate exit from that statement. Execution continues with the first statement after the control statement. Common uses of the `break` statement are to escape early from a loop or to skip the remainder of a `switch` (as in Fig. 5.9). Figure 5.12 demonstrates a `break` statement exiting a `for`.

```

1 // Fig. 5.12: BreakTest.java
2 // break statement exiting a for statement.
3 public class BreakTest
4 {
5     public static void main( String[] args )
6     {
7         int count; // control variable also used after loop terminates
8
9         for ( count = 1; count <= 10; count++ ) // loop 10 times
10        {
11            if ( count == 5 ) // if count is 5,
12                break; // terminate loop
13
14            System.out.printf( "%d ", count );
15        } // end for
16
17        System.out.printf( "\nBroke out of loop at count = %d\n", count );
18    } // end main
19 } // end class BreakTest

```

```

1 2 3 4
Broke out of loop at count = 5

```

Fig. 5.12 | `break` statement exiting a `for` statement.

When the `if` statement nested at lines 11–12 in the `for` statement (lines 9–15) detects that `count` is 5, the `break` statement at line 12 executes. This terminates the `for` statement, and the program proceeds to line 17 (immediately after the `for` statement), which displays a message indicating the value of the control variable when the loop terminated. The loop fully executes its body only four times instead of 10.

continue Statement

The `continue` statement, when executed in a `while`, `for` or `do...while`, skips the remaining statements in the loop body and proceeds with the *next iteration* of the loop. In `while` and `do...while` statements, the program evaluates the loop-continuation test immediately after the `continue` statement executes. In a `for` statement, the increment expression executes, then the program evaluates the loop-continuation test.

```

1 // Fig. 5.13: ContinueTest.java
2 // continue statement terminating an iteration of a for statement.
3 public class ContinueTest
4 {
5     public static void main( String[] args )
6     {
7         for ( int count = 1; count <= 10; count++ ) // loop 10 times
8         {
9             if ( count == 5 ) // if count is 5,
10                continue; // skip remaining code in loop
11
12             System.out.printf( "%d ", count );
13         } // end for
14
15         System.out.println( "\nUsed continue to skip printing 5" );
16     } // end main
17 } // end class ContinueTest

```

```

1 2 3 4 6 7 8 9 10
Used continue to skip printing 5

```

Fig. 5.13 | continue statement terminating an iteration of a for statement.

Figure 5.13 uses `continue` to skip the statement at line 12 when the nested `if` (line 9) determines that `count`'s value is 5. When the `continue` statement executes, program control continues with the increment of the control variable in the `for` statement (line 7).

In Section 5.3, we stated that `while` could be used in most cases in place of `for`. This is *not* true when the increment expression in the `while` follows a `continue` statement. In this case, the increment does *not* execute before the program evaluates the repetition-continuation condition, so the `while` does not execute in the same manner as the `for`.



Software Engineering Observation 5.4

Some programmers feel that `break` and `continue` violate structured programming. Since the same effects are achievable with structured programming techniques, these programmers do not use `break` or `continue`.



Software Engineering Observation 5.5

There's a tension between achieving quality software engineering and achieving the best-performing software. Sometimes one of these goals is achieved at the expense of the other. For all but the most performance-intensive situations, apply the following rule of thumb: First, make your code simple and correct; then make it fast and small, but only if necessary.

5.8 Logical Operators

The `if`, `if...else`, `while`, `do...while` and `for` statements each require a condition to determine how to continue a program's flow of control. So far, we've studied only simple conditions, such as `count <= 10`, `number != sentinelValue` and `total > 1000`. Simple conditions are expressed in terms of the relational operators `>`, `<`, `>=` and `<=` and the equality operators `==` and `!=`, and each expression tests only one condition. To test multiple conditions in the process of making a decision, we performed these tests in separate statements

or in nested `if` or `if...else` statements. Sometimes control statements require more complex conditions to determine a program's flow of control.

Java's **logical operators** enable you to form more complex conditions by *combining* simple conditions. The logical operators are `&&` (conditional AND), `||` (conditional OR), `&` (boolean logical AND), `|` (boolean logical inclusive OR), `^` (boolean logical exclusive OR) and `!` (logical NOT). [Note: The `&`, `|` and `^` operators are also bitwise operators when they're applied to integral operands. We discuss the bitwise operators in Appendix N.]

Conditional AND (&&) Operator

Suppose we wish to ensure at some point in a program that two conditions are *both* true before we choose a certain path of execution. In this case, we can use the **&& (conditional AND)** operator, as follows:

```
if ( gender == FEMALE && age >= 65 )
    ++seniorFemales;
```

This `if` statement contains two simple conditions. The condition `gender == FEMALE` compares variable `gender` to the constant `FEMALE` to determine whether a person is female. The condition `age >= 65` might be evaluated to determine whether a person is a senior citizen. The `if` statement considers the combined condition

```
gender == FEMALE && age >= 65
```

which is true if and only if *both* simple conditions are true. In this case, the `if` statement's body increments `seniorFemales` by 1. If either or both of the simple conditions are false, the program skips the increment. Some programmers find that the preceding combined condition is more readable when redundant parentheses are added, as in:

```
( gender == FEMALE ) && ( age >= 65 )
```

The table in Fig. 5.14 summarizes the `&&` operator. The table shows all four possible combinations of false and true values for *expression1* and *expression2*. Such tables are called **truth tables**. Java evaluates to false or true all expressions that include relational operators, equality operators or logical operators.

expression1	expression2	expression1 && expression2
false	false	false
false	true	false
true	false	false
true	true	true

Fig. 5.14 | `&&` (conditional AND) operator truth table.

Conditional OR (||) Operator

Now suppose we wish to ensure that *either or both* of two conditions are true before we choose a certain path of execution. In this case, we use the **|| (conditional OR)** operator, as in the following program segment:

```
if ( semesterAverage >= 90 ) || ( finalExam >= 90 ) )
    System.out.println ( "Student grade is A" );
```

This statement also contains two simple conditions. The condition `semesterAverage >= 90` evaluates to determine whether the student deserves an A in the course because of a solid performance throughout the semester. The condition `finalExam >= 90` evaluates to determine whether the student deserves an A in the course because of an outstanding performance on the final exam. The `if` statement then considers the combined condition

```
( semesterAverage >= 90 ) || ( finalExam >= 90 )
```

and awards the student an A if *either or both* of the simple conditions are true. The only time the message "Student grade is A" is *not* printed is when *both* of the simple conditions are *false*. Figure 5.15 is a truth table for operator conditional OR (`||`). Operator `&&` has a higher precedence than operator `||`. Both operators associate from left to right.

expression1	expression2	expression1 expression2
false	false	false
false	true	true
true	false	true
true	true	true

Fig. 5.15 | `||` (conditional OR) operator truth table.

Short-Circuit Evaluation of Complex Conditions

The parts of an expression containing `&&` or `||` operators are evaluated *only* until it's known whether the condition is true or false. Thus, evaluation of the expression

```
( gender == FEMALE ) && ( age >= 65 )
```

stops immediately if `gender` is not equal to `FEMALE` (i.e., the entire expression is `false`) and continues if `gender` *is* equal to `FEMALE` (i.e., the entire expression could still be `true` if the condition `age >= 65` is true). This feature of conditional AND and conditional OR expressions is called **short-circuit evaluation**.



Common Programming Error 5.7

In expressions using operator `&&`, a condition—we'll call this the dependent condition—may require another condition to be true for the evaluation of the dependent condition to be meaningful. In this case, the dependent condition should be placed after the other condition, or an error might occur. For example, in the expression `(i != 0) && (10 / i == 2)`, the second condition must appear after the first condition, or a divide-by-zero error might occur.

Boolean Logical AND (&) and Boolean Logical Inclusive OR (|) Operators

The **boolean logical AND** (`&`) and **boolean logical inclusive OR** (`|`) operators are identical to the `&&` and `||` operators, except that the `&` and `|` operators *always* evaluate *both* of their operands (i.e., they do *not* perform short-circuit evaluation). So, the expression

```
( gender == 1 ) & ( age >= 65 )
```

evaluates `age >= 65` *regardless* of whether `gender` is equal to 1. This is useful if the right operand of the boolean logical AND or boolean logical inclusive OR operator has a required **side effect**—a modification of a variable's value. For example, the expression

```
( birthday == true ) | ( ++age >= 65 )
```

guarantees that the condition `++age >= 65` will be evaluated. Thus, the variable `age` is incremented, regardless of whether the overall expression is `true` or `false`.



Error-Prevention Tip 5.6

For clarity, avoid expressions with side effects in conditions. The side effects may seem clever, but they can make it harder to understand code and can lead to subtle logic errors.

Boolean Logical Exclusive OR (\wedge)

A simple condition containing the **boolean logical exclusive OR** (\wedge) operator is true *if and only if one of its operands is true and the other is false*. If both are true or both are false, the entire condition is false. Figure 5.16 is a truth table for the boolean logical exclusive OR operator (\wedge). This operator is guaranteed to evaluate *both* of its operands.

expression1	expression2	expression1 \wedge expression2
false	false	false
false	true	true
true	false	true
true	true	false

Fig. 5.16 | \wedge (boolean logical exclusive OR) operator truth table.

Logical Negation (!) Operator

The **!** (**logical NOT**, also called **logical negation** or **logical complement**) operator “reverses” the meaning of a condition. Unlike the logical operators `&&`, `||`, `&`, `|` and `^`, which are *binary* operators that combine two conditions, the logical negation operator is a *unary* operator that has only a single condition as an operand. The operator is placed *before* a condition to choose a path of execution if the original condition (without the logical negation operator) is false, as in the program segment

```
if ( ! ( grade == sentinelValue ) )
    System.out.printf( "The next grade is %d\n", grade );
```

which executes the `printf` call only if `grade` is *not* equal to `sentinelValue`. The parentheses around the condition `grade == sentinelValue` are needed because the logical negation operator has a higher precedence than the equality operator.

In most cases, you can avoid using logical negation by expressing the condition differently with an appropriate relational or equality operator. For example, the previous statement may also be written as follows:

```
if ( grade != sentinelValue )
    System.out.printf( "The next grade is %d\n", grade );
```

This flexibility can help you express a condition in a more convenient manner. Figure 5.17 is a truth table for the logical negation operator.

expression	!expression
false	true
true	false

Fig. 5.17 | ! (logical negation, or logical NOT) operator truth table.

Logical Operators Example

Figure 5.18 uses logical operators to produce the truth tables discussed in this section. The output shows the boolean expression that was evaluated and its result. We used the **%b format specifier** to display the word “true” or the word “false” based on a boolean expression’s value. Lines 9–13 produce the truth table for `&&`. Lines 16–20 produce the truth table for `||`. Lines 23–27 produce the truth table for `&`. Lines 30–35 produce the truth table for `|`. Lines 38–43 produce the truth table for `^`. Lines 46–47 produce the truth table for `!`.

```

1 // Fig. 5.18: LogicalOperators.java
2 // Logical operators.
3
4 public class LogicalOperators
5 {
6     public static void main( String[] args )
7     {
8         // create truth table for && (conditional AND) operator
9         System.out.printf( "%s\n%s: %b\n%s: %b\n%s: %b\n%s: %b\n\n",
10             "Conditional AND (&&)", "false && false", ( false && false ),
11             "false && true", ( false && true ),
12             "true && false", ( true && false ),
13             "true && true", ( true && true ) );
14
15         // create truth table for || (conditional OR) operator
16         System.out.printf( "%s\n%s: %b\n%s: %b\n%s: %b\n%s: %b\n\n",
17             "Conditional OR (||)", "false || false", ( false || false ),
18             "false || true", ( false || true ),
19             "true || false", ( true || false ),
20             "true || true", ( true || true ) );
21
22         // create truth table for & (boolean logical AND) operator
23         System.out.printf( "%s\n%s: %b\n%s: %b\n%s: %b\n%s: %b\n\n",
24             "Boolean logical AND (&)", "false & false", ( false & false ),
25             "false & true", ( false & true ),
26             "true & false", ( true & false ),
27             "true & true", ( true & true ) );
28
29         // create truth table for | (boolean logical inclusive OR) operator
30         System.out.printf( "%s\n%s: %b\n%s: %b\n%s: %b\n%s: %b\n\n",
31             "Boolean logical inclusive OR (|)",

```

Fig. 5.18 | Logical operators. (Part 1 of 2.)

```

32     "false | false", ( false | false ),
33     "false | true", ( false | true ),
34     "true | false", ( true | false ),
35     "true | true", ( true | true );
36
37     // create truth table for ^ (boolean logical exclusive OR) operator
38     System.out.printf( "%s\n%s: %b\n%s: %b\n%s: %b\n%s: %b\n\n",
39         "Boolean logical exclusive OR (^)",
40         "false ^ false", ( false ^ false ),
41         "false ^ true", ( false ^ true ),
42         "true ^ false", ( true ^ false ),
43         "true ^ true", ( true ^ true );
44
45     // create truth table for ! (logical negation) operator
46     System.out.printf( "%s\n%s: %b\n%s: %b\n", "Logical NOT (!)",
47         "!false", ( !false ), "!true", ( !true );
48     } // end main
49 } // end class LogicalOperators

```

```

Conditional AND (&&)
false && false: false
false && true: false
true && false: false
true && true: true

Conditional OR (||)
false || false: false
false || true: true
true || false: true
true || true: true

Boolean logical AND (&)
false & false: false
false & true: false
true & false: false
true & true: true

Boolean logical inclusive OR (|)
false | false: false
false | true: true
true | false: true
true | true: true

Boolean logical exclusive OR (^)
false ^ false: false
false ^ true: true
true ^ false: true
true ^ true: false

Logical NOT (!)
!false: true
!true: false

```

Fig. 5.18 | Logical operators. (Part 2 of 2.)

Figure 5.19 shows the precedence and associativity of the Java operators introduced so far. The operators are shown from top to bottom in decreasing order of precedence.

Operators	Associativity	Type
++ --	right to left	unary postfix
++ -- + - ! (type)	right to left	unary prefix
* / %	left to right	multiplicative
+ -	left to right	additive
< <= > >=	left to right	relational
== !=	left to right	equality
&	left to right	boolean logical AND
^	left to right	boolean logical exclusive OR
	left to right	boolean logical inclusive OR
&&	left to right	conditional AND
	left to right	conditional OR
?:	right to left	conditional
= += -= *= /= %=	right to left	assignment

Fig. 5.19 | Precedence/associativity of the operators discussed so far.

5.9 Structured Programming Summary

Just as architects design buildings by employing the collective wisdom of their profession, so should programmers design programs. Our field is much younger than architecture, and our collective wisdom is considerably sparser. We've learned that structured programming produces programs that are easier than unstructured programs to understand, test, debug, modify and even prove correct in a mathematical sense.

Figure 5.20 uses UML activity diagrams to summarize Java's control statements. The initial and final states indicate the *single entry point* and the *single exit point* of each control statement. Arbitrarily connecting individual symbols in an activity diagram can lead to unstructured programs. Therefore, the programming profession has chosen a limited set of control statements that can be combined in only two simple ways to build structured programs.

For simplicity, Java includes only *single-entry/single-exit* control statements—there's only one way to enter and only one way to exit each control statement. Connecting control statements in sequence to form structured programs is simple. The final state of one control statement is connected to the initial state of the next—that is, the control statements are placed one after another in a program in sequence. We call this *control-statement stacking*. The rules for forming structured programs also allow for control statements to be *nested*.

Figure 5.21 shows the rules for forming structured programs. The rules assume that action states may be used to indicate any action. The rules also assume that we begin with the simplest activity diagram (Fig. 5.22) consisting of only an initial state, an action state, a final state and transition arrows.

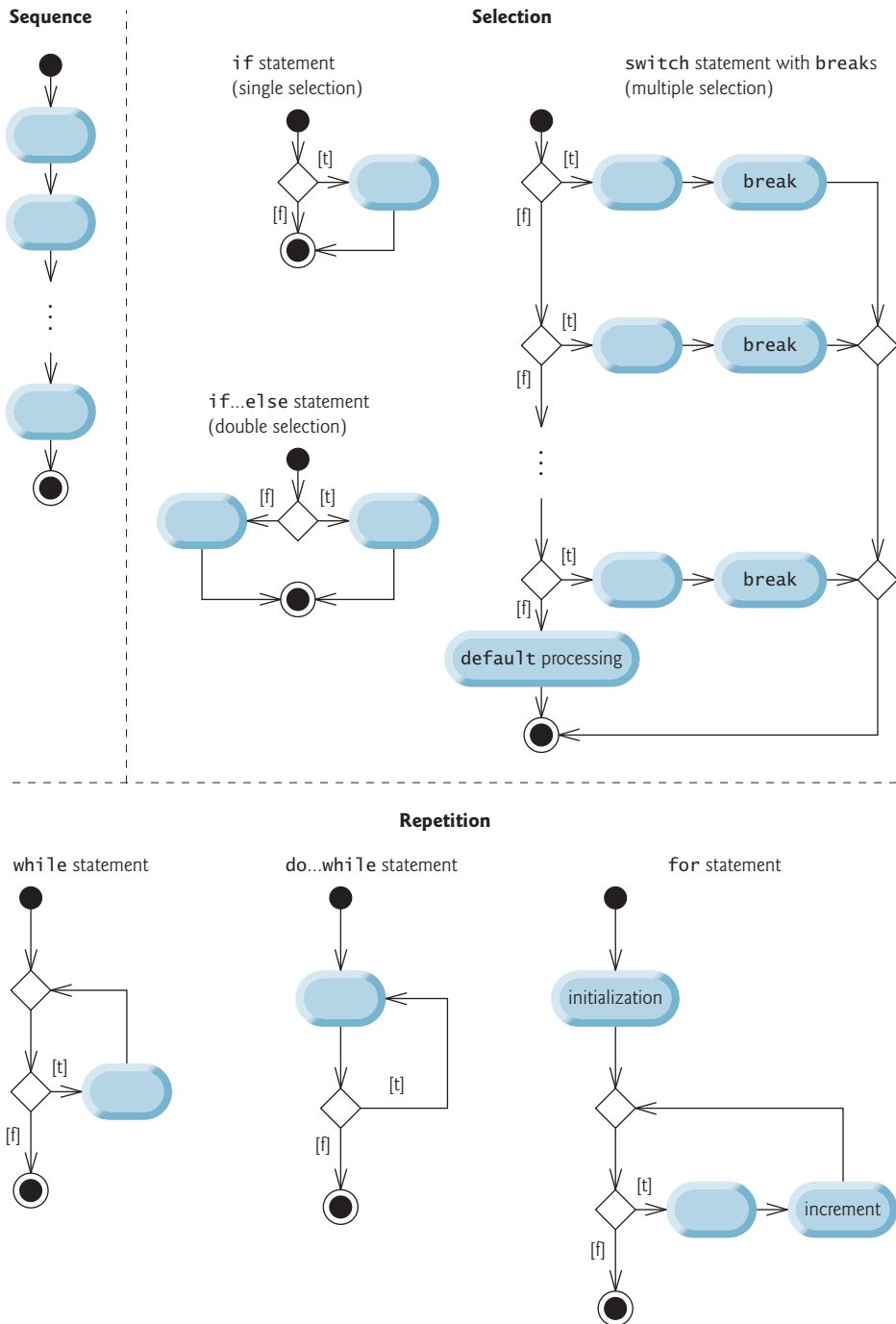

Fig. 5.20 | Java's single-entry/single-exit sequence, selection and repetition statements.

Rules for forming structured programs

1. Begin with the simplest activity diagram (Fig. 5.22).
2. Any action state can be replaced by two action states in sequence.
3. Any action state can be replaced by any control statement (sequence of action states, if, if...else, switch, while, do...while or for).
4. Rules 2 and 3 can be applied as often as you like and in any order.

Fig. 5.21 | Rules for forming structured programs.

Applying the rules in Fig. 5.21 always results in a properly structured activity diagram with a neat, building-block appearance. For example, repeatedly applying rule 2 to the simplest activity diagram results in an activity diagram containing many action states in sequence (Fig. 5.23). Rule 2 generates a stack of control statements, so let's call rule 2 the **stacking rule**. The vertical dashed lines in Fig. 5.23 are not part of the UML—we use them to separate the four activity diagrams that demonstrate rule 2 of Fig. 5.21 being applied.

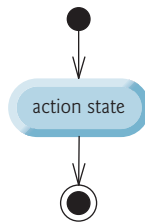

Fig. 5.22 | Simplest activity diagram.

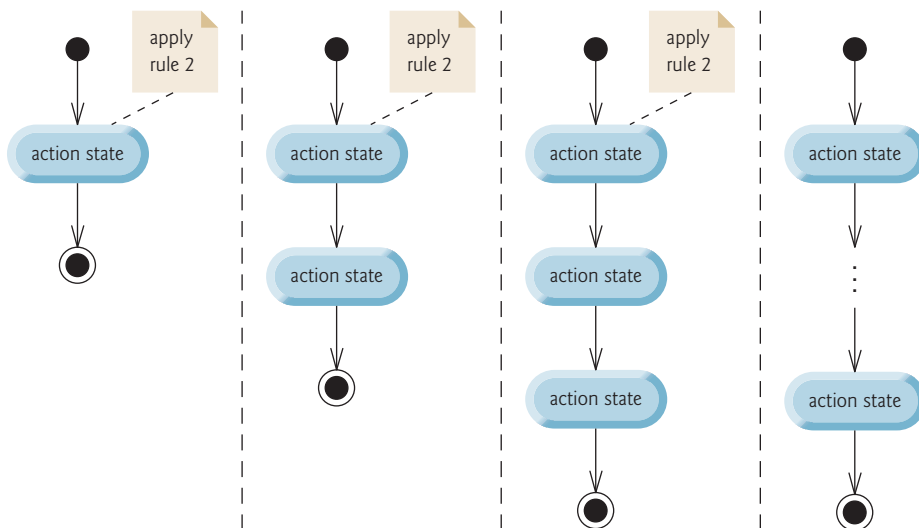

Fig. 5.23 | Repeatedly applying the Rule 2 of Fig. 5.21 to the simplest activity diagram.

Rule 3 is called the **nesting rule**. Repeatedly applying rule 3 to the simplest activity diagram results in one with neatly nested control statements. For example, in Fig. 5.24, the action state in the simplest activity diagram is replaced with a double-selection (if...else) statement. Then rule 3 is applied again to the action states in the double-selection statement, replacing each with a double-selection statement. The dashed action-state symbol around each double-selection statement represents the action state that was replaced. [Note: The dashed arrows and dashed action-state symbols shown in Fig. 5.24 are not part of the UML. They're used here to illustrate that any action state can be replaced with a control statement.]

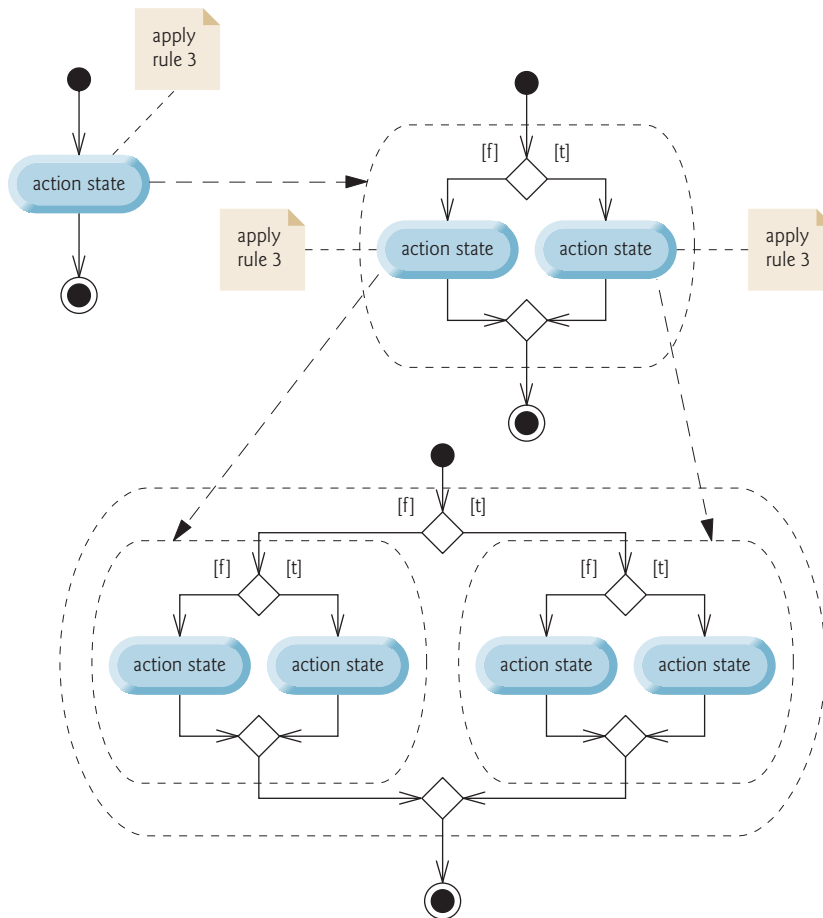

Fig. 5.24 | Repeatedly applying the Rule 3 of Fig. 5.21 to the simplest activity diagram.

Rule 4 generates larger, more involved and more deeply nested statements. The diagrams that emerge from applying the rules in Fig. 5.21 constitute the set of all possible structured activity diagrams and hence the set of all possible structured programs. The beauty of the structured approach is that we use *only seven* simple single-entry/single-exit control statements and assemble them in *only two* simple ways.

If the rules in Fig. 5.21 are followed, an “unstructured” activity diagram (like the one in Fig. 5.25) cannot be created. If you’re uncertain about whether a particular activity diagram is structured, apply the rules of Fig. 5.21 in reverse to reduce it to the simplest activity diagram. If you can reduce it, the original diagram is structured; otherwise, it’s not.

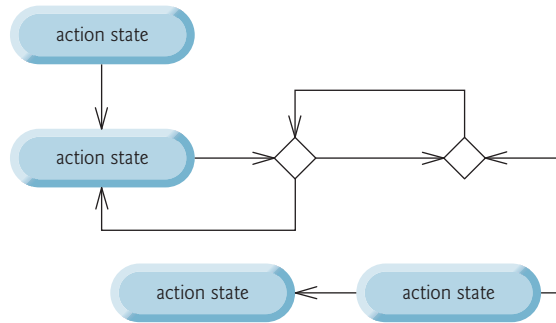

Fig. 5.25 | “Unstructured” activity diagram.

Structured programming promotes simplicity. Only three forms of control are needed to implement an algorithm:

- Sequence
- Selection
- Repetition

The sequence structure is trivial. Simply list the statements to execute in the order in which they should execute. Selection is implemented in one of three ways:

- `if` statement (single selection)
- `if...else` statement (double selection)
- `switch` statement (multiple selection)

In fact, it’s straightforward to prove that the simple `if` statement is sufficient to provide *any* form of selection—everything that can be done with the `if...else` statement and the `switch` statement can be implemented by combining `if` statements (although perhaps not as clearly and efficiently).

Repetition is implemented in one of three ways:

- `while` statement
- `do...while` statement
- `for` statement

[*Note:* There’s a fourth repetition statement—the enhanced `for` statement—that we discuss in Section 7.6.] It’s straightforward to prove that the `while` statement is sufficient to provide *any* form of repetition. Everything that can be done with `do...while` and `for` can be done with the `while` statement (although perhaps not as conveniently).

Combining these results illustrates that *any* form of control ever needed in a Java program can be expressed in terms of

- sequence
- if statement (selection)
- while statement (repetition)

and that these can be combined in only two ways—*stacking* and *nesting*. Indeed, structured programming is the essence of simplicity.

5.10 (Optional) GUI and Graphics Case Study: Drawing Rectangles and Ovals

This section demonstrates drawing rectangles and ovals, using the Graphics methods `drawRect` and `drawOval`, respectively. These methods are demonstrated in Fig. 5.26.

```

1 // Fig. 5.26: Shapes.java
2 // Demonstrates drawing different shapes.
3 import java.awt.Graphics;
4 import javax.swing.JPanel;
5
6 public class Shapes extends JPanel
7 {
8     private int choice; // user's choice of which shape to draw
9
10    // constructor sets the user's choice
11    public Shapes( int userChoice )
12    {
13        choice = userChoice;
14    } // end Shapes constructor
15
16    // draws a cascade of shapes starting from the top-left corner
17    public void paintComponent( Graphics g )
18    {
19        super.paintComponent( g );
20
21        for ( int i = 0; i < 10; i++ )
22        {
23            // pick the shape based on the user's choice
24            switch ( choice )
25            {
26                case 1: // draw rectangles
27                    g.drawRect( 10 + i * 10, 10 + i * 10,
28                               50 + i * 10, 50 + i * 10 );
29                    break;
30                case 2: // draw ovals
31                    g.drawOval( 10 + i * 10, 10 + i * 10,
32                               50 + i * 10, 50 + i * 10 );
33                    break;
34            } // end switch
35        } // end for
36    } // end method paintComponent
37 } // end class Shapes

```

Fig. 5.26 | Drawing a cascade of shapes based on the user's choice.

Line 6 begins the class declaration for `Shapes`, which extends `JPanel`. Instance variable `choice`, declared in line 8, determines whether `paintComponent` should draw rectangles or ovals. The `Shapes` constructor at lines 11–14 initializes `choice` with the value passed in parameter `userChoice`.

Method `paintComponent` (lines 17–36) performs the actual drawing. Remember, the first statement in every `paintComponent` method should be a call to `super.paintComponent`, as in line 19. Lines 21–35 loop 10 times to draw 10 shapes. The nested `switch` statement (lines 24–34) chooses between drawing rectangles and drawing ovals.

If `choice` is 1, then the program draws rectangles. Lines 27–28 call `Graphics` method `drawRect`. Method `drawRect` requires four arguments. The first two represent the x - and y -coordinates of the upper-left corner of the rectangle; the next two represent the rectangle's width and height. In this example, we start at a position 10 pixels down and 10 pixels right of the top-left corner, and every iteration of the loop moves the upper-left corner another 10 pixels down and to the right. The width and the height of the rectangle start at 50 pixels and increase by 10 pixels in each iteration.

If `choice` is 2, the program draws ovals. It creates an imaginary rectangle called a **bounding rectangle** and places inside it an oval that touches the midpoints of all four sides. Method `drawOval` (lines 31–32) requires the same four arguments as method `drawRect`. The arguments specify the position and size of the bounding rectangle for the oval. The values passed to `drawOval` in this example are exactly the same as those passed to `drawRect` in lines 27–28. Since the width and height of the bounding rectangle are identical in this example, lines 27–28 draw a circle. As an exercise, try modifying the program to draw both rectangles and ovals to see how `drawOval` and `drawRect` are related.

Class `ShapesTest`

Figure 5.27 is responsible for handling input from the user and creating a window to display the appropriate drawing based on the user's response. Line 3 imports `JFrame` to handle the display, and line 4 imports `JOptionPane` to handle the input.

```

1 // Fig. 5.27: ShapesTest.java
2 // Test application that displays class Shapes.
3 import javax.swing.JFrame;
4 import javax.swing.JOptionPane;
5
6 public class ShapesTest
7 {
8     public static void main( String[] args )
9     {
10         // obtain user's choice
11         String input = JOptionPane.showInputDialog(
12             "Enter 1 to draw rectangles\n" +
13             "Enter 2 to draw ovals" );
14
15         int choice = Integer.parseInt( input ); // convert input to int
16
17         // create the panel with the user's input
18         Shapes panel = new Shapes( choice );

```

Fig. 5.27 | Obtaining user input and creating a `JFrame` to display `Shapes`. (Part 1 of 2.)

```

19
20     JFrame application = new JFrame(); // creates a new JFrame
21
22     application.setDefaultCloseOperation( JFrame.EXIT_ON_CLOSE );
23     application.add( panel ); // add the panel to the frame
24     application.setSize( 300, 300 ); // set the desired size
25     application.setVisible( true ); // show the frame
26     } // end main
27 } // end class ShapesTest

```

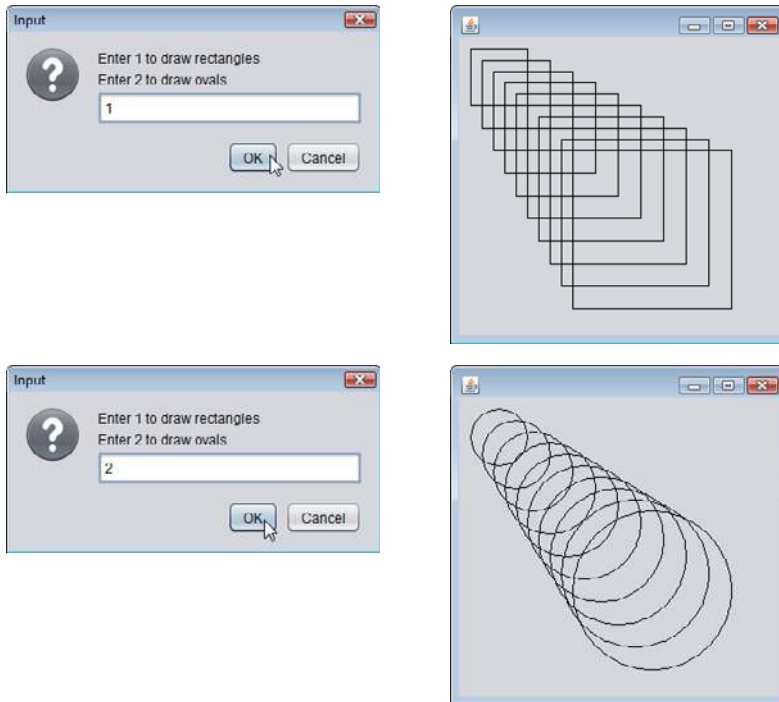

Fig. 5.27 | Obtaining user input and creating a JFrame to display Shapes. (Part 2 of 2.)

Lines 11–13 prompt the user with an input dialog and store the user’s response in variable input. Line 15 uses Integer method `parseInt` to convert the String entered by the user to an `int` and stores the result in variable `choice`. Line 18 creates a `Shapes` object and passes the user’s choice to the constructor. Lines 20–25 perform the standard operations that create and set up a window in this case study—create a frame, set it to exit the application when closed, add the drawing to the frame, set the frame size and make it visible.

GUI and Graphics Case Study Exercises

5.1 Draw 12 concentric circles in the center of a `JPanel` (Fig. 5.28). The innermost circle should have a radius of 10 pixels, and each successive circle should have a radius 10 pixels larger than the previous one. Begin by finding the center of the `JPanel`. To get the upper-left corner of a circle, move up one radius and to the left one radius from the center. The width and height of the bounding rectangle are both the same as the circle’s diameter (i.e., twice the radius).

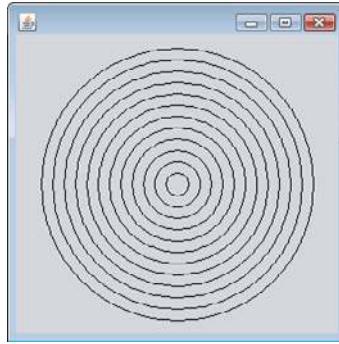

Fig. 5.28 | Drawing concentric circles.

5.2 Modify Exercise 5.16 from the end-of-chapter exercises to read input using dialogs and to display the bar chart using rectangles of varying lengths.

5.11 Wrap-Up

In this chapter, we completed our introduction to Java's control statements, which enable you to control the flow of execution in methods. Chapter 4 discussed Java's `if`, `if...else` and `while` statements. The current chapter demonstrated the `for`, `do...while` and `switch` statements. We showed that any algorithm can be developed using combinations of the sequence structure (i.e., statements listed in the order in which they should execute), the three types of selection statements—`if`, `if...else` and `switch`—and the three types of repetition statements—`while`, `do...while` and `for`. In this chapter and Chapter 4, we discussed how you can combine these building blocks to utilize proven program-construction and problem-solving techniques. This chapter also introduced Java's logical operators, which enable you to use more complex conditional expressions in control statements. In Chapter 6, we examine methods in greater depth.

Summary

Section 5.2 Essentials of Counter-Controlled Repetition

- Counter-controlled repetition (p. 152) requires a control variable, the initial value of the control variable, the increment (or decrement) by which the control variable is modified each time through the loop (also known as each iteration of the loop) and the loop-continuation condition that determines whether looping should continue.
- You can declare a variable and initialize it in the same statement.

Section 5.3 For Repetition Statement

- The `while` statement can be used to implement any counter-controlled loop.
- The `for` statement (p. 154) specifies all the details of counter-controlled repetition in its header
- When the `for` statement begins executing, its control variable is declared and initialized. Next, the program checks the loop-continuation condition. If the condition is initially true, the body executes. After executing the loop's body, the increment expression executes. Then the loop-con-

tinuation test is performed again to determine whether the program should continue with the next iteration of the loop.

- The general format of the `for` statement is

```
for ( initialization; loopContinuationCondition; increment )
    statement
```

where the *initialization* expression names the loop's control variable and provides its initial value, *loopContinuationCondition* determines whether the loop should continue executing and *increment* modifies the control variable's value, so that the loop-continuation condition eventually becomes false. The two semicolons in the `for` header are required.

- Most `for` statements can be represented with equivalent `while` statements as follows:

```
initialization;
while ( loopContinuationCondition )
{
    statement
    increment;
}
```

- Typically, `for` statements are used for counter-controlled repetition and `while` statements for sentinel-controlled repetition.
- If the *initialization* expression in the `for` header declares the control variable, the control variable can be used only in that `for` statement—it will not exist outside the `for` statement.
- The expressions in a `for` header are optional. If the *loopContinuationCondition* is omitted, Java assumes that it's always true, thus creating an infinite loop. You might omit the *initialization* expression if the control variable is initialized before the loop. You might omit the *increment* expression if the increment is calculated with statements in the loop's body or if no increment is needed.
- The increment expression in a `for` acts as if it's a standalone statement at the end of the `for`'s body.
- A `for` statement can count downward by using a negative increment (i.e., a decrement).
- If the loop-continuation condition is initially `false`, the program does not execute the `for` statement's body. Instead, execution proceeds with the statement following the `for`.

Section 5.4 Examples Using the `for` Statement

- Java treats floating-point constants like `1000.0` and `0.05` as type `double`. Similarly, Java treats whole-number constants like `7` and `-22` as type `int`.
- The format specifier `%4s` outputs a `String` in a field width (p. 160) of 4—that is, `printf` displays the value with at least 4 character positions. If the value to be output is less than 4 character positions wide, the value is right justified (p. 160) in the field by default. If the value is greater than 4 character positions wide, the field width expands to accommodate the appropriate number of characters. To left justify (p. 160) the value, use a negative integer to specify the field width.
- `Math.pow(x, y)` (p. 161) calculates the value of x raised to the y^{th} power. The method receives two `double` arguments and returns a `double` value.
- The comma (,) formatting flag (p. 161) in a format specifier indicates that a floating-point value should be output with a grouping separator (p. 161). The actual separator used is specific to the user's locale (i.e., country). In the United States, the number will have commas separating every three digits and a decimal point separating the fractional part of the number, as in `1,234.45`.
- The `.` in a format specifier indicates that the integer to its right is the number's precision.

Section 5.5 `do...while` Repetition Statement

- The `do...while` statement (p. 162) is similar to the `while` statement. In the `while`, the program tests the loop-continuation condition at the beginning of the loop, before executing its body; if the con-

dition is false, the body never executes. The `do...while` statement tests the loop-continuation condition *after* executing the loop's body; therefore, the body always executes at least once.

Section 5.6 *switch Multiple-Selection Statement*

- The `switch` statement (p. 164) performs different actions based on the possible values of a constant integral expression (a constant value of type `byte`, `short`, `int` or `char`, but not `long`).
- The end-of-file indicator (p. 167) is a system-dependent keystroke combination that terminates user input. On UNIX/Linux/Mac OS X systems, end-of-file is entered by typing the sequence `<Ctrl> d` on a line by itself. This notation means to simultaneously press both the `Ctrl` key and the `d` key. On Windows systems, enter end-of-file by typing `<Ctrl> z`.
- Scanner method `hasNext` (p. 167) determines whether there's more data to input. This method returns the `boolean` value `true` if there's more data; otherwise, it returns `false`. As long as the end-of-file indicator has not been typed, method `hasNext` will return `true`.
- The `switch` statement consists of a block that contains a sequence of case labels (p. 168) and an optional `default` case (p. 168).
- When the flow of control reaches a `switch`, the program evaluates the `switch`'s controlling expression and compares its value with each case label. If a match occurs, the program executes the statements for that case.
- Listing cases consecutively with no statements between them enables the cases to perform the same set of statements.
- Every value you wish to test in a `switch` must be listed in a separate case label.
- Each case can have multiple statements, and these need not be placed in braces.
- Without `break` statements, each time a match occurs in the `switch`, the statements for that case and subsequent cases execute until a `break` statement or the end of the `switch` is encountered.
- If no match occurs between the controlling expression's value and a case label, the optional `default` case executes. If no match occurs and the `switch` does not contain a `default` case, program control simply continues with the first statement after the `switch`.
- As of Java SE 7, you can use `Strings` in a `switch` statement's controlling expression and case labels.

Section 5.7 *break and continue Statements*

- The `break` statement (p. 168), when executed in a `while`, `for`, `do...while` or `switch`, causes immediate exit from that statement.
- The `continue` statement (p. 172), when executed in a `while`, `for` or `do...while`, skips the loop's remaining body statements and proceeds with its next iteration. In `while` and `do...while` statements, the program evaluates the loop-continuation test immediately. In a `for` statement, the increment expression executes, then the program evaluates the loop-continuation test.

Section 5.8 *Logical Operators*

- Simple conditions are expressed in terms of the relational operators `>`, `<`, `>=` and `<=` and the equality operators `==` and `!=`, and each expression tests only one condition.
- Logical operators (p. 174) enable you to form more complex conditions by combining simple conditions. The logical operators are `&&` (conditional AND), `||` (conditional OR), `&` (boolean logical AND), `|` (boolean logical inclusive OR), `^` (boolean logical exclusive OR) and `!` (logical NOT).
- To ensure that two conditions are *both* true, use the `&&` (conditional AND) operator. If either or both of the simple conditions are false, the entire expression is false.
- To ensure that either *or* both of two conditions are true, use the `||` (conditional OR) operator, which evaluates to true if either or both of its simple conditions are true.

- A condition using `&&` or `||` operators (p. 174) uses short-circuit evaluation (p. 175)—they’re evaluated only until it’s known whether the condition is true or false.
- The `&` and `|` operators (p. 175) work identically to the `&&` and `||` operators, but always evaluate both operands.
- A simple condition containing the boolean logical exclusive OR (`^`; p. 176) operator is true *if and only if one of its operands is true and the other is false*. If both operands are true or both are false, the entire condition is false. This operator is also guaranteed to evaluate both of its operands.
- The unary `!` (logical NOT; p. 176) operator “reverses” the value of a condition.

Self-Review Exercises

5.1 (*Fill in the Blanks*) Fill in the blanks in each of the following statements:

- Typically, _____ statements are used for counter-controlled repetition and _____ statements for sentinel-controlled repetition.
- The `do...while` statement tests the loop-continuation condition _____ executing the loop’s body; therefore, the body always executes at least once.
- The _____ statement selects among multiple actions based on the possible values of an integer variable or expression.
- The _____ statement, when executed in a repetition statement, skips the remaining statements in the loop body and proceeds with the next iteration of the loop.
- The _____ operator can be used to ensure that two conditions are *both* true before choosing a certain path of execution.
- If the loop-continuation condition in a `for` header is initially _____, the program does not execute the `for` statement’s body.
- Methods that perform common tasks and do not require objects are called _____ methods.

5.2 (*True/False Questions*) State whether each of the following is *true* or *false*. If *false*, explain why.

- The default case is required in the `switch` selection statement.
- The `break` statement is required in the last case of a `switch` selection statement.
- The expression `((x > y) && (a < b))` is true if either `x > y` is true or `a < b` is true.
- An expression containing the `||` operator is true if either or both of its operands are true.
- The comma `,` formatting flag in a format specifier (e.g., `%, 20.2f`) indicates that a value should be output with a thousands separator.
- To test for a range of values in a `switch` statement, use a hyphen `-` between the start and end values of the range in a case label.
- Listing cases consecutively with no statements between them enables the cases to perform the same set of statements.

5.3 (*Write a Statement*) Write a Java statement or a set of Java statements to accomplish each of the following tasks:

- Sum the odd integers between 1 and 99, using a `for` statement. Assume that the integer variables `sum` and `count` have been declared.
- Calculate the value of 2.5 raised to the power of 3, using the `pow` method.
- Print the integers from 1 to 20, using a `while` loop and the counter variable `i`. Assume that the variable `i` has been declared, but not initialized. Print only five integers per line. [*Hint: Use the calculation `i % 5`. When the value of this expression is 0, print a newline character; otherwise, print a tab character. Assume that this code is an application. Use the `System.out.println()` method to output the newline character, and use the `System.out.print('\t')` method to output the tab character.]*
- Repeat part (c), using a `for` statement.

5.4 (*Find the Error*) Find the error in each of the following code segments, and explain how to correct it:

- a) `i = 1;`
- ```

while (i <= 10);
 ++i;
}

```
- b) `for ( k = 0.1; k != 1.0; k += 0.1 )`  
`System.out.println( k );`
- c) `switch ( n )`  
`{`  
`case 1:`  
`System.out.println( "The number is 1" );`  
`case 2:`  
`System.out.println( "The number is 2" );`  
`break;`  
`default:`  
`System.out.println( "The number is not 1 or 2" );`  
`break;`  
`}`
- d) The following code should print the values 1 to 10:  
`n = 1;`  
`while ( n < 10 )`  
`System.out.println( n++ );`

## Answers to Self-Review Exercises

**5.1** a) for, while. b) after. c) switch. d) continue. e) && (conditional AND). f) false. g) static.

**5.2** a) False. The default case is optional. If no default action is needed, then there's no need for a default case. b) False. The break statement is used to exit the switch statement. The break statement is not required for the last case in a switch statement. c) False. Both of the relational expressions must be true for the entire expression to be true when using the && operator. d) True. e) True. f) False. The switch statement does not provide a mechanism for testing ranges of values, so every value that must be tested should be listed in a separate case label. g) True.

- 5.3** a) `sum = 0;`  
`for ( count = 1; count <= 99; count += 2 )`  
`sum += count;`
- b) `double result = Math.pow( 2.5, 3 );`
- c) `i = 1;`
- ```

while ( i <= 20 )
{
    System.out.print( i );

    if ( i % 5 == 0 )
        System.out.println();
    else
        System.out.print( '\t' );

    ++i;
}

```
- f) `for (i = 1; i <= 20; i++)`
`{`
`System.out.print(i);`

```

    if ( i % 5 == 0 )
        System.out.println();
    else
        System.out.print( '\t' );
}

```

- 5.4** a) Error: The semicolon after the `while` header causes an infinite loop, and there's a missing left brace.
Correction: Replace the semicolon by a `{`, or remove both the `;` and the `}`.
- b) Error: Using a floating-point number to control a `for` statement may not work, because floating-point numbers are represented only approximately by most computers.
Correction: Use an integer, and perform the proper calculation in order to get the values you desire:

```

    for ( k = 1; k != 10; k++ )
        System.out.println( (double) k / 10 );

```

- c) Error: The missing code is the `break` statement in the statements for the first case.
Correction: Add a `break` statement at the end of the statements for the first case. This omission is not necessarily an error if you want the statement of case 2: to execute every time the case 1: statement executes.
- d) Error: An improper relational operator is used in the `while`'s continuation condition.
Correction: Use `<=` rather than `<`, or change 10 to 11.

Exercises

- 5.5** Describe the four basic elements of counter-controlled repetition.
- 5.6** Compare and contrast the `while` and `for` repetition statements.
- 5.7** Discuss a situation in which it would be more appropriate to use a `do...while` statement than a `while` statement. Explain why.
- 5.8** Compare and contrast the `break` and `continue` statements.
- 5.9** Find and correct the error(s) in each of the following segments of code:
- a) `For (i = 100, i >= 1, i++)`
`System.out.println(i);`
- b) The following code should print whether integer value is odd or even:

```

switch ( value % 2 )
{
    case 0:
        System.out.println( "Even integer" );
    case 1:
        System.out.println( "Odd integer" );
}

```

- c) The following code should output the odd integers from 19 to 1:
- ```

for (i = 19; i >= 1; i += 2)
 System.out.println(i);

```
- d) The following code should output the even integers from 2 to 100:

```

counter = 2;
do
{
 System.out.println(counter);
 counter += 2;
} While (counter < 100);

```

**5.10** What does the following program do?

```

1 // Exercise 5.10: Printing.java
2 public class Printing
3 {
4 public static void main(String[] args)
5 {
6 for (int i = 1; i <= 10; i++)
7 {
8 for (int j = 1; j <= 5; j++)
9 System.out.print('@');
10
11 System.out.println();
12 } // end outer for
13 } // end main
14 } // end class Printing

```

**5.11** (*Find the Smallest Value*) Write an application that finds the smallest of several integers. Assume that the first value read specifies the number of values to input from the user.

**5.12** (*Calculating the Product of Odd Integers*) Write an application that calculates the product of the odd integers from 1 to 15.

**5.13** (*Factorials*) Factorials are used frequently in probability problems. The factorial of a positive integer  $n$  (written  $n!$  and pronounced “ $n$  factorial”) is equal to the product of the positive integers from 1 to  $n$ . Write an application that calculates the factorials of 1 through 20. Use type `long`. Display the results in tabular format. What difficulty might prevent you from calculating the factorial of 100?

**5.14** (*Modified Compound-Interest Program*) Modify the compound-interest application of Fig. 5.6 to repeat its steps for interest rates of 5%, 6%, 7%, 8%, 9% and 10%. Use a for loop to vary the interest rate.

**5.15** (*Triangle Printing Program*) Write an application that displays the following patterns separately, one below the other. Use for loops to generate the patterns. All asterisks (\*) should be printed by a single statement of the form `System.out.print( '*' );` which causes the asterisks to print side by side. A statement of the form `System.out.println();` can be used to move to the next line. A statement of the form `System.out.print( ' ' );` can be used to display a space for the last two patterns. There should be no other output statements in the program. [*Hint*: The last two patterns require that each line begin with an appropriate number of blank spaces.]

| (a)   | (b)   | (c)   | (d)   |
|-------|-------|-------|-------|
| *     | ***** | ***** | *     |
| **    | ***** | ***** | **    |
| ***   | ***** | ***** | ***   |
| ****  | ***** | ***** | ****  |
| ***** | ***** | ***** | ***** |
| ***** | ***** | ***** | ***** |
| ***** | ***** | ***** | ***** |
| ***** | ***   | ***   | ***** |
| ***** | **    | **    | ***** |
| ***** | *     | *     | ***** |

**5.16** (*Bar Chart Printing Program*) One interesting application of computers is to display graphs and bar charts. Write an application that reads five numbers between 1 and 30. For each number that's read, your program should display the same number of adjacent asterisks. For example, if your program reads the number 7, it should display `*****`. Display the bars of asterisks *after* you read all five numbers.

**5.17** (*Calculating Sales*) An online retailer sells five products whose retail prices are as follows: Product 1, \$2.98; product 2, \$4.50; product 3, \$9.98; product 4, \$4.49 and product 5, \$6.87. Write an application that reads a series of pairs of numbers as follows:

- a) product number
- b) quantity sold

Your program should use a switch statement to determine the retail price for each product. It should calculate and display the total retail value of all products sold. Use a sentinel-controlled loop to determine when the program should stop looping and display the final results.

**5.18** (*Modified Compound-Interest Program*) Modify the application in Fig. 5.6 to use only integers to calculate the compound interest. [*Hint*: Treat all monetary amounts as integral numbers of pennies. Then break the result into its dollars and cents portions by using the division and remainder operations, respectively. Insert a period between the dollars and the cents portions.]

**5.19** Assume that  $i = 1$ ,  $j = 2$ ,  $k = 3$  and  $m = 2$ . What does each of the following statements print?

- a) `System.out.println( i == 1 );`
- b) `System.out.println( j == 3 );`
- c) `System.out.println( ( i >= 1 ) && ( j < 4 ) );`
- d) `System.out.println( ( m <= 99 ) & ( k < m ) );`
- e) `System.out.println( ( j >= i ) || ( k == m ) );`
- f) `System.out.println( ( k + m < j ) | ( 3 - j >= k ) );`
- g) `System.out.println( !( k > m ) );`

**5.20** (*Calculating the Value of  $\pi$* ) Calculate the value of  $\pi$  from the infinite series

$$\pi = 4 - \frac{4}{3} + \frac{4}{5} - \frac{4}{7} + \frac{4}{9} - \frac{4}{11} + \dots$$

Print a table that shows the value of  $\pi$  approximated by computing the first 200,000 terms of this series. How many terms do you have to use before you first get a value that begins with 3.14159?

**5.21** (*Pythagorean Triples*) A right triangle can have sides whose lengths are all integers. The set of three integer values for the lengths of the sides of a right triangle is called a Pythagorean triple. The lengths of the three sides must satisfy the relationship that the sum of the squares of two of the sides is equal to the square of the hypotenuse. Write an application that displays a table of the Pythagorean triples for `side1`, `side2` and the hypotenuse, all no larger than 500. Use a triple-nested for loop that tries all possibilities. This method is an example of “brute-force” computing. You’ll learn in more advanced computer science courses that for many interesting problems there’s no known algorithmic approach other than using sheer brute force.

**5.22** (*Modified Triangle Printing Program*) Modify Exercise 5.15 to combine your code from the four separate triangles of asterisks such that all four patterns print side by side. [*Hint*: Make clever use of nested for loops.]

**5.23** (*De Morgan’s Laws*) In this chapter, we discussed the logical operators `&&`, `&`, `||`, `|`, `^` and `!`. De Morgan’s laws can sometimes make it more convenient for us to express a logical expression. These laws state that the expression `!(condition1 && condition2)` is logically equivalent to the expression `!(condition1 || !condition2)`. Also, the expression `!(condition1 || condition2)` is logically equivalent to the expression `!(condition1 && !condition2)`. Use De Morgan’s laws to write equivalent expressions for each of the following, then write an application to show that both the original expression and the new expression in each case produce the same value:

- a) `!( x < 5 ) && !( y >= 7 )`
- b) `!( a == b ) || !( g != 5 )`
- c) `!( ( x <= 8 ) && ( y > 4 ) )`
- d) `!( ( i > 4 ) || ( j <= 6 ) )`



**5.24** (*Diamond Printing Program*) Write an application that prints the following diamond shape. You may use output statements that print a single asterisk (\*), a single space or a single new-line character. Maximize your use of repetition (with nested for statements), and minimize the number of output statements.

```

 *

 *
```

**5.25** (*Modified Diamond Printing Program*) Modify the application you wrote in Exercise 5.24 to read an odd number in the range 1 to 19 to specify the number of rows in the diamond. Your program should then display a diamond of the appropriate size.

**5.26** A criticism of the `break` statement and the `continue` statement is that each is unstructured. Actually, these statements can always be replaced by structured statements, although doing so can be awkward. Describe in general how you'd remove any `break` statement from a loop in a program and replace it with some structured equivalent. [*Hint*: The `break` statement exits a loop from the body of the loop. The other way to exit is by failing the loop-continuation test. Consider using in the loop-continuation test a second test that indicates “early exit because of a ‘break’ condition.”] Use the technique you develop here to remove the `break` statement from the application in Fig. 5.12.

**5.27** What does the following program segment do?

```

for (i = 1; i <= 5; i++)
{
 for (j = 1; j <= 3; j++)
 {
 for (k = 1; k <= 4; k++)
 System.out.print('*');

 System.out.println();
 } // end inner for
 System.out.println();
} // end outer for
```

**5.28** Describe in general how you'd remove any `continue` statement from a loop in a program and replace it with some structured equivalent. Use the technique you develop here to remove the `continue` statement from the program in Fig. 5.13.

**5.29** (*“The Twelve Days of Christmas” Song*) Write an application that uses repetition and `switch` statements to print the song “The Twelve Days of Christmas.” One `switch` statement should be used to print the day (“first,” “second,” and so on). A separate `switch` statement should be used to print the remainder of each verse. Visit the website [en.wikipedia.org/wiki/The\\_Twelve\\_Days\\_of\\_Christmas\\_\(song\)](http://en.wikipedia.org/wiki/The_Twelve_Days_of_Christmas_(song)) for the lyrics of the song.

## Making a Difference

**5.30** (*Global Warming Facts Quiz*) The controversial issue of global warming has been widely publicized by the film “An Inconvenient Truth,” featuring former Vice President Al Gore. Mr. Gore and a U.N. network of scientists, the Intergovernmental Panel on Climate Change, shared the 2007 Nobel Peace Prize in recognition of “their efforts to build up and disseminate greater knowledge about man-made climate change.” Research *both* sides of the global warming issue online (you

might want to search for phrases like “global warming skeptics”). Create a five-question multiple-choice quiz on global warming, each question having four possible answers (numbered 1–4). Be objective and try to fairly represent both sides of the issue. Next, write an application that administers the quiz, calculates the number of correct answers (zero through five) and returns a message to the user. If the user correctly answers five questions, print “Excellent”; if four, print “Very good”; if three or fewer, print “Time to brush up on your knowledge of global warming,” and include a list of some of the websites where you found your facts.

**5.31** (*Tax Plan Alternatives; The “FairTax”*) There are many proposals to make taxation fairer. Check out the FairTax initiative in the United States at

[www.fairtax.org/site/PageSer PageServer?pagename=calculator](http://www.fairtax.org/site/PageSer PageServer?pagename=calculator)

Research how the proposed FairTax works. One suggestion is to eliminate income taxes and most other taxes in favor of a 23% consumption tax on all products and services that you buy. Some FairTax opponents question the 23% figure and say that because of the way the tax is calculated, it would be more accurate to say the rate is 30%—check this carefully. Write a program that prompts the user to enter expenses in various expense categories they have (e.g., housing, food, clothing, transportation, education, health care, vacations), then prints the estimated FairTax that person would pay.

**5.32** (*Facebook User Base Growth*) According to CNNMoney.com, Facebook hit 500 million users in July of 2010 and its user base has been growing at a rate of 5% per month. Using the compound-growth technique you learned in Fig. 5.6 and assuming this growth rate continues, how many months will it take for Facebook to grow its user base to one billion users? How many months will it take for Facebook to grow its user base to two billion users (which, at the time of this writing, was the total number of people on the Internet)?

# Methods: A Deeper Look

# 6



*E pluribus unum.*  
(One composed of many.)

—Virgil

*O! call back yesterday, bid time return.*

—William Shakespeare

*Call me Ishmael.*

—Herman Melville

*Answer me in one word.*

—William Shakespeare

*There is a point at which methods devour themselves.*

—Frantz Fanon

## Objectives

In this chapter you'll learn:

- How **static** methods and fields are associated with classes rather than objects.
- How the method call/return mechanism is supported by the method-call stack.
- How packages group related classes.
- How to use random-number generation to implement game-playing applications.
- How the visibility of declarations is limited to specific regions of programs.
- What method overloading is and how to create overloaded methods.

- 6.1 Introduction
- 6.2 Program Modules in Java
- 6.3 `static` Methods, `static` Fields and Class `Math`
- 6.4 Declaring Methods with Multiple Parameters
- 6.5 Notes on Declaring and Using Methods
- 6.6 Method-Call Stack and Activation Records
- 6.7 Argument Promotion and Casting
- 6.8 Java API Packages
- 6.9 Case Study: Random-Number Generation
  - 6.9.1 Generalized Scaling and Shifting of Random Numbers
  - 6.9.2 Random-Number Repeatability for Testing and Debugging
- 6.10 Case Study: A Game of Chance; Introducing Enumerations
- 6.11 Scope of Declarations
- 6.12 Method Overloading
- 6.13 (Optional) GUI and Graphics Case Study: Colors and Filled Shapes
- 6.14 Wrap-Up

*Summary | Self-Review Exercises | Answers to Self-Review Exercises | Exercises | Making a Difference*

## 6.1 Introduction

Experience has shown that the best way to develop and maintain a large program is to construct it from small, simple pieces, or **modules**. This technique is called **divide and conquer**. Methods, which we introduced in Chapter 3, help you modularize programs. In this chapter, we study methods in more depth. We emphasize how to declare and use methods to facilitate the design, implementation, operation and maintenance of large programs.

You'll see that it's possible to call certain methods, called `static` methods, without the need for an object of the class to exist. You'll learn how to declare a method with more than one parameter. You'll also learn how Java is able to keep track of which method is currently executing, how local variables of methods are maintained in memory and how a method knows where to return after it completes execution.

We'll take a brief diversion into simulation techniques with random-number generation and develop a version of the casino dice game called craps that uses most of the programming techniques you've used to this point in the book. In addition, you'll learn how to declare values that cannot change (i.e., constants) in your programs.

Many of the classes you'll use or create while developing applications will have more than one method of the same name. This technique, called overloading, is used to implement methods that perform similar tasks for arguments of different types or for different numbers of arguments.

We continue our discussion of methods in Chapter 18, Recursion. Recursion provides an intriguing way of thinking about methods and algorithms.

## 6.2 Program Modules in Java

You write Java programs by combining new methods and classes with predefined ones available in the **Java Application Programming Interface** (also referred to as the **Java API** or **Java class library**) and in various other class libraries. Related classes are typically grouped into packages so that they can be imported into programs and reused. You'll learn

how to group your own classes into packages in Chapter 8. The Java API provides a rich collection of predefined classes that contain methods for performing common mathematical calculations, string manipulations, character manipulations, input/output operations, database operations, networking operations, file processing, error checking and many other useful tasks.



### Software Engineering Observation 6.1

*Familiarize yourself with the rich collection of classes and methods provided by the Java API ([download.oracle.com/javase/6/docs/api/](http://download.oracle.com/javase/6/docs/api/)). Section 6.8 presents an overview of several common packages. Appendix E explains how to navigate the API documentation. Don't reinvent the wheel. When possible, reuse Java API classes and methods. This reduces program development time and avoids introducing programming errors.*

Methods (called **functions** or **procedures** in some languages) help you modularize a program by separating its tasks into self-contained units. You've declared methods in every program you've written. The statements in the method bodies are written only once, are hidden from other methods and can be reused from several locations in a program.

One motivation for modularizing a program into methods is the divide-and-conquer approach, which makes program development more manageable by constructing programs from small, simple pieces. Another is **software reusability**—using existing methods as building blocks to create new programs. Often, you can create programs mostly from standardized methods rather than by building customized code. For example, in earlier programs, we did not define how to read data from the keyboard—Java provides these capabilities in the methods of class `Scanner`. A third motivation is to avoid repeating code. Dividing a program into meaningful methods makes the program easier to debug and maintain.



### Software Engineering Observation 6.2

*To promote software reusability, every method should be limited to performing a single, well-defined task, and the name of the method should express that task effectively.*



### Error-Prevention Tip 6.1

*A method that performs one task is easier to test and debug than one that performs many tasks.*



### Software Engineering Observation 6.3

*If you cannot choose a concise name that expresses a method's task, your method might be attempting to perform too many tasks. Break such a method into several smaller ones.*

As you know, a method is invoked by a method call, and when the called method completes its task, it returns either a result or simply control to the caller. An analogy to this program structure is the hierarchical form of management (Fig. 6.1). A boss (the caller) asks a worker (the called method) to perform a task and report back (return) the results after completing the task. The boss method does not know how the worker method performs its designated tasks. The worker may also call other worker methods, unknown to the boss. This “hiding” of implementation details promotes good software engineering. Figure 6.1 shows the boss method communicating with several worker methods in a hierarchical manner. The boss method divides its responsibilities among the various worker methods. Here, `worker1` acts as a “boss method” to `worker4` and `worker5`.

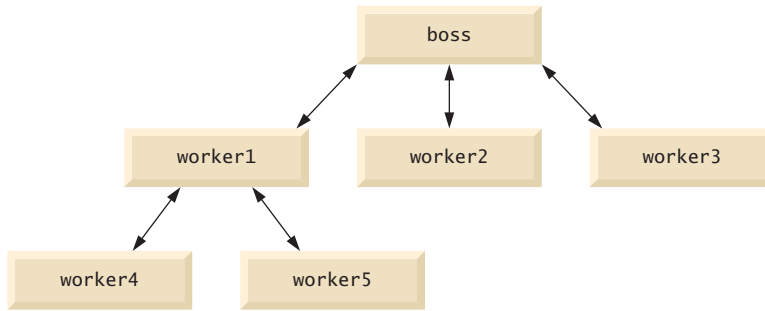

**Fig. 6.1** | Hierarchical boss-method/worker-method relationship.

### 6.3 static Methods, static Fields and Class Math

Although most methods execute in response to method calls on specific objects, this is not always the case. Sometimes a method performs a task that does not depend on the contents of any object. Such a method applies to the class in which it's declared as a whole and is known as a **static method** or a **class method**. It's common for classes to contain convenient static methods to perform common tasks. For example, recall that we used static method `pow` of class `Math` to raise a value to a power in Fig. 5.6. To declare a method as **static**, place the keyword `static` before the return type in the method's declaration. For any class imported into your program, you can call the class's static methods by specifying the name of the class in which the method is declared, followed by a dot (`.`) and the method name, as in

```
ClassName.methodName(arguments)
```

We use various `Math` class methods here to present the concept of static methods. Class `Math` provides a collection of methods that enable you to perform common mathematical calculations. For example, you can calculate the square root of `900.0` with the static method call

```
Math.sqrt(900.0)
```

The preceding expression evaluates to `30.0`. Method `sqrt` takes an argument of type `double` and returns a result of type `double`. To output the value of the preceding method call in the command window, you might write the statement

```
System.out.println(Math.sqrt(900.0));
```

In this statement, the value that `sqrt` returns becomes the argument to method `println`. There was no need to create a `Math` object before calling method `sqrt`. Also *all* `Math` class methods are **static**—therefore, each is called by preceding its name with the class name `Math` and the dot (`.`) separator.



#### Software Engineering Observation 6.4

*Class `Math` is part of the `java.lang` package, which is implicitly imported by the compiler, so it's not necessary to import class `Math` to use its methods.*

Method arguments may be constants, variables or expressions. If `c = 13.0`, `d = 3.0` and `f = 4.0`, then the statement

```
System.out.println(Math.sqrt(c + d * f));
```

calculates and prints the square root of  $13.0 + 3.0 * 4.0 = 25.0$ —namely, 5.0. Figure 6.2 summarizes several Math class methods. In the figure,  $x$  and  $y$  are of type double.

| Method                   | Description                                            | Example                                                                                                 |
|--------------------------|--------------------------------------------------------|---------------------------------------------------------------------------------------------------------|
| <code>abs( x )</code>    | absolute value of $x$                                  | <code>abs( 23.7 )</code> is 23.7<br><code>abs( 0.0 )</code> is 0.0<br><code>abs( -23.7 )</code> is 23.7 |
| <code>ceil( x )</code>   | rounds $x$ to the smallest integer not less than $x$   | <code>ceil( 9.2 )</code> is 10.0<br><code>ceil( -9.8 )</code> is -9.0                                   |
| <code>cos( x )</code>    | trigonometric cosine of $x$ ( $x$ in radians)          | <code>cos( 0.0 )</code> is 1.0                                                                          |
| <code>exp( x )</code>    | exponential method $e^x$                               | <code>exp( 1.0 )</code> is 2.71828<br><code>exp( 2.0 )</code> is 7.38906                                |
| <code>floor( x )</code>  | rounds $x$ to the largest integer not greater than $x$ | <code>floor( 9.2 )</code> is 9.0<br><code>floor( -9.8 )</code> is -10.0                                 |
| <code>log( x )</code>    | natural logarithm of $x$ (base $e$ )                   | <code>log( Math.E )</code> is 1.0<br><code>log( Math.E * Math.E )</code> is 2.0                         |
| <code>max( x, y )</code> | larger value of $x$ and $y$                            | <code>max( 2.3, 12.7 )</code> is 12.7<br><code>max( -2.3, -12.7 )</code> is -2.3                        |
| <code>min( x, y )</code> | smaller value of $x$ and $y$                           | <code>min( 2.3, 12.7 )</code> is 2.3<br><code>min( -2.3, -12.7 )</code> is -12.7                        |
| <code>pow( x, y )</code> | $x$ raised to the power $y$ (i.e., $x^y$ )             | <code>pow( 2.0, 7.0 )</code> is 128.0<br><code>pow( 9.0, 0.5 )</code> is 3.0                            |
| <code>sin( x )</code>    | trigonometric sine of $x$ ( $x$ in radians)            | <code>sin( 0.0 )</code> is 0.0                                                                          |
| <code>sqrt( x )</code>   | square root of $x$                                     | <code>sqrt( 900.0 )</code> is 30.0                                                                      |
| <code>tan( x )</code>    | trigonometric tangent of $x$ ( $x$ in radians)         | <code>tan( 0.0 )</code> is 0.0                                                                          |

**Fig. 6.2** | Math class methods.

### Math Class Constants PI and E

Class Math declares two fields that represent commonly used mathematical constants—**Math.PI** and **Math.E**. **Math.PI** (3.141592653589793) is the ratio of a circle’s circumference to its diameter. **Math.E** (2.718281828459045) is the base value for natural logarithms (calculated with `static Math` method `log`). These fields are declared in class Math with the modifiers `public`, `final` and `static`. Making them `public` allows you to use these fields in your own classes. Any field declared with keyword **final** is constant—its value cannot change after the field is initialized. **PI** and **E** are declared `final` because their values never change. Making these fields `static` allows them to be accessed via the class name Math and a dot (.) separator, just like class Math’s methods. Recall from Section 3.4 that when each object of a class maintains its own copy of an attribute, the field that represents the attribute is also known as an instance variable—each object (instance) of the class has a separate instance of the variable in memory. There are fields for which each object of a class does *not* have a separate instance of the field. That’s the case with `static` fields, which are also known as **class variables**. When objects of a class containing `static` fields are created, all

the objects of that class share one copy of the class's static fields. Together the class variables (i.e., static variables) and instance variables represent the fields of a class. You'll learn more about static fields in Section 8.11.

### Why Is Method `main` Declared `static`?

When you execute the Java Virtual Machine (JVM) with the `java` command, the JVM attempts to invoke the `main` method of the class you specify—when no objects of the class have been created. Declaring `main` as `static` allows the JVM to invoke `main` without creating an instance of the class. When you execute your application, you specify its class name as an argument to the command `java`, as in

```
java ClassName argument1 argument2 ...
```

The JVM loads the class specified by `ClassName` and uses that class name to invoke method `main`. In the preceding command, `ClassName` is a **command-line argument** to the JVM that tells it which class to execute. Following the `ClassName`, you can also specify a list of Strings (separated by spaces) as command-line arguments that the JVM will pass to your application. Such arguments might be used to specify options (e.g., a file name) to run the application. As you'll learn in Chapter 7, Arrays and ArrayLists, your application can access those command-line arguments and use them to customize the application.

## 6.4 Declaring Methods with Multiple Parameters

Methods often require more than one piece of information to perform their tasks. We now consider how to write your own methods with multiple parameters.

Figure 6.3 uses a method called `maximum` to determine and return the largest of three `double` values. In `main`, lines 14–18 prompt the user to enter three `double` values, then read them from the user. Line 21 calls method `maximum` (declared in lines 28–41) to determine the largest of the three values it receives as arguments. When method `maximum` returns the result to line 21, the program assigns `maximum`'s return value to local variable `result`. Then line 24 outputs the maximum value. At the end of this section, we'll discuss the use of operator `+` in line 24.

---

```

1 // Fig. 6.3: MaximumFinder.java
2 // Programmer-declared method maximum with three double parameters.
3 import java.util.Scanner;
4
5 public class MaximumFinder
6 {
7 // obtain three floating-point values and locate the maximum value
8 public static void main(String[] args)
9 {
10 // create Scanner for input from command window
11 Scanner input = new Scanner(System.in);
12
13 // prompt for and input three floating-point values
14 System.out.print(
15 "Enter three floating-point values separated by spaces: ");

```

---

**Fig. 6.3** | Programmer-declared method `maximum` with three `double` parameters. (Part 1 of 2.)



```

16 double number1 = input.nextDouble(); // read first double
17 double number2 = input.nextDouble(); // read second double
18 double number3 = input.nextDouble(); // read third double
19
20 // determine the maximum value
21 double result = maximum(number1, number2, number3);
22
23 // display maximum value
24 System.out.println("Maximum is: " + result);
25 } // end main
26
27 // returns the maximum of its three double parameters
28 public static double maximum(double x, double y, double z)
29 {
30 double maximumValue = x; // assume x is the largest to start
31
32 // determine whether y is greater than maximumValue
33 if (y > maximumValue)
34 maximumValue = y;
35
36 // determine whether z is greater than maximumValue
37 if (z > maximumValue)
38 maximumValue = z;
39
40 return maximumValue;
41 } // end method maximum
42 } // end class MaximumFinder

```

```

Enter three floating-point values separated by spaces: 9.35 2.74 5.1
Maximum is: 9.35

```

```

Enter three floating-point values separated by spaces: 5.8 12.45 8.32
Maximum is: 12.45

```

```

Enter three floating-point values separated by spaces: 6.46 4.12 10.54
Maximum is: 10.54

```

**Fig. 6.3** | Programmer-declared method `maximum` with three `double` parameters. (Part 2 of 2.)

### *The `public` and `static` Keywords*

Method `maximum`'s declaration begins with keyword `public` to indicate that the method is “available to the public”—it can be called from methods of other classes. The keyword `static` enables the `main` method (another `static` method) to call `maximum` as shown in line 21 without qualifying the method name with the class name `MaximumFinder`—`static` methods in the same class can call each other directly. Any other class that uses `maximum` must fully qualify the method name with the class name.

### *Method `maximum`*

Consider `maximum`'s declaration (lines 28–41). Line 28 indicates that it returns a `double` value, that the method's name is `maximum` and that the method requires three `double` pa-

parameters (*x*, *y* and *z*) to accomplish its task. Multiple parameters are specified as a comma-separated list. When `maximum` is called from line 21, the parameters *x*, *y* and *z* are initialized with the values of arguments `number1`, `number2` and `number3`, respectively. There must be one argument in the method call for each parameter in the method declaration. Also, each argument must be *consistent* with the type of the corresponding parameter. For example, a parameter of type `double` can receive values like 7.35, 22 or `-0.03456`, but not Strings like `"hello"` nor the boolean values `true` or `false`. Section 6.7 discusses the argument types that can be provided in a method call for each parameter of a primitive type.

To determine the maximum value, we begin with the assumption that parameter *x* contains the largest value, so line 30 declares local variable `maximumValue` and initializes it with the value of parameter *x*. Of course, it's possible that parameter *y* or *z* contains the actual largest value, so we must compare each of these values with `maximumValue`. The `if` statement at lines 33–34 determines whether *y* is greater than `maximumValue`. If so, line 34 assigns *y* to `maximumValue`. The `if` statement at lines 37–38 determines whether *z* is greater than `maximumValue`. If so, line 38 assigns *z* to `maximumValue`. At this point the largest of the three values resides in `maximumValue`, so line 40 returns that value to line 21. When program control returns to the point in the program where `maximum` was called, `maximum`'s parameters *x*, *y* and *z* no longer exist in memory.



### Software Engineering Observation 6.5

*Methods can return at most one value, but the returned value could be a reference to an object that contains many values.*



### Software Engineering Observation 6.6

*Variables should be declared as fields only if they're required for use in more than one method of the class or if the program should save their values between calls to the class's methods.*



### Common Programming Error 6.1

*Declaring method parameters of the same type as `float x, y` instead of `float x, float y` is a syntax error—a type is required for each parameter in the parameter list.*

## Implementing Method `maximum` by Reusing Method `Math.max`

The entire body of our `maximum` method could also be implemented with two calls to `Math.max`, as follows:

```
return Math.max(x, Math.max(y, z));
```

The first call to `Math.max` specifies arguments *x* and `Math.max( y, z )`. *Before* any method can be called, its arguments must be evaluated to determine their values. If an argument is a method call, the method call must be performed to determine its return value. So, in the preceding statement, `Math.max( y, z )` is evaluated to determine the maximum of *y* and *z*. Then the result is passed as the second argument to the other call to `Math.max`, which returns the larger of its two arguments. This is a good example of software reuse—we find the largest of three values by reusing `Math.max`, which finds the larger of two values. Note how concise this code is compared to lines 30–38 of Fig. 6.3.

## Assembling Strings with String Concatenation

Java allows you to assemble `String` objects into larger strings by using operators `+` or `+=`. This is known as **string concatenation**. When both operands of operator `+` are `String` ob-

jects, operator `+` creates a new `String` object in which the characters of the right operand are placed at the end of those in the left operand—e.g., the expression `"hello" + "there"` creates the `String` `"hello there"`.

In line 24 of Fig. 6.3, the expression `"Maximum is: " + result` uses operator `+` with operands of types `String` and `double`. *Every primitive value and object in Java has a String representation.* When one of the `+` operator's operands is a `String`, the other is converted to a `String`, then the two are *concatenated*. In line 24, the `double` value is converted to its `String` representation and placed at the end of the `String` `"Maximum is: "`. If there are any *trailing zeros* in a `double` value, these will be *discarded* when the number is converted to a `String`—for example 9.3500 would be represented as 9.35.

Primitive values used in `String` concatenation are converted to `Strings`. A `boolean` concatenated with a `String` is converted to the `String` `"true"` or `"false"`. All objects have a `toString` method that returns a `String` representation of the object. (We discuss `toString` in more detail in subsequent chapters.) When an object is concatenated with a `String`, the object's `toString` method is implicitly called to obtain the `String` representation of the object. `ToString` can be called explicitly.

You can break large `String` literals into several smaller `Strings` and place them on multiple lines of code for readability. In this case, the `Strings` can be reassembled using concatenation. We discuss the details of `Strings` in Chapter 16.



### Common Programming Error 6.2

*It's a syntax error to break a `String` literal across lines. If necessary, you can split a `String` into several smaller `Strings` and use concatenation to form the desired `String`.*



### Common Programming Error 6.3\

*Confusing the `+` operator used for string concatenation with the `+` operator used for addition can lead to strange results. Java evaluates the operands of an operator from left to right. For example, if integer variable `y` has the value 5, the expression `"y + 2 = " + y + 2` results in the string `"y + 2 = 52"`, not `"y + 2 = 7"`, because first the value of `y` (5) is concatenated to the string `"y + 2 = "`, then the value 2 is concatenated to the new larger string `"y + 2 = 5"`. The expression `"y + 2 = " + (y + 2)` produces the desired result `"y + 2 = 7"`.*

## 6.5 Notes on Declaring and Using Methods

There are three ways to call a method:

1. Using a method name by itself to call another method of the *same* class—such as `maximum(number1, number2, number3)` in line 21 of Fig. 6.3.
2. Using a variable that contains a reference to an object, followed by a dot (`.`) and the method name to call a non-static method of the referenced object—such as the method call in line 13 of Fig. 5.10, `myGradeBook.displayMessage()`, which calls a method of class `GradeBook` from the `main` method of `GradeBookTest`.
3. Using the class name and a dot (`.`) to call a static method of a class—such as `Math.sqrt(900.0)` in Section 6.3.

A static method can call *only* other static methods of the same class directly (i.e., using the method name by itself) and can manipulate *only* static variables in the same class directly. To access the class's non-static members, a static method must use a ref-

erence to an object of the class. Recall that `static` methods relate to a class as a whole, whereas non-`static` methods are associated with a specific instance (object) of the class and may manipulate the instance variables of that object. Many objects of a class, each with its own copies of the instance variables, may exist at the same time. Suppose a `static` method were to invoke a non-`static` method directly. How would the method know which object's instance variables to manipulate? What would happen if no objects of the class existed at the time the non-`static` method was invoked? Thus, Java does not allow a `static` method to access non-`static` members of the same class directly.

There are three ways to return control to the statement that calls a method. If the method does not return a result, control returns when the program flow reaches the method-ending right brace or when the statement

```
return;
```

is executed. If the method returns a result, the statement

```
return expression;
```

evaluates the *expression*, then returns the result to the caller.



#### Common Programming Error 6.4

*Declaring a method outside the body of a class declaration or inside the body of another method is a syntax error.*



#### Common Programming Error 6.5

*Placing a semicolon after the right parenthesis enclosing the parameter list of a method declaration is a syntax error.*



#### Common Programming Error 6.6

*Redeclaring a parameter as a local variable in the method's body is a compilation error.*



#### Common Programming Error 6.7

*Forgetting to return a value from a method that should return a value is a compilation error. If a return type other than `void` is specified, the method must contain a return statement that returns a value consistent with the method's return type. Returning a value from a method whose return type has been declared `void` is a compilation error.*

## 6.6 Method-Call Stack and Activation Records

To understand how Java performs method calls, we first need to consider a data structure (i.e., collection of related data items) known as a **stack**. You can think of a stack as analogous to a pile of dishes. When a dish is placed on the pile, it's normally placed at the top (referred to as **pushing** the dish onto the stack). Similarly, when a dish is removed from the pile, it's always removed from the top (referred to as **popping** the dish off the stack). Stacks are known as **last-in, first-out (LIFO) data structures**—the last item pushed (inserted) on the stack is the first item popped (removed) from the stack.

When a program calls a method, the called method must know how to return to its caller, so the return address of the calling method is pushed onto the **program-execution stack** (sometimes referred to as the **method-call stack**). If a series of method calls occurs, the successive return addresses are pushed onto the stack in last-in, first-out order so that each method can return to its caller.

The program-execution stack also contains the memory for the local variables used in each invocation of a method during a program's execution. This data, stored as a portion of the program-execution stack, is known as the **activation record** or **stack frame** of the method call. When a method call is made, the activation record for that method call is pushed onto the program-execution stack. When the method returns to its caller, the activation record for this method call is popped off the stack and those local variables are no longer known to the program. If a local variable holding a reference to an object is the only variable in the program with a reference to that object, then, when the activation record containing that local variable is popped off the stack, the object can no longer be accessed by the program and will eventually be deleted from memory by the JVM during “garbage collection.” We discuss garbage collection in Section 8.10.

Of course, a computer's memory is finite, so only a certain amount can be used to store activation records on the program-execution stack. If more method calls occur than can have their activation records stored, an error known as a **stack overflow** occurs.

## 6.7 Argument Promotion and Casting

Another important feature of method calls is **argument promotion**—converting an argument's value, if possible, to the type that the method expects to receive in its corresponding parameter. For example, a program can call `Math.sqrt` with an `int` argument even though a `double` argument is expected. The statement

```
System.out.println(Math.sqrt(4));
```

correctly evaluates `Math.sqrt(4)` and prints the value `2.0`. The method declaration's parameter list causes Java to convert the `int` value `4` to the `double` value `4.0` before passing the value to method `sqrt`. Such conversions may lead to compilation errors if Java's **promotion rules** are not satisfied. These rules specify which conversions are allowed—that is, which ones can be performed without losing data. In the `sqrt` example above, an `int` is converted to a `double` without changing its value. However, converting a `double` to an `int` truncates the fractional part of the `double` value—thus, part of the value is lost. Converting large integer types to small integer types (e.g., `long` to `int`, or `int` to `short`) may also result in changed values.

The promotion rules apply to expressions containing values of two or more primitive types and to primitive-type values passed as arguments to methods. Each value is promoted to the “highest” type in the expression. Actually, the expression uses a temporary copy of each value—the types of the original values remain unchanged. Figure 6.4 lists the primitive types and the types to which each can be promoted. The valid promotions for a given type are always to a type higher in the table. For example, an `int` can be promoted to the higher types `long`, `float` and `double`.

Converting values to types lower in the table of Fig. 6.4 will result in different values if the lower type cannot represent the value of the higher type (e.g., the `int` value `2000000` cannot be represented as a `short`, and any floating-point number with digits after its decimal point cannot be represented in an integer type such as `long`, `int` or `short`). There-

| Type    | Valid promotions                                               |
|---------|----------------------------------------------------------------|
| double  | None                                                           |
| float   | double                                                         |
| long    | float or double                                                |
| int     | long, float or double                                          |
| char    | int, long, float or double                                     |
| short   | int, long, float or double (but not char)                      |
| byte    | short, int, long, float or double (but not char)               |
| boolean | None (boolean values are not considered to be numbers in Java) |

**Fig. 6.4** | Promotions allowed for primitive types.

fore, in cases where information may be lost due to conversion, the Java compiler requires you to use a cast operator (introduced in Section 4.9) to explicitly force the conversion to occur—otherwise a compilation error occurs. This enables you to “take control” from the compiler. You essentially say, “I know this conversion might cause loss of information, but for my purposes here, that’s fine.” Suppose method `square` calculates the square of an integer and thus requires an `int` argument. To call `square` with a `double` argument named `doubleValue`, we would be required to write the method call as

```
square((int) doubleValue)
```

This method call explicitly casts (converts) a *copy* of variable `doubleValue`’s value to an integer for use in method `square`. Thus, if `doubleValue`’s value is 4.5, the method receives the value 4 and returns 16, not 20.25.



### Common Programming Error 6.8

*Converting a primitive-type value to another primitive type may change the value if the new type is not a valid promotion. For example, converting a floating-point value to an integer value may introduce truncation errors (loss of the fractional part) into the result.*

## 6.8 Java API Packages

As you’ve seen, Java contains many predefined classes that are grouped into categories of related classes called packages. Together, these are known as the Java Application Programming Interface (Java API), or the Java class library. A great strength of Java is the Java API’s thousands of classes. Some key Java API packages are described in Fig. 6.5, which represents only a small portion of the reusable components in the Java API.

The set of packages available in Java SE 6 is quite large. In addition to those summarized in Fig. 6.5, Java SE 6 includes packages for complex graphics, advanced graphical user interfaces, printing, advanced networking, security, database processing, multimedia, accessibility (for people with disabilities), concurrent programming, cryptography, XML processing and many other capabilities. For an overview of the packages in Java SE 6, visit

```
download.oracle.com/javase/6/docs/api/overview-summary.html
```

Many other packages are also available for download at `java.sun.com`.

| Package                           | Description                                                                                                                                                                                                                                                                                                                                                                                                                                                  |
|-----------------------------------|--------------------------------------------------------------------------------------------------------------------------------------------------------------------------------------------------------------------------------------------------------------------------------------------------------------------------------------------------------------------------------------------------------------------------------------------------------------|
| <code>java.applet</code>          | The <b>Java Applet Package</b> contains a class and several interfaces required to create Java applets—programs that execute in web browsers. Applets are discussed in Chapter 23, Applets and Java Web Start; interfaces are discussed in Chapter 10, Object-Oriented Programming: Polymorphism.)                                                                                                                                                           |
| <code>java.awt</code>             | The <b>Java Abstract Window Toolkit Package</b> contains the classes and interfaces required to create and manipulate GUIs in early versions of Java. In current versions, the Swing GUI components of the <code>javax.swing</code> packages are typically used instead. (Some elements of the <code>java.awt</code> package are discussed in Chapter 14, GUI Components: Part 1, Chapter 15, Graphics and Java 2D, and Chapter 25, GUI Components: Part 2.) |
| <code>java.awt.event</code>       | The <b>Java Abstract Window Toolkit Event Package</b> contains classes and interfaces that enable event handling for GUI components in both the <code>java.awt</code> and <code>javax.swing</code> packages. (See Chapter 14, GUI Components: Part 1, and Chapter 25, GUI Components: Part 2.)                                                                                                                                                               |
| <code>java.awt.geom</code>        | The <b>Java 2D Shapes Package</b> contains classes and interfaces for working with Java’s advanced two-dimensional graphics capabilities. (See Chapter 15, Graphics and Java 2D.)                                                                                                                                                                                                                                                                            |
| <code>java.io</code>              | The <b>Java Input/Output Package</b> contains classes and interfaces that enable programs to input and output data. (See Chapter 17, Files, Streams and Object Serialization.)                                                                                                                                                                                                                                                                               |
| <code>java.lang</code>            | The <b>Java Language Package</b> contains classes and interfaces (discussed bookwide) that are required by many Java programs. This package is imported by the compiler into all programs.                                                                                                                                                                                                                                                                   |
| <code>java.net</code>             | The <b>Java Networking Package</b> contains classes and interfaces that enable programs to communicate via computer networks like the Internet. (See Chapter 27, Networking.)                                                                                                                                                                                                                                                                                |
| <code>java.sql</code>             | The <b>JDBC Package</b> contains classes and interfaces for working with databases. (See Chapter 28, Accessing Databases with JDBC.)                                                                                                                                                                                                                                                                                                                         |
| <code>java.util</code>            | The <b>Java Utilities Package</b> contains utility classes and interfaces that enable such actions as date and time manipulations, random-number processing (class <code>Random</code> ) and the storing and processing of large amounts of data. (See Chapter 20, Generic Collections.)                                                                                                                                                                     |
| <code>java.util.concurrent</code> | The <b>Java Concurrency Package</b> contains utility classes and interfaces for implementing programs that can perform multiple tasks in parallel. (See Chapter 26, Multithreading.)                                                                                                                                                                                                                                                                         |
| <code>javax.media</code>          | The <b>Java Media Framework Package</b> contains classes and interfaces for working with Java’s multimedia capabilities. (See Chapter 24, Multimedia: Applets and Applications.)                                                                                                                                                                                                                                                                             |
| <code>javax.swing</code>          | The <b>Java Swing GUI Components Package</b> contains classes and interfaces for Java’s Swing GUI components that provide support for portable GUIs. (See Chapter 14, GUI Components: Part 1, and Chapter 25, GUI Components: Part 2.)                                                                                                                                                                                                                       |

**Fig. 6.5** | Java API packages (a subset). (Part 1 of 2.)

| Package                        | Description                                                                                                                                                                                                                                                                   |
|--------------------------------|-------------------------------------------------------------------------------------------------------------------------------------------------------------------------------------------------------------------------------------------------------------------------------|
| <code>javax.swing.event</code> | The <b>Java Swing Event Package</b> contains classes and interfaces that enable event handling (e.g., responding to button clicks) for GUI components in package <code>javax.swing</code> . (See Chapter 14, GUI Components: Part 1, and Chapter 25, GUI Components: Part 2.) |
| <code>javax.xml.ws</code>      | The <b>JAX-WS Package</b> contains classes and interfaces for working with web services in Java. (See Chapter 31, Web Services.)                                                                                                                                              |

**Fig. 6.5** | Java API packages (a subset). (Part 2 of 2.)

You can locate additional information about a predefined Java class’s methods in the Java API documentation at [download.oracle.com/javase/6/docs/api/](http://download.oracle.com/javase/6/docs/api/). When you visit this site, click the **Index** link to see an alphabetical listing of all the classes and methods in the Java API. Locate the class name and click its link to see the online description of the class. Click the **METHOD** link to see a table of the class’s methods. Each `static` method will be listed with the word “`static`” preceding its return type.

## 6.9 Case Study: Random-Number Generation

We now take a brief diversion into a popular type of programming application—simulation and game playing. In this and the next section, we develop a nicely structured game-playing program with multiple methods. The program uses most of the control statements presented thus far in the book and introduces several new programming concepts.

There’s something in the air of a casino that invigorates people—from the high rollers at the plush mahogany-and-felt craps tables to the quarter poppers at the one-armed bandits. It’s the **element of chance**, the possibility that luck will convert a pocketful of money into a mountain of wealth. The element of chance can be introduced in a program via an object of class **Random** (package `java.util`) or via the `static` method `random` of class `Math`. Objects of class `Random` can produce random `boolean`, `byte`, `float`, `double`, `int`, `long` and Gaussian values, whereas `Math` method `random` can produce only `double` values in the range  $0.0 \leq x < 1.0$ , where  $x$  is the value returned by method `random`. In the next several examples, we use objects of class `Random` to produce random values.

A new random-number generator object can be created as follows:

```
Random randomNumbers = new Random();
```

It can then be used to generate random `boolean`, `byte`, `float`, `double`, `int`, `long` and Gaussian values—we discuss only random `int` values here. For more information on the `Random` class, see [download.oracle.com/javase/6/docs/api/java/util/Random.html](http://download.oracle.com/javase/6/docs/api/java/util/Random.html).

Consider the following statement:

```
int randomValue = randomNumbers.nextInt();
```

`Random` method `nextInt` generates a random `int` value in the range  $-2,147,483,648$  to  $+2,147,483,647$ , inclusive. If it truly produces values at random, then every value in the range should have an equal chance (or probability) of being chosen each time `nextInt` is called. The numbers are actually **pseudorandom numbers**—a sequence of values pro-



duced by a complex mathematical calculation. The calculation uses the current time of day (which, of course, changes constantly) to **seed** the random-number generator such that each execution of a program yields a different sequence of random values.

The range of values produced directly by method `nextInt` generally differs from the range of values required in a particular Java application. For example, a program that simulates coin tossing might require only 0 for “heads” and 1 for “tails.” A program that simulates the rolling of a six-sided die might require random integers in the range 1–6. A program that randomly predicts the next type of spaceship (out of four possibilities) that will fly across the horizon in a video game might require random integers in the range 1–4. For cases like these, class `Random` provides another version of method `nextInt` that receives an `int` argument and returns a value from 0 up to, but not including, the argument’s value. For example, for coin tossing, the following statement returns 0 or 1.

```
int randomValue = randomNumbers.nextInt(2);
```

### *Rolling a Six-Sided Die*

To demonstrate random numbers, let’s develop a program that simulates 20 rolls of a six-sided die and displays the value of each roll. We begin by using `nextInt` to produce random values in the range 0–5, as follows:

```
face = randomNumbers.nextInt(6);
```

The argument 6—called the **scaling factor**—represents the number of unique values that `nextInt` should produce (in this case six—0, 1, 2, 3, 4 and 5). This manipulation is called **scaling** the range of values produced by `Random` method `nextInt`.

A six-sided die has the numbers 1–6 on its faces, not 0–5. So we **shift** the range of numbers produced by adding a **shifting value**—in this case 1—to our previous result, as in

```
face = 1 + randomNumbers.nextInt(6);
```

The shifting value (1) specifies the *first* value in the desired range of random integers. The preceding statement assigns `face` a random integer in the range 1–6.

Figure 6.6 shows two sample outputs which confirm that the results of the preceding calculation are integers in the range 1–6, and that each run of the program can produce a different sequence of random numbers. Line 3 imports class `Random` from the `java.util` package. Line 9 creates the `Random` object `randomNumbers` to produce random values. Line 16 executes 20 times in a loop to roll the die. The `if` statement (lines 21–22) in the loop starts a new line of output after every five numbers.

---

```

1 // Fig. 6.6: RandomIntegers.java
2 // Shifted and scaled random integers.
3 import java.util.Random; // program uses class Random
4
5 public class RandomIntegers
6 {
7 public static void main(String[] args)
8 {
9 Random randomNumbers = new Random(); // random number generator

```

---

**Fig. 6.6** | Shifted and scaled random integers. (Part 1 of 2.)

```

10 int face; // stores each random integer generated
11
12 // loop 20 times
13 for (int counter = 1; counter <= 20; counter++)
14 {
15 // pick random integer from 1 to 6
16 face = 1 + randomNumbers.nextInt(6);
17
18 System.out.printf("%d ", face); // display generated value
19
20 // if counter is divisible by 5, start a new line of output
21 if (counter % 5 == 0)
22 System.out.println();
23 } // end for
24 } // end main
25 } // end class RandomIntegers

```

```

1 5 3 6 2
5 2 6 5 2
4 4 4 2 6
3 1 6 2 2

```

```

6 5 4 2 6
1 2 5 1 3
6 3 2 2 1
6 4 2 6 4

```

**Fig. 6.6** | Shifted and scaled random integers. (Part 2 of 2.)

### *Rolling a Six-Sided Die 6,000,000 Times*

To show that the numbers produced by `nextInt` occur with approximately equal likelihood, let's simulate 6,000,000 rolls of a die with the application in Fig. 6.7. Each integer from 1 to 6 should appear approximately 1,000,000 times.

```

1 // Fig. 6.7: RollDie.java
2 // Roll a six-sided die 6,000,000 times.
3 import java.util.Random;
4
5 public class RollDie
6 {
7 public static void main(String[] args)
8 {
9 Random randomNumbers = new Random(); // random number generator
10
11 int frequency1 = 0; // maintains count of 1s rolled
12 int frequency2 = 0; // count of 2s rolled
13 int frequency3 = 0; // count of 3s rolled
14 int frequency4 = 0; // count of 4s rolled
15 int frequency5 = 0; // count of 5s rolled
16 int frequency6 = 0; // count of 6s rolled
17

```

**Fig. 6.7** | Roll a six-sided die 6,000,000 times. (Part 1 of 2.)

```

18 int face; // most recently rolled value
19
20 // tally counts for 6,000,000 rolls of a die
21 for (int roll = 1; roll <= 6000000; roll++)
22 {
23 face = 1 + randomNumbers.nextInt(6); // number from 1 to 6
24
25 // determine roll value 1-6 and increment appropriate counter
26 switch (face)
27 {
28 case 1:
29 ++frequency1; // increment the 1s counter
30 break;
31 case 2:
32 ++frequency2; // increment the 2s counter
33 break;
34 case 3:
35 ++frequency3; // increment the 3s counter
36 break;
37 case 4:
38 ++frequency4; // increment the 4s counter
39 break;
40 case 5:
41 ++frequency5; // increment the 5s counter
42 break;
43 case 6:
44 ++frequency6; // increment the 6s counter
45 break; // optional at end of switch
46 } // end switch
47 } // end for
48
49 System.out.println("Face\tFrequency"); // output headers
50 System.out.printf("1\t%d\n2\t%d\n3\t%d\n4\t%d\n5\t%d\n6\t%d\n",
51 frequency1, frequency2, frequency3, frequency4,
52 frequency5, frequency6);
53 } // end main
54 } // end class RollDie

```

| Face | Frequency |
|------|-----------|
| 1    | 999501    |
| 2    | 1000412   |
| 3    | 998262    |
| 4    | 1000820   |
| 5    | 1002245   |
| 6    | 998760    |

| Face | Frequency |
|------|-----------|
| 1    | 999647    |
| 2    | 999557    |
| 3    | 999571    |
| 4    | 1000376   |
| 5    | 1000701   |
| 6    | 1000148   |

**Fig. 6.7** | Roll a six-sided die 6,000,000 times. (Part 2 of 2.)

As the sample outputs show, scaling and shifting the values produced by `nextInt` enables the program to simulate rolling a six-sided die. The application uses nested control statements (the `switch` is nested inside the `for`) to determine the number of times each side of the die appears. The `for` statement (lines 21–47) iterates 6,000,000 times. During each iteration, line 23 produces a random value from 1 to 6. That value is then used as the controlling expression (line 26) of the `switch` statement (lines 26–46). Based on the face value, the `switch` statement increments one of the six counter variables during each iteration of the loop. When we study arrays in Chapter 7, we'll show an elegant way to replace the entire `switch` statement in this program with a single statement! This `switch` statement has no `default` case, because we have a case for every possible die value that the expression in line 23 could produce. Run the program, and observe the results. As you'll see, every time you run this program, it produces different results.

### 6.9.1 Generalized Scaling and Shifting of Random Numbers

Previously, we simulated the rolling of a six-sided die with the statement

```
face = 1 + randomNumbers.nextInt(6);
```

This statement always assigns to variable `face` an integer in the range  $1 \leq \text{face} \leq 6$ . The width of this range (i.e., the number of consecutive integers in the range) is 6, and the starting number in the range is 1. In the preceding statement, the width of the range is determined by the number 6 that's passed as an argument to `Random` method `nextInt`, and the starting number of the range is the number 1 that's added to `randomNumberGenerator.nextInt(6)`. We can generalize this result as

```
number = shiftingValue + randomNumbers.nextInt(scalingFactor);
```

where *shiftingValue* specifies the first number in the desired range of consecutive integers and *scalingFactor* specifies how many numbers are in the range.

It's also possible to choose integers at random from sets of values other than ranges of consecutive integers. For example, to obtain a random value from the sequence 2, 5, 8, 11 and 14, you could use the statement

```
number = 2 + 3 * randomNumbers.nextInt(5);
```

In this case, `randomNumberGenerator.nextInt(5)` produces values in the range 0–4. Each value produced is multiplied by 3 to produce a number in the sequence 0, 3, 6, 9 and 12. We add 2 to that value to shift the range of values and obtain a value from the sequence 2, 5, 8, 11 and 14. We can generalize this result as

```
number = shiftingValue +
 differenceBetweenValues * randomNumbers.nextInt(scalingFactor);
```

where *shiftingValue* specifies the first number in the desired range of values, *differenceBetweenValues* represents the constant difference between consecutive numbers in the sequence and *scalingFactor* specifies how many numbers are in the range.

### 6.9.2 Random-Number Repeatability for Testing and Debugging

Class `Random`'s methods actually generate pseudorandom numbers based on complex mathematical calculations—the sequence of numbers appears to be random. The calculation that produces the numbers uses the time of day as a **seed value** to change the se-

quence's starting point. Each new `Random` object seeds itself with a value based on the computer system's clock at the time the object is created, enabling each execution of a program to produce a different sequence of random numbers.

When debugging an application, it's often useful to repeat the exact same sequence of pseudorandom numbers during each execution of the program. This repeatability enables you to prove that your application is working for a specific sequence of random numbers before you test it with different sequences of random numbers. When repeatability is important, you can create a `Random` object as follows:

```
Random randomNumbers = new Random(seedValue);
```

The `seedValue` argument (of type `long`) seeds the random-number calculation. If the same `seedValue` is used every time, the `Random` object produces the same sequence of numbers. You can set a `Random` object's seed at any time during program execution by calling the object's `set` method, as in

```
randomNumbers.set(seedValue);
```



### Error-Prevention Tip 6.2

While developing a program, create the `Random` object with a specific seed value to produce a repeatable sequence of numbers each time the program executes. If a logic error occurs, fix the error and test the program again with the same seed value—this allows you to reconstruct the same sequence of numbers that caused the error. Once the logic errors have been removed, create the `Random` object without using a seed value, causing the `Random` object to generate a new sequence of random numbers each time the program executes.

## 6.10 Case Study: A Game of Chance; Introducing Enumerations

A popular game of chance is a dice game known as craps, which is played in casinos and back alleys throughout the world. The rules of the game are straightforward:

*You roll two dice. Each die has six faces, which contain one, two, three, four, five and six spots, respectively. After the dice have come to rest, the sum of the spots on the two upward faces is calculated. If the sum is 7 or 11 on the first throw, you win. If the sum is 2, 3 or 12 on the first throw (called “craps”), you lose (i.e., the “house” wins). If the sum is 4, 5, 6, 8, 9 or 10 on the first throw, that sum becomes your “point.” To win, you must continue rolling the dice until you “make your point” (i.e., roll that same point value). You lose by rolling a 7 before making your point.*

Figure 6.8 simulates the game of craps, using methods to implement the game's logic. The main method (lines 21–65) calls the `rollDice` method (lines 68–81) as necessary to roll the dice and compute their sum. The sample outputs show winning and losing on the first roll, and winning and losing on a subsequent roll.

```
1 // Fig. 6.8: Craps.java
2 // Craps class simulates the dice game craps.
3 import java.util.Random;
```

**Fig. 6.8** | Craps class simulates the dice game craps. (Part 1 of 3.)

```
4
5 public class Craps
6 {
7 // create random number generator for use in method rollDice
8 private static final Random randomNumbers = new Random();
9
10 // enumeration with constants that represent the game status
11 private enum Status { CONTINUE, WON, LOST };
12
13 // constants that represent common rolls of the dice
14 private static final int SNAKE_EYES = 2;
15 private static final int TREY = 3;
16 private static final int SEVEN = 7;
17 private static final int YO_LEVEN = 11;
18 private static final int BOX_CARS = 12;
19
20 // plays one game of craps
21 public static void main(String[] args)
22 {
23 int myPoint = 0; // point if no win or loss on first roll
24 Status gameStatus; // can contain CONTINUE, WON or LOST
25
26 int sumOfDice = rollDice(); // first roll of the dice
27
28 // determine game status and point based on first roll
29 switch (sumOfDice)
30 {
31 case SEVEN: // win with 7 on first roll
32 case YO_LEVEN: // win with 11 on first roll
33 gameStatus = Status.WON;
34 break;
35 case SNAKE_EYES: // lose with 2 on first roll
36 case TREY: // lose with 3 on first roll
37 case BOX_CARS: // lose with 12 on first roll
38 gameStatus = Status.LOST;
39 break;
40 default: // did not win or lose, so remember point
41 gameStatus = Status.CONTINUE; // game is not over
42 myPoint = sumOfDice; // remember the point
43 System.out.printf("Point is %d\n", myPoint);
44 break; // optional at end of switch
45 } // end switch
46
47 // while game is not complete
48 while (gameStatus == Status.CONTINUE) // not WON or LOST
49 {
50 sumOfDice = rollDice(); // roll dice again
51
52 // determine game status
53 if (sumOfDice == myPoint) // win by making point
54 gameStatus = Status.WON;
```

**Fig. 6.8** | Craps class simulates the dice game craps. (Part 2 of 3.)

```

55 else
56 if (sumOfDice == SEVEN) // lose by rolling 7 before point
57 gameStatus = Status.LOST;
58 } // end while
59
60 // display won or lost message
61 if (gameStatus == Status.WON)
62 System.out.println("Player wins");
63 else
64 System.out.println("Player loses");
65 } // end main
66
67 // roll dice, calculate sum and display results
68 public static int rollDice()
69 {
70 // pick random die values
71 int die1 = 1 + randomNumbers.nextInt(6); // first die roll
72 int die2 = 1 + randomNumbers.nextInt(6); // second die roll
73
74 int sum = die1 + die2; // sum of die values
75
76 // display results of this roll
77 System.out.printf("Player rolled %d + %d = %d\n",
78 die1, die2, sum);
79
80 return sum; // return sum of dice
81 } // end method rollDice
82 } // end class Craps

```

```

Player rolled 5 + 6 = 11
Player wins

```

```

Player rolled 5 + 4 = 9
Point is 9
Player rolled 4 + 2 = 6
Player rolled 3 + 6 = 9
Player wins

```

```

Player rolled 1 + 2 = 3
Player loses

```

```

Player rolled 2 + 6 = 8
Point is 8
Player rolled 5 + 1 = 6
Player rolled 2 + 1 = 3
Player rolled 1 + 6 = 7
Player loses

```

**Fig. 6.8** | Craps class simulates the dice game craps. (Part 3 of 3.)

### Method `rollDice`

In the rules of the game, the player must roll two dice on the first roll and must do the same on all subsequent rolls. We declare method `rollDice` (Fig. 6.8, lines 68–81) to roll the dice and compute and print their sum. Method `rollDice` is declared once, but it's called from two places (lines 26 and 50) in `main`, which contains the logic for one complete game of craps. Method `rollDice` takes no arguments, so it has an empty parameter list. Each time it's called, `rollDice` returns the sum of the dice, so the return type `int` is indicated in the method header (line 68). Although lines 71 and 72 look the same (except for the die names), they do not necessarily produce the same result. Each of these statements produces a random value in the range 1–6. Variable `randomNumbers` (used in lines 71–72) is *not* declared in the method. Instead it's declared as a `private static final` variable of the class and initialized in line 8. This enables us to create one `Random` object that's reused in each call to `rollDice`. If there were a program that contained multiple instances of class `Craps`, they'd all share this one `Random` object.

### Method `main`'s Local Variables

The game is reasonably involved. The player may win or lose on the first roll, or may win or lose on any subsequent roll. Method `main` (lines 21–65) uses local variable `myPoint` (line 23) to store the “point” if the player does not win or lose on the first roll, local variable `gameStatus` (line 24) to keep track of the overall game status and local variable `sumOfDice` (line 26) to hold the sum of the dice for the most recent roll. Variable `myPoint` is initialized to 0 to ensure that the application will compile. If you do not initialize `myPoint`, the compiler issues an error, because `myPoint` is not assigned a value in *every* case of the `switch` statement, and thus the program could try to use `myPoint` before it's assigned a value. By contrast, `gameStatus` *is* assigned a value in *every* case of the `switch` statement—thus, it's guaranteed to be initialized before it's used and does not need to be initialized.

### enum Type Status

Local variable `gameStatus` (line 24) is declared to be of a new type called `Status` (declared at line 11). Type `Status` is a private member of class `Craps`, because `Status` will be used only in that class. `Status` is a type called an **enumeration**, which, in its simplest form, declares a set of constants represented by identifiers. An enumeration is a special kind of class that's introduced by the keyword **enum** and a type name (in this case, `Status`). As with classes, braces delimit an enum declaration's body. Inside the braces is a comma-separated list of **enumeration constants**, each representing a unique value. The identifiers in an enum must be unique. You'll learn more about enumerations in Chapter 8.



#### Good Programming Practice 6.1

*It's a convention to use only uppercase letters in the names of enumeration constants. This makes them stand out and reminds you that they are not variables.*

Variables of type `Status` can be assigned only the three constants declared in the enumeration (line 11) or a compilation error will occur. When the game is won, the program sets local variable `gameStatus` to `Status.WON` (lines 33 and 54). When the game is lost, the program sets local variable `gameStatus` to `Status.LOST` (lines 38 and 57). Otherwise, the program sets local variable `gameStatus` to `Status.CONTINUE` (line 41) to indicate that the game is not over and the dice must be rolled again.





### Good Programming Practice 6.2

Using enumeration constants (like `Status.WON`, `Status.LOST` and `Status.CONTINUE`) rather than literal values (such as 0, 1 and 2) makes programs easier to read and maintain.

#### Logic of the main Method

Line 26 in `main` calls `rollDice`, which picks two random values from 1 to 6, displays the values of the first die, the second die and their sum, and returns the sum. Method `main` next enters the `switch` statement (lines 29–45), which uses the `sumOfDice` value from line 26 to determine whether the game has been won or lost, or should continue with another roll. The values that result in a win or loss on the first roll are declared as `public static final int` constants in lines 14–18. The identifier names use casino parlance for these sums. These constants, like `enum` constants, are declared by convention with all capital letters, to make them stand out in the program. Lines 31–34 determine whether the player won on the first roll with `SEVEN` (7) or `YO_LEVEN` (11). Lines 35–39 determine whether the player lost on the first roll with `SNAKE_EYES` (2), `TREY` (3), or `BOX_CARS` (12). After the first roll, if the game is not over, the default case (lines 40–44) sets `gameStatus` to `Status.CONTINUE`, saves `sumOfDice` in `myPoint` and displays the point.

If we're still trying to "make our point" (i.e., the game is continuing from a prior roll), lines 48–58 execute. Line 50 rolls the dice again. If `sumOfDice` matches `myPoint` (line 53), line 54 sets `gameStatus` to `Status.WON`, then the loop terminates because the game is complete. If `sumOfDice` is `SEVEN` (line 56), line 57 sets `gameStatus` to `Status.LOST`, and the loop terminates because the game is complete. When the game completes, lines 61–64 display a message indicating whether the player won or lost, and the program terminates.

The program uses the various program-control mechanisms we've discussed. The `Craps` class uses two methods—`main` and `rollDice` (called twice from `main`)—and the `switch`, `while`, `if...else` and nested `if` control statements. Note also the use of multiple case labels in the `switch` statement to execute the same statements for sums of `SEVEN` and `YO_LEVEN` (lines 31–32) and for sums of `SNAKE_EYES`, `TREY` and `BOX_CARS` (lines 35–37).

#### Why Some Constants Are Not Defined as enum Constants

You might be wondering why we declared the sums of the dice as `public final static int` constants rather than as `enum` constants. The reason is that the program must compare the `int` variable `sumOfDice` (line 26) to these constants to determine the outcome of each roll. Suppose we declared `enum Sum` containing constants (e.g., `Sum.SNAKE_EYES`) representing the five sums used in the game, then used these constants in the `switch` statement (lines 29–45). Doing so would prevent us from using `sumOfDice` as the `switch` statement's controlling expression, because Java does *not* allow an `int` to be compared to an enumeration constant. To achieve the same functionality as the current program, we would have to use a variable `currentSum` of type `Sum` as the `switch`'s controlling expression. Unfortunately, Java does not provide an easy way to convert an `int` value to a particular `enum` constant. This could be done with a separate `switch` statement. Clearly this would be cumbersome and not improve the program's readability (thus defeating the purpose of using an `enum`).

## 6.11 Scope of Declarations

You've seen declarations of various Java entities, such as classes, methods, variables and parameters. Declarations introduce names that can be used to refer to such Java entities. The

**scope** of a declaration is the portion of the program that can refer to the declared entity by its name. Such an entity is said to be “in scope” for that portion of the program. This section introduces several important scope issues.

The basic scope rules are as follows:

1. The scope of a parameter declaration is the body of the method in which the declaration appears.
2. The scope of a local-variable declaration is from the point at which the declaration appears to the end of that block.
3. The scope of a local-variable declaration that appears in the initialization section of a `for` statement’s header is the body of the `for` statement and the other expressions in the header.
4. A method or field’s scope is the entire body of the class. This enables non-static methods of a class to use the fields and other methods of the class.

Any block may contain variable declarations. If a local variable or parameter in a method has the same name as a field of the class, the field is “hidden” until the block terminates execution—this is called **shadowing**. In Chapter 8, we discuss how to access shadowed fields.



### Error-Prevention Tip 6.3

*Use different names for fields and local variables to help prevent subtle logic errors that occur when a method is called and a local variable of the method shadows a field in the class.*

Figure 6.9 demonstrates scoping issues with fields and local variables. Line 7 declares and initializes the field `x` to 1. This field is shadowed (hidden) in any block (or method) that declares a local variable named `x`. Method `main` (lines 11–23) declares a local variable `x` (line 13) and initializes it to 5. This local variable’s value is output to show that the field `x` (whose value is 1) is shadowed in `main`. The program declares two other methods—`useLocalVariable` (lines 26–35) and `useField` (lines 38–45)—that each take no arguments and return no results. Method `main` calls each method twice (lines 17–20). Method `useLocalVariable` declares local variable `x` (line 28). When `useLocalVariable` is first called (line 17), it creates local variable `x` and initializes it to 25 (line 28), outputs the value of `x` (lines 30–31), increments `x` (line 32) and outputs the value of `x` again (lines 33–34). When `useLocalVariable` is called a second time (line 19), it recreates local variable `x` and re-initializes it to 25, so the output of each `useLocalVariable` call is identical.

```

1 // Fig. 6.9: Scope.java
2 // Scope class demonstrates field and local variable scopes.
3
4 public class Scope
5 {
6 // field that is accessible to all methods of this class
7 private static int x = 1;
8

```

**Fig. 6.9** | Scope class demonstrates field and local variable scopes. (Part 1 of 2.)

```

 9 // method main creates and initializes local variable x
10 // and calls methods useLocalVariable and useField
11 public static void main(String[] args)
12 {
13 int x = 5; // method's local variable x shadows field x
14
15 System.out.printf("local x in main is %d\n", x);
16
17 useLocalVariable(); // useLocalVariable has local x
18 useField(); // useField uses class Scope's field x
19 useLocalVariable(); // useLocalVariable reinitializes local x
20 useField(); // class Scope's field x retains its value
21
22 System.out.printf("\nlocal x in main is %d\n", x);
23 } // end main
24
25 // create and initialize local variable x during each call
26 public static void useLocalVariable()
27 {
28 int x = 25; // initialized each time useLocalVariable is called
29
30 System.out.printf(
31 "\nlocal x on entering method useLocalVariable is %d\n", x);
32 ++x; // modifies this method's local variable x
33 System.out.printf(
34 "local x before exiting method useLocalVariable is %d\n", x);
35 } // end method useLocalVariable
36
37 // modify class Scope's field x during each call
38 public static void useField()
39 {
40 System.out.printf(
41 "\nfield x on entering method useField is %d\n", x);
42 x *= 10; // modifies class Scope's field x
43 System.out.printf(
44 "field x before exiting method useField is %d\n", x);
45 } // end method useField
46 } // end class Scope

```

```

local x in main is 5

local x on entering method useLocalVariable is 25
local x before exiting method useLocalVariable is 26

field x on entering method useField is 1
field x before exiting method useField is 10

local x on entering method useLocalVariable is 25
local x before exiting method useLocalVariable is 26

field x on entering method useField is 10
field x before exiting method useField is 100

local x in main is 5

```

**Fig. 6.9** | Scope class demonstrates field and local variable scopes. (Part 2 of 2.)

Method `useField` does not declare any local variables. Therefore, when it refers to `x`, field `x` (line 7) of the class is used. When method `useField` is first called (line 18), it outputs the value (1) of field `x` (lines 40–41), multiplies the field `x` by 10 (line 42) and outputs the value (10) of field `x` again (lines 43–44) before returning. The next time method `useField` is called (line 20), the field has its modified value (10), so the method outputs 10, then 100. Finally, in method `main`, the program outputs the value of local variable `x` again (line 22) to show that none of the method calls modified `main`'s local variable `x`, because the methods all referred to variables named `x` in other scopes.

## 6.12 Method Overloading

Methods of the same name can be declared in the same class, as long as they have different sets of parameters (determined by the number, types and order of the parameters)—this is called **method overloading**. When an overloaded method is called, the compiler selects the appropriate method by examining the number, types and order of the arguments in the call. Method overloading is commonly used to create several methods with the *same* name that perform the *same* or *similar* tasks, but on different types or different numbers of arguments. For example, `Math` methods `abs`, `min` and `max` (summarized in Section 6.3) are overloaded with four versions each:

1. One with two `double` parameters.
2. One with two `float` parameters.
3. One with two `int` parameters.
4. One with two `long` parameters.

Our next example demonstrates declaring and invoking overloaded methods. We demonstrate overloaded constructors in Chapter 8.

### Declaring Overloaded Methods

Class `MethodOverload` (Fig. 6.10) includes two overloaded versions of method `square`—one that calculates the square of an `int` (and returns an `int`) and one that calculates the square of a `double` (and returns a `double`). Although these methods have the same name and similar parameter lists and bodies, think of them simply as *different* methods. It may help to think of the method names as “square of `int`” and “square of `double`,” respectively.

---

```

1 // Fig. 6.10: MethodOverload.java
2 // Overloaded method declarations.
3
4 public class MethodOverload
5 {
6 // test overloaded square methods
7 public static void main(String[] args)
8 {
9 System.out.printf("Square of integer 7 is %d\n", square(7));
10 System.out.printf("Square of double 7.5 is %f\n", square(7.5));
11 } // end main
12
```

---

**Fig. 6.10** | Overloaded method declarations. (Part 1 of 2.)

```

13 // square method with int argument
14 public static int square(int intValue)
15 {
16 System.out.printf("\nCalled square with int argument: %d\n",
17 intValue);
18 return intValue * intValue;
19 } // end method square with int argument
20
21 // square method with double argument
22 public static double square(double doubleValue)
23 {
24 System.out.printf("\nCalled square with double argument: %f\n",
25 doubleValue);
26 return doubleValue * doubleValue;
27 } // end method square with double argument
28 } // end class MethodOverload

```

```

Called square with int argument: 7
Square of integer 7 is 49

Called square with double argument: 7.500000
Square of double 7.5 is 56.250000

```

**Fig. 6.10** | Overloaded method declarations. (Part 2 of 2.)

Line 9 invokes method `square` with the argument 7. Literal integer values are treated as type `int`, so the method call in line 9 invokes the version of `square` at lines 14–19 that specifies an `int` parameter. Similarly, line 10 invokes method `square` with the argument 7.5. Literal floating-point values are treated as type `double`, so the method call in line 10 invokes the version of `square` at lines 22–27 that specifies a `double` parameter. Each method first outputs a line of text to prove that the proper method was called in each case. The values in lines 10 and 24 are displayed with the format specifier `%f`. We did not specify a precision in either case. By default, floating-point values are displayed with six digits of precision if the precision is not specified in the format specifier.

### *Distinguishing Between Overloaded Methods*

The compiler distinguishes overloaded methods by their **signature**—a combination of the method’s name and the number, types and order of its parameters. If the compiler looked only at method names during compilation, the code in Fig. 6.10 would be ambiguous—the compiler would not know how to distinguish between the two `square` methods (lines 14–19 and 22–27). Internally, the compiler uses longer method names that include the original method name, the types of each parameter and the exact order of the parameters to determine whether the methods in a class are unique in that class.

For example, in Fig. 6.10, the compiler might use the logical name “square of `int`” for the `square` method that specifies an `int` parameter and “square of `double`” for the `square` method that specifies a `double` parameter (the actual names the compiler uses are messier). If `method1`’s declaration begins as

```
void method1(int a, float b)
```

then the compiler might use the logical name “method1 of `int` and `float`.” If the parameters are specified as

```
void method1(float a, int b)
```

then the compiler might use the logical name “method1 of float and int.” The *order* of the parameter types is important—the compiler considers the preceding two method1 headers to be distinct.

### Return Types of Overloaded Methods

In discussing the logical names of methods used by the compiler, we did not mention the return types of the methods. *Method calls cannot be distinguished by return type.* If you had overloaded methods that differed only by their return types and you called one of the methods in a standalone statement as in:

```
square(2);
```

the compiler would *not* be able to determine the version of the method to call, because the return value is ignored. When two methods have the same signature and different return types, the compiler issues an error message indicating that the method is already defined in the class. Overloaded methods *can* have different return types if the methods have different parameter lists. Also, overloaded methods need *not* have the same number of parameters.



### Common Programming Error 6.9

*Declaring overloaded methods with identical parameter lists is a compilation error regardless of whether the return types are different.*

## 6.13 (Optional) GUI and Graphics Case Study: Colors and Filled Shapes

Although you can create many interesting designs with just lines and basic shapes, class `Graphics` provides many more capabilities. The next two features we introduce are colors and filled shapes. Adding color enriches the drawings a user sees on the computer screen. Shapes can be filled with solid colors.

Colors displayed on computer screens are defined by their red, green, and blue components (called **RGB values**) that have integer values from 0 to 255. The higher the value of a component color, the richer that shade will be in the final color. Java uses class `Color` in package `java.awt` to represent colors using their RGB values. For convenience, class `Color` (package `java.awt`) contains 13 predefined static `Color` objects—`BLACK`, `BLUE`, `CYAN`, `DARK_GRAY`, `GRAY`, `GREEN`, `LIGHT_GRAY`, `MAGENTA`, `ORANGE`, `PINK`, `RED`, `WHITE` and `YELLOW`. Each can be accessed via the class name and a dot (`.`) as in `Color.RED`. Class `Color` also contains a constructor of the form:

```
public Color(int r, int g, int b)
```

so you can create custom colors by specifying the values of the red, green and blue components.

Graphics methods `fillRect` and `fillOval` draw filled rectangles and ovals, respectively. These have the same parameters as `drawRect` and `drawOval`; the first two are the coordinates for the upper-left corner of the shape, while the next two determine the width and height. The example in Fig. 6.11 and Fig. 6.12 demonstrates colors and filled shapes by drawing and displaying a yellow smiley face on the screen.

```
1 // Fig. 6.11: DrawSmiley.java
2 // Demonstrates filled shapes.
3 import java.awt.Color;
4 import java.awt.Graphics;
5 import javax.swing.JPanel;
6
7 public class DrawSmiley extends JPanel
8 {
9 public void paintComponent(Graphics g)
10 {
11 super.paintComponent(g);
12
13 // draw the face
14 g.setColor(Color.YELLOW);
15 g.fillOval(10, 10, 200, 200);
16
17 // draw the eyes
18 g.setColor(Color.BLACK);
19 g.fillOval(55, 65, 30, 30);
20 g.fillOval(135, 65, 30, 30);
21
22 // draw the mouth
23 g.fillOval(50, 110, 120, 60);
24
25 // "touch up" the mouth into a smile
26 g.setColor(Color.YELLOW);
27 g.fillRect(50, 110, 120, 30);
28 g.fillOval(50, 120, 120, 40);
29 } // end method paintComponent
30 } // end class DrawSmiley
```

**Fig. 6.11** | Drawing a smiley face using colors and filled shapes.

The `import` statements in lines 3–5 of Fig. 6.11 import classes `Color`, `Graphics` and `JPanel`. Class `DrawSmiley` (lines 7–30) uses class `Color` to specify drawing colors, and uses class `Graphics` to draw.

Class `JPanel` again provides the area in which we draw. Line 14 in method `paintComponent` uses `Graphics` method `setColor` to set the current drawing color to `Color.YELLOW`. Method `setColor` requires one argument, the `Color` to set as the drawing color. In this case, we use the predefined object `Color.YELLOW`.

Line 15 draws a circle with diameter 200 to represent the face—when the width and height arguments are identical, method `fillOval` draws a circle. Next, line 18 sets the color to `Color.Black`, and lines 19–20 draw the eyes. Line 23 draws the mouth as an oval, but this is not quite what we want.

To create a happy face, we’ll “touch up” the mouth. Line 26 sets the color to `Color.YELLOW`, so any shapes we draw will blend in with the face. Line 27 draws a rectangle that’s half the mouth’s height. This “erases” the top half of the mouth, leaving just the bottom half. To create a better smile, line 28 draws another oval to slightly cover the upper portion of the mouth. Class `DrawSmileyTest` (Fig. 6.12) creates and displays a `JFrame` containing the drawing. When the `JFrame` is displayed, the system calls method `paintComponent` to draw the smiley face.

```
1 // Fig. 6.12: DrawSmileyTest.java
2 // Test application that displays a smiley face.
3 import javax.swing.JFrame;
4
5 public class DrawSmileyTest
6 {
7 public static void main(String[] args)
8 {
9 DrawSmiley panel = new DrawSmiley();
10 JFrame application = new JFrame();
11
12 application.setDefaultCloseOperation(JFrame.EXIT_ON_CLOSE);
13 application.add(panel);
14 application.setSize(230, 250);
15 application.setVisible(true);
16 } // end main
17 } // end class DrawSmileyTest
```

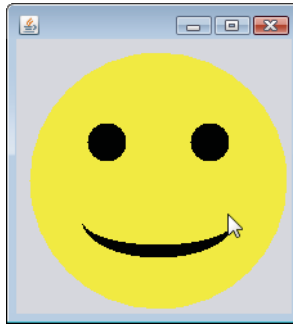

**Fig. 6.12** | Creating JFrame to display a smiley face.

### *GUI and Graphics Case Study Exercises*

**6.1** Using method `fillOval`, draw a bull's-eye that alternates between two random colors, as in Fig. 6.13. Use the constructor `Color( int r, int g, int b )` with random arguments to generate random colors.

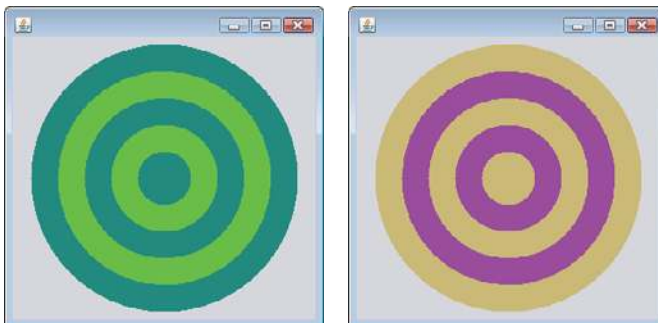

**Fig. 6.13** | A bull's-eye with two alternating, random colors.



**6.2** Create a program that draws 10 random filled shapes in random colors, positions and sizes (Fig. 6.14). Method `paintComponent` should contain a loop that iterates 10 times. In each iteration, the loop should determine whether to draw a filled rectangle or an oval, create a random color and choose coordinates and dimensions at random. The coordinates should be chosen based on the panel's width and height. Lengths of sides should be limited to half the width or height of the window.

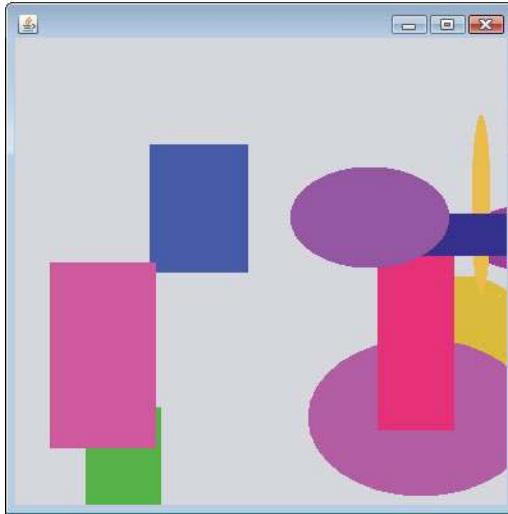

**Fig. 6.14** | Randomly generated shapes.

## 6.14 Wrap-Up

In this chapter, you learned more about method declarations. You also learned the difference between non-`static` and `static` methods and how to call `static` methods by preceding the method name with the name of the class in which it appears and the dot (`.`) separator. You learned how to use operators `+` and `+=` to perform string concatenations. We discussed how the method-call stack and activation records keep track of the methods that have been called and where each method must return to when it completes its task. We also discussed Java's promotion rules for converting implicitly between primitive types and how to perform explicit conversions with cast operators. Next, you learned about some of the commonly used packages in the Java API.

You saw how to declare named constants using both `enum` types and `public static final` variables. You used class `Random` to generate random numbers for simulations. You also learned about the scope of fields and local variables in a class. Finally, you learned that multiple methods in one class can be overloaded by providing methods with the same name and different signatures. Such methods can be used to perform the same or similar tasks using different types or different numbers of parameters.

In Chapter 7, you'll learn how to maintain lists and tables of data in arrays. You'll see a more elegant implementation of the application that rolls a die 6,000,000 times and two enhanced versions of our `GradeBook` case study that you studied in Chapters 3–5. You'll also learn how to access an application's command-line arguments that are passed to method `main` when an application begins execution.

## Summary

### Section 6.1 Introduction

- Experience has shown that the best way to develop and maintain a large program is to construct it from small, simple pieces, or modules. This technique is called divide and conquer (p. 198).

### Section 6.2 Program Modules in Java

- Methods are declared within classes. Classes are typically grouped into packages so they can be imported and reused.
- Methods allow you to modularize a program by separating its tasks into self-contained units. The statements in a method are written only once and hidden from other methods.
- Using existing methods as building blocks to create new programs is a form of software reusability (p. 199) that allows you to avoid repeating code within a program.

### Section 6.3 *static* Methods, *static* Fields and *Class Math*

- A method call specifies the name of the method to call and provides the arguments that the called method requires to perform its task. When the method call completes, the method returns either a result, or simply control, to its caller.
- A class may contain *static* methods to perform common tasks that do not require an object of the class. Any data a *static* method might require to perform its tasks can be sent to the method as arguments in a method call. A *static* method is called by specifying the name of the class in which the method is declared followed by a dot (.) and the method name, as in

*ClassName.methodName( arguments )*

- Class *Math* provides *static* methods for performing common mathematical calculations.
- The constant *Math.PI* (p. 201; 3.141592653589793) is the ratio of a circle's circumference to its diameter. The constant *Math.E* (p. 201; 2.718281828459045) is the base value for natural logarithms (calculated with *static Math* method *log*).
- *Math.PI* and *Math.E* are declared with the modifiers *public*, *final* and *static*. Making them *public* allows you to use these fields in your own classes. A field declared with keyword *final* (p. 201) is constant—its value cannot be changed after it's initialized. Both *PI* and *E* are declared *final* because their values never change. Making these fields *static* allows them to be accessed via the class name *Math* and a dot (.) separator, just like class *Math*'s methods.
- All the objects of a class share one copy of the class's *static* fields. Together the class variables (p. 201) and instance variables represent the fields of a class.
- When you execute the Java Virtual Machine (JVM) with the *java* command, the JVM loads the class you specify and uses that class name to invoke method *main*. You can specify additional command-line arguments (p. 202) that the JVM will pass to your application.
- You can place a *main* method in every class you declare—only the *main* method in the class you use to execute the application will be called by the *java* command.

### Section 6.4 Declaring Methods with Multiple Parameters

- When a method is called, the program makes a copy of the method's argument values and assigns them to the method's corresponding parameters. When program control returns to the point in the program where the method was called, the method's parameters are removed from memory.
- A method can return at most one value, but the returned value could be a reference to an object that contains many values.
- Variables should be declared as fields of a class only if they're required for use in more than one method of the class or if the program should save their values between calls to the class's methods.

- When a method has more than one parameter, the parameters are specified as a comma-separated list. There must be one argument in the method call for each parameter in the method declaration. Also, each argument must be consistent with the type of the corresponding parameter. If a method does not accept arguments, the parameter list is empty.
- Strings can be concatenated (p. 204) using operator `+`, which places the characters of the right operand at the end of those in the left operand.
- Every primitive value and object in Java has a `String` representation. When an object is concatenated with a `String`, the object is converted to a `String`, then the two `Strings` are concatenated.
- If a `boolean` is concatenated with a `String`, the word `"true"` or the word `"false"` is used to represent the `boolean` value.
- All objects in Java have a special method named `toString` that returns a `String` representation of the object's contents. When an object is concatenated with a `String`, the JVM implicitly calls the object's `toString` method to obtain the string representation of the object.
- You can break large `String` literals into several smaller `Strings` and place them on multiple lines of code for readability, then reassemble the `Strings` using concatenation.

### Section 6.5 Notes on Declaring and Using Methods

- There are three ways to call a method—using a method name by itself to call another method of the same class; using a variable that contains a reference to an object, followed by a dot (`.`) and the method name to call a method of the referenced object; and using the class name and a dot (`.`) to call a static method of a class.
- There are three ways to return control to a statement that calls a method. If the method does not return a result, control returns when the program flow reaches the method-ending right brace or when the statement

```
return;
```

is executed. If the method returns a result, the statement

```
return expression;
```

evaluates the *expression*, then immediately returns the resulting value to the caller.

### Section 6.6 Method-Call Stack and Activation Records

- Stacks (p. 206) are known as last-in, first-out (LIFO) data structures—the last item pushed (inserted) on the stack is the first item popped (removed) from the stack.
- A called method must know how to return to its caller, so the return address of the calling method is pushed onto the program-execution stack when the method is called. If a series of method calls occurs, the successive return addresses are pushed onto the stack in last-in, first-out order so that the last method to execute will be the first to return to its caller.
- The program-execution stack (p. 207) contains the memory for the local variables used in each invocation of a method during a program's execution. This data is known as the method call's activation record or stack frame. When a method call is made, the activation record for that method call is pushed onto the program-execution stack. When the method returns to its caller, its activation record call is popped off the stack and the local variables are no longer known to the program.
- If there are more method calls than can have their activation records stored on the program-execution stack, an error known as a stack overflow (p. 207) occurs. The application will compile correctly, but its execution causes a stack overflow.

### Section 6.7 Argument Promotion and Casting

- Argument promotion (p. 207) converts an argument's value to the type that the method expects to receive in its corresponding parameter.

- Promotion rules (p. 207) apply to expressions containing values of two or more primitive types and to primitive-type values passed as arguments to methods. Each value is promoted to the “highest” type in the expression. In cases where information may be lost due to conversion, the Java compiler requires you to use a cast operator to explicitly force the conversion to occur.

### Section 6.9 Case Study: Random-Number Generation

- Objects of class `Random` (p. 210; package `java.util`) can produce random values. `Math` method `random` can produce `double` values in the range  $0.0 \leq x < 1.0$ , where  $x$  is the value returned.
- `Random` method `nextInt` (p. 210) generates a random `int` value in the range  $-2,147,483,648$  to  $+2,147,483,647$ . The values returned by `nextInt` are actually pseudorandom numbers (p. 210)—a sequence of values produced by a complex mathematical calculation. That calculation uses the current time of day to seed (p. 211) the random-number generator such that each execution of a program yields a different sequence of random values.
- Class `Random` provides another version of method `nextInt` that receives an `int` argument and returns a value from 0 up to, but not including, the argument’s value.
- Random numbers in a range (p. 211) can be generated with

```
number = shiftingValue + randomNumbers.nextInt(scalingFactor);
```

where *shiftingValue* specifies the first number in the desired range of consecutive integers, and *scalingFactor* specifies how many numbers are in the range.

- Random numbers can be chosen from nonconsecutive integer ranges, as in

```
number = shiftingValue +
 differenceBetweenValues * randomNumbers.nextInt(scalingFactor);
```

where *shiftingValue* specifies the first number in the range of values, *differenceBetweenValues* represents the difference between consecutive numbers in the sequence and *scalingFactor* specifies how many numbers are in the range.

- For debugging, it’s sometimes useful to repeat the sequence of pseudorandom numbers during each program execution. To do so, pass a `long` integer value to the `Random` object’s constructor. Using the same seed every time the program executes, produces the same sequence of numbers.

### Section 6.10 Case Study: A Game of Chance; Introducing Enumerations

- An enumeration (p. 218) is introduced by the keyword `enum` and a type name. As with any class, braces (`{` and `}`) delimit the body of an `enum` declaration. Inside the braces is a comma-separated list of enumeration constants, each representing a unique value. The identifiers in an `enum` must be unique. Variables of an `enum` type can be assigned only constants of that `enum` type.
- Constants can also be declared as `public final static` variables. Such constants are declared by convention with all capital letters to make them stand out in the program.

### Section 6.11 Scope of Declarations

- Scope (p. 220) is the portion of the program in which an entity, such as a variable or a method, can be referred to by its name. Such an entity is said to be “in scope” for that portion of the program.
- The scope of a parameter declaration is the body of the method in which the declaration appears.
- The scope of a local-variable declaration is from the point at which the declaration appears to the end of that block.
- The scope of a local-variable declaration that appears in the initialization section of a `for` statement’s header is the body of the `for` statement and the other expressions in the header.
- The scope of a method or field of a class is the entire body of the class. This enables a class’s methods to use simple names to call the class’s other methods and to access the class’s fields.

- Any block may contain variable declarations. If a local variable or parameter in a method has the same name as a field, the field is shadowed (p. 220) until the block terminates execution.

### Section 6.12 Method Overloading

- Java allows overloaded methods (p. 222) in a class, as long as the methods have different sets of parameters (determined by the number, order and types of the parameters).
- Overloaded methods are distinguished by their signatures (p. 223)—combinations of the methods' names and the number, types and order of their parameters.

## Self-Review Exercises

- 6.1** Fill in the blanks in each of the following statements:
- A method is invoked with a(n) \_\_\_\_\_.
  - A variable known only within the method in which it's declared is called a(n) \_\_\_\_\_.
  - The \_\_\_\_\_ statement in a called method can be used to pass the value of an expression back to the calling method.
  - The keyword \_\_\_\_\_ indicates that a method does not return a value.
  - Data can be added or removed only from the \_\_\_\_\_ of a stack.
  - Stacks are known as \_\_\_\_\_ data structures; the last item pushed (inserted) on the stack is the first item popped (removed) from the stack.
  - The three ways to return control from a called method to a caller are \_\_\_\_\_, \_\_\_\_\_ and \_\_\_\_\_.
  - An object of class \_\_\_\_\_ produces random numbers.
  - The program-execution stack contains the memory for local variables on each invocation of a method during a program's execution. This data, stored as a portion of the program-execution stack, is known as the \_\_\_\_\_ or \_\_\_\_\_ of the method call.
  - If there are more method calls than can be stored on the program-execution stack, an error known as a(n) \_\_\_\_\_ occurs.
  - The \_\_\_\_\_ of a declaration is the portion of a program that can refer to the entity in the declaration by name.
  - It's possible to have several methods with the same name that each operate on different types or numbers of arguments. This feature is called method \_\_\_\_\_.
  - The program-execution stack is also referred to as the \_\_\_\_\_ stack.
- 6.2** For the class Craps in Fig. 6.8, state the scope of each of the following entities:
- the variable `randomNumbers`.
  - the variable `die1`.
  - the method `rollDice`.
  - the method `main`.
  - the variable `sumOfDice`.
- 6.3** Write an application that tests whether the examples of the Math class method calls shown in Fig. 6.2 actually produce the indicated results.
- 6.4** Give the method header for each of the following methods:
- Method `hypotenuse`, which takes two double-precision, floating-point arguments `side1` and `side2` and returns a double-precision, floating-point result.
  - Method `smallest`, which takes three integers `x`, `y` and `z` and returns an integer.
  - Method `instructions`, which does not take any arguments and does not return a value. [Note: Such methods are commonly used to display instructions to a user.]
  - Method `intToFloat`, which takes integer argument `number` and returns a `float`.
- 6.5** Find the error in each of the following program segments. Explain how to correct the error.

```

a) void g()
{
 System.out.println("Inside method g");

 void h()
 {
 System.out.println("Inside method h");
 }
}

b) int sum(int x, int y)
{
 int result;
 result = x + y;
}

c) void f(float a);
{
 float a;
 System.out.println(a);
}

d) void product()
{
 int a = 6, b = 5, c = 4, result;
 result = a * b * c;
 System.out.printf("Result is %d\n", result);
 return result;
}

```

**6.6** Write a complete Java application to prompt the user for the double radius of a sphere, and call method `sphereVolume` to calculate and display the volume of the sphere. Use the following statement to calculate the volume:

```
double volume = (4.0 / 3.0) * Math.PI * Math.pow(radius, 3)
```

## Answers to Self-Review Exercises

**6.1** a) method call. b) local variable. c) return. d) void. e) top. f) last-in, first-out (LIFO). g) return; or return *expression*; or encountering the closing right brace of a method. h) Random. i) activation record, stack frame. j) stack overflow. k) scope. l) method overloading. m) method call.

**6.2** a) class body. b) block that defines method `rollDice`'s body. c) class body. d) class body. e) block that defines method `main`'s body.

**6.3** The following solution demonstrates the `Math` class methods in Fig. 6.2:

```

1 // Exercise 6.3: MathTest.java
2 // Testing the Math class methods.
3
4 public class MathTest
5 {
6 public static void main(String[] args)
7 {
8 System.out.printf("Math.abs(23.7) = %f\n", Math.abs(23.7));
9 System.out.printf("Math.abs(0.0) = %f\n", Math.abs(0.0));
10 System.out.printf("Math.abs(-23.7) = %f\n", Math.abs(-23.7));
11 System.out.printf("Math.ceil(9.2) = %f\n", Math.ceil(9.2));

```

```

12 System.out.printf("Math.ceil(-9.8) = %f\n", Math.ceil(-9.8));
13 System.out.printf("Math.cos(0.0) = %f\n", Math.cos(0.0));
14 System.out.printf("Math.exp(1.0) = %f\n", Math.exp(1.0));
15 System.out.printf("Math.exp(2.0) = %f\n", Math.exp(2.0));
16 System.out.printf("Math.floor(9.2) = %f\n", Math.floor(9.2));
17 System.out.printf("Math.floor(-9.8) = %f\n",
18 Math.floor(-9.8));
19 System.out.printf("Math.log(Math.E) = %f\n",
20 Math.log(Math.E));
21 System.out.printf("Math.log(Math.E * Math.E) = %f\n",
22 Math.log(Math.E * Math.E));
23 System.out.printf("Math.max(2.3, 12.7) = %f\n",
24 Math.max(2.3, 12.7));
25 System.out.printf("Math.max(-2.3, -12.7) = %f\n",
26 Math.max(-2.3, -12.7));
27 System.out.printf("Math.min(2.3, 12.7) = %f\n",
28 Math.min(2.3, 12.7));
29 System.out.printf("Math.min(-2.3, -12.7) = %f\n",
30 Math.min(-2.3, -12.7));
31 System.out.printf("Math.pow(2.0, 7.0) = %f\n",
32 Math.pow(2.0, 7.0));
33 System.out.printf("Math.pow(9.0, 0.5) = %f\n",
34 Math.pow(9.0, 0.5));
35 System.out.printf("Math.sin(0.0) = %f\n", Math.sin(0.0));
36 System.out.printf("Math.sqrt(900.0) = %f\n",
37 Math.sqrt(900.0));
38 System.out.printf("Math.tan(0.0) = %f\n", Math.tan(0.0));
39 } // end main
40 } // end class MathTest

```

```

Math.abs(23.7) = 23.700000
Math.abs(0.0) = 0.000000
Math.abs(-23.7) = 23.700000
Math.ceil(9.2) = 10.000000
Math.ceil(-9.8) = -9.000000
Math.cos(0.0) = 1.000000
Math.exp(1.0) = 2.718282
Math.exp(2.0) = 7.389056
Math.floor(9.2) = 9.000000
Math.floor(-9.8) = -10.000000
Math.log(Math.E) = 1.000000
Math.log(Math.E * Math.E) = 2.000000
Math.max(2.3, 12.7) = 12.700000
Math.max(-2.3, -12.7) = -2.300000
Math.min(2.3, 12.7) = 2.300000
Math.min(-2.3, -12.7) = -12.700000
Math.pow(2.0, 7.0) = 128.000000
Math.pow(9.0, 0.5) = 3.000000
Math.sin(0.0) = 0.000000
Math.sqrt(900.0) = 30.000000
Math.tan(0.0) = 0.000000

```

- 6.4**
- `double` hypotenuse( `double` side1, `double` side2 )
  - `int` smallest( `int` x, `int` y, `int` z )
  - `void` instructions()
  - `float` intToFloat( `int` number )
- 6.5**
- Error: Method h is declared within method g.  
Correction: Move the declaration of h outside the declaration of g.
  - Error: The method is supposed to return an integer, but does not.  
Correction: Delete the variable result, and place the statement

```
return x + y;
```

in the method, or add the following statement at the end of the method body:

```
return result;
```

- c) Error: The semicolon after the right parenthesis of the parameter list is incorrect, and the parameter `a` should not be redeclared in the method.

Correction: Delete the semicolon after the right parenthesis of the parameter list, and delete the declaration `float a;`

- d) Error: The method returns a value when it's not supposed to.

Correction: Change the return type from `void` to `int`.

**6.6** The following solution calculates the volume of a sphere, using the radius entered by the user:

```

1 // Exercise 6.6: Sphere.java
2 // Calculate the volume of a sphere.
3 import java.util.Scanner;
4
5 public class Sphere
6 {
7 // obtain radius from user and display volume of sphere
8 public static void main(String[] args)
9 {
10 Scanner input = new Scanner(System.in);
11
12 System.out.print("Enter radius of sphere: ");
13 double radius = input.nextDouble();
14
15 System.out.printf("Volume is %f\n", sphereVolume(radius));
16 } // end method determineSphereVolume
17
18 // calculate and return sphere volume
19 public static double sphereVolume(double radius)
20 {
21 double volume = (4.0 / 3.0) * Math.PI * Math.pow(radius, 3);
22 return volume;
23 } // end method sphereVolume
24 } // end class Sphere

```

```

Enter radius of sphere: 4
Volume is 268.082573

```

## Exercises

**6.7** What is the value of `x` after each of the following statements is executed?

- `x = Math.abs( 7.5 );`
- `x = Math.floor( 7.5 );`
- `x = Math.abs( 0.0 );`
- `x = Math.ceil( 0.0 );`
- `x = Math.abs( -6.4 );`
- `x = Math.ceil( -6.4 );`
- `x = Math.ceil( -Math.abs( -8 + Math.floor( -5.5 ) ) );`

**6.8** (*Parking Charges*) A parking garage charges a \$2.00 minimum fee to park for up to three hours. The garage charges an additional \$0.50 per hour for each hour *or part thereof* in excess of three hours. The maximum charge for any given 24-hour period is \$10.00. Assume that no car parks for longer than 24 hours at a time. Write an application that calculates and displays the parking charges for each customer who parked in the garage yesterday. You should enter the hours parked for each



customer. The program should display the charge for the current customer and should calculate and display the running total of yesterday's receipts. It should use the method `calculateCharges` to determine the charge for each customer.

**6.9 (Rounding Numbers)** `Math.floor` can be used to round values to the nearest integer—e.g.,

```
y = Math.floor(x + 0.5);
```

will round the number `x` to the nearest integer and assign the result to `y`. Write an application that reads `double` values and uses the preceding statement to round each of the numbers to the nearest integer. For each number processed, display both the original number and the rounded number.

**6.10 (Rounding Numbers)** To round numbers to specific decimal places, use a statement like

```
y = Math.floor(x * 10 + 0.5) / 10;
```

which rounds `x` to the tenths position (i.e., the first position to the right of the decimal point), or

```
y = Math.floor(x * 100 + 0.5) / 100;
```

which rounds `x` to the hundredths position (i.e., the second position to the right of the decimal point). Write an application that defines four methods for rounding a number `x` in various ways:

- `roundToInteger( number )`
- `roundToTenths( number )`
- `roundToHundredths( number )`
- `roundToThousandths( number )`

For each value read, your program should display the original value, the number rounded to the nearest integer, the number rounded to the nearest tenth, the number rounded to the nearest hundredth and the number rounded to the nearest thousandth.

**6.11** Answer each of the following questions:

- What does it mean to choose numbers “at random”?
- Why is the `nextInt` method of class `Random` useful for simulating games of chance?
- Why is it often necessary to scale or shift the values produced by a `Random` object?
- Why is computerized simulation of real-world situations a useful technique?

**6.12** Write statements that assign random integers to the variable `n` in the following ranges:

- $1 \leq n \leq 2$ .
- $1 \leq n \leq 100$ .
- $0 \leq n \leq 9$ .
- $1000 \leq n \leq 1112$ .
- $-1 \leq n \leq 1$ .
- $-3 \leq n \leq 11$ .

**6.13** Write statements that will display a random number from each of the following sets:

- 2, 4, 6, 8, 10.
- 3, 5, 7, 9, 11.
- 6, 10, 14, 18, 22.

**6.14 (Exponentiation)** Write a method `integerPower(base, exponent)` that returns the value of  $base^{exponent}$

For example, `integerPower(3, 4)` calculates  $3^4$  (or  $3 * 3 * 3 * 3$ ). Assume that `exponent` is a positive, nonzero integer and that `base` is an integer. Use a `for` or `while` statement to control the calculation. Do not use any `Math` class methods. Incorporate this method into an application that reads integer values for `base` and `exponent` and performs the calculation with the `integerPower` method.

**6.15 (Hypotenuse Calculations)** Define a method `hypotenuse` that calculates the hypotenuse of a right triangle when the lengths of the other two sides are given. The method should take two ar-

gments of type `double` and return the hypotenuse as a `double`. Incorporate this method into an application that reads values for `side1` and `side2` and performs the calculation with the hypotenuse method. Use `Math` methods `pow` and `sqrt` to determine the length of the hypotenuse for each of the triangles in Fig. 6.15. [Note: Class `Math` also provides method `hypot` to perform this calculation.]

| Triangle | Side 1 | Side 2 |
|----------|--------|--------|
| 1        | 3.0    | 4.0    |
| 2        | 5.0    | 12.0   |
| 3        | 8.0    | 15.0   |

**Fig. 6.15** | Values for the sides of triangles in Exercise 6.15.

**6.16** (*Multiples*) Write a method `isMultiple` that determines, for a pair of integers, whether the second integer is a multiple of the first. The method should take two integer arguments and return `true` if the second is a multiple of the first and `false` otherwise. [Hint: Use the remainder operator.] Incorporate this method into an application that inputs a series of pairs of integers (one pair at a time) and determines whether the second value in each pair is a multiple of the first.

**6.17** (*Even or Odd*) Write a method `isEven` that uses the remainder operator (`%`) to determine whether an integer is even. The method should take an integer argument and return `true` if the integer is even and `false` otherwise. Incorporate this method into an application that inputs a sequence of integers (one at a time) and determines whether each is even or odd.

**6.18** (*Displaying a Square of Asterisks*) Write a method `squareOfAsterisks` that displays a solid square (the same number of rows and columns) of asterisks whose side is specified in integer parameter `side`. For example, if `side` is 4, the method should display

```



```

Incorporate this method into an application that reads an integer value for `side` from the user and outputs the asterisks with the `squareOfAsterisks` method.

**6.19** (*Displaying a Square of Any Character*) Modify the method created in Exercise 6.18 to receive a second parameter of type `char` called `fillCharacter`. Form the square using the `char` provided as an argument. Thus, if `side` is 5 and `fillCharacter` is `#`, the method should display

```
#####
#####
#####
#####
#####
```

Use the following statement (in which `input` is a `Scanner` object) to read a character from the user at the keyboard:

```
char fill = input.next().charAt(0);
```

**6.20** (*Circle Area*) Write an application that prompts the user for the radius of a circle and uses a method called `circleArea` to calculate the area of the circle.

**6.21** (*Separating Digits*) Write methods that accomplish each of the following tasks:

- Calculate the integer part of the quotient when integer `a` is divided by integer `b`.
- Calculate the integer remainder when integer `a` is divided by integer `b`.

- c) Use the methods developed in parts (a) and (b) to write a method `displayDigits` that receives an integer between 1 and 99999 and displays it as a sequence of digits, separating each pair of digits by two spaces. For example, the integer 4562 should appear as

```
4 5 6 2
```

Incorporate the methods into an application that inputs an integer and calls `displayDigits` by passing the method the integer entered. Display the results.

**6.22** (*Temperature Conversions*) Implement the following integer methods:

- a) Method `celsius` returns the Celsius equivalent of a Fahrenheit temperature, using the calculation

```
celsius = 5.0 / 9.0 * (fahrenheit - 32);
```

- b) Method `fahrenheit` returns the Fahrenheit equivalent of a Celsius temperature, using the calculation

```
fahrenheit = 9.0 / 5.0 * celsius + 32;
```

- c) Use the methods from parts (a) and (b) to write an application that enables the user either to enter a Fahrenheit temperature and display the Celsius equivalent or to enter a Celsius temperature and display the Fahrenheit equivalent.

**6.23** (*Find the Minimum*) Write a method `minimum3` that returns the smallest of three floating-point numbers. Use the `Math.min` method to implement `minimum3`. Incorporate the method into an application that reads three values from the user, determines the smallest value and displays the result.

**6.24** (*Perfect Numbers*) An integer number is said to be a *perfect number* if its factors, including 1 (but not the number itself), sum to the number. For example, 6 is a perfect number, because  $6 = 1 + 2 + 3$ . Write a method `isPerfect` that determines if parameter `number` is a perfect number. Use this method in an application that displays all the perfect numbers between 1 and 1000. Display the factors of each perfect number to confirm that the number is indeed perfect. Challenge the computing power of your computer by testing numbers much larger than 1000. Display the results.

**6.25** (*Prime Numbers*) A positive integer is *prime* if it's divisible by only 1 and itself. For example, 2, 3, 5 and 7 are prime, but 4, 6, 8 and 9 are not. The number 1, by definition, is not prime.

- Write a method that determines whether a number is prime.
- Use this method in an application that determines and displays all the prime numbers less than 10,000. How many numbers up to 10,000 do you have to test to ensure that you've found all the primes?
- Initially, you might think that  $n/2$  is the upper limit for which you must test to see whether a number  $n$  is prime, but you need only go as high as the square root of  $n$ . Rewrite the program, and run it both ways.

**6.26** (*Reversing Digits*) Write a method that takes an integer value and returns the number with its digits reversed. For example, given the number 7631, the method should return 1367. Incorporate the method into an application that reads a value from the user and displays the result.

**6.27** (*Greatest Common Divisor*) The *greatest common divisor* (*GCD*) of two integers is the largest integer that evenly divides each of the two numbers. Write a method `gcd` that returns the greatest common divisor of two integers. [*Hint:* You might want to use Euclid's algorithm. You can find information about it at [en.wikipedia.org/wiki/Euclidean\\_algorithm](http://en.wikipedia.org/wiki/Euclidean_algorithm).] Incorporate the method into an application that reads two values from the user and displays the result.

**6.28** Write a method `qualityPoints` that inputs a student's average and returns 4 if it's 90–100, 3 if 80–89, 2 if 70–79, 1 if 60–69 and 0 if lower than 60. Incorporate the method into an application that reads a value from the user and displays the result.

**6.29** (*Coin Tossing*) Write an application that simulates coin tossing. Let the program toss a coin each time the user chooses the “Toss Coin” menu option. Count the number of times each side of the coin appears. Display the results. The program should call a separate method `flip` that takes no arguments and returns a value from a `Coin` enum (`HEADS` and `TAILS`). [*Note:* If the program realistically simulates coin tossing, each side of the coin should appear approximately half the time.]

**6.30** (*Guess the Number*) Write an application that plays “guess the number” as follows: Your program chooses the number to be guessed by selecting a random integer in the range 1 to 1000. The application displays the prompt `Guess a number between 1 and 1000`. The player inputs a first guess. If the player's guess is incorrect, your program should display `Too high. Try again.` or `Too low. Try again.` to help the player “zero in” on the correct answer. The program should prompt the user for the next guess. When the user enters the correct answer, display `Congratulations. You guessed the number!`, and allow the user to choose whether to play again. [*Note:* The guessing technique employed in this problem is similar to a binary search, which is discussed in Chapter 19, Searching, Sorting and Big O.]

**6.31** (*Guess the Number Modification*) Modify the program of Exercise 6.30 to count the number of guesses the player makes. If the number is 10 or fewer, display `Either you know the secret or you got lucky!` If the player guesses the number in 10 tries, display `Aha! You know the secret!` If the player makes more than 10 guesses, display `You should be able to do better! Why should it take no more than 10 guesses? Well, with each “good guess,” the player should be able to eliminate half of the numbers, then half of the remaining numbers, and so on.`

**6.32** (*Distance Between Points*) Write method `distance` to calculate the distance between two points  $(x1, y1)$  and  $(x2, y2)$ . All numbers and return values should be of type `double`. Incorporate this method into an application that enables the user to enter the coordinates of the points.

**6.33** (*Craps Game Modification*) Modify the craps program of Fig. 6.8 to allow wagering. Initialize variable `bankBalance` to 1000 dollars. Prompt the player to enter a wager. Check that wager is less than or equal to `bankBalance`, and if it's not, have the user reenter `wager` until a valid wager is entered. Then, run one game of craps. If the player wins, increase `bankBalance` by `wager` and display the new `bankBalance`. If the player loses, decrease `bankBalance` by `wager`, display the new `bankBalance`, check whether `bankBalance` has become zero and, if so, display the message `Sorry. You busted!` As the game progresses, display various messages to create some “chatter,” such as `Oh, you're going for broke, huh?` or `Aw c'mon, take a chance!` or `You're up big. Now's the time to cash in your chips!`. Implement the “chatter” as a separate method that randomly chooses the string to display.

**6.34** (*Table of Binary, Octal and Hexadecimal Numbers*) Write an application that displays a table of the binary, octal and hexadecimal equivalents of the decimal numbers in the range 1 through 256. If you aren't familiar with these number systems, read Appendix H first.

## Making a Difference

As computer costs decline, it becomes feasible for every student, regardless of economic circumstance, to have a computer and use it in school. This creates exciting possibilities for improving the educational experience of all students worldwide, as suggested by the next five exercises. [*Note:* Check out initiatives such as the One Laptop Per Child Project ([www.laptop.org](http://www.laptop.org)). Also, research “green” laptops—what are some key “going green” characteristics of these devices? Look into the Electronic Product Environmental Assessment Tool ([www.epeat.net](http://www.epeat.net)), which can help you assess the “greenness” of desktops, notebooks and monitors to help you decide which products to purchase.]

**6.35** (*Computer-Assisted Instruction*) The use of computers in education is referred to as *computer-assisted instruction* (CAI). Write a program that will help an elementary school student learn

multiplication. Use a Random object to produce two positive one-digit integers. The program should then prompt the user with a question, such as

```
How much is 6 times 7?
```

The student then inputs the answer. Next, the program checks the student's answer. If it's correct, display the message "Very good!" and ask another multiplication question. If the answer is wrong, display the message "No. Please try again." and let the student try the same question repeatedly until the student finally gets it right. A separate method should be used to generate each new question. This method should be called once when the application begins execution and each time the user answers the question correctly.

**6.36** (*Computer-Assisted Instruction: Reducing Student Fatigue*) One problem in CAI environments is student fatigue. This can be reduced by varying the computer's responses to hold the student's attention. Modify the program of Exercise 6.35 so that various comments are displayed for each answer as follows:

Possible responses to a correct answer:

```
Very good!
Excellent!
Nice work!
Keep up the good work!
```

Possible responses to an incorrect answer:

```
No. Please try again.
Wrong. Try once more.
Don't give up!
No. Keep trying.
```

Use random-number generation to choose a number from 1 to 4 that will be used to select one of the four appropriate responses to each correct or incorrect answer. Use a switch statement to issue the responses.

**6.37** (*Computer-Assisted Instruction: Monitoring Student Performance*) More sophisticated computer-assisted instruction systems monitor the student's performance over a period of time. The decision to begin a new topic is often based on the student's success with previous topics. Modify the program of Exercise 6.36 to count the number of correct and incorrect responses typed by the student. After the student types 10 answers, your program should calculate the percentage that are correct. If the percentage is lower than 75%, display "Please ask your teacher for extra help.", then reset the program so another student can try it. If the percentage is 75% or higher, display "Congratulations, you are ready to go to the next level!", then reset the program so another student can try it.

**6.38** (*Computer-Assisted Instruction: Difficulty Levels*) Exercise 6.35 through Exercise 6.37 developed a computer-assisted instruction program to help teach an elementary school student multiplication. Modify the program to allow the user to enter a difficulty level. At a difficulty level of 1, the program should use only single-digit numbers in the problems; at a difficulty level of 2, numbers as large as two digits, and so on.

**6.39** (*Computer-Assisted Instruction: Varying the Types of Problems*) Modify the program of Exercise 6.38 to allow the user to pick a type of arithmetic problem to study. An option of 1 means addition problems only, 2 means subtraction problems only, 3 means multiplication problems only, 4 means division problems only and 5 means a random mixture of all these types.

# 7

## Arrays and ArrayLists

*Begin at the beginning, ... and go on till you come to the end: then stop.*

—Lewis Carroll

*Now go, write it before them in a table, and note it in a book.*

—Isaiah 30:8

*To go beyond is as wrong as to fall short.*

—Confucius 1

### Objectives

In this chapter you'll learn:

- What arrays are.
- To use arrays to store data in and retrieve data from lists and tables of values.
- To declare arrays, initialize arrays and refer to individual elements of arrays.
- To iterate through arrays with the enhanced `for` statement.
- To pass arrays to methods.
- To declare and manipulate multidimensional arrays.
- To use variable-length argument lists.
- To read command-line arguments into a program.
- To perform common array manipulations with the methods of class `Arrays`.
- To use class `ArrayList` to manipulate a dynamically resizable array-like data structure.

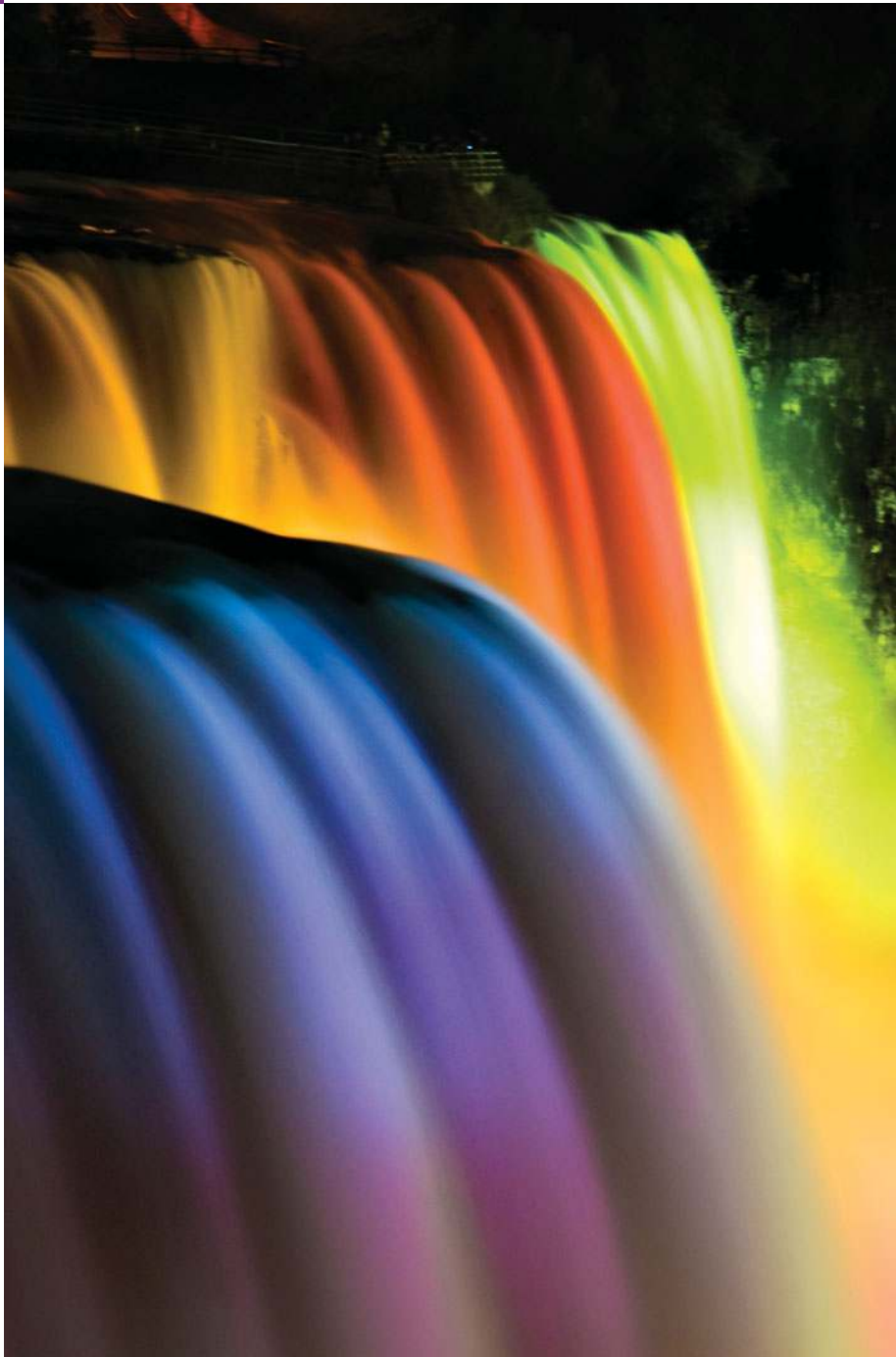

- |                                                                                    |                                                                                    |
|------------------------------------------------------------------------------------|------------------------------------------------------------------------------------|
| <b>7.1</b> Introduction                                                            | <b>7.10</b> Case Study: Class <code>GradeBook</code> Using a Two-Dimensional Array |
| <b>7.2</b> Arrays                                                                  | <b>7.11</b> Variable-Length Argument Lists                                         |
| <b>7.3</b> Declaring and Creating Arrays                                           | <b>7.12</b> Using Command-Line Arguments                                           |
| <b>7.4</b> Examples Using Arrays                                                   | <b>7.13</b> Class Arrays                                                           |
| <b>7.5</b> Case Study: Card Shuffling and Dealing Simulation                       | <b>7.14</b> Introduction to Collections and Class <code>ArrayList</code>           |
| <b>7.6</b> Enhanced <code>for</code> Statement                                     | <b>7.15</b> (Optional) GUI and Graphics Case Study: Drawing Arcs                   |
| <b>7.7</b> Passing Arrays to Methods                                               | <b>7.16</b> Wrap-Up                                                                |
| <b>7.8</b> Case Study: Class <code>GradeBook</code> Using an Array to Store Grades |                                                                                    |
| <b>7.9</b> Multidimensional Arrays                                                 |                                                                                    |

*Summary | Self-Review Exercises | Answers to Self-Review Exercises | Exercises | Special Section: Building Your Own Computer | Making a Difference*

## 7.1 Introduction

This chapter introduces **data structures**—collections of related data items. **Arrays** are data structures consisting of related data items of the same type. Arrays make it convenient to process related groups of values. Arrays remain the same length once they’re created, although an array variable may be reassigned such that it refers to a new array of a different length. We study data structures in depth in Chapters 20–22.

After discussing how arrays are declared, created and initialized, we present practical examples that demonstrate common array manipulations. We introduce Java’s exception-handling mechanism and use it to allow a program to continue executing when the program attempts to access an array element that does not exist. We also present a case study that examines how arrays can help simulate the shuffling and dealing of playing cards in a card-game application. We introduce Java’s enhanced `for` statement, which allows a program to access the data in an array more easily than does the counter-controlled `for` statement presented in Section 5.3. We enhance the `GradeBook` case study from Chapters 3–5. In particular, we use arrays to enable the class to maintain a set of grades *in memory* and analyze student grades from multiple exams. We show how to use variable-length argument lists to create methods that can be called with varying numbers of arguments, and we demonstrate how to process command-line arguments in method `main`. Next, we present some common array manipulations with `static` methods of class `Arrays` from the `java.util` package.

Although commonly used, arrays have limited capabilities. For instance, you must specify an array’s size, and if at execution time you wish to modify it, you must do so manually by creating a new array. At the end of this chapter, we introduce one of Java’s prebuilt data structures from the Java API’s collection classes. These offer greater capabilities than traditional arrays. They’re reusable, reliable, powerful and efficient. We focus on the `ArrayList` collection. `ArrayLists` are similar to arrays but provide additional functionality, such as **dynamic resizing**—they automatically increase their size at execution time to accommodate additional elements.

## 7.2 Arrays

An array is a group of variables (called **elements** or **components**) containing values that all have the same type. Arrays are *objects*, so they're considered reference types. As you'll soon see, what we typically think of as an array is actually a reference to an array object in memory. The *elements* of an array can be either primitive types or reference types (including arrays, as we'll see in Section 7.9). To refer to a particular element in an array, we specify the name of the reference to the array and the *position number* of the element in the array. The position number of the element is called the element's **index** or **subscript**.

Figure 7.1 shows a logical representation of an integer array called *c*. This array contains 12 elements. A program refers to any one of these elements with an **array-access expression** that includes the name of the array followed by the index of the particular element in **square brackets** (`[]`). The first element in every array has **index zero** and is sometimes called the **zeroth element**. Thus, the elements of array *c* are `c[0]`, `c[1]`, `c[2]` and so on. The highest index in array *c* is 11, which is 1 less than 12—the number of elements in the array. Array names follow the same conventions as other variable names.

|                     |                                                  |                      |      |
|---------------------|--------------------------------------------------|----------------------|------|
| Name of array (c) → | <code>c[ 0 ]</code>                              | -45                  |      |
|                     | <code>c[ 1 ]</code>                              | 6                    |      |
|                     | <code>c[ 2 ]</code>                              | 0                    |      |
|                     | <code>c[ 3 ]</code>                              | 72                   |      |
|                     | <code>c[ 4 ]</code>                              | 1543                 |      |
|                     | <code>c[ 5 ]</code>                              | -89                  |      |
|                     | <code>c[ 6 ]</code>                              | 0                    |      |
|                     | <code>c[ 7 ]</code>                              | 62                   |      |
|                     | <code>c[ 8 ]</code>                              | -3                   |      |
|                     | <code>c[ 9 ]</code>                              | 1                    |      |
|                     | Index (or subscript) of the element in array c → | <code>c[ 10 ]</code> | 6453 |
|                     |                                                  | <code>c[ 11 ]</code> | 78   |

**Fig. 7.1** | A 12-element array.

An index must be a nonnegative integer. A program can use an expression as an index. For example, if we assume that variable *a* is 5 and variable *b* is 6, then the statement

```
c[a + b] += 2;
```

adds 2 to array element `c[11]`. An indexed array name is an array-access expression, which can be used on the left side of an assignment to place a new value into an array element.



### Common Programming Error 7.1

*An index must be an `int` value or a value of a type that can be promoted to `int`—namely, `byte`, `short` or `char`, but not `long`; otherwise, a compilation error occurs.*

Let's examine array *c* in Fig. 7.1 more closely. The **name** of the array is *c*. Every array object knows its own length and stores it in a **length instance variable**. The expression



`c.length` accesses array `c`'s `length` field to determine the length of the array. Even though the `length` instance variable of an array is `public`, it cannot be changed because it's a `final` variable. This array's 12 elements are referred to as `c[0]`, `c[1]`, `c[2]`, ..., `c[11]`. The value of `c[0]` is -45, the value of `c[1]` is 6, the value of `c[2]` is 0, the value of `c[7]` is 62 and the value of `c[11]` is 78. To calculate the sum of the values contained in the first three elements of array `c` and store the result in variable `sum`, we would write

```
sum = c[0] + c[1] + c[2];
```

To divide the value of `c[6]` by 2 and assign the result to the variable `x`, we would write

```
x = c[6] / 2;
```

## 7.3 Declaring and Creating Arrays

Array objects occupy space in memory. Like other objects, arrays are created with keyword `new`. To create an array object, you specify the type of the array elements and the number of elements as part of an **array-creation expression** that uses keyword `new`. Such an expression returns a reference that can be stored in an array variable. The following declaration and array-creation expression create an array object containing 12 `int` elements and store the array's reference in array variable `c`:

```
int[] c = new int[12];
```

This expression can be used to create the array shown in Fig. 7.1. When an array is created, each element of the array receives a default value—zero for the numeric primitive-type elements, `false` for `boolean` elements and `null` for references. As you'll soon see, you can provide nondefault initial element values when you create an array.

Creating the array in Fig. 7.1 can also be performed in two steps as follows:

```
int[] c; // declare the array variable
c = new int[12]; // create the array; assign to array variable
```

In the declaration, the square brackets following the type indicate that `c` is a variable that will refer to an array (i.e., the variable will store an array reference). In the assignment statement, the array variable `c` receives the reference to a new array of 12 `int` elements.



### Common Programming Error 7.2

*In an array declaration, specifying the number of elements in the square brackets of the declaration (e.g., `int[12] c;`) is a syntax error.*

A program can create several arrays in a single declaration. The following declaration reserves 100 elements for `b` and 27 elements for `x`:

```
String[] b = new String[100], x = new String[27];
```

When the type of the array and the square brackets are combined at the beginning of the declaration, all the identifiers in the declaration are array variables. In this case, variables `b` and `x` refer to `String` arrays. For readability, we prefer to declare only one variable per declaration. The preceding declaration is equivalent to:

```
String[] b = new String[100]; // create array b
String[] x = new String[27]; // create array x
```



### Good Programming Practice 7.1

For readability, declare only one variable per declaration. Keep each declaration on a separate line, and include a comment describing the variable being declared.

When only one variable is declared in each declaration, the square brackets can be placed either after the type or after the array variable name, as in:

```
String b[] = new String[100]; // create array b
String x[] = new String[27]; // create array x
```



### Common Programming Error 7.3

Declaring multiple array variables in a single declaration can lead to subtle errors. Consider the declaration `int[] a, b, c;`. If `a`, `b` and `c` should be declared as array variables, then this declaration is correct—placing square brackets directly following the type indicates that all the identifiers in the declaration are array variables. However, if only `a` is intended to be an array variable, and `b` and `c` are intended to be individual `int` variables, then this declaration is incorrect—the declaration `int a[], b, c;` would achieve the desired result.

A program can declare arrays of any type. Every element of a primitive-type array contains a value of the array's declared element type. Similarly, in an array of a reference type, every element is a reference to an object of the array's declared element type. For example, every element of an `int` array is an `int` value, and every element of a `String` array is a reference to a `String` object.

## 7.4 Examples Using Arrays

This section presents several examples that demonstrate declaring arrays, creating arrays, initializing arrays and manipulating array elements.

### Creating and Initializing an Array

The application of Fig. 7.2 uses keyword `new` to create an array of 10 `int` elements, which are initially zero (the default for `int` variables). Line 8 declares `array`—a reference capable of referring to an array of `int` elements. Line 10 creates the array object and assigns its reference to variable `array`. Line 12 outputs the column headings. The first column contains the index (0–9) of each array element, and the second column contains the default value (0) of each array element.

```
1 // Fig. 7.2: InitArray.java
2 // Initializing the elements of an array to default values of zero.
3
4 public class InitArray
5 {
6 public static void main(String[] args)
7 {
8 int[] array; // declare array named array
9
10 array = new int[10]; // create the array object
```

**Fig. 7.2** | Initializing the elements of an array to default values of zero. (Part 1 of 2.)

```

11
12 System.out.printf("%s%8s\n", "Index", "Value"); // column headings
13
14 // output each array element's value
15 for (int counter = 0; counter < array.length; counter++)
16 System.out.printf("%5d%8d\n", counter, array[counter]);
17 } // end main
18 } // end class InitArray

```

| Index | Value |
|-------|-------|
| 0     | 0     |
| 1     | 0     |
| 2     | 0     |
| 3     | 0     |
| 4     | 0     |
| 5     | 0     |
| 6     | 0     |
| 7     | 0     |
| 8     | 0     |
| 9     | 0     |

**Fig. 7.2** | Initializing the elements of an array to default values of zero. (Part 2 of 2.)

The for statement in lines 15–16 outputs the index number (represented by counter) and the value of each array element (represented by array[counter]). The loop-control variable counter is initially 0—index values start at 0, so using **zero-based counting** allows the loop to access every element of the array. The for’s loop-continuation condition uses the expression array.length (line 15) to determine the length of the array. In this example, the length of the array is 10, so the loop continues executing as long as the value of control variable counter is less than 10. The highest index value of a 10-element array is 9, so using the less-than operator in the loop-continuation condition guarantees that the loop does not attempt to access an element *beyond* the end of the array (i.e., during the final iteration of the loop, counter is 9). We’ll soon see what Java does when it encounters such an *out-of-range index* at execution time.

### Using an Array Initializer

You can create an array and initialize its elements with an **array initializer**—a comma-separated list of expressions (called an **initializer list**) enclosed in braces. In this case, the array length is determined by the number of elements in the initializer list. For example,

```
int[] n = { 10, 20, 30, 40, 50 };
```

creates a five-element array with index values 0–4. Element n[0] is initialized to 10, n[1] is initialized to 20, and so on. When the compiler encounters an array declaration that includes an initializer list, it counts the number of initializers in the list to determine the size of the array, then sets up the appropriate new operation “behind the scenes.”

The application in Fig. 7.3 initializes an integer array with 10 values (line 9) and displays the array in tabular format. The code for displaying the array elements (lines 14–15) is identical to that in Fig. 7.2 (lines 15–16).

```

1 // Fig. 7.3: InitArray.java
2 // Initializing the elements of an array with an array initializer.
3
4 public class InitArray
5 {
6 public static void main(String[] args)
7 {
8 // initializer list specifies the value for each element
9 int[] array = { 32, 27, 64, 18, 95, 14, 90, 70, 60, 37 };
10
11 System.out.printf("%s%8s\n", "Index", "Value"); // column headings
12
13 // output each array element's value
14 for (int counter = 0; counter < array.length; counter++)
15 System.out.printf("%5d%8d\n", counter, array[counter]);
16 } // end main
17 } // end class InitArray

```

| Index | Value |
|-------|-------|
| 0     | 32    |
| 1     | 27    |
| 2     | 64    |
| 3     | 18    |
| 4     | 95    |
| 5     | 14    |
| 6     | 90    |
| 7     | 70    |
| 8     | 60    |
| 9     | 37    |

**Fig. 7.3** | Initializing the elements of an array with an array initializer.

### *Calculating the Values to Store in an Array*

The application in Fig. 7.4 creates a 10-element array and assigns to each element one of the even integers from 2 to 20 (2, 4, 6, ..., 20). Then the application displays the array in tabular format. The for statement at lines 12–13 calculates an array element's value by multiplying the current value of the control variable counter by 2, then adding 2.

```

1 // Fig. 7.4: InitArray.java
2 // Calculating the values to be placed into the elements of an array.
3
4 public class InitArray
5 {
6 public static void main(String[] args)
7 {
8 final int ARRAY_LENGTH = 10; // declare constant
9 int[] array = new int[ARRAY_LENGTH]; // create array
10
11 // calculate value for each array element
12 for (int counter = 0; counter < array.length; counter++)
13 array[counter] = 2 + 2 * counter;

```

**Fig. 7.4** | Calculating the values to be placed into the elements of an array. (Part 1 of 2.)

```

14
15 System.out.printf("%s%8s\n", "Index", "Value"); // column headings
16
17 // output each array element's value
18 for (int counter = 0; counter < array.length; counter++)
19 System.out.printf("%5d%8d\n", counter, array[counter]);
20 } // end main
21 } // end class InitArray

```

| Index | Value |
|-------|-------|
| 0     | 2     |
| 1     | 4     |
| 2     | 6     |
| 3     | 8     |
| 4     | 10    |
| 5     | 12    |
| 6     | 14    |
| 7     | 16    |
| 8     | 18    |
| 9     | 20    |

**Fig. 7.4** | Calculating the values to be placed into the elements of an array. (Part 2 of 2.)

Line 8 uses the modifier `final` to declare the constant variable `ARRAY_LENGTH` with the value 10. Constant variables must be initialized before they're used and cannot be modified thereafter. If you attempt to *modify* a `final` variable after it's initialized in its declaration, the compiler issues an error message like

```
cannot assign a value to final variable variableName
```

If an attempt is made to access the value of a `final` variable before it's initialized, the compiler issues an error message like

```
variable variableName might not have been initialized
```



### Good Programming Practice 7.2

Constant variables also are called *named constants*. They often make programs more readable than programs that use literal values (e.g., 10)—a named constant such as `ARRAY_LENGTH` clearly indicates its purpose, whereas a literal value could have different meanings based on its context.



### Common Programming Error 7.4

Assigning a value to a constant variable after it has been initialized is a compilation error.



### Common Programming Error 7.5

Attempting to use a constant before it's initialized is a compilation error.

## Summing the Elements of an Array

Often, the elements of an array represent a series of values to be used in a calculation. If, for example, they represent exam grades, a professor may wish to total the elements of the

array and use that sum to calculate the class average for the exam. The GradeBook examples in Figs. 7.14 and 7.18 use this technique.

Figure 7.5 sums the values contained in a 10-element integer array. The program declares, creates and initializes the array at line 8. The for statement performs the calculations. [Note: The values supplied as array initializers are often read into a program rather than specified in an initializer list. For example, an application could input the values from a user or from a file on disk (as discussed in Chapter 17, Files, Streams and Object Serialization). Reading the data into a program (rather than “hand coding” it into the program) makes the program more reusable, because it can be used with different sets of data.]

```

1 // Fig. 7.5: SumArray.java
2 // Computing the sum of the elements of an array.
3
4 public class SumArray
5 {
6 public static void main(String[] args)
7 {
8 int[] array = { 87, 68, 94, 100, 83, 78, 85, 91, 76, 87 };
9 int total = 0;
10
11 // add each element's value to total
12 for (int counter = 0; counter < array.length; counter++)
13 total += array[counter];
14
15 System.out.printf("Total of array elements: %d\n", total);
16 } // end main
17 } // end class SumArray

```

```
Total of array elements: 849
```

**Fig. 7.5** | Computing the sum of the elements of an array.

### *Using Bar Charts to Display Array Data Graphically*

Many programs present data to users in a graphical manner. For example, numeric values are often displayed as bars in a bar chart. In such a chart, longer bars represent proportionally larger numeric values. One simple way to display numeric data graphically is with a bar chart that shows each numeric value as a bar of asterisks (\*).

Professors often like to examine the distribution of grades on an exam. A professor might graph the number of grades in each of several categories to visualize the grade distribution. Suppose the grades on an exam were 87, 68, 94, 100, 83, 78, 85, 91, 76 and 87. They include one grade of 100, two grades in the 90s, four grades in the 80s, two grades in the 70s, one grade in the 60s and no grades below 60. Our next application (Fig. 7.6) stores this grade distribution data in an array of 11 elements, each corresponding to a category of grades. For example, array[0] indicates the number of grades in the range 0–9, array[7] the number of grades in the range 70–79 and array[10] the number of 100 grades. The GradeBook classes later in the chapter (Figs. 7.14 and 7.18) contain code that calculates these grade frequencies based on a set of grades. For now, we manually create the array with the given grade frequencies.

```

1 // Fig. 7.6: BarChart.java
2 // Bar chart printing program.
3
4 public class BarChart
5 {
6 public static void main(String[] args)
7 {
8 int[] array = { 0, 0, 0, 0, 0, 0, 0, 1, 2, 4, 2, 1 };
9
10 System.out.println("Grade distribution:");
11
12 // for each array element, output a bar of the chart
13 for (int counter = 0; counter < array.length; counter++)
14 {
15 // output bar label ("00-09: ", ..., "90-99: ", "100: ")
16 if (counter == 10)
17 System.out.printf("%5d: ", 100);
18 else
19 System.out.printf("%02d-%02d: ",
20 counter * 10, counter * 10 + 9);
21
22 // print bar of asterisks
23 for (int stars = 0; stars < array[counter]; stars++)
24 System.out.print("*");
25
26 System.out.println(); // start a new line of output
27 } // end outer for
28 } // end main
29 } // end class BarChart

```

```

Grade distribution:
00-09:
10-19:
20-29:
30-39:
40-49:
50-59:
60-69: *
70-79: **
80-89: ****
90-99: **
100: *

```

**Fig. 7.6** | Bar chart printing program.

The application reads the numbers from the array and graphs the information as a bar chart. It displays each grade range followed by a bar of asterisks indicating the number of grades in that range. To label each bar, lines 16–20 output a grade range (e.g., "70-79: ") based on the current value of `counter`. When `counter` is 10, line 17 outputs 100 with a field width of 5, followed by a colon and a space, to align the label "100: " with the other bar labels. The nested `for` statement (lines 23–24) outputs the bars. Note the loop-continuation condition at line 23 (`stars < array[counter]`). Each time the program reaches the inner `for`, the loop counts from 0 up to `array[counter]`, thus using a value in `array`

to determine the number of asterisks to display. In this example, no students received a grade below 60, so `array[0]–array[5]` contain zeroes, and no asterisks are displayed next to the first six grade ranges. In line 19, the format specifier `%02d` indicates that an `int` value should be formatted as a field of two digits. The **0 flag** in the format specifier displays a leading 0 for values with fewer digits than the field width (2).

### *Using the Elements of an Array as Counters*

Sometimes, programs use counter variables to summarize data, such as the results of a survey. In Fig. 6.7, we used separate counters in our die-rolling program to track the number of occurrences of each side of a six-sided die as the program rolled the die 6,000,000 times. An array version of this application is shown in Fig. 7.7.

```

1 // Fig. 7.7: RollDie.java
2 // Die-rolling program using arrays instead of switch.
3 import java.util.Random;
4
5 public class RollDie
6 {
7 public static void main(String[] args)
8 {
9 Random randomNumbers = new Random(); // random number generator
10 int[] frequency = new int[7]; // array of frequency counters
11
12 // roll die 6,000,000 times; use die value as frequency index
13 for (int roll = 1; roll <= 6000000; roll++)
14 ++frequency[1 + randomNumbers.nextInt(6)];
15
16 System.out.printf("%s%10s\n", "Face", "Frequency");
17
18 // output each array element's value
19 for (int face = 1; face < frequency.length; face++)
20 System.out.printf("%4d%10d\n", face, frequency[face]);
21 } // end main
22 } // end class RollDie

```

| Face | Frequency |
|------|-----------|
| 1    | 999690    |
| 2    | 999512    |
| 3    | 1000575   |
| 4    | 999815    |
| 5    | 999781    |
| 6    | 1000627   |

**Fig. 7.7** | Die-rolling program using arrays instead of `switch`.

Figure 7.7 uses the array `frequency` (line 10) to count the occurrences of each side of the die. *The single statement in line 14 of this program replaces lines 23–46 of Fig. 6.7.* Line 14 uses the random value to determine which frequency element to increment during each iteration of the loop. The calculation in line 14 produces random numbers from 1 to 6, so the array `frequency` must be large enough to store six counters. However, we use a seven-element array in which we ignore `frequency[0]`—it’s more logical to have the face value 1 increment `frequency[1]` than `frequency[0]`. Thus, each face value is used as an



index for array frequency. In line 14, the calculation inside the square brackets evaluates first to determine which element of the array to increment, then the ++ operator adds one to that element. We also replaced lines 50–52 from Fig. 6.7 by looping through array frequency to output the results (lines 19–20).

### Using Arrays to Analyze Survey Results

Our next example uses arrays to summarize data collected in a survey. Consider the following problem statement:

*Twenty students were asked to rate on a scale of 1 to 5 the quality of the food in the student cafeteria, with 1 being “awful” and 5 being “excellent.” Place the 20 responses in an integer array and determine the frequency of each rating.*

This is a typical array-processing application (Fig. 7.8). We wish to summarize the number of responses of each type (that is, 1–5). Array responses (lines 9–10) is a 20-element integer array containing the students’ survey responses. The last value in the array is intentionally an incorrect response (14). When a Java program executes, array element indices are checked for validity—all indices must be greater than or equal to 0 and less than the length of the array. Any attempt to access an element outside that range of indices results in a runtime error that’s known as an `ArrayIndexOutOfBoundsException`. At the end of this section, we’ll discuss the invalid response value, demonstrate array **bounds checking** and introduce Java’s exception-handling mechanism, which can be used to detect and handle an `ArrayIndexOutOfBoundsException`.

```

1 // Fig. 7.8: StudentPoll.java
2 // Poll analysis program.
3
4 public class StudentPoll
5 {
6 public static void main(String[] args)
7 {
8 // student response array (more typically, input at runtime)
9 int[] responses = { 1, 2, 5, 4, 3, 5, 2, 1, 3, 3, 1, 4, 3, 3, 3,
10 2, 3, 3, 2, 14 };
11 int[] frequency = new int[6]; // array of frequency counters
12
13 // for each answer, select responses element and use that value
14 // as frequency index to determine element to increment
15 for (int answer = 0; answer < responses.length; answer++)
16 {
17 try
18 {
19 ++frequency[responses[answer]];
20 } // end try
21 catch (ArrayIndexOutOfBoundsException e)
22 {
23 System.out.println(e);
24 System.out.printf(" responses[%d] = %d\n\n",
25 answer, responses[answer]);
26 } // end catch
27 } // end for

```

**Fig. 7.8** | Poll analysis program. (Part 1 of 2.)

```

28
29 System.out.printf("%s%10s\n", "Rating", "Frequency");
30
31 // output each array element's value
32 for (int rating = 1; rating < frequency.length; rating++)
33 System.out.printf("%6d%10d\n", rating, frequency[rating]);
34 } // end main
35 } // end class StudentPoll

```

```

java.lang.ArrayIndexOutOfBoundsException: 14
responses[19] = 14

```

| Rating | Frequency |
|--------|-----------|
| 1      | 3         |
| 2      | 4         |
| 3      | 8         |
| 4      | 2         |
| 5      | 2         |

**Fig. 7.8** | Poll analysis program. (Part 2 of 2.)

### *The frequency Array*

We use the *six-element* array `frequency` (line 11) to count the number of occurrences of each response. Each element is used as a counter for one of the possible types of survey responses—`frequency[1]` counts the number of students who rated the food as 1, `frequency[2]` counts the number of students who rated the food as 2, and so on.

### *Summarizing the Results*

The `for` statement (lines 15–27) reads the responses from the array `responses` one at a time and increments one of the counters `frequency[1]` to `frequency[5]`; we ignore `frequency[0]` because the survey responses are limited to the range 1–5. The key statement in the loop appears in line 19. This statement increments the appropriate frequency counter as determined by the value of `responses[answer]`.

Let's step through the first few iterations of the `for` statement:

- When the counter `answer` is 0, `responses[answer]` is the value of `responses[0]` (that is, 1—see line 9). In this case, `frequency[responses[answer]]` is interpreted as `frequency[1]`, and the counter `frequency[1]` is incremented by one. To evaluate the expression, we begin with the value in the *innermost* set of brackets (`answer`, currently 0). The value of `answer` is plugged into the expression, and the next set of brackets (`responses[answer]`) is evaluated. That value is used as the index for the frequency array to determine which counter to increment (in this case, `frequency[1]`).
- The next time through the loop `answer` is 1, `responses[answer]` is the value of `responses[1]` (that is, 2—see line 9), so `frequency[responses[answer]]` is interpreted as `frequency[2]`, causing `frequency[2]` to be incremented.
- When `answer` is 2, `responses[answer]` is the value of `responses[2]` (that is, 5—see line 9), so `frequency[responses[answer]]` is interpreted as `frequency[5]`, causing `frequency[5]` to be incremented, and so on.

Regardless of the number of responses processed in the survey, only a six-element array (in which we ignore element zero) is required to summarize the results, because all the correct response values are between 1 and 5, and the index values for a six-element array are 0–5. In the program’s output, the Frequency column summarizes only 19 of the 20 values in the responses array—the last element of the array responses contains an incorrect response that was not counted.

### *Exception Handling: Processing the Incorrect Response*

An **exception** indicates a problem that occurs while a program executes. The name “exception” suggests that the problem occurs infrequently—if the “rule” is that a statement normally executes correctly, then the problem represents the “exception to the rule.” **Exception handling** enables you to create **fault-tolerant programs** that can resolve (or handle) exceptions. In many cases, this allows a program to continue executing as if no problems were encountered. For example, the StudentPoll application still displays results (Fig. 7.8), even though one of the responses was out of range. More severe problems might prevent a program from continuing normal execution, instead requiring the program to notify the user of the problem, then terminate. When the JVM or a method detects a problem, such as an invalid array index or an invalid method argument, it **throws** an exception—that is, an exception occurs.

### *The try Statement*

To handle an exception, place any code that might throw an exception in a **try statement** (lines 17–26). The **try block** (lines 17–20) contains the code that might *throw* an exception, and the **catch block** (lines 21–26) contains the code that *handles* the exception if one occurs. You can have many catch blocks to handle different types of exceptions that might be thrown in the corresponding try block. When line 19 correctly increments an element of the frequency array, lines 21–26 are ignored. The braces that delimit the bodies of the try and catch blocks are required.

### *Executing the catch Block*

When the program encounters the value 14 in the responses array, it attempts to add 1 to frequency[14], which is *outside* the bounds of the array—the frequency array has only six elements. Because array bounds checking is performed at execution time, the JVM generates an exception—specifically line 19 throws an **ArrayIndexOutOfBoundsException** to notify the program of this problem. At this point the try block terminates and the catch block begins executing—if you declared any variables in the try block, they’re now out of scope and are not accessible in the catch block.

The catch block declares a type (IndexOutOfRangeException) and an exception parameter (e). The catch block can handle exceptions of the specified type. Inside the catch block, you can use the parameter’s identifier to interact with a caught exception object.



#### **Error-Prevention Tip 7.1**

*When writing code to access an array element, ensure that the array index remains greater than or equal to 0 and less than the length of the array. This helps prevent ArrayIndexOutOfBoundsException in your program.*

**toString Method of the Exception Parameter**

When lines 21–26 *catch* the exception, the program displays a message indicating the problem that occurred. Line 23 implicitly calls the exception object's `toString` method to get the error message that is stored in the exception object and display it. Once the message is displayed in this example, the exception is considered handled and the program continues with the next statement after the `catch` block's closing brace. In this example, the end of the `for` statement is reached (line 27), so the program continues with the increment of the control variable in line 15. We use exception handling again in Chapter 8, and Chapter 11 presents a deeper look at exception handling.

## 7.5 Case Study: Card Shuffling and Dealing Simulation

The examples in the chapter thus far have used arrays containing elements of primitive types. Recall from Section 7.2 that the elements of an array can be either primitive types or reference types. This section uses random-number generation and an array of reference-type elements, namely objects representing playing cards, to develop a class that simulates card shuffling and dealing. This class can then be used to implement applications that play specific card games. The exercises at the end of the chapter use the classes developed here to build a simple poker application.

We first develop class `Card` (Fig. 7.9), which represents a playing card that has a face (e.g., "Ace", "Deuce", "Three", ..., "Jack", "Queen", "King") and a suit (e.g., "Hearts", "Diamonds", "Clubs", "Spades"). Next, we develop the `DeckOfCards` class (Fig. 7.10), which creates a deck of 52 playing cards in which each element is a `Card` object. We then build a test application (Fig. 7.11) that demonstrates class `DeckOfCards`'s card shuffling and dealing capabilities.

**Class Card**

Class `Card` (Fig. 7.9) contains two `String` instance variables—`face` and `suit`—that are used to store references to the face name and suit name for a specific `Card`. The constructor for the class (lines 10–14) receives two `Strings` that it uses to initialize `face` and `suit`. Method `toString` (lines 17–20) creates a `String` consisting of the face of the card, the `String` " of " and the suit of the card. `Card`'s `toString` method can be invoked explicitly to obtain a string representation of a `Card` object (e.g., "Ace of Spades"). The `toString` method of an object is called *implicitly* when the object is used where a `String` is expected (e.g., when `printf` outputs the object as a `String` using the `%s` format specifier or when the object is concatenated to a `String` using the `+` operator). For this behavior to occur, `toString` must be declared with the header shown in Fig. 7.9.

---

```

1 // Fig. 7.9: Card.java
2 // Card class represents a playing card.
3
4 public class Card
5 {
6 private String face; // face of card ("Ace", "Deuce", ...)
7 private String suit; // suit of card ("Hearts", "Diamonds", ...)
8

```

---

**Fig. 7.9** | Card class represents a playing card. (Part 1 of 2.)

```

 9 // two-argument constructor initializes card's face and suit
10 public Card(String cardFace, String cardSuit)
11 {
12 face = cardFace; // initialize face of card
13 suit = cardSuit; // initialize suit of card
14 } // end two-argument Card constructor
15
16 // return String representation of Card
17 public String toString()
18 {
19 return face + " of " + suit;
20 } // end method toString
21 } // end class Card

```

**Fig. 7.9** | Card class represents a playing card. (Part 2 of 2.)

### *Class DeckOfCards*

Class `DeckOfCards` (Fig. 7.10) declares as an instance variable a `Card` array named `deck` (line 7). An array of a reference type is declared like any other array. Class `DeckOfCards` also declares an integer instance variable `currentCard` (line 8) representing the next `Card` to be dealt from the `deck` array and a named constant `NUMBER_OF_CARDS` (line 9) indicating the number of `Cards` in the deck (52).

```

 1 // Fig. 7.10: DeckOfCards.java
 2 // DeckOfCards class represents a deck of playing cards.
 3 import java.util.Random;
 4
 5 public class DeckOfCards
 6 {
 7 private Card[] deck; // array of Card objects
 8 private int currentCard; // index of next Card to be dealt (0-51)
 9 private static final int NUMBER_OF_CARDS = 52; // constant # of Cards
10 // random number generator
11 private static final Random randomNumbers = new Random();
12
13 // constructor fills deck of Cards
14 public DeckOfCards()
15 {
16 String[] faces = { "Ace", "Deuce", "Three", "Four", "Five", "Six",
17 "Seven", "Eight", "Nine", "Ten", "Jack", "Queen", "King" };
18 String[] suits = { "Hearts", "Diamonds", "Clubs", "Spades" };
19
20 deck = new Card[NUMBER_OF_CARDS]; // create array of Card objects
21 currentCard = 0; // set currentCard so first Card dealt is deck[0]
22
23 // populate deck with Card objects
24 for (int count = 0; count < deck.length; count++)
25 deck[count] =
26 new Card(faces[count % 13], suits[count / 13]);
27 } // end DeckOfCards constructor
28

```

**Fig. 7.10** | `DeckOfCards` class represents a deck of playing cards. (Part 1 of 2.)

```

29 // shuffle deck of Cards with one-pass algorithm
30 public void shuffle()
31 {
32 // after shuffling, dealing should start at deck[0] again
33 currentCard = 0; // reinitialize currentCard
34
35 // for each Card, pick another random Card (0-51) and swap them
36 for (int first = 0; first < deck.length; first++)
37 {
38 // select a random number between 0 and 51
39 int second = randomNumbers.nextInt(NUMBER_OF_CARDS);
40
41 // swap current Card with randomly selected Card
42 Card temp = deck[first];
43 deck[first] = deck[second];
44 deck[second] = temp;
45 } // end for
46 } // end method shuffle
47
48 // deal one Card
49 public Card dealCard()
50 {
51 // determine whether Cards remain to be dealt
52 if (currentCard < deck.length)
53 return deck[currentCard++]; // return current Card in array
54 else
55 return null; // return null to indicate that all Cards were dealt
56 } // end method dealCard
57 } // end class DeckOfCards

```

**Fig. 7.10** | DeckOfCards class represents a deck of playing cards. (Part 2 of 2.)

### *DeckOfCards Constructor*

The class's constructor instantiates the deck array (line 20) with `NUMBER_OF_CARDS` (52) elements. The elements of deck are null by default, so the constructor uses a for statement (lines 24–26) to fill the deck with Cards. The loop initializes control variable count to 0 and loops while count is less than deck.length, causing count to take on each integer value from 0 to 51 (the indices of the deck array). Each Card is instantiated and initialized with two Strings—one from the faces array (which contains the Strings "Ace" through "King") and one from the suits array (which contains the Strings "Hearts", "Diamonds", "Clubs" and "Spades"). The calculation `count % 13` always results in a value from 0 to 12 (the 13 indices of the faces array in lines 16–17), and the calculation `count / 13` always results in a value from 0 to 3 (the four indices of the suits array in line 18). When the deck array is initialized, it contains the Cards with faces "Ace" through "King" in order for each suit ("Hearts" then "Diamonds" then "Clubs" then "Spades"). We use arrays of Strings to represent the faces and suits in this example. In Exercise 7.34, we ask you to modify this example to use arrays of enumeration constants to represent the faces and suits.

### *DeckOfCards Method shuffle*

Method `shuffle` (lines 30–46) shuffles the Cards in the deck. The method loops through all 52 Cards (array indices 0 to 51). For each Card, a number between 0 and 51 is picked

randomly to select another Card. Next, the current Card object and the randomly selected Card object are swapped in the array. This exchange is performed by the three assignments in lines 42–44. The extra variable `temp` temporarily stores one of the two Card objects being swapped. The swap cannot be performed with only the two statements

```
deck[first] = deck[second];
deck[second] = deck[first];
```

If `deck[first]` is the "Ace" of "Spades" and `deck[second]` is the "Queen" of "Hearts", after the first assignment, both array elements contain the "Queen" of "Hearts" and the "Ace" of "Spades" is lost—hence, the extra variable `temp` is needed. After the for loop terminates, the Card objects are randomly ordered. A total of only 52 swaps are made in a single pass of the entire array, and the array of Card objects is shuffled!

[*Note:* It's recommended that you use a so-called unbiased shuffling algorithm for real card games. Such an algorithm ensures that all possible shuffled card sequences are equally likely to occur. A popular unbiased shuffling algorithm is the Fisher-Yates algorithm.]

### *DeckOfCards Method dealCard*

Method `dealCard` (lines 49–56) deals one Card in the array. Recall that `currentCard` indicates the index of the next Card to be dealt (i.e., the Card at the top of the deck). Thus, line 52 compares `currentCard` to the length of the deck array. If the deck is not empty (i.e., `currentCard` is less than 52), line 53 returns the “top” Card and postincrements `currentCard` to prepare for the next call to `dealCard`—otherwise, `null` is returned. Recall from Chapter 3 that `null` represents a “reference to nothing.”

### *Shuffling and Dealing Cards*

Figure 7.11 demonstrates class `DeckOfCards` (Fig. 7.10). Line 9 creates a `DeckOfCards` object named `myDeckOfCards`. The `DeckOfCards` constructor creates the deck with the 52 Card objects in order by suit and face. Line 10 invokes `myDeckOfCards`'s `shuffle` method to rearrange the Card objects. Lines 13–20 deal all 52 Cards and print them in four columns of 13 Cards each. Line 16 deals one Card object by invoking `myDeckOfCards`'s `dealCard` method, then displays the Card left justified in a field of 19 characters. When a Card is output as a String, the Card's `toString` method (lines 17–20 of Fig. 7.9) is implicitly invoked. Lines 18–19 start a new line after every four Cards.

---

```
1 // Fig. 7.11: DeckOfCardsTest.java
2 // Card shuffling and dealing.
3
4 public class DeckOfCardsTest
5 {
6 // execute application
7 public static void main(String[] args)
8 {
9 DeckOfCards myDeckOfCards = new DeckOfCards();
10 myDeckOfCards.shuffle(); // place Cards in random order
11 }
```

---

**Fig. 7.11** | Card shuffling and dealing. (Part 1 of 2.)

```

12 // print all 52 Cards in the order in which they are dealt
13 for (int i = 1; i <= 52; i++)
14 {
15 // deal and display a Card
16 System.out.printf("%-19s", myDeckOfCards.dealCard());
17
18 if (i % 4 == 0) // output a newline after every fourth card
19 System.out.println();
20 } // end for
21 } // end main
22 } // end class DeckOfCardsTest

```

|                   |                   |                   |                  |
|-------------------|-------------------|-------------------|------------------|
| Six of Spades     | Eight of Spades   | Six of Clubs      | Nine of Hearts   |
| Queen of Hearts   | Seven of Clubs    | Nine of Spades    | King of Hearts   |
| Three of Diamonds | Deuce of Clubs    | Ace of Hearts     | Ten of Spades    |
| Four of Spades    | Ace of Clubs      | Seven of Diamonds | Four of Hearts   |
| Three of Clubs    | Deuce of Hearts   | Five of Spades    | Jack of Diamonds |
| King of Clubs     | Ten of Hearts     | Three of Hearts   | Six of Diamonds  |
| Queen of Clubs    | Eight of Diamonds | Deuce of Diamonds | Ten of Diamonds  |
| Three of Spades   | King of Diamonds  | Nine of Clubs     | Six of Hearts    |
| Ace of Spades     | Four of Diamonds  | Seven of Hearts   | Eight of Clubs   |
| Deuce of Spades   | Eight of Hearts   | Five of Hearts    | Queen of Spades  |
| Jack of Hearts    | Seven of Spades   | Four of Clubs     | Nine of Diamonds |
| Ace of Diamonds   | Queen of Diamonds | Five of Clubs     | King of Spades   |
| Five of Diamonds  | Ten of Clubs      | Jack of Spades    | Jack of Clubs    |

**Fig. 7.11** | Card shuffling and dealing. (Part 2 of 2.)

## 7.6 Enhanced for Statement

The **enhanced for statement** iterates through the elements of an array *without* using a counter, thus avoiding the possibility of “stepping outside” the array. We show how to use the enhanced for statement with the Java API’s prebuilt data structures (called collections) in Section 7.14. The syntax of an enhanced for statement is:

```

for (parameter : arrayName)
 statement

```

where *parameter* has a type and an identifier (e.g., `int number`), and *arrayName* is the array through which to iterate. The type of the parameter must be consistent with the type of the elements in the array. As the next example illustrates, the identifier represents successive element values in the array on successive iterations of the loop.

Figure 7.12 uses the enhanced for statement (lines 12–13) to sum the integers in an array of student grades. The enhanced for’s parameter is of type `int`, because array contains `int` values—the loop selects one `int` value from the array during each iteration. The enhanced for statement iterates through successive values in the array one by one. The statement’s header can be read as “for each iteration, assign the next element of array to `int` variable `number`, then execute the following statement.” Thus, for each iteration, identifier `number` represents an `int` value in array. Lines 12–13 are equivalent to the following counter-controlled repetition used in lines 12–13 of Fig. 7.5 to total the integers in array, except that counter cannot be accessed in the enhanced for statement:

```

for (int counter = 0; counter < array.length; counter++)
 total += array[counter];

```



```

1 // Fig. 7.12: EnhancedForTest.java
2 // Using the enhanced for statement to total integers in an array.
3
4 public class EnhancedForTest
5 {
6 public static void main(String[] args)
7 {
8 int[] array = { 87, 68, 94, 100, 83, 78, 85, 91, 76, 87 };
9 int total = 0;
10
11 // add each element's value to total
12 for (int number : array)
13 total += number;
14
15 System.out.printf("Total of array elements: %d\n", total);
16 } // end main
17 } // end class EnhancedForTest

```

```
Total of array elements: 849
```

**Fig. 7.12** | Using the enhanced for statement to total integers in an array.

The enhanced for statement simplifies the code for iterating through an array. Note, however, that *the enhanced for statement can be used only to obtain array elements—it cannot be used to modify elements*. If your program needs to modify elements, use the traditional counter-controlled for statement.

The enhanced for statement can be used in place of the counter-controlled for statement whenever code looping through an array does *not* require access to the counter indicating the index of the current array element. For example, totaling the integers in an array requires access only to the element values—the index of each element is irrelevant. However, if a program must use a counter for some reason other than simply to loop through an array (e.g., to print an index number next to each array element value, as in the examples earlier in this chapter), use the counter-controlled for statement.

## 7.7 Passing Arrays to Methods

This section demonstrates how to pass arrays and individual array elements as arguments to methods. To pass an array argument to a method, specify the name of the array without any brackets. For example, if array `hourlyTemperatures` is declared as

```
double[] hourlyTemperatures = new double[24];
```

then the method call

```
modifyArray(hourlyTemperatures);
```

passes the reference of array `hourlyTemperatures` to method `modifyArray`. Every array object “knows” its own length (via its `length` field). Thus, when we pass an array object’s reference into a method, we need not pass the array length as an additional argument.

For a method to receive an array reference through a method call, the method’s parameter list must specify an array parameter. For example, the method header for method `modifyArray` might be written as

```
void modifyArray(double[] b)
```

indicating that `modifyArray` receives the reference of a `double` array in parameter `b`. The method call passes array `hourlyTemperature`'s reference, so when the called method uses the array variable `b`, it *refers to* the same array object as `hourlyTemperatures` in the caller.

When an argument to a method is an entire array or an individual array element of a reference type, the called method receives a *copy* of the reference. However, when an argument to a method is an individual array element of a primitive type, the called method receives a copy of the element's *value*. Such primitive values are called **scalars** or **scalar quantities**. To pass an individual array element to a method, use the indexed name of the array element as an argument in the method call.

Figure 7.13 demonstrates the difference between passing an entire array and passing a primitive-type array element to a method. Notice that `main` invokes static methods `modifyArray` (line 19) and `modifyElement` (line 30) directly. Recall from Section 6.4 that a static method of a class can invoke other static methods of the same class directly.

---

```

1 // Fig. 7.13: PassArray.java
2 // Passing arrays and individual array elements to methods.
3
4 public class PassArray
5 {
6 // main creates array and calls modifyArray and modifyElement
7 public static void main(String[] args)
8 {
9 int[] array = { 1, 2, 3, 4, 5 };
10
11 System.out.println(
12 "Effects of passing reference to entire array:\n" +
13 "The values of the original array are:");
14
15 // output original array elements
16 for (int value : array)
17 System.out.printf(" %d", value);
18
19 modifyArray(array); // pass array reference
20 System.out.println("\n\nThe values of the modified array are:");
21
22 // output modified array elements
23 for (int value : array)
24 System.out.printf(" %d", value);
25
26 System.out.printf(
27 "\n\nEffects of passing array element value:\n" +
28 "array[3] before modifyElement: %d\n", array[3]);
29
30 modifyElement(array[3]); // attempt to modify array[3]
31 System.out.printf(
32 "array[3] after modifyElement: %d\n", array[3]);
33 } // end main
34

```

**Fig. 7.13** | Passing arrays and individual array elements to methods. (Part 1 of 2.)

```

35 // multiply each element of an array by 2
36 public static void modifyArray(int[] array2)
37 {
38 for (int counter = 0; counter < array2.length; counter++)
39 array2[counter] *= 2;
40 } // end method modifyArray
41
42 // multiply argument by 2
43 public static void modifyElement(int element)
44 {
45 element *= 2;
46 System.out.printf(
47 "Value of element in modifyElement: %d\n", element);
48 } // end method modifyElement
49 } // end class PassArray

```

Effects of passing reference to entire array:

The values of the original array are:

1 2 3 4 5

The values of the modified array are:

2 4 6 8 10

Effects of passing array element value:

array[3] before modifyElement: 8

Value of element in modifyElement: 16

array[3] after modifyElement: 8

**Fig. 7.13** | Passing arrays and individual array elements to methods. (Part 2 of 2.)

The enhanced for statement at lines 16–17 outputs the five `int` elements of array. Line 19 invokes method `modifyArray`, passing array as an argument. Method `modifyArray` (lines 36–40) receives a copy of array’s reference and uses the reference to multiply each of array’s elements by 2. To prove that array’s elements were modified, lines 23–24 output the five elements of array again. As the output shows, method `modifyArray` doubled the value of each element. We could not use the enhanced for statement in lines 38–39 because we’re modifying the array’s elements.

Figure 7.13 next demonstrates that when a copy of an individual primitive-type array element is passed to a method, modifying the *copy* in the called method does *not* affect the original value of that element in the calling method’s array. Lines 26–28 output the value of `array[3]` *before* invoking method `modifyElement`. Remember that the value of this element is now 8 after it was modified in the call to `modifyArray`. Line 30 calls method `modifyElement` and passes `array[3]` as an argument. Remember that `array[3]` is actually one `int` value (8) in array. Therefore, the program passes a copy of the value of `array[3]`. Method `modifyElement` (lines 43–48) multiplies the value received as an argument by 2, stores the result in its parameter `element`, then outputs the value of `element` (16). Since method parameters, like local variables, cease to exist when the method in which they’re declared completes execution, the method parameter `element` is destroyed when method `modifyElement` terminates. When the program returns control to `main`, lines 31–32 output the *unmodified* value of `array[3]` (i.e., 8).

*Notes on Passing Arguments to Methods*

The preceding example demonstrated how arrays and primitive-type array elements are passed as arguments to methods. We now take a closer look at how arguments in general are passed to methods. Two ways to pass arguments in method calls in many programming languages are **pass-by-value** and **pass-by-reference** (also called **call-by-value** and **call-by-reference**). When an argument is passed by value, a copy of the argument's *value* is passed to the called method. The called method works exclusively with the copy. Changes to the called method's copy do *not* affect the original variable's value in the caller.

When an argument is passed by reference, the called method can access the argument's value in the caller directly and modify that data, if necessary. Pass-by-reference improves performance by eliminating the need to copy possibly large amounts of data.

Unlike some other languages, Java does *not* allow you to choose pass-by-value or pass-by-reference—all arguments are passed by value. A method call can pass two types of values to a method—copies of primitive values (e.g., values of type `int` and `double`) and copies of references to objects. Objects themselves cannot be passed to methods. When a method modifies a primitive-type parameter, changes to the parameter have no effect on the original argument value in the calling method. For example, when line 30 in `main` of Fig. 7.13 passes `array[3]` to method `modifyElement`, the statement in line 45 that doubles the value of parameter `element` has *no* effect on the value of `array[3]` in `main`. This is also true for reference-type parameters. If you modify a reference-type parameter so that it refers to another object, only the parameter refers to the new object—the reference stored in the caller's variable still refers to the original object.

Although an object's reference is passed by value, a method can still interact with the referenced object by calling its `public` methods using the copy of the object's reference. Since the reference stored in the parameter is a copy of the reference that was passed as an argument, the parameter in the called method and the argument in the calling method refer to the same object in memory. For example, in Fig. 7.13, both parameter `array2` in method `modifyArray` and variable `array` in `main` refer to the *same* array object in memory. Any changes made using the parameter `array2` are carried out on the object that `array` references in the calling method. In Fig. 7.13, the changes made in `modifyArray` using `array2` affect the contents of the array object referenced by `array` in `main`. Thus, with a reference to an object, the called method *can* manipulate the caller's object directly.

**Performance Tip 7.1**

*Passing arrays by reference makes sense for performance reasons. If arrays were passed by value, a copy of each element would be passed. For large, frequently passed arrays, this would waste time and consume considerable storage for the copies of the arrays.*

## 7.8 Case Study: Class `GradeBook` Using an Array to Store Grades

Previous versions of class `GradeBook` process a set of grades entered by the user, but do not maintain the individual grade values in instance variables of the class. Thus, repeat calculations require the user to reenter the same grades. One way to solve this problem would be to store each grade entered in an individual instance of the class. For example, we could create instance variables `grade1`, `grade2`, ..., `grade10` in class `GradeBook` to store 10 stu-

dent grades. But this would make the code to total the grades and determine the class average cumbersome, and the class would not be able to process any more than 10 grades at a time. We solve this problem by storing grades in an array.

### Storing Student Grades in an Array in Class GradeBook

Class GradeBook (Fig. 7.14) uses an array of ints to store several students' grades on a single exam. This eliminates the need to repeatedly input the same set of grades. Array grades is declared as an instance variable (line 7), so each GradeBook object maintains its own set of grades. The constructor (lines 10–14) has two parameters—the name of the course and an array of grades. When an application (e.g., class GradeBookTest in Fig. 7.15) creates a GradeBook object, the application passes an existing int array to the constructor, which assigns the array's reference to instance variable grades (line 13). The grades array's size is determined by the length of the array that's passed to the constructor. Thus, a GradeBook object can process a variable number of grades. The grade values in the passed array could have been input from a user or read from a file on disk (as discussed in Chapter 17). In our test application, we initialize an array with grade values (Fig. 7.15, line 10). Once the grades are stored in instance variable grades of class GradeBook, all the class's methods can access the elements of grades *as often as needed* to perform various calculations.

Method processGrades (lines 37–51) contains a series of method calls that output a report summarizing the grades. Line 40 calls method outputGrades to print the contents of the array grades. Lines 134–136 in method outputGrades use a for statement to output the students' grades. A counter-controlled for *must* be used in this case, because lines 135–136 use counter variable student's value to output each grade next to a particular student number (see output in Fig. 7.15). Although array indices start at 0, a professor would typically number students starting at 1. Thus, lines 135–136 output student + 1 as the student number to produce grade labels "Student 1: ", "Student 2: ", and so on.

---

```

1 // Fig. 7.14: GradeBook.java
2 // GradeBook class using an array to store test grades.
3
4 public class GradeBook
5 {
6 private String courseName; // name of course this GradeBook represents
7 private int[] grades; // array of student grades
8
9 // two-argument constructor initializes courseName and grades array
10 public GradeBook(String name, int[] gradesArray)
11 {
12 courseName = name; // initialize courseName
13 grades = gradesArray; // store grades
14 } // end two-argument GradeBook constructor
15
16 // method to set the course name
17 public void setCourseName(String name)
18 {
19 courseName = name; // store the course name
20 } // end method setCourseName

```

---

**Fig. 7.14** | GradeBook class using an array to store test grades. (Part 1 of 4.)

```
21
22 // method to retrieve the course name
23 public String getCourseName()
24 {
25 return courseName;
26 } // end method getCourseName
27
28 // display a welcome message to the GradeBook user
29 public void displayMessage()
30 {
31 // getCourseName gets the name of the course
32 System.out.printf("Welcome to the grade book for\n%s!\n\n",
33 getCourseName());
34 } // end method displayMessage
35
36 // perform various operations on the data
37 public void processGrades()
38 {
39 // output grades array
40 outputGrades();
41
42 // call method getAverage to calculate the average grade
43 System.out.printf("\nClass average is %.2f\n", getAverage());
44
45 // call methods getMinimum and getMaximum
46 System.out.printf("Lowest grade is %d\nHighest grade is %d\n\n",
47 getMinimum(), getMaximum());
48
49 // call outputBarChart to print grade distribution chart
50 outputBarChart();
51 } // end method processGrades
52
53 // find minimum grade
54 public int getMinimum()
55 {
56 int lowGrade = grades[0]; // assume grades[0] is smallest
57
58 // loop through grades array
59 for (int grade : grades)
60 {
61 // if grade lower than lowGrade, assign it to lowGrade
62 if (grade < lowGrade)
63 lowGrade = grade; // new lowest grade
64 } // end for
65
66 return lowGrade; // return lowest grade
67 } // end method getMinimum
68
69 // find maximum grade
70 public int getMaximum()
71 {
72 int highGrade = grades[0]; // assume grades[0] is largest
73
```

**Fig. 7.14** | GradeBook class using an array to store test grades. (Part 2 of 4.)

```
74 // loop through grades array
75 for (int grade : grades)
76 {
77 // if grade greater than highGrade, assign it to highGrade
78 if (grade > highGrade)
79 highGrade = grade; // new highest grade
80 } // end for
81
82 return highGrade; // return highest grade
83 } // end method getMaximum
84
85 // determine average grade for test
86 public double getAverage()
87 {
88 int total = 0; // initialize total
89
90 // sum grades for one student
91 for (int grade : grades)
92 total += grade;
93
94 // return average of grades
95 return (double) total / grades.length;
96 } // end method getAverage
97
98 // output bar chart displaying grade distribution
99 public void outputBarChart()
100 {
101 System.out.println("Grade distribution:");
102
103 // stores frequency of grades in each range of 10 grades
104 int[] frequency = new int[11];
105
106 // for each grade, increment the appropriate frequency
107 for (int grade : grades)
108 ++frequency[grade / 10];
109
110 // for each grade frequency, print bar in chart
111 for (int count = 0; count < frequency.length; count++)
112 {
113 // output bar label ("00-09: ", ..., "90-99: ", "100: ")
114 if (count == 10)
115 System.out.printf("%5d: ", 100);
116 else
117 System.out.printf("%02d-%02d: ",
118 count * 10, count * 10 + 9);
119
120 // print bar of asterisks
121 for (int stars = 0; stars < frequency[count]; stars++)
122 System.out.print("*");
123
124 System.out.println(); // start a new line of output
125 } // end outer for
126 } // end method outputBarChart
```

**Fig. 7.14** | GradeBook class using an array to store test grades. (Part 3 of 4.)

```

127
128 // output the contents of the grades array
129 public void outputGrades()
130 {
131 System.out.println("The grades are:\n");
132
133 // output each student's grade
134 for (int student = 0; student < grades.length; student++)
135 System.out.printf("Student %2d: %3d\n",
136 student + 1, grades[student]);
137 } // end method outputGrades
138 } // end class GradeBook

```

**Fig. 7.14** | GradeBook class using an array to store test grades. (Part 4 of 4.)

Method `processGrades` next calls method `getAverage` (line 43) to obtain the average of the grades in the array. Method `getAverage` (lines 86–96) uses an enhanced `for` statement to total the values in array `grades` before calculating the average. The parameter in the enhanced `for`'s header (e.g., `int grade`) indicates that for each iteration, the `int` variable `grade` takes on a value in the array `grades`. The averaging calculation in line 95 uses `grades.length` to determine the number of grades being averaged.

Lines 46–47 in method `processGrades` call methods `getMinimum` and `getMaximum` to determine the lowest and highest grades of any student on the exam, respectively. Each of these methods uses an enhanced `for` statement to loop through array `grades`. Lines 59–64 in method `getMinimum` loop through the array. Lines 62–63 compare each grade to `lowGrade`; if a grade is less than `lowGrade`, `lowGrade` is set to that grade. When line 66 executes, `lowGrade` contains the lowest grade in the array. Method `getMaximum` (lines 70–83) works similarly to method `getMinimum`.

Finally, line 50 in method `processGrades` calls method `outputBarChart` to print a distribution chart of the grade data using a technique similar to that in Fig. 7.6. In that example, we manually calculated the number of grades in each category (i.e., 0–9, 10–19, ..., 90–99 and 100) by simply looking at a set of grades. In this example, lines 107–108 use a technique similar to that in Figs. 7.7 and 7.8 to calculate the frequency of grades in each category. Line 104 declares and creates array `frequency` of 11 `ints` to store the frequency of grades in each grade category. For each grade in array `grades`, lines 107–108 increment the appropriate element of the `frequency` array. To determine which element to increment, line 108 divides the current grade by 10 using integer division. For example, if `grade` is 85, line 108 increments `frequency[8]` to update the count of grades in the range 80–89. Lines 111–125 next print the bar chart (see Fig. 7.15) based on the values in array `frequency`. Like lines 23–24 of Fig. 7.6, lines 121–122 of Fig. 7.14 use a value in array `frequency` to determine the number of asterisks to display in each bar.

### *Class GradeBookTest That Demonstrates Class GradeBook*

The application of Fig. 7.15 creates an object of class `GradeBook` (Fig. 7.14) using the `int` array `gradesArray` (declared and initialized in line 10). Lines 12–13 pass a course name and `gradesArray` to the `GradeBook` constructor. Line 14 displays a welcome message, and line 15 invokes the `GradeBook` object's `processGrades` method. The output summarizes the 10 grades in `myGradeBook`.





### Software Engineering Observation 7.1

A test harness (or test application) is responsible for creating an object of the class being tested and providing it with data. This data could come from any of several sources. Test data can be placed directly into an array with an array initializer, it can come from the user at the keyboard, it can come from a file (as you'll see in Chapter 17), or it can come from a network (as you'll see in Chapter 27). After passing this data to the class's constructor to instantiate the object, the test harness should call upon the object to test its methods and manipulate its data. Gathering data in the test harness like this allows the class to manipulate data from several sources.

```

1 // Fig. 7.15: GradeBookTest.java
2 // GradeBookTest creates a GradeBook object using an array of grades,
3 // then invokes method processGrades to analyze them.
4 public class GradeBookTest
5 {
6 // main method begins program execution
7 public static void main(String[] args)
8 {
9 // array of student grades
10 int[] gradesArray = { 87, 68, 94, 100, 83, 78, 85, 91, 76, 87 };
11
12 GradeBook myGradeBook = new GradeBook(
13 "CS101 Introduction to Java Programming", gradesArray);
14 myGradeBook.displayMessage();
15 myGradeBook.processGrades();
16 } // end main
17 } // end class GradeBookTest

```

```

Welcome to the grade book for
CS101 Introduction to Java Programming!

```

```
The grades are:
```

```

Student 1: 87
Student 2: 68
Student 3: 94
Student 4: 100
Student 5: 83
Student 6: 78
Student 7: 85
Student 8: 91
Student 9: 76
Student 10: 87

```

```

Class average is 84.90
Lowest grade is 68
Highest grade is 100

```

**Fig. 7.15** | GradeBookTest creates a GradeBook object using an array of grades, then invokes method processGrades to analyze them. (Part I of 2.)

```

Grade distribution:
00-09:
10-19:
20-29:
30-39:
40-49:
50-59:
60-69: *
70-79: **
80-89: ****
90-99: **
100: *

```

**Fig. 7.15** | GradeBookTest creates a GradeBook object using an array of grades, then invokes method processGrades to analyze them. (Part 2 of 2.)

## 7.9 Multidimensional Arrays

Multidimensional arrays with two dimensions are often used to represent *tables* of values consisting of information arranged in *rows* and *columns*. To identify a particular table element, we must specify two indices. *By convention*, the first identifies the element's row and the second its column. Arrays that require two indices to identify a particular element are called **two-dimensional arrays**. (Multidimensional arrays can have more than two dimensions.) Java does not support multidimensional arrays directly, but it does allow you to specify one-dimensional arrays whose elements are also one-dimensional arrays, thus achieving the same effect. Figure 7.16 illustrates a two-dimensional array named `a` that contains three rows and four columns (i.e., a three-by-four array). In general, an array with  $m$  rows and  $n$  columns is called an  *$m$ -by- $n$  array*.

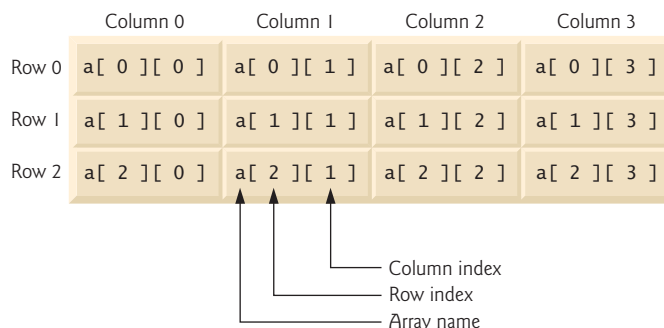

**Fig. 7.16** | Two-dimensional array with three rows and four columns.

Every element in array `a` is identified in Fig. 7.16 by an *array-access expression* of the form `a[row][column]`; `a` is the name of the array, and `row` and `column` are the indices that uniquely identify each element in array `a` by row and column number. The names of the elements in `row 0` all have a first index of 0, and the names of the elements in `column 3` all have a second index of 3.

### Arrays of One-Dimensional Arrays

Like one-dimensional arrays, multidimensional arrays can be initialized with array initializers in declarations. A two-dimensional array `b` with two rows and two columns could be declared and initialized with **nested array initializers** as follows:

```
int[][] b = { { 1, 2 }, { 3, 4 } };
```

The initial values are grouped by row in braces. So 1 and 2 initialize `b[0][0]` and `b[0][1]`, respectively, and 3 and 4 initialize `b[1][0]` and `b[1][1]`, respectively. The compiler counts the number of nested array initializers (represented by sets of braces within the outer braces) to determine the number of rows in array `b`. The compiler counts the initializer values in the nested array initializer for a row to determine the number of columns in that row. As we'll see momentarily, this means that *rows can have different lengths*.

Multidimensional arrays are maintained as arrays of one-dimensional arrays. Therefore array `b` in the preceding declaration is actually composed of two separate one-dimensional arrays—one containing the values in the first nested initializer list `{ 1, 2 }` and one containing the values in the second nested initializer list `{ 3, 4 }`. Thus, array `b` itself is an array of two elements, each a one-dimensional array of `int` values.

### Two-Dimensional Arrays with Rows of Different Lengths

The manner in which multidimensional arrays are represented makes them quite flexible. In fact, the lengths of the rows in array `b` are *not* required to be the same. For example,

```
int[][] b = { { 1, 2 }, { 3, 4, 5 } };
```

creates integer array `b` with two elements (determined by the number of nested array initializers) that represent the rows of the two-dimensional array. Each element of `b` is a reference to a one-dimensional array of `int` variables. The `int` array for row 0 is a one-dimensional array with two elements (1 and 2), and the `int` array for row 1 is a one-dimensional array with three elements (3, 4 and 5).

### Creating Two-Dimensional Arrays with Array-Creation Expressions

A multidimensional array with the same number of columns in every row can be created with an array-creation expression. For example, the following lines declare array `b` and assign it a reference to a three-by-four array:

```
int[][] b = new int[3][4];
```

In this case, we use the literal values 3 and 4 to specify the number of rows and number of columns, respectively, but this is not required. Programs can also use variables to specify array dimensions, because *new creates arrays at execution time—not at compile time*. As with one-dimensional arrays, the elements of a multidimensional array are initialized when the array object is created.

A multidimensional array in which each row has a different number of columns can be created as follows:

```
int[][] b = new int[2][] ; // create 2 rows
b[0] = new int[5] ; // create 5 columns for row 0
b[1] = new int[3] ; // create 3 columns for row 1
```

The preceding statements create a two-dimensional array with two rows. Row 0 has five columns, and row 1 has three columns.

*Two-Dimensional Array Example: Displaying Element Values*

Figure 7.17 demonstrates initializing two-dimensional arrays with array initializers and using nested for loops to **traverse** the arrays (i.e., manipulate every element of each array). Class `InitArray`'s `main` declares two arrays. The declaration of `array1` (line 9) uses nested array initializers of the *same* length to initialize the first row to the values 1, 2 and 3, and the second row to the values 4, 5 and 6. The declaration of `array2` (line 10) uses nested initializers of *different* lengths. In this case, the first row is initialized to two elements with the values 1 and 2, respectively. The second row is initialized to one element with the value 3. The third row is initialized to three elements with the values 4, 5 and 6, respectively.

```

1 // Fig. 7.17: InitArray.java
2 // Initializing two-dimensional arrays.
3
4 public class InitArray
5 {
6 // create and output two-dimensional arrays
7 public static void main(String[] args)
8 {
9 int[][] array1 = { { 1, 2, 3 }, { 4, 5, 6 } };
10 int[][] array2 = { { 1, 2 }, { 3 }, { 4, 5, 6 } };
11
12 System.out.println("Values in array1 by row are");
13 outputArray(array1); // displays array1 by row
14
15 System.out.println("\nValues in array2 by row are");
16 outputArray(array2); // displays array2 by row
17 } // end main
18
19 // output rows and columns of a two-dimensional array
20 public static void outputArray(int[][] array)
21 {
22 // loop through array's rows
23 for (int row = 0; row < array.length; row++)
24 {
25 // loop through columns of current row
26 for (int column = 0; column < array[row].length; column++)
27 System.out.printf("%d ", array[row][column]);
28
29 System.out.println(); // start new line of output
30 } // end outer for
31 } // end method outputArray
32 } // end class InitArray

```

```

Values in array1 by row are
1 2 3
4 5 6

Values in array2 by row are
1 2
3
4 5 6

```

**Fig. 7.17** | Initializing two-dimensional arrays.

Lines 13 and 16 call method `outputArray` (lines 20–31) to output the elements of `array1` and `array2`, respectively. Method `outputArray`'s parameter—`int[][] array`—indicates that the method receives a two-dimensional array. The `for` statement (lines 23–30) outputs the rows of a two-dimensional array. In the loop-continuation condition of the outer `for` statement, the expression `array.length` determines the number of rows in the array. In the inner `for` statement, the expression `array[row].length` determines the number of columns in the current row of the array. The inner `for` statement's condition enables the loop to determine the exact number of columns in each row.

### *Common Multidimensional-Array Manipulations Performed with `for` Statements*

Many common array manipulations use `for` statements. As an example, the following `for` statement sets all the elements in row 2 of array `a` in Fig. 7.16 to zero:

```
for (int column = 0; column < a[2].length; column++)
 a[2][column] = 0;
```

We specified row 2; therefore, we know that the first index is always 2 (0 is the first row, and 1 is the second row). This `for` loop varies only the second index (i.e., the column index). If row 2 of array `a` contains four elements, then the preceding `for` statement is equivalent to the assignment statements

```
a[2][0] = 0;
a[2][1] = 0;
a[2][2] = 0;
a[2][3] = 0;
```

The following nested `for` statement totals the values of all the elements in array `a`:

```
int total = 0;
for (int row = 0; row < a.length; row++)
{
 for (int column = 0; column < a[row].length; column++)
 total += a[row][column];
} // end outer for
```

These nested `for` statements total the array elements one row at a time. The outer `for` statement begins by setting the row index to 0 so that the first row's elements can be totaled by the inner `for` statement. The outer `for` then increments `row` to 1 so that the second row can be totaled. Then, the outer `for` increments `row` to 2 so that the third row can be totaled. The variable `total` can be displayed when the outer `for` statement terminates. In the next example, we show how to process a two-dimensional array in a similar manner using nested enhanced `for` statements.

## 7.10 Case Study: Class GradeBook Using a Two-Dimensional Array

In Section 7.8, we presented class `GradeBook` (Fig. 7.14), which used a one-dimensional array to store student grades on a single exam. In most semesters, students take several exams. Professors are likely to want to analyze grades across the entire semester, both for a single student and for the class as a whole.

*Storing Student Grades in a Two-Dimensional Array in Class GradeBook*

Figure 7.18 contains a `GradeBook` class that uses a two-dimensional array `grades` to store the grades of a number of students on multiple exams. Each row of the array represents a single student's grades for the entire course, and each column represents the grades of all the students who took a particular exam. Class `GradeBookTest` (Fig. 7.19) passes the array as an argument to the `GradeBook` constructor. In this example, we use a ten-by-three array for ten students' grades on three exams. Five methods perform array manipulations to process the grades. Each method is similar to its counterpart in the earlier one-dimensional array version of `GradeBook` (Fig. 7.14). Method `getMinimum` (lines 52–70) determines the lowest grade of any student for the semester. Method `getMaximum` (lines 73–91) determines the highest grade of any student for the semester. Method `getAverage` (lines 94–104) determines a particular student's semester average. Method `outputBarChart` (lines 107–137) outputs a grade bar chart for the entire semester's student grades. Method `outputGrades` (lines 140–164) outputs the array in a tabular format, along with each student's semester average.

---

```

1 // Fig. 7.18: GradeBook.java
2 // GradeBook class using a two-dimensional array to store grades.
3
4 public class GradeBook
5 {
6 private String courseName; // name of course this grade book represents
7 private int[][] grades; // two-dimensional array of student grades
8
9 // two-argument constructor initializes courseName and grades array
10 public GradeBook(String name, int[][] gradesArray)
11 {
12 courseName = name; // initialize courseName
13 grades = gradesArray; // store grades
14 } // end two-argument GradeBook constructor
15
16 // method to set the course name
17 public void setCourseName(String name)
18 {
19 courseName = name; // store the course name
20 } // end method setCourseName
21
22 // method to retrieve the course name
23 public String getCourseName()
24 {
25 return courseName;
26 } // end method getCourseName
27
28 // display a welcome message to the GradeBook user
29 public void displayMessage()
30 {
31 // getCourseName gets the name of the course
32 System.out.printf("Welcome to the grade book for\n%s!\n\n",
33 getCourseName());
34 } // end method displayMessage
35

```

---

**Fig. 7.18** | `GradeBook` class using a two-dimensional array to store grades. (Part I of 4.)

```
36 // perform various operations on the data
37 public void processGrades()
38 {
39 // output grades array
40 outputGrades();
41
42 // call methods getMinimum and getMaximum
43 System.out.printf("\n%s %d\n%s %d\n\n",
44 "Lowest grade in the grade book is", getMinimum(),
45 "Highest grade in the grade book is", getMaximum());
46
47 // output grade distribution chart of all grades on all tests
48 outputBarChart();
49 } // end method processGrades
50
51 // find minimum grade
52 public int getMinimum()
53 {
54 // assume first element of grades array is smallest
55 int lowGrade = grades[0][0];
56
57 // loop through rows of grades array
58 for (int[] studentGrades : grades)
59 {
60 // loop through columns of current row
61 for (int grade : studentGrades)
62 {
63 // if grade less than lowGrade, assign it to lowGrade
64 if (grade < lowGrade)
65 lowGrade = grade;
66 } // end inner for
67 } // end outer for
68
69 return lowGrade; // return lowest grade
70 } // end method getMinimum
71
72 // find maximum grade
73 public int getMaximum()
74 {
75 // assume first element of grades array is largest
76 int highGrade = grades[0][0];
77
78 // loop through rows of grades array
79 for (int[] studentGrades : grades)
80 {
81 // loop through columns of current row
82 for (int grade : studentGrades)
83 {
84 // if grade greater than highGrade, assign it to highGrade
85 if (grade > highGrade)
86 highGrade = grade;
87 } // end inner for
88 } // end outer for
```

**Fig. 7.18** | GradeBook class using a two-dimensional array to store grades. (Part 2 of 4.)

```
89
90 return highGrade; // return highest grade
91 } // end method getMaximum
92
93 // determine average grade for particular set of grades
94 public double getAverage(int[] setOfGrades)
95 {
96 int total = 0; // initialize total
97
98 // sum grades for one student
99 for (int grade : setOfGrades)
100 total += grade;
101
102 // return average of grades
103 return (double) total / setOfGrades.length;
104 } // end method getAverage
105
106 // output bar chart displaying overall grade distribution
107 public void outputBarChart()
108 {
109 System.out.println("Overall grade distribution:");
110
111 // stores frequency of grades in each range of 10 grades
112 int[] frequency = new int[11];
113
114 // for each grade in GradeBook, increment the appropriate frequency
115 for (int[] studentGrades : grades)
116 {
117 for (int grade : studentGrades)
118 ++frequency[grade / 10];
119 } // end outer for
120
121 // for each grade frequency, print bar in chart
122 for (int count = 0; count < frequency.length; count++)
123 {
124 // output bar label ("00-09: ", ..., "90-99: ", "100: ")
125 if (count == 10)
126 System.out.printf("%5d: ", 100);
127 else
128 System.out.printf("%02d-%02d: ",
129 count * 10, count * 10 + 9);
130
131 // print bar of asterisks
132 for (int stars = 0; stars < frequency[count]; stars++)
133 System.out.print("*");
134
135 System.out.println(); // start a new line of output
136 } // end outer for
137 } // end method outputBarChart
138
139 // output the contents of the grades array
140 public void outputGrades()
141 {
```

**Fig. 7.18** | GradeBook class using a two-dimensional array to store grades. (Part 3 of 4.)



```
142 System.out.println("The grades are:\n");
143 System.out.print(" "); // align column heads
144
145 // create a column heading for each of the tests
146 for (int test = 0; test < grades[0].length; test++)
147 System.out.printf("Test %d ", test + 1);
148
149 System.out.println("Average"); // student average column heading
150
151 // create rows/columns of text representing array grades
152 for (int student = 0; student < grades.length; student++)
153 {
154 System.out.printf("Student %2d", student + 1);
155
156 for (int test : grades[student]) // output student's grades
157 System.out.printf("%8d", test);
158
159 // call method getAverage to calculate student's average grade;
160 // pass row of grades as the argument to getAverage
161 double average = getAverage(grades[student]);
162 System.out.printf("%9.2f\n", average);
163 } // end outer for
164 } // end method outputGrades
165 } // end class GradeBook
```

**Fig. 7.18** | GradeBook class using a two-dimensional array to store grades. (Part 4 of 4.)

### *Methods getMinimum and getMaximum*

Methods `getMinimum`, `getMaximum`, `outputBarChart` and `outputGrades` each loop through array `grades` by using nested `for` statements—for example, the nested enhanced `for` statement from the declaration of method `getMinimum` (lines 58–67). The outer enhanced `for` statement iterates through the two-dimensional array `grades`, assigning successive rows to parameter `studentGrades` on successive iterations. The square brackets following the parameter name indicate that `studentGrades` refers to a one-dimensional `int` array—namely, a row in array `grades` containing one student's grades. To find the lowest overall grade, the inner `for` statement compares the elements of the current one-dimensional array `studentGrades` to variable `lowGrade`. For example, on the first iteration of the outer `for`, row 0 of `grades` is assigned to parameter `studentGrades`. The inner enhanced `for` statement then loops through `studentGrades` and compares each grade value with `lowGrade`. If a grade is less than `lowGrade`, `lowGrade` is set to that grade. On the second iteration of the outer enhanced `for` statement, row 1 of `grades` is assigned to `studentGrades`, and the elements of this row are compared with variable `lowGrade`. This repeats until all rows of `grades` have been traversed. When execution of the nested statement is complete, `lowGrade` contains the lowest grade in the two-dimensional array. Method `getMaximum` works similarly to method `getMinimum`.

### *Method outputBarChart*

Method `outputBarChart` in Fig. 7.18 is nearly identical to the one in Fig. 7.14. However, to output the overall grade distribution for a whole semester, the method here uses nested enhanced `for` statements (lines 115–119) to create the one-dimensional array `frequency`

based on all the grades in the two-dimensional array. The rest of the code in each of the two `outputBarChart` methods that displays the chart is identical.

### *Method outputGrades*

Method `outputGrades` (lines 140–164) uses nested `for` statements to output values of the array `grades` and each student’s semester average. The output (Fig. 7.19) shows the result, which resembles the tabular format of a professor’s physical grade book. Lines 146–147 print the column headings for each test. We use a counter-controlled `for` statement here so that we can identify each test with a number. Similarly, the `for` statement in lines 152–163 first outputs a row label using a counter variable to identify each student (line 154). Although array indices start at 0, lines 147 and 154 output `test + 1` and `student + 1`, respectively, to produce test and student numbers starting at 1 (see Fig. 7.19). The inner `for` statement (lines 156–157) uses the outer `for` statement’s counter variable `student` to loop through a specific row of array `grades` and output each student’s test grade. An enhanced `for` statement can be nested in a counter-controlled `for` statement, and vice versa. Finally, line 161 obtains each student’s semester average by passing the current row of `grades` (i.e., `grades[student]`) to method `getAverage`.

### *Method getAverage*

Method `getAverage` (lines 94–104) takes one argument—a one-dimensional array of test results for a particular student. When line 161 calls `getAverage`, the argument is `grades[student]`, which specifies that a particular row of the two-dimensional array `grades` should be passed to `getAverage`. For example, based on the array created in Fig. 7.19, the argument `grades[1]` represents the three values (a one-dimensional array of `grades`) stored in row 1 of the two-dimensional array `grades`. Recall that a two-dimensional array is one whose elements are one-dimensional arrays. Method `getAverage` calculates the sum of the array elements, divides the total by the number of test results and returns the floating-point result as a `double` value (line 103).

### *Class GradeBookTest That Demonstrates Class GradeBook*

Figure 7.19 creates an object of class `GradeBook` (Fig. 7.18) using the two-dimensional array of `ints` named `gradesArray` (declared and initialized in lines 10–19). Lines 21–22 pass a course name and `gradesArray` to the `GradeBook` constructor. Lines 23–24 then invoke `myGradeBook`’s `displayMessage` and `processGrades` methods to display a welcome message and obtain a report summarizing the students’ grades for the semester, respectively.

---

```

1 // Fig. 7.19: GradeBookTest.java
2 // GradeBookTest creates GradeBook object using a two-dimensional array
3 // of grades, then invokes method processGrades to analyze them.
4 public class GradeBookTest
5 {
6 // main method begins program execution
7 public static void main(String[] args)
8 {

```

---

**Fig. 7.19** | `GradeBookTest` creates `GradeBook` object using a two-dimensional array of grades, then invokes method `processGrades` to analyze them. (Part 1 of 2.)

```

9 // two-dimensional array of student grades
10 int[][] gradesArray = { { 87, 96, 70 },
11 { 68, 87, 90 },
12 { 94, 100, 90 },
13 { 100, 81, 82 },
14 { 83, 65, 85 },
15 { 78, 87, 65 },
16 { 85, 75, 83 },
17 { 91, 94, 100 },
18 { 76, 72, 84 },
19 { 87, 93, 73 } };
20
21 GradeBook myGradeBook = new GradeBook(
22 "CS101 Introduction to Java Programming", gradesArray);
23 myGradeBook.displayMessage();
24 myGradeBook.processGrades();
25 } // end main
26 } // end class GradeBookTest

```

```

Welcome to the grade book for
CS101 Introduction to Java Programming!

```

The grades are:

|            | Test 1 | Test 2 | Test 3 | Average |
|------------|--------|--------|--------|---------|
| Student 1  | 87     | 96     | 70     | 84.33   |
| Student 2  | 68     | 87     | 90     | 81.67   |
| Student 3  | 94     | 100    | 90     | 94.67   |
| Student 4  | 100    | 81     | 82     | 87.67   |
| Student 5  | 83     | 65     | 85     | 77.67   |
| Student 6  | 78     | 87     | 65     | 76.67   |
| Student 7  | 85     | 75     | 83     | 81.00   |
| Student 8  | 91     | 94     | 100    | 95.00   |
| Student 9  | 76     | 72     | 84     | 77.33   |
| Student 10 | 87     | 93     | 73     | 84.33   |

```

Lowest grade in the grade book is 65
Highest grade in the grade book is 100

```

Overall grade distribution:

```

00-09:
10-19:
20-29:
30-39:
40-49:
50-59:
60-69: ***
70-79: *****
80-89: *****
90-99: *****
100: ***

```

**Fig. 7.19** | GradeBookTest creates GradeBook object using a two-dimensional array of grades, then invokes method processGrades to analyze them. (Part 2 of 2.)

## 7.11 Variable-Length Argument Lists

With **variable-length argument lists**, you can create methods that receive an unspecified number of arguments. A type followed by an **ellipsis** (`...`) in a method's parameter list indicates that the method receives a variable number of arguments of that particular type. This use of the ellipsis can occur only once in a parameter list, and the ellipsis, together with its type, must be placed at the end of the parameter list. While you can use method overloading and array passing to accomplish much of what is accomplished with variable-length argument lists, using an ellipsis in a method's parameter list is more concise.

Figure 7.20 demonstrates method `average` (lines 7–16), which receives a variable-length sequence of `double`s. Java treats the variable-length argument list as an array whose elements are all of the same type. Hence, the method body can manipulate the parameter numbers as an array of `double`s. Lines 12–13 use the enhanced for loop to walk through the array and calculate the total of the `double`s in the array. Line 15 accesses `numbers.length` to obtain the size of the `numbers` array for use in the averaging calculation. Lines 29, 31 and 33 in `main` call method `average` with two, three and four arguments, respectively. Method `average` has a variable-length argument list (line 7), so it can average as many `double` arguments as the caller passes. The output shows that each call to method `average` returns the correct value.

---

```

1 // Fig. 7.20: VarargsTest.java
2 // Using variable-length argument lists.
3
4 public class VarargsTest
5 {
6 // calculate average
7 public static double average(double... numbers)
8 {
9 double total = 0.0; // initialize total
10
11 // calculate total using the enhanced for statement
12 for (double d : numbers)
13 total += d;
14
15 return total / numbers.length;
16 } // end method average
17
18 public static void main(String[] args)
19 {
20 double d1 = 10.0;
21 double d2 = 20.0;
22 double d3 = 30.0;
23 double d4 = 40.0;
24
25 System.out.printf("d1 = %.1f\n d2 = %.1f\n d3 = %.1f\n d4 = %.1f\n\n",
26 d1, d2, d3, d4);
27
28 System.out.printf("Average of d1 and d2 is %.1f\n",
29 average(d1, d2));

```

**Fig. 7.20** | Using variable-length argument lists. (Part I of 2.)

```

30 System.out.printf("Average of d1, d2 and d3 is %.1f\n",
31 average(d1, d2, d3));
32 System.out.printf("Average of d1, d2, d3 and d4 is %.1f\n",
33 average(d1, d2, d3, d4));
34 } // end main
35 } // end class VarargsTest

```

```

d1 = 10.0
d2 = 20.0
d3 = 30.0
d4 = 40.0

```

```

Average of d1 and d2 is 15.0
Average of d1, d2 and d3 is 20.0
Average of d1, d2, d3 and d4 is 25.0

```

**Fig. 7.20** | Using variable-length argument lists. (Part 2 of 2.)



### Common Programming Error 7.6

*Placing an ellipsis indicating a variable-length argument list in the middle of a parameter list is a syntax error. An ellipsis may be placed only at the end of the parameter list.*

## 7.12 Using Command-Line Arguments

It's possible to pass arguments from the command line (these are known as **command-line arguments**) to an application by including a parameter of type `String[]` (i.e., an array of `Strings`) in the parameter list of `main`, exactly as we've done in every application in the book. By convention, this parameter is named `args`. When an application is executed using the `java` command, Java passes the command-line arguments that appear after the class name in the `java` command to the application's `main` method as `Strings` in the array `args`. The number of command-line arguments is obtained by accessing the array's `length` attribute. Common uses of command-line arguments include passing options and file names to applications.

Our next example uses command-line arguments to determine the size of an array, the value of its first element and the increment used to calculate the values of the array's remaining elements. The command

```
java InitArray 5 0 4
```

passes three arguments, 5, 0 and 4, to the application `InitArray`. Command-line arguments are separated by white space, not commas. When this command executes, `InitArray`'s `main` method receives the three-element array `args` (i.e., `args.length` is 3) in which `args[0]` contains the `String` "5", `args[1]` contains the `String` "0" and `args[2]` contains the `String` "4". The program determines how to use these arguments—in Fig. 7.21 we convert the three command-line arguments to `int` values and use them to initialize an array. When the program executes, if `args.length` is not 3, the program prints an error message and terminates (lines 9–12). Otherwise, lines 14–32 initialize and display the array based on the values of the command-line arguments.

Line 16 gets `args[0]`—a `String` that specifies the array size—and converts it to an `int` value that the program uses to create the array in line 17. The static method `parseInt` of class `Integer` converts its `String` argument to an `int`.

```

1 // Fig. 7.21: InitArray.java
2 // Initializing an array using command-line arguments.
3
4 public class InitArray
5 {
6 public static void main(String[] args)
7 {
8 // check number of command-line arguments
9 if (args.length != 3)
10 System.out.println(
11 "Error: Please re-enter the entire command, including\n" +
12 "an array size, initial value and increment.");
13 else
14 {
15 // get array size from first command-line argument
16 int arrayLength = Integer.parseInt(args[0]);
17 int[] array = new int[arrayLength]; // create array
18
19 // get initial value and increment from command-line arguments
20 int initialValue = Integer.parseInt(args[1]);
21 int increment = Integer.parseInt(args[2]);
22
23 // calculate value for each array element
24 for (int counter = 0; counter < array.length; counter++)
25 array[counter] = initialValue + increment * counter;
26
27 System.out.printf("%s%8s\n", "Index", "Value");
28
29 // display array index and value
30 for (int counter = 0; counter < array.length; counter++)
31 System.out.printf("%5d%8d\n", counter, array[counter]);
32 } // end else
33 } // end main
34 } // end class InitArray

```

```
java InitArray
```

```
Error: Please re-enter the entire command, including
an array size, initial value and increment.
```

```
java InitArray 5 0 4
```

| Index | Value |
|-------|-------|
| 0     | 0     |
| 1     | 4     |
| 2     | 8     |
| 3     | 12    |
| 4     | 16    |

**Fig. 7.21** | Initializing an array using command-line arguments. (Part 1 of 2.)

```

java InitArray 8 1 2
Index Value
 0 1
 1 3
 2 5
 3 7
 4 9
 5 11
 6 13
 7 15

```

**Fig. 7.21** | Initializing an array using command-line arguments. (Part 2 of 2.)

Lines 20–21 convert the `args[1]` and `args[2]` command-line arguments to `int` values and store them in `initialValue` and `increment`, respectively. Lines 24–25 calculate the value for each array element.

The output of the first execution shows that the application received an insufficient number of command-line arguments. The second execution uses command-line arguments 5, 0 and 4 to specify the size of the array (5), the value of the first element (0) and the increment of each value in the array (4), respectively. The corresponding output shows that these values create an array containing the integers 0, 4, 8, 12 and 16. The output from the third execution shows that the command-line arguments 8, 1 and 2 produce an array whose 8 elements are the nonnegative odd integers from 1 to 15.

## 7.13 Class Arrays

Class **Arrays** helps you avoid reinventing the wheel by providing static methods for common array manipulations. These methods include **sort** for sorting an array (i.e., arranging elements into increasing order), **binarySearch** for searching an array (i.e., determining whether an array contains a specific value and, if so, where the value is located), **equals** for comparing arrays and **fill** for placing values into an array. These methods are overloaded for primitive-type arrays and for arrays of objects. Our focus in this section is on using the built-in capabilities provided by the Java API. Chapter 19, Searching, Sorting and Big O, shows how to implement your own sorting and searching algorithms, which are of great interest to computer-science researchers and students.

Figure 7.22 uses `Arrays` methods `sort`, `binarySearch`, `equals` and `fill`, and shows how to copy arrays with class `System`'s static **arraycopy method**. In `main`, line 11 sorts the elements of array `doubleArray`. The static method `sort` of class `Arrays` orders the array's elements in *ascending* order by default. We discuss how to sort in *descending* order later in the chapter. Overloaded versions of `sort` allow you to sort a specific range of elements. Lines 12–15 output the sorted array.

```

1 // Fig. 7.22: ArrayManipulations.java
2 // Arrays class methods and System.arraycopy.
3 import java.util.Arrays;
4

```

**Fig. 7.22** | `Arrays` class methods. (Part 1 of 3.)

```
5 public class ArrayManipulations
6 {
7 public static void main(String[] args)
8 {
9 // sort doubleArray into ascending order
10 double[] doubleArray = { 8.4, 9.3, 0.2, 7.9, 3.4 };
11 Arrays.sort(doubleArray);
12 System.out.printf("\ndoubleArray: ");
13
14 for (double value : doubleArray)
15 System.out.printf("%.1f ", value);
16
17 // fill 10-element array with 7s
18 int[] filledIntArray = new int[10];
19 Arrays.fill(filledIntArray, 7);
20 displayArray(filledIntArray, "filledIntArray");
21
22 // copy array intArray into array intArrayCopy
23 int[] intArray = { 1, 2, 3, 4, 5, 6 };
24 int[] intArrayCopy = new int[intArray.length];
25 System.arraycopy(intArray, 0, intArrayCopy, 0, intArray.length);
26 displayArray(intArray, "intArray");
27 displayArray(intArrayCopy, "intArrayCopy");
28
29 // compare intArray and intArrayCopy for equality
30 boolean b = Arrays.equals(intArray, intArrayCopy);
31 System.out.printf("\n\nintArray %s intArrayCopy\n",
32 (b ? "==" : "!="));
33
34 // compare intArray and filledIntArray for equality
35 b = Arrays.equals(intArray, filledIntArray);
36 System.out.printf("intArray %s filledIntArray\n",
37 (b ? "==" : "!="));
38
39 // search intArray for the value 5
40 int location = Arrays.binarySearch(intArray, 5);
41
42 if (location >= 0)
43 System.out.printf(
44 "Found 5 at element %d in intArray\n", location);
45 else
46 System.out.println("5 not found in intArray");
47
48 // search intArray for the value 8763
49 location = Arrays.binarySearch(intArray, 8763);
50
51 if (location >= 0)
52 System.out.printf(
53 "Found 8763 at element %d in intArray\n", location);
54 else
55 System.out.println("8763 not found in intArray");
56 } // end main
57}
```

**Fig. 7.22** | Arrays class methods. (Part 2 of 3.)



```

58 // output values in each array
59 public static void displayArray(int[] array, String description)
60 {
61 System.out.printf("\n%s: ", description);
62
63 for (int value : array)
64 System.out.printf("%d ", value);
65 } // end method displayArray
66 } // end class ArrayManipulations

```

```

doubleArray: 0.2 3.4 7.9 8.4 9.3
filledIntArray: 7 7 7 7 7 7 7 7 7
intArray: 1 2 3 4 5 6
intArrayCopy: 1 2 3 4 5 6

intArray == intArrayCopy
intArray != filledIntArray
Found 5 at element 4 in intArray
8763 not found in intArray

```

**Fig. 7.22** | Arrays class methods. (Part 3 of 3.)

Line 19 calls static method `fill` of class `Arrays` to populate all 10 elements of `filledIntArray` with 7s. Overloaded versions of `fill` allow you to populate a specific range of elements with the same value. Line 20 calls our class's `displayArray` method (declared at lines 59–65) to output the contents of `filledIntArray`.

Line 25 copies the elements of `intArray` into `intArrayCopy`. The first argument (`intArray`) passed to `System` method `arraycopy` is the array from which elements are to be copied. The second argument (0) is the index that specifies the starting point in the range of elements to copy from the array. This value can be any valid array index. The third argument (`intArrayCopy`) specifies the destination array that will store the copy. The fourth argument (0) specifies the index in the destination array where the first copied element should be stored. The last argument specifies the number of elements to copy from the array in the first argument. In this case, we copy all the elements in the array.

Lines 30 and 35 call static method `equals` of class `Arrays` to determine whether all the elements of two arrays are equivalent. If the arrays contain the same elements in the same order, the method returns `true`; otherwise, it returns `false`.

Lines 40 and 49 call static method `binarySearch` of class `Arrays` to perform a binary search on `intArray`, using the second argument (5 and 8763, respectively) as the key. If `value` is found, `binarySearch` returns the index of the element; otherwise, `binarySearch` returns a negative value. The negative value returned is based on the search key's insertion point—the index where the key would be inserted in the array if we were performing an insert operation. After `binarySearch` determines the insertion point, it changes its sign to negative and subtracts 1 to obtain the return value. For example, in Fig. 7.22, the insertion point for the value 8763 is the element with index 6 in the array. Method `binarySearch` changes the insertion point to -6, subtracts 1 from it and returns the value -7. Subtracting 1 from the insertion point guarantees that method `binarySearch` returns positive values ( $\geq 0$ ) if and only if the key is found. This return value is useful for inserting elements in a sorted array. Chapter 19 discusses binary searching in detail.



### Common Programming Error 7.7

Passing an unsorted array to `binarySearch` is a logic error—the value returned is undefined.

## 7.14 Introduction to Collections and Class `ArrayList`

The Java API provides several predefined data structures, called **collections**, used to store groups of related objects. These classes provide efficient methods that organize, store and retrieve your data without requiring knowledge of how the data is being stored. This reduces application-development time.

You've used arrays to store sequences of objects. Arrays do not automatically change their size at execution time to accommodate additional elements. The collection class `ArrayList<T>` (from package `java.util`) provides a convenient solution to this problem—it can *dynamically* change its size to accommodate more elements. The `T` (by convention) is a *placeholder*—when declaring a new `ArrayList`, replace it with the type of elements that you want the `ArrayList` to hold. This is similar to specifying the type when declaring an array, except that *only nonprimitive types can be used with these collection classes*. For example,

```
ArrayList<String> list;
```

declares `list` as an `ArrayList` collection that can store only `Strings`. Classes with this kind of placeholder that can be used with any type are called **generic classes**. Additional generic collection classes and generics are discussed in Chapters 20 and 21, respectively. Figure 7.23 shows some common methods of class `ArrayList<T>`.

| Method                  | Description                                                                                            |
|-------------------------|--------------------------------------------------------------------------------------------------------|
| <code>add</code>        | Adds an element to the end of the <code>ArrayList</code> .                                             |
| <code>clear</code>      | Removes all the elements from the <code>ArrayList</code> .                                             |
| <code>contains</code>   | Returns true if the <code>ArrayList</code> contains the specified element; otherwise, returns false.   |
| <code>get</code>        | Returns the element at the specified index.                                                            |
| <code>indexOf</code>    | Returns the index of the first occurrence of the specified element in the <code>ArrayList</code> .     |
| <code>remove</code>     | Overloaded. Removes the first occurrence of the specified value or the element at the specified index. |
| <code>size</code>       | Returns the number of elements stored in the <code>ArrayList</code> .                                  |
| <code>trimToSize</code> | Trims the capacity of the <code>ArrayList</code> to current number of elements.                        |

**Fig. 7.23** | Some methods and properties of class `ArrayList<T>`.

Figure 7.24 demonstrates some common `ArrayList` capabilities. Line 10 creates a new empty `ArrayList` of `Strings` with a default initial capacity of 10 elements. The capacity indicates how many items the `ArrayList` can hold without growing. `ArrayList` is implemented using an array behind the scenes. When the `ArrayList` grows, it must create a larger internal array and copy each element to the new array. This is a time-con-

suming operation. It would be inefficient for the ArrayList to grow each time an element is added. Instead, it grows only when an element is added *and* the number of elements is equal to the capacity—i.e., there's no space for the new element.

---

```

1 // Fig. 7.24: ArrayListCollection.java
2 // Generic ArrayList<T> collection demonstration.
3 import java.util.ArrayList;
4
5 public class ArrayListCollection
6 {
7 public static void main(String[] args)
8 {
9 // create a new ArrayList of Strings with an initial capacity of 10
10 ArrayList< String > items = new ArrayList< String >();
11
12 items.add("red"); // append an item to the list
13 items.add(0, "yellow"); // insert the value at index 0
14
15 // header
16 System.out.print(
17 "Display list contents with counter-controlled loop:");
18
19 // display the colors in the list
20 for (int i = 0; i < items.size(); i++)
21 System.out.printf(" %s", items.get(i));
22
23 // display colors using foreach in the display method
24 display(items,
25 "\nDisplay list contents with enhanced for statement:");
26
27 items.add("green"); // add "green" to the end of the list
28 items.add("yellow"); // add "yellow" to the end of the list
29 display(items, "List with two new elements:");
30
31 items.remove("yellow"); // remove the first "yellow"
32 display(items, "Remove first instance of yellow:");
33
34 items.remove(1); // remove item at index 1
35 display(items, "Remove second list element (green):");
36
37 // check if a value is in the List
38 System.out.printf("\n\"red\" is %sin the list\n",
39 items.contains("red") ? "" : "not ");
40
41 // display number of elements in the List
42 System.out.printf("Size: %s\n", items.size());
43 } // end main
44
45 // display the ArrayList's elements on the console
46 public static void display(ArrayList< String > items, String header)
47 {
48 System.out.print(header); // display header

```

**Fig. 7.24** | Generic ArrayList<T> collection demonstration. (Part I of 2.)

```

49
50 // display each element in items
51 for (String item : items)
52 System.out.printf(" %s", item);
53
54 System.out.println(); // display end of line
55 } // end method display
56 } // end class ArrayListCollection

```

```

Display list contents with counter-controlled loop: yellow red
Display list contents with enhanced for statement: yellow red
List with two new elements: yellow red green yellow
Remove first instance of yellow: red green yellow
Remove second list element (green): red yellow
"red" is in the list
Size: 2

```

**Fig. 7.24** | Generic `ArrayList<T>` collection demonstration. (Part 2 of 2.)

The **add** method adds elements to the `ArrayList` (lines 12–13). The `add` method with *one* argument appends its argument to the end of the `ArrayList`. The `add` method with *two* arguments inserts a new element at the specified position. The first argument is an index. As with arrays, collection indices start at zero. The second argument is the value to insert at that index. The indices of all subsequent elements are incremented by one. Inserting an element is usually slower than adding an element to the end of the `ArrayList`.

Lines 20–21 display the items in the `ArrayList`. The **size** method returns the number of elements currently in the `ArrayList`. `ArrayList`'s method **get** (line 21) obtains the element at a specified index. Lines 24–25 display the elements again by invoking method `display` (defined at lines 46–55). Lines 27–28 add two more elements to the `ArrayList`, then line 29 displays the elements again to confirm that the two elements were added to the end of the collection.

The **remove** method is used to remove an element with a specific value (line 31). It removes only the first such element. If no such element is in the `ArrayList`, `remove` does nothing. An overloaded version of the method removes the element at the specified index (line 34). When an element is removed, the indices of all elements after the removed element decrease by one.

Line 39 uses the **contains** method to check if an item is in the `ArrayList`. The `contains` method returns `true` if the element is found in the `ArrayList`, and `false` otherwise. The method compares its argument to each element of the `ArrayList` in order, so using `contains` on a large `ArrayList` can be inefficient. Line 42 displays the `ArrayList`'s size.

## 7.15 (Optional) GUI and Graphics Case Study: Drawing Arcs

Using Java's graphics features, we can create complex drawings that would be more tedious to code line by line. In Figs. 7.25–7.26, we use arrays and repetition statements to draw a rainbow by using `Graphics` method `fillArc`. Drawing arcs in Java is similar to drawing ovals—an arc is simply a section of an oval.

Figure 7.25 begins with the usual `import` statements for creating drawings (lines 3–5). Lines 10–11 declare and create two new color constants—`VIOLET` and `INDIGO`. As you may know, the colors of a rainbow are red, orange, yellow, green, blue, indigo and violet. Java has predefined constants only for the first five colors. Lines 15–17 initialize an array with the colors of the rainbow, starting with the innermost arcs first. The array begins with two `Color.WHITE` elements, which, as you’ll soon see, are for drawing the empty arcs at the center of the rainbow. The instance variables can be initialized when they’re declared, as shown in lines 10–17. The constructor (lines 20–23) contains a single statement that calls method `setBackground` (which is inherited from class `JPanel`) with the parameter `Color.WHITE`. Method `setBackground` takes a single `Color` argument and sets the background of the component to that color.

---

```

1 // Fig. 7.25: DrawRainbow.java
2 // Demonstrates using colors in an array.
3 import java.awt.Color;
4 import java.awt.Graphics;
5 import javax.swing.JPanel;
6
7 public class DrawRainbow extends JPanel
8 {
9 // define indigo and violet
10 private final static Color VIOLET = new Color(128, 0, 128);
11 private final static Color INDIGO = new Color(75, 0, 130);
12
13 // colors to use in the rainbow, starting from the innermost
14 // The two white entries result in an empty arc in the center
15 private Color[] colors =
16 { Color.WHITE, Color.VIOLET, Color.INDIGO, Color.BLUE,
17 Color.GREEN, Color.YELLOW, Color.ORANGE, Color.RED };
18
19 // constructor
20 public DrawRainbow()
21 {
22 setBackground(Color.WHITE); // set the background to white
23 } // end DrawRainbow constructor
24
25 // draws a rainbow using concentric arcs
26 public void paintComponent(Graphics g)
27 {
28 super.paintComponent(g);
29
30 int radius = 20; // radius of an arc
31
32 // draw the rainbow near the bottom-center
33 int centerX = getWidth() / 2;
34 int centerY = getHeight() - 10;
35
36 // draws filled arcs starting with the outermost
37 for (int counter = colors.length; counter > 0; counter--)
38 {

```

---

**Fig. 7.25** | Drawing a rainbow using arcs and an array of colors. (Part I of 2.)

---

```

39 // set the color for the current arc
40 g.setColor(colors[counter - 1]);
41
42 // fill the arc from 0 to 180 degrees
43 g.fillArc(centerX - counter * radius,
44 centerY - counter * radius,
45 counter * radius * 2, counter * radius * 2, 0, 180);
46 } // end for
47 } // end method paintComponent
48 } // end class DrawRainbow

```

---

**Fig. 7.25** | Drawing a rainbow using arcs and an array of colors. (Part 2 of 2.)

Line 30 in `paintComponent` declares local variable `radius`, which determines the radius of each arc. Local variables `centerX` and `centerY` (lines 33–34) determine the location of the midpoint on the base of the rainbow. The loop at lines 37–46 uses control variable `counter` to count backward from the end of the array, drawing the largest arcs first and placing each successive smaller arc on top of the previous one. Line 40 sets the color to draw the current arc from the array. The reason we have `Color.WHITE` entries at the beginning of the array is to create the empty arc in the center. Otherwise, the center of the rainbow would just be a solid violet semicircle. [*Note:* You can change the individual colors and the number of entries in the array to create new designs.]

The `fillArc` method call at lines 43–45 draws a filled semicircle. Method `fillArc` requires six parameters. The first four represent the bounding rectangle in which the arc will be drawn. The first two of these specify the coordinates for the upper-left corner of the bounding rectangle, and the next two specify its width and height. The fifth parameter is the starting angle on the oval, and the sixth specifies the **sweep**, or the amount of arc to cover. The starting angle and sweep are measured in degrees, with zero degrees pointing right. A positive sweep draws the arc counterclockwise, while a negative sweep draws the arc clockwise. A method similar to `fillArc` is `drawArc`—it requires the same parameters as `fillArc`, but draws the edge of the arc rather than filling it.

Class `DrawRainbowTest` (Fig. 7.26) creates and sets up a `JFrame` to display the rainbow. Once the program makes the `JFrame` visible, the system calls the `paintComponent` method in class `DrawRainbow` to draw the rainbow on the screen.

---

```

1 // Fig. 7.26: DrawRainbowTest.java
2 // Test application to display a rainbow.
3 import javax.swing.JFrame;
4
5 public class DrawRainbowTest
6 {
7 public static void main(String[] args)
8 {
9 DrawRainbow panel = new DrawRainbow();
10 JFrame application = new JFrame();
11
12 application.setDefaultCloseOperation(JFrame.EXIT_ON_CLOSE);

```

---

**Fig. 7.26** | Creating `JFrame` to display a rainbow. (Part 1 of 2.)

```

13 application.add(panel);
14 application.setSize(400, 250);
15 application.setVisible(true);
16 } // end main
17 } // end class DrawRainbowTest

```

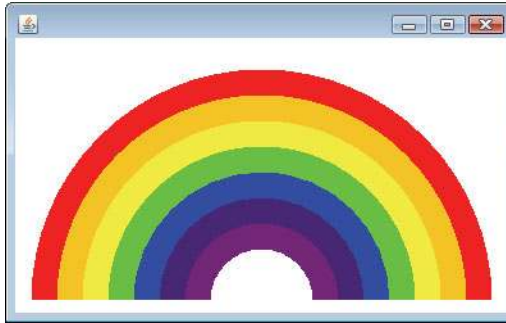

**Fig. 7.26** | Creating JFrame to display a rainbow. (Part 2 of 2.)

### GUI and Graphics Case Study Exercise

- 7.1** (*Drawing Spirals*) In this exercise, you'll draw spirals with methods `drawLine` and `drawArc`.
- Draw a square-shaped spiral (as in the left screen capture of Fig. 7.27), centered on the panel, using method `drawLine`. One technique is to use a loop that increases the line length after drawing every second line. The direction in which to draw the next line should follow a distinct pattern, such as down, left, up, right.
  - Draw a circular spiral (as in the right screen capture of Fig. 7.27), using method `drawArc` to draw one semicircle at a time. Each successive semicircle should have a larger radius (as specified by the bounding rectangle's width) and should continue drawing where the previous semicircle finished.

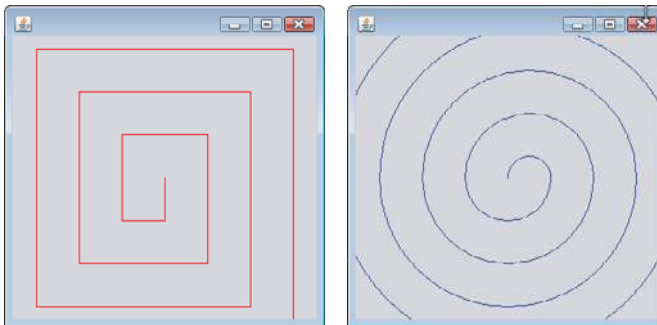

**Fig. 7.27** | Drawing a spiral using `drawLine` (left) and `drawArc` (right).

## 7.16 Wrap-Up

This chapter began our introduction to data structures, exploring the use of arrays to store data in and retrieve data from lists and tables of values. The chapter examples demonstrated

how to declare an array, initialize an array and refer to individual elements of an array. The chapter introduced the enhanced `for` statement to iterate through arrays. We used exception handling to test for `ArrayIndexOutOfBoundsException` that occur when a program attempts to access an array element outside the bounds of an array. We also illustrated how to pass arrays to methods and how to declare and manipulate multidimensional arrays. Finally, the chapter showed how to write methods that use variable-length argument lists and how to read arguments passed to a program from the command line.

We introduced the `ArrayList<T>` generic collection, which provides all the functionality and performance of arrays, along with other useful capabilities such as dynamic resizing. We used the `add` methods to add new items to the end of an `ArrayList` and to insert items in an `ArrayList`. The `remove` method was used to remove the first occurrence of a specified item, and an overloaded version of `remove` was used to remove an item at a specified index. We used the `size` method to obtain number of items in the `ArrayList`.

We continue our coverage of data structures in Chapter 20, *Generic Collections*. Chapter 20 introduces the Java Collections Framework, which uses generics to allow you to specify the exact types of objects that a particular data structure will store. Chapter 20 also introduces Java's other predefined data structures. The Collections API provides class `Arrays`, which contains utility methods for array manipulation. Chapter 20 uses several static methods of class `Arrays` to perform such manipulations as sorting and searching the data in an array. You'll be able to use some of the `Arrays` methods discussed in Chapter 20 after reading the current chapter, but some of the `Arrays` methods require knowledge of concepts presented later in the book. Chapter 21 presents the topic of generics, which provide the means to create general models of methods and classes that can be declared once, but used with many different data types. Chapter 22, *Custom Generic Data Structures*, shows how to build dynamic data structures, such as lists, queues, stacks and trees, that can grow and shrink as programs execute.

We've now introduced the basic concepts of classes, objects, control statements, methods, arrays and collections. In Chapter 8, we take a deeper look at classes and objects.

---

## Summary

### *Section 7.1 Introduction*

- Arrays (p. 241) are fixed-length data structures consisting of related data items of the same type.

### *Section 7.2 Arrays*

- An array is a group of variables (called elements or components; p. 242) containing values that all have the same type. Arrays are objects, so they're considered reference types.
- A program refers to any one of an array's elements with an array-access expression (p. 242) that includes the name of the array followed by the index of the particular element in square brackets (`[]`; p. 242).
- The first element in every array has index zero (p. 242) and is sometimes called the zeroth element.
- An index must be a nonnegative integer. A program can use an expression as an index.
- An array object knows its own length and stores this information in a `length` instance variable (p. 242).



### Section 7.3 Declaring and Creating Arrays

- To create an array object, specify the array's element type and the number of elements as part of an array-creation expression (p. 243) that uses keyword `new`.
- When an array is created, each element receives a default value—zero for numeric primitive-type elements, `false` for boolean elements and `null` for references.
- In an array declaration, the type and the square brackets can be combined at the beginning of the declaration to indicate that all the identifiers in the declaration are array variables.
- Every element of a primitive-type array contains a variable of the array's declared type. Every element of a reference-type array is a reference to an object of the array's declared type.

### Section 7.4 Examples Using Arrays

- A program can create an array and initialize its elements with an array initializer (p. 245).
- Constant variables (p. 247) are declared with keyword `final`, must be initialized before they're used and cannot be modified thereafter.
- When a Java program executes, the JVM checks array indices to ensure that they're greater than or equal to 0 and less than the array's length. If a program uses an invalid index, Java generates an exception (p. 253) to indicate that an error occurred in the program at execution time.
- When a program is executed, array element indices are checked for validity—all indices must be greater than or equal to 0 and less than the length of the array. If an attempt is made to use an invalid index to access an element, an `ArrayIndexOutOfBoundsException` (p. 253) exception occurs.
- An exception indicates a problem that occurs while a program executes. The name “exception” suggests that the problem occurs infrequently—if the “rule” is that a statement normally executes correctly, then the problem represents the “exception to the rule.”
- Exception handling (p. 253) enables you to create fault-tolerant programs.
- To handle an exception, place any code that might throw an exception (p. 253) in a try statement.
- The try block (p. 253) contains the code that might throw an exception, and the catch block (p. 253) contains the code that handles the exception if one occurs.
- You can have many catch blocks to handle different types of exceptions that might be thrown in the corresponding try block.
- When a try block terminates, any variables declared in the try block go out of scope.
- A catch block declares a type and an exception parameter. Inside the catch block, you can use the parameter's identifier to interact with a caught exception object.
- An exception object's `toString` method returns the exception's error message.

### Section 7.5 Case Study: Card Shuffling and Dealing Simulation

- The `toString` method of an object is called implicitly when the object is used where a `String` is expected (e.g., when `printf` outputs the object as a `String` using the `%s` format specifier or when the object is concatenated to a `String` using the `+` operator).

### Section 7.6 Enhanced for Statement

- The enhanced for statement (p. 258) allows you to iterate through the elements of an array or a collection without using a counter. The syntax of an enhanced for statement is:

```
for (parameter : arrayName)
 statement
```

where *parameter* has a type and an identifier (e.g., `int number`), and *arrayName* is the array through which to iterate.

- The enhanced for statement cannot be used to modify elements in an array. If a program needs to modify elements, use the traditional counter-controlled for statement.

### Section 7.7 Passing Arrays to Methods

- When an argument is passed by value, a copy of the argument's value is made and passed to the called method. The called method works exclusively with the copy.
- When an argument is passed by reference (p. 262), the called method can access the argument's value in the caller directly and possibly modify it.
- All arguments in Java are passed by value. A method call can pass two types of values to a method—copies of primitive values and copies of references to objects. Although an object's reference is passed by value (p. 262), a method can still interact with the referenced object by calling its `public` methods using the copy of the object's reference.
- To pass an object reference to a method, simply specify in the method call the name of the variable that refers to the object.
- When you pass an array or an individual array element of a reference type to a method, the called method receives a copy of the array or element's reference. When you pass an individual element of a primitive type, the called method receives a copy of the element's value.
- To pass an individual array element to a method, use the indexed name of the array.

### Section 7.9 Multidimensional Arrays

- Multidimensional arrays with two dimensions are often used to represent tables of values consisting of information arranged in rows and columns.
- A two-dimensional array (p. 268) with  $m$  rows and  $n$  columns is called an  $m$ -by- $n$  array. Such an array can be initialized with an array initializer of the form

```
arrayType[][] arrayName = { { row1 initializer }, { row2 initializer }, ... };
```

- Multidimensional arrays are maintained as arrays of separate one-dimensional arrays. As a result, the lengths of the rows in a two-dimensional array are not required to be the same.
- A multidimensional array with the same number of columns in every row can be created with an array-creation expression of the form

```
arrayType[][] arrayName = new arrayType[numRows][numColumns];
```

### Section 7.11 Variable-Length Argument Lists

- An argument type followed by an ellipsis (`...`; p. 278) in a method's parameter list indicates that the method receives a variable number of arguments of that particular type. The ellipsis can occur only once in a method's parameter list. It must be at the end of the parameter list.
- A variable-length argument list (p. 278) is treated as an array within the method body. The number of arguments in the array can be obtained using the array's `length` field.

### Section 7.12 Using Command-Line Arguments

- Passing arguments to `main` (p. 279) from the command line is achieved by including a parameter of type `String[]` in the parameter list of `main`. By convention, `main`'s parameter is named `args`.
- Java passes command-line arguments that appear after the class name in the `java` command to the application's `main` method as `Strings` in the array `args`.

### Section 7.13 Class Arrays

- Class `Arrays` (p. 281) provides static methods that perform common array manipulations, including `sort` to sort an array, `binarySearch` to search a sorted array, `equals` to compare arrays and `fill` to place items in an array.

- Class `System`'s `arraycopy` method (p. 281) enables you to copy the elements of one array into another.

### Section 7.14 Introduction to Collections and Class `ArrayList`

- The Java API's collection classes provide efficient methods that organize, store and retrieve data without requiring knowledge of how the data is being stored.
- An `ArrayList<T>` (p. 284) is similar to an array, but can be dynamically resized.
- The `add` method (p. 286) with one argument appends an element to the end of an `ArrayList`.
- The `add` method with two arguments inserts a new element at a specified position in an `ArrayList`.
- The `size` method (p. 286) returns the number of elements currently in an `ArrayList`.
- The `remove` method with a reference to an object as an argument removes the first element that matches the argument's value.
- The `remove` method with an integer argument removes the element at the specified index, and all elements above that index are shifted down by one.
- The `contains` method returns `true` if the element is found in the `ArrayList`, and `false` otherwise.

## Self-Review Exercises

- 7.1** Fill in the blank(s) in each of the following statements:
- Lists and tables of values can be stored in \_\_\_\_\_.
  - An array is a group of \_\_\_\_\_ (called elements or components) containing values that all have the same \_\_\_\_\_.
  - The \_\_\_\_\_ allows you to iterate through the elements in an array without using a counter.
  - The number used to refer to a particular array element is called the element's \_\_\_\_\_.
  - An array that uses two indices is referred to as a(n) \_\_\_\_\_ array.
  - Use the enhanced `for` statement \_\_\_\_\_ to walk through double array numbers.
  - Command-line arguments are stored in \_\_\_\_\_.
  - Use the expression \_\_\_\_\_ to receive the total number of arguments in a command line. Assume that command-line arguments are stored in `String[] args`.
  - Given the command `java MyClass test`, the first command-line argument is \_\_\_\_\_.
  - A(n) \_\_\_\_\_ in the parameter list of a method indicates that the method can receive a variable number of arguments.
- 7.2** Determine whether each of the following is *true* or *false*. If *false*, explain why.
- An array can store many different types of values.
  - An array index should normally be of type `float`.
  - An individual array element that's passed to a method and modified in that method will contain the modified value when the called method completes execution.
  - Command-line arguments are separated by commas.
- 7.3** Perform the following tasks for an array called `fractions`:
- Declare a constant `ARRAY_SIZE` that's initialized to 10.
  - Declare an array with `ARRAY_SIZE` elements of type `double`, and initialize the elements to 0.
  - Refer to array element 4.
  - Assign the value 1.667 to array element 9.
  - Assign the value 3.333 to array element 6.
  - Sum all the elements of the array, using a `for` statement. Declare the integer variable `x` as a control variable for the loop.
- 7.4** Perform the following tasks for an array called `table`:

- a) Declare and create the array as an integer array that has three rows and three columns. Assume that the constant `ARRAY_SIZE` has been declared to be 3.
- b) How many elements does the array contain?
- c) Use a `for` statement to initialize each element of the array to the sum of its indices. Assume that the integer variables `x` and `y` are declared as control variables.

**7.5** Find and correct the error in each of the following program segments:

- a) 

```
final int ARRAY_SIZE = 5;
ARRAY_SIZE = 10;
```
- b) Assume 

```
int[] b = new int[10];
for (int i = 0; i <= b.length; i++)
 b[i] = 1;
```
- c) Assume 

```
int[][] a = { { 1, 2 }, { 3, 4 } };
a[1, 1] = 5;
```

## Answers to Self-Review Exercises

**7.1** a) arrays. b) variables, type. c) enhanced `for` statement. d) index (or subscript or position number). e) two-dimensional. f) `for ( double d : numbers )`. g) an array of `Strings`, called `args` by convention. h) `args.length`. i) `test`. j) ellipsis (`...`).

- 7.2**
- a) False. An array can store only values of the same type.
  - b) False. An array index must be an integer or an integer expression.
  - c) For individual primitive-type elements of an array: False. A called method receives and manipulates a copy of the value of such an element, so modifications do not affect the original value. If the reference of an array is passed to a method, however, modifications to the array elements made in the called method are indeed reflected in the original. For individual elements of a reference type: True. A called method receives a copy of the reference of such an element, and changes to the referenced object will be reflected in the original array element.
  - d) False. Command-line arguments are separated by white space.

- 7.3**
- a) 

```
final int ARRAY_SIZE = 10;
```
  - b) 

```
double[] fractions = new double[ARRAY_SIZE];
```
  - c) 

```
fractions[4]
```
  - d) 

```
fractions[9] = 1.667;
```
  - e) 

```
fractions[6] = 3.333;
```
  - f) 

```
double total = 0.0;
for (int x = 0; x < fractions.length; x++)
 total += fractions[x];
```

- 7.4**
- a) 

```
int[][] table = new int[ARRAY_SIZE][ARRAY_SIZE];
```
  - b) Nine.
  - c) 

```
for (int x = 0; x < table.length; x++)
 for (int y = 0; y < table[x].length; y++)
 table[x][y] = x + y;
```

- 7.5**
- a) Error: Assigning a value to a constant after it has been initialized. Correction: Assign the correct value to the constant in a `final int ARRAY_SIZE` declaration or declare another variable.
  - b) Error: Referencing an array element outside the bounds of the array (`b[10]`). Correction: Change the `<=` operator to `<`.
  - c) Error: Array indexing is performed incorrectly. Correction: Change the statement to `a[ 1 ][ 1 ] = 5;`.

## Exercises

- 7.6** Fill in the blanks in each of the following statements:
- One-dimensional array `p` contains four elements. The names of those elements are \_\_\_\_\_, \_\_\_\_\_, \_\_\_\_\_ and \_\_\_\_\_.
  - Naming an array, stating its type and specifying the number of dimensions in the array is called \_\_\_\_\_ the array.
  - In a two-dimensional array, the first index identifies the \_\_\_\_\_ of an element and the second index identifies the \_\_\_\_\_ of an element.
  - An  $m$ -by- $n$  array contains \_\_\_\_\_ rows, \_\_\_\_\_ columns and \_\_\_\_\_ elements.
  - The name of the element in row 3 and column 5 of array `d` is \_\_\_\_\_.
- 7.7** Determine whether each of the following is *true* or *false*. If *false*, explain why.
- To refer to a particular location or element within an array, we specify the name of the array and the value of the particular element.
  - An array declaration reserves space for the array.
  - To indicate that 100 locations should be reserved for integer array `p`, you write the declaration  

```
p[100];
```
  - An application that initializes the elements of a 15-element array to zero must contain at least one `for` statement.
  - An application that totals the elements of a two-dimensional array must contain nested `for` statements.
- 7.8** Write Java statements to accomplish each of the following tasks:
- Display the value of element 6 of array `f`.
  - Initialize each of the five elements of one-dimensional integer array `g` to 8.
  - Total the 100 elements of floating-point array `c`.
  - Copy 11-element array `a` into the first portion of array `b`, which contains 34 elements.
  - Determine and display the smallest and largest values contained in 99-element floating-point array `w`.
- 7.9** Consider a two-by-three integer array `t`.
- Write a statement that declares and creates `t`.
  - How many rows does `t` have?
  - How many columns does `t` have?
  - How many elements does `t` have?
  - Write access expressions for all the elements in row 1 of `t`.
  - Write access expressions for all the elements in column 2 of `t`.
  - Write a single statement that sets the element of `t` in row 0 and column 1 to zero.
  - Write individual statements to initialize each element of `t` to zero.
  - Write a nested `for` statement that initializes each element of `t` to zero.
  - Write a nested `for` statement that inputs the values for the elements of `t` from the user.
  - Write a series of statements that determines and displays the smallest value in `t`.
  - Write a single `printf` statement that displays the elements of the first row of `t`.
  - Write a statement that totals the elements of the third column of `t`. Do not use repetition.
  - Write a series of statements that displays the contents of `t` in tabular format. List the column indices as headings across the top, and list the row indices at the left of each row.
- 7.10** (*Sales Commissions*) Use a one-dimensional array to solve the following problem: A company pays its salespeople on a commission basis. The salespeople receive \$200 per week plus 9% of their gross sales for that week. For example, a salesperson who grosses \$5000 in sales in a week receives \$200 plus 9% of \$5000, or a total of \$650. Write an application (using an array of counters)

that determines how many of the salespeople earned salaries in each of the following ranges (assume that each salesperson's salary is truncated to an integer amount):

- a) \$200–299
- b) \$300–399
- c) \$400–499
- d) \$500–599
- e) \$600–699
- f) \$700–799
- g) \$800–899
- h) \$900–999
- i) \$1000 and over

Summarize the results in tabular format.

**7.11** Write statements that perform the following one-dimensional-array operations:

- a) Set the 10 elements of integer array `counts` to zero.
- b) Add one to each of the 15 elements of integer array `bonus`.
- c) Display the five values of integer array `bestScores` in column format.

**7.12** (*Duplicate Elimination*) Use a one-dimensional array to solve the following problem: Write an application that inputs five numbers, each between 10 and 100, inclusive. As each number is read, display it only if it's not a duplicate of a number already read. Provide for the “worst case,” in which all five numbers are different. Use the smallest possible array to solve this problem. Display the complete set of unique values input after the user enters each new value.

**7.13** Label the elements of three-by-five two-dimensional array `sales` to indicate the order in which they're set to zero by the following program segment:

```
for (int row = 0; row < sales.length; row++)
{
 for (int col = 0; col < sales[row].length; col++)
 {
 sales[row][col] = 0;
 }
}
```

**7.14** (*Variable-Length Argument List*) Write an application that calculates the product of a series of integers that are passed to method `product` using a variable-length argument list. Test your method with several calls, each with a different number of arguments.

**7.15** (*Command-Line Arguments*) Rewrite Fig. 7.2 so that the size of the array is specified by the first command-line argument. If no command-line argument is supplied, use 10 as the default size of the array.

**7.16** (*Using the Enhanced for Statement*) Write an application that uses an enhanced `for` statement to sum the `double` values passed by the command-line arguments. [*Hint: Use the static method `parseDouble` of class `Double` to convert a `String` to a `double` value.*]

**7.17** (*Dice Rolling*) Write an application to simulate the rolling of two dice. The application should use an object of class `Random` once to roll the first die and again to roll the second die. The sum of the two values should then be calculated. Each die can show an integer value from 1 to 6, so the sum of the values will vary from 2 to 12, with 7 being the most frequent sum, and 2 and 12 the least frequent. Figure 7.28 shows the 36 possible combinations of the two dice. Your application should roll the dice 36,000,000 times. Use a one-dimensional array to tally the number of times each possible sum appears. Display the results in tabular format.

|   |   |   |   |    |    |    |
|---|---|---|---|----|----|----|
|   | 1 | 2 | 3 | 4  | 5  | 6  |
| 1 | 2 | 3 | 4 | 5  | 6  | 7  |
| 2 | 3 | 4 | 5 | 6  | 7  | 8  |
| 3 | 4 | 5 | 6 | 7  | 8  | 9  |
| 4 | 5 | 6 | 7 | 8  | 9  | 10 |
| 5 | 6 | 7 | 8 | 9  | 10 | 11 |
| 6 | 7 | 8 | 9 | 10 | 11 | 12 |

**Fig. 7.28** | The 36 possible sums of two dice.

**7.18** (*Game of Craps*) Write an application that runs 1,000,000 games of craps (Fig. 6.8) and answers the following questions:

- How many games are won on the first roll, second roll, ..., twentieth roll and after the twentieth roll?
- How many games are lost on the first roll, second roll, ..., twentieth roll and after the twentieth roll?
- What are the chances of winning at craps? [*Note:* You should discover that craps is one of the fairest casino games. What do you suppose this means?]
- What is the average length of a game of craps?
- Do the chances of winning improve with the length of the game?

**7.19** (*Airline Reservations System*) A small airline has just purchased a computer for its new automated reservations system. You've been asked to develop the new system. You're to write an application to assign seats on each flight of the airline's only plane (capacity: 10 seats).

Your application should display the following alternatives: Please type 1 for First Class and Please type 2 for Economy. If the user types 1, your application should assign a seat in the first-class section (seats 1–5). If the user types 2, your application should assign a seat in the economy section (seats 6–10). Your application should then display a boarding pass indicating the person's seat number and whether it's in the first-class or economy section of the plane.

Use a one-dimensional array of primitive type `boolean` to represent the seating chart of the plane. Initialize all the elements of the array to `false` to indicate that all the seats are empty. As each seat is assigned, set the corresponding element of the array to `true` to indicate that the seat is no longer available.

Your application should never assign a seat that has already been assigned. When the economy section is full, your application should ask the person if it's acceptable to be placed in the first-class section (and vice versa). If yes, make the appropriate seat assignment. If no, display the message "Next flight leaves in 3 hours."

**7.20** (*Total Sales*) Use a two-dimensional array to solve the following problem: A company has four salespeople (1 to 4) who sell five different products (1 to 5). Once a day, each salesperson passes in a slip for each type of product sold. Each slip contains the following:

- The salesperson number
- The product number
- The total dollar value of that product sold that day

Thus, each salesperson passes in between 0 and 5 sales slips per day. Assume that the information from all the slips for last month is available. Write an application that will read all this information for last month's sales and summarize the total sales by salesperson and by product. All totals should be stored in the two-dimensional array `sales`. After processing all the information for last month, display the results in tabular format, with each column representing a salesperson and each row repre-

sending a particular product. Cross-total each row to get the total sales of each product for last month. Cross-total each column to get the total sales by salesperson for last month. Your output should include these cross-totals to the right of the totaled rows and to the bottom of the totaled columns.

**7.21 (Turtle Graphics)** The Logo language made the concept of *turtle graphics* famous. Imagine a mechanical turtle that walks around the room under the control of a Java application. The turtle holds a pen in one of two positions, up or down. While the pen is down, the turtle traces out shapes as it moves, and while the pen is up, the turtle moves about freely without writing anything. In this problem, you'll simulate the operation of the turtle and create a computerized sketchpad.

Use a 20-by-20 array `floor` that's initialized to zeros. Read commands from an array that contains them. Keep track of the current position of the turtle at all times and whether the pen is currently up or down. Assume that the turtle always starts at position (0, 0) of the floor with its pen up. The set of turtle commands your application must process are shown in Fig. 7.29.

| Command | Meaning                                                              |
|---------|----------------------------------------------------------------------|
| 1       | Pen up                                                               |
| 2       | Pen down                                                             |
| 3       | Turn right                                                           |
| 4       | Turn left                                                            |
| 5, 10   | Move forward 10 spaces (replace 10 for a different number of spaces) |
| 6       | Display the 20-by-20 array                                           |
| 9       | End of data (sentinel)                                               |

**Fig. 7.29** | Turtle graphics commands.

Suppose that the turtle is somewhere near the center of the floor. The following “program” would draw and display a 12-by-12 square, leaving the pen in the up position:

```

2
5, 12
3
5, 12
3
5, 12
3
5, 12
1
6
9

```

As the turtle moves with the pen down, set the appropriate elements of array `floor` to 1s. When the 6 command (display the array) is given, wherever there's a 1 in the array, display an asterisk or any character you choose. Wherever there's a 0, display a blank.

Write an application to implement the turtle graphics capabilities discussed here. Write several turtle graphics programs to draw interesting shapes. Add other commands to increase the power of your turtle graphics language.

**7.22 (Knight's Tour)** An interesting puzzler for chess buffs is the Knight's Tour problem, originally proposed by the mathematician Euler. Can the knight piece move around an empty chessboard and touch each of the 64 squares once and only once? We study this intriguing problem in depth here.



The knight makes only L-shaped moves (two spaces in one direction and one space in a perpendicular direction). Thus, as shown in Fig. 7.30, from a square near the middle of an empty chessboard, the knight (labeled K) can make eight different moves (numbered 0 through 7).

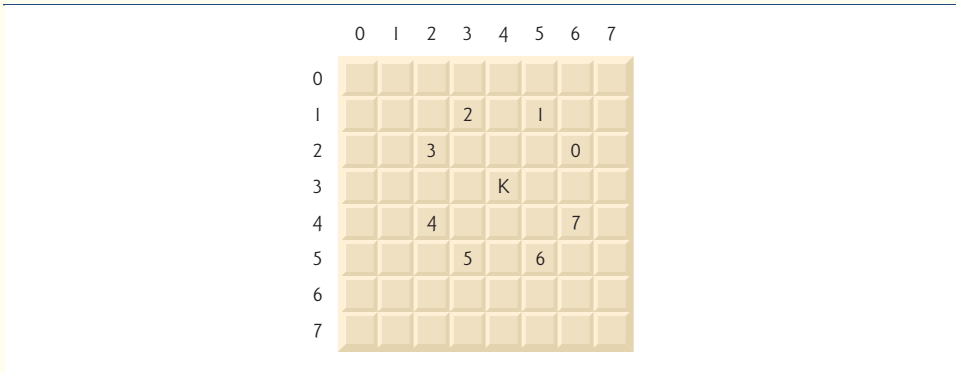

**Fig. 7.30** | The eight possible moves of the knight.

- Draw an eight-by-eight chessboard on a sheet of paper, and attempt a Knight's Tour by hand. Put a 1 in the starting square, a 2 in the second square, a 3 in the third, and so on. Before starting the tour, estimate how far you think you'll get, remembering that a full tour consists of 64 moves. How far did you get? Was this close to your estimate?
- Now let's develop an application that will move the knight around a chessboard. The board is represented by an eight-by-eight two-dimensional array `board`. Each square is initialized to zero. We describe each of the eight possible moves in terms of its horizontal and vertical components. For example, a move of type 0, as shown in Fig. 7.30, consists of moving two squares horizontally to the right and one square vertically upward. A move of type 2 consists of moving one square horizontally to the left and two squares vertically upward. Horizontal moves to the left and vertical moves upward are indicated with negative numbers. The eight moves may be described by two one-dimensional arrays, `horizontal` and `vertical`, as follows:

```
horizontal[0] = 2 vertical[0] = -1
horizontal[1] = 1 vertical[1] = -2
horizontal[2] = -1 vertical[2] = -2
horizontal[3] = -2 vertical[3] = -1
horizontal[4] = -2 vertical[4] = 1
horizontal[5] = -1 vertical[5] = 2
horizontal[6] = 1 vertical[6] = 2
horizontal[7] = 2 vertical[7] = 1
```

Let the variables `currentRow` and `currentColumn` indicate the row and column, respectively, of the knight's current position. To make a move of type `moveNumber`, where `moveNumber` is between 0 and 7, your application should use the statements

```
currentRow += vertical[moveNumber];
currentColumn += horizontal[moveNumber];
```

Write an application to move the knight around the chessboard. Keep a counter that varies from 1 to 64. Record the latest count in each square the knight moves to. Test each potential move to see if the knight has already visited that square. Test every potential move to ensure that the knight does not land off the chessboard. Run the application. How many moves did the knight make?

- c) After attempting to write and run a Knight's Tour application, you've probably developed some valuable insights. We'll use these insights to develop a *heuristic* (i.e., a common-sense rule) for moving the knight. Heuristics do not guarantee success, but a carefully developed heuristic greatly improves the chance of success. You may have observed that the outer squares are more troublesome than the squares nearer the center of the board. In fact, the most troublesome or inaccessible squares are the four corners.

Intuition may suggest that you should attempt to move the knight to the most troublesome squares first and leave open those that are easiest to get to, so that when the board gets congested near the end of the tour, there will be a greater chance of success.

We could develop an "accessibility heuristic" by classifying each of the squares according to how accessible it is and always moving the knight (using the knight's L-shaped moves) to the most inaccessible square. We label a two-dimensional array *accessibility* with numbers indicating from how many squares each particular square is accessible. On a blank chessboard, each of the 16 squares nearest the center is rated as 8, each corner square is rated as 2, and the other squares have accessibility numbers of 3, 4 or 6 as follows:

```

2 3 4 4 4 4 3 2
3 4 6 6 6 6 4 3
4 6 8 8 8 8 6 4
4 6 8 8 8 8 6 4
4 6 8 8 8 8 6 4
4 6 8 8 8 8 6 4
3 4 6 6 6 6 4 3
2 3 4 4 4 4 3 2

```

Write a new version of the Knight's Tour, using the accessibility heuristic. The knight should always move to the square with the lowest accessibility number. In case of a tie, the knight may move to any of the tied squares. Therefore, the tour may begin in any of the four corners. [Note: As the knight moves around the chessboard, your application should reduce the accessibility numbers as more squares become occupied. In this way, at any given time during the tour, each available square's accessibility number will remain equal to precisely the number of squares from which that square may be reached.] Run this version of your application. Did you get a full tour? Modify the application to run 64 tours, one starting from each square of the chessboard. How many full tours did you get?

- d) Write a version of the Knight's Tour application that, when encountering a tie between two or more squares, decides what square to choose by looking ahead to those squares reachable from the "tied" squares. Your application should move to the tied square for which the next move would arrive at a square with the lowest accessibility number.

**7.23** (*Knight's Tour: Brute-Force Approaches*) In part (c) of Exercise 7.22, we developed a solution to the Knight's Tour problem. The approach used, called the "accessibility heuristic," generates many solutions and executes efficiently.

As computers continue to increase in power, we'll be able to solve more problems with sheer computer power and relatively unsophisticated algorithms. Let's call this approach "brute-force" problem solving.

- a) Use random-number generation to enable the knight to walk around the chessboard (in its legitimate L-shaped moves) at random. Your application should run one tour and display the final chessboard. How far did the knight get?
- b) Most likely, the application in part (a) produced a relatively short tour. Now modify your application to attempt 1000 tours. Use a one-dimensional array to keep track of the number of tours of each length. When your application finishes attempting the 1000 tours, it should display this information in neat tabular format. What was the best result?

- c) Most likely, the application in part (b) gave you some “respectable” tours, but no full tours. Now let your application run until it produces a full tour. [*Caution:* This version of the application could run for hours on a powerful computer.] Once again, keep a table of the number of tours of each length, and display this table when the first full tour is found. How many tours did your application attempt before producing a full tour? How much time did it take?
- d) Compare the brute-force version of the Knight’s Tour with the accessibility-heuristic version. Which required a more careful study of the problem? Which algorithm was more difficult to develop? Which required more computer power? Could we be certain (in advance) of obtaining a full tour with the accessibility-heuristic approach? Could we be certain (in advance) of obtaining a full tour with the brute-force approach? Argue the pros and cons of brute-force problem solving in general.

**7.24** (*Eight Queens*) Another puzzler for chess buffs is the Eight Queens problem, which asks the following: Is it possible to place eight queens on an empty chessboard so that no queen is “attacking” any other (i.e., no two queens are in the same row, in the same column or along the same diagonal)? Use the thinking developed in Exercise 7.22 to formulate a heuristic for solving the Eight Queens problem. Run your application. [*Hint:* It’s possible to assign a value to each square of the chessboard to indicate how many squares of an empty chessboard are “eliminated” if a queen is placed in that square. Each of the corners would be assigned the value 22, as demonstrated by Fig. 7.31. Once these “elimination numbers” are placed in all 64 squares, an appropriate heuristic might be as follows: Place the next queen in the square with the smallest elimination number. Why is this strategy intuitively appealing?]

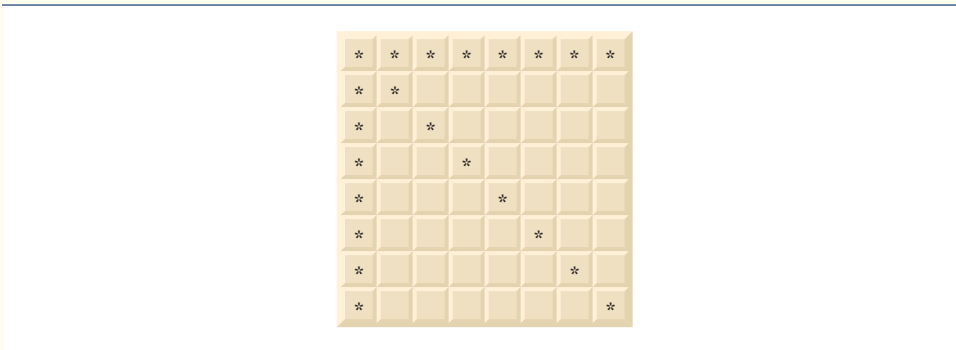

**Fig. 7.31** | The 22 squares eliminated by placing a queen in the upper left corner.

**7.25** (*Eight Queens: Brute-Force Approaches*) In this exercise, you’ll develop several brute-force approaches to solving the Eight Queens problem introduced in Exercise 7.24.

- Use the random brute-force technique developed in Exercise 7.23 to solve the Eight Queens problem.
- Use an exhaustive technique (i.e., try all possible combinations of eight queens on the chessboard) to solve the Eight Queens problem.
- Why might the exhaustive brute-force approach not be appropriate for solving the Knight’s Tour problem?
- Compare and contrast the random brute-force and exhaustive brute-force approaches.

**7.26** (*Knight’s Tour: Closed-Tour Test*) In the Knight’s Tour (Exercise 7.22), a full tour occurs when the knight makes 64 moves, touching each square of the chessboard once and only once. A closed tour occurs when the 64th move is one move away from the square in which the knight start-

ed the tour. Modify the application you wrote in Exercise 7.22 to test for a closed tour if a full tour has occurred.

**7.27** (*Sieve of Eratosthenes*) A prime number is any integer greater than 1 that's evenly divisible only by itself and 1. The Sieve of Eratosthenes is a method of finding prime numbers. It operates as follows:

- a) Create a primitive-type `boolean` array with all elements initialized to `true`. Array elements with prime indices will remain `true`. All other array elements will eventually be set to `false`.
- b) Starting with array index 2, determine whether a given element is `true`. If so, loop through the remainder of the array and set to `false` every element whose index is a multiple of the index for the element with value `true`. Then continue the process with the next element with value `true`. For array index 2, all elements beyond element 2 in the array that have indices which are multiples of 2 (indices 4, 6, 8, 10, etc.) will be set to `false`; for array index 3, all elements beyond element 3 in the array that have indices which are multiples of 3 (indices 6, 9, 12, 15, etc.) will be set to `false`; and so on.

When this process completes, the array elements that are still `true` indicate that the index is a prime number. These indices can be displayed. Write an application that uses an array of 1000 elements to determine and display the prime numbers between 2 and 999. Ignore array elements 0 and 1.

**7.28** (*Simulation: The Tortoise and the Hare*) In this problem, you'll re-create the classic race of the tortoise and the hare. You'll use random-number generation to develop a simulation of this memorable event.

Our contenders begin the race at square 1 of 70 squares. Each square represents a possible position along the race course. The finish line is at square 70. The first contender to reach or pass square 70 is rewarded with a pail of fresh carrots and lettuce. The course weaves its way up the side of a slippery mountain, so occasionally the contenders lose ground.

A clock ticks once per second. With each tick of the clock, your application should adjust the position of the animals according to the rules in Fig. 7.32. Use variables to keep track of the positions of the animals (i.e., position numbers are 1–70). Start each animal at position 1 (the “starting gate”). If an animal slips left before square 1, move it back to square 1.

| Animal   | Move type  | Percentage of the time | Actual move            |
|----------|------------|------------------------|------------------------|
| Tortoise | Fast plod  | 50%                    | 3 squares to the right |
|          | Slip       | 20%                    | 6 squares to the left  |
|          | Slow plod  | 30%                    | 1 square to the right  |
| Hare     | Sleep      | 20%                    | No move at all         |
|          | Big hop    | 20%                    | 9 squares to the right |
|          | Big slip   | 10%                    | 12 squares to the left |
|          | Small hop  | 30%                    | 1 square to the right  |
|          | Small slip | 20%                    | 2 squares to the left  |

**Fig. 7.32** | Rules for adjusting the positions of the tortoise and the hare.

Generate the percentages in Fig. 7.32 by producing a random integer  $i$  in the range  $1 \leq i \leq 10$ . For the tortoise, perform a “fast plod” when  $1 \leq i \leq 5$ , a “slip” when  $6 \leq i \leq 7$  or a “slow plod” when  $8 \leq i \leq 10$ . Use a similar technique to move the hare.

Begin the race by displaying

```
BANG !!!!!
AND THEY'RE OFF !!!!!
```

Then, for each tick of the clock (i.e., each repetition of a loop), display a 70-position line showing the letter T in the position of the tortoise and the letter H in the position of the hare. Occasionally, the contenders will land on the same square. In this case, the tortoise bites the hare, and your application should display OUCH!!! beginning at that position. All output positions other than the T, the H or the OUCH!!! (in case of a tie) should be blank.

After each line is displayed, test for whether either animal has reached or passed square 70. If so, display the winner and terminate the simulation. If the tortoise wins, display TORTOISE WINS!!! YAY!!! If the hare wins, display Hare wins. Yuch. If both animals win on the same tick of the clock, you may want to favor the tortoise (the “underdog”), or you may want to display It's a tie. If neither animal wins, perform the loop again to simulate the next tick of the clock. When you're ready to run your application, assemble a group of fans to watch the race. You'll be amazed at how involved your audience gets!

Later in the book, we introduce a number of Java capabilities, such as graphics, images, animation, sound and multithreading. As you study those features, you might enjoy enhancing your tortoise-and-hare contest simulation.

**7.29** (*Fibonacci Series*) The Fibonacci series

```
0, 1, 1, 2, 3, 5, 8, 13, 21, ...
```

begins with the terms 0 and 1 and has the property that each succeeding term is the sum of the two preceding terms.

- Write a method `fibonacci(n)` that calculates the  $n$ th Fibonacci number. Incorporate this method into an application that enables the user to enter the value of  $n$ .
- Determine the largest Fibonacci number that can be displayed on your system.
- Modify the application you wrote in part (a) to use `double` instead of `int` to calculate and return Fibonacci numbers, and use this modified application to repeat part (b).

*Exercises 7.30–7.33 are reasonably challenging. Once you've done them, you ought to be able to implement most popular card games easily.*

**7.30** (*Card Shuffling and Dealing*) Modify the application of Fig. 7.11 to deal a five-card poker hand. Then modify class `DeckOfCards` of Fig. 7.10 to include methods that determine whether a hand contains

- a pair
- two pairs
- three of a kind (e.g., three jacks)
- four of a kind (e.g., four aces)
- a flush (i.e., all five cards of the same suit)
- a straight (i.e., five cards of consecutive face values)
- a full house (i.e., two cards of one face value and three cards of another face value)

[Hint: Add methods `getFace` and `getSuit` to class `Card` of Fig. 7.9.]

**7.31** (*Card Shuffling and Dealing*) Use the methods developed in Exercise 7.30 to write an application that deals two five-card poker hands, evaluates each hand and determines which is better.

**7.32** (*Project: Card Shuffling and Dealing*) Modify the application developed in Exercise 7.31 so that it can simulate the dealer. The dealer's five-card hand is dealt “face down,” so the player cannot see it. The application should then evaluate the dealer's hand, and, based on the quality of the hand, the dealer should draw one, two or three more cards to replace the corresponding number of

unneeded cards in the original hand. The application should then reevaluate the dealer's hand. [*Caution:* This is a difficult problem!]

**7.33** (*Project: Card Shuffling and Dealing*) Modify the application developed in Exercise 7.32 so that it can handle the dealer's hand automatically, but the player is allowed to decide which cards of the player's hand to replace. The application should then evaluate both hands and determine who wins. Now use this new application to play 20 games against the computer. Who wins more games, you or the computer? Have a friend play 20 games against the computer. Who wins more games? Based on the results of these games, refine your poker-playing application. (This, too, is a difficult problem.) Play 20 more games. Does your modified application play a better game?

**7.34** (*Project: Card Shuffling and Dealing*) Modify the application of Figs. 7.9–7.11 to use `Face` and `Suit` enumerations to represent the faces and suits of the cards. Declare each of these enumerations as a `public` type in its own source-code file. Each `Card` should have a `Face` and a `Suit` instance variable. These should be initialized by the `Card` constructor. In class `DeckOfCards`, create an array of `Faces` that's initialized with the names of the constants in the `Face` enumeration and an array of `Suits` that's initialized with the names of the constants in the `Suit` enumeration. [*Note:* When you output an enumeration constant as a `String`, the name of the constant is displayed.]

## Special Section: Building Your Own Computer

In the next several problems, we take a temporary diversion from the world of high-level language programming to “peel open” a computer and look at its internal structure. We introduce machine-language programming and write several machine-language programs. To make this an especially valuable experience, we then build a computer (through the technique of software-based *simulation*) on which you can execute your machine-language programs.

**7.35** (*Machine-Language Programming*) Let's create a computer called the Simpletron. As its name implies, it's a simple, but powerful, machine. The Simpletron runs programs written in the only language it directly understands: Simpletron Machine Language (SML).

The Simpletron contains an *accumulator*—a special register in which information is put before the Simpletron uses that information in calculations or examines it in various ways. All the information in the Simpletron is handled in terms of *words*. A word is a signed four-digit decimal number, such as +3364, -1293, +0007 and -0001. The Simpletron is equipped with a 100-word memory, and these words are referenced by their location numbers 00, 01, ..., 99.

Before running an SML program, we must *load*, or place, the program into memory. The first instruction (or statement) of every SML program is always placed in location 00. The simulator will start executing at this location.

Each instruction written in SML occupies one word of the Simpletron's memory (and hence instructions are signed four-digit decimal numbers). We shall assume that the sign of an SML instruction is always plus, but the sign of a data word may be either plus or minus. Each location in the Simpletron's memory may contain an instruction, a data value used by a program or an unused (and hence undefined) area of memory. The first two digits of each SML instruction are the *operation code* specifying the operation to be performed. SML operation codes are summarized in Fig. 7.33.

| Operation code                    | Meaning                                                           |
|-----------------------------------|-------------------------------------------------------------------|
| <i>Input/output operations:</i>   |                                                                   |
| <code>final int READ = 10;</code> | Read a word from the keyboard into a specific location in memory. |

**Fig. 7.33** | Simpletron Machine Language (SML) operation codes. (Part I of 2.)

| Operation code                          | Meaning                                                                                                                    |
|-----------------------------------------|----------------------------------------------------------------------------------------------------------------------------|
| <code>final int WRITE = 11;</code>      | Write a word from a specific location in memory to the screen.                                                             |
| <i>Load/store operations:</i>           |                                                                                                                            |
| <code>final int LOAD = 20;</code>       | Load a word from a specific location in memory into the accumulator.                                                       |
| <code>final int STORE = 21;</code>      | Store a word from the accumulator into a specific location in memory.                                                      |
| <i>Arithmetic operations:</i>           |                                                                                                                            |
| <code>final int ADD = 30;</code>        | Add a word from a specific location in memory to the word in the accumulator (leave the result in the accumulator).        |
| <code>final int SUBTRACT = 31;</code>   | Subtract a word from a specific location in memory from the word in the accumulator (leave the result in the accumulator). |
| <code>final int DIVIDE = 32;</code>     | Divide a word from a specific location in memory into the word in the accumulator (leave result in the accumulator).       |
| <code>final int MULTIPLY = 33;</code>   | Multiply a word from a specific location in memory by the word in the accumulator (leave the result in the accumulator).   |
| <i>Transfer-of-control operations:</i>  |                                                                                                                            |
| <code>final int BRANCH = 40;</code>     | Branch to a specific location in memory.                                                                                   |
| <code>final int BRANCHNEG = 41;</code>  | Branch to a specific location in memory if the accumulator is negative.                                                    |
| <code>final int BRANCHZERO = 42;</code> | Branch to a specific location in memory if the accumulator is zero.                                                        |
| <code>final int HALT = 43;</code>       | Halt. The program has completed its task.                                                                                  |

**Fig. 7.33** | Simpletron Machine Language (SML) operation codes. (Part 2 of 2.)

The last two digits of an SML instruction are the *operand*—the address of the memory location containing the word to which the operation applies. Let's consider several simple SML programs.

The first SML program (Fig. 7.34) reads two numbers from the keyboard and computes and displays their sum. The instruction `+1007` reads the first number from the keyboard and places it into location 07 (which has been initialized to 0). Then instruction `+1008` reads the next number into location 08. The *load* instruction, `+2007`, puts the first number into the accumulator, and the *add* instruction, `+3008`, adds the second number to the number in the accumulator. *All SML arithmetic instructions leave their results in the accumulator.* The *store* instruction, `+2109`, places the result back into memory location 09, from which the *write* instruction, `+1109`, takes the number and displays it (as a signed four-digit decimal number). The *halt* instruction, `+4300`, terminates execution.

The second SML program (Fig. 7.35) reads two numbers from the keyboard and determines and displays the larger value. Note the use of the instruction `+4107` as a conditional transfer of control, much the same as Java's *if* statement.

Now write SML programs to accomplish each of the following tasks:

- Use a sentinel-controlled loop to read 10 positive numbers. Compute and display their sum.

| Location | Number | Instruction  |
|----------|--------|--------------|
| 00       | +1007  | (Read A)     |
| 01       | +1008  | (Read B)     |
| 02       | +2007  | (Load A)     |
| 03       | +3008  | (Add B)      |
| 04       | +2109  | (Store C)    |
| 05       | +1109  | (Write C)    |
| 06       | +4300  | (Halt)       |
| 07       | +0000  | (Variable A) |
| 08       | +0000  | (Variable B) |
| 09       | +0000  | (Result C)   |

**Fig. 7.34** | SML program that reads two integers and computes their sum.

| Location | Number | Instruction             |
|----------|--------|-------------------------|
| 00       | +1009  | (Read A)                |
| 01       | +1010  | (Read B)                |
| 02       | +2009  | (Load A)                |
| 03       | +3110  | (Subtract B)            |
| 04       | +4107  | (Branch negative to 07) |
| 05       | +1109  | (Write A)               |
| 06       | +4300  | (Halt)                  |
| 07       | +1110  | (Write B)               |
| 08       | +4300  | (Halt)                  |
| 09       | +0000  | (Variable A)            |
| 10       | +0000  | (Variable B)            |

**Fig. 7.35** | SML program that reads two integers and determines the larger.

- b) Use a counter-controlled loop to read seven numbers, some positive and some negative, and compute and display their average.
- c) Read a series of numbers, and determine and display the largest number. The first number read indicates how many numbers should be processed.

**7.36 (Computer Simulator)** In this problem, you're going to build your own computer. No, you'll not be soldering components together. Rather, you'll use the powerful technique of *software-based simulation* to create an object-oriented *software model* of the Simpletron of Exercise 7.35. Your Simpletron simulator will turn the computer you're using into a Simpletron, and you'll actually be able to run, test and debug the SML programs you wrote in Exercise 7.35.

When you run your Simpletron simulator, it should begin by displaying:

```
*** Welcome to Simpletron! ***
*** Please enter your program one instruction ***
*** (or data word) at a time. I will display ***
*** the location number and a question mark (?) ***
```



```

*** You then type the word for that location. ***
*** Type -99999 to stop entering your program. ***

```

Your application should simulate the memory of the Simpletron with a one-dimensional array memory that has 100 elements. Now assume that the simulator is running, and let's examine the dialog as we enter the program of Fig. 7.35 (Exercise 7.35):

```

00 ? +1009
01 ? +1010
02 ? +2009
03 ? +3110
04 ? +4107
05 ? +1109
06 ? +4300
07 ? +1110
08 ? +4300
09 ? +0000
10 ? +0000
11 ? -99999

```

Your program should display the memory location followed by a question mark. Each value to the right of a question mark is input by the user. When the sentinel value -99999 is input, the program should display the following:

```

*** Program loading completed ***
*** Program execution begins ***

```

The SML program has now been placed (or loaded) in array memory. Now the Simpletron executes the SML program. Execution begins with the instruction in location 00 and, as in Java, continues sequentially, unless directed to some other part of the program by a transfer of control.

Use the variable `accumulator` to represent the accumulator register. Use the variable `instructionCounter` to keep track of the location in memory that contains the instruction being performed. Use the variable `operationCode` to indicate the operation currently being performed (i.e., the left two digits of the instruction word). Use the variable `operand` to indicate the memory location on which the current instruction operates. Thus, `operand` is the rightmost two digits of the instruction currently being performed. Do not execute instructions directly from memory. Rather, transfer the next instruction to be performed from memory to a variable called `instructionRegister`. Then “pick off” the left two digits and place them in `operationCode`, and “pick off” the right two digits and place them in `operand`. When the Simpletron begins execution, the special registers are all initialized to zero.

Now, let's “walk through” execution of the first SML instruction, +1009 in memory location 00. This procedure is called an *instruction-execution cycle*.

The `instructionCounter` tells us the location of the next instruction to be performed. We *fetch* the contents of that location from memory by using the Java statement

```
instructionRegister = memory[instructionCounter];
```

The operation code and the operand are extracted from the instruction register by the statements

```
operationCode = instructionRegister / 100;
operand = instructionRegister % 100;
```

Now the Simpletron must determine that the operation code is actually a *read* (versus a *write*, a *load*, and so on). A *switch* differentiates among the 12 operations of SML. In the *switch* statement, the behavior of various SML instructions is simulated as shown in Fig. 7.36. We discuss branch instructions shortly and leave the others to you.

When the SML program completes execution, the name and contents of each register as well as the complete contents of memory should be displayed. Such a printout is often called a computer dump (no, a computer dump is not a place where old computers go). To help you program your dump method, a sample dump format is shown in Fig. 7.37. A dump after executing a

| Instruction  | Description                                                                                             |
|--------------|---------------------------------------------------------------------------------------------------------|
| <i>read:</i> | Display the prompt "Enter an integer", then input the integer and store it in location memory[operand]. |
| <i>load:</i> | accumulator = memory[ operand ];                                                                        |
| <i>add:</i>  | accumulator += memory[ operand ];                                                                       |
| <i>halt:</i> | This instruction displays the message<br>*** Simpletron execution terminated ***                        |

**Fig. 7.36** | Behavior of several SML instructions in the Simpletron.

```

REGISTERS:
accumulator +0000
instructionCounter 00
instructionRegister +0000
operationCode 00
operand 00

MEMORY:
 0 0 +0000 +0000 +0000 +0000 +0000 +0000 +0000 +0000 +0000
10 10 +0000 +0000 +0000 +0000 +0000 +0000 +0000 +0000 +0000
20 20 +0000 +0000 +0000 +0000 +0000 +0000 +0000 +0000 +0000
30 30 +0000 +0000 +0000 +0000 +0000 +0000 +0000 +0000 +0000
40 40 +0000 +0000 +0000 +0000 +0000 +0000 +0000 +0000 +0000
50 50 +0000 +0000 +0000 +0000 +0000 +0000 +0000 +0000 +0000
60 60 +0000 +0000 +0000 +0000 +0000 +0000 +0000 +0000 +0000
70 70 +0000 +0000 +0000 +0000 +0000 +0000 +0000 +0000 +0000
80 80 +0000 +0000 +0000 +0000 +0000 +0000 +0000 +0000 +0000
90 90 +0000 +0000 +0000 +0000 +0000 +0000 +0000 +0000 +0000

```

**Fig. 7.37** | A sample dump.

Simpletron program would show the actual values of instructions and data values at the moment execution terminated.

Let's proceed with the execution of our program's first instruction—namely, the +1009 in location 00. As we've indicated, the `switch` statement simulates this task by prompting the user to enter a value, reading the value and storing it in memory location `memory[ operand ]`. The value is then read into location 09.

At this point, simulation of the first instruction is completed. All that remains is to prepare the Simpletron to execute the next instruction. Since the instruction just performed was not a transfer of control, we need merely increment the instruction-counter register as follows:

```
instructionCounter++;
```

This action completes the simulated execution of the first instruction. The entire process (i.e., the instruction-execution cycle) begins anew with the fetch of the next instruction to execute.

Now let's consider how the branching instructions—the transfers of control—are simulated. All we need to do is adjust the value in the instruction counter appropriately. Therefore, the unconditional branch instruction (40) is simulated within the `switch` as

```
instructionCounter = operand;
```

The conditional "branch if accumulator is zero" instruction is simulated as

```
if (accumulator == 0)
 instructionCounter = operand;
```

At this point, you should implement your Simpletron simulator and run each of the SML programs you wrote in Exercise 7.35. If you desire, you may embellish SML with additional features and provide for these features in your simulator.

Your simulator should check for various types of errors. During the program-loading phase, for example, each number the user types into the Simpletron's memory must be in the range -9999 to +9999. Your simulator should test that each number entered is in this range and, if not, keep prompting the user to re-enter the number until the user enters a correct number.

During the execution phase, your simulator should check for various serious errors, such as attempts to divide by zero, attempts to execute invalid operation codes, and accumulator overflows (i.e., arithmetic operations resulting in values larger than +9999 or smaller than -9999). Such serious errors are called *fatal errors*. When a fatal error is detected, your simulator should display an error message, such as

```
*** Attempt to divide by zero ***
*** Simpletron execution abnormally terminated ***
```

and should display a full computer dump in the format we discussed previously. This treatment will help the user locate the error in the program.

**7.37** (*Simpletron Simulator Modifications*) In Exercise 7.36, you wrote a software simulation of a computer that executes programs written in Simpletron Machine Language (SML). In this exercise, we propose several modifications and enhancements to the Simpletron Simulator. In the exercises of Chapter 22, we propose building a compiler that converts programs written in a high-level programming language (a variation of Basic) to Simpletron Machine Language. Some of the following modifications and enhancements may be required to execute the programs produced by the compiler:

- a) Extend the Simpletron Simulator's memory to contain 1000 memory locations to enable the Simpletron to handle larger programs.
- b) Allow the simulator to perform remainder calculations. This modification requires an additional SML instruction.
- c) Allow the simulator to perform exponentiation calculations. This modification requires an additional SML instruction.
- d) Modify the simulator to use hexadecimal rather than integer values to represent SML instructions.
- e) Modify the simulator to allow output of a newline. This modification requires an additional SML instruction.
- f) Modify the simulator to process floating-point values in addition to integer values.
- g) Modify the simulator to handle string input. [*Hint*: Each Simpletron word can be divided into two groups, each holding a two-digit integer. Each two-digit integer represents the ASCII (see Appendix B) decimal equivalent of a character. Add a machine-language instruction that will input a string and store the string, beginning at a specific Simpletron memory location. The first half of the word at that location will be a count of the number of characters in the string (i.e., the length of the string). Each succeeding half-word contains one ASCII character expressed as two decimal digits. The machine-language instruction converts each character into its ASCII equivalent and assigns it to a half-word.]
- h) Modify the simulator to handle output of strings stored in the format of part (g). [*Hint*: Add a machine-language instruction that will display a string, beginning at a certain Simpletron memory location. The first half of the word at that location is a count of the number of characters in the string (i.e., the length of the string). Each succeeding half-word contains one ASCII character expressed as two decimal digits. The machine-language instruction checks the length and displays the string by translating each two-digit number into its equivalent character.]

## Making a Difference

**7.38** (*Polling*) The Internet and the web are enabling more people to network, join a cause, voice opinions, and so on. The presidential candidates in 2008 used the Internet intensively to get out their messages and raise money for their campaigns. In this exercise, you'll write a simple polling program that allows users to rate five social-consciousness issues from 1 (least important) to 10 (most important). Pick five causes that are important to you (e.g., political issues, global environmental issues). Use a one-dimensional array `topics` (of type `String`) to store the five causes. To summarize the survey responses, use a 5-row, 10-column two-dimensional array `responses` (of type `int`), each row corresponding to an element in the `topics` array. When the program runs, it should ask the user to rate each issue. Have your friends and family respond to the survey. Then have the program display a summary of the results, including:

- a) A tabular report with the five topics down the left side and the 10 ratings across the top, listing in each column the number of ratings received for each topic.
- b) To the right of each row, show the average of the ratings for that issue.
- c) Which issue received the highest point total? Display both the issue and the point total.
- d) Which issue received the lowest point total? Display both the issue and the point total.

# Classes and Objects: A Deeper Look

# 8



*Instead of this absurd division  
into sexes, they ought to class  
people as static and dynamic.*

—Evelyn Waugh

*Is it a world to hide virtues in?*

—William Shakespeare

*But what, to serve  
our private ends,  
Forbids the cheating  
of our friends?*

—Charles Churchill

*This above all: to thine own self  
be true.*

—William Shakespeare

*Don't be "consistent," but be  
simply true.*

—Oliver Wendell Holmes, Jr.

## Objectives

In this chapter you'll learn:

- Encapsulation and data hiding.
- To use keyword `this`.
- To use `static` variables and methods.
- To import `static` members of a class.
- To use the `enum` type to create sets of constants with unique identifiers.
- To declare `enum` constants with parameters.
- To organize classes in packages to promote reuse.

- |                                                                                           |                                                                                 |
|-------------------------------------------------------------------------------------------|---------------------------------------------------------------------------------|
| <b>8.1</b> Introduction                                                                   | <b>8.10</b> Garbage Collection and Method <code>finalize</code>                 |
| <b>8.2</b> Time Class Case Study                                                          | <b>8.11</b> <code>static</code> Class Members                                   |
| <b>8.3</b> Controlling Access to Members                                                  | <b>8.12</b> <code>static</code> Import                                          |
| <b>8.4</b> Referring to the Current Object's Members with the <code>this</code> Reference | <b>8.13</b> <code>final</code> Instance Variables                               |
| <b>8.5</b> Time Class Case Study: Overloaded Constructors                                 | <b>8.14</b> Time Class Case Study: Creating Packages                            |
| <b>8.6</b> Default and No-Argument Constructors                                           | <b>8.15</b> Package Access                                                      |
| <b>8.7</b> Notes on <code>Set</code> and <code>Get</code> Methods                         | <b>8.16</b> (Optional) GUI and Graphics Case Study: Using Objects with Graphics |
| <b>8.8</b> Composition                                                                    | <b>8.17</b> Wrap-Up                                                             |
| <b>8.9</b> Enumerations                                                                   |                                                                                 |

Summary | Self-Review Exercise | Answers to Self-Review Exercise | Exercises | Making a Difference

## 8.1 Introduction

We now take a deeper look at building classes, controlling access to members of a class and creating constructors. We discuss composition—a capability that allows a class to have references to objects of other classes as members. We reexamine the use of `set` and `get` methods. Recall that Section 6.10 introduced the basic `enum` type to declare a set of constants. In this chapter, we discuss the relationship between `enum` types and classes, demonstrating that an `enum`, like a class, can be declared in its own file with constructors, methods and fields. The chapter also discusses `static` class members and `final` instance variables in detail. Finally, we explain how to organize classes in packages to help manage large applications and promote reuse, then show a special relationship between classes in the same package.

## 8.2 Time Class Case Study

Our first example consists of two classes—`Time1` (Fig. 8.1) and `Time1Test` (Fig. 8.2). Class `Time1` represents the time of day. Class `Time1Test` is an application class in which the `main` method creates one object of class `Time1` and invokes its methods. These classes must be declared in *separate* files because they're both `public` classes. The output of this program appears in Fig. 8.2.

### *Time1 Class Declaration*

Class `Time1`'s `private int` instance variables `hour`, `minute` and `second` (Fig. 8.1, lines 6–8) represent the time in universal-time format (24-hour clock format in which hours are in the range 0–23). Class `Time1` contains `public` methods `setTime` (lines 12–25), `toUniversalString` (lines 28–31) and `toString` (lines 34–39). These methods are also called the **public services** or the **public interface** that the class provides to its clients.

### *Default Constructor*

In this example, class `Time1` does not declare a constructor, so the class has a default constructor that's supplied by the compiler. Each instance variable implicitly receives the

```

1 // Fig. 8.1: Time1.java
2 // Time1 class declaration maintains the time in 24-hour format.
3
4 public class Time1
5 {
6 private int hour; // 0 - 23
7 private int minute; // 0 - 59
8 private int second; // 0 - 59
9
10 // set a new time value using universal time; throw an
11 // exception if the hour, minute or second is invalid
12 public void setTime(int h, int m, int s)
13 {
14 // validate hour, minute and second
15 if ((h >= 0 && h < 24) && (m >= 0 && m < 60) &&
16 (s >= 0 && s < 60))
17 {
18 hour = h;
19 minute = m;
20 second = s;
21 } // end if
22 else
23 throw new IllegalArgumentException(
24 "hour, minute and/or second was out of range");
25 } // end method setTime
26
27 // convert to String in universal-time format (HH:MM:SS)
28 public String toUniversalString()
29 {
30 return String.format("%02d:%02d:%02d", hour, minute, second);
31 } // end method toUniversalString
32
33 // convert to String in standard-time format (H:MM:SS AM or PM)
34 public String toString()
35 {
36 return String.format("%d:%02d:%02d %s",
37 ((hour == 0 || hour == 12) ? 12 : hour % 12),
38 minute, second, (hour < 12 ? "AM" : "PM"));
39 } // end method toString
40 } // end class Time1

```

**Fig. 8.1** | Time1 class declaration maintains the time in 24-hour format.

default value 0 for an `int`. Instance variables also can be initialized when they're declared in the class body, using the same initialization syntax as with a local variable.

### *Method setTime and Throwing Exceptions*

Method `setTime` (lines 12–25) is a `public` method that declares three `int` parameters and uses them to set the time. Lines 15–16 test each argument to determine whether the value is in the proper range, and, if so, lines 18–20 assign the values to the `hour`, `minute` and `second` instance variables. The `hour` value must be greater than or equal to 0 and less than 24, because universal-time format represents hours as integers from 0 to 23 (e.g., 1 PM is hour 13 and 11 PM is hour 23; midnight is hour 0 and noon is hour 12). Similarly, both

minute and second values must be greater than or equal to 0 and less than 60. For values outside these ranges, `setTime` **throws an exception** of type `IllegalArgumentException` (lines 23–24), which notifies the client code that an invalid argument was passed to the method. As you learned in Chapter 7, you can use `try...catch` to catch exceptions and attempt to recover from them, which we'll do in Fig. 8.2. The **throw statement** (line 23) creates a new object of type `IllegalArgumentException`. The parentheses following the class name indicate a call to the `IllegalArgumentException` constructor. In this case, we call the constructor that allows us to specify a custom error message. After the exception object is created, the `throw` statement immediately terminates method `setTime` and the exception is returned to the code that attempted to set the time.

### *Method toUniversalString*

Method `toUniversalString` (lines 28–31) takes no arguments and returns a `String` in universal-time format, consisting of two digits each for the hour, minute and second. For example, if the time were 1:30:07 PM, the method would return 13:30:07. Line 22 uses static method `format` of class `String` to return a `String` containing the formatted hour, minute and second values, each with two digits and possibly a leading 0 (specified with the 0 flag). Method `format` is similar to method `System.out.printf` except that `format` *returns* a formatted `String` rather than displaying it in a command window. The formatted `String` is returned by method `toUniversalString`.

### *Method toString*

Method `toString` (lines 34–39) takes no arguments and returns a `String` in standard-time format, consisting of the hour, minute and second values separated by colons and followed by AM or PM (e.g., 1:27:06 PM). Like method `toUniversalString`, method `toString` uses static `String` method `format` to format the minute and second as two-digit values, with leading zeros if necessary. Line 29 uses a conditional operator (`?:`) to determine the value for hour in the `String`—if the hour is 0 or 12 (AM or PM), it appears as 12; otherwise, it appears as a value from 1 to 11. The conditional operator in line 30 determines whether AM or PM will be returned as part of the `String`.

Recall from Section 6.4 that all objects in Java have a `toString` method that returns a `String` representation of the object. We chose to return a `String` containing the time in standard-time format. Method `toString` is called implicitly whenever a `Time1` object appears in the code where a `String` is needed, such as the value to output with a `%s` format specifier in a call to `System.out.printf`.

### *Using Class Time1*

As you learned in Chapter 3, each class you declare represents a new *type* in Java. Therefore, after declaring class `Time1`, we can use it as a type in declarations such as

```
Time1 sunset; // sunset can hold a reference to a Time1 object
```

The `Time1Test` application class (Fig. 8.2) uses class `Time1`. Line 9 declares and creates a `Time1` object and assigns it to local variable `time`. Operator `new` implicitly invokes class `Time1`'s default constructor, since `Time1` does not declare any constructors. Lines 12–16 output the time first in universal-time format (by invoking `time`'s `toUniversalString` method in line 13), then in standard-time format (by explicitly invoking `time`'s `toString` method in line 15) to confirm that the `Time1` object was initialized properly. Next, line 19



invokes method `setTime` of the `time` object to change the time. Then lines 20–24 output the time again in both formats to confirm that it was set correctly.

```

1 // Fig. 8.2: Time1Test.java
2 // Time1 object used in an application.
3
4 public class Time1Test
5 {
6 public static void main(String[] args)
7 {
8 // create and initialize a Time1 object
9 Time1 time = new Time1(); // invokes Time1 constructor
10
11 // output string representations of the time
12 System.out.print("The initial universal time is: ");
13 System.out.println(time.toUniversalString());
14 System.out.print("The initial standard time is: ");
15 System.out.println(time.toString());
16 System.out.println(); // output a blank line
17
18 // change time and output updated time
19 time.setTime(13, 27, 6);
20 System.out.print("Universal time after setTime is: ");
21 System.out.println(time.toUniversalString());
22 System.out.print("Standard time after setTime is: ");
23 System.out.println(time.toString());
24 System.out.println(); // output a blank line
25
26 // attempt to set time with invalid values
27 try
28 {
29 time.setTime(99, 99, 99); // all values out of range
30 } // end try
31 catch (IllegalArgumentException e)
32 {
33 System.out.printf("Exception: %s\n\n", e.getMessage());
34 } // end catch
35
36 // display time after attempt to set invalid values
37 System.out.println("After attempting invalid settings:");
38 System.out.print("Universal time: ");
39 System.out.println(time.toUniversalString());
40 System.out.print("Standard time: ");
41 System.out.println(time.toString());
42 } // end main
43 } // end class Time1Test

```

```

The initial universal time is: 00:00:00
The initial standard time is: 12:00:00 AM

Universal time after setTime is: 13:27:06
Standard time after setTime is: 1:27:06 PM

```

**Fig. 8.2** | Time1 object used in an application. (Part I of 2.)

```
Exception: hour, minute and/or second was out of range

After attempting invalid settings:
Universal time: 13:27:06
Standard time: 1:27:06 PM
```

**Fig. 8.2** | Time1 object used in an application. (Part 2 of 2.)

### *Calling Time1 Method setTime with Invalid Values*

To illustrate that method `setTime` validates its arguments, line 29 calls method `setTime` with invalid arguments of 99 for the hour, minute and second. This statement is placed in a try block (lines 27–30) in case `setTime` throws an `IllegalArgumentException`, which it will do since the arguments are all invalid. When this occurs, the exception is caught at lines 31–34, and line 33 displays the exception’s error message by calling its `getMessage` method. Lines 37–41 output the time again in both formats to confirm that `setTime` did not change the time when invalid arguments were supplied.

### *Notes on the Time1 Class Declaration*

Consider several issues of class design with respect to class `Time1`. The instance variables `hour`, `minute` and `second` are each declared `private`. The actual data representation used within the class is of no concern to the class’s clients. For example, it would be perfectly reasonable for `Time1` to represent the time internally as the number of seconds since midnight or the number of minutes and seconds since midnight. Clients could use the same `public` methods and get the same results without being aware of this. (Exercise 8.5 asks you to represent the time in class `Time1` as the number of seconds since midnight and show that indeed no change is visible to the clients of the class.)



#### **Software Engineering Observation 8.1**

*Classes simplify programming, because the client can use only the `public` methods exposed by the class. Such methods are usually client oriented rather than implementation oriented. Clients are neither aware of, nor involved in, a class’s implementation. Clients generally care about what the class does but not how the class does it.*



#### **Software Engineering Observation 8.2**

*Interfaces change less frequently than implementations. When an implementation changes, implementation-dependent code must change accordingly. Hiding the implementation reduces the possibility that other program parts will become dependent on class implementation details.*

## 8.3 Controlling Access to Members

The access modifiers `public` and `private` control access to a class’s variables and methods. In Chapter 9, we’ll introduce the additional access modifier `protected`. As we stated in Section 8.2, the primary purpose of `public` methods is to present to the class’s clients a view of the services the class provides (the class’s `public` interface). Clients need not be concerned with how the class accomplishes its tasks. For this reason, the class’s `private` variables and `private` methods (i.e., its implementation details) are *not* accessible to its clients.

Figure 8.3 demonstrates that private class members are not accessible outside the class. Lines 9–11 attempt to access directly the private instance variables `hour`, `minute` and `second` of the `Time1` object `time`. When this program is compiled, the compiler generates error messages that these private members are not accessible. This program assumes that the `Time1` class from Fig. 8.1 is used.



### Common Programming Error 8.1

*An attempt by a method that's not a member of a class to access a private member of that class is a compilation error.*

```

1 // Fig. 8.3: MemberAccessTest.java
2 // Private members of class Time1 are not accessible.
3 public class MemberAccessTest
4 {
5 public static void main(String[] args)
6 {
7 Time1 time = new Time1(); // create and initialize Time1 object
8
9 time.hour = 7; // error: hour has private access in Time1
10 time.minute = 15; // error: minute has private access in Time1
11 time.second = 30; // error: second has private access in Time1
12 } // end main
13 } // end class MemberAccessTest

```

```

MemberAccessTest.java:9: hour has private access in Time1
 time.hour = 7; // error: hour has private access in Time1
 ^
MemberAccessTest.java:10: minute has private access in Time1
 time.minute = 15; // error: minute has private access in Time1
 ^
MemberAccessTest.java:11: second has private access in Time1
 time.second = 30; // error: second has private access in Time1
 ^
3 errors

```

**Fig. 8.3** | Private members of class `Time1` are not accessible.

## 8.4 Referring to the Current Object's Members with the `this` Reference

Every object can access a reference to itself with keyword **this** (sometimes called the **this reference**). When a non-static method is called for a particular object, the method's body implicitly uses keyword `this` to refer to the object's instance variables and other methods. This enables the class's code to know which object should be manipulated. As you'll see in Fig. 8.4, you can also use keyword `this` explicitly in a non-static method's body. Section 8.5 shows another interesting use of keyword `this`. Section 8.11 explains why keyword `this` cannot be used in a static method.

We now demonstrate implicit and explicit use of the `this` reference (Fig. 8.4). This example is the first in which we declare *two* classes in one file—class `ThisTest` is declared

in lines 4–11, and class `SimpleTime` in lines 14–47. We do this to demonstrate that when you compile a `.java` file containing more than one class, the compiler produces a separate class file with the `.class` extension for every compiled class. In this case, two separate files are produced—`SimpleTime.class` and `ThisTest.class`. When one source-code (`.java`) file contains multiple class declarations, the compiler places both class files for those classes in the same directory. Note also in Fig. 8.4 that only class `ThisTest` is declared `public`. A source-code file can contain only one `public` class—otherwise, a compilation error occurs. Non-`public` classes can be used only by other classes in the same package. So, in this example, class `SimpleTime` can be used only by class `ThisTest`.

---

```

1 // Fig. 8.4: ThisTest.java
2 // this used implicitly and explicitly to refer to members of an object.
3
4 public class ThisTest
5 {
6 public static void main(String[] args)
7 {
8 SimpleTime time = new SimpleTime(15, 30, 19);
9 System.out.println(time.buildString());
10 } // end main
11 } // end class ThisTest
12
13 // class SimpleTime demonstrates the "this" reference
14 class SimpleTime
15 {
16 private int hour; // 0-23
17 private int minute; // 0-59
18 private int second; // 0-59
19
20 // if the constructor uses parameter names identical to
21 // instance variable names the "this" reference is
22 // required to distinguish between the names
23 public SimpleTime(int hour, int minute, int second)
24 {
25 this.hour = hour; // set "this" object's hour
26 this.minute = minute; // set "this" object's minute
27 this.second = second; // set "this" object's second
28 } // end SimpleTime constructor
29
30 // use explicit and implicit "this" to call toUniversalString
31 public String buildString()
32 {
33 return String.format("%24s: %s\n%24s: %s",
34 "this.toUniversalString()", this.toUniversalString(),
35 "toUniversalString()", toUniversalString());
36 } // end method buildString
37
38 // convert to String in universal-time format (HH:MM:SS)
39 public String toUniversalString()
40 {

```

---

**Fig. 8.4** | this used implicitly and explicitly to refer to members of an object. (Part I of 2.)

```

41 // "this" is not required here to access instance variables,
42 // because method does not have local variables with same
43 // names as instance variables
44 return String.format("%02d:%02d:%02d",
45 this.hour, this.minute, this.second);
46 } // end method toUniversalString
47 } // end class SimpleTime

```

```

this.toUniversalString(): 15:30:19
toUniversalString(): 15:30:19

```

**Fig. 8.4** | `this` used implicitly and explicitly to refer to members of an object. (Part 2 of 2.)

Class `SimpleTime` (lines 14–47) declares three private instance variables—`hour`, `minute` and `second` (lines 16–18). The constructor (lines 23–28) receives three `int` arguments to initialize a `SimpleTime` object. We used parameter names for the constructor (line 23) that are identical to the class's instance-variable names (lines 16–18). We don't recommend this practice, but we did it here to shadow (hide) the corresponding instance variables so that we could illustrate a case in which *explicit* use of the `this` reference is required. If a method contains a local variable with the *same* name as a field, that method will refer to the local variable rather than the field. In this case, the local variable shadows the field in the method's scope. However, the method can use the `this` reference to refer to the shadowed field explicitly, as shown on the left sides of the assignments in lines 25–27 for `SimpleTime`'s shadowed instance variables.

Method `buildString` (lines 31–36) returns a `String` created by a statement that uses the `this` reference explicitly and implicitly. Line 34 uses it explicitly to call method `toUniversalString`. Line 35 uses it implicitly to call the same method. Both lines perform the same task. You typically will not use `this` explicitly to reference other methods within the current object. Also, line 45 in method `toUniversalString` explicitly uses the `this` reference to access each instance variable. This is *not* necessary here, because the method does *not* have any local variables that shadow the instance variables of the class.



### Common Programming Error 8.2

*It's often a logic error when a method contains a parameter or local variable that has the same name as a field of the class. In this case, use reference `this` if you wish to access the field of the class—otherwise, the method parameter or local variable will be referenced.*



### Error-Prevention Tip 8.1

*Avoid method-parameter names or local-variable names that conflict with field names. This helps prevent subtle, hard-to-locate bugs.*



### Performance Tip 8.1

*Java conserves storage by maintaining only one copy of each method per class—this method is invoked by every object of the class. Each object, on the other hand, has its own copy of the class's instance variables (i.e., non-static fields). Each method of the class implicitly uses `this` to determine the specific object of the class to manipulate.*

Application class `ThisTest` (lines 4–11) demonstrates class `SimpleTime`. Line 8 creates an instance of class `SimpleTime` and invokes its constructor. Line 9 invokes the object's `buildString` method, then displays the results.

## 8.5 Time Class Case Study: Overloaded Constructors

As you know, you can declare your own constructor to specify how objects of a class should be initialized. Next, we demonstrate a class with several **overloaded constructors** that enable objects of that class to be initialized in different ways. To overload constructors, simply provide multiple constructor declarations with different signatures.

### *Class Time2 with Overloaded Constructors*

The default constructor for class `Time1` (Fig. 8.1) initialized `hour`, `minute` and `second` to their default 0 values (which is midnight in universal time). The default constructor does not enable the class's clients to initialize the time with specific nonzero values. Class `Time2` (Fig. 8.5) contains five overloaded constructors that provide convenient ways to initialize objects of the new class `Time2`. Each constructor initializes the object to begin in a consistent state. In this program, four of the constructors invoke a fifth, which in turn calls method `setTime` to ensure that the value supplied for `hour` is in the range 0 to 23, and the values for `minute` and `second` are each in the range 0 to 59. The compiler invokes the appropriate constructor by matching the number, types and order of the types of the arguments specified in the constructor call with the number, types and order of the types of the parameters specified in each constructor declaration. Class `Time2` also provides *set* and *get* methods for each instance variable.

---

```

1 // Fig. 8.5: Time2.java
2 // Time2 class declaration with overloaded constructors.
3
4 public class Time2
5 {
6 private int hour; // 0 - 23
7 private int minute; // 0 - 59
8 private int second; // 0 - 59
9
10 // Time2 no-argument constructor:
11 // initializes each instance variable to zero
12 public Time2()
13 {
14 this(0, 0, 0); // invoke Time2 constructor with three arguments
15 } // end Time2 no-argument constructor
16
17 // Time2 constructor: hour supplied, minute and second defaulted to 0
18 public Time2(int h)
19 {
20 this(h, 0, 0); // invoke Time2 constructor with three arguments
21 } // end Time2 one-argument constructor
22

```

---

**Fig. 8.5** | Time2 class with overloaded constructors. (Part 1 of 3.)

```

23 // Time2 constructor: hour and minute supplied, second defaulted to 0
24 public Time2(int h, int m)
25 {
26 this(h, m, 0); // invoke Time2 constructor with three arguments
27 } // end Time2 two-argument constructor
28
29 // Time2 constructor: hour, minute and second supplied
30 public Time2(int h, int m, int s)
31 {
32 setTime(h, m, s); // invoke setTime to validate time
33 } // end Time2 three-argument constructor
34
35 // Time2 constructor: another Time2 object supplied
36 public Time2(Time2 time)
37 {
38 // invoke Time2 three-argument constructor
39 this(time.getHour(), time.getMinute(), time.getSecond());
40 } // end Time2 constructor with a Time2 object argument
41
42 // Set Methods
43 // set a new time value using universal time;
44 // validate the data
45 public void setTime(int h, int m, int s)
46 {
47 setHour(h); // set the hour
48 setMinute(m); // set the minute
49 setSecond(s); // set the second
50 } // end method setTime
51
52 // validate and set hour
53 public void setHour(int h)
54 {
55 if (h >= 0 && h < 24)
56 hour = h;
57 else
58 throw new IllegalArgumentException("hour must be 0-23");
59 } // end method setHour
60
61 // validate and set minute
62 public void setMinute(int m)
63 {
64 if (m >= 0 && m < 60)
65 minute = m;
66 else
67 throw new IllegalArgumentException("minute must be 0-59");
68 } // end method setMinute
69
70 // validate and set second
71 public void setSecond(int s)
72 {
73 if (s >= 0 && s < 60)
74 second = ((s >= 0 && s < 60) ? s : 0);

```

**Fig. 8.5** | Time2 class with overloaded constructors. (Part 2 of 3.)

```

75 else
76 throw new IllegalArgumentException("second must be 0-59");
77 } // end method setSecond
78
79 // Get Methods
80 // get hour value
81 public int getHour()
82 {
83 return hour;
84 } // end method getHour
85
86 // get minute value
87 public int getMinute()
88 {
89 return minute;
90 } // end method getMinute
91
92 // get second value
93 public int getSecond()
94 {
95 return second;
96 } // end method getSecond
97
98 // convert to String in universal-time format (HH:MM:SS)
99 public String toUniversalString()
100 {
101 return String.format(
102 "%02d:%02d:%02d", getHour(), getMinute(), getSecond());
103 } // end method toUniversalString
104
105 // convert to String in standard-time format (H:MM:SS AM or PM)
106 public String toString()
107 {
108 return String.format("%d:%02d:%02d %s",
109 (getHour() == 0 || getHour() == 12) ? 12 : getHour() % 12),
110 getMinute(), getSecond(), (getHour() < 12 ? "AM" : "PM"));
111 } // end method toString
112 } // end class Time2

```

**Fig. 8.5** | Time2 class with overloaded constructors. (Part 3 of 3.)

### *Class Time2's Constructors*

Lines 12–15 declare a so-called **no-argument constructor** that's invoked without arguments. Once you declare any constructors in a class, the compiler will *not* provide a default constructor. This no-argument constructor ensures that class Time2's clients can create Time2 objects with default values. Such a constructor simply initializes the object as specified in the constructor's body. In the body, we introduce a use of the `this` reference that's allowed only as the *first* statement in a constructor's body. Line 14 uses `this` in method-call syntax to invoke the Time2 constructor that takes three parameters (lines 30–33) with values of 0 for the hour, minute and second. Using the `this` reference as shown here is a popular way to reuse initialization code provided by another of the class's constructors rather than defining similar code in the no-argument constructor's body. We use this syn-



tax in four of the five `Time2` constructors to make the class easier to maintain and modify. If we need to change how objects of class `Time2` are initialized, only the constructor that the class's other constructors call will need to be modified. In fact, even that constructor might not need modification in this example. That constructor simply calls the `setTime` method to perform the actual initialization, so it's possible that the changes the class might require would be localized to the *set* methods.



### Common Programming Error 8.3

*It's a compilation error when `this` is used in a constructor's body to call another constructor of the same class if that call is not the first statement in the constructor. It's also a compilation error when a method attempts to invoke a constructor directly via `this`.*



### Common Programming Error 8.4

*A constructor can call methods of the class. Be aware that the instance variables might not yet be initialized, because the constructor is in the process of initializing the object. Using instance variables before they've been initialized properly is a logic error.*

Lines 18–21 declare a `Time2` constructor with a single `int` parameter representing the hour, which is passed with 0 for the minute and second to the constructor at lines 30–33. Lines 24–27 declare a `Time2` constructor that receives two `int` parameters representing the hour and minute, which are passed with 0 for the second to the constructor at lines 30–33. Like the no-argument constructor, each of these constructors invokes the constructor at lines 30–33 to minimize code duplication. Lines 30–33 declare the `Time2` constructor that receives three `int` parameters representing the hour, minute and second. This constructor calls `setTime` to initialize the instance variables.

Lines 36–40 declare a `Time2` constructor that receives a reference to another `Time2` object. In this case, the values from the `Time2` argument are passed to the three-argument constructor at lines 30–33 to initialize the hour, minute and second. Line 39 could have directly accessed the hour, minute and second values of the constructor's argument `time` with the expressions `time.hour`, `time.minute` and `time.second`—even though hour, minute and second are declared as `private` variables of class `Time2`. This is due to a special relationship between objects of the same class. We'll see in a moment why it's preferable to use the *get* methods.



### Software Engineering Observation 8.3

*When one object of a class has a reference to another object of the same class, the first object can access all the second object's data and methods (including those that are private).*

#### *Class `Time2`'s `setTime` Method*

Method `setTime` (lines 45–50) invokes the `setHour` (lines 53–59), `setMinute` (lines 62–68) and `setSecond` (lines 71–77) methods, which ensure that the value supplied for hour is in the range 0 to 23 and the values for minute and second are each in the range 0 to 59. If a value is out of range, each of these methods throws an `IllegalArgumentException` (lines 58, 67 and 76) indicating which value was out of range.

#### *Notes Regarding Class `Time2`'s `set` and `get` Methods and Constructors*

`Time2`'s *set* and *get* methods are called throughout the class. In particular, method `setTime` calls methods `setHour`, `setMinute` and `setSecond` in lines 47–49, and methods `toUni-`

`universalString` and `toString` call methods `getHour`, `getMinute` and `getSecond` in line 93 and lines 100–101, respectively. In each case, these methods could have accessed the class's private data directly without calling the *set* and *get* methods. However, consider changing the representation of the time from three `int` values (requiring 12 bytes of memory) to a single `int` value representing the total number of seconds that have elapsed since midnight (requiring only 4 bytes of memory). If we made such a change, only the bodies of the methods that access the private data directly would need to change—in particular, the individual *set* and *get* methods for the hour, minute and second. There would be no need to modify the bodies of methods `setTime`, `toUniversalString` or `toString` because they do not access the data directly. Designing the class in this manner reduces the likelihood of programming errors when altering the class's implementation.

Similarly, each `Time2` constructor could include a copy of the appropriate statements from methods `setHour`, `setMinute` and `setSecond`. Doing so may be slightly more efficient, because the extra calls to the constructor and `setTime` are eliminated. However, *duplicating* statements in multiple methods or constructors makes changing the class's internal data representation more difficult. Having the `Time2` constructors call the constructor with three arguments (or even call `setTime` directly) requires that any changes to the implementation of `setTime` be made only once. Also, the compiler can optimize programs by removing calls to simple methods and replacing them with the expanded code of their declarations—a technique known as **inlining the code**, which improves program performance.



#### Software Engineering Observation 8.4

*When implementing a method of a class, use the class's set and get methods to access the class's private data. This simplifies code maintenance and reduces the likelihood of errors.*

#### Using Class `Time2`'s Overloaded Constructors

Class `Time2Test` (Fig. 8.6) invokes the overloaded `Time2` constructors (lines 8–12 and 40). Line 8 invokes the no-argument constructor (Fig. 8.5, lines 12–15). Lines 9–13 of the program demonstrate passing arguments to the other `Time2` constructors. Line 9 invokes the single-argument constructor that receives an `int` at lines 18–21 of Fig. 8.5. Line 10 invokes the two-argument constructor at lines 24–27 of Fig. 8.5. Line 11 invokes the three-argument constructor at lines 30–33 of Fig. 8.5. Line 12 invokes the single-argument constructor that takes a `Time2` at lines 36–40 of Fig. 8.5. Next, the application displays the `String` representations of each `Time2` object to confirm that it was initialized properly. Line 40 attempts to initialize `t6` by creating a new `Time2` object and passing three invalid values to the constructor. When the constructor attempts to use the invalid hour value to initialize the object's hour, an `IllegalArgumentException` occurs. We catch this exception at line 42 and display its error message, which results in the last line of the output.

```

1 // Fig. 8.6: Time2Test.java
2 // Overloaded constructors used to initialize Time2 objects.
3
4 public class Time2Test
5 {

```

**Fig. 8.6** | Overloaded constructors used to initialize `Time2` objects. (Part 1 of 3.)

```
6 public static void main(String[] args)
7 {
8 Time2 t1 = new Time2(); // 00:00:00
9 Time2 t2 = new Time2(2); // 02:00:00
10 Time2 t3 = new Time2(21, 34); // 21:34:00
11 Time2 t4 = new Time2(12, 25, 42); // 12:25:42
12 Time2 t5 = new Time2(t4); // 12:25:42
13
14 System.out.println("Constructed with:");
15 System.out.println("t1: all arguments defaulted");
16 System.out.printf(" %s\n", t1.toUniversalString());
17 System.out.printf(" %s\n", t1.toString());
18
19 System.out.println(
20 "t2: hour specified; minute and second defaulted");
21 System.out.printf(" %s\n", t2.toUniversalString());
22 System.out.printf(" %s\n", t2.toString());
23
24 System.out.println(
25 "t3: hour and minute specified; second defaulted");
26 System.out.printf(" %s\n", t3.toUniversalString());
27 System.out.printf(" %s\n", t3.toString());
28
29 System.out.println("t4: hour, minute and second specified");
30 System.out.printf(" %s\n", t4.toUniversalString());
31 System.out.printf(" %s\n", t4.toString());
32
33 System.out.println("t5: Time2 object t4 specified");
34 System.out.printf(" %s\n", t5.toUniversalString());
35 System.out.printf(" %s\n", t5.toString());
36
37 // attempt to initialize t6 with invalid values
38 try
39 {
40 Time2 t6 = new Time2(27, 74, 99); // invalid values
41 } // end try
42 catch (IllegalArgumentException e)
43 {
44 System.out.printf("\nException while initializing t6: %s\n",
45 e.getMessage());
46 } // end catch
47 } // end main
48 } // end class Time2Test
```

```
Constructed with:
t1: all arguments defaulted
 00:00:00
 12:00:00 AM
t2: hour specified; minute and second defaulted
 02:00:00
 2:00:00 AM
```

**Fig. 8.6** | Overloaded constructors used to initialize Time2 objects. (Part 2 of 3.)

```

t3: hour and minute specified; second defaulted
 21:34:00
 9:34:00 PM
t4: hour, minute and second specified
 12:25:42
 12:25:42 PM
t5: Time2 object t4 specified
 12:25:42
 12:25:42 PM

Exception while initializing t6: hour must be 0-23

```

**Fig. 8.6** | Overloaded constructors used to initialize `Time2` objects. (Part 3 of 3.)

## 8.6 Default and No-Argument Constructors

Every class must have at least one constructor. If you do not provide any in a class's declaration, the compiler creates a default constructor that takes no arguments when it's invoked. The default constructor initializes the instance variables to the initial values specified in their declarations or to their default values (zero for primitive numeric types, `false` for boolean values and `null` for references). In Section 9.4.1, you'll learn that the default constructor performs another task also.

If your class declares constructors, the compiler will *not* create a default constructor. In this case, you must declare a no-argument constructor if default initialization is required. Like a default constructor, a no-argument constructor is invoked with empty parentheses. The `Time2` no-argument constructor (lines 12–15 of Fig. 8.5) explicitly initializes a `Time2` object by passing to the three-argument constructor 0 for each parameter. Since 0 is the default value for `int` instance variables, the no-argument constructor in this example could actually be declared with an empty body. In this case, each instance variable would receive its default value when the no-argument constructor was called. If we omit the no-argument constructor, clients of this class would not be able to create a `Time2` object with the expression `new Time2()`.



### Common Programming Error 8.5

*A compilation error occurs if a program attempts to initialize an object of a class by passing the wrong number or types of arguments to the class's constructor.*



### Error-Prevention Tip 8.2

*Ensure that you do not include a return type in a constructor definition. Java allows other methods of the class besides its constructors to have the same name as the class and to specify return types. Such methods are not constructors and will not be called when an object of the class is instantiated.*

## 8.7 Notes on Set and Get Methods

As you know, a class's private fields can be manipulated only by its methods. A typical manipulation might be the adjustment of a customer's bank balance (e.g., a private instance variable of a class `BankAccount`) by a method `computeInterest`. Classes often provide `public` methods to allow clients of the class to *set* (i.e., assign values to) or *get* (i.e., obtain the values of) private instance variables.

As a naming example, a method that sets instance variable `interestRate` would typically be named `setInterestRate` and a method that gets the `interestRate` would typically be called `getInterestRate`. *Set* methods are also commonly called **mutator methods**, because they typically change an object's state—i.e., modify the values of instance variables. *Get* methods are also commonly called **accessor methods** or **query methods**.

### Set and Get Methods vs. `public` Data

It would seem that providing *set* and *get* capabilities is essentially the same as making the instance variables `public`. This is one of the subtleties that makes Java so desirable for software engineering. A `public` instance variable can be read or written by any method that has a reference to an object containing that variable. If an instance variable is declared `private`, a `public` *get* method certainly allows other methods to access it, but the *get* method can *control* how the client can access it. For example, a *get* method might control the format of the data it returns and thus shield the client code from the actual data representation. A `public` *set* method can—and should—carefully scrutinize attempts to modify the variable's value and throw an exception if necessary. For example, an attempt to *set* the day of the month to 37 would be rejected, an attempt to *set* a person's weight to a negative value would be rejected, and so on. Thus, although *set* and *get* methods provide access to private data, the access is restricted by the implementation of the methods. This helps promote good software engineering.

### Validity Checking in Set Methods

The benefits of data integrity do not follow automatically simply because instance variables are declared `private`—you must provide validity checking. Java enables you to design better programs in a convenient manner. A class's *set* methods could return values indicating that attempts were made to assign invalid data to objects of the class. A client of the class could test the return value of a *set* method to determine whether the client's attempt to modify the object was successful and to take appropriate action. Typically, however, *set* methods have `void` return type and use exception handling to indicate attempts to assign invalid data. We discuss exception handling in detail in Chapter 11.



### Software Engineering Observation 8.5

*When appropriate, provide `public` methods to change and retrieve the values of private instance variables. This architecture helps hide the implementation of a class from its clients, which improves program modifiability.*



### Error-Prevention Tip 8.3

*Using *set* and *get* methods helps you create classes that are easier to debug and maintain. If only one method performs a particular task, such as setting the hour in a `Time2` object, it's easier to debug and maintain the class. If the hour is not being set properly, the code that actually modifies instance variable `hour` is localized to one method's body—`setHour`. Thus, your debugging efforts can be focused on method `setHour`.*

### Predicate Methods

Another common use for accessor methods is to test whether a condition is true or false—such methods are often called **predicate methods**. An example would be class `ArrayList`'s `isEmpty` method, which returns `true` if the `ArrayList` is empty. A program might test `isEmpty` before attempting to read another item from an `ArrayList`.

## 8.8 Composition

A class can have references to objects of other classes as members. This is called **composition** and is sometimes referred to as a *has-a relationship*. For example, an `AlarmClock` object needs to know the current time *and* the time when it's supposed to sound its alarm, so it's reasonable to include *two* references to `Time` objects in an `AlarmClock` object.

### Class Date

This composition example contains classes `Date` (Fig. 8.7), `Employee` (Fig. 8.8) and `EmployeeTest` (Fig. 8.9). Class `Date` (Fig. 8.7) declares instance variables `month`, `day` and `year` (lines 6–8) to represent a date. The constructor receives three `int` parameters. Line 17 invokes utility method `checkMonth` (lines 26–32) to validate the month—if the value is out-of-range the method throws an exception. Line 15 assumes that the value for year is correct and doesn't validate it. Line 19 invokes utility method `checkDay` (lines 35–48) to validate the day based on the current month and year. Line 38 determines whether the day is correct based on the number of days in the particular month. If the day is not correct, lines 42–43 determine whether the month is February, the day is 29 and the year is a leap year. If the day is still invalid, the method throws an exception. Lines 21–22 in the constructor output the `this` reference as a `String`. Since `this` is a reference to the current `Date` object, the object's `toString` method (lines 51–54) is called *implicitly* to obtain the object's `String` representation.

---

```

1 // Fig. 8.7: Date.java
2 // Date class declaration.
3
4 public class Date
5 {
6 private int month; // 1-12
7 private int day; // 1-31 based on month
8 private int year; // any year
9
10 private static final int[] daysPerMonth = // days in each month
11 { 0, 31, 28, 31, 30, 31, 30, 31, 31, 30, 31, 30, 31 };
12
13 // constructor: call checkMonth to confirm proper value for month;
14 // call checkDay to confirm proper value for day
15 public Date(int theMonth, int theDay, int theYear)
16 {
17 month = checkMonth(theMonth); // validate month
18 year = theYear; // could validate year
19 day = checkDay(theDay); // validate day
20
21 System.out.printf(
22 "Date object constructor for date %s\n", this);
23 } // end Date constructor
24
25 // utility method to confirm proper month value
26 private int checkMonth(int testMonth)
27 {
28 if (testMonth > 0 && testMonth <= 12) // validate month
29 return testMonth;

```

---

**Fig. 8.7** | Date class declaration. (Part 1 of 2.)

---

```

30 else // month is invalid
31 throw new IllegalArgumentException("month must be 1-12");
32 } // end method checkMonth
33
34 // utility method to confirm proper day value based on month and year
35 private int checkDay(int testDay)
36 {
37 // check if day in range for month
38 if (testDay > 0 && testDay <= daysPerMonth[month])
39 return testDay;
40
41 // check for leap year
42 if (month == 2 && testDay == 29 && (year % 400 == 0 ||
43 (year % 4 == 0 && year % 100 != 0)))
44 return testDay;
45
46 throw new IllegalArgumentException(
47 "day out-of-range for the specified month and year");
48 } // end method checkDay
49
50 // return a String of the form month/day/year
51 public String toString()
52 {
53 return String.format("%d/%d/%d", month, day, year);
54 } // end method toString
55 } // end class Date

```

---

**Fig. 8.7** | Date class declaration. (Part 2 of 2.)

### *Class Employee*

Class `Employee` (Fig. 8.8) has instance variables `firstName`, `lastName`, `birthDate` and `hireDate`. Members `firstName` and `lastName` (lines 6–7) are references to `String` objects. Members `birthDate` and `hireDate` (lines 8–9) are references to `Date` objects. This demonstrates that a class can have as instance variables references to objects of other classes. The `Employee` constructor (lines 12–19) takes four parameters—`first`, `last`, `dateOfBirth` and `dateOfHire`. The objects referenced by the parameters are assigned to the `Employee` object's instance variables. When class `Employee`'s `toString` method is called, it returns a `String` containing the employee's name and the `String` representations of the two `Date` objects. Each of these `Strings` is obtained with an *implicit* call to the `Date` class's `toString` method.

---

```

1 // Fig. 8.8: Employee.java
2 // Employee class with references to other objects.
3
4 public class Employee
5 {
6 private String firstName;
7 private String lastName;
8 private Date birthDate;
9 private Date hireDate;

```

---

**Fig. 8.8** | `Employee` class with references to other objects. (Part 1 of 2.)

```

10
11 // constructor to initialize name, birth date and hire date
12 public Employee(String first, String last, Date dateOfBirth,
13 Date dateOfHire)
14 {
15 firstName = first;
16 lastName = last;
17 birthDate = dateOfBirth;
18 hireDate = dateOfHire;
19 } // end Employee constructor
20
21 // convert Employee to String format
22 public String toString()
23 {
24 return String.format("%s, %s Hired: %s Birthday: %s",
25 lastName, firstName, hireDate, birthDate);
26 } // end method toString
27 } // end class Employee

```

**Fig. 8.8** | Employee class with references to other objects. (Part 2 of 2.)

### *Class EmployeeTest*

Class `EmployeeTest` (Fig. 8.9) creates two `Date` objects (lines 8–9) to represent an `Employee`'s birthday and hire date, respectively. Line 10 creates an `Employee` and initializes its instance variables by passing to the constructor two `Strings` (representing the `Employee`'s first and last names) and two `Date` objects (representing the birthday and hire date). Line 12 implicitly invokes the `Employee`'s `toString` method to display the values of its instance variables and demonstrate that the object was initialized properly.

```

1 // Fig. 8.9: EmployeeTest.java
2 // Composition demonstration.
3
4 public class EmployeeTest
5 {
6 public static void main(String[] args)
7 {
8 Date birth = new Date(7, 24, 1949);
9 Date hire = new Date(3, 12, 1988);
10 Employee employee = new Employee("Bob", "Blue", birth, hire);
11
12 System.out.println(employee);
13 } // end main
14 } // end class EmployeeTest

```

```

Date object constructor for date 7/24/1949
Date object constructor for date 3/12/1988
Blue, Bob Hired: 3/12/1988 Birthday: 7/24/1949

```

**Fig. 8.9** | Composition demonstration.



## 8.9 Enumerations

In Fig. 6.8, we introduced the basic enum type, which defines a set of constants represented as unique identifiers. In that program the enum constants represented the game's status. In this section we discuss the relationship between enum types and classes. Like classes, all enum types are reference types. An enum type is declared with an **enum declaration**, which is a comma-separated list of enum constants—the declaration may optionally include other components of traditional classes, such as constructors, fields and methods. Each enum declaration declares an enum class with the following restrictions:

1. enum constants are implicitly `final`, because they declare constants that shouldn't be modified.
2. enum constants are implicitly `static`.
3. Any attempt to create an object of an enum type with operator `new` results in a compilation error.

The enum constants can be used anywhere constants can be used, such as in the case labels of `switch` statements and to control enhanced `for` statements.

Figure 8.10 illustrates how to declare instance variables, a constructor and methods in an enum type. The enum declaration (lines 5–37) contains two parts—the enum constants and the other members of the enum type. The first part (lines 8–13) declares six enum constants. Each is optionally followed by arguments which are passed to the **enum constructor** (lines 20–24). Like the constructors you've seen in classes, an enum constructor can specify any number of parameters and can be overloaded. In this example, the enum constructor requires two `String` parameters. To properly initialize each enum constant, we follow it with parentheses containing two `String` arguments, which are passed to the enum's constructor. The second part (lines 16–36) declares the other members of the enum type—two instance variables (lines 16–17), a constructor (lines 20–24) and two methods (lines 27–30 and 33–36).

---

```

1 // Fig. 8.10: Book.java
2 // Declaring an enum type with constructor and explicit instance fields
3 // and accessors for these fields
4
5 public enum Book
6 {
7 // declare constants of enum type
8 JHTP("Java How to Program", "2012"),
9 CHTP("C How to Program", "2007"),
10 IW3HTP("Internet & World Wide Web How to Program", "2008"),
11 CPPHTP("C++ How to Program", "2012"),
12 VBHTP("Visual Basic 2010 How to Program", "2011"),
13 CSHARPHTP("Visual C# 2010 How to Program", "2011");
14
15 // instance fields
16 private final String title; // book title
17 private final String copyrightYear; // copyright year

```

---

**Fig. 8.10** | Declaring an enum type with constructor and explicit instance fields and accessors for these fields. (Part 1 of 2.)

---

```

18
19 // enum constructor
20 Book(String bookTitle, String year)
21 {
22 title = bookTitle;
23 copyrightYear = year;
24 } // end enum Book constructor
25
26 // accessor for field title
27 public String getTitle()
28 {
29 return title;
30 } // end method getTitle
31
32 // accessor for field copyrightYear
33 public String getCopyrightYear()
34 {
35 return copyrightYear;
36 } // end method getCopyrightYear
37 } // end enum Book

```

---

**Fig. 8.10** | Declaring an enum type with constructor and explicit instance fields and accessors for these fields. (Part 2 of 2.)

Lines 16–17 declare the instance variables `title` and `copyrightYear`. Each enum constant in `Book` is actually an object of type `Book` that has its own copy of instance variables `title` and `copyrightYear`. The constructor (lines 20–24) takes two `String` parameters, one that specifies the book’s title and one that specifies its copyright year. Lines 22–23 assign these parameters to the instance variables. Lines 27–36 declare two methods, which return the book title and copyright year, respectively.

Figure 8.11 tests the enum type `Book` and illustrates how to iterate through a range of enum constants. For every enum, the compiler generates the static method `values` (called in line 12) that returns an array of the enum’s constants in the order they were declared. Lines 12–14 use the enhanced `for` statement to display all the constants declared in the enum `Book`. Line 14 invokes the enum `Book`’s `getTitle` and `getCopyrightYear` methods to get the title and copyright year associated with the constant. When an enum constant is converted to a `String` (e.g., `book` in line 13), the constant’s identifier is used as the `String` representation (e.g., `JHTP` for the first enum constant).

---

```

1 // Fig. 8.11: EnumTest.java
2 // Testing enum type Book.
3 import java.util.EnumSet;
4
5 public class EnumTest
6 {
7 public static void main(String[] args)
8 {
9 System.out.println("All books:\n");

```

---

**Fig. 8.11** | Testing an enum type. (Part 1 of 2.)

```

10
11 // print all books in enum Book
12 for (Book book : Book.values())
13 System.out.printf("%-10s%-45s%s\n", book,
14 book.getTitle(), book.getCopyrightYear());
15
16 System.out.println("\nDisplay a range of enum constants:\n");
17
18 // print first four books
19 for (Book book : EnumSet.range(Book.JHTP, Book.CPPHTP))
20 System.out.printf("%-10s%-45s%s\n", book,
21 book.getTitle(), book.getCopyrightYear());
22 } // end main
23 } // end class EnumTest

```

All books:

|           |                                          |      |
|-----------|------------------------------------------|------|
| JHTP      | Java How to Program                      | 2012 |
| CHTP      | C How to Program                         | 2007 |
| IW3HTP    | Internet & World Wide Web How to Program | 2008 |
| CPPHTP    | C++ How to Program                       | 2012 |
| VBHTP     | Visual Basic 2010 How to Program         | 2011 |
| CSHARPHTP | Visual C# 2010 How to Program            | 2011 |

Display a range of enum constants:

|        |                                          |      |
|--------|------------------------------------------|------|
| JHTP   | Java How to Program                      | 2012 |
| CHTP   | C How to Program                         | 2007 |
| IW3HTP | Internet & World Wide Web How to Program | 2008 |
| CPPHTP | C++ How to Program                       | 2012 |

**Fig. 8.11** | Testing an enum type. (Part 2 of 2.)

Lines 19–21 use the static method **range** of class **EnumSet** (declared in package `java.util`) to display a range of the enum `Book`'s constants. Method `range` takes two parameters—the first and the last enum constants in the range—and returns an `EnumSet` that contains all the constants between these two constants, inclusive. For example, the expression `EnumSet.range( Book.JHTP, Book.CPPHTP )` returns an `EnumSet` containing `Book.JHTP`, `Book.CHTP`, `Book.IW3HTP` and `Book.CPPHTP`. The enhanced `for` statement can be used with an `EnumSet` just as it can with an array, so lines 12–14 use it to display the title and copyright year of every book in the `EnumSet`. Class `EnumSet` provides several other static methods for creating sets of enum constants from the same enum type.



### Common Programming Error 8.6

*In an enum declaration, it's a syntax error to declare enum constants after the enum type's constructors, fields and methods.*

## 8.10 Garbage Collection and Method finalize

Every class in Java has the methods of class `Object` (package `java.lang`), one of which is the `finalize` method. This method is rarely used because it can cause performance problems and there's some uncertainty as to whether it will get called. Nevertheless, because

`finalize` is part of every class, we discuss it here to help you understand its intended purpose. The complete details of the `finalize` method are beyond the scope of this book, and most programmers should not use it—you'll soon see why. You'll learn more about class `Object` in Chapter 9.

Every object uses system resources, such as memory. We need a disciplined way to give resources back to the system when they're no longer needed; otherwise, "resource leaks" might occur that would prevent them from being reused by your program or possibly by other programs. The JVM performs automatic **garbage collection** to reclaim the memory occupied by objects that are no longer used. When there are no more references to an object, the object is eligible to be collected. This typically occurs when the JVM executes its **garbage collector**. So, memory leaks that are common in other languages like C and C++ (because memory is not automatically reclaimed in those languages) are less likely in Java, but some can still happen in subtle ways. Other types of resource leaks can occur. For example, an application may open a file on disk to modify its contents. If it does not close the file, the application must terminate before any other application can use it.

The **finalize method** is called by the garbage collector to perform **termination housekeeping** on an object just before the garbage collector reclaims the object's memory. Method `finalize` does not take parameters and has return type `void`. A problem with method `finalize` is that the garbage collector is not guaranteed to execute at a specified time. In fact, the garbage collector may never execute before a program terminates. Thus, it's unclear whether, or when, method `finalize` will be called. For this reason, most programmers should avoid method `finalize`.



### Software Engineering Observation 8.6

*A class that uses system resources, such as files on disk, should provide a method that programmers can call to release resources when they're no longer needed in a program. Many Java API classes provide `close` or `dispose` methods for this purpose. For example, class `Scanner` has a `close` method. We discuss new Java SE 7 features related to this in Section 11.13.*

## 8.11 static Class Members

Every object has its own copy of all the instance variables of the class. In certain cases, only one copy of a particular variable should be *shared* by all objects of a class. A **static field**—called a **class variable**—is used in such cases. A static variable represents **classwide information**—all objects of the class share the *same* piece of data. The declaration of a static variable begins with the keyword `static`.

Let's motivate static data with an example. Suppose that we have a video game with Martians and other space creatures. Each Martian tends to be brave and willing to attack other space creatures when the Martian is aware that at least four other Martians are present. If fewer than five Martians are present, each of them becomes cowardly. Thus, each Martian needs to know the `martianCount`. We could endow class `Martian` with `martianCount` as an instance variable. If we do this, then every Martian will have a *separate copy* of the instance variable, and every time we create a new Martian, we'll have to update the instance variable `martianCount` in every Martian object. This wastes space with the redundant copies, wastes time in updating the separate copies and is error prone. Instead, we declare `martianCount` to be `static`, making `martianCount` classwide data. Every Mar-

tian can see the `martianCount` as if it were an instance variable of class `Martian`, but only one copy of the static `martianCount` is maintained. This saves space. We save time by having the `Martian` constructor increment the static `martianCount`—there’s only one copy, so we do not have to increment separate copies for each `Martian` object.



### Software Engineering Observation 8.7

*Use a static variable when all objects of a class must use the same copy of the variable.*

Static variables have class scope. We can access a class’s public static members through a reference to any object of the class, or by qualifying the member name with the class name and a dot (`.`), as in `Math.random()`. A class’s private static class members can be accessed by client code only through methods of the class. Actually, *static class members exist even when no objects of the class exist*—they’re available as soon as the class is loaded into memory at execution time. To access a public static member when no objects of the class exist (and even when they do), prefix the class name and a dot (`.`) to the static member, as in `Math.PI`. To access a private static member when no objects of the class exist, provide a public static method and call it by qualifying its name with the class name and a dot.



### Software Engineering Observation 8.8

*Static class variables and methods exist, and can be used, even if no objects of that class have been instantiated.*

A static method cannot access non-static class members, because a static method can be called even when no objects of the class have been instantiated. For the same reason, the `this` reference cannot be used in a static method. The `this` reference must refer to a specific object of the class, and when a static method is called, there might not be any objects of its class in memory.



### Common Programming Error 8.7

*A compilation error occurs if a static method calls an instance (non-static) method in the same class by using only the method name. Similarly, a compilation error occurs if a static method attempts to access an instance variable in the same class by using only the variable name.*



### Common Programming Error 8.8

*Referring to `this` in a static method is a compilation error.*

## Tracking the Number of Employee Objects That Have Been Created

Our next program declares two classes—`Employee` (Fig. 8.12) and `EmployeeTest` (Fig. 8.13). Class `Employee` declares private static variable `count` (Fig. 8.12, line 9) and public static method `getCount` (lines 36–39). The static variable `count` is initialized to zero in line 9. If a static variable is not initialized, the compiler assigns it a default value—in this case 0, the default value for type `int`. Variable `count` maintains a count of the number of objects of class `Employee` that have been created so far.

When `Employee` objects exist, variable `count` can be used in any method of an `Employee` object—this example increments `count` in the constructor (line 18). The public

```

1 // Fig. 8.12: Employee.java
2 // Static variable used to maintain a count of the number of
3 // Employee objects in memory.
4
5 public class Employee
6 {
7 private String firstName;
8 private String lastName;
9 private static int count = 0; // number of Employees created
10
11 // initialize Employee, add 1 to static count and
12 // output String indicating that constructor was called
13 public Employee(String first, String last)
14 {
15 firstName = first;
16 lastName = last;
17
18 ++count; // increment static count of employees
19 System.out.printf("Employee constructor: %s %s; count = %d\n",
20 firstName, lastName, count);
21 } // end Employee constructor
22
23 // get first name
24 public String getFirstName()
25 {
26 return firstName;
27 } // end method getFirstName
28
29 // get last name
30 public String getLastName()
31 {
32 return lastName;
33 } // end method getLastName
34
35 // static method to get static count value
36 public static int getCount()
37 {
38 return count;
39 } // end method getCount
40 } // end class Employee

```

**Fig. 8.12** | static variable used to maintain a count of the number of Employee objects in memory.

static method `getCount` (lines 36–39) returns the number of Employee objects that have been created so far. When no objects of class Employee exist, client code can access variable `count` by calling method `getCount` via the class name, as in `Employee.getCount()`. When objects exist, method `getCount` can also be called via any reference to an Employee object.



### Good Programming Practice 8.1

Invoke every static method by using the class name and a dot (.) to emphasize that the method being called is a static method.

EmployeeTest method main (Fig. 8.13) instantiates two Employee objects (lines 13–14). When each Employee object’s constructor is invoked, lines 15–16 of Fig. 8.12 assign the Employee’s first name and last name to instance variables firstName and lastName. These two statements do *not* make copies of the original String arguments. Actually, String objects in Java are **immutable**—they cannot be modified after they’re created. Therefore, it’s safe to have many references to one String object. This is not normally the case for objects of most other classes in Java. If String objects are immutable, you might wonder why we’re able to use operators + and += to concatenate String objects. String-concatenation operations actually result in a *new* Strings object containing the concatenated values. The original String objects are not modified.

When main has finished using the two Employee objects, the references e1 and e2 are set to null at lines 31–32. At this point, references e1 and e2 no longer refer to the objects that were instantiated in lines 13–14. The objects become “eligible for garbage collection” because there are no more references to them in the program.

---

```

1 // Fig. 8.13: EmployeeTest.java
2 // static member demonstration.
3
4 public class EmployeeTest
5 {
6 public static void main(String[] args)
7 {
8 // show that count is 0 before creating Employees
9 System.out.printf("Employees before instantiation: %d\n",
10 Employee.getCount());
11
12 // create two Employees; count should be 2
13 Employee e1 = new Employee("Susan", "Baker");
14 Employee e2 = new Employee("Bob", "Blue");
15
16 // show that count is 2 after creating two Employees
17 System.out.println("\nEmployees after instantiation: ");
18 System.out.printf("via e1.getCount(): %d\n", e1.getCount());
19 System.out.printf("via e2.getCount(): %d\n", e2.getCount());
20 System.out.printf("via Employee.getCount(): %d\n",
21 Employee.getCount());
22
23 // get names of Employees
24 System.out.printf("\nEmployee 1: %s %s\nEmployee 2: %s %s\n",
25 e1.getFirstName(), e1.getLastName(),
26 e2.getFirstName(), e2.getLastName());
27
28 // in this example, there is only one reference to each Employee,
29 // so the following two statements indicate that these objects
30 // are eligible for garbage collection
31 e1 = null;
32 e2 = null;
33 } // end main
34 } // end class EmployeeTest

```

---

**Fig. 8.13** | static member demonstration. (Part I of 2.)

```

Employees before instantiation: 0
Employee constructor: Susan Baker; count = 1
Employee constructor: Bob Blue; count = 2

Employees after instantiation:
via e1.getCount(): 2
via e2.getCount(): 2
via Employee.getCount(): 2

Employee 1: Susan Baker
Employee 2: Bob Blue

```

**Fig. 8.13** | static member demonstration. (Part 2 of 2.)

Eventually, the garbage collector might reclaim the memory for these objects (or the operating system will reclaim the memory when the program terminates). The JVM does not guarantee when, or even whether, the garbage collector will execute. When it does, it's possible that no objects or only a subset of the eligible objects will be collected.

## 8.12 static Import

In Section 6.3, you learned about the `static` fields and methods of class `Math`. We invoked class `Math`'s `static` fields and methods by preceding each with the class name `Math` and a dot (`.`). A **static import** declaration enables you to import the `static` members of a class or interface so you can access them via their unqualified names in your class—the class name and a dot (`.`) are not required to use an imported `static` member.

A `static import` declaration has two forms—one that imports a particular `static` member (which is known as **single static import**) and one that imports *all* `static` members of a class (known as **static import on demand**). The following syntax imports a particular `static` member:

```
import static packageName.ClassName.staticMemberName;
```

where *packageName* is the package of the class (e.g., `java.lang`), *ClassName* is the name of the class (e.g., `Math`) and *staticMemberName* is the name of the `static` field or method (e.g., `PI` or `abs`). The following syntax imports all `static` members of a class:

```
import static packageName.ClassName.*;
```

The asterisk (`*`) indicates that *all* `static` members of the specified class should be available for use in the file. `static import` declarations import only `static` class members. Regular `import` statements should be used to specify the classes used in a program.

Figure 8.14 demonstrates a `static import`. Line 3 is a `static import` declaration, which imports all `static` fields and methods of class `Math` from package `java.lang`. Lines 9–12 access the `Math` class's `static` fields `E` (line 11) and `PI` (line 12) and the `static` methods `sqrt` (line 9) and `ceil` (line 10) without preceding the field names or method names with class name `Math` and a dot.



### Common Programming Error 8.9

A compilation error occurs if a program attempts to import two or more classes' `static` methods that have the same signature or `static` fields that have the same name.



```

1 // Fig. 8.14: StaticImportTest.java
2 // Static import of Math class methods.
3 import static java.lang.Math.*;
4
5 public class StaticImportTest
6 {
7 public static void main(String[] args)
8 {
9 System.out.printf("sqrt(900.0) = %.1f\n", sqrt(900.0));
10 System.out.printf("ceil(-9.8) = %.1f\n", ceil(-9.8));
11 System.out.printf("E = %f\n", E);
12 System.out.printf("PI = %f\n", PI);
13 } // end main
14 } // end class StaticImportTest

```

```

sqrt(900.0) = 30.0
ceil(-9.8) = -9.0
log(E) = 1.0
cos(0.0) = 1.0

```

**Fig. 8.14** | Static import of Math class methods.

## 8.13 final Instance Variables

The **principle of least privilege** is fundamental to good software engineering. In the context of an application, it states that code should be granted only the amount of privilege and access that it needs to accomplish its designated task, but no more. This makes your programs more robust by preventing code from accidentally (or maliciously) modifying variable values and calling methods that should not be accessible.

Let's see how this principle applies to instance variables. Some of them need to be modifiable and some do not. You can use the keyword `final` to specify that a variable is not modifiable (i.e., it's a constant) and that any attempt to modify it is an error. For example,

```
private final int INCREMENT;
```

declares a `final` (constant) instance variable `INCREMENT` of type `int`. Such variables can be initialized when they're declared. If they are not, they *must* be initialized in every constructor of the class. Initializing constants in constructors enables each object of the class to have a different value for the constant. If a `final` variable is not initialized in its declaration or in every constructor, a compilation error occurs.



### Software Engineering Observation 8.9

Declaring an instance variable as `final` helps enforce the principle of least privilege. If an instance variable should not be modified, declare it to be `final` to prevent modification.



### Common Programming Error 8.10

Attempting to modify a `final` instance variable after it's initialized is a compilation error.



#### Error-Prevention Tip 8.4

Attempts to modify a `final` instance variable are caught at compilation time rather than causing execution-time errors. It's always preferable to get bugs out at compilation time, if possible, rather than allow them to slip through to execution time (where experience has found that repair is often many times more expensive).



#### Software Engineering Observation 8.10

A `final` field should also be declared `static` if it's initialized in its declaration to a value that's the same for all objects of the class. After this initialization, its value can never change. Therefore, we don't need a separate copy of the field for every object of the class. Making the field `static` enables all objects of the class to share the `final` field.

## 8.14 Time Class Case Study: Creating Packages

We've seen in almost every example in the text that classes from preexisting libraries, such as the Java API, can be imported into a Java program. Each class in the Java API belongs to a package that contains a group of related classes. These packages are defined once, but can be imported into many programs. As applications become more complex, packages help you manage the complexity of application components. Packages also facilitate software reuse by enabling programs to *import* classes from other packages (as we've done in most examples), rather than *copying* the classes into each program that uses them. Another benefit of packages is that they provide a convention for unique class names, which helps prevent class-name conflicts (discussed later in this section). This section introduces how to create your own packages.

### *Steps for Declaring a Reusable Class*

Before a class can be imported into multiple applications, it must be placed in a package to make it reusable. Figure 8.15 shows how to specify the package in which a class should be placed. Figure 8.16 shows how to import our packaged class so that it can be used in an application. The steps for creating a reusable class are:

1. Declare a `public` class. If the class is not `public`, it can be used only by other classes in the same package.
2. Choose a unique package name and add a **package declaration** to the source-code file for the reusable class declaration. In each Java source-code file there can be only one package declaration, and it must precede all other declarations and statements. Comments are not statements, so comments can be placed before a package statement in a file. [*Note:* If no package statement is provided, the class is placed in the so-called default package and is accessible only to other classes in the default package that are located in the same directory. All prior programs in this book having two or more classes have used this default package.]
3. Compile the class so that it's placed in the appropriate package directory.
4. Import the reusable class into a program and use the class.

We'll now discuss each of these steps in detail.

*Steps 1 and 2: Creating a public Class and Adding the package Statement*

For *Step 1*, we modify the public class `Time1` declared in Fig. 8.1. The new version is shown in Fig. 8.15. No modifications have been made to the implementation of the class, so we'll not discuss its implementation details again here.

For *Step 2*, we add a package declaration (line 3) that declares a package named `com.deitel.jhttp.ch08`. Placing a package declaration at the beginning of a Java source file indicates that the class declared in the file is part of the specified package. Only package declarations, import declarations and comments can appear outside the braces of a class declaration. A Java source-code file must have the following order:

---

```

1 // Fig. 8.15: Time1.java
2 // Time1 class declaration maintains the time in 24-hour format.
3 package com.deitel.jhttp.ch08;
4
5 public class Time1
6 {
7 private int hour; // 0 - 23
8 private int minute; // 0 - 59
9 private int second; // 0 - 59
10
11 // set a new time value using universal time; throw an
12 // exception if the hour, minute or second is invalid
13 public void setTime(int h, int m, int s)
14 {
15 // validate hour, minute and second
16 if ((h >= 0 && h < 24) && (m >= 0 && m < 60) &&
17 (s >= 0 && s < 60))
18 {
19 hour = h;
20 minute = m;
21 second = s;
22 } // end if
23 else
24 throw new IllegalArgumentException(
25 "hour, minute and/or second was out of range");
26 } // end method setTime
27
28 // convert to String in universal-time format (HH:MM:SS)
29 public String toUniversalString()
30 {
31 return String.format("%02d:%02d:%02d", hour, minute, second);
32 } // end method toUniversalString
33
34 // convert to String in standard-time format (H:MM:SS AM or PM)
35 public String toString()
36 {
37 return String.format("%d:%02d:%02d %s",
38 ((hour == 0 || hour == 12) ? 12 : hour % 12),
39 minute, second, (hour < 12 ? "AM" : "PM"));
40 } // end method toString
41 } // end class Time1

```

---

**Fig. 8.15** | Packaging class `Time1` for reuse.

1. a package declaration (if any),
2. import declarations (if any), then
3. class declarations.

Only one of the class declarations in a particular file can be `public`. Other classes in the file are placed in the package and can be used only by the other classes in the package. Non-`public` classes are in a package to support the reusable classes in the package.

To provide unique package names, start each one with your Internet domain name in reverse order. For example, our domain name is `deitel.com`, so our package names begin with `com.deitel`. For the domain name `yourcollege.edu`, the package name should begin with `edu.yourcollege`. After the domain name is reversed, you can choose any other names you want for your package. If you're part of a company with many divisions or a university with many schools, you may want to use the name of your division or school as the next name in the package. We chose to use `jhttp` as the next name in our package name to indicate that this class is from *Java How to Program*. The last name in our package name specifies that this package is for Chapter 8 (`ch08`).

### Step 3: Compiling the Packaged Class

Step 3 is to compile the class so that it's stored in the appropriate package. When a Java file containing a package declaration is compiled, the resulting class file is placed in the directory specified by the declaration. The package declaration in Fig. 8.15 indicates that class `Time1` should be placed in the directory

```
com
 deitel
 jhttp
 ch08
```

The names in the package declaration specify the exact location of the package's classes.

When compiling a class in a package, the `javac` command-line option `-d` causes the `javac` compiler to create appropriate directories based on the class's package declaration. The option also specifies where the directories should be stored. For example, in a command window, we used the compilation command

```
javac -d . Time1.java
```

to specify that the first directory in our package name should be placed in the current directory. The period (`.`) after `-d` in the preceding command represents the current directory on the Windows, UNIX, Linux and Mac OS X operating systems (and several others as well). After execution of the compilation command, the current directory contains a directory called `com`, `com` contains a directory called `deitel`, `deitel` contains a directory called `jhttp` and `jhttp` contains a directory called `ch08`. In the `ch08` directory, you can find the file `Time1.class`. [Note: If you do not use the `-d` option, then you must copy or move the class file to the appropriate package directory after compiling it.]

The package name is part of the **fully qualified class name**, so the name of class `Time1` is actually `com.deitel.jhttp.ch08.Time1`. You can use this fully qualified name in your programs, or you can `import` the class and use its **simple name** (the class name by itself—`Time1`) in the program. If another package also contains a `Time1` class, the fully qualified class names can be used to distinguish between the classes in the program and prevent a **name conflict** (also called a **name collision**).

*Step 4: Importing the Reusable Class*

Once it's compiled and stored in its package, the class can be imported into programs (*Step 4*). In the `Time1PackageTest` application of Fig. 8.16, line 3 specifies that class `Time1` should be imported for use in class `Time1PackageTest`. This class is in the default package because its `.java` file does not contain a package declaration. Since the two classes are in different packages, the `import` at line 3 is required so that class `Time1PackageTest` can use class `Time1`.

---

```

1 // Fig. 8.16: Time1PackageTest.java
2 // Time1 object used in an application.
3 import com.deitel.jhttp.ch08.Time1; // import class Time1
4
5 public class Time1PackageTest
6 {
7 public static void main(String[] args)
8 {
9 // create and initialize a Time1 object
10 Time1 time = new Time1(); // invokes Time1 constructor
11
12 // output string representations of the time
13 System.out.print("The initial universal time is: ");
14 System.out.println(time.toUniversalString());
15 System.out.print("The initial standard time is: ");
16 System.out.println(time.toString());
17 System.out.println(); // output a blank line
18
19 // change time and output updated time
20 time.setTime(13, 27, 6);
21 System.out.print("Universal time after setTime is: ");
22 System.out.println(time.toUniversalString());
23 System.out.print("Standard time after setTime is: ");
24 System.out.println(time.toString());
25 System.out.println(); // output a blank line
26
27 // attempt to set time with invalid values
28 try
29 {
30 time.setTime(99, 99, 99); // all values out of range
31 } // end try
32 catch (IllegalArgumentException e)
33 {
34 System.out.printf("Exception: %s\n\n", e.getMessage());
35 } // end catch
36
37 // display time after attempt to set invalid values
38 System.out.println("After attempting invalid settings:");
39 System.out.print("Universal time: ");
40 System.out.println(time.toUniversalString());
41 System.out.print("Standard time: ");
42 System.out.println(time.toString());
43 } // end main
44 } // end class Time1PackageTest

```

---

**Fig. 8.16** | Time1 object used in an application. (Part 1 of 2.)

```

The initial universal time is: 00:00:00
The initial standard time is: 12:00:00 AM

Universal time after setTime is: 13:27:06
Standard time after setTime is: 1:27:06 PM

Exception: hour, minute and/or second was out of range

After attempting invalid settings:
Universal time: 13:27:06
Standard time: 1:27:06 PM

```

**Fig. 8.16** | Time1 object used in an application. (Part 2 of 2.)

Line 3 is known as a **single-type-import declaration**—that is, the import declaration specifies one class to import. When your program uses multiple classes from the same package, you can import those classes with a single import declaration. For example, the import declaration

```
import java.util.*; // import classes from package java.util
```

uses an asterisk (\*) at its end to inform the compiler that all public classes from the `java.util` package are available for use in the program. This is known as a **type-import-on-demand declaration**. Only the classes from package `java.util` that are used in the program are loaded by the JVM. The preceding import allows you to use the simple name of any class from the `java.util` package in the program. Throughout this book, we use single-type-import declarations for clarity.



### Common Programming Error 8.11

*Using the import declaration `import java.*`; causes a compilation error. You must specify the exact name of the package from which you want to import classes.*

### Specifying the Classpath During Compilation

When compiling `Time1PackageTest`, `javac` must locate the `.class` file for `Time1` to ensure that class `Time1PackageTest` uses class `Time1` correctly. The compiler uses a special object called a **class loader** to locate the classes it needs. The class loader begins by searching the standard Java classes that are bundled with the JDK. Then it searches for **optional packages**. Java provides an **extension mechanism** that enables new (optional) packages to be added to Java for development and execution purposes. If the class is not found in the standard Java classes or in the extension classes, the class loader searches the **classpath**, which contains a list of locations in which classes are stored. The classpath consists of a list of directories or **archive files**, each separated by a **directory separator**—a semicolon (;) on Windows or a colon (:) on UNIX/Linux/Mac OS X. Archive files are individual files that contain directories of other files, typically in a compressed format. For example, the standard classes used by your programs are contained in the archive file `rt.jar`, which is installed with the JDK. Archive files normally end with the `.jar` or `.zip` file-name extensions. The directories and archive files specified in the classpath contain the classes you wish to make available to the Java compiler and the JVM.

By default, the classpath consists only of the current directory. However, the classpath can be modified by

1. providing the **-classpath** option to the javac compiler or
2. setting the **CLASSPATH environment variable** (a special variable that you define and the operating system maintains so that applications can search for classes in the specified locations).

For more information on the classpath, visit [download.oracle.com/javase/6/docs/technotes/tools/index.html#general](http://download.oracle.com/javase/6/docs/technotes/tools/index.html#general). The section entitled “General Information” contains information on setting the classpath for UNIX/Linux and Windows.



### Common Programming Error 8.12

*Specifying an explicit classpath eliminates the current directory from the classpath. This prevents classes in the current directory (including packages in the current directory) from loading properly. If classes must be loaded from the current directory, include a dot (.) in the classpath to specify the current directory.*



### Software Engineering Observation 8.11

*In general, it's a better practice to use the `-classpath` option of the compiler, rather than the CLASSPATH environment variable, to specify the classpath for a program. This enables each application to have its own classpath.*



### Error-Prevention Tip 8.5

*Specifying the classpath with the CLASSPATH environment variable can cause subtle and difficult-to-locate errors in programs that use different versions of the same package.*

For Figs. 8.15–8.16, we didn't specify an explicit classpath. Thus, to locate the classes in the `com.deitel.jhttp.ch08` package from this example, the class loader looks in the current directory for the first name in the package—`com`—then navigates the directory structure. Directory `com` contains the subdirectory `deitel`, `deitel` contains the subdirectory `jhttp`, and `jhttp` contains subdirectory `ch08`. In the `ch08` directory is the file `Time1.class`, which is loaded by the class loader to ensure that the class is used properly in our program.

### *Specifying the Classpath When Executing an Application*

When you execute an application, the JVM must be able to locate the `.class` files of the classes used in that application. Like the compiler, the `java` command uses a class loader that searches the standard classes and extension classes first, then searches the classpath (the current directory by default). The classpath can be specified explicitly by using either of the techniques discussed for the compiler. As with the compiler, it's better to specify an individual program's classpath via command-line JVM options. You can specify the classpath in the `java` command via the **-classpath** or **-cp** command-line options, followed by a list of directories or archive files separated by semicolons (;) on Microsoft Windows or by colons (:) on UNIX/Linux/Mac OS X. Again, if classes must be loaded from the current directory, be sure to include a dot (.) in the classpath to specify the current directory.

## 8.15 Package Access

If no access modifier (`public`, `protected` or `private`—we discuss `protected` in Chapter 9) is specified for a method or variable when it's declared in a class, the method or variable is considered to have **package access**. In a program that consists of one class

declaration, this has no specific effect. However, if a program uses multiple classes from the same package (i.e., a group of related classes), these classes can access each other's package-access members directly through references to objects of the appropriate classes, or in the case of static members through the class name. Package access is rarely used.

The application in Fig. 8.17 demonstrates package access. The application contains two classes in one source-code file—the `PackageDataTest` application class (lines 5–21) and the `PackageData` class (lines 24–41). When you compile this program, the compiler produces two separate `.class` files—`PackageDataTest.class` and `PackageData.class`. The compiler places the two `.class` files in the same directory, so the classes are considered to be part of the same package. Consequently, class `PackageDataTest` is allowed to modify the package-access data of `PackageData` objects. You can also place class `PackageData` (lines 24–41) in a separate source-code file. As long as both classes are compiled in the same directory on disk, the package-access relationship will still work.

---

```

1 // Fig. 8.17: PackageDataTest.java
2 // Package-access members of a class are accessible by other classes
3 // in the same package.
4
5 public class PackageDataTest
6 {
7 public static void main(String[] args)
8 {
9 PackageData packageData = new PackageData();
10
11 // output String representation of packageData
12 System.out.printf("After instantiation:\n%s\n", packageData);
13
14 // change package access data in packageData object
15 packageData.number = 77;
16 packageData.string = "Goodbye";
17
18 // output String representation of packageData
19 System.out.printf("\nAfter changing values:\n%s\n", packageData);
20 } // end main
21 } // end class PackageDataTest
22
23 // class with package access instance variables
24 class PackageData
25 {
26 int number; // package-access instance variable
27 String string; // package-access instance variable
28
29 // constructor
30 public PackageData()
31 {
32 number = 0;
33 string = "Hello";
34 } // end PackageData constructor
35

```

---

**Fig. 8.17** | Package-access members of a class are accessible by other classes in the same package. (Part I of 2.)



```

36 // return PackageData object String representation
37 public String toString()
38 {
39 return String.format("number: %d; string: %s", number, string);
40 } // end method toString
41 } // end class PackageData

```

```

After instantiation:
number: 0; string: Hello

After changing values:
number: 77; string: Goodbye

```

**Fig. 8.17** | Package-access members of a class are accessible by other classes in the same package. (Part 2 of 2.)

In the `PackageData` class declaration, lines 26–27 declare the instance variables `number` and `string` with no access modifiers—therefore, these are package-access instance variables. The `PackageDataTest` application’s `main` method creates an instance of the `PackageData` class (line 9) to demonstrate the ability to modify the `PackageData` instance variables directly (as shown in lines 15–16). The results of the modification can be seen in the output window.

## 8.16 (Optional) GUI and Graphics Case Study: Using Objects with Graphics

Most of the graphics you’ve seen to this point did not vary with each program execution. Exercise 6.2 in Section 6.13 asked you to create a program that generated shapes and colors at random. In that exercise, the drawing changed every time the system called `paintComponent` to redraw the panel. To create a more consistent drawing that remains the same each time it’s drawn, we must store information about the displayed shapes so that we can reproduce them each time the system calls `paintComponent`. To do this, we’ll create a set of shape classes that store information about each shape. We’ll make these classes “smart” by allowing objects of these classes to draw themselves by using a `Graphics` object.

### *Class MyLine*

Figure 8.18 declares class `MyLine`, which has all these capabilities. Class `MyLine` imports `Color` and `Graphics` (lines 3–4). Lines 8–11 declare instance variables for the coordinates needed to draw a line, and line 12 declares the instance variable that stores the color of the line. The constructor at lines 15–22 takes five parameters, one for each instance variable that it initializes. Method `draw` at lines 25–29 requires a `Graphics` object and uses it to draw the line in the proper color and at the proper coordinates.

```

1 // Fig. 8.18: MyLine.java
2 // MyLine class represents a line.
3 import java.awt.Color;
4 import java.awt.Graphics;

```

**Fig. 8.18** | `MyLine` class represents a line. (Part 1 of 2.)

```

5
6 public class MyLine
7 {
8 private int x1; // x-coordinate of first endpoint
9 private int y1; // y-coordinate of first endpoint
10 private int x2; // x-coordinate of second endpoint
11 private int y2; // y-coordinate of second endpoint
12 private Color myColor; // color of this shape
13
14 // constructor with input values
15 public MyLine(int x1, int y1, int x2, int y2, Color color)
16 {
17 this.x1 = x1; // set x-coordinate of first endpoint
18 this.y1 = y1; // set y-coordinate of first endpoint
19 this.x2 = x2; // set x-coordinate of second endpoint
20 this.y2 = y2; // set y-coordinate of second endpoint
21 myColor = color; // set the color
22 } // end MyLine constructor
23
24 // Draw the line in the specified color
25 public void draw(Graphics g)
26 {
27 g.setColor(myColor);
28 g.drawLine(x1, y1, x2, y2);
29 } // end method draw
30 } // end class MyLine

```

**Fig. 8.18** | MyLine class represents a line. (Part 2 of 2.)

### *Class DrawPanel*

In Fig. 8.19, we declare class `DrawPanel`, which will generate random objects of class `MyLine`. Line 12 declares a `MyLine` array to store the lines to draw. Inside the constructor (lines 15–37), line 17 sets the background color to `Color.WHITE`. Line 19 creates the array with a random length between 5 and 9. The loop at lines 22–36 creates a new `MyLine` for every element in the array. Lines 25–28 generate random coordinates for each line’s endpoints, and lines 31–32 generate a random color for the line. Line 35 creates a new `MyLine` object with the randomly generated values and stores it in the array.

Method `paintComponent` iterates through the `MyLine` objects in array `lines` using an enhanced `for` statement (lines 45–46). Each iteration calls the `draw` method of the current `MyLine` object and passes it the `Graphics` object for drawing on the panel.

```

1 // Fig. 8.19: DrawPanel.java
2 // Program that uses class MyLine
3 // to draw random lines.
4 import java.awt.Color;
5 import java.awt.Graphics;
6 import java.util.Random;
7 import javax.swing.JPanel;
8

```

**Fig. 8.19** | Creating random `MyLine` objects. (Part 1 of 2.)

```

9 public class DrawPanel extends JPanel
10 {
11 private Random randomNumbers = new Random();
12 private MyLine[] lines; // array of lines
13
14 // constructor, creates a panel with random shapes
15 public DrawPanel()
16 {
17 setBackground(Color.WHITE);
18
19 lines = new MyLine[5 + randomNumbers.nextInt(5)];
20
21 // create lines
22 for (int count = 0; count < lines.length; count++)
23 {
24 // generate random coordinates
25 int x1 = randomNumbers.nextInt(300);
26 int y1 = randomNumbers.nextInt(300);
27 int x2 = randomNumbers.nextInt(300);
28 int y2 = randomNumbers.nextInt(300);
29
30 // generate a random color
31 Color color = new Color(randomNumbers.nextInt(256),
32 randomNumbers.nextInt(256), randomNumbers.nextInt(256));
33
34 // add the line to the list of lines to be displayed
35 lines[count] = new MyLine(x1, y1, x2, y2, color);
36 } // end for
37 } // end DrawPanel constructor
38
39 // for each shape array, draw the individual shapes
40 public void paintComponent(Graphics g)
41 {
42 super.paintComponent(g);
43
44 // draw the lines
45 for (MyLine line : lines)
46 line.draw(g);
47 } // end method paintComponent
48 } // end class DrawPanel

```

**Fig. 8.19** | Creating random MyLine objects. (Part 2 of 2.)

### *Class TestDraw*

Class TestDraw in Fig. 8.20 sets up a new window to display our drawing. Since we're setting the coordinates for the lines only once in the constructor, the drawing does not change if paintComponent is called to refresh the drawing on the screen.

```

1 // Fig. 8.20: TestDraw.java
2 // Creating a JFrame to display a DrawPanel.
3 import javax.swing.JFrame;

```

**Fig. 8.20** | Creating a JFrame to display a DrawPanel. (Part 1 of 2.)

```

4
5 public class TestDraw
6 {
7 public static void main(String[] args)
8 {
9 DrawPanel panel = new DrawPanel();
10 JFrame application = new JFrame();
11
12 application.setDefaultCloseOperation(JFrame.EXIT_ON_CLOSE);
13 application.add(panel);
14 application.setSize(300, 300);
15 application.setVisible(true);
16 } // end main
17 } // end class TestDraw

```

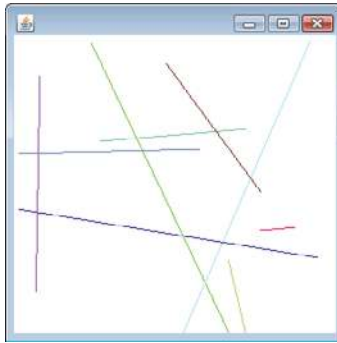

**Fig. 8.20** | Creating a JFrame to display a DrawPanel. (Part 2 of 2.)

### *GUI and Graphics Case Study Exercise*

**8.1** Extend the program in Figs. 8.18–8.20 to randomly draw rectangles and ovals. Create classes `MyRectangle` and `MyOval`. Both of these classes should include  $x1$ ,  $y1$ ,  $x2$ ,  $y2$  coordinates, a color and a boolean flag to determine whether the shape is filled. Declare a constructor in each class with arguments for initializing all the instance variables. To help draw rectangles and ovals, each class should provide methods `getUpperLeftX`, `getUpperLeftY`, `getWidth` and `getHeight` that calculate the upper-left  $x$ -coordinate, upper-left  $y$ -coordinate, width and height, respectively. The upper-left  $x$ -coordinate is the smaller of the two  $x$ -coordinate values, the upper-left  $y$ -coordinate is the smaller of the two  $y$ -coordinate values, the width is the absolute value of the difference between the two  $x$ -coordinate values, and the height is the absolute value of the difference between the two  $y$ -coordinate values.

Class `DrawPanel`, which extends `JPanel` and handles the creation of the shapes, should declare three arrays, one for each shape type. The length of each array should be a random number between 1 and 5. The constructor of class `DrawPanel` will fill each array with shapes of random position, size, color and fill.

In addition, modify all three shape classes to include the following:

- A constructor with no arguments that sets the shape's coordinates to 0, the color of the shape to `Color.BLACK`, and the filled property to `false` (`MyRectangle` and `MyOval` only).
- Set* methods for the instance variables in each class. The methods that set a coordinate value should verify that the argument is greater than or equal to zero before setting the coordinate—if it's not, they should set the coordinate to zero. The constructor should call the *set* methods rather than initialize the local variables directly.

- c) *Get* methods for the instance variables in each class. Method *draw* should reference the coordinates by the *get* methods rather than access them directly.

## 8.17 Wrap-Up

In this chapter, we presented additional class concepts. The `Time` class case study presented a complete class declaration consisting of `private` data, overloaded `public` constructors for initialization flexibility, *set* and *get* methods for manipulating the class's data, and methods that returned `String` representations of a `Time` object in two different formats. You also learned that every class can declare a `toString` method that returns a `String` representation of an object of the class and that method `toString` can be called implicitly whenever an object of a class appears in the code where a `String` is expected.

You learned that the `this` reference is used implicitly in a class's non-static methods to access the class's instance variables and other non-static methods. You also saw explicit uses of the `this` reference to access the class's members (including shadowed fields) and how to use keyword `this` in a constructor to call another constructor of the class.

We discussed the differences between default constructors provided by the compiler and no-argument constructors provided by the programmer. You learned that a class can have references to objects of other classes as members—a concept known as composition. You saw the `enum` class type and learned how it can be used to create a set of constants for use in a program. You learned about Java's garbage-collection capability and how it (unpredictably) reclaims the memory of objects that are no longer used. The chapter explained the motivation for `static` fields in a class and demonstrated how to declare and use `static` fields and methods in your own classes. You also learned how to declare and initialize `final` variables.

You learned how to package your own classes for reuse and how to import those classes into an application. Finally, you learned that fields declared without an access modifier are given package access by default. You saw the relationship between classes in the same package that allows each class in a package to access the package-access members of other classes in the package.

In the next chapter, you'll learn about an important aspect of object-oriented programming in Java—inheritance. You'll see that all classes in Java are related directly or indirectly to the class called `Object`. You'll also begin to understand how the relationships between classes enable you to build more powerful applications.

## Summary

### Section 8.2 Time Class Case Study

- The `public` methods of a class are also known as the class's `public` services or `public` interface (p. 312). They present to the class's clients a view of the services the class provides.
- A class's `private` members are not accessible to its clients.
- `String` class `static` method `format` (p. 314) is similar to method `System.out.printf` except that `format` returns a formatted `String` rather than displaying it in a command window.
- All objects in Java have a `toString` method that returns a `String` representation of the object. Method `toString` is called implicitly when an object appears in code where a `String` is needed.

### Section 8.3 Controlling Access to Members

- The access modifiers `public` and `private` control access to a class's variables and methods.

- The primary purpose of `public` methods is to present to the class's clients a view of the services the class provides. Clients need not be concerned with how the class accomplishes its tasks.
- A class's `private` variables and `private` methods (i.e., its implementation details) are not accessible to its clients.

#### *Section 8.4 Referring to the Current Object's Members with the `this` Reference*

- A non-static method of an object implicitly uses keyword `this` (p. 317) to refer to the object's instance variables and other methods. Keyword `this` can also be used explicitly.
- The compiler produces a separate file with the `.class` extension for every compiled class.
- If a local variable has the same name as a class's field, the local variable shadows the field. You can use the `this` reference in a method to refer to the shadowed field explicitly.

#### *Section 8.5 Time Class Case Study: Overloaded Constructors*

- Overloaded constructors enable objects of a class to be initialized in different ways. The compiler differentiates overloaded constructors (p. 320) by their signatures.
- To call one constructor of a class from another of the same class, you can use the `this` keyword followed by parentheses containing the constructor arguments. Such a constructor call must appear as the first statement in the constructor's body.

#### *Section 8.6 Default and No-Argument Constructors*

- If no constructors are provided in a class, the compiler creates a default constructor.
- If a class declares constructors, the compiler will not create a default constructor. In this case, you must declare a no-argument constructor (p. 322) if default initialization is required.

#### *Section 8.7 Notes on Set and Get Methods*

- *Set* methods are commonly called mutator methods (p. 327) because they typically change a value. *Get* methods are commonly called accessor methods (p. 327) or query methods. A predicate method (p. 327) tests whether a condition is true or false.

#### *Section 8.8 Composition*

- A class can have references to objects of other classes as members. This is called composition (p. 328) and is sometimes referred to as a *has-a* relationship.

#### *Section 8.9 Enumerations*

- All `enum` types (p. 331) are reference types. An `enum` type is declared with an `enum` declaration, which is a comma-separated list of `enum` constants. The declaration may optionally include other components of traditional classes, such as constructors, fields and methods.
- `enum` constants are implicitly `final`, because they declare constants that should not be modified.
- `enum` constants are implicitly `static`.
- Any attempt to create an object of an `enum` type with operator `new` results in a compilation error.
- `enum` constants can be used anywhere constants can be used, such as in the case labels of `switch` statements and to control enhanced `for` statements.
- Each `enum` constant in an `enum` declaration is optionally followed by arguments which are passed to the `enum` constructor.
- For every `enum`, the compiler generates a `static` method called `values` (p. 332) that returns an array of the `enum`'s constants in the order in which they were declared.
- `EnumSet` `static` method `range` (p. 333) receives the first and last `enum` constants in a range and returns an `EnumSet` that contains all the constants between these two constants, inclusive.

### Section 8.10 *Garbage Collection and Method finalize*

- Every class in Java has the methods of class `Object`, one of which is the `finalize` method.
- The Java Virtual Machine (JVM) performs automatic garbage collection (p. 334) to reclaim the memory occupied by objects that are no longer in use. When there are no more references to an object, the object is eligible for garbage collection. The memory for such an object can be reclaimed when the JVM executes its garbage collector.
- The `finalize` method (p. 334) is called by the garbage collector just before it reclaims the object's memory. Method `finalize` does not take parameters and has return type `void`.
- The garbage collector (p. 334) may never execute before a program terminates. Thus, it's unclear whether, or when, method `finalize` will be called.

### Section 8.11 *static Class Members*

- A `static` variable (p. 334) represents classwide information that's shared among the class's objects.
- Static variables have class scope. A class's `public static` members can be accessed through a reference to any object of the class, or they can be accessed by qualifying the member name with the class name and a dot (`.`). Client code can access a class's `private static` class members only through methods of the class.
- `static` class members exist as soon as the class is loaded into memory.
- A method declared `static` cannot access non-`static` class members, because a `static` method can be called even when no objects of the class have been instantiated.
- The `this` reference cannot be used in a `static` method.

### Section 8.12 *static Import*

- A `static import` declaration (p. 338) enables you to refer to imported `static` members without the class name and a dot (`.`). A single `static import` declaration imports one `static` member, and a `static import on demand` imports all `static` members of a class.

### Section 8.13 *final Instance Variables*

- In the context of an application, the principle of least privilege (p. 339) states that code should be granted only the amount of privilege and access that it needs to accomplish its designated task.
- Keyword `final` specifies that a variable is not modifiable. Such variables must be initialized when they're declared or by each of a class's constructors.

### Section 8.14 *Time Class Case Study: Creating Packages*

- Each class in the Java API belongs to a package that contains a group of related classes. Packages help manage the complexity of application components and facilitate software reuse.
- Packages provide a convention for unique class names that helps prevent class-name conflicts (p. 342).
- Before a class can be imported into multiple applications, it must be placed in a package. There can be only one package declaration (p. 340) in each Java source-code file, and it must precede all other declarations and statements in the file.
- Every package name should start with your Internet domain name in reverse order. After the domain name is reversed, you can choose any other names you want for your package.
- When compiling a class in a package, the `javac` command-line option `-d` (p. 342) specifies where to store the package and causes the compiler to create the package's directories if they do not exist.
- The package name is part of the fully qualified class name (p. 342). This helps prevent name conflicts.

- A single-type-import declaration (p. 344) specifies one class to import. A type-import-on-demand declaration (p. 344) imports only the classes that the program uses from a particular package.
- The compiler uses a class loader (p. 344) to locate the classes it needs in the classpath. The classpath consists of a list of directories or archive files, each separated by a directory separator (p. 344).
- The classpath for the compiler and JVM can be specified by providing the `-classpath` option (p. 345) to the `javac` or `java` command, or by setting the `CLASSPATH` environment variable. If classes must be loaded from the current directory, include a dot (`.`) in the classpath.

### Section 8.15 Package Access

- If no access modifier is specified for a method or variable when it's declared in a class, the method or variable is considered to have package access (p. 345).

## Self-Review Exercise

**8.1** Fill in the blanks in each of the following statements:

- When compiling a class in a package, the `javac` command-line option \_\_\_\_\_ specifies where to store the package and causes the compiler to create the package's directories if they do not exist.
- `String` class static method \_\_\_\_\_ is similar to method `System.out.printf`, but returns a formatted `String` rather than displaying a `String` in a command window.
- If a method contains a local variable with the same name as one of its class's fields, the local variable \_\_\_\_\_ the field in that method's scope.
- The \_\_\_\_\_ method is called by the garbage collector just before it reclaims an object's memory.
- A(n) \_\_\_\_\_ declaration specifies one class to import.
- If a class declares constructors, the compiler will not create a(n) \_\_\_\_\_.
- An object's \_\_\_\_\_ method is called implicitly when an object appears in code where a `String` is needed.
- `Get` methods are commonly called \_\_\_\_\_ or \_\_\_\_\_.
- A(n) \_\_\_\_\_ method tests whether a condition is true or false.
- For every enum, the compiler generates a static method called \_\_\_\_\_ that returns an array of the enum's constants in the order in which they were declared.
- Composition is sometimes referred to as a(n) \_\_\_\_\_ relationship.
- A(n) \_\_\_\_\_ declaration contains a comma-separated list of constants.
- A(n) \_\_\_\_\_ variable represents classwide information that's shared by all the objects of the class.
- A(n) \_\_\_\_\_ declaration imports one static member.
- The \_\_\_\_\_ states that code should be granted only the amount of privilege and access that it needs to accomplish its designated task.
- Keyword \_\_\_\_\_ specifies that a variable is not modifiable.
- There can be only one \_\_\_\_\_ in a Java source-code file, and it must precede all other declarations and statements in the file.
- A(n) \_\_\_\_\_ declaration imports only the classes that the program uses from a particular package.
- The compiler uses a(n) \_\_\_\_\_ to locate the classes it needs in the classpath.
- The classpath for the compiler and JVM can be specified with the \_\_\_\_\_ option to the `javac` or `java` command, or by setting the \_\_\_\_\_ environment variable.
- `Set` methods are commonly called \_\_\_\_\_ because they typically change a value.
- A(n) \_\_\_\_\_ imports all static members of a class.
- The `public` methods of a class are also known as the class's \_\_\_\_\_ or \_\_\_\_\_.



## Answers to Self-Review Exercise

**8.1** a) -d. b) format. c) shadows. d) finalize. e) single-type-import. f) default constructor. g) toString. h) accessor methods, query methods. i) predicate. j) values. k) *has-a*. l) enum. m) static. n) single static import. o) principle of least privilege. p) final. q) package declaration. r) type-import-on-demand. s) class loader. t) -classpath, CLASSPATH. u) mutator methods. v) static import on demand. w) public services, public interface.

## Exercises

**8.2** Explain the notion of package access in Java. Explain the negative aspects of package access.

**8.3** What happens when a return type, even void, is specified for a constructor?

**8.4** (*Rectangle Class*) Create a class Rectangle with attributes length and width, each of which defaults to 1. Provide methods that calculate the rectangle's perimeter and area. It has set and get methods for both length and width. The set methods should verify that length and width are each floating-point numbers larger than 0.0 and less than 20.0. Write a program to test class Rectangle.

**8.5** (*Modifying the Internal Data Representation of a Class*) It would be perfectly reasonable for the Time2 class of Fig. 8.5 to represent the time internally as the number of seconds since midnight rather than the three integer values hour, minute and second. Clients could use the same public methods and get the same results. Modify the Time2 class of Fig. 8.5 to implement the Time2 as the number of seconds since midnight and show that no change is visible to the clients of the class.

**8.6** (*Savings Account Class*) Create class SavingsAccount. Use a static variable annualInterestRate to store the annual interest rate for all account holders. Each object of the class contains a private instance variable savingsBalance indicating the amount the saver currently has on deposit. Provide method calculateMonthlyInterest to calculate the monthly interest by multiplying the savingsBalance by annualInterestRate divided by 12—this interest should be added to savingsBalance. Provide a static method modifyInterestRate that sets the annualInterestRate to a new value. Write a program to test class SavingsAccount. Instantiate two savingsAccount objects, saver1 and saver2, with balances of \$2000.00 and \$3000.00, respectively. Set annualInterestRate to 4%, then calculate the monthly interest for each of 12 months and print the new balances for both savers. Next, set the annualInterestRate to 5%, calculate the next month's interest and print the new balances for both savers.

**8.7** (*Enhancing Class Time2*) Modify class Time2 of Fig. 8.5 to include a tick method that increments the time stored in a Time2 object by one second. Provide method incrementMinute to increment the minute by one and method incrementHour to increment the hour by one. Write a program that tests the tick method, the incrementMinute method and the incrementHour method to ensure that they work correctly. Be sure to test the following cases:

- a) incrementing into the next minute,
- b) incrementing into the next hour and
- c) incrementing into the next day (i.e., 11:59:59 PM to 12:00:00 AM).

**8.8** (*Enhancing Class Date*) Modify class Date of Fig. 8.7 to perform error checking on the initializer values for instance variables month, day and year (currently it validates only the month and day). Provide a method nextDay to increment the day by one. Write a program that tests method nextDay in a loop that prints the date during each iteration to illustrate that the method works correctly. Test the following cases:

- a) incrementing into the next month and
- b) incrementing into the next year.

**8.9** Rewrite the code in Fig. 8.14 to use a separate import declaration for each static member of class Math that's used in the example.

**8.10** Write an enum type `TrafficLight`, whose constants (`RED`, `GREEN`, `YELLOW`) take one parameter—the duration of the light. Write a program to test the `TrafficLight` enum so that it displays the enum constants and their durations.

**8.11** (*Complex Numbers*) Create a class called `Complex` for performing arithmetic with complex numbers. Complex numbers have the form

$$\text{realPart} + \text{imaginaryPart} * i$$

where  $i$  is

$$\sqrt{-1}$$

Write a program to test your class. Use floating-point variables to represent the private data of the class. Provide a constructor that enables an object of this class to be initialized when it's declared. Provide a no-argument constructor with default values in case no initializers are provided. Provide public methods that perform the following operations:

- Add two `Complex` numbers: The real parts are added together and the imaginary parts are added together.
- Subtract two `Complex` numbers: The real part of the right operand is subtracted from the real part of the left operand, and the imaginary part of the right operand is subtracted from the imaginary part of the left operand.
- Print `Complex` numbers in the form (*realPart*, *imaginaryPart*).

**8.12** (*Date and Time Class*) Create class `DateAndTime` that combines the modified `Time2` class of Exercise 8.7 and the modified `Date` class of Exercise 8.8. Modify method `incrementHour` to call method `nextDay` if the time is incremented into the next day. Modify methods `toString` and `toUniversalString` to output the date in addition to the time. Write a program to test the new class `DateAndTime`. Specifically, test incrementing the time to the next day.

**8.13** (*Set of Integers*) Create class `IntegerSet`. Each `IntegerSet` object can hold integers in the range 0–100. The set is represented by an array of `booleans`. Array element `a[i]` is `true` if integer  $i$  is in the set. Array element `a[j]` is `false` if integer  $j$  is not in the set. The no-argument constructor initializes the array to the “empty set” (i.e., all `false` values).

Provide the following methods: The static method `union` creates a set that's the set-theoretic union of two existing sets (i.e., an element of the new set's array is set to `true` if that element is `true` in either or both of the existing sets—otherwise, the new set's element is set to `false`). The static method `intersection` creates a set which is the set-theoretic intersection of two existing sets (i.e., an element of the new set's array is set to `false` if that element is `false` in either or both of the existing sets—otherwise, the new set's element is set to `true`). Method `insertElement` inserts a new integer  $k$  into a set (by setting `a[k]` to `true`). Method `deleteElement` deletes integer  $m$  (by setting `a[m]` to `false`). Method `toString` returns a `String` containing a set as a list of numbers separated by spaces. Include only those elements that are present in the set. Use `---` to represent an empty set. Method `isEqualTo` determines whether two sets are equal. Write a program to test class `IntegerSet`. Instantiate several `IntegerSet` objects. Test that all your methods work properly.

**8.14** (*Date Class*) Create class `Date` with the following capabilities:

- Output the date in multiple formats, such as
 

```
MM/DD/YYYY
June 14, 1992
DDD YYYY
```
- Use overloaded constructors to create `Date` objects initialized with dates of the formats in part (a). In the first case the constructor should receive three integer values. In the second case it should receive a `String` and two integer values. In the third case it should receive two integer values, the first of which represents the day number in the year.

[*Hint:* To convert the `String` representation of the month to a numeric value, compare `Strings` using the `equals` method. For example, if `s1` and `s2` are `Strings`, the method call `s1.equals( s2 )` returns `true` if the `Strings` are identical and otherwise returns `false`.]

**8.15** (*Rational Numbers*) Create a class called `Rational` for performing arithmetic with fractions. Write a program to test your class. Use integer variables to represent the private instance variables of the class—the numerator and the denominator. Provide a constructor that enables an object of this class to be initialized when it's declared. The constructor should store the fraction in reduced form. The fraction

$$2/4$$

is equivalent to  $1/2$  and would be stored in the object as 1 in the numerator and 2 in the denominator. Provide a no-argument constructor with default values in case no initializers are provided. Provide `public` methods that perform each of the following operations:

- Add two `Rational` numbers: The result of the addition should be stored in reduced form. Implement this as a `static` method.
- Subtract two `Rational` numbers: The result of the subtraction should be stored in reduced form. Implement this as a `static` method.
- Multiply two `Rational` numbers: The result of the multiplication should be stored in reduced form. Implement this as a `static` method.
- Divide two `Rational` numbers: The result of the division should be stored in reduced form. Implement this as a `static` method.
- Return a `String` representation of a `Rational` number in the form `a/b`, where `a` is the numerator and `b` is the denominator.
- Return a `String` representation of a `Rational` number in floating-point format. (Consider providing formatting capabilities that enable the user of the class to specify the number of digits of precision to the right of the decimal point.)

**8.16** (*Huge Integer Class*) Create a class `HugeInteger` which uses a 40-element array of digits to store integers as large as 40 digits each. Provide methods `parse`, `toString`, `add` and `subtract`. Method `parse` should receive a `String`, extract each digit using method `charAt` and place the integer equivalent of each digit into the integer array. For comparing `HugeInteger` objects, provide the following methods: `isEqualTo`, `isNotEqualTo`, `isGreaterThan`, `isLessThan`, `isGreaterThanOrEqualTo` and `isLessThanOrEqualTo`. Each of these is a predicate method that returns `true` if the relationship holds between the two `HugeInteger` objects and returns `false` if the relationship does not hold. Provide a predicate method `isZero`. If you feel ambitious, also provide methods `multiply`, `divide` and `remainder`. [*Note:* Primitive `boolean` values can be output as the word “true” or the word “false” with format specifier `%b`.]

**8.17** (*Tic-Tac-Toe*) Create a class `TicTacToe` that will enable you to write a program to play Tic-Tac-Toe. The class contains a private 3-by-3 two-dimensional array. Use an enumeration to represent the value in each cell of the array. The enumeration's constants should be named `X`, `O` and `EMPTY` (for a position that does not contain an `X` or an `O`). The constructor should initialize the board elements to `EMPTY`. Allow two human players. Wherever the first player moves, place an `X` in the specified square, and place an `O` wherever the second player moves. Each move must be to an empty square. After each move, determine whether the game has been won and whether it's a draw. If you feel ambitious, modify your program so that the computer makes the moves for one of the players. Also, allow the player to specify whether he or she wants to go first or second. If you feel exceptionally ambitious, develop a program that will play three-dimensional Tic-Tac-Toe on a 4-by-4-by-4 board [*Note:* This is an extremely challenging project!].

## Making a Difference

**8.18** (*Project: Emergency Response Class*) The North American emergency response service, 9-1-1, connects callers to a *local* Public Service Answering Point (PSAP). Traditionally, the PSAP would ask the caller for identification information—including the caller’s address, phone number and the nature of the emergency, then dispatch the appropriate emergency responders (such as the police, an ambulance or the fire department). *Enhanced 9-1-1 (or E9-1-1)* uses computers and databases to determine the caller’s physical address, directs the call to the nearest PSAP, and displays the caller’s phone number and address to the call taker. *Wireless Enhanced 9-1-1* provides call takers with identification information for wireless calls. Rolled out in two phases, the first phase required carriers to provide the wireless phone number and the location of the cell site or base station transmitting the call. The second phase required carriers to provide the location of the caller (using technologies such as GPS). To learn more about 9-1-1, visit [www.fcc.gov/pshs/services/911-services/Wel-come.htm](http://www.fcc.gov/pshs/services/911-services/Wel-come.htm) and [people.howstuffworks.com/9-1-1.htm](http://people.howstuffworks.com/9-1-1.htm).

An important part of creating a class is determining the class’s attributes (instance variables). For this class design exercise, research 9-1-1 services on the Internet. Then, design a class called *Emergency* that might be used in an object-oriented 9-1-1 emergency response system. List the attributes that an object of this class might use to represent the emergency. For example, the class might include information on who reported the emergency (including their phone number), the location of the emergency, the time of the report, the nature of the emergency, the type of response and the status of the response. The class attributes should completely describe the nature of the problem and what’s happening to resolve that problem.

# Object-Oriented Programming: Inheritance

# 9

*Say not you know another  
entirely,  
till you have divided an  
inheritance with him.*

—Johann Kasper Lavater

*This method is to define as the  
number of a class the class of all  
classes similar to the given class.*

—Bertrand Russell

## Objectives

In this chapter you'll learn:

- How inheritance promotes software reusability.
- The notions of superclasses and subclasses and the relationship between them.
- To use keyword **extends** to create a class that inherits attributes and behaviors from another class.
- To use access modifier **protected** to give subclass methods access to superclass members.
- To access superclass members with **super**.
- How constructors are used in inheritance hierarchies.
- The methods of class **Object**, the direct or indirect superclass of all classes.



- 9.1 Introduction
- 9.2 Superclasses and Subclasses
- 9.3 protected Members
- 9.4 Relationship between Superclasses and Subclasses
  - 9.4.1 Creating and Using a `CommissionEmployee` Class
  - 9.4.2 Creating and Using a `BasePlusCommissionEmployee` Class
  - 9.4.3 Creating a `CommissionEmployee–BasePlusCommissionEmployee` Inheritance Hierarchy
  - 9.4.4 `CommissionEmployee–BasePlusCommissionEmployee` Inheritance Hierarchy Using `protected` Instance Variables
  - 9.4.5 `CommissionEmployee–BasePlusCommissionEmployee` Inheritance Hierarchy Using `private` Instance Variables
- 9.5 Constructors in Subclasses
- 9.6 Software Engineering with Inheritance
- 9.7 Class Object
- 9.8 (Optional) GUI and Graphics Case Study: Displaying Text and Images Using `Label`s
- 9.9 Wrap-Up

*Summary | Self-Review Exercises | Answers to Self-Review Exercises | Exercises*

## 9.1 Introduction

This chapter continues our discussion of object-oriented programming (OOP) by introducing one of its primary capabilities—**inheritance**, which is a form of software reuse in which a new class is created by absorbing an existing class’s members and embellishing them with new or modified capabilities. With inheritance, you can save time during program development by basing new classes on existing proven and debugged high-quality software. This also increases the likelihood that a system will be implemented and maintained effectively.

When creating a class, rather than declaring completely new members, you can designate that the new class should inherit the members of an existing class. The existing class is called the **superclass**, and the new class is the **subclass**. (The C++ programming language refers to the superclass as the **base class** and the subclass as the **derived class**.) Each subclass can become a superclass for future subclasses.

A subclass can add its own fields and methods. Therefore, a subclass is *more specific* than its superclass and represents a more specialized group of objects. The subclass exhibits the behaviors of its superclass and can modify those behaviors so that they operate appropriately for the subclass. This is why inheritance is sometimes referred to as **specialization**.

The **direct superclass** is the superclass from which the subclass explicitly inherits. An **indirect superclass** is any class above the direct superclass in the **class hierarchy**, which defines the inheritance relationships between classes. In Java, the class hierarchy begins with class `Object` (in package `java.lang`), which *every* class in Java directly or indirectly **extends** (or “inherits from”). Section 9.7 lists the methods of class `Object` that are inherited by all other Java classes. Java supports only **single inheritance**, in which each class is derived from exactly *one* direct superclass. Unlike C++, Java does *not* support multiple inheritance (which occurs when a class is derived from more than one direct superclass). Chapter 10, Object-Oriented Programming: Polymorphism, explains how to use Java interfaces to realize many of the benefits of multiple inheritance while avoiding the associated problems.

We distinguish between the *is-a relationship* and the *has-a relationship*. *Is-a* represents inheritance. In an *is-a* relationship, *an object of a subclass can also be treated as an object of its superclass*—e.g., a car *is a* vehicle. By contrast, *has-a* represents composition (see Chapter 8). In a *has-a* relationship, *an object contains as members references to other objects*—e.g., a car *has a* steering wheel (and a car object has a reference to a steering-wheel object).

New classes can inherit from classes in **class libraries**. Organizations develop their own class libraries and can take advantage of others available worldwide. Some day, most new software likely will be constructed from **standardized reusable components**, just as automobiles and most computer hardware are constructed today. This will facilitate the development of more powerful, abundant and economical software.

## 9.2 Superclasses and Subclasses

Often, an object of one class *is an* object of another class as well. Figure 9.1 lists several simple examples of superclasses and subclasses—superclasses tend to be “more general” and subclasses “more specific.” For example, a CarLoan *is a* Loan as are HomeImprovementLoans and MortgageLoans. Thus, in Java, class CarLoan can be said to inherit from class Loan. In this context, class Loan is a superclass and class CarLoan is a subclass. A CarLoan *is a* specific type of Loan, but it’s incorrect to claim that every Loan *is a* CarLoan—the Loan could be any type of loan.

| Superclass  | Subclasses                                 |
|-------------|--------------------------------------------|
| Student     | GraduateStudent, UndergraduateStudent      |
| Shape       | Circle, Triangle, Rectangle, Sphere, Cube  |
| Loan        | CarLoan, HomeImprovementLoan, MortgageLoan |
| Employee    | Faculty, Staff                             |
| BankAccount | CheckingAccount, SavingsAccount            |

**Fig. 9.1** | Inheritance examples.

Because every subclass object *is an* object of its superclass, and one superclass can have many subclasses, the set of objects represented by a superclass is often larger than the set of objects represented by any of its subclasses. For example, the superclass Vehicle represents all vehicles, including cars, trucks, boats, bicycles and so on. By contrast, subclass Car represents a smaller, more specific subset of vehicles.

### University Community Member Hierarchy

Inheritance relationships form treelike hierarchical structures. A superclass exists in a hierarchical relationship with its subclasses. Let’s develop a sample class hierarchy (Fig. 9.2), also called an **inheritance hierarchy**. A university community has thousands of members, including employees, students and alumni. Employees are either faculty or staff members. Faculty members are either administrators (e.g., deans and department chairpersons) or teachers. The hierarchy could contain many other classes. For example, students can be graduate or undergraduate students. Undergraduate students can be freshmen, sophomores, juniors or seniors.

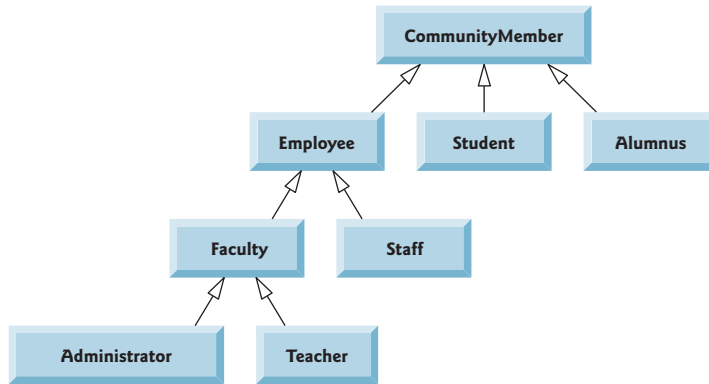
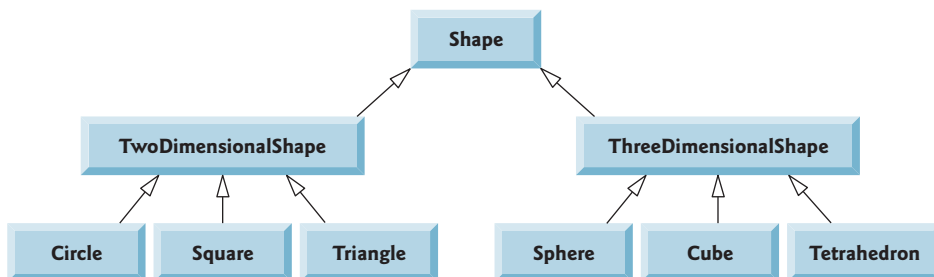

**Fig. 9.2** | Inheritance hierarchy for university CommunityMembers.

Each arrow in the hierarchy represents an *is-a* relationship. As we follow the arrows upward in this class hierarchy, we can state, for instance, that “an Employee *is a* CommunityMember” and “a Teacher *is a* Faculty member.” CommunityMember is the direct superclass of Employee, Student and Alumnus and is an indirect superclass of all the other classes in the diagram. Starting from the bottom, you can follow the arrows and apply the *is-a* relationship up to the topmost superclass. For example, an Administrator *is a* Faculty member, *is an* Employee, *is a* CommunityMember and, of course, *is an* Object.

### Shape Hierarchy

Now consider the Shape inheritance hierarchy in Fig. 9.3. This hierarchy begins with superclass Shape, which is extended by subclasses TwoDimensionalShape and ThreeDimensionalShape—Shapes are either TwoDimensionalShapes or ThreeDimensionalShapes. The third level of this hierarchy contains specific types of TwoDimensionalShapes and ThreeDimensionalShapes. As in Fig. 9.2, we can follow the arrows from the bottom of the diagram to the topmost superclass in this class hierarchy to identify several *is-a* relationships. For instance, a Triangle *is a* TwoDimensionalShape and *is a* Shape, while a Sphere *is a* ThreeDimensionalShape and *is a* Shape. This hierarchy could contain many other classes. For example, ellipses and trapezoids are TwoDimensionalShapes.



**Fig. 9.3** | Inheritance hierarchy for Shapes.



Not every class relationship is an inheritance relationship. In Chapter 8, we discussed the *has-a* relationship, in which classes have members that are references to objects of other classes. Such relationships create classes by composition of existing classes. For example, given the classes `Employee`, `BirthDate` and `TelephoneNumber`, it's improper to say that an `Employee` *is a* `BirthDate` or that an `Employee` *is a* `TelephoneNumber`. However, an `Employee` *has a* `BirthDate`, and an `Employee` *has a* `TelephoneNumber`.

It's possible to treat superclass objects and subclass objects similarly—their commonalities are expressed in the superclass's members. Objects of all classes that extend a common superclass can be treated as objects of that superclass—such objects have an *is-a* relationship with the superclass. Later in this chapter and in Chapter 10, we consider many examples that take advantage of the *is-a* relationship.

A subclass can customize methods that it inherits from its superclass. To do this, the subclass **overrides** (redefines) the superclass method with an appropriate implementation, as we'll see often in the chapter's code examples.

## 9.3 protected Members

Chapter 8 discussed access modifiers `public` and `private`. A class's `public` members are accessible wherever the program has a reference to an object of that class or one of its subclasses. A class's `private` members are accessible only within the class itself. In this section, we introduce access modifier **protected**. Using `protected` access offers an intermediate level of access between `public` and `private`. A superclass's `protected` members can be accessed by members of that superclass, by members of its subclasses and by members of other classes in the same package—`protected` members also have package access.

All `public` and `protected` superclass members retain their original access modifier when they become members of the subclass—`public` members of the superclass become `public` members of the subclass, and `protected` members of the superclass become `protected` members of the subclass. A superclass's `private` members are not accessible outside the class itself. Rather, they're *hidden* in its subclasses and can be accessed only through the `public` or `protected` methods inherited from the superclass.

Subclass methods can refer to `public` and `protected` members inherited from the superclass simply by using the member names. When a subclass method overrides an inherited superclass method, the *superclass* method can be accessed from the *subclass* by preceding the superclass method name with keyword **super** and a dot (`.`) separator. We discuss accessing overridden members of the superclass in Section 9.4.



### Software Engineering Observation 9.1

*Methods of a subclass cannot directly access private members of their superclass. A subclass can change the state of private superclass instance variables only through non-private methods provided in the superclass and inherited by the subclass.*



### Software Engineering Observation 9.2

*Declaring private instance variables helps you test, debug and correctly modify systems. If a subclass could access its superclass's private instance variables, classes that inherit from that subclass could access the instance variables as well. This would propagate access to what should be private instance variables, and the benefits of information hiding would be lost.*

## 9.4 Relationship between Superclasses and Subclasses

We now use an inheritance hierarchy containing types of employees in a company's payroll application to discuss the relationship between a superclass and its subclass. In this company, commission employees (who will be represented as objects of a superclass) are paid a percentage of their sales, while base-salaried commission employees (who will be represented as objects of a subclass) receive a base salary *plus* a percentage of their sales.

We divide our discussion of the relationship between these classes into five examples. The first declares class `CommissionEmployee`, which directly inherits from class `Object` and declares as `private` instance variables a first name, last name, social security number, commission rate and gross (i.e., total) sales amount.

The second example declares class `BasePlusCommissionEmployee`, which also directly inherits from class `Object` and declares as `private` instance variables a first name, last name, social security number, commission rate, gross sales amount *and* base salary. We create this class by *writing every line of code* the class requires—we'll soon see that it's much more efficient to create it by inheriting from class `CommissionEmployee`.

The third example declares a new `BasePlusCommissionEmployee` class that *extends* class `CommissionEmployee` (i.e., a `BasePlusCommissionEmployee` *is a* `CommissionEmployee` who also has a base salary). This *software reuse lets us write less code* when developing the new subclass. In this example, class `BasePlusCommissionEmployee` attempts to access class `CommissionEmployee`'s `private` members—this results in compilation errors, because the subclass cannot access the superclass's `private` instance variables.

The fourth example shows that if `CommissionEmployee`'s instance variables are declared as `protected`, the `BasePlusCommissionEmployee` subclass can access that data directly. Both `BasePlusCommissionEmployee` classes contain identical functionality, but we show how the inherited version is easier to create and manage.

After we discuss the convenience of using `protected` instance variables, we create the fifth example, which sets the `CommissionEmployee` instance variables back to `private` to enforce good software engineering. Then we show how the `BasePlusCommissionEmployee` subclass can use `CommissionEmployee`'s `public` methods to manipulate (in a controlled manner) the `private` instance variables inherited from `CommissionEmployee`.

### 9.4.1 Creating and Using a `CommissionEmployee` Class

We begin by declaring class `CommissionEmployee` (Fig. 9.4). Line 4 begins the class declaration and indicates that class `CommissionEmployee` **extends** (i.e., inherits from) class **Object** (from package `java.lang`). This causes class `CommissionEmployee` to inherit the class `Object`'s methods—class `Object` does not have any fields. If you don't explicitly specify which class a new class extends, the class extends `Object` implicitly. For this reason, you typically will not include “extends `Object`” in your code—we do so in this example only for demonstration purposes.

#### *Overview of Class `CommissionEmployee`'s Methods and Instance Variables*

Class `CommissionEmployee`'s `public` services include a constructor (lines 13–22) and methods `earnings` (lines 93–96) and `toString` (lines 99–107). Lines 25–90 declare `public` *get* and *set* methods for the class's instance variables (declared in lines 6–10) `firstName`, `lastName`, `socialSecurityNumber`, `grossSales` and `commissionRate`. The class declares its instance variables as `private`, so objects of other classes cannot directly access

these variables. Declaring instance variables as *private* and providing *get* and *set* methods to manipulate and validate them helps enforce good software engineering. Methods *setGrossSales* and *setCommissionRate*, for example, validate their arguments before assigning the values to instance variables *grossSales* and *commissionRate*. In a real-world, business-critical application, we'd also perform validation in the class's other *set* methods.

---

```

1 // Fig. 9.4: CommissionEmployee.java
2 // CommissionEmployee class represents an employee paid a
3 // percentage of gross sales.
4 public class CommissionEmployee extends Object
5 {
6 private String firstName;
7 private String lastName;
8 private String socialSecurityNumber;
9 private double grossSales; // gross weekly sales
10 private double commissionRate; // commission percentage
11
12 // five-argument constructor
13 public CommissionEmployee(String first, String last, String ssn,
14 double sales, double rate)
15 {
16 // implicit call to Object constructor occurs here
17 firstName = first;
18 lastName = last;
19 socialSecurityNumber = ssn;
20 setGrossSales(sales); // validate and store gross sales
21 setCommissionRate(rate); // validate and store commission rate
22 } // end five-argument CommissionEmployee constructor
23
24 // set first name
25 public void setFirstName(String first)
26 {
27 firstName = first; // should validate
28 } // end method setFirstName
29
30 // return first name
31 public String getFirstName()
32 {
33 return firstName;
34 } // end method getFirstName
35
36 // set last name
37 public void setLastName(String last)
38 {
39 lastName = last; // should validate
40 } // end method setLastName
41
42 // return last name
43 public String getLastName()
44 {

```

---

**Fig. 9.4** | CommissionEmployee class represents an employee paid a percentage of gross sales. (Part I of 3.)

```
45 return lastName;
46 } // end method getLastName
47
48 // set social security number
49 public void setSocialSecurityNumber(String ssn)
50 {
51 socialSecurityNumber = ssn; // should validate
52 } // end method setSocialSecurityNumber
53
54 // return social security number
55 public String getSocialSecurityNumber()
56 {
57 return socialSecurityNumber;
58 } // end method getSocialSecurityNumber
59
60 // set gross sales amount
61 public void setGrossSales(double sales)
62 {
63 if (sales >= 0.0)
64 grossSales = sales;
65 else
66 throw new IllegalArgumentException(
67 "Gross sales must be >= 0.0");
68 } // end method setGrossSales
69
70 // return gross sales amount
71 public double getGrossSales()
72 {
73 return grossSales;
74 } // end method getGrossSales
75
76 // set commission rate
77 public void setCommissionRate(double rate)
78 {
79 if (rate > 0.0 && rate < 1.0)
80 commissionRate = rate;
81 else
82 throw new IllegalArgumentException(
83 "Commission rate must be > 0.0 and < 1.0");
84 } // end method setCommissionRate
85
86 // return commission rate
87 public double getCommissionRate()
88 {
89 return commissionRate;
90 } // end method getCommissionRate
91
92 // calculate earnings
93 public double earnings()
94 {
95 return commissionRate * grossSales;
96 } // end method earnings
```

**Fig. 9.4** | CommissionEmployee class represents an employee paid a percentage of gross sales.  
(Part 2 of 3.)

```

97
98 // return String representation of CommissionEmployee object
99 @Override // indicates that this method overrides a superclass method
100 public String toString()
101 {
102 return String.format("%s: %s %s\n%s: %s\n%s: %.2f\n%s: %.2f",
103 "commission employee", firstName, lastName,
104 "social security number", socialSecurityNumber,
105 "gross sales", grossSales,
106 "commission rate", commissionRate);
107 } // end method toString
108 } // end class CommissionEmployee

```

**Fig. 9.4** | CommissionEmployee class represents an employee paid a percentage of gross sales. (Part 3 of 3.)

### *Class CommissionEmployee's Constructor*

Constructors are *not* inherited, so class `CommissionEmployee` does not inherit class `Object`'s constructor. However, a superclass's constructors are still available to subclasses. In fact, *the first task of any subclass constructor is to call its direct superclass's constructor*, either explicitly or implicitly (if no constructor call is specified), to ensure that the instance variables inherited from the superclass are initialized properly. In this example, class `CommissionEmployee`'s constructor calls class `Object`'s constructor implicitly. The syntax for calling a superclass constructor explicitly is discussed in Section 9.4.3. If the code does not include an explicit call to the superclass constructor, Java *implicitly* calls the superclass's default or no-argument constructor. The comment in line 16 of Fig. 9.4 indicates where the implicit call to the superclass `Object`'s default constructor is made (you do not write the code for this call). `Object`'s default (empty) constructor does nothing. Even if a class does not have constructors, the default constructor that the compiler implicitly declares for the class will call the superclass's default or no-argument constructor.

After the implicit call to `Object`'s constructor, lines 17–21 of `CommissionEmployee`'s constructor assign values to the class's instance variables. We do not validate the values of arguments `first`, `last` and `ssn` before assigning them to the corresponding instance variables. We could validate the first and last names—perhaps to ensure that they're of a reasonable length. Similarly, a social security number could be validated using regular expressions (Section 16.7) to ensure that it contains nine digits, with or without dashes (e.g., 123-45-6789 or 123456789).

### *Class CommissionEmployee's earnings Method*

Method `earnings` (lines 93–96) calculates a `CommissionEmployee`'s earnings. Line 95 multiplies the `commissionRate` by the `grossSales` and returns the result.

### *Class CommissionEmployee's toString Method and the @Override Annotation*

Method `toString` (lines 99–107) is special—it's one of the methods that *every* class inherits directly or indirectly from class `Object` (summarized in Section 9.7). Method `toString` returns a `String` representing an object. It's called implicitly whenever an object must be converted to a `String` representation, such as when an object is output by `printf` or output by `String` method `format` via the `%s` format specifier. Class `Object`'s `toString` method returns a `String` that includes the name of the object's class. It's primarily a placeholder

that can be overridden by a subclass to specify an appropriate `String` representation of the data in a subclass object. Method `toString` of class `CommissionEmployee` overrides (redefines) class `Object`'s `toString` method. When invoked, `CommissionEmployee`'s `toString` method uses `String` method `format` to return a `String` containing information about the `CommissionEmployee`. To override a superclass method, a subclass must declare a method with the same signature (method name, number of parameters, parameter types and order of parameter types) as the superclass method—`Object`'s `toString` method takes no parameters, so `CommissionEmployee` declares `toString` with no parameters.

Line 99 uses the **@Override annotation** to indicate that method `toString` should override a superclass method. Annotations have several purposes. For example, when you attempt to override a superclass method, common errors include naming the subclass method incorrectly, or using the wrong number or types of parameters in the parameter list. Each of these problems creates an *unintentional overload* of the superclass method. If you then attempt to call the method on a subclass object, the superclass's version is invoked and the subclass version is ignored—potentially leading to subtle logic errors. When the compiler encounters a method declared with **@Override**, it compares the method's signature with the superclass's method signatures. If there isn't an exact match, the compiler issues an error message, such as "method does not override or implement a method from a supertype." This indicates that you've accidentally overloaded a superclass method. You can then fix your method's signature so that it matches one in the superclass.

As you'll see when we discuss web applications and web services in Chapters 29–31, annotations can also add complex support code to your classes to simplify the development process and can be used by servers to configure certain aspects of web applications.



### Common Programming Error 9.1

*Using an incorrect method signature when attempting to override a superclass method causes an unintentional method overload that can lead to subtle logic errors.*



### Error-Prevention Tip 9.1

*Declare overridden methods with the **@Override** annotation to ensure at compilation time that you defined their signatures correctly. It's always better to find errors at compile time rather than at runtime.*



### Common Programming Error 9.2

*It's a syntax error to override a method with a more restricted access modifier—a `public` method of the superclass cannot become a `protected` or `private` method in the subclass; a `protected` method of the superclass cannot become a `private` method in the subclass. Doing so would break the *is-a* relationship in which it's required that all subclass objects be able to respond to method calls that are made to `public` methods declared in the superclass. If a `public` method, for example, could be overridden as a `protected` or `private` method, the subclass objects would not be able to respond to the same method calls as superclass objects. Once a method is declared `public` in a superclass, the method remains `public` for all that class's direct and indirect subclasses.*

## Class `CommissionEmployeeTest`

Figure 9.5 tests class `CommissionEmployee`. Lines 9–10 instantiate a `CommissionEmployee` object and invoke `CommissionEmployee`'s constructor (lines 13–22 of Fig. 9.4) to initialize

it with "Sue" as the first name, "Jones" as the last name, "222-22-2222" as the social security number, 10000 as the gross sales amount and .06 as the commission rate. Lines 15–24 use `CommissionEmployee`'s *get* methods to retrieve the object's instance-variable values for output. Lines 26–27 invoke the object's methods `setGrossSales` and `setCommissionRate` to change the values of instance variables `grossSales` and `commissionRate`. Lines 29–30 output the `String` representation of the updated `CommissionEmployee`. When an object is output using the `%s` format specifier, the object's `toString` method is invoked implicitly to obtain the object's `String` representation. [*Note:* In this chapter, we do not use the earnings methods of our classes—they're used extensively in Chapter 10.]

```

1 // Fig. 9.5: CommissionEmployeeTest.java
2 // CommissionEmployee class test program.
3
4 public class CommissionEmployeeTest
5 {
6 public static void main(String[] args)
7 {
8 // instantiate CommissionEmployee object
9 CommissionEmployee employee = new CommissionEmployee(
10 "Sue", "Jones", "222-22-2222", 10000, .06);
11
12 // get commission employee data
13 System.out.println(
14 "Employee information obtained by get methods: \n");
15 System.out.printf("%s %s\n", "First name is",
16 employee.getFirstName());
17 System.out.printf("%s %s\n", "Last name is",
18 employee.getLastName());
19 System.out.printf("%s %s\n", "Social security number is",
20 employee.getSocialSecurityNumber());
21 System.out.printf("%s %.2f\n", "Gross sales is",
22 employee.getGrossSales());
23 System.out.printf("%s %.2f\n", "Commission rate is",
24 employee.getCommissionRate());
25
26 employee.setGrossSales(500); // set gross sales
27 employee.setCommissionRate(.1); // set commission rate
28
29 System.out.printf("\n%s:\n\n%s\n",
30 "Updated employee information obtained by toString", employee);
31 } // end main
32 } // end class CommissionEmployeeTest

```

Employee information obtained by get methods:

```

First name is Sue
Last name is Jones
Social security number is 222-22-2222
Gross sales is 10000.00
Commission rate is 0.06

```

**Fig. 9.5** | `CommissionEmployee` class test program. (Part 1 of 2.)

Updated employee information obtained by toString:

```
commission employee: Sue Jones
social security number: 222-22-2222
gross sales: 500.00
commission rate: 0.10
```

**Fig. 9.5** | CommissionEmployee class test program. (Part 2 of 2.)

### 9.4.2 Creating and Using a BasePlusCommissionEmployee Class

We now discuss the second part of our introduction to inheritance by declaring and testing (a completely new and independent) class `BasePlusCommissionEmployee` (Fig. 9.6), which contains a first name, last name, social security number, gross sales amount, commission rate *and* base salary. Class `BasePlusCommissionEmployee`'s public services include a `BasePlusCommissionEmployee` constructor (lines 15–25) and methods `earnings` (lines 112–115) and `toString` (lines 118–127). Lines 28–109 declare public *get* and *set* methods for the class's private instance variables (declared in lines 7–12) `firstName`, `lastName`, `socialSecurityNumber`, `grossSales`, `commissionRate` *and* `baseSalary`. These variables and methods encapsulate all the necessary features of a base-salaried commission employee. Note the *similarity* between this class and class `CommissionEmployee` (Fig. 9.4)—in this example, we'll not yet exploit that similarity.

```
1 // Fig. 9.6: BasePlusCommissionEmployee.java
2 // BasePlusCommissionEmployee class represents an employee who receives
3 // a base salary in addition to commission.
4
5 public class BasePlusCommissionEmployee
6 {
7 private String firstName;
8 private String lastName;
9 private String socialSecurityNumber;
10 private double grossSales; // gross weekly sales
11 private double commissionRate; // commission percentage
12 private double baseSalary; // base salary per week
13
14 // six-argument constructor
15 public BasePlusCommissionEmployee(String first, String last,
16 String ssn, double sales, double rate, double salary)
17 {
18 // implicit call to Object constructor occurs here
19 firstName = first;
20 lastName = last;
21 socialSecurityNumber = ssn;
22 setGrossSales(sales); // validate and store gross sales
23 setCommissionRate(rate); // validate and store commission rate
24 setBaseSalary(salary); // validate and store base salary
25 } // end six-argument BasePlusCommissionEmployee constructor
```

**Fig. 9.6** | `BasePlusCommissionEmployee` class represents an employee who receives a base salary in addition to a commission. (Part 1 of 3.)



```
26
27 // set first name
28 public void setFirstName(String first)
29 {
30 firstName = first; // should validate
31 } // end method setFirstName
32
33 // return first name
34 public String getFirstName()
35 {
36 return firstName;
37 } // end method getFirstName
38
39 // set last name
40 public void setLastName(String last)
41 {
42 lastName = last; // should validate
43 } // end method setLastName
44
45 // return last name
46 public String getLastName()
47 {
48 return lastName;
49 } // end method getLastName
50
51 // set social security number
52 public void setSocialSecurityNumber(String ssn)
53 {
54 socialSecurityNumber = ssn; // should validate
55 } // end method setSocialSecurityNumber
56
57 // return social security number
58 public String getSocialSecurityNumber()
59 {
60 return socialSecurityNumber;
61 } // end method getSocialSecurityNumber
62
63 // set gross sales amount
64 public void setGrossSales(double sales)
65 {
66 if (sales >= 0.0)
67 grossSales = sales;
68 else
69 throw new IllegalArgumentException(
70 "Gross sales must be >= 0.0");
71 } // end method setGrossSales
72
73 // return gross sales amount
74 public double getGrossSales()
75 {
76 return grossSales;
77 } // end method getGrossSales
```

**Fig. 9.6** | BasePlusCommissionEmployee class represents an employee who receives a base salary in addition to a commission. (Part 2 of 3.)

```
78
79 // set commission rate
80 public void setCommissionRate(double rate)
81 {
82 if (rate > 0.0 && rate < 1.0)
83 commissionRate = rate;
84 else
85 throw new IllegalArgumentException(
86 "Commission rate must be > 0.0 and < 1.0");
87 } // end method setCommissionRate
88
89 // return commission rate
90 public double getCommissionRate()
91 {
92 return commissionRate;
93 } // end method getCommissionRate
94
95 // set base salary
96 public void setBaseSalary(double salary)
97 {
98 if (salary >= 0.0)
99 baseSalary = salary;
100 else
101 throw new IllegalArgumentException(
102 "Base salary must be >= 0.0");
103 } // end method setBaseSalary
104
105 // return base salary
106 public double getBaseSalary()
107 {
108 return baseSalary;
109 } // end method getBaseSalary
110
111 // calculate earnings
112 public double earnings()
113 {
114 return baseSalary + (commissionRate * grossSales);
115 } // end method earnings
116
117 // return String representation of BasePlusCommissionEmployee
118 @Override // indicates that this method overrides a superclass method
119 public String toString()
120 {
121 return String.format(
122 "%s: %s %s\n%s: %s\n%s: %.2f\n%s: %.2f\n%s: %.2f",
123 "base-salaried commission employee", firstName, lastName,
124 "social security number", socialSecurityNumber,
125 "gross sales", grossSales, "commission rate", commissionRate,
126 "base salary", baseSalary);
127 } // end method toString
128 } // end class BasePlusCommissionEmployee
```

**Fig. 9.6** | BasePlusCommissionEmployee class represents an employee who receives a base salary in addition to a commission. (Part 3 of 3.)

Class `BasePlusCommissionEmployee` does not specify “extends `Object`” in line 5, so the class implicitly extends `Object`. Also, like class `CommissionEmployee`’s constructor (lines 13–22 of Fig. 9.4), class `BasePlusCommissionEmployee`’s constructor invokes class `Object`’s default constructor implicitly, as noted in the comment in line 18.

Class `BasePlusCommissionEmployee`’s `earnings` method (lines 112–115) returns the result of adding the `BasePlusCommissionEmployee`’s base salary to the product of the commission rate and the employee’s gross sales.

Class `BasePlusCommissionEmployee` overrides `Object` method `toString` to return a `String` containing the `BasePlusCommissionEmployee`’s information. Once again, we use format specifier `%.2f` to format the gross sales, commission rate and base salary with two digits of precision to the right of the decimal point (line 122).

### Testing Class `BasePlusCommissionEmployee`

Figure 9.7 tests class `BasePlusCommissionEmployee`. Lines 9–11 create a `BasePlusCommissionEmployee` object and pass “Bob”, “Lewis”, “333-33-3333”, 5000, .04 and 300 to the constructor as the first name, last name, social security number, gross sales, commission rate and base salary, respectively. Lines 16–27 use `BasePlusCommissionEmployee`’s `get` methods to retrieve the values of the object’s instance variables for output. Line 29 invokes the object’s `setBaseSalary` method to change the base salary. Method `setBaseSalary` (Fig. 9.6, lines 88–91) ensures that instance variable `baseSalary` is not assigned a negative value. Lines 31–33 of Fig. 9.7 invoke method `toString` explicitly to get the object’s `String` representation.

---

```

1 // Fig. 9.7: BasePlusCommissionEmployeeTest.java
2 // BasePlusCommissionEmployee test program.
3
4 public class BasePlusCommissionEmployeeTest
5 {
6 public static void main(String[] args)
7 {
8 // instantiate BasePlusCommissionEmployee object
9 BasePlusCommissionEmployee employee =
10 new BasePlusCommissionEmployee(
11 "Bob", "Lewis", "333-33-3333", 5000, .04, 300);
12
13 // get base-salaried commission employee data
14 System.out.println(
15 "Employee information obtained by get methods: \n");
16 System.out.printf("%s %s\n", "First name is",
17 employee.getFirstName());
18 System.out.printf("%s %s\n", "Last name is",
19 employee.getLastName());
20 System.out.printf("%s %s\n", "Social security number is",
21 employee.getSocialSecurityNumber());
22 System.out.printf("%s %.2f\n", "Gross sales is",
23 employee.getGrossSales());
24 System.out.printf("%s %.2f\n", "Commission rate is",
25 employee.getCommissionRate());
26 System.out.printf("%s %.2f\n", "Base salary is",
27 employee.getBaseSalary());

```

---

**Fig. 9.7** | `BasePlusCommissionEmployee` test program. (Part I of 2.)

```

28
29 employee.setBaseSalary(1000); // set base salary
30
31 System.out.printf("\n%s:\n\n%s\n",
32 "Updated employee information obtained by toString",
33 employee.toString());
34 } // end main
35 } // end class BasePlusCommissionEmployeeTest

```

Employee information obtained by get methods:

```

First name is Bob
Last name is Lewis
Social security number is 333-33-3333
Gross sales is 5000.00
Commission rate is 0.04
Base salary is 300.00

```

Updated employee information obtained by toString:

```

base-salaried commission employee: Bob Lewis
social security number: 333-33-3333
gross sales: 5000.00
commission rate: 0.04
base salary: 1000.00

```

**Fig. 9.7** | BasePlusCommissionEmployee test program. (Part 2 of 2.)

### *Notes on Class BasePlusCommissionEmployee*

Much of class `BasePlusCommissionEmployee`'s code (Fig. 9.6) is similar, or identical, to that of class `CommissionEmployee` (Fig. 9.4). For example, private instance variables `firstName` and `lastName` and methods `setFirstName`, `getFirstName`, `setLastName` and `getLastName` are identical to those of class `CommissionEmployee`. The classes also both contain private instance variables `socialSecurityNumber`, `commissionRate` and `grossSales`, and corresponding *get* and *set* methods. In addition, the `BasePlusCommissionEmployee` constructor is almost identical to that of class `CommissionEmployee`, except that `BasePlusCommissionEmployee`'s constructor also sets the `baseSalary`. The other additions to class `BasePlusCommissionEmployee` are private instance variable `baseSalary` and methods `setBaseSalary` and `getBaseSalary`. Class `BasePlusCommissionEmployee`'s `toString` method is nearly identical to that of class `CommissionEmployee` except that it also outputs instance variable `baseSalary` with two digits of precision to the right of the decimal point.

We literally *copied* code from class `CommissionEmployee` and *pasted* it into class `BasePlusCommissionEmployee`, then modified class `BasePlusCommissionEmployee` to include a base salary and methods that manipulate the base salary. This “copy-and-paste” approach is often error prone and time consuming. Worse yet, it spreads copies of the same code throughout a system, creating a code-maintenance nightmare. Is there a way to “absorb” the instance variables and methods of one class in a way that makes them part of other classes *without duplicating code*? Next we answer this question, using a more elegant approach to building classes that emphasizes the benefits of inheritance.



### Software Engineering Observation 9.3

With inheritance, the common instance variables and methods of all the classes in the hierarchy are declared in a superclass. When changes are made for these common features in the superclass—subclasses then inherit the changes. Without inheritance, changes would need to be made to all the source-code files that contain a copy of the code in question.

## 9.4.3 Creating a CommissionEmployee–BasePlusCommissionEmployee Inheritance Hierarchy

Now we redeclare class `BasePlusCommissionEmployee` (Fig. 9.8) to *extend* class `CommissionEmployee` (Fig. 9.4). A `BasePlusCommissionEmployee` object *is a* `CommissionEmployee`, because inheritance passes on class `CommissionEmployee`'s capabilities. Class `BasePlusCommissionEmployee` also has instance variable `baseSalary` (Fig. 9.8, line 6). Keyword `extends` (line 4) indicates inheritance. `BasePlusCommissionEmployee` *inherits* `CommissionEmployee`'s instance variables and methods, but only the superclass's `public` and `protected` members are directly accessible in the subclass. The `CommissionEmployee` constructor is *not* inherited. So, the `public` `BasePlusCommissionEmployee` services include its constructor (lines 9–16), `public` methods inherited from `CommissionEmployee`, and methods `setBaseSalary` (lines 19–26), `getBaseSalary` (lines 29–32), `earnings` (lines 35–40) and `toString` (lines 43–53). Methods `earnings` and `toString` *override* the corresponding methods in class `CommissionEmployee` because their superclass versions do not properly calculate a `BasePlusCommissionEmployee`'s earnings or return an appropriate `String` representation.

```

1 // Fig. 9.8: BasePlusCommissionEmployee.java
2 // private superclass members cannot be accessed in a subclass.
3
4 public class BasePlusCommissionEmployee extends CommissionEmployee
5 {
6 private double baseSalary; // base salary per week
7
8 // six-argument constructor
9 public BasePlusCommissionEmployee(String first, String last,
10 String ssn, double sales, double rate, double salary)
11 {
12 // explicit call to superclass CommissionEmployee constructor
13 super(first, last, ssn, sales, rate);
14
15 setBaseSalary(salary); // validate and store base salary
16 } // end six-argument BasePlusCommissionEmployee constructor
17
18 // set base salary
19 public void setBaseSalary(double salary)
20 {
21 if (salary >= 0.0)
22 baseSalary = salary;
23 else
24 throw new IllegalArgumentException(
25 "Base salary must be >= 0.0");
26 } // end method setBaseSalary

```

**Fig. 9.8** | private superclass members cannot be accessed in a subclass. (Part I of 3.)

```

27
28 // return base salary
29 public double getBaseSalary()
30 {
31 return baseSalary;
32 } // end method getBaseSalary
33
34 // calculate earnings
35 @Override // indicates that this method overrides a superclass method
36 public double earnings()
37 {
38 // not allowed: commissionRate and grossSales private in superclass
39 return baseSalary + (commissionRate * grossSales);
40 } // end method earnings
41
42 // return String representation of BasePlusCommissionEmployee
43 @Override // indicates that this method overrides a superclass method
44 public String toString()
45 {
46 // not allowed: attempts to access private superclass members
47 return String.format(
48 "%s: %s %s\n%s: %s\n%s: %.2f\n%s: %.2f\n%s: %.2f",
49 "base-salaried commission employee", firstName, lastName,
50 "social security number", socialSecurityNumber,
51 "gross sales", grossSales, "commission rate", commissionRate,
52 "base salary", baseSalary);
53 } // end method toString
54 } // end class BasePlusCommissionEmployee

```

```

BasePlusCommissionEmployee.java:39: commissionRate has private access in
CommissionEmployee
 return baseSalary + (commissionRate * grossSales);
 ^
BasePlusCommissionEmployee.java:39: grossSales has private access in
CommissionEmployee
 return baseSalary + (commissionRate * grossSales);
 ^
BasePlusCommissionEmployee.java:49: firstName has private access in
CommissionEmployee
 "base-salaried commission employee", firstName, lastName,
 ^
BasePlusCommissionEmployee.java:49: lastName has private access in
CommissionEmployee
 "base-salaried commission employee", firstName, lastName,
 ^
BasePlusCommissionEmployee.java:50: socialSecurityNumber has private access
in CommissionEmployee
 "social security number", socialSecurityNumber,
 ^
BasePlusCommissionEmployee.java:51: grossSales has private access in
CommissionEmployee
 "gross sales", grossSales, "commission rate", commissionRate,
 ^

```

**Fig. 9.8** | private superclass members cannot be accessed in a subclass. (Part 2 of 3.)

```

BasePlusCommissionEmployee.java:51: commissionRate has private access in
CommissionEmployee
 "gross sales", grossSales, "commission rate", commissionRate,
 ^
7 errors

```

**Fig. 9.8** | private superclass members cannot be accessed in a subclass. (Part 3 of 3.)

### *A Subclass's Constructor Must Call Its Superclass's Constructor*

Each subclass constructor must implicitly or explicitly call its superclass constructor to initialize the instance variables inherited from the superclass. Line 13 in `BasePlusCommissionEmployee`'s six-argument constructor (lines 9–16) explicitly calls class `CommissionEmployee`'s five-argument constructor (declared at lines 13–22 of Fig. 9.4) to initialize the superclass portion of a `BasePlusCommissionEmployee` object (i.e., variables `firstName`, `lastName`, `socialSecurityNumber`, `grossSales` and `commissionRate`). We do this by using the **superclass constructor call syntax**—keyword `super`, followed by a set of parentheses containing the superclass constructor arguments. The arguments `first`, `last`, `ssn`, `sales` and `rate` are used to initialize superclass members `firstName`, `lastName`, `socialSecurityNumber`, `grossSales` and `commissionRate`, respectively. If `BasePlusCommissionEmployee`'s constructor did not invoke the superclass's constructor explicitly, Java would attempt to invoke the superclass's no-argument or default constructor. Class `CommissionEmployee` does not have such a constructor, so the compiler would issue an error. The explicit superclass constructor call in line 13 of Fig. 9.8 must be the *first* statement in the subclass constructor's body. When a superclass contains a no-argument constructor, you can use `super()` to call that constructor explicitly, but this is rarely done.

### *BasePlusCommissionEmployee Method Earnings*

The compiler generates errors for line 39 because superclass `CommissionEmployee`'s instance variables `commissionRate` and `grossSales` are `private`—subclass `BasePlusCommissionEmployee`'s methods are not allowed to access superclass `CommissionEmployee`'s `private` instance variables. We used red text in Fig. 9.8 to indicate erroneous code. The compiler issues additional errors at lines 49–51 of `BasePlusCommissionEmployee`'s `toString` method for the same reason. The errors in `BasePlusCommissionEmployee` could have been prevented by using the *get* methods inherited from class `CommissionEmployee`. For example, line 39 could have used `getCommissionRate` and `getGrossSales` to access `CommissionEmployee`'s `private` instance variables `commissionRate` and `grossSales`, respectively. Lines 49–51 also could have used appropriate *get* methods to retrieve the values of the superclass's instance variables.

## 9.4.4 CommissionEmployee–BasePlusCommissionEmployee Inheritance Hierarchy Using protected Instance Variables

To enable class `BasePlusCommissionEmployee` to directly access superclass instance variables `firstName`, `lastName`, `socialSecurityNumber`, `grossSales` and `commissionRate`, we can declare those members as `protected` in the superclass. As we discussed in Section 9.3, a superclass's `protected` members are accessible by all subclasses of that superclass. In the new `CommissionEmployee` class, we modified only lines 6–10 of Fig. 9.4 to declare the instance variables with the `protected` access modifier as follows:

```

protected String firstName;
protected String lastName;
protected String socialSecurityNumber;
protected double grossSales; // gross weekly sales
protected double commissionRate; // commission percentage

```

The rest of the class declaration (which is not shown here) is identical to that of Fig. 9.4.

We could have declared `CommissionEmployee`'s instance variables `public` to enable subclass `BasePlusCommissionEmployee` to access them. However, declaring `public` instance variables is poor software engineering because it allows unrestricted access to these variables, greatly increasing the chance of errors. With `protected` instance variables, the subclass gets access to the instance variables, but classes that are not subclasses and classes that are not in the same package cannot access these variables directly—recall that `protected` class members are also visible to other classes in the same package.

### Class `BasePlusCommissionEmployee`

Class `BasePlusCommissionEmployee` (Fig. 9.9) extends the new version of class `CommissionEmployee` with `protected` instance variables. `BasePlusCommissionEmployee` objects inherit `CommissionEmployee`'s `protected` instance variables `firstName`, `lastName`, `socialSecurityNumber`, `grossSales` and `commissionRate`—all these variables are now `protected` members of `BasePlusCommissionEmployee`. As a result, the compiler does not generate errors when compiling line 37 of method `earnings` and lines 46–48 of method `toString`. If another class extends this version of class `BasePlusCommissionEmployee`, the new subclass also can access the `protected` members.

When you create a `BasePlusCommissionEmployee` object, it contains all instance variables declared in the class hierarchy to that point—i.e., those from classes `Object`, `CommissionEmployee` and `BasePlusCommissionEmployee`. Class `BasePlusCommissionEmployee` does not inherit class `CommissionEmployee`'s constructor. However, class `BasePlusCommissionEmployee`'s six-argument constructor (lines 10–15) calls class `CommissionEmployee`'s five-argument constructor *explicitly* to initialize the instance variables that `BasePlusCommissionEmployee` inherited from class `CommissionEmployee`. Similarly, class `CommissionEmployee`'s constructor *implicitly* calls class `Object`'s constructor. `BasePlusCommissionEmployee`'s constructor must do this *explicitly* because `CommissionEmployee` does *not* provide a no-argument constructor that could be invoked implicitly.

---

```

1 // Fig. 9.9: BasePlusCommissionEmployee.java
2 // BasePlusCommissionEmployee inherits protected instance
3 // variables from CommissionEmployee.
4
5 public class BasePlusCommissionEmployee extends CommissionEmployee
6 {
7 private double baseSalary; // base salary per week
8
9 // six-argument constructor
10 public BasePlusCommissionEmployee(String first, String last,
11 String ssn, double sales, double rate, double salary)
12 {

```

---

**Fig. 9.9** | `BasePlusCommissionEmployee` inherits `protected` instance variables from `CommissionEmployee`. (Part 1 of 2.)



```

13 super(first, last, ssn, sales, rate);
14 setBaseSalary(salary); // validate and store base salary
15 } // end six-argument BasePlusCommissionEmployee constructor
16
17 // set base salary
18 public void setBaseSalary(double salary)
19 {
20 if (salary >= 0.0)
21 baseSalary = salary;
22 else
23 throw new IllegalArgumentException(
24 "Base salary must be >= 0.0");
25 } // end method setBaseSalary
26
27 // return base salary
28 public double getBaseSalary()
29 {
30 return baseSalary;
31 } // end method getBaseSalary
32
33 // calculate earnings
34 @Override // indicates that this method overrides a superclass method
35 public double earnings()
36 {
37 return baseSalary + (commissionRate * grossSales);
38 } // end method earnings
39
40 // return String representation of BasePlusCommissionEmployee
41 @Override // indicates that this method overrides a superclass method
42 public String toString()
43 {
44 return String.format(
45 "%s: %s %s\n%s: %s\n%s: %.2f\n%s: %.2f\n%s: %.2f",
46 "base-salaried commission employee", firstName, lastName,
47 "social security number", socialSecurityNumber,
48 "gross sales", grossSales, "commission rate", commissionRate,
49 "base salary", baseSalary);
50 } // end method toString
51 } // end class BasePlusCommissionEmployee

```

**Fig. 9.9** | BasePlusCommissionEmployee inherits protected instance variables from CommissionEmployee. (Part 2 of 2.)

### Testing Class BasePlusCommissionEmployee

The BasePlusCommissionEmployeeTest class for this example is identical to that of Fig. 9.7 and produces the same output, so we do not show it here. Although the version of class BasePlusCommissionEmployee in Fig. 9.6 does not use inheritance and the version in Fig. 9.9 does, *both classes provide the same functionality*. The source code in Fig. 9.9 (47 lines) is considerably shorter than that in Fig. 9.6 (116 lines), because most of BasePlusCommissionEmployee's functionality is now inherited from CommissionEmployee—there's now only one copy of the CommissionEmployee functionality. This makes the code easier to maintain, modify and debug, because the code related to a commission employee exists only in class CommissionEmployee.

*Notes on Using protected Instance Variables*

In this example, we declared superclass instance variables as `protected` so that subclasses could access them. Inheriting `protected` instance variables slightly increases performance, because we can directly access the variables in the subclass without incurring the overhead of a `set` or `get` method call. In most cases, however, it's better to use `private` instance variables to encourage proper software engineering, and leave code optimization issues to the compiler. Your code will be easier to maintain, modify and debug.

Using `protected` instance variables creates several potential problems. First, the subclass object can set an inherited variable's value directly without using a `set` method. Therefore, a subclass object can assign an invalid value to the variable, possibly leaving the object in an inconsistent state. For example, if we were to declare `CommissionEmployee`'s instance variable `grossSales` as `protected`, a subclass object (e.g., `BasePlusCommissionEmployee`) could then assign a negative value to `grossSales`. Another problem with using `protected` instance variables is that subclass methods are more likely to be written so that they depend on the superclass's data implementation. In practice, subclasses should depend only on the superclass services (i.e., non-`private` methods) and not on the superclass data implementation. With `protected` instance variables in the superclass, we may need to modify all the subclasses of the superclass if the superclass implementation changes. For example, if for some reason we were to change the names of instance variables `firstName` and `lastName` to `first` and `last`, then we would have to do so for all occurrences in which a subclass directly references superclass instance variables `firstName` and `lastName`. In such a case, the software is said to be **fragile** or **brittle**, because a small change in the superclass can “break” subclass implementation. You should be able to change the superclass implementation while still providing the same services to the subclasses. Of course, if the superclass services change, we must reimplement our subclasses. A third problem is that a class's `protected` members are visible to all classes in the same package as the class containing the `protected` members—this is not always desirable.

**Software Engineering Observation 9.4**

*Use the `protected` access modifier when a superclass should provide a method only to its subclasses and other classes in the same package, but not to other clients.*

**Software Engineering Observation 9.5**

*Declaring superclass instance variables `private` (as opposed to `protected`) enables the superclass implementation of these instance variables to change without affecting subclass implementations.*

**Error-Prevention Tip 9.2**

*When possible, do not include `protected` instance variables in a superclass. Instead, include non-`private` methods that access `private` instance variables. This will help ensure that objects of the class maintain consistent states.*

### 9.4.5 `CommissionEmployee`–`BasePlusCommissionEmployee` Inheritance Hierarchy Using `private` Instance Variables

Let's reexamine our hierarchy once more, this time using good software engineering practices. Class `CommissionEmployee` (Fig. 9.10) declares instance variables `firstName`, `lastName`,

socialSecurityNumber, grossSales and commissionRate as *private* (lines 6–10) and provides public methods setFirstName, getFirstName, setLastName, getLastName, setSocialSecurityNumber, getSocialSecurityNumber, setGrossSales, getGrossSales, setCommissionRate, getCommissionRate, earnings and toString for manipulating these values. Methods earnings (lines 93–96) and toString (lines 99–107) use the class's *get* methods to obtain the values of its instance variables. If we decide to change the instance-variable names, the earnings and toString declarations will not require modification—only the bodies of the *get* and *set* methods that directly manipulate the instance variables will need to change. These changes occur solely within the superclass—no changes to the subclass are needed. *Localizing the effects of changes* like this is a good software engineering practice.

---

```

1 // Fig. 9.10: CommissionEmployee.java
2 // CommissionEmployee class uses methods to manipulate its
3 // private instance variables.
4 public class CommissionEmployee
5 {
6 private String firstName;
7 private String lastName;
8 private String socialSecurityNumber;
9 private double grossSales; // gross weekly sales
10 private double commissionRate; // commission percentage
11
12 // five-argument constructor
13 public CommissionEmployee(String first, String last, String ssn,
14 double sales, double rate)
15 {
16 // implicit call to Object constructor occurs here
17 firstName = first;
18 lastName = last;
19 socialSecurityNumber = ssn;
20 setGrossSales(sales); // validate and store gross sales
21 setCommissionRate(rate); // validate and store commission rate
22 } // end five-argument CommissionEmployee constructor
23
24 // set first name
25 public void setFirstName(String first)
26 {
27 firstName = first; // should validate
28 } // end method setFirstName
29
30 // return first name
31 public String getFirstName()
32 {
33 return firstName;
34 } // end method getFirstName
35
36 // set last name
37 public void setLastName(String last)
38 {

```

---

**Fig. 9.10** | CommissionEmployee class uses methods to manipulate its private instance variables. (Part 1 of 3.)

```
39 lastName = last; // should validate
40 } // end method setLastName
41
42 // return last name
43 public String getLastName()
44 {
45 return lastName;
46 } // end method getLastName
47
48 // set social security number
49 public void setSocialSecurityNumber(String ssn)
50 {
51 socialSecurityNumber = ssn; // should validate
52 } // end method setSocialSecurityNumber
53
54 // return social security number
55 public String getSocialSecurityNumber()
56 {
57 return socialSecurityNumber;
58 } // end method getSocialSecurityNumber
59
60 // set gross sales amount
61 public void setGrossSales(double sales)
62 {
63 if (sales >= 0.0)
64 grossSales = sales;
65 else
66 throw new IllegalArgumentException(
67 "Gross sales must be >= 0.0");
68 } // end method setGrossSales
69
70 // return gross sales amount
71 public double getGrossSales()
72 {
73 return grossSales;
74 } // end method getGrossSales
75
76 // set commission rate
77 public void setCommissionRate(double rate)
78 {
79 if (rate > 0.0 && rate < 1.0)
80 commissionRate = rate;
81 else
82 throw new IllegalArgumentException(
83 "Commission rate must be > 0.0 and < 1.0");
84 } // end method setCommissionRate
85
86 // return commission rate
87 public double getCommissionRate()
88 {
89 return commissionRate;
90 } // end method getCommissionRate
```

**Fig. 9.10** | CommissionEmployee class uses methods to manipulate its private instance variables. (Part 2 of 3.)

---

```

91
92 // calculate earnings
93 public double earnings()
94 {
95 return getCommissionRate() * getGrossSales();
96 } // end method earnings
97
98 // return String representation of CommissionEmployee object
99 @Override // indicates that this method overrides a superclass method
100 public String toString()
101 {
102 return String.format("%s: %s %s\n%s: %s\n%s: %.2f\n%s: %.2f",
103 "commission employee", getFirstName(), getLastName(),
104 "social security number", getSocialSecurityNumber(),
105 "gross sales", getGrossSales(),
106 "commission rate", getCommissionRate());
107 } // end method toString
108 } // end class CommissionEmployee

```

---

**Fig. 9.10** | CommissionEmployee class uses methods to manipulate its private instance variables. (Part 3 of 3.)

Subclass BasePlusCommissionEmployee (Fig. 9.11) inherits CommissionEmployee's non-private methods and can access the private superclass members via those methods. Class BasePlusCommissionEmployee has several changes that distinguish it from Fig. 9.9. Methods earnings (lines 35–39) and toString (lines 42–47) each invoke method getBaseSalary to obtain the base salary value, rather than accessing baseSalary directly. If we decide to rename instance variable baseSalary, only the bodies of method setBaseSalary and getBaseSalary will need to change.

---

```

1 // Fig. 9.11: BasePlusCommissionEmployee.java
2 // BasePlusCommissionEmployee class inherits from CommissionEmployee
3 // and accesses the superclass's private data via inherited
4 // public methods.
5
6 public class BasePlusCommissionEmployee extends CommissionEmployee
7 {
8 private double baseSalary; // base salary per week
9
10 // six-argument constructor
11 public BasePlusCommissionEmployee(String first, String last,
12 String ssn, double sales, double rate, double salary)
13 {
14 super(first, last, ssn, sales, rate);
15 setBaseSalary(salary); // validate and store base salary
16 } // end six-argument BasePlusCommissionEmployee constructor
17

```

---

**Fig. 9.11** | BasePlusCommissionEmployee class inherits from CommissionEmployee and accesses the superclass's private data via inherited public methods. (Part 1 of 2.)

```

18 // set base salary
19 public void setBaseSalary(double salary)
20 {
21 if (salary >= 0.0)
22 baseSalary = salary;
23 else
24 throw new IllegalArgumentException(
25 "Base salary must be >= 0.0");
26 } // end method setBaseSalary
27
28 // return base salary
29 public double getBaseSalary()
30 {
31 return baseSalary;
32 } // end method getBaseSalary
33
34 // calculate earnings
35 @Override // indicates that this method overrides a superclass method
36 public double earnings()
37 {
38 return getBaseSalary() + super.earnings();
39 } // end method earnings
40
41 // return String representation of BasePlusCommissionEmployee
42 @Override // indicates that this method overrides a superclass method
43 public String toString()
44 {
45 return String.format("%s %s\n%s: %.2f", "base-salaried",
46 super.toString(), "base salary", getBaseSalary());
47 } // end method toString
48 } // end class BasePlusCommissionEmployee

```

**Fig. 9.11** | BasePlusCommissionEmployee class inherits from CommissionEmployee and accesses the superclass’s private data via inherited public methods. (Part 2 of 2.)

### *Class BasePlusCommissionEmployee’s earnings Method*

Method earnings (lines 35–39) overrides class CommissionEmployee’s earnings method (Fig. 9.10, lines 93–96) to calculate a base-salaried commission employee’s earnings. The new version obtains the portion of the earnings based on commission alone by calling CommissionEmployee’s earnings method with super.earnings() (line 34), then adds the base salary to this value to calculate the total earnings. Note the syntax used to invoke an overridden superclass method from a subclass—place the keyword super and a dot (.) separator before the superclass method name. This method invocation is a good software engineering practice—if a method performs all or some of the actions needed by another method, call that method rather than duplicate its code. By having BasePlusCommissionEmployee’s earnings method invoke CommissionEmployee’s earnings method to calculate part of a BasePlusCommissionEmployee object’s earnings, we *avoid duplicating the code* and *reduce code-maintenance problems*. If we did not use “super.” then BasePlusCommissionEmployee’s earnings method would *call itself* rather than the superclass version. This would result in a phenomenon we study in Chapter 18 called *infinite recursion*, which would eventually cause the method-call stack to overflow—a fatal runtime error.

### *Class BasePlusCommissionEmployee's toString Method*

Similarly, `BasePlusCommissionEmployee`'s `toString` method (Fig. 9.11, lines 38–43) overrides class `CommissionEmployee`'s `toString` method (Fig. 9.10, lines 91–99) to return a `String` representation that's appropriate for a base-salaried commission employee. The new version creates part of a `BasePlusCommissionEmployee` object's `String` representation (i.e., the `String` "commission employee" and the values of class `CommissionEmployee`'s private instance variables) by calling `CommissionEmployee`'s `toString` method with the expression `super.toString()` (Fig. 9.11, line 42). `BasePlusCommissionEmployee`'s `toString` method then outputs the remainder of a `BasePlusCommissionEmployee` object's `String` representation (i.e., the value of class `BasePlusCommissionEmployee`'s base salary).



### **Common Programming Error 9.3**

*When a superclass method is overridden in a subclass, the subclass version often calls the superclass version to do a portion of the work. Failure to prefix the superclass method name with the keyword `super` and a dot (`.`) separator when calling the superclass's method causes the subclass method to call itself, potentially creating an error called infinite recursion. Recursion, used correctly, is a powerful capability discussed in Chapter 18.*

### *Testing Class BasePlusCommissionEmployee*

Class `BasePlusCommissionEmployeeTest` performs the same manipulations on a `BasePlusCommissionEmployee` object as in Fig. 9.7 and produces the same output, so we do not show it here. Although each `BasePlusCommissionEmployee` class you've seen behaves identically, the version in Fig. 9.11 is the best engineered. By using inheritance and by calling methods that hide the data and ensure consistency, we've efficiently and effectively constructed a well-engineered class.

### *Summary of the Inheritance Examples in Sections 9.4.1–9.4.5*

You've now seen a set of examples that were designed to teach good software engineering with inheritance. You used the keyword `extends` to create a subclass using inheritance, used protected superclass members to enable a subclass to access inherited superclass instance variables, and overrode superclass methods to provide versions that are more appropriate for subclass objects. In addition, you applied software engineering techniques from Chapter 8 and this chapter to create classes that are easy to maintain, modify and debug.

## **9.5 Constructors in Subclasses**

As we explained in the preceding section, instantiating a subclass object begins a chain of constructor calls in which the subclass constructor, before performing its own tasks, invokes its direct superclass's constructor either explicitly via the `super` reference or implicitly calling the superclass's default constructor or no-argument constructor. Similarly, if the superclass is derived from another class—as is, of course, every class except `Object`—the superclass constructor invokes the constructor of the next class up the hierarchy, and so on. The last constructor called in the chain is *always* the constructor for class `Object`. The original subclass constructor's body finishes executing *last*. Each superclass's constructor manipulates the superclass instance variables that the subclass object inherits. For example, consider again the `CommissionEmployee`–`BasePlusCommissionEmployee` hierarchy from Fig. 9.10 and Fig. 9.11. When a program creates a `BasePlusCommissionEmployee` object, its constructor is called. That constructor calls `CommissionEmployee`'s constructor,

which in turn calls `Object`'s constructor. Class `Object`'s constructor has an empty body, so it immediately returns control to `CommissionEmployee`'s constructor, which then initializes the `CommissionEmployee` private instance variables that are part of the `BasePlusCommissionEmployee` object. When `CommissionEmployee`'s constructor completes execution, it returns control to `BasePlusCommissionEmployee`'s constructor, which initializes the `BasePlusCommissionEmployee` object's `baseSalary`.



### Software Engineering Observation 9.6

*Java ensures that even if a constructor does not assign a value to an instance variable, the variable is still initialized to its default value (e.g., 0 for primitive numeric types, false for booleans, null for references).*

## 9.6 Software Engineering with Inheritance

When you extend a class, the new class inherits the superclass's members—though the private superclass members are *hidden* in the new class. You can *customize* the new class to meet your needs by *including additional members* and by *overriding* superclass members. Doing this does not require the subclass programmer to change (or even have access to) the superclass's source code. Java simply requires access to the superclass's `.class` file so it can compile and execute any program that uses or extends the superclass. This powerful capability is attractive to independent software vendors (ISVs), who can develop proprietary classes for sale or license and make them available to users in bytecode format. Users then can derive new classes from these library classes rapidly and without accessing the ISVs' proprietary source code.



### Software Engineering Observation 9.7

*Although inheriting from a class does not require access to the class's source code, developers often insist on seeing the source code to understand how the class is implemented. Developers in industry want to ensure that they're extending a solid class—for example, a class that performs well and is implemented robustly and securely.*

It's sometimes difficult to appreciate the scope of the problems faced by designers who work on large-scale software projects. People experienced with such projects say that effective software reuse improves the software-development process. Object-oriented programming facilitates software reuse, often significantly shortening development time.

The availability of substantial and useful class libraries delivers the maximum benefits of software reuse through inheritance. The standard Java class libraries that are shipped with Java tend to be rather general purpose, encouraging broad software reuse. Many other class libraries exist.

Reading subclass declarations can be confusing, because inherited members are not declared explicitly in the subclasses but are nevertheless present in them. A similar problem exists in documenting subclass members.



### Software Engineering Observation 9.8

*At the design stage in an object-oriented system, you'll often find that certain classes are closely related. You should "factor out" common instance variables and methods and place them in a superclass. Then use inheritance to develop subclasses, specializing them with capabilities beyond those inherited from the superclass.*





### Software Engineering Observation 9.9

*Declaring a subclass does not affect its superclass's source code. Inheritance preserves the integrity of the superclass.*



### Software Engineering Observation 9.10

*Designers of object-oriented systems should avoid class proliferation. Such proliferation creates management problems and can hinder software reusability, because in a huge class library it becomes difficult to locate the most appropriate classes. The alternative is to create fewer classes that provide more substantial functionality, but such classes might prove cumbersome.*

## 9.7 Class Object

As we discussed earlier in this chapter, all classes in Java inherit directly or indirectly from the `Object` class (package `java.lang`), so its 11 methods (some are overloaded) are inherited by all other classes. Figure 9.12 summarizes `Object`'s methods. We discuss several `Object` methods throughout this book (as indicated in Fig. 9.12).

| Method                | Description                                                                                                                                                                                                                                                                                                                                                                                                                                                                                                                                                                                                                                                                                                                                                                                                                                                                                                                                                                                                                      |
|-----------------------|----------------------------------------------------------------------------------------------------------------------------------------------------------------------------------------------------------------------------------------------------------------------------------------------------------------------------------------------------------------------------------------------------------------------------------------------------------------------------------------------------------------------------------------------------------------------------------------------------------------------------------------------------------------------------------------------------------------------------------------------------------------------------------------------------------------------------------------------------------------------------------------------------------------------------------------------------------------------------------------------------------------------------------|
| <code>clone</code>    | This protected method, which takes no arguments and returns an <code>Object</code> reference, makes a copy of the object on which it's called. The default implementation performs a so-called <b>shallow copy</b> —instance-variable values in one object are copied into another object of the same type. For reference types, only the references are copied. A typical overridden <code>clone</code> method's implementation would perform a <b>deep copy</b> that creates a new object for each reference-type instance variable. Implementing <code>clone</code> correctly is difficult. For this reason, its use is discouraged. Many industry experts suggest that object serialization should be used instead. We discuss object serialization in Chapter 17, Files, Streams and Object Serialization.                                                                                                                                                                                                                  |
| <code>equals</code>   | This method compares two objects for equality and returns <code>true</code> if they're equal and <code>false</code> otherwise. The method takes any <code>Object</code> as an argument. When objects of a particular class must be compared for equality, the class should override method <code>equals</code> to compare the <i>contents</i> of the two objects. For the requirements of implementing this method, refer to the method's documentation at <a href="http://download.oracle.com/javase/6/docs/api/java/lang/Object.html#equals(java.lang.Object)">download.oracle.com/javase/6/docs/api/java/lang/Object.html#equals(java.lang.Object)</a> . The default <code>equals</code> implementation uses operator <code>==</code> to determine whether two references <i>refer to the same object</i> in memory. Section 16.3.3 demonstrates class <code>String</code> 's <code>equals</code> method and differentiates between comparing <code>String</code> objects with <code>==</code> and with <code>equals</code> . |
| <code>finalize</code> | This protected method (introduced in Section 8.10) is called by the garbage collector to perform termination housekeeping on an object just before the garbage collector reclaims the object's memory. Recall that it's unclear whether, or when, method <code>finalize</code> will be called. For this reason, most programmers should avoid method <code>finalize</code> .                                                                                                                                                                                                                                                                                                                                                                                                                                                                                                                                                                                                                                                     |

**Fig. 9.12** | Object methods. (Part 1 of 2.)

| Method                                                              | Description                                                                                                                                                                                                                                                                                                                                             |
|---------------------------------------------------------------------|---------------------------------------------------------------------------------------------------------------------------------------------------------------------------------------------------------------------------------------------------------------------------------------------------------------------------------------------------------|
| <code>getClass</code>                                               | Every object in Java knows its own type at execution time. Method <code>getClass</code> (used in Sections 10.5, 14.5 and 24.3) returns an object of class <code>Class</code> (package <code>java.lang</code> ) that contains information about the object's type, such as its class name (returned by <code>Class</code> method <code>getName</code> ). |
| <code>hashCode</code>                                               | Hashcodes are <code>int</code> values that are useful for high-speed storage and retrieval of information stored in a data structure that's known as a hashtable (discussed in Section 20.11). This method is also called as part of class <code>Object</code> 's default <code>toString</code> method implementation.                                  |
| <code>wait</code> , <code>notify</code> ,<br><code>notifyAll</code> | Methods <code>notify</code> , <code>notifyAll</code> and the three overloaded versions of <code>wait</code> are related to multithreading, which is discussed in Chapter 26.                                                                                                                                                                            |
| <code>toString</code>                                               | This method (introduced in Section 9.4.1) returns a <code>String</code> representation of an object. The default implementation of this method returns the package name and class name of the object's class followed by a hexadecimal representation of the value returned by the object's <code>hashCode</code> method.                               |

**Fig. 9.12** | Object methods. (Part 2 of 2.)

Recall from Chapter 7 that arrays are objects. As a result, like all other objects, arrays inherit the members of class `Object`. Every array has an overridden `clone` method that copies the array. However, if the array stores references to objects, the objects are not copied—a *shallow copy* is performed.

## 9.8 (Optional) GUI and Graphics Case Study: Displaying Text and Images Using Labels

Programs often use labels when they need to display information or instructions to the user in a graphical user interface. **Labels** are a convenient way of identifying GUI components on the screen and keeping the user informed about the current state of the program. In Java, an object of class `JLabel` (from package `javax.swing`) can display text, an image or both. The example in Fig. 9.13 demonstrates several `JLabel` features, including a plain text label, an image label and a label with both text and an image.

Lines 3–6 import the classes we need to display `JLabels`. `BorderLayout` from package `java.awt` contains constants that specify where we can place GUI components in the `JFrame`. Class `ImageIcon` represents an image that can be displayed on a `JLabel`, and class `JFrame` represents the window that will contain all the labels.

```

1 // Fig 9.13: LabelDemo.java
2 // Demonstrates the use of labels.
3 import java.awt.BorderLayout;
4 import javax.swing.ImageIcon;
5 import javax.swing.JLabel;
6 import javax.swing.JFrame;
7

```

**Fig. 9.13** | `JLabel` with text and with images. (Part 1 of 2.)

```

8 public class LabelDemo
9 {
10 public static void main(String[] args)
11 {
12 // Create a label with plain text
13 JLabel northLabel = new JLabel("North");
14
15 // create an icon from an image so we can put it on a JLabel
16 ImageIcon labelIcon = new ImageIcon("GUItip.gif");
17
18 // create a label with an Icon instead of text
19 JLabel centerLabel = new JLabel(labelIcon);
20
21 // create another label with an Icon
22 JLabel southLabel = new JLabel(labelIcon);
23
24 // set the label to display text (as well as an icon)
25 southLabel.setText("South");
26
27 // create a frame to hold the labels
28 JFrame application = new JFrame();
29
30 application.setDefaultCloseOperation(JFrame.EXIT_ON_CLOSE);
31
32 // add the labels to the frame; the second argument specifies
33 // where on the frame to add the label
34 application.add(northLabel, BorderLayout.NORTH);
35 application.add(centerLabel, BorderLayout.CENTER);
36 application.add(southLabel, BorderLayout.SOUTH);
37
38 application.setSize(300, 300); // set the size of the frame
39 application.setVisible(true); // show the frame
40 } // end main
41 } // end class LabelDemo

```



**Fig. 9.13** | JLabel with text and with images. (Part 2 of 2.)

Line 13 creates a JLabel that displays its constructor argument—the string "North". Line 16 declares local variable labelIcon and assigns it a new ImageIcon. The constructor

for `ImageIcon` receives a `String` that specifies the path to the image. Since we specify only a file name, Java assumes that it's in the same directory as class `LabelDemo`. `ImageIcon` can load images in GIF, JPEG and PNG image formats. Line 19 declares and initializes local variable `centerLabel` with a `JLabel` that displays the `LabelIcon`. Line 22 declares and initializes local variable `southLabel` with a `JLabel` similar to the one in line 19. However, line 25 calls method `setText` to change the text the label displays. Method `setText` can be called on any `JLabel` to change its text. This `JLabel` displays both the icon and the text.

Line 28 creates the `JFrame` that displays the `JLabels`, and line 30 indicates that the program should terminate when the `JFrame` is closed. We attach the labels to the `JFrame` in lines 34–36 by calling an overloaded version of method `add` that takes two parameters. The first parameter is the component we want to attach, and the second is the region in which it should be placed. Each `JFrame` has an associated **layout** that helps the `JFrame` position the GUI components that are attached to it. The default layout for a `JFrame` is known as a **BorderLayout** and has five regions—NORTH (top), SOUTH (bottom), EAST (right side), WEST (left side) and CENTER. Each of these is declared as a constant in class `BorderLayout`. When calling method `add` with one argument, the `JFrame` places the component in the CENTER automatically. If a position already contains a component, then the new component takes its place. Lines 38 and 39 set the size of the `JFrame` and make it visible on screen.

### *GUI and Graphics Case Study Exercise*

**9.1** Modify GUI and Graphics Case Study Exercise 8.1 to include a `JLabel` as a status bar that displays counts representing the number of each shape displayed. Class `DrawPanel` should declare a method that returns a `String` containing the status text. In `main`, first create the `DrawPanel`, then create the `JLabel` with the status text as an argument to the `JLabel`'s constructor. Attach the `JLabel` to the SOUTH region of the `JFrame`, as shown in Fig. 9.14.

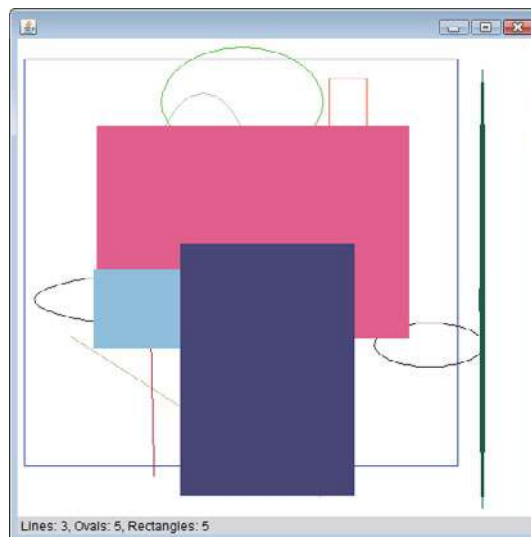

**Fig. 9.14** | `JLabel` displaying shape statistics.

## 9.9 Wrap-Up

This chapter introduced inheritance—the ability to create classes by absorbing an existing class’s members and embellishing them with new capabilities. You learned the notions of superclasses and subclasses and used keyword `extends` to create a subclass that inherits members from a superclass. We showed how to use the `@Override` annotation to prevent unintended overloading by indicating that a method overrides a superclass method. We introduced the access modifier `protected`; subclass methods can directly access `protected` superclass members. You learned how to use `super` to access overridden superclass members. You also saw how constructors are used in inheritance hierarchies. Finally, you learned about the methods of class `Object`, the direct or indirect superclass of all Java classes.

In Chapter 10, *Object-Oriented Programming: Polymorphism*, we build on our discussion of inheritance by introducing polymorphism—an object-oriented concept that enables us to write programs that conveniently handle, in a more general manner, objects of a wide variety of classes related by inheritance. After studying Chapter 10, you’ll be familiar with classes, objects, encapsulation, inheritance and polymorphism—the key technologies of object-oriented programming.

### Summary

#### *Section 9.1 Introduction*

- Inheritance (p. 360) reduces program-development time.
- The direct superclass (p. 360) of a subclass (specified by the keyword `extends` in the first line of a class declaration) is the superclass from which the subclass inherits. An indirect superclass (p. 360) of a subclass is two or more levels up the class hierarchy from that subclass.
- In single inheritance (p. 360), a class is derived from one direct superclass. In multiple inheritance, a class is derived from more than one direct superclass. Java does not support multiple inheritance.
- A subclass is more specific than its superclass and represents a smaller group of objects (p. 360).
- Every object of a subclass is also an object of that class’s superclass. However, a superclass object is not an object of its class’s subclasses.
- An *is-a* relationship (p. 361) represents inheritance. In an *is-a* relationship, an object of a subclass also can be treated as an object of its superclass.
- A *has-a* relationship (p. 361) represents composition. In a *has-a* relationship, a class object contains references to objects of other classes.

#### *Section 9.2 Superclasses and Subclasses*

- Single-inheritance relationships form treelike hierarchical structures—a superclass exists in a hierarchical relationship with its subclasses.

#### *Section 9.3 protected Members*

- A superclass’s `public` members are accessible wherever the program has a reference to an object of that superclass or one of its subclasses.
- A superclass’s `private` members can be accessed directly only within the superclass’s declaration.
- A superclass’s `protected` members (p. 363) have an intermediate level of protection between `public` and `private` access. They can be accessed by members of the superclass, by members of its subclasses and by members of other classes in the same package.

- A superclass's private members are hidden in its subclasses and can be accessed only through the `public` or protected methods inherited from the superclass.
- An overridden superclass method can be accessed from a subclass if the superclass method name is preceded by `super` (p. 363) and a dot (`.`) separator.

### Section 9.4 Relationship between Superclasses and Subclasses

- A subclass cannot access the private members of its superclass, but it can access the non-private members.
- A subclass can invoke a constructor of its superclass by using the keyword `super`, followed by a set of parentheses containing the superclass constructor arguments. This must appear as the first statement in the subclass constructor's body.
- A superclass method can be overridden in a subclass to declare an appropriate implementation for the subclass.
- The annotation `@Override` (p. 368) indicates that a method should override a superclass method. When the compiler encounters a method declared with `@Override`, it compares the method's signature with the superclass's method signatures. If there isn't an exact match, the compiler issues an error message, such as "method does not override or implement a method from a supertype."
- Method `toString` takes no arguments and returns a `String`. The `Object` class's `toString` method is normally overridden by a subclass.
- When an object is output using the `%s` format specifier, the object's `toString` method is called implicitly to obtain its `String` representation.

### Section 9.5 Constructors in Subclasses

- The first task of a subclass constructor is to call its direct superclass's constructor (p. 377) to ensure that the instance variables inherited from the superclass are initialized.

### Section 9.6 Software Engineering with Inheritance

- Declaring instance variables `private`, while providing non-private methods to manipulate and perform validation, helps enforce good software engineering.

### Section 9.7 Object Class

- See the table of class `Object`'s methods in Fig. 9.12.

## Self-Review Exercises

- 9.1 Fill in the blanks in each of the following statements:
- \_\_\_\_\_ is a form of software reusability in which new classes acquire the members of existing classes and embellish those classes with new capabilities.
  - A superclass's \_\_\_\_\_ members can be accessed in the superclass declaration *and in* subclass declarations.
  - In a(n) \_\_\_\_\_ relationship, an object of a subclass can also be treated as an object of its superclass.
  - In a(n) \_\_\_\_\_ relationship, a class object has references to objects of other classes as members.
  - In single inheritance, a class exists in a(n) \_\_\_\_\_ relationship with its subclasses.
  - A superclass's \_\_\_\_\_ members are accessible anywhere that the program has a reference to an object of that superclass or to an object of one of its subclasses.
  - When an object of a subclass is instantiated, a superclass \_\_\_\_\_ is called implicitly or explicitly.

h) Subclass constructors can call superclass constructors via the \_\_\_\_\_ keyword.

- 9.2** State whether each of the following is *true* or *false*. If a statement is *false*, explain why.
- Superclass constructors are not inherited by subclasses.
  - A *has-a* relationship is implemented via inheritance.
  - A Car class has an *is-a* relationship with the SteeringWheel and Brakes classes.
  - When a subclass redefines a superclass method by using the same signature, the subclass is said to overload that superclass method.

## Answers to Self-Review Exercises

**9.1** a) Inheritance. b) `public` and `protected`. c) *is-a* or inheritance. d) *has-a* or composition. e) hierarchical. f) `public`. g) constructor. h) `super`.

**9.2** a) True. b) False. A *has-a* relationship is implemented via composition. An *is-a* relationship is implemented via inheritance. c) False. This is an example of a *has-a* relationship. Class Car has an *is-a* relationship with class Vehicle. d) False. This is known as overriding, not overloading—an overloaded method has the same name, but a different signature.

## Exercises

**9.3** Many programs written with inheritance could be written with composition instead, and vice versa. Rewrite class `BasePlusCommissionEmployee` (Fig. 9.11) of the `CommissionEmployee–BasePlusCommissionEmployee` hierarchy to use composition rather than inheritance.

**9.4** Discuss the ways in which inheritance promotes software reuse, saves time during program development and helps prevent errors.

**9.5** Draw an inheritance hierarchy for students at a university similar to the hierarchy shown in Fig. 9.2. Use `Student` as the superclass of the hierarchy, then extend `Student` with classes `UndergraduateStudent` and `GraduateStudent`. Continue to extend the hierarchy as deep (i.e., as many levels) as possible. For example, `Freshman`, `Sophomore`, `Junior` and `Senior` might extend `UndergraduateStudent`, and `DoctoralStudent` and `MastersStudent` might be subclasses of `GraduateStudent`. After drawing the hierarchy, discuss the relationships that exist between the classes. [Note: You do not need to write any code for this exercise.]

**9.6** The world of shapes is much richer than the shapes included in the inheritance hierarchy of Fig. 9.3. Write down all the shapes you can think of—both two-dimensional and three-dimensional—and form them into a more complete `Shape` hierarchy with as many levels as possible. Your hierarchy should have class `Shape` at the top. Classes `TwoDimensionalShape` and `ThreeDimensionalShape` should extend `Shape`. Add additional subclasses, such as `Quadrilateral` and `Sphere`, at their correct locations in the hierarchy as necessary.

**9.7** Some programmers prefer not to use `protected` access, because they believe it breaks the encapsulation of the superclass. Discuss the relative merits of using `protected` access vs. using `private` access in superclasses.

**9.8** Write an inheritance hierarchy for classes `Quadrilateral`, `Trapezoid`, `Parallelogram`, `Rectangle` and `Square`. Use `Quadrilateral` as the superclass of the hierarchy. Create and use a `Point` class to represent the points in each shape. Make the hierarchy as deep (i.e., as many levels) as possible. Specify the instance variables and methods for each class. The `private` instance variables of `Quadrilateral` should be the *x-y* coordinate pairs for the four endpoints of the `Quadrilateral`. Write a program that instantiates objects of your classes and outputs each object's area (except `Quadrilateral`).

# 10

## Object-Oriented Programming: Polymorphism

*One Ring to rule them all,  
One Ring to find them,  
One Ring to bring them all  
and in the darkness bind them.*

—John Ronald Reuel Tolkien

*General propositions do not  
decide concrete cases.*

—Oliver Wendell Holmes

*A philosopher of imposing  
stature doesn't think in a  
vacuum. Even his most abstract  
ideas are, to some extent,  
conditioned by what is or is not  
known in the time when he lives.*

—Alfred North Whitehead

*Why art thou cast down, O my  
soul?*

—Psalms 42:5

### Objectives

In this chapter you'll learn:

- The concept of polymorphism.
- To use overridden methods to effect polymorphism.
- To distinguish between abstract and concrete classes.
- To declare abstract methods to create abstract classes.
- How polymorphism makes systems extensible and maintainable.
- To determine an object's type at execution time.
- To declare and implement interfaces.

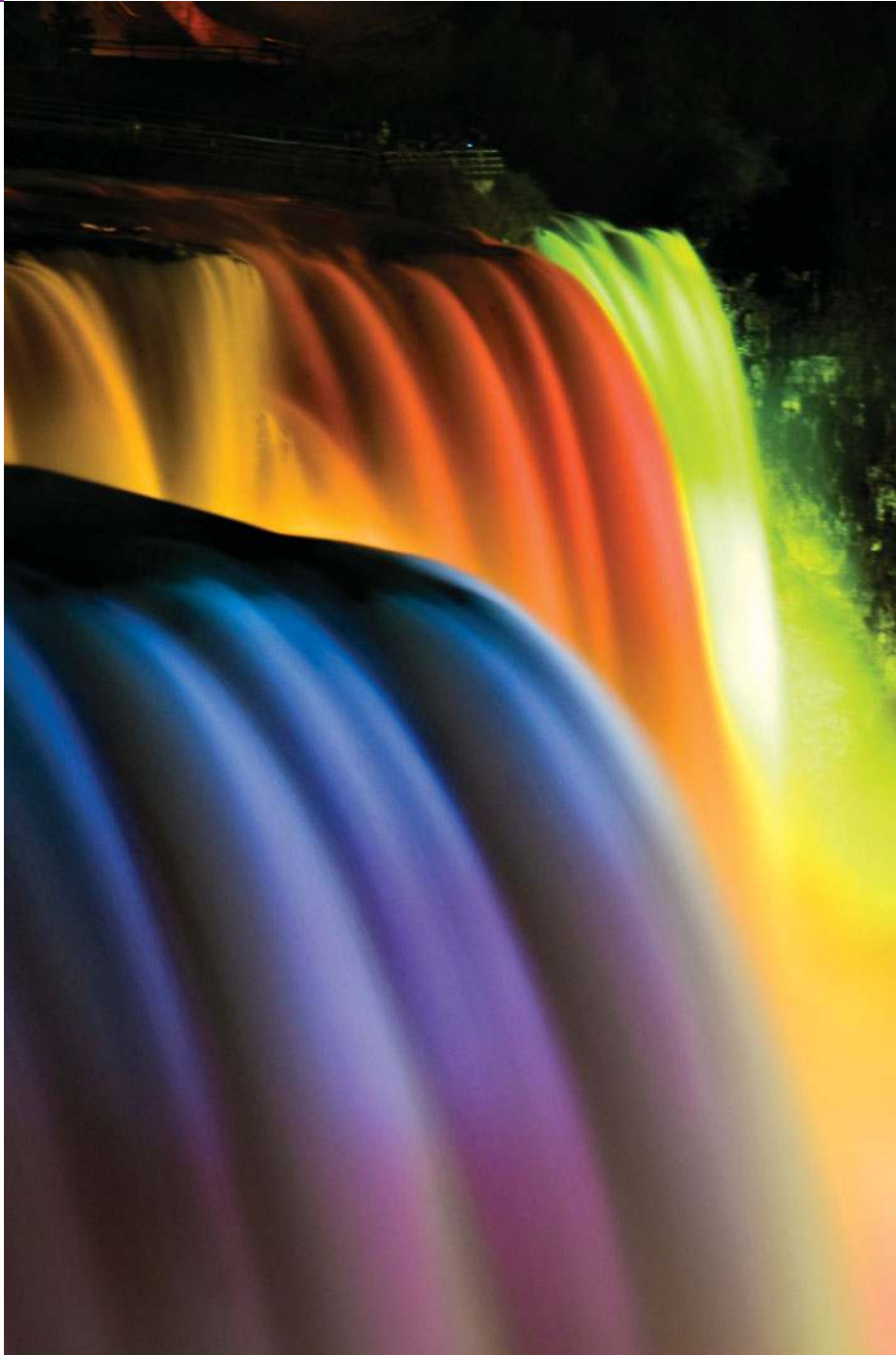



- 10.1 Introduction
- 10.2 Polymorphism Examples
- 10.3 Demonstrating Polymorphic Behavior
- 10.4 Abstract Classes and Methods
- 10.5 Case Study: Payroll System Using Polymorphism
  - 10.5.1 Abstract Superclass `Employee`
  - 10.5.2 Concrete Subclass `SalariedEmployee`
  - 10.5.3 Concrete Subclass `HourlyEmployee`
  - 10.5.4 Concrete Subclass `CommissionEmployee`
  - 10.5.5 Indirect Concrete Subclass `BasePlusCommissionEmployee`
  - 10.5.6 Polymorphic Processing, Operator `instanceof` and Downcasting
  - 10.5.7 Summary of the Allowed Assignments Between Superclass and Subclass Variables
- 10.6 `final` Methods and Classes
- 10.7 Case Study: Creating and Using Interfaces
  - 10.7.1 Developing a `Payable` Hierarchy
  - 10.7.2 Interface `Payable`
  - 10.7.3 Class `Invoice`
  - 10.7.4 Modifying Class `Employee` to Implement Interface `Payable`
  - 10.7.5 Modifying Class `SalariedEmployee` for Use in the `Payable` Hierarchy
  - 10.7.6 Using Interface `Payable` to Process `Invoices` and `Employees` Polymorphically
  - 10.7.7 Common Interfaces of the Java API
- 10.8 (Optional) GUI and Graphics Case Study: Drawing with Polymorphism
- 10.9 Wrap-Up

Summary | Self-Review Exercises | Answers to Self-Review Exercises | Exercises | Making a Difference

## 10.1 Introduction

We continue our study of object-oriented programming by explaining and demonstrating **polymorphism** with inheritance hierarchies. Polymorphism enables you to “program in the general” rather than “program in the specific.” In particular, polymorphism enables you to write programs that process objects that share the same superclass (either directly or indirectly) as if they’re all objects of the superclass; this can simplify programming.

Consider the following example of polymorphism. Suppose we create a program that simulates the movement of several types of animals for a biological study. Classes `Fish`, `Frog` and `Bird` represent the types of animals under investigation. Imagine that each class extends superclass `Animal`, which contains a method `move` and maintains an animal’s current location as  $x$ - $y$  coordinates. Each subclass implements method `move`. Our program maintains an `Animal` array containing references to objects of the various `Animal` subclasses. To simulate the animals’ movements, the program sends each object the *same* message once per second—namely, `move`. Each specific type of `Animal` responds to a `move` message in its own way—a `Fish` might swim three feet, a `Frog` might jump five feet and a `Bird` might fly ten feet. Each object knows how to modify its  $x$ - $y$  coordinates appropriately for its *specific* type of movement. Relying on each object to know how to “do the right thing” (i.e., do what is appropriate for that type of object) in response to the same method call is the key concept of polymorphism. The same message (in this case, `move`) sent to a variety of objects has “many forms” of results—hence the term polymorphism.

### *Implementing for Extensibility*

With polymorphism, we can design and implement systems that are easily extensible—new classes can be added with little or no modification to the general portions of the pro-

gram, as long as the new classes are part of the inheritance hierarchy that the program processes generically. The only parts of a program that must be altered are those that require direct knowledge of the new classes that we add to the hierarchy. For example, if we extend class `Animal` to create class `Tortoise` (which might respond to a move message by crawling one inch), we need to write only the `Tortoise` class and the part of the simulation that instantiates a `Tortoise` object. The portions of the simulation that tell each `Animal` to move generically can remain the same.

### Chapter Overview

First, we discuss common examples of polymorphism. We then provide a simple example demonstrating polymorphic behavior. We use superclass references to manipulate *both* superclass objects and subclass objects polymorphically.

We then present a case study that revisits the employee hierarchy of Section 9.4.5. We develop a simple payroll application that polymorphically calculates the weekly pay of several different types of employees using each employee's earnings method. Though the earnings of each type of employee are calculated in a specific way, polymorphism allows us to process the employees "in the general." In the case study, we enlarge the hierarchy to include two new classes—`SalariedEmployee` (for people paid a fixed weekly salary) and `HourlyEmployee` (for people paid an hourly salary and "time-and-a-half" for overtime). We declare a common set of functionality for all the classes in the updated hierarchy in an "abstract" class, `Employee`, from which "concrete" classes `SalariedEmployee`, `HourlyEmployee` and `CommissionEmployee` inherit directly and "concrete" class `BasePlusCommissionEmployee` inherits indirectly. As you'll soon see, *when we invoke each employee's earnings method off a superclass Employee reference, the correct earnings subclass calculation is performed*, due to Java's polymorphic capabilities.

### Programming in the Specific

Occasionally, when performing polymorphic processing, we need to program "in the specific." Our `Employee` case study demonstrates that a program can determine the type of an object at *execution time* and act on that object accordingly. In the case study, we've decided that `BasePlusCommissionEmployee`s should receive 10% raises on their base salaries. So, we use these capabilities to determine whether a particular employee object *is a* `BasePlusCommissionEmployee`. If so, we increase that employee's base salary by 10%.

### Interfaces

The chapter continues with an introduction to Java interfaces. An interface describes a set of methods that can be called on an object, but does *not* provide concrete implementations for all the methods. You can declare classes that **implement** (i.e., provide concrete implementations for the methods of) one or more interfaces. Each interface method must be declared in all the classes that explicitly implement the interface. Once a class implements an interface, all objects of that class have an *is-a* relationship with the interface type, and all objects of the class are guaranteed to provide the functionality described by the interface. This is true of all subclasses of that class as well.

Interfaces are particularly useful for assigning common functionality to possibly *unrelated* classes. This allows objects of unrelated classes to be processed polymorphically—objects of classes that implement the same interface can respond to all of the interface

method calls. To demonstrate creating and using interfaces, we modify our payroll application to create a general accounts payable application that can calculate payments due for company employees and invoice amounts to be billed for purchased goods. As you'll see, interfaces enable polymorphic capabilities similar to those possible with inheritance.

## 10.2 Polymorphism Examples

We now consider several additional examples of polymorphism.

### *Quadrilaterals*

If class `Rectangle` is derived from class `Quadrilateral`, then a `Rectangle` object is a more specific version of a `Quadrilateral`. Any operation (e.g., calculating the perimeter or the area) that can be performed on a `Quadrilateral` can also be performed on a `Rectangle`. These operations can also be performed on other `Quadrilaterals`, such as `Squares`, `Parallelograms` and `Trapezoids`. The polymorphism occurs when a program invokes a method through a superclass `Quadrilateral` variable—at execution time, the correct subclass version of the method is called, based on the type of the reference stored in the superclass variable. You'll see a simple code example that illustrates this process in Section 10.3.

### *Space Objects in a Video Game*

Suppose we design a video game that manipulates objects of classes `Martian`, `Venusian`, `Plutonian`, `SpaceShip` and `LaserBeam`. Imagine that each class inherits from the superclass `SpaceObject`, which contains method `draw`. Each subclass implements this method. A screen manager maintains a collection (e.g., a `SpaceObject` array) of references to objects of the various classes. To refresh the screen, the screen manager periodically sends each object the same message—namely, `draw`. However, each object responds its own way, based on its class. For example, a `Martian` object might draw itself in red with green eyes and the appropriate number of antennae. A `SpaceShip` object might draw itself as a bright silver flying saucer. A `LaserBeam` object might draw itself as a bright red beam across the screen. Again, the *same* message (in this case, `draw`) sent to a variety of objects has “many forms” of results.

A screen manager might use polymorphism to facilitate adding new classes to a system with minimal modifications to the system's code. Suppose that we want to add `Mercurian` objects to our video game. To do so, we'd build a class `Mercurian` that extends `SpaceObject` and provides its own `draw` method implementation. When `Mercurian` objects appear in the `SpaceObject` collection, the screen manager code *invokes method `draw`, exactly as it does for every other object in the collection, regardless of its type*. So the new `Mercurian` objects simply “plug right in” without any modification of the screen manager code by the programmer. Thus, without modifying the system (other than to build new classes and modify the code that creates new objects), you can use polymorphism to conveniently include additional types that were not envisioned when the system was created.



### Software Engineering Observation 10.1

*Polymorphism enables you to deal in generalities and let the execution-time environment handle the specifics. You can command objects to behave in manners appropriate to those objects, without knowing their types (as long as the objects belong to the same inheritance hierarchy).*



### Software Engineering Observation 10.2

*Polymorphism promotes extensibility: Software that invokes polymorphic behavior is independent of the object types to which messages are sent. New object types that can respond to existing method calls can be incorporated into a system without modifying the base system. Only client code that instantiates new objects must be modified to accommodate new types.*

## 10.3 Demonstrating Polymorphic Behavior

Section 9.4 created a class hierarchy, in which class `BasePlusCommissionEmployee` inherited from `CommissionEmployee`. The examples in that section manipulated `CommissionEmployee` and `BasePlusCommissionEmployee` objects by using references to them to invoke their methods—we aimed superclass variables at superclass objects and subclass variables at subclass objects. These assignments are natural and straightforward—superclass variables are *intended* to refer to superclass objects, and subclass variables are *intended* to refer to subclass objects. However, as you'll soon see, other assignments are possible.

In the next example, we aim a *superclass* reference at a *subclass* object. We then show how invoking a method on a subclass object via a superclass reference invokes the *subclass* functionality—the type of the *referenced object*, not the type of the *variable*, determines which method is called. This example demonstrates that *an object of a subclass can be treated as an object of its superclass*, enabling various interesting manipulations. A program can create an array of superclass variables that refer to objects of many subclass types. This is allowed because each subclass object *is an* object of its superclass. For instance, we can assign the reference of a `BasePlusCommissionEmployee` object to a superclass `CommissionEmployee` variable, because a `BasePlusCommissionEmployee` *is a* `CommissionEmployee`—we can treat a `BasePlusCommissionEmployee` as a `CommissionEmployee`.

As you'll learn later in the chapter, you *cannot treat a superclass object as a subclass object*, because a superclass object is *not* an object of any of its subclasses. For example, we cannot assign the reference of a `CommissionEmployee` object to a subclass `BasePlusCommissionEmployee` variable, because a `CommissionEmployee` is *not* a `BasePlusCommissionEmployee`—a `CommissionEmployee` does *not* have a `baseSalary` instance variable and does *not* have methods `setBaseSalary` and `getBaseSalary`. The *is-a* relationship applies only *up the hierarchy* from a subclass to its direct (and indirect) superclasses, and *not vice versa* (i.e., not down the hierarchy from a superclass to its subclasses).

The Java compiler *does* allow the assignment of a superclass reference to a subclass variable if we explicitly cast the superclass reference to the subclass type—a technique we discuss in Section 10.5. Why would we ever want to perform such an assignment? A superclass reference can be used to invoke only the methods declared in the superclass—attempting to invoke subclass-only methods through a superclass reference results in compilation errors. If a program needs to perform a subclass-specific operation on a subclass object referenced by a superclass variable, the program must first cast the superclass reference to a subclass reference through a technique known as **downcasting**. This enables the program to invoke subclass methods that are not in the superclass. We show a downcasting example in Section 10.5.

The example in Fig. 10.1 demonstrates three ways to use superclass and subclass variables to store references to superclass and subclass objects. The first two are straightfor-

ward—as in Section 9.4, we assign a superclass reference to a superclass variable, and a subclass reference to a subclass variable. Then we demonstrate the relationship between subclasses and superclasses (i.e., the *is-a* relationship) by assigning a subclass reference to a superclass variable. This program uses classes `CommissionEmployee` and `BasePlusCommissionEmployee` from Fig. 9.10 and Fig. 9.11, respectively.

```

1 // Fig. 10.1: PolymorphismTest.java
2 // Assigning superclass and subclass references to superclass and
3 // subclass variables.
4
5 public class PolymorphismTest
6 {
7 public static void main(String[] args)
8 {
9 // assign superclass reference to superclass variable
10 CommissionEmployee commissionEmployee = new CommissionEmployee(
11 "Sue", "Jones", "222-22-2222", 10000, .06);
12
13 // assign subclass reference to subclass variable
14 BasePlusCommissionEmployee basePlusCommissionEmployee =
15 new BasePlusCommissionEmployee(
16 "Bob", "Lewis", "333-33-3333", 5000, .04, 300);
17
18 // invoke toString on superclass object using superclass variable
19 System.out.printf("%s %s:\n\n%s\n\n",
20 "Call CommissionEmployee's toString with superclass reference ",
21 "to superclass object", commissionEmployee.toString());
22
23 // invoke toString on subclass object using subclass variable
24 System.out.printf("%s %s:\n\n%s\n\n",
25 "Call BasePlusCommissionEmployee's toString with subclass",
26 "reference to subclass object",
27 basePlusCommissionEmployee.toString());
28
29 // invoke toString on subclass object using superclass variable
30 CommissionEmployee commissionEmployee2 =
31 basePlusCommissionEmployee;
32 System.out.printf("%s %s:\n\n%s\n",
33 "Call BasePlusCommissionEmployee's toString with superclass",
34 "reference to subclass object", commissionEmployee2.toString());
35 } // end main
36 } // end class PolymorphismTest

```

Call CommissionEmployee's toString with superclass reference to superclass object:

```

commission employee: Sue Jones
social security number: 222-22-2222
gross sales: 10000.00
commission rate: 0.06

```

**Fig. 10.1** | Assigning superclass and subclass references to superclass and subclass variables. (Part 1 of 2.)

```

Call BasePlusCommissionEmployee's toString with subclass reference to
subclass object:

base-salaried commission employee: Bob Lewis
social security number: 333-33-3333
gross sales: 5000.00
commission rate: 0.04
base salary: 300.00

Call BasePlusCommissionEmployee's toString with superclass reference to
subclass object:

base-salaried commission employee: Bob Lewis
social security number: 333-33-3333
gross sales: 5000.00
commission rate: 0.04
base salary: 300.00

```

**Fig. 10.1** | Assigning superclass and subclass references to superclass and subclass variables. (Part 2 of 2.)

In Fig. 10.1, lines 10–11 create a `CommissionEmployee` object and assign its reference to a `CommissionEmployee` variable. Lines 14–16 create a `BasePlusCommissionEmployee` object and assign its reference to a `BasePlusCommissionEmployee` variable. These assignments are natural—for example, a `CommissionEmployee` variable’s primary purpose is to hold a reference to a `CommissionEmployee` object. Lines 19–21 use `commissionEmployee` to invoke `toString` explicitly. Because `commissionEmployee` refers to a `CommissionEmployee` object, superclass `CommissionEmployee`’s version of `toString` is called. Similarly, lines 24–27 use `basePlusCommissionEmployee` to invoke `toString` explicitly on the `BasePlusCommissionEmployee` object. This invokes subclass `BasePlusCommissionEmployee`’s version of `toString`.

Lines 30–31 then assign the reference of subclass object `basePlusCommissionEmployee` to a superclass `CommissionEmployee` variable, which lines 32–34 use to invoke method `toString`. *When a superclass variable contains a reference to a subclass object, and that reference is used to call a method, the subclass version of the method is called.* Hence, `commissionEmployee2.toString()` in line 34 actually calls class `BasePlusCommissionEmployee`’s `toString` method. The Java compiler allows this “crossover” because an object of a subclass *is an* object of its superclass (but not vice versa). When the compiler encounters a method call made through a variable, the compiler determines if the method can be called by checking the variable’s class type. If that class contains the proper method declaration (or inherits one), the call is compiled. At execution time, the type of the object to which the variable refers determines the actual method to use. This process, called *dynamic binding*, is discussed in detail in Section 10.5.

## 10.4 Abstract Classes and Methods

When we think of a class, we assume that programs will create objects of that type. Sometimes it’s useful to declare classes—called **abstract classes**—for which you *never* intend to create objects. Because they’re used only as superclasses in inheritance hierarchies, we refer

to them as **abstract superclasses**. These classes cannot be used to instantiate objects, because, as we'll soon see, abstract classes are *incomplete*. Subclasses must declare the “missing pieces” to become “concrete” classes, from which you can instantiate objects. Otherwise, these subclasses, too, will be abstract. We demonstrate abstract classes in Section 10.5.

### *Purpose of Abstract Classes*

An abstract class's purpose is to provide an appropriate superclass from which other classes can inherit and thus share a common design. In the Shape hierarchy of Fig. 9.3, for example, subclasses inherit the notion of what it means to be a Shape—perhaps common attributes such as `location`, `color` and `borderThickness`, and behaviors such as `draw`, `move`, `resize` and `changeColor`. Classes that can be used to instantiate objects are called **concrete classes**. Such classes provide implementations of *every* method they declare (some of the implementations can be inherited). For example, we could derive concrete classes `Circle`, `Square` and `Triangle` from abstract superclass `TwoDimensionalShape`. Similarly, we could derive concrete classes `Sphere`, `Cube` and `Tetrahedron` from abstract superclass `ThreeDimensionalShape`. Abstract superclasses are *too general* to create real objects—they specify only what is common among subclasses. We need to be more *specific* before we can create objects. For example, if you send the `draw` message to abstract class `TwoDimensionalShape`, the class knows that two-dimensional shapes should be drawable, but it does not know what specific shape to draw, so it cannot implement a real `draw` method. Concrete classes provide the specifics that make it reasonable to instantiate objects.

Not all hierarchies contain abstract classes. However, you'll often write client code that uses only abstract superclass types to reduce the client code's dependencies on a range of subclass types. For example, you can write a method with a parameter of an abstract superclass type. When called, such a method can receive an object of any concrete class that directly or indirectly extends the superclass specified as the parameter's type.

Abstract classes sometimes constitute several levels of a hierarchy. For example, the Shape hierarchy of Fig. 9.3 begins with abstract class `Shape`. On the next level of the hierarchy are *abstract* classes `TwoDimensionalShape` and `ThreeDimensionalShape`. The next level of the hierarchy declares *concrete* classes for `TwoDimensionalShapes` (`Circle`, `Square` and `Triangle`) and for `ThreeDimensionalShapes` (`Sphere`, `Cube` and `Tetrahedron`).

### *Declaring an Abstract Class and Abstract Methods*

You make a class abstract by declaring it with keyword **abstract**. An abstract class normally contains one or more **abstract methods**. An abstract method is one with keyword `abstract` in its declaration, as in

```
public abstract void draw(); // abstract method
```

Abstract methods do *not* provide implementations. A class that contains *any* abstract methods must be explicitly declared `abstract` even if that class contains some concrete (nonabstract) methods. Each concrete subclass of an abstract superclass also must provide concrete implementations of each of the superclass's abstract methods. Constructors and static methods cannot be declared `abstract`. Constructors are not inherited, so an abstract constructor could never be implemented. Though non-private static methods are inherited, they cannot be overridden. Since abstract methods are meant to be overridden so that they can process objects based on their types, it would not make sense to declare a static method as `abstract`.



### Software Engineering Observation 10.3

*An abstract class declares common attributes and behaviors (both abstract and concrete) of the various classes in a class hierarchy. An abstract class typically contains one or more abstract methods that subclasses must override if they are to be concrete. The instance variables and concrete methods of an abstract class are subject to the normal rules of inheritance.*



### Common Programming Error 10.1

*Attempting to instantiate an object of an abstract class is a compilation error.*



### Common Programming Error 10.2

*Failure to implement a superclass's abstract methods in a subclass is a compilation error unless the subclass is also declared abstract.*

## Using Abstract Classes to Declare Variables

Although we cannot instantiate objects of abstract superclasses, you'll soon see that we *can* use abstract superclasses to declare variables that can hold references to objects of any concrete class derived from those abstract superclasses. Programs typically use such variables to manipulate subclass objects polymorphically. You also can use abstract superclass names to invoke `static` methods declared in those abstract superclasses.

Consider another application of polymorphism. A drawing program needs to display many shapes, including types of new shapes that you'll add to the system after writing the drawing program. The drawing program might need to display shapes, such as `Circles`, `Triangles`, `Rectangles` or others, that derive from abstract class `Shape`. The drawing program uses `Shape` variables to manage the objects that are displayed. To draw any object in this inheritance hierarchy, the drawing program uses a superclass `Shape` variable containing a reference to the subclass object to invoke the object's `draw` method. This method is declared abstract in superclass `Shape`, so each concrete subclass *must* implement method `draw` in a manner specific to that shape—each object in the `Shape` inheritance hierarchy *knows how to draw itself*. The drawing program does not have to worry about the type of each object or whether the program has ever encountered objects of that type.

## Layered Software Systems

Polymorphism is particularly effective for implementing so-called layered software systems. In operating systems, for example, each type of physical device could operate quite differently from the others. Even so, commands to read or write data from and to devices may have a certain uniformity. For each device, the operating system uses a piece of software called a *device driver* to control all communication between the system and the device. The write message sent to a device-driver object needs to be interpreted specifically in the context of that driver and how it manipulates devices of a specific type. However, the write call itself really is no different from the write to any other device in the system—place some number of bytes from memory onto that device. An object-oriented operating system might use an abstract superclass to provide an “interface” appropriate for all device drivers. Then, through inheritance from that abstract superclass, subclasses are formed



that all behave similarly. The device-driver methods are declared as abstract methods in the abstract superclass. The implementations of these abstract methods are provided in the concrete subclasses that correspond to the specific types of device drivers. New devices are always being developed, often long after the operating system has been released. When you buy a new device, it comes with a device driver provided by the device vendor. The device is immediately operational after you connect it to your computer and install the driver. This is another elegant example of how polymorphism makes systems *extensible*.

## 10.5 Case Study: Payroll System Using Polymorphism

This section reexamines the `CommissionEmployee-BasePlusCommissionEmployee` hierarchy that we explored throughout Section 9.4. Now we use an abstract method and polymorphism to perform payroll calculations based on an enhanced employee inheritance hierarchy that meets the following requirements:

*A company pays its employees on a weekly basis. The employees are of four types: Salaried employees are paid a fixed weekly salary regardless of the number of hours worked, hourly employees are paid by the hour and receive overtime pay (i.e., 1.5 times their hourly salary rate) for all hours worked in excess of 40 hours, commission employees are paid a percentage of their sales and base-salaried commission employees receive a base salary plus a percentage of their sales. For the current pay period, the company has decided to reward salaried-commission employees by adding 10% to their base salaries. The company wants to write an application that performs its payroll calculations polymorphically.*

We use abstract class `Employee` to represent the general concept of an employee. The classes that extend `Employee` are `SalariedEmployee`, `CommissionEmployee` and `HourlyEmployee`. Class `BasePlusCommissionEmployee`—which extends `CommissionEmployee`—represents the last employee type. The UML class diagram in Fig. 10.2 shows the inheritance hierarchy for our polymorphic employee-payroll application. Abstract class name `Employee` is italicized—a convention of the UML.

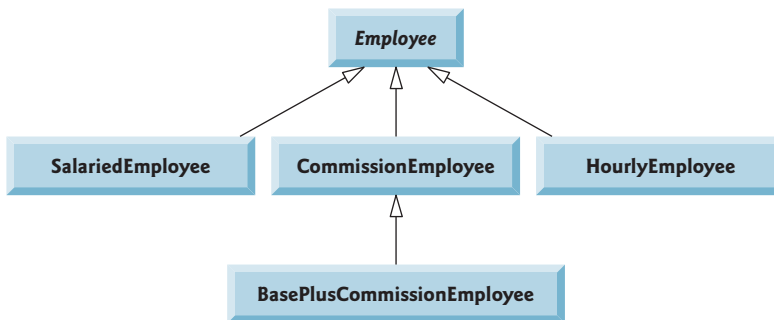

**Fig. 10.2** | `Employee` hierarchy UML class diagram.

Abstract superclass `Employee` declares the “interface” to the hierarchy—that is, the set of methods that a program can invoke on all `Employee` objects. We use the term “interface” here in a general sense to refer to the various ways programs can communicate with objects

of any `Employee` subclass. Be careful not to confuse the general notion of an “interface” with the formal notion of a Java interface, the subject of Section 10.7. Each employee, regardless of the way his or her earnings are calculated, has a first name, a last name and a social security number, so private instance variables `firstName`, `lastName` and `socialSecurityNumber` appear in abstract superclass `Employee`.

The following sections implement the `Employee` class hierarchy of Fig. 10.2. The first section implements abstract superclass `Employee`. The next four sections each implement one of the concrete classes. The last section implements a test program that builds objects of all these classes and processes those objects polymorphically.

### 10.5.1 Abstract Superclass `Employee`

Class `Employee` (Fig. 10.4) provides methods `earnings` and `toString`, in addition to the `get` and `set` methods that manipulate `Employee`’s instance variables. An `earnings` method certainly applies generically to all employees. But each `earnings` calculation depends on the employee’s class. So we declare `earnings` as abstract in superclass `Employee` because a default implementation does not make sense for that method—there isn’t enough information to determine what amount `earnings` should return. Each subclass overrides `earnings` with an appropriate implementation. To calculate an employee’s `earnings`, the program assigns to a superclass `Employee` variable a reference to the employee’s object, then invokes the `earnings` method on that variable. We maintain an array of `Employee` variables, each holding a reference to an `Employee` object. (Of course, there cannot be `Employee` objects, because `Employee` is an abstract class. Because of inheritance, however, all objects of all subclasses of `Employee` may nevertheless be thought of as `Employee` objects.) The program will iterate through the array and call method `earnings` for each `Employee` object. Java processes these method calls polymorphically. Declaring `earnings` as an abstract method in `Employee` enables the calls to `earnings` through `Employee` variables to compile and forces every direct concrete subclass of `Employee` to override `earnings`.

Method `toString` in class `Employee` returns a `String` containing the first name, last name and social security number of the employee. As we’ll see, each subclass of `Employee` overrides method `toString` to create a `String` representation of an object of that class that contains the employee’s type (e.g., “salaried employee:”) followed by the rest of the employee’s information.

The diagram in Fig. 10.3 shows each of the five classes in the hierarchy down the left side and methods `earnings` and `toString` across the top. For each class, the diagram shows the desired results of each method. We do not list superclass `Employee`’s `get` and `set` methods because they’re not overridden in any of the subclasses—each of these methods is inherited and used “as is” by each subclass.

Let’s consider class `Employee`’s declaration (Fig. 10.4). The class includes a constructor that takes the first name, last name and social security number as arguments (lines 11–16); `get` methods that return the first name, last name and social security number (lines 25–28, 37–40 and 49–52, respectively); `set` methods that set the first name, last name and social security number (lines 19–22, 31–34 and 43–46, respectively); method `toString` (lines 55–60), which returns the `String` representation of an `Employee`; and abstract method `earnings` (line 63), which will be implemented by each of the concrete subclasses. The `Employee` constructor does not validate its parameters in this example; normally, such validation should be provided.

|                                      | earnings                                                                                                                        | toString                                                                                                                                                                                                                |
|--------------------------------------|---------------------------------------------------------------------------------------------------------------------------------|-------------------------------------------------------------------------------------------------------------------------------------------------------------------------------------------------------------------------|
| Employee                             | abstract                                                                                                                        | <i>firstName lastName</i><br>social security number: <i>SSN</i>                                                                                                                                                         |
| Salaried-<br>Employee                | weeklySalary                                                                                                                    | salaried employee: <i>firstName lastName</i><br>social security number: <i>SSN</i><br>weekly salary: <i>weeklySalary</i>                                                                                                |
| Hourly-<br>Employee                  | <pre>if (hours &lt;= 40)     wage * hours else if (hours &gt; 40) {     40 * wage +     ( hours - 40 ) *     wage * 1.5 }</pre> | hourly employee: <i>firstName lastName</i><br>social security number: <i>SSN</i><br>hourly wage: <i>wage</i> ; hours worked: <i>hours</i>                                                                               |
| Commission-<br>Employee              | commissionRate *<br>grossSales                                                                                                  | commission employee: <i>firstName lastName</i><br>social security number: <i>SSN</i><br>gross sales: <i>grossSales</i> ;<br>commission rate: <i>commissionRate</i>                                                      |
| BasePlus-<br>Commission-<br>Employee | (commissionRate *<br>grossSales) +<br>baseSalary                                                                                | base salaried commission employee:<br><i>firstName lastName</i><br>social security number: <i>SSN</i><br>gross sales: <i>grossSales</i> ;<br>commission rate: <i>commissionRate</i> ;<br>base salary: <i>baseSalary</i> |

**Fig. 10.3** | Polymorphic interface for the Employee hierarchy classes.

```

1 // Fig. 10.4: Employee.java
2 // Employee abstract superclass.
3
4 public abstract class Employee
5 {
6 private String firstName;
7 private String lastName;
8 private String socialSecurityNumber;
9
10 // three-argument constructor
11 public Employee(String first, String last, String ssn)
12 {
13 firstName = first;
14 lastName = last;
15 socialSecurityNumber = ssn;
16 } // end three-argument Employee constructor
17
```

**Fig. 10.4** | Employee abstract superclass. (Part I of 2.)

```
18 // set first name
19 public void setFirstName(String first)
20 {
21 firstName = first; // should validate
22 } // end method setFirstName
23
24 // return first name
25 public String getFirstName()
26 {
27 return firstName;
28 } // end method getFirstName
29
30 // set last name
31 public void setLastName(String last)
32 {
33 lastName = last; // should validate
34 } // end method setLastName
35
36 // return last name
37 public String getLastName()
38 {
39 return lastName;
40 } // end method getLastName
41
42 // set social security number
43 public void setSocialSecurityNumber(String ssn)
44 {
45 socialSecurityNumber = ssn; // should validate
46 } // end method setSocialSecurityNumber
47
48 // return social security number
49 public String getSocialSecurityNumber()
50 {
51 return socialSecurityNumber;
52 } // end method getSocialSecurityNumber
53
54 // return String representation of Employee object
55 @Override
56 public String toString()
57 {
58 return String.format("%s %s\nsocial security number: %s",
59 getFirstName(), getLastName(), getSocialSecurityNumber());
60 } // end method toString
61
62 // abstract method overridden by concrete subclasses
63 public abstract double earnings(); // no implementation here
64 } // end abstract class Employee
```

**Fig. 10.4** | Employee abstract superclass. (Part 2 of 2.)

Why did we decide to declare `earnings` as an abstract method? It simply does not make sense to provide an implementation of this method in class `Employee`. We cannot calculate the earnings for a *general* `Employee`—we first must know the *specific* type of `Employee` to determine the appropriate earnings calculation. By declaring this method

abstract, we indicate that each concrete subclass *must* provide an appropriate earnings implementation and that a program will be able to use superclass `Employee` variables to invoke method `earnings` polymorphically for any type of `Employee`.

### 10.5.2 Concrete Subclass `SalariedEmployee`

Class `SalariedEmployee` (Fig. 10.5) extends class `Employee` (line 4) and overrides abstract method `earnings` (lines 33–37), which makes `SalariedEmployee` a concrete class. The class includes a constructor (lines 9–14) that takes a first name, a last name, a social security number and a weekly salary as arguments; a `set` method to assign a new nonnegative value to instance variable `weeklySalary` (lines 17–24); a `get` method to return `weeklySalary`'s value (lines 27–30); a method `earnings` (lines 33–37) to calculate a `SalariedEmployee`'s earnings; and a method `toString` (lines 40–45), which returns a `String` including the employee's type, namely, "salaried employee: " followed by employee-specific information produced by superclass `Employee`'s `toString` method and `SalariedEmployee`'s `getWeeklySalary` method. Class `SalariedEmployee`'s constructor passes the first name, last name and social security number to the `Employee` constructor (line 12) to initialize the private instance variables not inherited from the superclass. Method `earnings` overrides `Employee`'s abstract method `earnings` to provide a concrete implementation that returns the `SalariedEmployee`'s weekly salary. If we do not implement `earnings`, class `SalariedEmployee` must be declared abstract—otherwise, class `SalariedEmployee` will not compile. Of course, we want `SalariedEmployee` to be a concrete class in this example.

---

```

1 // Fig. 10.5: SalariedEmployee.java
2 // SalariedEmployee concrete class extends abstract class Employee.
3
4 public class SalariedEmployee extends Employee
5 {
6 private double weeklySalary;
7
8 // four-argument constructor
9 public SalariedEmployee(String first, String last, String ssn,
10 double salary)
11 {
12 super(first, last, ssn); // pass to Employee constructor
13 setWeeklySalary(salary); // validate and store salary
14 } // end four-argument SalariedEmployee constructor
15
16 // set salary
17 public void setWeeklySalary(double salary)
18 {
19 if (salary >= 0.0)
20 baseSalary = salary;
21 else
22 throw new IllegalArgumentException(
23 "Weekly salary must be >= 0.0");
24 } // end method setWeeklySalary
25

```

---

**Fig. 10.5** | `SalariedEmployee` concrete class extends abstract class `Employee`. (Part 1 of 2.)

```

26 // return salary
27 public double getWeeklySalary()
28 {
29 return weeklySalary;
30 } // end method getWeeklySalary
31
32 // calculate earnings; override abstract method earnings in Employee
33 @Override
34 public double earnings()
35 {
36 return getWeeklySalary();
37 } // end method earnings
38
39 // return String representation of SalariedEmployee object
40 @Override
41 public String toString()
42 {
43 return String.format("salaried employee: %s\n%s: $%,.2f",
44 super.toString(), "weekly salary", getWeeklySalary());
45 } // end method toString
46 } // end class SalariedEmployee

```

**Fig. 10.5** | SalariedEmployee concrete class extends abstract class Employee. (Part 2 of 2.)

Method `toString` (lines 40–45) overrides `Employee` method `toString`. If class `SalariedEmployee` did not override `toString`, `SalariedEmployee` would have inherited the `Employee` version of `toString`. In that case, `SalariedEmployee`'s `toString` method would simply return the employee's full name and social security number, which does not adequately represent a `SalariedEmployee`. To produce a complete `String` representation of a `SalariedEmployee`, the subclass's `toString` method returns "salaried employee: " followed by the superclass `Employee`-specific information (i.e., first name, last name and social security number) obtained by invoking the superclass's `toString` method (line 44)—this is a nice example of code reuse. The `String` representation of a `SalariedEmployee` also contains the employee's weekly salary obtained by invoking the class's `getWeeklySalary` method.

### 10.5.3 Concrete Subclass `HourlyEmployee`

Class `HourlyEmployee` (Fig. 10.6) also extends `Employee` (line 4). The class includes a constructor (lines 10–16) that takes as arguments a first name, a last name, a social security number, an hourly wage and the number of hours worked. Lines 19–26 and 35–42 declare *set* methods that assign new values to instance variables `wage` and `hours`, respectively. Method `setWage` (lines 19–26) ensures that `wage` is nonnegative, and method `setHours` (lines 35–42) ensures that `hours` is between 0 and 168 (the total number of hours in a week) inclusive. Class `HourlyEmployee` also includes *get* methods (lines 29–32 and 45–48) to return the values of `wage` and `hours`, respectively; a method `earnings` (lines 51–58) to calculate an `HourlyEmployee`'s earnings; and a method `toString` (lines 61–67), which returns a `String` containing the employee's type ("hourly employee: ") and the employee-specific information. The `HourlyEmployee` constructor, like the `SalariedEmployee` constructor, passes the first name, last name and social security number to the superclass `Employee` constructor

(line 13) to initialize the private instance variables. In addition, method `toString` calls superclass method `toString` (line 65) to obtain the `Employee`-specific information (i.e., first name, last name and social security number)—this is another nice example of code reuse.

---

```

1 // Fig. 10.6: HourlyEmployee.java
2 // HourlyEmployee class extends Employee.
3
4 public class HourlyEmployee extends Employee
5 {
6 private double wage; // wage per hour
7 private double hours; // hours worked for week
8
9 // five-argument constructor
10 public HourlyEmployee(String first, String last, String ssn,
11 double hourlyWage, double hoursWorked)
12 {
13 super(first, last, ssn);
14 setWage(hourlyWage); // validate hourly wage
15 setHours(hoursWorked); // validate hours worked
16 } // end five-argument HourlyEmployee constructor
17
18 // set wage
19 public void setWage(double hourlyWage)
20 {
21 if (hourlyWage >= 0.0)
22 wage = hourlyWage;
23 else
24 throw new IllegalArgumentException(
25 "Hourly wage must be >= 0.0");
26 } // end method setWage
27
28 // return wage
29 public double getWage()
30 {
31 return wage;
32 } // end method getWage
33
34 // set hours worked
35 public void setHours(double hoursWorked)
36 {
37 if ((hoursWorked >= 0.0) && (hoursWorked <= 168.0))
38 hours = hoursWorked;
39 else
40 throw new IllegalArgumentException(
41 "Hours worked must be >= 0.0 and <= 168.0");
42 } // end method setHours
43
44 // return hours worked
45 public double getHours()
46 {
47 return hours;
48 } // end method getHours

```

**Fig. 10.6** | HourlyEmployee class extends Employee. (Part I of 2.)

```

49
50 // calculate earnings; override abstract method earnings in Employee
51 @Override
52 public double earnings()
53 {
54 if (getHours() <= 40) // no overtime
55 return getWage() * getHours();
56 else
57 return 40 * getWage() + (getHours() - 40) * getWage() * 1.5;
58 } // end method earnings
59
60 // return String representation of HourlyEmployee object
61 @Override
62 public String toString()
63 {
64 return String.format("hourly employee: %s\n%s: $%,.2f; %s: $%,.2f",
65 super.toString(), "hourly wage", getWage(),
66 "hours worked", getHours());
67 } // end method toString
68 } // end class HourlyEmployee

```

**Fig. 10.6** | HourlyEmployee class extends Employee. (Part 2 of 2.)

### 10.5.4 Concrete Subclass CommissionEmployee

Class `CommissionEmployee` (Fig. 10.7) extends class `Employee` (line 4). The class includes a constructor (lines 10–16) that takes a first name, a last name, a social security number, a sales amount and a commission rate; *set* methods (lines 19–26 and 35–42) to assign new values to instance variables `commissionRate` and `grossSales`, respectively; *get* methods (lines 29–32 and 45–48) that retrieve the values of these instance variables; method `earnings` (lines 51–55) to calculate a `CommissionEmployee`'s earnings; and method `toString` (lines 58–65), which returns the employee's type, namely, "commission employee: " and employee-specific information. The constructor also passes the first name, last name and social security number to `Employee`'s constructor (line 13) to initialize `Employee`'s private instance variables. Method `toString` calls superclass method `toString` (line 62) to obtain the `Employee`-specific information (i.e., first name, last name and social security number).

```

1 // Fig. 10.7: CommissionEmployee.java
2 // CommissionEmployee class extends Employee.
3
4 public class CommissionEmployee extends Employee
5 {
6 private double grossSales; // gross weekly sales
7 private double commissionRate; // commission percentage
8
9 // five-argument constructor
10 public CommissionEmployee(String first, String last, String ssn,
11 double sales, double rate)
12 {
13 super(first, last, ssn);

```

**Fig. 10.7** | CommissionEmployee class extends Employee. (Part 1 of 2.)



```

14 setGrossSales(sales);
15 setCommissionRate(rate);
16 } // end five-argument CommissionEmployee constructor
17
18 // set commission rate
19 public void setCommissionRate(double rate)
20 {
21 if (rate > 0.0 && rate < 1.0)
22 commissionRate = rate;
23 else
24 throw new IllegalArgumentException(
25 "Commission rate must be > 0.0 and < 1.0");
26 } // end method setCommissionRate
27
28 // return commission rate
29 public double getCommissionRate()
30 {
31 return commissionRate;
32 } // end method getCommissionRate
33
34 // set gross sales amount
35 public void setGrossSales(double sales)
36 {
37 if (sales >= 0.0)
38 grossSales = sales;
39 else
40 throw new IllegalArgumentException(
41 "Gross sales must be >= 0.0");
42 } // end method setGrossSales
43
44 // return gross sales amount
45 public double getGrossSales()
46 {
47 return grossSales;
48 } // end method getGrossSales
49
50 // calculate earnings; override abstract method earnings in Employee
51 @Override
52 public double earnings()
53 {
54 return getCommissionRate() * getGrossSales();
55 } // end method earnings
56
57 // return String representation of CommissionEmployee object
58 @Override
59 public String toString()
60 {
61 return String.format("%s: %s\n%s: $%,.2f; %s: %.2f",
62 "commission employee", super.toString(),
63 "gross sales", getGrossSales(),
64 "commission rate", getCommissionRate());
65 } // end method toString
66 } // end class CommissionEmployee

```

**Fig. 10.7** | CommissionEmployee class extends Employee. (Part 2 of 2.)

### 10.5.5 Indirect Concrete Subclass BasePlusCommissionEmployee

Class `BasePlusCommissionEmployee` (Fig. 10.8) extends class `CommissionEmployee` (line 4) and therefore is an *indirect* subclass of class `Employee`. Class `BasePlusCommissionEmployee` has a constructor (lines 9–14) that takes as arguments a first name, a last name, a social security number, a sales amount, a commission rate and a base salary. It then passes all of these except the base salary to the `CommissionEmployee` constructor (line 12) to initialize the inherited members. `BasePlusCommissionEmployee` also contains a *set* method (lines 17–24) to assign a new value to instance variable `baseSalary` and a *get* method (lines 27–30) to return `baseSalary`'s value. Method `earnings` (lines 33–37) calculates a `BasePlusCommissionEmployee`'s earnings. Line 36 in method `earnings` calls superclass `CommissionEmployee`'s `earnings` method to calculate the commission-based portion of the employee's earnings—this is another nice example of code reuse. `BasePlusCommissionEmployee`'s `toString` method (lines 40–46) creates a `String` representation of a `BasePlusCommissionEmployee` that contains "base-salaried", followed by the `String` obtained by invoking superclass `CommissionEmployee`'s `toString` method (another example of code reuse), then the base salary. The result is a `String` beginning with "base-salaried commission employee" followed by the rest of the `BasePlusCommissionEmployee`'s information. Recall that `CommissionEmployee`'s `toString` obtains the employee's first name, last name and social security number by invoking the `toString` method of its superclass (i.e., `Employee`)—yet another example of code reuse. `BasePlusCommissionEmployee`'s `toString` initiates a chain of method calls that span all three levels of the `Employee` hierarchy.

---

```

1 // Fig. 10.8: BasePlusCommissionEmployee.java
2 // BasePlusCommissionEmployee class extends CommissionEmployee.
3
4 public class BasePlusCommissionEmployee extends CommissionEmployee
5 {
6 private double baseSalary; // base salary per week
7
8 // six-argument constructor
9 public BasePlusCommissionEmployee(String first, String last,
10 String ssn, double sales, double rate, double salary)
11 {
12 super(first, last, ssn, sales, rate);
13 setBaseSalary(salary); // validate and store base salary
14 } // end six-argument BasePlusCommissionEmployee constructor
15
16 // set base salary
17 public void setBaseSalary(double salary)
18 {
19 if (salary >= 0.0)
20 baseSalary = salary;
21 else
22 throw new IllegalArgumentException(
23 "Base salary must be >= 0.0");
24 } // end method setBaseSalary
25

```

---

**Fig. 10.8** | `BasePlusCommissionEmployee` class extends `CommissionEmployee`. (Part 1 of 2.)

```

26 // return base salary
27 public double getBaseSalary()
28 {
29 return baseSalary;
30 } // end method getBaseSalary
31
32 // calculate earnings; override method earnings in CommissionEmployee
33 @Override
34 public double earnings()
35 {
36 return getBaseSalary() + super.earnings();
37 } // end method earnings
38
39 // return String representation of BasePlusCommissionEmployee object
40 @Override
41 public String toString()
42 {
43 return String.format("%s %s; %s: $%,.2F",
44 "base-salaried", super.toString(),
45 "base salary", getBaseSalary());
46 } // end method toString
47 } // end class BasePlusCommissionEmployee

```

**Fig. 10.8** | BasePlusCommissionEmployee class extends CommissionEmployee. (Part 2 of 2.)

### 10.5.6 Polymorphic Processing, Operator instanceof and Downcasting

To test our Employee hierarchy, the application in Fig. 10.9 creates an object of each of the four concrete classes SalariedEmployee, HourlyEmployee, CommissionEmployee and BasePlusCommissionEmployee. The program manipulates these objects nonpolymorphically, via variables of each object's own type, then polymorphically, using an array of Employee variables. While processing the objects polymorphically, the program increases the base salary of each BasePlusCommissionEmployee by 10%—this requires *determining the object's type at execution time*. Finally, the program polymorphically determines and outputs the type of each object in the Employee array. Lines 9–18 create objects of each of the four concrete Employee subclasses. Lines 22–30 output the String representation and earnings of each of these objects *nonpolymorphically*. Each object's toString method is called *implicitly* by printf when the object is output as a String with the %s format specifier.

```

1 // Fig. 10.9: PayrollSystemTest.java
2 // Employee hierarchy test program.
3
4 public class PayrollSystemTest
5 {
6 public static void main(String[] args)
7 {
8 // create subclass objects
9 SalariedEmployee salariedEmployee =
10 new SalariedEmployee("John", "Smith", "111-11-1111", 800.00);

```

**Fig. 10.9** | Employee hierarchy test program. (Part 1 of 4.)

```

11 HourlyEmployee hourlyEmployee =
12 new HourlyEmployee("Karen", "Price", "222-22-2222", 16.75, 40);
13 CommissionEmployee commissionEmployee =
14 new CommissionEmployee(
15 "Sue", "Jones", "333-33-3333", 10000, .06);
16 BasePlusCommissionEmployee basePlusCommissionEmployee =
17 new BasePlusCommissionEmployee(
18 "Bob", "Lewis", "444-44-4444", 5000, .04, 300);
19
20 System.out.println("Employees processed individually:\n");
21
22 System.out.printf("%s\n%s: $%,.2f\n\n",
23 salariedEmployee, "earned", salariedEmployee.earnings());
24 System.out.printf("%s\n%s: $%,.2f\n\n",
25 hourlyEmployee, "earned", hourlyEmployee.earnings());
26 System.out.printf("%s\n%s: $%,.2f\n\n",
27 commissionEmployee, "earned", commissionEmployee.earnings());
28 System.out.printf("%s\n%s: $%,.2f\n\n",
29 basePlusCommissionEmployee,
30 "earned", basePlusCommissionEmployee.earnings());
31
32 // create four-element Employee array
33 Employee[] employees = new Employee[4];
34
35 // initialize array with Employees
36 employees[0] = salariedEmployee;
37 employees[1] = hourlyEmployee;
38 employees[2] = commissionEmployee;
39 employees[3] = basePlusCommissionEmployee;
40
41 System.out.println("Employees processed polymorphically:\n");
42
43 // generically process each element in array employees
44 for (Employee currentEmployee : employees)
45 {
46 System.out.println(currentEmployee); // invokes toString
47
48 // determine whether element is a BasePlusCommissionEmployee
49 if (currentEmployee instanceof BasePlusCommissionEmployee)
50 {
51 // downcast Employee reference to
52 // BasePlusCommissionEmployee reference
53 BasePlusCommissionEmployee employee =
54 (BasePlusCommissionEmployee) currentEmployee;
55
56 employee.setBaseSalary(1.10 * employee.getBaseSalary());
57
58 System.out.printf(
59 "new base salary with 10%% increase is: $%,.2f\n",
60 employee.getBaseSalary());
61 } // end if
62

```

**Fig. 10.9** | Employee hierarchy test program. (Part 2 of 4.)

```

63 System.out.printf(
64 "earned $%,.2F\n\n", currentEmployee.earnings());
65 } // end for
66
67 // get type name of each object in employees array
68 for (int j = 0; j < employees.length; j++)
69 System.out.printf("Employee %d is a %s\n", j,
70 employees[j].getClass().getName());
71 } // end main
72 } // end class PayrollSystemTest

```

Employees processed individually:

salaried employee: John Smith  
social security number: 111-11-1111  
weekly salary: \$800.00  
earned: \$800.00

hourly employee: Karen Price  
social security number: 222-22-2222  
hourly wage: \$16.75; hours worked: 40.00  
earned: \$670.00

commission employee: Sue Jones  
social security number: 333-33-3333  
gross sales: \$10,000.00; commission rate: 0.06  
earned: \$600.00

base-salaried commission employee: Bob Lewis  
social security number: 444-44-4444  
gross sales: \$5,000.00; commission rate: 0.04; base salary: \$300.00  
earned: \$500.00

Employees processed polymorphically:

salaried employee: John Smith  
social security number: 111-11-1111  
weekly salary: \$800.00  
earned \$800.00

hourly employee: Karen Price  
social security number: 222-22-2222  
hourly wage: \$16.75; hours worked: 40.00  
earned \$670.00

commission employee: Sue Jones  
social security number: 333-33-3333  
gross sales: \$10,000.00; commission rate: 0.06  
earned \$600.00

base-salaried commission employee: Bob Lewis  
social security number: 444-44-4444  
gross sales: \$5,000.00; commission rate: 0.04; base salary: \$300.00  
new base salary with 10% increase is: \$330.00  
earned \$530.00

**Fig. 10.9** | Employee hierarchy test program. (Part 3 of 4.)

```

Employee 0 is a SalariedEmployee
Employee 1 is a HourlyEmployee
Employee 2 is a CommissionEmployee
Employee 3 is a BasePlusCommissionEmployee

```

**Fig. 10.9** | Employee hierarchy test program. (Part 4 of 4.)

### *Creating the Array of Employees*

Line 33 declares `employees` and assigns it an array of four `Employee` variables. Line 36 assigns the reference to a `SalariedEmployee` object to `employees[0]`. Line 37 assigns the reference to an `HourlyEmployee` object to `employees[1]`. Line 38 assigns the reference to a `CommissionEmployee` object to `employees[2]`. Line 39 assigns the reference to a `BasePlusCommissionEmployee` object to `employees[3]`. These assignments are allowed, because a `SalariedEmployee` *is an* `Employee`, an `HourlyEmployee` *is an* `Employee`, a `CommissionEmployee` *is an* `Employee` and a `BasePlusCommissionEmployee` *is an* `Employee`. Therefore, we can assign the references of `SalariedEmployee`, `HourlyEmployee`, `CommissionEmployee` and `BasePlusCommissionEmployee` objects to superclass `Employee` variables, *even though* `Employee` *is an abstract class*.

### *Polymorphically Processing Employees*

Lines 44–65 iterate through array `employees` and invoke methods `toString` and `earnings` with `Employee` variable `currentEmployee`, which is assigned the reference to a different `Employee` in the array on each iteration. The output illustrates that the appropriate methods for each class are indeed invoked. All calls to method `toString` and `earnings` are resolved at execution time, based on the type of the object to which `currentEmployee` refers. This process is known as **dynamic binding** or **late binding**. For example, line 46 *implicitly* invokes method `toString` of the object to which `currentEmployee` refers. As a result of dynamic binding, Java decides which class's `toString` method to call *at execution time rather than at compile time*. Only the methods of class `Employee` can be called via an `Employee` variable (and `Employee`, of course, includes the methods of class `Object`). A superclass reference can be used to invoke only methods of the superclass—the subclass method implementations are invoked polymorphically.

### *Performing Type-Specific Operations on BasePlusCommissionEmployees*

We perform special processing on `BasePlusCommissionEmployee` objects—as we encounter these objects at execution time, we increase their base salary by 10%. When processing objects polymorphically, we typically do not need to worry about the “specifics,” but to adjust the base salary, we *do* have to determine the specific type of `Employee` object at execution time. Line 49 uses the **instanceof** operator to determine whether a particular `Employee` object's type is `BasePlusCommissionEmployee`. The condition in line 49 is true if the object referenced by `currentEmployee` *is a* `BasePlusCommissionEmployee`. This would also be true for any object of a `BasePlusCommissionEmployee` subclass because of the *is-a* relationship a subclass has with its superclass. Lines 53–54 downcast `currentEmployee` from type `Employee` to type `BasePlusCommissionEmployee`—this cast is allowed only if the object has an *is-a* relationship with `BasePlusCommissionEmployee`. The condition at line 49 ensures that this is the case. This cast is required if we're to invoke subclass `BasePlusCommissionEmployee` methods `getBaseSalary` and `setBaseSalary` on the cur-

rent `Employee` object—as you’ll see momentarily, *attempting to invoke a subclass-only method directly on a superclass reference is a compilation error.*



### Common Programming Error 10.3

*Assigning a superclass variable to a subclass variable (without an explicit cast) is a compilation error.*



### Software Engineering Observation 10.4

*If a subclass object’s reference has been assigned to a variable of one of its direct or indirect superclasses at execution time, it’s acceptable to downcast the reference stored in that superclass variable back to a subclass-type reference. Before performing such a cast, use the `instanceof` operator to ensure that the object is indeed an object of an appropriate subclass.*



### Common Programming Error 10.4

*When downcasting a reference, a `ClassCastException` occurs if the referenced object at execution time does not have an is-a relationship with the type specified in the cast operator.*

If the `instanceof` expression in line 49 is true, lines 53–60 perform the special processing required for the `BasePlusCommissionEmployee` object. Using `BasePlusCommissionEmployee` variable `employee`, line 56 invokes subclass-only methods `getBaseSalary` and `setBaseSalary` to retrieve and update the employee’s base salary with the 10% raise.

### Calling earnings Polymorphically

Lines 63–64 invoke method `earnings` on `currentEmployee`, which polymorphically calls the appropriate subclass object’s `earnings` method. Obtaining the earnings of the `SalaryedEmployee`, `HourlyEmployee` and `CommissionEmployee` polymorphically in lines 63–64 produces the same results as obtaining these employees’ earnings individually in lines 22–27. The earnings amount obtained for the `BasePlusCommissionEmployee` in lines 63–64 is higher than that obtained in lines 28–30, due to the 10% increase in its base salary.

### Using Reflection to Get Each Employee’s Class Name

Lines 68–70 display each employee’s type as a `String`, using basic features of Java’s so-called reflection capabilities. Every object knows its own class and can access this information through the `getClass` method, which all classes inherit from class `Object`. Method `getClass` returns an object of type `Class` (from package `java.lang`), which contains information about the object’s type, including its class name. Line 70 invokes `getClass` on the current object to get its runtime class. The result of the `getClass` call is used to invoke `getName` to get the object’s class name.

### Avoiding Compilation Errors with Downcasting

In the previous example, we avoided several compilation errors by downcasting an `Employee` variable to a `BasePlusCommissionEmployee` variable in lines 53–54. If you remove the cast operator (`BasePlusCommissionEmployee`) from line 54 and attempt to assign `Employee` variable `currentEmployee` directly to `BasePlusCommissionEmployee` variable `employee`, you’ll receive an “incompatible types” compilation error. This error indicates that the attempt to assign the reference of superclass object `currentEmployee` to subclass variable `employee` is not allowed. The compiler prevents this assignment because a `CommissionEmployee` is not a `BasePlusCommissionEmployee`—*the is-a relationship applies only between the subclass and its superclasses, not vice versa.*

Similarly, if lines 56 and 60 used superclass variable `currentEmployee` to invoke subclass-only methods `getBaseSalary` and `setBaseSalary`, we'd receive “cannot find symbol” compilation errors at these lines. Attempting to invoke subclass-only methods via a superclass variable is not allowed—even though lines 56 and 60 execute only if `instanceof` in line 49 returns true to indicate that `currentEmployee` holds a reference to a `BasePlusCommissionEmployee` object. Using a superclass `Employee` variable, we can invoke only methods found in class `Employee`—`earnings`, `toString` and `Employee`'s `get` and `set` methods.



### Software Engineering Observation 10.5

*Although the actual method that's called depends on the runtime type of the object to which a variable refers, a variable can be used to invoke only those methods that are members of that variable's type, which the compiler verifies.*

## 10.5.7 Summary of the Allowed Assignments Between Superclass and Subclass Variables

Now that you've seen a complete application that processes diverse subclass objects polymorphically, we summarize what you can and cannot do with superclass and subclass objects and variables. Although a subclass object also *is a* superclass object, the two objects are nevertheless different. As discussed previously, subclass objects can be treated as objects of their superclass. But because the subclass can have additional subclass-only members, assigning a superclass reference to a subclass variable is not allowed without an explicit cast—such an assignment would leave the subclass members undefined for the superclass object.

We've discussed four ways to assign superclass and subclass references to variables of superclass and subclass types:

1. Assigning a superclass reference to a superclass variable is straightforward.
2. Assigning a subclass reference to a subclass variable is straightforward.
3. Assigning a subclass reference to a superclass variable is safe, because the subclass object *is an* object of its superclass. However, the superclass variable can be used to refer *only* to superclass members. If this code refers to subclass-only members through the superclass variable, the compiler reports errors.
4. Attempting to assign a superclass reference to a subclass variable is a compilation error. To avoid this error, the superclass reference must be cast to a subclass type explicitly. At *execution time*, if the object to which the reference refers is *not* a subclass object, an exception will occur. (For more on exception handling, see Chapter 11.) You should use the `instanceof` operator to ensure that such a cast is performed only if the object is a subclass object.

## 10.6 final Methods and Classes

We saw in Sections 6.3 and 6.10 that variables can be declared `final` to indicate that they cannot be modified after they're initialized—such variables represent constant values. It's also possible to declare methods, method parameters and classes with the `final` modifier.

### *Final Methods Cannot Be Overridden*

A **final method** in a superclass *cannot* be overridden in a subclass—this guarantees that the `final` method implementation will be used by all direct and indirect subclasses in the



hierarchy. Methods that are declared `private` are implicitly `final`, because it's not possible to override them in a subclass. Methods that are declared `static` are also implicitly `final`. A `final` method's declaration can never change, so all subclasses use the same method implementation, and calls to `final` methods are resolved at compile time—this is known as **static binding**.

### *Final Classes Cannot Be Superclasses*

A **final class** that's declared `final` cannot be a superclass (i.e., a class cannot extend a `final` class). All methods in a `final` class are implicitly `final`. Class `String` is an example of a `final` class. If you were allowed to create a subclass of `String`, objects of that subclass could be used wherever `Strings` are expected. Since class `String` cannot be extended, programs that use `Strings` can rely on the functionality of `String` objects as specified in the Java API. Making the class `final` also prevents programmers from creating subclasses that might bypass security restrictions. For more insights on the use of keyword `final`, visit

[download.oracle.com/javase/tutorial/java/IandI/final.html](http://download.oracle.com/javase/tutorial/java/IandI/final.html)

and

[www.ibm.com/developerworks/java/library/j-jtp1029.html](http://www.ibm.com/developerworks/java/library/j-jtp1029.html)



### **Common Programming Error 10.5**

*Attempting to declare a subclass of a `final` class is a compilation error.*



### **Software Engineering Observation 10.6**

*In the Java API, the vast majority of classes are not declared `final`. This enables inheritance and polymorphism. However, in some cases, it's important to declare classes `final`—typically for security reasons.*

## 10.7 Case Study: Creating and Using Interfaces

Our next example (Figs. 10.11–10.15) reexamines the payroll system of Section 10.5. Suppose that the company involved wishes to perform several accounting operations in a single accounts payable application—in addition to calculating the earnings that must be paid to each employee, the company must also calculate the payment due on each of several invoices (i.e., bills for goods purchased). Though applied to unrelated things (i.e., employees and invoices), both operations have to do with obtaining some kind of payment amount. For an employee, the payment refers to the employee's earnings. For an invoice, the payment refers to the total cost of the goods listed on the invoice. Can we calculate such *different* things as the payments due for employees and invoices in *a single* application polymorphically? Does Java offer a capability requiring that *unrelated* classes implement a set of *common* methods (e.g., a method that calculates a payment amount)? Java **interfaces** offer exactly this capability.

### *Standardizing Interactions*

Interfaces define and standardize the ways in which things such as people and systems can interact with one another. For example, the controls on a radio serve as an interface between radio users and a radio's internal components. The controls allow users to perform

only a limited set of operations (e.g., change the station, adjust the volume, choose between AM and FM), and different radios may implement the controls in different ways (e.g., using push buttons, dials, voice commands). The interface specifies *what* operations a radio must permit users to perform but does not specify *how* the operations are performed.

### Software Objects Communicate Via Interfaces

Software objects also communicate via interfaces. A Java interface describes a set of methods that can be called on an object to tell it, for example, to perform some task or return some piece of information. The next example introduces an interface named `Payable` to describe the functionality of any object that must be capable of being paid and thus must offer a method to determine the proper payment amount due. An **interface declaration** begins with the keyword **interface** and contains only constants and abstract methods. Unlike classes, all interface members must be `public`, and *interfaces may not specify any implementation details*, such as concrete method declarations and instance variables. All methods declared in an interface are implicitly `public` abstract methods, and all fields are implicitly `public`, `static` and `final`. [Note: As of Java SE 5, it became a better programming practice to declare sets of constants as enumerations with keyword `enum`. See Section 6.10 for an introduction to `enum` and Section 8.9 for additional `enum` details.]



#### Good Programming Practice 10.1

According to Chapter 9 of the Java Language Specification, it's proper style to declare an interface's methods without keywords `public` and `abstract`, because they're redundant in interface method declarations. Similarly, constants should be declared without keywords `public`, `static` and `final`, because they, too, are redundant.

### Using an Interface

To use an interface, a concrete class must specify that it **implements** the interface and must declare each method in the interface with the signature specified in the interface declaration. To specify that a class implements an interface add the `implements` keyword and the name of the interface to the end of your class declaration's first line. A class that does not implement *all* the methods of the interface is an *abstract* class and must be declared `abstract`. Implementing an interface is like signing a *contract* with the compiler that states, "I will declare all the methods specified by the interface or I will declare my class `abstract`."



#### Common Programming Error 10.6

Failing to implement any method of an interface in a concrete class that implements the interface results in a compilation error indicating that the class must be declared `abstract`.

### Relating Disparate Types

An interface is often used when disparate (i.e., unrelated) classes need to share common methods and constants. This allows objects of unrelated classes to be processed polymorphically—objects of classes that implement the same interface can respond to the same method calls. You can create an interface that describes the desired functionality, then implement this interface in any classes that require that functionality. For example, in the accounts payable application developed in this section, we implement interface `Payable` in any class that must be able to calculate a payment amount (e.g., `Employee`, `Invoice`).

### Interfaces vs. Abstract Classes

An interface is often used in place of an abstract class when there's no default implementation to inherit—that is, no fields and no default method implementations. Like public abstract classes, interfaces are typically public types. Like a public class, a public interface must be declared in a file with the same name as the interface and the .java file-name extension.

### Tagging Interfaces

We'll see in Chapter 17, Files, Streams and Object Serialization, the notion of “tagging interfaces”—empty interfaces that have *no* methods or constant values. They're used to add *is-a* relationships to classes. For example, in Chapter 17 we'll discuss a mechanism called object serialization, which can convert objects to byte representations and can convert those byte representations back to objects. To enable this mechanism to work with your objects, you simply have to mark them as `Serializable` by adding `implements Serializable` to the end of your class declaration's first line. Then, all the objects of your class have the *is-a* relationship with `Serializable`.

## 10.7.1 Developing a Payable Hierarchy

To build an application that can determine payments for employees and invoices alike, we first create interface `Payable`, which contains method `getPaymentAmount` that returns a `double` amount that must be paid for an object of any class that implements the interface. Method `getPaymentAmount` is a general-purpose version of method `earnings` of the `Employee` hierarchy—method `earnings` calculates a payment amount specifically for an `Employee`, while `getPaymentAmount` can be applied to a broad range of unrelated objects. After declaring interface `Payable`, we introduce class `Invoice`, which implements interface `Payable`. We then modify class `Employee` such that it also implements interface `Payable`. Finally, we update `Employee` subclass `SalariedEmployee` to “fit” into the `Payable` hierarchy by renaming `SalariedEmployee` method `earnings` as `getPaymentAmount`.



### Good Programming Practice 10.2

*When declaring a method in an interface, choose a method name that describes the method's purpose in a general manner, because the method may be implemented by many unrelated classes.*

Classes `Invoice` and `Employee` both represent things for which the company must be able to calculate a payment amount. Both classes implement the `Payable` interface, so a program can invoke method `getPaymentAmount` on `Invoice` objects and `Employee` objects alike. As we'll soon see, this enables the polymorphic processing of `Invoices` and `Employees` required for the company's accounts payable application.

The UML class diagram in Fig. 10.10 shows the hierarchy used in our accounts payable application. The hierarchy begins with interface `Payable`. The UML distinguishes an interface from other classes by placing the word “interface” in guillemets (« and ») above the interface name. The UML expresses the relationship between a class and an interface through a relationship known as **realization**. A class is said to “realize,” or implement, the methods of an interface. A class diagram models a realization as a dashed arrow with a hollow arrowhead pointing from the implementing class to the interface. The diagram in Fig. 10.10 indicates that classes `Invoice` and `Employee` each realize (i.e., implement) inter-

face `Payable`. As in the class diagram of Fig. 10.2, class `Employee` appears in italics, indicating that it's an abstract class. Concrete class `SalariedEmployee` extends `Employee` and inherits its superclass's realization relationship with interface `Payable`.

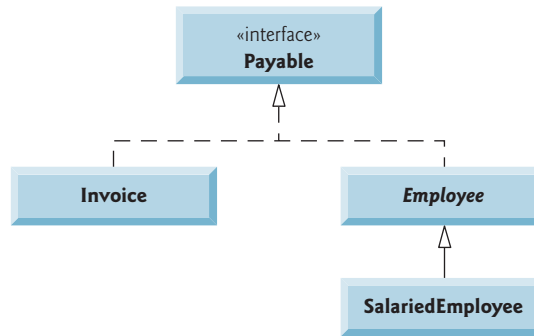

**Fig. 10.10** | `Payable` interface hierarchy UML class diagram.

### 10.7.2 Interface `Payable`

The declaration of interface `Payable` begins in Fig. 10.11 at line 4. Interface `Payable` contains public abstract method `getPaymentAmount` (line 6). The method is not explicitly declared `public` or `abstract`. Interface methods are always `public` and `abstract`, so they do not need to be declared as such. Interface `Payable` has only one method—interfaces can have any number of methods. In addition, method `getPaymentAmount` has no parameters, but interface methods *can* have parameters. Interfaces may also contain fields that are implicitly `final` and `static`.

```

1 // Fig. 10.11: Payable.java
2 // Payable interface declaration.
3
4 public interface Payable
5 {
6 double getPaymentAmount(); // calculate payment; no implementation
7 } // end interface Payable

```

**Fig. 10.11** | `Payable` interface declaration.

### 10.7.3 Class `Invoice`

We now create class `Invoice` (Fig. 10.12) to represent a simple invoice that contains billing information for only one kind of part. The class declares private instance variables `partNumber`, `partDescription`, `quantity` and `pricePerItem` (in lines 6–9) that indicate the part number, a description of the part, the quantity of the part ordered and the price per item. Class `Invoice` also contains a constructor (lines 12–19), *get* and *set* methods (lines 22–74) that manipulate the class's instance variables and a `toString` method (lines 77–83) that returns a `String` representation of an `Invoice` object. Methods `setQuantity` (lines 46–52) and `setPricePerItem` (lines 61–68) ensure that `quantity` and `pricePerItem` obtain only nonnegative values.

```
1 // Fig. 10.12: Invoice.java
2 // Invoice class that implements Payable.
3
4 public class Invoice implements Payable
5 {
6 private String partNumber;
7 private String partDescription;
8 private int quantity;
9 private double pricePerItem;
10
11 // four-argument constructor
12 public Invoice(String part, String description, int count,
13 double price)
14 {
15 partNumber = part;
16 partDescription = description;
17 setQuantity(count); // validate and store quantity
18 setPricePerItem(price); // validate and store price per item
19 } // end four-argument Invoice constructor
20
21 // set part number
22 public void setPartNumber(String part)
23 {
24 partNumber = part; // should validate
25 } // end method setPartNumber
26
27 // get part number
28 public String getPartNumber()
29 {
30 return partNumber;
31 } // end method getPartNumber
32
33 // set description
34 public void setPartDescription(String description)
35 {
36 partDescription = description; // should validate
37 } // end method setPartDescription
38
39 // get description
40 public String getPartDescription()
41 {
42 return partDescription;
43 } // end method getPartDescription
44
45 // set quantity
46 public void setQuantity(int count)
47 {
48 if (count >= 0)
49 quantity = count;
50 else
51 throw new IllegalArgumentException("Quantity must be >= 0");
52 } // end method setQuantity
53
```

**Fig. 10.12** | Invoice class that implements Payable. (Part I of 2.)

```

54 // get quantity
55 public int getQuantity()
56 {
57 return quantity;
58 } // end method getQuantity
59
60 // set price per item
61 public void setPricePerItem(double price)
62 {
63 if (price >= 0.0)
64 pricePerItem = price;
65 else
66 throw new IllegalArgumentException(
67 "Price per item must be >= 0");
68 } // end method setPricePerItem
69
70 // get price per item
71 public double getPricePerItem()
72 {
73 return pricePerItem;
74 } // end method getPricePerItem
75
76 // return String representation of Invoice object
77 @Override
78 public String toString()
79 {
80 return String.format("%s: \n%s: %s (%s) \n%s: %d \n%s: $%,.2f",
81 "invoice", "part number", getPartNumber(), getPartDescription(),
82 "quantity", getQuantity(), "price per item", getPricePerItem());
83 } // end method toString
84
85 // method required to carry out contract with interface Payable
86 @Override
87 public double getPaymentAmount()
88 {
89 return getQuantity() * getPricePerItem(); // calculate total cost
90 } // end method getPaymentAmount
91 } // end class Invoice

```

**Fig. 10.12** | Invoice class that implements Payable. (Part 2 of 2.)

Line 4 indicates that class `Invoice` implements interface `Payable`. Like all classes, class `Invoice` also implicitly extends `Object`. Java does not allow subclasses to inherit from more than one superclass, but it allows a class to inherit from one superclass and implement as many interfaces as it needs. To implement more than one interface, use a comma-separated list of interface names after keyword `implements` in the class declaration, as in:

```
public class ClassName extends SuperclassName implements FirstInterface,
 SecondInterface, ...
```



### Software Engineering Observation 10.7

All objects of a class that implement multiple interfaces have the is-a relationship with each implemented interface type.

Class `Invoice` implements the one method in interface `Payable`—method `getPaymentAmount` is declared in lines 86–90. The method calculates the total payment required to pay the invoice. The method multiplies the values of `quantity` and `pricePerItem` (obtained through the appropriate *get* methods) and returns the result (line 89). This method satisfies the implementation requirement for this method in interface `Payable`—we’ve fulfilled the interface contract with the compiler.

### 10.7.4 Modifying Class `Employee` to Implement Interface `Payable`

We now modify class `Employee` such that it implements interface `Payable`. Figure 10.13 contains the modified class, which is identical to that of Fig. 10.4 with two exceptions. First, line 4 of Fig. 10.13 indicates that class `Employee` now implements interface `Payable`. So we must rename `earnings` to `getPaymentAmount` throughout the `Employee` hierarchy. As with method `earnings` in the version of class `Employee` in Fig. 10.4, however, it does not make sense to implement method `getPaymentAmount` in class `Employee` because we cannot calculate the earnings payment owed to a general `Employee`—we must first know the specific type of `Employee`. In Fig. 10.4, we declared method `earnings` as abstract for this reason, so class `Employee` had to be declared abstract. This forced each `Employee` concrete subclass to override `earnings` with an implementation.

---

```

1 // Fig. 10.13: Employee.java
2 // Employee abstract superclass that implements Payable.
3
4 public abstract class Employee implements Payable
5 {
6 private String firstName;
7 private String lastName;
8 private String socialSecurityNumber;
9
10 // three-argument constructor
11 public Employee(String first, String last, String ssn)
12 {
13 firstName = first;
14 lastName = last;
15 socialSecurityNumber = ssn;
16 } // end three-argument Employee constructor
17
18 // set first name
19 public void setFirstName(String first)
20 {
21 firstName = first; // should validate
22 } // end method setFirstName
23
24 // return first name
25 public String getFirstName()
26 {
27 return firstName;
28 } // end method getFirstName
29

```

**Fig. 10.13** | `Employee` class that implements `Payable`. (Part I of 2.)

```

30 // set last name
31 public void setLastName(String last)
32 {
33 lastName = last; // should validate
34 } // end method setLastName
35
36 // return last name
37 public String getLastName()
38 {
39 return lastName;
40 } // end method getLastName
41
42 // set social security number
43 public void setSocialSecurityNumber(String ssn)
44 {
45 socialSecurityNumber = ssn; // should validate
46 } // end method setSocialSecurityNumber
47
48 // return social security number
49 public String getSocialSecurityNumber()
50 {
51 return socialSecurityNumber;
52 } // end method getSocialSecurityNumber
53
54 // return String representation of Employee object
55 @Override
56 public String toString()
57 {
58 return String.format("%s %s\nsocial security number: %s",
59 getFirstName(), getLastName(), getSocialSecurityNumber());
60 } // end method toString
61
62 // Note: We do not implement Payable method getPaymentAmount here so
63 // this class must be declared abstract to avoid a compilation error.
64 } // end abstract class Employee

```

**Fig. 10.13** | Employee class that implements Payable. (Part 2 of 2.)

In Fig. 10.13, we handle this situation differently. Recall that when a class implements an interface, it makes a *contract* with the compiler stating either that the class will implement *each* of the methods in the interface or that the class will be declared abstract. If the latter option is chosen, we do not need to declare the interface methods as abstract in the abstract class—they’re already implicitly declared as such in the interface. Any concrete subclass of the abstract class must implement the interface methods to fulfill the superclass’s contract with the compiler. If the subclass does not do so, it too must be declared abstract. As indicated by the comments in lines 62–63, class `Employee` of Fig. 10.13 does *not* implement method `getPaymentAmount`, so the class is declared abstract. Each direct `Employee` subclass *inherits the superclass’s contract* to implement method `getPaymentAmount` and thus must implement this method to become a concrete class for which objects can be instantiated. A class that extends one of `Employee`’s concrete subclasses will inherit an implementation of `getPaymentAmount` and thus will also be a concrete class.



### 10.7.5 Modifying Class SalariedEmployee for Use in the Payable Hierarchy

Figure 10.14 contains a modified SalariedEmployee class that extends Employee and fulfills superclass Employee's contract to implement Payable method getPaymentAmount. This version of SalariedEmployee is identical to that of Fig. 10.5, but it replaces method earnings with method getPaymentAmount (lines 34–38). Recall that the Payable version of the method has a more *general* name to be applicable to possibly *disparate* classes. The remaining Employee subclasses (e.g., HourlyEmployee, CommissionEmployee and BasePlusCommissionEmployee) also must be modified to contain method getPaymentAmount in place of earnings to reflect the fact that Employee now implements Payable. We leave these modifications as an exercise (Exercise 10.11) and use only SalariedEmployee in our test program here. Exercise 10.12 asks you to implement interface Payable in the entire Employee class hierarchy of Figs. 10.4–10.9 without modifying the Employee subclasses.

When a class implements an interface, the same *is-a* relationship provided by inheritance applies. Class Employee implements Payable, so we can say that an Employee *is a* Payable. In fact, objects of any classes that extend Employee are also Payable objects. SalariedEmployee objects, for instance, are Payable objects. Objects of any subclasses of the class that implements the interface can also be thought of as objects of the interface type. Thus, just as we can assign the reference of a SalariedEmployee object to a superclass Employee variable, we can assign the reference of a SalariedEmployee object to an interface Payable variable. Invoice implements Payable, so an Invoice object also *is a* Payable object, and we can assign the reference of an Invoice object to a Payable variable.



#### Software Engineering Observation 10.8

*When a method parameter is declared with a superclass or interface type, the method processes the object received as an argument polymorphically.*



#### Software Engineering Observation 10.9

*Using a superclass reference, we can polymorphically invoke any method declared in the superclass and its superclasses (e.g., class Object). Using an interface reference, we can polymorphically invoke any method declared in the interface, its superinterfaces (one interface can extend another) and in class Object—a variable of an interface type must refer to an object to call methods, and all objects have the methods of class Object.*

```

1 // Fig. 10.14: SalariedEmployee.java
2 // SalariedEmployee class extends Employee, which implements Payable.
3
4 public class SalariedEmployee extends Employee
5 {
6 private double weeklySalary;
7
8 // four-argument constructor
9 public SalariedEmployee(String first, String last, String ssn,
10 double salary)
11 {

```

**Fig. 10.14** | SalariedEmployee class that implements interface Payable method getPaymentAmount. (Part 1 of 2.)

```

12 super(first, last, ssn); // pass to Employee constructor
13 setWeeklySalary(salary); // validate and store salary
14 } // end four-argument SalariedEmployee constructor
15
16 // set salary
17 public void setWeeklySalary(double salary)
18 {
19 if (salary >= 0.0)
20 baseSalary = salary;
21 else
22 throw new IllegalArgumentException(
23 "Weekly salary must be >= 0.0");
24 } // end method setWeeklySalary
25
26 // return salary
27 public double getWeeklySalary()
28 {
29 return weeklySalary;
30 } // end method getWeeklySalary
31
32 // calculate earnings; implement interface Payable method that was
33 // abstract in superclass Employee
34 @Override
35 public double getPaymentAmount()
36 {
37 return getWeeklySalary();
38 } // end method getPaymentAmount
39
40 // return String representation of SalariedEmployee object
41 @Override
42 public String toString()
43 {
44 return String.format("salaried employee: %s\n%s: $%,.2f",
45 super.toString(), "weekly salary", getWeeklySalary());
46 } // end method toString
47 } // end class SalariedEmployee

```

**Fig. 10.14** | SalariedEmployee class that implements interface Payable method getPaymentAmount. (Part 2 of 2.)

### 10.7.6 Using Interface Payable to Process Invoices and Employees Polymorphically

PayableInterfaceTest (Fig. 10.15) illustrates that interface Payable can be used to process a set of Invoices and Employees polymorphically in a single application. Line 9 declares payableObjects and assigns it an array of four Payable variables. Lines 12–13 assign the references of Invoice objects to the first two elements of payableObjects. Lines 14–17 then assign the references of SalariedEmployee objects to the remaining two elements of payableObjects. These assignments are allowed because an Invoice *is a* Payable, a SalariedEmployee *is an* Employee and an Employee *is a* Payable. Lines 23–29 use the enhanced for statement to polymorphically process each Payable object in payableObjects, printing the object as a String, along with the payment amount due. Line 27

invokes method `toString` via a `Payable` interface reference, even though `toString` is not declared in interface `Payable`—*all references (including those of interface types) refer to objects that extend `Object` and therefore have a `toString` method.* (Method `toString` also can be invoked *implicitly* here.) Line 28 invokes `Payable` method `getPaymentAmount` to obtain the payment amount for each object in `payableObjects`, regardless of the actual type of the object. The output reveals that the method calls in lines 27–28 invoke the appropriate class’s implementation of methods `toString` and `getPaymentAmount`. For instance, when `currentPayable` refers to an `Invoice` during the first iteration of the `for` loop, class `Invoice`’s `toString` and `getPaymentAmount` execute.

```

1 // Fig. 10.15: PayableInterfaceTest.java
2 // Tests interface Payable.
3
4 public class PayableInterfaceTest
5 {
6 public static void main(String[] args)
7 {
8 // create four-element Payable array
9 Payable[] payableObjects = new Payable[4];
10
11 // populate array with objects that implement Payable
12 payableObjects[0] = new Invoice("01234", "seat", 2, 375.00);
13 payableObjects[1] = new Invoice("56789", "tire", 4, 79.95);
14 payableObjects[2] =
15 new SalariedEmployee("John", "Smith", "111-11-1111", 800.00);
16 payableObjects[3] =
17 new SalariedEmployee("Lisa", "Barnes", "888-88-8888", 1200.00);
18
19 System.out.println(
20 "Invoices and Employees processed polymorphically:\n");
21
22 // generically process each element in array payableObjects
23 for (Payable currentPayable : payableObjects)
24 {
25 // output currentPayable and its appropriate payment amount
26 System.out.printf("%s \n%s: $%,.2f\n\n",
27 currentPayable.toString(),
28 "payment due", currentPayable.getPaymentAmount());
29 } // end for
30 } // end main
31 } // end class PayableInterfaceTest

```

Invoices and Employees processed polymorphically:

```

invoice:
part number: 01234 (seat)
quantity: 2
price per item: $375.00
payment due: $750.00

```

**Fig. 10.15** | `Payable` interface test program processing `Invoices` and `Employees` polymorphically. (Part I of 2.)

```

invoice:
part number: 56789 (tire)
quantity: 4
price per item: $79.95
payment due: $319.80

salaried employee: John Smith
social security number: 111-11-1111
weekly salary: $800.00
payment due: $800.00

salaried employee: Lisa Barnes
social security number: 888-88-8888
weekly salary: $1,200.00
payment due: $1,200.00

```

**Fig. 10.15** | Payable interface test program processing Invoices and Employees polymorphically. (Part 2 of 2.)

### 10.7.7 Common Interfaces of the Java API

In this section, we overview several common interfaces found in the Java API. The power and flexibility of interfaces is used frequently throughout the Java API. These interfaces are implemented and used in the same manner as the interfaces you create (e.g., interface `Payable` in Section 10.7.2). The Java API's interfaces enable you to use your own classes within the frameworks provided by Java, such as comparing objects of your own types and creating tasks that can execute concurrently with other tasks in the same program. Figure 10.16 overviews a few of the more popular interfaces of the Java API that we use in *Java How to Program, Ninth Edition*.

| Interface                 | Description                                                                                                                                                                                                                                                                                                                                                                                                                                                                                                                                                                                                                                         |
|---------------------------|-----------------------------------------------------------------------------------------------------------------------------------------------------------------------------------------------------------------------------------------------------------------------------------------------------------------------------------------------------------------------------------------------------------------------------------------------------------------------------------------------------------------------------------------------------------------------------------------------------------------------------------------------------|
| <code>Comparable</code>   | Java contains several comparison operators (e.g., <code>&lt;</code> , <code>&lt;=</code> , <code>&gt;</code> , <code>&gt;=</code> , <code>==</code> , <code>!=</code> ) that allow you to compare primitive values. However, these operators <i>cannot</i> be used to compare objects. Interface <code>Comparable</code> is used to allow objects of a class that implements the interface to be compared to one another. Interface <code>Comparable</code> is commonly used for ordering objects in a collection such as an array. We use <code>Comparable</code> in Chapter 20, Generic Collections, and Chapter 21, Generic Classes and Methods. |
| <code>Serializable</code> | An interface used to identify classes whose objects can be written to (i.e., serialized) or read from (i.e., deserialized) some type of storage (e.g., file on disk, database field) or transmitted across a network. We use <code>Serializable</code> in Chapter 17, Files, Streams and Object Serialization, and Chapter 27, Networking.                                                                                                                                                                                                                                                                                                          |
| <code>Runnable</code>     | Implemented by any class for which objects of that class should be able to execute in parallel using a technique called multithreading (discussed in Chapter 26, Multithreading). The interface contains one method, <code>run</code> , which describes the behavior of an object when executed.                                                                                                                                                                                                                                                                                                                                                    |

**Fig. 10.16** | Common interfaces of the Java API. (Part 1 of 2.)

| Interface                     | Description                                                                                                                                                                                                                                                                                                                                                                                                                                                                                                                                                                                                                                                                                                                                                                                |
|-------------------------------|--------------------------------------------------------------------------------------------------------------------------------------------------------------------------------------------------------------------------------------------------------------------------------------------------------------------------------------------------------------------------------------------------------------------------------------------------------------------------------------------------------------------------------------------------------------------------------------------------------------------------------------------------------------------------------------------------------------------------------------------------------------------------------------------|
| GUI event-listener interfaces | You work with graphical user interfaces (GUIs) every day. In your web browser, you might type the address of a website to visit, or you might click a button to return to a previous site. The browser responds to your interaction and performs the desired task. Your interaction is known as an event, and the code that the browser uses to respond to an event is known as an event handler. In Chapter 14, GUI Components: Part 1, and Chapter 25, GUI Components: Part 2, you'll learn how to build GUIs and event handlers that respond to user interactions. Event handlers are declared in classes that implement an appropriate event-listener interface. Each event-listener interface specifies one or more methods that must be implemented to respond to user interactions. |
| SwingConstants                | Contains a set of constants used in GUI programming to position GUI elements on the screen. We explore GUI programming in Chapters 14 and 25.                                                                                                                                                                                                                                                                                                                                                                                                                                                                                                                                                                                                                                              |

**Fig. 10.16** | Common interfaces of the Java API. (Part 2 of 2.)

## 10.8 (Optional) GUI and Graphics Case Study: Drawing with Polymorphism

You may have noticed in the drawing program created in GUI and Graphics Case Study Exercise 8.1 (and modified in GUI and Graphics Case Study Exercise 9.1) that shape classes have many similarities. Using inheritance, we can “factor out” the common features from all three classes and place them in a single shape superclass. Then, using variables of the superclass type, we can manipulate shape objects polymorphically. Removing the redundant code will result in a smaller, more flexible program that’s easier to maintain.

### *GUI and Graphics Case Study Exercises*

**10.1** Modify the `MyLine`, `MyOval` and `MyRectangle` classes of GUI and Graphics Case Study Exercise 8.1 and Exercise 9.1 to create the class hierarchy in Fig. 10.17. Classes of the `MyShape` hierarchy should be “smart” shape classes that know how to draw themselves (if provided with a `Graphics` object that tells them where to draw). Once the program creates an object from this hierarchy, it can manipulate it polymorphically for the rest of its lifetime as a `MyShape`.

In your solution, class `MyShape` in Fig. 10.17 *must* be abstract. Since `MyShape` represents any shape in general, you cannot implement a `draw` method without knowing exactly what shape it is. The data representing the coordinates and color of the shapes in the hierarchy should be declared as `private` members of class `MyShape`. In addition to the common data, class `MyShape` should declare the following methods:

- A no-argument constructor that sets all the coordinates of the shape to 0 and the color to `Color.BLACK`.
- A constructor that initializes the coordinates and color to the values of the arguments supplied.
- Set* methods for the individual coordinates and color that allow the programmer to set any piece of data independently for a shape in the hierarchy.
- Get* methods for the individual coordinates and color that allow the programmer to retrieve any piece of data independently for a shape in the hierarchy.

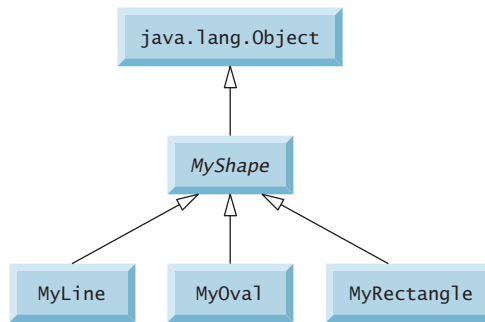

**Fig. 10.17** | MyShape hierarchy.

e) The abstract method

```
public abstract void draw(Graphics g);
```

which the program's `paintComponent` method will call to draw a shape on the screen.

To ensure proper encapsulation, all data in class `MyShape` must be private. This requires declaring proper *set* and *get* methods to manipulate the data. Class `MyLine` should provide a no-argument constructor and a constructor with arguments for the coordinates and color. Classes `MyOval` and `MyRectangle` should provide a no-argument constructor and a constructor with arguments for the coordinates, color and determining whether the shape is filled. The no-argument constructor should, in addition to setting the default values, set the shape to be an unfilled shape.

You can draw lines, rectangles and ovals if you know two points in space. Lines require  $x1$ ,  $y1$ ,  $x2$  and  $y2$  coordinates. The `drawLine` method of the `Graphics` class will connect the two points supplied with a line. If you have the same four coordinate values ( $x1$ ,  $y1$ ,  $x2$  and  $y2$ ) for ovals and rectangles, you can calculate the four arguments needed to draw them. Each requires an upper-left  $x$ -coordinate value (the smaller of the two  $x$ -coordinate values), an upper-left  $y$ -coordinate value (the smaller of the two  $y$ -coordinate values), a *width* (the absolute value of the difference between the two  $x$ -coordinate values) and a *height* (the absolute value of the difference between the two  $y$ -coordinate values). Rectangles and ovals should also have a `filled` flag that determines whether to draw the shape as a filled shape.

There should be no `MyLine`, `MyOval` or `MyRectangle` variables in the program—only `MyShape` variables that contain references to `MyLine`, `MyOval` and `MyRectangle` objects. The program should generate random shapes and store them in an array of type `MyShape`. Method `paintComponent` should walk through the `MyShape` array and draw every shape (i.e., polymorphically calling every shape's `draw` method).

Allow the user to specify (via an input dialog) the number of shapes to generate. The program will then generate and display the shapes along with a status bar that informs the user how many of each shape were created.

**10.2 (Drawing Application Modification)** In Exercise 10.1, you created a `MyShape` hierarchy in which classes `MyLine`, `MyOval` and `MyRectangle` extend `MyShape` directly. If your hierarchy was properly designed, you should be able to see the similarities between the `MyOval` and `MyRectangle` classes. Redesign and reimplement the code for the `MyOval` and `MyRectangle` classes to “factor out” the common features into the abstract class `MyBoundedShape` to produce the hierarchy in Fig. 10.18.

Class `MyBoundedShape` should declare two constructors that mimic those of class `MyShape`, only with an added parameter to set whether the shape is filled. Class `MyBoundedShape` should also declare *get* and *set* methods for manipulating the filled flag and methods that calculate the upper-left  $x$ -coordinate, upper-left  $y$ -coordinate, width and height. Remember, the values needed to draw

an oval or a rectangle can be calculated from two  $(x, y)$  coordinates. If designed properly, the new `MyOval` and `MyRectangle` classes should each have two constructors and a `draw` method.

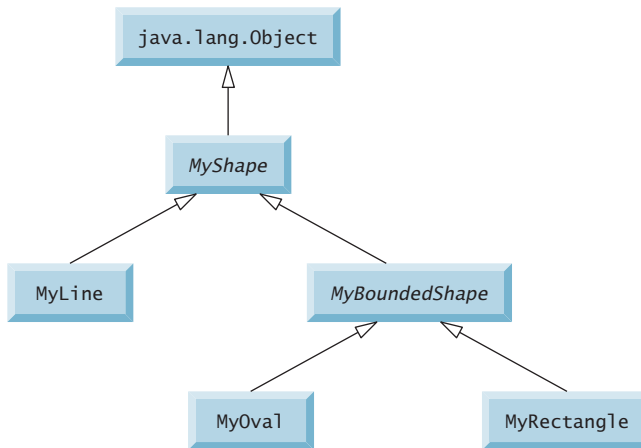

**Fig. 10.18** | `MyShape` hierarchy with `MyBoundedShape`.

## 10.9 Wrap-Up

This chapter introduced polymorphism—the ability to process objects that share the same superclass in a class hierarchy as if they’re all objects of the superclass. The chapter discussed how polymorphism makes systems extensible and maintainable, then demonstrated how to use overridden methods to effect polymorphic behavior. We introduced abstract classes, which allow you to provide an appropriate superclass from which other classes can inherit. You learned that an abstract class can declare abstract methods that each subclass must implement to become a concrete class and that a program can use variables of an abstract class to invoke the subclasses’ implementations of abstract methods polymorphically. You also learned how to determine an object’s type at execution time. We discussed the concepts of `final` methods and classes. Finally, the chapter discussed declaring and implementing an interface as another way to achieve polymorphic behavior.

You should now be familiar with classes, objects, encapsulation, inheritance, interfaces and polymorphism—the most essential aspects of object-oriented programming.

In the next chapter, you’ll learn about exceptions, useful for handling errors during a program’s execution. Exception handling provides for more robust programs.

## Summary

### Section 10.1 Introduction

- Polymorphism (p. 395) enables us to write programs that process objects that share the same superclass as if they’re all objects of the superclass; this can simplify programming.
- With polymorphism, we can design and implement systems that are easily extensible. The only parts of a program that must be altered to accommodate new classes are those that require direct knowledge of the new classes that you add to the hierarchy.

### Section 10.3 Demonstrating Polymorphic Behavior

- When the compiler encounters a method call made through a variable, the compiler determines if the method can be called by checking the variable's class type. If that class contains the proper method declaration (or inherits one), the call is compiled. At execution time, the type of the object to which the variable refers determines the actual method to use.

### Section 10.4 Abstract Classes and Methods

- Abstract classes (p. 400) cannot be used to instantiate objects, because they're incomplete.
- The primary purpose of an abstract class is to provide an appropriate superclass from which other classes can inherit and thus share a common design.
- Classes that can be used to instantiate objects are called concrete classes (p. 401). They provide implementations of every method they declare (some of the implementations can be inherited).
- Programmers often write client code that uses only abstract superclasses (p. 401) to reduce client code's dependencies on specific subclass types.
- Abstract classes sometimes constitute several levels of a hierarchy.
- An abstract class normally contains one or more abstract methods (p. 401).
- Abstract methods do not provide implementations.
- A class that contains any abstract methods must be declared as an abstract class (p. 401). Each concrete subclass must provide implementations of each of the superclass's abstract methods.
- Constructors and `static` methods cannot be declared abstract.
- Abstract superclass variables can hold references to objects of any concrete class derived from the superclass. Programs typically use such variables to manipulate subclass objects polymorphically.
- Polymorphism is particularly effective for implementing layered software systems.

### Section 10.5 Case Study: Payroll System Using Polymorphism

- A hierarchy designer can demand that each concrete subclass provide an appropriate method implementation by including an abstract method in a superclass.
- Most method calls are resolved at execution time, based on the type of the object being manipulated. This process is known as dynamic binding (p. 416) or late binding.
- A superclass variable can be used to invoke only methods declared in the superclass.
- Operator `instanceof` (p. 416) determines if an object has the *is-a* relationship with a specific type.
- Every object in Java knows its own class and can access it through `Object` method `getClass` (p. 417), which returns an object of type `Class` (package `java.lang`).
- The *is-a* relationship applies only between the subclass and its superclasses, not vice versa.

### Section 10.6 `final` Methods and Classes

- A method that's declared `final` (p. 418) in a superclass cannot be overridden in a subclass.
- Methods declared `private` are implicitly `final`, because you can't override them in a subclass.
- Methods that are declared `static` are implicitly `final`.
- A `final` method's declaration can never change, so all subclasses use the same implementation, and calls to `final` methods are resolved at compile time—this is known as static binding (p. 419).
- Since the compiler knows that `final` methods cannot be overridden, it can optimize programs by removing calls to `final` methods and replacing them with the expanded code of their declarations at each method-call location—a technique known as inlining the code.
- A class that's declared `final` cannot be a superclass (p. 419).
- All methods in a `final` class are implicitly `final`.



### Section 10.7 Case Study: Creating and Using Interfaces

- An interface (p. 419) specifies *what* operations are allowed but not *how* they're performed.
- A Java interface describes a set of methods that can be called on an object.
- An interface declaration begins with the keyword `interface` (p. 420).
- All interface members must be `public`, and interfaces may not specify any implementation details, such as concrete method declarations and instance variables.
- All methods declared in an interface are implicitly `public` abstract methods and all fields are implicitly `public`, `static` and `final`.
- To use an interface, a concrete class must specify that it `implements` (p. 420) the interface and must declare each interface method with the signature specified in the interface declaration. A class that does not implement all the interface's methods must be declared `abstract`.
- Implementing an interface is like signing a contract with the compiler that states, "I will declare all the methods specified by the interface or I will declare my class `abstract`."
- An interface is typically used when disparate (i.e., unrelated) classes need to share common methods and constants. This allows objects of unrelated classes to be processed polymorphically—objects of classes that implement the same interface can respond to the same method calls.
- You can create an interface that describes the desired functionality, then implement the interface in any classes that require that functionality.
- An interface is often used in place of an abstract class when there's no default implementation to inherit—that is, no instance variables and no default method implementations.
- Like `public` abstract classes, interfaces are typically `public` types, so they're normally declared in files by themselves with the same name as the interface and the `.java` file-name extension.
- Java does not allow subclasses to inherit from more than one superclass, but it does allow a class to inherit from a superclass and implement more than one interface.
- All objects of a class that implement multiple interfaces have the *is-a* relationship with each implemented interface type.
- An interface can declare constants. The constants are implicitly `public`, `static` and `final`.

## Self-Review Exercises

- 10.1** Fill in the blanks in each of the following statements:
- If a class contains at least one abstract method, it's a(n) \_\_\_\_\_ class.
  - Classes from which objects can be instantiated are called \_\_\_\_\_ classes.
  - \_\_\_\_\_ involves using a superclass variable to invoke methods on superclass and subclass objects, enabling you to "program in the general."
  - Methods that are not interface methods and that do not provide implementations must be declared using keyword \_\_\_\_\_.
  - Casting a reference stored in a superclass variable to a subclass type is called \_\_\_\_\_.
- 10.2** State whether each of the statements that follows is *true* or *false*. If *false*, explain why.
- All methods in an abstract class must be declared as abstract methods.
  - Invoking a subclass-only method through a subclass variable is not allowed.
  - If a superclass declares an abstract method, a subclass must implement that method.
  - An object of a class that implements an interface may be thought of as an object of that interface type.

## Answers to Self-Review Exercises

- 10.1** a) abstract. b) concrete. c) Polymorphism. d) abstract. e) downcasting.

- 10.2** a) False. An abstract class can include methods with implementations and abstract methods. b) False. Trying to invoke a subclass-only method with a superclass variable is not allowed. c) False. Only a concrete subclass must implement the method. d) True.

## Exercises

**10.3** How does polymorphism enable you to program “in the general” rather than “in the specific”? Discuss the key advantages of programming “in the general.”

**10.4** What are abstract methods? Describe the circumstances in which an abstract method would be appropriate.

**10.5** How does polymorphism promote extensibility?

**10.6** Discuss four ways in which you can assign superclass and subclass references to variables of superclass and subclass types.

**10.7** Compare and contrast abstract classes and interfaces. Why would you use an abstract class? Why would you use an interface?

**10.8** (*Payroll System Modification*) Modify the payroll system of Figs. 10.4–10.9 to include private instance variable `birthDate` in class `Employee`. Use class `Date` of Fig. 8.7 to represent an employee’s birthday. Add *get* methods to class `Date`. Assume that payroll is processed once per month. Create an array of `Employee` variables to store references to the various employee objects. In a loop, calculate the payroll for each `Employee` (polymorphically), and add a \$100.00 bonus to the person’s payroll amount if the current month is the one in which the `Employee`’s birthday occurs.

**10.9** (*Project: Shape Hierarchy*) Implement the Shape hierarchy shown in Fig. 9.3. Each `TwoDimensionalShape` should contain method `getArea` to calculate the area of the two-dimensional shape. Each `ThreeDimensionalShape` should have methods `getArea` and `getVolume` to calculate the surface area and volume, respectively, of the three-dimensional shape. Create a program that uses an array of `Shape` references to objects of each concrete class in the hierarchy. The program should print a text description of the object to which each array element refers. Also, in the loop that processes all the shapes in the array, determine whether each shape is a `TwoDimensionalShape` or a `ThreeDimensionalShape`. If it’s a `TwoDimensionalShape`, display its area. If it’s a `ThreeDimensionalShape`, display its area and volume.

**10.10** (*Payroll System Modification*) Modify the payroll system of Figs. 10.4–10.9 to include an additional `Employee` subclass `PieceWorker` that represents an employee whose pay is based on the number of pieces of merchandise produced. Class `PieceWorker` should contain private instance variables `wage` (to store the employee’s wage per piece) and `pieces` (to store the number of pieces produced). Provide a concrete implementation of method `earnings` in class `PieceWorker` that calculates the employee’s earnings by multiplying the number of pieces produced by the wage per piece. Create an array of `Employee` variables to store references to objects of each concrete class in the new `Employee` hierarchy. For each `Employee`, display its `String` representation and earnings.

**10.11** (*Accounts Payable System Modification*) In this exercise, we modify the accounts payable application of Figs. 10.11–10.15 to include the complete functionality of the payroll application of Figs. 10.4–10.9. The application should still process two `Invoice` objects, but now should process one object of each of the four `Employee` subclasses. If the object currently being processed is a `BasePlusCommissionEmployee`, the application should increase the `BasePlusCommissionEmployee`’s base salary by 10%. Finally, the application should output the payment amount for each object. Complete the following steps to create the new application:

- a) Modify classes `HourlyEmployee` (Fig. 10.6) and `CommissionEmployee` (Fig. 10.7) to place them in the `Payable` hierarchy as subclasses of the version of `Employee` (Fig. 10.13) that implements `Payable`. [*Hint*: Change the name of method `earnings` to `getPaymentAmount` in each subclass so that the class satisfies its inherited contract with interface `Payable`.]

- b) Modify class `BasePlusCommissionEmployee` (Fig. 10.8) such that it extends the version of class `CommissionEmployee` created in part (a).
- c) Modify `PayableInterfaceTest` (Fig. 10.15) to polymorphically process two `Invoices`, one `SalariedEmployee`, one `HourlyEmployee`, one `CommissionEmployee` and one `BasePlusCommissionEmployee`. First output a `String` representation of each `Payable` object. Next, if an object is a `BasePlusCommissionEmployee`, increase its base salary by 10%. Finally, output the payment amount for each `Payable` object.

**10.12 (Accounts Payable System Modification)** It's possible to include the functionality of the payroll application (Figs. 10.4–10.9) in the accounts payable application without modifying `Employee` subclasses `SalariedEmployee`, `HourlyEmployee`, `CommissionEmployee` or `BasePlusCommissionEmployee`. To do so, you can modify class `Employee` (Fig. 10.4) to implement interface `Payable` and declare method `getPaymentAmount` to invoke method `earnings`. Method `getPaymentAmount` would then be inherited by the subclasses in the `Employee` hierarchy. When `getPaymentAmount` is called for a particular subclass object, it polymorphically invokes the appropriate `earnings` method for that subclass. Reimplement Exercise 10.11 using the original `Employee` hierarchy from the payroll application of Figs. 10.4–10.9. Modify class `Employee` as described in this exercise, and *do not* modify any of class `Employee`'s subclasses.

## Making a Difference

**10.13 (CarbonFootprint Interface: Polymorphism)** Using interfaces, as you learned in this chapter, you can specify similar behaviors for possibly disparate classes. Governments and companies worldwide are becoming increasingly concerned with carbon footprints (annual releases of carbon dioxide into the atmosphere) from buildings burning various types of fuels for heat, vehicles burning fuels for power, and the like. Many scientists blame these greenhouse gases for the phenomenon called global warming. Create three small classes unrelated by inheritance—classes `Building`, `Car` and `Bicycle`. Give each class some unique appropriate attributes and behaviors that it does not have in common with other classes. Write an interface `CarbonFootprint` with a `getCarbonFootprint` method. Have each of your classes implement that interface, so that its `getCarbonFootprint` method calculates an appropriate carbon footprint for that class (check out a few websites that explain how to calculate carbon footprints). Write an application that creates objects of each of the three classes, places references to those objects in `ArrayList<CarbonFootprint>`, then iterates through the `ArrayList`, polymorphically invoking each object's `getCarbonFootprint` method. For each object, print some identifying information and the object's carbon footprint.

# 11

## Exception Handling: A Deeper Look

*It is common sense to take a method and try it. If it fails, admit it frankly and try another. But above all, try something.*

—Franklin Delano Roosevelt

*O! throw away the  
worse part of it,  
And live the purer  
with the other half.*

—William Shakespeare

*If they're running and they don't  
look where they're going  
I have to come out from  
somewhere and catch them.*

—Jerome David Salinger

### Objectives

In this chapter you'll learn:

- What exceptions are and how they're handled.
- When to use exception handling.
- To use `try` blocks to delimit code in which exceptions might occur.
- To `throw` exceptions to indicate a problem.
- To use `catch` blocks to specify exception handlers.
- To use the `finally` block to release resources.
- The exception class hierarchy.
- To create user-defined exceptions.

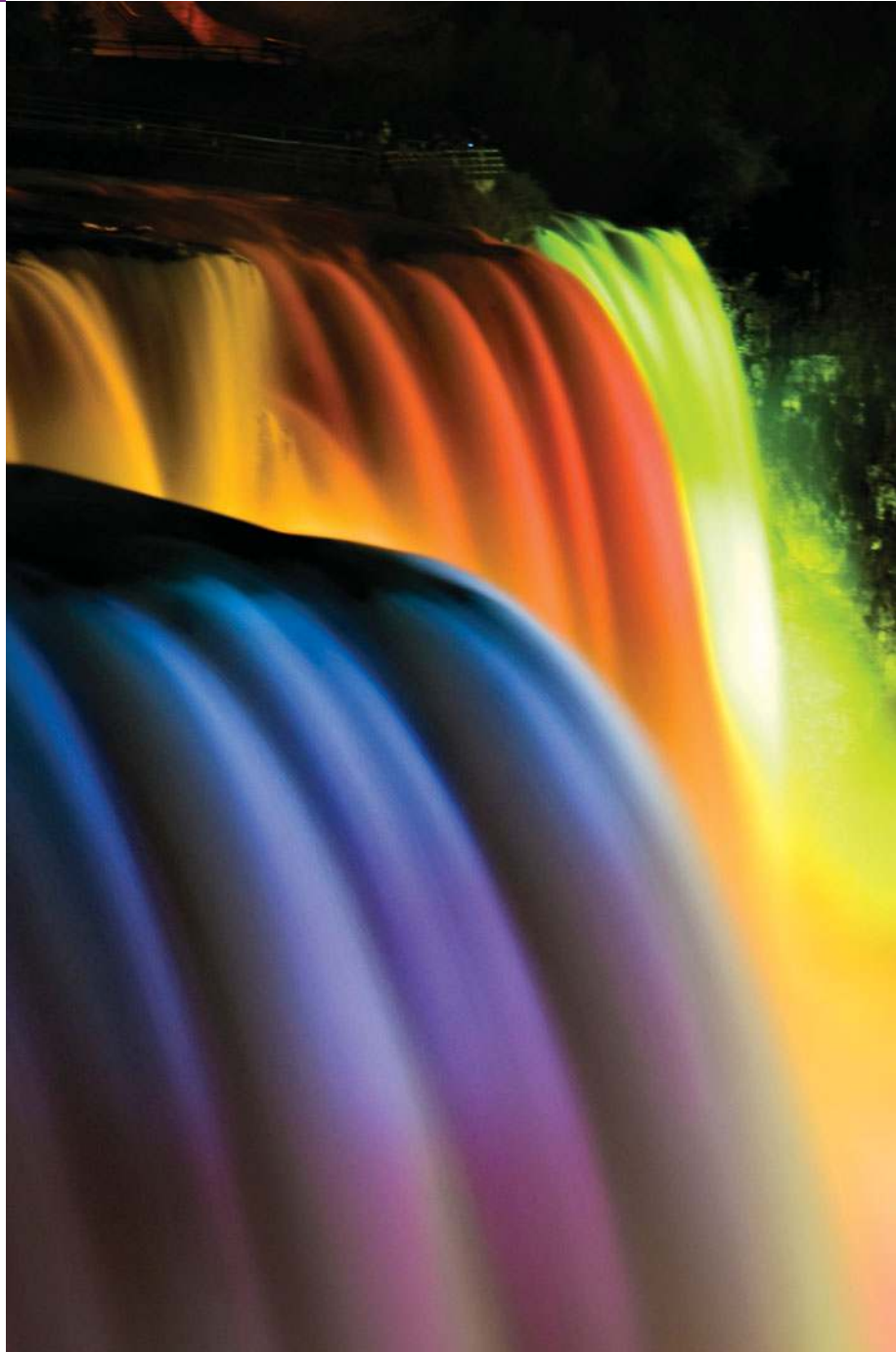

- |                                                                                                          |                                                                                                   |
|----------------------------------------------------------------------------------------------------------|---------------------------------------------------------------------------------------------------|
| <b>11.1</b> Introduction                                                                                 | <b>11.8</b> Chained Exceptions                                                                    |
| <b>11.2</b> Example: Divide by Zero without Exception Handling                                           | <b>11.9</b> Declaring New Exception Types                                                         |
| <b>11.3</b> Example: Handling <code>ArithmeticExceptions</code> and <code>InputMismatchExceptions</code> | <b>11.10</b> Preconditions and Postconditions                                                     |
| <b>11.4</b> When to Use Exception Handling                                                               | <b>11.11</b> Assertions                                                                           |
| <b>11.5</b> Java Exception Hierarchy                                                                     | <b>11.12</b> (New in Java SE 7) Multi-catch: Handling Multiple Exceptions in One catch            |
| <b>11.6</b> <code>finally</code> Block                                                                   | <b>11.13</b> (New in Java SE 7) <code>try-with-Resources</code> : Automatic Resource Deallocation |
| <b>11.7</b> Stack Unwinding and Obtaining Information from an Exception Object                           | <b>11.14</b> Wrap-Up                                                                              |

Summary | Self-Review Exercises | Answers to Self-Review Exercises | Exercises

## 11.1 Introduction

As you know from Chapter 7, an exception is an indication of a problem that occurs during a program's execution. Exception handling enables you to create applications that can resolve (or handle) exceptions. In many cases, handling an exception allows a program to continue executing as if no problem had been encountered. The features presented in this chapter help you write robust and fault-tolerant programs that can deal with problems and continue executing or terminate gracefully. Java exception handling is based in part on the work of Andrew Koenig and Bjarne Stroustrup.<sup>1</sup>

First, we demonstrate basic exception-handling techniques by handling an exception that occurs when a method attempts to divide an integer by zero. Next, we introduce several classes at the top of Java's exception-handling class hierarchy. As you'll see, only classes that extend `Throwable` (package `java.lang`) directly or indirectly can be used with exception handling. We then show how to use chained exceptions. When you invoke a method that indicates an exception, you can throw another exception and chain the original one to the new one—this enables you to add application-specific information to the original exception. Next, we introduce preconditions and postconditions, which must be true when your methods are called and when they return, respectively. We then present assertions, which you can use at development time to help debug your code. Finally, we introduce two new Java SE 7 exception-handling features—catching multiple exceptions with one catch handler and the new `try-with-resources` statement that automatically releases a resource after it's used in the `try` block.

## 11.2 Example: Divide by Zero without Exception Handling

First we demonstrate what happens when errors arise in an application that does not use exception handling. Figure 11.1 prompts the user for two integers and passes them to method `quotient`, which calculates the integer quotient and returns an `int` result. In this

1. A. Koenig and B. Stroustrup, "Exception Handling for C++ (revised)," *Proceedings of the Usenix C++ Conference*, pp. 149–176, San Francisco, April 1990.

example, you'll see that exceptions are **thrown** (i.e., the exception occurs) when a method detects a problem and is unable to handle it.

```

1 // Fig. 11.1: DivideByZeroNoExceptionHandling.java
2 // Integer division without exception handling.
3 import java.util.Scanner;
4
5 public class DivideByZeroNoExceptionHandling
6 {
7 // demonstrates throwing an exception when a divide-by-zero occurs
8 public static int quotient(int numerator, int denominator)
9 {
10 return numerator / denominator; // possible division by zero
11 } // end method quotient
12
13 public static void main(String[] args)
14 {
15 Scanner scanner = new Scanner(System.in); // scanner for input
16
17 System.out.print("Please enter an integer numerator: ");
18 int numerator = scanner.nextInt();
19 System.out.print("Please enter an integer denominator: ");
20 int denominator = scanner.nextInt();
21
22 int result = quotient(numerator, denominator);
23 System.out.printf(
24 "\nResult: %d / %d = %d\n", numerator, denominator, result);
25 } // end main
26 } // end class DivideByZeroNoExceptionHandling

```

```

Please enter an integer numerator: 100
Please enter an integer denominator: 7

Result: 100 / 7 = 14

```

```

Please enter an integer numerator: 100
Please enter an integer denominator: 0
Exception in thread "main" java.lang.ArithmeticException: / by zero
 at DivideByZeroNoExceptionHandling.quotient(
 DivideByZeroNoExceptionHandling.java:10)
 at DivideByZeroNoExceptionHandling.main(
 DivideByZeroNoExceptionHandling.java:22)

```

```

Please enter an integer numerator: 100
Please enter an integer denominator: hello
Exception in thread "main" java.util.InputMismatchException
 at java.util.Scanner.throwFor(Unknown Source)
 at java.util.Scanner.next(Unknown Source)
 at java.util.Scanner.nextInt(Unknown Source)
 at java.util.Scanner.nextInt(Unknown Source)
 at DivideByZeroNoExceptionHandling.main(
 DivideByZeroNoExceptionHandling.java:20)

```

**Fig. 11.1** | Integer division without exception handling.

The first sample execution in Fig. 11.1 shows a successful division. In the second execution, the user enters the value 0 as the denominator. Several lines of information are displayed in response to this invalid input. This information is known as a **stack trace**, which includes the name of the exception (`java.lang.ArithmeticException`) in a descriptive message that indicates the problem that occurred and the method-call stack (i.e., the call chain) at the time it occurred. The stack trace includes the path of execution that led to the exception method by method. This helps you debug the program. The first line specifies that an `ArithmeticException` has occurred. The text after the name of the exception (“/ by zero”) indicates that this exception occurred as a result of an attempt to divide by zero. Java *does not* allow division by zero in integer arithmetic. When this occurs, Java throws an **ArithmeticException**. `ArithmeticExceptions` can arise from a number of different problems in arithmetic, so the extra data (“/ by zero”) provides more specific information. Java *does* allow division by zero with floating-point values. Such a calculation results in the value positive or negative infinity, which is represented in Java as a floating-point value (but displays as the string `Infinity` or `-Infinity`). If 0.0 is divided by 0.0, the result is NaN (not a number), which is also represented in Java as a floating-point value (but displays as `NaN`).

Starting from the last line of the stack trace, we see that the exception was detected in line 22 of method `main`. Each line of the stack trace contains the class name and method (`DivideByZeroNoExceptionHandling.main`) followed by the file name and line number (`DivideByZeroNoExceptionHandling.java:22`). Moving up the stack trace, we see that the exception occurs in line 10, in method `quotient`. The top row of the call chain indicates the **throw point**—the initial point at which the exception occurs. The throw point of this exception is in line 10 of method `quotient`.

In the third execution, the user enters the string “hello” as the denominator. Notice again that a stack trace is displayed. This informs us that an `InputMismatchException` has occurred (package `java.util`). Our prior examples that read numeric values from the user assumed that the user would input a proper integer value. However, users sometimes make mistakes and input noninteger values. An **InputMismatchException** occurs when `Scanner` method `nextInt` receives a `string` that does not represent a valid integer. Starting from the end of the stack trace, we see that the exception was detected in line 20 of method `main`. Moving up the stack trace, we see that the exception occurred in method `nextInt`. Notice that in place of the file name and line number, we’re provided with the text `Unknown Source`. This means that the so-called debugging symbols that provide the file-name and line number information for that method’s class were not available to the JVM—this is typically the case for the classes of the Java API. Many IDEs have access to the Java API source code and will display file names and line numbers in stack traces.

In the sample executions of Fig. 11.1 when exceptions occur and stack traces are displayed, the program also exits. This does not always occur in Java—sometimes a program may continue even though an exception has occurred and a stack trace has been printed. In such cases, the application may produce unexpected results. For example, a graphical user interface (GUI) application will often continue executing. The next section demonstrates how to handle these exceptions.

In Fig. 11.1 both types of exceptions were detected in method `main`. In the next example, we’ll see how to handle these exceptions to enable the program to run to normal completion.

## 11.3 Example: Handling ArithmeticExceptions and InputMismatchExceptions

The application in Fig. 11.2, which is based on Fig. 11.1, uses exception handling to process any ArithmeticExceptions and InputMismatchExceptions that arise. The application still prompts the user for two integers and passes them to method quotient, which calculates the quotient and returns an int result. This version of the application uses exception handling so that if the user makes a mistake, the program catches and handles (i.e., deals with) the exception—in this case, allowing the user to enter the input again.

```

1 // Fig. 11.2: DivideByZeroWithExceptionHandling.java
2 // Handling ArithmeticExceptions and InputMismatchExceptions.
3 import java.util.InputMismatchException;
4 import java.util.Scanner;
5
6 public class DivideByZeroWithExceptionHandling
7 {
8 // demonstrates throwing an exception when a divide-by-zero occurs
9 public static int quotient(int numerator, int denominator)
10 throws ArithmeticException
11 {
12 return numerator / denominator; // possible division by zero
13 } // end method quotient
14
15 public static void main(String[] args)
16 {
17 Scanner scanner = new Scanner(System.in); // scanner for input
18 boolean continueLoop = true; // determines if more input is needed
19
20 do
21 {
22 try // read two numbers and calculate quotient
23 {
24 System.out.print("Please enter an integer numerator: ");
25 int numerator = scanner.nextInt();
26 System.out.print("Please enter an integer denominator: ");
27 int denominator = scanner.nextInt();
28
29 int result = quotient(numerator, denominator);
30 System.out.printf("\nResult: %d / %d = %d\n", numerator,
31 denominator, result);
32 continueLoop = false; // input successful; end looping
33 } // end try
34 catch (InputMismatchException inputMismatchException)
35 {
36 System.err.printf("\nException: %s\n",
37 inputMismatchException);
38 scanner.nextLine(); // discard input so user can try again
39 System.out.println(
40 "You must enter integers. Please try again.\n");
41 } // end catch

```

**Fig. 11.2** | Handling ArithmeticExceptions and InputMismatchExceptions. (Part I of 2.)



```

42 catch (ArithmeticException arithmeticException)
43 {
44 System.err.printf("\nException: %s\n", arithmeticException);
45 System.out.println(
46 "Zero is an invalid denominator. Please try again.\n");
47 } // end catch
48 } while (continueLoop); // end do...while
49 } // end main
50 } // end class DivideByZeroWithExceptionHandling

```

```

Please enter an integer numerator: 100
Please enter an integer denominator: 7

Result: 100 / 7 = 14

```

```

Please enter an integer numerator: 100
Please enter an integer denominator: 0

Exception: java.lang.ArithmeticException: / by zero
Zero is an invalid denominator. Please try again.

Please enter an integer numerator: 100
Please enter an integer denominator: 7

Result: 100 / 7 = 14

```

```

Please enter an integer numerator: 100
Please enter an integer denominator: hello

Exception: java.util.InputMismatchException
You must enter integers. Please try again.

Please enter an integer numerator: 100
Please enter an integer denominator: 7

Result: 100 / 7 = 14

```

**Fig. 11.2** | Handling ArithmeticExceptions and InputMismatchExceptions. (Part 2 of 2.)

The first sample execution in Fig. 11.2 is a successful one that does not encounter any problems. In the second execution the user enters a zero denominator, and an `ArithmeticException` exception occurs. In the third execution the user enters the string "hello" as the denominator, and an `InputMismatchException` occurs. For each exception, the user is informed of the mistake and asked to try again, then is prompted for two new integers. In each sample execution, the program runs successfully to completion.

Class `InputMismatchException` is imported in line 3. Class `ArithmeticException` does not need to be imported because it's in package `java.lang`. Line 18 creates the boolean variable `continueLoop`, which is true if the user has not yet entered valid input. Lines 20–48 repeatedly ask users for input until a valid input is received.

### Enclosing Code in a `try` Block

Lines 22–33 contain a **try block**, which encloses the code that might throw an exception and the code that should not execute if an exception occurs (i.e., if an exception occurs, the remaining code in the try block will be skipped). A try block consists of the keyword `try` followed by a block of code enclosed in curly braces. [Note: The term “try block” sometimes refers only to the block of code that follows the try keyword (not including the try keyword itself). For simplicity, we use the term “try block” to refer to the block of code that follows the try keyword, as well as the try keyword.] The statements that read the integers from the keyboard (lines 25 and 27) each use method `nextInt` to read an `int` value. Method `nextInt` throws an `InputMismatchException` if the value read in is not an integer.

The division that can cause an `ArithmeticException` is not performed in the try block. Rather, the call to method `quotient` (line 29) invokes the code that attempts the division (line 12); the JVM throws an `ArithmeticException` object when the denominator is zero.



### Software Engineering Observation 11.1

*Exceptions may surface through explicitly mentioned code in a try block, through calls to other methods, through deeply nested method calls initiated by code in a try block or from the Java Virtual Machine as it executes Java bytecodes.*

### Catching Exceptions

The try block in this example is followed by two catch blocks—one that handles an `InputMismatchException` (lines 34–41) and one that handles an `ArithmeticException` (lines 42–47). A **catch block** (also called a **catch clause** or **exception handler**) catches (i.e., receives) and handles an exception. A catch block begins with the keyword `catch` and is followed by a parameter in parentheses (called the exception parameter, discussed shortly) and a block of code enclosed in curly braces. [Note: The term “catch clause” is sometimes used to refer to the keyword `catch` followed by a block of code, whereas the term “catch block” refers to only the block of code following the `catch` keyword, but not including it. For simplicity, we use the term “catch block” to refer to the block of code following the `catch` keyword, as well as the keyword itself.]

At least one catch block or a **finally block** (discussed in Section 11.6) must immediately follow the try block. Each catch block specifies in parentheses an **exception parameter** that identifies the exception type the handler can process. When an exception occurs in a try block, the catch block that executes is the *first* one whose type matches the type of the exception that occurred (i.e., the type in the catch block matches the thrown exception type exactly or is a superclass of it). The exception parameter’s name enables the catch block to interact with a caught exception object—e.g., to implicitly invoke the caught exception’s `toString` method (as in lines 37 and 44), which displays basic information about the exception. Notice that we use the **System.err** (**standard error stream**) **object** to output error messages. By default, `System.err`’s print methods, like those of `System.out`, display data to the command prompt.

Line 38 of the first catch block calls `Scanner` method `nextLine`. Because an `InputMismatchException` occurred, the call to method `nextInt` never successfully read in the user’s data—so we read that input with a call to method `nextLine`. We do not do anything with the input at this point, because we know that it’s invalid. Each catch block displays an error message and asks the user to try again. After either catch block terminates, the

user is prompted for input. We'll soon take a deeper look at how this flow of control works in exception handling.



### Common Programming Error 11.1

*It's a syntax error to place code between a try block and its corresponding catch blocks.*



### Common Programming Error 11.2

*Each catch block can have only a single parameter—specifying a comma-separated list of exception parameters is a syntax error.*

An **uncaught exception** is one for which there are no matching catch blocks. You saw uncaught exceptions in the second and third outputs of Fig. 11.1. Recall that when exceptions occurred in that example, the application terminated early (after displaying the exception's stack trace). This does not always occur as a result of uncaught exceptions. Java uses a “multithreaded” model of program execution—each **thread** is a parallel activity. One program can have many threads. If a program has only one thread, an uncaught exception will cause the program to terminate. If a program has multiple threads, an uncaught exception will terminate *only* the thread where the exception occurred. In such programs, however, certain threads may rely on others, and if one thread terminates due to an uncaught exception, there may be adverse effects to the rest of the program. Chapter 26, Multithreading, discusses these issues in depth.

### Termination Model of Exception Handling

If an exception occurs in a try block (such as an `InputMismatchException` being thrown as a result of the code at line 25 of Fig. 11.2), the try block terminates immediately and program control transfers to the *first* of the following catch blocks in which the exception parameter's type matches the thrown exception's type. In Fig. 11.2, the first catch block catches `InputMismatchExceptions` (which occur if invalid input is entered) and the second catch block catches `ArithmeticExceptions` (which occur if an attempt is made to divide by zero). After the exception is handled, program control does *not* return to the throw point, because the try block has *expired* (and its local variables have been lost). Rather, control resumes after the last catch block. This is known as the **termination model of exception handling**. Some languages use the **resumption model of exception handling**, in which, after an exception is handled, control resumes just after the throw point.

Notice that we name our exception parameters (`inputMismatchException` and `arithmeticException`) based on their type. Java programmers often simply use the letter *e* as the name of their exception parameters.



### Good Programming Practice 11.1

*Using an exception-parameter name that reflects the parameter's type promotes clarity by reminding you of the type of exception being handled.*

After executing a catch block, this program's flow of control proceeds to the first statement after the last catch block (line 48 in this case). The condition in the `do...while` statement is true (variable `continueLoop` contains its initial value of true), so control returns to the beginning of the loop and the user is once again prompted for input. This

control statement will loop until valid input is entered. At that point, program control reaches line 32, which assigns `false` to variable `continueLoop`. The `try` block then terminates. If no exceptions are thrown in the `try` block, the `catch` blocks are skipped and control continues with the first statement after the `catch` blocks (we'll learn about another possibility when we discuss the `finally` block in Section 11.6). Now the condition for the `do...while` loop is `false`, and method `main` ends.

The `try` block and its corresponding `catch` and/or `finally` blocks form a **try statement**. Do not confuse the terms “try block” and “try statement”—the latter includes the `try` block as well as the following `catch` blocks and/or `finally` block.

As with any other block of code, when a `try` block terminates, local variables declared in the block go out of scope and are no longer accessible; thus, the local variables of a `try` block are not accessible in the corresponding `catch` blocks. When a `catch` block terminates, local variables declared within the `catch` block (including the exception parameter of that `catch` block) also go out of scope and are destroyed. Any remaining `catch` blocks in the `try` statement are ignored, and execution resumes at the first line of code after the `try...catch` sequence—this will be a `finally` block, if one is present.

### Using the `throws` Clause

Now let's examine method `quotient` (Fig. 11.2, lines 9–13). The portion of the method declaration located at line 10 is known as a **throws clause**. It specifies the exceptions the method throws. This clause appears *after* the method's parameter list and *before* the method's body. It contains a comma-separated list of the exceptions that the method will throw if various problems occur. Such exceptions may be thrown by statements in the method's body or by methods called from the body. A method can throw exceptions of the classes listed in its `throws` clause or of their subclasses. We've added the `throws` clause to this application to indicate to the rest of the program that this method may throw an `ArithmeticException`. Clients of method `quotient` are thus informed that the method may throw an `ArithmeticException`. You'll learn more about the `throws` clause in Section 11.5.



#### Error-Prevention Tip 11.1

*Read the online API documentation for a method before using it in a program. The documentation specifies the exceptions thrown by the method (if any) and indicates reasons why such exceptions may occur. Next, read the online API documentation for the specified exception classes. The documentation for an exception class typically contains potential reasons that such exceptions occur. Finally, provide for handling those exceptions in your program.*

When line 12 executes, if the denominator is zero, the JVM throws an `ArithmeticException` object. This object will be caught by the `catch` block at lines 42–47, which displays basic information about the exception by implicitly invoking the exception's `toString` method, then asks the user to try again.

If the denominator is not zero, method `quotient` performs the division and returns the result to the point of invocation of method `quotient` in the `try` block (line 29). Lines 30–31 display the result of the calculation and line 32 sets `continueLoop` to `false`. In this case, the `try` block completes successfully, so the program skips the `catch` blocks and fails the condition at line 48, and method `main` completes execution normally.

When `quotient` throws an `ArithmeticException`, `quotient` terminates and does not return a value, and `quotient`'s local variables go out of scope (and are destroyed). If quo-

tient contained local variables that were references to objects and there were no other references to those objects, the objects would be marked for garbage collection. Also, when an exception occurs, the try block from which quotient was called terminates before lines 30–32 can execute. Here, too, if local variables were created in the try block prior to the exception’s being thrown, these variables would go out of scope.

If an `InputMismatchException` is generated by lines 25 or 27, the try block terminates and execution continues with the catch block at lines 34–41. In this case, method `quotient` is not called. Then method `main` continues after the last catch block (line 48).

## 11.4 When to Use Exception Handling

Exception handling is designed to process **synchronous errors**, which occur when a statement executes. Common examples we’ll see throughout the book are out-of-range array indices, arithmetic overflow (i.e., a value outside the representable range of values), division by zero, invalid method parameters, thread interruption (as we’ll see in Chapter 26) and unsuccessful memory allocation (due to lack of memory). Exception handling is not designed to process problems associated with **asynchronous events** (e.g., disk I/O completions, network message arrivals, mouse clicks and keystrokes), which occur in parallel with, and independent of, the program’s flow of control.



### Software Engineering Observation 11.2

*Incorporate your exception-handling strategy into your system from the inception of the design process. Including exception handling after a system has been implemented can be difficult.*



### Software Engineering Observation 11.3

*Exception handling provides a single, uniform technique for processing problems. This helps programmers working on large projects understand each other’s error-processing code.*

## 11.5 Java Exception Hierarchy

All Java exception classes inherit directly or indirectly from class **Exception**, forming an inheritance hierarchy. You can extend this hierarchy with your own exception classes.

Figure 11.3 shows a small portion of the inheritance hierarchy for class **Throwable** (a subclass of `Object`), which is the superclass of class `Exception`. Only `Throwable` objects can be used with the exception-handling mechanism. Class `Throwable` has two subclasses: `Exception` and `Error`. Class `Exception` and its subclasses—for instance, `RuntimeException` (package `java.lang`) and `IOException` (package `java.io`)—represent exceptional situations that can occur in a Java program and that can be caught by the application. Class **Error** and its subclasses represent abnormal situations that happen in the JVM. Most *Errors happen infrequently and should not be caught by applications—it’s usually not possible for applications to recover from Errors.*

The Java exception hierarchy contains hundreds of classes. Information about Java’s exception classes can be found throughout the Java API. You can view `Throwable`’s documentation at [download.oracle.com/javase/6/docs/api/java/lang/Throwable.html](http://download.oracle.com/javase/6/docs/api/java/lang/Throwable.html). From there, you can look at this class’s subclasses to get more information about Java’s `Exceptions` and `Errors`.

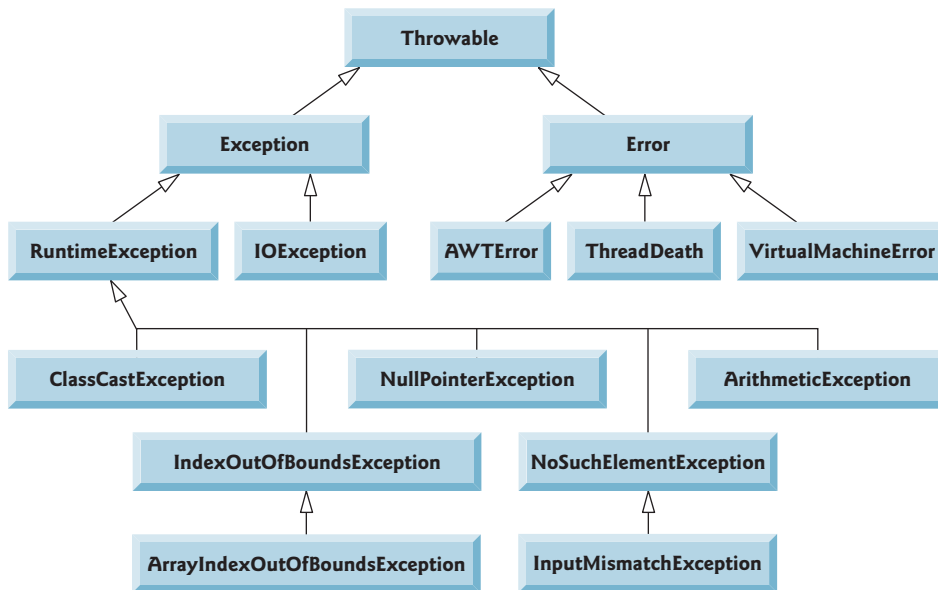

**Fig. 11.3** | Portion of class `Throwable`'s inheritance hierarchy.

### *Checked vs. Unchecked Exceptions*

Java distinguishes between **checked exceptions** and **unchecked exceptions**. This distinction is important, because the Java compiler enforces a **catch-or-declare requirement** for checked exceptions. An exception's type determines whether it's checked or unchecked. All exception types that are direct or indirect subclasses of class `RuntimeException` (package `java.lang`) are unchecked exceptions. These are typically caused by defects in your program's code. Examples of unchecked exceptions include `ArrayIndexOutOfBoundsException` (discussed in Chapter 7) and `ArithmeticException` (shown in Fig. 11.3). All classes that inherit from class `Exception` but not class `RuntimeException` are considered to be checked exceptions. Such exceptions are typically caused by conditions that are not under the control of the program—for example, in file processing, the program can't open a file because the file does not exist. Classes that inherit from class `Error` are considered to be unchecked.

The compiler *checks* each method call and method declaration to determine whether the method throws checked exceptions. If so, the compiler verifies that the checked exception is caught or is declared in a `throws` clause. We show how to catch and declare checked exceptions in the next several examples. Recall from Section 11.3 that the `throws` clause specifies the exceptions a method throws. Such exceptions are not caught in the method's body. To satisfy the *catch* part of the catch-or-declare requirement, the code that generates the exception must be wrapped in a `try` block and must provide a catch handler for the checked-exception type (or one of its superclass types). To satisfy the *declare* part of the catch-or-declare requirement, the method containing the code that generates the exception must provide a `throws` clause containing the checked-exception type after its parameter list and before its method body. If the catch-or-declare requirement is not satisfied, the compiler will issue an error message indicating that the exception must be caught or

declared. This forces you to think about the problems that may occur when a method that throws checked exceptions is called.



#### Software Engineering Observation 11.4

*You must deal with checked exceptions. This results in more robust code than would be created if you were able to simply ignore the exceptions.*



#### Common Programming Error 11.3

*A compilation error occurs if a method explicitly attempts to throw a checked exception (or calls another method that throws a checked exception) and that exception is not listed in that method's throws clause.*



#### Common Programming Error 11.4

*If a subclass method overrides a superclass method, it's an error for the subclass method to list more exceptions in its throws clause than the overridden superclass method does. However, a subclass's throws clause can contain a subset of a superclass's throws list.*



#### Software Engineering Observation 11.5

*If your method calls other methods that throw checked exceptions, those exceptions must be caught or declared in your method. If an exception can be handled meaningfully in a method, the method should catch the exception rather than declare it.*

Unlike checked exceptions, the Java compiler does *not* check the code to determine whether an unchecked exception is caught or declared. Unchecked exceptions typically can be prevented by proper coding. For example, the unchecked `ArithmeticException` thrown by method `quotient` (lines 9–13) in Fig. 11.2 can be avoided if the method ensures that the denominator is not zero *before* attempting to perform the division. Unchecked exceptions are not required to be listed in a method's throws clause—even if they are, it's not required that such exceptions be caught by an application.



#### Software Engineering Observation 11.6

*Although the compiler does not enforce the catch-or-declare requirement for unchecked exceptions, provide appropriate exception-handling code when it's known that such exceptions might occur. For example, a program should process the `NumberFormatException` from `Integer` method `parseInt`, even though `NumberFormatException` (an indirect subclass of `RuntimeException`) is an unchecked exception type. This makes your programs more robust.*

### Catching Subclass Exceptions

If a catch handler is written to catch superclass-type exception objects, it can also catch all objects of that class's subclasses. This enables catch to handle related errors with a concise notation and allows for polymorphic processing of related exceptions. You can certainly catch each subclass type individually if those exceptions require different processing.

### Only the First Matching catch Executes

If there are *multiple* catch blocks that match a particular exception type, only the *first* matching catch block executes when an exception of that type occurs. It's a compilation error to catch the *exact same type* in two different catch blocks associated with a particular try block. However, there may be several catch blocks that match an exception—i.e., sev-

eral catch blocks whose types are the same as the exception type or a superclass of that type. For instance, we could follow a catch block for type `ArithmeticException` with a catch block for type `Exception`—both would match `ArithmeticExceptions`, but only the first matching catch block would execute.



### Error-Prevention Tip 11.2

*Catching subclass types individually is subject to error if you forget to test for one or more of the subclass types explicitly; catching the superclass guarantees that objects of all subclasses will be caught. Positioning a catch block for the superclass type after all other subclass catch blocks ensures that all subclass exceptions are eventually caught.*



### Common Programming Error 11.5

*Placing a catch block for a superclass exception type before other catch blocks that catch subclass exception types would prevent those catch blocks from executing, so a compilation error occurs.*

## 11.6 finally Block

Programs that obtain certain types of resources must return them to the system explicitly to avoid so-called **resource leaks**. In programming languages such as C and C++, the most common kind of resource leak is a memory leak. Java performs automatic garbage collection of memory no longer used by programs, thus avoiding most memory leaks. However, other types of resource leaks can occur. For example, files, database connections and network connections that are not closed properly after they're no longer needed might not be available for use in other programs.



### Error-Prevention Tip 11.3

*A subtle issue is that Java does not entirely eliminate memory leaks. Java will not garbage-collect an object until there are no remaining references to it. Thus, if you erroneously keep references to unwanted objects, memory leaks can occur. To help avoid this problem, set reference-type variables to `null` when they're no longer needed.*

The `finally` block (which consists of the `finally` keyword, followed by code enclosed in curly braces), sometimes referred to as the **finally clause**, is optional. If it's present, it's placed after the last catch block. If there are no catch blocks, the `finally` block immediately follows the `try` block.

The `finally` block will execute whether or not an exception is thrown in the corresponding `try` block. The `finally` block also will execute if a `try` block exits by using a `return`, `break` or `continue` statement or simply by reaching its closing right brace. The `finally` block will *not* execute if the application exits early from a `try` block by calling method `System.exit`. This method, which we demonstrate in Chapter 17, immediately terminates an application.

Because a `finally` block almost always executes, it typically contains resource-release code. Suppose a resource is allocated in a `try` block. If no exception occurs, the catch blocks are skipped and control proceeds to the `finally` block, which frees the resource. Control then proceeds to the first statement after the `finally` block. If an exception occurs in the `try` block, the `try` block terminates. If the program catches the exception in one of the corresponding catch blocks, it processes the exception, then the `finally` block



releases the resource and control proceeds to the first statement after the finally block. If the program doesn't catch the exception, the finally block *still* releases the resource and an attempt is made to catch the exception in a calling method.



#### Error-Prevention Tip 11.4

*The finally block is an ideal place to release resources acquired in a try block (such as opened files), which helps eliminate resource leaks.*



#### Performance Tip 11.1

*Always release a resource explicitly and at the earliest possible moment at which it's no longer needed. This makes resources available for reuse as early as possible, thus improving resource utilization.*

If an exception that occurs in a try block cannot be caught by one of that try block's catch handlers, the program skips the rest of the try block and control proceeds to the finally block. Then the program passes the exception to the next outer try block—normally in the calling method—where an associated catch block might catch it. This process can occur through many levels of try blocks. Also, the exception could go uncaught.

If a catch block throws an exception, the finally block still executes. Then the exception is passed to the next outer try block—again, normally in the calling method.

Figure 11.4 demonstrates that the finally block executes even if an exception is not thrown in the corresponding try block. The program contains static methods main (lines 6–18), throwException (lines 21–44) and doesNotThrowException (lines 47–64). Methods throwException and doesNotThrowException are declared static, so main can call them directly without instantiating a UsingExceptions object.

```

1 // Fig. 11.4: UsingExceptions.java
2 // try...catch...finally exception handling mechanism.
3
4 public class UsingExceptions
5 {
6 public static void main(String[] args)
7 {
8 try
9 {
10 throwException(); // call method throwException
11 } // end try
12 catch (Exception exception) // exception thrown by throwException
13 {
14 System.err.println("Exception handled in main");
15 } // end catch
16
17 doesNotThrowException();
18 } // end main
19
20 // demonstrate try...catch...finally
21 public static void throwException() throws Exception
22 {

```

**Fig. 11.4** | try...catch...finally exception-handling mechanism. (Part I of 2.)

```

23 try // throw an exception and immediately catch it
24 {
25 System.out.println("Method throwException");
26 throw new Exception(); // generate exception
27 } // end try
28 catch (Exception exception) // catch exception thrown in try
29 {
30 System.err.println(
31 "Exception handled in method throwException");
32 throw exception; // rethrow for further processing
33
34 // code here would not be reached; would cause compilation errors
35
36 } // end catch
37 finally // executes regardless of what occurs in try...catch
38 {
39 System.err.println("Finally executed in throwException");
40 } // end finally
41
42 // code here would not be reached; would cause compilation errors
43
44 } // end method throwException
45
46 // demonstrate finally when no exception occurs
47 public static void doesNotThrowException()
48 {
49 try // try block does not throw an exception
50 {
51 System.out.println("Method doesNotThrowException");
52 } // end try
53 catch (Exception exception) // does not execute
54 {
55 System.err.println(exception);
56 } // end catch
57 finally // executes regardless of what occurs in try...catch
58 {
59 System.err.println(
60 "Finally executed in doesNotThrowException");
61 } // end finally
62
63 System.out.println("End of method doesNotThrowException");
64 } // end method doesNotThrowException
65 } // end class UsingExceptions

```

```

Method throwException
Exception handled in method throwException
Finally executed in throwException
Exception handled in main
Method doesNotThrowException
Finally executed in doesNotThrowException
End of method doesNotThrowException

```

**Fig. 11.4** | try...catch...finally exception-handling mechanism. (Part 2 of 2.)

`System.out` and `System.err` are **streams**—sequences of bytes. While `System.out` (known as the **standard output stream**) displays a program's output, `System.err` (known as the **standard error stream**) displays a program's errors. Output from these streams can be redirected (i.e., sent to somewhere other than the command prompt, such as to a file). Using two different streams enables you to easily separate error messages from other output. For instance, data output from `System.err` could be sent to a log file, while data output from `System.out` can be displayed on the screen. For simplicity, this chapter will not redirect output from `System.err`, but will display such messages to the command prompt. You'll learn more about streams in Chapter 17.

### Throwing Exceptions Using the `throw` Statement

Method `main` (Fig. 11.4) begins executing, enters its try block and immediately calls method `throwException` (line 10). Method `throwException` throws an `Exception`. The statement at line 26 is known as a **throw statement**—it's executed to indicate that an exception has occurred. So far, you've only caught exceptions thrown by called methods. You can throw exceptions yourself by using the `throw` statement. Just as with exceptions thrown by the Java API's methods, this indicates to client applications that an error has occurred. A `throw` statement specifies an object to be thrown. The operand of a `throw` can be of any class derived from class `Throwable`.



#### Software Engineering Observation 11.7

*When `toString` is invoked on any `Throwable` object, its resulting string includes the descriptive string that was supplied to the constructor, or simply the class name if no string was supplied.*



#### Software Engineering Observation 11.8

*An object can be thrown without containing information about the problem that occurred. In this case, simply knowing that an exception of a particular type occurred may provide sufficient information for the handler to process the problem correctly.*



#### Software Engineering Observation 11.9

*Exceptions can be thrown from constructors. When an error is detected in a constructor, an exception should be thrown to avoid creating an improperly formed object.*

### Rethrowing Exceptions

Line 32 of Fig. 11.4 **rethrows the exception**. Exceptions are rethrown when a catch block, upon receiving an exception, decides either that it cannot process that exception or that it can only partially process it. Rethrowing an exception defers the exception handling (or perhaps a portion of it) to another catch block associated with an outer try statement. An exception is rethrown by using the **throw keyword**, followed by a reference to the exception object that was just caught. Exceptions cannot be rethrown from a `finally` block, as the exception parameter (a local variable) from the catch block no longer exists.

When a rethrow occurs, the *next enclosing try block* detects the rethrown exception, and that try block's catch blocks attempt to handle it. In this case, the next enclosing try block is found at lines 8–11 in method `main`. Before the rethrown exception is handled, however, the `finally` block (lines 37–40) executes. Then method `main` detects the rethrown exception in the try block and handles it in the catch block (lines 12–15).

Next, `main` calls `methodDoesNotThrowException` (line 17). No exception is thrown in `methodDoesNotThrowException`'s `try` block (lines 49–52), so the program skips the `catch` block (lines 53–56), but the `finally` block (lines 57–61) nevertheless executes. Control proceeds to the statement after the `finally` block (line 63). Then control returns to `main` and the program terminates.



### Common Programming Error 11.6

*If an exception has not been caught when control enters a `finally` block and the `finally` block throws an exception that's not caught in the `finally` block, the first exception will be lost and the exception from the `finally` block will be returned to the calling method.*



### Error-Prevention Tip 11.5

*Avoid placing code that can throw an exception in a `finally` block. If such code is required, enclose the code in a `try...catch` within the `finally` block.*



### Common Programming Error 11.7

*Assuming that an exception thrown from a `catch` block will be processed by that `catch` block or any other `catch` block associated with the same `try` statement can lead to logic errors.*



### Good Programming Practice 11.2

*Exception handling is intended to remove error-processing code from the main line of a program's code to improve program clarity. Do not place `try...catch...finally` around every statement that may throw an exception. This makes programs difficult to read. Rather, place one `try` block around a significant portion of your code, follow that `try` block with `catch` blocks that handle each possible exception and follow the `catch` blocks with a single `finally` block (if one is required).*

## 11.7 Stack Unwinding and Obtaining Information from an Exception Object

When an exception is thrown but not caught in a particular scope, the method-call stack is “unwound,” and an attempt is made to catch the exception in the next outer `try` block. This process is called **stack unwinding**. Unwinding the method-call stack means that the method in which the exception was not caught *terminates*, all local variables in that method go out of scope and control returns to the statement that originally invoked that method. If a `try` block encloses that statement, an attempt is made to catch the exception. If a `try` block does not enclose that statement or if the exception is not caught, stack unwinding occurs again. Figure 11.5 demonstrates stack unwinding, and the exception handler in `main` shows how to access the data in an exception object.

### Stack Unwinding

In `main`, the `try` block (lines 8–11) calls `method1` (declared at lines 35–38), which in turn calls `method2` (declared at lines 41–44), which in turn calls `method3` (declared at lines 47–50). Line 49 of `method3` throws an `Exception` object—this is the *throw point*. Because the `throw` statement at line 49 is *not* enclosed in a `try` block, *stack unwinding* occurs—`method3` terminates at line 49, then returns control to the statement in `method2` that invoked `method3` (i.e., line 43). Because *no* `try` block encloses line 43, *stack unwinding* occurs

```
1 // Fig. 11.5: UsingExceptions.java
2 // Stack unwinding and obtaining data from an exception object.
3
4 public class UsingExceptions
5 {
6 public static void main(String[] args)
7 {
8 try
9 {
10 method1(); // call method1
11 } // end try
12 catch (Exception exception) // catch exception thrown in method1
13 {
14 System.err.printf("%s\n\n", exception.getMessage());
15 exception.printStackTrace(); // print exception stack trace
16
17 // obtain the stack-trace information
18 StackTraceElement[] traceElements = exception.getStackTrace();
19
20 System.out.println("\nStack trace from getStackTrace:");
21 System.out.println("Class\t\tFile\t\t\tLine\tMethod");
22
23 // loop through traceElements to get exception description
24 for (StackTraceElement element : traceElements)
25 {
26 System.out.printf("%s\t", element.getClassName());
27 System.out.printf("%s\t", element.getFileName());
28 System.out.printf("%s\t", element.getLineNumber());
29 System.out.printf("%s\n", element.getMethodName());
30 } // end for
31 } // end catch
32 } // end main
33
34 // call method2; throw exceptions back to main
35 public static void method1() throws Exception
36 {
37 method2();
38 } // end method method1
39
40 // call method3; throw exceptions back to method1
41 public static void method2() throws Exception
42 {
43 method3();
44 } // end method method2
45
46 // throw Exception back to method2
47 public static void method3() throws Exception
48 {
49 throw new Exception("Exception thrown in method3");
50 } // end method method3
51 } // end class UsingExceptions
```

**Fig. 11.5** | Stack unwinding and obtaining data from an exception object. (Part I of 2.)

```

Exception thrown in method3

java.lang.Exception: Exception thrown in method3
 at UsingExceptions.method3(UsingExceptions.java:49)
 at UsingExceptions.method2(UsingExceptions.java:43)
 at UsingExceptions.method1(UsingExceptions.java:37)
 at UsingExceptions.main(UsingExceptions.java:10)

Stack trace from getStackTrace:
Class File Line Method
UsingExceptions UsingExceptions.java 49 method3
UsingExceptions UsingExceptions.java 43 method2
UsingExceptions UsingExceptions.java 37 method1
UsingExceptions UsingExceptions.java 10 main

```

**Fig. 11.5** | Stack unwinding and obtaining data from an exception object. (Part 2 of 2.)

again—method2 terminates at line 43 and returns control to the statement in method1 that invoked method2 (i.e., line 37). Because *no* try block encloses line 37, *stack unwinding* occurs one more time—method1 terminates at line 37 and returns control to the statement in main that invoked method1 (i.e., line 10). The try block at lines 8–11 encloses this statement. The exception has not been handled, so the try block terminates and the first matching catch block (lines 12–31) catches and processes the exception. If there were no matching catch blocks, and the exception is not declared in each method that throws it, a compilation error would occur. Remember that this is not always the case—for *unchecked* exceptions, the application will compile, but it will run with unexpected results.

### Obtaining Data from an Exception Object

Recall that exceptions derive from class `Throwable`. Class `Throwable` offers a **`printStackTrace`** method that outputs to the standard error stream the stack trace (discussed in Section 11.2). Often, this is helpful in testing and debugging. Class `Throwable` also provides a **`getStackTrace`** method that retrieves the stack-trace information that might be printed by `printStackTrace`. Class `Throwable`'s **`getMessage`** method returns the descriptive string stored in an exception.



#### Error-Prevention Tip 11.6

*An exception that's not caught in an application causes Java's default exception handler to run. This displays the name of the exception, a descriptive message that indicates the problem that occurred and a complete execution stack trace. In an application with a single thread of execution, the application terminates. In an application with multiple threads, the thread that caused the exception terminates.*



#### Error-Prevention Tip 11.7

*`Throwable` method `toString` (inherited by all `Throwable` subclasses) returns a `String` containing the name of the exception's class and a descriptive message.*

The catch handler in Fig. 11.5 (lines 12–31) demonstrates `getMessage`, `printStackTrace` and `getStackTrace`. If we wanted to output the stack-trace information to

streams other than the standard error stream, we could use the information returned from `getStackTrace` and output it to another stream or use one of the overloaded versions of method `printStackTrace`. Sending data to other streams is discussed in Chapter 17.

Line 14 invokes the exception's `getMessage` method to get the exception description. Line 15 invokes the exception's `printStackTrace` method to output the stack trace that indicates where the exception occurred. Line 18 invokes the exception's `getStackTrace` method to obtain the stack-trace information as an array of `StackTraceElement` objects. Lines 24–30 get each `StackTraceElement` in the array and invoke its methods `getClassName`, `getFileName`, `getLineNumber` and `getMethodName` to get the class name, file name, line number and method name, respectively, for that `StackTraceElement`. Each `StackTraceElement` represents one method call on the method-call stack.

The program's output shows that the stack-trace information printed by `printStackTrace` follows the pattern: *className.methodName(fileName:lineNumber)*, where *className*, *methodName* and *fileName* indicate the names of the class, method and file in which the exception occurred, respectively, and the *lineNumber* indicates where in the file the exception occurred. You saw this in the output for Fig. 11.1. Method `getStackTrace` enables custom processing of the exception information. Compare the output of `printStackTrace` with the output created from the `StackTraceElements` to see that both contain the same stack-trace information.



### Software Engineering Observation 11.10

*Never provide a catch handler with an empty body—this effectively ignores the exception. At least use `printStackTrace` to output an error message to indicate that a problem exists.*

## 11.8 Chained Exceptions

Sometimes a method responds to an exception by throwing a different exception type that's specific to the current application. If a catch block throws a new exception, the original exception's information and stack trace are *lost*. Earlier Java versions provided no mechanism to wrap the original exception information with the new exception's information to provide a complete stack trace showing where the original problem occurred. This made debugging such problems particularly difficult. **Chained exceptions** enable an exception object to maintain the complete stack-trace information from the original exception. Figure 11.6 demonstrates chained exceptions.

```

1 // Fig. 11.6: UsingChainedExceptions.java
2 // Chained exceptions.
3
4 public class UsingChainedExceptions
5 {
6 public static void main(String[] args)
7 {
8 try
9 {
```

Fig. 11.6 | Chained exceptions. (Part I of 2.)

```

10 method1(); // call method1
11 } // end try
12 catch (Exception exception) // exceptions thrown from method1
13 {
14 exception.printStackTrace();
15 } // end catch
16 } // end main
17
18 // call method2; throw exceptions back to main
19 public static void method1() throws Exception
20 {
21 try
22 {
23 method2(); // call method2
24 } // end try
25 catch (Exception exception) // exception thrown from method2
26 {
27 throw new Exception("Exception thrown in method1", exception);
28 } // end catch
29 } // end method method1
30
31 // call method3; throw exceptions back to method1
32 public static void method2() throws Exception
33 {
34 try
35 {
36 method3(); // call method3
37 } // end try
38 catch (Exception exception) // exception thrown from method3
39 {
40 throw new Exception("Exception thrown in method2", exception);
41 } // end catch
42 } // end method method2
43
44 // throw Exception back to method2
45 public static void method3() throws Exception
46 {
47 throw new Exception("Exception thrown in method3");
48 } // end method method3
49 } // end class UsingChainedExceptions

```

```

java.lang.Exception: Exception thrown in method1
 at UsingChainedExceptions.method1(UsingChainedExceptions.java:27)
 at UsingChainedExceptions.main(UsingChainedExceptions.java:10)
Caused by: java.lang.Exception: Exception thrown in method2
 at UsingChainedExceptions.method2(UsingChainedExceptions.java:40)
 at UsingChainedExceptions.method1(UsingChainedExceptions.java:23)
 ... 1 more
Caused by: java.lang.Exception: Exception thrown in method3
 at UsingChainedExceptions.method3(UsingChainedExceptions.java:47)
 at UsingChainedExceptions.method2(UsingChainedExceptions.java:36)
 ... 2 more

```

**Fig. 11.6** | Chained exceptions. (Part 2 of 2.)



The program consists of four methods—`main` (lines 6–16), `method1` (lines 19–29), `method2` (lines 32–42) and `method3` (lines 45–48). Line 10 in method `main`'s try block calls `method1`. Line 23 in `method1`'s try block calls `method2`. Line 36 in `method2`'s try block calls `method3`. In `method3`, line 47 throws a new `Exception`. Because this statement is not in a try block, `method3` terminates, and the exception is returned to the calling method (`method2`) at line 36. This statement *is* in a try block; therefore, the try block terminates and the exception is caught at lines 38–41. Line 40 in the catch block throws a new exception. In this case, the `Exception` constructor with *two* arguments is called. The second argument represents the exception that was the original cause of the problem. In this program, that exception occurred at line 47. Because an exception is thrown from the catch block, `method2` terminates and returns the new exception to the calling method (`method1`) at line 23. Once again, this statement is in a try block, so the try block terminates and the exception is caught at lines 25–28. Line 27 in the catch block throws a new exception and uses the exception that was caught as the second argument to the `Exception` constructor. Because an exception is thrown from the catch block, `method1` terminates and returns the new exception to the calling method (`main`) at line 10. The try block in `main` terminates, and the exception is caught at lines 12–15. Line 14 prints a stack trace.

Notice in the program output that the first three lines show the most recent exception that was thrown (i.e., the one from `method1` at line 27). The next four lines indicate the exception that was thrown from `method2` at line 40. Finally, the last four lines represent the exception that was thrown from `method3` at line 47. Also notice that, as you read the output in reverse, it shows how many more chained exceptions remain.

## 11.9 Declaring New Exception Types

Most Java programmers use existing classes from the Java API, third-party vendors and freely available class libraries (usually downloadable from the Internet) to build Java applications. The methods of those classes typically are declared to throw appropriate exceptions when problems occur. You write code that processes these existing exceptions to make your programs more robust.

If you build classes that other programmers will use, you might find it useful to declare your own exception classes that are specific to the problems that can occur when another programmer uses your reusable classes.



### Software Engineering Observation 11.11

*If possible, indicate exceptions from your methods by using existing exception classes, rather than creating new ones. The Java API contains many exception classes that might be suitable for the type of problems your methods need to indicate.*

A new exception class must extend an existing exception class to ensure that the class can be used with the exception-handling mechanism. Like any other class, an exception class can contain fields and methods. A typical new exception class contains only four constructors: one that takes no arguments and passes a default error message `String` to the superclass constructor; one that receives a customized error message as a `String` and passes it to the superclass constructor; one that receives a customized error message as a `String` and a `Throwable` (for chaining exceptions) and passes both to the superclass constructor; and one that receives a `Throwable` (for chaining exceptions) and passes it to the superclass constructor.



### Good Programming Practice 11.3

*Associating each type of serious execution-time malfunction with an appropriately named Exception class improves program clarity.*



### Software Engineering Observation 11.12

*When defining your own exception type, study the existing exception classes in the Java API and try to extend a related exception class. For example, if you're creating a new class to represent when a method attempts a division by zero, you might extend class `ArithmeticException` because division by zero occurs during arithmetic. If the existing classes are not appropriate superclasses for your new exception class, decide whether your new class should be a checked or an unchecked exception class. The new exception class should be a checked exception (i.e., extend `Exception` but not `RuntimeException`) if clients should be required to handle the exception. The client application should be able to reasonably recover from such an exception. The new exception class should extend `RuntimeException` if the client code should be able to ignore the exception (i.e., the exception is an unchecked one).*

In Chapter 22, Custom Generic Data Structures, we provide an example of a custom exception class. We declare a reusable class called `List` that's capable of storing a list of references to objects. Some operations typically performed on a `List` are not allowed if the `List` is empty, such as removing an item from the front or back of the list. For this reason, some `List` methods throw exceptions of exception class `EmptyListException`.



### Good Programming Practice 11.4

*By convention, all exception-class names should end with the word `Exception`.*

## 11.10 Preconditions and Postconditions

Programmers spend significant amounts of time maintaining and debugging code. To facilitate these tasks and to improve the overall design, you can specify the expected states before and after a method's execution. These states are called preconditions and postconditions, respectively.

A **precondition** must be true when a method is *invoked*. Preconditions describe constraints on method parameters and any other expectations the method has about the current state of a program just before it begins executing. If the preconditions are not met, then the method's behavior is *undefined*—it may throw an exception, proceed with an illegal value or attempt to recover from the error. You should not expect consistent behavior if the preconditions are not satisfied.

A **postcondition** is true *after the method successfully returns*. Postconditions describe constraints on the return value and any other side effects the method may have. When defining a method, you should document all postconditions so that others know what to expect when they call your method, and you should make certain that your method honors all its postconditions if its preconditions are indeed met.

When their preconditions or postconditions are not met, methods typically throw exceptions. As an example, examine `String` method `charAt`, which has one `int` parameter—an index in the `String`. For a precondition, method `charAt` assumes that index is

greater than or equal to zero and less than the length of the `String`. If the precondition is met, the postcondition states that the method will return the character at the position in the `String` specified by the parameter `index`. Otherwise, the method throws an `IndexOutOfBoundsException`. We trust that method `charAt` satisfies its postcondition, provided that we meet the precondition. We need not be concerned with the details of how the method actually retrieves the character at the index.

Typically, a method's preconditions and postconditions are described as part of its specification. When designing your own methods, you should state the preconditions and postconditions in a comment before the method declaration.

## 11.11 Assertions

When implementing and debugging a class, it's sometimes useful to state conditions that should be true at a particular point in a method. These conditions, called **assertions**, help ensure a program's validity by catching potential bugs and identifying possible logic errors during development. Preconditions and postconditions are two types of assertions. Preconditions are assertions about its state when a method is invoked, and postconditions are assertions about a program's state after a method finishes.

While assertions can be stated as comments to guide you during program development, Java includes two versions of the **assert** statement for validating assertions programmatically. The `assert` statement evaluates a `boolean` expression and, if `false`, throws an **AssertionError** (a subclass of `Error`). The first form of the `assert` statement is

```
assert expression;
```

which throws an `AssertionError` if *expression* is `false`. The second form is

```
assert expression1 : expression2;
```

which evaluates *expression1* and throws an `AssertionError` with *expression2* as the error message if *expression1* is `false`.

You can use assertions to implement preconditions and postconditions programmatically or to verify any other intermediate states that help you ensure that your code is working correctly. Figure 11.7 demonstrates the `assert` statement. Line 11 prompts the user to enter a number between 0 and 10, then line 12 reads the number. Line 15 determines whether the user entered a number within the valid range. If the number is out of range, the `assert` statement reports an error; otherwise, the program proceeds normally.

---

```

1 // Fig. 11.7: AssertTest.java
2 // Checking with assert that a value is within range
3 import java.util.Scanner;
4
5 public class AssertTest
6 {
7 public static void main(String[] args)
8 {
9 Scanner input = new Scanner(System.in);
10

```

**Fig. 11.7** | Checking with `assert` that a value is within range. (Part 1 of 2.)

```

11 System.out.print("Enter a number between 0 and 10: ");
12 int number = input.nextInt();
13
14 // assert that the value is >= 0 and <= 10
15 assert (number >= 0 && number <= 10) : "bad number: " + number;
16
17 System.out.printf("You entered %d\n", number);
18 } // end main
19 } // end class AssertTest

```

```

Enter a number between 0 and 10: 5
You entered 5

```

```

Enter a number between 0 and 10: 50
Exception in thread "main" java.lang.AssertionError: bad number: 50
 at AssertTest.main(AssertTest.java:15)

```

**Fig. 11.7** | Checking with `assert` that a value is within range. (Part 2 of 2.)

You use assertions primarily for debugging and identifying logic errors in an application. You must explicitly enable assertions when executing a program, because they reduce performance and are unnecessary for the program's user. To do so, use the `java` command's `-ea` command-line option, as in

```
java -ea AssertTest
```

Users should not encounter any `AssertionErrors` through normal execution of a properly written program. Such errors should only indicate bugs in the implementation. As a result, you should never catch an `AssertionError`. Rather, you should allow the program to terminate when the error occurs, so you can see the error message, then locate and fix the source of the problem. Since application users can choose not to enable assertions at runtime, you should not use `assert` to indicate runtime problems in production code—use the exception mechanism for this purpose.

## 11.12 (New in Java SE 7) Multi-catch: Handling Multiple Exceptions in One catch

It's relatively common for a `try` block to be followed by several `catch` blocks to handle various types of exceptions. If the bodies of several `catch` blocks are identical, you can use the new Java SE 7 **multi-catch** feature to catch those exception types in a single `catch` handler and perform the same task. The syntax for a multi-catch is:

```
catch (Type1 | Type2 | Type3 e)
```

Each exception type is separated from the next with a vertical bar (`|`). The preceding line of code indicates that one of the specified types (or any subclasses of those types) can be caught in the exception handler. Any number of `Throwable` types can be specified in a multi-catch.

## 11.13 (New in Java SE 7) try-with-Resources: Automatic Resource Deallocation

Typically resource-release code should be placed in a `finally` block to ensure that a resource is released, regardless of whether there were exceptions when the resource was used in the corresponding `try` block. An alternative notation—the **try-with-resources** statement (which is new in Java SE 7)—simplifies writing code in which you obtain one or more resources, use them in a `try` block and release them in a corresponding `finally` block. For example, a file-processing application (Chapter 17) could process a file with a `try-with-resources` statement to ensure that the file is closed properly when it's no longer needed. Each resource must be an object of a class that implements the **AutoCloseable** interface—such a class has a `close` method. The general form of a `try-with-resources` statement is

```
try (ClassName theObject = new ClassName())
{
 // use theObject here
}
catch (Exception e)
{
 // catch exceptions that occur while using the resource
}
```

where *ClassName* is a class that implements the `AutoCloseable` interface. This code creates an object of type *ClassName* and uses it in the `try` block, then calls its `close` method to release any resources used by the object. The `try-with-resources` statement *implicitly* calls the `theObject`'s `close` method *at the end of the try block*. You can allocate multiple resources in the parentheses following `try` by separating them with a semicolon (;).

## 11.14 Wrap-Up

In this chapter, you learned how to use exception handling to deal with errors. You learned that exception handling enables you to remove error-handling code from the “main line” of the program’s execution. We showed how to use `try` blocks to enclose code that may throw an exception, and how to use `catch` blocks to deal with exceptions that may arise. You learned about the termination model of exception handling, which dictates that after an exception is handled, program control does not return to the throw point. We discussed checked vs. unchecked exceptions, and how to specify with the `throws` clause the exceptions that a method might throw. You learned how to use the `finally` block to release resources whether or not an exception occurs. You also learned how to throw and rethrow exceptions. We showed how to obtain information about an exception using methods `printStackTrace`, `getStackTrace` and `getMessage`. Next, we presented chained exceptions, which allow you to wrap original exception information with new exception information. Then, we showed how to create your own exception classes. We introduced preconditions and postconditions to help programmers using your methods understand conditions that must be true when the method is called and when it returns, respectively. When preconditions and postconditions are not met, methods typically throw exceptions. We discussed the `assert` statement and how it can be used to help you debug your programs. In particular, `assert` can be used to ensure that preconditions and postconditions

are met. Finally, we introduced Java SE 7's new exception-handling features, including multi-catch for processing several types of exceptions in the same catch handler and the try-with-resources statement for automatically deallocating a resource after it's used in the try block. In the next chapter, we begin our two-chapter, optional case study on object-oriented design with the UML.

## Summary

### *Section 11.1 Introduction*

- An exception is an indication of a problem that occurs during a program's execution.
- Exception handling enables programmers to create applications that can resolve exceptions.

### *Section 11.2 Example: Divide by Zero without Exception Handling*

- Exceptions are thrown (p. 440) when a method detects a problem and is unable to handle it.
- An exception's stack trace (p. 441) includes the name of the exception in a message that indicates the problem that occurred and the complete method-call stack at the time the exception occurred.
- The point in the program at which an exception occurs is called the throw point (p. 441).

### *Section 11.3 Example: Handling ArithmeticExceptions and InputMismatchExceptions*

- A try block (p. 444) encloses code that might throw an exception and code that should not execute if that exception occurs.
- Exceptions may surface through explicitly mentioned code in a try block, through calls to other methods or even through deeply nested method calls initiated by code in the try block.
- A catch block (p. 444) begins with keyword catch and an exception parameter followed by a block of code that handles the exception. This code executes when the try block detects the exception.
- An uncaught exception is an exception that occurs for which there are no matching catch blocks.
- An uncaught exception (p. 445) will cause a program to terminate early if that program contains only one thread. Otherwise, only the thread where the exception occurred will terminate. The rest of the program will run but possibly with adverse results.
- At least one catch block or a finally block (p. 444) must immediately follow the try block.
- A catch block specifies in parentheses an exception parameter identifying the exception type to handle. The parameter's name enables the catch block to interact with a caught exception object.
- If an exception occurs in a try block, the try block terminates immediately and program control transfers to the first catch block with a parameter type that matches the thrown exception's type.
- After an exception is handled, program control does not return to the throw point, because the try block has expired. This is known as the termination model of exception handling (p. 445).
- If there are multiple matching catch blocks when an exception occurs, only the first is executed.
- A throws clause (p. 446) specifies a comma-separated list of exceptions that the method might throw, and appears after the method's parameter list and before the method body.

### *Section 11.4 When to Use Exception Handling*

- Exception handling processes synchronous errors (p. 447), which occur when a statement executes.
- Exception handling is not designed to process problems associated with asynchronous events (p. 447), which occur in parallel with, and independent of, the program's flow of control.

### *Section 11.5 Java Exception Hierarchy*

- All Java exception classes inherit directly or indirectly from class `Exception`.
- Programmers can extend the Java exception hierarchy with their own exception classes.
- Class `Throwable` is the superclass of class `Exception` and is therefore also the superclass of all exceptions. Only `Throwable` objects can be used with the exception-handling mechanism.
- Class `Throwable` (p. 447) has two subclasses: `Exception` and `Error`.
- Class `Exception` and its subclasses represent problems that could occur in a Java program and be caught by the application.
- Class `Error` and its subclasses represent problems that could happen in the Java runtime system. Errors happen infrequently and typically should not be caught by an application.
- Java distinguishes between two categories of exceptions (p. 448): checked and unchecked.
- The Java compiler does not check to determine if an unchecked exception is caught or declared. Unchecked exceptions typically can be prevented by proper coding.
- Subclasses of `RuntimeException` represent unchecked exceptions. All exception types that inherit from class `Exception` but not from `RuntimeException` (p. 448) are checked.
- If a catch block is written to catch exception objects of a superclass type, it can also catch all objects of that class's subclasses. This allows for polymorphic processing of related exceptions.

### *Section 11.6 finally block*

- Programs that obtain certain types of resources must return them to the system to avoid so-called resource leaks (p. 450). Resource-release code typically is placed in a `finally` block (p. 450).
- The `finally` block is optional. If it's present, it's placed after the last catch block.
- The `finally` block will execute whether or not an exception is thrown in the corresponding try block or any of its corresponding catch blocks.
- If an exception cannot be caught by one of that try block's associated catch handlers, control proceeds to the `finally` block. Then the exception is passed to the next outer try block.
- If a catch block throws an exception, the `finally` block still executes. Then the exception is passed to the next outer try block.
- A `throw` statement (p. 453) can throw any `Throwable` object.
- Exceptions are rethrown (p. 453) when a catch block, upon receiving an exception, decides either that it cannot process that exception or that it can only partially process it. Rethrowing an exception defers the exception handling (or perhaps a portion of it) to another catch block.
- When a rethrow occurs, the next enclosing try block detects the rethrown exception, and that try block's catch blocks attempt to handle it.

### *Section 11.7 Stack Unwinding and Obtaining Information from an Exception Object*

- When an exception is thrown but not caught in a particular scope, the method-call stack is unwound, and an attempt is made to catch the exception in the next outer try statement.
- Class `Throwable` offers a `printStackTrace` method that prints the method-call stack. Often, this is helpful in testing and debugging.
- Class `Throwable` also provides a `getStackTrace` method that obtains the same stack-trace information that's printed by `printStackTrace` (p. 456).
- Class `Throwable`'s `getMessage` method (p. 456) returns the descriptive string stored in an exception.
- Method `getStackTrace` (p. 456) obtains the stack-trace information as an array of `StackTraceElement` objects. Each `StackTraceElement` represents one method call on the method-call stack.

- StackTraceElement methods (p. 457) getClassName, getFileName, getLineNumber and getMethodName get the class name, file name, line number and method name, respectively.

### Section 11.8 Chained Exceptions

- Chained exceptions (p. 457) enable an exception object to maintain the complete stack-trace information, including information about previous exceptions that caused the current exception.

### Section 11.9 Declaring New Exception Types

- A new exception class must extend an existing exception class to ensure that the class can be used with the exception-handling mechanism.

### Section 11.10 Preconditions and Postconditions

- A method's precondition (p. 460) must be true when the method is invoked.
- A method's postcondition (p. 460) is true after the method successfully returns.
- When designing your own methods, you should state the preconditions and postconditions in a comment before the method declaration.

### Section 11.11 Assertions

- Assertions (p. 461) help catch potential bugs and identify possible logic errors.
- The assert statement (p. 461) allows for validating assertions programmatically.
- To enable assertions at runtime, use the -ea switch when running the java command.

### Section 11.12 Multi-catch: Handling Multiple Exceptions in One catch

- Java SE 7's multi-catch (p. 462) enables you to catch multiple exception types in a single catch handler and perform the same task for each type of exception. The syntax for a multi-catch is:

```
catch (Type1 | Type2 | Type3 e)
```

- Each exception type is separated from the next with a vertical bar (|).

### Section 11.13 try-with-Resources: Automatic Resource Deallocation

- The try-with-resources statement (p. 463) simplifies writing code in which you obtain a resource, use it in a try block and release the resource in a corresponding finally block. Instead, you allocate the resource in the parentheses following the try keyword and use the resource in the try block; then the statement implicitly calls the resource's close method at the end of the try block.
- Each resource must be an object of a class that implements the AutoCloseable interface (p. 463)—such a class has a close method.
- You can allocate multiple resources in the parentheses following try by separating them with a semicolon (;).

## Self-Review Exercises

- 11.1 List five common examples of exceptions.
- 11.2 Give several reasons why exception-handling techniques should not be used for conventional program control.
- 11.3 Why are exceptions particularly appropriate for dealing with errors produced by methods of classes in the Java API?
- 11.4 What is a “resource leak”?
- 11.5 If no exceptions are thrown in a try block, where does control proceed to when the try block completes execution?



- 11.6 Give a key advantage of using `catch( Exception exceptionName )`.
- 11.7 Should a conventional application catch `Error` objects? Explain.
- 11.8 What happens if no catch handler matches the type of a thrown object?
- 11.9 What happens if several catch blocks match the type of the thrown object?
- 11.10 Why would a programmer specify a superclass type as the type in a catch block?
- 11.11 What is the key reason for using `finally` blocks?
- 11.12 What happens when a catch block throws an `Exception`?
- 11.13 What does the statement `throw exceptionReference` do in a catch block?
- 11.14 What happens to a local reference in a `try` block when that block throws an `Exception`?

## Answers to Self-Review Exercises

- 11.1 Memory exhaustion, array index out of bounds, arithmetic overflow, division by zero, invalid method parameters.
- 11.2 (a) Exception handling is designed to handle infrequently occurring situations that often result in program termination, not situations that arise all the time. (b) Flow of control with conventional control structures is generally clearer and more efficient than with exceptions. (c) The additional exceptions can get in the way of genuine error-type exceptions. It becomes more difficult for you to keep track of the larger number of exception cases.
- 11.3 It's unlikely that methods of classes in the Java API could perform error processing that would meet the unique needs of all users.
- 11.4 A "resource leak" occurs when an executing program does not properly release a resource when it's no longer needed.
- 11.5 The catch blocks for that `try` statement are skipped, and the program resumes execution after the last catch block. If there's a `finally` block, it's executed first; then the program resumes execution after the `finally` block.
- 11.6 The form `catch( Exception exceptionName )` catches any type of exception thrown in a `try` block. An advantage is that no thrown `Exception` can slip by without being caught. You can then decide to handle the exception or possibly rethrow it.
- 11.7 Errors are usually serious problems with the underlying Java system; most programs will not want to catch `Errors` because they will not be able to recover from them.
- 11.8 This causes the search for a match to continue in the next enclosing `try` statement. If there's a `finally` block, it will be executed before the exception goes to the next enclosing `try` statement. If there are no enclosing `try` statements for which there are matching catch blocks and the exceptions are declared (or unchecked), a stack trace is printed and the current thread terminates early. If the exceptions are checked, but not caught or declared, compilation errors occur.
- 11.9 The first matching catch block after the `try` block is executed.
- 11.10 This enables a program to catch related types of exceptions and process them in a uniform manner. However, it's often useful to process the subclass types individually for more precise exception handling.
- 11.11 The `finally` block is the preferred means for releasing resources to prevent resource leaks.
- 11.12 First, control passes to the `finally` block if there is one. Then the exception will be processed by a catch block (if one exists) associated with an enclosing `try` block (if one exists).
- 11.13 It rethrows the exception for processing by an exception handler of an enclosing `try` statement, after the `finally` block of the current `try` statement executes.

**11.14** The reference goes out of scope. If the referenced object becomes unreachable, the object can be garbage collected.

## Exercises

**11.15** (*Exceptional Conditions*) List the various exceptional conditions that have occurred in programs throughout this text so far. List as many additional exceptional conditions as you can. For each of these, describe briefly how a program typically would handle the exception by using the exception-handling techniques discussed in this chapter. Typical exceptions include division by zero and array index out of bounds.

**11.16** (*Exceptions and Constructor Failure*) Until this chapter, we've found dealing with errors detected by constructors to be a bit awkward. Explain why exception handling is an effective means for dealing with constructor failure.

**11.17** (*Catching Exceptions with Superclasses*) Use inheritance to create an exception superclass (called `ExceptionA`) and exception subclasses `ExceptionB` and `ExceptionC`, where `ExceptionB` inherits from `ExceptionA` and `ExceptionC` inherits from `ExceptionB`. Write a program to demonstrate that the catch block for type `ExceptionA` catches exceptions of types `ExceptionB` and `ExceptionC`.

**11.18** (*Catching Exceptions Using Class Exception*) Write a program that demonstrates how various exceptions are caught with

```
catch (Exception exception)
```

This time, define classes `ExceptionA` (which inherits from class `Exception`) and `ExceptionB` (which inherits from class `ExceptionA`). In your program, create try blocks that throw exceptions of types `ExceptionA`, `ExceptionB`, `NullPointerException` and `IOException`. All exceptions should be caught with catch blocks specifying type `Exception`.

**11.19** (*Order of catch Blocks*) Write a program that shows that the order of catch blocks is important. If you try to catch a superclass exception type before a subclass type, the compiler should generate errors.

**11.20** (*Constructor Failure*) Write a program that shows a constructor passing information about constructor failure to an exception handler. Define class `SomeClass`, which throws an `Exception` in the constructor. Your program should try to create an object of type `SomeClass` and catch the exception that's thrown from the constructor.

**11.21** (*Rethrowing Exceptions*) Write a program that illustrates rethrowing an exception. Define methods `someMethod` and `someMethod2`. Method `someMethod2` should initially throw an exception. Method `someMethod` should call `someMethod2`, catch the exception and rethrow it. Call `someMethod` from method `main`, and catch the rethrown exception. Print the stack trace of this exception.

**11.22** (*Catching Exceptions Using Outer Scopes*) Write a program showing that a method with its own try block does not have to catch every possible error generated within the try. Some exceptions can slip through to, and be handled in, other scopes.

# ATM Case Study, Part I: Object-Oriented Design with the UML

# 12

*Action speaks louder than words  
but not nearly as often.*

—Mark Twain

*Always design a thing by  
considering it in its next larger  
context.*

—Eliel Saarinen

*Oh, life is a glorious cycle of  
song.*

—Dorothy Parker

*The Wright brothers' design ...  
allowed them to survive long  
enough to learn how to fly.*

—Michael Potts

## Objectives

In this chapter you'll learn:

- A simple object-oriented design methodology.
- What a requirements document is.
- To identify classes and class attributes from a requirements document.
- To identify objects' states, activities and operations from a requirements document.
- To determine the collaborations among objects in a system.
- To work with the UML's use case, class, state, activity, communication and sequence diagrams to graphically model an object-oriented system.



|                                                                |                                                        |
|----------------------------------------------------------------|--------------------------------------------------------|
| <b>12.1</b> Case Study Introduction                            | <b>12.5</b> Identifying Objects' States and Activities |
| <b>12.2</b> Examining the Requirements Document                | <b>12.6</b> Identifying Class Operations               |
| <b>12.3</b> Identifying the Classes in a Requirements Document | <b>12.7</b> Indicating Collaboration Among Objects     |
| <b>12.4</b> Identifying Class Attributes                       | <b>12.8</b> Wrap-Up                                    |

*Answers to Self-Review Exercises*

## 12.1 Case Study Introduction

Now we begin the *optional* portion of our object-oriented design and implementation case study. In this chapter and Chapter 13, you'll design and implement an object-oriented automated teller machine (ATM) software system. The case study provides you with a concise, carefully paced, complete design and implementation experience. In Sections 12.2–12.7 and 13.2–13.3, you'll perform the steps of an object-oriented design (OOD) process using the UML while relating these steps to the object-oriented concepts discussed in Chapters 2–10. In this chapter, you'll work with six popular types of UML diagrams to graphically represent the design. In Chapter 13, you'll tune the design with inheritance, then fully implement the ATM in a 673-line Java application (Section 13.4).

This is not an exercise; rather, it's an end-to-end learning experience that concludes with a detailed walkthrough of the complete Java code that implements our design. It will begin to acquaint you with the kinds of substantial problems encountered in industry.

These chapters can be studied as a continuous unit after you've completed the introduction to object-oriented programming in Chapters 8–11. Or, you can pace the sections one at a time after Chapters 2–8 and 10. Each section of the case study begins with a note telling you the chapter after which it can be covered.

## 12.2 Examining the Requirements Document

[*Note:* This section can be taught after Chapter 2.]

We begin our design process by presenting a **requirements document** that specifies the purpose of the ATM system and *what* it must do. Throughout the case study, we refer often to this requirements document.

### *Requirements Document*

A local bank intends to install a new automated teller machine (ATM) to allow users (i.e., bank customers) to perform basic financial transactions (Fig. 12.1). Each user can have only one account at the bank. ATM users should be able to view their account balance, withdraw cash (i.e., take money out of an account) and deposit funds (i.e., place money into an account). The user interface of the automated teller machine contains:

- a screen that displays messages to the user
- a keypad that receives numeric input from the user
- a cash dispenser that dispenses cash to the user and
- a deposit slot that receives deposit envelopes from the user.

The cash dispenser begins each day loaded with 500 \$20 bills. [Note: Owing to the limited scope of this case study, certain elements of the ATM described here do not accurately mimic those of a real ATM. For example, a real ATM typically contains a device that reads a user's account number from an ATM card, whereas this ATM asks the user to type the account number on the keypad. A real ATM also usually prints a receipt at the end of a session, but all output from this ATM appears on the screen.]

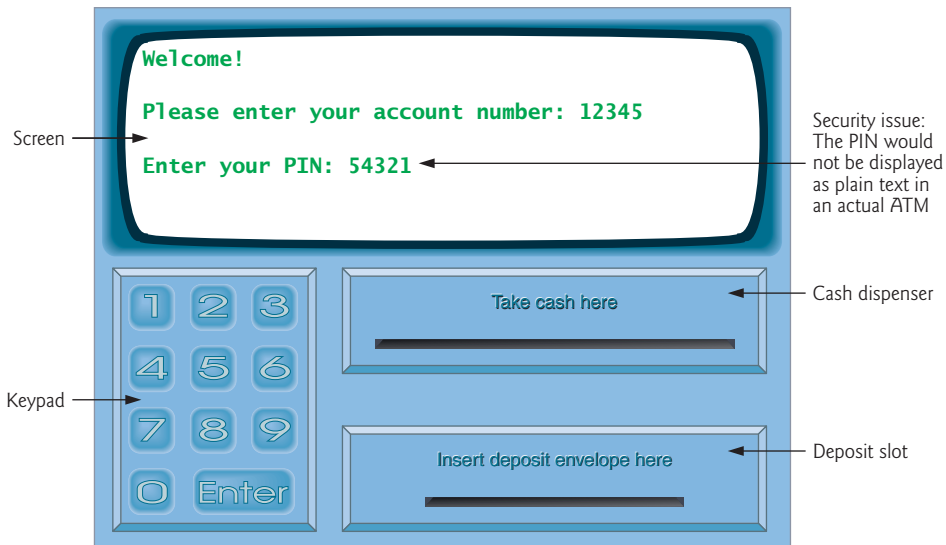

**Fig. 12.1** | Automated teller machine user interface.

The bank wants you to develop software to perform the financial transactions initiated by bank customers through the ATM. The bank will integrate the software with the ATM's hardware at a later time. The software should encapsulate the functionality of the hardware devices (e.g., cash dispenser, deposit slot) within software components, but it need not concern itself with how these devices perform their duties. The ATM hardware has not been developed yet, so instead of writing your software to run on the ATM, you should develop a first version to run on a personal computer. This version should use the computer's monitor to simulate the ATM's screen, and the computer's keyboard to simulate the ATM's keypad.

An ATM session consists of authenticating a user (i.e., proving the user's identity) based on an account number and personal identification number (PIN), followed by creating and executing financial transactions. To authenticate a user and perform transactions, the ATM must interact with the bank's account information database (i.e., an organized collection of data stored on a computer; we study database access in Chapter 28). For each bank account, the database stores an account number, a PIN and a balance indicating the amount of money in the account. [Note: We assume that the bank plans to build only one ATM, so we need not worry about multiple ATMs accessing this database at the same time. Furthermore, we assume that the bank does not make any changes to the information in the database while a user is accessing the ATM. Also, any

business system like an ATM faces complex and challenging security issues that are beyond the scope of a first or second programming course. We make the simplifying assumption, however, that the bank trusts the ATM to access and manipulate the information in the database without significant security measures.]

Upon first approaching the ATM (assuming no one is currently using it), the user should experience the following sequence of events (shown in Fig. 12.1):

1. The screen displays Welcome! and prompts the user to enter an account number.
2. The user enters a five-digit account number using the keypad.
3. The screen prompts the user to enter the PIN (personal identification number) associated with the specified account number.
4. The user enters a five-digit PIN using the keypad.<sup>1</sup>
5. If the user enters a valid account number and the correct PIN for that account, the screen displays the main menu (Fig. 12.2). If the user enters an invalid account number or an incorrect PIN, the screen displays an appropriate message, then the ATM returns to *Step 1* to restart the authentication process.

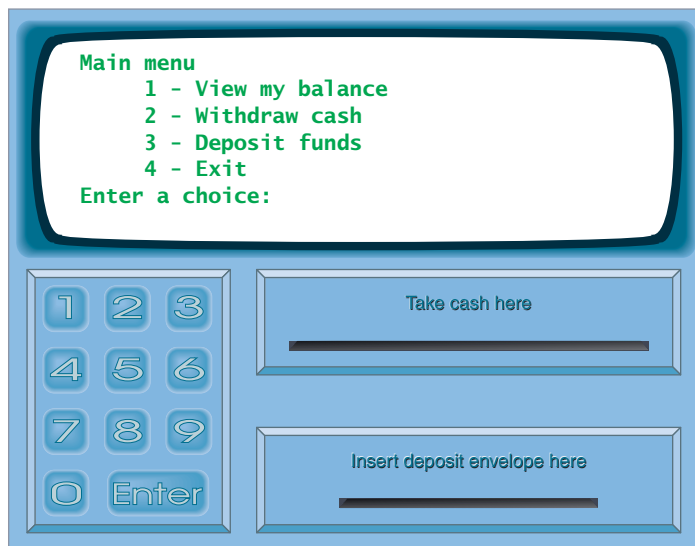

**Fig. 12.2** | ATM main menu.

After the ATM authenticates the user, the main menu (Fig. 12.2) should contain a numbered option for each of the three types of transactions: balance inquiry (option 1),

1. In this simple, command-line, text-based ATM, as you type the PIN, it appears on the screen. This is an obvious security breach—you would not want someone looking over your shoulder at an ATM and seeing your PIN displayed on the screen. In Chapter 14, we introduce the `JPasswordField` GUI component, which displays asterisks as the user types—making it more appropriate for entering PIN numbers and passwords. Exercise 14.18 asks you to build a GUI-based version of the ATM and to use a `JPasswordField` to obtain the user's PIN.

withdrawal (option 2) and deposit (option 3). It also should contain an option to allow the user to exit the system (option 4). The user then chooses either to perform a transaction (by entering 1, 2 or 3) or to exit the system (by entering 4).

If the user enters 1 to make a balance inquiry, the screen displays the user's account balance. To do so, the ATM must retrieve the balance from the bank's database. The following steps describe what occurs when the user enters 2 to make a withdrawal:

1. The screen displays a menu (Fig. 12.3) containing standard withdrawal amounts: \$20 (option 1), \$40 (option 2), \$60 (option 3), \$100 (option 4) and \$200 (option 5). The menu also contains an option to allow the user to cancel the transaction (option 6).

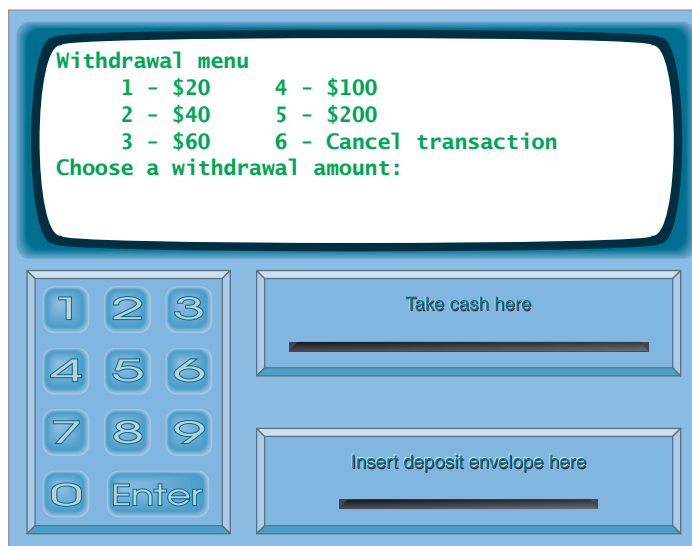

**Fig. 12.3** | ATM withdrawal menu.

2. The user enters a menu selection using the keypad.
3. If the withdrawal amount chosen is greater than the user's account balance, the screen displays a message stating this and telling the user to choose a smaller amount. The ATM then returns to *Step 1*. If the withdrawal amount chosen is less than or equal to the user's account balance (i.e., an acceptable amount), the ATM proceeds to *Step 4*. If the user chooses to cancel the transaction (option 6), the ATM displays the main menu and waits for user input.
4. If the cash dispenser contains enough cash, the ATM proceeds to *Step 5*. Otherwise, the screen displays a message indicating the problem and telling the user to choose a smaller withdrawal amount. The ATM then returns to *Step 1*.
5. The ATM debits the withdrawal amount from the user's account in the bank's database (i.e., subtracts the withdrawal amount from the user's account balance).
6. The cash dispenser dispenses the desired amount of money to the user.

7. The screen displays a message reminding the user to take the money.

The following steps describe the actions that occur when the user enters 3 (when viewing the main menu of Fig. 12.2) to make a deposit:

1. The screen prompts the user to enter a deposit amount or type 0 (zero) to cancel.
2. The user enters a deposit amount or 0 using the keypad. [*Note:* The keypad does not contain a decimal point or a dollar sign, so the user cannot type a real dollar amount (e.g., \$27.25). Instead, the user must enter a deposit amount as a number of cents (e.g., 2725). The ATM then divides this number by 100 to obtain a number representing a dollar amount (e.g.,  $2725 \div 100 = 27.25$ ).]
3. If the user specifies a deposit amount, the ATM proceeds to *Step 4*. If the user chooses to cancel the transaction (by entering 0), the ATM displays the main menu and waits for user input.
4. The screen displays a message telling the user to insert a deposit envelope.
5. If the deposit slot receives a deposit envelope within two minutes, the ATM credits the deposit amount to the user's account in the bank's database (i.e., adds the deposit amount to the user's account balance). [*Note:* This money is *not* immediately available for withdrawal. The bank first must physically verify the amount of cash in the deposit envelope, and any checks in the envelope must clear (i.e., money must be transferred from the check writer's account to the check recipient's account). When either of these events occurs, the bank appropriately updates the user's balance stored in its database. This occurs independently of the ATM system.] If the deposit slot does not receive a deposit envelope within this time period, the screen displays a message that the system has canceled the transaction due to inactivity. The ATM then displays the main menu and waits for user input.

After the system successfully executes a transaction, it should return to the main menu so that the user can perform additional transactions. If the user exits the system, the screen should display a thank you message, then display the welcome message for the next user.

### *Analyzing the ATM System*

The preceding statement is a simplified example of a requirements document. Typically, such a document is the result of a detailed process of **requirements gathering**, which might include interviews with possible users of the system and specialists in fields related to the system. For example, a systems analyst who is hired to prepare a requirements document for banking software (e.g., the ATM system described here) might interview banking experts to gain a better understanding of what the software must do. The analyst would use the information gained to compile a list of **system requirements** to guide systems designers as they design the system.

The process of requirements gathering is a key task of the first stage of the software life cycle. The **software life cycle** specifies the stages through which software goes from the time it's first conceived to the time it's retired from use. These stages typically include: analysis, design, implementation, testing and debugging, deployment, maintenance and retirement. Several software life-cycle models exist, each with its own preferences and specifications for when and how often software engineers should perform each of these stages.



**Waterfall models** perform each stage once in succession, whereas **iterative models** may *repeat* one or more stages several times throughout a product’s life cycle.

The analysis stage focuses on defining the problem to be solved. When designing any system, one must *solve the problem right*, but of equal importance, one must *solve the right problem*. Systems analysts collect the requirements that indicate the specific problem to solve. Our requirements document describes the requirements of our ATM system in sufficient detail that you need not go through an extensive analysis stage—it’s been done for you.

To capture what a proposed system should do, developers often employ a technique known as **use case modeling**. This process identifies the **use cases** of the system, each representing a different capability that the system provides to its clients. For example, ATMs typically have several use cases, such as “View Account Balance,” “Withdraw Cash,” “Deposit Funds,” “Transfer Funds Between Accounts” and “Buy Postage Stamps.” The simplified ATM system we build in this case study allows only the first three.

Each use case describes a typical scenario for which the user uses the system. You’ve already read descriptions of the ATM system’s use cases in the requirements document; the lists of steps required to perform each transaction type (i.e., balance inquiry, withdrawal and deposit) actually described the three use cases of our ATM—“View Account Balance,” “Withdraw Cash” and “Deposit Funds,” respectively.

### Use Case Diagrams

We now introduce the first of several UML diagrams in the case study. We create a **use case diagram** to model the interactions between a system’s clients (in this case study, bank customers) and its use cases. The goal is to show the kinds of interactions users have with a system without providing the details—these are provided in other UML diagrams (which we present throughout this case study). Use case diagrams are often accompanied by informal text that gives more detail—like the text that appears in the requirements document. Use case diagrams are produced during the analysis stage of the software life cycle. In larger systems, use case diagrams are indispensable tools that help system designers remain focused on satisfying the users’ needs.

Figure 12.4 shows the use case diagram for our ATM system. The stick figure represents an **actor**, which defines the roles that an external entity—such as a person or another system—plays when interacting with the system. For our automated teller machine, the actor is a User who can view an account balance, withdraw cash and deposit funds from

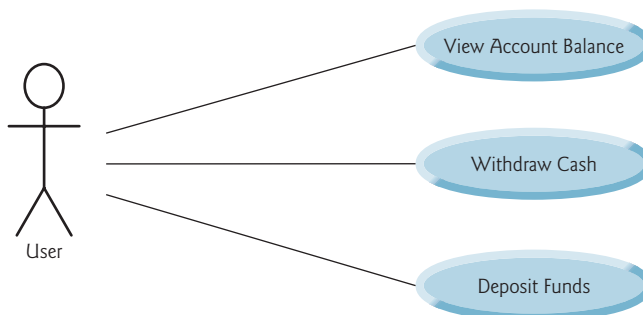

**Fig. 12.4** | Use case diagram for the ATM system from the User’s perspective.

the ATM. The User is not an actual person, but instead comprises the roles that a real person—when playing the part of a User—can play while interacting with the ATM. A use case diagram can include multiple actors. For example, the use case diagram for a real bank’s ATM system might also include an actor named Administrator who refills the cash dispenser each day.

Our requirements document supplies the actors—“ATM users should be able to view their account balance, withdraw cash and deposit funds.” Therefore, the actor in each of the three use cases is the user who interacts with the ATM. An external entity—a real person—plays the part of the user to perform financial transactions. Figure 12.4 shows one actor, whose name, User, appears below the actor in the diagram. The UML models each use case as an oval connected to an actor with a solid line.

Software engineers (more precisely, systems designers) must analyze the requirements document or a set of use cases and design the system before programmers implement it in a particular programming language. During the analysis stage, systems designers focus on understanding the requirements document to produce a high-level specification that describes *what* the system is supposed to do. The output of the design stage—a **design specification**—should specify clearly *how* the system should be constructed to satisfy these requirements. In the next several sections, we perform the steps of a simple object-oriented design (OOD) process on the ATM system to produce a design specification containing a collection of UML diagrams and supporting text.

The UML is designed for use with any OOD process. Many such processes exist, the best known of which is the Rational Unified Process™ (RUP) developed by Rational Software Corporation, now part of IBM. RUP is a rich process intended for designing “industrial strength” applications. For this case study, we present our own simplified design process, designed for students in first and second programming courses.

### *Designing the ATM System*

We now begin the design stage of our ATM system. A **system** is a set of components that interact to solve a problem. For example, to perform the ATM system’s designated tasks, our ATM system has a user interface (Fig. 12.1), and contains software that executes financial transactions and interacts with a database of bank account information. **System structure** describes the system’s objects and their interrelationships. **System behavior** describes how the system changes as its objects interact with one another.

Every system has both structure and behavior—designers must specify both. There are several types of system structures and behaviors. For example, the interactions among objects in the system differ from those between the user and the system, yet both constitute a portion of the system behavior.

The UML 2 standard specifies 13 diagram types for documenting the system models. Each models a distinct characteristic of a system’s structure or behavior—six diagrams relate to system structure, the remaining seven to system behavior. We list here only the six diagram types used in our case study—one models system structure; the other five model system behavior. We provide an overview of the remaining seven UML diagram types in Appendix P, UML 2: Additional Diagram Types.

1. **Use case diagrams**, such as the one in Fig. 12.4, model the interactions between a system and its external entities (actors) in terms of use cases (system capabilities, such as “View Account Balance,” “Withdraw Cash” and “Deposit Funds”).

2. **Class diagrams**, which you'll study in Section 12.3, model the classes, or “building blocks,” used in a system. Each noun or “thing” described in the requirements document is a candidate to be a class in the system (e.g., Account, Keypad). Class diagrams help us specify the *structural relationships* between parts of the system. For example, the ATM system class diagram will specify that the ATM is physically *composed of* a screen, a keypad, a cash dispenser and a deposit slot.
3. **State machine diagrams**, which you'll study in Section 12.5, model the ways in which an object changes state. An object's **state** is indicated by the values of all its attributes at a given time. When an object changes state, it may behave differently in the system. For example, after validating a user's PIN, the ATM transitions from the “user not authenticated” state to the “user authenticated” state, at which point it allows the user to perform financial transactions (e.g., view account balance, withdraw cash, deposit funds).
4. **Activity diagrams**, which you'll also study in Section 12.5, model an object's **activity**—is workflow (sequence of events) during program execution. An activity diagram models the *actions* the object performs and specifies the *order* in which it performs them. For example, an activity diagram shows that the ATM must obtain the balance of the user's account (from the bank's account information database) *before* the screen can display the balance to the user.
5. **Communication diagrams** (called **collaboration diagrams** in earlier versions of the UML) model the interactions among objects in a system, with an emphasis on *what* interactions occur. You'll learn in Section 12.7 that these diagrams show which objects must interact to perform an ATM transaction. For example, the ATM must communicate with the bank's account information database to retrieve an account balance.
6. **Sequence diagrams** also model the interactions among the objects in a system, but unlike communication diagrams, they emphasize *when* interactions occur. You'll learn in Section 12.7 that these diagrams help show the order in which interactions occur in executing a financial transaction. For example, the screen prompts the user to enter a withdrawal amount before cash is dispensed.

In Section 12.3, we continue designing our ATM system by identifying the classes from the requirements document. We accomplish this by extracting key *nouns and noun phrases* from the requirements document. Using these classes, we develop our first draft of the class diagram that models the structure of our ATM system.

### Web Resource

We've created an extensive UML Resource Center that contains many links to additional information, including introductions, tutorials, blogs, books, certification, conferences, developer tools, documentation, e-books, FAQs, forums, groups, UML in Java, podcasts, security, tools, downloads, training courses, videos and more. Browse our UML Resource Center at [www.deitel.com/UML/](http://www.deitel.com/UML/).

## Self-Review Exercises for Section 12.2

**12.1** Suppose we enabled a user of our ATM system to transfer money between two bank accounts. Modify the use case diagram of Fig. 12.4 to reflect this change.

**12.2** \_\_\_\_\_ model the interactions among objects in a system with an emphasis on *when* these interactions occur.

- a) Class diagrams
- b) Sequence diagrams
- c) Communication diagrams
- d) Activity diagrams

**12.3** Which of the following choices lists stages of a typical software life cycle in sequential order?

- a) design, analysis, implementation, testing
- b) design, analysis, testing, implementation
- c) analysis, design, testing, implementation
- d) analysis, design, implementation, testing

## 12.3 Identifying the Classes in a Requirements Document

[*Note: This section can be taught after Chapter 3.*]

Now we begin designing the ATM system. In this section, we identify the classes that are needed to build the system by analyzing the *nouns* and *noun phrases* that appear in the requirements document. We introduce UML class diagrams to model these classes. This is an important first step in defining the system’s structure.

### *Identifying the Classes in a System*

We begin our OOD process by identifying the classes required to build the ATM system. We’ll eventually describe these classes using UML class diagrams and implement these classes in Java. First, we review the requirements document of Section 12.2 and identify key nouns and noun phrases to help us identify classes that comprise the ATM system. We may decide that some of these are actually attributes of other classes in the system. We may also conclude that some of the nouns do not correspond to parts of the system and thus should not be modeled at all. Additional classes may become apparent to us as we proceed through the design process.

Figure 12.5 lists the nouns and noun phrases found in the requirements document. We list them from left to right in the order in which we first encounter them. We list only the singular form of each.

| Nouns and noun phrases in the ATM requirements document |                  |                |                  |
|---------------------------------------------------------|------------------|----------------|------------------|
| bank                                                    | money / funds    | account number | ATM              |
| screen                                                  | PIN              | user           | keypad           |
| bank database                                           | customer         | cash dispenser | balance inquiry  |
| transaction                                             | \$20 bill / cash | withdrawal     | account          |
| deposit slot                                            | deposit          | balance        | deposit envelope |

**Fig. 12.5** | Nouns and noun phrases in the ATM requirements document.

We create classes only for the nouns and noun phrases that have significance in the ATM system. We don’t model “bank” as a class, because the bank is not a part of the ATM system—the bank simply wants us to build the ATM. “Customer” and “user” also repre-

sent outside entities—they're important because they *interact* with our ATM system, but we do not need to model them as classes in the ATM software. Recall that we modeled an ATM user (i.e., a bank customer) as the actor in the use case diagram of Fig. 12.4.

We do not model “\$20 bill” or “deposit envelope” as classes. These are physical objects in the real world, but they're not part of what is being automated. We can adequately represent the presence of bills in the system using an attribute of the class that models the cash dispenser. (We assign attributes to the ATM system's classes in Section 12.4.) For example, the cash dispenser maintains a count of the number of bills it contains. The requirements document does not say anything about what the system should do with deposit envelopes after it receives them. We can assume that simply acknowledging the receipt of an envelope—an operation performed by the class that models the deposit slot—is sufficient to represent the presence of an envelope in the system. We assign operations to the ATM system's classes in Section 12.6.

In our simplified ATM system, representing various amounts of “money,” including an account's “balance,” as attributes of classes seems most appropriate. Likewise, the nouns “account number” and “PIN” represent significant pieces of information in the ATM system. They're important attributes of a bank account. They do not, however, exhibit behaviors. Thus, we can most appropriately model them as attributes of an account class.

Though the requirements document frequently describes a “transaction” in a general sense, we do not model the broad notion of a financial transaction at this time. Instead, we model the three types of transactions (i.e., “balance inquiry,” “withdrawal” and “deposit”) as individual classes. These classes possess specific attributes needed for executing the transactions they represent. For example, a withdrawal needs to know the amount of the withdrawal. A balance inquiry, however, does not require any additional data other than the account number. Furthermore, the three transaction classes exhibit unique behaviors. A withdrawal includes dispensing cash to the user, whereas a deposit involves receiving deposit envelopes from the user. In Section 13.3, we “factor out” common features of all transactions into a general “transaction” class using the object-oriented concept of inheritance.

We determine the classes for our system based on the remaining nouns and noun phrases from Fig. 12.5. Each of these refers to one or more of the following:

- ATM
- screen
- keypad
- cash dispenser
- deposit slot
- account
- bank database
- balance inquiry
- withdrawal
- deposit

The elements of this list are likely to be classes that we'll need to implement our system.

We can now model the classes in our system based on the list we've created. We capitalize class names in the design process—a UML convention—as we'll do when we write

the actual Java code that implements our design. If the name of a class contains more than one word, we run the words together and capitalize each word (e.g., `MultipleWordName`). Using this convention, we create classes `ATM`, `Screen`, `Keypad`, `CashDispenser`, `DepositSlot`, `Account`, `BankDatabase`, `BalanceInquiry`, `Withdrawal` and `Deposit`. We construct our system using these classes as building blocks. Before we begin building the system, however, we must gain a better understanding of how the classes relate to one another.

### Modeling Classes

The UML enables us to model, via **class diagrams**, the classes in the ATM system and their interrelationships. Figure 12.6 represents class `ATM`. Each class is modeled as a rectangle with three compartments. The top one contains the name of the class centered horizontally in boldface. The middle compartment contains the class's attributes. (We discuss attributes in Sections 12.4–12.5.) The bottom compartment contains the class's operations (discussed in Section 12.6). In Fig. 12.6, the middle and bottom compartments are empty because we've not yet determined this class's attributes and operations.

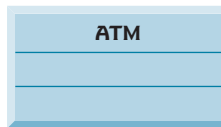

**Fig. 12.6** | Representing a class in the UML using a class diagram.

Class diagrams also show the relationships between the classes of the system. Figure 12.7 shows how our classes `ATM` and `Withdrawal` relate to one another. For the moment, for simplicity, we choose to model only this subset of classes. We present a more complete class diagram later in this section. Notice that the rectangles representing classes in this diagram are not subdivided into compartments. The UML allows the suppression of class attributes and operations in this manner to create more readable diagrams, when appropriate. Such a diagram is said to be an **elided diagram**—one in which some information, such as the contents of the second and third compartments, is *not* modeled. We'll place information in these compartments in Sections 12.4–12.6.

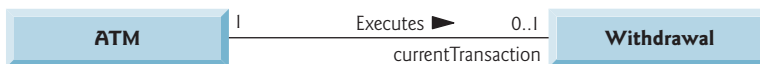

**Fig. 12.7** | Class diagram showing an association among classes.

In Fig. 12.7, the solid line that connects the two classes represents an **association**—a relationship between classes. The numbers near each end of the line are **multiplicity** values, which indicate how many objects of each class participate in the association. In this case, following the line from left to right reveals that, at any given moment, one `ATM` object participates in an association with either zero or one `Withdrawal` objects—zero if the current user is not currently performing a transaction or has requested a different type of transaction, and one if the user has requested a withdrawal. The UML can model many types of multiplicity. Figure 12.8 lists and explains the multiplicity types.

| Symbol | Meaning                                |
|--------|----------------------------------------|
| 0      | None                                   |
| 1      | One                                    |
| $m$    | An integer value                       |
| 0..1   | Zero or one                            |
| $m, n$ | $m$ or $n$                             |
| $m..n$ | At least $m$ , but not more than $n$   |
| *      | Any nonnegative integer (zero or more) |
| 0..*   | Zero or more (identical to *)          |
| 1..*   | One or more                            |

**Fig. 12.8** | Multiplicity types.

An association can be named. For example, the word `Executes` above the line connecting classes `ATM` and `Withdrawal` in Fig. 12.7 indicates the name of that association. This part of the diagram reads “one object of class `ATM` executes zero or one objects of class `Withdrawal`.” Association names are *directional*, as indicated by the filled arrowhead—so it would be improper, for example, to read the preceding association from right to left as “zero or one objects of class `Withdrawal` execute one object of class `ATM`.”

The word `currentTransaction` at the `Withdrawal` end of the association line in Fig. 12.7 is a **role name**, identifying the role the `Withdrawal` object plays in its relationship with the `ATM`. A role name adds meaning to an association between classes by identifying the role a class plays in the context of an association. A class can play several roles in the same system. For example, in a school personnel system, a person may play the role of “professor” when relating to students. The same person may take on the role of “colleague” when participating in an association with another professor, and “coach” when coaching student athletes. In Fig. 12.7, the role name `currentTransaction` indicates that the `Withdrawal` object participating in the `Executes` association with an object of class `ATM` represents the transaction currently being processed by the `ATM`. In other contexts, a `Withdrawal` object may take on other roles (e.g., the “previous transaction”). Notice that we do not specify a role name for the `ATM` end of the `Executes` association. Role names in class diagrams are often omitted when the meaning of an association is clear without them.

In addition to indicating simple relationships, associations can specify more complex relationships, such as objects of one class being *composed of* objects of other classes. Consider a real-world automated teller machine. What “pieces” does a manufacturer put together to build a working `ATM`? Our requirements document tells us that the `ATM` is composed of a screen, a keypad, a cash dispenser and a deposit slot.

In Fig. 12.9, the **solid diamonds** attached to the `ATM` class’s association lines indicate that `ATM` has a **composition** relationship with classes `Screen`, `Keypad`, `CashDispenser` and `DepositSlot`. Composition implies a *whole/part relationship*. The class that has the composition symbol (the solid diamond) on its end of the association line is the *whole* (in this case, `ATM`), and the classes on the other end of the association lines are the *parts*—in this case, `Screen`, `Keypad`, `CashDispenser` and `DepositSlot`. The compositions in Fig. 12.9 indicate that an object of class `ATM` is formed from one object of class `Screen`, one object

of class `CashDispenser`, one object of class `Keypad` and one object of class `DepositSlot`. The ATM *has a* screen, a keypad, a cash dispenser and a deposit slot. (As we saw in Chapter 9, the *is-a* relationship defines inheritance. We'll see in Section 13.3 that there's a nice opportunity to use inheritance in the ATM system design.)

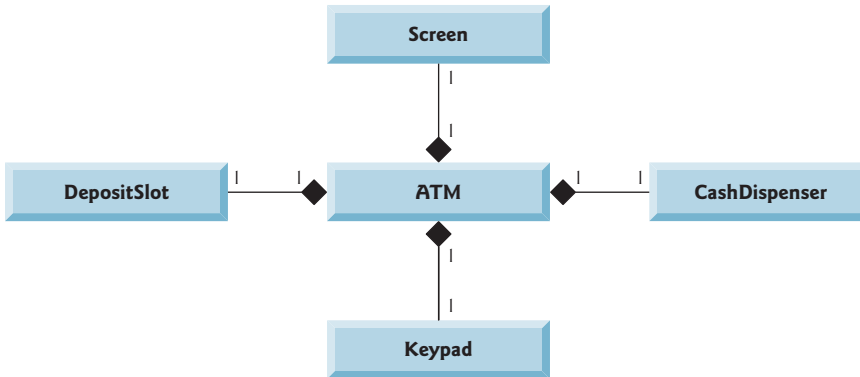

**Fig. 12.9** | Class diagram showing composition relationships.

According to the UML specification ([www.omg.org/technology/documents/formal/uml.htm](http://www.omg.org/technology/documents/formal/uml.htm)), composition relationships have the following properties:

1. Only one class in the relationship can represent the *whole* (i.e., the diamond can be placed on only *one* end of the association line). For example, either the screen is part of the ATM or the ATM is part of the screen, but the screen and the ATM cannot both represent the whole in the relationship.
2. The *parts* in the composition relationship exist only as long as the whole does, and the whole is responsible for the creation and destruction of its parts. For example, the act of constructing an ATM includes manufacturing its parts. Also, if the ATM is destroyed, its screen, keypad, cash dispenser and deposit slot are also destroyed.
3. A *part* may belong to only one *whole* at a time, although it may be removed and attached to another whole, which then assumes responsibility for the part.

The solid diamonds in our class diagrams indicate composition relationships that fulfill these properties. If a *has-a* relationship does not satisfy one or more of these criteria, the UML specifies that **hollow diamonds** be attached to the ends of association lines to indicate **aggregation**—a weaker form of composition. For example, a personal computer and a computer monitor participate in an aggregation relationship—the computer *has a* monitor, but the two parts can exist independently, and the same monitor can be attached to multiple computers at once, thus violating composition's second and third properties.

Figure 12.10 shows a class diagram for the ATM system. This diagram models most of the classes that we've identified, as well as the associations between them that we can infer from the requirements document. Classes `BalanceInquiry` and `Deposit` participate in associations similar to those of class `Withdrawal`, so we've chosen to omit them from this diagram to keep it simple. In Section 13.3, we expand our class diagram to include all the classes in the ATM system.



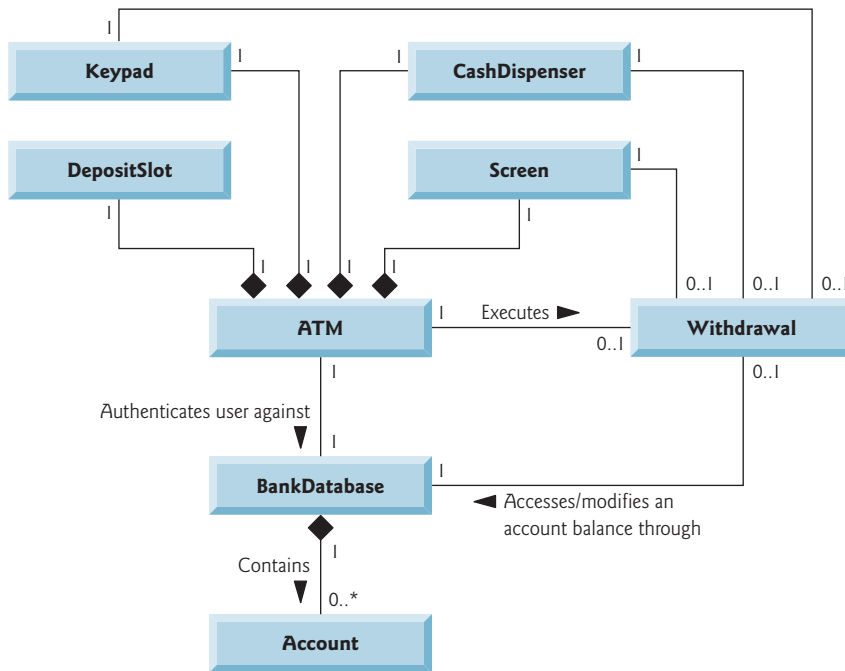

**Fig. 12.10** | Class diagram for the ATM system model.

Figure 12.10 presents a graphical model of ATM system’s structure. It includes classes BankDatabase and Account, and several associations that were not present in either Fig. 12.7 or Fig. 12.9. It shows that class ATM has a **one-to-one relationship** with class BankDatabase—one ATM object *authenticates users against* one BankDatabase object. In Fig. 12.10, we also model the fact that the bank’s database contains information about many accounts—one BankDatabase object participates in a *composition* relationship with zero or more Account objects. The multiplicity value 0..\* at the Account end of the association between class BankDatabase and class Account indicates that zero or more objects of class Account take part in the association. Class BankDatabase has a **one-to-many relationship** with class Account—the BankDatabase can contain many Accounts. Similarly, class Account has a **many-to-one relationship** with class BankDatabase—there can be many Accounts stored in the BankDatabase. Recall from Fig. 12.8 that the multiplicity value \* is identical to 0..\*. We include 0..\* in our class diagrams for clarity.

Figure 12.10 also indicates that at any given time 0 or 1 Withdrawal objects can exist. If the user is performing a withdrawal, “one object of class Withdrawal accesses/modifies an account balance through one object of class BankDatabase.” We could have created an association directly between class Withdrawal and class Account. The requirements document, however, states that the “ATM must interact with the bank’s account information database” to perform transactions. A bank account contains sensitive information, and systems engineers must always consider the security of personal data when designing a system. Thus, only the BankDatabase can access and manipulate an account directly. All other

parts of the system must interact with the database to retrieve or update account information (e.g., an account balance).

The class diagram in Fig. 12.10 also models associations between class `Withdrawal` and classes `Screen`, `CashDispenser` and `Keypad`. A withdrawal transaction includes prompting the user to choose a withdrawal amount, and receiving numeric input. These actions require the use of the screen and the keypad, respectively. Furthermore, dispensing cash to the user requires access to the cash dispenser.

Classes `BalanceInquiry` and `Deposit`, though not shown in Fig. 12.10, take part in several associations with the other classes of the ATM system. Like class `Withdrawal`, each of these classes associates with classes `ATM` and `BankDatabase`. An object of class `BalanceInquiry` also associates with an object of class `Screen` to display the balance of an account to the user. Class `Deposit` associates with classes `Screen`, `Keypad` and `DepositSlot`. Like withdrawals, deposit transactions require use of the screen and the keypad to display prompts and receive input, respectively. To receive deposit envelopes, an object of class `Deposit` accesses the deposit slot.

We've now identified the initial classes in our ATM system—we may discover others as we proceed with the design and implementation. In Section 12.4 we determine the attributes for each of these classes, and in Section 12.5 we use these attributes to examine how the system changes over time.

### Self-Review Exercises for Section 12.3

**12.4** Suppose we have a class `Car` that represents a car. Think of some of the different pieces that a manufacturer would put together to produce a whole car. Create a class diagram (similar to Fig. 12.9) that models some of the composition relationships of class `Car`.

**12.5** Suppose we have a class `File` that represents an electronic document in a standalone, non-networked computer represented by class `Computer`. What sort of association exists between class `Computer` and class `File`?

- Class `Computer` has a one-to-one relationship with class `File`.
- Class `Computer` has a many-to-one relationship with class `File`.
- Class `Computer` has a one-to-many relationship with class `File`.
- Class `Computer` has a many-to-many relationship with class `File`.

**12.6** State whether the following statement is *true* or *false*, and if *false*, explain why: A UML diagram in which a class's second and third compartments are not modeled is said to be an elided diagram.

**12.7** Modify the class diagram of Fig. 12.10 to include class `Deposit` instead of class `Withdrawal`.

## 12.4 Identifying Class Attributes

[*Note: This section can be taught after Chapter 4.*]

Classes have attributes (data) and operations (behaviors). Class attributes are implemented as fields, and class operations are implemented as methods. In this section, we determine many of the attributes needed in the ATM system. In Section 12.5 we examine how these attributes represent an object's state. In Section 12.6 we determine class operations.

### Identifying Attributes

Consider the attributes of some real-world objects: A person's attributes include height, weight and whether the person is left-handed, right-handed or ambidextrous. A radio's at-

tributes include its station, volume and AM or FM settings. A car’s attributes include its speedometer and odometer readings, the amount of gas in its tank and what gear it’s in. A personal computer’s attributes include its manufacturer (e.g., Dell, Sun, Apple or IBM), type of screen (e.g., LCD or CRT), main memory size and hard disk size.

We can identify many attributes of the classes in our system by looking for descriptive words and phrases in the requirements document. For each such word and phrase we find that plays a significant role in the ATM system, we create an attribute and assign it to one or more of the classes identified in Section 12.3. We also create attributes to represent any additional data that a class may need, as such needs become clear throughout the design process.

Figure 12.11 lists the words or phrases from the requirements document that describe each class. We formed this list by reading the requirements document and identifying any words or phrases that refer to characteristics of the classes in the system. For example, the requirements document describes the steps taken to obtain a “withdrawal amount,” so we list “amount” next to class `Withdrawal`.

| Class                       | Descriptive words and phrases              |
|-----------------------------|--------------------------------------------|
| <code>ATM</code>            | user is authenticated                      |
| <code>BalanceInquiry</code> | account number                             |
| <code>Withdrawal</code>     | account number<br>amount                   |
| <code>Deposit</code>        | account number<br>amount                   |
| <code>BankDatabase</code>   | <i>[no descriptive words or phrases]</i>   |
| <code>Account</code>        | account number<br>PIN<br>balance           |
| <code>Screen</code>         | <i>[no descriptive words or phrases]</i>   |
| <code>Keypad</code>         | <i>[no descriptive words or phrases]</i>   |
| <code>CashDispenser</code>  | begins each day loaded with 500 \$20 bills |
| <code>DepositSlot</code>    | <i>[no descriptive words or phrases]</i>   |

**Fig. 12.11** | Descriptive words and phrases from the ATM requirements document.

Figure 12.11 leads us to create one attribute of class `ATM`. Class `ATM` maintains information about the state of the ATM. The phrase “user is authenticated” describes a state of the ATM (we introduce states in Section 12.5), so we include `userAuthenticated` as a **Boolean attribute** (i.e., an attribute that has a value of either `true` or `false`) in class `ATM`. The `Boolean` attribute type in the UML is equivalent to the `boolean` type in Java. This attribute indicates whether the ATM has successfully authenticated the current user—`userAuthenticated` must be `true` for the system to allow the user to perform transactions and access account information. This attribute helps ensure the security of the data in the system.

Classes `BalanceInquiry`, `Withdrawal` and `Deposit` share one attribute. Each transaction involves an “account number” that corresponds to the account of the user making the

transaction. We assign an integer attribute `accountNumber` to each transaction class to identify the account to which an object of the class applies.

Descriptive words and phrases in the requirements document also suggest some differences in the attributes required by each transaction class. The requirements document indicates that to withdraw cash or deposit funds, users must input a specific “amount” of money to be withdrawn or deposited, respectively. Thus, we assign to classes `Withdrawal` and `Deposit` an attribute `amount` to store the value supplied by the user. The amounts of money related to a withdrawal and a deposit are defining characteristics of these transactions that the system requires for these transactions to take place. Class `BalanceInquiry`, however, needs no additional data to perform its task—it requires only an account number to indicate the account whose balance should be retrieved.

Class `Account` has several attributes. The requirements document states that each bank account has an “account number” and “PIN,” which the system uses for identifying accounts and authenticating users. We assign to class `Account` two integer attributes: `accountNumber` and `pin`. The requirements document also specifies that an account maintains a “balance” of the amount of money in the account and that money the user deposits does not become available for a withdrawal until the bank verifies the amount of cash in the deposit envelope, and any checks in the envelope clear. An account must still record the amount of money that a user deposits, however. Therefore, we decide that an account should represent a balance using two attributes: `availableBalance` and `totalBalance`. Attribute `availableBalance` tracks the amount of money that a user can withdraw from the account. Attribute `totalBalance` refers to the total amount of money that the user has “on deposit” (i.e., the amount of money available, plus the amount waiting to be verified or cleared). For example, suppose an ATM user deposits \$50.00 into an empty account. The `totalBalance` attribute would increase to \$50.00 to record the deposit, but the `availableBalance` would remain at \$0. [Note: We assume that the bank updates the `availableBalance` attribute of an `Account` some length of time after the ATM transaction occurs, in response to confirming that \$50 worth of cash or checks was found in the deposit envelope. We assume that this update occurs through a transaction that a bank employee performs using some piece of bank software other than the ATM. Thus, we do not discuss this transaction in our case study.]

Class `CashDispenser` has one attribute. The requirements document states that the cash dispenser “begins each day loaded with 500 \$20 bills.” The cash dispenser must keep track of the number of bills it contains to determine whether enough cash is on hand to satisfy withdrawal requests. We assign to class `CashDispenser` an integer attribute `count`, which is initially set to 500.

For real problems in industry, there’s no guarantee that requirements documents will be precise enough for the object-oriented systems designer to determine all the attributes or even all the classes. The need for additional classes, attributes and behaviors may become clear as the design process proceeds. As we progress through this case study, we will continue to add, modify and delete information about the classes in our system.

### *Modeling Attributes*

The class diagram in Fig. 12.12 lists some of the attributes for the classes in our system—the descriptive words and phrases in Fig. 12.11 lead us to identify these attributes. For simplicity, Fig. 12.12 does not show the associations among classes—we showed these in Fig. 12.10. This is a common practice of systems designers when designs are being devel-

oped. Recall from Section 12.3 that in the UML, a class's attributes are placed in the middle compartment of the class's rectangle. We list each attribute's name and type separated by a colon (:), followed in some cases by an equal sign (=) and an initial value.

Consider the `userAuthenticated` attribute of class `ATM`:

```
userAuthenticated : Boolean = false
```

This attribute declaration contains three pieces of information about the attribute. The **attribute name** is `userAuthenticated`. The **attribute type** is `Boolean`. In Java, an attribute can be represented by a primitive type, such as `boolean`, `int` or `double`, or a reference type like a class. We've chosen to model only primitive-type attributes in Fig. 12.12—we discuss the reasoning behind this decision shortly. The attribute types in Fig. 12.12 are in UML notation. We'll associate the types `Boolean`, `Integer` and `Double` in the UML diagram with the primitive types `boolean`, `int` and `double` in Java, respectively.

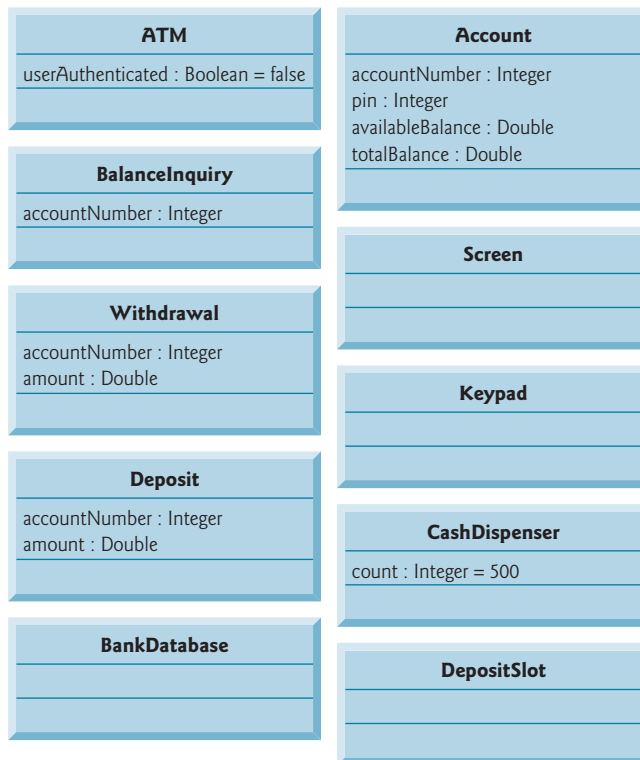

**Fig. 12.12** | Classes with attributes.

We can also indicate an initial value for an attribute. The `userAuthenticated` attribute in class `ATM` has an initial value of `false`. This indicates that the system initially does not consider the user to be authenticated. If an attribute has no initial value specified, only its name and type (separated by a colon) are shown. For example, the `accountNumber` attribute of class `BalanceInquiry` is an integer. Here we show no initial value, because the

value of this attribute is a number that we do not yet know. This number will be determined at execution time based on the account number entered by the current ATM user.

Figure 12.12 does not include attributes for classes `Screen`, `Keypad` and `DepositSlot`. These are important components of our system, for which our design process has not yet revealed any attributes. We may discover some, however, in the remaining phases of design or when we implement these classes in Java. This is perfectly normal.



### Software Engineering Observation 12.1

*At early stages in the design process, classes often lack attributes (and operations). Such classes should not be eliminated, however, because attributes (and operations) may become evident in the later phases of design and implementation.*

Figure 12.12 also does not include attributes for class `BankDatabase`. Recall that attributes in Java can be represented by either primitive types or reference types. We've chosen to include only primitive-type attributes in the class diagram in Fig. 12.12 (and in similar class diagrams throughout the case study). A reference-type attribute is modeled more clearly as an association between the class holding the reference and the class of the object to which the reference points. For example, the class diagram in Fig. 12.10 indicates that class `BankDatabase` participates in a composition relationship with zero or more `Account` objects. From this composition, we can determine that when we implement the ATM system in Java, we'll be required to create an attribute of class `BankDatabase` to hold references to zero or more `Account` objects. Similarly, we can determine reference-type attributes of class `ATM` that correspond to its composition relationships with classes `Screen`, `Keypad`, `CashDispenser` and `DepositSlot`. These composition-based attributes would be redundant if modeled in Fig. 12.12, because the compositions modeled in Fig. 12.10 already convey the fact that the database contains information about zero or more accounts and that an ATM is composed of a screen, keypad, cash dispenser and deposit slot. Software developers typically model these whole/part relationships as compositions rather than as attributes required to implement the relationships.

The class diagram in Fig. 12.12 provides a solid basis for the structure of our model, but the diagram is not complete. In Section 12.5 we identify the states and activities of the objects in the model, and in Section 12.6 we identify the operations that the objects perform. As we present more of the UML and object-oriented design, we'll continue to strengthen the structure of our model.

## Self-Review Exercises for Section 12.4

**12.8** We typically identify the attributes of the classes in our system by analyzing the \_\_\_\_\_ in the requirements document.

- nouns and noun phrases
- descriptive words and phrases
- verbs and verb phrases
- All of the above.

**12.9** Which of the following is *not* an attribute of an airplane?

- length
- wingspan
- fly
- number of seats

**12.10** Describe the meaning of the following attribute declaration of class `CashDispenser` in the class diagram in Fig. 12.12:

```
count : Integer = 500
```

## 12.5 Identifying Objects' States and Activities

[*Note:* This section can be taught after Chapter 5.]

In Section 12.4, we identified many of the class attributes needed to implement the ATM system and added them to the class diagram in Fig. 12.12. We now show how these attributes represent an object's state. We identify some key states that our objects may occupy and discuss how objects *change state* in response to various events occurring in the system. We also discuss the workflow, or **activities**, that objects perform in the ATM system, and we present the activities of `BalanceInquiry` and `Withdrawal` transaction objects.

### State Machine Diagrams

Each object in a system goes through a series of states. An object's state is indicated by the values of its attributes at a given time. **State machine diagrams** (commonly called **state diagrams**) model several states of an object and show under what circumstances the object changes state. Unlike the class diagrams presented in earlier case study sections, which focused primarily on the system's *structure*, state diagrams model some of the system's *behavior*.

Figure 12.13 is a simple state diagram that models some of the states of an object of class `ATM`. The UML represents each state in a state diagram as a **rounded rectangle** with the name of the state placed inside it. A **solid circle** with an attached stick ( $\Rightarrow$ ) arrowhead designates the **initial state**. Recall that we modeled this state information as the `Boolean` attribute `userAuthenticated` in the class diagram of Fig. 12.12. This attribute is initialized to `false`, or the “User not authenticated” state, according to the state diagram.

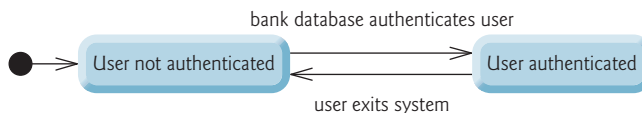

**Fig. 12.13** | State diagram for the ATM object.

The arrows with stick ( $\Rightarrow$ ) arrowhead indicate **transitions** between states. An object can transition from one state to another in response to various *events* that occur in the system. The name or description of the event that causes a transition is written near the line that corresponds to the transition. For example, the ATM object changes from the “User not authenticated” to the “User authenticated” state after the database authenticates the user. Recall from the requirements document that the database authenticates a user by comparing the account number and PIN entered by the user with those of an account in the database. If the user has entered a valid account number and the correct PIN, the ATM object transitions to the “User authenticated” state and changes its `userAuthenticated` attribute to a value of `true`. When the user exits the system by choosing the “exit” option from the main menu, the ATM object returns to the “User not authenticated” state.



### Software Engineering Observation 12.2

Software designers do not generally create state diagrams showing every possible state and state transition for all attributes—there are simply too many of them. State diagrams typically show only key states and state transitions.

### Activity Diagrams

Like a state diagram, an activity diagram models aspects of system behavior. Unlike a state diagram, an activity diagram models an object's **workflow** (sequence of events) during program execution. An activity diagram models the **actions** the object will perform and in what *order*. The activity diagram in Fig. 12.14 models the actions involved in executing a balance-inquiry transaction. We assume that a `BalanceInquiry` object has already been initialized and assigned a valid account number (that of the current user), so the object knows which balance to retrieve. The diagram includes the actions that occur after the user selects a balance inquiry from the main menu and before the ATM returns the user to the main menu—a `BalanceInquiry` object does not perform or initiate these actions, so we do not model them here. The diagram begins with retrieving the balance of the account from the database. Next, the `BalanceInquiry` displays the balance on the screen. This action completes the execution of the transaction. Recall that we've chosen to represent an account balance as both the `availableBalance` and `totalBalance` attributes of class `Account`, so the actions modeled in Fig. 12.14 refer to the retrieval and display of *both* balance attributes.

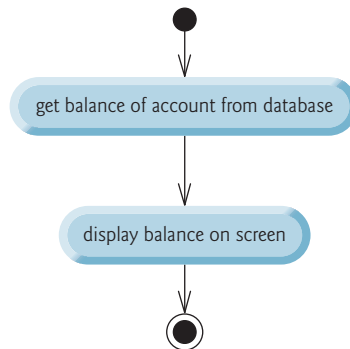

**Fig. 12.14** | Activity diagram for a `BalanceInquiry` object.

The UML represents an action in an activity diagram as an action state modeled by a rectangle with its left and right sides replaced by arcs curving outward. Each action state contains an *action expression*—for example, “get balance of account from database”—that specifies an action to be performed. An arrow with a stick ( $\Rightarrow$ ) arrowhead connects two action states, indicating the order in which the actions represented by the action states occur. The solid circle (at the top of Fig. 12.14) represents the activity's *initial state*—the beginning of the workflow before the object performs the modeled actions. In this case, the transaction first executes the “get balance of account from database” action expression. The transaction then displays *both* balances on the screen. The solid circle enclosed in an open circle (at the bottom of Fig. 12.14) represents the *final state*—the end of the work-



flow after the object performs the modeled actions. We used UML activity diagrams to illustrate the flow of control for the control statements presented in Chapters 4–5.

Figure 12.15 shows an activity diagram for a withdrawal transaction. We assume that a `Withdrawal` object has been assigned a valid account number. We do not model the user

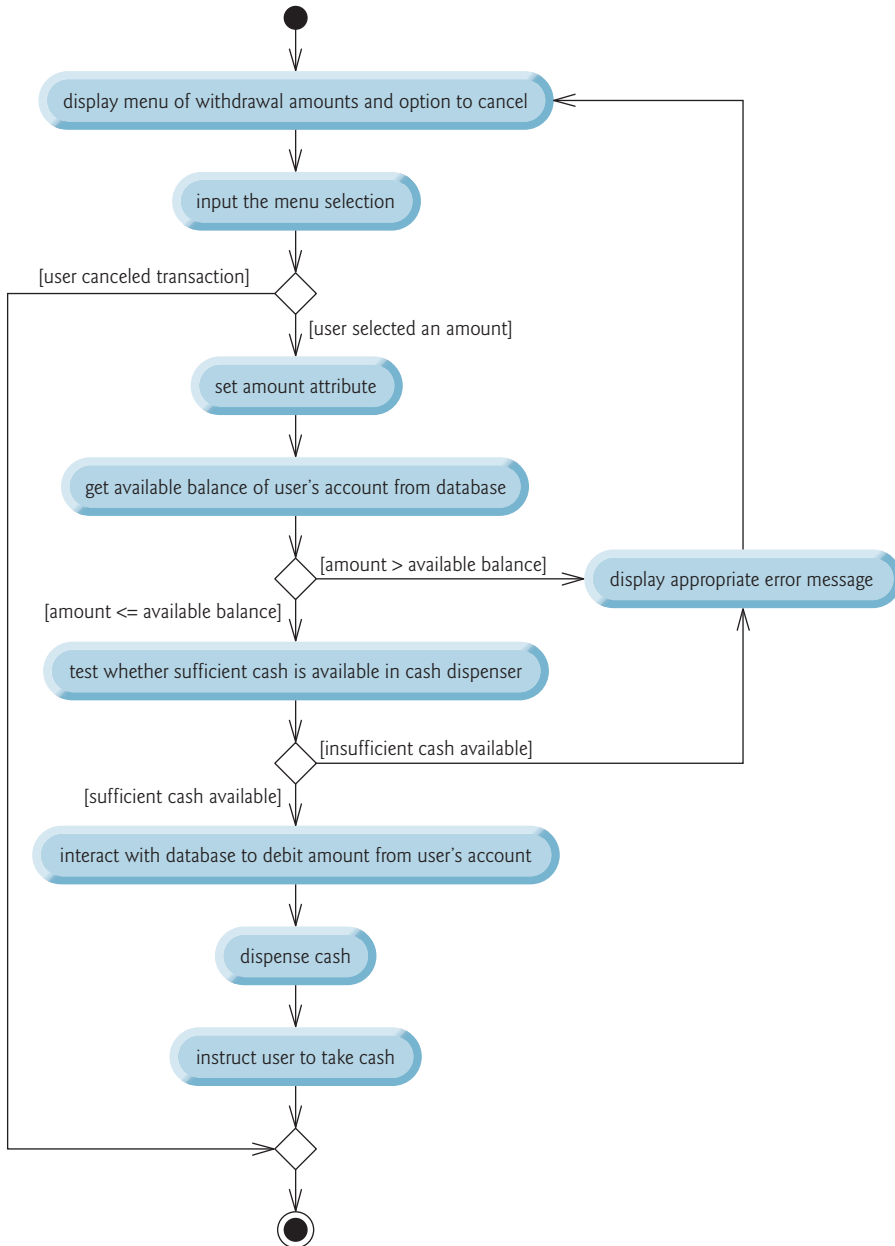

**Fig. 12.15** | Activity diagram for a withdrawal transaction.

selecting a withdrawal from the main menu or the ATM returning the user to the main menu because these are not actions performed by a `Withdrawal` object. The transaction first displays a menu of standard withdrawal amounts (shown in Fig. 12.3) and an option to cancel the transaction. The transaction then receives a menu selection from the user. The activity flow now arrives at a decision (a fork indicated by the small diamond symbol). This point determines the next action based on the associated guard condition (in square brackets next to the transition), which states that the transition occurs if this guard condition is met. If the user cancels the transaction by choosing the “cancel” option from the menu, the activity flow immediately skips to the final state. Note the merge (indicated by the small diamond symbol) where the cancellation flow of activity joins the main flow of activity before reaching the activity’s final state. If the user selects a withdrawal amount from the menu, `Withdrawal` sets `amount` (an attribute originally modeled in Fig. 12.12) to the value chosen by the user.

After setting the withdrawal amount, the transaction retrieves the available balance of the user’s account (i.e., the `availableBalance` attribute of the user’s `Account` object) from the database. The activity flow then arrives at another decision. If the requested withdrawal amount exceeds the user’s available balance, the system displays an appropriate error message informing the user of the problem, then returns to the beginning of the activity diagram and prompts the user to input a new amount. If the requested withdrawal amount is less than or equal to the user’s available balance, the transaction proceeds. The transaction next tests whether the cash dispenser has enough cash remaining to satisfy the withdrawal request. If it does not, the transaction displays an appropriate error message, then returns to the beginning of the activity diagram and prompts the user to choose a new amount. If sufficient cash is available, the transaction interacts with the database to debit the withdrawal amount from the user’s account (i.e., subtract the amount from *both* the `availableBalance` and `totalBalance` attributes of the user’s `Account` object). The transaction then dispenses the desired amount of cash and instructs the user to take it. Finally, the main flow of activity merges with the cancellation flow of activity before reaching the final state.

We’ve taken the first steps in modeling the ATM software system’s behavior and have shown how an object’s attributes participate in performing the object’s activities. In Section 12.6, we investigate the behaviors for all classes to give a more accurate interpretation of the system behavior by filling in the third compartments of the classes in our class diagram.

## Self-Review Exercises for Section 12.5

**12.11** State whether the following statement is *true* or *false*, and if *false*, explain why: State diagrams model structural aspects of a system.

**12.12** An activity diagram models the \_\_\_\_\_ that an object performs and the order in which it performs them.

- a) actions
- b) attributes
- c) states
- d) state transitions

**12.13** Based on the requirements document, create an activity diagram for a deposit transaction.

## 12.6 Identifying Class Operations

[*Note:* This section can be taught after Chapter 6.]

In this section, we determine some of the class operations (or behaviors) needed to implement the ATM system. An operation is a service that objects of a class provide to clients (users) of the class. Consider the operations of some real-world objects. A radio's operations include setting its station and volume (typically invoked by a person's adjusting the radio's controls). A car's operations include accelerating (invoked by the driver's pressing the accelerator pedal), decelerating (invoked by the driver's pressing the brake pedal or releasing the gas pedal), turning and shifting gears. Software objects can offer operations as well—for example, a software graphics object might offer operations for drawing a circle, drawing a line, drawing a square and the like. A spreadsheet software object might offer operations like printing the spreadsheet, totaling the elements in a row or column and graphing information in the spreadsheet as a bar chart or pie chart.

We can derive many of the class operations by examining the key *verbs and verb phrases* in the requirements document. We then relate these verbs and verb phrases to classes in our system (Fig. 12.16). The verb phrases in Fig. 12.16 help us determine the operations of each class.

| Class          | Verbs and verb phrases                                                                                                                 |
|----------------|----------------------------------------------------------------------------------------------------------------------------------------|
| ATM            | executes financial transactions                                                                                                        |
| BalanceInquiry | <i>[none in the requirements document]</i>                                                                                             |
| Withdrawal     | <i>[none in the requirements document]</i>                                                                                             |
| Deposit        | <i>[none in the requirements document]</i>                                                                                             |
| BankDatabase   | authenticates a user, retrieves an account balance, credits a deposit amount to an account, debits a withdrawal amount from an account |
| Account        | retrieves an account balance, credits a deposit amount to an account, debits a withdrawal amount from an account                       |
| Screen         | displays a message to the user                                                                                                         |
| Keypad         | receives numeric input from the user                                                                                                   |
| CashDispenser  | dispenses cash, indicates whether it contains enough cash to satisfy a withdrawal request                                              |
| DepositSlot    | receives a deposit envelope                                                                                                            |

**Fig. 12.16** | Verbs and verb phrases for each class in the ATM system.

### *Modeling Operations*

To identify operations, we examine the verb phrases listed for each class in Fig. 12.16. The “executes financial transactions” phrase associated with class ATM implies that class ATM instructs transactions to execute. Therefore, classes `BalanceInquiry`, `Withdrawal` and `Deposit` each need an operation to provide this service to the ATM. We place this operation (which we’ve named `execute`) in the third compartment of the three transaction classes in the updated class diagram of Fig. 12.17. During an ATM session, the ATM object will invoke these transaction operations as necessary.

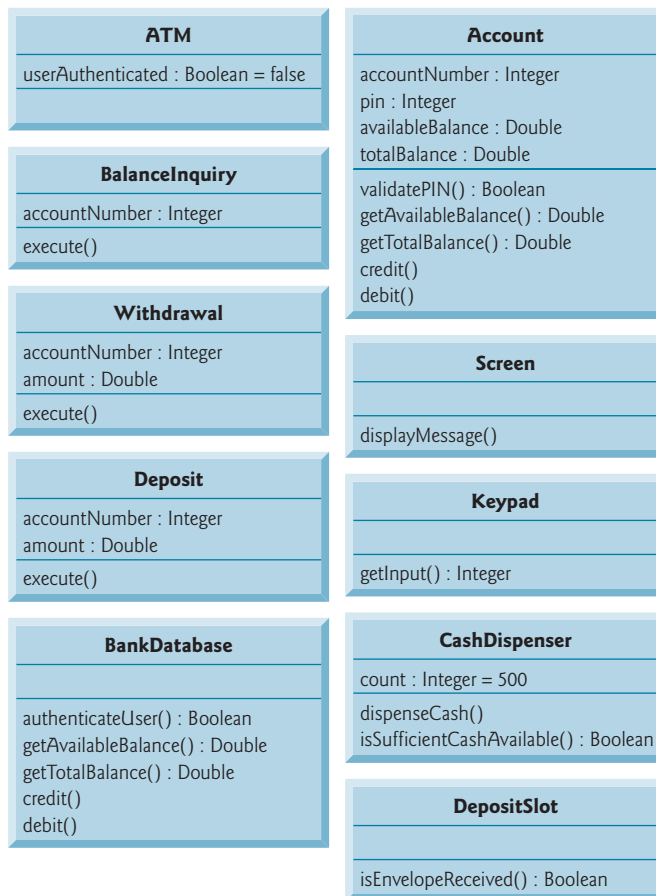

**Fig. 12.17** | Classes in the ATM system with attributes and operations.

The UML represents operations (that is, methods) by listing the operation name, followed by a comma-separated list of parameters in parentheses, a colon and the return type:

*operationName( parameter1, parameter2, ..., parameterN ) : return type*

Each parameter in the comma-separated parameter list consists of a parameter name, followed by a colon and the parameter type:

*parameterName : parameterType*

For the moment, we do not list the parameters of our operations—we’ll identify and model some of them shortly. For some of the operations, we do not yet know the return types, so we also omit them from the diagram. These omissions are perfectly normal at this point. As our design and implementation proceed, we’ll add the remaining return types.

### *Authenticating a User*

Figure 12.16 lists the phrase “authenticates a user” next to class BankDatabase—the database is the object that contains the account information necessary to determine whether

the account number and PIN entered by a user match those of an account held at the bank. Therefore, class `BankDatabase` needs an operation that provides an authentication service to the ATM. We place the operation `authenticateUser` in the third compartment of class `BankDatabase` (Fig. 12.17). However, an object of class `Account`, not class `BankDatabase`, stores the account number and PIN that must be accessed to authenticate a user, so class `Account` must provide a service to validate a PIN obtained through user input against a PIN stored in an `Account` object. Therefore, we add a `validatePIN` operation to class `Account`. We specify a return type of `Boolean` for the `authenticateUser` and `validatePIN` operations. Each operation returns a value indicating either that the operation was successful in performing its task (i.e., a return value of `true`) or that it was not (i.e., a return value of `false`).

### *Other BankDatabase and Account Operations*

Figure 12.16 lists several additional verb phrases for class `BankDatabase`: “retrieves an account balance,” “credits a deposit amount to an account” and “debits a withdrawal amount from an account.” Like “authenticates a user,” these remaining phrases refer to services that the database must provide to the ATM, because the database holds all the account data used to authenticate a user and perform ATM transactions. However, objects of class `Account` actually perform the operations to which these phrases refer. Thus, we assign an operation to both class `BankDatabase` and class `Account` to correspond to each of these phrases. Recall from Section 12.3 that, because a bank account contains sensitive information, we do not allow the ATM to access accounts directly. The database acts as an intermediary between the ATM and the account data, thus preventing unauthorized access. As we’ll see in Section 12.7, class `ATM` invokes the operations of class `BankDatabase`, each of which in turn invokes the operation with the same name in class `Account`.

### *Getting the Balances*

The phrase “retrieves an account balance” suggests that classes `BankDatabase` and `Account` each need a `getBalance` operation. However, recall that we created *two* attributes in class `Account` to represent a balance—`availableBalance` and `totalBalance`. A balance inquiry requires access to *both* balance attributes so that it can display them to the user, but a withdrawal needs to check *only* the value of `availableBalance`. To allow objects in the system to obtain each balance attribute individually, we add operations `getAvailableBalance` and `getTotalBalance` to the third compartment of classes `BankDatabase` and `Account` (Fig. 12.17). We specify a return type of `Double` for these operations because the balance attributes they retrieve are of type `Double`.

### *Crediting and Debiting an Account*

The phrases “credits a deposit amount to an account” and “debits a withdrawal amount from an account” indicate that classes `BankDatabase` and `Account` must perform operations to update an account during a deposit and withdrawal, respectively. We therefore assign `credit` and `debit` operations to classes `BankDatabase` and `Account`. You may recall that crediting an account (as in a deposit) adds an amount only to the `totalBalance` attribute. Debiting an account (as in a withdrawal), on the other hand, subtracts the amount from *both* balance attributes. We hide these implementation details inside class `Account`. This is a good example of encapsulation and information hiding.

### *Deposit Confirmations Performed by Another Banking System*

If this were a real ATM system, classes `BankDatabase` and `Account` would also provide a set of operations to allow another banking system to update a user's account balance after either confirming or rejecting all or part of a deposit. Operation `confirmDepositAmount`, for example, would add an amount to the `availableBalance` attribute, thus making deposited funds available for withdrawal. Operation `rejectDepositAmount` would subtract an amount from the `totalBalance` attribute to indicate that a specified amount, which had recently been deposited through the ATM and added to the `totalBalance`, was not found in the deposit envelope. The bank would invoke this operation after determining either that the user failed to include the correct amount of cash or that any checks did not clear (i.e., they “bounced”). While adding these operations would make our system more complete, we do *not* include them in our class diagrams or our implementation because they're beyond the scope of the case study.

### *Displaying Messages*

Class `Screen` “displays a message to the user” at various times in an ATM session. All visual output occurs through the screen of the ATM. The requirements document describes many types of messages (e.g., a welcome message, an error message, a thank you message) that the screen displays to the user. The requirements document also indicates that the screen displays prompts and menus to the user. However, a prompt is really just a message describing what the user should input next, and a menu is essentially a type of prompt consisting of a series of messages (i.e., menu options) displayed consecutively. Therefore, rather than assign class `Screen` an individual operation to display each type of message, prompt and menu, we simply create one operation that can display any message specified by a parameter. We place this operation (`displayMessage`) in the third compartment of class `Screen` in our class diagram (Fig. 12.17). We do not worry about the parameter of this operation at this time—we model it later in this section.

### *Keyboard Input*

From the phrase “receives numeric input from the user” listed by class `Keypad` in Fig. 12.16, we conclude that class `Keypad` should perform a `getInput` operation. Because the ATM's keypad, unlike a computer keyboard, contains only the numbers 0–9, we specify that this operation returns an integer value. Recall from the requirements document that in different situations the user may be required to enter a different type of number (e.g., an account number, a PIN, the number of a menu option, a deposit amount as a number of cents). Class `Keypad` simply obtains a numeric value for a client of the class—it does not determine whether the value meets any specific criteria. Any class that uses this operation must verify that the user entered an appropriate number in a given situation, then respond accordingly (i.e., display an error message via class `Screen`). [*Note:* When we implement the system, we simulate the ATM's keypad with a computer keyboard, and for simplicity we assume that the user does not enter nonnumeric input using keys on the computer keyboard that do not appear on the ATM's keypad.]

### *Dispensing Cash*

Figure 12.16 lists “dispenses cash” for class `CashDispenser`. Therefore, we create operation `dispenseCash` and list it under class `CashDispenser` in Fig. 12.17. Class `CashDispenser` also “indicates whether it contains enough cash to satisfy a withdrawal request.”

Thus, we include `isSufficientCashAvailable`, an operation that returns a value of UML type `Boolean`, in class `CashDispenser`.

Figure 12.16 also lists “receives a deposit envelope” for class `DepositSlot`. The deposit slot must indicate whether it received an envelope, so we place an operation `isEnvelopeReceived`, which returns a `Boolean` value, in the third compartment of class `DepositSlot`. [Note: A real hardware deposit slot would most likely send the ATM a signal to indicate that an envelope was received. We simulate this behavior, however, with an operation in class `DepositSlot` that class `ATM` can invoke to find out whether the deposit slot received an envelope.]

### Class ATM

We do not list any operations for class `ATM` at this time. We’re not yet aware of any services that class `ATM` provides to other classes in the system. When we implement the system with Java code, however, operations of this class, and additional operations of the other classes in the system, may emerge.

### Identifying and Modeling Operation Parameters for Class `BankDatabase`

So far, we’ve not been concerned with the *parameters* of our operations—we’ve attempted to gain only a basic understanding of the operations of each class. Let’s now take a closer look at some operation parameters. We identify an operation’s parameters by examining what data the operation requires to perform its assigned task.

Consider `BankDatabase`’s `authenticateUser` operation. To authenticate a user, this operation must know the account number and PIN supplied by the user. So we specify that `authenticateUser` takes integer parameters `userAccountNumber` and `userPIN`, which the operation must compare to an `Account` object’s account number and PIN in the database. We prefix these parameter names with “user” to avoid confusion between the operation’s parameter names and class `Account`’s attribute names. We list these parameters in the class diagram in Fig. 12.18 that models only class `BankDatabase`. [Note: It’s perfectly normal to model only one class. In this case, we’re examining the parameters of this one class, so we omit the other classes. In class diagrams later in the case study, in which parameters are no longer the focus of our attention, we omit these parameters to save space. Remember, however, that the operations listed in these diagrams still have parameters.]

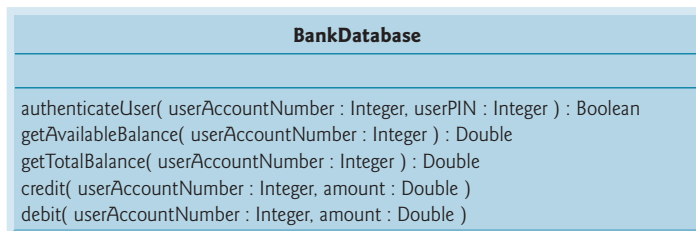

**Fig. 12.18** | Class `BankDatabase` with operation parameters.

Recall that the UML models each parameter in an operation’s comma-separated parameter list by listing the parameter name, followed by a colon and the parameter type

(in UML notation). Figure 12.18 thus specifies that operation `authenticateUser` takes two parameters—`userAccountNumber` and `userPIN`, both of type `Integer`. When we implement the system in Java, we'll represent these parameters with `int` values.

Class `BankDatabase` operations `getAvailableBalance`, `getTotalBalance`, `credit` and `debit` also each require a `userAccountNumber` parameter to identify the account to which the database must apply the operations, so we include these parameters in the class diagram of Fig. 12.18. In addition, operations `credit` and `debit` each require a `Double` parameter `amount` to specify the amount of money to be credited or debited, respectively.

### *Identifying and Modeling Operation Parameters for Class Account*

Figure 12.19 models class `Account`'s operation parameters. Operation `validatePIN` requires only a `userPIN` parameter, which contains the user-specified PIN to be compared with the account's PIN. Like their `BankDatabase` counterparts, operations `credit` and `debit` in class `Account` each require a `Double` parameter `amount` that indicates the amount of money involved in the operation. Operations `getAvailableBalance` and `getTotalBalance` in class `Account` require no additional data to perform their tasks. Class `Account`'s operations do *not* require an account-number parameter to distinguish between `Accounts`, because these operations can be invoked only on a specific `Account` object.

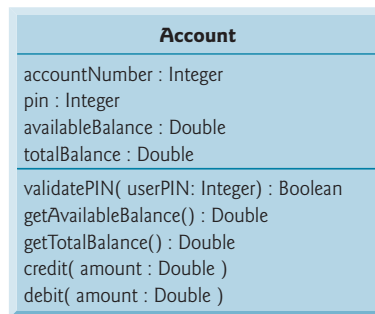

**Fig. 12.19** | Class `Account` with operation parameters.

### *Identifying and Modeling Operation Parameters for Class Screen*

Figure 12.20 models class `Screen` with a parameter specified for operation `displayMessage`. This operation requires only a `String` parameter `message` that indicates the text to be displayed. Recall that the parameter types listed in our class diagrams are in UML notation, so the `String` type listed in Fig. 12.20 refers to the UML type. When we implement the system in Java, we'll use the Java class `String` to represent this parameter.

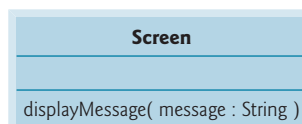
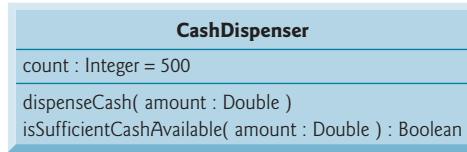

**Fig. 12.20** | Class `Screen` with operation parameters.



*Identifying and Modeling Operation Parameters for Class CashDispenser*

Figure 12.21 specifies that operation `dispenseCash` of class `CashDispenser` takes a `Double` parameter `amount` to indicate the amount of cash (in dollars) to be dispensed. Operation `isSufficientCashAvailable` also takes a `Double` parameter `amount` to indicate the amount of cash in question.



**Fig. 12.21** | Class `CashDispenser` with operation parameters.

*Identifying and Modeling Operation Parameters for Other Classes*

We do not discuss parameters for operation `execute` of classes `BalanceInquiry`, `Withdrawal` and `Deposit`, operation `getInput` of class `Keypad` and operation `isEnvelopeReceived` of class `DepositSlot`. At this point in our design process, we cannot determine whether these operations require additional data, so we leave their parameter lists empty. Later, we may decide to add parameters.

In this section, we've determined many of the operations performed by the classes in the ATM system. We've identified the parameters and return types of some of the operations. As we continue our design process, the number of operations belonging to each class may vary—we might find that new operations are needed or that some current operations are unnecessary. We also might determine that some of our class operations need additional parameters and different return types, or that some parameters are unnecessary or require different types.

**Self-Review Exercises for Section 12.6**

**12.14** Which of the following is *not* a behavior?

- reading data from a file
- printing output
- text output
- obtaining input from the user

**12.15** If you were to add to the ATM system an operation that returns the amount attribute of class `Withdrawal`, how and where would you specify this operation in the class diagram of Fig. 12.17?

**12.16** Describe the meaning of the following operation listing that might appear in a class diagram for an object-oriented design of a calculator:

```
add(x : Integer, y : Integer) : Integer
```

**12.7 Indicating Collaboration Among Objects**

[*Note:* This section can be taught after Chapter 7.]

In this section, we concentrate on the collaborations (interactions) among objects. When two objects communicate with each other to accomplish a task, they're said to **collaborate**—objects do this by invoking one another's operations. A **collaboration** consists of an

object of one class sending a **message** to an object of another class. Messages are sent in Java via method calls.

In Section 12.6, we determined many of the operations of the system's classes. Now, we concentrate on the messages that invoke these operations. To identify the collaborations in the system, we return to the requirements document in Section 12.2. Recall that this document specifies the range of activities that occur during an ATM session (e.g., authenticating a user, performing transactions). The steps used to describe how the system must perform each of these tasks are our first indication of the collaborations in our system. As we proceed through this section and Chapter 13, we may discover additional collaborations.

### *Identifying the Collaborations in a System*

We identify the collaborations in the system by carefully reading the sections of the requirements document that specify what the ATM should do to authenticate a user and to perform each transaction type. For each action or step described, we decide which objects in our system must interact to achieve the desired result. We identify one object as the sending object and another as the receiving object. We then select one of the receiving object's operations (identified in Section 12.6) that must be invoked by the sending object to produce the proper behavior. For example, the ATM displays a welcome message when idle. We know that an object of class `Screen` displays a message to the user via its `displayMessage` operation. Thus, we decide that the system can display a welcome message by employing a collaboration between the ATM and the `Screen` in which the ATM sends a `displayMessage` message to the `Screen` by invoking the `displayMessage` operation of class `Screen`. [Note: To avoid repeating the phrase "an object of class...", we refer to an object by using its class name preceded by an article (e.g., "a," "an" or "the")—for example, "the ATM" refers to an object of class `ATM`.]

Figure 12.22 lists the collaborations that can be derived from the requirements document. For each sending object, we list the collaborations in the order in which they first occur during an ATM session (i.e., the order in which they're discussed in the requirements document). We list each collaboration involving a unique sender, message and recipient only once, even though the collaborations may occur at several different times throughout an ATM session. For example, the first row in Fig. 12.22 indicates that the ATM collaborates with the `Screen` whenever the ATM needs to display a message to the user.

Let's consider the collaborations in Fig. 12.22. Before allowing a user to perform any transactions, the ATM must prompt the user to enter an account number, then to enter a PIN. It accomplishes these tasks by sending a `displayMessage` message to the `Screen`. Both actions refer to the same collaboration between the ATM and the `Screen`, which is already listed in Fig. 12.22. The ATM obtains input in response to a prompt by sending a `getInput` message to the `Keypad`. Next, the ATM must determine whether the user-specified account number and PIN match those of an account in the database. It does so by sending an `authenticateUser` message to the `BankDatabase`. Recall that the `BankDatabase` cannot authenticate a user directly—only the user's `Account` (i.e., the `Account` that contains the account number specified by the user) can access the user's PIN on record to authenticate the user. Figure 12.22 therefore lists a collaboration in which the `BankDatabase` sends a `validatePIN` message to an `Account`.

After the user is authenticated, the ATM displays the main menu by sending a series of `displayMessage` messages to the `Screen` and obtains input containing a menu selection by sending a `getInput` message to the `Keypad`. We've already accounted for these collab-

orations, so we do not add anything to Fig. 12.22. After the user chooses a type of transaction to perform, the ATM executes the transaction by sending an execute message to an object of the appropriate transaction class (i.e., a `BalanceInquiry`, a `Withdrawal` or a `Deposit`). For example, if the user chooses to perform a balance inquiry, the ATM sends an execute message to a `BalanceInquiry`.

| An object of class... | sends the message...                   | to an object of class... |
|-----------------------|----------------------------------------|--------------------------|
| ATM                   | <code>displayMessage</code>            | Screen                   |
|                       | <code>getInput</code>                  | Keypad                   |
|                       | <code>authenticateUser</code>          | BankDatabase             |
|                       | <code>execute</code>                   | BalanceInquiry           |
|                       | <code>execute</code>                   | Withdrawal               |
|                       | <code>execute</code>                   | Deposit                  |
| BalanceInquiry        | <code>getAvailableBalance</code>       | BankDatabase             |
|                       | <code>getTotalBalance</code>           | BankDatabase             |
|                       | <code>displayMessage</code>            | Screen                   |
| Withdrawal            | <code>displayMessage</code>            | Screen                   |
|                       | <code>getInput</code>                  | Keypad                   |
|                       | <code>getAvailableBalance</code>       | BankDatabase             |
|                       | <code>isSufficientCashAvailable</code> | CashDispenser            |
|                       | <code>debit</code>                     | BankDatabase             |
|                       | <code>dispenseCash</code>              | CashDispenser            |
| Deposit               | <code>displayMessage</code>            | Screen                   |
|                       | <code>getInput</code>                  | Keypad                   |
|                       | <code>isEnvelopeReceived</code>        | DepositSlot              |
|                       | <code>credit</code>                    | BankDatabase             |
| BankDatabase          | <code>validatePIN</code>               | Account                  |
|                       | <code>getAvailableBalance</code>       | Account                  |
|                       | <code>getTotalBalance</code>           | Account                  |
|                       | <code>debit</code>                     | Account                  |
|                       | <code>credit</code>                    | Account                  |

**Fig. 12.22** | Collaborations in the ATM system.

Further examination of the requirements document reveals the collaborations involved in executing each transaction type. A `BalanceInquiry` retrieves the amount of money available in the user's account by sending a `getAvailableBalance` message to the `BankDatabase`, which responds by sending a `getAvailableBalance` message to the user's `Account`. Similarly, the `BalanceInquiry` retrieves the amount of money on deposit by sending a `getTotalBalance` message to the `BankDatabase`, which sends the same message to the user's `Account`. To display both parts of the user's account balance at the same time, the `BalanceInquiry` sends a `displayMessage` message to the `Screen`.

A `Withdrawal` responds to an `execute` message by sending `displayMessage` messages to the `Screen` to display a menu of standard withdrawal amounts (i.e., \$20, \$40, \$60, \$100, \$200). The `Withdrawal` sends a `getInput` message to the `Keypad` to obtain the user's selection. Next, the `Withdrawal` determines whether the requested amount is less than or equal

to the user's account balance. The `Withdrawal` can obtain the amount of money available by sending a `getAvailableBalance` message to the `BankDatabase`. The `Withdrawal` then tests whether the cash dispenser contains enough cash by sending an `isSufficientCashAvailable` message to the `CashDispenser`. A `Withdrawal` sends a debit message to the `BankDatabase` to decrease the user's account balance. The `BankDatabase` in turn sends the same message to the appropriate `Account`, which decreases both the `totalBalance` and the `availableBalance`. To dispense the requested amount of cash, the `Withdrawal` sends a `dispenseCash` message to the `CashDispenser`. Finally, the `Withdrawal` sends a `displayMessage` message to the `Screen`, instructing the user to take the cash.

A `Deposit` responds to an `execute` message first by sending a `displayMessage` message to the `Screen` to prompt the user for a deposit amount. The `Deposit` sends a `getInput` message to the `Keypad` to obtain the user's input. The `Deposit` then sends a `displayMessage` message to the `Screen` to tell the user to insert a deposit envelope. To determine whether the deposit slot received an incoming deposit envelope, the `Deposit` sends an `isEnvelopeReceived` message to the `DepositSlot`. The `Deposit` updates the user's account by sending a `credit` message to the `BankDatabase`, which subsequently sends a `credit` message to the user's `Account`. Recall that crediting funds to an `Account` increases the `totalBalance` but not the `availableBalance`.

### Interaction Diagrams

Now that we've identified possible collaborations between our ATM system's objects, let's graphically model these interactions using the UML. The UML provides several types of **interaction diagrams** that model the behavior of a system by modeling how objects interact. The **communication diagram** emphasizes *which objects* participate in collaborations. Like the communication diagram, the **sequence diagram** shows collaborations among objects, but it emphasizes *when* messages are sent between objects *over time*.

### Communication Diagrams

Figure 12.23 shows a communication diagram that models the ATM executing a `BalanceInquiry`. Objects are modeled in the UML as rectangles containing names in the form `objectName : ClassName`. In this example, which involves only one object of each type, we disregard the object name and list only a colon followed by the class name. [Note: Specifying each object's name in a communication diagram is recommended when modeling multiple objects of the same type.] Communicating objects are connected with solid lines, and messages are passed between objects along these lines in the direction shown by arrows. The name of the message, which appears next to the arrow, is the name of an operation (i.e., a method in Java) belonging to the receiving object—think of the name as a “service” that the receiving object provides to sending objects (its clients).



**Fig. 12.23** | Communication diagram of the ATM executing a balance inquiry.

The solid filled arrow represents a message—or **synchronous call**—in the UML and a method call in Java. This arrow indicates that the flow of control is from the sending object

(the ATM) to the receiving object (a `BalanceInquiry`). Since this is a synchronous call, the sending object can't send another message, or do anything at all, until the receiving object processes the message and returns control to the sending object. The sender just waits. In Fig. 12.23, the ATM calls `BalanceInquiry` method `execute` and can't send another message until `execute` has finished and returns control to the ATM. [Note: If this were an **asynchronous call**, represented by a stick ( $\Rightarrow$ ) arrowhead, the sending object would not have to wait for the receiving object to return control—it would continue sending additional messages immediately following the asynchronous call. Asynchronous calls are implemented in Java using a technique called multithreading, which is discussed in Chapter 26.]

### Sequence of Messages in a Communication Diagram

Figure 12.24 shows a communication diagram that models the interactions among system objects when an object of class `BalanceInquiry` executes. We assume that the object's `accountNumber` attribute contains the account number of the current user. The collaborations in Fig. 12.24 begin after the ATM sends an `execute` message to a `BalanceInquiry` (i.e., the interaction modeled in Fig. 12.23). The number to the left of a message name indicates the order in which the message is passed. The **sequence of messages** in a communication diagram progresses in numerical order from least to greatest. In this diagram, the numbering starts with message 1 and ends with message 3. The `BalanceInquiry` first sends a `getAvailableBalance` message to the `BankDatabase` (message 1), then sends a `getTotalBalance` message to the `BankDatabase` (message 2). Within the parentheses following a message name, we can specify a comma-separated list of the names of the parameters sent with the message (i.e., arguments in a Java method call)—the `BalanceInquiry` passes attribute `accountNumber` with its messages to the `BankDatabase` to indicate which Account's balance information to retrieve. Recall from Fig. 12.18 that operations `getAvailableBalance` and `getTotalBalance` of class `BankDatabase` each require a parameter to identify an account. The `BalanceInquiry` next displays the `availableBalance` and the `totalBalance` to the user by passing a `displayMessage` message to the `Screen` (message 3) that includes a parameter indicating the message to be displayed.

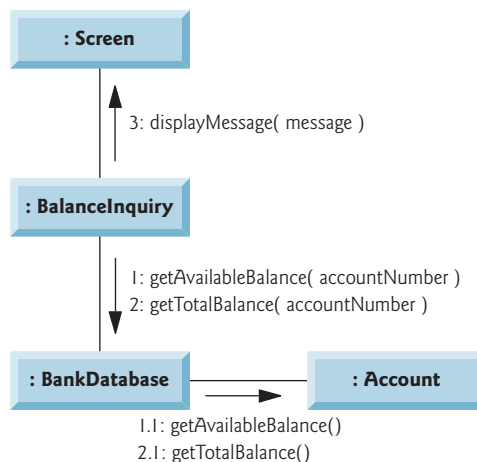

**Fig. 12.24** | Communication diagram for executing a balance inquiry.

Figure 12.24 models two additional messages passing from the BankDatabase to an Account (message 1.1 and message 2.1). To provide the ATM with the *two* balances of the user's Account (as requested by messages 1 and 2), the BankDatabase must pass a `getAvailableBalance` and a `getTotalBalance` message to the user's Account. Such messages passed within the handling of another message are called **nested messages**. The UML recommends using a decimal numbering scheme to indicate nested messages. For example, message 1.1 is the first message nested in message 1—the BankDatabase passes a `getAvailableBalance` message during BankDatabase's processing of a message by the same name. [Note: If the BankDatabase needed to pass a second nested message while processing message 1, the second message would be numbered 1.2.] A message may be passed only when *all* the nested messages from the previous message have been passed. For example, the `BalanceInquiry` passes message 3 only after messages 2 and 2.1 have been passed, in that order.

The nested numbering scheme used in communication diagrams helps clarify precisely when and in what context each message is passed. For example, if we numbered the messages in Fig. 12.24 using a flat numbering scheme (i.e., 1, 2, 3, 4, 5), someone looking at the diagram might not be able to determine that BankDatabase passes the `getAvailableBalance` message (message 1.1) to an Account *during* the BankDatabase's processing of message 1, as opposed to *after* completing the processing of message 1. The nested decimal numbers make it clear that the second `getAvailableBalance` message (message 1.1) is passed to an Account within the handling of the first `getAvailableBalance` message (message 1) by the BankDatabase.

### Sequence Diagrams

Communication diagrams emphasize the participants in collaborations, but model their timing a bit awkwardly. A sequence diagram helps model the timing of collaborations more clearly. Figure 12.25 shows a sequence diagram modeling the sequence of interactions that occur when a `Withdrawal` executes. The dotted line extending down from an object's rectangle is that object's **lifeline**, which represents the progression of time. Actions occur along an object's lifeline in chronological order from top to bottom—an action near the top happens before one near the bottom.

Message passing in sequence diagrams is similar to message passing in communication diagrams. A solid arrow with a filled arrowhead extending from the sending object to the receiving object represents a message between two objects. The arrowhead points to an activation on the receiving object's lifeline. An **activation**, shown as a thin vertical rectangle, indicates that an object is executing. When an object returns control, a return message, represented as a dashed line with a stick ( $\Rightarrow$ ) arrowhead, extends from the activation of the object returning control to the activation of the object that initially sent the message. To eliminate clutter, we omit the return-message arrows—the UML allows this practice to make diagrams more readable. Like communication diagrams, sequence diagrams can indicate message parameters between the parentheses following a message name.

The sequence of messages in Fig. 12.25 begins when a `Withdrawal` prompts the user to choose a withdrawal amount by sending a `displayMessage` message to the `Screen`. The `Withdrawal` then sends a `getInput` message to the `Keypad`, which obtains input from the user. We've already modeled the control logic involved in a `Withdrawal` in the activity diagram of Fig. 12.15, so we do not show this logic in the sequence diagram of Fig. 12.25. Instead, we model the best-case scenario in which the balance of the user's account is

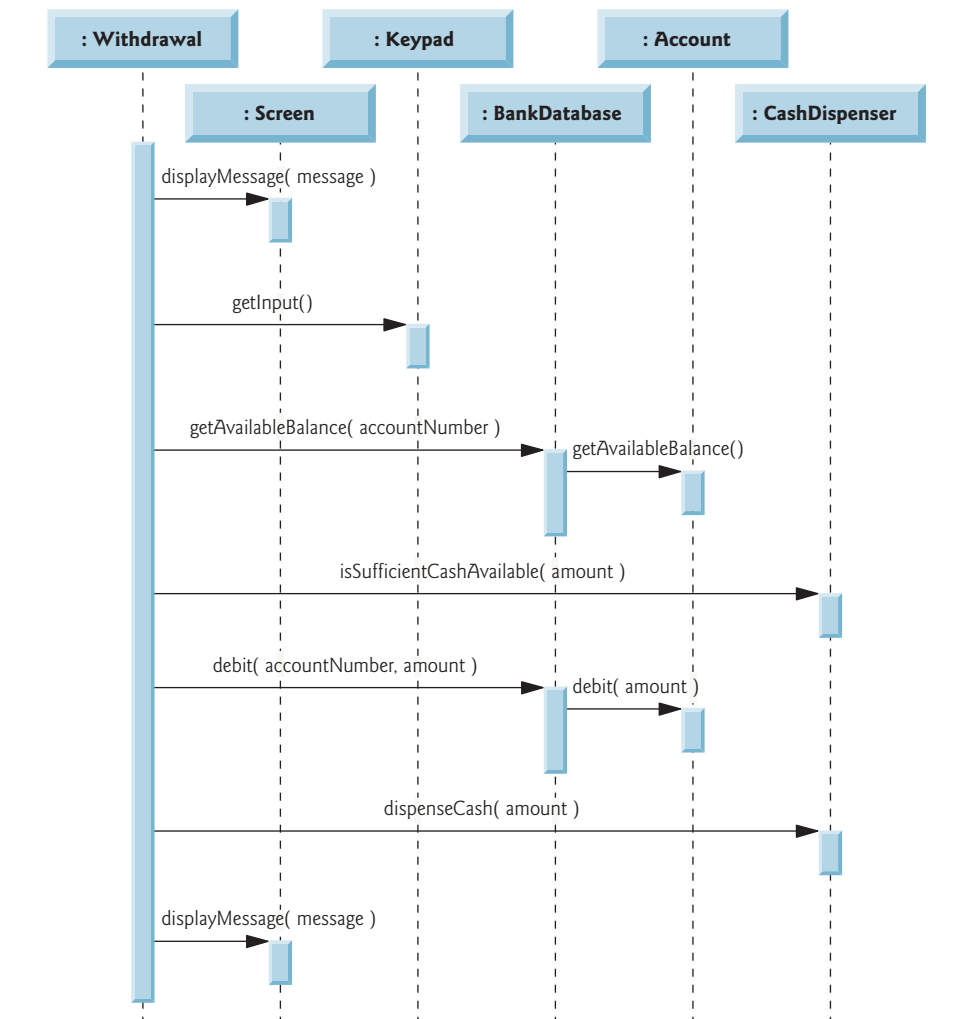

**Fig. 12.25** | Sequence diagram that models a `Withdrawal` executing.

greater than or equal to the chosen withdrawal amount, and the cash dispenser contains a sufficient amount of cash to satisfy the request. You can model control logic in a sequence diagram with UML frames (which are not covered in this case study). For a quick overview of UML frames, visit [www.agilemodeling.com/style/frame.htm](http://www.agilemodeling.com/style/frame.htm).

After obtaining a withdrawal amount, the `Withdrawal` sends a `getAvailableBalance` message to the `BankDatabase`, which in turn sends a `getAvailableBalance` message to the user's `Account`. Assuming that the user's account has enough money available to permit the transaction, the `Withdrawal` next sends an `isSufficientCashAvailable` message to the `CashDispenser`. Assuming that there's enough cash available, the `Withdrawal` decreases the balance of the user's account (i.e., both the `totalBalance` and the `availableBalance`) by sending a `debit` message to the `BankDatabase`. The `BankDatabase` responds by sending a `debit` message to the user's `Account`. Finally, the `Withdrawal` sends

a `dispenseCash` message to the `CashDispenser` and a `displayMessage` message to the `Screen`, telling the user to remove the cash from the machine.

We've identified the collaborations among objects in the ATM system and modeled some of them using UML interaction diagrams—both communication diagrams and sequence diagrams. In Section 13.2, we enhance the structure of our model to complete a preliminary object-oriented design, then we begin implementing the ATM system in Java.

## Self-Review Exercises for Section 12.7

**12.17** A(n) \_\_\_\_\_ consists of an object of one class sending a message to an object of another class.

- |                  |                |
|------------------|----------------|
| a) association   | b) aggregation |
| c) collaboration | d) composition |

**12.18** Which form of interaction diagram emphasizes *what* collaborations occur? Which form emphasizes *when* collaborations occur?

**12.19** Create a sequence diagram that models the interactions among objects in the ATM system that occur when a `Deposit` executes successfully, and explain the sequence of messages modeled by the diagram.

## 12.8 Wrap-Up

In this chapter, you learned how to work from a detailed requirements document to develop an object-oriented design. You worked with six popular types of UML diagrams to graphically model an object-oriented automated teller machine software system. In Chapter 13, we tune the design using inheritance, then completely implement the design in a 673-line Java application.

## Answers to Self-Review Exercises

**12.1** Figure 12.26 contains a use case diagram for a modified version of our ATM system that also allows users to transfer money between accounts.

**12.2** b.

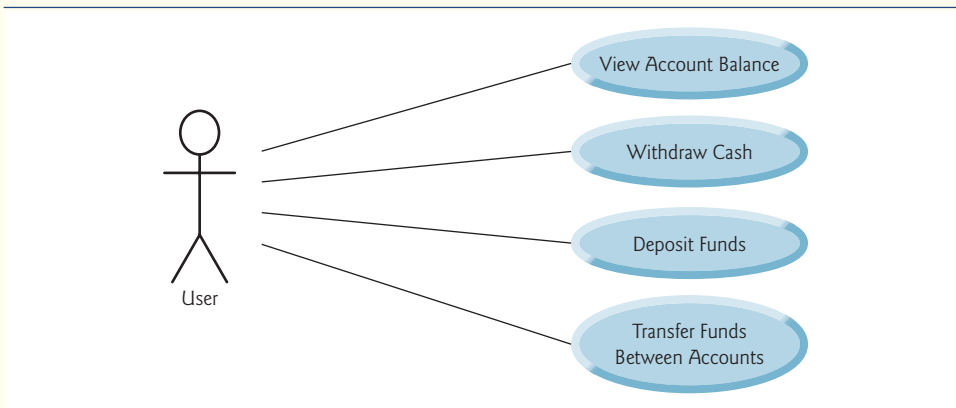

**Fig. 12.26** | Use case diagram for a modified version of our ATM system that also allows users to transfer money between accounts.



12.3 d.

12.4 [Note: Student answers may vary.] Figure 12.27 presents a class diagram that shows some of the composition relationships of a class Car.

12.5 c. [Note: In a computer network, this relationship could be many-to-many.]

12.6 True.

12.7 Figure 12.28 presents a class diagram for the ATM including class Deposit instead of class Withdrawal (as in Fig. 12.10). Deposit does not access CashDispenser, but does access DepositSlot.

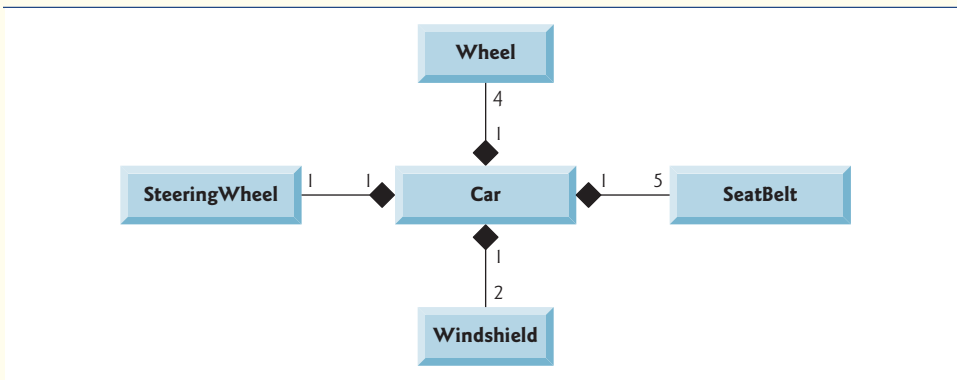

Fig. 12.27 | Class diagram showing composition relationships of a class Car.

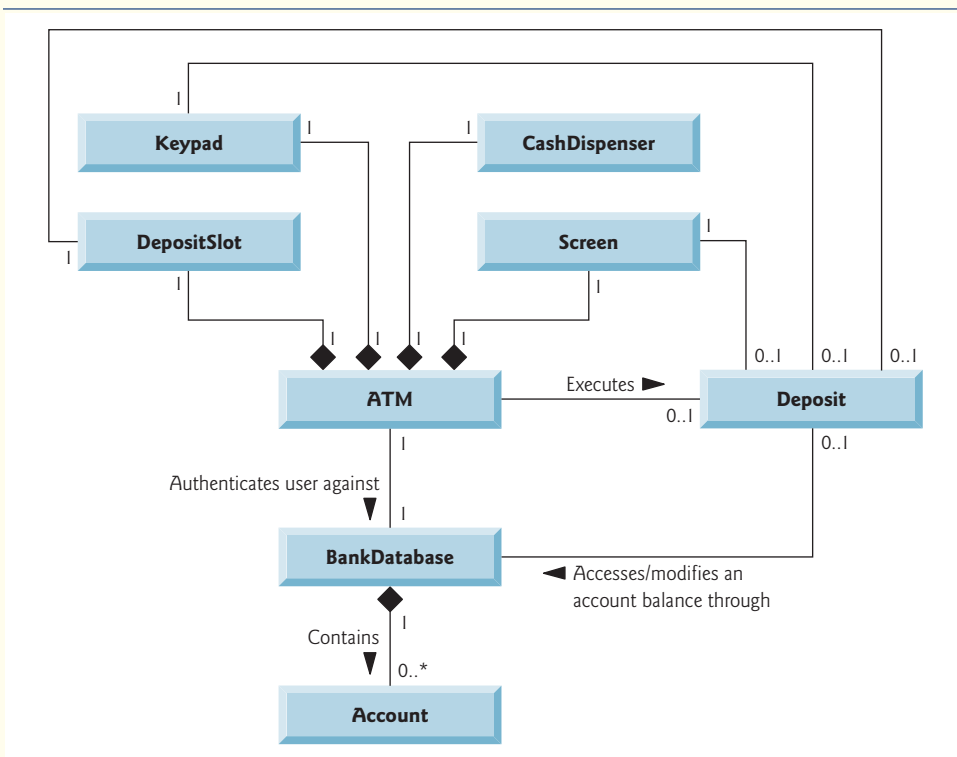

Fig. 12.28 | Class diagram for the ATM system model including class Deposit.

**12.8** b.

**12.9** c. Fly is an operation or behavior of an airplane, not an attribute.

**12.10** This indicates that count is an Integer with an initial value of 500. This attribute keeps track of the number of bills available in the CashDispenser at any given time.

**12.11** False. State diagrams model some of the behavior of a system.

**12.12** a.

**12.13** Figure 12.29 models the actions that occur after the user chooses the deposit option from the main menu and before the ATM returns the user to the main menu. Recall that part of receiving a deposit amount from the user involves converting an integer number of cents to a dollar amount. Also recall that crediting a deposit amount to an account increases only the totalBalance attribute of the user's Account object. The bank updates the availableBalance attribute of the user's Account object only after confirming the amount of cash in the deposit envelope and after the enclosed checks clear—this occurs independently of the ATM system.

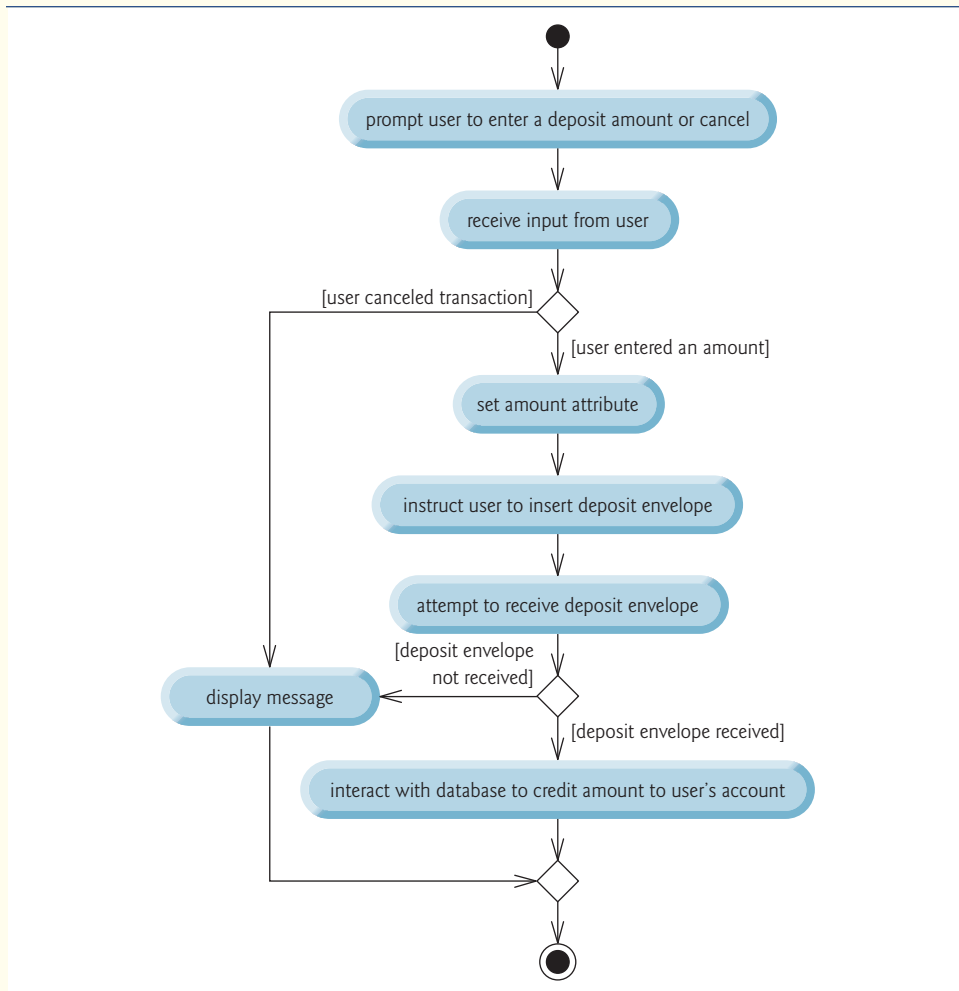

**Fig. 12.29** | Activity diagram for a deposit transaction.

12.14 c.

12.15 To specify an operation that retrieves the amount attribute of class `Withdrawal`, the following operation listing would be placed in the operation (i.e., third) compartment of class `Withdrawal`:

```
getAmount() : Double
```

12.16 This operation listing indicates an operation named `add` that takes integers `x` and `y` as parameters and returns an integer value.

12.17 c.

12.18 Communication diagrams emphasize *what* collaborations occur. Sequence diagrams emphasize *when* collaborations occur.

12.19 Figure 12.30 presents a sequence diagram that models the interactions between objects in the ATM system that occur when a `Deposit` executes successfully. A `Deposit` first sends a `displayMessage` message to the `Screen` to ask the user to enter a deposit amount. Next the `Deposit` sends a `getInput` message to the `Keypad` to receive input from the user. The `Deposit` then instructs the user to enter a deposit envelope by sending a `displayMessage` message to the `Screen`. The `Deposit` next sends an `isEnvelopeReceived` message to the `DepositSlot` to confirm that the deposit envelope has been received by the ATM. Finally, the `Deposit` increases the `totalBalance` attribute (but not the `availableBalance` attribute) of the user's `Account` by sending a `credit` message to the `BankDatabase`. The `BankDatabase` responds by sending the same message to the user's `Account`.

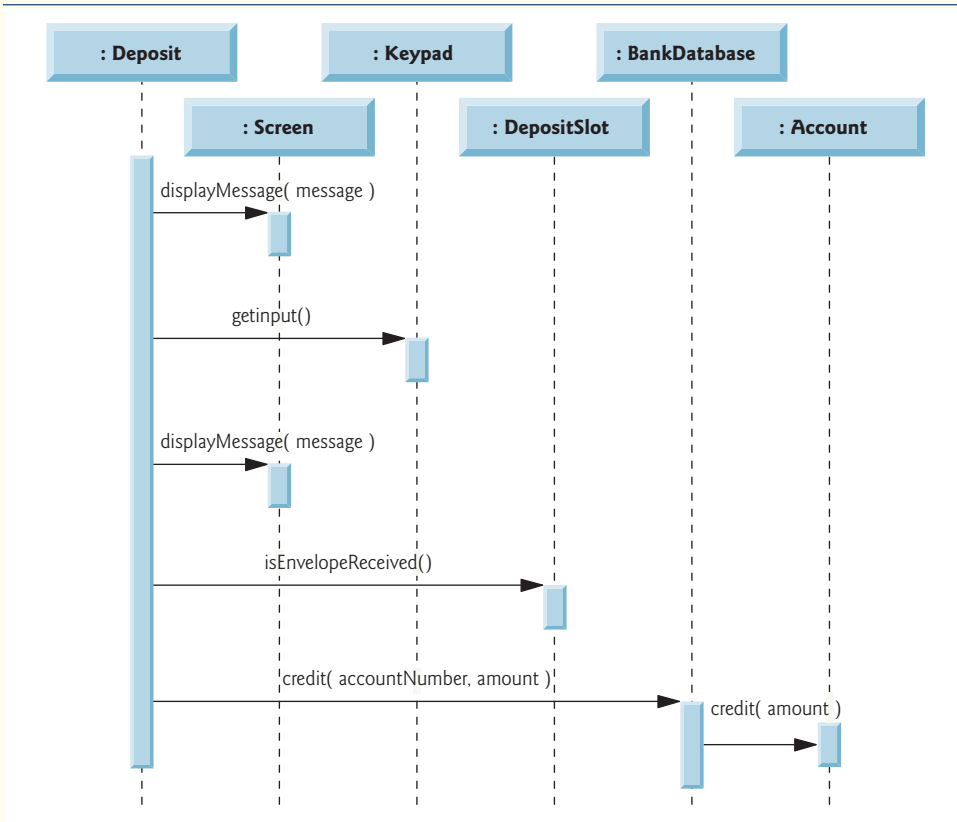

Fig. 12.30 | Sequence diagram that models a `Deposit` executing.

# 13

## ATM Case Study Part 2: Implementing an Object- Oriented Design

*You can't work in the abstract.*  
—I. M. Pei

*To generalize means to think.*  
—Georg Wilhelm Friedrich Hegel

*We are all gifted. That is our inheritance.*  
—Ethel Waters

*Let me walk through the fields  
of paper  
touching with my wand  
dry stems and stunted  
butterflies...*  
—Denise Levertov

### Objectives

In this chapter you'll:

- Incorporate inheritance into the design of the ATM.
- Incorporate polymorphism into the design of the ATM.
- Fully implement in Java the UML-based object-oriented design of the ATM software.
- Study a detailed code walkthrough of the ATM software system that explains the implementation issues.

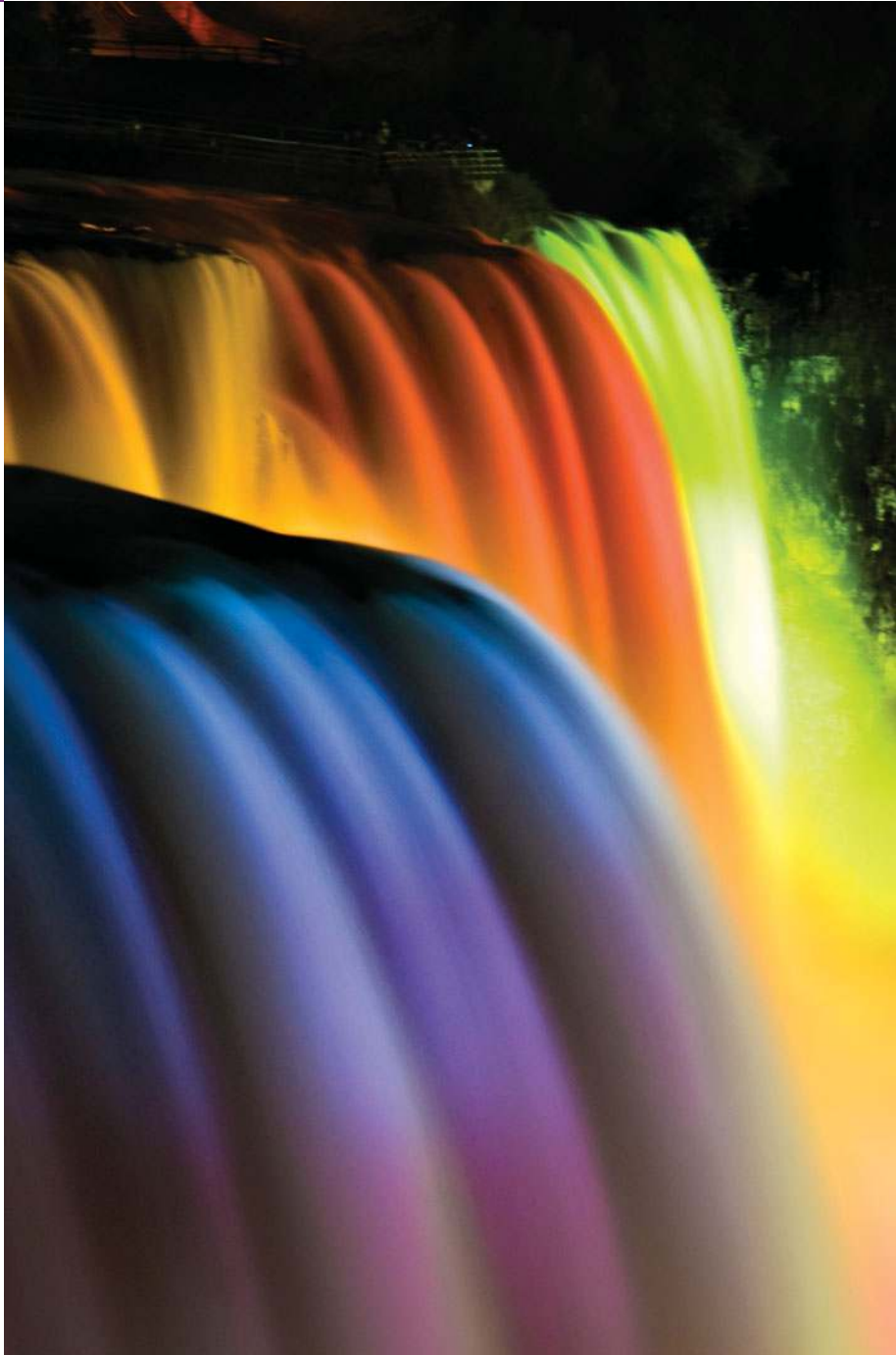

- |                                                                                                                                                                                                                                                                                                                                                                                                                                  |                                                                                                                                                                                                                                                                                                                                                                                          |
|----------------------------------------------------------------------------------------------------------------------------------------------------------------------------------------------------------------------------------------------------------------------------------------------------------------------------------------------------------------------------------------------------------------------------------|------------------------------------------------------------------------------------------------------------------------------------------------------------------------------------------------------------------------------------------------------------------------------------------------------------------------------------------------------------------------------------------|
| <ul style="list-style-type: none"> <li><b>13.1</b> Introduction</li> <li><b>13.2</b> Starting to Program the Classes of the ATM System</li> <li><b>13.3</b> Incorporating Inheritance and Polymorphism into the ATM System</li> <li><b>13.4</b> ATM Case Study Implementation           <ul style="list-style-type: none"> <li>13.4.1 Class ATM</li> <li>13.4.2 Class Screen</li> <li>13.4.3 Class Keypad</li> </ul> </li> </ul> | <ul style="list-style-type: none"> <li>13.4.4 Class CashDispenser</li> <li>13.4.5 Class DepositSlot</li> <li>13.4.6 Class Account</li> <li>13.4.7 Class BankDatabase</li> <li>13.4.8 Class Transaction</li> <li>13.4.9 Class BalanceInquiry</li> <li>13.4.10 Class Withdrawal</li> <li>13.4.11 Class Deposit</li> <li>13.4.12 Class ATMCaseStudy</li> <li><b>13.5</b> Wrap-Up</li> </ul> |
|----------------------------------------------------------------------------------------------------------------------------------------------------------------------------------------------------------------------------------------------------------------------------------------------------------------------------------------------------------------------------------------------------------------------------------|------------------------------------------------------------------------------------------------------------------------------------------------------------------------------------------------------------------------------------------------------------------------------------------------------------------------------------------------------------------------------------------|

*Answers to Self-Review Exercises*

## 13.1 Introduction

In Chapter 12, we developed an object-oriented design for our ATM system. We now implement our object-oriented design in Java. In Section 13.2, we show how to convert class diagrams to Java code. In Section 13.3, we tune the design with inheritance and polymorphism. Then we present a full Java code implementation of the ATM software in Section 13.4. The code is carefully commented and the discussions of the implementation are thorough and precise. Studying this application provides the opportunity for you to see a more substantial application of the kind you're likely to encounter in industry.

## 13.2 Starting to Program the Classes of the ATM System

[*Note:* This section can be taught after Chapter 8.]

### *Visibility*

We now apply access modifiers to the members of our classes. We've introduced access modifiers `public` and `private`. Access modifiers determine the **visibility** or accessibility of an object's attributes and methods to other objects. Before we can begin implementing our design, we must consider which attributes and methods of our classes should be `public` and which should be `private`.

We've observed that attributes normally should be `private` and that methods invoked by clients of a given class should be `public`. Methods that are called as "utility methods" only by other methods of the same class normally should be `private`. The UML employs **visibility markers** for modeling the visibility of attributes and operations. Public visibility is indicated by placing a plus sign (+) before an operation or an attribute, whereas a minus sign (−) indicates private visibility. Figure 13.1 shows our updated class diagram with visibility markers included. [*Note:* We do not include any operation parameters in Fig. 13.1—this is perfectly normal. Adding visibility markers does not affect the parameters already modeled in the class diagrams of Figs. 12.17–12.21.]

### *Navigability*

Before we begin implementing our design in Java, we introduce an additional UML notation. The class diagram in Fig. 13.2 further refines the relationships among classes in the ATM system by adding navigability arrows to the association lines. **Navigability arrows** (represented as arrows with stick ( $\Rightarrow$ ) arrowheads in the class diagram) indicate in the

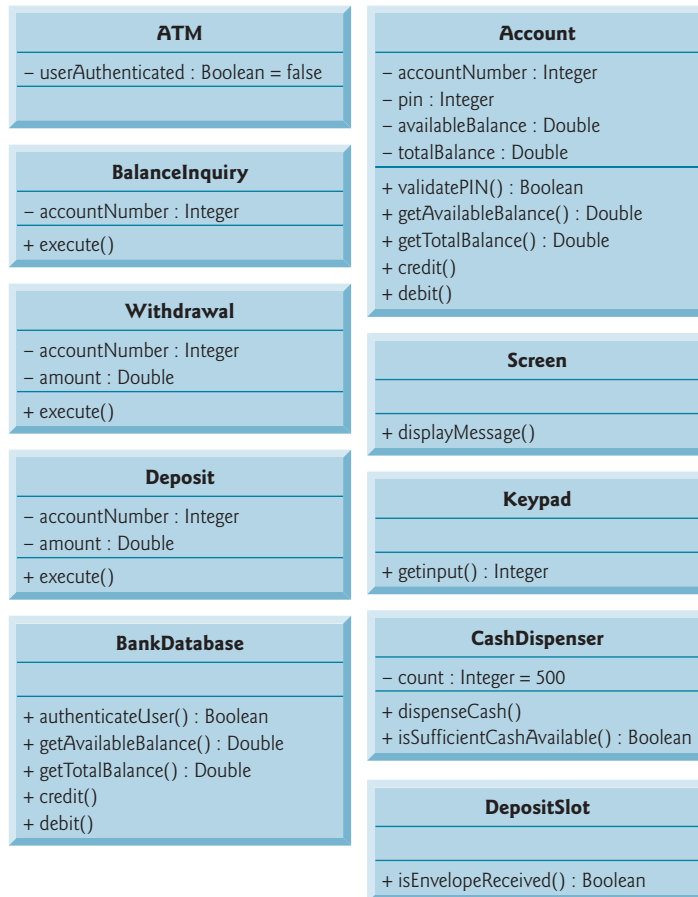

**Fig. 13.1** | Class diagram with visibility markers.

direction which an association can be traversed. When implementing a system designed using the UML, you use navigability arrows to determine which objects need references to other objects. For example, the navigability arrow pointing from class ATM to class BankDatabase indicates that we can navigate from the former to the latter, thereby enabling the ATM to invoke the BankDatabase's operations. However, since Fig. 13.2 does *not* contain a navigability arrow pointing from class BankDatabase to class ATM, the BankDatabase cannot access the ATM's operations. Associations in a class diagram that have navigability arrows at both ends or have none at all indicate **bidirectional navigability**—navigation can proceed in either direction across the association.

Like the class diagram of Fig. 12.10, that of Fig. 13.2 omits classes BalanceInquiry and Deposit for simplicity. The navigability of the associations in which these classes participate closely parallels that of class Withdrawal. Recall from Section 12.3 that BalanceInquiry has an association with class Screen. We can navigate from class BalanceInquiry to class Screen along this association, but we cannot navigate from class Screen to class BalanceInquiry. Thus, if we were to model class BalanceInquiry in Fig. 13.2, we would place a navigability

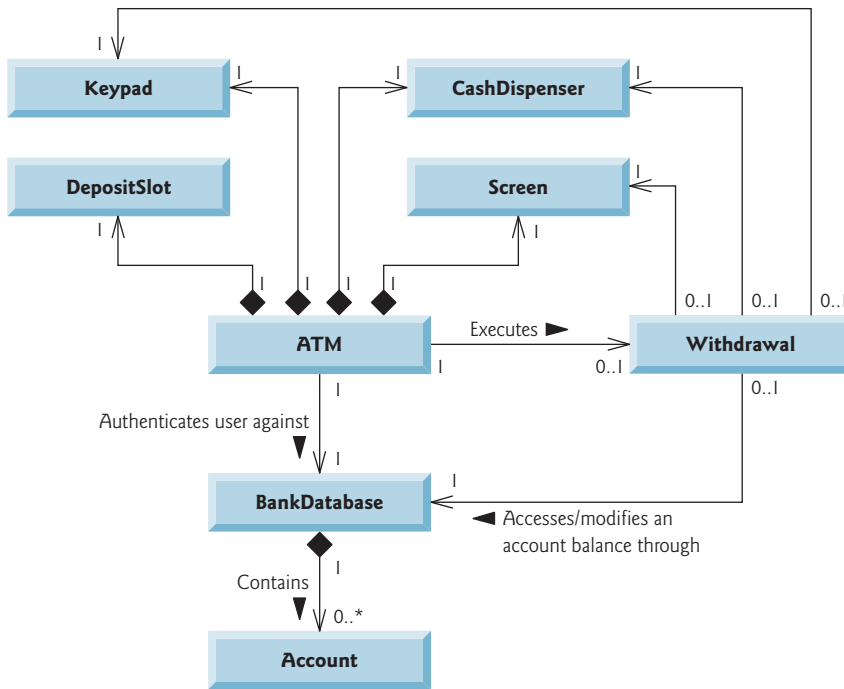

**Fig. 13.2** | Class diagram with navigability arrows.

arrow at class `Screen`'s end of this association. Also recall that class `Deposit` associates with classes `Screen`, `Keypad` and `DepositSlot`. We can navigate from class `Deposit` to each of these classes, but *not* vice versa. We therefore would place navigability arrows at the `Screen`, `Keypad` and `DepositSlot` ends of these associations. [Note: We model these additional classes and associations in our final class diagram in Section 13.3, after we've simplified the structure of our system by incorporating the object-oriented concept of inheritance.]

### Implementing the ATM System from Its UML Design

We're now ready to begin implementing the ATM system. We first convert the classes in the diagrams of Fig. 13.1 and Fig. 13.2 into Java code. The code will represent the "skeleton" of the system. In Section 13.3, we modify the code to incorporate inheritance. In Section 13.4, we present the complete working Java code for our model.

As an example, we develop the code from our design of class `Withdrawal` in Fig. 13.1. We use this figure to determine the attributes and operations of the class. We use the UML model in Fig. 13.2 to determine the associations among classes. We follow the following four guidelines for each class:

1. Use the name located in the first compartment to declare the class as a `public` class with an empty no-argument constructor. We include this constructor simply as a placeholder to remind us that *most classes will indeed need custom constructors*. In Section 13.4, when we complete a working version of this class, we'll add arguments and code the body of the constructor as needed. For example, class

Withdrawal yields the code in Fig. 13.3. If we find that the class's instance variables require only default initialization, then we'll remove the empty no-argument constructor because it's unnecessary.

---

```

1 // Class Withdrawal represents an ATM withdrawal transaction
2 public class Withdrawal
3 {
4 // no-argument constructor
5 public Withdrawal()
6 {
7 } // end no-argument Withdrawal constructor
8 } // end class Withdrawal

```

---

**Fig. 13.3** | Java code for class Withdrawal based on Figs. 13.1–13.2.

2. Use the attributes located in the second compartment to declare the instance variables. For example, the private attributes `accountNumber` and `amount` of class `Withdrawal` yield the code in Fig. 13.4. [*Note:* The constructor of the complete working version of this class will assign values to these attributes.]

---

```

1 // Class Withdrawal represents an ATM withdrawal transaction
2 public class Withdrawal
3 {
4 // attributes
5 private int accountNumber; // account to withdraw funds from
6 private double amount; // amount to withdraw
7
8 // no-argument constructor
9 public Withdrawal()
10 {
11 } // end no-argument Withdrawal constructor
12 } // end class Withdrawal

```

---

**Fig. 13.4** | Java code for class Withdrawal based on Figs. 13.1–13.2.

3. Use the associations described in the class diagram to declare the references to other objects. For example, according to Fig. 13.2, `Withdrawal` can access one object of class `Screen`, one object of class `Keypad`, one object of class `CashDispenser` and one object of class `BankDatabase`. This yields the code in Fig. 13.5. [*Note:* The constructor of the complete working version of this class will initialize these instance variables with references to actual objects.]
4. Use the operations located in the third compartment of Fig. 13.1 to declare the shells of the methods. If we have not yet specified a return type for an operation, we declare the method with return type `void`. Refer to the class diagrams of Figs. 12.17–12.21 to declare any necessary parameters. For example, adding the public operation `execute` in class `Withdrawal`, which has an empty parameter list, yields the code in Fig. 13.6. [*Note:* We code the bodies of methods when we implement the complete system in Section 13.4.]

This concludes our discussion of the basics of generating classes from UML diagrams.



---

```

1 // Class Withdrawal represents an ATM withdrawal transaction
2 public class Withdrawal
3 {
4 // attributes
5 private int accountNumber; // account to withdraw funds from
6 private double amount; // amount to withdraw
7
8 // references to associated objects
9 private Screen screen; // ATM's screen
10 private Keypad keypad; // ATM's keypad
11 private CashDispenser cashDispenser; // ATM's cash dispenser
12 private BankDatabase bankDatabase; // account info database
13
14 // no-argument constructor
15 public Withdrawal()
16 {
17 } // end no-argument Withdrawal constructor
18 } // end class Withdrawal

```

---

**Fig. 13.5** | Java code for class `Withdrawal` based on Figs. 13.1–13.2.

---

```

1 // Class Withdrawal represents an ATM withdrawal transaction
2 public class Withdrawal
3 {
4 // attributes
5 private int accountNumber; // account to withdraw funds from
6 private double amount; // amount to withdraw
7
8 // references to associated objects
9 private Screen screen; // ATM's screen
10 private Keypad keypad; // ATM's keypad
11 private CashDispenser cashDispenser; // ATM's cash dispenser
12 private BankDatabase bankDatabase; // account info database
13
14 // no-argument constructor
15 public Withdrawal()
16 {
17 } // end no-argument Withdrawal constructor
18
19 // operations
20 public void execute()
21 {
22 } // end method execute
23 } // end class Withdrawal

```

---

**Fig. 13.6** | Java code for class `Withdrawal` based on Figs. 13.1–13.2.

## Self-Review Exercises for Section 13.2

**13.1** State whether the following statement is *true* or *false*, and if *false*, explain why: If an attribute of a class is marked with a minus sign (-) in a class diagram, the attribute is not directly accessible outside the class.

**13.2** In Fig. 13.2, the association between the ATM and the Screen indicates that:

- we can navigate from the Screen to the ATM
- we can navigate from the ATM to the Screen
- Both (a) and (b); the association is bidirectional
- None of the above

**13.3** Write Java code to begin implementing the design for class Keypad.

## 13.3 Incorporating Inheritance and Polymorphism into the ATM System

[*Note: This section can be taught after Chapter 10.*]

We now revisit our ATM system design to see how it might benefit from inheritance. To apply inheritance, we first look for *commonality among classes* in the system. We create an inheritance hierarchy to model similar (yet not identical) classes in a more elegant and efficient manner. We then modify our class diagram to incorporate the new inheritance relationships. Finally, we demonstrate how our updated design is translated into Java code.

In Section 12.3, we encountered the problem of representing a financial transaction in the system. Rather than create one class to represent all transaction types, we decided to create three individual transaction classes—`BalanceInquiry`, `Withdrawal` and `Deposit`—to represent the transactions that the ATM system can perform. Figure 13.7 shows the attributes and operations of classes `BalanceInquiry`, `Withdrawal` and `Deposit`. These classes have one attribute (`accountNumber`) and one operation (`execute`) in common. Each class requires attribute `accountNumber` to specify the account to which the transaction applies. Each class contains operation `execute`, which the ATM invokes to perform the transaction. Clearly, `BalanceInquiry`, `Withdrawal` and `Deposit` represent *types of* transactions. Figure 13.7 reveals commonality among the transaction classes, so using inheritance to factor out the common features seems appropriate for designing classes `BalanceInquiry`, `Withdrawal` and `Deposit`. We place the common functionality in a superclass, `Transaction`, that classes `BalanceInquiry`, `Withdrawal` and `Deposit` extend.

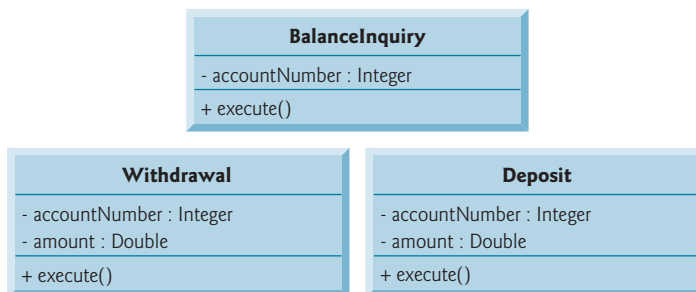
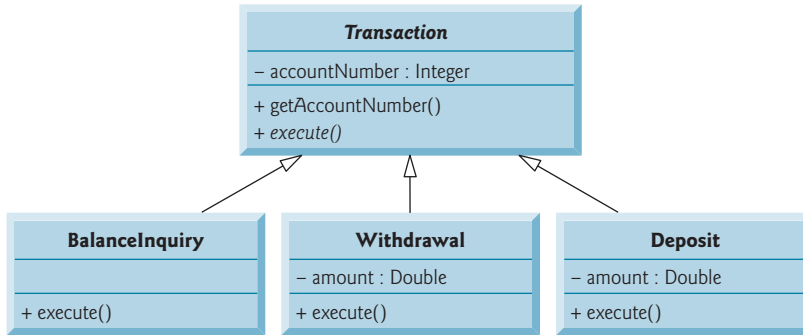

**Fig. 13.7** | Attributes and operations of `BalanceInquiry`, `Withdrawal` and `Deposit`.

### Generalization

The UML specifies a relationship called a **generalization** to model inheritance. Figure 13.8 is the class diagram that models the generalization of superclass `Transaction` and subclasses `BalanceInquiry`, `Withdrawal` and `Deposit`. The arrows with triangular

hollow arrowheads indicate that classes `BalanceInquiry`, `Withdrawal` and `Deposit` extend class `Transaction`. Class `Transaction` is said to be a generalization of classes `BalanceInquiry`, `Withdrawal` and `Deposit`. Class `BalanceInquiry`, `Withdrawal` and `Deposit` are said to be **specializations** of class `Transaction`.



**Fig. 13.8** | Class diagram modeling generalization of superclass `Transaction` and subclasses `BalanceInquiry`, `Withdrawal` and `Deposit`. Abstract class names (e.g., `Transaction`) and method names (e.g., `execute` in class `Transaction`) appear in italics.

Classes `BalanceInquiry`, `Withdrawal` and `Deposit` share integer attribute `accountNumber`, so we *factor out* this *common attribute* and place it in superclass `Transaction`. We no longer list `accountNumber` in the second compartment of each subclass, because the three subclasses *inherit* this attribute from `Transaction`. Recall, however, that subclasses cannot directly access private attributes of a superclass. We therefore include public method `getAccountNumber` in class `Transaction`. Each subclass will inherit this method, enabling the subclass to access its `accountNumber` as needed to execute a transaction.

According to Fig. 13.7, classes `BalanceInquiry`, `Withdrawal` and `Deposit` also share operation `execute`, so we placed public method `execute` in superclass `Transaction`. However, it does *not* make sense to implement `execute` in class `Transaction`, because the functionality that this method provides *depends on the type of the actual transaction*. We therefore declare method `execute` as abstract in superclass `Transaction`. Any class that contains at least one abstract method must also be declared abstract. This forces any subclass of `Transaction` that must be a *concrete* class (i.e., `BalanceInquiry`, `Withdrawal` and `Deposit`) to implement method `execute`. The UML requires that we place abstract class names (and abstract methods) in italics, so `Transaction` and its method `execute` appear in italics in Fig. 13.8. Method `execute` is *not* italicized in subclasses `BalanceInquiry`, `Withdrawal` and `Deposit`. Each subclass overrides superclass `Transaction`'s `execute` method with a concrete implementation that performs the steps appropriate for completing that type of transaction. Figure 13.8 includes operation `execute` in the third compartment of classes `BalanceInquiry`, `Withdrawal` and `Deposit`, because each class has a different concrete implementation of the overridden method.

### *Processing Transactions Polymorphically*

Polymorphism provides the ATM with an elegant way to execute all transactions “in the general.” For example, suppose a user chooses to perform a balance inquiry. The ATM sets a

Transaction reference to a new `BalanceInquiry` object. When the ATM uses its `Transaction` reference to invoke method `execute`, `BalanceInquiry`'s version of `execute` is called.

This *polymorphic* approach also makes the system easily *extensible*. Should we wish to create a new transaction type (e.g., funds transfer or bill payment), we would just create an additional `Transaction` subclass that overrides the `execute` method with a version of the method appropriate for executing the new transaction type. We would need to make only minimal changes to the system code to allow users to choose the new transaction type from the main menu and for the ATM to instantiate and execute objects of the new subclass. The ATM could execute transactions of the new type using the current code, because it executes all transactions *polymorphically* using a general `Transaction` reference.

Recall that an abstract class like `Transaction` is one for which you never intend to instantiate objects. An abstract class simply declares common attributes and behaviors of its subclasses in an inheritance hierarchy. Class `Transaction` defines the concept of what it means to be a transaction that has an account number and executes. You may wonder why we bother to include abstract method `execute` in class `Transaction` if it lacks a concrete implementation. Conceptually, we include it because it corresponds to the defining behavior of *all* transactions—executing. Technically, we must include method `execute` in superclass `Transaction` so that the ATM (or any other class) can polymorphically invoke each subclass's *overridden* version of this method through a `Transaction` reference. Also, from a software engineering perspective, including an abstract method in a superclass forces the implementor of the subclasses to override that method with concrete implementations in the subclasses, or else the subclasses, too, will be abstract, preventing objects of those subclasses from being instantiated.

### *Additional Attribute of Classes `Withdrawal` and `Deposit`*

Subclasses `BalanceInquiry`, `Withdrawal` and `Deposit` inherit attribute `accountNumber` from superclass `Transaction`, but classes `Withdrawal` and `Deposit` contain the additional attribute `amount` that distinguishes them from class `BalanceInquiry`. Classes `Withdrawal` and `Deposit` require this additional attribute to store the amount of money that the user wishes to withdraw or deposit. Class `BalanceInquiry` has no need for such an attribute and requires only an account number to execute. Even though two of the three `Transaction` subclasses share this attribute, we do *not* place it in superclass `Transaction`—we place only features *common* to all the subclasses in the superclass, otherwise subclasses could inherit attributes (and methods) that they do not need and should not have.

### *Class Diagram with `Transaction` Hierarchy Incorporated*

Figure 13.9 presents an updated class diagram of our model that incorporates inheritance and introduces class `Transaction`. We model an association between class `ATM` and class `Transaction` to show that the ATM, at any given moment, either is executing a transaction or is not (i.e., zero or one objects of type `Transaction` exist in the system at a time). Because a `Withdrawal` is a type of `Transaction`, we no longer draw an association line directly between class `ATM` and class `Withdrawal`. Subclass `Withdrawal` inherits superclass `Transaction`'s association with class `ATM`. Subclasses `BalanceInquiry` and `Deposit` inherit this association, too, so the previously omitted associations between `ATM` and classes `BalanceInquiry` and `Deposit` no longer exist either.

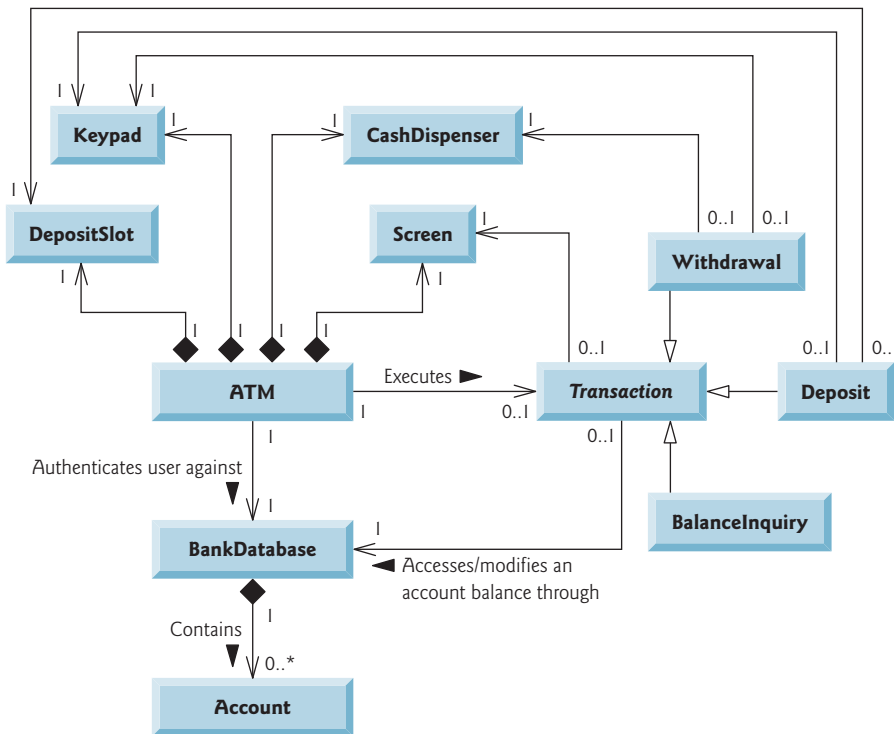

**Fig. 13.9** | Class diagram of the ATM system (incorporating inheritance). The abstract class name *Transaction* appears in italics.

We also add an association between class *Transaction* and the *BankDatabase* (Fig. 13.9). All *Transactions* require a reference to the *BankDatabase* so they can access and modify account information. Because each *Transaction* subclass inherits this reference, we no longer model the association between class *Withdrawal* and the *BankDatabase*. Similarly, the previously omitted associations between the *BankDatabase* and classes *BalanceInquiry* and *Deposit* no longer exist.

We show an association between class *Transaction* and the *Screen*. All *Transactions* display output to the user via the *Screen*. Thus, we no longer include the association previously modeled between *Withdrawal* and the *Screen*, although *Withdrawal* still participates in associations with the *CashDispenser* and the *Keypad*. Our class diagram incorporating inheritance also models *Deposit* and *BalanceInquiry*. We show associations between *Deposit* and both the *DepositSlot* and the *Keypad*. Class *BalanceInquiry* takes part in no associations other than those inherited from class *Transaction*—a *BalanceInquiry* needs to interact only with the *BankDatabase* and with the *Screen*.

Figure 13.1 showed attributes and operations with visibility markers. Now in Fig. 13.10 we present a modified class diagram that incorporates inheritance. This abbreviated diagram does not show inheritance relationships, but instead shows the attributes and methods after we've employed inheritance in our system. To save space, as we did in

Fig. 12.12, we do not include those attributes shown by associations in Fig. 13.9—we do, however, include them in the Java implementation in Section 13.4. We also omit all operation parameters, as we did in Fig. 13.1—incorporating inheritance does not affect the parameters already modeled in Figs. 12.17–12.21.



**Software Engineering Observation 13.1**

*A complete class diagram shows all the associations among classes and all the attributes and operations for each class. When the number of class attributes, methods and associations is substantial (as in Figs. 13.9 and 13.10), a good practice that promotes readability is to divide this information between two class diagrams—one focusing on associations and the other on attributes and methods.*

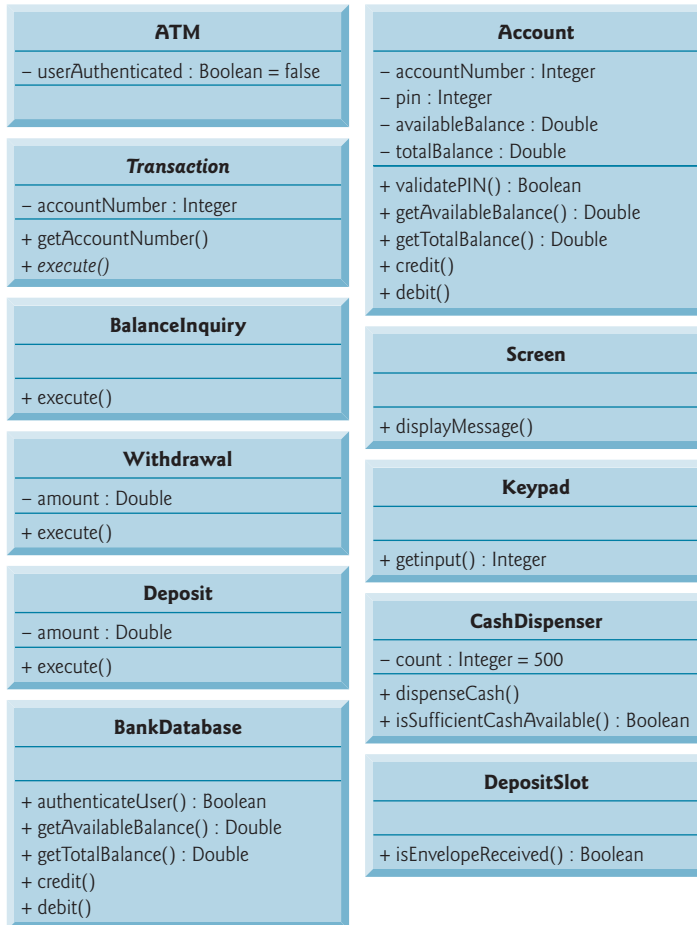

**Fig. 13.10** | Class diagram with attributes and operations (incorporating inheritance). The abstract class name *Transaction* and the abstract method name *execute* in class *Transaction* appear in italics.

*Implementing the ATM System Design (Incorporating Inheritance)*

In Section 13.2, we began implementing the ATM system design in Java code. We now modify our implementation to incorporate inheritance, using class `Withdrawal` as an example.

1. If a class A is a generalization of class B, then class B extends class A in the class declaration. For example, abstract superclass `Transaction` is a generalization of class `Withdrawal`. Figure 13.11 shows the declaration of class `Withdrawal`.

---

```

1 // Class Withdrawal represents an ATM withdrawal transaction
2 public class Withdrawal extends Transaction
3 {
4 } // end class Withdrawal

```

---

**Fig. 13.11** | Java code for shell of class `Withdrawal`.

2. If class A is an abstract class and class B is a subclass of class A, then class B must implement the *abstract* methods of class A if class B is to be a *concrete* class. For example, class `Transaction` contains abstract method `execute`, so class `Withdrawal` must implement this method if we want to instantiate a `Withdrawal` object. Figure 13.12 is the Java code for class `Withdrawal` from Fig. 13.9 and Fig. 13.10. Class `Withdrawal` inherits field `accountNumber` from superclass `Transaction`, so `Withdrawal` does not need to declare this field. Class `Withdrawal` also inherits references to the `Screen` and the `BankDatabase` from its superclass `Transaction`, so we do not include these references in our code. Figure 13.10 specifies attribute `amount` and operation `execute` for class `Withdrawal`. Line 6 of Fig. 13.12 declares a field for attribute `amount`. Lines 16–19 declare the shell of a method for operation `execute`. Recall that subclass `Withdrawal` must provide a concrete implementation of the abstract method `execute` in superclass `Transaction`. The keypad and `cashDispenser` references (lines 7–8) are fields derived from `Withdrawal`'s associations in Fig. 13.9. The constructor in the complete working version of this class will initialize these references to actual objects.

---

```

1 // Withdrawal.java
2 // Generated using the class diagrams in Fig. 13.9 and Fig. 13.10
3 public class Withdrawal extends Transaction
4 {
5 // attributes
6 private double amount; // amount to withdraw
7 private Keypad keypad; // reference to keypad
8 private CashDispenser cashDispenser; // reference to cash dispenser
9
10 // no-argument constructor
11 public Withdrawal()
12 {
13 } // end no-argument Withdrawal constructor
14

```

---

**Fig. 13.12** | Java code for class `Withdrawal` based on Figs. 13.9 and 13.10. (Part I of 2.)

```

15 // method overriding execute
16 @Override
17 public void execute()
18 {
19 } // end method execute
20 } // end class Withdrawal

```

**Fig. 13.12** | Java code for class `Withdrawal` based on Figs. 13.9 and 13.10. (Part 2 of 2.)



### Software Engineering Observation 13.2

Several UML modeling tools can convert UML-based designs into Java code, speeding the implementation process considerably. For more information on these tools, visit our UML Resource Center at [www.deitel.com/UML/](http://www.deitel.com/UML/).

Congratulations on completing the case study's design portion! We implement the ATM system in Java code in Section 13.4. We recommend that you carefully read the code and its description. The code is abundantly commented and precisely follows the design with which you're now familiar. The accompanying description is carefully written to guide your understanding of the implementation based on the UML design. Mastering this code is a wonderful culminating accomplishment after studying Sections 12.2–12.7 and 13.2–13.3.

## Self-Review Exercises for Section 13.3

- 13.4** The UML uses an arrow with a \_\_\_\_\_ to indicate a generalization relationship.
- solid filled arrowhead
  - triangular hollow arrowhead
  - diamond-shaped hollow arrowhead
  - stick arrowhead
- 13.5** State whether the following statement is *true* or *false*, and if *false*, explain why: The UML requires that we underline abstract class names and method names.
- 13.6** Write Java code to begin implementing the design for class `Transaction` specified in Figs. 13.9 and 13.10. Be sure to include private reference-type attributes based on class `Transaction`'s associations. Also be sure to include public *get* methods that provide access to any of these private attributes that the subclasses require to perform their tasks.

## 13.4 ATM Case Study Implementation

This section contains the complete working 673-line implementation of the ATM system. We consider the classes in the order in which we identified them in Section 12.3—`ATM`, `Screen`, `Keypad`, `CashDispenser`, `DepositSlot`, `Account`, `BankDatabase`, `Transaction`, `BalanceInquiry`, `Withdrawal` and `Deposit`.

We apply the guidelines discussed in Sections 13.2–13.3 to code these classes based on how we modeled them in the UML class diagrams of Figs. 13.9 and 13.10. To develop the bodies of class methods, we refer to the activity diagrams in Section 12.5 and the communication and sequence diagrams presented in Section 12.7. Our ATM design does *not* specify all the program logic and may not specify all the attributes and operations required to complete the ATM implementation. This is a *normal* part of the object-oriented design



process. As we implement the system, we complete the program logic and add attributes and behaviors as necessary to construct the ATM system specified by the requirements document in Section 12.2.

We conclude the discussion by presenting a Java application (`ATMCaseStudy`) that starts the ATM and puts the other classes in the system in use. Recall that we're developing a first version of the ATM system that runs on a personal computer and uses the computer's keyboard and monitor to approximate the ATM's keypad and screen. We also simulate only the actions of the ATM's cash dispenser and deposit slot. We attempt to implement the system, however, so that real hardware versions of these devices could be integrated without significant changes in the code.

### 13.4.1 Class ATM

Class `ATM` (Fig. 13.13) represents the ATM as a whole. Lines 6–12 implement the class's attributes. We determine all but one of these attributes from the UML class diagrams of Figs. 13.9 and 13.10. We implement the UML `Boolean` attribute `userAuthenticated` in Fig. 13.10 as a `boolean` in Java (line 6). Line 7 declares an attribute not found in our UML design—an `int` attribute `currentAccountNumber` that keeps track of the account number of the current authenticated user. We'll soon see how the class uses this attribute. Lines 8–12 declare reference-type attributes corresponding to the ATM class's associations modeled in the class diagram of Fig. 13.9. These attributes allow the ATM to access its parts (i.e., its `Screen`, `Keypad`, `CashDispenser` and `DepositSlot`) and interact with the bank's account-information database (i.e., a `BankDatabase` object).

---

```

1 // ATM.java
2 // Represents an automated teller machine
3
4 public class ATM
5 {
6 private boolean userAuthenticated; // whether user is authenticated
7 private int currentAccountNumber; // current user's account number
8 private Screen screen; // ATM's screen
9 private Keypad keypad; // ATM's keypad
10 private CashDispenser cashDispenser; // ATM's cash dispenser
11 private DepositSlot depositSlot; // ATM's deposit slot
12 private BankDatabase bankDatabase; // account information database
13
14 // constants corresponding to main menu options
15 private static final int BALANCE_INQUIRY = 1;
16 private static final int WITHDRAWAL = 2;
17 private static final int DEPOSIT = 3;
18 private static final int EXIT = 4;
19
20 // no-argument ATM constructor initializes instance variables
21 public ATM()
22 {
23 userAuthenticated = false; // user is not authenticated to start
24 currentAccountNumber = 0; // no current account number to start
25 screen = new Screen(); // create screen

```

---

**Fig. 13.13** | Class `ATM` represents the ATM. (Part I of 4.)

```

26 keypad = new Keypad(); // create keypad
27 cashDispenser = new CashDispenser(); // create cash dispenser
28 depositSlot = new DepositSlot(); // create deposit slot
29 bankDatabase = new BankDatabase(); // create acct info database
30 } // end no-argument ATM constructor
31
32 // start ATM
33 public void run()
34 {
35 // welcome and authenticate user; perform transactions
36 while (true)
37 {
38 // loop while user is not yet authenticated
39 while (!userAuthenticated)
40 {
41 screen.displayMessageLine("\nWelcome!");
42 authenticateUser(); // authenticate user
43 } // end while
44
45 performTransactions(); // user is now authenticated
46 userAuthenticated = false; // reset before next ATM session
47 currentAccountNumber = 0; // reset before next ATM session
48 screen.displayMessageLine("\nThank you! Goodbye!");
49 } // end while
50 } // end method run
51
52 // attempts to authenticate user against database
53 private void authenticateUser()
54 {
55 screen.displayMessage("\nPlease enter your account number: ");
56 int accountNumber = keypad.getInput(); // input account number
57 screen.displayMessage("\nEnter your PIN: "); // prompt for PIN
58 int pin = keypad.getInput(); // input PIN
59
60 // set userAuthenticated to boolean value returned by database
61 userAuthenticated =
62 bankDatabase.authenticateUser(accountNumber, pin);
63
64 // check whether authentication succeeded
65 if (userAuthenticated)
66 {
67 currentAccountNumber = accountNumber; // save user's account #
68 } // end if
69 else
70 screen.displayMessageLine(
71 "Invalid account number or PIN. Please try again.");
72 } // end method authenticateUser
73
74 // display the main menu and perform transactions
75 private void performTransactions()
76 {
77 // local variable to store transaction currently being processed
78 Transaction currentTransaction = null;

```

**Fig. 13.13** | Class ATM represents the ATM. (Part 2 of 4.)

```

79
80 boolean userExited = false; // user has not chosen to exit
81
82 // loop while user has not chosen option to exit system
83 while (!userExited)
84 {
85 // show main menu and get user selection
86 int mainMenuSelection = displayMainMenu();
87
88 // decide how to proceed based on user's menu selection
89 switch (mainMenuSelection)
90 {
91 // user chose to perform one of three transaction types
92 case BALANCE_INQUIRY:
93 case WITHDRAWAL:
94 case DEPOSIT:
95
96 // initialize as new object of chosen type
97 currentTransaction =
98 createTransaction(mainMenuSelection);
99
100 currentTransaction.execute(); // execute transaction
101 break;
102 case EXIT: // user chose to terminate session
103 screen.displayMessageLine("\nExiting the system...");
104 userExited = true; // this ATM session should end
105 break;
106 default: // user did not enter an integer from 1-4
107 screen.displayMessageLine(
108 "\nYou did not enter a valid selection. Try again.");
109 break;
110 } // end switch
111 } // end while
112 } // end method performTransactions
113
114 // display the main menu and return an input selection
115 private int displayMainMenu()
116 {
117 screen.displayMessageLine("\nMain menu:");
118 screen.displayMessageLine("1 - View my balance");
119 screen.displayMessageLine("2 - Withdraw cash");
120 screen.displayMessageLine("3 - Deposit funds");
121 screen.displayMessageLine("4 - Exit\n");
122 screen.displayMessage("Enter a choice: ");
123 return keypad.getInput(); // return user's selection
124 } // end method displayMainMenu
125
126 // return object of specified Transaction subclass
127 private Transaction createTransaction(int type)
128 {
129 Transaction temp = null; // temporary Transaction variable
130

```

**Fig. 13.13** | Class ATM represents the ATM. (Part 3 of 4.)

```

131 // determine which type of Transaction to create
132 switch (type)
133 {
134 case BALANCE_INQUIRY: // create new BalanceInquiry transaction
135 temp = new BalanceInquiry(
136 currentAccountNumber, screen, bankDatabase);
137 break;
138 case WITHDRAWAL: // create new Withdrawal transaction
139 temp = new Withdrawal(currentAccountNumber, screen,
140 bankDatabase, keypad, cashDispenser);
141 break;
142 case DEPOSIT: // create new Deposit transaction
143 temp = new Deposit(currentAccountNumber, screen,
144 bankDatabase, keypad, depositSlot);
145 break;
146 } // end switch
147
148 return temp; // return the newly created object
149 } // end method createTransaction
150 } // end class ATM

```

**Fig. 13.13** | Class ATM represents the ATM. (Part 4 of 4.)

Lines 15–18 declare integer constants that correspond to the four options in the ATM’s main menu (i.e., balance inquiry, withdrawal, deposit and exit). Lines 21–30 declare the constructor, which initializes the class’s attributes. When an ATM object is first created, no user is authenticated, so line 23 initializes `userAuthenticated` to `false`. Likewise, line 24 initializes `currentAccountNumber` to 0 because there’s no current user yet. Lines 25–28 instantiate new objects to represent the ATM’s parts. Recall that class ATM has composition relationships with classes `Screen`, `Keypad`, `CashDispenser` and `DepositSlot`, so class ATM is responsible for their creation. Line 29 creates a new `BankDatabase`. [Note: If this were a real ATM system, the ATM class would receive a reference to an existing database object created by the bank. However, in this implementation we’re only simulating the bank’s database, so class ATM creates the `BankDatabase` object with which it interacts.]

### *ATM Method run*

The class diagram of Fig. 13.10 does not list any operations for class ATM. We now implement one operation (i.e., `public` method) in class ATM that allows an external client of the class (i.e., class `ATMCaseStudy`) to tell the ATM to run. ATM method `run` (lines 33–50) uses an infinite loop (lines 36–49) to repeatedly welcome a user, attempt to authenticate the user and, if authentication succeeds, allow the user to perform transactions. After an authenticated user performs the desired transactions and chooses to exit, the ATM resets itself, displays a goodbye message to the user and restarts the process. We use an infinite loop here to simulate the fact that an ATM appears to run continuously until the bank turns it off (an action beyond the user’s control). An ATM user has the option to exit the system but not the ability to turn off the ATM completely.

### *Authenticating a User*

In method `run`’s infinite loop, lines 39–43 cause the ATM to repeatedly welcome and attempt to authenticate the user as long as the user has not been authenticated (i.e., `!user-`

Authenticated is true). Line 41 invokes method `displayMessageLine` of the ATM's screen to display a welcome message. Like Screen method `displayMessage` designed in the case study, method `displayMessageLine` (declared in lines 13–16 of Fig. 13.14) displays a message to the user, but this method also outputs a newline after the message. We've added this method during implementation to give class Screen's clients more control over the placement of displayed messages. Line 42 invokes class ATM's private utility method `authenticateUser` (declared in lines 53–72) to attempt to authenticate the user.

We refer to the requirements document to determine the steps necessary to authenticate the user before allowing transactions to occur. Line 55 of method `authenticateUser` invokes method `displayMessage` of the screen to prompt the user to enter an account number. Line 56 invokes method `getInput` of the keypad to obtain the user's input, then stores the integer value entered by the user in a local variable `accountNumber`. Method `authenticateUser` next prompts the user to enter a PIN (line 57), and stores the PIN input by the user in a local variable `pin` (line 58). Next, lines 61–62 attempt to authenticate the user by passing the `accountNumber` and `pin` entered by the user to the `bankDatabase`'s `authenticateUser` method. Class ATM sets its `userAuthenticated` attribute to the `boolean` value returned by this method—`userAuthenticated` becomes `true` if authentication succeeds (i.e., `accountNumber` and `pin` match those of an existing `Account` in `bankDatabase`) and remains `false` otherwise. If `userAuthenticated` is `true`, line 67 saves the account number entered by the user (i.e., `accountNumber`) in the ATM attribute `currentAccountNumber`. The other ATM methods use this variable whenever an ATM session requires access to the user's account number. If `userAuthenticated` is `false`, lines 70–71 use the screen's `displayMessageLine` method to indicate that an invalid account number and/or PIN was entered and the user must try again. We set `currentAccountNumber` only after authenticating the user's account number and the associated PIN—if the database could not authenticate the user, `currentAccountNumber` remains 0.

After method `run` attempts to authenticate the user (line 42), if `userAuthenticated` is still `false`, the `while` loop in lines 39–43 executes again. If `userAuthenticated` is now `true`, the loop terminates and control continues with line 45, which calls class ATM's utility method `performTransactions`.

### *Performing Transactions*

Method `performTransactions` (lines 75–112) carries out an ATM session for an authenticated user. Line 78 declares a local `Transaction` variable to which we'll assign a `BalanceInquiry`, `Withdrawal` or `Deposit` object representing the ATM transaction the user selected. We use a `Transaction` variable here to allow us to take advantage of polymorphism. Also, we name this variable after the *role name* included in the class diagram of Fig. 12.7—`currentTransaction`. Line 80 declares another local variable—a `boolean` called `userExited` that keeps track of whether the user has chosen to exit. This variable controls a `while` loop (lines 83–111) that allows the user to execute an unlimited number of transactions before choosing to exit. Within this loop, line 86 displays the main menu and obtains the user's menu selection by calling an ATM utility method `displayMainMenu` (declared in lines 115–124). This method displays the main menu by invoking methods of the ATM's screen and returns a menu selection obtained from the user through the ATM's keypad. Line 86 stores the user's selection returned by `displayMainMenu` in local variable `mainMenuSelection`.

After obtaining a main menu selection, method `performTransactions` uses a `switch` statement (lines 89–110) to respond to the selection appropriately. If `mainMenuSelection`

is equal to any of the three integer constants representing transaction types (i.e., if the user chose to perform a transaction), lines 97–98 call utility method `createTransaction` (declared in lines 127–149) to return a newly instantiated object of the type that corresponds to the selected transaction. Variable `currentTransaction` is assigned the reference returned by `createTransaction`, then line 100 invokes method `execute` of this transaction to execute it. We'll discuss `Transaction` method `execute` and the three `Transaction` subclasses shortly. We assign the `Transaction` variable `currentTransaction` an object of one of the three `Transaction` subclasses so that we can execute transactions *polymorphically*. For example, if the user chooses to perform a balance inquiry, `mainMenuSelection` equals `BALANCE_INQUIRY`, leading `createTransaction` to return a `BalanceInquiry` object. Thus, `currentTransaction` refers to a `BalanceInquiry`, and invoking `currentTransaction.execute()` results in `BalanceInquiry`'s version of `execute` being called.

### *Creating a Transaction*

Method `createTransaction` (lines 127–149) uses a `switch` statement (lines 132–146) to instantiate a new `Transaction` subclass object of the type indicated by the parameter `type`. Recall that method `performTransactions` passes `mainMenuSelection` to this method only when `mainMenuSelection` contains a value corresponding to one of the three transaction types. Therefore `type` is `BALANCE_INQUIRY`, `WITHDRAWAL` or `DEPOSIT`. Each case in the `switch` statement instantiates a new object by calling the appropriate `Transaction` subclass constructor. Each constructor has a unique parameter list, based on the specific data required to initialize the subclass object. A `BalanceInquiry` requires only the account number of the current user and references to the ATM's screen and the `bankDatabase`. In addition to these parameters, a `Withdrawal` requires references to the ATM's keypad and `cashDispenser`, and a `Deposit` requires references to the ATM's keypad and `depositSlot`. We discuss the transaction classes in more detail in Sections 13.4.8–13.4.11.

### *Exiting the Main Menu and Processing Invalid Selections*

After executing a transaction (line 100 in `performTransactions`), `userExited` remains `false` and lines 83–111 repeat, returning the user to the main menu. However, if a user does not perform a transaction and instead selects the main menu option to exit, line 104 sets `userExited` to `true`, causing the condition of the `while` loop (`!userExited`) to become `false`. This `while` is the final statement of method `performTransactions`, so control returns to the calling method `run`. If the user enters an invalid main menu selection (i.e., not an integer from 1–4), lines 107–108 display an appropriate error message, `userExited` remains `false` and the user returns to the main menu to try again.

### *Awaiting the Next ATM User*

When `performTransactions` returns control to method `run`, the user has chosen to exit the system, so lines 46–47 reset the ATM's attributes `userAuthenticated` and `currentAccountNumber` to prepare for the next ATM user. Line 48 displays a goodbye message before the ATM starts over and welcomes the next user.

## 13.4.2 Class Screen

`Class Screen` (Fig. 13.14) represents the screen of the ATM and encapsulates all aspects of displaying output to the user. `Class Screen` approximates a real ATM's screen with a computer monitor and outputs text messages using standard console output methods

`System.out.print`, `System.out.println` and `System.out.printf`. In this case study, we designed class `Screen` to have one operation—`displayMessage`. For greater flexibility in displaying messages to the `Screen`, we now declare three `Screen` methods—`displayMessage`, `displayMessageLine` and `displayDollarAmount`.

---

```

1 // Screen.java
2 // Represents the screen of the ATM
3
4 public class Screen
5 {
6 // display a message without a carriage return
7 public void displayMessage(String message)
8 {
9 System.out.print(message);
10 } // end method displayMessage
11
12 // display a message with a carriage return
13 public void displayMessageLine(String message)
14 {
15 System.out.println(message);
16 } // end method displayMessageLine
17
18 // displays a dollar amount
19 public void displayDollarAmount(double amount)
20 {
21 System.out.printf("$%,.2f", amount);
22 } // end method displayDollarAmount
23 } // end class Screen

```

---

**Fig. 13.14** | Class `Screen` represents the screen of the ATM.

Method `displayMessage` (lines 7–10) takes a `String` argument and prints it to the console. The cursor stays on the same line, making this method appropriate for displaying prompts to the user. Method `displayMessageLine` (lines 13–16) does the same using `System.out.println`, which outputs a newline to move the cursor to the next line. Finally, method `displayDollarAmount` (lines 19–22) outputs a properly formatted dollar amount (e.g., \$1,234.56). Line 21 uses `System.out.printf` to output a `double` value formatted with commas to increase readability and two decimal places.

### 13.4.3 Class Keypad

Class `Keypad` (Fig. 13.15) represents the keypad of the ATM and is responsible for receiving all user input. Recall that we’re simulating this hardware, so we use the computer’s keyboard to approximate the keypad. We use class `Scanner` to obtain console input from the user. A computer keyboard contains many keys not found on the ATM’s keypad. However, we assume that the user presses only the keys on the computer keyboard that also appear on the keypad—the keys numbered 0–9 and the *Enter* key.

Line 3 of class `Keypad` imports class `Scanner` for use in class `Keypad`. Line 7 declares `Scanner` variable `input` as an instance variable. Line 12 in the constructor creates a new `Scanner` object that reads input from the standard input stream (`System.in`) and assigns the object’s reference to variable `input`. Method `getInput` (lines 16–19) invokes `Scanner`

---

```

1 // Keypad.java
2 // Represents the keypad of the ATM
3 import java.util.Scanner; // program uses Scanner to obtain user input
4
5 public class Keypad
6 {
7 private Scanner input; // reads data from the command line
8
9 // no-argument constructor initializes the Scanner
10 public Keypad()
11 {
12 input = new Scanner(System.in);
13 } // end no-argument Keypad constructor
14
15 // return an integer value entered by user
16 public int getInput()
17 {
18 return input.nextInt(); // we assume that user enters an integer
19 } // end method getInput
20 } // end class Keypad

```

---

**Fig. 13.15** | Class Keypad represents the ATM's keypad.

method `nextInt` (line 18) to return the next integer input by the user. [*Note:* Method `nextInt` can throw an `InputMismatchException` if the user enters non-integer input. Because the real ATM's keypad permits only integer input, we assume that no exception will occur and do not attempt to fix this problem. See Chapter 11, *Exception Handling: A Deeper Look*, for information on catching exceptions.] Recall that `nextInt` obtains all the input used by the ATM. Keypad's `getInput` method simply returns the integer input by the user. If a client of class Keypad requires input that satisfies some criteria (i.e., a number corresponding to a valid menu option), the client must perform the error checking.

### 13.4.4 Class CashDispenser

Class `CashDispenser` (Fig. 13.16) represents the cash dispenser of the ATM. Line 7 declares constant `INITIAL_COUNT`, which indicates the initial count of bills in the cash dispenser when the ATM starts (i.e., 500). Line 8 implements attribute `count` (modeled in Fig. 13.10), which keeps track of the number of bills remaining in the `CashDispenser` at any time. The constructor (lines 11–14) sets `count` to the initial count. `CashDispenser` has two public methods—`dispenseCash` (lines 17–21) and `isSufficientCashAvailable` (lines 24–32). The class trusts that a client (i.e., `Withdrawal`) calls `dispenseCash` only after establishing that sufficient cash is available by calling `isSufficientCashAvailable`. Thus, `dispenseCash` simply simulates dispensing the requested amount without checking whether sufficient cash is available.

---

```

1 // CashDispenser.java
2 // Represents the cash dispenser of the ATM
3

```

---

**Fig. 13.16** | Class CashDispenser represents the ATM's cash dispenser. (Part I of 2.)



```

4 public class CashDispenser
5 {
6 // the default initial number of bills in the cash dispenser
7 private final static int INITIAL_COUNT = 500;
8 private int count; // number of $20 bills remaining
9
10 // no-argument CashDispenser constructor initializes count to default
11 public CashDispenser()
12 {
13 count = INITIAL_COUNT; // set count attribute to default
14 } // end CashDispenser constructor
15
16 // simulates dispensing of specified amount of cash
17 public void dispenseCash(int amount)
18 {
19 int billsRequired = amount / 20; // number of $20 bills required
20 count -= billsRequired; // update the count of bills
21 } // end method dispenseCash
22
23 // indicates whether cash dispenser can dispense desired amount
24 public boolean isSufficientCashAvailable(int amount)
25 {
26 int billsRequired = amount / 20; // number of $20 bills required
27
28 if (count >= billsRequired)
29 return true; // enough bills available
30 else
31 return false; // not enough bills available
32 } // end method isSufficientCashAvailable
33 } // end class CashDispenser

```

**Fig. 13.16** | Class `CashDispenser` represents the ATM's cash dispenser. (Part 2 of 2.)

Method `isSufficientCashAvailable` (lines 24–32) has a parameter `amount` that specifies the amount of cash in question. Line 26 calculates the number of \$20 bills required to dispense the specified amount. The ATM allows the user to choose only withdrawal amounts that are multiples of \$20, so we divide `amount` by 20 to obtain the number of `billsRequired`. Lines 28–31 return `true` if the `CashDispenser`'s `count` is greater than or equal to `billsRequired` (i.e., enough bills are available) and `false` otherwise (i.e., not enough bills). For example, if a user wishes to withdraw \$80 (i.e., `billsRequired` is 4), but only three bills remain (i.e., `count` is 3), the method returns `false`.

Method `dispenseCash` (lines 17–21) simulates cash dispensing. If our system were hooked up to a real hardware cash dispenser, this method would interact with the device to physically dispense cash. Our version of the method simply decreases the count of bills remaining by the number required to dispense the specified amount (line 20). It's the responsibility of the client of the class (i.e., `Withdrawal`) to inform the user that cash has been dispensed—`CashDispenser` cannot interact directly with `Screen`.

### 13.4.5 Class `DepositSlot`

Class `DepositSlot` (Fig. 13.17) represents the ATM's deposit slot. Like class `CashDispenser`, class `DepositSlot` merely simulates the functionality of a real hardware deposit

slot. `DepositSlot` has no attributes and only one method—`isEnvelopeReceived` (lines 8–11)—which indicates whether a deposit envelope was received.

---

```

1 // DepositSlot.java
2 // Represents the deposit slot of the ATM
3
4 public class DepositSlot
5 {
6 // indicates whether envelope was received (always returns true,
7 // because this is only a software simulation of a real deposit slot)
8 public boolean isEnvelopeReceived()
9 {
10 return true; // deposit envelope was received
11 } // end method isEnvelopeReceived
12 } // end class DepositSlot

```

---

**Fig. 13.17** | Class `DepositSlot` represents the ATM's deposit slot.

Recall from the requirements document that the ATM allows the user up to two minutes to insert an envelope. The current version of method `isEnvelopeReceived` simply returns `true` immediately (line 10), because this is only a software simulation, and we assume that the user has inserted an envelope within the required time frame. If an actual hardware deposit slot were connected to our system, method `isEnvelopeReceived` might be implemented to wait for a maximum of two minutes to receive a signal from the hardware deposit slot indicating that the user has indeed inserted a deposit envelope. If `isEnvelopeReceived` were to receive such a signal within two minutes, the method would return `true`. If two minutes elapsed and the method still had not received a signal, then the method would return `false`.

### 13.4.6 Class Account

Class `Account` (Fig. 13.18) represents a bank account. Each `Account` has four attributes (modeled in Fig. 13.10)—`accountNumber`, `pin`, `availableBalance` and `totalBalance`. Lines 6–9 implement these attributes as private fields. Variable `availableBalance` represents the amount of funds available for withdrawal. Variable `totalBalance` represents the amount of funds available, plus the amount of deposited funds still pending confirmation or clearance.

---

```

1 // Account.java
2 // Represents a bank account
3
4 public class Account
5 {
6 private int accountNumber; // account number
7 private int pin; // PIN for authentication
8 private double availableBalance; // funds available for withdrawal
9 private double totalBalance; // funds available + pending deposits

```

---

**Fig. 13.18** | Class `Account` represents a bank account. (Part 1 of 2.)

```
10
11 // Account constructor initializes attributes
12 public Account(int theAccountNumber, int thePIN,
13 double theAvailableBalance, double theTotalBalance)
14 {
15 accountNumber = theAccountNumber;
16 pin = thePIN;
17 availableBalance = theAvailableBalance;
18 totalBalance = theTotalBalance;
19 } // end Account constructor
20
21 // determines whether a user-specified PIN matches PIN in Account
22 public boolean validatePIN(int userPIN)
23 {
24 if (userPIN == pin)
25 return true;
26 else
27 return false;
28 } // end method validatePIN
29
30 // returns available balance
31 public double getAvailableBalance()
32 {
33 return availableBalance;
34 } // end getAvailableBalance
35
36 // returns the total balance
37 public double getTotalBalance()
38 {
39 return totalBalance;
40 } // end method getTotalBalance
41
42 // credits an amount to the account
43 public void credit(double amount)
44 {
45 totalBalance += amount; // add to total balance
46 } // end method credit
47
48 // debits an amount from the account
49 public void debit(double amount)
50 {
51 availableBalance -= amount; // subtract from available balance
52 totalBalance -= amount; // subtract from total balance
53 } // end method debit
54
55 // returns account number
56 public int getAccountNumber()
57 {
58 return accountNumber;
59 } // end method getAccountNumber
60 } // end class Account
```

**Fig. 13.18** | Class Account represents a bank account. (Part 2 of 2.)

The `Account` class has a constructor (lines 12–19) that takes an account number, the PIN established for the account, the account’s initial available balance and the account’s initial total balance as arguments. Lines 15–18 assign these values to the class’s attributes (i.e., fields).

Method `validatePIN` (lines 22–28) determines whether a user-specified PIN (i.e., parameter `userPIN`) matches the PIN associated with the account (i.e., attribute `pin`). Recall that we modeled this method’s parameter `userPIN` in Fig. 12.19. If the two PINs match, the method returns `true` (line 25); otherwise, it returns `false` (line 27).

Methods `getAvailableBalance` (lines 31–34) and `getTotalBalance` (lines 37–40) return the values of `double` attributes `availableBalance` and `totalBalance`, respectively.

Method `credit` (lines 43–46) adds an amount of money (i.e., parameter `amount`) to an `Account` as part of a deposit transaction. This method adds the amount only to attribute `totalBalance` (line 45). The money credited to an account during a deposit does *not* become available immediately, so we modify only the total balance. We assume that the bank updates the available balance appropriately at a later time. Our implementation of class `Account` includes only methods required for carrying out ATM transactions. Therefore, we omit the methods that some other bank system would invoke to add to attribute `availableBalance` (to confirm a deposit) or subtract from attribute `totalBalance` (to reject a deposit).

Method `debit` (lines 49–53) subtracts an amount of money (i.e., parameter `amount`) from an `Account` as part of a withdrawal transaction. This method subtracts the amount from *both* attribute `availableBalance` (line 51) and attribute `totalBalance` (line 52), because a withdrawal affects *both* measures of an account balance.

Method `getAccountNumber` (lines 56–59) provides access to an `Account`’s account-number. We include this method in our implementation so that a client of the class (i.e., `BankDatabase`) can identify a particular `Account`. For example, `BankDatabase` contains many `Account` objects, and it can invoke this method on each of its `Account` objects to locate the one with a specific account number.

### 13.4.7 Class `BankDatabase`

Class `BankDatabase` (Fig. 13.19) models the bank’s database with which the ATM interacts to access and modify a user’s account information. We study database access in Chapter 28. For now we model the database as an array. An exercise in Chapter 28 asks you to reimplement this portion of the ATM using an actual database.

---

```

1 // BankDatabase.java
2 // Represents the bank account information database
3
4 public class BankDatabase
5 {
6 private Account[] accounts; // array of Accounts
7
8 // no-argument BankDatabase constructor initializes accounts
9 public BankDatabase()
10 {

```

**Fig. 13.19** | Class `BankDatabase` represents the bank’s account information database. (Part 1 of 3.)

```

11 accounts = new Account[2]; // just 2 accounts for testing
12 accounts[0] = new Account(12345, 54321, 1000.0, 1200.0);
13 accounts[1] = new Account(98765, 56789, 200.0, 200.0);
14 } // end no-argument BankDatabase constructor
15
16 // retrieve Account object containing specified account number
17 private Account getAccount(int accountNumber)
18 {
19 // loop through accounts searching for matching account number
20 for (Account currentAccount : accounts)
21 {
22 // return current account if match found
23 if (currentAccount.getAccountNumber() == accountNumber)
24 return currentAccount;
25 } // end for
26
27 return null; // if no matching account was found, return null
28 } // end method getAccount
29
30 // determine whether user-specified account number and PIN match
31 // those of an account in the database
32 public boolean authenticateUser(int userAccountNumber, int userPIN)
33 {
34 // attempt to retrieve the account with the account number
35 Account userAccount = getAccount(userAccountNumber);
36
37 // if account exists, return result of Account method validatePIN
38 if (userAccount != null)
39 return userAccount.validatePIN(userPIN);
40 else
41 return false; // account number not found, so return false
42 } // end method authenticateUser
43
44 // return available balance of Account with specified account number
45 public double getAvailableBalance(int userAccountNumber)
46 {
47 return getAccount(userAccountNumber).getAvailableBalance();
48 } // end method getAvailableBalance
49
50 // return total balance of Account with specified account number
51 public double getTotalBalance(int userAccountNumber)
52 {
53 return getAccount(userAccountNumber).getTotalBalance();
54 } // end method getTotalBalance
55
56 // credit an amount to Account with specified account number
57 public void credit(int userAccountNumber, double amount)
58 {
59 getAccount(userAccountNumber).credit(amount);
60 } // end method credit
61

```

**Fig. 13.19** | Class BankDatabase represents the bank's account information database. (Part 2 of 3.)

---

```

62 // debit an amount from Account with specified account number
63 public void debit(int userAccountNumber, double amount)
64 {
65 getAccount(userAccountNumber).debit(amount);
66 } // end method debit
67 } // end class BankDatabase

```

---

**Fig. 13.19** | Class `BankDatabase` represents the bank’s account information database. (Part 3 of 3.)

We determine one reference-type attribute for class `BankDatabase` based on its composition relationship with class `Account`. Recall from Fig. 13.9 that a `BankDatabase` is composed of zero or more objects of class `Account`. Line 6 implements attribute `accounts`—an array of `Account` objects—to implement this composition relationship. Class `BankDatabase` has a no-argument constructor (lines 9–14) that initializes `accounts` to contain a set of new `Account` objects. For the sake of testing the system, we declare `accounts` to hold just two array elements (line 11), which we instantiate as new `Account` objects with test data (lines 12–13). The `Account` constructor has four parameters—the account number, the PIN assigned to the account, the initial available balance and the initial total balance. Recall that class `BankDatabase` serves as an intermediary between class `ATM` and the actual `Account` objects that contain a user’s account information. Thus, the methods of class `BankDatabase` do nothing more than invoke the corresponding methods of the `Account` object belonging to the current `ATM` user.

We include private utility method `getAccount` (lines 17–28) to allow the `BankDatabase` to obtain a reference to a particular `Account` within array `accounts`. To locate the user’s `Account`, the `BankDatabase` compares the value returned by method `getAccountNumber` for each element of `accounts` to a specified account number until it finds a match. Lines 20–25 traverse the `accounts` array. If the account number of `currentAccount` equals the value of parameter `accountNumber`, the method immediately returns the `currentAccount`. If no account has the given account number, then line 27 returns `null`.

Method `authenticateUser` (lines 32–42) proves or disproves the identity of an `ATM` user. This method takes a user-specified account number and PIN as arguments and indicates whether they match the account number and PIN of an `Account` in the database. Line 35 calls method `getAccount`, which returns either an `Account` with `userAccountNumber` as its account number or `null` to indicate that `userAccountNumber` is invalid. If `getAccount` returns an `Account` object, line 39 returns the `boolean` value returned by that object’s `validatePIN` method. `BankDatabase`’s `authenticateUser` method does not perform the PIN comparison itself—rather, it forwards `userPIN` to the `Account` object’s `validatePIN` method to do so. The value returned by `Account` method `validatePIN` indicates whether the user-specified PIN matches the PIN of the user’s `Account`, so method `authenticateUser` simply returns this value to the class’s client (i.e., `ATM`).

`BankDatabase` trusts the `ATM` to invoke method `authenticateUser` and receive a return value of `true` before allowing the user to perform transactions. `BankDatabase` also trusts that each `Transaction` object created by the `ATM` contains the valid account number of the current authenticated user and that this is the account number passed to the remaining `BankDatabase` methods as argument `userAccountNumber`. Methods `getAvailableBalance` (lines 45–48), `getTotalBalance` (lines 51–54), `credit` (lines 57–60) and

debit (lines 63–66) therefore simply retrieve the user’s Account object with utility method `getAccount`, then invoke the appropriate Account method on that object. We know that the calls to `getAccount` from these methods will never return `null`, because `userAccountNumber` must refer to an existing Account. Methods `getAvailableBalance` and `getTotalBalance` return the values returned by the corresponding Account methods. Also, `credit` and `debit` simply redirect parameter amount to the Account methods they invoke.

### 13.4.8 Class Transaction

Class Transaction (Fig. 13.20) is an abstract superclass that represents the notion of an ATM transaction. It contains the common features of subclasses `BalanceInquiry`, `Withdrawal` and `Deposit`. This class expands upon the “skeleton” code first developed in Section 13.3. Line 4 declares this class to be abstract. Lines 6–8 declare the class’s private attributes. Recall from the class diagram of Fig. 13.10 that class Transaction contains an attribute `accountNumber` (line 6) that indicates the account involved in the Transaction. We derive attributes `screen` (line 7) and `bankDatabase` (line 8) from class Transaction’s associations modeled in Fig. 13.9—all transactions require access to the ATM’s screen and the bank’s database.

---

```

1 // Transaction.java
2 // Abstract superclass Transaction represents an ATM transaction
3
4 public abstract class Transaction
5 {
6 private int accountNumber; // indicates account involved
7 private Screen screen; // ATM's screen
8 private BankDatabase bankDatabase; // account info database
9
10 // Transaction constructor invoked by subclasses using super()
11 public Transaction(int userAccountNumber, Screen atmScreen,
12 BankDatabase atmBankDatabase)
13 {
14 accountNumber = userAccountNumber;
15 screen = atmScreen;
16 bankDatabase = atmBankDatabase;
17 } // end Transaction constructor
18
19 // return account number
20 public int getAccountNumber()
21 {
22 return accountNumber;
23 } // end method getAccountNumber
24
25 // return reference to screen
26 public Screen getScreen()
27 {
28 return screen;
29 } // end method getScreen
30

```

---

**Fig. 13.20** | Abstract superclass Transaction represents an ATM transaction. (Part I of 2.)

---

```

31 // return reference to bank database
32 public BankDatabase getBankDatabase()
33 {
34 return bankDatabase;
35 } // end method getBankDatabase
36
37 // perform the transaction (overridden by each subclass)
38 abstract public void execute();
39 } // end class Transaction

```

---

**Fig. 13.20** | Abstract superclass Transaction represents an ATM transaction. (Part 2 of 2.)

Class Transaction has a constructor (lines 11–17) that takes as arguments the current user’s account number and references to the ATM’s screen and the bank’s database. Because Transaction is an *abstract* class, this constructor will be called only by the constructors of the Transaction subclasses.

The class has three public *get* methods—getAccountNumber (lines 20–23), getScreen (lines 26–29) and getBankDatabase (lines 32–35). These are inherited by Transaction subclasses and used to gain access to class Transaction’s private attributes.

Class Transaction also declares abstract method execute (line 38). It does not make sense to provide this method’s implementation, because a generic transaction cannot be executed. So, we declare this method abstract and force each Transaction subclass to provide a concrete implementation that executes that particular type of transaction.

### 13.4.9 Class BalanceInquiry

Class BalanceInquiry (Fig. 13.21) extends Transaction and represents a balance-inquiry ATM transaction. BalanceInquiry does not have any attributes of its own, but it inherits Transaction attributes accountNumber, screen and bankDatabase, which are accessible through Transaction’s public *get* methods. The BalanceInquiry constructor takes arguments corresponding to these attributes and simply forwards them to Transaction’s constructor using super (line 10).

---

```

1 // BalanceInquiry.java
2 // Represents a balance inquiry ATM transaction
3
4 public class BalanceInquiry extends Transaction
5 {
6 // BalanceInquiry constructor
7 public BalanceInquiry(int userAccountNumber, Screen atmScreen,
8 BankDatabase atmBankDatabase)
9 {
10 super(userAccountNumber, atmScreen, atmBankDatabase);
11 } // end BalanceInquiry constructor
12
13 // performs the transaction
14 @Override
15 public void execute()
16 {

```

---

**Fig. 13.21** | Class BalanceInquiry represents a balance-inquiry ATM transaction. (Part 1 of 2.)



```

17 // get references to bank database and screen
18 BankDatabase bankDatabase = getBankDatabase();
19 Screen screen = getScreen();
20
21 // get the available balance for the account involved
22 double availableBalance =
23 bankDatabase.getAvailableBalance(getAccountNumber());
24
25 // get the total balance for the account involved
26 double totalBalance =
27 bankDatabase.getTotalBalance(getAccountNumber());
28
29 // display the balance information on the screen
30 screen.displayMessageLine("\nBalance Information:");
31 screen.displayMessage(" - Available balance: ");
32 screen.displayDollarAmount(availableBalance);
33 screen.displayMessage("\n - Total balance: ");
34 screen.displayDollarAmount(totalBalance);
35 screen.displayMessageLine("");
36 } // end method execute
37 } // end class BalanceInquiry

```

**Fig. 13.21** | Class `BalanceInquiry` represents a balance-inquiry ATM transaction. (Part 2 of 2.)

Class `BalanceInquiry` overrides `Transaction`'s abstract method `execute` to provide a concrete implementation (lines 14–36) that performs the steps involved in a balance inquiry. Lines 18–19 get references to the bank database and the ATM's screen by invoking methods inherited from superclass `Transaction`. Lines 22–23 retrieve the available balance of the account involved by invoking method `getAvailableBalance` of `BankDatabase`. Line 23 uses inherited method `getAccountNumber` to get the account number of the current user, which it then passes to `getAvailableBalance`. Lines 26–27 retrieve the total balance of the current user's account. Lines 30–35 display the balance information on the ATM's screen. Recall that `displayDollarAmount` takes a `double` argument and outputs it to the screen formatted as a dollar amount. For example, if a user's `availableBalance` is 1000.5, line 32 outputs \$1,000.50. Line 35 inserts a blank line of output to separate the balance information from subsequent output (i.e., the main menu repeated by class `ATM` after executing the `BalanceInquiry`).

### 13.4.10 Class `Withdrawal`

Class `Withdrawal` (Fig. 13.22) extends `Transaction` and represents a withdrawal ATM transaction. This class expands upon the “skeleton” code for this class developed in Fig. 13.12. Recall from the class diagram of Fig. 13.10 that class `Withdrawal` has one attribute, `amount`, which line 6 implements as an `int` field. Figure 13.9 models associations between class `Withdrawal` and classes `Keypad` and `CashDispenser`, for which lines 7–8 implement reference-type attributes `keypad` and `cashDispenser`, respectively. Line 11 declares a constant corresponding to the cancel menu option. We'll soon discuss how the class uses this constant.

```
1 // Withdrawal.java
2 // Represents a withdrawal ATM transaction
3
4 public class Withdrawal extends Transaction
5 {
6 private int amount; // amount to withdraw
7 private Keypad keypad; // reference to keypad
8 private CashDispenser cashDispenser; // reference to cash dispenser
9
10 // constant corresponding to menu option to cancel
11 private final static int CANCELED = 6;
12
13 // Withdrawal constructor
14 public Withdrawal(int userAccountNumber, Screen atmScreen,
15 BankDatabase atmBankDatabase, Keypad atmKeypad,
16 CashDispenser atmCashDispenser)
17 {
18 // initialize superclass variables
19 super(userAccountNumber, atmScreen, atmBankDatabase);
20
21 // initialize references to keypad and cash dispenser
22 keypad = atmKeypad;
23 cashDispenser = atmCashDispenser;
24 } // end Withdrawal constructor
25
26 // perform transaction
27 @Override
28 public void execute()
29 {
30 boolean cashDispensed = false; // cash was not dispensed yet
31 double availableBalance; // amount available for withdrawal
32
33 // get references to bank database and screen
34 BankDatabase bankDatabase = getBankDatabase();
35 Screen screen = getScreen();
36
37 // loop until cash is dispensed or the user cancels
38 do
39 {
40 // obtain a chosen withdrawal amount from the user
41 amount = displayMenuOfAmounts();
42
43 // check whether user chose a withdrawal amount or canceled
44 if (amount != CANCELED)
45 {
46 // get available balance of account involved
47 availableBalance =
48 bankDatabase.getAvailableBalance(getAccountNumber());
49
50 // check whether the user has enough money in the account
51 if (amount <= availableBalance)
52 {
```

**Fig. 13.22** | Class Withdrawal represents a withdrawal ATM transaction. (Part 1 of 3.)

```

53 // check whether the cash dispenser has enough money
54 if (cashDispenser.isSufficientCashAvailable(amount))
55 {
56 // update the account involved to reflect the withdrawal
57 bankDatabase.debit(getAccountNumber(), amount);
58
59 cashDispenser.dispenseCash(amount); // dispense cash
60 cashDispensed = true; // cash was dispensed
61
62 // instruct user to take cash
63 screen.displayMessageLine("\nYour cash has been" +
64 " dispensed. Please take your cash now.");
65 } // end if
66 else // cash dispenser does not have enough cash
67 screen.displayMessageLine(
68 "\nInsufficient cash available in the ATM." +
69 "\n\nPlease choose a smaller amount.");
70 } // end if
71 else // not enough money available in user's account
72 {
73 screen.displayMessageLine(
74 "\nInsufficient funds in your account." +
75 "\n\nPlease choose a smaller amount.");
76 } // end else
77 } // end if
78 else // user chose cancel menu option
79 {
80 screen.displayMessageLine("\nCanceling transaction...");
81 return; // return to main menu because user canceled
82 } // end else
83 } while (!cashDispensed);
84
85 } // end method execute
86
87 // display a menu of withdrawal amounts and the option to cancel;
88 // return the chosen amount or 0 if the user chooses to cancel
89 private int displayMenuOfAmounts()
90 {
91 int userChoice = 0; // local variable to store return value
92
93 Screen screen = getScreen(); // get screen reference
94
95 // array of amounts to correspond to menu numbers
96 int[] amounts = { 0, 20, 40, 60, 100, 200 };
97
98 // loop while no valid choice has been made
99 while (userChoice == 0)
100 {
101 // display the withdrawal menu
102 screen.displayMessageLine("\nWithdrawal Menu:");
103 screen.displayMessageLine("1 - $20");
104 screen.displayMessageLine("2 - $40");
105 screen.displayMessageLine("3 - $60");

```

**Fig. 13.22** | Class `Withdrawal` represents a withdrawal ATM transaction. (Part 2 of 3.)

```

106 screen.displayMessageLine("4 - $100");
107 screen.displayMessageLine("5 - $200");
108 screen.displayMessageLine("6 - Cancel transaction");
109 screen.displayMessage("\nChoose a withdrawal amount: ");
110
111 int input = keypad.getInput(); // get user input through keypad
112
113 // determine how to proceed based on the input value
114 switch (input)
115 {
116 case 1: // if the user chose a withdrawal amount
117 case 2: // (i.e., chose option 1, 2, 3, 4 or 5), return the
118 case 3: // corresponding amount from amounts array
119 case 4:
120 case 5:
121 userChoice = amounts[input]; // save user's choice
122 break;
123 case CANCELED: // the user chose to cancel
124 userChoice = CANCELED; // save user's choice
125 break;
126 default: // the user did not enter a value from 1-6
127 screen.displayMessageLine(
128 "\nInvalid selection. Try again.");
129 } // end switch
130 } // end while
131
132 return userChoice; // return withdrawal amount or CANCELED
133 } // end method displayMenuOfAmounts
134 } // end class Withdrawal

```

**Fig. 13.22** | Class `Withdrawal` represents a withdrawal ATM transaction. (Part 3 of 3.)

Class `Withdrawal`'s constructor (lines 14–24) has five parameters. It uses `super` to pass parameters `userAccountNumber`, `atmScreen` and `atmBankDatabase` to superclass `Transaction`'s constructor to set the attributes that `Withdrawal` inherits from `Transaction`. The constructor also takes references `atmKeypad` and `atmCashDispenser` as parameters and assigns them to reference-type attributes `keypad` and `cashDispenser`.

Class `Withdrawal` overrides `Transaction` method `execute` with a concrete implementation (lines 27–85) that performs the steps of a withdrawal. Line 30 declares and initializes a local `boolean` variable `cashDispensed`, which indicates whether cash has been dispensed (i.e., whether the transaction has completed successfully) and is initially `false`. Line 31 declares local `double` variable `availableBalance`, which will store the user's available balance during a withdrawal transaction. Lines 34–35 get references to the bank database and the ATM's screen by invoking methods inherited from superclass `Transaction`.

Lines 38–83 contain a `do...while` that executes its body until cash is dispensed (i.e., until `cashDispensed` becomes `true`) or until the user chooses to cancel (in which case, the loop terminates). We use this loop to continuously return the user to the start of the transaction if an error occurs (i.e., the requested withdrawal amount is greater than the user's available balance or greater than the amount of cash in the cash dispenser). Line 41 displays a menu of withdrawal amounts and obtains a user selection by calling private utility method `displayMenuOfAmounts` (declared in lines 89–133). This method displays the

menu of amounts and returns either an `int` withdrawal amount or an `int` constant `CANCELED` to indicate that the user has chosen to cancel the transaction.

Method `displayMenuOfAmounts` (lines 89–133) first declares local variable `userChoice` (initially 0) to store the value that the method will return (line 91). Line 93 gets a reference to the screen by calling method `getScreen` inherited from superclass `Transaction`. Line 96 declares an integer array of withdrawal amounts that correspond to the amounts displayed in the withdrawal menu. We ignore the first element in the array (index 0) because the menu has no option 0. The `while` statement at lines 99–130 repeats until `userChoice` takes on a value other than 0. We'll see shortly that this occurs when the user makes a valid selection from the menu. Lines 102–109 display the withdrawal menu on the screen and prompt the user to enter a choice. Line 111 obtains integer input through the keypad. The `switch` statement at lines 114–129 determines how to proceed based on the user's input. If the user selects a number between 1 and 5, line 121 sets `userChoice` to the value of the element in `amounts` at index `input`. For example, if the user enters 3 to withdraw \$60, line 121 sets `userChoice` to the value of `amounts[ 3 ]` (i.e., 60). Line 122 terminates the `switch`. Variable `userChoice` no longer equals 0, so the `while` at lines 99–130 terminates and line 132 returns `userChoice`. If the user selects the cancel menu option, lines 124–125 execute, setting `userChoice` to `CANCELED` and causing the method to return this value. If the user does not enter a valid menu selection, lines 127–128 display an error message and the user is returned to the withdrawal menu.

Line 44 in method `execute` determines whether the user has selected a withdrawal amount or chosen to cancel. If the user cancels, lines 80–81 execute and display an appropriate message to the user before returning control to the calling method (i.e., ATM method `performTransactions`). If the user has chosen a withdrawal amount, lines 47–48 retrieve the available balance of the current user's `Account` and store it in variable `availableBalance`. Next, line 51 determines whether the selected amount is less than or equal to the user's available balance. If it's not, lines 73–75 display an appropriate error message. Control then continues to the end of the `do...while`, and the loop repeats because `cashDispensed` is still `false`. If the user's balance is high enough, the `if` statement at line 54 determines whether the cash dispenser has enough money to satisfy the withdrawal request by invoking the cash dispenser's `isSufficientCashAvailable` method. If this method returns `false`, lines 67–69 display an appropriate error message and the `do...while` repeats. If sufficient cash is available, then the requirements for the withdrawal are satisfied, and line 57 debits `amount` from the user's account in the database. Lines 59–60 then instruct the cash dispenser to dispense the cash to the user and set `cashDispensed` to `true`. Finally, lines 63–64 display a message to the user that cash has been dispensed. Because `cashDispensed` is now `true`, control continues after the `do...while`. No additional statements appear below the loop, so the method returns.

### 13.4.11 Class `Deposit`

Class `Deposit` (Fig. 13.23) extends `Transaction` and represents a deposit transaction. Recall from Fig. 13.10 that class `Deposit` has one attribute `amount`, which line 6 implements as an `int` field. Lines 7–8 create reference attributes `keypad` and `depositSlot` that implement the associations between class `Deposit` and classes `Keypad` and `DepositSlot` modeled in Fig. 13.9. Line 9 declares a constant `CANCELED` that corresponds to the value a user enters to cancel. We'll soon discuss how the class uses this constant.

```

1 // Deposit.java
2 // Represents a deposit ATM transaction
3
4 public class Deposit extends Transaction
5 {
6 private double amount; // amount to deposit
7 private Keypad keypad; // reference to keypad
8 private DepositSlot depositSlot; // reference to deposit slot
9 private final static int CANCELED = 0; // constant for cancel option
10
11 // Deposit constructor
12 public Deposit(int userAccountNumber, Screen atmScreen,
13 BankDatabase atmBankDatabase, Keypad atmKeypad,
14 DepositSlot atmDepositSlot)
15 {
16 // initialize superclass variables
17 super(userAccountNumber, atmScreen, atmBankDatabase);
18
19 // initialize references to keypad and deposit slot
20 keypad = atmKeypad;
21 depositSlot = atmDepositSlot;
22 } // end Deposit constructor
23
24 // perform transaction
25 @Override
26 public void execute()
27 {
28 BankDatabase bankDatabase = getBankDatabase(); // get reference
29 Screen screen = getScreen(); // get reference
30
31 amount = promptForDepositAmount(); // get deposit amount from user
32
33 // check whether user entered a deposit amount or canceled
34 if (amount != CANCELED)
35 {
36 // request deposit envelope containing specified amount
37 screen.displayMessage(
38 "\nPlease insert a deposit envelope containing ");
39 screen.displayDollarAmount(amount);
40 screen.displayMessageLine(".");
41
42 // receive deposit envelope
43 boolean envelopeReceived = depositSlot.isEnvelopeReceived();
44
45 // check whether deposit envelope was received
46 if (envelopeReceived)
47 {
48 screen.displayMessageLine("\nYour envelope has been " +
49 "received.\nNOTE: The money just deposited will not " +
50 "be available until we verify the amount of any " +
51 "enclosed cash and your checks clear.");
52

```

**Fig. 13.23** | Class `Deposit` represents a deposit ATM transaction. (Part 1 of 2.)

```

53 // credit account to reflect the deposit
54 bankDatabase.credit(getAccountNumber(), amount);
55 } // end if
56 else // deposit envelope not received
57 {
58 screen.displayMessageLine("\nYou did not insert an " +
59 "envelope, so the ATM has canceled your transaction.");
60 } // end else
61 } // end if
62 else // user canceled instead of entering amount
63 {
64 screen.displayMessageLine("\nCanceling transaction...");
65 } // end else
66 } // end method execute
67
68 // prompt user to enter a deposit amount in cents
69 private double promptForDepositAmount()
70 {
71 Screen screen = getScreen(); // get reference to screen
72
73 // display the prompt
74 screen.displayMessage("\nPlease enter a deposit amount in " +
75 "CENTS (or 0 to cancel): ");
76 int input = keypad.getInput(); // receive input of deposit amount
77
78 // check whether the user canceled or entered a valid amount
79 if (input == CANCELED)
80 return CANCELED;
81 else
82 {
83 return (double) input / 100; // return dollar amount
84 } // end else
85 } // end method promptForDepositAmount
86 } // end class Deposit

```

**Fig. 13.23** | Class `Deposit` represents a deposit ATM transaction. (Part 2 of 2.)

Like `Withdrawal`, class `Deposit` contains a constructor (lines 12–22) that passes three parameters to superclass `Transaction`'s constructor. The constructor also has parameters `atmKeypad` and `atmDepositSlot`, which it assigns to corresponding attributes (lines 20–21).

Method `execute` (lines 25–66) overrides the abstract version in superclass `Transaction` with a concrete implementation that performs the steps required in a deposit transaction. Lines 28–29 get references to the database and the screen. Line 31 prompts the user to enter a deposit amount by invoking private utility method `promptForDepositAmount` (declared in lines 69–85) and sets attribute `amount` to the value returned. Method `promptForDepositAmount` asks the user to enter a deposit amount as an integer number of cents (because the ATM's keypad does not contain a decimal point; this is consistent with many real ATMs) and returns the `double` value representing the dollar amount to be deposited.

Line 71 in method `promptForDepositAmount` gets a reference to the ATM's screen. Lines 74–75 display a message asking the user to input a deposit amount as a number of cents or "0" to cancel the transaction. Line 76 receives the user's input from the keypad. Lines 79–84 determine whether the user has entered a real deposit amount or chosen to

cancel. If the latter, line 80 returns the constant `CANCELED`. Otherwise, line 83 returns the deposit amount after converting from the number of cents to a dollar amount by casting input to a `double`, then dividing by 100. For example, if the user enters 125 as the number of cents, line 83 returns 125.0 divided by 100, or 1.25—125 cents is \$1.25.

Lines 34–65 in method `execute` determine whether the user has chosen to cancel the transaction instead of entering a deposit amount. If the user cancels, line 64 displays an appropriate message, and the method returns. If the user enters a deposit amount, lines 37–40 instruct the user to insert a deposit envelope with the correct amount. Recall that `Screen` method `displayDollarAmount` outputs a `double` formatted as a dollar amount.

Line 43 sets a local `boolean` variable to the value returned by `depositSlot`'s `isEnvelopeReceived` method, indicating whether a deposit envelope has been received. Recall that we coded method `isEnvelopeReceived` (lines 8–11 of Fig. 13.17) to always return `true`, because we're simulating the functionality of the deposit slot and assume that the user always inserts an envelope. However, we code method `execute` of class `Deposit` to test for the possibility that the user does not insert an envelope—good software engineering demands that programs account for *all* possible return values. Thus, class `Deposit` is prepared for future versions of `isEnvelopeReceived` that could return `false`. Lines 48–54 execute if the deposit slot receives an envelope. Lines 48–51 display an appropriate message to the user. Line 54 then credits the deposit amount to the user's account in the database. Lines 58–59 will execute if the deposit slot does not receive a deposit envelope. In this case, we display a message to the user stating that the ATM has canceled the transaction. The method then returns without modifying the user's account.

### 13.4.12 Class `ATMCaseStudy`

Class `ATMCaseStudy` (Fig. 13.24) is a simple class that allows us to start, or “turn on,” the ATM and test the implementation of our ATM system model. Class `ATMCaseStudy`'s `main` method (lines 7–11) does nothing more than instantiate a new ATM object named `theATM` (line 9) and invoke its `run` method (line 10) to start the ATM.

---

```

1 // ATMCaseStudy.java
2 // Driver program for the ATM case study
3
4 public class ATMCaseStudy
5 {
6 // main method creates and runs the ATM
7 public static void main(String[] args)
8 {
9 ATM theATM = new ATM();
10 theATM.run();
11 } // end main
12 } // end class ATMCaseStudy

```

---

**Fig. 13.24** | `ATMCaseStudy.java` starts the ATM.

## 13.5 Wrap-Up

In this chapter, you used inheritance to tune the design of the ATM software system, and you fully implemented the ATM in Java. Congratulations on completing the entire ATM



case study! We hope you found this experience to be valuable and that it reinforced many of the object-oriented programming concepts that you've learned. In the next chapter, we take a deeper look at graphical user interfaces (GUIs).

## Answers to Self-Review Exercises

**13.1** True. The minus sign (-) indicates private visibility.

**13.2** b.

**13.3** The design for class Keypad yields the code in Fig. 13.25. Recall that class Keypad has no attributes for the moment, but attributes may become apparent as we continue the implementation. Also, if we were designing a real ATM, method `getInput` would need to interact with the ATM's keypad hardware. We'll actually read input from the keyboard of a personal computer when we write the complete Java code in Section 13.4.

```

1 // Class Keypad represents an ATM's keypad
2 public class Keypad
3 {
4 // no attributes have been specified yet
5
6 // no-argument constructor
7 public Keypad()
8 {
9 } // end no-argument Keypad constructor
10
11 // operations
12 public int getInput()
13 {
14 } // end method getInput
15 } // end class Keypad

```

**Fig. 13.25** | Java code for class Keypad based on Figs. 13.1–13.2.

**13.4** b.

**13.5** False. The UML requires that we italicize abstract class names and method names.

**13.6** The design for class Transaction yields the code in Fig. 13.26. The bodies of the class constructor and methods are completed in Section 13.4. When fully implemented, methods `getScreen` and `getBankDatabase` will return superclass Transaction's private reference attributes `screen` and `bankDatabase`, respectively. These methods allow the Transaction subclasses to access the ATM's screen and interact with the bank's database.

```

1 // Abstract class Transaction represents an ATM transaction
2 public abstract class Transaction
3 {
4 // attributes
5 private int accountNumber; // indicates account involved
6 private Screen screen; // ATM's screen
7 private BankDatabase bankDatabase; // account info database

```

**Fig. 13.26** | Java code for class Transaction based on Figs. 13.9 and 13.10. (Part 1 of 2.)

```
8
9 // no-argument constructor invoked by subclasses using super()
10 public Transaction()
11 {
12 } // end no-argument Transaction constructor
13
14 // return account number
15 public int getAccountNumber()
16 {
17 } // end method getAccountNumber
18
19 // return reference to screen
20 public Screen getScreen()
21 {
22 } // end method getScreen
23
24 // return reference to bank database
25 public BankDatabase getBankDatabase()
26 {
27 } // end method getBankDatabase
28
29 // abstract method overridden by subclasses
30 public abstract void execute();
31 } // end class Transaction
```

**Fig. 13.26** | Java code for class Transaction based on Figs. 13.9 and 13.10. (Part 2 of 2.)

# GUI Components: Part I

# 14



*Do you think I can listen all day  
to such stuff?*

—Lewis Carroll

*Even a minor event in the life of  
a child is an event of that child's  
world and thus a world event.*

—Gaston Bachelard

*You pays your money and you  
takes your choice.*

—Punch

## Objectives

In this chapter you'll learn:

- How to use Java's elegant, cross-platform Nimbus look-and-feel.
- To build GUIs and handle events generated by user interactions with GUIs.
- To understand the packages containing GUI components, event-handling classes and interfaces.
- To create and manipulate buttons, labels, lists, text fields and panels.
- To handle mouse events and keyboard events.
- To use layout managers to arrange GUI components.

- 14.1 Introduction
- 14.2 Java's New Nimbus Look-and-Feel
- 14.3 Simple GUI-Based Input/Output with JOptionPane
- 14.4 Overview of Swing Components
- 14.5 Displaying Text and Images in a Window
- 14.6 Text Fields and an Introduction to Event Handling with Nested Classes
- 14.7 Common GUI Event Types and Listener Interfaces
- 14.8 How Event Handling Works
- 14.9 JButton
- 14.10 Buttons That Maintain State
  - 14.10.1 JCheckBox
  - 14.10.2 JRadioButton
- 14.11 JComboBox; Using an Anonymous Inner Class for Event Handling
- 14.12 JList
- 14.13 Multiple-Selection Lists
- 14.14 Mouse Event Handling
- 14.15 Adapter Classes
- 14.16 JPanel Subclass for Drawing with the Mouse
- 14.17 Key Event Handling
- 14.18 Introduction to Layout Managers
  - 14.18.1 FlowLayout
  - 14.18.2 BorderLayout
  - 14.18.3 GridLayout
- 14.19 Using Panels to Manage More Complex Layouts
- 14.20 JTextArea
- 14.21 Wrap-Up

Summary | Self-Review Exercises | Answers to Self-Review Exercises | Exercises | Making a Difference

## 14.1 Introduction

A **graphical user interface (GUI)** presents a user-friendly mechanism for interacting with an application. A GUI (pronounced “GOO-ee”) gives an application a distinctive “look and feel.” GUIs are built from **GUI components**. These are sometimes called controls or widgets—short for window gadgets. A GUI component is an object with which the user interacts via the mouse, the keyboard or another form of input, such as voice recognition. In this chapter and Chapter 25, GUI Components: Part 2, you'll learn about many of Java's so-called **Swing GUI components** from the **javax.swing** package. We cover other GUI components as they're needed throughout the rest of the book.



### Look-and-Feel Observation 14.1

*Providing different applications with consistent, intuitive user-interface components gives users a sense of familiarity with a new application, so that they can learn it more quickly and use it more productively.*

### IDE Support for GUI Design

Many IDEs provide GUI design tools with which you can specify a component's exact size and location in a visual manner by using the mouse. The IDE generates the GUI code for you. Though this greatly simplifies creating GUIs, each IDE generates this code differently. For this reason, we wrote the GUI code by hand.

### Sample GUI: The SwingSet3 Demo Application

As an example of a GUI, consider Fig. 14.1, which shows the SwingSet3 application that's available at [download.java.net/javadesktop/swingset3/SwingSet3.jnlp](http://download.java.net/javadesktop/swingset3/SwingSet3.jnlp). This application is a nice way for you to browse through the various GUI components provided by Java's Swing GUI APIs. Simply click a component name (e.g., JFrame, JTabbedPane, etc.) in the **GUI Components** area at the left of the window to see a demonstration of the GUI component in the right side of the window. The source code for each demo is shown in the text area at the bottom of the window. We've labeled a few of the GUI components in the application. At the top of the window is a **title bar** that contains the window's title. Below that is a **menu bar** containing **menus** (File and View). In the top-right region of the window is a set of **buttons**—typically, users press buttons to perform tasks. In the **GUI Components** area of the window is a **combo box**; the user can click the down arrow at the right side of the box to select from a list of items. The menus, buttons and combo box are part of the application's GUI. They enable you to interact with the application.

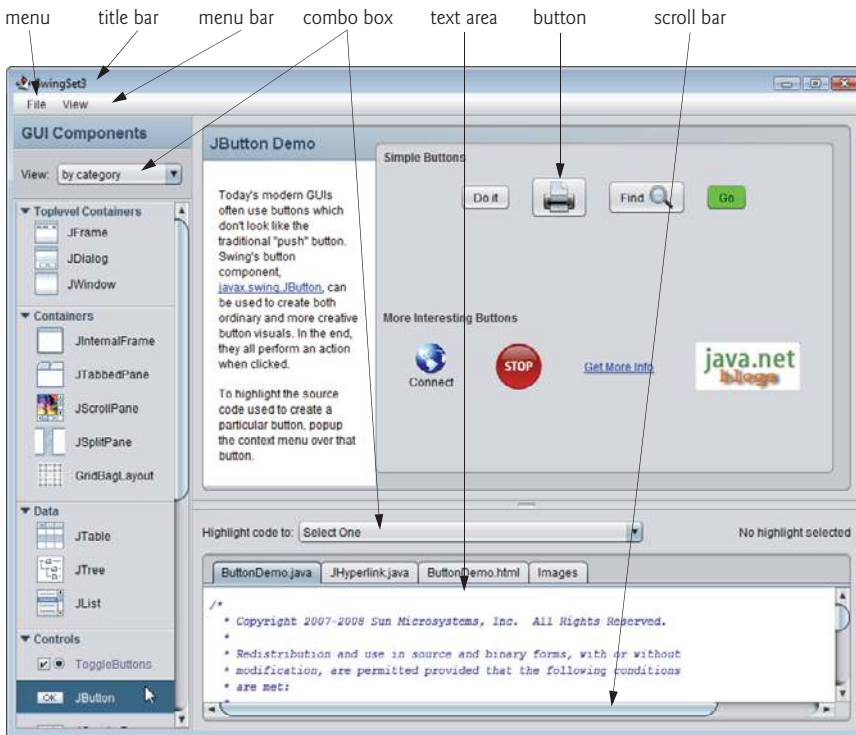

**Fig. 14.1** | SwingSet3 application demonstrates many of Java's Swing GUI components.

## 14.2 Java's New Nimbus Look-and-Feel

In Java SE 6 update 10, Java's elegant, cross-platform look-and-feel known as **Nimbus** was introduced. For GUI screen captures like Fig. 14.1, we've configured our systems to use Nimbus as the default look-and-feel. There are three ways that you can use Nimbus:

1. Set it as the default for all Java applications that run on your computer.
2. Set it as the look-and-feel at the time that you launch an application by passing a command-line argument to the `java` command.
3. Set it as the look-and-feel programmatically in your application (see Section 25.6).

To set Nimbus as the default for all Java applications, you must create a text file named `swing.properties` in the `lib` folder of both your JDK installation folder and your JRE installation folder. Place the following line of code in the file:

```
swing.defaultlaf=com.sun.java.swing.plaf.nimbus.NimbusLookAndFeel
```

For more information on locating these installation folders visit

```
bit.ly/JavaInstallationInstructions
```

In addition to the standalone JRE, there is a JRE nested in your JDK's installation folder. If you're using an IDE that depends on the JDK, you may also need to place the `swing.properties` file in the nested `jre` folder's `lib` folder.

If you prefer to select Nimbus on an application-by-application basis, place the following command-line argument after the `java` command and before the application's name when you run the application:

```
-Dswing.defaultlaf=com.sun.java.swing.plaf.nimbus.NimbusLookAndFeel
```

### 14.3 Simple GUI-Based Input/Output with `JOptionPane`

The applications in Chapters 2–10 display text in the command window and obtain input from the command window. Most applications you use on a daily basis use windows or **dialog boxes** (also called **dialogs**) to interact with the user. For example, an e-mail program allows you to type and read messages in a window the program provides. Dialog boxes are windows in which programs display important messages to the user or obtain information from the user. Java's **`JOptionPane`** class (package `javax.swing`) provides prebuilt dialog boxes for both input and output. These are displayed by invoking static `JOptionPane` methods. Figure 14.2 presents a simple addition application that uses two **input dialogs** to obtain integers from the user and a **message dialog** to display the sum of the integers the user enters.

```

1 // Fig. 14.2: Addition.java
2 // Addition program that uses JOptionPane for input and output.
3 import javax.swing.JOptionPane; // program uses JOptionPane
4
5 public class Addition
6 {
7 public static void main(String[] args)
8 {
9 // obtain user input from JOptionPane input dialogs
10 String firstNumber =
11 JOptionPane.showInputDialog("Enter first integer");
12 String secondNumber =
13 JOptionPane.showInputDialog("Enter second integer");

```

**Fig. 14.2** | Addition program that uses `JOptionPane` for input and output. (Part I of 2.)

```

14
15 // convert String inputs to int values for use in a calculation
16 int number1 = Integer.parseInt(firstNumber);
17 int number2 = Integer.parseInt(secondNumber);
18
19 int sum = number1 + number2; // add numbers
20
21 // display result in a JOptionPane message dialog
22 JOptionPane.showMessageDialog(null, "The sum is " + sum,
23 "Sum of Two Integers", JOptionPane.PLAIN_MESSAGE);
24 } // end method main
25 } // end class Addition

```

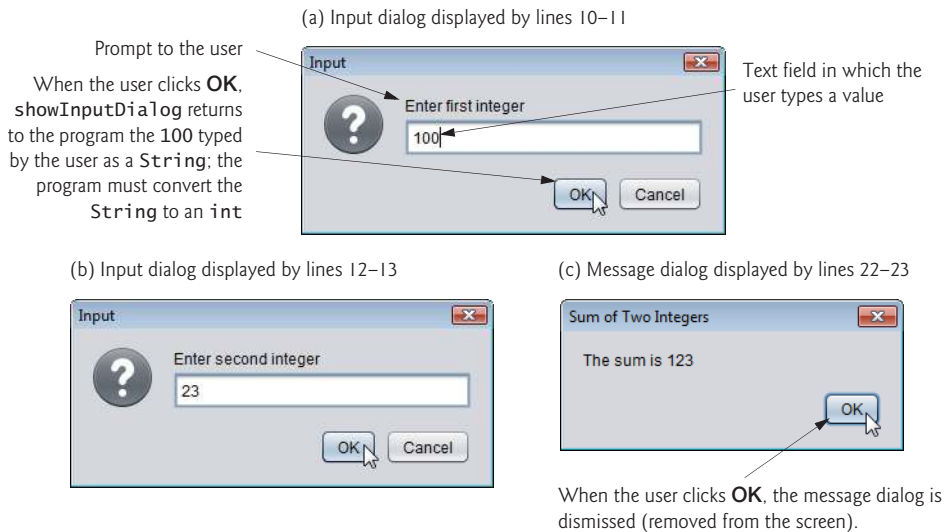

**Fig. 14.2** | Addition program that uses `JOptionPane` for input and output. (Part 2 of 2.)

### Input Dialogs

Line 3 imports class `JOptionPane`. Lines 10–11 declare the local `String` variable `firstNumber` and assign it the result of the call to `JOptionPane` static method **`showInputDialog`**. This method displays an input dialog (see the first screen capture in Fig. 14.2), using the method's `String` argument ("Enter first integer") as a prompt.



#### Look-and-Feel Observation 14.2

The prompt in an input dialog typically uses *sentence-style capitalization*—a style that capitalizes only the first letter of the first word in the text unless the word is a proper noun (for example, *Jones*).

The user types characters in the text field, then clicks **OK** or presses the *Enter* key to submit the `String` to the program. Clicking **OK** also **dismisses (hides) the dialog**. [Note: If you type in the text field and nothing appears, activate the text field by clicking it with the mouse.] Unlike `Scanner`, which can be used to input values of *several* types from the user at the keyboard, an input dialog can input only `Strings`. This is typical of most GUI

components. The user can type any characters in the input dialog's text field. Our program assumes that the user enters a valid integer. If the user clicks **Cancel**, `showInputDialog` returns `null`. If the user either types a noninteger value or clicks the **Cancel** button in the input dialog, an exception will occur and the program will not operate correctly. Chapter 11 discussed how to handle such errors. Lines 12–13 display another input dialog that prompts the user to enter the second integer. Each `JOptionPane` dialog that you display is a so called **modal dialog**—while the dialog is on the screen, the user *cannot* interact with the rest of the application.



### Look-and-Feel Observation 14.3

*Do not overuse modal dialogs, as they can reduce the usability of your applications. Use a modal dialog only when it's necessary to prevent users from interacting with the rest of an application until they dismiss the dialog.*

### Converting Strings to int Values

To perform the calculation, we convert the `Strings` that the user entered to `int` values. Recall that the `Integer` class's static method `parseInt` converts its `String` argument to an `int` value. Lines 16–17 assign the converted values to local variables `number1` and `number2`, and line 19 sums these values.

### Message Dialogs

Lines 22–23 use `JOptionPane` static method `showMessageDialog` to display a message dialog (the last screen of Fig. 14.2) containing the sum. The first argument helps the Java application determine where to position the dialog box. A dialog is typically displayed from a GUI application with its own window. The first argument refers to that window (known as the parent window) and causes the dialog to appear centered over the parent (as we'll do in Section 14.9). If the first argument is `null`, the dialog box is displayed at the center of your screen. The second argument is the message to display—in this case, the result of concatenating the `String` "The sum is " and the value of `sum`. The third argument—"Sum of Two Integers"—is the `String` that should appear in the *title bar* at the top of the dialog. The fourth argument—`JOptionPane.PLAIN_MESSAGE`—is the type of message dialog to display. A `PLAIN_MESSAGE` dialog does not display an icon to the left of the message. Class `JOptionPane` provides several overloaded versions of methods `showInputDialog` and `showMessageDialog`, as well as methods that display other dialog types. For complete information on class `JOptionPane`, visit [download.oracle.com/javase/6/docs/api/javax/swing/JOptionPane.html](http://download.oracle.com/javase/6/docs/api/javax/swing/JOptionPane.html).







### Look-and-Feel Observation 14.4

*The title bar of a window typically uses **book-title capitalization**—a style that capitalizes the first letter of each significant word in the text and does not end with any punctuation (for example, *Capitalization in a Book Title*).*

### JOptionPane Message Dialog Constants

The constants that represent the message dialog types are shown in Fig. 14.3. All message dialog types except `PLAIN_MESSAGE` display an icon to the left of the message. These icons provide a visual indication of the message's importance to the user. A `QUESTION_MESSAGE` icon is the *default icon* for an input dialog box (see Fig. 14.2).



| Message dialog type | Icon                                                                              | Description                                                                                                      |
|---------------------|-----------------------------------------------------------------------------------|------------------------------------------------------------------------------------------------------------------|
| ERROR_MESSAGE       |  | Indicates an error.                                                                                              |
| INFORMATION_MESSAGE |  | Indicates an informational message.                                                                              |
| WARNING_MESSAGE     |  | Warns of a potential problem.                                                                                    |
| QUESTION_MESSAGE    |  | Poses a question. This dialog normally requires a response, such as clicking a <b>Yes</b> or a <b>No</b> button. |
| PLAIN_MESSAGE       | no icon                                                                           | A dialog that contains a message, but no icon.                                                                   |

**Fig. 14.3** | JOptionPane static constants for message dialogs.

## 14.4 Overview of Swing Components

Though it's possible to perform input and output using the JOptionPane dialogs, most GUI applications require more elaborate user interfaces. The remainder of this chapter discusses many GUI components that enable application developers to create robust GUIs. Figure 14.4 lists several basic Swing GUI components that we discuss.

| Component | Description                                                                                                                 |
|-----------|-----------------------------------------------------------------------------------------------------------------------------|
| JLabel    | Displays uneditable text and/or icons.                                                                                      |
| TextField | Typically receives input from the user.                                                                                     |
| Button    | Triggers an event when clicked with the mouse.                                                                              |
| CheckBox  | Specifies an option that can be selected or not selected.                                                                   |
| ComboBox  | A drop-down list of items from which the user can make a selection.                                                         |
| List      | A list of items from which the user can make a selection by clicking on any one of them. Multiple elements can be selected. |
| Panel     | An area in which components can be placed and organized.                                                                    |

**Fig. 14.4** | Some basic GUI components.

### *Swing vs. AWT*

There are actually two sets of Java GUI components. In Java's early days, GUIs were built with components from the **Abstract Window Toolkit (AWT)** in package `java.awt`. These look like the native GUI components of the platform on which a Java program executes. For example, a Button object displayed in a Java program running on Microsoft Windows looks like those in other *Windows* applications. On Apple Mac OS X, the Button looks like those in other *Mac* applications. Sometimes, even the manner in which a user can interact with an AWT component *differs between platforms*. The component's appearance and the way in which the user interacts with it are known as its **look-and-feel**.



### Look-and-Feel Observation 14.5

Swing GUI components allow you to specify a uniform look-and-feel for your application across all platforms or to use each platform's custom look-and-feel. An application can even change the look-and-feel during execution to enable users to choose their own preferred look-and-feel.

### Lightweight vs. Heavyweight GUI Components

Most Swing components are **lightweight components**—they're written, manipulated and displayed completely in Java. AWT components are **heavyweight components**, because they rely on the local platform's **windowing system** to determine their functionality and their look-and-feel. Several Swing components are heavyweight components.

### Superclasses of Swing's Lightweight GUI Components

The UML class diagram of Fig. 14.5 shows an inheritance hierarchy of classes from which lightweight Swing components inherit their common attributes and behaviors.

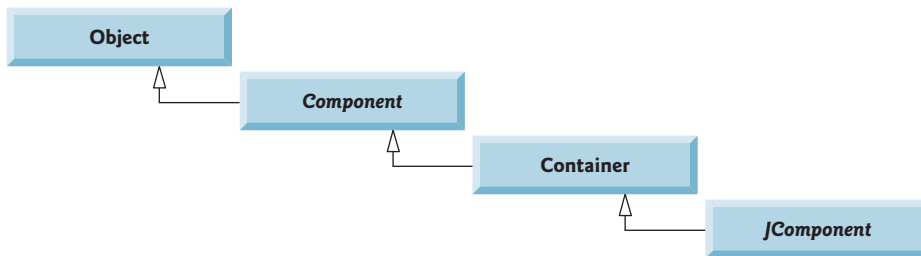

**Fig. 14.5** | Common superclasses of the lightweight Swing components.

Class **Component** (package `java.awt`) is a superclass that declares the common features of GUI components in packages `java.awt` and `javax.swing`. Any object that is a **Container** (package `java.awt`) can be used to organize Components by attaching the Components to the Container. Containers can be placed in other Containers to organize a GUI.

Class **JComponent** (package `javax.swing`) is a subclass of **Container**. **JComponent** is the superclass of all lightweight Swing components and declares their common attributes and behaviors. Because **JComponent** is a subclass of **Container**, all lightweight Swing components are also Containers. Some common features supported by **JComponent** include:

1. A **pluggable look-and-feel** for customizing the appearance of components (e.g., for use on particular platforms). You'll see an example of this in Section 25.6.
2. Shortcut keys (called **mnemonics**) for direct access to GUI components through the keyboard. You'll see an example of this in Section 25.4.
3. Brief descriptions of a GUI component's purpose (called **tool tips**) that are displayed when the mouse cursor is positioned over the component for a short time. You'll see an example of this in the next section.
4. Support for accessibility, such as braille screen readers for the visually impaired.
5. Support for user-interface **localization**—that is, customizing the user interface to display in different languages and use local cultural conventions.

## 14.5 Displaying Text and Images in a Window

Our next example introduces a framework for building GUI applications. Several concepts in this framework will appear in many of our GUI applications. This is our first example in which the application appears in its own window. Most windows you'll create that can contain Swing GUI components are instances of class `JFrame` or a subclass of `JFrame`. `JFrame` is an indirect subclass of class `java.awt.Window` that provides the basic attributes and behaviors of a window—a title bar at the top, and buttons to minimize, maximize and close the window. Since an application's GUI is typically specific to the application, most of our examples will consist of two classes—a subclass of `JFrame` that helps us demonstrate new GUI concepts and an application class in which `main` creates and displays the application's primary window.

### Labeling GUI Components

A typical GUI consists of many components. GUI designers often provide text stating the purpose of each. Such text is known as a **label** and is created with a `JLabel`—a subclass of `JComponent`. A `JLabel` displays read-only text, an image, or both text and an image. Applications rarely change a label's contents after creating it.



#### Look-and-Feel Observation 14.6

*Text in a `JLabel` normally uses sentence-style capitalization.*

The application of Figs. 14.6–14.7 demonstrates several `JLabel` features and presents the framework we use in most of our GUI examples. We did not highlight the code in this example, since most of it is new. [Note: There are many more features for each GUI component than we can cover in our examples. To learn the complete details of each GUI component, visit its page in the online documentation. For class `JLabel`, visit [download.oracle.com/javase/6/docs/api/javaw/swing/JLabel.html](http://download.oracle.com/javase/6/docs/api/javaw/swing/JLabel.html).]

```

1 // Fig. 14.6: LabelFrame.java
2 // Demonstrating the JLabel class.
3 import java.awt.FlowLayout; // specifies how components are arranged
4 import javax.swing.JFrame; // provides basic window features
5 import javax.swing.JLabel; // displays text and images
6 import javax.swing.SwingConstants; // common constants used with Swing
7 import javax.swing.Icon; // interface used to manipulate images
8 import javax.swing.ImageIcon; // loads images
9
10 public class LabelFrame extends JFrame
11 {
12 private JLabel label1; // JLabel with just text
13 private JLabel label2; // JLabel constructed with text and icon
14 private JLabel label3; // JLabel with added text and icon
15
16 // LabelFrame constructor adds JLabels to JFrame
17 public LabelFrame()
18 {

```

**Fig. 14.6** | `JLabel`s with text and icons. (Part 1 of 2.)

```

19 super("Testing JLabel");
20 setLayout(new FlowLayout()); // set frame layout
21
22 // JLabel constructor with a string argument
23 label1 = new JLabel("Label with text");
24 label1.setToolTipText("This is label1");
25 add(label1); // add label1 to JFrame
26
27 // JLabel constructor with string, Icon and alignment arguments
28 Icon bug = new ImageIcon(getClass().getResource("bug1.png"));
29 label2 = new JLabel("Label with text and icon", bug,
30 SwingConstants.LEFT);
31 label2.setToolTipText("This is label2");
32 add(label2); // add label2 to JFrame
33
34 label3 = new JLabel(); // JLabel constructor no arguments
35 label3.setText("Label with icon and text at bottom");
36 label3.setIcon(bug); // add icon to JLabel
37 label3.setHorizontalTextPosition(SwingConstants.CENTER);
38 label3.setVerticalTextPosition(SwingConstants.BOTTOM);
39 label3.setToolTipText("This is label3");
40 add(label3); // add label3 to JFrame
41 } // end LabelFrame constructor
42 } // end class LabelFrame

```

**Fig. 14.6** | JLabels with text and icons. (Part 2 of 2.)

```

1 // Fig. 14.7: LabelTest.java
2 // Testing LabelFrame.
3 import javax.swing.JFrame;
4
5 public class LabelTest
6 {
7 public static void main(String[] args)
8 {
9 LabelFrame labelFrame = new LabelFrame(); // create LabelFrame
10 labelFrame.setDefaultCloseOperation(JFrame.EXIT_ON_CLOSE);
11 labelFrame.setSize(260, 180); // set frame size
12 labelFrame.setVisible(true); // display frame
13 } // end main
14 } // end class LabelTest

```

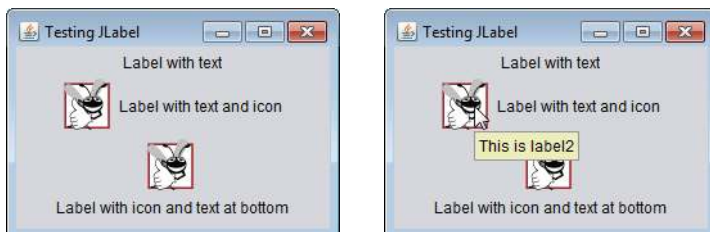

**Fig. 14.7** | Test class for LabelFrame.

Class `LabelFrame` (Fig. 14.6) is a subclass of `JFrame`. We'll use an instance of class `LabelFrame` to display a window containing three `JLabels`. Lines 3–8 import the classes used in class `LabelFrame`. The class extends `JFrame` to inherit the features of a window. Lines 12–14 declare the three `JLabel` instance variables that are instantiated in the `LabelFrame` constructor (lines 17–41). Typically, the `JFrame` subclass's constructor builds the GUI that's displayed in the window when the application executes. Line 19 invokes superclass `JFrame`'s constructor with the argument `"Testing JLabel"`. `JFrame`'s constructor uses this `String` as the text in the window's title bar.

### Specifying the Layout

When building a GUI, you must attach each GUI component to a container, such as a window created with a `JFrame`. Also, you typically must decide *where* to position each GUI component—known as specifying the layout. Java provides several **layout managers** that can help you position components, as you'll learn at the end of this chapter and in Chapter 25.

Many IDEs provide GUI design tools in which you can specify components' exact sizes and locations in a visual manner by using the mouse; then the IDE will generate the GUI code for you. Such IDEs can greatly simplify GUI creation.

To ensure that our GUIs can be used with *any* IDE, we did *not* use an IDE to create the GUI code. We use Java's layout managers to size and position components. With the **FlowLayout** layout manager, components are placed on a container from left to right in the order in which they're added. When no more components can fit on the current line, they continue to display left to right on the next line. If the container is resized, a `FlowLayout` *reflows* the components, possibly with fewer or more rows based on the new container width. Every container has a default layout, which we're changing for `LabelFrame` to a `FlowLayout` (line 20). Method **setLayout** is inherited into class `LabelFrame` indirectly from class `Container`. The argument to the method must be an object of a class that implements the `LayoutManager` interface (e.g., `FlowLayout`). Line 20 creates a new `FlowLayout` object and passes its reference as the argument to `setLayout`.

### Creating and Attaching `Label1`

Now that we've specified the window's layout, we can begin creating and attaching GUI components to the window. Line 23 creates a `JLabel` object and passes `"Label with text"` to the constructor. The `JLabel` displays this text on the screen as part of the application's GUI. Line 24 uses method **setToolTipText** (inherited by `JLabel` from `JComponent`) to specify the tool tip that's displayed when the user positions the mouse cursor over the `JLabel` in the GUI. You can see a sample tool tip in the second screen capture of Fig. 14.7. When you execute this application, try positioning the mouse over each `JLabel` to see its tool tip. Line 25 attaches `label1` to the `LabelFrame` by passing `label1` to the **add** method, which is inherited indirectly from class `Container`.



#### Common Programming Error 14.1

*If you do not explicitly add a GUI component to a container, the GUI component will not be displayed when the container appears on the screen.*



#### Look-and-Feel Observation 14.7

*Use tool tips to add descriptive text to your GUI components. This text helps the user determine the GUI component's purpose in the user interface.*

### *The Icon Interface and Class ImageIcon*

Icons are a popular way to enhance the look-and-feel of an application and are also commonly used to indicate functionality. For example, the same icon is used to play most of today's media on devices like DVD players and MP3 players. Several Swing components can display images. An icon is normally specified with an **Icon** argument to a constructor or to the component's **setIcon** method. An **Icon** is an object of any class that implements interface **Icon** (package `javax.swing`). Class **ImageIcon** supports several image formats, including Graphics Interchange Format (GIF), Portable Network Graphics (PNG) and Joint Photographic Experts Group (JPEG).

Line 28 declares an **ImageIcon**. The file `bug1.png` contains the image to load and store in the **ImageIcon** object. This image is included in the directory for this example. The **ImageIcon** object is assigned to **Icon** reference `bug`.

### *Loading an Image Resource*

In line 28, the expression `getClass().getResource("bug1.png")` invokes method **getResource** (inherited indirectly from class **Object**) to retrieve a reference to the **Class** object that represents the `LabelFrame` class declaration. That reference is then used to invoke **Class** method **getResource**, which returns the location of the image as a URL. The **ImageIcon** constructor uses the URL to locate the image, then loads it into memory. As we discussed in Chapter 1, the JVM loads class declarations into memory, using a class loader. The class loader knows where each class it loads is located on disk. Method **getResource** uses the **Class** object's class loader to determine the location of a resource, such as an image file. In this example, the image file is stored in the same location as the `LabelFrame.class` file. The techniques described here enable an application to load image files from locations that are relative to the class file's location.

### *Creating and Attaching label2*

Lines 29–30 use another **JLabel** constructor to create a **JLabel** that displays the text "Label with text and icon" and the **Icon** `bug` created in line 28. The last constructor argument indicates that the label's contents are left justified, or left aligned (i.e., the icon and text are at the left side of the label's area on the screen). Interface **SwingConstants** (package `javax.swing`) declares a set of common integer constants (such as `SwingConstants.LEFT`) that are used with many Swing components. By default, the text appears to the right of the image when a label contains both text and an image. The horizontal and vertical alignments of a **JLabel** can be set with methods **setHorizontalAlignment** and **setVerticalAlignment**, respectively. Line 31 specifies the tool-tip text for `label2`, and line 32 adds `label2` to the **JFrame**.

### *Creating and Attaching label3*

Class **JLabel** provides methods to change a label's appearance after it's been instantiated. Line 34 creates an empty **JLabel** with the no-argument constructor. Line 35 uses **JLabel** method **setText** to set the text displayed on the label. Method **getText** can be used to retrieve the current text displayed on a label. Line 36 uses **JLabel** method **setIcon** to specify the **Icon** to display on the label. Method **getIcon** can be used to retrieve the current **Icon** displayed on a label. Lines 37–38 use **JLabel** methods **setHorizontalTextPosition** and **setVerticalTextPosition** to specify the text position in the label. In this case, the text will be centered horizontally and will appear at the bottom of the label. Thus, the **Icon**

will appear above the text. The horizontal-position constants in `SwingConstants` are `LEFT`, `CENTER` and `RIGHT` (Fig. 14.8). The vertical-position constants in `SwingConstants` are `TOP`, `CENTER` and `BOTTOM` (Fig. 14.8). Line 39 sets the tool-tip text for `label3`. Line 40 adds `label3` to the `JFrame`.

| Constant                             | Description              | Constant                           | Description              |
|--------------------------------------|--------------------------|------------------------------------|--------------------------|
| <i>Horizontal-position constants</i> |                          | <i>Vertical-position constants</i> |                          |
| <code>LEFT</code>                    | Place text on the left   | <code>TOP</code>                   | Place text at the top    |
| <code>CENTER</code>                  | Place text in the center | <code>CENTER</code>                | Place text in the center |
| <code>RIGHT</code>                   | Place text on the right  | <code>BOTTOM</code>                | Place text at the bottom |

**Fig. 14.8** | Positioning constants (static members of interface `SwingConstants`).

### *Creating and Displaying a `LabelFrame` Window*

Class `LabelTest` (Fig. 14.7) creates an object of class `LabelFrame` (line 9), then specifies the default close operation for the window. By default, closing a window simply hides the window. However, when the user closes the `LabelFrame` window, we would like the application to terminate. Line 10 invokes `LabelFrame`'s `setDefaultCloseOperation` method (inherited from class `JFrame`) with constant `JFrame.EXIT_ON_CLOSE` as the argument to indicate that the program should terminate when the window is closed by the user. This line is important. Without it the application will not terminate when the user closes the window. Next, line 11 invokes `LabelFrame`'s `setSize` method to specify the width and height of the window in pixels. Finally, line 12 invokes `LabelFrame`'s `setVisible` method with the argument `true` to display the window on the screen. Try resizing the window to see how the `FlowLayout` changes the `JLabel` positions as the window width changes.

## 14.6 Text Fields and an Introduction to Event Handling with Nested Classes

Normally, a user interacts with an application's GUI to indicate the tasks that the application should perform. For example, when you write an e-mail in an e-mail application, clicking the **Send** button tells the application to send the e-mail to the specified e-mail addresses. GUIs are **event driven**. When the user interacts with a GUI component, the interaction—known as an **event**—drives the program to perform a task. Some common user interactions that cause an application to perform a task include clicking a button, typing in a text field, selecting an item from a menu, closing a window and moving the mouse. The code that performs a task in response to an event is called an **event handler**, and the overall process of responding to events is known as **event handling**.

Let's consider two other GUI components that can generate events—**`JTextField`**s and **`JPasswordField`**s (package `javax.swing`). Class `JTextField` extends class `JTextComponent` (package `javax.swing.text`), which provides many features common to Swing's text-based components. Class `JPasswordField` extends `JTextField` and adds methods that are specific to processing passwords. Each of these components is a single-line area in which the user can enter text via the keyboard. Applications can also display text in a `JTextField` (see the output of Fig. 14.10). A `JPasswordField` shows that characters are

being typed as the user enters them, but hides the actual characters with an **echo character**, assuming that they represent a password that should remain known only to the user.

When the user types in a `JTextField` or a `JPasswordField`, then presses *Enter*, an event occurs. Our next example demonstrates how a program can perform a task in response to that event. The techniques shown here are applicable to all GUI components that generate events.

The application of Figs. 14.9–14.10 uses classes `JTextField` and `JPasswordField` to create and manipulate four text fields. When the user types in one of the text fields, then presses *Enter*, the application displays a message dialog box containing the text the user typed. You can type only in the text field that’s “in **focus**.” When you click a component, it *receives the focus*. This is important, because the text field with the focus is the one that generates an event when you press *Enter*. In this example, you press *Enter* in the `JPasswordField`, the password is revealed. We begin by discussing the setup of the GUI, then discuss the event-handling code.

Lines 3–9 import the classes and interfaces we use in this example. Class `TextFieldFrame` extends `JFrame` and declares three `JTextField` variables and a `JPasswordField` variable (lines 13–16). Each of the corresponding text fields is instantiated and attached to the `TextFieldFrame` in the constructor (lines 19–47).

---

```

1 // Fig. 14.9: TextFieldFrame.java
2 // Demonstrating the JTextField class.
3 import java.awt.FlowLayout;
4 import java.awt.event.ActionListener;
5 import java.awt.event.ActionEvent;
6 import javax.swing.JFrame;
7 import javax.swing.JTextField;
8 import javax.swing.JPasswordField;
9 import javax.swing.JOptionPane;
10
11 public class TextFieldFrame extends JFrame
12 {
13 private JTextField textField1; // text field with set size
14 private JTextField textField2; // text field constructed with text
15 private JTextField textField3; // text field with text and size
16 private JPasswordField passwordField; // password field with text
17
18 // TextFieldFrame constructor adds JTextFields to JFrame
19 public TextFieldFrame()
20 {
21 super("Testing JTextField and JPasswordField");
22 setLayout(new FlowLayout()); // set frame layout
23
24 // construct textfield with 10 columns
25 textField1 = new JTextField(10);
26 add(textField1); // add textField1 to JFrame
27
28 // construct textfield with default text
29 textField2 = new JTextField("Enter text here");
30 add(textField2); // add textField2 to JFrame

```

---

**Fig. 14.9** | `JTextFields` and `JPasswordFields`. (Part I of 2.)



```
31
32 // construct textfield with default text and 21 columns
33 textField3 = new JTextField("Uneditable text field", 21);
34 textField3.setEditable(false); // disable editing
35 add(textField3); // add textField3 to JFrame
36
37 // construct passwordfield with default text
38 passwordField = new JPasswordField("Hidden text");
39 add(passwordField); // add passwordField to JFrame
40
41 // register event handlers
42 TextFieldHandler handler = new TextFieldHandler();
43 textField1.addActionListener(handler);
44 textField2.addActionListener(handler);
45 textField3.addActionListener(handler);
46 passwordField.addActionListener(handler);
47 } // end TextFieldFrame constructor
48
49 // private inner class for event handling
50 private class TextFieldHandler implements ActionListener
51 {
52 // process text field events
53 public void actionPerformed((ActionEvent event))
54 {
55 String string = ""; // declare string to display
56
57 // user pressed Enter in JTextField textField1
58 if (event.getSource() == textField1)
59 string = String.format("textField1: %s",
60 event.getActionCommand());
61
62 // user pressed Enter in JTextField textField2
63 else if (event.getSource() == textField2)
64 string = String.format("textField2: %s",
65 event.getActionCommand());
66
67 // user pressed Enter in JTextField textField3
68 else if (event.getSource() == textField3)
69 string = String.format("textField3: %s",
70 event.getActionCommand());
71
72 // user pressed Enter in JTextField passwordField
73 else if (event.getSource() == passwordField)
74 string = String.format("passwordField: %s",
75 event.getActionCommand());
76
77 // display JTextField content
78 JOptionPane.showMessageDialog(null, string);
79 } // end method actionPerformed
80 } // end private inner class TextFieldHandler
81 } // end class TextFieldFrame
```

**Fig. 14.9** | JTextFields and JPasswordField. (Part 2 of 2.)

### Creating the GUI

Line 22 sets the `TextField`'s layout to `FlowLayout`. Line 25 creates `textField1` with 10 columns of text. A text column's width in *pixels* is determined by the average width of a character in the text field's current font. When text is displayed in a text field and the text is wider than the field itself, a portion of the text at the right side is not visible. If you're typing in a text field and the cursor reaches the right edge, the text at the left edge is pushed off the left side of the field and is no longer visible. Users can use the left and right arrow keys to move through the complete text. Line 26 adds `textField1` to the `JFrame`.

Line 29 creates `textField2` with the initial text "Enter text here" to display in the text field. The width of the field is determined by the width of the default text specified in the constructor. Line 30 adds `textField2` to the `JFrame`.

Line 33 creates `textField3` and calls the `JTextField` constructor with two arguments—the default text "Uneditable text field" to display and the text field's width in columns (21). Line 34 uses method `setEditable` (inherited by `JTextField` from class `JTextComponent`) to make the text field *uneditable*—i.e., the user cannot modify the text in the field. Line 35 adds `textField3` to the `JFrame`.

Line 38 creates `passwordField` with the text "Hidden text" to display in the text field. The width of the field is determined by the width of the default text. When you execute the application, notice that the text is displayed as a string of asterisks. Line 39 adds `passwordField` to the `JFrame`.

### Steps Required to Set Up Event Handling for a GUI Component

This example should display a message dialog containing the text from a text field when the user presses *Enter* in that text field. Before an application can respond to an event for a particular GUI component, you must:

1. Create a class that represents the event handler and implements an appropriate interface—known as an **event-listener interface**.
2. Indicate that an object of the class from *Step 1* should be notified when the event occurs—known as **registering the event handler**.

### Using a Nested Class to Implement an Event Handler

All the classes discussed so far were so-called **top-level classes**—that is, they were not declared inside another class. Java allows you to declare classes *inside* other classes—these are called **nested classes**. Nested classes can be *static* or *non-static*. *Non-static* nested classes are called **inner classes** and are frequently used to implement *event handlers*.

An inner-class object must be created by an object of the top-level class that contains the inner class. Each inner-class object *implicitly* has a reference to an object of its top-level class. The inner-class object is allowed to use this implicit reference to directly access all the variables and methods of the top-level class. A nested class that's *static* does not require an object of its top-level class and does not implicitly have a reference to an object of the top-level class. As you'll see in Chapter 15, Graphics and Java 2D, the Java 2D graphics API uses *static* nested classes extensively.

### Inner Class `TextFieldHandler`

The event handling in this example is performed by an object of the private inner class `TextFieldHandler` (lines 50–80). This class is *private* because it will be used only to cre-

ate event handlers for the text fields in top-level class `TextFieldFrame`. As with other class members, *inner classes* can be declared `public`, `protected` or `private`. Since event handlers tend to be specific to the application in which they're defined, they're often implemented as `private` inner classes or as *anonymous inner classes* (Section 14.11).

GUI components can generate many events in response to user interactions. Each event is represented by a class and can be processed only by the appropriate type of event handler. Normally, a component's supported events are described in the Java API documentation for that component's class and its superclasses. When the user presses *Enter* in a `JTextField` or `JPasswordField`, an **ActionEvent** (package `java.awt.event`) occurs. Such an event is processed by an object that implements the interface **ActionListener** (package `java.awt.event`). The information discussed here is available in the Java API documentation for classes `JTextField` and `ActionEvent`. Since `JPasswordField` is a subclass of `JTextField`, `JPasswordField` supports the same events.

To prepare to handle the events in this example, inner class `TextFieldHandler` implements interface `ActionListener` and declares the only method in that interface—`actionPerformed` (lines 53–79). This method specifies the tasks to perform when an `ActionEvent` occurs. So, inner class `TextFieldHandler` satisfies *Step 1* listed earlier in this section. We'll discuss the details of method `actionPerformed` shortly.

### *Registering the Event Handler for Each Text Field*

In the `TextFieldFrame` constructor, line 42 creates a `TextFieldHandler` object and assigns it to variable `handler`. This object's `actionPerformed` method will be called automatically when the user presses *Enter* in any of the GUI's text fields. However, before this can occur, the program must register this object as the event handler for each text field. Lines 43–46 are the event-registration statements that specify `handler` as the event handler for the three `JTextFields` and the `JPasswordField`. The application calls `JTextField` method **addActionListener** to register the event handler for each component. This method receives as its argument an `ActionListener` object, which can be an object of any class that implements `ActionListener`. The object `handler` *is an* `ActionListener`, because class `TextFieldHandler` implements `ActionListener`. After lines 43–46 execute, the object `handler` **listens for events**. Now, when the user presses *Enter* in any of these four text fields, method `actionPerformed` (line 53–79) in class `TextFieldHandler` is called to handle the event. If an event handler is not registered for a particular text field, the event that occurs when the user presses *Enter* in that text field is **consumed**—i.e., it's simply ignored by the application.



#### **Software Engineering Observation 14.1**

*The event listener for an event must implement the appropriate event-listener interface.*



#### **Common Programming Error 14.2**

*Forgetting to register an event-handler object for a particular GUI component's event type causes events of that type to be ignored.*

### *Details of Class `TextFieldHandler`'s `actionPerformed` Method*

In this example, we're using one event-handling object's `actionPerformed` method (lines 53–79) to handle the events generated by four text fields. Since we'd like to output the

name of each text field's instance variable for demonstration purposes, we must determine which text field generated the event each time `actionPerformed` is called. The **event source** is the GUI component with which the user interacted. When the user presses *Enter* while one of the text fields or the password field *has the focus*, the system creates a unique `ActionEvent` object that contains information about the event that just occurred, such as the event source and the text in the text field. The system passes this `ActionEvent` object to the event listener's `actionPerformed` method. Line 55 declares the `String` that will be displayed. The variable is initialized with the **empty string**—a `String` containing no characters. The compiler requires the variable to be initialized in case none of the branches of the nested `if` in lines 58–75 executes.

`ActionEvent` method `getSource` (called in lines 58, 63, 68 and 73) returns a reference to the event source. The condition in line 58 asks, “Is the event source `textField1`?” This condition compares references with the `==` operator to determine if they refer to the same object. If they *both* refer to `textField1`, the user pressed *Enter* in `textField1`. Then, lines 59–60 create a `String` containing the message that line 78 displays in a message dialog. Line 60 uses `ActionEvent` method **`getActionCommand`** to obtain the text the user typed in the text field that generated the event.

In this example, we display the text of the password in the `JPasswordField` when the user presses *Enter* in that field. Sometimes it's necessary to programmatically process the characters in a password. Class `JPasswordField` method **`getPassword`** returns the password's characters as an array of type `char`.

### Class `TextFieldTest`

Class `TextFieldTest` (Fig. 14.10) contains the `main` method that executes this application and displays an object of class `TextFieldFrame`. When you execute the application, even the uneditable `JTextField` (`textField3`) can generate an `ActionEvent`. To test this, click the text field to give it the focus, then press *Enter*. Also, the actual text of the password is displayed when you press *Enter* in the `JPasswordField`. Of course, you would normally not display the password!

This application used a single object of class `TextFieldHandler` as the event listener for four text fields. Starting in Section 14.10, you'll see that it's possible to declare several event-listener objects of the same type and register each object for a separate GUI component's event. This technique enables us to eliminate the `if...else` logic used in this example's event handler by providing separate event handlers for each component's events.

---

```

1 // Fig. 14.10: TextFieldTest.java
2 // Testing TextFieldFrame.
3 import javax.swing.JFrame;
4
5 public class TextFieldTest
6 {
7 public static void main(String[] args)
8 {
9 TextFieldFrame textFieldFrame = new TextFieldFrame();
10 textFieldFrame.setDefaultCloseOperation(JFrame.EXIT_ON_CLOSE);
11 textFieldFrame.setSize(350, 100); // set frame size

```

---

**Fig. 14.10** | Test class for `TextFieldFrame`. (Part I of 2.)

```

12 textFieldFrame.setVisible(true); // display frame
13 } // end main
14 } // end class TextFieldTest

```

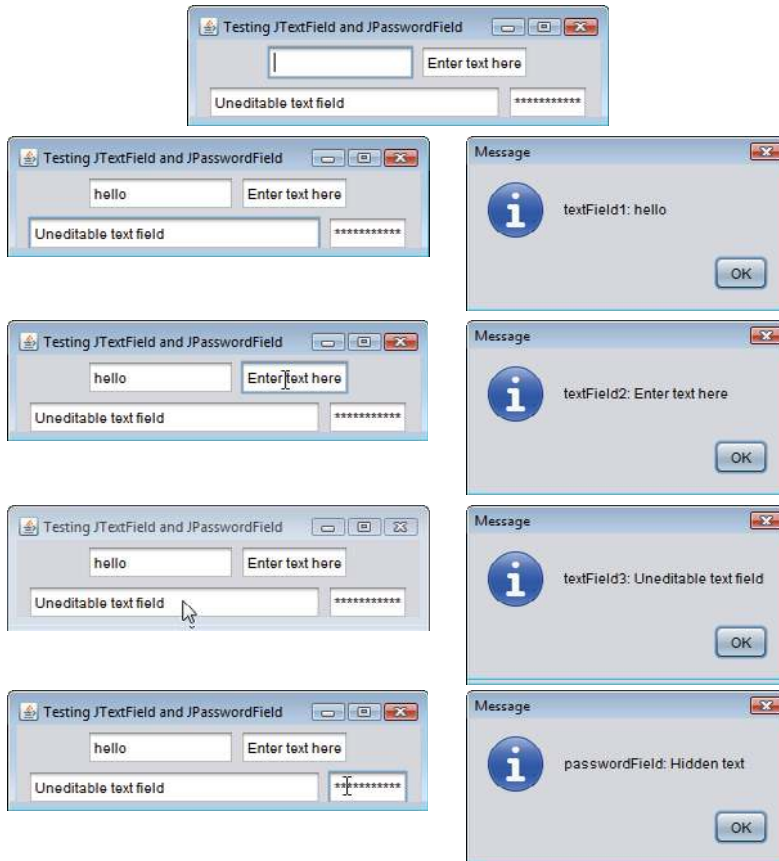
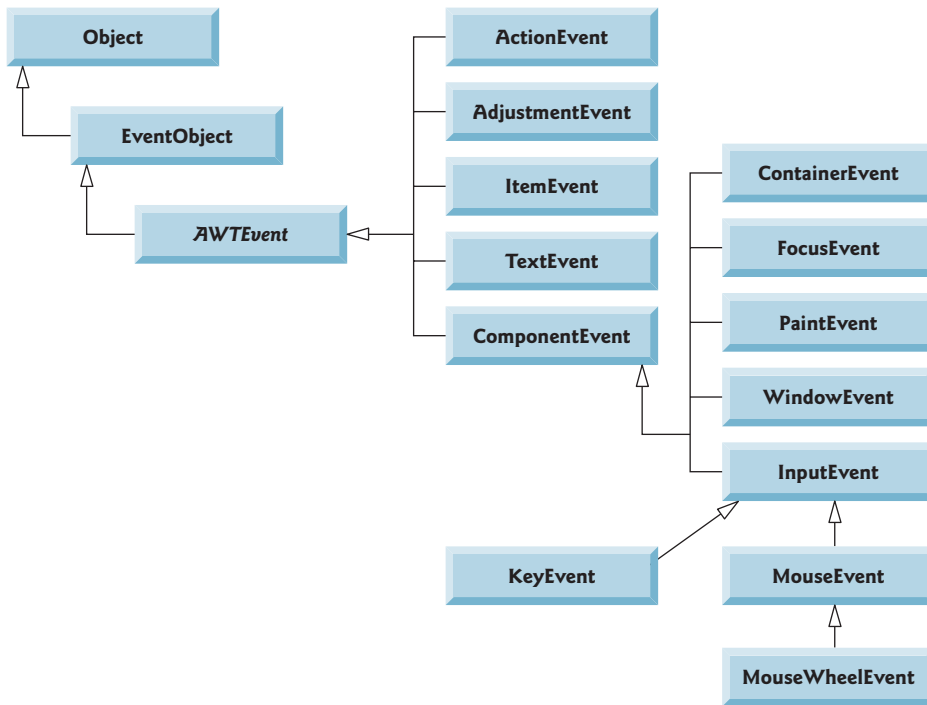

**Fig. 14.10** | Test class for TextFieldFrame. (Part 2 of 2.)

## 14.7 Common GUI Event Types and Listener Interfaces

In Section 14.6, you learned that information about the event that occurs when the user presses *Enter* in a text field is stored in an `ActionEvent` object. Many different types of events can occur when the user interacts with a GUI. The event information is stored in an object of a class that extends `AWTEvent` (from package `java.awt`). Figure 14.11 illustrates a hierarchy containing many event classes from the package `java.awt.event`. Some of these are discussed in this chapter and Chapter 25. These event types are used with both AWT and Swing components. Additional event types that are specific to Swing GUI components are declared in package `javax.swing.event`.

Let's summarize the three parts to the event-handling mechanism that you saw in Section 14.6—the *event source*, the *event object* and the *event listener*. The event source is

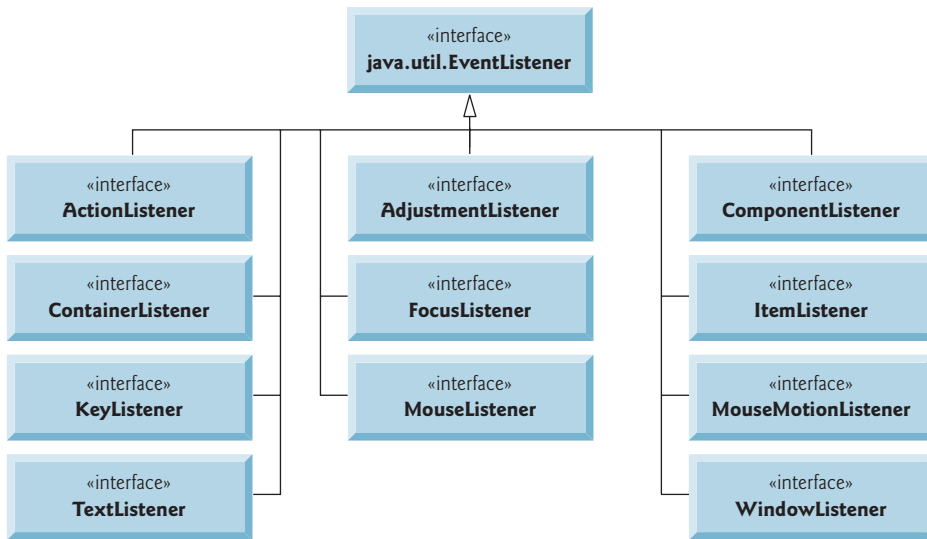

**Fig. 14.11** | Some event classes of package `java.awt.event`.

the GUI component with which the user interacts. The event object encapsulates information about the event that occurred, such as a reference to the event source and any event-specific information that may be required by the event listener for it to handle the event. The event listener is an object that's notified by the event source when an event occurs; in effect, it “listens” for an event, and one of its methods executes in response to the event. A method of the event listener receives an event object when the event listener is notified of the event. The event listener then uses the event object to respond to the event. This event-handling model is known as the **delegation event model**—an event's processing is delegated to an object (the event listener) in the application.

For each event-object type, there's typically a corresponding event-listener interface. An event listener for a GUI event is an object of a class that implements one or more of the event-listener interfaces from packages `java.awt.event` and `javax.swing.event`. Many of the event-listener types are common to both Swing and AWT components. Such types are declared in package `java.awt.event`, and some of them are shown in Fig. 14.12. Additional event-listener types that are specific to Swing components are declared in package `javax.swing.event`.

Each event-listener interface specifies one or more event-handling methods that *must* be declared in the class that implements the interface. Recall from Section 10.7 that any class which implements an interface must declare *all* the abstract methods of that interface; otherwise, the class is an abstract class and cannot be used to create objects.



**Fig. 14.12** | Some common event-listener interfaces of package `java.awt.event`.

When an event occurs, the GUI component with which the user interacted notifies its *registered listeners* by calling each listener’s appropriate *event-handling method*. For example, when the user presses the *Enter* key in a `JTextField`, the registered listener’s `actionPerformed` method is called. How did the event handler get registered? How does the GUI component know to call `actionPerformed` rather than another event-handling method? We answer these questions and diagram the interaction in the next section.

## 14.8 How Event Handling Works

Let’s illustrate how the event-handling mechanism works, using `textField1` from the example of Fig. 14.9. We have two remaining open questions from Section 14.7:

1. How did the *event handler* get *registered*?
2. How does the GUI component know to call `actionPerformed` rather than some other event-handling method?

The first question is answered by the event registration performed in lines 43–46 of Fig. 14.9. Figure 14.13 diagrams `JTextField` variable `textField1`, `TextFieldHandler` variable `handler` and the objects to which they refer.

### Registering Events

Every `JComponent` has an instance variable called `listenerList` that refers to an object of class `EventListenerList` (package `javax.swing.event`). Each object of a `JComponent` subclass maintains references to its registered listeners in the `listenerList`. For simplicity, we’ve diagrammed `listenerList` as an array below the `JTextField` object in Fig. 14.13.

When line 43 of Fig. 14.9

```
textField1.addActionListener(handler);
```

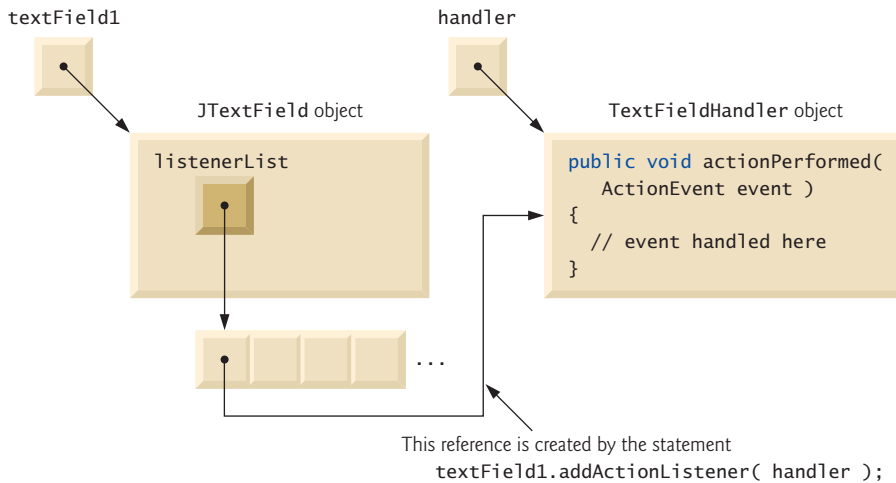

**Fig. 14.13** | Event registration for `JTextField` `textField1`.

executes, a new entry containing a reference to the `TextFieldHandler` object is placed in `textField1`'s `listenerList`. Although not shown in the diagram, this new entry also includes the listener's type (in this case, `ActionListener`). Using this mechanism, each lightweight Swing GUI component maintains its own list of *listeners* that were *registered* to *handle* the component's *events*.

### Event-Handler Invocation

The event-listener type is important in answering the second question: How does the GUI component know to call `actionPerformed` rather than another method? Every GUI component supports several *event types*, including **mouse events**, **key events** and others. When an event occurs, the event is **dispatched** only to the *event listeners* of the appropriate type. Dispatching is simply the process by which the GUI component calls an event-handling method on each of its listeners that are registered for the event type that occurred.

Each *event type* has one or more corresponding *event-listener interfaces*. For example, `ActionEvents` are handled by `ActionListeners`, **MouseEvents** by **MouseListeners** and **MouseMotionListeners**, and **KeyEvents** by **KeyListener**s. When an event occurs, the GUI component receives (from the JVM) a unique *event ID* specifying the event type. The GUI component uses the event ID to decide the listener type to which the event should be dispatched and to decide which method to call on each listener object. For an `ActionEvent`, the event is dispatched to *every* registered `ActionListener`'s `actionPerformed` method (the only method in interface `ActionListener`). For a `MouseEvent`, the event is dispatched to *every* registered `MouseListener` or `MouseMotionListener`, depending on the mouse event that occurs. The `MouseEvent`'s event ID determines which of the several mouse event-handling methods are called. All these decisions are handled for you by the GUI components. All you need to do is register an event handler for the particular event type that your application requires, and the GUI component will ensure that the event handler's appropriate method gets called when the event occurs. We discuss



other event types and event-listener interfaces as they're needed with each new component we introduce.

## 14.9 JButton

A **button** is a component the user clicks to trigger a specific action. A Java application can use several types of buttons, including **command buttons**, **checkboxes**, **toggle buttons** and **radio buttons**. Figure 14.14 shows the inheritance hierarchy of the Swing buttons we cover in this chapter. As you can see, all the button types are subclasses of **AbstractButton** (package `javax.swing`), which declares the common features of Swing buttons. In this section, we concentrate on buttons that are typically used to initiate a command.

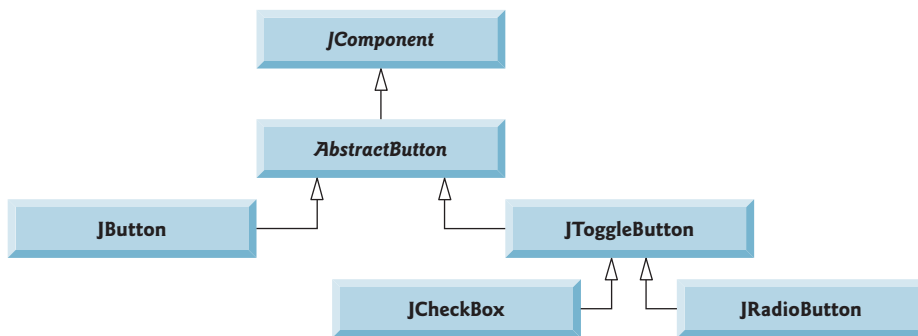

**Fig. 14.14** | Swing button hierarchy.

A command button (see Fig. 14.16's output) generates an `ActionEvent` when the user clicks it. Command buttons are created with class **JButton**. The text on the face of a `JButton` is called a **button label**. A GUI can have many `JButtons`, but each button label should be unique in the portion of the GUI that's currently displayed.



### Look-and-Feel Observation 14.8

*The text on buttons typically uses book-title capitalization.*



### Look-and-Feel Observation 14.9

*Having more than one `JButton` with the same label makes the `JButtons` ambiguous to the user. Provide a unique label for each button.*

The application of Figs. 14.15 and 14.16 creates two `JButtons` and demonstrates that `JButtons` support the display of `Icons`. Event handling for the buttons is performed by a single instance of *inner class* `ButtonHandler` (lines 39–47).

Lines 14–15 declare `JButton` variables `plainJButton` and `fancyJButton`. The corresponding objects are instantiated in the constructor. Line 23 creates `plainJButton` with the button label "Plain Button". Line 24 adds the `JButton` to the `JFrame`.

A `JButton` can display an `Icon`. To provide the user with an extra level of visual interaction with the GUI, a `JButton` can also have a **rollover `Icon`**—an `Icon` that's displayed

```

1 // Fig. 14.15: ButtonFrame.java
2 // Creating JButtons.
3 import java.awt.FlowLayout;
4 import java.awt.event.ActionListener;
5 import java.awt.event.ActionEvent;
6 import javax.swing.JFrame;
7 import javax.swing.JButton;
8 import javax.swing.Icon;
9 import javax.swing.ImageIcon;
10 import javax.swing.JOptionPane;
11
12 public class ButtonFrame extends JFrame
13 {
14 private JButton plainJButton; // button with just text
15 private JButton fancyJButton; // button with icons
16
17 // ButtonFrame adds JButtons to JFrame
18 public ButtonFrame()
19 {
20 super("Testing Buttons");
21 setLayout(new FlowLayout()); // set frame layout
22
23 plainJButton = new JButton("Plain Button"); // button with text
24 add(plainJButton); // add plainJButton to JFrame
25
26 Icon bug1 = new ImageIcon(getClass().getResource("bug1.gif"));
27 Icon bug2 = new ImageIcon(getClass().getResource("bug2.gif"));
28 fancyJButton = new JButton("Fancy Button", bug1); // set image
29 fancyJButton.setRolloverIcon(bug2); // set rollover image
30 add(fancyJButton); // add fancyJButton to JFrame
31
32 // create new ButtonHandler for button event handling
33 ButtonHandler handler = new ButtonHandler();
34 fancyJButton.addActionListener(handler);
35 plainJButton.addActionListener(handler);
36 } // end ButtonFrame constructor
37
38 // inner class for button event handling
39 private class ButtonHandler implements ActionListener
40 {
41 // handle button event
42 public void actionPerformed(ActionEvent event)
43 {
44 JOptionPane.showMessageDialog(ButtonFrame.this, String.format(
45 "You pressed: %s", event.getActionCommand()));
46 } // end method actionPerformed
47 } // end private inner class ButtonHandler
48 } // end class ButtonFrame

```

**Fig. 14.15** | Command buttons and action events.

when the user positions the mouse over the JButton. The icon on the JButton changes as the mouse moves in and out of the JButton's area on the screen. Lines 26–27 (Fig. 14.15) create two ImageIcon objects that represent the default Icon and rollover Icon for the

```

1 // Fig. 14.16: ButtonTest.java
2 // Testing ButtonFrame.
3 import javax.swing.JFrame;
4
5 public class ButtonTest
6 {
7 public static void main(String[] args)
8 {
9 ButtonFrame buttonFrame = new ButtonFrame(); // create ButtonFrame
10 buttonFrame.setDefaultCloseOperation(JFrame.EXIT_ON_CLOSE);
11 buttonFrame.setSize(275, 110); // set frame size
12 buttonFrame.setVisible(true); // display frame
13 } // end main
14 } // end class ButtonTest

```

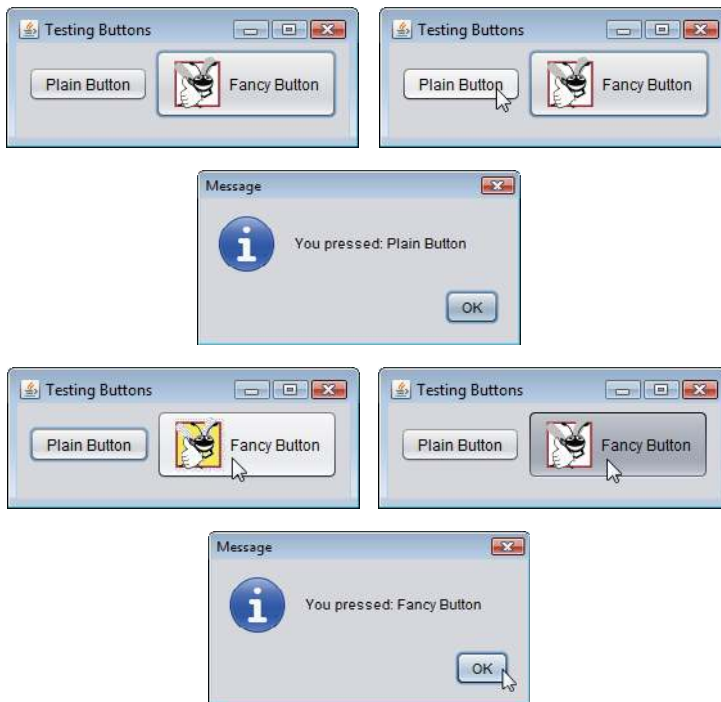

**Fig. 14.16** | Test class for ButtonFrame.

JButton created at line 28. Both statements assume that the image files are stored in the same directory as the application. Images are commonly placed in the same directory as the application or a subdirectory like `images`). These image files have been provided for you with the example.

Line 28 creates `fancyButton` with the text "Fancy Button" and the icon `bug1`. By default, the text is displayed to the right of the icon. Line 29 uses `setRollOverIcon` (inherited from class `AbstractButton`) to specify the image displayed on the JButton when the user positions the mouse over it. Line 30 adds the JButton to the JFrame.



### Look-and-Feel Observation 14.10

Because class `AbstractButton` supports displaying text and images on a button, all subclasses of `AbstractButton` also support displaying text and images.



### Look-and-Feel Observation 14.11

Using rollover icons for `JButtons` provides users with visual feedback indicating that when they click the mouse while the cursor is positioned over the `JButton`, an action will occur.

`JButtons`, like `JTextFields`, generate `ActionEvents` that can be processed by any `ActionListener` object. Lines 33–35 create an object of private inner class `ButtonHandler` and use `addActionListener` to register it as the event handler for each `JButton`. Class `ButtonHandler` (lines 39–47) declares `actionPerformed` to display a message dialog box containing the label for the button the user pressed. For a `JButton` event, `ActionEvent` method `getActionCommand` returns the label on the `JButton`.

### Accessing the `this` Reference in an Object of a Top-Level Class From an Inner Class

When you execute this application and click one of its buttons, notice that the message dialog that appears is centered over the application's window. This occurs because the call to `JOptionPane` method `showMessageDialog` (lines 44–45 of Fig. 14.15) uses `ButtonFrame.this` rather than `null` as the first argument. When this argument is not `null`, it represents the so-called *parent GUI component* of the message dialog (in this case the application window is the parent component) and enables the dialog to be centered over that component when the dialog is displayed. `ButtonFrame.this` represents the `this` reference of the object of top-level class `ButtonFrame`.



### Software Engineering Observation 14.2

When used in an inner class, keyword `this` refers to the current inner-class object being manipulated. An inner-class method can use its outer-class object's `this` by preceding `this` with the outer-class name and a dot, as in `ButtonFrame.this`.

## 14.10 Buttons That Maintain State

The Swing GUI components contain three types of **state buttons**—`JToggleButton`, `JCheckBox` and `JRadioButton`—that have on/off or true/false values. Classes `JCheckBox` and `JRadioButton` are subclasses of `JToggleButton` (Fig. 14.14). A `JRadioButton` is different from a `JCheckBox` in that normally several `JRadioButtons` are grouped together and are mutually exclusive—only one in the group can be selected at any time, just like the buttons on a car radio. We first discuss class `JCheckBox`.

### 14.10.1 `JCheckBox`

The application of Figs. 14.17–14.18 uses two `JCheckBoxes` to select the desired font style of the text displayed in a `JTextField`. When selected, one applies a bold style and the other an italic style. If *both* are selected, the style is bold and italic. When the application initially executes, neither `JCheckBox` is checked (i.e., they're both `false`), so the font is plain. Class `CheckBoxTest` (Fig. 14.18) contains the main method that executes this application.

```

1 // Fig. 14.17: CheckBoxFrame.java
2 // Creating JCheckBox buttons.
3 import java.awt.FlowLayout;
4 import java.awt.Font;
5 import java.awt.event.ItemListener;
6 import java.awt.event.ItemEvent;
7 import javax.swing.JFrame;
8 import javax.swing.JTextField;
9 import javax.swing.JCheckBox;
10
11 public class CheckBoxFrame extends JFrame
12 {
13 private JTextField textField; // displays text in changing fonts
14 private JCheckBox boldJCheckBox; // to select/deselect bold
15 private JCheckBox italicJCheckBox; // to select/deselect italic
16
17 // CheckBoxFrame constructor adds JCheckBoxes to JFrame
18 public CheckBoxFrame()
19 {
20 super("JCheckBox Test");
21 setLayout(new FlowLayout()); // set frame layout
22
23 // set up JTextField and set its font
24 textField = new JTextField("Watch the font style change", 20);
25 textField.setFont(new Font("Serif", Font.PLAIN, 14));
26 add(textField); // add textField to JFrame
27
28 boldJCheckBox = new JCheckBox("Bold"); // create bold checkbox
29 italicJCheckBox = new JCheckBox("Italic"); // create italic
30 add(boldJCheckBox); // add bold checkbox to JFrame
31 add(italicJCheckBox); // add italic checkbox to JFrame
32
33 // register listeners for JCheckBoxes
34 CheckBoxHandler handler = new CheckBoxHandler();
35 boldJCheckBox.addItemListener(handler);
36 italicJCheckBox.addItemListener(handler);
37 } // end CheckBoxFrame constructor
38
39 // private inner class for ItemListener event handling
40 private class CheckBoxHandler implements ItemListener
41 {
42 // respond to checkbox events
43 public void itemStateChanged(ItemEvent event)
44 {
45 Font font = null; // stores the new Font
46
47 // determine which CheckBoxes are checked and create Font
48 if (boldJCheckBox.isSelected() && italicJCheckBox.isSelected())
49 font = new Font("Serif", Font.BOLD + Font.ITALIC, 14);
50 else if (boldJCheckBox.isSelected())
51 font = new Font("Serif", Font.BOLD, 14);
52 else if (italicJCheckBox.isSelected())
53 font = new Font("Serif", Font.ITALIC, 14);

```

**Fig. 14.17** | JCheckBox buttons and item events. (Part 1 of 2.)

```

54 else
55 font = new Font("Serif", Font.PLAIN, 14);
56
57 textField.setFont(font); // set textField's font
58 } // end method itemStateChanged
59 } // end private inner class CheckBoxHandler
60 } // end class CheckBoxFrame

```

**Fig. 14.17** | JCheckBox buttons and item events. (Part 2 of 2.)

```

1 // Fig. 14.18: CheckBoxTest.java
2 // Testing CheckBoxFrame.
3 import javax.swing.JFrame;
4
5 public class CheckBoxTest
6 {
7 public static void main(String[] args)
8 {
9 CheckBoxFrame checkBoxFrame = new CheckBoxFrame();
10 checkBoxFrame.setDefaultCloseOperation(JFrame.EXIT_ON_CLOSE);
11 checkBoxFrame.setSize(275, 100); // set frame size
12 checkBoxFrame.setVisible(true); // display frame
13 } // end main
14 } // end class CheckBoxTest

```

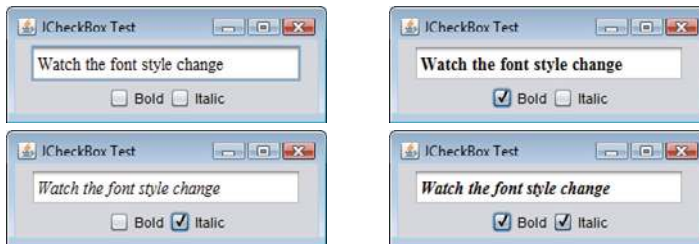

**Fig. 14.18** | Test class for CheckBoxFrame.

After the `JTextField` is created and initialized (Fig. 14.17, line 24), line 25 uses method `setFont` (inherited by `JTextField` indirectly from class `Component`) to set the font of the `JTextField` to a new object of class `Font` (package `java.awt`). The new `Font` is initialized with "Serif" (a generic font name that represents a font such as Times and is supported on all Java platforms), `Font.PLAIN` style and 14-point size. Next, lines 28–29 create two `JCheckBox` objects. The `String` passed to the `JCheckBox` constructor is the **checkbox label** that appears to the right of the `JCheckBox` by default.

When the user clicks a `JCheckBox`, an **ItemEvent** occurs. This event can be handled by an **ItemListener** object, which *must* implement method `itemStateChanged`. In this example, the event handling is performed by an instance of private *inner class* `CheckBoxHandler` (lines 40–59). Lines 34–36 create an instance of class `CheckBoxHandler` and register it with method `addItemListener` as the listener for both the `JCheckBox` objects.

`CheckBoxHandler` method `itemStateChanged` (lines 43–58) is called when the user clicks the `boldJCheckBox` or the `italicJCheckBox`. In this example, we don't need to

know which of the two `JCheckBox`s was clicked, just whether or not each one is checked. Line 48 uses `JCheckBox` method `isSelected` to determine if both `JCheckBox`s are selected. If so, line 49 creates a bold italic font by adding the `Font` constants `Font.BOLD` and `Font.ITALIC` for the font-style argument of the `Font` constructor. Line 50 determines whether the `boldJCheckBox` is selected, and if so line 51 creates a bold font. Line 52 determines whether the `italicJCheckBox` is selected, and if so line 53 creates an italic font. If none of the preceding conditions are true, line 55 creates a plain font using the `Font` constant `Font.PLAIN`. Finally, line 57 sets `textField`'s new font, which changes the font in the `JTextField` on the screen.

### *Relationship Between an Inner Class and Its Top-Level Class*

Class `CheckBoxHandler` used variables `boldJCheckBox` (Fig. 14.17, lines 48 and 50), `italicJCheckBox` (lines 48 and 52) and `textField` (line 57) even though they are *not* declared in the inner class. Recall that an inner class has a special relationship with its top-level class—it's allowed to access *all* the variables and methods of the top-level class. `CheckBoxHandler` method `itemStateChanged` (line 43–58) uses this relationship to determine which `JCheckBox`s are checked and to set the font on the `JTextField`. Notice that none of the code in inner class `CheckBoxHandler` requires an explicit reference to the top-level class object.

## 14.10.2 JRadioButton

**Radio buttons** (declared with class `JRadioButton`) are similar to checkboxes in that they have two states—selected and not selected (also called deselected). However, radio buttons normally appear as a **group** in which only one button can be selected at a time (see the output of Fig. 14.20). Selecting a different radio button forces all others to be deselected. Radio buttons are used to represent **mutually exclusive options** (i.e., multiple options in the group *cannot* be selected at the same time). The logical relationship between radio buttons is maintained by a **ButtonGroup** object (package `javax.swing`), which itself is not a GUI component. A `ButtonGroup` object organizes a group of buttons and is not itself displayed in a user interface. Rather, the individual `JRadioButton` objects from the group are displayed in the GUI.



### Common Programming Error 14.3

*Adding a `ButtonGroup` object (or an object of any other class that does not derive from `Component`) to a container results in a compilation error.*

The application of Figs. 14.19–14.20 is similar to that of Figs. 14.17–14.18. The user can alter the font style of a `JTextField`'s text. The application uses radio buttons that permit only a single font style in the group to be selected at a time. Class `RadioButtonTest` (Fig. 14.20) contains the `main` method that executes this application.

---

```

1 // Fig. 14.19: RadioButtonFrame.java
2 // Creating radio buttons using ButtonGroup and JRadioButton.
3 import java.awt.FlowLayout;
4 import java.awt.Font;

```

---

```

5 import java.awt.event.ItemListener;
6 import java.awt.event.ItemEvent;
7 import javax.swing.JFrame;
8 import javax.swing.JTextField;
9 import javax.swing.JRadioButton;
10 import javax.swing.ButtonGroup;
11
12 public class RadioButtonFrame extends JFrame
13 {
14 private JTextField textField; // used to display font changes
15 private Font plainFont; // font for plain text
16 private Font boldFont; // font for bold text
17 private Font italicFont; // font for italic text
18 private Font boldItalicFont; // font for bold and italic text
19 private JRadioButton plainJRadioButton; // selects plain text
20 private JRadioButton boldJRadioButton; // selects bold text
21 private JRadioButton italicJRadioButton; // selects italic text
22 private JRadioButton boldItalicJRadioButton; // bold and italic
23 private ButtonGroup radioGroup; // buttongroup to hold radio buttons
24
25 // RadioButtonFrame constructor adds JRadioButtons to JFrame
26 public RadioButtonFrame()
27 {
28 super("RadioButton Test");
29 setLayout(new FlowLayout()); // set frame layout
30
31 textField = new JTextField("Watch the font style change", 25);
32 add(textField); // add textField to JFrame
33
34 // create radio buttons
35 plainJRadioButton = new JRadioButton("Plain", true);
36 boldJRadioButton = new JRadioButton("Bold", false);
37 italicJRadioButton = new JRadioButton("Italic", false);
38 boldItalicJRadioButton = new JRadioButton("Bold/Italic", false);
39 add(plainJRadioButton); // add plain button to JFrame
40 add(boldJRadioButton); // add bold button to JFrame
41 add(italicJRadioButton); // add italic button to JFrame
42 add(boldItalicJRadioButton); // add bold and italic button
43
44 // create logical relationship between JRadioButtons
45 radioGroup = new ButtonGroup(); // create ButtonGroup
46 radioGroup.add(plainJRadioButton); // add plain to group
47 radioGroup.add(boldJRadioButton); // add bold to group
48 radioGroup.add(italicJRadioButton); // add italic to group
49 radioGroup.add(boldItalicJRadioButton); // add bold and italic
50
51 // create font objects
52 plainFont = new Font("Serif", Font.PLAIN, 14);
53 boldFont = new Font("Serif", Font.BOLD, 14);
54 italicFont = new Font("Serif", Font.ITALIC, 14);
55 boldItalicFont = new Font("Serif", Font.BOLD + Font.ITALIC, 14);
56 textField.setFont(plainFont); // set initial font to plain
57

```

**Fig. 14.19** | JRadioButtons and ButtonGroups. (Part 2 of 3.)



```

58 // register events for JRadioButtons
59 plainJRadioButton.addItemListener(
60 new RadioButtonHandler(plainFont));
61 boldJRadioButton.addItemListener(
62 new RadioButtonHandler(boldFont));
63 italicJRadioButton.addItemListener(
64 new RadioButtonHandler(italicFont));
65 boldItalicJRadioButton.addItemListener(
66 new RadioButtonHandler(boldItalicFont));
67 } // end RadioButtonFrame constructor
68
69 // private inner class to handle radio button events
70 private class RadioButtonHandler implements ItemListener
71 {
72 private Font font; // font associated with this listener
73
74 public RadioButtonHandler(Font f)
75 {
76 font = f; // set the font of this listener
77 } // end constructor RadioButtonHandler
78
79 // handle radio button events
80 public void itemStateChanged(ItemEvent event)
81 {
82 textField.setFont(font); // set font of textField
83 } // end method itemStateChanged
84 } // end private inner class RadioButtonHandler
85 } // end class RadioButtonFrame

```

**Fig. 14.19** | JRadioButtons and ButtonGroups. (Part 3 of 3.)

```

1 // Fig. 14.20: RadioButtonTest.java
2 // Testing RadioButtonFrame.
3 import javax.swing.JFrame;
4
5 public class RadioButtonTest
6 {
7 public static void main(String[] args)
8 {
9 RadioButtonFrame radioButtonFrame = new RadioButtonFrame();
10 radioButtonFrame.setDefaultCloseOperation(JFrame.EXIT_ON_CLOSE);
11 radioButtonFrame.setSize(300, 100); // set frame size
12 radioButtonFrame.setVisible(true); // display frame
13 } // end main
14 } // end class RadioButtonTest

```

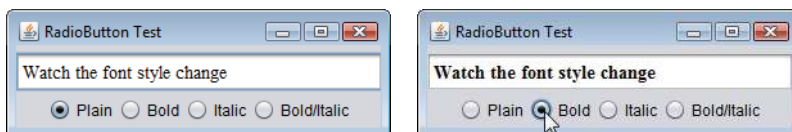

**Fig. 14.20** | Test class for RadioButtonFrame. (Part 1 of 2.)

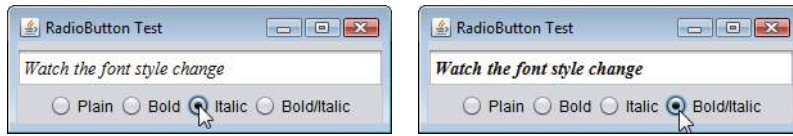

**Fig. 14.20** | Test class for `RadioButtonFrame`. (Part 2 of 2.)

Lines 35–42 in the constructor (Fig. 14.19) create four `JRadioButton` objects and add them to the `JFrame`. Each `JRadioButton` is created with a constructor call like that in line 35. This constructor specifies the label that appears to the right of the `JRadioButton` by default and the initial state of the `JRadioButton`. A true second argument indicates that the `JRadioButton` should appear selected when it’s displayed.

Line 45 instantiates `ButtonGroup` object `radioGroup`. This object is the “glue” that forms the logical relationship between the four `JRadioButton` objects and allows only one of the four to be selected at a time. It’s possible that no `JRadioButtons` in a `ButtonGroup` are selected, but this can occur *only* if no preselected `JRadioButtons` are added to the `ButtonGroup` and the user has not selected a `JRadioButton` yet. Lines 46–49 use `ButtonGroup` method `add` to associate each of the `JRadioButtons` with `radioGroup`. If more than one selected `JRadioButton` object is added to the group, the selected one that was added first will be selected when the GUI is displayed.

`JRadioButtons`, like `JCheckBoxes`, generate `ItemEvents` when they’re clicked. Lines 59–66 create four instances of inner class `RadioButtonHandler` (declared at lines 70–84). In this example, each event-listener object is registered to handle the `ItemEvent` generated when the user clicks a particular `JRadioButton`. Notice that each `RadioButtonHandler` object is initialized with a particular `Font` object (created in lines 52–55).

Class `RadioButtonHandler` (line 70–84) implements interface `ItemListener` so it can handle `ItemEvents` generated by the `JRadioButtons`. The constructor stores the `Font` object it receives as an argument in the event-listener object’s instance variable `font` (declared at line 72). When the user clicks a `JRadioButton`, `radioGroup` turns off the previously selected `JRadioButton`, and method `itemStateChanged` (line 80–83) sets the font in the `JTextField` to the `Font` stored in the `JRadioButton`’s corresponding event-listener object. Notice that line 82 of inner class `RadioButtonHandler` uses the top-level class’s `textField` instance variable to set the font.

## 14.11 JComboBox; Using an Anonymous Inner Class for Event Handling

A combo box (sometimes called a **drop-down list**) enables the user to select one item from a list (Fig. 14.22). Combo boxes are implemented with class `JComboBox`, which extends class `JComponent`. `JComboBoxes` generate `ItemEvents` just as `JCheckBoxes` and `JRadioButtons` do. This example also demonstrates a special form of inner class that’s used frequently in event handling. The application (Figs. 14.21–14.22) uses a `JComboBox` to provide a list of four image-file names from which the user can select one image to display. When the user selects a name, the application displays the corresponding image as an `Icon` on a `JLabel`. Class `ComboBoxTest` (Fig. 14.22) contains the main method that executes this appli-

caution. The screen captures for this application show the JComboBox list after the selection was made to illustrate which image-file name was selected.

Lines 19–23 (Fig. 14.21) declare and initialize array icons with four new ImageIcon objects. String array names (lines 17–18) contains the names of the four image files that are stored in the same directory as the application.

---

```

1 // Fig. 14.21: ComboBoxFrame.java
2 // JComboBox that displays a list of image names.
3 import java.awt.FlowLayout;
4 import java.awt.event.ItemListener;
5 import java.awt.event.ItemEvent;
6 import javax.swing.JFrame;
7 import javax.swing.JLabel;
8 import javax.swing.JComboBox;
9 import javax.swing.Icon;
10 import javax.swing.ImageIcon;
11
12 public class ComboBoxFrame extends JFrame
13 {
14 private JComboBox imagesJComboBox; // combobox to hold names of icons
15 private JLabel label; // label to display selected icon
16
17 private static final String[] names =
18 { "bug1.gif", "bug2.gif", "travelbug.gif", "buganim.gif" };
19 private Icon[] icons = {
20 new ImageIcon(getClass().getResource(names[0])),
21 new ImageIcon(getClass().getResource(names[1])),
22 new ImageIcon(getClass().getResource(names[2])),
23 new ImageIcon(getClass().getResource(names[3])) };
24
25 // ComboBoxFrame constructor adds JComboBox to JFrame
26 public ComboBoxFrame()
27 {
28 super("Testing JComboBox");
29 setLayout(new FlowLayout()); // set frame layout
30
31 imagesJComboBox = new JComboBox(names); // set up JComboBox
32 imagesJComboBox.setMaximumRowCount(3); // display three rows
33
34 imagesJComboBox.addItemListener(
35 new ItemListener() // anonymous inner class
36 {
37 // handle JComboBox event
38 public void itemStateChanged(ItemEvent event)
39 {
40 // determine whether item selected
41 if (event.getStateChange() == ItemEvent.SELECTED)
42 label.setIcon(icons[
43 imagesJComboBox.getSelectedIndex()]);
44 } // end method itemStateChanged
45 } // end anonymous inner class
46); // end call to addItemListener

```

---

**Fig. 14.21** | JComboBox that displays a list of image names. (Part 1 of 2.)

```

47
48 add(imagesJComboBox); // add combobox to JFrame
49 label = new JLabel(icons[0]); // display first icon
50 add(label); // add label to JFrame
51 } // end ComboBoxFrame constructor
52 } // end class ComboBoxFrame

```

**Fig. 14.21** | JComboBox that displays a list of image names. (Part 2 of 2.)

```

1 // Fig. 14.22: ComboBoxTest.java
2 // Testing ComboBoxFrame.
3 import javax.swing.JFrame;
4
5 public class ComboBoxTest
6 {
7 public static void main(String[] args)
8 {
9 ComboBoxFrame comboBoxFrame = new ComboBoxFrame();
10 comboBoxFrame.setDefaultCloseOperation(JFrame.EXIT_ON_CLOSE);
11 comboBoxFrame.setSize(350, 150); // set frame size
12 comboBoxFrame.setVisible(true); // display frame
13 } // end main
14 } // end class ComboBoxTest

```

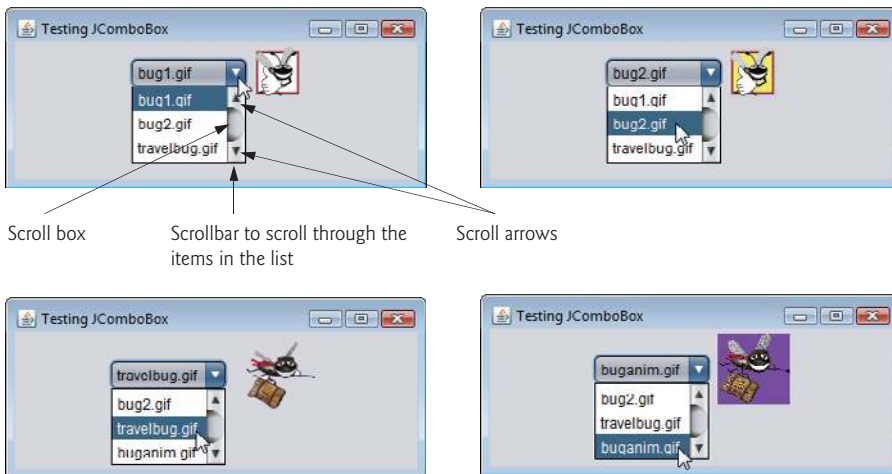

**Fig. 14.22** | Testing ComboBoxFrame.

At line 31, the constructor initializes a JComboBox object with the Strings in array names as the elements in the list. Each item in the list has an **index**. The first item is added at index 0, the next at index 1 and so forth. The first item added to a JComboBox appears as the currently selected item when the JComboBox is displayed. Other items are selected by clicking the JComboBox, then selecting an item from the list that appears.

Line 32 uses JComboBox method `setMaximumRowCount` to set the maximum number of elements that are displayed when the user clicks the JComboBox. If there are additional items, the JComboBox provides a **scrollbar** (see the first screen) that allows the user to scroll through all the elements in the list. The user can click the **scroll arrows** at the top and bottom of the scrollbar to move up and down through the list one element at a time, or else drag the **scroll box** in the middle of the scrollbar up and down. To drag the scroll box, position the mouse cursor on it, hold the mouse button down and move the mouse. In this example, the drop-down list is too short to drag the scroll box, so you can click the up and down arrows or use your mouse's wheel to scroll through the four items in the list.



### Look-and-Feel Observation 14.12

*Set the maximum row count for a JComboBox to a number of rows that prevents the list from expanding outside the bounds of the window in which it's used.*

Line 48 attaches the JComboBox to the ComboBoxFrame's FlowLayout (set in line 29). Line 49 creates the JLabel that displays ImageIcon and initializes it with the first ImageIcon in array icons. Line 50 attaches the JLabel to the ComboBoxFrame's FlowLayout.

### Using an Anonymous Inner Class for Event Handling

Lines 34–46 are one statement that declares the event listener's class, creates an object of that class and registers it as the listener for imagesJComboBox's ItemEvents. This event-listener object is an instance of an **anonymous inner class**—an inner class that's declared without a name and typically appears inside a method declaration. *As with other inner classes, an anonymous inner class can access its top-level class's members.* However, an anonymous inner class has limited access to the local variables of the method in which it's declared. Since an anonymous inner class has no name, one object of the class must be created at the point where the class is declared (starting at line 35).



### Software Engineering Observation 14.3

*An anonymous inner class declared in a method can access the instance variables and methods of the top-level class object that declared it, as well as the method's final local variables, but cannot access the method's non-final local variables.*

Lines 34–46 are a call to imagesJComboBox's addItemListener method. The argument to this method must be an object that *is* an ItemListener (i.e., any object of a class that implements ItemListener). Lines 35–45 are a class-instance creation expression that declares an anonymous inner class and creates one object of that class. A reference to that object is then passed as the argument to addItemListener. The syntax ItemListener() after new begins the declaration of an anonymous inner class that implements interface ItemListener. This is similar to beginning a class declaration with

```
public class MyHandler implements ItemListener
```

The opening left brace at 36 and the closing right brace at line 45 delimit the body of the anonymous inner class. Lines 38–44 declare the ItemListener's itemStateChanged method. When the user makes a selection from imagesJComboBox, this method sets label's Icon. The Icon is selected from array icons by determining the index of the selected item in the JComboBox with method `getSelectedIndex` in line 43. For each item selected from a JComboBox, another item is first deselected—so two ItemEvents occur

when an item is selected. We wish to display only the icon for the item the user just selected. For this reason, line 41 determines whether `ItemEvent` method `getStateChange` returns `ItemEvent.SELECTED`. If so, lines 42–43 set `label`'s icon.



#### Software Engineering Observation 14.4

*Like any other class, when an anonymous inner class implements an interface, the class must implement every method in the interface.*

The syntax shown in lines 35–45 for creating an event handler with an anonymous inner class is similar to the code that would be generated by a Java integrated development environment (IDE). Typically, an IDE enables you to design a GUI visually, then it generates code that implements the GUI. You simply insert statements in the event-handling methods that declare how to handle each event.

## 14.12 JList

A list displays a series of items from which the user may *select one or more items* (see the output of Fig. 14.24). Lists are created with class `JList`, which directly extends class `JComponent`. Class `JList` supports **single-selection lists** (which allow only one item to be selected at a time) and **multiple-selection lists** (which allow any number of items to be selected). In this section, we discuss single-selection lists.

The application of Figs. 14.23–14.24 creates a `JList` containing 13 color names. When a color name is clicked in the `JList`, a `ListSelectionEvent` occurs and the application changes the background color of the application window to the selected color. Class `ListTest` (Fig. 14.24) contains the `main` method that executes this application.

---

```

1 // Fig. 14.23: ListFrame.java
2 // JList that displays a list of colors.
3 import java.awt.FlowLayout;
4 import java.awt.Color;
5 import javax.swing.JFrame;
6 import javax.swing.JList;
7 import javax.swing.JScrollPane;
8 import javax.swing.event.ListSelectionListener;
9 import javax.swing.event.ListSelectionEvent;
10 import javax.swing.ListSelectionModel;
11
12 public class ListFrame extends JFrame
13 {
14 private JList colorJList; // list to display colors
15 private static final String[] colorNames = { "Black", "Blue", "Cyan",
16 "Dark Gray", "Gray", "Green", "Light Gray", "Magenta",
17 "Orange", "Pink", "Red", "White", "Yellow" };
18 private static final Color[] colors = { Color.BLACK, Color.BLUE,
19 Color.CYAN, Color.DARK_GRAY, Color.GRAY, Color.GREEN,
20 Color.LIGHT_GRAY, Color.MAGENTA, Color.ORANGE, Color.PINK,
21 Color.RED, Color.WHITE, Color.YELLOW };
22

```

---

**Fig. 14.23** | `JList` that displays a list of colors. (Part I of 2.)

```

23 // ListFrame constructor add JScrollPane containing JList to JFrame
24 public ListFrame()
25 {
26 super("List Test");
27 setLayout(new FlowLayout()); // set frame layout
28
29 colorJList = new JList(colorNames); // create with colorNames
30 colorJList.setVisibleRowCount(5); // display five rows at once
31
32 // do not allow multiple selections
33 colorJList.setSelectionMode(ListSelectionMode.SINGLE_SELECTION);
34
35 // add a JScrollPane containing JList to frame
36 add(new JScrollPane(colorJList));
37
38 colorJList.addListSelectionListener(
39 new ListSelectionListener() // anonymous inner class
40 {
41 // handle list selection events
42 public void valueChanged(ListSelectionEvent event)
43 {
44 getContentPane().setBackground(
45 colors[colorJList.getSelectedIndex()]);
46 } // end method valueChanged
47 } // end anonymous inner class
48); // end call to addListSelectionListener
49 } // end ListFrame constructor
50 } // end class ListFrame

```

**Fig. 14.23** | JList that displays a list of colors. (Part 2 of 2.)

```

1 // Fig. 14.24: ListTest.java
2 // Selecting colors from a JList.
3 import javax.swing.JFrame;
4
5 public class ListTest
6 {
7 public static void main(String[] args)
8 {
9 ListFrame listFrame = new ListFrame(); // create ListFrame
10 listFrame.setDefaultCloseOperation(JFrame.EXIT_ON_CLOSE);
11 listFrame.setSize(350, 150); // set frame size
12 listFrame.setVisible(true); // display frame
13 } // end main
14 } // end class ListTest

```

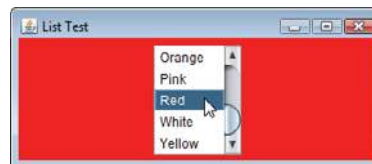

**Fig. 14.24** | Test class for ListFrame.

Line 29 (Fig. 14.23) creates `JList` object `colorJList`. The argument to the `JList` constructor is the array of `Objects` (in this case `Strings`) to display in the list. Line 30 uses `JList` method `setVisibleRowCount` to determine the number of items visible in the list.

Line 33 uses `JList` method `setSelectionMode` to specify the list's **selection mode**. Class `ListSelectionMode1` (of package `javax.swing`) declares three constants that specify a `JList`'s selection mode—`SINGLE_SELECTION` (which allows only one item to be selected at a time), `SINGLE_INTERVAL_SELECTION` (for a multiple-selection list that allows selection of several contiguous items) and `MULTIPLE_INTERVAL_SELECTION` (for a multiple-selection list that does not restrict the items that can be selected).

Unlike a `JComboBox`, a `JList` *does not provide a scrollbar* if there are more items in the list than the number of visible rows. In this case, a `JScrollPane` object is used to provide the scrolling capability. Line 36 adds a new instance of class `JScrollPane` to the `JFrame`. The `JScrollPane` constructor receives as its argument the `JComponent` that needs scrolling functionality (in this case, `colorJList`). Notice in the screen captures that a scrollbar created by the `JScrollPane` appears at the right side of the `JList`. By default, the scrollbar appears only when the number of items in the `JList` exceeds the number of visible items.

Lines 38–48 use `JList` method `addListSelectionListener` to register an object that implements `ListSelectionListener` (package `javax.swing.event`) as the listener for the `JList`'s selection events. Once again, we use an instance of an anonymous inner class (lines 39–47) as the listener. In this example, when the user makes a selection from `colorJList`, method `valueChanged` (line 42–46) should change the background color of the `ListFrame` to the selected color. This is accomplished in lines 44–45. Note the use of `JFrame` method `getContentPane` in line 44. Each `JFrame` actually consists of *three layers*—the *background*, the *content pane* and the *glass pane*. The content pane appears in front of the background and is where the GUI components in the `JFrame` are displayed. The glass pane is used to display tool tips and other items that should appear in front of the GUI components on the screen. The content pane completely hides the background of the `JFrame`; thus, to change the background color behind the GUI components, you must change the content pane's background color. Method `getContentPane` returns a reference to the `JFrame`'s content pane (an object of class `Container`). In line 44, we then use that reference to call method `setBackground`, which sets the content pane's background color to an element in the `colors` array. The color is selected from the array by using the selected item's index. `JList` method `getSelectedIndex` returns the selected item's index. As with arrays and `JComboBoxes`, `JList` indexing is zero based.

## 14.13 Multiple-Selection Lists

A **multiple-selection list** enables the user to select many items from a `JList` (see the output of Fig. 14.26). A `SINGLE_INTERVAL_SELECTION` list allows selecting a contiguous range of items. To do so, click the first item, then press and hold the *Shift* key while clicking the last item in the range. A `MULTIPLE_INTERVAL_SELECTION` list (the default) allows continuous range selection as described for a `SINGLE_INTERVAL_SELECTION` list. Such a list also allows miscellaneous items to be selected by pressing and holding the *Ctrl* key while clicking each item to select. To deselect an item, press and hold the *Ctrl* key while clicking the item a second time.

The application of Figs. 14.25–14.26 uses multiple-selection lists to copy items from one `JList` to another. One list is a `MULTIPLE_INTERVAL_SELECTION` list and the other is a



SINGLE\_INTERVAL\_SELECTION list. When you execute the application, try using the selection techniques described previously to select items in both lists.

```

1 // Fig. 14.25: MultipleSelectionFrame.java
2 // Copying items from one List to another.
3 import java.awt.FlowLayout;
4 import java.awt.event.ActionListener;
5 import java.awt.event.ActionEvent;
6 import javax.swing.JFrame;
7 import javax.swing.JList;
8 import javax.swing.JButton;
9 import javax.swing.JScrollPane;
10 import javax.swing.ListSelectionModel;
11
12 public class MultipleSelectionFrame extends JFrame
13 {
14 private JList colorJList; // list to hold color names
15 private JList copyJList; // list to copy color names into
16 private JButton copyJButton; // button to copy selected names
17 private static final String[] colorNames = { "Black", "Blue", "Cyan",
18 "Dark Gray", "Gray", "Green", "Light Gray", "Magenta", "Orange",
19 "Pink", "Red", "White", "Yellow" };
20
21 // MultipleSelectionFrame constructor
22 public MultipleSelectionFrame()
23 {
24 super("Multiple Selection Lists");
25 setLayout(new FlowLayout()); // set frame layout
26
27 colorJList = new JList(colorNames); // holds names of all colors
28 colorJList.setVisibleRowCount(5); // show five rows
29 colorJList.setSelectionMode(
30 ListSelectionModel.MULTIPLE_INTERVAL_SELECTION);
31 add(new JScrollPane(colorJList)); // add list with scrollpane
32
33 copyJButton = new JButton("Copy >>>"); // create copy button
34 copyJButton.addActionListener(
35 new ActionListener() // anonymous inner class
36 {
37 // handle button event
38 public void actionPerformed(ActionEvent event)
39 {
40 // place selected values in copyJList
41 copyJList.setListData(colorJList.getSelectedValues());
42 } // end method actionPerformed
43 } // end anonymous inner class
44); // end call to addActionListener
45
46 add(copyJButton); // add copy button to JFrame
47
48 copyJList = new JList(); // create list to hold copied color names
49

```

**Fig. 14.25** | JList that allows multiple selections. (Part 1 of 2.)

```

50 copyJList.setVisibleRowCount(5); // show 5 rows
51 copyJList.setFixedCellWidth(100); // set width
52 copyJList.setFixedCellHeight(15); // set height
53 copyJList.setSelectionMode(
54 ListSelectionMode.SINGLE_INTERVAL_SELECTION);
55 add(new JScrollPane(copyJList)); // add list with scrollpane
56 } // end MultipleSelectionFrame constructor
57 } // end class MultipleSelectionFrame

```

**Fig. 14.25** | JList that allows multiple selections. (Part 2 of 2.)

```

1 // Fig. 14.26: MultipleSelectionTest.java
2 // Testing MultipleSelectionFrame.
3 import javax.swing.JFrame;
4
5 public class MultipleSelectionTest
6 {
7 public static void main(String[] args)
8 {
9 MultipleSelectionFrame multipleSelectionFrame =
10 new MultipleSelectionFrame();
11 multipleSelectionFrame.setDefaultCloseOperation(
12 JFrame.EXIT_ON_CLOSE);
13 multipleSelectionFrame.setSize(350, 150); // set frame size
14 multipleSelectionFrame.setVisible(true); // display frame
15 } // end main
16 } // end class MultipleSelectionTest

```

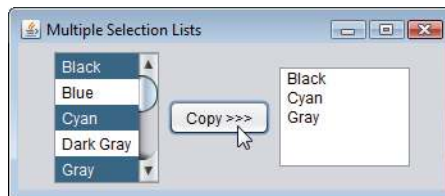

**Fig. 14.26** | Test class for MultipleSelectionFrame.

Line 27 of Fig. 14.25 creates JList `colorJList` and initializes it with the Strings in the array `colorNames`. Line 28 sets the number of visible rows in `colorJList` to 5. Lines 29–30 specify that `colorJList` is a `MULTIPLE_INTERVAL_SELECTION` list. Line 31 adds a new `JScrollPane` containing `colorJList` to the `JFrame`. Lines 49–55 perform similar tasks for `copyJList`, which is declared as a `SINGLE_INTERVAL_SELECTION` list. If a JList does not contain items, it will not display in a `FlowLayout`. For this reason, lines 51–52 use JList methods `setFixedCellWidth` and `setFixedCellHeight` to set `copyJList`'s width to 100 pixels and the height of each item in the JList to 15 pixels, respectively.

Normally, an event generated by another GUI component (known as an **external event**) specifies when the multiple selections in a JList should be processed. In this example, the user clicks the JButton called `copyJButton` to trigger the event that copies the selected items in `colorJList` to `copyJList`.

Lines 34–45 declare, create and register an `ActionListener` for the `copyJButton`. When the user clicks `copyJButton`, method `actionPerformed` (lines 39–43) uses `JList` method `setListData` to set the items displayed in `copyJList`. Line 42 calls `colorJList`'s method `getSelectedValues`, which returns an array of `Objects` representing the selected items in `colorJList`. In this example, the returned array is passed as the argument to `copyJList`'s `setListData` method.

You might be wondering why `copyJList` can be used in line 42 even though the application does not create the object to which it refers until line 49. Remember that method `actionPerformed` (lines 39–43) does not execute until the user presses the `copyJButton`, which cannot occur until after the constructor completes execution and the application displays the GUI. At that point in the application's execution, `copyJList` is already initialized with a new `JList` object.

## 14.14 Mouse Event Handling

This section presents the `MouseListener` and `MouseMotionListener` event-listener interfaces for handling **mouse events**. Mouse events can be processed for any GUI component that derives from `java.awt.Component`. The methods of interfaces `MouseListener` and `MouseMotionListener` are summarized in Figure 14.27. Package `javax.swing.event` contains interface `MouseEvent`, which extends interfaces `MouseListener` and `MouseMotionListener` to create a single interface containing all the `MouseListener` and `MouseMotionListener` methods. The `MouseListener` and `MouseMotionListener` methods are called when the mouse interacts with a `Component` if appropriate event-listener objects are registered for that `Component`.

Each of the mouse event-handling methods receives as an argument a `MouseEvent` object that contains information about the mouse event that occurred, including the *x*- and *y*-coordinates of its location. These coordinates are measured from the upper-left corner of the GUI component on which the event occurred. The *x*-coordinates start at 0 and increase from left to right. The *y*-coordinates start at 0 and increase from top to bottom. The methods and constants of class `MouseEvent` (`MouseEvent`'s superclass) enable you to determine which mouse button the user clicked.

### MouseListener and MouseMotionListener interface methods

#### *Methods of interface MouseListener*

```
public void mousePressed(MouseEvent event)
```

Called when a mouse button is *pressed* while the mouse cursor is on a component.

```
public void mouseClicked(MouseEvent event)
```

Called when a mouse button is *pressed and released* while the mouse cursor remains stationary on a component. This event is always preceded by a call to `mousePressed`.

```
public void mouseReleased(MouseEvent event)
```

Called when a mouse button is *released after being pressed*. This event is always preceded by a call to `mousePressed` and one or more calls to `mouseDragged`.

**Fig. 14.27** | `MouseListener` and `MouseMotionListener` interface methods. (Part 1 of 2.)

## MouseListener and MouseMotionListener interface methods

```
public void mouseEntered(MouseEvent event)
```

Called when the mouse cursor *enters* the bounds of a component.

```
public void mouseExited(MouseEvent event)
```

Called when the mouse cursor *leaves* the bounds of a component.

*Methods of interface MouseMotionListener*

```
public void mouseDragged(MouseEvent event)
```

Called when the mouse button is *pressed* while the mouse cursor is on a component and the mouse is *moved* while the mouse button *remains pressed*. This event is always preceded by a call to `mousePressed`. All drag events are sent to the component on which the user began to drag the mouse.

```
public void mouseMoved(MouseEvent event)
```

Called when the mouse is *moved* (with no mouse buttons pressed) when the mouse cursor is on a component. All move events are sent to the component over which the mouse is currently positioned.

**Fig. 14.27** | MouseListener and MouseMotionListener interface methods. (Part 2 of 2.)



### Software Engineering Observation 14.5

*Calls to `mouseDragged` are sent to the `MouseMotionListener` for the Component on which the drag started. Similarly, the `mouseReleased` call at the end of a drag operation is sent to the `MouseListener` for the Component on which the drag operation started.*

Java also provides interface **MouseWheelListener** to enable applications to respond to the *rotation of a mouse wheel*. This interface declares method **mouseWheelMoved**, which receives a **MouseWheelEvent** as its argument. Class `MouseWheelEvent` (a subclass of `MouseEvent`) contains methods that enable the event handler to obtain information about the amount of wheel rotation.

### Tracking Mouse Events on a JPanel

The `MouseTracker` application (Figs. 14.28–14.29) demonstrates the `MouseListener` and `MouseMotionListener` interface methods. The event-handler class (lines 36–90) implements both interfaces. You *must* declare all seven methods from these two interfaces when your class implements them both. Each mouse event in this example displays a `String` in the `JLabel` called `statusBar` that is attached to the bottom of the window.

```
1 // Fig. 14.28: MouseTrackerFrame.java
2 // Demonstrating mouse events.
3 import java.awt.Color;
4 import java.awt.BorderLayout;
5 import java.awt.event.MouseListener;
6 import java.awt.event.MouseMotionListener;
7 import java.awt.event.MouseEvent;
```

**Fig. 14.28** | Mouse event handling. (Part 1 of 3.)

```

8 import javax.swing.JFrame;
9 import javax.swing.JLabel;
10 import javax.swing.JPanel;
11
12 public class MouseTrackerFrame extends JFrame
13 {
14 private JPanel mousePanel; // panel in which mouse events will occur
15 private JLabel statusBar; // label that displays event information
16
17 // MouseTrackerFrame constructor sets up GUI and
18 // registers mouse event handlers
19 public MouseTrackerFrame()
20 {
21 super("Demonstrating Mouse Events");
22
23 mousePanel = new JPanel(); // create panel
24 mousePanel.setBackground(Color.WHITE); // set background color
25 add(mousePanel, BorderLayout.CENTER); // add panel to JFrame
26
27 statusBar = new JLabel("Mouse outside JPanel");
28 add(statusBar, BorderLayout.SOUTH); // add label to JFrame
29
30 // create and register listener for mouse and mouse motion events
31 MouseHandler handler = new MouseHandler();
32 mousePanel.addMouseListener(handler);
33 mousePanel.addMouseMotionListener(handler);
34 } // end MouseTrackerFrame constructor
35
36 private class MouseHandler implements MouseListener,
37 MouseMotionListener
38 {
39 // MouseListener event handlers
40 // handle event when mouse released immediately after press
41 public void mouseClicked(MouseEvent event)
42 {
43 statusBar.setText(String.format("Clicked at [%d, %d]",
44 event.getX(), event.getY()));
45 } // end method mouseClicked
46
47 // handle event when mouse pressed
48 public void mousePressed(MouseEvent event)
49 {
50 statusBar.setText(String.format("Pressed at [%d, %d]",
51 event.getX(), event.getY()));
52 } // end method mousePressed
53
54 // handle event when mouse released
55 public void mouseReleased(MouseEvent event)
56 {
57 statusBar.setText(String.format("Released at [%d, %d]",
58 event.getX(), event.getY()));
59 } // end method mouseReleased
60

```

**Fig. 14.28** | Mouse event handling. (Part 2 of 3.)

```

61 // handle event when mouse enters area
62 public void mouseEntered(MouseEvent event)
63 {
64 statusBar.setText(String.format("Mouse entered at [%d, %d]",
65 event.getX(), event.getY()));
66 mousePanel.setBackground(Color.GREEN);
67 } // end method mouseEntered
68
69 // handle event when mouse exits area
70 public void mouseExited(MouseEvent event)
71 {
72 statusBar.setText("Mouse outside JPanel");
73 mousePanel.setBackground(Color.WHITE);
74 } // end method mouseExited
75
76 // MouseMotionListener event handlers
77 // handle event when user drags mouse with button pressed
78 public void mouseDragged(MouseEvent event)
79 {
80 statusBar.setText(String.format("Dragged at [%d, %d]",
81 event.getX(), event.getY()));
82 } // end method mouseDragged
83
84 // handle event when user moves mouse
85 public void mouseMoved(MouseEvent event)
86 {
87 statusBar.setText(String.format("Moved at [%d, %d]",
88 event.getX(), event.getY()));
89 } // end method mouseMoved
90 } // end inner class MouseHandler
91 } // end class MouseTrackerFrame

```

**Fig. 14.28** | Mouse event handling. (Part 3 of 3.)

Line 23 in Fig. 14.28 creates `JPanel` `mousePanel`. This `JPanel`'s mouse events will be tracked by the application. Line 24 sets `mousePanel`'s background color to white. When the user moves the mouse into the `mousePanel`, the application will change `mousePanel`'s background color to green. When the user moves the mouse out of the `mousePanel`, the application will change the background color back to white. Line 25 attaches `mousePanel` to the `JFrame`. As you learned in Section 14.5, you typically must specify the layout of the GUI components in a `JFrame`. In that section, we introduced the layout manager `FlowLayout`. Here we use the default layout of a `JFrame`'s content pane—**BorderLayout**. This layout manager arranges components into five regions: **NORTH**, **SOUTH**, **EAST**, **WEST** and **CENTER**. **NORTH** corresponds to the top of the container. This example uses the **CENTER** and **SOUTH** regions. Line 25 uses a two-argument version of method `add` to place `mousePanel` in the **CENTER** region. The `BorderLayout` automatically sizes the component in the **CENTER** to use all the space in the `JFrame` that is not occupied by components in the other regions. Section 14.18.2 discusses `BorderLayout` in more detail.

Lines 27–28 in the constructor declare `JLabel` `statusBar` and attach it to the `JFrame`'s **SOUTH** region. This `JLabel` occupies the width of the `JFrame`. The region's height is determined by the `JLabel`.

```

1 // Fig. 14.29: MouseTrackerFrame.java
2 // Testing MouseTrackerFrame.
3 import javax.swing.JFrame;
4
5 public class MouseTracker
6 {
7 public static void main(String[] args)
8 {
9 MouseTrackerFrame mouseTrackerFrame = new MouseTrackerFrame();
10 mouseTrackerFrame.setDefaultCloseOperation(JFrame.EXIT_ON_CLOSE);
11 mouseTrackerFrame.setSize(300, 100); // set frame size
12 mouseTrackerFrame.setVisible(true); // display frame
13 } // end main
14 } // end class MouseTracker

```

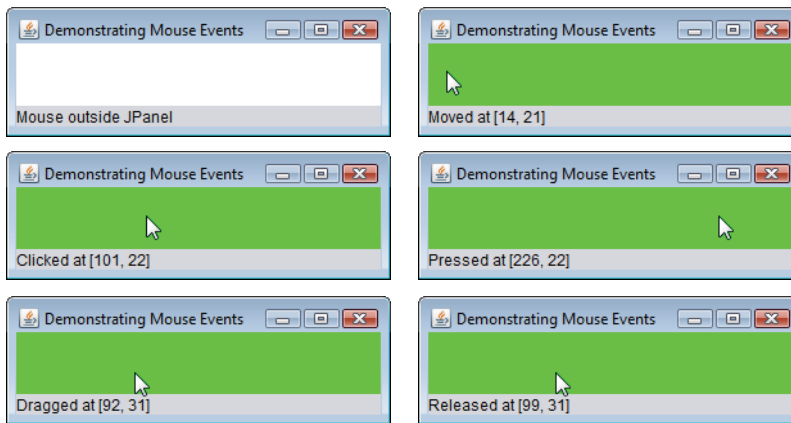

**Fig. 14.29** | Test class for MouseTrackerFrame.

Line 31 creates an instance of inner class `MouseHandler` (lines 36–90) called `handler` that responds to mouse events. Lines 32–33 register `handler` as the listener for `mousePanel`'s mouse events. Methods `addMouseListener` and `addMouseMotionListener` are inherited indirectly from class `Component` and can be used to register `MouseListener`s and `MouseMotionListener`s, respectively. A `MouseHandler` object *is a* `MouseListener` and *is a* `MouseMotionListener` because the class implements *both* interfaces. We chose to implement both interfaces here to demonstrate a class that implements more than one interface, but we could have implemented interface `MouseListener` instead.]

When the mouse enters and exits `mousePanel`'s area, methods `mouseEntered` (lines 62–67) and `mouseExited` (lines 70–74) are called, respectively. Method `mouseEntered` displays a message in the status bar indicating that the mouse entered the `JPanel` and changes the background color to green. Method `mouseExited` displays a message in the status bar indicating that the mouse is outside the `JPanel` (see the first sample output window) and changes the background color to white.

The other five events display a string in the status bar that includes the event and the coordinates at which it occurred. `MouseEvent` methods `getX` and `getY` return the *x*- and *y*-coordinates, respectively, of the mouse at the time the event occurred.

## 14.15 Adapter Classes

Many event-listener interfaces, such as `MouseListener` and `MouseMotionListener`, contain multiple methods. It's not always desirable to declare every method in an event-listener interface. For instance, an application may need only the `mouseClicked` handler from `MouseListener` or the `mouseDragged` handler from `MouseMotionListener`. Interface `WindowListener` specifies seven window event-handling methods. For many of the listener interfaces that have multiple methods, packages `java.awt.event` and `javax.swing.event` provide event-listener adapter classes. An **adapter class** implements an interface and provides a default implementation (with an empty method body) of each method in the interface. Figure 14.30 shows several `java.awt.event` adapter classes and the interfaces they implement. You can extend an adapter class to inherit the default implementation of every method and subsequently override only the method(s) you need for event handling.



### Software Engineering Observation 14.6

*When a class implements an interface, the class has an is-a relationship with that interface. All direct and indirect subclasses of that class inherit this interface. Thus, an object of a class that extends an event-adapter class is an object of the corresponding event-listener type (e.g., an object of a subclass of `MouseAdapter` is a `MouseListener`).*

| Event-adapter class in <code>java.awt.event</code> | Implements interface             |
|----------------------------------------------------|----------------------------------|
| <code>ComponentAdapter</code>                      | <code>ComponentListener</code>   |
| <code>ContainerAdapter</code>                      | <code>ContainerListener</code>   |
| <code>FocusAdapter</code>                          | <code>FocusListener</code>       |
| <code>KeyAdapter</code>                            | <code>KeyListener</code>         |
| <code>MouseAdapter</code>                          | <code>MouseListener</code>       |
| <code>MouseMotionAdapter</code>                    | <code>MouseMotionListener</code> |
| <code>WindowAdapter</code>                         | <code>WindowListener</code>      |

**Fig. 14.30** | Event-adapter classes and the interfaces they implement in package `java.awt.event`.

### Extending `MouseAdapter`

The application of Figs. 14.31–14.32 demonstrates how to determine the number of mouse clicks (i.e., the click count) and how to distinguish between the different mouse buttons. The event listener in this application is an object of inner class `MouseClickedHandler` (lines 25–45) that extends `MouseAdapter`, so we can declare just the `mouseClicked` method we need in this example.

```

1 // Fig. 14.31: MouseDetailsFrame.java
2 // Demonstrating mouse clicks and distinguishing between mouse buttons.
3 import java.awt.BorderLayout;
4 import java.awt.event.MouseAdapter;

```

**Fig. 14.31** | Left, center and right mouse-button clicks. (Part I of 2.)



```

5 import java.awt.event.MouseEvent;
6 import javax.swing.JFrame;
7 import javax.swing.JLabel;
8
9 public class MouseDetailsFrame extends JFrame
10 {
11 private String details; // String that is displayed in the statusBar
12 private JLabel statusBar; // JLabel that appears at bottom of window
13
14 // constructor sets title bar String and register mouse listener
15 public MouseDetailsFrame()
16 {
17 super("Mouse clicks and buttons");
18
19 statusBar = new JLabel("Click the mouse");
20 add(statusBar, BorderLayout.SOUTH);
21 addMouseListener(new MouseClickHandler()); // add handler
22 } // end MouseDetailsFrame constructor
23
24 // inner class to handle mouse events
25 private class MouseClickHandler extends MouseAdapter
26 {
27 // handle mouse-click event and determine which button was pressed
28 public void mouseClicked(MouseEvent event)
29 {
30 int xPos = event.getX(); // get x-position of mouse
31 int yPos = event.getY(); // get y-position of mouse
32
33 details = String.format("Clicked %d time(s)",
34 event.getClickCount());
35
36 if (event.isMetaDown()) // right mouse button
37 details += " with right mouse button";
38 else if (event.isAltDown()) // middle mouse button
39 details += " with center mouse button";
40 else // left mouse button
41 details += " with left mouse button";
42
43 statusBar.setText(details); // display message in statusBar
44 } // end method mouseClicked
45 } // end private inner class MouseClickHandler
46 } // end class MouseDetailsFrame

```

**Fig. 14.31** | Left, center and right mouse-button clicks. (Part 2 of 2.)

```

1 // Fig. 14.32: MouseDetails.java
2 // Testing MouseDetailsFrame.
3 import javax.swing.JFrame;
4
5 public class MouseDetails
6 {

```

**Fig. 14.32** | Test class for MouseDetailsFrame. (Part 1 of 2.)

```

7 public static void main(String[] args)
8 {
9 MouseDetailsFrame mouseDetailsFrame = new MouseDetailsFrame();
10 mouseDetailsFrame.setDefaultCloseOperation(JFrame.EXIT_ON_CLOSE);
11 mouseDetailsFrame.setSize(400, 150); // set frame size
12 mouseDetailsFrame.setVisible(true); // display frame
13 } // end main
14 } // end class MouseDetails

```

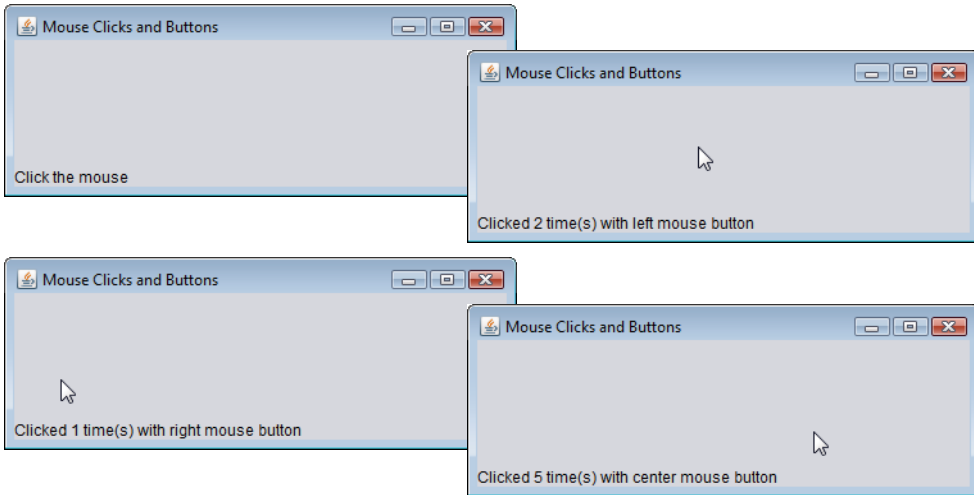

**Fig. 14.32** | Test class for `MouseDetailsFrame`. (Part 2 of 2.)



#### Common Programming Error 14.4

*If you extend an adapter class and misspell the name of the method you're overriding, your method simply becomes another method in the class. This is a logic error that is difficult to detect, since the program will call the empty version of the method inherited from the adapter class.*

A user of a Java application may be on a system with a one-, two- or three-button mouse. Java provides a mechanism to distinguish among mouse buttons. Class `MouseEvent` inherits several methods from class `InputEvent` that can distinguish among mouse buttons on a multibutton mouse or can mimic a multibutton mouse with a combined keystroke and mouse-button click. Figure 14.33 shows the `InputEvent` methods used to distinguish among mouse-button clicks. Java assumes that every mouse contains a left mouse button. Thus, it's simple to test for a left-mouse-button click. However, users with a one- or two-button mouse must use a combination of keystrokes and mouse-button clicks at the same time to simulate the missing buttons on the mouse. In the case of a one- or two-button mouse, a Java application assumes that the center mouse button is clicked if the user holds down the *Alt* key and clicks the left mouse button on a two-button mouse or the only mouse button on a one-button mouse. In the case of a one-button mouse, a Java application assumes that the right mouse button is clicked if the user holds down the *Meta* key (sometimes called the *Command* key or the “Apple” key on a Mac) and clicks the mouse button.

| InputEvent method         | Description                                                                                                                                                                                                                                                                      |
|---------------------------|----------------------------------------------------------------------------------------------------------------------------------------------------------------------------------------------------------------------------------------------------------------------------------|
| <code>isMetaDown()</code> | Returns <code>true</code> when the user clicks the <i>right mouse button</i> on a mouse with two or three buttons. To simulate a right-mouse-button click on a one-button mouse, the user can hold down the <i>Meta</i> key on the keyboard and click the mouse button.          |
| <code>isAltDown()</code>  | Returns <code>true</code> when the user clicks the <i>middle mouse button</i> on a mouse with three buttons. To simulate a middle-mouse-button click on a one- or two-button mouse, the user can press the <i>Alt</i> key and click the only or left mouse button, respectively. |

**Fig. 14.33** | InputEvent methods that help determine whether the right or center mouse button was clicked.

Line 21 of Fig. 14.31 registers a `MouseListener` for the `MouseDetailsFrame`. The event listener is an object of class `MouseClickedHandler`, which extends `MouseAdapter`. This enables us to declare only method `MouseClicked` (lines 28–44). This method first captures the coordinates where the event occurred and stores them in local variables `xPos` and `yPos` (lines 30–31). Lines 33–34 create a `String` called `details` containing the number of consecutive mouse clicks, which is returned by `MouseEvent` method `getClickCount` at line 34. Lines 36–41 use methods `isMetaDown` and `isAltDown` to determine which mouse button the user clicked and append an appropriate `String` to `details` in each case. The resulting `String` is displayed in the `statusBar`. Class `MouseDetails` (Fig. 14.32) contains the main method that executes the application. Try clicking with each of your mouse’s buttons repeatedly to see the click count increment.

## 14.16 JPanel Subclass for Drawing with the Mouse

Section 14.14 showed how to track mouse events in a `JPanel`. In this section, we use a `JPanel` as a **dedicated drawing area** in which the user can draw by dragging the mouse. In addition, this section demonstrates an event listener that extends an adapter class.

### *Method paintComponent*

Lightweight Swing components that extend class `JComponent` (such as `JPanel`) contain method `paintComponent`, which is called when a lightweight Swing component is displayed. By overriding this method, you can specify how to draw shapes using Java’s graphics capabilities. When customizing a `JPanel` for use as a dedicated drawing area, the subclass should override method `paintComponent` and call the superclass version of `paintComponent` as the first statement in the body of the overridden method to ensure that the component displays correctly. The reason is that subclasses of `JComponent` support **transparency**. To display a component correctly, the program must determine whether the component is transparent. The code that determines this is in superclass `JComponent`’s `paintComponent` implementation. When a component is transparent, `paintComponent` will not clear its background when the program displays the component. When a component is **opaque**, `paintComponent` clears the component’s background before the component is displayed. The transparency of a Swing lightweight component can be set with method `setOpaque` (a `false` argument indicates that the component is transparent).



### Error-Prevention Tip 14.1

In a `JComponent` subclass's `paintComponent` method, the first statement should always call the superclass's `paintComponent` method to ensure that an object of the subclass displays correctly.



### Common Programming Error 14.5

If an overridden `paintComponent` method does not call the superclass's version, the subclass component may not display properly. If an overridden `paintComponent` method calls the superclass's version after other drawing is performed, the drawing will be erased.

## Defining the Custom Drawing Area

The Painter application of Figs. 14.34–14.35 demonstrates a customized subclass of `JPanel` that is used to create a dedicated drawing area. The application uses the mouse-Draged event handler to create a simple drawing application. The user can draw pictures by dragging the mouse on the `JPanel`. This example does not use method `mouseMoved`, so our *event-listener class* (the *anonymous inner class* at lines 22–34) extends `MouseMotionAdapter`. Since this class already declares both `mouseMoved` and `mouseDragged`, we can simply override `mouseDragged` to provide the event handling this application requires.

```

1 // Fig. 14.34: PaintPanel.java
2 // Using class MouseMotionAdapter.
3 import java.awt.Point;
4 import java.awt.Graphics;
5 import java.awt.event.MouseEvent;
6 import java.awt.event.MouseMotionAdapter;
7 import javax.swing.JPanel;
8
9 public class PaintPanel extends JPanel
10 {
11 private int pointCount = 0; // count number of points
12
13 // array of 10000 java.awt.Point references
14 private Point[] points = new Point[10000];
15
16 // set up GUI and register mouse event handler
17 public PaintPanel()
18 {
19 // handle frame mouse motion event
20 addMouseMotionListener(
21
22 new MouseMotionAdapter() // anonymous inner class
23 {
24 // store drag coordinates and repaint
25 public void mouseDragged(MouseEvent event)
26 {
27 if (pointCount < points.length)
28 {

```

**Fig. 14.34** | Adapter class used to implement event handlers. (Part I of 2.)

```

29 points[pointCount] = event.getPoint(); // find point
30 ++pointCount; // increment number of points in array
31 repaint(); // repaint JFrame
32 } // end if
33 } // end method mouseDragged
34 } // end anonymous inner class
35); // end call to addMouseListener
36 } // end PaintPanel constructor
37
38 // draw ovals in a 4-by-4 bounding box at specified locations on window
39 public void paintComponent(Graphics g)
40 {
41 super.paintComponent(g); // clears drawing area
42
43 // draw all points in array
44 for (int i = 0; i < pointCount; i++)
45 g.fillOval(points[i].x, points[i].y, 4, 4);
46 } // end method paintComponent
47 } // end class PaintPanel

```

**Fig. 14.34** | Adapter class used to implement event handlers. (Part 2 of 2.)

Class `PaintPanel` (Fig. 14.34) extends `JPanel` to create the dedicated drawing area. Lines 3–7 import the classes used in class `PaintPanel`. Class **Point** (package `java.awt`) represents an  $x$ - $y$  coordinate. We use objects of this class to store the coordinates of each mouse drag event. Class **Graphics** is used to draw.

In this example, we use an array of 10,000 `Points` (line 14) to store the location at which each mouse drag event occurs. As you’ll see, method `paintComponent` uses these `Points` to draw. Instance variable `pointCount` (line 11) maintains the total number of `Points` captured from mouse drag events so far.

Lines 20–35 register a `MouseListener` to listen for the `PaintPanel`’s mouse motion events. Lines 22–34 create an object of an anonymous inner class that extends the adapter class `MouseMotionAdapter`. Recall that `MouseMotionAdapter` implements `MouseListener`, so the *anonymous inner class* object is a `MouseListener`. The anonymous inner class inherits default `mouseMoved` and `mouseDragged` implementations, so it already implements all the interface’s methods. However, the default methods do nothing when they’re called. So, we override method `mouseDragged` at lines 25–33 to capture the coordinates of a mouse drag event and store them as a `Point` object. Line 27 ensures that we store the event’s coordinates *only* if there are still empty elements in the array. If so, line 29 invokes the `MouseEvent`’s `getPoint` method to obtain the `Point` where the event occurred and stores it in the array at index `pointCount`. Line 30 increments the `pointCount`, and line 31 calls method `repaint` (inherited indirectly from class `Component`) to indicate that the `PaintPanel` should be refreshed on the screen as soon as possible with a call to the `PaintPanel`’s `paintComponent` method.

Method `paintComponent` (lines 39–46), which receives a `Graphics` parameter, is called automatically any time the `PaintPanel` needs to be displayed on the screen—such as when the GUI is first displayed—or refreshed on the screen—such as when method `repaint` is called or when the GUI component has been hidden by another window on the screen and subsequently becomes visible again.



### Look-and-Feel Observation 14.13

Calling `repaint` for a Swing GUI component indicates that the component should be re-freshed on the screen as soon as possible. The component's background is cleared only if the component is opaque. `JComponent` method `setOpaque` can be passed a `boolean` argument indicating whether the component is opaque (`true`) or transparent (`false`).

Line 41 invokes the superclass version of `paintComponent` to clear the `PaintPanel`'s background (`JPanel`s are opaque by default). Lines 44–45 draw an oval at the location specified by each `Point` in the array (up to the `pointCount`). Graphics method `fillOval` draws a solid oval. The method's four parameters represent a rectangular area (called the bounding box) in which the oval is displayed. The first two parameters are the upper-left *x*-coordinate and the upper-left *y*-coordinate of the rectangular area. The last two coordinates represent the rectangular area's width and height. Method `fillOval` draws the oval so it touches the middle of each side of the rectangular area. In line 45, the first two arguments are specified by using class `Point`'s two public instance variables—`x` and `y`. The loop terminates when `pointCount` points have been displayed. You'll learn more Graphics features in Chapter 15.



### Look-and-Feel Observation 14.14

Drawing on any GUI component is performed with coordinates that are measured from the upper-left corner (0, 0) of that GUI component, not the upper-left corner of the screen.

### Using the Custom `JPanel` in an Application

Class `Painter` (Fig. 14.35) contains the main method that executes this application. Line 14 creates a `PaintPanel` object on which the user can drag the mouse to draw. Line 15 attaches the `PaintPanel` to the `JFrame`.

```

1 // Fig. 14.35: Painter.java
2 // Testing PaintPanel.
3 import java.awt.BorderLayout;
4 import javax.swing.JFrame;
5 import javax.swing.JLabel;
6
7 public class Painter
8 {
9 public static void main(String[] args)
10 {
11 // create JFrame
12 JFrame application = new JFrame("A simple paint program");
13
14 PaintPanel paintPanel = new PaintPanel(); // create paint panel
15 application.add(paintPanel, BorderLayout.CENTER); // in center
16
17 // create a label and place it in SOUTH of BorderLayout
18 application.add(new JLabel("Drag the mouse to draw"),
19 BorderLayout.SOUTH);
20
21 application.setDefaultCloseOperation(JFrame.EXIT_ON_CLOSE);

```

**Fig. 14.35** | Test class for `PaintPanel`. (Part I of 2.)

```

22 application.setSize(400, 200); // set frame size
23 application.setVisible(true); // display frame
24 } // end main
25 } // end class Painter

```



**Fig. 14.35** | Test class for PaintPane1. (Part 2 of 2.)

## 14.17 Key Event Handling

This section presents the `KeyListener` interface for handling **key events**. Key events are generated when keys on the keyboard are pressed and released. A class that implements `KeyListener` must provide declarations for methods **`keyPressed`**, **`keyReleased`** and **`keyTyped`**, each of which receives a `KeyEvent` as its argument. Class `KeyEvent` is a subclass of `InputEvent`. Method `keyPressed` is called in response to pressing any key. Method `keyTyped` is called in response to pressing any key that is not an **action key**. (The action keys are any arrow key, *Home*, *End*, *Page Up*, *Page Down*, any function key, etc.) Method `keyReleased` is called when the key is released after any `keyPressed` or `keyTyped` event.

The application of Figs. 14.36–14.37 demonstrates the `KeyListener` methods. Class `KeyDemoFrame` implements the `KeyListener` interface, so all three methods are declared in the application. The constructor (Fig. 14.36, lines 17–28) registers the application to handle its own key events by using method **`addKeyListener`** at line 27. Method `addKeyListener` is declared in class `Component`, so every subclass of `Component` can notify `KeyListener` objects of key events for that `Component`.

```

1 // Fig. 14.36: KeyDemoFrame.java
2 // Demonstrating keystroke events.
3 import java.awt.Color;
4 import java.awt.event.KeyListener;
5 import java.awt.event.KeyEvent;
6 import javax.swing.JFrame;
7 import javax.swing.JTextArea;
8
9 public class KeyDemoFrame extends JFrame implements KeyListener
10 {
11 private String line1 = ""; // first line of textarea
12 private String line2 = ""; // second line of textarea
13 private String line3 = ""; // third line of textarea
14 private JTextArea textarea; // textarea to display output
15

```

**Fig. 14.36** | Key event handling. (Part 1 of 2.)

```

16 // KeyDemoFrame constructor
17 public KeyDemoFrame()
18 {
19 super("Demonstrating Keystroke Events");
20
21 textArea = new JTextArea(10, 15); // set up JTextArea
22 textArea.setText("Press any key on the keyboard...");
23 textArea.setEnabled(false); // disable textarea
24 textArea.setDisabledTextColor(Color.BLACK); // set text color
25 add(textArea); // add textarea to JFrame
26
27 addKeyListener(this); // allow frame to process key events
28 } // end KeyDemoFrame constructor
29
30 // handle press of any key
31 public void keyPressed(KeyEvent event)
32 {
33 line1 = String.format("Key pressed: %s",
34 KeyEvent.getKeyText(event.getKeyCode())); // show pressed key
35 setLines2and3(event); // set output lines two and three
36 } // end method keyPressed
37
38 // handle release of any key
39 public void keyReleased(KeyEvent event)
40 {
41 line1 = String.format("Key released: %s",
42 KeyEvent.getKeyText(event.getKeyCode())); // show released key
43 setLines2and3(event); // set output lines two and three
44 } // end method keyReleased
45
46 // handle press of an action key
47 public void keyTyped(KeyEvent event)
48 {
49 line1 = String.format("Key typed: %s", event.getKeyChar());
50 setLines2and3(event); // set output lines two and three
51 } // end method keyTyped
52
53 // set second and third lines of output
54 private void setLines2and3(KeyEvent event)
55 {
56 line2 = String.format("This key is %san action key",
57 (event.isActionKey() ? "" : "not "));
58
59 String temp = KeyEvent.getKeyModifiersText(event.getModifiers());
60
61 line3 = String.format("Modifier keys pressed: %s",
62 (temp.equals("") ? "none" : temp)); // output modifiers
63
64 textArea.setText(String.format("%s\n%s\n%s\n",
65 line1, line2, line3)); // output three lines of text
66 } // end method setLines2and3
67 } // end class KeyDemoFrame

```

**Fig. 14.36** | Key event handling. (Part 2 of 2.)



```

1 // Fig. 14.37: KeyDemo.java
2 // Testing KeyDemoFrame.
3 import javax.swing.JFrame;
4
5 public class KeyDemo
6 {
7 public static void main(String[] args)
8 {
9 KeyDemoFrame keyDemoFrame = new KeyDemoFrame();
10 keyDemoFrame.setDefaultCloseOperation(JFrame.EXIT_ON_CLOSE);
11 keyDemoFrame.setSize(350, 100); // set frame size
12 keyDemoFrame.setVisible(true); // display frame
13 } // end main
14 } // end class KeyDemo

```

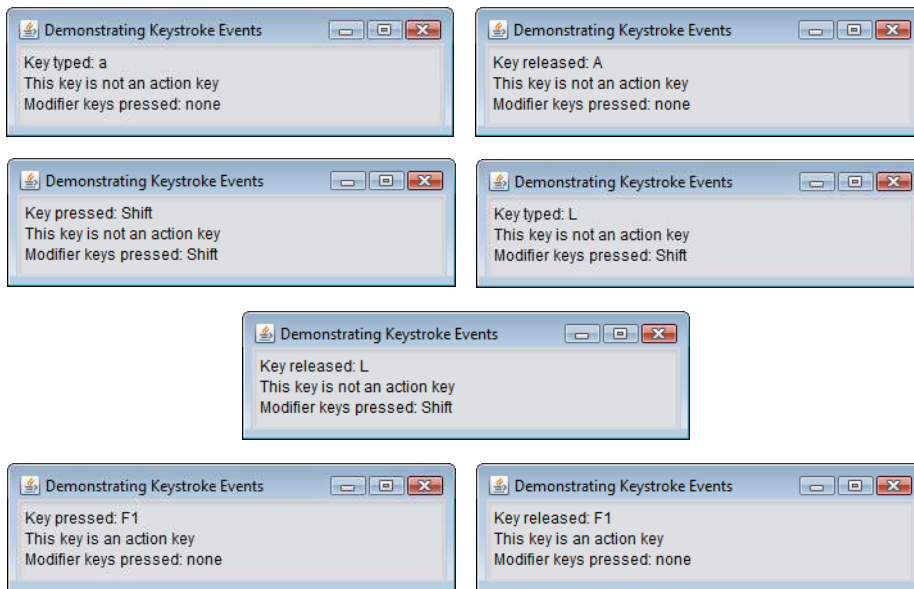

**Fig. 14.37** | Test class for KeyDemoFrame.

At line 25, the constructor adds the `JTextArea` `textArea` (where the application's output is displayed) to the `JFrame`. A `JTextArea` is a *multiline area* in which you can display text. (We discuss `JTextAreas` in more detail in Section 14.20.) Notice in the screen captures that `textArea` occupies the *entire window*. This is due to the `JFrame`'s default `BorderLayout` (discussed in Section 14.18.2 and demonstrated in Fig. 14.41). When a single `Component` is added to a `BorderLayout`, the `Component` occupies the entire `Container`. Line 23 disables the `JTextArea` so the user cannot type in it. This causes the text in the `JTextArea` to become gray. Line 24 uses method `setDisabledTextColor` to change the text color in the `JTextArea` to black for readability.

Methods `keyPressed` (lines 31–36) and `keyReleased` (lines 39–44) use `KeyEvent` method `getKeyCode` to get the **virtual key code** of the pressed key. Class `KeyEvent` contains virtual key-code constants that represent every key on the keyboard. These constants

can be compared with `getKeyCode`'s return value to test for individual keys on the keyboard. The value returned by `getKeyCode` is passed to static `KeyEvent` method **`getKeyText`**, which returns a string containing the name of the key that was pressed. For a complete list of virtual key constants, see the on-line documentation for class `KeyEvent` (package `java.awt.event`). Method `keyTyped` (lines 47–51) uses `KeyEvent` method **`getKeyChar`** (which returns a `char`) to get the Unicode value of the character typed.

All three event-handling methods finish by calling method `setLines2and3` (lines 54–66) and passing it the `KeyEvent` object. This method uses `KeyEvent` method **`isActionKey`** (line 57) to determine whether the key in the event was an action key. Also, `InputEvent` method **`getModifiers`** is called (line 59) to determine whether any modifier keys (such as *Shift*, *Alt* and *Ctrl*) were pressed when the key event occurred. The result of this method is passed to static `KeyEvent` method **`getKeyModifiersText`**, which produces a string containing the names of the pressed modifier keys.

[*Note:* If you need to test for a specific key on the keyboard, class `KeyEvent` provides a **key constant** for each one. These constants can be used from the key event handlers to determine whether a particular key was pressed. Also, to determine whether the *Alt*, *Ctrl*, *Meta* and *Shift* keys are pressed individually, `InputEvent` methods **`isAltDown`**, **`isControlDown`**, **`isMetaDown`** and **`isShiftDown`** each return a `boolean` indicating whether the particular key was pressed during the key event.]

## 14.18 Introduction to Layout Managers

**Layout managers** arrange GUI components in a container for presentation purposes. You can use the layout managers for basic layout capabilities instead of determining every GUI component's exact position and size. This functionality enables you to concentrate on the basic look-and-feel and lets the layout managers process most of the layout details. All layout managers implement the interface **`LayoutManager`** (in package `java.awt`). Class `Container`'s `setLayout` method takes an object that implements the `LayoutManager` interface as an argument. There are basically three ways for you to arrange components in a GUI:

1. *Absolute positioning:* This provides the greatest level of control over a GUI's appearance. By setting a `Container`'s layout to `null`, you can specify the absolute position of each GUI component with respect to the upper-left corner of the `Container` by using `Component` methods `setSize` and `setLocation` or `setBounds`. If you do this, you also must specify each GUI component's size. Programming a GUI with absolute positioning can be tedious, unless you have an integrated development environment (IDE) that can generate the code for you.
2. *Layout managers:* Using layout managers to position elements can be simpler and faster than creating a GUI with absolute positioning, but you lose some control over the size and the precise positioning of GUI components.
3. *Visual programming in an IDE:* IDEs provide tools that make it easy to create GUIs. Each IDE typically provides a **GUI design tool** that allows you to drag and drop GUI components from a tool box onto a design area. You can then position, size and align GUI components as you like. The IDE generates the Java code that creates the GUI. In addition, you can typically add event-handling code for a particular component by double-clicking the component. Some design tools also allow you to use the layout managers described in this chapter and in Chapter 25.



### Look-and-Feel Observation 14.15

Most Java IDEs provide GUI design tools for visually designing a GUI; the tools then write Java code that creates the GUI. Such tools often provide greater control over the size, position and alignment of GUI components than do the built-in layout managers.



### Look-and-Feel Observation 14.16

It's possible to set a Container's layout to `null`, which indicates that no layout manager should be used. In a Container without a layout manager, you must position and size the components in the given container and take care that, on resize events, all components are repositioned as necessary. A component's resize events can be processed by a `ComponentListener`.

Figure 14.38 summarizes the layout managers presented in this chapter. Others are discussed in Chapter 25, and the powerful `GridLayout` layout manager is discussed in Appendix I.

| Layout manager            | Description                                                                                                                                                                                                                                                                                                                         |
|---------------------------|-------------------------------------------------------------------------------------------------------------------------------------------------------------------------------------------------------------------------------------------------------------------------------------------------------------------------------------|
| <code>FlowLayout</code>   | Default for <code>javax.swing.JPanel</code> . Places components sequentially (left to right) in the order they were added. It's also possible to specify the order of the components by using the <code>Container</code> method <code>add</code> , which takes a <code>Component</code> and an integer index position as arguments. |
| <code>BorderLayout</code> | Default for <code>JFrames</code> (and other windows). Arranges the components into five areas: NORTH, SOUTH, EAST, WEST and CENTER.                                                                                                                                                                                                 |
| <code>GridLayout</code>   | Arranges the components into rows and columns.                                                                                                                                                                                                                                                                                      |

**Fig. 14.38** | Layout managers.

## 14.18.1 `FlowLayout`

`FlowLayout` is the *simplest* layout manager. GUI components are placed on a container from left to right in the order in which they're added to the container. When the edge of the container is reached, components continue to display on the next line. Class `FlowLayout` allows GUI components to be *left aligned*, *centered* (the default) and *right aligned*.

The application of Figs. 14.39–14.40 creates three  `JButton`  objects and adds them to the application, using a `FlowLayout` layout manager. The components are center aligned by default. When the user clicks **Left**, the alignment for the layout manager is changed to a left-aligned `FlowLayout`. When the user clicks **Right**, the alignment for the layout manager is changed to a right-aligned `FlowLayout`. When the user clicks **Center**, the alignment for the layout manager is changed to a center-aligned `FlowLayout`. Each button has its own event handler that's declared with an anonymous inner class that implements `ActionListener`. The sample output windows show each of the `FlowLayout` alignments. Also, the last sample output window shows the centered alignment after the window has been resized to a smaller width. Notice that the button **Right** flows onto a new line.

As seen previously, a container's layout is set with method `setLayout` of class `Container`. Line 25 sets the layout manager to the `FlowLayout` declared at line 23. Normally, the layout is set before any GUI components are added to a container.



### Look-and-Feel Observation 14.17

*Each individual container can have only one layout manager, but multiple containers in the same application can each use different layout managers.*

```

1 // Fig. 14.39: FlowLayoutFrame.java
2 // Demonstrating FlowLayout alignments.
3 import java.awt.FlowLayout;
4 import java.awt.Container;
5 import java.awt.event.ActionListener;
6 import java.awt.event.ActionEvent;
7 import javax.swing.JFrame;
8 import javax.swing.JButton;
9
10 public class FlowLayoutFrame extends JFrame
11 {
12 private JButton leftJButton; // button to set alignment left
13 private JButton centerJButton; // button to set alignment center
14 private JButton rightJButton; // button to set alignment right
15 private FlowLayout layout; // layout object
16 private Container container; // container to set layout
17
18 // set up GUI and register button listeners
19 public FlowLayoutFrame()
20 {
21 super("FlowLayout Demo");
22
23 layout = new FlowLayout(); // create FlowLayout
24 container = getContentPane(); // get container to layout
25 setLayout(layout); // set frame layout
26
27 // set up leftJButton and register listener
28 leftJButton = new JButton("Left"); // create Left button
29 add(leftJButton); // add Left button to frame
30 leftJButton.addActionListener(
31
32 new ActionListener() // anonymous inner class
33 {
34 // process leftJButton event
35 public void actionPerformed(ActionEvent event)
36 {
37 layout.setAlignment(FlowLayout.LEFT);
38
39 // realign attached components
40 layout.layoutContainer(container);
41 } // end method actionPerformed
42 } // end anonymous inner class
43); // end call to addActionListener
44
45 // set up centerJButton and register listener
46 centerJButton = new JButton("Center"); // create Center button
47 add(centerJButton); // add Center button to frame

```

**Fig. 14.39** | FlowLayout allows components to flow over multiple lines. (Part I of 2.)

```

48 centerJButton.addActionListener(
49
50 new ActionListener() // anonymous inner class
51 {
52 // process centerJButton event
53 public void actionPerformed(ActionEvent event)
54 {
55 layout.setAlignment(FlowLayout.CENTER);
56
57 // realign attached components
58 layout.layoutContainer(container);
59 } // end method actionPerformed
60 } // end anonymous inner class
61); // end call to addActionListener
62
63 // set up rightJButton and register listener
64 rightJButton = new JButton("Right"); // create Right button
65 add(rightJButton); // add Right button to frame
66 rightJButton.addActionListener(
67
68 new ActionListener() // anonymous inner class
69 {
70 // process rightJButton event
71 public void actionPerformed(ActionEvent event)
72 {
73 layout.setAlignment(FlowLayout.RIGHT);
74
75 // realign attached components
76 layout.layoutContainer(container);
77 } // end method actionPerformed
78 } // end anonymous inner class
79); // end call to addActionListener
80 } // end FlowLayoutFrame constructor
81 } // end class FlowLayoutFrame

```

**Fig. 14.39** | FlowLayout allows components to flow over multiple lines. (Part 2 of 2.)

```

1 // Fig. 14.40: FlowLayoutDemo.java
2 // Testing FlowLayoutFrame.
3 import javax.swing.JFrame;
4
5 public class FlowLayoutDemo
6 {
7 public static void main(String[] args)
8 {
9 FlowLayoutFrame flowLayoutFrame = new FlowLayoutFrame();
10 flowLayoutFrame.setDefaultCloseOperation(JFrame.EXIT_ON_CLOSE);
11 flowLayoutFrame.setSize(300, 75); // set frame size
12 flowLayoutFrame.setVisible(true); // display frame
13 } // end main
14 } // end class FlowLayoutDemo

```

**Fig. 14.40** | Test class for FlowLayoutFrame. (Part 1 of 2.)

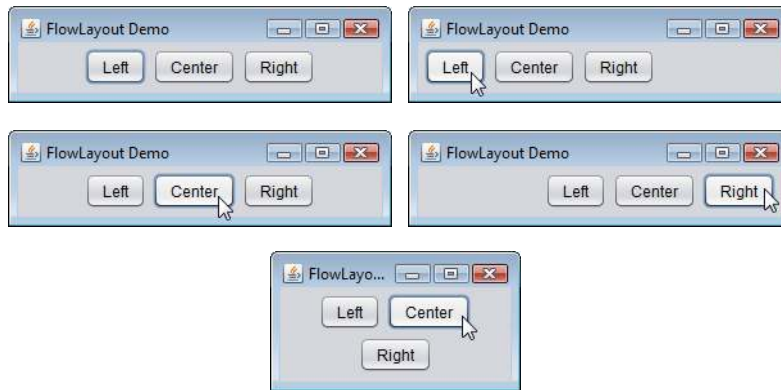

**Fig. 14.40** | Test class for `FlowLayoutFrame`. (Part 2 of 2.)

Each button's event handler is specified with a separate anonymous inner-class object (Fig. 14.39, lines 30–43, 48–61 and 66–79, respectively), and method `actionPerformed` in each case executes two statements. For example, line 37 in the event handler for `LeftJButton` uses `FlowLayout` method **`setAlignment`** to change the alignment for the `FlowLayout` to a left-aligned (**`FlowLayout.LEFT`**) `FlowLayout`. Line 40 uses `LayoutManager` interface method **`layoutContainer`** (which is inherited by all layout managers) to specify that the `JFrame` should be rearranged based on the adjusted layout. According to which button was clicked, the `actionPerformed` method for each button sets the `FlowLayout`'s alignment to `FlowLayout.LEFT` (line 37), **`FlowLayout.CENTER`** (line 55) or **`FlowLayout.RIGHT`** (line 73).

### 14.18.2 BorderLayout

The `BorderLayout` layout manager (the default layout manager for a `JFrame`) arranges components into five regions: `NORTH`, `SOUTH`, `EAST`, `WEST` and `CENTER`. `NORTH` corresponds to the top of the container. Class `BorderLayout` extends `Object` and implements interface **`LayoutManager2`** (a subinterface of `LayoutManager` that adds several methods for enhanced layout processing).

A `BorderLayout` limits a `Container` to containing at most five components—one in each region. The component placed in each region can be a container to which other components are attached. The components placed in the `NORTH` and `SOUTH` regions extend horizontally to the sides of the container and are as tall as the components placed in those regions. The `EAST` and `WEST` regions expand vertically between the `NORTH` and `SOUTH` regions and are as wide as the components placed in those regions. The component placed in the `CENTER` region expands to fill all remaining space in the layout (which is the reason the `JTextArea` in Fig. 14.37 occupies the entire window). If all five regions are occupied, the entire container's space is covered by GUI components. If the `NORTH` or `SOUTH` region is not occupied, the GUI components in the `EAST`, `CENTER` and `WEST` regions expand vertically to fill the remaining space. If the `EAST` or `WEST` region is not occupied, the GUI component in the `CENTER` region expands horizontally to fill the remaining space. If the `CENTER` region is not occupied, the area is left empty—the other GUI components do *not* expand

to fill the remaining space. The application of Figs. 14.41–14.42 demonstrates the BorderLayout layout manager by using five JButtons.

```

1 // Fig. 14.41: BorderLayoutFrame.java
2 // Demonstrating BorderLayout.
3 import java.awt.BorderLayout;
4 import java.awt.event.ActionListener;
5 import java.awt.event.ActionEvent;
6 import javax.swing.JFrame;
7 import javax.swing.JButton;
8
9 public class BorderLayoutFrame extends JFrame implements ActionListener
10 {
11 private JButton[] buttons; // array of buttons to hide portions
12 private static final String[] names = { "Hide North", "Hide South",
13 "Hide East", "Hide West", "Hide Center" };
14 private BorderLayout layout; // borderlayout object
15
16 // set up GUI and event handling
17 public BorderLayoutFrame()
18 {
19 super("BorderLayout Demo");
20
21 layout = new BorderLayout(5, 5); // 5 pixel gaps
22 setLayout(layout); // set frame layout
23 buttons = new JButton[names.length]; // set size of array
24
25 // create JButtons and register listeners for them
26 for (int count = 0; count < names.length; count++)
27 {
28 buttons[count] = new JButton(names[count]);
29 buttons[count].addActionListener(this);
30 } // end for
31
32 add(buttons[0], BorderLayout.NORTH); // add button to north
33 add(buttons[1], BorderLayout.SOUTH); // add button to south
34 add(buttons[2], BorderLayout.EAST); // add button to east
35 add(buttons[3], BorderLayout.WEST); // add button to west
36 add(buttons[4], BorderLayout.CENTER); // add button to center
37 } // end BorderLayoutFrame constructor
38
39 // handle button events
40 public void actionPerformed(ActionEvent event)
41 {
42 // check event source and lay out content pane correspondingly
43 for (JButton button : buttons)
44 {
45 if (event.getSource() == button)
46 button.setVisible(false); // hide button clicked
47 else
48 button.setVisible(true); // show other buttons
49 } // end for

```

**Fig. 14.41** | BorderLayout containing five buttons. (Part I of 2.)

```

50
51 layout.layoutContainer(getContentPane()); // lay out content pane
52 } // end method actionPerformed
53 } // end class BorderLayoutFrame

```

**Fig. 14.41** | BorderLayout containing five buttons. (Part 2 of 2.)

```

1 // Fig. 14.42: BorderLayoutDemo.java
2 // Testing BorderLayoutFrame.
3 import javax.swing.JFrame;
4
5 public class BorderLayoutDemo
6 {
7 public static void main(String[] args)
8 {
9 BorderLayoutFrame borderLayoutFrame = new BorderLayoutFrame();
10 borderLayoutFrame.setDefaultCloseOperation(JFrame.EXIT_ON_CLOSE);
11 borderLayoutFrame.setSize(300, 200); // set frame size
12 borderLayoutFrame.setVisible(true); // display frame
13 } // end main
14 } // end class BorderLayoutDemo

```

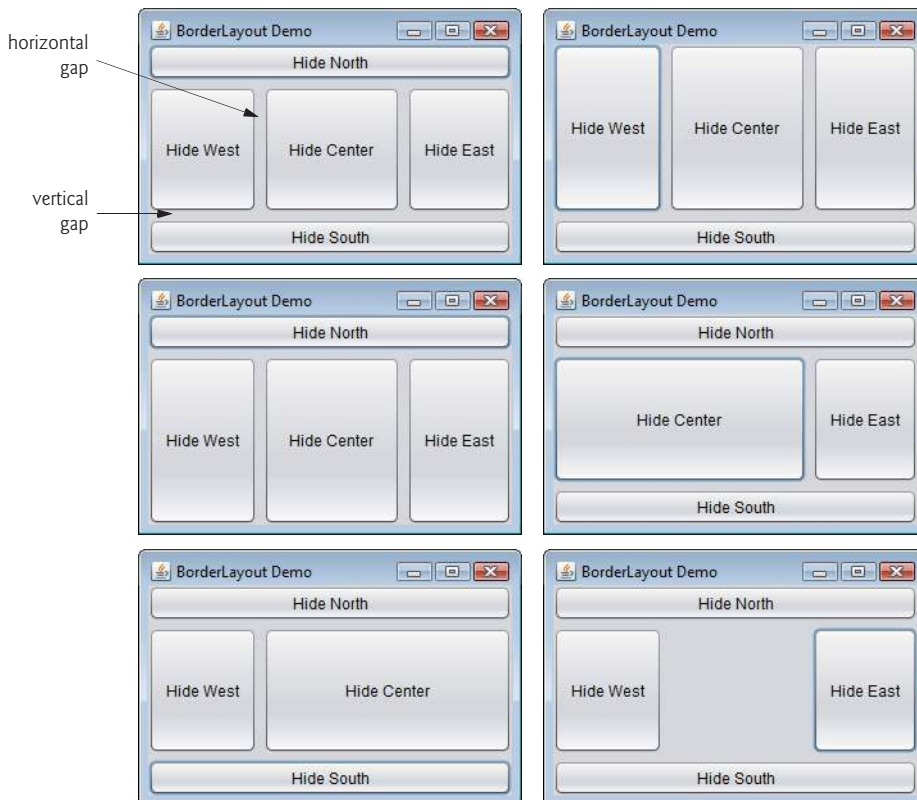

**Fig. 14.42** | Test class for BorderLayoutFrame.



Line 21 of Fig. 14.41 creates a `BorderLayout`. The constructor arguments specify the number of pixels between components that are arranged horizontally (**horizontal gap space**) and between components that are arranged vertically (**vertical gap space**), respectively. The default is one pixel of gap space horizontally and vertically. Line 22 uses method `setLayout` to set the content pane's layout to `layout`.

We add Components to a `BorderLayout` with another version of `Container` method `add` that takes two arguments—the `Component` to add and the region in which the `Component` should appear. For example, line 32 specifies that `buttons[ 0 ]` should appear in the `NORTH` region. The components can be added in any order, but only one component should be added to each region.



### Look-and-Feel Observation 14.18

*If no region is specified when adding a `Component` to a `BorderLayout`, the layout manager assumes that the `Component` should be added to region `BorderLayout.CENTER`.*



### Common Programming Error 14.6

*When more than one component is added to a region in a `BorderLayout`, only the last component added to that region will be displayed. There's no error that indicates this problem.*

Class `BorderLayoutFrame` implements `ActionListener` directly in this example, so the `BorderLayoutFrame` will handle the events of the `JButtons`. For this reason, line 29 passes the `this` reference to the `addActionListener` method of each `JButton`. When the user clicks a particular `JButton` in the layout, method `actionPerformed` (lines 40–52) executes. The enhanced `for` statement at lines 43–49 uses an `if...else` to hide the particular `JButton` that generated the event. Method `setVisible` (inherited into `JButton` from class `Component`) is called with a `false` argument (line 46) to hide the `JButton`. If the current `JButton` in the array is not the one that generated the event, method `setVisible` is called with a `true` argument (line 48) to ensure that the `JButton` is displayed on the screen. Line 51 uses `LayoutManager` method `layoutContainer` to recalculate the layout of the content pane. Notice in the screen captures of Fig. 14.42 that certain regions in the `BorderLayout` change shape as `JButtons` are hidden and displayed in other regions. Try resizing the application window to see how the various regions resize based on the window's width and height. *For more complex layouts, group components in `JPanels`, each with a separate layout manager.* Place the `JPanels` on the `JFrame` using either the default `BorderLayout` or some other layout.

## 14.18.3 GridLayout

The **GridLayout** layout manager divides the container into a *grid* so that components can be placed in *rows* and *columns*. Class `GridLayout` inherits directly from class `Object` and implements interface `LayoutManager`. Every `Component` in a `GridLayout` has the *same* width and height. Components are added to a `GridLayout` starting at the top-left cell of the grid and proceeding left to right until the row is full. Then the process continues left to right on the next row of the grid, and so on. The application of Figs. 14.43–14.44 demonstrates the `GridLayout` layout manager by using six `JButtons`.

Lines 24–25 create two `GridLayout` objects. The `GridLayout` constructor used at line 24 specifies a `GridLayout` with 2 rows, 3 columns, 5 pixels of horizontal-gap space between components in the grid and 5 pixels of vertical-gap space between components in the grid.

```

1 // Fig. 14.43: GridLayoutFrame.java
2 // Demonstrating GridLayout.
3 import java.awt.GridLayout;
4 import java.awt.Container;
5 import java.awt.event.ActionListener;
6 import java.awt.event.ActionEvent;
7 import javax.swing.JFrame;
8 import javax.swing.JButton;
9
10 public class GridLayoutFrame extends JFrame implements ActionListener
11 {
12 private JButton[] buttons; // array of buttons
13 private static final String[] names =
14 { "one", "two", "three", "four", "five", "six" };
15 private boolean toggle = true; // toggle between two layouts
16 private Container container; // frame container
17 private GridLayout GridLayout1; // first GridLayout
18 private GridLayout GridLayout2; // second GridLayout
19
20 // no-argument constructor
21 public GridLayoutFrame()
22 {
23 super("GridLayout Demo");
24 GridLayout1 = new GridLayout(2, 3, 5, 5); // 2 by 3; gaps of 5
25 GridLayout2 = new GridLayout(3, 2); // 3 by 2; no gaps
26 container = getContentPane(); // get content pane
27 setLayout(GridLayout1); // set JFrame layout
28 buttons = new JButton[names.length]; // create array of JButtons
29
30 for (int count = 0; count < names.length; count++)
31 {
32 buttons[count] = new JButton(names[count]);
33 buttons[count].addActionListener(this); // register listener
34 add(buttons[count]); // add button to JFrame
35 } // end for
36 } // end GridLayoutFrame constructor
37
38 // handle button events by toggling between layouts
39 public void actionPerformed(ActionEvent event)
40 {
41 if (toggle)
42 container.setLayout(GridLayout2); // set layout to second
43 else
44 container.setLayout(GridLayout1); // set layout to first
45
46 toggle = !toggle; // set toggle to opposite value
47 container.validate(); // re-lay out container
48 } // end method actionPerformed
49 } // end class GridLayoutFrame

```

**Fig. 14.43** | GridLayout containing six buttons.

The GridLayout constructor used at line 25 specifies a GridLayout with 3 rows and 2 columns that uses the default gap space (1 pixel).

```

1 // Fig. 14.44: GridLayoutDemo.java
2 // Testing GridLayoutFrame.
3 import javax.swing.JFrame;
4
5 public class GridLayoutDemo
6 {
7 public static void main(String[] args)
8 {
9 GridLayoutFrame gridLayoutFrame = new GridLayoutFrame();
10 gridLayoutFrame.setDefaultCloseOperation(JFrame.EXIT_ON_CLOSE);
11 gridLayoutFrame.setSize(300, 200); // set frame size
12 gridLayoutFrame.setVisible(true); // display frame
13 } // end main
14 } // end class GridLayoutDemo

```



**Fig. 14.44** | Test class for GridLayoutFrame.

The JButton objects in this example initially are arranged using `gridLayout1` (set for the content pane at line 27 with method `setLayout`). The first component is added to the first column of the first row. The next component is added to the second column of the first row, and so on. When a JButton is pressed, method `actionPerformed` (lines 39–48) is called. Every call to `actionPerformed` toggles the layout between `gridLayout2` and `gridLayout1`, using boolean variable `toggle` to determine the next layout to set.

Line 47 shows another way to reformat a container for which the layout has changed. Container method `validate` recomputes the container's layout based on the current layout manager for the Container and the current set of displayed GUI components.

## 14.19 Using Panels to Manage More Complex Layouts

Complex GUIs (like Fig. 14.1) require that each component be placed in an exact location. They often consist of multiple panels, with each panel's components arranged in a specific layout. Class `JPanel` extends `JComponent` and `JComponent` extends class `Container`, so every `JPanel` is a `Container`. Thus, every `JPanel` may have components, including other panels, attached to it with `Container` method `add`. The application of Figs. 14.45–14.46 demonstrates how a `JPanel` can be used to create a more complex layout in which several JButtons are placed in the SOUTH region of a `BorderLayout`.

After `JPanel` `buttonJPanel` is declared (line 11) and created (line 19), line 20 sets `buttonJPanel`'s layout to a `GridLayout` of one row and five columns (there are five JButtons in array `buttons`). Lines 23–27 add the JButtons in the array to the `JPanel`. Line 26 adds the buttons directly to the `JPanel`—class `JPanel` does not have a content pane, unlike a `JFrame`. Line 29 uses the `JFrame`'s default `BorderLayout` to add `buttonJPanel` to the SOUTH region. The SOUTH region is as tall as the buttons on `buttonJPanel`. A `JPanel` is sized

to the components it contains. As more components are added, the JPanel grows (according to the restrictions of its layout manager) to accommodate the components. Resize the window to see how the layout manager affects the size of the JButtons.

---

```

1 // Fig. 14.45: PanelFrame.java
2 // Using a JPanel to help lay out components.
3 import java.awt.GridLayout;
4 import java.awt.BorderLayout;
5 import javax.swing.JFrame;
6 import javax.swing.JPanel;
7 import javax.swing.JButton;
8
9 public class PanelFrame extends JFrame
10 {
11 private JPanel buttonJPanel; // panel to hold buttons
12 private JButton[] buttons; // array of buttons
13
14 // no-argument constructor
15 public PanelFrame()
16 {
17 super("Panel Demo");
18 buttons = new JButton[5]; // create buttons array
19 buttonJPanel = new JPanel(); // set up panel
20 buttonJPanel.setLayout(new GridLayout(1, buttons.length));
21
22 // create and add buttons
23 for (int count = 0; count < buttons.length; count++)
24 {
25 buttons[count] = new JButton("Button " + (count + 1));
26 buttonJPanel.add(buttons[count]); // add button to panel
27 } // end for
28
29 add(buttonJPanel, BorderLayout.SOUTH); // add panel to JFrame
30 } // end PanelFrame constructor
31 } // end class PanelFrame

```

---

**Fig. 14.45** | JPanel with five JButtons in a GridLayout attached to the SOUTH region of a BorderLayout.

---

```

1 // Fig. 14.46: PanelDemo.java
2 // Testing PanelFrame.
3 import javax.swing.JFrame;
4
5 public class PanelDemo extends JFrame
6 {
7 public static void main(String[] args)
8 {
9 PanelFrame panelFrame = new PanelFrame();
10 panelFrame.setDefaultCloseOperation(JFrame.EXIT_ON_CLOSE);
11 panelFrame.setSize(450, 200); // set frame size

```

---

**Fig. 14.46** | Test class for PanelFrame. (Part I of 2.)

```

12 panelFrame.setVisible(true); // display frame
13 } // end main
14 } // end class PanelDemo

```



**Fig. 14.46** | Test class for PanelFrame. (Part 2 of 2.)

## 14.20 JTextArea

A **JTextArea** provides an area for *manipulating multiple lines of text*. Like class **JTextField**, **JTextArea** is a subclass of **JTextComponent**, which declares common methods for **JTextFields**, **JTextAreas** and several other text-based GUI components.

The application in Figs. 14.47–14.48 demonstrates **JTextAreas**. One **JTextArea** displays text that the user can select. The other is uneditable and is used to display the text the user selected in the first **JTextArea**. Unlike **JTextFields**, **JTextAreas** do not have action events—when you press *Enter* while typing in a **JTextArea**, the cursor simply moves to the next line. As with multiple-selection **JLists** (Section 14.13), an external event from another GUI component indicates when to process the text in a **JTextArea**. For example, when typing an e-mail message, you normally click a **Send** button to send the text of the message to the recipient. Similarly, when editing a document in a word processor, you normally save the file by selecting a **Save** or **Save As...** menu item. In this program, the button **Copy >>>** generates the external event that copies the selected text in the left **JTextArea** and displays it in the right **JTextArea**.

```

1 // Fig. 14.47: TextAreaFrame.java
2 // Copying selected text from one textarea to another.
3 import java.awt.event.ActionListener;
4 import java.awt.event.ActionEvent;
5 import javax.swing.Box;
6 import javax.swing.JFrame;
7 import javax.swing.JTextArea;
8 import javax.swing.JButton;
9 import javax.swing.JScrollPane;
10
11 public class TextAreaFrame extends JFrame
12 {
13 private JTextArea textArea1; // displays demo string
14 private JTextArea textArea2; // highlighted text is copied here
15 private JButton copyJButton; // initiates copying of text
16

```

**Fig. 14.47** | Copying selected text from one JTextArea to another. (Part 1 of 2.)

```

17 // no-argument constructor
18 public TextAreaFrame()
19 {
20 super("TextArea Demo");
21 Box box = Box.createHorizontalBox(); // create box
22 String demo = "This is a demo string to\n" +
23 "illustrate copying text\nfrom one textarea to \n" +
24 "another textarea using an\nexternal event\n";
25
26 textArea1 = new JTextArea(demo, 10, 15); // create textArea1
27 box.add(new JScrollPane(textArea1)); // add scrollpane
28
29 copyJButton = new JButton("Copy >>>"); // create copy button
30 box.add(copyJButton); // add copy button to box
31 copyJButton.addActionListener(
32
33 new ActionListener() // anonymous inner class
34 {
35 // set text in textArea2 to selected text from textArea1
36 public void actionPerformed(ActionEvent event)
37 {
38 textArea2.setText(textArea1.getSelectedText());
39 } // end method actionPerformed
40 } // end anonymous inner class
41); // end call to addActionListener
42
43 textArea2 = new JTextArea(10, 15); // create second textarea
44 textArea2.setEditable(false); // disable editing
45 box.add(new JScrollPane(textArea2)); // add scrollpane
46
47 add(box); // add box to frame
48 } // end TextAreaFrame constructor
49 } // end class TextAreaFrame

```

**Fig. 14.47** | Copying selected text from one JTextArea to another. (Part 2 of 2.)

```

1 // Fig. 14.48: TextAreaDemo.java
2 // Copying selected text from one textarea to another.
3 import javax.swing.JFrame;
4
5 public class TextAreaDemo
6 {
7 public static void main(String[] args)
8 {
9 TextAreaFrame textAreaFrame = new TextAreaFrame();
10 textAreaFrame.setDefaultCloseOperation(JFrame.EXIT_ON_CLOSE);
11 textAreaFrame.setSize(425, 200); // set frame size
12 textAreaFrame.setVisible(true); // display frame
13 } // end main
14 } // end class TextAreaDemo

```

**Fig. 14.48** | Test class for TextAreaFrame. (Part 1 of 2.)

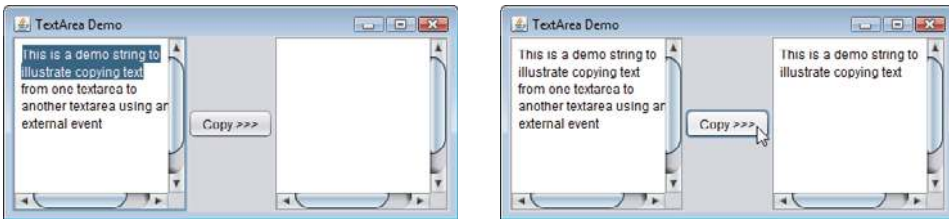

**Fig. 14.48** | Test class for TextAreaFrame. (Part 2 of 2.)

In the constructor (lines 18–48), line 21 creates a **Box** container (package `javax.swing`) to organize the GUI components. `Box` is a subclass of `Container` that uses a **BoxLayout** layout manager (discussed in detail in Section 25.9) to arrange the GUI components either horizontally or vertically. `Box`'s static method `createHorizontalBox` creates a `Box` that arranges components from left to right in the order that they're attached.

Lines 26 and 43 create `JTextAreas` `textArea1` and `textArea2`. Line 26 uses `JTextArea`'s three-argument constructor, which takes a `String` representing the initial text and two `ints` specifying that the `JTextArea` has 10 rows and 15 columns. Line 43 uses `JTextArea`'s two-argument constructor, specifying that the `JTextArea` has 10 rows and 15 columns. Line 26 specifies that `demo` should be displayed as the default `JTextArea` content. A `JTextArea` does not provide scrollbars if it cannot display its complete contents. So, line 27 creates a `JScrollPane` object, initializes it with `textArea1` and attaches it to container `box`. By default, horizontal and vertical scrollbars appear as necessary in a `JScrollPane`.

Lines 29–41 create `JButton` object `copyJButton` with the label "Copy >>>", add `copyJButton` to container `box` and register the event handler for `copyJButton`'s `ActionEvent`. This button provides the external event that determines when the program should copy the selected text in `textArea1` to `textArea2`. When the user clicks `copyJButton`, line 38 in `actionPerformed` indicates that method `getSelectedText` (inherited into `JTextArea` from `JTextComponent`) should return the selected text from `textArea1`. The user selects text by dragging the mouse over the desired text to highlight it. Method `setText` changes the text in `textArea2` to the string returned by `getSelectedText`.

Lines 43–45 create `textArea2`, set its `editable` property to `false` and add it to container `box`. Line 47 adds `box` to the `JFrame`. Recall from Section 14.18 that the default layout of a `JFrame` is a `BorderLayout` and that the `add` method by default attaches its argument to the `CENTER` of the `BorderLayout`.

When text reaches the right edge of a `JTextArea` the text can wrap to the next line. This is referred to as **line wrapping**. By default, `JTextArea` does *not* wrap lines.



### Look-and-Feel Observation 14.19

To provide line wrapping functionality for a `JTextArea`, invoke `JTextArea` method `setLineWrap` with a true argument.

### *JScrollPane* Scrollbar Policies

This example uses a `JScrollPane` to provide scrolling for a `JTextArea`. By default, `JScrollPane` displays scrollbars only if they're required. You can set the horizontal and vertical **scrollbar policies** of a `JScrollPane` when it's constructed. If a program has a ref-

reference to a `JScrollPane`, the program can use `JScrollPane` methods `setHorizontalScrollBarPolicy` and `setVerticalScrollBarPolicy` to change the scrollbar policies at any time. Class `JScrollPane` declares the constants

```
JScrollPane.VERTICAL_SCROLLBAR_ALWAYS
JScrollPane.HORIZONTAL_SCROLLBAR_ALWAYS
```

to indicate that *a scrollbar should always appear*, constants

```
JScrollPane.VERTICAL_SCROLLBAR_AS_NEEDED
JScrollPane.HORIZONTAL_SCROLLBAR_AS_NEEDED
```

to indicate that *a scrollbar should appear only if necessary* (the defaults) and constants

```
JScrollPane.VERTICAL_SCROLLBAR_NEVER
JScrollPane.HORIZONTAL_SCROLLBAR_NEVER
```

to indicate that *a scrollbar should never appear*. If the horizontal scrollbar policy is set to `JScrollPane.HORIZONTAL_SCROLLBAR_NEVER`, a `JTextArea` attached to the `JScrollPane` will automatically wrap lines.

## 14.21 Wrap-Up

In this chapter, you learned many GUI components and how to implement event handling. You also learned about nested classes, inner classes and anonymous inner classes. You saw the special relationship between an inner-class object and an object of its top-level class. You learned how to use `JOptionPane` dialogs to obtain text input from the user and how to display messages to the user. You also learned how to create applications that execute in their own windows. We discussed class `JFrame` and components that enable a user to interact with an application. We also showed you how to display text and images to the user. You learned how to customize `JPanels` to create custom drawing areas, which you'll use extensively in the next chapter. You saw how to organize components on a window using layout managers and how to creating more complex GUIs by using `JPanels` to organize components. Finally, you learned about the `JTextArea` component in which a user can enter text and an application can display text. In Chapter 25, you'll learn about more advanced GUI components, such as sliders, menus and more complex layout managers. In the next chapter, you'll learn how to add graphics to your GUI application. Graphics allow you to draw shapes and text with colors and styles.

## Summary

### Section 14.1 Introduction

- A graphical user interface (GUI; p. 550) presents a user-friendly mechanism for interacting with an application. A GUI gives an application a distinctive look and feel (p. 555).
- Providing different applications with consistent, intuitive user-interface components gives users a sense of familiarity with a new application, so that they can learn it more quickly.
- GUIs are built from GUI components (p. 550)—sometimes called controls or widgets.

### Section 14.2 Java's New Nimbus Look-and-Feel

- As of Java SE 6 update 10, Java comes bundled with a new, elegant, cross-platform look-and-feel known as Nimbus (p. 551).



- To set Nimbus as the default for all Java applications, create a `swing.properties` text file in the `lib` folder of your JDK and JRE installation folders. Place the following line of code in the file:
 

```
swing.defaultlaf=com.sun.java.swing.plaf.nimbus.NimbusLookAndFeel
```
- To select Nimbus on an application-by-application basis, place the following command-line argument after the `java` command and before the application's name when you run the application:
 

```
-Dswing.defaultlaf=com.sun.java.swing.plaf.nimbus.NimbusLookAndFeel
```

### *Section 14.3 Simple GUI-Based Input/Output with JOptionPane*

- Most applications use windows or dialog boxes (p. 552) to interact with the user.
- Class `JOptionPane` (p. 552) of package `javax.swing` (p. 550) provides prebuilt dialog boxes for both input and output. `JOptionPane` static method `showInputDialog` (p. 553) displays an input dialog (p. 552).
- A prompt typically uses sentence-style capitalization—capitalizing only the first letter of the first word in the text unless the word is a proper noun.
- An input dialog can input only input `Strings`. This is typical of most GUI components.
- `JOptionPane` static method `showMessageDialog` (p. 554) displays a message dialog (p. 552).

### *Section 14.4 Overview of Swing Components*

- Most Swing GUI components (p. 550) are located in package `javax.swing`.
- Together, the appearance and the way in which the user interacts with the application are known as that application's look-and-feel. Swing GUI components allow you to specify a uniform look-and-feel for your application across all platforms or to use each platform's custom look-and-feel.
- Lightweight Swing components are not tied to actual GUI components supported by the underlying platform on which an application executes.
- Several Swing components are heavyweight components (p. 556) that require direct interaction with the local windowing system (p. 556), which may restrict their appearance and functionality.
- Class `Component` (p. 556; package `java.awt`) declares many of the attributes and behaviors common to the GUI components in packages `java.awt` (p. 555) and `javax.swing`.
- Class `Container` (p. 556; package `java.awt`) is a subclass of `Component`. Components are attached to Containers so the Components can be organized and displayed on the screen.
- Class `JComponent` (p. 556) of package `javax.swing` is a subclass of `Container`. `JComponent` is the superclass of all lightweight Swing components and declares their common attributes and behaviors.
- Some common `JComponent` features include a pluggable look-and-feel (p. 556), shortcut keys called mnemonics (p. 556), tool tips (p. 556), support for assistive technologies and support for user-interface localization (p. 556).

### *Section 14.5 Displaying Text and Images in a Window*

- Class `JFrame` provides the basic attributes and behaviors of a window.
- A `JLabel` (p. 557) displays read-only text, an image, or both text and an image. Text in a `JLabel` normally uses sentence-style capitalization.
- Each GUI component must be attached to a container, such as a window created with a `JFrame` (p. 559).
- Many IDEs provide GUI design tools (p. 604) in which you can specify the exact size and location of a component by using the mouse; then the IDE will generate the GUI code for you.
- `JComponent` method `setToolTipText` (p. 559) specifies the tool tip that's displayed when the user positions the mouse cursor over a lightweight component (p. 556).

- Container method `add` attaches a GUI component to a Container.
- Class `ImageIcon` (p. 560) supports several image formats, including GIF, PNG and JPEG.
- Method `getClass` of class `Object` (p. 560) retrieves a reference to the `Class` object that represents the the class declaration for the object on which the method is called.
- Class method `getResource` (p. 560) returns the location of its argument as a URL. The method `getResource` uses the `Class` object's class loader to determine the location of the resource.
- The horizontal and vertical alignments of a `JLabel` can be set with methods `setHorizontalAlignment` (p. 560) and `setVerticalAlignment` (p. 560), respectively.
- `JLabel` methods `setText` (p. 560) and `getText` (p. 560) set and get the text displayed on a label.
- `JLabel` methods `setIcon` (p. 560) and `getIcon` (p. 560) set and get the `Icon` (p. 560) on a label.
- `JLabel` methods `setHorizontalTextPosition` (p. 560) and `setVerticalTextPosition` (p. 560) specify the text position in the label.
- `JFrame` method `setDefaultCloseOperation` (p. 561) with constant `JFrame.EXIT_ON_CLOSE` as the argument indicates that the program should terminate when the window is closed by the user.
- Component method `setSize` (p. 561) specifies the width and height of a component.
- Component method `setVisible` (p. 561) with the argument `true` displays a `JFrame` on the screen.

### *Section 14.6 Text Fields and an Introduction to Event Handling with Nested Classes*

- GUIs are event driven—when the user interacts with a GUI component, events (p. 561) drive the program to perform tasks.
- An event handler (p. 561) performs a task in response to an event.
- Class `JTextField` (p. 561) extends `JTextComponent` (p. 561) of package `javax.swing.text`, which provides common text-based component features. Class `JPasswordField` (p. 561) extends `JTextField` and adds several methods that are specific to processing passwords.
- A `JPasswordField` (p. 561) shows that characters are being typed as the user enters them, but hides the actual characters with echo characters (p. 562).
- A component receives the focus (p. 562) when the user clicks the component.
- `JTextComponent` method `setEditable` (p. 564) can be used to make a text field uneditable.
- To respond to an event for a particular GUI component, you must create a class that represents the event handler and implements an appropriate event-listener interface (p. 564), then register an object of the event-handling class as the event handler (p. 564).
- Non-static nested classes (p. 564) are called inner classes and are frequently used for event handling.
- An object of a non-static inner class (p. 564) must be created by an object of the top-level class (p. 564) that contains the inner class.
- An inner-class object can directly access the instance variables and methods of its top-level class.
- A nested class that's `static` does not require an object of its top-level class and does not implicitly have a reference to an object of the top-level class.
- Pressing *Enter* in a `JTextField` (p. 561) or `JPasswordField` generates an `ActionEvent` (p. 565) from package `java.awt.event` (p. 567) that can be handled by an `ActionListener` (p. 565; package `java.awt.event`).
- `JTextField` method `addActionListener` (p. 565) registers an event handler for a text field's `ActionEvent`.
- The GUI component with which the user interacts is the event source (p. 566).

- An `ActionEvent` object contains information about the event that just occurred, such as the event source and the text in the text field.
- `ActionEvent` method `getSource` returns a reference to the event source. `ActionEvent` method `getActionCommand` (p. 566) returns the text the user typed in a text field or the label on a `JButton`.
- `JPasswordField` method `getPassword` (p. 566) returns the password the user typed.

### *Section 14.7 Common GUI Event Types and Listener Interfaces*

- Each event-object type typically has a corresponding event-listener interface that specifies one or more event-handling methods which must be declared in the class that implements the interface.

### *Section 14.8 How Event Handling Works*

- When an event occurs, the GUI component with which the user interacted notifies its registered listeners by calling each listener's appropriate event-handling method.
- Every GUI component supports several event types. When an event occurs, the event is dispatched (p. 570) only to the event listeners of the appropriate type.

### *Section 14.9 JButton*

- A button is a component the user clicks to trigger an action. All the button types are subclasses of `AbstractButton` (p. 571; package `javax.swing`). Button labels (p. 571) typically use book-title capitalization (p. 554).
- Command buttons (p. 571) are created with class `JButton`.
- A `JButton` can display an `Icon`. A `JButton` can also have a rollover `Icon` (p. 571)—an `Icon` that's displayed when the user positions the mouse over the button.
- Method `setRolloverIcon` (p. 573) of class `AbstractButton` specifies the image displayed on a button when the user positions the mouse over it.

### *Section 14.10 Buttons That Maintain State*

- There are three Swing state button types—`JToggleButton` (p. 574), `JCheckBox` (p. 574) and `JRadioButton` (p. 574).
- Classes `JCheckBox` and `JRadioButton` are subclasses of `JToggleButton`.
- Component method `setFont` (p. 576) sets the component's font to a new `Font` object (p. 576; package `java.awt`).
- Clicking a `JCheckBox` causes an `ItemEvent` (p. 576) that can be handled by an `ItemListener` (p. 576) which defines method `itemStateChanged` (p. 576). Method `addItemListener` registers the listener for the `ItemEvent` of a `JCheckBox` or `JRadioButton` object.
- `JCheckBox` method `isSelected` determines whether a `JCheckBox` is selected.
- `JRadioButtons` have two states—selected and not selected. Radio buttons (p. 571) normally appear as a group (p. 577) in which only one button can be selected at a time.
- `JRadioButtons` are used to represent mutually exclusive options (p. 577).
- The logical relationship between `JRadioButtons` is maintained by a `ButtonGroup` object (p. 577).
- `ButtonGroup` method `add` (p. 580) associates each `JRadioButton` with a `ButtonGroup`. If more than one selected `JRadioButton` object is added to a group, the selected one that was added first will be selected when the GUI is displayed.
- `JRadioButtons` generate `ItemEvents` when they're clicked.

### *Section 14.11 JComboBox and Using an Anonymous Inner Class for Event Handling*

- A `JComboBox` (p. 580) provides a list of items from which the user can make a single selection. `JComboBoxes` generate `ItemEvents`.

- Each item in a JComboBox has an index (p. 582). The first item added to a JComboBox appears as the currently selected item when the JComboBox is displayed.
- JComboBox method `setMaximumRowCount` (p. 583) sets the maximum number of elements that are displayed when the user clicks the JComboBox.
- An anonymous inner class (p. 583) is an inner class without a name and typically appears inside a method declaration. One object of the anonymous inner class must be created when the class is declared.
- JComboBox method `getSelectedIndex` (p. 583) returns the index of the selected item.

### Section 14.12 JList

- A JList displays a series of items from which the user may select one or more items. Class JList supports single-selection lists (p. 584) and multiple-selection lists.
- When the user clicks an item in a JList, a `ListSelectionEvent` (p. 584) occurs. JList method `addListSelectionListener` (p. 586) registers a `ListSelectionListener` (p. 586) for a JList's selection events. A `ListSelectionListener` of package `javax.swing.event` (p. 567) must implement method `valueChanged`.
- JList method `setVisibleRowCount` (p. 586) specifies the number of visible items in the list.
- JList method `setSelectionMode` (p. 586) specifies a list's selection mode (p. 586).
- A JList can be attached to a `JScrollPane` (p. 586) to provide a scrollbar (p. 583) for the JList.
- `JFrame` method `getContentPane` (p. 586) returns a reference to the `JFrame`'s content pane where GUI components are displayed.
- JList method `getSelectedIndex` (p. 586) returns the selected item's index.

### Section 14.13 Multiple-Selection Lists

- A multiple-selection list (p. 584) enables the user to select many items from a JList.
- JList method `setFixedCellWidth` (p. 588) sets a JList's width. Method `setFixedCellHeight` (p. 588) sets the height of each item in a JList.
- Normally, an external event (p. 588) generated by another GUI component (such as a `JButton`) specifies when the multiple selections in a JList should be processed.
- JList method `setListData` (p. 589) sets the items displayed in a JList. JList method `getSelectedValues` (p. 589) returns an array of `Object`s representing the selected items in a JList.

### Section 14.14 Mouse Event Handling

- The `MouseListener` (p. 570) and `MouseMotionListener` (p. 589) event-listener interfaces are used to handle mouse events (p. 570). Mouse events can be trapped for any GUI component that extends `Component`.
- Interface `MouseEvent` (p. 589) of package `javax.swing.event` extends interfaces `MouseListener` and `MouseMotionListener` to create a single interface containing all their methods.
- Each mouse event-handling method receives a `MouseEvent` object (p. 570) that contains information about the event, including the *x*- and *y*-coordinates where the event occurred. Coordinates are measured from the upper-left corner of the GUI component on which the event occurred.
- The methods and constants of class `MouseEvent` (p. 589; `MouseEvent`'s superclass) enable an application to determine which mouse button the user clicked.
- Interface `MouseWheelListener` (p. 590) enables applications to respond to the rotation of a mouse wheel.

### Section 14.15 Adapter Classes

- An adapter class (p. 594) implements an interface and provides default implementations of its methods. When you extend an adapter class, you can override just the method(s) you need.
- `MouseEvent` method `getClickCount` (p. 597) returns the number of consecutive mouse-button clicks. Methods `isMetaDown` (p. 604) and `isAltDown` (p. 597) determine which mouse button the user clicked.

### Section 14.16 `JPanel` Subclass for Drawing with the Mouse

- `JComponent`'s method `paintComponent` (p. 597) is called when a lightweight Swing component is displayed. Override this method to specify how to draw shapes using Java's graphics capabilities.
- When overriding `paintComponent`, call the superclass version as the first statement in the body.
- Subclasses of `JComponent` support transparency. When a component is opaque (p. 597), `paintComponent` clears its background before the component is displayed.
- The transparency of a Swing lightweight component can be set with method `setOpaque` (p. 597); a `false` argument indicates that the component is transparent).
- Class `Point` (p. 599) package `java.awt` represents an *x-y* coordinate.
- Class `Graphics` (p. 599) is used to draw.
- `MouseEvent` method `getPoint` (p. 599) obtains the `Point` where a mouse event occurred.
- Method `repaint` (p. 599), inherited indirectly from class `Component`, indicates that a component should be refreshed on the screen as soon as possible.
- Method `paintComponent` receives a `Graphics` parameter and is called automatically whenever a lightweight component needs to be displayed on the screen.
- `Graphics` method `fillOval` (p. 600) draws a solid oval. The first two arguments are the upper-left *x-y* coordinate of the bounding box, and the last two are the bounding box's width and height.

### Section 14.17 Key Event Handling

- Interface `KeyListener` (p. 570) is used to handle key events (p. 570) that are generated when keys on the keyboard are pressed and released. Method `addKeyListener` of class `Component` (p. 601) registers a `KeyListener`.
- `KeyEvent` (p. 570) method `getKeyCode` (p. 603) gets the virtual key code (p. 603) of the key that was pressed. Class `KeyEvent` maintains a set of virtual key-code constants that represent every key on the keyboard.
- `KeyEvent` method `getKeyText` (p. 604) returns a string containing the name of the key that was pressed.
- `KeyEvent` method `getKeyChar` (p. 604) gets the Unicode value of the character typed.
- `KeyEvent` method `isActionKey` (p. 604) determines whether the key in an event was an action key (p. 601).
- `InputEvent` method `getModifiers` (p. 604) determines whether any modifier keys (such as *Shift*, *Alt* and *Ctrl*) were pressed when the key event occurred.
- `KeyEvent` method `getKeyModifiersText` (p. 604) returns a string containing the pressed modifier keys.

### Section 14.18 Introduction to Layout Managers

- Layout managers (p. 559) arrange GUI components in a container for presentation purposes.
- All layout managers implement the interface `LayoutManager` (p. 604) of package `java.awt`.
- Container method `setLayout` (p. 559) specifies the layout of a container.

- `FlowLayout` (p. 559) places components left to right in the order in which they're added to the container. When the container's edge is reached, components continue to display on the next line. `FlowLayout` allows GUI components to be left aligned, centered (the default) and right aligned.
- `FlowLayout` method `setAlignment` (p. 608) changes the alignment for a `FlowLayout`.
- `BorderLayout` (p. 592) the default for a `JFrame`) arranges components into five regions: NORTH, SOUTH, EAST, WEST and CENTER. NORTH corresponds to the top of the container.
- A `BorderLayout` limits a `Container` to containing at most five components—one in each region.
- `GridLayout` (p. 611) divides a container into a grid of rows and columns.
- `Container` method `validate` (p. 613) recomputes a container's layout based on the current layout manager for the `Container` and the current set of displayed GUI components.

### Section 14.19 Using Panels to Manage More Complex Layouts

- Complex GUIs often consist of multiple panels with different layouts. Every `JPanel` may have components, including other panels, attached to it with `Container` method `add`.

### Section 14.20 JTextArea

- A `JTextArea` (p. 615) may contain multiple lines of text. `JTextArea` is a subclass of `JTextComponent`.
- Class `Box` (p. 617) is a subclass of `Container` that uses a `BoxLayout` layout manager (p. 617) to arrange the GUI components either horizontally or vertically.
- `Box` static method `createHorizontalBox` (p. 617) creates a `Box` that arranges components from left to right in the order that they're attached.
- Method `getSelectedText` (p. 617) returns the selected text from a `JTextArea`.
- You can set the horizontal and vertical scrollbar policies (p. 617) of a `JScrollPane` when it's constructed. `JScrollPane` methods `setHorizontalScrollBarPolicy` (p. 618), and `setVerticalScrollBarPolicy` (p. 618) can be used to change the scrollbar policies at any time.

## Self-Review Exercises

- 14.1** Fill in the blanks in each of the following statements:
- Method \_\_\_\_\_ is called when the mouse is moved with no buttons pressed and an event listener is registered to handle the event.
  - Text that cannot be modified by the user is called \_\_\_\_\_ text.
  - A(n) \_\_\_\_\_ arranges GUI components in a `Container`.
  - The add method for attaching GUI components is a method of class \_\_\_\_\_.
  - GUI is an acronym for \_\_\_\_\_.
  - Method \_\_\_\_\_ is used to specify the layout manager for a container.
  - A `mouseDragged` method call is preceded by a(n) \_\_\_\_\_ method call and followed by a(n) \_\_\_\_\_ method call.
  - Class \_\_\_\_\_ contains methods that display message dialogs and input dialogs.
  - An input dialog capable of receiving input from the user is displayed with method \_\_\_\_\_ of class \_\_\_\_\_.
  - A dialog capable of displaying a message to the user is displayed with method of class \_\_\_\_\_.
  - Both `JTextField`s and `JTextAreas` directly extend class \_\_\_\_\_.
- 14.2** Determine whether each statement is *true* or *false*. If *false*, explain why.
- `BorderLayout` is the default layout manager for a `JFrame`'s content pane.
  - When the mouse cursor is moved into the bounds of a GUI component, method `mouseOver` is called.
  - A `JPanel` cannot be added to another `JPanel`.

- d) In a BorderLayout, two buttons added to the NORTH region will be placed side by side.
- e) A maximum of five components can be added to a BorderLayout.
- f) Inner classes are not allowed to access the members of the enclosing class.
- g) A JTextArea's text is always read-only.
- h) Class JTextArea is a direct subclass of class Component.

**14.3** Find the error(s) in each of the following statements, and explain how to correct it (them):

- a) `buttonName = JButton( "Caption" );`
- b) `JLabel aLabel, JLabel; // create references`
- c) `txtField = new JTextField( 50, "Default Text" );`
- d) `setLayout( new BorderLayout() );`  
`button1 = new JButton( "North Star" );`  
`button2 = new JButton( "South Pole" );`  
`add( button1 );`  
`add( button2 );`

## Answers to Self-Review Exercises

**14.1** a) mouseMoved. b) uneditable (read-only). c) layout manager. d) Container. e) graphical user interface. f) setLayout. g) mousePressed, mouseReleased. h) JOptionPane. i) showInputDialog, JOptionPane. j) showMessageDialog, JOptionPane. k) JTextComponent.

- 14.2**
- a) True.
  - b) False. Method mouseEntered is called.
  - c) False. A JPanel can be added to another JPanel, because JPanel is an indirect subclass of Component. So, a JPanel is a Component. Any Component can be added to a Container.
  - d) False. Only the last button added will be displayed. Remember that only one component should be added to each region in a BorderLayout.
  - e) True. [*Note:* Panels containing multiple components can be added to each region.]
  - f) False. Inner classes have access to all members of the enclosing class declaration.
  - g) False. JTextAreas are editable by default.
  - h) False. JTextArea derives from class JTextComponent.

- 14.3**
- a) new is needed to create an object.
  - b) JLabel is a class name and cannot be used as a variable name.
  - c) The arguments passed to the constructor are reversed. The String must be passed first.
  - d) BorderLayout has been set, and components are being added without specifying the region, so both are added to the center region. Proper add statements might be  
`add( button1, BorderLayout.NORTH );`  
`add( button2, BorderLayout.SOUTH );`

## Exercises

**14.4** Fill in the blanks in each of the following statements:

- a) The JTextField class directly extends class \_\_\_\_\_.
- b) Container method \_\_\_\_\_ attaches a GUI component to a container.
- c) Method \_\_\_\_\_ is called when a mouse button is released (without moving the mouse).
- d) The \_\_\_\_\_ class is used to create a group of JRadioButtons.

**14.5** Determine whether each statement is *true* or *false*. If *false*, explain why.

- a) Only one layout manager can be used per Container.
- b) GUI components can be added to a Container in any order in a BorderLayout.
- c) JRadioButtons provide a series of mutually exclusive options (i.e., only one can be true at a time).

- d) Graphics method `setFont` is used to set the font for text fields.
- e) A `JList` displays a scrollbar if there are more items in the list than can be displayed.
- f) A `Mouse` object has a method called `mouseDragged`.

**14.6** Determine whether each statement is *true* or *false*. If *false*, explain why.

- a) A `JPanel` is a `JComponent`.
- b) A `JPanel` is a `Component`.
- c) A `JLabel` is a `Container`.
- d) A `JList` is a `JPanel`.
- e) An `AbstractButton` is a `JButton`.
- f) A `TextField` is an `Object`.
- g) `ButtonGroup` is a subclass of `JComponent`.

**14.7** Find any errors in each of the following lines of code, and explain how to correct them.

- a) `import javax.swing.JFrame`
- b) `pane1Object.GridLayout( 8, 8 ); // set GridLayout`
- c) `container.setLayout( new FlowLayout( FlowLayout.DEFAULT ) );`
- d) `container.add( eastButton, EAST ); // BorderLayout`

**14.8** Create the following GUI. You do not have to provide any functionality.

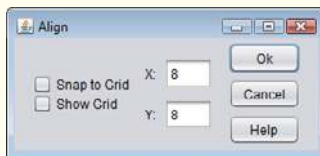

**14.9** Create the following GUI. You do not have to provide any functionality.

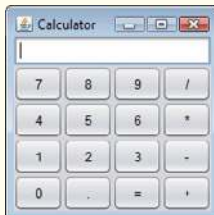

**14.10** Create the following GUI. You do not have to provide any functionality.

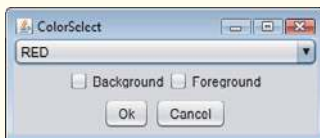

**14.11** Create the following GUI. You do not have to provide any functionality.

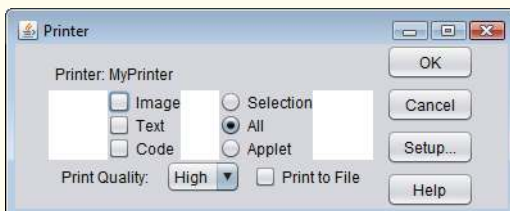



**14.12 (Temperature Conversion)** Write a temperature-conversion application that converts from Fahrenheit to Celsius. The Fahrenheit temperature should be entered from the keyboard (via a `JTextField`). A `JLabel` should be used to display the converted temperature. Use the following formula for the conversion:

$$\text{Celsius} = \frac{5}{9} \times (\text{Fahrenheit} - 32)$$

**14.13 (Temperature-Conversion Modification)** Enhance the temperature-conversion application of Exercise 14.12 by adding the Kelvin temperature scale. The application should also allow the user to make conversions between any two scales. Use the following formula for the conversion between Kelvin and Celsius (in addition to the formula in Exercise 14.12):

$$\text{Kelvin} = \text{Celsius} + 273.15$$

**14.14 (Guess-the-Number Game)** Write an application that plays “guess the number” as follows: Your application chooses the number to be guessed by selecting an integer at random in the range 1–1000. The application then displays the following in a label:

I have a number between 1 and 1000. Can you guess my number?  
Please enter your first guess.

A `JTextField` should be used to input the guess. As each guess is input, the background color should change to either red or blue. Red indicates that the user is getting “warmer,” and blue, “colder.” A `JLabel` should display either “Too High” or “Too Low” to help the user zero in. When the user gets the correct answer, “Correct!” should be displayed, and the `JTextField` used for input should be changed to be uneditable. A `JButton` should be provided to allow the user to play the game again. When the `JButton` is clicked, a new random number should be generated and the input `JTextField` changed to be editable.

**14.15 (Displaying Events)** It’s often useful to display the events that occur during the execution of an application. This can help you understand when the events occur and how they’re generated. Write an application that enables the user to generate and process every event discussed in this chapter. The application should provide methods from the `ActionListener`, `ItemListener`, `ListSelectionListener`, `MouseListener`, `MouseMotionListener` and `KeyListener` interfaces to display messages when the events occur. Use method `toString` to convert the event objects received in each event handler into `Strings` that can be displayed. Method `toString` creates a `String` containing all the information in the event object.

**14.16 (GUI-Based Craps Game)** Modify the application of Section 6.10 to provide a GUI that enables the user to click a `JButton` to roll the dice. The application should also display four `JLabels` and four `JTextFields`, with one `JLabel` for each `JTextField`. The `JTextFields` should be used to display the values of each die and the sum of the dice after each roll. The point should be displayed in the fourth `JTextField` when the user does not win or lose on the first roll and should continue to be displayed until the game is lost.

### (Optional) GUI and Graphics Case Study Exercise: Expanding the Interface

**14.17 (Interactive Drawing Application)** In this exercise, you’ll implement a GUI application that uses the `MyShape` hierarchy from GUI and Graphics Case Study Exercise 10.2 to create an interactive drawing application. You’ll create two classes for the GUI and provide a test class that launches the application. The classes of the `MyShape` hierarchy require no additional changes.

The first class to create is a subclass of `JPanel` called `DrawPanel`, which represents the area on which the user draws the shapes. Class `DrawPanel` should have the following instance variables:

- An array `shapes` of type `MyShape` that will store all the shapes the user draws.
- An integer `shapeCount` that counts the number of shapes in the array.
- An integer `shapeType` that determines the type of shape to draw.
- A `MyShape` `currentShape` that represents the current shape the user is drawing.

- e) A `Color` `currentColor` that represents the current drawing color.
- f) A boolean `filledShape` that determines whether to draw a filled shape.
- g) A `JLabel` `statusLabel` that represents the status bar. The status bar will display the coordinates of the current mouse position.

Class `DrawPanel` should also declare the following methods:

- a) Overridden method `paintComponent` that draws the shapes in the array. Use instance variable `shapeCount` to determine how many shapes to draw. Method `paintComponent` should also call `currentShape`'s `draw` method, provided that `currentShape` is not `null`.
- b) Set methods for the `shapeType`, `currentColor` and `filledShape`.
- c) Method `clearLastShape` should clear the last shape drawn by decrementing instance variable `shapeCount`. Ensure that `shapeCount` is never less than zero.
- d) Method `clearDrawing` should remove all the shapes in the current drawing by setting `shapeCount` to zero.

Methods `clearLastShape` and `clearDrawing` should call `repaint` (inherited from `JPanel`) to refresh the drawing on the `DrawPanel` by indicating that the system should call method `paintComponent`.

Class `DrawPanel` should also provide event handling to enable the user to draw with the mouse. Create a single inner class that both extends `MouseAdapter` and implements `MouseListener` to handle all mouse events in one class.

In the inner class, override method `mousePressed` so that it assigns `currentShape` a new shape of the type specified by `shapeType` and initializes both points to the mouse position. Next, override method `mouseReleased` to finish drawing the current shape and place it in the array. Set the second point of `currentShape` to the current mouse position and add `currentShape` to the array. Instance variable `shapeCount` determines the insertion index. Set `currentShape` to `null` and call method `repaint` to update the drawing with the new shape.

Override method `mouseMoved` to set the text of the `statusLabel` so that it displays the mouse coordinates—this will update the label with the coordinates every time the user moves (but does not drag) the mouse within the `DrawPanel`. Next, override method `mouseDragged` so that it sets the second point of the `currentShape` to the current mouse position and calls method `repaint`. This will allow the user to see the shape while dragging the mouse. Also, update the `JLabel` in `mouseDragged` with the current position of the mouse.

Create a constructor for `DrawPanel` that has a single `JLabel` parameter. In the constructor, initialize `statusLabel` with the value passed to the parameter. Also initialize array `shapes` with 100 entries, `shapeCount` to 0, `shapeType` to the value that represents a line, `currentShape` to `null` and `currentColor` to `Color.BLACK`. The constructor should then set the background color of the `DrawPanel` to `Color.WHITE` and register the `MouseListener` and `MouseMotionListener` so the `JPanel` properly handles mouse events.

Next, create a `JFrame` subclass called `DrawFrame` that provides a GUI that enables the user to control various aspects of drawing. For the layout of the `DrawFrame`, we recommend a `BorderLayout`, with the components in the `NORTH` region, the main drawing panel in the `CENTER` region, and a status bar in the `SOUTH` region, as in Fig. 14.49. In the top panel, create the components listed below. Each component's event handler should call the appropriate method in class `DrawPanel`.

- a) A button to undo the last shape drawn.
- b) A button to clear all shapes from the drawing.
- c) A combo box for selecting the color from the 13 predefined colors.
- d) A combo box for selecting the shape to draw.
- e) A checkbox that specifies whether a shape should be filled or unfilled.

Declare and create the interface components in `DrawFrame`'s constructor. You'll need to create the status bar `JLabel` before you create the `DrawPanel`, so you can pass the `JLabel` as an argument to `DrawPanel`'s constructor. Finally, create a test class that initializes and displays the `DrawFrame` to execute the application.

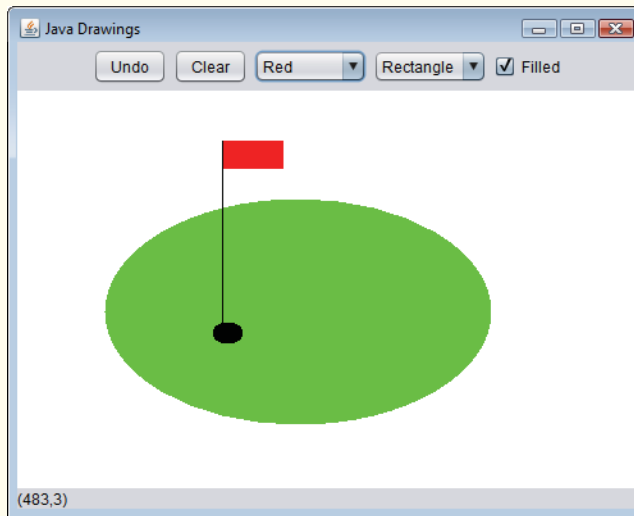

**Fig. 14.49** | Interface for drawing shapes.

**14.18** (*GUI-Based Version of the ATM Case Study*) Reimplement the ATM Case Study of Chapters 12–13 as a GUI-based application. Use GUI components to approximate the ATM user interface shown in Fig. 12.1. For the cash dispenser and the deposit slot use `JButtons` labeled **Remove Cash** and **Insert Envelope**. This will enable the application to receive events indicating when the user takes the cash and inserts a deposit envelope, respectively.

## Making a Difference

**14.19** (*Ecofont*) Ecofont ([www.ecofont.eu/ecofont\\_en.html](http://www.ecofont.eu/ecofont_en.html))—developed by SPRANQ (a Netherlands-based company)—is a free, open-source computer font designed to reduce by as much as 20% the amount of ink used for printing, thus reducing also the number of ink cartridges used and the environmental impact of the manufacturing and shipping processes (using less energy, less fuel for shipping, and so on). The font, based on sans-serif Verdana, has small circular “holes” in the letters that are not visible in smaller sizes—such as the 9- or 10-point type frequently used. Download Ecofont, then install the font file `Spranq_eco_sans_regular.ttf` using the instructions from the Ecofont website. Next, develop a GUI-based program that allows you to type in a text string to be displayed in the Ecofont. Create **Increase Font Size** and **Decrease Font Size** buttons that allow you to scale up or down by one point at a time. Start with a default font size of 9 points. As you scale up, you’ll be able to see the holes in the letters more clearly. As you scale down, the holes will be less apparent. What is the smallest font size at which you begin to notice the holes?

**14.20** (*Typing Tutor: Tuning a Crucial Skill in the Computer Age*) Typing quickly and correctly is an essential skill for working effectively with computers and the Internet. In this exercise, you’ll build a GUI application that can help users learn to “touch type” (i.e., type correctly without looking at the keyboard). The application should display a *virtual keyboard* (Fig. 14.50) and should allow the user to watch what he or she is typing on the screen without looking at the *actual keyboard*. Use `JButtons` to represent the keys. As the user presses each key, the application highlights the corresponding `JButton` on the GUI and adds the character to a `JTextArea` that shows what the user has typed so far. [*Hint*: To highlight a `JButton`, use its `setBackground` method to change its background

color. When the key is released, reset its original background color. You can obtain the JButton's original background color with the `getBackground` method before you change its color.]

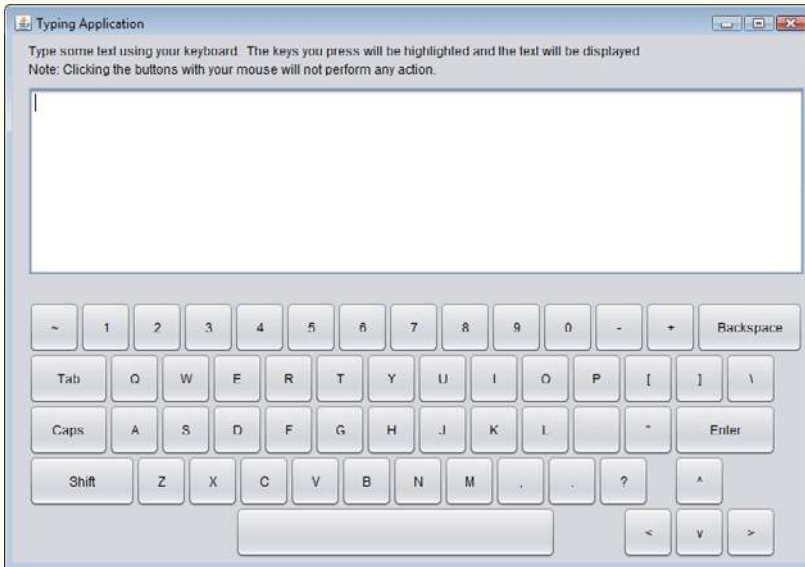

**Fig. 14.50** | Typing tutor.

You can test your program by typing a pangram—a phrase that contains every letter of the alphabet at least once—such as “The quick brown fox jumped over a lazy dog.” You can find other pangrams on the web.

To make the program more interesting you could monitor the user's accuracy. You could have the user type specific phrases that you've prestored in your program and that you display on the screen above the virtual keyboard. You could keep track of how many keystrokes the user types correctly and how many are typed incorrectly. You could also keep track of which keys the user is having difficulty with and display a report showing those keys.



*One picture is worth ten thousand words.*

—Chinese proverb

*Treat nature in terms of the cylinder, the sphere, the cone, all in perspective.*

—Paul Cézanne

*Colors, like features, follow the changes of the emotions.*

—Pablo Picasso

*Nothing ever becomes real till it is experienced—even a proverb is no proverb to you till your life has illustrated it.*

—John Keats

## Objectives

In this chapter you'll learn:

- To understand graphics contexts and graphics objects.
- To manipulate colors and fonts.
- To use methods of class `Graphics` to draw various shapes.
- To use methods of class `Graphics2D` from the Java 2D API to draw various shapes.
- To specify `Paint` and `Stroke` characteristics of shapes displayed with `Graphics2D`.

- |                                                    |                                            |
|----------------------------------------------------|--------------------------------------------|
| <b>15.1</b> Introduction                           | <b>15.6</b> Drawing Arcs                   |
| <b>15.2</b> Graphics Contexts and Graphics Objects | <b>15.7</b> Drawing Polygons and Polylines |
| <b>15.3</b> Color Control                          | <b>15.8</b> Java 2D API                    |
| <b>15.4</b> Manipulating Fonts                     | <b>15.9</b> Wrap-Up                        |
| <b>15.5</b> Drawing Lines, Rectangles and Ovals    |                                            |

*Summary | Self-Review Exercises | Answers to Self-Review Exercises | Exercises | Optional GUI and Graphics Case Study: Adding Java 2D | Making a Difference*

## 15.1 Introduction

In this chapter, we overview several of Java’s capabilities for drawing two-dimensional shapes, controlling colors and controlling fonts. Part of Java’s initial appeal was its support for graphics that enabled programmers to visually enhance their applications. Java now contains many more sophisticated drawing capabilities as part of the Java 2D API. This chapter begins by introducing many of Java’s original drawing capabilities. Next we present several of the more powerful Java 2D capabilities, such as controlling the style of lines used to draw shapes and the way shapes are filled with colors and patterns. The classes that were part of Java’s original graphics capabilities are now considered to be part of the Java 2D API.

Figure 15.1 shows a portion of the Java class hierarchy that includes several of the basic graphics classes and Java 2D API classes and interfaces covered in this chapter. Class **Color** contains methods and constants for manipulating colors. Class **JComponent** contains method `paintComponent`, which is used to draw graphics on a component. Class **Font** contains methods and constants for manipulating fonts. Class **FontMetrics** contains methods for obtaining font information. Class **Graphics** contains methods for drawing strings, lines, rectangles and other shapes. Class **Graphics2D**, which extends class **Graphics**, is used for drawing with the Java 2D API. Class **Polygon** contains methods for creating polygons. The bottom half of the figure lists several classes and interfaces from the Java 2D API. Class **BasicStroke** helps specify the drawing characteristics of lines. Classes **GradientPaint** and **TexturePaint** help specify the characteristics for filling shapes with colors or patterns. Classes `GeneralPath`, `Line2D`, `Arc2D`, `Ellipse2D`, `Rectangle2D` and `RoundRectangle2D` represent several Java 2D shapes.

To begin drawing in Java, we must first understand Java’s **coordinate system** (Fig. 15.2), which is a scheme for identifying every point on the screen. By default, the upper-left corner of a GUI component (e.g., a window) has the coordinates (0, 0). A coordinate pair is composed of an **x-coordinate** (the **horizontal coordinate**) and a **y-coordinate** (the **vertical coordinate**). The **x-coordinate** is the horizontal distance moving *right* from the left of the screen. The **y-coordinate** is the vertical distance moving *down* from the top of the screen. The **x-axis** describes every horizontal coordinate, and the **y-axis** every vertical coordinate. The coordinates are used to indicate where graphics should be displayed on a screen. Coordinate units are measured in **pixels** (which stands for “picture element”). A pixel is a display monitor’s smallest unit of resolution.



### Portability Tip 15.1

*Different display monitors have different resolutions (i.e., the density of the pixels varies). This can cause graphics to appear in different sizes on different monitors or on the same monitor with different settings.*

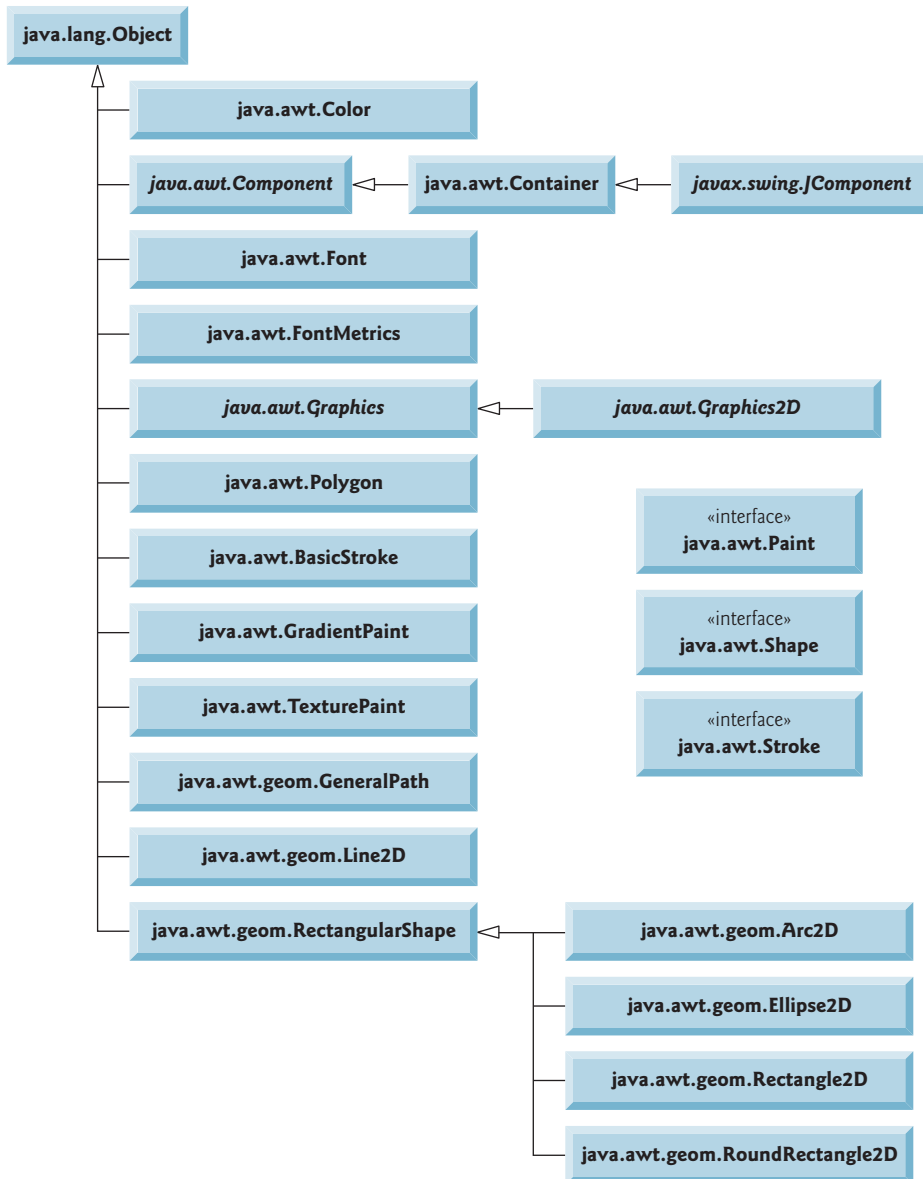

**Fig. 15.1** | Classes and interfaces used in this chapter from Java's original graphics capabilities and from the Java 2D API.

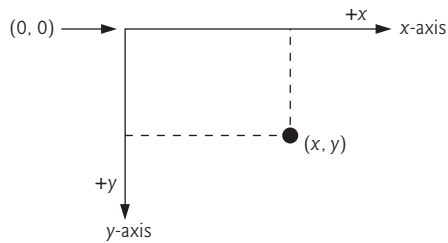

**Fig. 15.2** | Java coordinate system. Units are measured in pixels.

## 15.2 Graphics Contexts and Graphics Objects

A **graphics context** enables drawing on the screen. A `Graphics` object manages a graphics context and draws pixels on the screen that represent text and other graphical objects (e.g., lines, ellipses, rectangles and other polygons). `Graphics` objects contain methods for drawing, font manipulation, color manipulation and the like.

Class `Graphics` is an abstract class (i.e., `Graphics` objects cannot be instantiated). This contributes to Java's portability. Because drawing is performed differently on every platform that supports Java, there cannot be only one implementation of the drawing capabilities across all systems. For example, the graphics capabilities that enable a PC running Microsoft Windows to draw a rectangle are different from those that enable a Linux workstation to draw a rectangle—and they're both different from the graphics capabilities that enable a Macintosh to draw a rectangle. When Java is implemented on each platform, a subclass of `Graphics` is created that implements the drawing capabilities. This implementation is hidden by class `Graphics`, which supplies the interface that enables us to use graphics in a platform-independent manner.

Recall from Chapter 14 that class `Component` is the superclass for many of the classes in package `java.awt`. Class `JComponent` (package `javax.swing`), which inherits indirectly from class `Component`, contains a `paintComponent` method that can be used to draw graphics. Method `paintComponent` takes a `Graphics` object as an argument. This object is passed to the `paintComponent` method by the system when a lightweight Swing component needs to be repainted. The header for the `paintComponent` method is

```
public void paintComponent(Graphics g)
```

Parameter `g` receives a reference to an instance of the system-specific subclass that `Graphics` extends. The preceding method header should look familiar to you—it's the same one we used in some of the applications in Chapter 14. Actually, class `JComponent` is a superclass of `JPanel`. Many capabilities of class `JPanel` are inherited from class `JComponent`.

You seldom call method `paintComponent` directly, because drawing graphics is an event-driven process. As we mentioned in Chapter 11, Java uses a multithreaded model of program execution. Each thread is a parallel activity. Each program can have many threads. When you create a GUI-based application, one of those threads is known as the **event-dispatch thread (EDT)**—it's used to process all GUI events. All drawing and manipulation of GUI components should be performed in that thread. When a GUI application executes, the application container calls method `paintComponent` (in the



event-dispatch thread) for each lightweight component as the GUI is displayed. For `paintComponent` to be called again, an event must occur (such as covering and uncovering the component with another window).

If you need `paintComponent` to execute (i.e., if you want to update the graphics drawn on a Swing component), you can call method **repaint**, which is inherited by all `JComponent`s indirectly from class `Component` (package `java.awt`). The header for `repaint` is

```
public void repaint()
```

## 15.3 Color Control

Class `Color` declares methods and constants for manipulating colors in a Java program. The predeclared color constants are summarized in Fig. 15.3, and several color methods and constructors are summarized in Fig. 15.4. Two of the methods in Fig. 15.4 are Graphics methods that are specific to colors.

| Color constant                                    | RGB value     |
|---------------------------------------------------|---------------|
| <code>public final static Color RED</code>        | 255, 0, 0     |
| <code>public final static Color GREEN</code>      | 0, 255, 0     |
| <code>public final static Color BLUE</code>       | 0, 0, 255     |
| <code>public final static Color ORANGE</code>     | 255, 200, 0   |
| <code>public final static Color PINK</code>       | 255, 175, 175 |
| <code>public final static Color CYAN</code>       | 0, 255, 255   |
| <code>public final static Color MAGENTA</code>    | 255, 0, 255   |
| <code>public final static Color YELLOW</code>     | 255, 255, 0   |
| <code>public final static Color BLACK</code>      | 0, 0, 0       |
| <code>public final static Color WHITE</code>      | 255, 255, 255 |
| <code>public final static Color GRAY</code>       | 128, 128, 128 |
| <code>public final static Color LIGHT_GRAY</code> | 192, 192, 192 |
| <code>public final static Color DARK_GRAY</code>  | 64, 64, 64    |

**Fig. 15.3** | `Color` constants and their RGB values.

| Method                                                 | Description                                                                                                 |
|--------------------------------------------------------|-------------------------------------------------------------------------------------------------------------|
| <i>Color constructors and methods</i>                  |                                                                                                             |
| <code>public Color( int r, int g, int b )</code>       | Creates a color based on red, green and blue components expressed as integers from 0 to 255.                |
| <code>public Color( float r, float g, float b )</code> | Creates a color based on red, green and blue components expressed as floating-point values from 0.0 to 1.0. |

**Fig. 15.4** | `Color` methods and color-related Graphics methods. (Part 1 of 2.)

| Method                                          | Description                                                                            |
|-------------------------------------------------|----------------------------------------------------------------------------------------|
| <code>public int getRed()</code>                | Returns a value between 0 and 255 representing the red content.                        |
| <code>public int getGreen()</code>              | Returns a value between 0 and 255 representing the green content.                      |
| <code>public int getBlue()</code>               | Returns a value between 0 and 255 representing the blue content.                       |
| <i>Graphics methods for manipulating Colors</i> |                                                                                        |
| <code>public Color getColor()</code>            | Returns <code>Color</code> object representing current color for the graphics context. |
| <code>public void setColor( Color c )</code>    | Sets the current color for drawing with the graphics context.                          |

**Fig. 15.4** | `Color` methods and color-related `Graphics` methods. (Part 2 of 2.)

Every color is created from a red, a green and a blue component. Together these components are called **RGB values**. All three RGB components can be integers in the range from 0 to 255, or all three can be floating-point values in the range 0.0 to 1.0. The first RGB component specifies the amount of red, the second the amount of green and the third the amount of blue. The larger the RGB value, the greater the amount of that particular color. Java enables you to choose from  $256 \times 256 \times 256$  (approximately 16.7 million) colors. Not all computers are capable of displaying all these colors. The computer will display the closest color it can.

Two of class `Color`'s constructors are shown in Fig. 15.4—one that takes three `int` arguments and one that takes three `float` arguments, with each argument specifying the amount of red, green and blue. The `int` values must be in the range 0–255 and the `float` values in the range 0.0–1.0. The new `Color` object will have the specified amounts of red, green and blue. `Color` methods **`getRed`**, **`getGreen`** and **`getBlue`** return integer values from 0 to 255 representing the amounts of red, green and blue, respectively. `Graphics` method **`getColor`** returns a `Color` object representing the current drawing color. `Graphics` method **`setColor`** sets the current drawing color.

### *Drawing in Different Colors*

Figures 15.5–15.6 demonstrate several methods from Fig. 15.4 by drawing filled rectangles and `Strings` in several different colors. When the application begins execution, class `ColorJPanel`'s `paintComponent` method (lines 10–37 of Fig. 15.5) is called to paint the window. Line 17 uses `Graphics` method `setColor` to set the drawing color. Method `setColor` receives a `Color` object. The expression `new Color( 255, 0, 0 )` creates a new `Color` object that represents red (red value 255, and 0 for the green and blue values). Line 18 uses `Graphics` method **`fillRect`** to draw a filled rectangle in the current color. Method `fillRect` draws a rectangle based on its four arguments. The first two integer values represent the upper-left *x*-coordinate and upper-left *y*-coordinate, where the `Graphics` object begins drawing the rectangle. The third and fourth arguments are nonnegative integers that

represent the width and the height of the rectangle in pixels, respectively. A rectangle drawn using method `fillRect` is filled by the current color of the `Graphics` object.

---

```

1 // Fig. 15.5: ColorJPanel.java
2 // Demonstrating Colors.
3 import java.awt.Graphics;
4 import java.awt.Color;
5 import javax.swing.JPanel;
6
7 public class ColorJPanel extends JPanel
8 {
9 // draw rectangles and Strings in different colors
10 public void paintComponent(Graphics g)
11 {
12 super.paintComponent(g); // call superclass's paintComponent
13
14 this.setBackground(Color.WHITE);
15
16 // set new drawing color using integers
17 g.setColor(new Color(255, 0, 0));
18 g.fillRect(15, 25, 100, 20);
19 g.drawString("Current RGB: " + g.getColor(), 130, 40);
20
21 // set new drawing color using floats
22 g.setColor(new Color(0.50f, 0.75f, 0.0f));
23 g.fillRect(15, 50, 100, 20);
24 g.drawString("Current RGB: " + g.getColor(), 130, 65);
25
26 // set new drawing color using static Color objects
27 g.setColor(Color.BLUE);
28 g.fillRect(15, 75, 100, 20);
29 g.drawString("Current RGB: " + g.getColor(), 130, 90);
30
31 // display individual RGB values
32 Color color = Color.MAGENTA;
33 g.setColor(color);
34 g.fillRect(15, 100, 100, 20);
35 g.drawString("RGB values: " + color.getRed() + ", " +
36 color.getGreen() + ", " + color.getBlue(), 130, 115);
37 } // end method paintComponent
38 } // end class ColorJPanel

```

---

**Fig. 15.5** | Color changed for drawing.

---

```

1 // Fig. 15.6: ShowColors.java
2 // Demonstrating Colors.
3 import javax.swing.JFrame;
4
5 public class ShowColors
6 {

```

---

**Fig. 15.6** | Creating `JFrame` to display colors on `JPanel`. (Part I of 2.)

```

7 // execute application
8 public static void main(String[] args)
9 {
10 // create frame for ColorJPanel
11 JFrame frame = new JFrame("Using colors");
12 frame.setDefaultCloseOperation(JFrame.EXIT_ON_CLOSE);
13
14 ColorJPanel colorJPanel = new ColorJPanel(); // create ColorJPanel
15 frame.add(colorJPanel); // add colorJPanel to frame
16 frame.setSize(400, 180); // set frame size
17 frame.setVisible(true); // display frame
18 } // end main
19 } // end class ShowColors

```

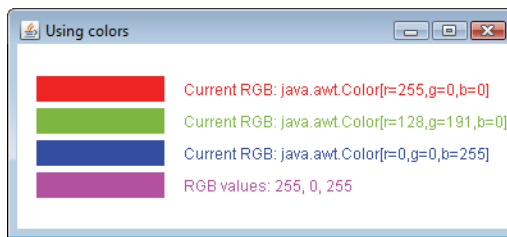

**Fig. 15.6** | Creating JFrame to display colors on JPanel. (Part 2 of 2.)

Line 19 (Fig. 15.5) uses Graphics method **drawString** to draw a String in the current color. The expression `g.getColor()` retrieves the current color from the Graphics object. We then concatenate the Color with string "Current RGB: ", resulting in an implicit call to class Color's `toString` method. The String representation of a Color contains the class name and package (`java.awt.Color`) and the red, green and blue values.



### Look-and-Feel Observation 15.1

*People perceive colors differently. Choose your colors carefully to ensure that your application is readable, both for people who can perceive color and for those who are color blind. Try to avoid using many different colors in close proximity.*

Lines 22–24 and 27–29 perform the same tasks again. Line 22 uses the Color constructor with three float arguments to create a dark green color (0.50f for red, 0.75f for green and 0.0f for blue). Note the syntax of the values. The letter f appended to a floating-point literal indicates that the literal should be treated as type float. Recall that by default, floating-point literals are treated as type double.

Line 27 sets the current drawing color to one of the predeclared Color constants (Color.BLUE). The Color constants are static, so they're created when class Color is loaded into memory at execution time.

The statement in lines 35–36 makes calls to Color methods `getRed`, `getGreen` and `getBlue` on the predeclared Color.MAGENTA constant. Method `main` of class ShowColors (lines 8–18 of Fig. 15.6) creates the JFrame that will contain a ColorJPanel object where the colors will be displayed.



### Software Engineering Observation 15.1

To change the color, you must create a new `Color` object (or use one of the predeclared `Color` constants). Like `String` objects, `Color` objects are immutable (not modifiable).

Package `javax.swing` provides the `JColorChooser` GUI component that enables application users to select colors. The application of Figs. 15.7–15.8 demonstrates a `JColorChooser` dialog. When you click the **Change Color** button, a `JColorChooser` dialog appears. When you select a color and press the dialog's **OK** button, the background color of the application window changes.

```

1 // Fig. 15.7: ShowColors2JFrame.java
2 // Choosing colors with JColorChooser.
3 import java.awt.BorderLayout;
4 import java.awt.Color;
5 import java.awt.event.ActionEvent;
6 import java.awt.event.ActionListener;
7 import javax.swing.JButton;
8 import javax.swing.JFrame;
9 import javax.swing.JColorChooser;
10 import javax.swing.JPanel;
11
12 public class ShowColors2JFrame extends JFrame
13 {
14 private JButton changeColorJButton;
15 private Color color = Color.LIGHT_GRAY;
16 private JPanel colorJPanel;
17
18 // set up GUI
19 public ShowColors2JFrame()
20 {
21 super("Using JColorChooser");
22
23 // create JPanel for display color
24 colorJPanel = new JPanel();
25 colorJPanel.setBackground(color);
26
27 // set up changeColorJButton and register its event handler
28 changeColorJButton = new JButton("Change Color");
29 changeColorJButton.addActionListener(
30
31 new ActionListener() // anonymous inner class
32 {
33 // display JColorChooser when user clicks button
34 public void actionPerformed(ActionEvent event)
35 {
36 color = JColorChooser.showDialog(
37 ShowColors2JFrame.this, "Choose a color", color);
38
39 // set default color, if no color is returned
40 if (color == null)
41 color = Color.LIGHT_GRAY;

```

**Fig. 15.7** | `JColorChooser` dialog. (Part I of 2.)

```

42
43 // change content pane's background color
44 colorJPanel.setBackground(color);
45 } // end method actionPerformed
46 } // end anonymous inner class
47); // end call to addActionListener
48
49 add(colorJPanel, BorderLayout.CENTER); // add colorJPanel
50 add(changeColorJButton, BorderLayout.SOUTH); // add button
51
52 setSize(400, 130); // set frame size
53 setVisible(true); // display frame
54 } // end ShowColor2JFrame constructor
55 } // end class ShowColors2JFrame

```

**Fig. 15.7** | JColorChooser dialog. (Part 2 of 2.)

```

1 // Fig. 15.8: ShowColors2.java
2 // Choosing colors with JColorChooser.
3 import javax.swing.JFrame;
4
5 public class ShowColors2
6 {
7 // execute application
8 public static void main(String[] args)
9 {
10 ShowColors2JFrame application = new ShowColors2JFrame();
11 application.setDefaultCloseOperation(JFrame.EXIT_ON_CLOSE);
12 } // end main
13 } // end class ShowColors2

```

(a) Initial application window

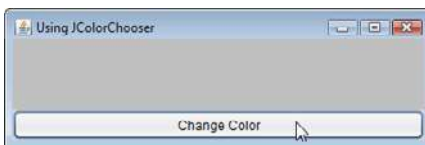

(b) JColorChooser window

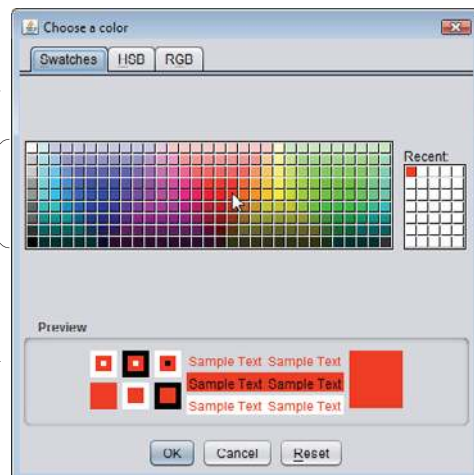

Select a color from  
one of the color  
swatches

(c) Application window after changing JPanel's background color

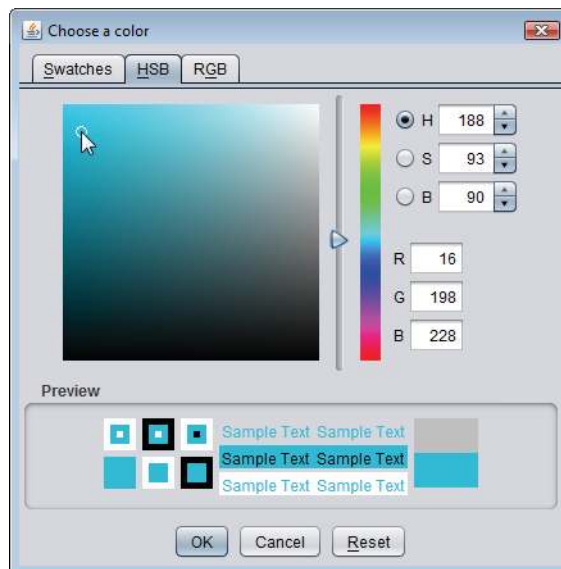

**Fig. 15.8** | Choosing colors with JColorChooser.

Class `JColorChooser` provides static method `showDialog`, which creates a `JColorChooser` object, attaches it to a dialog box and displays the dialog. Lines 36–37 of Fig. 15.7 invoke this method to display the color chooser dialog. Method `showDialog` returns the selected `Color` object, or `null` if the user presses **Cancel** or closes the dialog without pressing **OK**. The method takes three arguments—a reference to its parent `Component`, a `String` to display in the title bar of the dialog and the initial selected `Color` for the dialog. The parent component is a reference to the window from which the dialog is displayed (in this case the `JFrame`, with the reference name `frame`). The dialog will be centered on the parent. If the parent is `null`, the dialog is centered on the screen. While the color chooser dialog is on the screen, the user cannot interact with the parent component until the dialog is dismissed. This type of dialog is called a modal dialog.

After the user selects a color, lines 40–41 determine whether `color` is `null`, and, if so, set `color` to `Color.LIGHT_GRAY`. Line 44 invokes method `setBackground` to change the background color of the `JPanel`. Method `setBackground` is one of the many `Component` methods that can be used on most GUI components. The user can continue to use the **Change Color** button to change the background color of the application. Figure 15.8 contains method `main`, which executes the program.

Figure 15.8(b) shows the default `JColorChooser` dialog that allows the user to select a color from a variety of **color swatches**. There are three tabs across the top of the dialog—**Swatches**, **HSB** and **RGB**. These represent three different ways to select a color. The **HSB** tab allows you to select a color based on **hue**, **saturation** and **brightness**—values that are used to define the amount of light in a color. We do not discuss HSB values. For more information on them, visit [en.wikipedia.org/wiki/HSL\\_and\\_HSV](http://en.wikipedia.org/wiki/HSL_and_HSV). The **RGB** tab allows you to select a color by using sliders to select the red, green and blue components. The **HSB** and **RGB** tabs are shown in Fig. 15.9.



**Fig. 15.9** | HSB and RGB tabs of the `JColorChooser` dialog. (Part 1 of 2.)

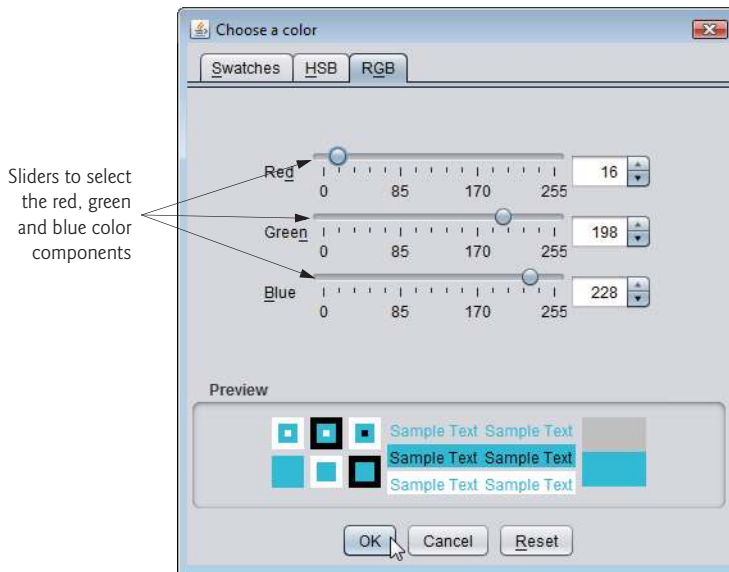

**Fig. 15.9** | HSB and RGB tabs of the JColorChooser dialog. (Part 2 of 2.)

## 15.4 Manipulating Fonts

This section introduces methods and constants for manipulating fonts. Most font methods and font constants are part of class `Font`. Some methods of class `Font` and class `Graphics` are summarized in Fig. 15.10.

| Method or constant                                               | Description                                                                      |
|------------------------------------------------------------------|----------------------------------------------------------------------------------|
| <i>Font constants, constructors and methods</i>                  |                                                                                  |
| <code>public final static int PLAIN</code>                       | A constant representing a plain font style.                                      |
| <code>public final static int BOLD</code>                        | A constant representing a bold font style.                                       |
| <code>public final static int ITALIC</code>                      | A constant representing an italic font style.                                    |
| <code>public Font( String name,<br/>int style, int size )</code> | Creates a <code>Font</code> object with the specified font name, style and size. |
| <code>public int getStyle()</code>                               | Returns an <code>int</code> indicating the current font style.                   |
| <code>public int getSize()</code>                                | Returns an <code>int</code> indicating the current font size.                    |
| <code>public String getName()</code>                             | Returns the current font name as a string.                                       |
| <code>public String getFamily()</code>                           | Returns the font's family name as a string.                                      |
| <code>public boolean isPlain()</code>                            | Returns <code>true</code> if the font is plain, else <code>false</code> .        |
| <code>public boolean isBold()</code>                             | Returns <code>true</code> if the font is bold, else <code>false</code> .         |
| <code>public boolean isItalic()</code>                           | Returns <code>true</code> if the font is italic, else <code>false</code> .       |

**Fig. 15.10** | Font-related methods and constants. (Part 1 of 2.)



| Method or constant                             | Description                                                                                                            |
|------------------------------------------------|------------------------------------------------------------------------------------------------------------------------|
| <i>Graphics methods for manipulating Fonts</i> |                                                                                                                        |
| <code>public Font getFont()</code>             | Returns a <code>Font</code> object reference representing the current font.                                            |
| <code>public void setFont( Font f )</code>     | Sets the current font to the font, style and size specified by the <code>Font</code> object reference <code>f</code> . |

**Fig. 15.10** | Font-related methods and constants. (Part 2 of 2.)

Class `Font`'s constructor takes three arguments—the **font name**, **font style** and **font size**. The font name is any font currently supported by the system on which the program is running, such as standard Java fonts `Monospaced`, `SansSerif` and `Serif`. The font style is **`Font.PLAIN`**, **`Font.ITALIC`** or **`Font.BOLD`** (each is a static field of class `Font`). Font styles can be used in combination (e.g., `Font.ITALIC + Font.BOLD`). The font size is measured in points. A **point** is 1/72 of an inch. `Graphics` method **`setFont`** sets the current drawing font—the font in which text will be displayed—to its `Font` argument.



### Portability Tip 15.2

*The number of fonts varies across systems. Java provides five font names—`Serif`, `Monospaced`, `SansSerif`, `Dialog` and `DialogInput`—that can be used on all Java platforms. The Java runtime environment (JRE) on each platform maps these logical font names to actual fonts installed on the platform. The actual fonts used may vary by platform.*

The application of Figs. 15.11–15.12 displays text in four different fonts, with each font in a different size. Figure 15.11 uses the `Font` constructor to initialize `Font` objects (in lines 16, 20, 24 and 29) that are each passed to `Graphics` method `setFont` to change the drawing font. Each call to the `Font` constructor passes a font name (`Serif`, `Monospaced` or `SansSerif`) as a string, a font style (`Font.PLAIN`, `Font.ITALIC` or `Font.BOLD`) and a font size. Once `Graphics` method `setFont` is invoked, all text displayed following the call will appear in the new font until the font is changed. Each font's information is displayed in lines 17, 21, 25 and 30–31 using method `drawString`. The coordinates passed to `drawString` corresponds to the lower-left corner of the baseline of the font. Line 28 changes the drawing color to red, so the next string displayed appears in red. Lines 30–31 display information about the final `Font` object. Method **`getFont`** of class `Graphics` returns a `Font` object representing the current font. Method **`getName`** returns the current font name as a string. Method **`getSize`** returns the font size in points.



### Software Engineering Observation 15.2

*To change the font, you must create a new `Font` object. `Font` objects are immutable—class `Font` has no set methods to change the characteristics of the current font.*

Figure 15.12 contains the main method, which creates a `JFrame` to display a `FontJPanel`. We add a `FontJPanel` object to this `JFrame` (line 15), which displays the graphics created in Fig. 15.11.

---

```

1 // Fig. 15.11: FontJPanel.java
2 // Display strings in different fonts and colors.
3 import java.awt.Font;
4 import java.awt.Color;
5 import java.awt.Graphics;
6 import javax.swing.JPanel;
7
8 public class FontJPanel extends JPanel
9 {
10 // display Strings in different fonts and colors
11 public void paintComponent(Graphics g)
12 {
13 super.paintComponent(g); // call superclass's paintComponent
14
15 // set font to Serif (Times), bold, 12pt and draw a string
16 g.setFont(new Font("Serif", Font.BOLD, 12));
17 g.drawString("Serif 12 point bold.", 20, 30);
18
19 // set font to Monospaced (Courier), italic, 24pt and draw a string
20 g.setFont(new Font("Monospaced", Font.ITALIC, 24));
21 g.drawString("Monospaced 24 point italic.", 20, 50);
22
23 // set font to SansSerif (Helvetica), plain, 14pt and draw a string
24 g.setFont(new Font("SansSerif", Font.PLAIN, 14));
25 g.drawString("SansSerif 14 point plain.", 20, 70);
26
27 // set font to Serif (Times), bold/italic, 18pt and draw a string
28 g.setColor(Color.RED);
29 g.setFont(new Font("Serif", Font.BOLD + Font.ITALIC, 18));
30 g.drawString(g.getFont().getName() + " " + g.getFont().getSize() +
31 " point bold italic.", 20, 90);
32 } // end method paintComponent
33 } // end class FontJPanel

```

---

**Fig. 15.11** | Graphics method `setFont` changes the drawing font.

---

```

1 // Fig. 15.12: Fonts.java
2 // Using fonts.
3 import javax.swing.JFrame;
4
5 public class Fonts
6 {
7 // execute application
8 public static void main(String[] args)
9 {
10 // create frame for FontJPanel
11 JFrame frame = new JFrame("Using fonts");
12 frame.setDefaultCloseOperation(JFrame.EXIT_ON_CLOSE);
13
14 FontJPanel fontJPanel = new FontJPanel(); // create FontJPanel
15 frame.add(fontJPanel); // add fontJPanel to frame

```

---

**Fig. 15.12** | Creating a `JFrame` to display fonts. (Part I of 2.)

```

16 frame.setSize(420, 150); // set frame size
17 frame.setVisible(true); // display frame
18 } // end main
19 } // end class Fonts

```

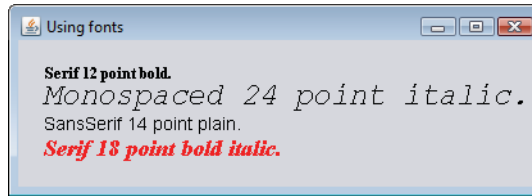

**Fig. 15.12** | Creating a JFrame to display fonts. (Part 2 of 2.)

### Font Metrics

Sometimes it's necessary to get information about the current drawing font, such as its name, style and size. Several `Font` methods used to get font information are summarized in Fig. 15.10. Method `getStyle` returns an integer value representing the current style. The integer value returned is either `Font.PLAIN`, `Font.ITALIC`, `Font.BOLD` or the combination of `Font.ITALIC` and `Font.BOLD`. Method `getFamily` returns the name of the font family to which the current font belongs. The name of the font family is platform specific. `Font` methods are also available to test the style of the current font, and these too are summarized in Fig. 15.10. Methods `isPlain`, `isBold` and `isItalic` return `true` if the current font style is plain, bold or italic, respectively.

Figure 15.13 illustrates some of the common **font metrics**, which provide precise information about a font, such as **height**, **descent** (the amount a character dips below the baseline), **ascent** (the amount a character rises above the baseline) and **leading** (the difference between the descent of one line of text and the ascent of the line of text below it—that is, the interline spacing).



**Fig. 15.13** | Font metrics.

Class `FontMetrics` declares several methods for obtaining font metrics. These methods and `Graphics` method `getFontMetrics` are summarized in Fig. 15.14. The application of Figs. 15.15–15.16 uses the methods of Fig. 15.14 to obtain font metric information for two fonts.

| Method                                                   | Description                                                     |
|----------------------------------------------------------|-----------------------------------------------------------------|
| <i>FontMetrics methods</i>                               |                                                                 |
| <code>public int getAscent()</code>                      | Returns the ascent of a font in points.                         |
| <code>public int getDescent()</code>                     | Returns the descent of a font in points.                        |
| <code>public int getLeading()</code>                     | Returns the leading of a font in points.                        |
| <code>public int getHeight()</code>                      | Returns the height of a font in points.                         |
| <i>Graphics methods for getting a Font's FontMetrics</i> |                                                                 |
| <code>public FontMetrics getFontMetrics()</code>         | Returns the FontMetrics object for the current drawing Font.    |
| <code>public FontMetrics getFontMetrics( Font f )</code> | Returns the FontMetrics object for the specified Font argument. |

**Fig. 15.14** | FontMetrics and Graphics methods for obtaining font metrics.

```

1 // Fig. 15.15: MetricsJPanel.java
2 // FontMetrics and Graphics methods useful for obtaining font metrics.
3 import java.awt.Font;
4 import java.awt.FontMetrics;
5 import java.awt.Graphics;
6 import javax.swing.JPanel;
7
8 public class MetricsJPanel extends JPanel
9 {
10 // display font metrics
11 public void paintComponent(Graphics g)
12 {
13 super.paintComponent(g); // call superclass's paintComponent
14
15 g.setFont(new Font("SansSerif", Font.BOLD, 12));
16 FontMetrics metrics = g.getFontMetrics();
17 g.drawString("Current font: " + g.getFont(), 10, 30);
18 g.drawString("Ascent: " + metrics.getAscent(), 10, 45);
19 g.drawString("Descent: " + metrics.getDescent(), 10, 60);
20 g.drawString("Height: " + metrics.getHeight(), 10, 75);
21 g.drawString("Leading: " + metrics.getLeading(), 10, 90);
22
23 Font font = new Font("Serif", Font.ITALIC, 14);
24 metrics = g.getFontMetrics(font);
25 g.setFont(font);
26 g.drawString("Current font: " + font, 10, 120);
27 g.drawString("Ascent: " + metrics.getAscent(), 10, 135);
28 g.drawString("Descent: " + metrics.getDescent(), 10, 150);
29 g.drawString("Height: " + metrics.getHeight(), 10, 165);
30 g.drawString("Leading: " + metrics.getLeading(), 10, 180);
31 } // end method paintComponent
32 } // end class MetricsJPanel

```

**Fig. 15.15** | Font metrics.

```

1 // Fig. 15.16: Metrics.java
2 // Displaying font metrics.
3 import javax.swing.JFrame;
4
5 public class Metrics
6 {
7 // execute application
8 public static void main(String[] args)
9 {
10 // create frame for MetricsJPanel
11 JFrame frame = new JFrame("Demonstrating FontMetrics");
12 frame.setDefaultCloseOperation(JFrame.EXIT_ON_CLOSE);
13
14 MetricsJPanel metricsJPanel = new MetricsJPanel();
15 frame.add(metricsJPanel); // add metricsJPanel to frame
16 frame.setSize(510, 240); // set frame size
17 frame.setVisible(true); // display frame
18 } // end main
19 } // end class Metrics

```

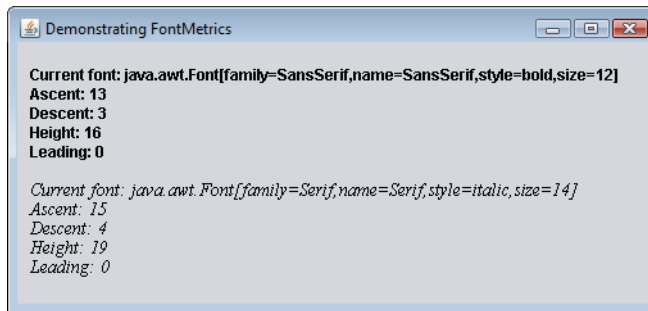

**Fig. 15.16** | Creating JFrame to display font metric information.

Line 15 of Fig. 15.15 creates and sets the current drawing font to a SansSerif, bold, 12-point font. Line 16 uses Graphics method `getFontMetrics` to obtain the `FontMetrics` object for the current font. Line 17 outputs the `String` representation of the `Font` returned by `g.getFont()`. Lines 18–21 use `FontMetric` methods to obtain the ascent, descent, height and leading for the font.

Line 23 creates a new `Serif`, `italic`, 14-point font. Line 24 uses a second version of Graphics method `getFontMetrics`, which accepts a `Font` argument and returns a corresponding `FontMetrics` object. Lines 27–30 obtain the ascent, descent, height and leading for the font. The font metrics are slightly different for the two fonts.

## 15.5 Drawing Lines, Rectangles and Ovals

This section presents Graphics methods for drawing lines, rectangles and ovals. The methods and their parameters are summarized in Fig. 15.17. For each drawing method that requires a width and height parameter, the width and height must be nonnegative values. Otherwise, the shape will not display.

| Method                                                                                                     | Description                                                                                                                                                                                                                                                                           |
|------------------------------------------------------------------------------------------------------------|---------------------------------------------------------------------------------------------------------------------------------------------------------------------------------------------------------------------------------------------------------------------------------------|
| <code>public void drawLine( int x1, int y1, int x2, int y2 )</code>                                        | Draws a line between the point (x1, y1) and the point (x2, y2).                                                                                                                                                                                                                       |
| <code>public void drawRect( int x, int y, int width, int height )</code>                                   | Draws a rectangle of the specified width and height. The rectangle's top-left corner is located at (x, y). Only the outline of the rectangle is drawn using the Graphics object's color—the body of the rectangle is not filled with this color.                                      |
| <code>public void fillRect( int x, int y, int width, int height )</code>                                   | Draws a filled rectangle in the current color with the specified width and height. The rectangle's top-left corner is located at (x, y).                                                                                                                                              |
| <code>public void clearRect( int x, int y, int width, int height )</code>                                  | Draws a filled rectangle with the specified width and height in the current background color. The rectangle's top-left corner is located at (x, y). This method is useful if you want to remove a portion of an image.                                                                |
| <code>public void drawRoundRect( int x, int y, int width, int height, int arcWidth, int arcHeight )</code> | Draws a rectangle with rounded corners in the current color with the specified width and height. The arcWidth and arcHeight determine the rounding of the corners (see Fig. 15.20). Only the outline of the shape is drawn.                                                           |
| <code>public void fillRoundRect( int x, int y, int width, int height, int arcWidth, int arcHeight )</code> | Draws a filled rectangle in the current color with rounded corners with the specified width and height. The arcWidth and arcHeight determine the rounding of the corners (see Fig. 15.20).                                                                                            |
| <code>public void draw3DRect( int x, int y, int width, int height, boolean b )</code>                      | Draws a three-dimensional rectangle in the current color with the specified width and height. The rectangle's top-left corner is located at (x, y). The rectangle appears raised when b is true and lowered when b is false. Only the outline of the shape is drawn.                  |
| <code>public void fill3DRect( int x, int y, int width, int height, boolean b )</code>                      | Draws a filled three-dimensional rectangle in the current color with the specified width and height. The rectangle's top-left corner is located at (x, y). The rectangle appears raised when b is true and lowered when b is false.                                                   |
| <code>public void drawOval( int x, int y, int width, int height )</code>                                   | Draws an oval in the current color with the specified width and height. The bounding rectangle's top-left corner is located at (x, y). The oval touches all four sides of the bounding rectangle at the center of each side (see Fig. 15.21). Only the outline of the shape is drawn. |
| <code>public void fillOval( int x, int y, int width, int height )</code>                                   | Draws a filled oval in the current color with the specified width and height. The bounding rectangle's top-left corner is located at (x, y). The oval touches the center of all four sides of the bounding rectangle (see Fig. 15.21).                                                |

**Fig. 15.17** | Graphics methods that draw lines, rectangles and ovals.

The application of Figs. 15.18–15.19 demonstrates drawing a variety of lines, rectangles, three-dimensional rectangles, rounded rectangles and ovals. In Fig. 15.18, line 17 draws a red line, line 20 draws an empty blue rectangle and line 21 draws a filled blue rectangle. Methods `fillRoundRect` (line 24) and `drawRoundRect` (line 25) draw rectangles with rounded corners. Their first two arguments specify the coordinates of the upper-left corner of the **bounding rectangle**—the area in which the rounded rectangle will be drawn. The upper-left corner coordinates are *not* the edge of the rounded rectangle, but the coordinates where the edge would be if the rectangle had square corners. The third and fourth arguments specify the width and height of the rectangle. The last two arguments determine the horizontal and vertical diameters of the arc (i.e., the arc width and arc height) used to represent the corners.

Figure 15.20 labels the arc width, arc height, width and height of a rounded rectangle. Using the same value for the arc width and arc height produces a quarter-circle at each

---

```

1 // Fig. 15.18: LinesRectsOvalsJPanel.java
2 // Drawing lines, rectangles and ovals.
3 import java.awt.Color;
4 import java.awt.Graphics;
5 import javax.swing.JPanel;
6
7 public class LinesRectsOvalsJPanel extends JPanel
8 {
9 // display various lines, rectangles and ovals
10 public void paintComponent(Graphics g)
11 {
12 super.paintComponent(g); // call superclass's paint method
13
14 this.setBackground(Color.WHITE);
15
16 g.setColor(Color.RED);
17 g.drawLine(5, 30, 380, 30);
18
19 g.setColor(Color.BLUE);
20 g.drawRect(5, 40, 90, 55);
21 g.fillRect(100, 40, 90, 55);
22
23 g.setColor(Color.CYAN);
24 g.fillRoundRect(195, 40, 90, 55, 50, 50);
25 g.drawRoundRect(290, 40, 90, 55, 20, 20);
26
27 g.setColor(Color.GREEN);
28 g.draw3DRect(5, 100, 90, 55, true);
29 g.fill3DRect(100, 100, 90, 55, false);
30
31 g.setColor(Color.MAGENTA);
32 g.drawOval(195, 100, 90, 55);
33 g.fillOval(290, 100, 90, 55);
34 } // end method paintComponent
35 } // end class LinesRectsOvalsJPanel

```

---

**Fig. 15.18** | Drawing lines, rectangles and ovals.

```

1 // Fig. 15.19: LinesRectsOvals.java
2 // Drawing lines, rectangles and ovals.
3 import java.awt.Color;
4 import javax.swing.JFrame;
5
6 public class LinesRectsOvals
7 {
8 // execute application
9 public static void main(String[] args)
10 {
11 // create frame for LinesRectsOvalsJPanel
12 JFrame frame =
13 new JFrame("Drawing lines, rectangles and ovals");
14 frame.setDefaultCloseOperation(JFrame.EXIT_ON_CLOSE);
15
16 LinesRectsOvalsJPanel linesRectsOvalsJPanel =
17 new LinesRectsOvalsJPanel();
18 linesRectsOvalsJPanel.setBackground(Color.WHITE);
19 frame.add(linesRectsOvalsJPanel); // add panel to frame
20 frame.setSize(400, 210); // set frame size
21 frame.setVisible(true); // display frame
22 } // end main
23 } // end class LinesRectsOvals

```

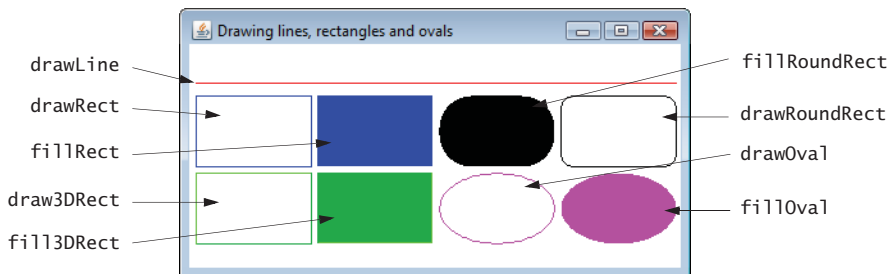

**Fig. 15.19** | Creating JFrame to display lines, rectangles and ovals.

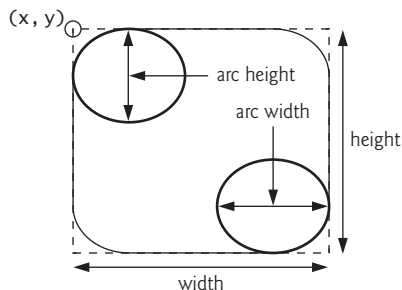

**Fig. 15.20** | Arc width and arc height for rounded rectangles.



corner. When the arc width, arc height, width and height have the same values, the result is a circle. If the values for width and height are the same and the values of arcWidth and arcHeight are 0, the result is a square.

Methods `draw3DRect` (line 28) and `fill3DRect` (line 29) take the same arguments. The first two specify the top-left corner of the rectangle. The next two arguments specify the width and height of the rectangle, respectively. The last argument determines whether the rectangle is **raised** (true) or **lowered** (false). The three-dimensional effect of `draw3DRect` appears as two edges of the rectangle in the original color and two edges in a slightly darker color. The three-dimensional effect of `fill3DRect` appears as two edges of the rectangle in the original drawing color and the fill and other two edges in a slightly darker color. Raised rectangles have the original drawing color edges at the top and left of the rectangle. Lowered rectangles have the original drawing color edges at the bottom and right of the rectangle. The three-dimensional effect is difficult to see in some colors.

Methods `drawOval` and `fillOval` (Fig. 15.18, lines 32–33) take the same four arguments. The first two specify the top-left coordinate of the bounding rectangle that contains the oval. The last two specify the width and height of the bounding rectangle, respectively. Figure 15.21 shows an oval bounded by a rectangle. The oval touches the center of all four sides of the bounding rectangle. (The bounding rectangle is not displayed on the screen.)

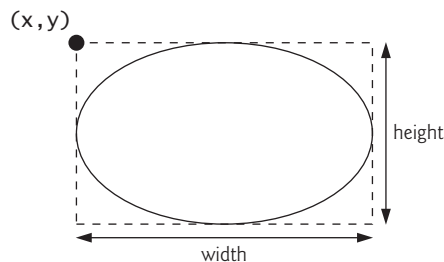

**Fig. 15.21** | Oval bounded by a rectangle.

## 15.6 Drawing Arcs

An **arc** is drawn as a portion of an oval. Arc angles are measured in degrees. Arcs **sweep** (i.e., move along a curve) from a **starting angle** through the number of degrees specified by their **arc angle**. The starting angle indicates in degrees where the arc begins. The arc angle specifies the total number of degrees through which the arc sweeps. Figure 15.22 illustrates two arcs. The left set of axes shows an arc sweeping from zero degrees to approximately 110 degrees. Arcs that sweep in a counterclockwise direction are measured in **positive degrees**. The set of axes on the right shows an arc sweeping from zero degrees to approximately  $-110$  degrees. Arcs that sweep in a clockwise direction are measured in **negative degrees**. Note the dashed boxes around the arcs in Fig. 15.22. When drawing an arc, we specify a bounding rectangle for an oval. The arc will sweep along part of the oval. Graphics methods `drawArc` and `fillArc` for drawing arcs are summarized in Fig. 15.23.

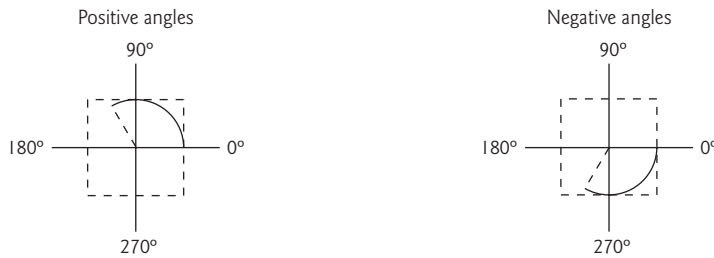

**Fig. 15.22** | Positive and negative arc angles.

| Method                                                                                                                  | Description                                                                                                                                                                                                                                               |
|-------------------------------------------------------------------------------------------------------------------------|-----------------------------------------------------------------------------------------------------------------------------------------------------------------------------------------------------------------------------------------------------------|
| <pre>public void drawArc( int x, int y, int width, int height, int startAngle,                     int arcAngle )</pre> | <p>Draws an arc relative to the bounding rectangle's top-left x- and y-coordinates with the specified width and height. The arc segment is drawn starting at <code>startAngle</code> and sweeps <code>arcAngle</code> degrees.</p>                        |
| <pre>public void fillArc( int x, int y, int width, int height, int startAngle,                     int arcAngle )</pre> | <p>Draws a filled arc (i.e., a sector) relative to the bounding rectangle's top-left x- and y-coordinates with the specified width and height. The arc segment is drawn starting at <code>startAngle</code> and sweeps <code>arcAngle</code> degrees.</p> |

**Fig. 15.23** | Graphics methods for drawing arcs.

Figures 15.24–15.25 demonstrate the arc methods of Fig. 15.23. The application draws six arcs (three unfilled and three filled). To illustrate the bounding rectangle that helps determine where the arc appears, the first three arcs are displayed inside a red rectangle that has the same x, y, width and height arguments as the arcs.

```

1 // Fig. 15.24: ArcsJPanel.java
2 // Drawing arcs.
3 import java.awt.Color;
4 import java.awt.Graphics;
5 import javax.swing.JPanel;
6
7 public class ArcsJPanel extends JPanel
8 {
9 // draw rectangles and arcs
10 public void paintComponent(Graphics g)
11 {
12 super.paintComponent(g); // call superclass's paintComponent
13 }

```

**Fig. 15.24** | Arcs displayed with `drawArc` and `fillArc`. (Part 1 of 2.)

```

14 // start at 0 and sweep 360 degrees
15 g.setColor(Color.RED);
16 g.drawRect(15, 35, 80, 80);
17 g.setColor(Color.BLACK);
18 g.drawArc(15, 35, 80, 80, 0, 360);
19
20 // start at 0 and sweep 110 degrees
21 g.setColor(Color.RED);
22 g.drawRect(100, 35, 80, 80);
23 g.setColor(Color.BLACK);
24 g.drawArc(100, 35, 80, 80, 0, 110);
25
26 // start at 0 and sweep -270 degrees
27 g.setColor(Color.RED);
28 g.drawRect(185, 35, 80, 80);
29 g.setColor(Color.BLACK);
30 g.drawArc(185, 35, 80, 80, 0, -270);
31
32 // start at 0 and sweep 360 degrees
33 g.fillArc(15, 120, 80, 40, 0, 360);
34
35 // start at 270 and sweep -90 degrees
36 g.fillArc(100, 120, 80, 40, 270, -90);
37
38 // start at 0 and sweep -270 degrees
39 g.fillArc(185, 120, 80, 40, 0, -270);
40 } // end method paintComponent
41 } // end class ArcsJPanel

```

**Fig. 15.24** | Arcs displayed with drawArc and fillArc. (Part 2 of 2.)

```

1 // Fig. 15.25: DrawArcs.java
2 // Drawing arcs.
3 import javax.swing.JFrame;
4
5 public class DrawArcs
6 {
7 // execute application
8 public static void main(String[] args)
9 {
10 // create frame for ArcsJPanel
11 JFrame frame = new JFrame("Drawing Arcs");
12 frame.setDefaultCloseOperation(JFrame.EXIT_ON_CLOSE);
13
14 ArcsJPanel arcsJPanel = new ArcsJPanel(); // create ArcsJPanel
15 frame.add(arcsJPanel); // add arcsJPanel to frame
16 frame.setSize(300, 210); // set frame size
17 frame.setVisible(true); // display frame
18 } // end main
19 } // end class DrawArcs

```

**Fig. 15.25** | Creating JFrame to display arcs. (Part 1 of 2.)

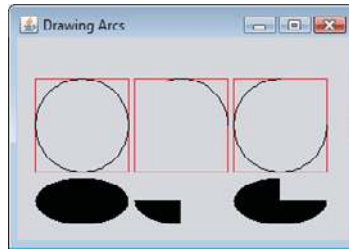

**Fig. 15.25** | Creating JFrame to display arcs. (Part 2 of 2.)

## 15.7 Drawing Polygons and Polylines

**Polygons** are closed multisided shapes composed of straight-line segments. **Polylines** are sequences of connected points. Figure 15.26 discusses methods for drawing polygons and polylines. Some methods require a **Polygon** object (package `java.awt`). Class `Polygon`'s constructors are also described in Fig. 15.26. The application of Figs. 15.27–15.28 draws polygons and polylines.

| Method                                                                            | Description                                                                                                                                                                                                                                                                                                                                                                                                 |
|-----------------------------------------------------------------------------------|-------------------------------------------------------------------------------------------------------------------------------------------------------------------------------------------------------------------------------------------------------------------------------------------------------------------------------------------------------------------------------------------------------------|
| <i>Graphics methods for drawing polygons</i>                                      |                                                                                                                                                                                                                                                                                                                                                                                                             |
| <code>public void drawPolygon( int[] xPoints, int[] yPoints, int points )</code>  | Draws a polygon. The <i>x</i> -coordinate of each point is specified in the <code>xPoints</code> array and the <i>y</i> -coordinate of each point in the <code>yPoints</code> array. The last argument specifies the number of points. This method draws a closed polygon. If the last point is different from the first, the polygon is closed by a line that connects the last point to the first.        |
| <code>public void drawPolyline( int[] xPoints, int[] yPoints, int points )</code> | Draws a sequence of connected lines. The <i>x</i> -coordinate of each point is specified in the <code>xPoints</code> array and the <i>y</i> -coordinate of each point in the <code>yPoints</code> array. The last argument specifies the number of points. If the last point is different from the first, the polyline is not closed.                                                                       |
| <code>public void drawPolygon( Polygon p )</code>                                 | Draws the specified polygon.                                                                                                                                                                                                                                                                                                                                                                                |
| <code>public void fillPolygon( int[] xPoints, int[] yPoints, int points )</code>  | Draws a filled polygon. The <i>x</i> -coordinate of each point is specified in the <code>xPoints</code> array and the <i>y</i> -coordinate of each point in the <code>yPoints</code> array. The last argument specifies the number of points. This method draws a closed polygon. If the last point is different from the first, the polygon is closed by a line that connects the last point to the first. |
| <code>public void fillPolygon( Polygon p )</code>                                 | Draws the specified filled polygon. The polygon is closed.                                                                                                                                                                                                                                                                                                                                                  |

**Fig. 15.26** | Graphics methods for polygons and class `Polygon` methods. (Part 1 of 2.)

| Method                                                                          | Description                                                                                                                                                                                                                |
|---------------------------------------------------------------------------------|----------------------------------------------------------------------------------------------------------------------------------------------------------------------------------------------------------------------------|
| <i>Polygon constructors and methods</i>                                         |                                                                                                                                                                                                                            |
| <code>public Polygon()</code>                                                   | Constructs a new polygon object. The polygon does not contain any points.                                                                                                                                                  |
| <code>public Polygon( int[] xValues, int[] yValues, int numberOfPoints )</code> | Constructs a new polygon object. The polygon has <code>numberOfPoints</code> sides, with each point consisting of an <i>x</i> -coordinate from <code>xValues</code> and a <i>y</i> -coordinate from <code>yValues</code> . |
| <code>public void addPoint( int x, int y )</code>                               | Adds pairs of <i>x</i> - and <i>y</i> -coordinates to the <code>Polygon</code> .                                                                                                                                           |

**Fig. 15.26** | Graphics methods for polygons and class `Polygon` methods. (Part 2 of 2.)

```

1 // Fig. 15.27: PolygonsJPanel.java
2 // Drawing polygons.
3 import java.awt.Graphics;
4 import java.awt.Polygon;
5 import javax.swing.JPanel;
6
7 public class PolygonsJPanel extends JPanel
8 {
9 // draw polygons and polylines
10 public void paintComponent(Graphics g)
11 {
12 super.paintComponent(g); // call superclass's paintComponent
13
14 // draw polygon with Polygon object
15 int[] xValues = { 20, 40, 50, 30, 20, 15 };
16 int[] yValues = { 50, 50, 60, 80, 80, 60 };
17 Polygon polygon1 = new Polygon(xValues, yValues, 6);
18 g.drawPolygon(polygon1);
19
20 // draw polylines with two arrays
21 int[] xValues2 = { 70, 90, 100, 80, 70, 65, 60 };
22 int[] yValues2 = { 100, 100, 110, 110, 130, 110, 90 };
23 g.drawPolyline(xValues2, yValues2, 7);
24
25 // fill polygon with two arrays
26 int[] xValues3 = { 120, 140, 150, 190 };
27 int[] yValues3 = { 40, 70, 80, 60 };
28 g.fillPolygon(xValues3, yValues3, 4);
29
30 // draw filled polygon with Polygon object
31 Polygon polygon2 = new Polygon();
32 polygon2.addPoint(165, 135);
33 polygon2.addPoint(175, 150);
34 polygon2.addPoint(270, 200);

```

**Fig. 15.27** | Polygons displayed with `drawPolygon` and `fillPolygon`. (Part 1 of 2.)

```

35 polygon2.addPoint(200, 220);
36 polygon2.addPoint(130, 180);
37 g.fillPolygon(polygon2);
38 } // end method paintComponent
39 } // end class PolygonsJPanel

```

**Fig. 15.27** | Polygons displayed with `drawPolygon` and `fillPolygon`. (Part 2 of 2.)

```

1 // Fig. 15.28: DrawPolygons.java
2 // Drawing polygons.
3 import javax.swing.JFrame;
4
5 public class DrawPolygons
6 {
7 // execute application
8 public static void main(String[] args)
9 {
10 // create frame for PolygonsJPanel
11 JFrame frame = new JFrame("Drawing Polygons");
12 frame.setDefaultCloseOperation(JFrame.EXIT_ON_CLOSE);
13
14 PolygonsJPanel polygonsJPanel = new PolygonsJPanel();
15 frame.add(polygonsJPanel); // add polygonsJPanel to frame
16 frame.setSize(280, 270); // set frame size
17 frame.setVisible(true); // display frame
18 } // end main
19 } // end class DrawPolygons

```

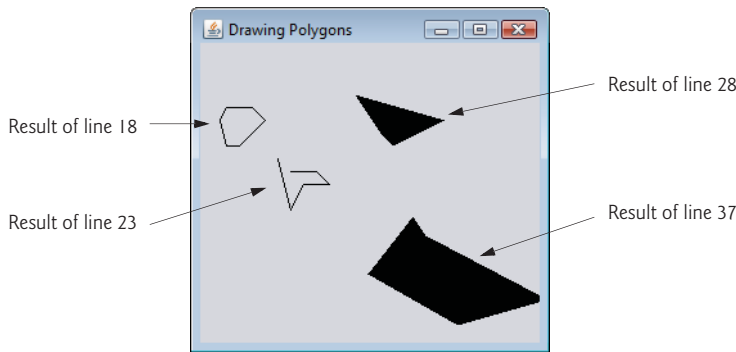

**Fig. 15.28** | Creating `JFrame` to display polygons.

Lines 15–16 of Fig. 15.27 create two `int` arrays and use them to specify the points for `Polygon` `polygon1`. The `Polygon` constructor call in line 17 receives array `xValues`, which contains the *x*-coordinate of each point; array `yValues`, which contains the *y*-coordinate of each point; and 6 (the number of points in the polygon). Line 18 displays `polygon1` by passing it as an argument to `Graphics` method `drawPolygon`.

Lines 21–22 create two `int` arrays and use them to specify the points for a series of connected lines. Array `xValues2` contains the *x*-coordinate of each point and array `yValues2` the *y*-coordinate of each point. Line 23 uses `Graphics` method `drawPolyline` to

display the series of connected lines specified with the arguments `xValues2`, `yValues2` and 7 (the number of points).

Lines 26–27 create two `int` arrays and use them to specify the points of a polygon. Array `xValues3` contains the *x*-coordinate of each point and array `yValues3` the *y*-coordinate of each point. Line 28 displays a polygon by passing to Graphics method **fillPolygon** the two arrays (`xValues3` and `yValues3`) and the number of points to draw (4).



### Common Programming Error 15.1

*An `ArrayIndexOutOfBoundsException` is thrown if the number of points specified in the third argument to method `drawPolygon` or method `fillPolygon` is greater than the number of elements in the arrays of coordinates that specify the polygon to display.*

Line 31 creates Polygon `polygon2` with no points. Lines 32–36 use Polygon method **addPoint** to add pairs of *x*- and *y*-coordinates to the Polygon. Line 37 displays Polygon `polygon2` by passing it to Graphics method `fillPolygon`.

## 15.8 Java 2D API

The **Java 2D API** provides advanced two-dimensional graphics capabilities for programmers who require detailed and complex graphical manipulations. The API includes features for processing line art, text and images in packages `java.awt`, `java.awt.image`, `java.awt.color`, `java.awt.font`, `java.awt.geom`, `java.awt.print` and `java.awt.image.renderable`. The capabilities of the API are far too broad to cover in this textbook. For an overview, see the Java 2D demo (discussed in Chapter 23, Applets and Java Web Start) or visit [download.oracle.com/javase/6/docs/technotes/guides/2d/](http://download.oracle.com/javase/6/docs/technotes/guides/2d/). In this section, we overview several Java 2D capabilities.

Drawing with the Java 2D API is accomplished with a **Graphics2D** reference (package `java.awt`). `Graphics2D` is an abstract subclass of class `Graphics`, so it has all the graphics capabilities demonstrated earlier in this chapter. In fact, the actual object used to draw in every `paintComponent` method is an instance of a subclass of `Graphics2D` that is passed to method `paintComponent` and accessed via the superclass `Graphics`. To access `Graphics2D` capabilities, we must cast the `Graphics` reference (`g`) passed to `paintComponent` into a `Graphics2D` reference with a statement such as

```
Graphics2D g2d = (Graphics2D) g;
```

The next two examples use this technique.

### *Lines, Rectangles, Round Rectangles, Arcs and Ellipses*

This example demonstrates several Java 2D shapes from package `java.awt.geom`, including **Line2D.Double**, **Rectangle2D.Double**, **RoundRectangle2D.Double**, **Arc2D.Double** and **Ellipse2D.Double**. Note the syntax of each class name. Each class represents a shape with dimensions specified as `double` values. There's a separate version of each represented with `float` values (e.g., **Ellipse2D.Float**). In each case, `Double` is a `public static` nested class of the class specified to the left of the dot (e.g., `Ellipse2D`). To use the `static` nested class, we simply qualify its name with the outer class name.

In Figs. 15.29–15.30, we draw Java 2D shapes and modify their drawing characteristics, such as changing line thickness, filling shapes with patterns and drawing dashed lines. These are just a few of the many capabilities provided by Java 2D.

Line 25 of Fig. 15.29 casts the Graphics reference received by paintComponent to a Graphics2D reference and assigns it to g2d to allow access to the Java 2D features.

```

1 // Fig. 15.29: ShapesJPanel.java
2 // Demonstrating some Java 2D shapes.
3 import java.awt.Color;
4 import java.awt.Graphics;
5 import java.awt.BasicStroke;
6 import java.awt.GradientPaint;
7 import java.awt.TexturePaint;
8 import java.awt.Rectangle;
9 import java.awt.Graphics2D;
10 import java.awt.geom.Ellipse2D;
11 import java.awt.geom.Rectangle2D;
12 import java.awt.geom.RoundRectangle2D;
13 import java.awt.geom.Arc2D;
14 import java.awt.geom.Line2D;
15 import java.awt.image.BufferedImage;
16 import javax.swing.JPanel;
17
18 public class ShapesJPanel extends JPanel
19 {
20 // draw shapes with Java 2D API
21 public void paintComponent(Graphics g)
22 {
23 super.paintComponent(g); // call superclass's paintComponent
24
25 Graphics2D g2d = (Graphics2D) g; // cast g to Graphics2D
26
27 // draw 2D ellipse filled with a blue-yellow gradient
28 g2d.setPaint(new GradientPaint(5, 30, Color.BLUE, 35, 100,
29 Color.YELLOW, true));
30 g2d.fill(new Ellipse2D.Double(5, 30, 65, 100));
31
32 // draw 2D rectangle in red
33 g2d.setPaint(Color.RED);
34 g2d.setStroke(new BasicStroke(10.0f));
35 g2d.draw(new Rectangle2D.Double(80, 30, 65, 100));
36
37 // draw 2D rounded rectangle with a buffered background
38 BufferedImage buffImage = new BufferedImage(10, 10,
39 BufferedImage.TYPE_INT_RGB);
40
41 // obtain Graphics2D from buffImage and draw on it
42 Graphics2D gg = buffImage.createGraphics();
43 gg.setColor(Color.YELLOW); // draw in yellow
44 gg.fillRect(0, 0, 10, 10); // draw a filled rectangle
45 gg.setColor(Color.BLACK); // draw in black
46 gg.drawRect(1, 1, 6, 6); // draw a rectangle
47 gg.setColor(Color.BLUE); // draw in blue
48 gg.fillRect(1, 1, 3, 3); // draw a filled rectangle
49 gg.setColor(Color.RED); // draw in red

```

**Fig. 15.29** | Java 2D shapes. (Part I of 2.)



```

50 gg.fillRect(4, 4, 3, 3); // draw a filled rectangle
51
52 // paint buffImage onto the JFrame
53 g2d.setPaint(new TexturePaint(buffImage,
54 new Rectangle(10, 10)));
55 g2d.fill(
56 new RoundRectangle2D.Double(155, 30, 75, 100, 50, 50));
57
58 // draw 2D pie-shaped arc in white
59 g2d.setPaint(Color.WHITE);
60 g2d.setStroke(new BasicStroke(6.0f));
61 g2d.draw(
62 new Arc2D.Double(240, 30, 75, 100, 0, 270, Arc2D.PIE));
63
64 // draw 2D lines in green and yellow
65 g2d.setPaint(Color.GREEN);
66 g2d.draw(new Line2D.Double(395, 30, 320, 150));
67
68 // draw 2D line using stroke
69 float[] dashes = { 10 }; // specify dash pattern
70 g2d.setPaint(Color.YELLOW);
71 g2d.setStroke(new BasicStroke(4, BasicStroke.CAP_ROUND,
72 BasicStroke.JOIN_ROUND, 10, dashes, 0));
73 g2d.draw(new Line2D.Double(320, 30, 395, 150));
74 } // end method paintComponent
75 } // end class ShapesJPanel

```

**Fig. 15.29** | Java 2D shapes. (Part 2 of 2.)

```

1 // Fig. 15.30: Shapes.java
2 // Demonstrating some Java 2D shapes.
3 import javax.swing.JFrame;
4
5 public class Shapes
6 {
7 // execute application
8 public static void main(String[] args)
9 {
10 // create frame for ShapesJPanel
11 JFrame frame = new JFrame("Drawing 2D shapes");
12 frame.setDefaultCloseOperation(JFrame.EXIT_ON_CLOSE);
13
14 // create ShapesJPanel
15 ShapesJPanel shapesJPanel = new ShapesJPanel();
16
17 frame.add(shapesJPanel); // add shapesJPanel to frame
18 frame.setSize(425, 200); // set frame size
19 frame.setVisible(true); // display frame
20 } // end main
21 } // end class Shapes

```

**Fig. 15.30** | Creating JFrame to display shapes. (Part 1 of 2.)

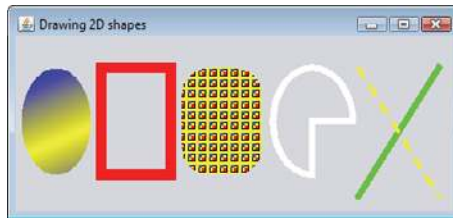

**Fig. 15.30** | Creating JFrame to display shapes. (Part 2 of 2.)

### *Ovals, Gradient Fills and Paint Objects*

The first shape we draw is an oval filled with gradually changing colors. Lines 28–29 invoke Graphics2D method **setPaint** to set the **Paint** object that determines the color for the shape to display. A **Paint** object implements interface `java.awt.Paint`. It can be something as simple as one of the predeclared `Color` objects introduced in Section 15.3 (class `Color` implements `Paint`), or it can be an instance of the Java 2D API's `GradientPaint`, `SystemColor`, `TexturePaint`, `LinearGradientPaint` or `RadialGradientPaint` classes. In this case, we use a `GradientPaint` object.

Class `GradientPaint` helps draw a shape in gradually changing colors—called a **gradient**. The `GradientPaint` constructor used here requires seven arguments. The first two specify the starting coordinate for the gradient. The third specifies the starting `Color` for the gradient. The fourth and fifth specify the ending coordinate for the gradient. The sixth specifies the ending `Color` for the gradient. The last argument specifies whether the gradient is **cyclic** (`true`) or **acyclic** (`false`). The two sets of coordinates determine the direction of the gradient. Because the second coordinate (35, 100) is down and to the right of the first coordinate (5, 30), the gradient goes down and to the right at an angle. Because this gradient is cyclic (`true`), the color starts with blue, gradually becomes yellow, then gradually returns to blue. If the gradient is acyclic, the color transitions from the first color specified (e.g., blue) to the second color (e.g., yellow).

Line 30 uses Graphics2D method **fill** to draw a filled **Shape** object—an object that implements interface `Shape` (package `java.awt`). In this case, we display an `Ellipse2D.Double` object. The `Ellipse2D.Double` constructor receives four arguments specifying the bounding rectangle for the ellipse to display.

### *Rectangles, Strokes*

Next we draw a red rectangle with a thick border. Line 33 invokes `setPaint` to set the `Paint` object to `Color.RED`. Line 34 uses Graphics2D method **setStroke** to set the characteristics of the rectangle's border (or the lines for any other shape). Method `setStroke` requires as its argument an object that implements interface **Stroke** (package `java.awt`). In this case, we use an instance of class `BasicStroke`. Class `BasicStroke` provides several constructors to specify the width of the line, how the line ends (called the **end caps**), how lines join together (called **line joins**) and the dash attributes of the line (if it's a dashed line). The constructor here specifies that the line should be 10 pixels wide.

Line 35 uses Graphics2D method **draw** to draw a `Shape` object—in this case, a `Rectangle2D.Double`. The `Rectangle2D.Double` constructor receives arguments specifying the rectangle's upper-left *x*-coordinate, upper-left *y*-coordinate, width and height.

### *Rounded Rectangles, BufferedImages and TexturePaint Objects*

Next we draw a rounded rectangle filled with a pattern created in a **BufferedImage** (package `java.awt.image`) object. Lines 38–39 create the **BufferedImage** object. Class **BufferedImage** can be used to produce images in color and grayscale. This particular **BufferedImage** is 10 pixels wide and 10 pixels tall (as specified by the first two arguments of the constructor). The third argument **BufferedImage.TYPE\_INT\_RGB** indicates that the image is stored in color using the RGB color scheme.

To create the rounded rectangle’s fill pattern, we must first draw into the **BufferedImage**. Line 42 creates a **Graphics2D** object (by calling **BufferedImage** method **createGraphics**) that can be used to draw into the **BufferedImage**. Lines 43–50 use methods **setColor**, **fillRect** and **drawRect** to create the pattern.

Lines 53–54 set the **Paint** object to a new **TexturePaint** (package `java.awt`) object. A **TexturePaint** object uses the image stored in its associated **BufferedImage** (the first constructor argument) as the fill texture for a filled-in shape. The second argument specifies the **Rectangle** area from the **BufferedImage** that will be replicated through the texture. In this case, the **Rectangle** is the same size as the **BufferedImage**. However, a smaller portion of the **BufferedImage** can be used.

Lines 55–56 use **Graphics2D** method **fill** to draw a filled **Shape** object—in this case, a **RoundRectangle2D.Double**. The constructor for class **RoundRectangle2D.Double** receives six arguments specifying the rectangle dimensions and the arc width and arc height used to determine the rounding of the corners.

### *Arcs*

Next we draw a pie-shaped arc with a thick white line. Line 59 sets the **Paint** object to **Color.WHITE**. Line 60 sets the **Stroke** object to a new **BasicStroke** for a line 6 pixels wide. Lines 61–62 use **Graphics2D** method **draw** to draw a **Shape** object—in this case, an **Arc2D.Double**. The **Arc2D.Double** constructor’s first four arguments specify the upper-left *x*-coordinate, upper-left *y*-coordinate, width and height of the bounding rectangle for the arc. The fifth argument specifies the start angle. The sixth argument specifies the arc angle. The last argument specifies how the arc is closed. Constant **Arc2D.PIE** indicates that the arc is closed by drawing two lines—one line from the arc’s starting point to the center of the bounding rectangle and one line from the center of the bounding rectangle to the ending point. Class **Arc2D** provides two other static constants for specifying how the arc is closed. Constant **Arc2D.CHORD** draws a line from the starting point to the ending point. Constant **Arc2D.OPEN** specifies that the arc should *not* be closed.

### *Lines*

Finally, we draw two lines using **Line2D** objects—one solid and one dashed. Line 65 sets the **Paint** object to **Color.GREEN**. Line 66 uses **Graphics2D** method **draw** to draw a **Shape** object—in this case, an instance of class **Line2D.Double**. The **Line2D.Double** constructor’s arguments specify the starting coordinates and ending coordinates of the line.

Line 69 declares a one-element **float** array containing the value 10. This array describes the dashes in the dashed line. In this case, each dash will be 10 pixels long. To create dashes of different lengths in a pattern, simply provide the length of each dash as an element in the array. Line 70 sets the **Paint** object to **Color.YELLOW**. Lines 71–72 set the **Stroke** object to a new **BasicStroke**. The line will be 4 pixels wide and will have rounded

ends (**BasicStroke.CAP\_ROUND**). If lines join together (as in a rectangle at the corners), their joining will be rounded (**BasicStroke.JOIN\_ROUND**). The dashes argument specifies the dash lengths for the line. The last argument indicates the starting index in the dashes array for the first dash in the pattern. Line 73 then draws a line with the current Stroke.

### *Creating Your Own Shapes with General Paths*

Next we present a **general path**—a shape constructed from straight lines and complex curves. A general path is represented with an object of class **GeneralPath** (package `java.awt.geom`). The application of Figs. 15.31 and 15.32 demonstrates drawing a general path in the shape of a five-pointed star.

---

```

1 // Fig. 15.31: Shapes2JPanel.java
2 // Demonstrating a general path.
3 import java.awt.Color;
4 import java.awt.Graphics;
5 import java.awt.Graphics2D;
6 import java.awt.geom.GeneralPath;
7 import java.util.Random;
8 import javax.swing.JPanel;
9
10 public class Shapes2JPanel extends JPanel
11 {
12 // draw general paths
13 public void paintComponent(Graphics g)
14 {
15 super.paintComponent(g); // call superclass's paintComponent
16 Random random = new Random(); // get random number generator
17
18 int[] xPoints = { 55, 67, 109, 73, 83, 55, 27, 37, 1, 43 };
19 int[] yPoints = { 0, 36, 36, 54, 96, 72, 96, 54, 36, 36 };
20
21 Graphics2D g2d = (Graphics2D) g;
22 GeneralPath star = new GeneralPath(); // create GeneralPath object
23
24 // set the initial coordinate of the General Path
25 star.moveTo(xPoints[0], yPoints[0]);
26
27 // create the star--this does not draw the star
28 for (int count = 1; count < xPoints.length; count++)
29 star.lineTo(xPoints[count], yPoints[count]);
30
31 star.closePath(); // close the shape
32
33 g2d.translate(150, 150); // translate the origin to (150, 150)
34
35 // rotate around origin and draw stars in random colors
36 for (int count = 1; count <= 20; count++)
37 {
38 g2d.rotate(Math.PI / 10.0); // rotate coordinate system
39

```

---

**Fig. 15.31** | Java 2D general paths. (Part 1 of 2.)

```

40 // set random drawing color
41 g2d.setColor(new Color(random.nextInt(256),
42 random.nextInt(256), random.nextInt(256)));
43
44 g2d.fill(star); // draw filled star
45 } // end for
46 } // end method paintComponent
47 } // end class Shapes2JPanel

```

**Fig. 15.31** | Java 2D general paths. (Part 2 of 2.)

```

1 // Fig. 15.32: Shapes2.java
2 // Demonstrating a general path.
3 import java.awt.Color;
4 import javax.swing.JFrame;
5
6 public class Shapes2
7 {
8 // execute application
9 public static void main(String[] args)
10 {
11 // create frame for Shapes2JPanel
12 JFrame frame = new JFrame("Drawing 2D Shapes");
13 frame.setDefaultCloseOperation(JFrame.EXIT_ON_CLOSE);
14
15 Shapes2JPanel shapes2JPanel = new Shapes2JPanel();
16 frame.add(shapes2JPanel); // add shapes2JPanel to frame
17 frame.setBackground(Color.WHITE); // set frame background color
18 frame.setSize(315, 330); // set frame size
19 frame.setVisible(true); // display frame
20 } // end main
21 } // end class Shapes2

```

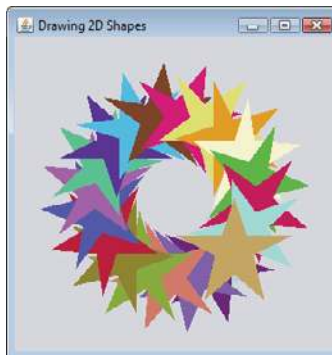

**Fig. 15.32** | Creating JFrame to display stars.

Lines 18–19 declare two `int` arrays representing the  $x$ - and  $y$ -coordinates of the points in the star. Line 22 creates `GeneralPath` object `star`. Line 25 uses `GeneralPath` method `moveTo` to specify the first point in the star. The `for` statement in lines 28–29 uses `GeneralPath` method `lineTo` to draw a line to the next point in the star. Each new call to

`lineTo` draws a line from the previous point to the current point. Line 31 uses `GeneralPath` method `closePath` to draw a line from the last point to the point specified in the last call to `moveTo`. This completes the general path.

Line 33 uses `Graphics2D` method `translate` to move the drawing origin to location (150, 150). All drawing operations now use location (150, 150) as (0, 0).

The `for` statement in lines 36–45 draws the star 20 times by rotating it around the new origin point. Line 38 uses `Graphics2D` method `rotate` to rotate the next displayed shape. The argument specifies the rotation angle in radians (with  $360^\circ = 2\pi$  radians). Line 44 uses `Graphics2D` method `fill` to draw a filled version of the star.

## 15.9 Wrap-Up

In this chapter, you learned how to use Java's graphics capabilities to produce colorful drawings. You learned how to specify the location of an object using Java's coordinate system, and how to draw on a window using the `paintComponent` method. You were introduced to class `Color`, and you learned how to use this class to specify different colors using their RGB components. You used the `JColorChooser` dialog to allow users to select colors in a program. You then learned how to work with fonts when drawing text on a window. You learned how to create a `Font` object from a font name, style and size, as well as how to access the metrics of a font. From there, you learned how to draw various shapes on a window, such as rectangles (regular, rounded and 3D), ovals and polygons, as well as lines and arcs. You then used the Java 2D API to create more complex shapes and to fill them with gradients or patterns. The chapter concluded with a discussion of general paths, used to construct shapes from straight lines and complex curves. In the next chapter, we discuss class `String` and its methods. We introduce regular expressions for pattern matching in strings and demonstrate how to validate user input with regular expressions.

## Summary

### Section 15.1 Introduction

- Java's coordinate system (p. 632) is a scheme for identifying every point (p. 643) on the screen.
- A coordinate pair (p. 632) has an *x*-coordinate (horizontal) and a *y*-coordinate (vertical).
- Coordinates are used to indicate where graphics should be displayed on a screen.
- Coordinate units are measured in pixels (p. 632). A pixel is a display monitor's smallest unit of resolution.

### Section 15.2 Graphics Contexts and Graphics Objects

- A Java graphics context (p. 634) enables drawing on the screen.
- Class `Graphics` (p. 632) contains methods for drawing strings, lines, rectangles and other shapes. Methods are also included for font manipulation and color manipulation.
- A `Graphics` object manages a graphics context and draws pixels on the screen that represent text and other graphical objects, e.g., lines, ellipses, rectangles and other polygons (p. 654).
- Class `Graphics` is an abstract class. Each Java implementation has a `Graphics` subclass that provides drawing capabilities. This implementation is hidden from us by class `Graphics`, which supplies the interface that enables us to use graphics in a platform-independent manner.

- Method `paintComponent` can be used to draw graphics in any `JComponent` component.
- Method `paintComponent` receives a `Graphics` object that is passed to the method by the system when a lightweight Swing component needs to be repainted.
- When an application executes, the application container calls method `paintComponent`. For `paintComponent` to be called again, an event must occur.
- When a `JComponent` is displayed, its `paintComponent` method is called.
- Calling method `repaint` (p. 635) on a component updates the graphics drawn on that component.

### Section 15.3 Color Control

- Class `Color` (p. 632) declares methods and constants for manipulating colors in a Java program.
- Every color is created from a red, a green and a blue component. Together these components are called RGB values (p. 636). The RGB components specify the amount of red, green and blue in a color, respectively. The larger the RGB value, the greater the amount of that particular color.
- `Color` methods `getRed`, `getGreen` and `getBlue` (p. 636) return `int` values from 0 to 255 representing the amount of red, green and blue, respectively.
- `Graphics` method `getColor` (p. 636) returns a `Color` object with the current drawing color.
- `Graphics` method `setColor` (p. 636) sets the current drawing color.
- `Graphics` method `fillRect` (p. 636) draws a rectangle filled by the `Graphics` object's current color.
- `Graphics` method `drawString` (p. 638) draws a `String` in the current color.
- The `JColorChooser` GUI component (p. 639) enables application users to select colors.
- `JColorChooser` static method `showDialog` (p. 641) displays a modal `JColorChooser` dialog.

### Section 15.4 Manipulating Fonts

- Class `Font` (p. 632) contains methods and constants for manipulating fonts.
- Class `Font`'s constructor takes three arguments—the font name (p. 643), font style and font size.
- A `Font`'s font style can be `Font.PLAIN`, `Font.ITALIC` or `Font.BOLD` (each is a static field of class `Font`). Font styles can be used in combination (e.g., `Font.ITALIC + Font.BOLD`).
- The font size is measured in points. A point is 1/72 of an inch.
- `Graphics` method `setFont` (p. 643) sets the drawing font in which text will be displayed.
- `Font` method `getStyle` (p. 645) returns an integer value representing the current `Font`'s style.
- `Font` method `getSize` (p. 643) returns the font size in points.
- `Font` method `getName` (p. 643) returns the current font name as a string.
- `Font` method `getFamily` (p. 645) returns the name of the font family to which the current font belongs. The name of the font family is platform specific.
- Class `FontMetrics` (p. 645) contains methods for obtaining font information.
- `Font` metrics (p. 645) include height, descent and leading.

### Section 15.5 Drawing Lines, Rectangles and Ovals

- `Graphics` methods `fillRoundRect` (p. 649) and `drawRoundRect` (p. 649) draw rectangles with rounded corners.
- `Graphics` methods `draw3DRect` (p. 651) and `fill3DRect` (p. 651) draw three-dimensional rectangles.
- `Graphics` methods `drawOval` (p. 651) and `fillOval` (p. 651) draw ovals.

### Section 15.6 Drawing Arcs

- An arc (p. 651) is drawn as a portion of an oval.

- Arcs sweep from a starting angle by the number of degrees specified by their arc angle (p. 651).
- Graphics methods `drawArc` (p. 651) and `fillArc` (p. 651) are used for drawing arcs.

### Section 15.7 Drawing Polygons and Polylines

- Class `Polygon` contains methods for creating polygons.
- Polygons are closed multisided shapes composed of straight-line segments.
- Polylines (p. 654) are a sequence of connected points.
- Graphics method `drawPolyline` (p. 656) displays a series of connected lines.
- Graphics methods `drawPolygon` (p. 656) and `fillPolygon` (p. 657) are used to draw polygons.
- `Polygon` method `addPoint` (p. 657) adds pairs of *x*- and *y*-coordinates to the `Polygon`.

### Section 15.8 Java 2D API

- The Java 2D API (p. 657) provides advanced two-dimensional graphics capabilities.
- Class `Graphics2D` (p. 632)—a subclass of `Graphics`—is used for drawing with the Java 2D API.
- The Java 2D API's classes for drawing shapes include `Line2D.Double`, `Rectangle2D.Double`, `RoundRectangle2D.Double`, `Arc2D.Double` and `Ellipse2D.Double` (p. 657).
- Class `GradientPaint` (p. 632) helps draw a shape in gradually changing colors—called a gradient (p. 660).
- `Graphics2D` method `fill` (p. 660) draws a filled object of any type that implements interface `Shape` (p. 660).
- Class `BasicStroke` (p. 632) helps specify the drawing characteristics of lines.
- `Graphics2D` method `draw` (p. 660) is used to draw a `Shape` object.
- Classes `GradientPaint` and `TexturePaint` (p. 632) help specify the characteristics for filling shapes with colors or patterns.
- A general path (p. 662) is a shape constructed from straight lines and complex curves and is represented with an object of class `GeneralPath` (p. 662).
- `GeneralPath` method `moveTo` (p. 663) specifies the first point in a general path.
- `GeneralPath` method `lineTo` (p. 663) draws a line to the next point in the path. Each new call to `lineTo` draws a line from the previous point to the current point.
- `GeneralPath` method `closePath` (p. 664) draws a line from the last point to the point specified in the last call to `moveTo`. This completes the general path.
- `Graphics2D` method `translate` (p. 664) is used to move the drawing origin to a new location.
- `Graphics2D` method `rotate` (p. 664) is used to rotate the next displayed shape.

## Self-Review Exercises

- 15.1** Fill in the blanks in each of the following statements:
- In Java 2D, method \_\_\_\_\_ of class \_\_\_\_\_ sets the characteristics of a line used to draw a shape.
  - Class \_\_\_\_\_ helps specify the fill for a shape such that the fill gradually changes from one color to another.
  - The \_\_\_\_\_ method of class `Graphics` draws a line between two points.
  - RGB is short for \_\_\_\_\_, \_\_\_\_\_ and \_\_\_\_\_.
  - Font sizes are measured in units called \_\_\_\_\_.
  - Class \_\_\_\_\_ helps specify the fill for a shape using a pattern drawn in a `BufferedImage`.



- 15.2** State whether each of the following is *true* or *false*. If *false*, explain why.
- The first two arguments of `Graphics` method `drawOval` specify the center coordinate of the oval.
  - In the Java coordinate system,  $x$ -coordinates increase from left to right and  $y$ -coordinates from top to bottom.
  - `Graphics` method `fillPolygon` draws a filled polygon in the current color.
  - `Graphics` method `drawArc` allows negative angles.
  - `Graphics` method `getSize` returns the size of the current font in centimeters.
  - Pixel coordinate  $(0, 0)$  is located at the exact center of the monitor.
- 15.3** Find the error(s) in each of the following and explain how to correct them. Assume that `g` is a `Graphics` object.
- `g.setFont( "SansSerif" );`
  - `g.erase( x, y, w, h ); // clear rectangle at (x, y)`
  - `Font f = new Font( "Serif", Font.BOLDITALIC, 12 );`
  - `g.setColor( 255, 255, 0 ); // change color to yellow`

## Answers to Self-Review Exercises

- 15.1** a) `setStroke`, `Graphics2D`. b) `GradientPaint`. c) `drawLine`. d) red, green, blue. e) points. f) `TexturePaint`.
- 15.2** a) False. The first two arguments specify the upper-left corner of the bounding rectangle.  
 b) True.  
 c) True.  
 d) True.  
 e) False. Font sizes are measured in points.  
 f) False. The coordinate  $(0,0)$  corresponds to the upper-left corner of a GUI component on which drawing occurs.
- 15.3** a) The `setFont` method takes a `Font` object as an argument—not a `String`.  
 b) The `Graphics` class does not have an `erase` method. The `clearRect` method should be used.  
 c) `Font.BOLDITALIC` is not a valid font style. To get a bold italic font, use `Font.BOLD + Font.ITALIC`.  
 d) Method `setColor` takes a `Color` object as an argument, not three integers.

## Exercises

- 15.4** Fill in the blanks in each of the following statements:
- Class \_\_\_\_\_ of the Java 2D API is used to draw ovals.
  - Methods `draw` and `fill` of class `Graphics2D` require an object of type \_\_\_\_\_ as their argument.
  - The three constants that specify font style are \_\_\_\_\_, \_\_\_\_\_ and \_\_\_\_\_.
  - `Graphics2D` method \_\_\_\_\_ sets the painting color for Java 2D shapes.
- 15.5** State whether each of the following is *true* or *false*. If *false*, explain why.
- `Graphics` method `drawPolygon` automatically connects the endpoints of the polygon.
  - `Graphics` method `drawLine` draws a line between two points.
  - `Graphics` method `fillArc` uses degrees to specify the angle.
  - In the Java coordinate system, values on the  $y$ -axis increase from left to right.
  - `Graphics` inherits directly from class `Object`.
  - `Graphics` is an abstract class.
  - The `Font` class inherits directly from class `Graphics`.

**15.6** (*Concentric Circles Using Method drawArc*) Write an application that draws a series of eight concentric circles. The circles should be separated by 10 pixels. Use Graphics method drawArc.

**15.7** (*Concentric Circles Using Class Ellipse2D.Double*) Modify your solution to Exercise 15.6 to draw the ovals by using class Ellipse2D.Double and method draw of class Graphics2D.

**15.8** (*Random Lines Using Class Line2D.Double*) Modify your solution to Exercise 15.7 to draw random lines in random colors and random line thicknesses. Use class Line2D.Double and method draw of class Graphics2D to draw the lines.

**15.9** (*Random Triangles*) Write an application that displays randomly generated triangles in different colors. Each triangle should be filled with a different color. Use class GeneralPath and method fill of class Graphics2D to draw the triangles.

**15.10** (*Random Characters*) Write an application that randomly draws characters in different fonts, sizes and colors.

**15.11** (*Grid Using Method drawLine*) Write an application that draws an 8-by-8 grid. Use Graphics method drawLine.

**15.12** (*Grid Using Class Line2D.Double*) Modify your solution to Exercise 15.11 to draw the grid using instances of class Line2D.Double and method draw of class Graphics2D.

**15.13** (*Grid Using Method drawRect*) Write an application that draws a 10-by-10 grid. Use the Graphics method drawRect.

**15.14** (*Grid Using Class Rectangle2D.Double*) Modify your solution to Exercise 15.13 to draw the grid by using class Rectangle2D.Double and method draw of class Graphics2D.

**15.15** (*Drawing Tetrahedrons*) Write an application that draws a tetrahedron (a three-dimensional shape with four triangular faces). Use class GeneralPath and method draw of class Graphics2D.

**15.16** (*Drawing Cubes*) Write an application that draws a cube. Use class GeneralPath and method draw of class Graphics2D.

**15.17** (*Circles Using Class Ellipse2D.Double*) Write an application that asks the user to input the radius of a circle as a floating-point number and draws the circle, as well as the values of the circle's diameter, circumference and area. Use the value 3.14159 for  $\pi$ . [Note: You may also use the predefined constant Math.PI for the value of  $\pi$ . This constant is more precise than the value 3.14159. Class Math is declared in the java.lang package, so you need not import it.] Use the following formulas ( $r$  is the radius):

$$\begin{aligned} \text{diameter} &= 2r \\ \text{circumference} &= 2\pi r \\ \text{area} &= \pi r^2 \end{aligned}$$

The user should also be prompted for a set of coordinates in addition to the radius. Then draw the circle and display its diameter, circumference and area, using an Ellipse2D.Double object to represent the circle and method draw of class Graphics2D to display it.

**15.18** (*Screen Saver*) Write an application that simulates a screen saver. The application should randomly draw lines using method drawLine of class Graphics. After drawing 100 lines, the application should clear itself and start drawing lines again. To allow the program to draw continuously, place a call to repaint as the last line in method paintComponent. Do you notice any problems with this on your system?

**15.19** (*Screen Saver Using Timer*) Package javax.swing contains a class called Timer that is capable of calling method actionPerformed of interface ActionListener at a fixed time interval (specified in milliseconds). Modify your solution to Exercise 15.18 to remove the call to repaint from method paintComponent. Declare your class to implement ActionListener. (The actionPerformed

method should simply call `repaint()`.) Declare an instance variable of type `Timer` called `timer` in your class. In the constructor for your class, write the following statements:

```
timer = new Timer(1000, this);
timer.start();
```

This creates an instance of class `Timer` that will call `this` object's `actionPerformed` method every 1000 milliseconds (i.e., every second).

**15.20** (*Screen Saver for a Random Number of Lines*) Modify your solution to Exercise 15.19 to enable the user to enter the number of random lines that should be drawn before the application clears itself and starts drawing lines again. Use a `JTextField` to obtain the value. The user should be able to type a new number into the `JTextField` at any time during the program's execution. Use an inner class to perform event handling for the `JTextField`.

**15.21** (*Screen Saver with Shapes*) Modify your solution to Exercise 15.19 such that it uses random-number generation to choose different shapes to display. Use methods of class `Graphics`.

**15.22** (*Screen Saver Using the Java 2D API*) Modify your solution to Exercise 15.21 to use classes and drawing capabilities of the Java 2D API. Draw shapes like rectangles and ellipses, with randomly generated gradients. Use class `GradientPaint` to generate the gradient.

**15.23** (*Turtle Graphics*) Modify your solution to Exercise 7.21—*Turtle Graphics*—to add a graphical user interface using `JTextFields` and `JButtons`. Draw lines rather than asterisks (\*). When the turtle graphics program specifies a move, translate the number of positions into a number of pixels on the screen by multiplying the number of positions by 10 (or any value you choose). Implement the drawing with Java 2D API features.

**15.24** (*Knight's Tour*) Produce a graphical version of the Knight's Tour problem (Exercise 7.22, Exercise 7.23 and Exercise 7.26). As each move is made, the appropriate cell of the chessboard should be updated with the proper move number. If the result of the program is a *full tour* or a *closed tour*, the program should display an appropriate message. If you like, use class `Timer` (see Exercise 15.19) to help animate the Knight's Tour.

**15.25** (*Tortoise and Hare*) Produce a graphical version of the *Tortoise and Hare* simulation (Exercise 7.28). Simulate the mountain by drawing an arc that extends from the bottom-left corner of the window to the top-right corner. The tortoise and the hare should race up the mountain. Implement the graphical output to actually print the tortoise and the hare on the arc for every move. [*Hint*: Extend the length of the race from 70 to 300 to allow yourself a larger graphics area.]

**15.26** (*Drawing Spirals*) Write an application that uses `Graphics` method `drawPolyline` to draw a spiral similar to the one shown in Fig. 15.33.

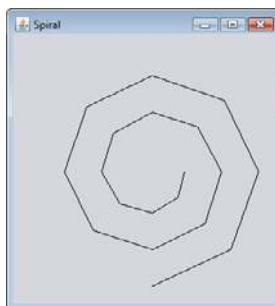

**Fig. 15.33** | Spiral drawn using method `drawPolyline`.

**15.27 (Pie Chart)** Write a program that inputs four numbers and graphs them as a pie chart. Use class `Arc2D.Double` and method `fill` of class `Graphics2D` to perform the drawing. Draw each piece of the pie in a separate color.

**15.28 (Selecting Shapes)** Write an application that allows the user to select a shape from a `JComboBox` and draws it 20 times with random locations and dimensions in method `paintComponent`. The first item in the `JComboBox` should be the default shape that is displayed the first time `paintComponent` is called.

**15.29 (Random Colors)** Modify Exercise 15.28 to draw each of the 20 randomly sized shapes in a randomly selected color. Use all 13 predefined `Color` objects in an array of `Colors`.

**15.30 (JColorChooser Dialog)** Modify Exercise 15.28 to allow the user to select the color in which shapes should be drawn from a `JColorChooser` dialog.

### *(Optional) GUI and Graphics Case Study: Adding Java 2D*

**15.31** Java 2D introduces many new capabilities for creating unique and impressive graphics. We'll add a small subset of these features to the drawing application you created in Exercise 14.17. In this version, you'll enable the user to specify gradients for filling shapes and to change stroke characteristics for drawing lines and outlines of shapes. The user will be able to choose which colors compose the gradient and set the width and dash length of the stroke.

First, you must update the `MyShape` hierarchy to support Java 2D functionality. Make the following changes in class `MyShape`:

- a) Change abstract method `draw`'s parameter type from `Graphics` to `Graphics2D`.
- b) Change all variables of type `Color` to type `Paint` to enable support for gradients. [*Note:* Recall that class `Color` implements interface `Paint`.]
- c) Add an instance variable of type `Stroke` in class `MyShape` and a `Stroke` parameter in the constructor to initialize the new instance variable. The default stroke should be an instance of class `BasicStroke`.

Classes `MyLine`, `MyBoundedShape`, `MyOval` and `MyRectangle` should each add a `Stroke` parameter to their constructors. In the `draw` methods, each shape should set the `Paint` and the `Stroke` before drawing or filling a shape. Since `Graphics2D` is a subclass of `Graphics`, we can continue to use `Graphics` methods `drawLine`, `drawOval`, `fillOval`, and so on, to draw the shapes. When these methods are called, they'll draw the appropriate shape using the specified `Paint` and `Stroke` settings.

Next, you'll update the `DrawPanel` to handle the Java 2D features. Change all `Color` variables to `Paint` variables. Declare an instance variable `currentStroke` of type `Stroke` and provide a *set* method for it. Update the calls to the individual shape constructors to include the `Paint` and `Stroke` arguments. In method `paintComponent`, cast the `Graphics` reference to type `Graphics2D` and use the `Graphics2D` reference in each call to `MyShape` method `draw`.

Next, make the new Java 2D features accessible from the GUI. Create a `JPanel` of GUI components for setting the Java 2D options. Add these components at the top of the `DrawFrame` below the panel that currently contains the standard shape controls (see Fig. 15.34). These GUI components should include:

- a) A check box to specify whether to paint using a gradient.
- b) Two `JButtons` that each show a `JColorChooser` dialog to allow the user to choose the first and second color in the gradient. (These will replace the `JComboBox` used for choosing the color in Exercise 14.17.)
- c) A text field for entering the `Stroke` width.
- d) A text field for entering the `Stroke` dash length.
- e) A check box for selecting whether to draw a dashed or solid line.

If the user selects to draw with a gradient, set the `Paint` on the `DrawPanel` to be a gradient of the two colors chosen by the user. The expression

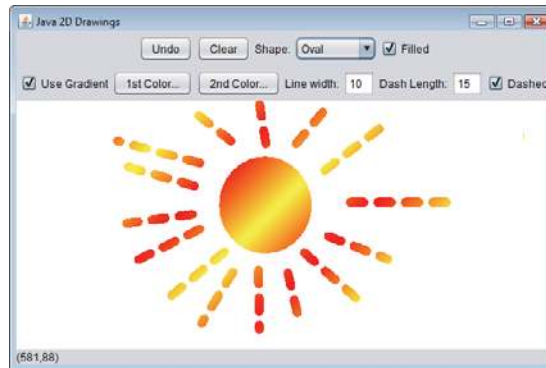

**Fig. 15.34** | Drawing with Java 2D.

```
new GradientPaint(0, 0, color1, 50, 50, color2, true)
```

creates a `GradientPaint` that cycles diagonally from the upper-left to the bottom-right every 50 pixels. Variables `color1` and `color2` represent the colors chosen by the user. If the user does not select to use a gradient, then simply set the `Paint` on the `DrawPane1` to be the first `Color` chosen by the user.

For strokes, if the user chooses a solid line, then create the `Stroke` with the expression

```
new BasicStroke(width, BasicStroke.CAP_ROUND, BasicStroke.JOIN_ROUND)
```

where variable `width` is the width specified by the user in the line-width text field. If the user chooses a dashed line, then create the `Stroke` with the expression

```
new BasicStroke(width, BasicStroke.CAP_ROUND, BasicStroke.JOIN_ROUND,
 10, dashes, 0)
```

where `width` again is the width in the line-width field, and `dashes` is an array with one element whose value is the length specified in the dash-length field. The `Panel` and `Stroke` objects should be passed to the shape object's constructor when the shape is created in `DrawPane1`.

## Making a Difference

**15.32** (*Large-Type Displays for People with Low Vision*) The accessibility of computers and the Internet to all people, regardless of disabilities, is becoming more important as these tools play increasing roles in our personal and business lives. According to a recent estimate by the World Health Organization ([www.who.int/mediacentre/factsheets/fs282/en/](http://www.who.int/mediacentre/factsheets/fs282/en/)), 124 million people worldwide have low vision. To learn more about low vision, check out the GUI-based low-vision simulation at [www.webaim.org/simulations/lowvision.php](http://www.webaim.org/simulations/lowvision.php). People with low vision might prefer to choose a font and/or a larger font size when reading electronic documents and web pages. Java has five built-in “logical” fonts that are guaranteed to be available in any Java implementation, including `Serif`, `Sans-serif` and `Monospaced`. Write a GUI application that provides a `JTextArea` in which the user can type text. Allow the user to select `Serif`, `Sans-serif` or `Monospaced` from a `JComboBox`. Provide a `Bold` `JCheckBox`, which, if checked, makes the text bold. Include `Increase Font Size` and `Decrease Font Size` `JButtons` that allow the user to scale the size of the font up or down, respectively, by one point at a time. Start with a font size of 18 points. For the purposes of this exercise, set the font size on the `JComboBox`, `JButtons` and `JCheckBox` to 20 points so that a person with low vision will be able to read the text on them.

# 16

## Strings, Characters and Regular Expressions

*The chief defect of Henry King  
Was chewing little bits of string.*

—Hilaire Belloc

*Vigorous writing is concise. A  
sentence should contain no  
unnecessary words, a paragraph  
no unnecessary sentences.*

—William Strunk, Jr.

*I have made this letter longer  
than usual, because I lack the  
time to make it short.*

—Blaise Pascal

### Objectives

In this chapter you'll learn:

- To create and manipulate immutable character-string objects of class `String`.
- To create and manipulate mutable character-string objects of class `StringBuilder`.
- To create and manipulate objects of class `Character`.
- To break a `String` object into tokens using `String` method `split`.
- To use regular expressions to validate `String` data entered into an application.

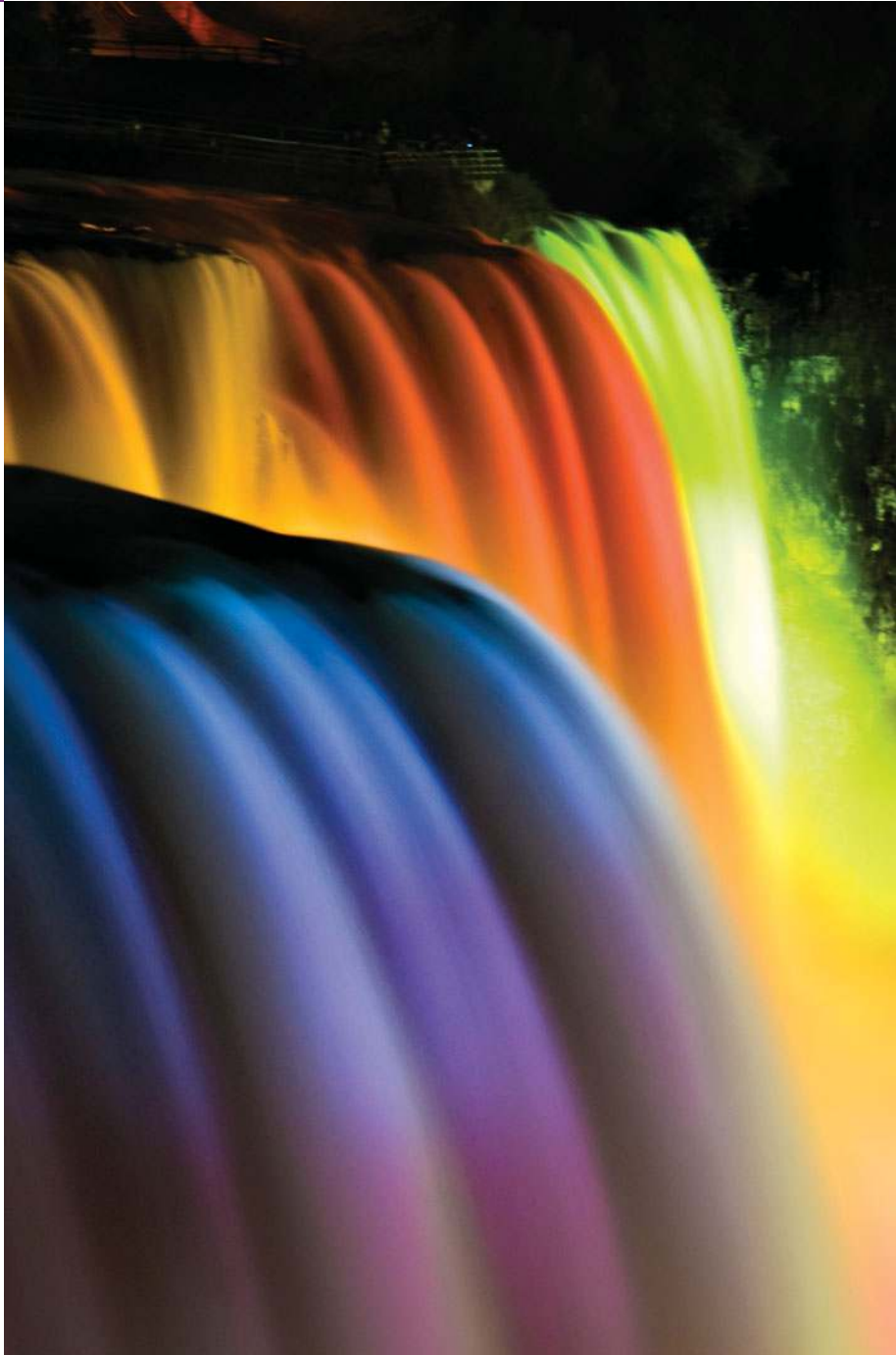

- 16.1 Introduction
- 16.2 Fundamentals of Characters and Strings
- 16.3 Class `String`
  - 16.3.1 `String` Constructors
  - 16.3.2 `String` Methods `length`, `charAt` and `getChars`
  - 16.3.3 Comparing Strings
  - 16.3.4 Locating Characters and Substrings in Strings
  - 16.3.5 Extracting Substrings from Strings
  - 16.3.6 Concatenating Strings
  - 16.3.7 Miscellaneous `String` Methods
  - 16.3.8 `String` Method `valueOf`
- 16.4 Class `StringBuilder`
  - 16.4.1 `StringBuilder` Constructors
  - 16.4.2 `StringBuilder` Methods `length`, `capacity`, `setLength` and `ensureCapacity`
  - 16.4.3 `StringBuilder` Methods `charAt`, `setCharAt`, `getChars` and `reverse`
  - 16.4.4 `StringBuilder` `append` Methods
  - 16.4.5 `StringBuilder` Insertion and Deletion Methods
- 16.5 Class `Character`
- 16.6 Tokenizing Strings
- 16.7 Regular Expressions, Class `Pattern` and Class `Matcher`
- 16.8 Wrap-Up

*Summary | Self-Review Exercises | Answers to Self-Review Exercises | Exercises | Special Section:  
Advanced String-Manipulation Exercises |  
Special Section: Challenging String-Manipulation Projects | Making a Difference*

## 16.1 Introduction

This chapter introduces Java's string- and character-processing capabilities. The techniques discussed here are appropriate for validating program input, displaying information to users and other text-based manipulations. They're also appropriate for developing text editors, word processors, page-layout software, computerized typesetting systems and other kinds of text-processing software. We've presented several string-processing capabilities in earlier chapters. This chapter discusses in detail the capabilities of classes `String`, `StringBuilder` and `Character` from the `java.lang` package. These classes provide the foundation for string and character manipulation in Java.

The chapter also discusses regular expressions that provide applications with the capability to validate input. The functionality is located in the `String` class along with classes `Matcher` and `Pattern` located in the `java.util.regex` package.

## 16.2 Fundamentals of Characters and Strings

Characters are the fundamental building blocks of Java source programs. Every program is composed of a sequence of characters that—when grouped together meaningfully—are interpreted by the Java compiler as a series of instructions used to accomplish a task. A program may contain **character literals**. A character literal is an integer value represented as a character in single quotes. For example, `'z'` represents the integer value of `z`, and `'\n'` represents the integer value of newline. The value of a character literal is the integer value of the character in the **Unicode character set**. Appendix B presents the integer equivalents of the characters in the ASCII character set, which is a subset of Unicode (discussed in Appendix L).

Recall from Section 2.2 that a string is a sequence of characters treated as a single unit. A string may include letters, digits and various **special characters**, such as `+`, `-`, `*`, `/` and `$`.

A string is an object of class `String`. **String literals** (stored in memory as `String` objects) are written as a sequence of characters in double quotation marks, as in:

|                          |                      |
|--------------------------|----------------------|
| "John Q. Doe"            | (a name)             |
| "9999 Main Street"       | (a street address)   |
| "Waltham, Massachusetts" | (a city and state)   |
| "(201) 555-1212"         | (a telephone number) |

A string may be assigned to a `String` reference. The declaration

```
String color = "blue";
```

initializes `String` variable `color` to refer to a `String` object that contains the string "blue".



### Performance Tip 16.1

To conserve memory, Java treats all string literals with the same contents as a single `String` object that has many references to it.

## 16.3 Class String

Class `String` is used to represent strings in Java. The next several subsections cover many of class `String`'s capabilities.

### 16.3.1 String Constructors

Class `String` provides constructors for initializing `String` objects in a variety of ways. Four of the constructors are demonstrated in the main method of Fig. 16.1.

Line 12 instantiates a new `String` using class `String`'s no-argument constructor and assigns its reference to `s1`. The new `String` object contains no characters (i.e., the **empty**

```

1 // Fig. 16.1: StringConstructors.java
2 // String class constructors.
3
4 public class StringConstructors
5 {
6 public static void main(String[] args)
7 {
8 char[] charArray = { 'b', 'i', 'r', 't', 'h', ' ', 'd', 'a', 'y' };
9 String s = new String("hello");
10
11 // use String constructors
12 String s1 = new String();
13 String s2 = new String(s);
14 String s3 = new String(charArray);
15 String s4 = new String(charArray, 6, 3);
16
17 System.out.printf(
18 "s1 = %s\ns2 = %s\ns3 = %s\ns4 = %s\n",
19 s1, s2, s3, s4); // display strings
20 } // end main
21 } // end class StringConstructors

```

**Fig. 16.1** | String class constructors. (Part 1 of 2.)



```
s1 =
s2 = hello
s3 = birth day
s4 = day
```

**Fig. 16.1** | String class constructors. (Part 2 of 2.)

**string**, which can also be represented as `""`) and has a length of 0. Line 13 instantiates a new `String` object using class `String`'s constructor that takes a `String` object as an argument and assigns its reference to `s2`. The new `String` object contains the same sequence of characters as the `String` object `s` that's passed as an argument to the constructor.



### Software Engineering Observation 16.1

*It's not necessary to copy an existing `String` object. `String` objects are **immutable**—their character contents cannot be changed after they're created, because class `String` does not provide methods that allow the contents of a `String` object to be modified.*

Line 14 instantiates a new `String` object and assigns its reference to `s3` using class `String`'s constructor that takes a `char` array as an argument. The new `String` object contains a copy of the characters in the array.

Line 15 instantiates a new `String` object and assigns its reference to `s4` using class `String`'s constructor that takes a `char` array and two integers as arguments. The second argument specifies the starting position (the offset) from which characters in the array are accessed. Remember that the first character is at position 0. The third argument specifies the number of characters (the count) to access in the array. The new `String` object is formed from the accessed characters. If the offset or the count specified as an argument results in accessing an element outside the bounds of the character array, a `StringIndexOutOfBoundsException` is thrown.



### Common Programming Error 16.1

*Accessing a character outside the bounds of a `String` (i.e., an index less than 0 or an index greater than or equal to the `String`'s length) results in a `StringIndexOutOfBoundsException`.*

## 16.3.2 String Methods `length`, `charAt` and `getChars`

`String` methods **`length`**, **`charAt`** and **`getChars`** return the length of a `String`, obtain the character at a specific location in a `String` and retrieve a set of characters from a `String` as a `char` array, respectively. Figure 16.2 demonstrates each of these methods.

```
1 // Fig. 16.2: StringMiscellaneous.java
2 // This application demonstrates the length, charAt and getChars
3 // methods of the String class.
4
5 public class StringMiscellaneous
6 {
```

**Fig. 16.2** | String methods `length`, `charAt` and `getChars`. (Part 1 of 2.)

```

7 public static void main(String[] args)
8 {
9 String s1 = "hello there";
10 char[] charArray = new char[5];
11
12 System.out.printf("s1: %s", s1);
13
14 // test length method
15 System.out.printf("\nLength of s1: %d", s1.length());
16
17 // loop through characters in s1 with charAt and display reversed
18 System.out.print("\nThe string reversed is: ");
19
20 for (int count = s1.length() - 1; count >= 0; count--)
21 System.out.printf("%c ", s1.charAt(count));
22
23 // copy characters from string into charArray
24 s1.getChars(0, 5, charArray, 0);
25 System.out.print("\nThe character array is: ");
26
27 for (char character : charArray)
28 System.out.print(character);
29
30 System.out.println();
31 } // end main
32 } // end class StringMiscellaneous

```

```

s1: hello there
Length of s1: 11
The string reversed is: e r e h t o l l e h
The character array is: hello

```

**Fig. 16.2** | String methods `length`, `charAt` and `getChars`. (Part 2 of 2.)

Line 15 uses `String` method `length` to determine the number of characters in `String` `s1`. Like arrays, strings know their own length. However, unlike arrays, you access a `String`'s length via class `String`'s `length` method.

Lines 20–21 print the characters of the `String` `s1` in reverse order (and separated by spaces). `String` method `charAt` (line 21) returns the character at a specific position in the `String`. Method `charAt` receives an integer argument that's used as the index and returns the character at that position. Like arrays, the first element of a `String` is at position 0.

Line 24 uses `String` method `getChars` to copy the characters of a `String` into a character array. The first argument is the starting index from which characters are to be copied. The second argument is the index that's one past the last character to be copied from the `String`. The third argument is the character array into which the characters are to be copied. The last argument is the starting index where the copied characters are placed in the target character array. Next, lines 27–28 print the char array contents one character at a time.

### 16.3.3 Comparing Strings

Chapter 19 discusses sorting and searching arrays. Frequently, the information being sorted or searched consists of `Strings` that must be compared to place them into order or to

determine whether a string appears in an array (or other collection). Class `String` provides methods for comparing strings, as demonstrated in the next two examples.

To understand what it means for one string to be greater than or less than another, consider the process of alphabetizing a series of last names. No doubt, you'd place "Jones" before "Smith" because the first letter of "Jones" comes before the first letter of "Smith" in the alphabet. But the alphabet is more than just a list of 26 letters—it's an ordered set of characters. Each letter occurs in a specific position within the set. Z is more than just a letter of the alphabet—it's specifically the twenty-sixth letter of the alphabet.

How does the computer know that one letter "comes before" another? All characters are represented in the computer as numeric codes (see Appendix B). When the computer compares `Strings`, it actually compares the numeric codes of the characters in the `Strings`.

Figure 16.3 demonstrates `String` methods `equals`, `equalsIgnoreCase`, `compareTo` and `regionMatches` and using the equality operator `==` to compare `String` objects.

---

```

1 // Fig. 16.3: StringCompare.java
2 // String methods equals, equalsIgnoreCase, compareTo and regionMatches.
3
4 public class StringCompare
5 {
6 public static void main(String[] args)
7 {
8 String s1 = new String("hello"); // s1 is a copy of "hello"
9 String s2 = "goodbye";
10 String s3 = "Happy Birthday";
11 String s4 = "happy birthday";
12
13 System.out.printf(
14 "s1 = %s\ns2 = %s\ns3 = %s\ns4 = %s\n\n", s1, s2, s3, s4);
15
16 // test for equality
17 if (s1.equals("hello")) // true
18 System.out.println("s1 equals \"hello\"");
19 else
20 System.out.println("s1 does not equal \"hello\"");
21
22 // test for equality with ==
23 if (s1 == "hello") // false; they are not the same object
24 System.out.println("s1 is the same object as \"hello\"");
25 else
26 System.out.println("s1 is not the same object as \"hello\"");
27
28 // test for equality (ignore case)
29 if (s3.equalsIgnoreCase(s4)) // true
30 System.out.printf("%s equals %s with case ignored\n", s3, s4);
31 else
32 System.out.println("s3 does not equal s4");
33

```

---

**Fig. 16.3** | String methods `equals`, `equalsIgnoreCase`, `compareTo` and `regionMatches`.  
(Part I of 2.)

```

34 // test compareTo
35 System.out.printf(
36 "\ns1.compareTo(s2) is %d", s1.compareTo(s2));
37 System.out.printf(
38 "\ns2.compareTo(s1) is %d", s2.compareTo(s1));
39 System.out.printf(
40 "\ns1.compareTo(s1) is %d", s1.compareTo(s1));
41 System.out.printf(
42 "\ns3.compareTo(s4) is %d", s3.compareTo(s4));
43 System.out.printf(
44 "\ns4.compareTo(s3) is %d\n\n", s4.compareTo(s3));
45
46 // test regionMatches (case sensitive)
47 if (s3.regionMatches(0, s4, 0, 5))
48 System.out.println("First 5 characters of s3 and s4 match");
49 else
50 System.out.println(
51 "First 5 characters of s3 and s4 do not match");
52
53 // test regionMatches (ignore case)
54 if (s3.regionMatches(true, 0, s4, 0, 5))
55 System.out.println(
56 "First 5 characters of s3 and s4 match with case ignored");
57 else
58 System.out.println(
59 "First 5 characters of s3 and s4 do not match");
60 } // end main
61 } // end class StringCompare

```

```

s1 = hello
s2 = goodbye
s3 = Happy Birthday
s4 = happy birthday

s1 equals "hello"
s1 is not the same object as "hello"
Happy Birthday equals happy birthday with case ignored

s1.compareTo(s2) is 1
s2.compareTo(s1) is -1
s1.compareTo(s1) is 0
s3.compareTo(s4) is -32
s4.compareTo(s3) is 32

First 5 characters of s3 and s4 do not match
First 5 characters of s3 and s4 match with case ignored

```

**Fig. 16.3** | String methods equals, equalsIgnoreCase, compareTo and regionMatches. (Part 2 of 2.)

### *String Method equals*

The condition at line 17 uses method equals to compare String s1 and the String literal "hello" for equality. Method equals (a method of class Object overridden in String) tests any two objects for equality—the strings contained in the two objects are identical.

The method returns true if the contents of the objects are equal, and false otherwise. The preceding condition is true because String s1 was initialized with the string literal "hello". Method equals uses a **lexicographical comparison**—it compares the integer Unicode values (see Appendix L, for more information) that represent each character in each String. Thus, if the String "hello" is compared with the string "HELLO", the result is false, because the integer representation of a lowercase letter is different from that of the corresponding uppercase letter.

### Comparing Strings with the == Operator

The condition at line 23 uses the equality operator == to compare String s1 for equality with the String literal "hello". When primitive-type values are compared with ==, the result is true if *both values are identical*. When references are compared with ==, the result is true if *both references refer to the same object in memory*. To compare the actual contents (or state information) of objects for equality, a method must be invoked. In the case of Strings, that method is equals. The preceding condition evaluates to false at line 23 because the reference s1 was initialized with the statement

```
s1 = new String("hello");
```

which creates a new String object with a copy of string literal "hello" and assigns the new object to variable s1. If s1 had been initialized with the statement

```
s1 = "hello";
```

which directly assigns the string literal "hello" to variable s1, the condition would be true. Remember that Java treats all string literal objects with the same contents as one String object to which there can be many references. Thus, lines 8, 17 and 23 all refer to the same String object "hello" in memory.



### Common Programming Error 16.2

*Comparing references with == can lead to logic errors, because == compares the references to determine whether they refer to the same object, not whether two objects have the same contents. When two identical (but separate) objects are compared with ==, the result will be false. When comparing objects to determine whether they have the same contents, use method equals.*

### String Method equalsIgnoreCase

If you're sorting Strings, you may compare them for equality with method equalsIgnoreCase, which ignores whether the letters in each String are uppercase or lowercase when performing the comparison. Thus, "hello" and "HELLO" compare as equal. Line 29 uses String method equalsIgnoreCase to compare String s3—Happy Birthday—for equality with String s4—happy birthday. The result of this comparison is true because the comparison ignores case sensitivity.

### String Method compareTo

Lines 35–44 use method compareTo to compare Strings. Method compareTo is declared in the Comparable interface and implemented in the String class. Line 36 compares String s1 to String s2. Method compareTo returns 0 if the Strings are equal, a negative number if the String that invokes compareTo is less than the String that's passed as an argument and a positive number if the String that invokes compareTo is greater than the

String that's passed as an argument. Method `compareTo` uses a lexicographical comparison—it compares the numeric values of corresponding characters in each String.

### *String Method `regionMatches`*

The condition at line 47 uses String method `regionMatches` to compare portions of two Strings for equality. The first argument is the starting index in the String that invokes the method. The second argument is a comparison String. The third argument is the starting index in the comparison String. The last argument is the number of characters to compare between the two Strings. The method returns true only if the specified number of characters are lexicographically equal.

Finally, the condition at line 54 uses a five-argument version of String method `regionMatches` to compare portions of two Strings for equality. When the first argument is true, the method ignores the case of the characters being compared. The remaining arguments are identical to those described for the four-argument `regionMatches` method.

### *String Methods `startsWith` and `endsWith`*

The next example (Fig. 16.4) demonstrates String methods `startsWith` and `endsWith`. Method `main` creates array `strings` containing "started", "starting", "ended" and "ending". The remainder of method `main` consists of three `for` statements that test the elements of the array to determine whether they start with or end with a particular set of characters.

---

```

1 // Fig. 16.4: StringStartEnd.java
2 // String methods startsWith and endsWith.
3
4 public class StringStartEnd
5 {
6 public static void main(String[] args)
7 {
8 String[] strings = { "started", "starting", "ended", "ending" };
9
10 // test method startsWith
11 for (String string : strings)
12 {
13 if (string.startsWith("st"))
14 System.out.printf("%s starts with \"st\"\n", string);
15 } // end for
16
17 System.out.println();
18
19 // test method startsWith starting from position 2 of string
20 for (String string : strings)
21 {
22 if (string.startsWith("art", 2))
23 System.out.printf(
24 "%s starts with \"art\" at position 2\n", string);
25 } // end for
26
27 System.out.println();

```

---

**Fig. 16.4** | String methods `startsWith` and `endsWith`. (Part I of 2.)

```

28
29 // test method endsWith
30 for (String string : strings)
31 {
32 if (string.endsWith("ed"))
33 System.out.printf("%s\n" ends with "ed"\n", string);
34 } // end for
35 } // end main
36 } // end class StringStartEnd

```

```

"started" starts with "st"
"starting" starts with "st"

"started" starts with "art" at position 2
"starting" starts with "art" at position 2

"started" ends with "ed"
"ended" ends with "ed"

```

**Fig. 16.4** | String methods `startsWith` and `endsWith`. (Part 2 of 2.)

Lines 11–15 use the version of method `startsWith` that takes a `String` argument. The condition in the `if` statement (line 13) determines whether each `String` in the array starts with the characters "st". If so, the method returns `true` and the application prints that `String`. Otherwise, the method returns `false` and nothing happens.

Lines 20–25 use the `startsWith` method that takes a `String` and an integer as arguments. The integer specifies the index at which the comparison should begin in the `String`. The condition in the `if` statement (line 22) determines whether each `String` in the array has the characters "art" beginning with the third character in each `String`. If so, the method returns `true` and the application prints the `String`.

The third `for` statement (lines 30–34) uses method `endsWith`, which takes a `String` argument. The condition at line 32 determines whether each `String` in the array ends with the characters "ed". If so, the method returns `true` and the application prints the `String`.

### 16.3.4 Locating Characters and Substrings in Strings

Often it's useful to search a string for a character or set of characters. For example, if you're creating your own word processor, you might want to provide a capability for searching through documents. Figure 16.5 demonstrates the many versions of `String` methods `indexOf` and `lastIndexOf` that search for a specified character or substring in a `String`.

```

1 // Fig. 16.5: StringIndexMethods.java
2 // String searching methods indexOf and lastIndexOf.
3
4 public class StringIndexMethods
5 {
6 public static void main(String[] args)
7 {
8 String letters = "abcdefghijklmabcdefghijklm";

```

**Fig. 16.5** | String-searching methods `indexOf` and `lastIndexOf`. (Part 1 of 2.)

```

9
10 // test indexOf to locate a character in a string
11 System.out.printf(
12 "'c' is located at index %d\n", letters.indexOf('c'));
13 System.out.printf(
14 "'a' is located at index %d\n", letters.indexOf('a', 1));
15 System.out.printf(
16 "'$' is located at index %d\n\n", letters.indexOf('$'));
17
18 // test lastIndexOf to find a character in a string
19 System.out.printf("Last 'c' is located at index %d\n",
20 letters.lastIndexOf('c'));
21 System.out.printf("Last 'a' is located at index %d\n",
22 letters.lastIndexOf('a', 25));
23 System.out.printf("Last '$' is located at index %d\n\n",
24 letters.lastIndexOf('$'));
25
26 // test indexOf to locate a substring in a string
27 System.out.printf("\"def\" is located at index %d\n",
28 letters.indexOf("def"));
29 System.out.printf("\"def\" is located at index %d\n",
30 letters.indexOf("def", 7));
31 System.out.printf("\"hello\" is located at index %d\n\n",
32 letters.indexOf("hello"));
33
34 // test lastIndexOf to find a substring in a string
35 System.out.printf("Last \"def\" is located at index %d\n",
36 letters.lastIndexOf("def"));
37 System.out.printf("Last \"def\" is located at index %d\n",
38 letters.lastIndexOf("def", 25));
39 System.out.printf("Last \"hello\" is located at index %d\n",
40 letters.lastIndexOf("hello"));
41 } // end main
42 } // end class StringIndexMethods

```

```

'c' is located at index 2
'a' is located at index 13
'$' is located at index -1

Last 'c' is located at index 15
Last 'a' is located at index 13
Last '$' is located at index -1

"def" is located at index 3
"def" is located at index 16
"hello" is located at index -1

Last "def" is located at index 16
Last "def" is located at index 16
Last "hello" is located at index -1

```

**Fig. 16.5** | String-searching methods `indexOf` and `lastIndexOf`. (Part 2 of 2.)

All the searches in this example are performed on the String `letters` (initialized with "abcdefghijklmabcdehijklm"). Lines 11–16 use method `indexOf` to locate the first



occurrence of a character in a `String`. If the method finds the character, it returns the character's index in the `String`—otherwise, it returns `-1`. There are two versions of `indexOf` that search for characters in a `String`. The expression in line 12 uses the version of method `indexOf` that takes an integer representation of the character to find. The expression at line 14 uses another version of method `indexOf`, which takes two integer arguments—the character and the starting index at which the search of the `String` should begin.

Lines 19–24 use method `lastIndexOf` to locate the last occurrence of a character in a `String`. The method searches from the end of the `String` toward the beginning. If it finds the character, it returns the character's index in the `String`—otherwise, it returns `-1`. There are two versions of `lastIndexOf` that search for characters in a `String`. The expression at line 20 uses the version that takes the integer representation of the character. The expression at line 22 uses the version that takes two integer arguments—the integer representation of the character and the index from which to begin searching backward.

Lines 27–40 demonstrate versions of methods `indexOf` and `lastIndexOf` that each take a `String` as the first argument. These versions perform identically to those described earlier except that they search for sequences of characters (or substrings) that are specified by their `String` arguments. If the substring is found, these methods return the index in the `String` of the first character in the substring.

### 16.3.5 Extracting Substrings from Strings

Class `String` provides two substring methods to enable a new `String` object to be created by copying part of an existing `String` object. Each method returns a new `String` object. Both methods are demonstrated in Fig. 16.6.

```

1 // Fig. 16.6: SubString.java
2 // String class substring methods.
3
4 public class SubString
5 {
6 public static void main(String[] args)
7 {
8 String letters = "abcdefghijklmabcdefghijklm";
9
10 // test substring methods
11 System.out.printf("Substring from index 20 to end is \"%s\"\n",
12 letters.substring(20));
13 System.out.printf("%s \"%s\"\n",
14 "Substring from index 3 up to, but not including 6 is",
15 letters.substring(3, 6));
16 } // end main
17 } // end class SubString

```

```

Substring from index 20 to end is "hijklm"
Substring from index 3 up to, but not including 6 is "def"

```

**Fig. 16.6** | String class substring methods.

The expression `letters.substring(20)` at line 12 uses the substring method that takes one integer argument. The argument specifies the starting index in the original

String letters from which characters are to be copied. The substring returned contains a copy of the characters from the starting index to the end of the String. Specifying an index outside the bounds of the String causes a **StringIndexOutOfBoundsException**.

Line 15 uses the substring method that takes two integer arguments—the starting index from which to copy characters in the original String and the index one beyond the last character to copy (i.e., copy up to, but not including, that index in the String). The substring returned contains a copy of the specified characters from the original String. An index outside the bounds of the String causes a **StringIndexOutOfBoundsException**.

### 16.3.6 Concatenating Strings

String method **concat** (Fig. 16.7) concatenates two String objects and returns a new String object containing the characters from both original Strings. The expression `s1.concat( s2 )` at line 13 forms a String by appending the characters in `s2` to the characters in `s1`. The original Strings to which `s1` and `s2` refer are not modified.

```

1 // Fig. 16.7: StringConcatenation.java
2 // String method concat.
3
4 public class StringConcatenation
5 {
6 public static void main(String[] args)
7 {
8 String s1 = "Happy ";
9 String s2 = "Birthday";
10
11 System.out.printf("s1 = %s\ns2 = %s\n\n", s1, s2);
12 System.out.printf(
13 "Result of s1.concat(s2) = %s\n", s1.concat(s2));
14 System.out.printf("s1 after concatenation = %s\n", s1);
15 } // end main
16 } // end class StringConcatenation

```

```

s1 = Happy
s2 = Birthday

```

```

Result of s1.concat(s2) = Happy Birthday
s1 after concatenation = Happy

```

**Fig. 16.7** | String method `concat`.

### 16.3.7 Miscellaneous String Methods

Class String provides several methods that return modified copies of Strings or that return character arrays. These methods are demonstrated in the application in Fig. 16.8.

Line 16 uses String method `replace` to return a new String object in which every occurrence in `s1` of character 'l' (lowercase el) is replaced with character 'L'. Method `replace` leaves the original String unchanged. If there are no occurrences of the first argument in the String, method `replace` returns the original String. An overloaded version of method `replace` enables you to replace substrings rather than individual characters.

```

1 // Fig. 16.8: StringMiscellaneous2.java
2 // String methods replace, toLowerCase, toUpperCase, trim and toCharArray.
3
4 public class StringMiscellaneous2
5 {
6 public static void main(String[] args)
7 {
8 String s1 = "hello";
9 String s2 = "GOODBYE";
10 String s3 = " spaces ";
11
12 System.out.printf("s1 = %s\ns2 = %s\ns3 = %s\n\n", s1, s2, s3);
13
14 // test method replace
15 System.out.printf(
16 "Replace 'l' with 'L' in s1: %s\n\n", s1.replace('l', 'L'));
17
18 // test toLowerCase and toUpperCase
19 System.out.printf("s1.toUpperCase() = %s\n", s1.toUpperCase());
20 System.out.printf("s2.toLowerCase() = %s\n\n", s2.toLowerCase());
21
22 // test trim method
23 System.out.printf("s3 after trim = \"%s\"\n\n", s3.trim());
24
25 // test toCharArray method
26 char[] charArray = s1.toCharArray();
27 System.out.print("s1 as a character array = ");
28
29 for (char character : charArray)
30 System.out.print(character);
31
32 System.out.println();
33 } // end main
34 } // end class StringMiscellaneous2

```

```

s1 = hello
s2 = GOODBYE
s3 = spaces

Replace 'l' with 'L' in s1: heLLo

s1.toUpperCase() = HELLO
s2.toLowerCase() = goodbye

s3 after trim = "spaces"

s1 as a character array = hello

```

**Fig. 16.8** | String methods `replace`, `toLowerCase`, `toUpperCase`, `trim` and `toCharArray`.

Line 19 uses String method **`toUpperCase`** to generate a new String with uppercase letters where corresponding lowercase letters exist in `s1`. The method returns a new String object containing the converted String and leaves the original String unchanged. If there are no characters to convert, method `toUpperCase` returns the original String.

Line 20 uses String method `toLowerCase` to return a new String object with lowercase letters where corresponding uppercase letters exist in `s2`. The original String remains unchanged. If there are no characters in the original String to convert, `toLowerCase` returns the original String.

Line 23 uses String method `trim` to generate a new String object that removes all white-space characters that appear at the beginning and/or end of the String on which `trim` operates. The method returns a new String object containing the String without leading or trailing white space. The original String remains unchanged. If there are no whitespace characters at the beginning and/or end, `trim` returns the original String.

Line 26 uses String method `toCharArray` to create a new character array containing a copy of the characters in `s1`. Lines 29–30 output each char in the array.

### 16.3.8 String Method `valueOf`

As we've seen, every object in Java has a `toString` method that enables a program to obtain the object's string representation. Unfortunately, this technique cannot be used with primitive types because they do not have methods. Class String provides static methods that take an argument of any type and convert it to a String object. Figure 16.9 demonstrates the String class `valueOf` methods.

The expression `String.valueOf(charArray)` at line 18 uses the character array `charArray` to create a new String object. The expression `String.valueOf(charArray, 3, 3)` at line 20 uses a portion of the character array `charArray` to create a new String object. The second argument specifies the starting index from which the characters are used. The third argument specifies the number of characters to be used.

---

```

1 // Fig. 16.9: StringValueOf.java
2 // String valueOf methods.
3
4 public class StringValueOf
5 {
6 public static void main(String[] args)
7 {
8 char[] charArray = { 'a', 'b', 'c', 'd', 'e', 'f' };
9 boolean booleanValue = true;
10 char characterValue = 'Z';
11 int integerValue = 7;
12 long longValue = 10000000000L; // L suffix indicates long
13 float floatValue = 2.5f; // f indicates that 2.5 is a float
14 double doubleValue = 33.333; // no suffix, double is default
15 Object objectRef = "hello"; // assign string to an Object reference
16
17 System.out.printf(
18 "char array = %s\n", String.valueOf(charArray));
19 System.out.printf("part of char array = %s\n",
20 String.valueOf(charArray, 3, 3));
21 System.out.printf(
22 "boolean = %s\n", String.valueOf(booleanValue));
23 System.out.printf(
24 "char = %s\n", String.valueOf(characterValue));

```

---

**Fig. 16.9** | String `valueOf` methods. (Part 1 of 2.)

```

25 System.out.printf("int = %s\n", String.valueOf(integerValue));
26 System.out.printf("long = %s\n", String.valueOf(longValue));
27 System.out.printf("float = %s\n", String.valueOf(floatValue));
28 System.out.printf(
29 "double = %s\n", String.valueOf(doubleValue));
30 System.out.printf("Object = %s", String.valueOf(objectRef));
31 } // end main
32 } // end class StringValueOf

```

```

char array = abcdef
part of char array = def
boolean = true
char = Z
int = 7
long = 10000000000L
float = 2.5f
double = 33.333
Object = hello

```

**Fig. 16.9** | String valueOf methods. (Part 2 of 2.)

There are seven other versions of method `valueOf`, which take arguments of type `boolean`, `char`, `int`, `long`, `float`, `double` and `Object`, respectively. These are demonstrated in lines 21–30. The version of `valueOf` that takes an `Object` as an argument can do so because all `Objects` can be converted to `Strings` with method `toString`.

[*Note:* Lines 12–13 use literal values `10000000000L` and `2.5f` as the initial values of `long` variable `longValue` and `float` variable `floatValue`, respectively. By default, Java treats integer literals as type `int` and floating-point literals as type `double`. Appending the letter `L` to the literal `10000000000` and appending letter `f` to the literal `2.5` indicates to the compiler that `10000000000` should be treated as a `long` and `2.5` as a `float`. An uppercase `L` or lowercase `l` can be used to denote a variable of type `long` and an uppercase `F` or lowercase `f` can be used to denote a variable of type `float`.]

## 16.4 Class StringBuilder

We now discuss the features of class `StringBuilder` for creating and manipulating *dynamic* string information—that is, *modifiable* strings. Every `StringBuilder` is capable of storing a number of characters specified by its capacity. If a `StringBuilder`'s capacity is exceeded, the capacity expands to accommodate the additional characters.



### Performance Tip 16.2

Java can perform certain optimizations involving `String` objects (such as referring to one `String` object from multiple variables) because it knows these objects will not change. `Strings` (not `StringBuilders`) should be used if the data will not change.



### Performance Tip 16.3

In programs that frequently perform string concatenation, or other string modifications, it's often more efficient to implement the modifications with class `StringBuilder`.



### Software Engineering Observation 16.2

*StringBuilders are not thread safe. If multiple threads require access to the same dynamic string information, use class **StringBuffer** in your code. Classes `StringBuilder` and `StringBuffer` provide identical capabilities, but class `StringBuffer` is thread safe. For more details on threading, see Chapter 26.*

## 16.4.1 StringBuilder Constructors

Class `StringBuilder` provides four constructors. We demonstrate three of these in Fig. 16.10. Line 8 uses the no-argument `StringBuilder` constructor to create a `StringBuilder` with no characters in it and an initial capacity of 16 characters (the default for a `StringBuilder`). Line 9 uses the `StringBuilder` constructor that takes an integer argument to create a `StringBuilder` with no characters in it and the initial capacity specified by the integer argument (i.e., 10). Line 10 uses the `StringBuilder` constructor that takes a `String` argument to create a `StringBuilder` containing the characters in the `String` argument. The initial capacity is the number of characters in the `String` argument plus 16.

Lines 12–14 implicitly use the method `toString` of class `StringBuilder` to output the `StringBuilder`s with the `printf` method. In Section 16.4.4, we discuss how Java uses `StringBuilder` objects to implement the `+` and `+=` operators for string concatenation.

```

1 // Fig. 16.10: StringBuilderConstructors.java
2 // StringBuilder constructors.
3
4 public class StringBuilderConstructors
5 {
6 public static void main(String[] args)
7 {
8 StringBuilder buffer1 = new StringBuilder();
9 StringBuilder buffer2 = new StringBuilder(10);
10 StringBuilder buffer3 = new StringBuilder("hello");
11
12 System.out.printf("buffer1 = \"%s\"\n", buffer1);
13 System.out.printf("buffer2 = \"%s\"\n", buffer2);
14 System.out.printf("buffer3 = \"%s\"\n", buffer3);
15 } // end main
16 } // end class StringBuilderConstructors

```

```

buffer1 = ""
buffer2 = ""
buffer3 = "hello"

```

**Fig. 16.10** | `StringBuilder` constructors.

## 16.4.2 StringBuilder Methods `length`, `capacity`, `setLength` and `ensureCapacity`

Class `StringBuilder` provides methods **length** and **capacity** to return the number of characters currently in a `StringBuilder` and the number of characters that can be stored in a `StringBuilder` without allocating more memory, respectively. Method **ensureCapacity** guarantees that a `StringBuilder` has at least the specified capacity. Method

setLength increases or decreases the length of a StringBuilder. Figure 16.11 demonstrates these methods.

```

1 // Fig. 16.11: StringBuilderCapLen.java
2 // StringBuilder length, setLength, capacity and ensureCapacity methods.
3
4 public class StringBuilderCapLen
5 {
6 public static void main(String[] args)
7 {
8 StringBuilder buffer = new StringBuilder("Hello, how are you?");
9
10 System.out.printf("buffer = %s\nlength = %d\ncapacity = %d\n\n",
11 buffer.toString(), buffer.length(), buffer.capacity());
12
13 buffer.ensureCapacity(75);
14 System.out.printf("New capacity = %d\n\n", buffer.capacity());
15
16 buffer.setLength(10);
17 System.out.printf("New length = %d\nbuffer = %s\n",
18 buffer.length(), buffer.toString());
19 } // end main
20 } // end class StringBuilderCapLen

```

```

buffer = Hello, how are you?
length = 19
capacity = 35

New capacity = 75

New length = 10
buffer = Hello, how

```

**Fig. 16.11** | StringBuilder length, setLength, capacity and ensureCapacity methods.

The application contains one `StringBuilder` called `buffer`. Line 8 uses the `StringBuilder` constructor that takes a `String` argument to initialize the `StringBuilder` with "Hello, how are you?". Lines 10–11 print the contents, length and capacity of the `StringBuilder`. Note in the output window that the capacity of the `StringBuilder` is initially 35. Recall that the `StringBuilder` constructor that takes a `String` argument initializes the capacity to the length of the string passed as an argument plus 16.

Line 13 uses method `ensureCapacity` to expand the capacity of the `StringBuilder` to a minimum of 75 characters. Actually, if the original capacity is less than the argument, the method ensures a capacity that's the greater of the number specified as an argument and twice the original capacity plus 2. The `StringBuilder`'s current capacity remains unchanged if it's more than the specified capacity.



#### Performance Tip 16.4

*Dynamically increasing the capacity of a `StringBuilder` can take a relatively long time. Executing a large number of these operations can degrade the performance of an application. If a `StringBuilder` is going to increase greatly in size, possibly multiple times, setting its capacity high at the beginning will increase performance.*

Line 16 uses method `setLength` to set the length of the `StringBuilder` to 10. If the specified length is less than the current number of characters in the `StringBuilder`, the buffer is truncated to the specified length (i.e., the characters in the `StringBuilder` after the specified length are discarded). If the specified length is greater than the number of characters currently in the `StringBuilder`, null characters (characters with the numeric representation 0) are appended until the total number of characters in the `StringBuilder` is equal to the specified length.

### 16.4.3 `StringBuilder` Methods `charAt`, `setCharAt`, `getChars` and `reverse`

Class `StringBuilder` provides methods `charAt`, `setCharAt`, `getChars` and `reverse` to manipulate the characters in a `StringBuilder` (Fig. 16.12). Method `charAt` (line 12) takes an integer argument and returns the character in the `StringBuilder` at that index. Method `getChars` (line 15) copies characters from a `StringBuilder` into the character array passed as an argument. This method takes four arguments—the starting index from which characters should be copied in the `StringBuilder`, the index one past the last character to be copied from the `StringBuilder`, the character array into which the characters are to be copied and the starting location in the character array where the first character should be placed. Method `setCharAt` (lines 21 and 22) takes an integer and a character argument and sets the character at the specified position in the `StringBuilder` to the character argument. Method `reverse` (line 25) reverses the contents of the `StringBuilder`.



#### Common Programming Error 16.3

*Attempting to access a character that's outside the bounds of a `StringBuilder` (i.e., with an index less than 0 or greater than or equal to the `StringBuilder`'s length) results in a `StringIndexOutOfBoundsException`.*

```

1 // Fig. 16.12: StringBuilderChars.java
2 // StringBuilder methods charAt, setCharAt, getChars and reverse.
3
4 public class StringBuilderChars
5 {
6 public static void main(String[] args)
7 {
8 StringBuilder buffer = new StringBuilder("hello there");
9
10 System.out.printf("buffer = %s\n", buffer.toString());
11 System.out.printf("Character at 0: %s\nCharacter at 4: %s\n\n",
12 buffer.charAt(0), buffer.charAt(4));
13
14 char[] charArray = new char[buffer.length()];
15 buffer.getChars(0, buffer.length(), charArray, 0);
16 System.out.print("The characters are: ");
17
18 for (char character : charArray)
19 System.out.print(character);

```

**Fig. 16.12** | `StringBuilder` methods `charAt`, `setCharAt`, `getChars` and `reverse`. (Part 1 of 2.)



```

20
21 buffer.setCharAt(0, 'H');
22 buffer.setCharAt(6, 'T');
23 System.out.printf("\n\nbuffer = %s", buffer.toString());
24
25 buffer.reverse();
26 System.out.printf("\n\nbuffer = %s\n", buffer.toString());
27 } // end main
28 } // end class StringBuilderChars

```

```

buffer = hello there
Character at 0: h
Character at 4: o

The characters are: hello there

buffer = Hello There

buffer = erehT olleH

```

**Fig. 16.12** | StringBuilder methods charAt, setCharAt, getChars and reverse. (Part 2 of 2.)

#### 16.4.4 StringBuilder append Methods

Class `StringBuilder` provides overloaded **append** methods (Fig. 16.13) to allow values of various types to be appended to the end of a `StringBuilder`. Versions are provided for each of the primitive types, and for character arrays, `Strings`, `Objects`, and more. (Remember that method `toString` produces a string representation of any `Object`.) Each method takes its argument, converts it to a string and appends it to the `StringBuilder`.

```

1 // Fig. 16.13: StringBuilderAppend.java
2 // StringBuilder append methods.
3
4 public class StringBuilderAppend
5 {
6 public static void main(String[] args)
7 {
8 Object objectRef = "hello";
9 String string = "goodbye";
10 char[] charArray = { 'a', 'b', 'c', 'd', 'e', 'f' };
11 boolean booleanValue = true;
12 char characterValue = 'Z';
13 int integerValue = 7;
14 long longValue = 10000000000L;
15 float floatValue = 2.5f;
16 double doubleValue = 33.333;
17
18 StringBuilder lastBuffer = new StringBuilder("last buffer");
19 StringBuilder buffer = new StringBuilder();
20
21 buffer.append(objectRef);

```

**Fig. 16.13** | StringBuilder append methods. (Part 1 of 2.)

```

22 buffer.append("\n");
23 buffer.append(string);
24 buffer.append("\n");
25 buffer.append(charArray);
26 buffer.append("\n");
27 buffer.append(charArray, 0, 3);
28 buffer.append("\n");
29 buffer.append(booleanValue);
30 buffer.append("\n");
31 buffer.append(characterValue);
32 buffer.append("\n");
33 buffer.append(integerValue);
34 buffer.append("\n");
35 buffer.append(longValue);
36 buffer.append("\n");
37 buffer.append(floatValue);
38 buffer.append("\n");
39 buffer.append(doubleValue);
40 buffer.append("\n");
41 buffer.append(lastBuffer);
42
43 System.out.printf("buffer contains %s\n", buffer.toString());
44 } // end main
45 } // end StringBuilderAppend

```

```

buffer contains hello
goodbye
abcdef
abc
true
Z
7
10000000000
2.5
33.333
last buffer

```

**Fig. 16.13** | StringBuilder append methods. (Part 2 of 2.)

Actually, a compiler can use `StringBuilder` (or `StringBuffer`) and the `append` methods to implement the `+` and `+=` String concatenation operators. For example, assuming the declarations

```

String string1 = "hello";
String string2 = "BC";
int value = 22;

```

the statement

```
String s = string1 + string2 + value;
```

concatenates "hello", "BC" and 22. The concatenation can be performed as follows:

```
String s = new StringBuilder().append("hello").append("BC").
append(22).toString();
```

First, the preceding statement creates an empty `StringBuilder`, then appends to it the strings "hello" and "BC" and the integer 22. Next, `StringBuilder`'s `toString` method converts the `StringBuilder` to a `String` object to be assigned to `String s`. The statement

```
s += "!";
```

can be performed as follows (this may differ by compiler):

```
s = new StringBuilder().append(s).append("!").toString();
```

This creates an empty `StringBuilder`, then appends to it the current contents of `s` followed by "!". Next, `StringBuilder`'s method `toString` (which must be called explicitly here) returns the `StringBuilder`'s contents as a `String`, and the result is assigned to `s`.

### 16.4.5 StringBuilder Insertion and Deletion Methods

`StringBuilder` provides overloaded **insert** methods to insert values of various types at any position in a `StringBuilder`. Versions are provided for the primitive types and for character arrays, `Strings`, `Objects` and `CharSequences`. Each method takes its second argument and inserts it at the index specified by the first argument. If the first argument is less than 0 or greater than the `StringBuilder`'s length, a `StringIndexOutOfBoundsException` occurs. Class `StringBuilder` also provides methods **delete** and **deleteCharAt** to delete characters at any position in a `StringBuilder`. Method `delete` takes two arguments—the starting index and the index one past the end of the characters to delete. All characters beginning at the starting index up to but not including the ending index are deleted. Method `deleteCharAt` takes one argument—the index of the character to delete. Invalid indices cause both methods to throw a `StringIndexOutOfBoundsException`. Figure 16.14 demonstrates methods `insert`, `delete` and `deleteCharAt`.

---

```

1 // Fig. 16.14: StringBuilderInsertDelete.java
2 // StringBuilder methods insert, delete and deleteCharAt.
3
4 public class StringBuilderInsertDelete
5 {
6 public static void main(String[] args)
7 {
8 Object objectRef = "hello";
9 String string = "goodbye";
10 char[] charArray = { 'a', 'b', 'c', 'd', 'e', 'f' };
11 boolean booleanValue = true;
12 char characterValue = 'K';
13 int integerValue = 7;
14 long longValue = 10000000;
15 float floatValue = 2.5f; // f suffix indicates that 2.5 is a float
16 double doubleValue = 33.333;
17
18 StringBuilder buffer = new StringBuilder();
19
20 buffer.insert(0, objectRef);
21 buffer.insert(0, " "); // each of these contains two spaces
22 buffer.insert(0, string);

```

---

**Fig. 16.14** | `StringBuilder` methods `insert`, `delete` and `deleteCharAt`. (Part 1 of 2.)

```

23 buffer.insert(0, " ");
24 buffer.insert(0, charArray);
25 buffer.insert(0, " ");
26 buffer.insert(0, charArray, 3, 3);
27 buffer.insert(0, " ");
28 buffer.insert(0, booleanValue);
29 buffer.insert(0, " ");
30 buffer.insert(0, characterValue);
31 buffer.insert(0, " ");
32 buffer.insert(0, integerValue);
33 buffer.insert(0, " ");
34 buffer.insert(0, longValue);
35 buffer.insert(0, " ");
36 buffer.insert(0, floatValue);
37 buffer.insert(0, " ");
38 buffer.insert(0, doubleValue);
39
40 System.out.printf(
41 "buffer after inserts:\n%s\n\n", buffer.toString());
42
43 buffer.deleteCharAt(10); // delete 5 in 2.5
44 buffer.delete(2, 6); // delete .333 in 33.333
45
46 System.out.printf(
47 "buffer after deletes:\n%s\n", buffer.toString());
48 } // end main
49 } // end class StringBuilderInsertDelete

```

```

buffer after inserts:
33.333 2.5 10000000 7 K true def abcdef goodbye hello

buffer after deletes:
33 2. 10000000 7 K true def abcdef goodbye hello

```

**Fig. 16.14** | StringBuilder methods insert, delete and deleteCharAt. (Part 2 of 2.)

## 16.5 Class Character

Java provides eight type-wrapper classes—Boolean, Character, Double, Float, Byte, Short, Integer and Long—that enable primitive-type values to be treated as objects. In this section, we present class Character—the type-wrapper class for primitive type char.

Most Character methods are static methods designed for convenience in processing individual char values. These methods take at least a character argument and perform either a test or a manipulation of the character. Class Character also contains a constructor that receives a char argument to initialize a Character object. Most of the methods of class Character are presented in the next three examples. For more information on class Character (and all the type-wrapper classes), see the `java.lang` package in the Java API documentation.

Figure 16.15 demonstrates static methods that test characters to determine whether they're a specific character type and the static methods that perform case conversions on characters. You can enter any character and apply the methods to the character.

Line 15 uses Character method **isDefined** to determine whether character *c* is defined in the Unicode character set. If so, the method returns true; otherwise, it returns false. Line 16 uses Character method **isDigit** to determine whether character *c* is a defined Unicode digit. If so, the method returns true, and otherwise, false.

```

1 // Fig. 16.15: StaticCharMethods.java
2 // Character static methods for testing characters and converting case.
3 import java.util.Scanner;
4
5 public class StaticCharMethods
6 {
7 public static void main(String[] args)
8 {
9 Scanner scanner = new Scanner(System.in); // create scanner
10 System.out.println("Enter a character and press Enter");
11 String input = scanner.next();
12 char c = input.charAt(0); // get input character
13
14 // display character info
15 System.out.printf("is defined: %b\n", Character.isDefined(c));
16 System.out.printf("is digit: %b\n", Character.isDigit(c));
17 System.out.printf("is first character in a Java identifier: %b\n",
18 Character.isJavaIdentifierStart(c));
19 System.out.printf("is part of a Java identifier: %b\n",
20 Character.isJavaIdentifierPart(c));
21 System.out.printf("is letter: %b\n", Character.isLetter(c));
22 System.out.printf(
23 "is letter or digit: %b\n", Character.isLetterOrDigit(c));
24 System.out.printf(
25 "is lower case: %b\n", Character.isLowerCase(c));
26 System.out.printf(
27 "is upper case: %b\n", Character.isUpperCase(c));
28 System.out.printf(
29 "to upper case: %s\n", Character.toUpperCase(c));
30 System.out.printf(
31 "to lower case: %s\n", Character.toLowerCase(c));
32 } // end main
33 } // end class StaticCharMethods

```

```

Enter a character and press Enter
A
is defined: true
is digit: false
is first character in a Java identifier: true
is part of a Java identifier: true
is letter: true
is letter or digit: true
is lower case: false
is upper case: true
to upper case: A
to lower case: a

```

**Fig. 16.15** | Character static methods for testing characters and converting case. (Part 1 of 2.)

```

Enter a character and press Enter
8
is defined: true
is digit: true
is first character in a Java identifier: false
is part of a Java identifier: true
is letter: false
is letter or digit: true
is lower case: false
is upper case: false
to upper case: 8
to lower case: 8

```

```

Enter a character and press Enter
$
is defined: true
is digit: false
is first character in a Java identifier: true
is part of a Java identifier: true
is letter: false
is letter or digit: false
is lower case: false
is upper case: false
to upper case: $
to lower case: $

```

**Fig. 16.15** | Character static methods for testing characters and converting case. (Part 2 of 2.)

Line 18 uses Character method **isJavaIdentifierStart** to determine whether *c* is a character that can be the first character of an identifier in Java—that is, a letter, an underscore (`_`) or a dollar sign (`$`). If so, the method returns `true`, and otherwise, `false`. Line 20 uses Character method **isJavaIdentifierPart** to determine whether character *c* is a character that can be used in an identifier in Java—that is, a digit, a letter, an underscore (`_`) or a dollar sign (`$`). If so, the method returns `true`, and otherwise, `false`.

Line 21 uses Character method **isLetter** to determine whether character *c* is a letter. If so, the method returns `true`, and otherwise, `false`. Line 23 uses Character method **isLetterOrDigit** to determine whether character *c* is a letter or a digit. If so, the method returns `true`, and otherwise, `false`.

Line 25 uses Character method **isLowerCase** to determine whether character *c* is a lowercase letter. If so, the method returns `true`, and otherwise, `false`. Line 27 uses Character method **isUpperCase** to determine whether character *c* is an uppercase letter. If so, the method returns `true`, and otherwise, `false`.

Line 29 uses Character method **toUpperCase** to convert the character *c* to its uppercase equivalent. The method returns the converted character if the character has an uppercase equivalent, and otherwise, the method returns its original argument. Line 31 uses Character method **toLowerCase** to convert the character *c* to its lowercase equivalent. The method returns the converted character if the character has a lowercase equivalent, and otherwise, the method returns its original argument.

Figure 16.16 demonstrates static Character methods **digit** and **forDigit**, which convert characters to digits and digits to characters, respectively, in different number sys-

tems. Common number systems include decimal (base 10), octal (base 8), hexadecimal (base 16) and binary (base 2). The base of a number is also known as its **radix**. For more information on conversions between number systems, see Appendix H.

Line 28 uses method `forDigit` to convert the integer `digit` into a character in the number system specified by the integer `radix` (the base of the number). For example, the decimal integer 13 in base 16 (the `radix`) has the character value 'd'. Lowercase and uppercase letters represent the same value in number systems. Line 35 uses method `digit` to convert variable `character` into an integer in the number system specified by the integer `radix` (the base of the number). For example, the character 'A' is the base 16 (the `radix`) representation of the base 10 value 10. The `radix` must be between 2 and 36, inclusive.

---

```

1 // Fig. 16.16: StaticCharMethods2.java
2 // Character class static conversion methods.
3 import java.util.Scanner;
4
5 public class StaticCharMethods2
6 {
7 // executes application
8 public static void main(String[] args)
9 {
10 Scanner scanner = new Scanner(System.in);
11
12 // get radix
13 System.out.println("Please enter a radix:");
14 int radix = scanner.nextInt();
15
16 // get user choice
17 System.out.printf("Please choose one:\n1 -- %s\n2 -- %s\n",
18 "Convert digit to character", "Convert character to digit");
19 int choice = scanner.nextInt();
20
21 // process request
22 switch (choice)
23 {
24 case 1: // convert digit to character
25 System.out.println("Enter a digit:");
26 int digit = scanner.nextInt();
27 System.out.printf("Convert digit to character: %s\n",
28 Character.forDigit(digit, radix));
29 break;
30
31 case 2: // convert character to digit
32 System.out.println("Enter a character:");
33 char character = scanner.next().charAt(0);
34 System.out.printf("Convert character to digit: %s\n",
35 Character.digit(character, radix));
36 break;
37 } // end switch
38 } // end main
39 } // end class StaticCharMethods2

```

---

**Fig. 16.16** | Character class static conversion methods. (Part 1 of 2.)

```

Please enter a radix:
16
Please choose one:
1 -- Convert digit to character
2 -- Convert character to digit
2
Enter a character:
A
Convert character to digit: 10

```

```

Please enter a radix:
16
Please choose one:
1 -- Convert digit to character
2 -- Convert character to digit
1
Enter a digit:
13
Convert digit to character: d

```

**Fig. 16.16** | Character class static conversion methods. (Part 2 of 2.)

Figure 16.17 demonstrates the constructor and several non-static methods of class `Character`—`charValue`, `toString` and `equals`. Lines 7–8 instantiate two `Character` objects by assigning the character constants 'A' and 'a', respectively, to the `Character` variables. Java automatically converts these `char` literals into `Character` objects—a process known as *autoboxing* that we discuss in more detail in Section 20.4. Line 11 uses `Character` method `charValue` to return the `char` value stored in `Character` object `c1`. Line 11 returns a string representation of `Character` object `c2` using method `toString`. The condition in line 13 uses method `equals` to determine whether the object `c1` has the same contents as the object `c2` (i.e., the characters inside each object are equal).

```

1 // Fig. 16.17: OtherCharMethods.java
2 // Character class non-static methods.
3 public class OtherCharMethods
4 {
5 public static void main(String[] args)
6 {
7 Character c1 = 'A';
8 Character c2 = 'a';
9
10 System.out.printf(
11 "c1 = %s\nc2 = %s\n", c1.charValue(), c2.toString());
12
13 if (c1.equals(c2))
14 System.out.println("c1 and c2 are equal\n");
15 else
16 System.out.println("c1 and c2 are not equal\n");
17 } // end main
18 } // end class OtherCharMethods

```

**Fig. 16.17** | Character class non-static methods. (Part 1 of 2.)



```
c1 = A
c2 = a
c1 and c2 are not equal
```

**Fig. 16.17** | Character class non-static methods. (Part 2 of 2.)

## 16.6 Tokenizing Strings

When you read a sentence, your mind breaks it into **tokens**—individual words and punctuation marks that convey meaning to you. Compilers also perform tokenization. They break up statements into individual pieces like keywords, identifiers, operators and other programming-language elements. We now study class `String`'s **`split`** method, which breaks a `String` into its component tokens. Tokens are separated from one another by **delimiters**, typically white-space characters such as space, tab, newline and carriage return. Other characters can also be used as delimiters to separate tokens. The application in Fig. 16.18 demonstrates `String`'s `split` method.

When the user presses the *Enter* key, the input sentence is stored in variable `sentence`. Line 17 invokes `String` method `split` with the `String` argument " ", which returns an array of `Strings`. The space character in the argument `String` is the delimiter that method `split` uses to locate the tokens in the `String`. As you'll learn in the next section, the argument to method `split` can be a regular expression for more complex tokenizing. Line 19 displays the length of the array `tokens`—i.e., the number of tokens in `sentence`. Lines 21–22 output each token on a separate line.

```
1 // Fig. 16.18: TokenTest.java
2 // StringTokenizer object used to tokenize strings.
3 import java.util.Scanner;
4 import java.util.StringTokenizer;
5
6 public class TokenTest
7 {
8 // execute application
9 public static void main(String[] args)
10 {
11 // get sentence
12 Scanner scanner = new Scanner(System.in);
13 System.out.println("Enter a sentence and press Enter");
14 String sentence = scanner.nextLine();
15
16 // process user sentence
17 String[] tokens = sentence.split(" ");
18 System.out.printf("Number of elements: %d\nThe tokens are:\n",
19 tokens.length);
20
21 for (String token : tokens)
22 System.out.println(token);
23 } // end main
24 } // end class TokenTest
```

**Fig. 16.18** | `StringTokenizer` object used to tokenize strings. (Part 1 of 2.)

```

Enter a sentence and press Enter
This is a sentence with seven tokens
Number of elements: 7
The tokens are:
This
is
a
sentence
with
seven
tokens

```

**Fig. 16.18** | StringTokenizer object used to tokenize strings. (Part 2 of 2.)

## 16.7 Regular Expressions, Class Pattern and Class Matcher

A **regular expression** is a `String` that describes a search pattern for matching characters in other `Strings`. Such expressions are useful for validating input and ensuring that data is in a particular format. For example, a ZIP code must consist of five digits, and a last name must contain only letters, spaces, apostrophes and hyphens. One application of regular expressions is to facilitate the construction of a compiler. Often, a large and complex regular expression is used to validate the syntax of a program. If the program code does not match the regular expression, the compiler knows that there's a syntax error in the code.

Class `String` provides several methods for performing regular-expression operations, the simplest of which is the matching operation. `String` method **`matches`** receives a `String` that specifies the regular expression and matches the contents of the `String` object on which it's called to the regular expression. The method returns a `boolean` indicating whether the match succeeded.

A regular expression consists of literal characters and special symbols. Figure 16.19 specifies some **predefined character classes** that can be used with regular expressions. A character class is an escape sequence that represents a group of characters. A digit is any numeric character. A **word character** is any letter (uppercase or lowercase), any digit or the underscore character. A white-space character is a space, a tab, a carriage return, a newline or a form feed. Each character class matches a single character in the `String` we're attempting to match with the regular expression.

Regular expressions are not limited to these predefined character classes. The expressions employ various operators and other forms of notation to match complex patterns.

| Character       | Matches                   | Character       | Matches                      |
|-----------------|---------------------------|-----------------|------------------------------|
| <code>\d</code> | any digit                 | <code>\D</code> | any nondigit                 |
| <code>\w</code> | any word character        | <code>\W</code> | any nonword character        |
| <code>\s</code> | any white-space character | <code>\S</code> | any nonwhite-space character |

**Fig. 16.19** | Predefined character classes.

We examine several of these techniques in the application in Figs. 16.20 and 16.21, which validates user input via regular expressions. [*Note:* This application is not designed to match all possible valid user input.]

---

```

1 // Fig. 16.20: ValidateInput.java
2 // Validate user information using regular expressions.
3
4 public class ValidateInput
5 {
6 // validate first name
7 public static boolean validateFirstName(String firstName)
8 {
9 return firstName.matches("[A-Z][a-zA-Z]*");
10 } // end method validateFirstName
11
12 // validate last name
13 public static boolean validateLastName(String lastName)
14 {
15 return lastName.matches("[a-zA-Z]+(['-'][a-zA-Z]+)*");
16 } // end method validateLastName
17
18 // validate address
19 public static boolean validateAddress(String address)
20 {
21 return address.matches(
22 "\\d+\\s+([a-zA-Z]+|[a-zA-Z]+\\s[a-zA-Z]+)");
23 } // end method validateAddress
24
25 // validate city
26 public static boolean validateCity(String city)
27 {
28 return city.matches("([a-zA-Z]+|[a-zA-Z]+\\s[a-zA-Z]+)");
29 } // end method validateCity
30
31 // validate state
32 public static boolean validateState(String state)
33 {
34 return state.matches("([a-zA-Z]+|[a-zA-Z]+\\s[a-zA-Z]+)");
35 } // end method validateState
36
37 // validate zip
38 public static boolean validateZip(String zip)
39 {
40 return zip.matches("\\d{5}");
41 } // end method validateZip
42
43 // validate phone
44 public static boolean validatePhone(String phone)
45 {
46 return phone.matches("[1-9]\\d{2}-[1-9]\\d{2}-\\d{4}");
47 } // end method validatePhone
48 } // end class ValidateInput

```

**Fig. 16.20** | Validating user information using regular expressions.

```

1 // Fig. 16.21: Validate.java
2 // Validate user information using regular expressions.
3 import java.util.Scanner;
4
5 public class Validate
6 {
7 public static void main(String[] args)
8 {
9 // get user input
10 Scanner scanner = new Scanner(System.in);
11 System.out.println("Please enter first name:");
12 String firstName = scanner.nextLine();
13 System.out.println("Please enter last name:");
14 String lastName = scanner.nextLine();
15 System.out.println("Please enter address:");
16 String address = scanner.nextLine();
17 System.out.println("Please enter city:");
18 String city = scanner.nextLine();
19 System.out.println("Please enter state:");
20 String state = scanner.nextLine();
21 System.out.println("Please enter zip:");
22 String zip = scanner.nextLine();
23 System.out.println("Please enter phone:");
24 String phone = scanner.nextLine();
25
26 // validate user input and display error message
27 System.out.println("\nValidate Result:");
28
29 if (!ValidateInput.validateFirstName(firstName))
30 System.out.println("Invalid first name");
31 else if (!ValidateInput.validateLastName(lastName))
32 System.out.println("Invalid last name");
33 else if (!ValidateInput.validateAddress(address))
34 System.out.println("Invalid address");
35 else if (!ValidateInput.validateCity(city))
36 System.out.println("Invalid city");
37 else if (!ValidateInput.validateState(state))
38 System.out.println("Invalid state");
39 else if (!ValidateInput.validateZip(zip))
40 System.out.println("Invalid zip code");
41 else if (!ValidateInput.validatePhone(phone))
42 System.out.println("Invalid phone number");
43 else
44 System.out.println("Valid input. Thank you.");
45 } // end main
46 } // end class Validate

```

```

Please enter first name:
Jane
Please enter last name:
Doe
Please enter address:
123 Some Street

```

**Fig. 16.21** | Inputs and validates data from user using the `ValidateInput` class. (Part 1 of 2.)

```
Please enter city:
Some City
Please enter state:
SS
Please enter zip:
123
Please enter phone:
123-456-7890

Validate Result:
Invalid zip code
```

```
Please enter first name:
Jane
Please enter last name:
Doe
Please enter address:
123 Some Street
Please enter city:
Some City
Please enter state:
SS
Please enter zip:
12345
Please enter phone:
123-456-7890

Validate Result:
Valid input. Thank you.
```

**Fig. 16.21** | Inputs and validates data from user using the `ValidateInput` class. (Part 2 of 2.)

Figure 16.20 validates user input. Line 9 validates the first name. To match a set of characters that does not have a predefined character class, use square brackets, `[]`. For example, the pattern `"[aeiou]"` matches a single character that's a vowel. Character ranges are represented by placing a dash (`-`) between two characters. In the example, `"[A-Z]"` matches a single uppercase letter. If the first character in the brackets is `"^"`, the expression accepts any character other than those indicated. However, `"[^Z]"` is not the same as `"[A-Y]"`, which matches uppercase letters A–Y—`"[^Z]"` matches any character other than capital Z, including lowercase letters and nonletters such as the newline character. Ranges in character classes are determined by the letters' integer values. In this example, `"[A-Za-z]"` matches all uppercase and lowercase letters. The range `"[A-z]"` matches all letters and also matches those characters (such as `[` and `\`) with an integer value between uppercase Z and lowercase a (for more information on integer values of characters see Appendix B). Like predefined character classes, character classes delimited by square brackets match a single character in the search object.

In line 9, the asterisk after the second character class indicates that any number of letters can be matched. In general, when the regular-expression operator `"*"` appears in a regular expression, the application attempts to match zero or more occurrences of the subexpression immediately preceding the `"*"`. Operator `"+"` attempts to match one or

more occurrences of the subexpression immediately preceding "+". So both "A\*" and "A+" will match "AAA" or "A", but only "A\*" will match an empty string.

If method `validateFirstName` returns `true` (line 29 of Fig. 16.21), the application attempts to validate the last name (line 31) by calling `validateLastName` (lines 13–16 of Fig. 16.20). The regular expression to validate the last name matches any number of letters split by spaces, apostrophes or hyphens.

Line 33 of Fig. 16.21 calls method `validateAddress` (lines 19–23 of Fig. 16.20) to validate the address. The first character class matches any digit one or more times (`\d+`). Two `\` characters are used, because `\` normally starts an escape sequence in a string. So `\\d` in a `String` represents the regular expression pattern `\d`. Then we match one or more white-space characters (`\\s+`). The character `|` matches the expression to its left or to its right. For example, `"Hi (John|Jane)"` matches both `"Hi John"` and `"Hi Jane"`. The parentheses are used to group parts of the regular expression. In this example, the left side of `|` matches a single word, and the right side matches two words separated by any amount of white space. So the address must contain a number followed by one or two words. Therefore, `"10 Broadway"` and `"10 Main Street"` are both valid addresses in this example. The city (lines 26–29 of Fig. 16.20) and state (lines 32–35 of Fig. 16.20) methods also match any word of at least one character or, alternatively, any two words of at least one character if the words are separated by a single space, so both `Wal``tham` and `West` `Newton` would match.

### Quantifiers

The asterisk (`*`) and plus (`+`) are formally called **quantifiers**. Figure 16.22 lists all the quantifiers. We've already discussed how the asterisk (`*`) and plus (`+`) quantifiers work. All quantifiers affect only the subexpression immediately preceding the quantifier. Quantifier question mark (`?`) matches zero or one occurrences of the expression that it quantifies. A set of braces containing one number (`{n}`) matches exactly  $n$  occurrences of the expression it quantifies. We demonstrate this quantifier to validate the zip code in Fig. 16.20 at line 40. Including a comma after the number enclosed in braces matches at least  $n$  occurrences of the quantified expression. The set of braces containing two numbers (`{n,m}`), matches between  $n$  and  $m$  occurrences of the expression that it qualifies. Quantifiers may be applied to patterns enclosed in parentheses to create more complex regular expressions.

| Quantifier         | Matches                                              |
|--------------------|------------------------------------------------------|
| <code>*</code>     | Matches zero or more occurrences of the pattern.     |
| <code>+</code>     | Matches one or more occurrences of the pattern.      |
| <code>?</code>     | Matches zero or one occurrences of the pattern.      |
| <code>{n}</code>   | Matches exactly $n$ occurrences.                     |
| <code>{n,}</code>  | Matches at least $n$ occurrences.                    |
| <code>{n,m}</code> | Matches between $n$ and $m$ (inclusive) occurrences. |

**Fig. 16.22** | Quantifiers used in regular expressions.

All of the quantifiers are **greedy**. This means that they'll match as many occurrences as they can as long as the match is still successful. However, if any of these quantifiers is

followed by a question mark (?), the quantifier becomes **reluctant** (sometimes called **lazy**). It then will match as few occurrences as possible as long as the match is still successful.

The zip code (line 40 in Fig. 16.20) matches a digit five times. This regular expression uses the digit character class and a quantifier with the digit 5 between braces. The phone number (line 46 in Fig. 16.20) matches three digits (the first one cannot be zero) followed by a dash followed by three more digits (again the first one cannot be zero) followed by four more digits.

String method `matches` checks whether an entire String conforms to a regular expression. For example, we want to accept "Smith" as a last name, but not "9@Smith#". If only a substring matches the regular expression, method `matches` returns false.

### *Replacing Substrings and Splitting Strings*

Sometimes it's useful to replace parts of a string or to split a string into pieces. For this purpose, class String provides methods **`replaceAll`**, **`replaceFirst`** and **`split`**. These methods are demonstrated in Fig. 16.23.

---

```

1 // Fig. 16.23: RegexSubstitution.java
2 // String methods replaceFirst, replaceAll and split.
3 import java.util.Arrays;
4
5 public class RegexSubstitution
6 {
7 public static void main(String[] args)
8 {
9 String firstString = "This sentence ends in 5 stars *****";
10 String secondString = "1, 2, 3, 4, 5, 6, 7, 8";
11
12 System.out.printf("Original String 1: %s\n", firstString);
13
14 // replace '*' with '^'
15 firstString = firstString.replaceAll("*", "^");
16
17 System.out.printf("^ substituted for *: %s\n", firstString);
18
19 // replace 'stars' with 'carets'
20 firstString = firstString.replaceAll("stars", "carets");
21
22 System.out.printf(
23 "\"carets\" substituted for \"stars\": %s\n", firstString);
24
25 // replace words with 'word'
26 System.out.printf("Every word replaced by \"word\": %s\n\n",
27 firstString.replaceAll("\\w+", "word"));
28
29 System.out.printf("Original String 2: %s\n", secondString);
30
31 // replace first three digits with 'digit'
32 for (int i = 0; i < 3; i++)
33 secondString = secondString.replaceFirst("\\d", "digit");
34

```

---

**Fig. 16.23** | String methods `replaceFirst`, `replaceAll` and `split`. (Part I of 2.)

```

35 System.out.printf(
36 "First 3 digits replaced by \"digit\" : %s\n", secondString);
37
38 System.out.print("String split at commas: ");
39 String[] results = secondString.split(",\\s*"); // split on commas
40 System.out.println(Arrays.toString(results));
41 } // end main
42 } // end class RegexSubstitution

```

```

Original String 1: This sentence ends in 5 stars *****
^ substituted for *: This sentence ends in 5 stars ^^^^^
"carets" substituted for "stars": This sentence ends in 5 carets ^^^^^
Every word replaced by "word": word word word word word word ^^^^^

Original String 2: 1, 2, 3, 4, 5, 6, 7, 8
First 3 digits replaced by "digit" : digit, digit, digit, 4, 5, 6, 7, 8
String split at commas: ["digit", "digit", "digit", "4", "5", "6", "7", "8"]

```

**Fig. 16.23** | String methods `replaceFirst`, `replaceAll` and `split`. (Part 2 of 2.)

Method `replaceAll` replaces text in a `String` with new text (the second argument) wherever the original `String` matches a regular expression (the first argument). Line 15 replaces every instance of "\*" in `firstString` with "^". The regular expression ("\\s\*") precedes character \* with two backslashes. Normally, \* is a quantifier indicating that a regular expression should match any number of occurrences of a preceding pattern. However, in line 15, we want to find all occurrences of the literal character \*—to do this, we must escape character \* with character \. Escaping a special regular-expression character with \ instructs the matching engine to find the actual character. Since the expression is stored in a Java `String` and \ is a special character in Java `Strings`, we must include an additional \. So the Java `String` "\\s\*" represents the regular-expression pattern \\* which matches a single \* character in the search string. In line 20, every match for the regular expression "stars" in `firstString` is replaced with "carets". Line 27 uses `replaceAll` to replace all words in the string with "word".

Method `replaceFirst` (line 33) replaces the first occurrence of a pattern match. Java `Strings` are immutable; therefore, method `replaceFirst` returns a new `String` in which the appropriate characters have been replaced. This line takes the original `String` and replaces it with the `String` returned by `replaceFirst`. By iterating three times we replace the first three instances of a digit (\d) in `secondString` with the text "digit".

Method `split` divides a `String` into several substrings. The original is broken in any location that matches a specified regular expression. Method `split` returns an array of `Strings` containing the substrings between matches for the regular expression. In line 39, we use method `split` to tokenize a `String` of comma-separated integers. The argument is the regular expression that locates the delimiter. In this case, we use the regular expression ",\\s\*" to separate the substrings wherever a comma occurs. By matching any white-space characters, we eliminate extra spaces from the resulting substrings. The commas and white-space characters are not returned as part of the substrings. Again, the Java `String` ",\\s\*" represents the regular expression ,\s\*. Line 40 uses `Arrays` method `toString` to display the contents of array `results` in square brackets and separated by commas.



### Classes Pattern and Matcher

In addition to the regular-expression capabilities of class `String`, Java provides other classes in package `java.util.regex` that help developers manipulate regular expressions. Class **Pattern** represents a regular expression. Class **Matcher** contains both a regular-expression pattern and a `CharSequence` in which to search for the pattern.

**CharSequence** (package `java.lang`) is an interface that allows read access to a sequence of characters. The interface requires that the methods `charAt`, `length`, `subSequence` and `toString` be declared. Both `String` and `StringBuilder` implement interface `CharSequence`, so an instance of either of these classes can be used with class `Matcher`.



#### Common Programming Error 16.4

*A regular expression can be tested against an object of any class that implements interface `CharSequence`, but the regular expression must be a `String`. Attempting to create a regular expression as a `StringBuilder` is an error.*

If a regular expression will be used only once, static `Pattern` method **matches** can be used. This method takes a `String` that specifies the regular expression and a `CharSequence` on which to perform the match. This method returns a `boolean` indicating whether the search object (the second argument) matches the regular expression.

If a regular expression will be used more than once (in a loop, for example), it's more efficient to use static `Pattern` method **compile** to create a specific `Pattern` object for that regular expression. This method receives a `String` representing the pattern and returns a new `Pattern` object, which can then be used to call method **matcher**. This method receives a `CharSequence` to search and returns a `Matcher` object.

`Matcher` provides method **matches**, which performs the same task as `Pattern` method `matches`, but receives no arguments—the search pattern and search object are encapsulated in the `Matcher` object. Class `Matcher` provides other methods, including **find**, **lookingAt**, **replaceFirst** and **replaceAll**.

Figure 16.24 presents a simple example that employs regular expressions. This program matches birthdays against a regular expression. The expression matches only birthdays that do not occur in April and that belong to people whose names begin with "J".

Lines 11–12 create a `Pattern` by invoking static `Pattern` method `compile`. The dot character "." in the regular expression (line 12) matches any single character except a new-line character.

```

1 // Fig. 16.24: RegexMatches.java
2 // Classes Pattern and Matcher.
3 import java.util.regex.Matcher;
4 import java.util.regex.Pattern;
5
6 public class RegexMatches
7 {
8 public static void main(String[] args)
9 {
10 // create regular expression
11 Pattern expression =
12 Pattern.compile("J.*\\d[0-35-9]-\\d\\d-\\d\\d");

```

**Fig. 16.24** | Classes Pattern and Matcher. (Part I of 2.)

```

13
14 String string1 = "Jane's Birthday is 05-12-75\n" +
15 "Dave's Birthday is 11-04-68\n" +
16 "John's Birthday is 04-28-73\n" +
17 "Joe's Birthday is 12-17-77";
18
19 // match regular expression to string and print matches
20 Matcher matcher = expression.matcher(string1);
21
22 while (matcher.find())
23 System.out.println(matcher.group());
24 } // end main
25 } // end class RegexMatches

```

```

Jane's Birthday is 05-12-75
Joe's Birthday is 12-17-77

```

**Fig. 16.24** | Classes Pattern and Matcher. (Part 2 of 2.)

Line 20 creates the `Matcher` object for the compiled regular expression and the matching sequence (`string1`). Lines 22–23 use a `while` loop to iterate through the `String`. Line 22 uses `Matcher` method `find` to attempt to match a piece of the search object to the search pattern. Each call to this method starts at the point where the last call ended, so multiple matches can be found. `Matcher` method `lookingAt` performs the same way, except that it always starts from the beginning of the search object and will always find the first match if there is one.



### Common Programming Error 16.5

*Method `matches` (from class `String`, `Pattern` or `Matcher`) will return `true` only if the entire search object matches the regular expression. Methods `find` and `lookingAt` (from class `Matcher`) will return `true` if a portion of the search object matches the regular expression.*

Line 23 uses `Matcher` method `group`, which returns the `String` from the search object that matches the search pattern. The `String` that's returned is the one that was last matched by a call to `find` or `lookingAt`. The output in Fig. 16.24 shows the two matches that were found in `string1`.

For more information on regular expressions, visit our Regular Expressions Resource Center at [www.deitel.com/regexexpressions/](http://www.deitel.com/regexexpressions/).

## 16.8 Wrap-Up

In this chapter, you learned about more `String` methods for selecting portions of `Strings` and manipulating `Strings`. You learned about the `Character` class and some of the methods it declares to handle chars. The chapter also discussed the capabilities of the `StringBuilder` class for creating `Strings`. The end of the chapter discussed regular expressions, which provide a powerful capability to search and match portions of `Strings` that fit a particular pattern. In the next chapter, you'll learn about file processing, including how persistent data is stored and retrieved.

## Summary

### Section 16.2 Fundamentals of Characters and Strings

- A character literal's value (p. 673) is its integer value in Unicode (p. 673). Strings can include letters, digits and special characters such as +, -, \*, / and \$. A string in Java is an object of class `String`. String literals (p. 674) are often referred to as `String` objects and are written in a program in double quotes.

### Section 16.3 Class `String`

- `String` objects are immutable (p. 675)—after they're created, their character contents cannot be changed.
- `String` method `length` (p. 675) returns the number of characters in a `String`.
- `String` method `charAt` (p. 675) returns the character at a specific position.
- `String` method `equals` tests for equality. The method returns `true` if the contents of the `Strings` are equal, `false` otherwise. Method `equals` uses a lexicographical comparison (p. 679) for `Strings`.
- When primitive-type values are compared with `==`, the result is `true` if both values are identical. When references are compared with `==`, the result is `true` if both refer to the same object.
- Java treats all string literals with the same contents as a single `String` object.
- `String` method `equalsIgnoreCase` performs a case-insensitive string comparison.
- `String` method `compareTo` uses a lexicographical comparison and returns 0 if the `Strings` are equal, a negative number if the string that calls `compareTo` is less than the argument `String` and a positive number if the string that calls `compareTo` is greater than than the argument `String`.
- `String` method `regionMatches` (p. 677) compares portions of two strings for equality.
- `String` methods `startsWith` and `endsWith` (p. 680) determine whether a string starts with or ends with the specified characters, respectively.
- `String` method `indexOf` (p. 681) locates the first occurrence of a character or a substring in a string. `String` method `lastIndexOf` (p. 681) locates the last occurrence of a character or a substring in a string.
- `String` method `substring` copies and returns part of an existing string object.
- `String` method `concat` concatenates two string objects and returns a new string object.
- `String` method `replace` returns a new string object that replaces every occurrence in a `String` of its first character argument with its second character argument.
- `String` method `toUpperCase` (p. 685) returns a new string with uppercase letters in the positions where the original string had lowercase letters. `String` method `toLowerCase` (p. 686) returns a new string with lowercase letters in the positions where the original string had uppercase letters.
- `String` method `trim` (p. 686) returns a new string object in which all white-space characters (e.g., spaces, newlines and tabs) have been removed from the beginning and end of a string.
- `String` method `toCharArray` (p. 686) returns a `char` array containing a copy of the string's characters.
- `String` class static method `valueOf` returns its argument converted to a string.

### Section 16.4 Class `StringBuilder`

- Class `StringBuilder` provides constructors that enable `StringBuilders` to be initialized with no characters and an initial capacity of 16 characters, with no characters and an initial capacity specified in the integer argument, or with a copy of the characters of the `String` argument and an initial capacity that's the number of characters in the `String` argument plus 16.

- `StringBuilder` method `length` (p. 688) returns the number of characters currently stored in a `StringBuilder`. `StringBuilder` method `capacity` (p. 688) returns the number of characters that can be stored in a `StringBuilder` without allocating more memory.
- `StringBuilder` method `ensureCapacity` (p. 688) ensures that a `StringBuilder` has at least the specified capacity. Method `setLength` increases or decreases the length of a `StringBuilder`.
- `StringBuilder` method `charAt` (p. 690) returns the character at the specified index. Method `setCharAt` (p. 690) sets the character at the specified position. `StringBuilder` method `getChars` (p. 690) copies characters in the `StringBuilder` into the character array passed as an argument.
- `StringBuilder`'s overloaded `append` methods (p. 691) add primitive-type, character array, `String`, `Object` or `CharSequence` (p. 707) values to the end of a `StringBuilder`.
- `StringBuilder`'s overloaded `insert` (p. 693) methods insert primitive-type, character array, `String`, `Object` or `CharSequence` values at any position in a `StringBuilder`.

### Section 16.5 Class Character

- `Character` method `isDefined` (p. 695) determines whether a character is in the Unicode character set.
- `Character` method `isDigit` (p. 695) determines whether a character is a defined Unicode digit.
- `Character` method `isJavaIdentifierStart` (p. 696) determines whether a character can be used as the first character of a Java identifier. `Character` method `isJavaIdentifierPart` (p. 696) determines if a character can be used in an identifier.
- `Character` method `isLetter` (p. 696) determines if a character is a letter. `Character` method `isLetterOrDigit` (p. 696) determines if a character is a letter or a digit.
- `Character` method `isLowerCase` (p. 696) determines whether a character is a lowercase letter. `Character` method `isUpperCase` (p. 696) determines whether a character is an uppercase letter.
- `Character` method `toUpperCase` (p. 696) converts a character to its uppercase equivalent. `Character` method `toLowerCase` (p. 696) converts a character to its lowercase equivalent.
- `Character` method `digit` (p. 696) converts its character argument into an integer in the number system specified by its integer argument `radix` (p. 697). `Character` method `forDigit` (p. 696) converts its integer argument `digit` into a character in the number system specified by its integer argument `radix`.
- `Character` method `charValue` (p. 698) returns the char stored in a `Character` object. `Character` method `toString` returns a `String` representation of a `Character`.

### Section 16.6 Tokenizing Strings

- Class `String`'s `split` method (p. 705) tokenizes a `String` based on the delimiter (p. 699) specified as an argument and returns an array of `Strings` containing the tokens (p. 699).

### Section 16.7 Regular Expressions, Class Pattern and Class Matcher

- Regular expressions (p. 700) are sequences of characters and symbols that define a set of strings. They're useful for validating input and ensuring that data is in a particular format.
- `String` method `matches` (p. 700) receives a string that specifies the regular expression and matches the contents of the `String` object on which it's called to the regular expression. The method returns a `boolean` indicating whether the match succeeded.
- A character class is an escape sequence that represents a group of characters. Each character class matches a single character in the string we're attempting to match with the regular expression.
- A word character (`\w`; p. 700) is any letter (uppercase or lowercase), any digit or the underscore character.

- A white-space character (`\s`) is a space, a tab, a carriage return, a newline or a form feed.
- A digit (`\d`) is any numeric character.
- To match a set of characters that does not have a predefined character class (p. 700), use square brackets, `[]`. Ranges can be represented by placing a dash (`-`) between two characters. If the first character in the brackets is `^`, the expression accepts any character other than those indicated.
- When the regular expression operator `*` appears in a regular expression, the program attempts to match zero or more occurrences of the subexpression immediately preceding the `*`.
- Operator `+` attempts to match one or more occurrences of the subexpression preceding it.
- The character `|` allows a match of the expression to its left or to its right.
- Parentheses `()` are used to group parts of the regular expression.
- The asterisk (`*`) and plus (`+`) are formally called quantifiers (p. 704).
- A quantifier affects only the subexpression immediately preceding it.
- Quantifier question mark (`?`) matches zero or one occurrences of the expression that it quantifies.
- A set of braces containing one number (`{n}`) matches exactly  $n$  occurrences of the expression it quantifies. Including a comma after the number enclosed in braces matches at least  $n$  occurrences.
- A set of braces containing two numbers (`{n,m}`) matches between  $n$  and  $m$  occurrences of the expression that it qualifies.
- Quantifiers are greedy (p. 704)—they'll match as many occurrences as they can as long as the match is successful. If a quantifier is followed by a question mark (`?`), the quantifier becomes reluctant (p. 705), matching as few occurrences as possible as long as the match is successful.
- String method `replaceAll` (p. 705) replaces text in a string with new text (the second argument) wherever the original string matches a regular expression (the first argument).
- Escaping a special regular-expression character with a `\` instructs the regular-expression matching engine to find the actual character, as opposed to what it represents in a regular expression.
- String method `replaceFirst` (p. 705) replaces the first occurrence of a pattern match and returns a new string in which the appropriate characters have been replaced.
- String method `split` divides a string into substrings at any location that matches a specified regular expression and returns an array of the substrings.
- Class `Pattern` (p. 707) represents a regular expression.
- Class `Matcher` (p. 707) contains a regular-expression pattern and a `CharSequence` in which to search.
- `CharSequence` is an interface (p. 707) that allows read access to a sequence of characters. Both `String` and `StringBuilder` implement this interface, so they can be used with class `Matcher`.
- If a regular expression will be used only once, static `Pattern` method `matches` (p. 707) takes a string that specifies the regular expression and a `CharSequence` on which to perform the match. This method returns a `boolean` indicating whether the search object matches the regular expression.
- If a regular expression will be used more than once, it's more efficient to use static `Pattern` method `compile` (p. 707) to create a specific `Pattern` object for that regular expression. This method receives a string representing the pattern and returns a new `Pattern` object.
- `Pattern` method `matcher` (p. 707) receives a `CharSequence` to search and returns a `Matcher` object. `Matcher` method `matches` (p. 707) performs the same task as `Pattern` method `matches` but without arguments.
- `Matcher` method `find` (p. 707) attempts to match a piece of the search object to the search pattern. Each call to this method starts at the point where the last call ended, so multiple matches can be found.

- Matcher method `lookingAt` (p. 707) performs the same as `find`, except that it always starts from the beginning of the search object and will always find the first match if there is one.
- Matcher method `group` (p. 708) returns the string from the search object that matches the search pattern. The string returned is the one that was last matched by a call to `find` or `lookingAt`.

## Self-Review Exercises

- 16.1** State whether each of the following is *true* or *false*. If *false*, explain why.
- When `String` objects are compared using `==`, the result is *true* if the `Strings` contain the same values.
  - A `String` can be modified after it's created.
- 16.2** For each of the following, write a single statement that performs the indicated task:
- Compare the string in `s1` to the string in `s2` for equality of contents.
  - Append the string `s2` to the string `s1`, using `+=`.
  - Determine the length of the string in `s1`.

## Answers to Self-Review Exercises

- 16.1**
- False. `String` objects are compared using operator `==` to determine whether they're the same object in memory.
  - False. `String` objects are immutable and cannot be modified after they're created. `StringBuilder` objects can be modified after they're created.
- 16.2**
- `s1.equals( s2 )`
  - `s1 += s2;`
  - `s1.length()`

## Exercises

**16.3** (*Comparing Strings*) Write an application that uses `String` method `compareTo` to compare two strings input by the user. Output whether the first string is less than, equal to or greater than the second.

**16.4** (*Comparing Portions of Strings*) Write an application that uses `String` method `regionMatches` to compare two strings input by the user. The application should input the number of characters to be compared and the starting index of the comparison. The application should state whether the strings are equal. Ignore the case of the characters when performing the comparison.

**16.5** (*Random Sentences*) Write an application that uses random-number generation to create sentences. Use four arrays of strings called `article`, `noun`, `verb` and `preposition`. Create a sentence by selecting a word at random from each array in the following order: `article`, `noun`, `verb`, `preposition`, `article` and `noun`. As each word is picked, concatenate it to the previous words in the sentence. The words should be separated by spaces. When the final sentence is output, it should start with a capital letter and end with a period. The application should generate and display 20 sentences.

The `article` array should contain the articles "the", "a", "one", "some" and "any"; the `noun` array should contain the nouns "boy", "girl", "dog", "town" and "car"; the `verb` array should contain the verbs "drove", "jumped", "ran", "walked" and "skipped"; the `preposition` array should contain the prepositions "to", "from", "over", "under" and "on".

**16.6** (*Project: Limericks*) A limerick is a humorous five-line verse in which the first and second lines rhyme with the fifth, and the third line rhymes with the fourth. Using techniques similar to those developed in Exercise 16.5, write a Java application that produces random limericks. Polishing this application to produce good limericks is a challenging problem, but the result will be worth the effort!

**16.7** (*Pig Latin*) Write an application that encodes English-language phrases into pig Latin. Pig Latin is a form of coded language. There are many different ways to form pig Latin phrases. For simplicity, use the following algorithm:

To form a pig Latin phrase from an English-language phrase, tokenize the phrase into words with `String` method `split`. To translate each English word into a pig Latin word, place the first letter of the English word at the end of the word and add the letters “ay.” Thus, the word “jump” becomes “umpjay,” the word “the” becomes “hetay,” and the word “computer” becomes “omputer-cay.” Blanks between words remain as blanks. Assume the following: The English phrase consists of words separated by blanks, there are no punctuation marks and all words have two or more letters. Method `printLatinWord` should display each word. Each token is passed to method `printLatinWord` to print the pig Latin word. Enable the user to input the sentence. Keep a running display of all the converted sentences in a text area.

**16.8** (*Tokenizing Telephone Numbers*) Write an application that inputs a telephone number as a string in the form (555) 555-5555. The application should use `String` method `split` to extract the area code as a token, the first three digits of the phone number as a token and the last four digits of the phone number as a token. The seven digits of the phone number should be concatenated into one string. Both the area code and the phone number should be printed. Remember that you’ll have to change delimiter characters during the tokenization process.

**16.9** (*Displaying a Sentence with Its Words Reversed*) Write an application that inputs a line of text, tokenizes the line with `String` method `split` and outputs the tokens in reverse order. Use space characters as delimiters.

**16.10** (*Displaying Strings in Uppercase and Lowercase*) Write an application that inputs a line of text and outputs the text twice—once in all uppercase letters and once in all lowercase letters.

**16.11** (*Searching Strings*) Write an application that inputs a line of text and a search character and uses `String` method `indexOf` to determine the number of occurrences of the character in the text.

**16.12** (*Searching Strings*) Write an application based on the application in Exercise 16.11 that inputs a line of text and uses `String` method `indexOf` to determine the total number of occurrences of each letter of the alphabet in the text. Uppercase and lowercase letters should be counted together. Store the totals for each letter in an array, and print the values in tabular format after the totals have been determined.

**16.13** (*Tokenizing and Comparing Strings*) Write an application that reads a line of text, tokenizes the line using space characters as delimiters and outputs only those words beginning with the letter “b”.

**16.14** (*Tokenizing and Comparing Strings*) Write an application that reads a line of text, tokenizes it using space characters as delimiters and outputs only those words ending with the letters “ED”.

**16.15** (*Converting int Values to Characters*) Write an application that inputs an integer code for a character and displays the corresponding character. Modify this application so that it generates all possible three-digit codes in the range from 000 to 255 and attempts to print the corresponding characters.

**16.16** (*Defining Your Own String Methods*) Write your own versions of `String` search methods `indexOf` and `lastIndexOf`.

**16.17** (*Creating Three-Letter Strings from a Five-Letter Word*) Write an application that reads a five-letter word from the user and produces every possible three-letter string that can be derived from the letters of that word. For example, the three-letter words produced from the word “bathe” include “ate,” “bat,” “bet,” “tab,” “hat,” “the” and “tea.”

## Special Section: Advanced String-Manipulation Exercises

The preceding exercises are keyed to the text and designed to test your understanding of fundamental string-manipulation concepts. This section includes a collection of intermediate and advanced string-manipulation exercises. You should find these problems challenging, yet entertaining. The problems vary considerably in difficulty. Some require an hour or two of application writing and implementation. Others are useful for lab assignments that might require two or three weeks of study and implementation. Some are challenging term projects.

**16.18 (Text Analysis)** The availability of computers with string-manipulation capabilities has resulted in some rather interesting approaches to analyzing the writings of great authors. Much attention has been focused on whether William Shakespeare ever lived. Some scholars believe there's substantial evidence indicating that Christopher Marlowe actually penned the masterpieces attributed to Shakespeare. Researchers have used computers to find similarities in the writings of these two authors. This exercise examines three methods for analyzing texts with a computer.

- a) Write an application that reads a line of text from the keyboard and prints a table indicating the number of occurrences of each letter of the alphabet in the text. For example, the phrase

To be, or not to be: that is the question:

contains one "a," two "b's," no "c's," and so on.

- b) Write an application that reads a line of text and prints a table indicating the number of one-letter words, two-letter words, three-letter words, and so on, appearing in the text. For example, Fig. 16.25 shows the counts for the phrase

Whether 'tis nobler in the mind to suffer

| Word length | Occurrences        |
|-------------|--------------------|
| 1           | 0                  |
| 2           | 2                  |
| 3           | 1                  |
| 4           | 2 (including 'tis) |
| 5           | 0                  |
| 6           | 2                  |
| 7           | 1                  |

**Fig. 16.25** | Word-length counts for the string "Whether 'tis nobler in the mind to suffer".

- c) Write an application that reads a line of text and prints a table indicating the number of occurrences of each different word in the text. The application should include the words in the table in the same order in which they appear in the text. For example, the lines

To be, or not to be: that is the question:  
Whether 'tis nobler in the mind to suffer

contain the word "to" three times, the word "be" two times, the word "or" once, etc.

**16.19 (Printing Dates in Various Formats)** Dates are printed in several common formats. Two of the more common formats are

04/25/1955 and April 25, 1955

Write an application that reads a date in the first format and prints it in the second format.



**16.20 (Check Protection)** Computers are frequently employed in check-writing systems, such as payroll and accounts payable applications. There are many strange stories about weekly paychecks being printed (by mistake) for amounts in excess of \$1 million. Incorrect amounts are printed by computerized check-writing systems because of human error or machine failure. Systems designers build controls into their systems to prevent such erroneous checks from being issued.

Another serious problem is the intentional alteration of a check amount by someone who plans to cash a check fraudulently. To prevent a dollar amount from being altered, some computerized check-writing systems employ a technique called check protection. Checks designed for imprinting by computer contain a fixed number of spaces in which the computer may print an amount. Suppose a paycheck contains eight blank spaces in which the computer is supposed to print the amount of a weekly paycheck. If the amount is large, then all eight of the spaces will be filled. For example,

```
1,230.60 (check amount)

12345678 (position numbers)
```

On the other hand, if the amount is less than \$1000, then several of the spaces would ordinarily be left blank. For example,

```
99.87

12345678
```

contains three blank spaces. If a check is printed with blank spaces, it's easier for someone to alter the amount. To prevent alteration, many check-writing systems insert *leading asterisks* to protect the amount as follows:

```
***99.87

12345678
```

Write an application that inputs a dollar amount to be printed on a check, then prints the amount in check-protected format with leading asterisks if necessary. Assume that nine spaces are available for printing the amount.

**16.21 (Writing the Word Equivalent of a Check Amount)** Continuing the discussion in Exercise 16.20, we reiterate the importance of designing check-writing systems to prevent alteration of check amounts. One common security method requires that the amount be written in numbers and spelled out in words as well. Even if someone is able to alter the numerical amount of the check, it's extremely difficult to change the amount in words. Write an application that inputs a numeric check amount that's less than \$1000 and writes the word equivalent of the amount. For example, the amount 112.43 should be written as

```
ONE hundred TWELVE and 43/100
```

**16.22 (Morse Code)** Perhaps the most famous of all coding schemes is the Morse code, developed by Samuel Morse in 1832 for use with the telegraph system. The Morse code assigns a series of dots and dashes to each letter of the alphabet, each digit, and a few special characters (e.g., period, comma, colon, semicolon). In sound-oriented systems, the dot represents a short sound and the dash a long sound. Other representations of dots and dashes are used with light-oriented systems and signal-flag systems. Separation between words is indicated by a space or, simply, the absence of a dot or dash. In a sound-oriented system, a space is indicated by a short time during which no sound is transmitted. The international version of the Morse code appears in Fig. 16.26.

Write an application that reads an English-language phrase and encodes it into Morse code. Also write an application that reads a phrase in Morse code and converts it into the English-language equivalent. Use one blank between each Morse-coded letter and three blanks between each Morse-coded word.

| Character | Code   | Character | Code   | Character     | Code   |
|-----------|--------|-----------|--------|---------------|--------|
| A         | .-     | N         | -.     | <i>Digits</i> |        |
| B         | -...   | O         | ---    | 1             | ....-  |
| C         | -.-. . | P         | ..-. . | 2             | ..-..- |
| D         | -..    | Q         | ---.-  | 3             | ...--  |
| E         | .      | R         | ..-    | 4             | ....-  |
| F         | ...-   | S         | ...    | 5             | .....  |
| G         | --.    | T         | -      | 6             | -..... |
| H         | ....   | U         | ...-   | 7             | ---... |
| I         | ..     | V         | ...-   | 8             | ----.. |
| J         | ....-  | W         | ..-    | 9             | ----.  |
| K         | -.-    | X         | -..-   | 0             | -----  |
| L         | ... .  | Y         | -.-.-  |               |        |
| M         | --     | Z         | ---..  |               |        |

**Fig. 16.26** | Letters and digits as expressed in international Morse code.

**16.23** (*Metric Conversions*) Write an application that will assist the user with metric conversions. Your application should allow the user to specify the names of the units as strings (i.e., centimeters, liters, grams, and so on, for the metric system and inches, quarts, pounds, and so on, for the English system) and should respond to simple questions, such as

```
"How many inches are in 2 meters?"
"How many liters are in 10 quarts?"
```

Your application should recognize invalid conversions. For example, the question

```
"How many feet are in 5 kilograms?"
```

is not meaningful because "feet" is a unit of length, whereas "kilograms" is a unit of mass.

## Special Section: Challenging String-Manipulation Projects

**16.24** (*Project: A Spelling Checker*) Many popular word-processing software packages have built-in spell checkers. In this project, you're asked to develop your own spell-checker utility. We make suggestions to help get you started. You should then consider adding more capabilities. Use a computerized dictionary (if you have access to one) as a source of words.

Why do we type so many words with incorrect spellings? In some cases, it's because we simply do not know the correct spelling, so we make a best guess. In some cases, it's because we transpose two letters (e.g., "defualt" instead of "default"). Sometimes we double-type a letter accidentally (e.g., "hannidy" instead of "handy"). Sometimes we type a nearby key instead of the one we intended (e.g., "biryhday" instead of "birthday"), and so on.

Design and implement a spell-checker application in Java. Your application should maintain an array `wordList` of strings. Enable the user to enter these strings. [Note: In Chapter 17, we introduce file processing. With this capability, you can obtain the words for the spell checker from a computerized dictionary stored in a file.]

Your application should ask a user to enter a word. The application should then look up that word in the `wordList` array. If the word is in the array, your application should print "Word is spelled correctly." If the word is not in the array, your application should print "Word is not

spelled correctly." Then your application should try to locate other words in `wordList` that might be the word the user intended to type. For example, you can try all possible single transpositions of adjacent letters to discover that the word "default" is a direct match to a word in `wordList`. Of course, this implies that your application will check all other single transpositions, such as "edfault," "dfeault," "deafult," "defalut" and "default." When you find a new word that matches one in `wordList`, print it in a message, such as

```
Did you mean "default"?
```

Implement other tests, such as replacing each double letter with a single letter, and any other tests you can develop to improve the value of your spell checker.

**16.25** (*Project: A Crossword Puzzle Generator*) Most people have worked a crossword puzzle, but few have ever attempted to generate one. Generating a crossword puzzle is suggested here as a string-manipulation project requiring substantial sophistication and effort.

There are many issues the programmer must resolve to get even the simplest crossword-puzzle-generator application working. For example, how do you represent the grid of a crossword puzzle inside the computer? Should you use a series of strings or two-dimensional arrays?

The programmer needs a source of words (i.e., a computerized dictionary) that can be directly referenced by the application. In what form should these words be stored to facilitate the complex manipulations required by the application?

If you're really ambitious, you'll want to generate the clues portion of the puzzle, in which the brief hints for each across word and each down word are printed. Merely printing a version of the blank puzzle itself is not a simple problem.

## Making a Difference

**16.26** (*Cooking with Healthier Ingredients*) Obesity in America is increasing at an alarming rate. Check the map from the Centers for Disease Control and Prevention (CDC) at [www.cdc.gov/nccdphp/dnpa/Obesity/trend/maps/index.htm](http://www.cdc.gov/nccdphp/dnpa/Obesity/trend/maps/index.htm), which shows obesity trends in the United States over the last 20 years. As obesity increases, so do occurrences of related problems (e.g., heart disease, high blood pressure, high cholesterol, type 2 diabetes). Write a program that helps users choose healthier ingredients when cooking, and helps those allergic to certain foods (e.g., nuts, gluten) find substitutes. The program should read a recipe from a `JTextArea` and suggest healthier replacements for some of the ingredients. For simplicity, your program should assume the recipe has no abbreviations for measures such as teaspoons, cups, and tablespoons, and uses numerical digits for quantities (e.g., 1 egg, 2 cups) rather than spelling them out (one egg, two cups). Some common substitutions are shown in Fig. 16.27. Your program should display a warning such as, "Always consult your physician before making significant changes to your diet."

Your program should take into consideration that replacements are not always one-for-one. For example, if a cake recipe calls for three eggs, it might reasonably use six egg whites instead. Conversion data for measurements and substitutes can be obtained at websites such as:

```
chinesefood.about.com/od/recipeconversionfaqs/f/usmetricrecipes.htm
www.pioneerthinking.com/eggsub.html
www.gourmets1euth.com/conversions.htm
```

Your program should consider the user's health concerns, such as high cholesterol, high blood pressure, weight loss, gluten allergy, and so on. For high cholesterol, the program should suggest substitutes for eggs and dairy products; if the user wishes to lose weight, low-calorie substitutes for ingredients such as sugar should be suggested.

**16.27** (*Spam Scanner*) Spam (or junk e-mail) costs U.S. organizations billions of dollars a year in spam-prevention software, equipment, network resources, bandwidth, and lost productivity. Research online some of the most common spam e-mail messages and words, and check your own

| Ingredient             | Substitution                                                                                                       |
|------------------------|--------------------------------------------------------------------------------------------------------------------|
| 1 cup sour cream       | 1 cup yogurt                                                                                                       |
| 1 cup milk             | 1/2 cup evaporated milk and 1/2 cup water                                                                          |
| 1 teaspoon lemon juice | 1/2 teaspoon vinegar                                                                                               |
| 1 cup sugar            | 1/2 cup honey, 1 cup molasses<br>or 1/4 cup agave nectar                                                           |
| 1 cup butter           | 1 cup margarine or yogurt                                                                                          |
| 1 cup flour            | 1 cup rye or rice flour                                                                                            |
| 1 cup mayonnaise       | 1 cup cottage cheese<br>or 1/8 cup mayonnaise and 7/8 cup yogurt                                                   |
| 1 egg                  | 2 tablespoons cornstarch, arrowroot flour<br>or potato starch or 2 egg whites<br>or 1/2 of a large banana (mashed) |
| 1 cup milk             | 1 cup soy milk                                                                                                     |
| 1/4 cup oil            | 1/4 cup applesauce                                                                                                 |
| white bread            | whole-grain bread                                                                                                  |

**Fig. 16.27** | Ingredients and substitutions.

junk e-mail folder. Create a list of 30 words and phrases commonly found in spam messages. Write an application in which the user enters an e-mail message in a `JTextArea`. Then, scan the message for each of the 30 keywords or phrases. For each occurrence of one of these within the message, add a point to the message's "spam score." Next, rate the likelihood that the message is spam, based on the number of points it received.

**16.28** (*SMS Language*) Short Message Service (SMS) is a communications service that allows sending text messages of 160 or fewer characters between mobile phones. With the proliferation of mobile phone use worldwide, SMS is being used in many developing nations for political purposes (e.g., voicing opinions and opposition), reporting news about natural disasters, and so on. For example, check out [comunica.org/radio2.0/archives/87](http://comunica.org/radio2.0/archives/87). Since the length of SMS messages is limited, SMS Language—abbreviations of common words and phrases in mobile text messages, e-mails, instant messages, etc.—is often used. For example, "in my opinion" is "imo" in SMS Language. Research SMS Language online. Write a GUI application in which the user can enter a message using SMS Language, then click a button to translate it into English (or your own language). Also provide a mechanism to translate text written in English (or your own language) into SMS Language. One potential problem is that one SMS abbreviation could expand into a variety of phrases. For example, IMO (as used above) could also stand for "International Maritime Organization," "in memory of," etc.

# Files, Streams and Object Serialization

# 17



*I can only assume that a “Do Not File” document is filed in a “Do Not File” file.*

—Senator Frank Church  
Senate Intelligence Subcommittee  
Hearing, 1975

*Consciousness ... does not appear to itself chopped up in bits. ... A “river” or a “stream” are the metaphors by which it is most naturally described.*

—William James

## Objectives

In this chapter you'll learn:

- To create, read, write and update files.
- To retrieve information about files and directories.
- The Java input/output stream class hierarchy.
- The differences between text files and binary files.
- To use classes `Scanner` and `Formatter` to process text files.
- To use classes `FileInputStream` and `FileOutputStream` to read from and write to files.
- To use classes `ObjectInputStream` and `ObjectOutputStream` to read objects from and write objects to files.
- To use a `JFileChooser` dialog.

|                                                        |                                                                     |
|--------------------------------------------------------|---------------------------------------------------------------------|
| <b>17.1</b> Introduction                               | 17.5.1 Creating a Sequential-Access File Using Object Serialization |
| <b>17.2</b> Files and Streams                          | 17.5.2 Reading and Deserializing Data from a Sequential-Access File |
| <b>17.3</b> Class <code>File</code>                    | <b>17.6</b> Additional <code>java.io</code> Classes                 |
| <b>17.4</b> Sequential-Access Text Files               | 17.6.1 Interfaces and Classes for Byte-Based Input and Output       |
| 17.4.1 Creating a Sequential-Access Text File          | 17.6.2 Interfaces and Classes for Character-Based Input and Output  |
| 17.4.2 Reading Data from a Sequential-Access Text File | <b>17.8</b> Opening Files with <code>JFileChooser</code>            |
| 17.4.3 Case Study: A Credit-Inquiry Program            | <b>17.8</b> Wrap-Up                                                 |
| 17.4.4 Updating Sequential-Access Files                |                                                                     |

Summary | Self-Review Exercises | Answers to Self-Review Exercises | Exercises | Making a Difference

## 17.1 Introduction<sup>1</sup>

Data stored in variables and arrays is temporary—it’s lost when a local variable goes out of scope or when the program terminates. For long-term retention of data, even after the programs that create the data terminate, computers use **files**. You use files every day for tasks such as writing a document or creating a spreadsheet. Computers store files on **secondary storage devices** such as hard disks, optical disks, flash drives and magnetic tapes. Data maintained in files is **persistent data**—it exists beyond the duration of program execution. In this chapter, we explain how Java programs create, update and process files.

We begin with a discussion of Java’s architecture for handling files programmatically. Next we explain that data can be stored in text files and binary files—and we cover the differences between them. We demonstrate retrieving information about files and directories using class `File`, then devote several sections to the different mechanisms for writing data to and reading data from files. We show how to create and manipulate sequential-access text files. Working with text files allows you to quickly and easily start manipulating files. As you’ll learn, however, it’s difficult to read data from text files back into object form. Fortunately, many object-oriented languages (including Java) provide ways to write objects to and read objects from files (known as object serialization and deserialization). To demonstrate this, we recreate some of our sequential-access programs that used text files, this time by storing objects in binary files.

## 17.2 Files and Streams

Java views each file as a sequential **stream of bytes** (Fig. 17.1). Every operating system provides a mechanism to determine the end of a file, such as an **end-of-file marker** or a count of the total bytes in the file that’s recorded in a system-maintained administrative data structure. A Java program processing a stream of bytes simply receives an indication from the operating system when it reaches the end of the stream—the program does *not* need to know how the underlying platform represents files or streams. In some cases, the end-

1. The techniques shown in this chapter are based on Java SE 6. Java SE 7 introduces new file-system APIs for interacting with files and directories. On the book’s Companion Website (accessible via [www.pearsonhighered.com/deitel](http://www.pearsonhighered.com/deitel)) we’ve posted a version of this chapter implemented using these Java SE 7 APIs.

of-file indication occurs as an exception. In other cases, the indication is a return value from a method invoked on a stream-processing object.



**Fig. 17.1** | Java's view of a file of  $n$  bytes.

### *Byte-Based and Character-Based Streams*

File streams can be used to input and output data as bytes or characters. **Byte-based streams** input and output data in its binary format. **Character-based streams** input and output data as a sequence of characters. If the value 5 were being stored using a byte-based stream, it would be stored in the binary format of the numeric value 5, or 101. If the value 5 were being stored using a character-based stream, it would be stored in the binary format of the character 5, or 00000000 00110101 (this is the binary representation for the numeric value 53, which indicates the Unicode<sup>®</sup> character 5). The difference between the two forms is that the numeric value can be used as an integer in calculations, whereas the character 5 is simply a character that can be used in a string of text, as in "Sarah Miller is 15 years old". Files that are created using byte-based streams are referred to as **binary files**, while files created using character-based streams are referred to as **text files**. Text files can be read by text editors, while binary files are read by programs that understand the file's specific content and its ordering.

### *Standard Input, Standard Output and Standard Error Streams*

A Java program **opens** a file by creating an object and associating a stream of bytes or characters with it. The object's constructor interacts with the operating system to open the file. Java can also associate streams with different devices. When a Java program begins executing, in fact, it creates three stream objects that are associated with devices—`System.in`, `System.out` and `System.err`. `System.in` (the standard input stream object) normally enables a program to input bytes from the keyboard; object `System.out` (the standard output stream object) normally enables a program to output character data to the screen; and object `System.err` (the standard error stream object) normally enables a program to output character-based error messages to the screen. Each stream can be redirected. For `System.in`, this capability enables the program to read bytes from a different source. For `System.out` and `System.err`, it enables the output to be sent to a different location, such as a file on disk. Class `System` provides methods **setIn**, **setOut** and **setErr** to **redirect** the standard input, output and error streams, respectively.

### *The java.io Package*

Java programs perform file processing by using classes from package `java.io`. This package includes definitions for stream classes, such as **FileInputStream** (for byte-based input from a file), **FileOutputStream** (for byte-based output to a file), **FileReader** (for character-based input from a file) and **FileWriter** (for character-based output to a file), which inherit from classes `InputStream`, `OutputStream`, `Reader` and `Writer`, respectively. Thus, the methods of the these stream classes can also be applied to file streams.

Java contains classes that enable you to perform input and output of objects or variables of primitive data types. The data will still be stored as bytes or characters behind the scenes, allowing you to read or write data in the form of ints, Strings, or other types without having to worry about the details of converting such values to byte format. To perform such input and output, objects of classes **ObjectInputStream** and **ObjectOutputStream** can be used together with the byte-based file stream classes `FileInputStream` and `FileOutputStream` (these classes will be discussed in more detail shortly). The complete hierarchy of types in package `java.io` can be viewed in the online documentation at

[download.oracle.com/javase/6/docs/api/java/io/package-tree.html](http://download.oracle.com/javase/6/docs/api/java/io/package-tree.html)

As you can see in the hierarchy, Java offers many classes for performing input/output operations. We use several of these classes in this chapter to implement file-processing programs that create and manipulate sequential-access files. In Chapter 27, we use stream classes extensively to implement networking applications.

In addition to the `java.io` classes, character-based input and output can be performed with classes `Scanner` and **Formatter**. Class `Scanner` is used extensively to input data from the keyboard—it can also read data from a file. Class `Formatter` enables formatted data to be output to any text-based stream in a manner similar to method `System.out.printf`. Appendix G presents the details of formatted output with `printf`. All these features can be used to format text files as well.

## 17.3 Class File

This section presents class **File**, which is useful for retrieving information about files or directories from disk. Objects of class `File` do not open files or provide any file-processing capabilities. However, `File` objects are used frequently with objects of other `java.io` classes to specify files or directories to manipulate.

### *Creating File Objects*

Class `File` provides four constructors. The one with a `String` argument specifies the name of a file or directory to associate with the `File` object. The name can contain **path information** as well as a file or directory name. A file or directory's path specifies its location on disk. The path includes some or all of the directories leading to the file or directory. An **absolute path** contains all the directories, starting with the **root directory**, that lead to a specific file or directory. Every file or directory on a particular disk drive has the same root directory in its path. A **relative path** normally starts from the directory in which the application began executing and is therefore “relative” to the current directory. The constructor with two `String` arguments specifies an absolute or relative path as the first argument and the file or directory to associate with the `File` object as the second argument. The constructor with `File` and `String` arguments uses an existing `File` object that specifies the parent directory of the file or directory specified by the `String` argument. The fourth constructor uses a `URI` object to locate the file. A **Uniform Resource Identifier (URI)** is a more general form of the **Uniform Resource Locators (URLs)** that are used to locate websites. For example, `http://www.deitel.com/` is the URL for the Deitel & Associates website. URIs for locating files vary across operating systems. On Windows platforms, the URI

`file://C:/data.txt`



identifies the file data.txt stored in the root directory of the C: drive. On UNIX/Linux platforms, the URI

```
file:/home/student/data.txt
```

identifies the file data.txt stored in the home directory of the user student.

Figure 17.2 lists some common File methods. The complete list can be viewed at [download.oracle.com/javase/6/docs/api/java/io/File.html](http://download.oracle.com/javase/6/docs/api/java/io/File.html).

| Method                                | Description                                                                                                                                                                                           |
|---------------------------------------|-------------------------------------------------------------------------------------------------------------------------------------------------------------------------------------------------------|
| <code>boolean canRead()</code>        | Returns true if a file is readable by the current application; false otherwise.                                                                                                                       |
| <code>boolean canWrite()</code>       | Returns true if a file is writable by the current application; false otherwise.                                                                                                                       |
| <code>boolean exists()</code>         | Returns true if the file or directory represented by the File object exists; false otherwise.                                                                                                         |
| <code>boolean isFile()</code>         | Returns true if the name specified as the argument to the File constructor is a file; false otherwise.                                                                                                |
| <code>boolean isDirectory()</code>    | Returns true if the name specified as the argument to the File constructor is a directory; false otherwise.                                                                                           |
| <code>boolean isAbsolute()</code>     | Returns true if the arguments specified to the File constructor indicate an absolute path to a file or directory; false otherwise.                                                                    |
| <code>String getAbsolutePath()</code> | Returns a String with the absolute path of the file or directory.                                                                                                                                     |
| <code>String getName()</code>         | Returns a String with the name of the file or directory.                                                                                                                                              |
| <code>String getPath()</code>         | Returns a String with the path of the file or directory.                                                                                                                                              |
| <code>String getParent()</code>       | Returns a String with the parent directory of the file or directory (i.e., the directory in which the file or directory is located).                                                                  |
| <code>long length()</code>            | Returns the length of the file, in bytes. If the File object represents a directory, an unspecified value is returned.                                                                                |
| <code>long lastModified()</code>      | Returns a platform-dependent representation of the time at which the file or directory was last modified. The value returned is useful only for comparison with other values returned by this method. |
| <code>String[] list()</code>          | Returns an array of Strings representing a directory's contents. Returns null if the File object does not represent a directory.                                                                      |

**Fig. 17.2** | File methods.

### *Demonstrating Class File*

Figure 17.3 prompts the user to enter the name of a file or directory, then uses class File to output information about the file or directory.

The program begins by prompting the user for a file or directory (line 12). Line 13 inputs the file name or directory name and passes it to method `analyzePath` (lines 17–50). The method creates a new File object (line 20) and assigns its reference to `name`. Line 22 invokes File method `exists` to determine whether the name input by the user exists

```

1 // Fig. 17.3: FileDemonstration.java
2 // File class used to obtain file and directory information.
3 import java.io.File;
4 import java.util.Scanner;
5
6 public class FileDemonstration
7 {
8 public static void main(String[] args)
9 {
10 Scanner input = new Scanner(System.in);
11
12 System.out.print("Enter file or directory name: ");
13 analyzePath(input.nextLine());
14 } // end main
15
16 // display information about file user specifies
17 public static void analyzePath(String path)
18 {
19 // create File object based on user input
20 File name = new File(path);
21
22 if (name.exists()) // if name exists, output information about it
23 {
24 // display file (or directory) information
25 System.out.printf(
26 "%s%s\n%s\n%s\n%s\n%s\n%s\n%s\n%s\n%s\n%s\n%s\n%s\n",
27 name.getName(), " exists",
28 (name.isFile() ? "is a file" : "is not a file"),
29 (name.isDirectory() ? "is a directory" :
30 "is not a directory"),
31 (name.isAbsolute() ? "is absolute path" :
32 "is not absolute path"), "Last modified: ",
33 name.lastModified(), "Length: ", name.length(),
34 "Path: ", name.getPath(), "Absolute path: ",
35 name.getAbsolutePath(), "Parent: ", name.getParent());
36
37 if (name.isDirectory()) // output directory listing
38 {
39 String[] directory = name.list();
40 System.out.println("\n\nDirectory contents:\n");
41
42 for (String directoryName : directory)
43 System.out.println(directoryName);
44 } // end if
45 } // end outer if
46 else // not file or directory, output error message
47 {
48 System.out.printf("%s %s", path, "does not exist.");
49 } // end else
50 } // end method analyzePath
51 } // end class FileDemonstration

```

**Fig. 17.3** | File class used to obtain file and directory information. (Part 1 of 2.)

```

Enter file or directory name: E:\Program Files\Java\jdk1.6.0_11\demo\jfc
jfc exists
is not a file
is a directory
is absolute path
Last modified: 1228404395024
Length: 4096
Path: E:\Program Files\Java\jdk1.6.0_11\demo\jfc
Absolute path: E:\Program Files\Java\jdk1.6.0_11\demo\jfc
Parent: E:\Program Files\Java\jdk1.6.0_11\demo

```

Directory contents:

```

CodePointIM
FileChooserDemo
Font2DTest
Java2D
Laffy
Metalworks
Notepad
SampleTree
Stylepad
SwingApplet
SwingSet2
SwingSet3

```

```

Enter file or directory name: C:\Program Files\Java\jdk1.6.0_11\demo\jfc
\Java2D\README.txt
README.txt exists
is a file
is not a directory
is absolute path
Last modified: 1228404384270
Length: 7518
Path: E:\Program Files\Java\jdk1.6.0_11\demo\jfc\Java2D\README.txt
Absolute path: E:\Program Files\Java\jdk1.6.0_11\demo\jfc\Java2D\README.txt
Parent: E:\Program Files\Java\jdk1.6.0_11\demo\jfc\Java2D

```

**Fig. 17.3** | File class used to obtain file and directory information. (Part 2 of 2.)

(either as a file or as a directory) on the disk. If the name does not exist, control proceeds to lines 46–49 and displays a message to the screen containing the name the user typed, followed by “does not exist.” Otherwise, the `if` statement (lines 22–45) executes. The program outputs the name of the file or directory (line 27), followed by the results of testing the `File` object with `isFile` (line 28), `isDirectory` (line 29) and `isAbsolute` (line 31). Next, the program displays the values returned by `lastModified` (line 33), `length` (line 33), `getPath` (line 34), `getAbsolutePath` (line 35) and `getParent` (line 35). If the `File` object represents a directory (line 37), the program obtains a list of the directory’s contents as an array of `Strings` by using `File` method `list` (line 39) and displays the list on the screen.

The first output of this program demonstrates a `File` object associated with the `jfc` directory from the JDK. The second output demonstrates a `File` object associated with

the `README.txt` file from the Java 2D example that comes with the JDK. In both cases, we specified an absolute path on our computer.

A **separator character** is used to separate directories and files in the path. On a Windows computer, the separator character is a backslash (`\`). On a UNIX system, it's a forward slash (`/`). Java processes both characters identically in a path name. For example, if we were to use the path

```
c:\Program Files\Java\jdk1.6.0_11\demo/jfc
```

which employs each separator character, Java would still process the path properly. When building `Strings` that represent path information, use `File.separator` to obtain the local computer's proper separator character rather than explicitly using `/` or `\`. This constant returns a `String` consisting of one character—the proper separator for the system.



### Common Programming Error 17.1

*Using `\` as a directory separator rather than `\\` in a string literal is a logic error. A single `\` indicates that the `\` followed by the next character represents an escape sequence. Use `\\` to insert a `\` in a string literal.*

## 17.4 Sequential-Access Text Files

Next, we create and manipulate sequential-access files in which records are stored in order by the record-key field. We begin with text files, enabling the reader to quickly create and edit human-readable files. We discuss creating, writing data to, reading data from and updating sequential-access text files. We also include a credit-inquiry program that retrieves specific data from a file.

### 17.4.1 Creating a Sequential-Access Text File

*Java imposes no structure on a file— notions such as records do not exist as part of the Java language.* Therefore, you must structure files to meet the requirements of your applications. In the following example, we see how to impose a keyed record structure on a file.

The program in Figs. 17.4, 17.5 and 17.8 creates a simple sequential-access file that might be used in an accounts receivable system to keep track of the amounts owed to a company by its credit clients. For each client, the program obtains from the user an account number and the client's name and balance (i.e., the amount the client owes the company for goods and services received). Each client's data constitutes a "record" for that client. This application uses the account number as the record key—the file will be created and maintained in account-number order. The program assumes that the user enters the records in account-number order. In a comprehensive accounts receivable system (based on sequential-access files), a sorting capability would be provided so that the user could enter the records in any order. The records would then be sorted and written to the file.

#### *Class AccountRecord*

Class `AccountRecord` (Fig. 17.4) encapsulates the client record information used by the examples in this chapter. `AccountRecord` is declared in package `com.deitel.ch17` (line 3), so that it can be imported into several of this chapter's examples for reuse. (Section 8.14 provides information on compiling and using your own packages.) Class `AccountRecord` contains private instance variables `account`, `firstName`, `lastName` and `balance` (lines 7–

10) and *set* and *get* methods for accessing these fields. Though the *set* methods do not validate the data in this example, they should do so in an “industrial-strength” system.

---

```

1 // Fig. 17.4: AccountRecord.java
2 // AccountRecord class maintains information for one account.
3 package com.deitel.ch17; // packaged for reuse
4
5 public class AccountRecord
6 {
7 private int account;
8 private String firstName;
9 private String lastName;
10 private double balance;
11
12 // no-argument constructor calls other constructor with default values
13 public AccountRecord()
14 {
15 this(0, "", "", 0.0); // call four-argument constructor
16 } // end no-argument AccountRecord constructor
17
18 // initialize a record
19 public AccountRecord(int acct, String first, String last, double bal)
20 {
21 setAccount(acct);
22 setFirstName(first);
23 setLastName(last);
24 setBalance(bal);
25 } // end four-argument AccountRecord constructor
26
27 // set account number
28 public void setAccount(int acct)
29 {
30 account = acct;
31 } // end method setAccount
32
33 // get account number
34 public int getAccount()
35 {
36 return account;
37 } // end method getAccount
38
39 // set first name
40 public void setFirstName(String first)
41 {
42 firstName = first;
43 } // end method setFirstName
44
45 // get first name
46 public String getFirstName()
47 {
48 return firstName;
49 } // end method getFirstName

```

---

**Fig. 17.4** | AccountRecord class maintains information for one account. (Part 1 of 2.)

```

50
51 // set last name
52 public void setLastName(String last)
53 {
54 lastName = last;
55 } // end method setLastName
56
57 // get last name
58 public String getLastName()
59 {
60 return lastName;
61 } // end method getLastName
62
63 // set balance
64 public void setBalance(double bal)
65 {
66 balance = bal;
67 } // end method setBalance
68
69 // get balance
70 public double getBalance()
71 {
72 return balance;
73 } // end method getBalance
74 } // end class AccountRecord

```

**Fig. 17.4** | AccountRecord class maintains information for one account. (Part 2 of 2.)

To compile class `AccountRecord`, open a command window, change directories to this chapter's `fig17_05` directory (which contains `AccountRecord.java`), then type:

```
javac -d .. AccountRecord.java
```

This places `AccountRecord.class` in its package directory structure and places the package in the `ch17` folder that contains all the examples for this chapter. When you compile class `AccountRecord` (or any other classes that will be reused in this chapter), you should place them in a common directory. When you compile or execute classes that use class `AccountRecord` (e.g., `CreateTextFile` in Fig. 17.5), you must specify the command-line argument `-classpath` to both `javac` and `java`, as in

```
javac -classpath .;c:\examples\ch17 CreateTextFile.java
java -classpath .;c:\examples\ch17 CreateTextFile
```

The current directory (specified with `.`) is included in the classpath to ensure that the compiler can locate other classes in the same directory as the class being compiled. The path separator used in the preceding commands must be appropriate for your platform—a semicolon (`;`) on Windows and a colon (`:`) on UNIX/Linux/Mac OS X. The preceding commands assume that the package containing `AccountRecord` is located at in the directory `C:\examples\ch17` on a Windows computer.

### *Class CreateTextFile*

Now let's examine class `CreateTextFile` (Fig. 17.5). Line 14 declares `Formatter` variable `output`. As discussed in Section 17.2, a `Formatter` object outputs formatted `Strings`, us-

ing the same formatting capabilities as method `System.out.printf`. A `Formatter` object can output to various locations, such as the screen or a file, as is done here. The `Formatter` object is instantiated in line 21 in method `openFile` (lines 17–34). The constructor used in line 21 takes one argument—a `String` containing the name of the file, including its path. If a path is not specified, as is the case here, the JVM assumes that the file is in the directory from which the program was executed. For text files, we use the `.txt` file extension. If the file does not exist, it will be created. If an existing file is opened, its contents are **truncated**—all the data in the file is discarded. At this point the file is open for writing, and the resulting `Formatter` object can be used to write data to the file.

---

```

1 // Fig. 17.5: CreateTextFile.java
2 // Writing data to a sequential text file with class Formatter.
3 import java.io.FileNotFoundException;
4 import java.lang.SecurityException;
5 import java.util.Formatter;
6 import java.util.FormatterClosedException;
7 import java.util.NoSuchElementException;
8 import java.util.Scanner;
9
10 import com.deitel.ch17.AccountRecord;
11
12 public class CreateTextFile
13 {
14 private Formatter output; // object used to output text to file
15
16 // enable user to open file
17 public void openFile()
18 {
19 try
20 {
21 output = new Formatter("clients.txt"); // open the file
22 } // end try
23 catch (SecurityException securityException)
24 {
25 System.err.println(
26 "You do not have write access to this file.");
27 System.exit(1); // terminate the program
28 } // end catch
29 catch (FileNotFoundException fileNotFoundException)
30 {
31 System.err.println("Error opening or creating file.");
32 System.exit(1); // terminate the program
33 } // end catch
34 } // end method openFile
35
36 // add records to file
37 public void addRecords()
38 {
39 // object to be written to file
40 AccountRecord record = new AccountRecord();

```

---

**Fig. 17.5** | Writing data to a sequential text file with class `Formatter`. (Part I of 3.)

```

41
42 Scanner input = new Scanner(System.in);
43
44 System.out.printf("%s\n%s\n%s\n%s\n\n",
45 "To terminate input, type the end-of-file indicator ",
46 "when you are prompted to enter input.",
47 "On UNIX/Linux/Mac OS X type <ctrl> d then press Enter",
48 "On Windows type <ctrl> z then press Enter");
49
50 System.out.printf("%s\n%s",
51 "Enter account number (> 0), first name, last name and balance.",
52 "? ");
53
54 while (input.hasNext()) // loop until end-of-file indicator
55 {
56 try // output values to file
57 {
58 // retrieve data to be output
59 record.setAccount(input.nextInt()); // read account number
60 record.setFirstName(input.next()); // read first name
61 record.setLastName(input.next()); // read last name
62 record.setBalance(input.nextDouble()); // read balance
63
64 if (record.getAccount() > 0)
65 {
66 // write new record
67 output.format("%d %s %s %.2f\n", record.getAccount(),
68 record.getFirstName(), record.getLastName(),
69 record.getBalance());
70 } // end if
71 else
72 {
73 System.out.println(
74 "Account number must be greater than 0.");
75 } // end else
76 } // end try
77 catch (FormatterClosedException formatterClosedException)
78 {
79 System.err.println("Error writing to file.");
80 return;
81 } // end catch
82 catch (NoSuchElementException elementException)
83 {
84 System.err.println("Invalid input. Please try again.");
85 input.nextLine(); // discard input so user can try again
86 } // end catch
87
88 System.out.printf("%s %s\n%s", "Enter account number (>0)",
89 "first name, last name and balance.", "? ");
90 } // end while
91 } // end method addRecords
92

```

**Fig. 17.5** | Writing data to a sequential text file with class `Formatter`. (Part 2 of 3.)



```

93 // close file
94 public void closeFile()
95 {
96 if (output != null)
97 output.close();
98 } // end method closeFile
99 } // end class CreateTextFile

```

**Fig. 17.5** | Writing data to a sequential text file with class `Formatter`. (Part 3 of 3.)

Lines 23–28 handle the **`SecurityException`**, which occurs if the user does not have permission to write data to the file. Lines 29–33 handle the **`FileNotFoundException`**, which occurs if the file does not exist and a new file cannot be created. This exception may also occur if there’s an error opening the file. In both exception handlers we call static method **`System.exit`** and pass the value 1. This method terminates the application. An argument of 0 to method `exit` indicates successful program termination. A nonzero value, such as 1 in this example, normally indicates that an error has occurred. This value is passed to the command window that executed the program. The argument is useful if the program is executed from a **batch file** on Windows systems or a **shell script** on UNIX/Linux/Mac OS X systems. Batch files and shell scripts offer a convenient way of executing several programs in sequence. When the first program ends, the next program begins execution. It’s possible to use the argument to method `exit` in a batch file or shell script to determine whether other programs should execute. For more information on batch files or shell scripts, see your operating system’s documentation.

Method `addRecords` (lines 37–91) prompts the user to enter the various fields for each record or to enter the end-of-file key sequence when data entry is complete. Figure 17.6 lists the key combinations for entering end-of-file for various computer systems.

| Operating system    | Key combination                                        |
|---------------------|--------------------------------------------------------|
| UNIX/Linux/Mac OS X | <code>&lt;Enter&gt;</code> <code>&lt;Ctrl&gt; d</code> |
| Windows             | <code>&lt;Ctrl&gt; z</code>                            |

**Fig. 17.6** | End-of-file key combinations.

Line 40 creates an `AccountRecord` object, which will be used to store the values of the current record entered by the user. Line 42 creates a `Scanner` object to read input from the user at the keyboard. Lines 44–48 and 50–52 prompt the user for input.

Line 54 uses `Scanner` method `hasNext` to determine whether the end-of-file key combination has been entered. The loop executes until `hasNext` encounters end-of-file.

Lines 59–62 read data from the user, storing the record information in the `AccountRecord` object. Each statement throws a **`NoSuchElementException`** (handled in lines 82–86) if the data is in the wrong format (e.g., a `String` when an `int` is expected) or if there’s no more data to input. If the account number is greater than 0 (line 64), the record’s information is written to `clients.txt` (lines 67–69) using method **`format`**, which can perform identical formatting to the `System.out.printf` method used extensively in earlier chapters. Method `format` outputs a formatted `String` to the output destination of

the `Formatter` object—the file `clients.txt`. The format string `"%d %s %s %.2f\n"` indicates that the current record will be stored as an integer (the account number) followed by a `String` (the first name), another `String` (the last name) and a floating-point value (the balance). Each piece of information is separated from the next by a space, and the double value (the balance) is output with two digits to the right of the decimal point (as indicated by the `.2` in `%.2f`). The data in the text file can be viewed with a text editor or retrieved later by a program designed to read the file (Section 17.4.2).

When lines 67–69 execute, if the `Formatter` object is closed, a **`FormatterClosedException`** will be thrown. This exception is handled in lines 77–81. [Note: You can also output data to a text file using class `java.io.PrintWriter`, which provides format and `printf` methods for outputting formatted data.]

Lines 94–98 declare method `closeFile`, which closes the `Formatter` and the underlying output file. Line 97 closes the object by simply calling method `close`. If method `close` is not called explicitly, the operating system normally will close the file when program execution terminates—this is an example of operating-system “housekeeping.” However, you should always explicitly close a file when it’s no longer needed.

### *Platform-Specific Line-Separator Characters*

Lines 67–69 output a line of text followed by a newline (`\n`). If you use a text editor to open the `clients.txt` file produced, each record might not display on a separate line. For example, in Notepad (Microsoft Windows), users will see one continuous line of text. This occurs because different platforms use different line-separator characters. On UNIX/Linux/Mac OS X, the line separator is a newline (`\n`). On Windows, it’s a combination of a carriage return and a line feed—represented as `\r\n`. You can use the `%n` format specifier in a format control string to output a platform-specific line separator, thus ensuring that the text file can be opened and viewed correctly in a text editor for the platform on which the file was created. The method `System.out.println` outputs a platform-specific line separator after its argument. Also, regardless of the line separator used in a text file, a Java program can still recognize the lines of text and read them.

### *Class `CreateTextFileTest`*

Figure 17.7 runs the program. Line 8 creates a `CreateTextFile` object, which is then used to open, add records to and close the file (lines 10–12). The sample data for this application is shown in Fig. 17.8. In the sample execution for this program, the user enters information for five accounts, then enters end-of-file to signal that data entry is complete. The sample execution does not show how the data records actually appear in the file. In the next section, to verify that the file has been created successfully, we present a program that reads the file and prints its contents. Because this is a text file, you can also verify the information simply by opening the file in a text editor.

---

```

1 // Fig. 17.7: CreateTextFileTest.java
2 // Testing the CreateTextFile class.
3
4 public class CreateTextFileTest
5 {
```

---

**Fig. 17.7** | Testing the `CreateTextFile` class. (Part 1 of 2.)

```

6 public static void main(String[] args)
7 {
8 CreateTextFile application = new CreateTextFile();
9
10 application.openFile();
11 application.addRecords();
12 application.closeFile();
13 } // end main
14 } // end class CreateTextFileTest

```

To terminate input, type the end-of-file indicator when you are prompted to enter input.  
 On UNIX/Linux/Mac OS X type <ctrl> d then press Enter  
 On Windows type <ctrl> z then press Enter

```

Enter account number (> 0), first name, last name and balance.
? 100 Bob Jones 24.98
Enter account number (> 0), first name, last name and balance.
? 200 Steve Doe -345.67
Enter account number (> 0), first name, last name and balance.
? 300 Pam White 0.00
Enter account number (> 0), first name, last name and balance.
? 400 Sam Stone -42.16
Enter account number (> 0), first name, last name and balance.
? 500 Sue Rich 224.62
Enter account number (> 0), first name, last name and balance.
? ^Z

```

**Fig. 17.7** | Testing the CreateTextFile class. (Part 2 of 2.)

| Sample data |       |       |         |
|-------------|-------|-------|---------|
| 100         | Bob   | Jones | 24.98   |
| 200         | Steve | Doe   | -345.67 |
| 300         | Pam   | White | 0.00    |
| 400         | Sam   | Stone | -42.16  |
| 500         | Sue   | Rich  | 224.62  |

**Fig. 17.8** | Sample data for the program in Figs. 17.5–17.7.

## 17.4.2 Reading Data from a Sequential-Access Text File

Data is stored in files so that it may be retrieved for processing when needed. Section 17.4.1 demonstrated how to create a file for sequential access. This section shows how to read data sequentially from a text file. We demonstrate how class Scanner can be used to input data from a file rather than the keyboard.

The application in Figs. 17.9 and 17.10 reads records from the file "clients.txt" created by the application of Section 17.4.1 and displays the record contents. Line 13 of Fig. 17.9 declares a Scanner that will be used to retrieve input from the file.

```
1 // Fig. 17.9: ReadTextFile.java
2 // This program reads a text file and displays each record.
3 import java.io.File;
4 import java.io.FileNotFoundException;
5 import java.lang.IllegalStateException;
6 import java.util.NoSuchElementException;
7 import java.util.Scanner;
8
9 import com.deitel.ch17.AccountRecord;
10
11 public class ReadTextFile
12 {
13 private Scanner input;
14
15 // enable user to open file
16 public void openFile()
17 {
18 try
19 {
20 input = new Scanner(new File("clients.txt"));
21 } // end try
22 catch (FileNotFoundException fileNotFoundException)
23 {
24 System.err.println("Error opening file.");
25 System.exit(1);
26 } // end catch
27 } // end method openFile
28
29 // read record from file
30 public void readRecords()
31 {
32 // object to be written to screen
33 AccountRecord record = new AccountRecord();
34
35 System.out.printf("%-10s%-12s%-12s%10s\n", "Account",
36 "First Name", "Last Name", "Balance");
37
38 try // read records from file using Scanner object
39 {
40 while (input.hasNext())
41 {
42 record.setAccount(input.nextInt()); // read account number
43 record.setFirstName(input.next()); // read first name
44 record.setLastName(input.next()); // read last name
45 record.setBalance(input.nextDouble()); // read balance
46
47 // display record contents
48 System.out.printf("%-10d%-12s%-12s%10.2f\n",
49 record.getAccount(), record.getFirstName(),
50 record.getLastName(), record.getBalance());
51 } // end while
52 } // end try
```

**Fig. 17.9** | Sequential file reading using a Scanner. (Part I of 2.)

```

53 catch (NoSuchElementException elementException)
54 {
55 System.err.println("File improperly formed.");
56 input.close();
57 System.exit(1);
58 } // end catch
59 catch (IllegalStateException stateException)
60 {
61 System.err.println("Error reading from file.");
62 System.exit(1);
63 } // end catch
64 } // end method readRecords
65
66 // close file and terminate application
67 public void closeFile()
68 {
69 if (input != null)
70 input.close(); // close file
71 } // end method closeFile
72 } // end class ReadTextFile

```

**Fig. 17.9** | Sequential file reading using a Scanner. (Part 2 of 2.)

```

1 // Fig. 17.10: ReadTextFileTest.java
2 // Testing the ReadTextFile class.
3
4 public class ReadTextFileTest
5 {
6 public static void main(String[] args)
7 {
8 ReadTextFile application = new ReadTextFile();
9
10 application.openFile();
11 application.readRecords();
12 application.closeFile();
13 } // end main
14 } // end class ReadTextFileTest

```

| Account | First Name | Last Name | Balance |
|---------|------------|-----------|---------|
| 100     | Bob        | Jones     | 24.98   |
| 200     | Steve      | Doe       | -345.67 |
| 300     | Pam        | White     | 0.00    |
| 400     | Sam        | Stone     | -42.16  |
| 500     | Sue        | Rich      | 224.62  |

**Fig. 17.10** | Testing the ReadTextFile class.

Method `openFile` (lines 16–27) opens the file for reading by instantiating a `Scanner` object in line 20. We pass a `File` object to the constructor, which specifies that the `Scanner` object will read from the file "clients.txt" located in the directory from which the application executes. If the file cannot be found, a `FileNotFoundException` occurs. The exception is handled in lines 22–26.

Method `readRecords` (lines 30–64) reads and displays records from the file. Line 33 creates `AccountRecord` object `record` to store the current record's information. Lines 35–36 display headers for the columns in the application's output. Lines 40–51 read data from the file until the end-of-file marker is reached (in which case, method `hasNext` will return `false` at line 40). Lines 42–45 use `Scanner` methods `nextInt`, `next` and `nextDouble` to input an `int` (the account number), two `Strings` (the first and last names) and a `double` value (the balance). Each record is one line of data in the file. The values are stored in object `record`. If the information in the file is not properly formed (e.g., there's a last name where there should be a balance), a `NoSuchElementException` occurs when the record is input. This exception is handled in lines 53–58. If the `Scanner` was closed before the data was input, an `IllegalStateException` occurs (handled in lines 59–63). If no exceptions occur, the record's information is displayed on the screen (lines 48–50). Note in the format string in line 48 that the account number, first name and last name are left justified, while the balance is right justified and output with two digits of precision. Each iteration of the loop inputs one line of text from the text file, which represents one record.

Lines 67–71 define method `closeFile`, which closes the `Scanner`. Method `main` is defined in Fig. 17.10 in lines 6–13. Line 8 creates a `ReadTextFile` object, which is then used to open, add records to and close the file (lines 10–12).

### 17.4.3 Case Study: A Credit-Inquiry Program

To retrieve data sequentially from a file, programs start from the beginning of the file and read all the data consecutively until the desired information is found. It might be necessary to process the file sequentially several times (from the beginning of the file) during the execution of a program. Class `Scanner` does *not* allow repositioning to the beginning of the file. If it's necessary to read the file again, the program must close the file and reopen it.

The program in Figs. 17.11–17.13 allows a credit manager to obtain lists of customers with zero balances (i.e., customers who do not owe any money), customers with credit balances (i.e., customers to whom the company owes money) and customers with debit balances (i.e., customers who owe the company money for goods and services received). A credit balance is a negative amount, a debit balance a positive amount.

#### *MenuOption Enumeration*

We begin by creating an enum type (Fig. 17.11) to define the different menu options the user will have. The options and their values are listed in lines 7–10. Method `getValue` (lines 19–22) retrieves the value of a specific enum constant.

---

```

1 // Fig. 17.11: MenuOption.java
2 // Enumeration for the credit-inquiry program's options.
3
4 public enum MenuOption
5 {
6 // declare contents of enum type
7 ZERO_BALANCE(1),
8 CREDIT_BALANCE(2),
9 DEBIT_BALANCE(3),
10 END(4);

```

---

**Fig. 17.11** | Enumeration for the credit-inquiry program's menu options. (Part 1 of 2.)

```

11
12 private final int value; // current menu option
13
14 // constructor
15 MenuOption(int valueOption)
16 {
17 value = valueOption;
18 } // end MenuOptions enum constructor
19
20 // return the value of a constant
21 public int getValue()
22 {
23 return value;
24 } // end method getValue
25 } // end enum MenuOption

```

**Fig. 17.11** | Enumeration for the credit-inquiry program's menu options. (Part 2 of 2.)

### *CreditInquiry Class*

Figure 17.12 contains the functionality for the credit-inquiry program, and Fig. 17.13 contains the main method that executes the program. The program displays a text menu and allows the credit manager to enter one of three options to obtain credit information. Option 1 (ZERO\_BALANCE) displays accounts with zero balances. Option 2 (CREDIT\_BALANCE) displays accounts with credit balances. Option 3 (DEBIT\_BALANCE) displays accounts with debit balances. Option 4 (END) terminates program execution.

```

1 // Fig. 17.12: CreditInquiry.java
2 // This program reads a file sequentially and displays the
3 // contents based on the type of account the user requests
4 // (credit balance, debit balance or zero balance).
5 import java.io.File;
6 import java.io.FileNotFoundException;
7 import java.lang.IllegalStateException;
8 import java.util.NoSuchElementException;
9 import java.util.Scanner;
10
11 import com.deitel.ch17.AccountRecord;
12
13 public class CreditInquiry
14 {
15 private MenuOption accountType;
16 private Scanner input;
17 private final static MenuOption[] choices = { MenuOption.ZERO_BALANCE,
18 MenuOption.CREDIT_BALANCE, MenuOption.DEBIT_BALANCE,
19 MenuOption.END };
20
21 // read records from file and display only records of appropriate type
22 private void readRecords()
23 {
24 // object to store data that will be written to file
25 AccountRecord record = new AccountRecord();

```

**Fig. 17.12** | Credit-inquiry program. (Part 1 of 4.)

```

26
27 try // read records
28 {
29 // open file to read from beginning
30 input = new Scanner(new File("clients.txt"));
31
32 while (input.hasNext()) // input the values from the file
33 {
34 record.setAccount(input.nextInt()); // read account number
35 record.setFirstName(input.next()); // read first name
36 record.setLastName(input.next()); // read last name
37 record.setBalance(input.nextDouble()); // read balance
38
39 // if proper account type, display record
40 if (shouldDisplay(record.getBalance()))
41 System.out.printf("%-10d%-12s%-12s%10.2f\n",
42 record.getAccount(), record.getFirstName(),
43 record.getLastName(), record.getBalance());
44 } // end while
45 } // end try
46 catch (NoSuchElementException elementException)
47 {
48 System.err.println("File improperly formed.");
49 input.close();
50 System.exit(1);
51 } // end catch
52 catch (IllegalStateException stateException)
53 {
54 System.err.println("Error reading from file.");
55 System.exit(1);
56 } // end catch
57 catch (FileNotFoundException fileNotFoundException)
58 {
59 System.err.println("File cannot be found.");
60 System.exit(1);
61 } // end catch
62 finally
63 {
64 if (input != null)
65 input.close(); // close the Scanner and the file
66 } // end finally
67 } // end method readRecords
68
69 // use record type to determine if record should be displayed
70 private boolean shouldDisplay(double balance)
71 {
72 if ((accountType == MenuOption.CREDIT_BALANCE)
73 && (balance < 0))
74 return true;
75
76 else if ((accountType == MenuOption.DEBIT_BALANCE)
77 && (balance > 0))
78 return true;

```

**Fig. 17.12** | Credit-inquiry program. (Part 2 of 4.)



```

79
80 else if ((accountType == MenuOption.ZERO_BALANCE)
81 && (balance == 0))
82 return true;
83
84 return false;
85 } // end method shouldDisplay
86
87 // obtain request from user
88 private MenuOption getRequest()
89 {
90 Scanner textIn = new Scanner(System.in);
91 int request = 1;
92
93 // display request options
94 System.out.printf("\n%s\n%s\n%s\n%s\n%s\n",
95 "Enter request", " 1 - List accounts with zero balances",
96 " 2 - List accounts with credit balances",
97 " 3 - List accounts with debit balances", " 4 - End of run");
98
99 try // attempt to input menu choice
100 {
101 do // input user request
102 {
103 System.out.print("\n? ");
104 request = textIn.nextInt();
105 } while ((request < 1) || (request > 4));
106 } // end try
107 catch (NoSuchElementException elementException)
108 {
109 System.err.println("Invalid input.");
110 System.exit(1);
111 } // end catch
112
113 return choices[request - 1]; // return enum value for option
114 } // end method getRequest
115
116 public void processRequests()
117 {
118 // get user's request (e.g., zero, credit or debit balance)
119 accountType = getRequest();
120
121 while (accountType != MenuOption.END)
122 {
123 switch (accountType)
124 {
125 case ZERO_BALANCE:
126 System.out.println("\nAccounts with zero balances:\n");
127 break;
128 case CREDIT_BALANCE:
129 System.out.println("\nAccounts with credit balances:\n");
130 break;

```

**Fig. 17.12** | Credit-inquiry program. (Part 3 of 4.)

```

131 case DEBIT_BALANCE:
132 System.out.println("\nAccounts with debit balances:\n");
133 break;
134 } // end switch
135
136 readRecords();
137 accountType = getRequest();
138 } // end while
139 } // end method processRequests
140 } // end class CreditInquiry

```

**Fig. 17.12** | Credit-inquiry program. (Part 4 of 4.)

```

1 // Fig. 17.13: CreditInquiryTest.java
2 // This program tests class CreditInquiry.
3
4 public class CreditInquiryTest
5 {
6 public static void main(String[] args)
7 {
8 CreditInquiry application = new CreditInquiry();
9 application.processRequests();
10 } // end main
11 } // end class CreditInquiryTest

```

**Fig. 17.13** | Testing the CreditInquiry class.

```

Enter request
1 - List accounts with zero balances
2 - List accounts with credit balances
3 - List accounts with debit balances
4 - End of run

? 1

Accounts with zero balances:
300 Pam White 0.00

Enter request
1 - List accounts with zero balances
2 - List accounts with credit balances
3 - List accounts with debit balances
4 - End of run

? 2

Accounts with credit balances:
200 Steve Doe -345.67
400 Sam Stone -42.16

```

**Fig. 17.14** | Sample output of the credit-inquiry program in Fig. 17.13. (Part 1 of 2.)

```

Enter request
1 - List accounts with zero balances
2 - List accounts with credit balances
3 - List accounts with debit balances
4 - End of run

? 3

Accounts with debit balances:
100 Bob Jones 24.98
500 Sue Rich 224.62

? 4

```

**Fig. 17.14** | Sample output of the credit-inquiry program in Fig. 17.13. (Part 2 of 2.)

The record information is collected by reading through the file and determining if each record satisfies the criteria for the selected account type. Method `processRequests` (lines 116–139 of Fig. 17.12) calls method `getRequest` to display the menu options (line 119), translates the number typed by the user into a `MenuOption` and stores the result in `MenuOption` variable `accountType`. Lines 121–138 loop until the user specifies that the program should terminate. Lines 123–134 display a header for the current set of records to be output to the screen. Line 136 calls method `readRecords` (lines 22–67), which loops through the file and reads every record.

Line 30 of method `readRecords` opens the file for reading with a `Scanner`. The file will be opened for reading with a new `Scanner` object each time this method is called, so that we can again read from the beginning of the file. Lines 34–37 read a record. Line 40 calls method `shouldDisplay` (lines 70–85) to determine whether the current record satisfies the account type requested. If `shouldDisplay` returns `true`, the program displays the account information. When the end-of-file marker is reached, the loop terminates and line 65 calls the `Scanner`'s `close` method to close the `Scanner` and the file. Notice that this occurs in a `finally` block, which will execute whether or not the file was successfully read. Once all the records have been read, control returns to method `processRequests` and `getRequest` is again called (line 137) to retrieve the user's next menu option. Figure 17.13 contains method `main`, and calls method `processRequests` in line 9.

#### 17.4.4 Updating Sequential-Access Files

The data in many sequential files cannot be modified without the risk of destroying other data in the file. For example, if the name “white” needs to be changed to “Worthington,” the old name cannot simply be overwritten, because the new name requires more space. The record for `White` was written to the file as

```
300 Pam White 0.00
```

If the record is rewritten beginning at the same location in the file using the new name, the record will be

```
300 Pam Worthington 0.00
```

The new record is larger (has more characters) than the original record. The characters beyond the second “o” in “Worthington” will overwrite the beginning of the next sequential

record in the file. The problem here is that fields in a text file—and hence records—can vary in size. For example, 7, 14, -117, 2074 and 27383 are all `ints` stored in the same number of bytes (4) internally, but they're different-sized fields when displayed on the screen or written to a file as text. Therefore, records in a sequential-access file are not usually updated in place. Instead, the entire file is usually rewritten. To make the preceding name change, the records before `300 Pam White 0.00` would be copied to a new file, the new record (which can be of a different size than the one it replaces) would be written and the records after `300 Pam White 0.00` would be copied to the new file. Rewriting the entire file is uneconomical to update just one record, but reasonable if a substantial number of records need to be updated.

## 17.5 Object Serialization

In Section 17.4, we demonstrated how to write the individual fields of an `AccountRecord` object into a file as text, and how to read those fields from a file and place their values into an `AccountRecord` object in memory. In the examples, `AccountRecord` was used to aggregate the information for one record. When the instance variables for an `AccountRecord` were output to a disk file, certain information was lost, such as the type of each value. For instance, if the value "3" is read from a file, there's no way to tell whether it came from an `int`, a `String` or a `double`. We have only data, not type information, on a disk. If the program that's going to read this data "knows" what object type the data corresponds to, then the data is simply read into objects of that type. For example, in Section 17.4.2, we know that we're inputting an `int` (the account number), followed by two `Strings` (the first and last name) and a `double` (the balance). We also know that these values are separated by spaces, with only one record on each line. Sometimes we'll not know exactly how the data is stored in a file. In such cases, we want to read or write an entire object from a file. Java provides such a mechanism, called **object serialization**. A so-called **serialized object** is an object represented as a sequence of bytes that includes the object's data as well as information about the object's type and the types of data stored in the object. After a serialized object has been written into a file, it can be read from the file and **deserialized**—that is, the type information and bytes that represent the object and its data can be used to recreate the object in memory.



### Software Engineering Observation 17.1

*The serialization mechanism makes exact copies of objects. This makes it a simple way to clone objects without having to override `Object` method `clone`.*

### Classes `ObjectInputStream` and `ObjectOutputStream`

Classes `ObjectInputStream` and `ObjectOutputStream`, which respectively implement the **ObjectInput** and **ObjectOutput** interfaces, enable entire objects to be read from or written to a stream (possibly a file). To use serialization with files, we initialize `ObjectInputStream` and `ObjectOutputStream` objects with stream objects that read from and write to files—objects of classes `FileInputStream` and `FileOutputStream`, respectively. Initializing stream objects with other stream objects in this manner is sometimes called **wrapping**—the new stream object being created wraps the stream object specified as a constructor argument. To wrap a `FileInputStream` in an `ObjectInputStream`, for instance, we pass the `FileInputStream` object to the `ObjectInputStream`'s constructor.

### Interfaces *ObjectOutput* and *ObjectInput*

The *ObjectOutput* interface contains method `writeObject`, which takes an *Object* as an argument and writes its information to an *OutputStream*. A class that implements interface *ObjectOutput* (such as *ObjectOutputStream*) declares this method and ensures that the object being output implements interface *Serializable* (discussed shortly). Correspondingly, the *ObjectInput* interface contains method `readObject`, which reads and returns a reference to an *Object* from an *InputStream*. After an object has been read, its reference can be cast to the object's actual type. As you'll see in Chapter 27, applications that communicate via a network, such as the Internet, can also transmit entire objects across the network.

## 17.5.1 Creating a Sequential-Access File Using Object Serialization

This section and Section 17.5.2 create and manipulate sequential-access files using object serialization. The object serialization we show here is performed with byte-based streams, so the sequential files created and manipulated will be binary files. Recall that binary files typically cannot be viewed in standard text editors. For this reason, we write a separate application that knows how to read and display serialized objects. We begin by creating and writing serialized objects to a sequential-access file. The example is similar to the one in Section 17.4, so we focus only on the new features.

### Defining Class *AccountRecordSerializable*

Let's begin by modifying our *AccountRecord* class so that objects of this class can be serialized. Class *AccountRecordSerializable* (Fig. 17.15) implements interface ***Serializable*** (line 7), which allows objects of *AccountRecordSerializable* to be serialized and deserialized with *ObjectOutputStreams* and *ObjectInputStreams*, respectively. Interface *Serializable* is a **tagging interface**. Such an interface does not contain methods. A class that implements *Serializable* is tagged as being a *Serializable* object. This is important, because an *ObjectOutputStream* will *not* output an object unless it *is a* *Serializable* object, which is the case for any object of a class that implements *Serializable*.

---

```

1 // Fig. 17.15: AccountRecordSerializable.java
2 // AccountRecordSerializable class for serializable objects.
3 package com.deitel.ch17; // packaged for reuse
4
5 import java.io.Serializable;
6
7 public class AccountRecordSerializable implements Serializable
8 {
9 private int account;
10 private String firstName;
11 private String lastName;
12 private double balance;
13
14 // no-argument constructor calls other constructor with default values
15 public AccountRecordSerializable()
16 {
17 this(0, "", "", 0.0);
18 } // end no-argument AccountRecordSerializable constructor

```

---

**Fig. 17.15** | *AccountRecordSerializable* class for serializable objects. (Part 1 of 3.)

```
19
20 // four-argument constructor initializes a record
21 public AccountRecordSerializable(
22 int acct, String first, String last, double bal)
23 {
24 setAccount(acct);
25 setFirstName(first);
26 setLastName(last);
27 setBalance(bal);
28 } // end four-argument AccountRecordSerializable constructor
29
30 // set account number
31 public void setAccount(int acct)
32 {
33 account = acct;
34 } // end method setAccount
35
36 // get account number
37 public int getAccount()
38 {
39 return account;
40 } // end method getAccount
41
42 // set first name
43 public void setFirstName(String first)
44 {
45 firstName = first;
46 } // end method setFirstName
47
48 // get first name
49 public String getFirstName()
50 {
51 return firstName;
52 } // end method getFirstName
53
54 // set last name
55 public void setLastName(String last)
56 {
57 lastName = last;
58 } // end method setLastName
59
60 // get last name
61 public String getLastName()
62 {
63 return lastName;
64 } // end method getLastName
65
66 // set balance
67 public void setBalance(double bal)
68 {
69 balance = bal;
70 } // end method setBalance
71
```

**Fig. 17.15** | AccountRecordSerializable class for serializable objects. (Part 2 of 3.)

```

72 // get balance
73 public double getBalance()
74 {
75 return balance;
76 } // end method getBalance
77 } // end class AccountRecordSerializable

```

**Fig. 17.15** | AccountRecordSerializable class for serializable objects. (Part 3 of 3.)

In a Serializable class, every instance variable must be Serializable. Non-Serializable instance variables must be declared **transient** to indicate that they should be ignored during the serialization process. *By default, all primitive-type variables are serializable.* For reference-type variables, you must check the class's documentation (and possibly its superclasses) to ensure that the type is Serializable. For example, Strings are Serializable. By default, arrays are serializable; however, in a reference-type array, the referenced objects might not be. Class AccountRecordSerializable contains private data members account, firstName, lastName and balance—all of which are Serializable. This class also provides public *get* and *set* methods for accessing the private fields.

### Writing Serialized Objects to a Sequential-Access File

Now let's discuss the code that creates the sequential-access file (Figs. 17.16–17.17). We concentrate only on new concepts here. As stated in Section 17.2, a program can open a file by creating an object of stream class FileInputStream or FileOutputStream. In this example, the file is to be opened for output, so the program creates a FileOutputStream (line 21 of Fig. 17.16). The String argument that's passed to the FileOutputStream's constructor represents the name and path of the file to be opened. Existing files that are opened for output in this manner are truncated. We chose the .ser file extension for binary files that contain serialized objects, but this is not required.



### Common Programming Error 17.2

*It's a logic error to open an existing file for output when, in fact, you wish to preserve the file. Class FileOutputStream provides an overloaded constructor that enables you to open a file and append data to the end of the file. This will preserve the file's contents.*

```

1 // Fig. 17.16: CreateSequentialFile.java
2 // Writing objects sequentially to a file with class ObjectOutputStream.
3 import java.io.FileOutputStream;
4 import java.io.IOException;
5 import java.io.ObjectOutputStream;
6 import java.util.NoSuchElementException;
7 import java.util.Scanner;
8
9 import com.deitel.ch17.AccountRecordSerializable;
10
11 public class CreateSequentialFile
12 {
13 private ObjectOutputStream output; // outputs data to file

```

**Fig. 17.16** | Sequential file created using ObjectOutputStream. (Part 1 of 3.)

```
14
15 // allow user to specify file name
16 public void openFile()
17 {
18 try // open file
19 {
20 output = new ObjectOutputStream(
21 new FileOutputStream("clients.ser"));
22 } // end try
23 catch (IOException ioException)
24 {
25 System.err.println("Error opening file.");
26 } // end catch
27 } // end method openFile
28
29 // add records to file
30 public void addRecords()
31 {
32 AccountRecordSerializable record; // object to be written to file
33 int accountNumber = 0; // account number for record object
34 String firstName; // first name for record object
35 String lastName; // last name for record object
36 double balance; // balance for record object
37
38 Scanner input = new Scanner(System.in);
39
40 System.out.printf("%s\n%s\n%s\n%s\n\n",
41 "To terminate input, type the end-of-file indicator ",
42 "when you are prompted to enter input.",
43 "On UNIX/Linux/Mac OS X type <ctrl> d then press Enter",
44 "On Windows type <ctrl> z then press Enter");
45
46 System.out.printf("%s\n%s",
47 "Enter account number (> 0), first name, last name and balance.",
48 "? ");
49
50 while (input.hasNext()) // loop until end-of-file indicator
51 {
52 try // output values to file
53 {
54 accountNumber = input.nextInt(); // read account number
55 firstName = input.next(); // read first name
56 lastName = input.next(); // read last name
57 balance = input.nextDouble(); // read balance
58
59 if (accountNumber > 0)
60 {
61 // create new record
62 record = new AccountRecordSerializable(accountNumber,
63 firstName, lastName, balance);
64 output.writeObject(record); // output record
65 } // end if

```

**Fig. 17.16** | Sequential file created using ObjectOutputStream. (Part 2 of 3.)



```

66 else
67 {
68 System.out.println(
69 "Account number must be greater than 0.");
70 } // end else
71 } // end try
72 catch (IOException ioException)
73 {
74 System.err.println("Error writing to file.");
75 return;
76 } // end catch
77 catch (NoSuchElementException elementException)
78 {
79 System.err.println("Invalid input. Please try again.");
80 input.nextLine(); // discard input so user can try again
81 } // end catch
82
83 System.out.printf("%s %s\n%s", "Enter account number (>0)",
84 "first name, last name and balance.", "? ");
85 } // end while
86 } // end method addRecords
87
88 // close file and terminate application
89 public void closeFile()
90 {
91 try // close file
92 {
93 if (output != null)
94 output.close();
95 } // end try
96 catch (IOException ioException)
97 {
98 System.err.println("Error closing file.");
99 System.exit(1);
100 } // end catch
101 } // end method closeFile
102 } // end class CreateSequentialFile

```

**Fig. 17.16** | Sequential file created using ObjectOutputStream. (Part 3 of 3.)

```

1 // Fig. 17.17: CreateSequentialFileTest.java
2 // Testing class CreateSequentialFile.
3
4 public class CreateSequentialFileTest
5 {
6 public static void main(String[] args)
7 {
8 CreateSequentialFile application = new CreateSequentialFile();
9
10 application.openFile();
11 application.addRecords();

```

**Fig. 17.17** | Testing class CreateSequentialFile. (Part 1 of 2.)

```

12 application.closeFile();
13 } // end main
14 } // end class CreateSequentialFileTest

```

To terminate input, type the end-of-file indicator when you are prompted to enter input.  
 On UNIX/Linux/Mac OS X type <ctrl> d then press Enter  
 On Windows type <ctrl> z then press Enter

```

Enter account number (> 0), first name, last name and balance.
? 100 Bob Jones 24.98
Enter account number (> 0), first name, last name and balance.
? 200 Steve Doe -345.67
Enter account number (> 0), first name, last name and balance.
? 300 Pam White 0.00
Enter account number (> 0), first name, last name and balance.
? 400 Sam Stone -42.16
Enter account number (> 0), first name, last name and balance.
? 500 Sue Rich 224.62
Enter account number (> 0), first name, last name and balance.
? ^Z

```

**Fig. 17.17** | Testing class `CreateSequentialFile`. (Part 2 of 2.)

Class `FileOutputStream` provides methods for writing byte arrays and individual bytes to a file, but we wish to write objects to a file. For this reason, we wrap a `FileOutputStream` in an `ObjectOutputStream` by passing the new `FileOutputStream` object to the `ObjectOutputStream`'s constructor (lines 20–21). The `ObjectOutputStream` object uses the `FileOutputStream` object to write objects into the file. Lines 20–21 may throw an **`IOException`** if a problem occurs while opening the file (e.g., when a file is opened for writing on a drive with insufficient space or when a read-only file is opened for writing). If so, the program displays an error message (lines 23–26). If no exception occurs, the file is open, and variable output can be used to write objects to it.

This program assumes that data is input correctly and in the proper record-number order. Method `addRecords` (lines 30–86) performs the write operation. Lines 62–63 create an `AccountRecordSerializable` object from the data entered by the user. Line 64 calls `ObjectOutputStream` method `writeObject` to write the record object to the output file. Only one statement is required to write the entire object.

Method `closeFile` (lines 89–101) calls `ObjectOutputStream` method **`close`** on output to close both the `ObjectOutputStream` and its underlying `FileOutputStream` (line 94). The call to method `close` is contained in a try block. Method `close` throws an `IOException` if the file cannot be closed properly. In this case, it's important to notify the user that the information in the file might be corrupted. When using wrapped streams, closing the outermost stream also closes the underlying file.

In the sample execution for the program in Fig. 17.17, we entered information for five accounts—the same information shown in Fig. 17.8. The program does not show how the data records actually appear in the file. Remember that now we're using binary files, which are not humanly readable. To verify that the file has been created successfully, the next section presents a program to read the file's contents.

## 17.5.2 Reading and Deserializing Data from a Sequential-Access File

The preceding section showed how to create a file for sequential access using object serialization. In this section, we discuss how to read serialized data sequentially from a file.

The program in Figs. 17.18–17.19 reads records from a file created by the program in Section 17.5.1 and displays the contents. The program opens the file for input by creating a `FileInputStream` object (line 21). The name of the file to open is specified as an argument to the `FileInputStream` constructor. In Fig. 17.16, we wrote objects to the file, using an `ObjectOutputStream` object. Data must be read from the file in the same format in which it was written. Therefore, we use an `ObjectInputStream` wrapped around a `FileInputStream` in this program (lines 20–21). If no exceptions occur when opening the file, variable `input` can be used to read objects from the file.

---

```

1 // Fig. 17.18: ReadSequentialFile.java
2 // Reading a file of objects sequentially with ObjectInputStream
3 // and displaying each record.
4 import java.io.EOFException;
5 import java.io.FileInputStream;
6 import java.io.IOException;
7 import java.io.ObjectInputStream;
8
9 import com.deitel.ch17.AccountRecordSerializable;
10
11 public class ReadSequentialFile
12 {
13 private ObjectInputStream input;
14
15 // enable user to select file to open
16 public void openFile()
17 {
18 try // open file
19 {
20 input = new ObjectInputStream(
21 new FileInputStream("clients.ser"));
22 } // end try
23 catch (IOException ioException)
24 {
25 System.err.println("Error opening file.");
26 } // end catch
27 } // end method openFile
28
29 // read record from file
30 public void readRecords()
31 {
32 AccountRecordSerializable record;
33 System.out.printf("%-10s%-12s%-12s%10s\n", "Account",
34 "First Name", "Last Name", "Balance");
35
36 try // input the values from the file
37 {

```

---

**Fig. 17.18** | Reading a file of objects sequentially with `ObjectInputStream` and displaying each record. (Part 1 of 2.)

```

38 while (true)
39 {
40 record = (AccountRecordSerializable) input.readObject();
41
42 // display record contents
43 System.out.printf("%-10d%-12s%-12s%10.2f\n",
44 record.getAccount(), record.getFirstName(),
45 record.getLastName(), record.getBalance());
46 } // end while
47 } // end try
48 catch (EOFException eofException)
49 {
50 return; // end of file was reached
51 } // end catch
52 catch (ClassNotFoundException classNotFoundException)
53 {
54 System.err.println("Unable to create object.");
55 } // end catch
56 catch (IOException ioException)
57 {
58 System.err.println("Error during read from file.");
59 } // end catch
60 } // end method readRecords
61
62 // close file and terminate application
63 public void closeFile()
64 {
65 try // close file and exit
66 {
67 if (input != null)
68 input.close();
69 } // end try
70 catch (IOException ioException)
71 {
72 System.err.println("Error closing file.");
73 System.exit(1);
74 } // end catch
75 } // end method closeFile
76 } // end class ReadSequentialFile

```

**Fig. 17.18** | Reading a file of objects sequentially with `ObjectInputStream` and displaying each record. (Part 2 of 2.)

The program reads records from the file in method `readRecords` (lines 30–60). Line 40 calls `ObjectInputStream` method `readObject` to read an `Object` from the file. To use `AccountRecordSerializable`-specific methods, we downcast the returned `Object` to type `AccountRecordSerializable`. Method `readObject` throws an **`EOFException`** (processed at lines 48–51) if an attempt is made to read beyond the end of the file. Method `readObject` throws a **`ClassNotFoundException`** if the class for the object being read cannot be located. This may occur if the file is accessed on a computer that does not have the class. Figure 17.19 contains method `main` (lines 6–13), which opens the file, calls method `readRecords` and closes the file.

```

1 // Fig. 17.19: ReadSequentialFileTest.java
2 // Testing class ReadSequentialFile.
3
4 public class ReadSequentialFileTest
5 {
6 public static void main(String[] args)
7 {
8 ReadSequentialFile application = new ReadSequentialFile();
9
10 application.openFile();
11 application.readRecords();
12 application.closeFile();
13 } // end main
14 } // end class ReadSequentialFileTest

```

| Account | First Name | Last Name | Balance |
|---------|------------|-----------|---------|
| 100     | Bob        | Jones     | 24.98   |
| 200     | Steve      | Doe       | -345.67 |
| 300     | Pam        | White     | 0.00    |
| 400     | Sam        | Stone     | -42.16  |
| 500     | Sue        | Rich      | 224.62  |

**Fig. 17.19** | Testing class `ReadSequentialFile`.

## 17.6 Additional java.io Classes

This section overviews additional interfaces and classes (from package `java.io`) for byte-based input and output streams and character-based input and output streams.

### 17.6.1 Interfaces and Classes for Byte-Based Input and Output

**InputStream** and **OutputStream** are abstract classes that declare methods for performing byte-based input and output, respectively. We used various concrete subclasses `FileInputStream` `InputStream` and `OutputStream` to manipulate files in this chapter.

#### *Pipe Streams*

**Pipes** are synchronized communication channels between threads. We discuss threads in Chapter 26. Java provides **PipedOutputStream** (a subclass of `OutputStream`) and **PipedInputStream** (a subclass of `InputStream`) to establish pipes between two threads in a program. One thread sends data to another by writing to a `PipedOutputStream`. The target thread reads information from the pipe via a `PipedInputStream`.

#### *Filter Streams*

A **FilterInputStream** filters an `InputStream`, and a `FilterOutputStream` filters an `OutputStream`. **Filtering** means simply that the filter stream provides additional functionality, such as aggregating data bytes into meaningful primitive-type units. `FilterInputStream` and `FilterOutputStream` are typically extended, so some of their filtering capabilities are provided by their subclasses.

A **PrintStream** (a subclass of `FilterOutputStream`) performs text output to the specified stream. Actually, we've been using `PrintStream` output throughout the text to this point—`System.out` and `System.err` are `PrintStream` objects.

### Data Streams

Reading data as raw bytes is fast, but crude. Usually, programs read data as aggregates of bytes that form ints, floats, doubles and so on. Java programs can use several classes to input and output data in aggregate form.

Interface `DataInput` describes methods for reading primitive types from an input stream. Classes `DataInputStream` and `RandomAccessFile` each implement this interface to read sets of bytes and view them as primitive-type values. Interface `DataInput` includes methods such as `readBoolean`, `readByte`, `readChar`, `readDouble`, `readFloat`, `readFully` (for byte arrays), `readInt`, `readLong`, `readShort`, `readUnsignedByte`, `readUnsignedShort`, `readUTF` (for reading Unicode characters encoded by Java—we discuss UTF encoding in Appendix L) and `skipBytes`.

Interface `DataOutput` describes a set of methods for writing primitive types to an output stream. Classes `DataOutputStream` (a subclass of `FilterOutputStream`) and `RandomAccessFile` each implement this interface to write primitive-type values as bytes. Interface `DataOutput` includes overloaded versions of method `write` (for a byte or for a byte array) and methods `writeBoolean`, `writeByte`, `writeBytes`, `writeChar`, `writeChars` (for Unicode Strings), `writeDouble`, `writeFloat`, `writeInt`, `writeLong`, `writeShort` and `writeUTF` (to output text modified for Unicode).

### Buffered Streams

**Buffering** is an I/O-performance-enhancement technique. With a **BufferedOutputStream** (a subclass of class `FilterOutputStream`), each output statement does *not* necessarily result in an actual physical transfer of data to the output device (which is a slow operation compared to processor and main memory speeds). Rather, each output operation is directed to a region in memory called a **buffer** that's large enough to hold the data of many output operations. Then, actual transfer to the output device is performed in one large **physical output operation** each time the buffer fills. The output operations directed to the output buffer in memory are often called **logical output operations**. With a `BufferedOutputStream`, a partially filled buffer can be forced out to the device at any time by invoking the stream object's **flush** method.

Using buffering can greatly increase the performance of an application. Typical I/O operations are extremely slow compared with the speed of accessing data in computer memory. Buffering reduces the number of I/O operations by first combining smaller outputs together in memory. The number of actual physical I/O operations is small compared with the number of I/O requests issued by the program. Thus, the program that's using buffering is more efficient.



#### Performance Tip 17.1

*Buffered I/O can yield significant performance improvements over unbuffered I/O.*

With a **BufferedInputStream** (a subclass of class `FilterInputStream`), many “logical” chunks of data from a file are read as one large **physical input operation** into a memory buffer. As a program requests each new chunk of data, it's taken from the buffer. (This procedure is sometimes referred to as a **logical input operation**.) When the buffer is empty, the next actual physical input operation from the input device is performed to read in the next group of “logical” chunks of data. Thus, the number of actual physical input operations is small compared with the number of read requests issued by the program.

### *Memory-Based byte Array Streams*

Java stream I/O includes capabilities for inputting from byte arrays in memory and outputting to byte arrays in memory. A `ByteArrayInputStream` (a subclass of `InputStream`) reads from a byte array in memory. A `ByteArrayOutputStream` (a subclass of `OutputStream`) outputs to a byte array in memory. One use of byte-array I/O is *data validation*. A program can input an entire line at a time from the input stream into a byte array. Then a validation routine can scrutinize the contents of the byte array and correct the data if necessary. Finally, the program can proceed to input from the byte array, “knowing” that the input data is in the proper format. Outputting to a byte array is a nice way to take advantage of the powerful output-formatting capabilities of Java streams. For example, data can be stored in a byte array, using the same formatting that will be displayed at a later time, and the byte array can then be output to a file to preserve the formatting.

### *Sequencing Input from Multiple Streams*

A `SequenceInputStream` (a subclass of `InputStream`) logically concatenates several `InputStream`s—the program sees the group as one continuous `InputStream`. When the program reaches the end of one input stream, that stream closes, and the next stream in the sequence opens.

## 17.6.2 Interfaces and Classes for Character-Based Input and Output

In addition to the byte-based streams, Java provides the **Reader** and **Writer** abstract classes, which are Unicode two-byte, character-based streams. Most of the byte-based streams have corresponding character-based concrete `Reader` or `Writer` classes.

### *Character-Based Buffering Readers and Writers*

Classes **BufferedReader** (a subclass of abstract class `Reader`) and **BufferedWriter** (a subclass of abstract class `Writer`) enable buffering for character-based streams. Remember that character-based streams use Unicode characters—such streams can process data in any language that the Unicode character set represents.

### *Memory-Based char Array Readers and Writers*

Classes **CharArrayReader** and **CharArrayWriter** read and write, respectively, a stream of characters to a char array. A **LineNumberReader** (a subclass of `BufferedReader`) is a buffered character stream that keeps track of the number of lines read—newlines, returns and carriage-return–line-feed combinations increment the line count. Keeping track of line numbers can be useful if the program needs to inform the reader of an error on a specific line.

### *Character-Based File, Pipe and String Readers and Writers*

An `InputStream` can be converted to a `Reader` via class **InputStreamReader**. Similarly, an `OutputStream` can be converted to a `Writer` via class **OutputStreamWriter**. Class `FileReader` (a subclass of `InputStreamReader`) and class `FileWriter` (a subclass of `OutputStreamWriter`) read characters from and write characters to a file, respectively. Class **PipedReader** and class **PipedWriter** implement piped-character streams for transferring data between threads. Class **StringReader** and **StringWriter** read characters from and write characters to `Strings`, respectively. A `PrintWriter` writes characters to a stream.

## 17.7 Opening Files with JFileChooser

Class **JFileChooser** displays a dialog (known as the JFileChooser dialog) that enables the user to easily select files or directories. To demonstrate this dialog, we enhance the example in Section 17.3, as shown in Figs. 17.20–17.21. The example now contains a graphical user interface, but still displays the same data as before. The constructor calls method `analyzePath` in line 34. This method then calls method `getFile` in line 68 to retrieve the `File` object.

---

```

1 // Fig. 17.20: FileDemonstration.java
2 // Demonstrating JFileChooser.
3 import java.awt.BorderLayout;
4 import java.awt.event.ActionEvent;
5 import java.awt.event.ActionListener;
6 import java.io.File;
7 import javax.swing.JFileChooser;
8 import javax.swing.JFrame;
9 import javax.swing.JOptionPane;
10 import javax.swing.JScrollPane;
11 import javax.swing.JTextArea;
12 import javax.swing.JTextField;
13
14 public class FileDemonstration extends JFrame
15 {
16 private JTextArea outputArea; // used for output
17 private JScrollPane scrollPane; // used to provide scrolling to output
18
19 // set up GUI
20 public FileDemonstration()
21 {
22 super("Testing class File");
23
24 outputArea = new JTextArea();
25
26 // add outputArea to scrollPane
27 scrollPane = new JScrollPane(outputArea);
28
29 add(scrollPane, BorderLayout.CENTER); // add scrollPane to GUI
30
31 setSize(400, 400); // set GUI size
32 setVisible(true); // display GUI
33
34 analyzePath(); // create and analyze File object
35 } // end FileDemonstration constructor
36
37 // allow user to specify file or directory name
38 private File getFileOrDirectory()
39 {
40 // display file dialog, so user can choose file or directory to open
41 JFileChooser fileChooser = new JFileChooser();
42 fileChooser.setFileSelectionMode(
43 JFileChooser.FILES_AND_DIRECTORIES);

```

---

**Fig. 17.20** | Demonstrating JFileChooser. (Part I of 3.)



```
44
45 int result = fileChooser.showOpenDialog(this);
46
47 // if user clicked Cancel button on dialog, return
48 if (result == JFileChooser.CANCEL_OPTION)
49 System.exit(1);
50
51 File fileName = fileChooser.getSelectedFile(); // get File
52
53 // display error if invalid
54 if ((fileName == null) || (fileName.getName().equals("")))
55 {
56 JOptionPane.showMessageDialog(this, "Invalid Name",
57 "Invalid Name", JOptionPane.ERROR_MESSAGE);
58 System.exit(1);
59 } // end if
60
61 return fileName;
62 } // end method getFile
63
64 // display information about file or directory user specifies
65 public void analyzePath()
66 {
67 // create File object based on user input
68 File name = getFileOrDirectory();
69
70 if (name.exists()) // if name exists, output information about it
71 {
72 // display file (or directory) information
73 outputArea.setText(String.format(
74 "%s%s\n%s\n%s\n%s\n%s\n%s\n%s\n%s\n%s\n%s\n%s\n%s\n%s\n%s\n",
75 name.getName(), " exists",
76 (name.isFile() ? "is a file" : "is not a file"),
77 (name.isDirectory() ? "is a directory" :
78 "is not a directory"),
79 (name.isAbsolute() ? "is absolute path" :
80 "is not absolute path"), "Last modified: ",
81 name.lastModified(), "Length: ", name.length(),
82 "Path: ", name.getPath(), "Absolute path: ",
83 name.getAbsolutePath(), "Parent: ", name.getParent()));
84
85 if (name.isDirectory()) // output directory listing
86 {
87 String[] directory = name.list();
88 outputArea.append("\n\nDirectory contents:\n");
89
90 for (String directoryName : directory)
91 outputArea.append(directoryName + "\n");
92 } // end else
93 } // end outer if
94 else // not file or directory, output error message
95 {
```

Fig. 17.20 | Demonstrating JFileChooser. (Part 2 of 3.)

```

96 JOptionPane.showMessageDialog(this, name +
97 " does not exist.", "ERROR", JOptionPane.ERROR_MESSAGE);
98 } // end else
99 } // end method analyzePath
100 } // end class FileDemonstration

```

**Fig. 17.20** | Demonstrating JFileChooser. (Part 3 of 3.)

```

1 // Fig. 17.21: FileDemonstrationTest.java
2 // Testing class FileDemonstration.
3 import javax.swing.JFrame;
4
5 public class FileDemonstrationTest
6 {
7 public static void main(String[] args)
8 {
9 FileDemonstration application = new FileDemonstration();
10 application.setDefaultCloseOperation(JFrame.EXIT_ON_CLOSE);
11 } // end main
12 } // end class FileDemonstrationTest

```

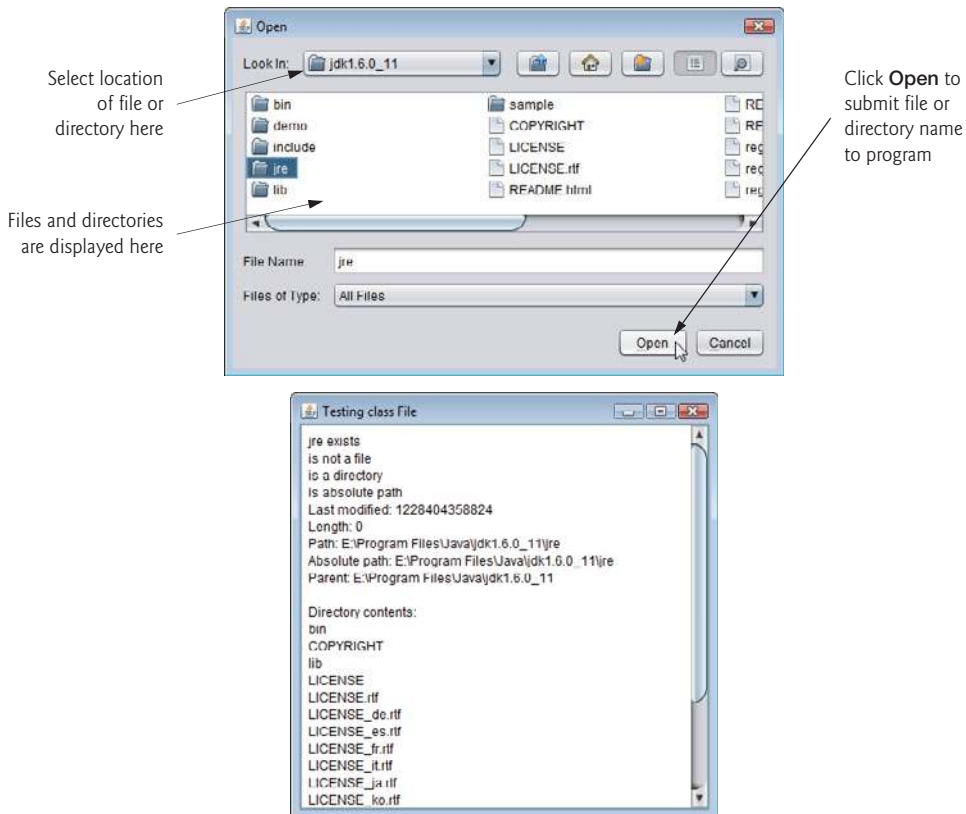

**Fig. 17.21** | Testing class FileDemonstration.

Method `getFile` is defined in lines 38–62 of Fig. 17.20. Line 41 creates a `JFileChooser` and assigns its reference to `fileChooser`. Lines 42–43 call method `setFileSelectionMode` to specify what the user can select from the `fileChooser`. For this program, we use `JFileChooser` static constant `FILES_AND_DIRECTORIES` to indicate that files and directories can be selected. Other static constants include `FILES_ONLY` (the default) and `DIRECTORIES_ONLY`.

Line 45 calls method `showOpenDialog` to display the `JFileChooser` dialog titled `Open`. Argument `this` specifies the `JFileChooser` dialog's parent window, which determines the position of the dialog on the screen. If `null` is passed, the dialog is displayed in the center of the screen—otherwise, the dialog is centered over the application window (specified by the argument `this`). A `JFileChooser` dialog is a *modal dialog* that does not allow the user to interact with any other window in the program until the user closes the `JFileChooser` by clicking the `Open` or `Cancel` button. The user selects the drive, directory or file name, then clicks `Open`. Method `showOpenDialog` returns an integer specifying which button (`Open` or `Cancel`) the user clicked to close the dialog. Line 48 tests whether the user clicked `Cancel` by comparing the result with static constant `CANCEL_OPTION`. If they're equal, the program terminates. Line 51 retrieves the file the user selected by calling `JFileChooser` method `getSelectedFile`. The program then displays information about the selected file or directory.

## 17.8 Wrap-Up

In this chapter, you learned how to manipulate persistent data. We compared character-based and byte-based streams, and introduced several file-processing classes from the `java.io` package. You used class `File` to retrieve information about a file or directory. You used sequential-access file processing to manipulate records that are stored in order by the record-key field. You learned the differences between text-file processing and object serialization, and used serialization to store and retrieve entire objects. The chapter concluded with a small example of using a `JFileChooser` dialog to allow users to easily select files from a GUI. The next chapter presents recursion—methods that call themselves.

## Summary

### Section 17.1 Introduction

- Computers use files for long-term retention of large amounts of persistent data (p. 720), even after the programs that created the data terminate.
- Computers store files on secondary storage devices (p. 720) such as hard disks.

### Section 17.2 Files and Streams

- Java views each file as a sequential stream of bytes (p. 720).
- Every operating system provides a mechanism to determine the end of a file, such as an end-of-file marker (p. 720) or a count of the total bytes in the file.
- Byte-based streams (p. 721) represent data in binary format.
- Character-based streams (p. 721) represent data as sequences of characters.
- Files that are created using byte-based streams are binary files (p. 721). Files created using character-based streams are text files (p. 721). Text files can be read by text editors, whereas binary files are read by a program that converts the data to a human-readable format.

- Java also can associate streams with different devices. Three stream objects are associated with devices when a Java program begins executing—`System.in`, `System.out` and `System.err`.

### Section 17.3 Class File

- `Class File` (p. 722) is used to obtain information about files and directories.
- Character-based input and output can be performed with classes `Scanner` and `Formatter`.
- `Class Formatter` (p. 722) enables formatted data to be output to the screen or to a file in a manner similar to `System.out.printf`.
- A file or directory's path (p. 722) specifies its location on disk.
- An absolute path (p. 722) contains all the directories, starting with the root directory (p. 722), that lead to a specific file or directory. Every file or directory on a disk drive has the same root directory in its path.
- A relative path (p. 722) starts from the directory in which the application began executing.
- A separator character (p. 726) is used to separate directories and files in the path.

### Section 17.4 Sequential-Access Text Files

- Java imposes no structure on a file. You must structure files to meet your application's needs.
- To retrieve data sequentially from a file, programs normally start from the beginning of the file and read all the data consecutively until the desired information is found.
- Data in many sequential files cannot be modified without the risk of destroying other data in the file. Records in a sequential-access file are usually updated by rewriting the entire file.

### Section 17.5 Object Serialization

- Java provides a mechanism called object serialization (p. 742) that enables entire objects to be written to or read from a stream.
- A serialized object (p. 742) is represented as a sequence of bytes that includes the object's data as well as information about the object's type and the types of data it stores.
- After a serialized object has been written into a file, it can be read from the file and deserialized (p. 742) to recreate the object in memory.
- Classes `ObjectInputStream` (p. 722) and `ObjectOutputStream` (p. 722) enable entire objects to be read from or written to a stream (possibly a file).
- Only classes that implement interface `Serializable` (p. 743) can be serialized and deserialized.
- The `ObjectOutput` interface (p. 742) contains method `writeObject` (p. 743), which takes an `Object` as an argument and writes its information to an `OutputStream` (p. 751). A class that implements this interface, such as `ObjectOutputStream`, would ensure that the `Object` is `Serializable`.
- The `ObjectInput` interface (p. 742) contains method `readObject` (p. 743), which reads and returns a reference to an `Object` from an `InputStream`. After an object has been read, its reference can be cast to the object's actual type.

### Section 17.6 Additional java.io Classes

- `InputStream` and `OutputStream` are abstract classes for performing byte-based I/O.
- `Pipes` (p. 751) are synchronized communication channels between threads. One thread sends data via a `PipedOutputStream` (p. 751). The target thread reads information from the pipe via a `PipedInputStream` (p. 751).
- A filter stream (p. 751) provides additional functionality, such as aggregating data bytes into meaningful primitive-type units. `FilterInputStream` (p. 751) and `FilterOutputStream` are typically extended, so some of their filtering capabilities are provided by their concrete subclasses.

- A `PrintStream` (p. 751) performs text output. `System.out` and `System.err` are `PrintStreams`.
- Interface `DataInput` describes methods for reading primitive types from an input stream. Classes `DataInputStream` (p. 752) and `RandomAccessFile` each implement this interface.
- Interface `DataOutput` describes methods for writing primitive types to an output stream. Classes `DataOutputStream` (p. 752) and `RandomAccessFile` each implement this interface.
- Buffering is an I/O-performance-enhancement technique. Buffering reduces the number of I/O operations by combining smaller outputs together in memory. The number of physical I/O operations is much smaller than the number of I/O requests issued by the program.
- With a `BufferedOutputStream` (p. 752) each output operation is directed to a buffer (p. 752) large enough to hold the data of many output operations. Transfer to the output device is performed in one large physical output operation (p. 752) when the buffer fills. A partially filled buffer can be forced out to the device at any time by invoking the stream object's `flush` method (p. 752).
- With a `BufferedInputStream` (p. 752), many “logical” chunks of data from a file are read as one large physical input operation (p. 752) into a memory buffer. As a program requests data, it's taken from the buffer. When the buffer is empty, the next actual physical input operation is performed.
- A `ByteArrayInputStream` reads from a byte array in memory. A `ByteArrayOutputStream` outputs to a byte array in memory.
- A `SequenceInputStream` concatenates several `InputStreams`. When the program reaches the end of an input stream, that stream closes, and the next stream in the sequence opens.
- The `Reader` (p. 753) and `Writer` (p. 753) abstract classes are Unicode character-based streams. Most byte-based streams have corresponding character-based concrete `Reader` or `Writer` classes.
- Classes `BufferedReader` (p. 753) and `BufferedWriter` (p. 753) buffer character-based streams.
- Classes `CharArrayReader` (p. 753) and `CharArrayWriter` (p. 753) manipulate char arrays.
- A `LineNumberReader` (p. 753) is a buffered character stream tracks the number of lines read.
- Classes `FileReader` (p. 753) and `FileWriter` (p. 753) perform character-based file I/O.
- Class `PipedReader` (p. 753) and class `PipedWriter` (p. 753) implement piped-character streams for transferring data between threads.
- Class `StringReader` (p. 753) and `StringWriter` (p. 753) read characters from and write characters to `Strings`, respectively. A `PrintWriter` (p. 732) writes characters to a stream.

### Section 17.7 Opening Files with `JFileChooser`

- Class `JFileChooser` (p. 754) is used to display a dialog that enables users of a program to easily select files or directories from a GUI.

## Self-Review Exercises

- 17.1** Determine whether each of the following statements is *true* or *false*. If *false*, explain why.
- You must explicitly create the stream objects `System.in`, `System.out` and `System.err`.
  - When reading data from a file using class `Scanner`, if you wish to read data in the file multiple times, the file must be closed and reopened to read from the beginning of the file.
  - Method `exists` of class `File` returns `true` if the name specified as the argument to the `File` constructor is a file or directory in the specified path.
  - Binary files are human readable in a text editor.
  - An absolute path contains all the directories, starting with the root directory, that lead to a specific file or directory.
  - Class `Formatter` contains method `printf`, which enables formatted data to be output to the screen or to a file.

- 17.2** Complete the following tasks, assuming that each applies to the same program:
- Write a statement that opens file "oldmast.txt" for input—use Scanner variable inOldMaster.
  - Write a statement that opens file "trans.txt" for input—use Scanner variable inTransaction.
  - Write a statement that opens file "newmast.txt" for output (and creation)—use formatter variable outNewMaster.
  - Write the statements needed to read a record from the file "oldmast.txt". Use the data to create an object of class AccountRecord—use Scanner variable inOldMaster. Assume that class AccountRecord is the same as the AccountRecord class in Fig. 17.4.
  - Write the statements needed to read a record from the file "trans.txt". The record is an object of class TransactionRecord—use Scanner variable inTransaction. Assume that class TransactionRecord contains method setAccount (which takes an int) to set the account number and method setAmount (which takes a double) to set the amount of the transaction.
  - Write a statement that outputs a record to the file "newmast.txt". The record is an object of type AccountRecord—use Formatter variable outNewMaster.
- 17.3** Complete the following tasks, assuming that each applies to the same program:
- Write a statement that opens file "oldmast.ser" for input—use ObjectInputStream variable inOldMaster to wrap a FileInputStream object.
  - Write a statement that opens file "trans.ser" for input—use ObjectInputStream variable inTransaction to wrap a FileInputStream object.
  - Write a statement that opens file "newmast.ser" for output (and creation)—use ObjectOutputStream variable outNewMaster to wrap a FileOutputStream.
  - Write a statement that reads a record from the file "oldmast.ser". The record is an object of class AccountRecordSerializable—use ObjectInputStream variable inOldMaster. Assume class AccountRecordSerializable is the same as the AccountRecordSerializable class in Fig. 17.15
  - Write a statement that reads a record from the file "trans.ser". The record is an object of class TransactionRecord—use ObjectInputStream variable inTransaction.
  - Write a statement that outputs a record of type AccountRecordSerializable to the file "newmast.ser"—use ObjectOutputStream variable outNewMaster.
- 17.4** Find the error in each block of code and show how to correct it.
- Assume that account, company and amount are declared.
 

```
ObjectOutputStream outputStream;
outputStream.writeInt(account);
outputStream.writeChars(company);
outputStream.writeDouble(amount);
```
  - The following statements should read a record from the file "payables.txt". The Scanner variable inPayable should be used to refer to this file.
 

```
Scanner inPayable = new Scanner(new File("payables.txt"));
PayablesRecord record = (PayablesRecord) inPayable.readObject();
```

## Answers to Self-Review Exercises

- 17.1**
- False. These three streams are created for you when a Java application begins executing.
  - True.
  - True.
  - False. Text files are human readable in a text editor. Binary files might be human readable, but only if the bytes in the file represent ASCII characters

- e) True.
- f) False. Class `Formatter` contains method `format`, which enables formatted data to be output to the screen or to a file.

**17.2** a) `Scanner inOldMaster = new Scanner( new File( "oldmast.txt" ) );`

b) `Scanner inTransaction = new Scanner( new File( "trans.txt" ) );`

c) `Formatter outNewMaster = new Formatter( "newmast.txt" );`

d) `AccountRecord account = new AccountRecord();`  
`account.setAccount( inOldMaster.nextInt() );`  
`account.setFirstName( inOldMaster.next() );`  
`account.setLastName( inOldMaster.next() );`  
`account.setBalance( inOldMaster.nextDouble() );`

e) `TransactionRecord transaction = new Transaction();`  
`transaction.setAccount( inTransaction.nextInt() );`  
`transaction.setAmount( inTransaction.nextDouble() );`

f) `outNewMaster.format( "%d %s %s %.2f\n",`  
`account.getAccount(), account.getFirstName(),`  
`account.getLastName(), account.getBalance() );`

**17.3** a) `ObjectInputStream inOldMaster = new ObjectInputStream(`  
`new FileInputStream( "oldmast.ser" ) );`

b) `ObjectInputStream inTransaction = new ObjectInputStream(`  
`new FileInputStream( "trans.ser" ) );`

c) `ObjectOutputStream outNewMaster = new ObjectOutputStream(`  
`new FileOutputStream( "newmast.ser" ) );`

d) `accountRecord = ( AccountRecordSerializable ) inOldMaster.readObject();`

e) `transactionRecord = ( TransactionRecord ) inTransaction.readObject();`

f) `outNewMaster.writeObject( newAccountRecord );`

**17.4** a) Error: The file was not opened before the attempt to output data to the stream.

Correction: Open a file for output by creating a new `ObjectOutputStream` object that wraps a `FileOutputStream` object.

b) Error: This example uses text files with a `Scanner`; there's no object serialization. As a result, method `readObject` cannot be used to read that data from the file. Each piece of data must be read separately, then used to create a `PayablesRecord` object.

Correction: Use methods of `inPayable` to read each piece of the `PayablesRecord` object.

## Exercises

**17.5 (File Matching)** Self-Review Exercise 17.2 asked you to write a series of single statements. Actually, these statements form the core of an important type of file-processing program—namely, a file-matching program. In commercial data processing, it's common to have several files in each application system. In an accounts receivable system, for example, there's generally a master file containing detailed information about each customer, such as the customer's name, address, telephone number, outstanding balance, credit limit, discount terms, contract arrangements and possibly a condensed history of recent purchases and cash payments.

As transactions occur (i.e., sales are made and payments arrive in the mail), information about them is entered into a file. At the end of each business period (a month for some companies, a week for others, and a day in some cases), the file of transactions (called "trans.txt") is applied to the master file (called "oldmast.txt") to update each account's purchase and payment record. During an update, the master file is rewritten as the file "newmast.txt", which is then used at the end of the next business period to begin the updating process again.

File-matching programs must deal with certain problems that do not arise in single-file programs. For example, a match does not always occur. If a customer on the master file has not made any purchases or cash payments in the current business period, no record for this customer will appear on the transaction file. Similarly, a customer who did make some purchases or cash payments could have just moved to this community, and if so, the company may not have had a chance to create a master record for this customer.

Write a complete file-matching accounts receivable program. Use the account number on each file as the record key for matching purposes. Assume that each file is a sequential text file with records stored in increasing account-number order.

- Define class `TransactionRecord`. Objects of this class contain an account number and amount for the transaction. Provide methods to modify and retrieve these values.
- Modify class `AccountRecord` in Fig. 17.4 to include method `combine`, which takes a `TransactionRecord` object and combines the balance of the `AccountRecord` object and the amount value of the `TransactionRecord` object.
- Write a program to create data for testing the program. Use the sample account data in Figs. 17.22 and 17.23. Run the program to create the files `trans.txt` and `oldmast.txt` to be used by your file-matching program.

| Master file<br>account number | Name       | Balance |
|-------------------------------|------------|---------|
| 100                           | Alan Jones | 348.17  |
| 300                           | Mary Smith | 27.19   |
| 500                           | Sam Sharp  | 0.00    |
| 700                           | Suzy Green | -14.22  |

**Fig. 17.22** | Sample data for master file.

| Transaction file<br>account number | Transaction<br>amount |
|------------------------------------|-----------------------|
| 100                                | 27.14                 |
| 300                                | 62.11                 |
| 400                                | 100.56                |
| 900                                | 82.17                 |

**Fig. 17.23** | Sample data for transaction file.

- Create class `FileMatch` to perform the file-matching functionality. The class should contain methods that read `oldmast.txt` and `trans.txt`. When a match occurs (i.e., records with the same account number appear in both the master file and the transaction file), add the dollar amount in the transaction record to the current balance in the master record, and write the "newmast.txt" record. (Assume that purchases are indicated by positive amounts in the transaction file and payments by negative amounts.) When there's a master record for a particular account, but no corresponding transaction record, merely write the master record to "newmast.txt". When there's a transaction record, but no corresponding master record, print to a log file the message "Unmatched transaction record for account number..." (fill in the account number from the transaction record). The log file should be a text file named "log.txt".



**17.6** (*File Matching with Multiple Transactions*) It's possible (and actually common) to have several transaction records with the same record key. This situation occurs, for example, when a customer makes several purchases and cash payments during a business period. Rewrite your accounts receivable file-matching program from Exercise 17.5 to provide for the possibility of handling several transaction records with the same record key. Modify the test data of `CreateData.java` to include the additional transaction records in Fig. 17.24.

| Account number | Dollar amount |
|----------------|---------------|
| 300            | 83.89         |
| 700            | 80.78         |
| 700            | 1.53          |

**Fig. 17.24** | Additional transaction records.

**17.7** (*File Matching with Object Serialization*) Recreate your solution for Exercise 17.6 using object serialization. Use the statements from Exercise 17.3 as your basis for this program. You may want to create applications to read the data stored in the `.ser` files—the code in Section 17.5.2 can be modified for this purpose.

**17.8** (*Telephone-Number Word Generator*) Standard telephone keypads contain the digits zero through nine. The numbers two through nine each have three letters associated with them (Fig. 17.25). Many people find it difficult to memorize phone numbers, so they use the correspondence between digits and letters to develop seven-letter words that correspond to their phone numbers. For example, a person whose telephone number is 686-2377 might use the correspondence indicated in Fig. 17.25 to develop the seven-letter word “NUMBERS.” Every seven-letter word corresponds to exactly one seven-digit telephone number. A restaurant wishing to increase its takeout business could surely do so with the number 825-3688 (i.e., “TAKEOUT”).

| Digit | Letters | Digit | Letters | Digit | Letters |
|-------|---------|-------|---------|-------|---------|
| 2     | A B C   | 5     | J K L   | 8     | T U V   |
| 3     | D E F   | 6     | M N O   | 9     | W X Y   |
| 4     | G H I   | 7     | P R S   |       |         |

**Fig. 17.25** | Telephone keypad digits and letters.

Every seven-letter phone number corresponds to many different seven-letter words, but most of these words represent unrecognizable juxtapositions of letters. It's possible, however, that the owner of a barbershop would be pleased to know that the shop's telephone number, 424-7288, corresponds to “HAIRCUT.” A veterinarian with the phone number 738-2273 would be pleased to know that the number corresponds to the letters “PETCARE.” An automotive dealership would be pleased to know that the dealership number, 639-2277, corresponds to “NEWCARS.”

Write a program that, given a seven-digit number, uses a `PrintStream` object to write to a file every possible seven-letter word combination corresponding to that number. There are 2,187 (3<sup>7</sup>) such combinations. Avoid phone numbers with the digits 0 and 1.

**17.9** (*Student Poll*) Figure 7.8 contains an array of survey responses that's hard coded into the program. Suppose we wish to process survey results that are stored in a file. This exercise requires two

separate programs. First, create an application that prompts the user for survey responses and outputs each response to a file. Use a `Formatter` to create a file called `numbers.txt`. Each integer should be written using method `format`. Then modify the program in Fig. 7.8 to read the survey responses from `numbers.txt`. The responses should be read from the file by using a `Scanner`. Use method `nextInt` to input one integer at a time from the file. The program should continue to read responses until it reaches the end of the file. The results should be output to the text file "output.txt".

**17.10** (*Adding Object Serialization to the MyShape Drawing Application*) Modify Exercise 14.17 to allow the user to save a drawing into a file or load a prior drawing from a file using object serialization. Add buttons **Load** (to read objects from a file) and **Save** (to write objects to a file). Use an `ObjectOutputStream` to write to the file and an `ObjectInputStream` to read from the file. Write the array of `MyShape` objects using method `writeObject` (class `ObjectOutputStream`), and read the array using method `readObject` (`ObjectInputStream`). The object-serialization mechanism can read or write entire arrays—it's not necessary to manipulate each element of the array of `MyShape` objects individually. It's simply required that all the shapes be `Serializable`. For both the **Load** and **Save** buttons, use a `JFileChooser` to allow the user to select the file in which the shapes will be stored or from which they'll be read. When the user first runs the program, no shapes should be displayed on the screen. The user can display shapes by opening a previously saved file or by drawing new shapes. Once there are shapes on the screen, users can save them to a file using the **Save** button.

## Making a Difference

**17.11** (*Phishing Scanner*) Phishing is a form of identity theft in which, in an e-mail, a sender posing as a trustworthy source attempts to acquire private information, such as your user names, passwords, credit-card numbers and social security number. Phishing e-mails claiming to be from popular banks, credit-card companies, auction sites, social networks and online payment services may look quite legitimate. These fraudulent messages often provide links to spoofed (fake) websites where you're asked to enter sensitive information.

Visit McAfee® ([www.mcafee.com/us/threat\\_center/anti\\_phishing/phishing\\_top10.html](http://www.mcafee.com/us/threat_center/anti_phishing/phishing_top10.html)), Security Extra ([www.securityextra.com/](http://www.securityextra.com/)) and other websites to find lists of the top phishing scams. Also check out the Anti-Phishing Working Group ([www.antiphishing.org/](http://www.antiphishing.org/)), and the FBI's Cyber Investigations website ([www.fbi.gov/cyberinvest/cyberhome.htm](http://www.fbi.gov/cyberinvest/cyberhome.htm)), where you'll find information about the latest scams and how to protect yourself.

Create a list of 30 words, phrases and company names commonly found in phishing messages. Assign a point value to each based on your estimate of its likeliness to be in a phishing message (e.g., one point if it's somewhat likely, two points if moderately likely, or three points if highly likely). Write an application that scans a file of text for these terms and phrases. For each occurrence of a keyword or phrase within the text file, add the assigned point value to the total points for that word or phrase. For each keyword or phrase found, output one line with the word or phrase, the number of occurrences and the point total. Then show the point total for the entire message. Does your program assign a high point total to some actual phishing e-mails you've received? Does it assign a high point total to some legitimate e-mails you've received?

# Recursion

# 18



*We must learn to explore all the options and possibilities that confront us in a complex and rapidly changing world.*

—James William Fulbright

*O! thou bast damnable iteration, and art indeed able to corrupt a saint.*

—William Shakespeare

*It's a poor sort of memory that only works backwards.*

—Lewis Carroll

*Life can only be understood backwards; but it must be lived forwards.*

—Soren Kierkegaard

## Objectives

In this chapter you'll learn:

- The concept of recursion.
- How to write and use recursive methods.
- How to determine the base case and recursion step in a recursive algorithm.
- How recursive method calls are handled by the system.
- The differences between recursion and iteration, and when to use each.
- What the geometric shapes called fractals are and how to draw them using recursion.
- What recursive backtracking is and why it's an effective problem-solving technique.

- |                                                       |                                     |
|-------------------------------------------------------|-------------------------------------|
| <b>18.1</b> Introduction                              | <b>18.6</b> Recursion vs. Iteration |
| <b>18.2</b> Recursion Concepts                        | <b>18.7</b> Towers of Hanoi         |
| <b>18.3</b> Example Using Recursion: Factorials       | <b>18.8</b> Fractals                |
| <b>18.4</b> Example Using Recursion: Fibonacci Series | <b>18.9</b> Recursive Backtracking  |
| <b>18.5</b> Recursion and the Method-Call Stack       | <b>18.10</b> Wrap-Up                |

Summary | Self-Review Exercises | Answers to Self-Review Exercises | Exercises

## 18.1 Introduction

The programs we've discussed so far are generally structured as methods that call one another in a hierarchical manner. For some problems, it's useful to have a method call itself. A method that does so is known as a **recursive method**. A recursive method can call itself either *directly* or *indirectly through another method*. Recursion is an important topic discussed at length in upper-level computer science courses. In this chapter, we consider recursion conceptually, then present several programs containing recursive methods. Figure 18.1 summarizes the recursion examples and exercises in this book.

| Chapter | Recursion examples and exercises in this book                                                                                                                                                                                                                                                                                                                                                                                                                                                                                                                                                                                                                                                                                                                                                                                                                                                                      |
|---------|--------------------------------------------------------------------------------------------------------------------------------------------------------------------------------------------------------------------------------------------------------------------------------------------------------------------------------------------------------------------------------------------------------------------------------------------------------------------------------------------------------------------------------------------------------------------------------------------------------------------------------------------------------------------------------------------------------------------------------------------------------------------------------------------------------------------------------------------------------------------------------------------------------------------|
| 18      | Factorial Method (Figs. 18.3 and 18.4)<br>Fibonacci Method (Fig. 18.5)<br>Towers of Hanoi (Fig. 18.11)<br>Fractals (Figs. 18.18 and 18.19)<br>What Does This Code Do? (Exercise 18.7, Exercise 18.12 and Exercise 18.13)<br>Find the Error in the Following Code (Exercise 18.8)<br>Raising an Integer to an Integer Power (Exercise 18.9)<br>Visualizing Recursion (Exercise 18.10)<br>Greatest Common Divisor (Exercise 18.11)<br>Determine Whether a String Is a Palindrome (Exercise 18.14)<br>Eight Queens (Exercise 18.15)<br>Print an Array (Exercise 18.16)<br>Print an Array Backward (Exercise 18.17)<br>Minimum Value in an Array (Exercise 18.18)<br>Star Fractal (Exercise 18.19)<br>Maze Traversal Using Recursive Backtracking (Exercise 18.20)<br>Generating Mazes Randomly (Exercise 18.21)<br>Mazes of Any Size (Exercise 18.22)<br>Time Needed to Calculate a Fibonacci Number (Exercise 18.23) |
| 19      | Merge Sort (Figs. 19.10 and 19.11)<br>Linear Search (Exercise 19.8)<br>Binary Search (Exercise 19.9)<br>Quicksort (Exercise 19.10)                                                                                                                                                                                                                                                                                                                                                                                                                                                                                                                                                                                                                                                                                                                                                                                 |

**Fig. 18.1** | Summary of the recursion examples and exercises in this text. (Part 1 of 2.)

| Chapter | Recursion examples and exercises in this book                                                                                                                                                                                                                                         |
|---------|---------------------------------------------------------------------------------------------------------------------------------------------------------------------------------------------------------------------------------------------------------------------------------------|
| 22      | Binary-Tree Insert (Fig. 22.17)<br>Preorder Traversal of a Binary Tree (Fig. 22.17)<br>Inorder Traversal of a Binary Tree (Fig. 22.17)<br>Postorder Traversal of a Binary Tree (Fig. 22.17)<br>Print a Linked List Backward (Exercise 22.20)<br>Search a Linked List (Exercise 22.21) |

**Fig. 18.1** | Summary of the recursion examples and exercises in this text. (Part 2 of 2.)

## 18.2 Recursion Concepts

Recursive problem-solving approaches have a number of elements in common. When a recursive method is called to solve a problem, it actually is capable of solving only the simplest case(s), or **base case(s)**. If the method is called with a base case, it returns a result. If the method is called with a more complex problem, it typically divides the problem into two conceptual pieces—a piece that the method knows how to do and a piece that it does not know how to do. To make recursion feasible, the latter piece must resemble the original problem, but be a slightly simpler or smaller version of it. Because this new problem looks like the original problem, the method calls a fresh copy of itself to work on the smaller problem—this is referred to as a **recursive call** and is also called the **recursion step**. The recursion step normally includes a **return** statement, because its result will be combined with the portion of the problem the method knew how to solve to form a result that will be passed back to the original caller. This concept of separating the problem into two smaller portions is a form of the divide-and-conquer approach introduced in Chapter 6.

The recursion step executes while the original method call is still active (i.e., it has not finished executing). It can result in many more recursive calls as the method divides each new subproblem into two conceptual pieces. For the recursion to eventually terminate, each time the method calls itself with a simpler version of the original problem, the sequence of smaller and smaller problems must *converge on a base case*. When the method recognizes the base case, it returns a result to the previous copy of the method. A sequence of returns ensues until the original method call returns the final result to the caller.

A recursive method may call another method, which may in turn make a call back to the recursive method. This is known as an **indirect recursive call** or **indirect recursion**. For example, method A calls method B, which makes a call back to method A. This is still recursion, because the second call to method A is made while the first call to method A is active—that is, the first call to method A has not yet finished executing (because it's waiting on method B to return a result to it) and has not returned to method A's original caller.

To better understand the concept of recursion, let's look at an example that's quite familiar to computer users—the recursive definition of a directory on a computer. A computer normally stores related files in a directory. A directory can be empty, can contain files and/or can contain other directories (usually referred to as subdirectories). Each of these subdirectories, in turn, may also contain both files and directories. If we want to list each file in a directory (including all the files in the directory's subdirectories), we need to create a method that first lists the initial directory's files, then makes recursive calls to list the files in each of that directory's subdirectories. The base case occurs when a directory is reached

that does not contain any subdirectories. At this point, all the files in the original directory have been listed and no further recursion is necessary.

### 18.3 Example Using Recursion: Factorials

Let's write a recursive program to perform a popular mathematical calculation. Consider the *factorial* of a positive integer  $n$ , written  $n!$  (pronounced “ $n$  factorial”), which is the product

$$n \cdot (n-1) \cdot (n-2) \cdot \dots \cdot 1$$

with  $1!$  equal to 1 and  $0!$  defined to be 1. For example,  $5!$  is the product  $5 \cdot 4 \cdot 3 \cdot 2 \cdot 1$ , which is equal to 120.

The factorial of integer number (where  $\text{number} \geq 0$ ) can be calculated iteratively (non-recursively) using a `for` statement as follows:

```
factorial = 1;
for (int counter = number; counter >= 1; counter--)
 factorial *= counter;
```

A recursive declaration of the factorial method is arrived at by observing the following relationship:

$$n! = n \cdot (n-1)!$$

For example,  $5!$  is clearly equal to  $5 \cdot 4!$ , as shown by the following equations:

$$\begin{aligned} 5! &= 5 \cdot 4 \cdot 3 \cdot 2 \cdot 1 \\ 5! &= 5 \cdot (4 \cdot 3 \cdot 2 \cdot 1) \\ 5! &= 5 \cdot (4!) \end{aligned}$$

The evaluation of  $5!$  would proceed as shown in Fig. 18.2. Figure 18.2(a) shows how the succession of recursive calls proceeds until  $1!$  (the base case) is evaluated to be 1, which

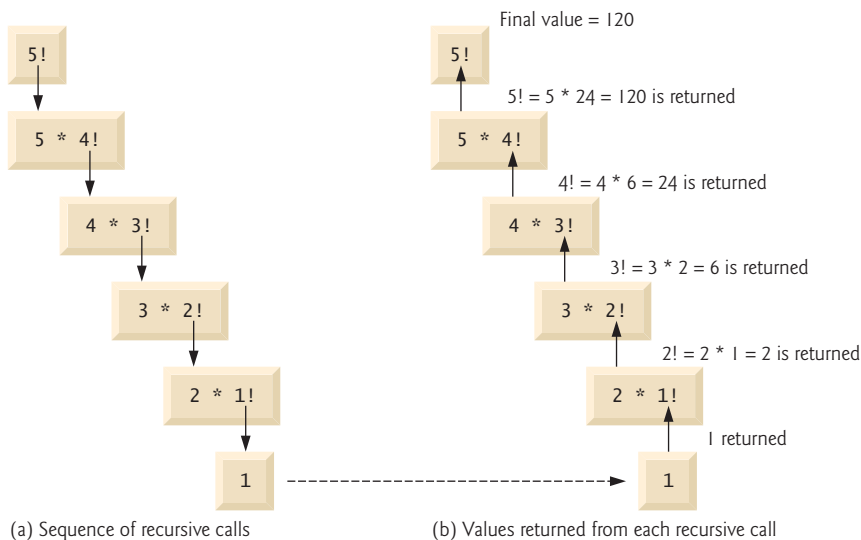

**Fig. 18.2** | Recursive evaluation of  $5!$ .

terminates the recursion. Figure 18.2(b) shows the values returned from each recursive call to its caller until the final value is calculated and returned.

Figure 18.3 uses recursion to calculate and print the factorials of the integers from 0–21. The recursive method `factorial` (lines 7–13) first tests to determine whether a terminating condition (line 9) is true. If `number` is less than or equal to 1 (the base case), `factorial` returns 1, no further recursion is necessary and the method returns. If `number` is greater than 1, line 12 expresses the problem as the product of `number` and a recursive call to `factorial` evaluating the factorial of `number - 1`, which is a slightly smaller problem than the original calculation, `factorial( number )`.

```

1 // Fig. 18.3: FactorialCalculator.java
2 // Recursive factorial method.
3
4 public class FactorialCalculator
5 {
6 // recursive method factorial (assumes its parameter is >= 0)
7 public long factorial(long number)
8 {
9 if (number <= 1) // test for base case
10 return 1; // base cases: 0! = 1 and 1! = 1
11 else // recursion step
12 return number * factorial(number - 1);
13 } // end method factorial
14
15 // output factorials for values 0-21
16 public static void main(String[] args)
17 {
18 // calculate the factorials of 0 through 21
19 for (int counter = 0; counter <= 21; counter++)
20 System.out.printf("%d! = %d\n", counter, factorial(counter));
21 } // end main
22 } // end class FactorialCalculator

```

```

0! = 1
1! = 1
2! = 2
3! = 6
4! = 24
5! = 120
...
12! = 479001600 — 12! causes overflow for int variables
...
20! = 2432902008176640000
21! = -4249290049419214848 — 21! causes overflow for long variables

```

**Fig. 18.3** | Factorial calculations with a recursive method.



### Common Programming Error 18.1

Either omitting the base case or writing the recursion step incorrectly so that it does not converge on the base case can cause a logic error known as **infinite recursion**, where recursive calls are continuously made until memory is exhausted. This error is analogous to the problem of an infinite loop in an iterative (nonrecursive) solution.

Method `main` (lines 16–21) displays the factorials of 0–21. The call to the `factorial` method occurs in line 20. Method `factorial` receives a parameter of type `long` and returns a result of type `long`. The program’s output shows that factorial values become large quickly. We use type `long` (which can represent relatively large integers) so the program can calculate factorials greater than 12!. Unfortunately, the `factorial` method produces large values so quickly that we exceed the largest `long` value when we attempt to calculate 21!, as you can see in the last line of the program’s output.

Due to the limitations of integral types, `float` or `double` variables may ultimately be needed to calculate factorials of larger numbers. This points to a weakness in some programming languages—namely, that they aren’t easily extended with new types to handle unique application requirements. As we saw in Chapter 9, Java is an *extensible* language that allows us to create arbitrarily large integers if we wish. In fact, package `java.math` provides classes **BigInteger** and **BigDecimal** explicitly for arbitrary precision calculations that cannot be performed with primitive types. You can learn more about these classes at

[download.oracle.com/javase/6/docs/api/java/math/BigInteger.html](http://download.oracle.com/javase/6/docs/api/java/math/BigInteger.html)  
[download.oracle.com/javase/6/docs/api/java/math/BigDecimal.html](http://download.oracle.com/javase/6/docs/api/java/math/BigDecimal.html)

### Reimplementing Class `FactorialCalculator` Using Class `BigInteger`

Figure 18.4 reimplements class `FactorialCalculator` using `BigInteger` variables. To demonstrate larger values than what `long` variables can store, we calculate the factorials of the numbers 0–50. Line 3 imports class `BigInteger` from package `java.math`. The new `factorial` method (lines 8–15) receives a `BigInteger` as an argument and returns a `BigInteger`.

```

1 // Fig. 18.4: FactorialCalculator.java
2 // Recursive factorial method.
3 import java.math.BigInteger;
4
5 public class FactorialCalculator
6 {
7 // recursive method factorial (assumes its parameter is >= 0)
8 public static BigInteger factorial(BigInteger number)
9 {
10 if (number.compareTo(BigInteger.ONE) <= 0) // test base case
11 return BigInteger.ONE; // base cases: 0! = 1 and 1! = 1
12 else // recursion step
13 return number.multiply(
14 factorial(number.subtract(BigInteger.ONE)));
15 } // end method factorial
16
17 // output factorials for values 0-50
18 public static void main(String[] args)
19 {
20 // calculate the factorials of 0 through 50
21 for (int counter = 0; counter <= 50; counter++)
22 System.out.printf("%d! = %d\n", counter,
23 factorial(BigInteger.valueOf(counter)));
24 } // end main
25 } // end class FactorialCalculator

```

**Fig. 18.4** | Factorial calculations with a recursive method. (Part 1 of 2.)



```

0! = 1
1! = 1
2! = 2
3! = 6
...
21! = 51090942171709440000 — 21! and larger values no longer cause overflow
22! = 1124000727777607680000
...
47! = 258623241511168180642964355153611979969197632389120000000000
48! = 12413915592536072670862289047373375038521486354677760000000000
49! = 608281864034267560872252163321295376887552831379210240000000000
50! = 30414093201713378043612608166064768844377641568960512000000000000

```

**Fig. 18.4** | Factorial calculations with a recursive method. (Part 2 of 2.)

Since `BigInteger` is not a primitive type, we can't use the arithmetic, relational and equality operators with `BigIntegers`; instead, we must use `BigInteger` methods to perform these tasks. Line 10 tests for the base case using `BigInteger` method `compareTo`. This method compares the `BigInteger` that calls the method to the method's `BigInteger` argument. The method returns `-1` if the `BigInteger` that calls the method is less than the argument, `0` if they're equal or `1` if the `BigInteger` that calls the method is greater than the argument. Line 10 compares the `BigInteger` number with the `BigInteger` constant `ONE`, which represents the integer value 1. If `compareTo` returns `-1` or `0`, then number is less than or equal to 1 (the base case) and the method returns the constant `BigInteger.ONE`. Otherwise, lines 13–14 perform the recursion step using `BigInteger` methods `multiply` and `subtract` to implement the calculations required to multiply number by the factorial of number - 1). The program's output shows that `BigInteger` easily handles the large values produced by the factorial calculation.

## 18.4 Example Using Recursion: Fibonacci Series

The **Fibonacci series**,

0, 1, 1, 2, 3, 5, 8, 13, 21, ...

begins with 0 and 1 and has the property that each subsequent Fibonacci number is the sum of the previous two. This series occurs in nature and describes a form of spiral. The ratio of successive Fibonacci numbers converges on a constant value of 1.618..., a number that has been called the **golden ratio** or the **golden mean**. Humans tend to find the golden mean aesthetically pleasing. Architects often design windows, rooms and buildings whose length and width are in the ratio of the golden mean. Postcards are often designed with a golden-mean length-to-width ratio.

The Fibonacci series may be defined recursively as follows:

```

fibonacci(0) = 0
fibonacci(1) = 1
fibonacci(n) = fibonacci(n - 1) + fibonacci(n - 2)

```

There are *two base cases* for the Fibonacci calculation: `fibonacci(0)` is defined to be 0, and `fibonacci(1)` to be 1. The program in Fig. 18.5 calculates the *i*th Fibonacci number recursively, using method `fibonacci` (lines 10–18). Method `main` (lines 21–26) tests `fibonacci`,

displaying the Fibonacci values of 0–40. The variable counter created in the for header (line 23) indicates which Fibonacci number to calculate for each iteration of the loop. Fibonacci numbers tend to become large quickly (though not as quickly as factorials). Therefore, we use type `BigInteger` as the parameter type and the return type of method `fibonacci`.

```

1 // Fig. 18.5: FibonacciCalculator.java
2 // Recursive fibonacci method.
3 import java.math.BigInteger;
4
5 public class FibonacciCalculator
6 {
7 private static BigInteger TWO = BigInteger.valueOf(2);
8
9 // recursive declaration of method fibonacci
10 public static BigInteger fibonacci(BigInteger number)
11 {
12 if (number.equals(BigInteger.ZERO) ||
13 number.equals(BigInteger.ONE)) // base cases
14 return number;
15 else // recursion step
16 return fibonacci(number.subtract(BigInteger.ONE)).add(
17 fibonacci(number.subtract(TWO)));
18 } // end method fibonacci
19
20 // displays the fibonacci values from 0-40
21 public static void main(String[] args)
22 {
23 for (int counter = 0; counter <= 40; counter++)
24 System.out.printf("Fibonacci of %d is: %d\n", counter,
25 fibonacci(BigInteger.valueOf(counter)));
26 } // end main
27 } // end class FibonacciCalculator

```

```

Fibonacci of 0 is: 0
Fibonacci of 1 is: 1
Fibonacci of 2 is: 1
Fibonacci of 3 is: 2
Fibonacci of 4 is: 3
Fibonacci of 5 is: 5
Fibonacci of 6 is: 8
Fibonacci of 7 is: 13
Fibonacci of 8 is: 21
Fibonacci of 9 is: 34
Fibonacci of 10 is: 55
...
Fibonacci of 37 is: 24157817
Fibonacci of 38 is: 39088169
Fibonacci of 39 is: 63245986
Fibonacci of 40 is: 102334155

```

**Fig. 18.5** | Fibonacci numbers generated with a recursive method.

The call to method `fibonacci` (line 25 of Fig. 18.5) from `main` is not a recursive call, but all subsequent calls to `fibonacci` performed from lines 16–17 of Fig. 18.5 are recur-

sive, because at that point the calls are initiated by method `fibonacci` itself. Each time `fibonacci` is called, it immediately tests for the base cases—number equal to 0 or number equal to 1 (Fig. 18.5, lines 12–13). We use `BigInteger` constants `ZERO` and `ONE` to represent the values 0 and 1, respectively. If the condition in lines 12–13 is true, `fibonacci` simply returns `number`, because `fibonacci(0)` is 0 and `fibonacci(1)` is 1. Interestingly, if `number` is greater than 1, the recursion step generates *two* recursive calls (lines 16–17), each for a slightly smaller problem than the original call to `fibonacci`. Lines 16–17 use `BigInteger` methods `add` and `subtract` to help implement the recursive step. We also use a constant of type `BigInteger` named `TWO` that we defined at line 7.

### Analyzing the Calls to Method `Fibonacci`

Figure 18.6 shows how method `fibonacci` evaluates `fibonacci(3)`. At the bottom of the figure we're left with the values 1, 0 and 1—the results of evaluating the base cases. The first two return values (from left to right), 1 and 0, are returned as the values for the calls `fibonacci(1)` and `fibonacci(0)`. The sum 1 plus 0 is returned as the value of `fibonacci(2)`. This is added to the result (1) of the call to `fibonacci(1)`, producing the value 2. This final value is then returned as the value of `fibonacci(3)`.

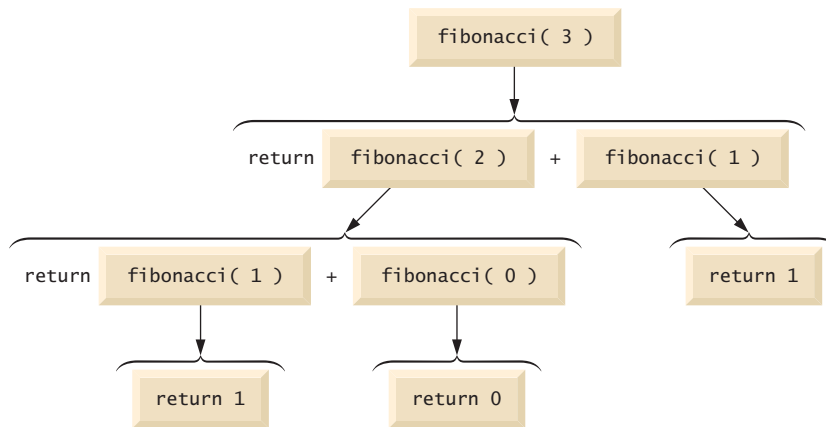

**Fig. 18.6** | Set of recursive calls for `fibonacci(3)`.

Figure 18.6 raises some interesting issues about *the order in which Java compilers evaluate the operands of operators*. This order is different from that in which operators are applied to their operands—namely, the order dictated by the rules of operator precedence. From Figure 18.6, it appears that while `fibonacci(3)` is being evaluated, two recursive calls will be made—`fibonacci(2)` and `fibonacci(1)`. But in what order will they be made? *The Java language specifies that the order of evaluation of the operands is from left to right*. Thus, the call `fibonacci(2)` is made first and the call `fibonacci(1)` second.

A word of caution is in order about recursive programs like the one we use here to generate Fibonacci numbers. Each invocation of the `fibonacci` method that does not match one of the base cases (0 or 1) results in *two more recursive calls* to the `fibonacci` method. Hence, this set of recursive calls rapidly gets out of hand. Calculating the Fibonacci value of

20 with the program in Fig. 18.5 requires 21,891 calls to the `fibonacci` method; calculating the Fibonacci value of 30 requires 2,692,537 calls! As you try to calculate larger Fibonacci values, you'll notice that each consecutive Fibonacci number you use the application to calculate results in a substantial increase in calculation time and in the number of calls to the `fibonacci` method. For example, the Fibonacci value of 31 requires 4,356,617 calls, and the Fibonacci value of 32 requires 7,049,155 calls! As you can see, the number of calls to `fibonacci` increases quickly—1,664,080 additional calls between Fibonacci values of 30 and 31 and 2,692,538 additional calls between Fibonacci values of 31 and 32! The difference in the number of calls made between Fibonacci values of 31 and 32 is more than 1.5 times the difference in the number of calls for Fibonacci values between 30 and 31. Problems of this nature can humble even the world's most powerful computers. [Note: In the field of complexity theory, computer scientists study how hard algorithms work to complete their tasks. Complexity issues are discussed in detail in the upper-level computer science curriculum course generally called "Algorithms." We introduce various complexity issues in Chapter 19, Searching, Sorting and Big O.] In the exercises, you'll be asked to enhance the Fibonacci program of Fig. 18.5 so that it calculates the approximate amount of time required to perform the calculation. For this purpose, you'll call `static System` method `currentTimeMillis`, which takes no arguments and returns the computer's current time in milliseconds.



### Performance Tip 18.1

*Avoid Fibonacci-style recursive programs, because they result in an exponential "explosion" of method calls.*

## 18.5 Recursion and the Method-Call Stack

In Chapter 6, the stack data structure was introduced in the context of understanding how Java performs method calls. We discussed both the method-call stack (also known as the program-execution stack) and activation records. In this section, we'll use these concepts to demonstrate how the program-execution stack handles recursive method calls.

Let's begin by returning to the Fibonacci example—specifically, calling method `fibonacci` with the value 3, as in Fig. 18.6. To show the order in which the method calls' activation records are placed on the stack, we've lettered the method calls in Fig. 18.7.

When the first method call (A) is made, an activation record containing the value of the local variable `number` (3, in this case) is pushed onto the program-execution stack. This stack, including the activation record for method call A, is illustrated in part (a) of Fig. 18.8. [Note: We use a simplified stack here. An actual program-execution stack and its activation records would be more complex than in Fig. 18.8, containing such information as where the method call is to return to when it has completed execution.]

Within method call A, method calls B and E are made. The original method call has not yet completed, so its activation record remains on the stack. The first method call to be made from within A is method call B, so the activation record for method call B is pushed onto the stack on top of the one for method call A. Method call B must execute and complete before method call E is made. Within method call B, method calls C and D will be made. Method call C is made first, and its activation record is pushed onto the stack [part (b) of Fig. 18.8]. Method call B has not yet finished, and its activation record is still on the method-call stack. When method call C executes, it makes no further method calls, but simply returns the value 1. When this method returns, its activation record is popped

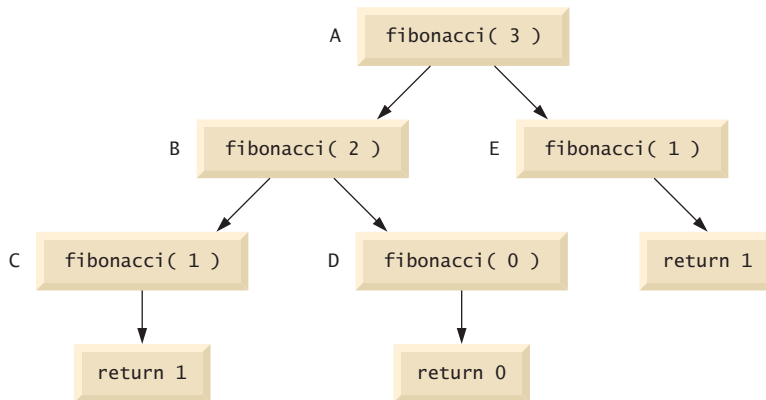

**Fig. 18.7** | Method calls made within the call `fibonacci( 3 )`.

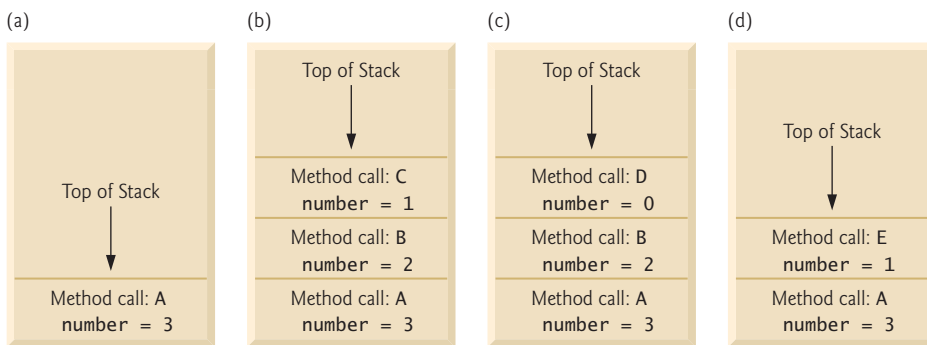

**Fig. 18.8** | Method calls on the program-execution stack.

off the top of the stack. The method call at the top of the stack is now B, which continues to execute by performing method call D. The activation record for method call D is pushed onto the stack [part (c) of Fig. 18.8]. Method call D completes without making any more method calls and returns the value 0. The activation record for this method call is then popped off the stack. Now, both method calls made from within method call B have returned. Method call B continues to execute, returning the value 1. Method call B completes, and its activation record is popped off the stack. At this point, the activation record for method call A is at the top of the stack and the method continues its execution. This method makes method call E, whose activation record is now pushed onto the stack [part (d) of Fig. 18.8]. Method call E completes and returns the value 1. The activation record for this method call is popped off the stack, and once again method call A continues to execute. At this point, method call A will not be making any other method calls and can finish its execution, returning the value 2 to A's caller (`fibonacci(3) = 2`). A's activation record is popped off the stack. The executing method is always the one whose activation record is at the top of the stack, and the activation record for that method contains the values of its local variables.

## 18.6 Recursion vs. Iteration

We've studied methods `factorial` and `fibonacci`, which can easily be implemented either recursively or iteratively. In this section, we compare the two approaches and discuss why you might choose one approach over the other in a particular situation.

Both iteration and recursion are *based on a control statement*: Iteration uses a repetition statement (e.g., `for`, `while` or `do...while`), whereas recursion uses a selection statement (e.g., `if`, `if...else` or `switch`). Both iteration and recursion involve *repetition*: Iteration explicitly uses a repetition statement, whereas recursion achieves repetition through repeated method calls. Iteration and recursion each involve a *termination test*: Iteration terminates when the loop-continuation condition fails, whereas recursion terminates when a base case is reached. Iteration with counter-controlled repetition and recursion both *gradually approach termination*: Iteration keeps modifying a counter until the counter assumes a value that makes the loop-continuation condition fail, whereas recursion keeps producing smaller versions of the original problem until the base case is reached. Both iteration and recursion *can occur infinitely*: An infinite loop occurs with iteration if the loop-continuation test never becomes false, whereas infinite recursion occurs if the recursion step does not reduce the problem each time in a manner that converges on the base case, or if the base case is not tested.

To illustrate the differences between iteration and recursion, let's examine an iterative solution to the factorial problem (Fig. 18.9). A repetition statement is used (lines 12–13) rather than the selection statement of the recursive solution (lines 9–12 of Fig. 18.3). Both solutions use a termination test. In the recursive solution, line 9 tests for the base case. In the iterative solution, line 12 tests the loop-continuation condition—if the test fails, the loop terminates. Finally, instead of producing smaller versions of the original problem, the iterative solution uses a counter that is modified until the loop-continuation condition becomes false.

---

```

1 // Fig. 18.9: FactorialCalculator.java
2 // Iterative factorial method.
3
4 public class FactorialCalculator
5 {
6 // recursive declaration of method factorial
7 public long factorial(long number)
8 {
9 long result = 1;
10
11 // iterative declaration of method factorial
12 for (long i = number; i >= 1; i--)
13 result *= i;
14
15 return result;
16 } // end method factorial
17
18 // output factorials for values 0-10
19 public static void main(String[] args)
20 {

```

---

**Fig. 18.9** | Iterative factorial solution. (Part 1 of 2.)

```

21 // calculate the factorials of 0 through 10
22 for (int counter = 0; counter <= 10; counter++)
23 System.out.printf("%d! = %d\n", counter, factorial(counter));
24 } // end main
25 } // end class FactorialCalculator

```

```

0! = 1
1! = 1
2! = 2
3! = 6
4! = 24
5! = 120
6! = 720
7! = 5040
8! = 40320
9! = 362880
10! = 3628800

```

**Fig. 18.9** | Iterative factorial solution. (Part 2 of 2.)

Recursion has many *negatives*. It repeatedly invokes the mechanism, and consequently the *overhead, of method calls*. This repetition can be expensive in terms of both processor time and memory space. Each recursive call causes another copy of the method (actually, only the method's variables, stored in the activation record) to be created—this set of copies *can consume considerable memory space*. Since iteration occurs within a method, repeated method calls and extra memory assignment are avoided.



### Software Engineering Observation 18.1

*Any problem that can be solved recursively can also be solved iteratively (nonrecursively). A recursive approach is normally preferred over an iterative approach when the recursive approach more naturally mirrors the problem and results in a program that is easier to understand and debug. A recursive approach can often be implemented with fewer lines of code. Another reason to choose a recursive approach is that an iterative one might not be apparent.*



### Performance Tip 18.2

*Avoid using recursion in situations requiring high performance. Recursive calls take time and consume additional memory.*



### Common Programming Error 18.2

*Accidentally having a nonrecursive method call itself either directly or indirectly through another method can cause infinite recursion.*

## 18.7 Towers of Hanoi

Earlier in this chapter we studied methods that can be easily implemented both recursively and iteratively. Now, we present a problem whose recursive solution demonstrates the elegance of recursion, and whose iterative solution may not be as apparent.

The **Towers of Hanoi** is one of the classic problems every budding computer scientist must grapple with. Legend has it that in a temple in the Far East, priests are attempting to

move a stack of golden disks from one diamond peg to another (Fig. 18.10). The initial stack has 64 disks threaded onto one peg and arranged from bottom to top by decreasing size. The priests are attempting to move the stack from one peg to another under the constraints that exactly one disk is moved at a time and at no time may a larger disk be placed above a smaller disk. Three pegs are provided, one being used for temporarily holding disks. Supposedly, the world will end when the priests complete their task, so there's little incentive for us to facilitate their efforts.

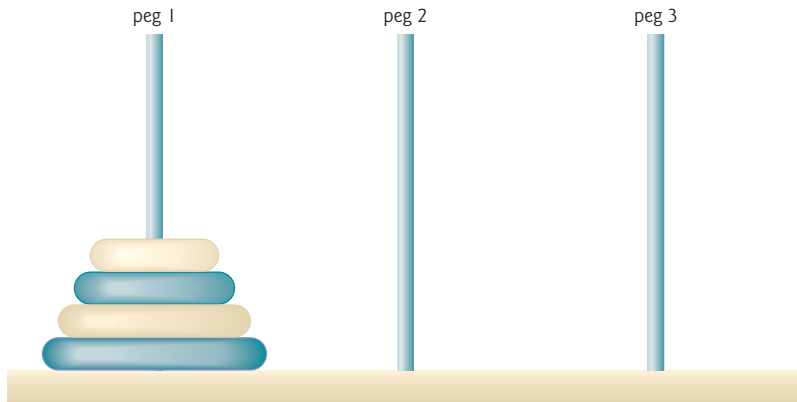

**Fig. 18.10** | Towers of Hanoi for the case with four disks.

Let's assume that the priests are attempting to move the disks from peg 1 to peg 3. We wish to develop an algorithm that prints the precise sequence of peg-to-peg disk transfers.

If we try to find an iterative solution, we'll likely find ourselves hopelessly “knotted up” in managing the disks. Instead, attacking this problem recursively quickly yields a solution. Moving  $n$  disks can be viewed in terms of moving only  $n - 1$  disks (hence the recursion) as follows:

1. Move  $n - 1$  disks from peg 1 to peg 2, using peg 3 as a temporary holding area.
2. Move the last disk (the largest) from peg 1 to peg 3.
3. Move  $n - 1$  disks from peg 2 to peg 3, using peg 1 as a temporary holding area.

The process ends when the last task involves moving  $n = 1$  disk (i.e., the base case). This task is accomplished by moving the disk, without using a temporary holding area.

In Fig. 18.11, method `solveTowers` (lines 6–25) solves the Towers of Hanoi, given the total number of disks (in this case 3), the starting peg, the ending peg, and the temporary holding peg as parameters. The base case (lines 10–14) occurs when only one disk needs to be moved from the starting peg to the ending peg. In the recursion step (lines 18–24), line 18 moves `disks - 1` disks from the first peg (`sourcePeg`) to the temporary holding peg (`tempPeg`). When all but one of the disks have been moved to the temporary peg, line 21 moves the largest disk from the start peg to the destination peg. Line 24 finishes the rest of the moves by calling the method `solveTowers` to recursively move `disks - 1` disks from the temporary peg (`tempPeg`) to the destination peg (`destinationPeg`), this time using the first peg (`sourcePeg`) as the temporary peg. Line 35 in `main` calls the recursive `solveTowers` method, which outputs the steps to the command prompt.



```

1 // Fig. 18.11: TowersOfHanoi.java
2 // Towers of Hanoi solution with a recursive method.
3 public class TowersOfHanoi
4 {
5 // recursively move disks between towers
6 public static void solveTowers(int disks, int sourcePeg,
7 int destinationPeg, int tempPeg)
8 {
9 // base case -- only one disk to move
10 if (disks == 1)
11 {
12 System.out.printf("\n%d --> %d", sourcePeg, destinationPeg);
13 return;
14 } // end if
15
16 // recursion step -- move (disk - 1) disks from sourcePeg
17 // to tempPeg using destinationPeg
18 solveTowers(disks - 1, sourcePeg, tempPeg, destinationPeg);
19
20 // move last disk from sourcePeg to destinationPeg
21 System.out.printf("\n%d --> %d", sourcePeg, destinationPeg);
22
23 // move (disks - 1) disks from tempPeg to destinationPeg
24 solveTowers(disks - 1, tempPeg, destinationPeg, sourcePeg);
25 } // end method solveTowers
26
27 public static void main(String[] args)
28 {
29 int startPeg = 1; // value 1 used to indicate startPeg in output
30 int endPeg = 3; // value 3 used to indicate endPeg in output
31 int tempPeg = 2; // value 2 used to indicate tempPeg in output
32 int totalDisks = 3; // number of disks
33
34 // initial nonrecursive call: move all disks.
35 towersOfHanoi.solveTowers(totalDisks, startPeg, endPeg, tempPeg);
36 } // end main
37 } // end class TowersOfHanoi

```

```

1 --> 3
1 --> 2
3 --> 2
1 --> 3
2 --> 1
2 --> 3
1 --> 3

```

**Fig. 18.11** | Towers of Hanoi solution with a recursive method.

## 18.8 Fractals

A **fractal** is a geometric figure that can be generated from a pattern repeated recursively (Fig. 18.12). The figure is modified by applying the pattern to each segment of the original figure. We'll look at a few such approximations in this section. [*Note:* We'll refer to our geometric figures as fractals, even though they're approximations.] Although these figures

had been studied before the 20th century, it was the mathematician Benoit Mandelbrot who in the 1970s introduced the term “fractal,” along with the specifics of how a fractal is created and the practical applications of fractals. Mandelbrot’s fractal geometry provides mathematical models for many complex forms found in nature, such as mountains, clouds and coastlines. Fractals have many uses in mathematics and science. They can be used to better understand systems or patterns that appear in nature (e.g., ecosystems), in the human body (e.g., in the folds of the brain), or in the universe (e.g., galaxy clusters). Not all fractals resemble objects in nature. Drawing fractals has become a popular art form. Fractals have a **self-similar property**—when subdivided into parts, each resembles a reduced-size copy of the whole. Many fractals yield an exact copy of the original when a portion of the fractal is magnified—such a fractal is said to be **strictly self-similar**. See our Recursion Resource Center ([www.deitel.com/recursion/](http://www.deitel.com/recursion/)) for websites that demonstrate fractals.

As an example, let’s look at the strictly self-similar **Koch Curve** fractal (Fig. 18.12). It’s formed by removing the middle third of each line in the drawing and replacing it with two lines that form a point, such that if the middle third of the original line remained, an equilateral triangle would be formed. Formulas for creating fractals often involve removing all or part of the previous fractal image. This pattern has already been determined for this fractal—we focus here on how to use those formulas in a recursive solution.

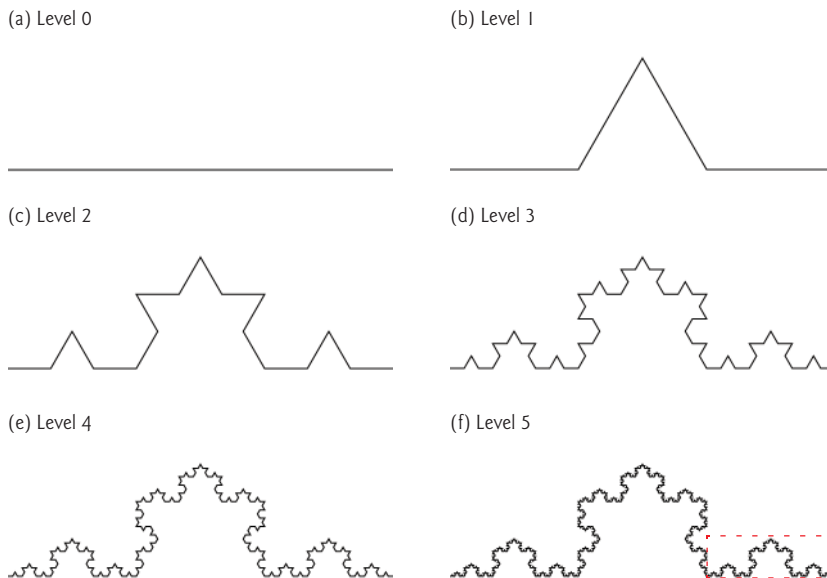

**Fig. 18.12** | Koch Curve fractal.

We start with a straight line (Fig. 18.12(a)) and apply the pattern, creating a triangle from the middle third (Fig. 18.12(b)). We then apply the pattern again to each straight line, resulting in Fig. 18.12(c). Each time the pattern is applied, we say that the fractal is at a new **level**, or **depth** (sometimes the term **order** is also used). Fractals can be displayed at many levels—for instance, a fractal at level 3 has had three iterations of the pattern applied (Fig. 18.12(d)). After only a few iterations, this fractal begins to look like a portion

of a snowflake (Fig. 18.12(e and f)). Since this is a strictly self-similar fractal, each portion of it contains an exact copy of the fractal. In Fig. 18.12(f), for example, we've highlighted a portion of the fractal with a dashed red box. If the image in this box were increased in size, it would look exactly like the entire fractal of part (f).

A similar fractal, the **Koch Snowflake**, is the same as the Koch Curve but begins with a triangle rather than a line. The same pattern is applied to each side of the triangle, resulting in an image that looks like an enclosed snowflake. For simplicity, we've chosen to focus on the Koch Curve. To learn more about the Koch Curve and Koch Snowflake, see the links in our Recursion Resource Center ([www.deitel.com/recursion/](http://www.deitel.com/recursion/)).

### The “Lo Fractal”

We now demonstrate the use of recursion to draw fractals by writing a program to create a strictly self-similar fractal. We call this the “Lo fractal,” named for Sin Han Lo, a Deitel & Associates colleague who created it. The fractal will eventually resemble one-half of a feather (see the outputs in Fig. 18.19). The base case, or fractal level of 0, begins as a line between two points, A and B (Fig. 18.13). To create the next higher level, we find the mid-point (C) of the line. To calculate the location of point C, use the following formula:

$$\begin{aligned}x_C &= (x_A + x_B) / 2; \\y_C &= (y_A + y_B) / 2;\end{aligned}$$

[*Note:* The  $x$  and  $y$  to the left of each letter refer to the  $x$ -coordinate and  $y$ -coordinate of that point, respectively. For instance,  $x_A$  refers to the  $x$ -coordinate of point A, while  $y_C$  refers to the  $y$ -coordinate of point C. In our diagrams we denote the point by its letter, followed by two numbers representing the  $x$ - and  $y$ -coordinates.]

To create this fractal, we also must find a point D that lies left of segment AC and creates an isosceles right triangle ADC. To calculate point D's location, use the following formulas:

$$\begin{aligned}x_D &= x_A + (x_C - x_A) / 2 - (y_C - y_A) / 2; \\y_D &= y_A + (y_C - y_A) / 2 + (x_C - x_A) / 2;\end{aligned}$$



**Fig. 18.13** | “Lo fractal” at level 0.

We now move from level 0 to level 1 as follows: First, add points C and D (as in Fig. 18.14). Then, remove the original line and add segments DA, DC and DB. The

remaining lines will curve at an angle, causing our fractal to look like a feather. For the next level of the fractal, this algorithm is repeated on each of the three lines in level 1. For each line, the formulas above are applied, where the former point D is now considered to be point A, while the other end of each line is considered to be point B. Figure 18.15 contains the line from level 0 (now a dashed line) and the three added lines from level 1. We've changed point D to be point A, and the original points A, C and B to B1, B2 and B3, respectively. The preceding formulas have been used to find the new points C and D on each line. These points are also numbered 1–3 to keep track of which point is associated with each line. The points C1 and D1, for instance, represent points C and D associated with the line formed from points A to B1. To achieve level 2, the three lines in Fig. 18.15 are removed and replaced with new lines from the C and D points just added. Figure 18.16 shows the new lines (the lines from level 2 are shown as dashed lines for your convenience). Figure 18.17 shows level 2 without the dashed lines from level 1. Once this process has been repeated several times, the fractal created will begin to look like one-half of a feather, as shown in the output of Fig. 18.19. We'll present the code for this application shortly.

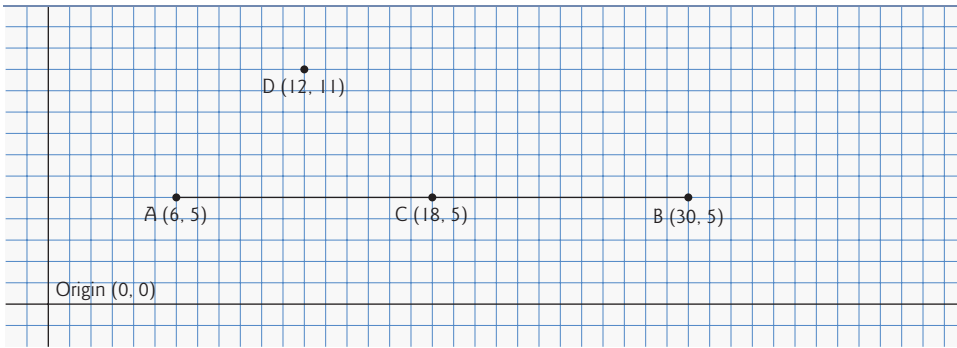

**Fig. 18.14** | Determining points C and D for level 1 of the “Lo fractal.”

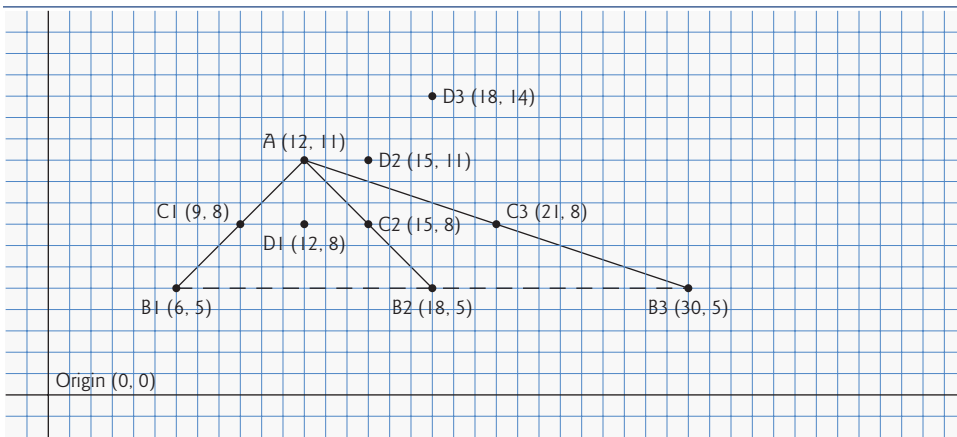

**Fig. 18.15** | “Lo fractal” at level 1, with C and D points determined for level 2. [Note: The fractal at level 0 is included as a dashed line as a reminder of where the line was located in relation to the current fractal.]

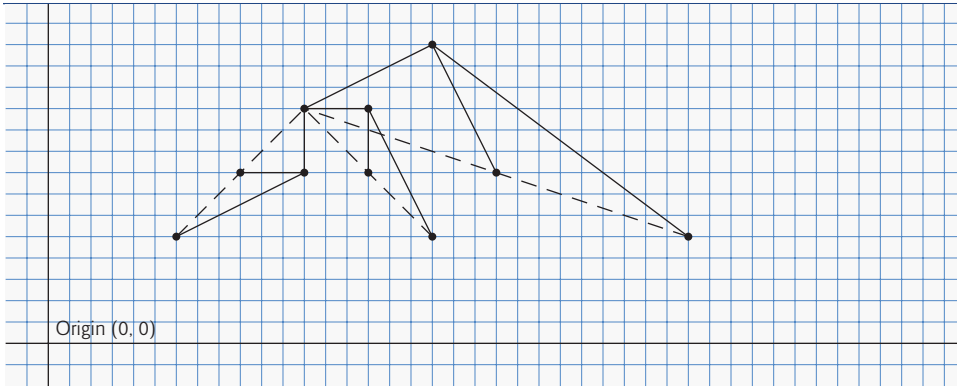

**Fig. 18.16** | “Lo fractal” at level 2, with dashed lines from level 1 provided.

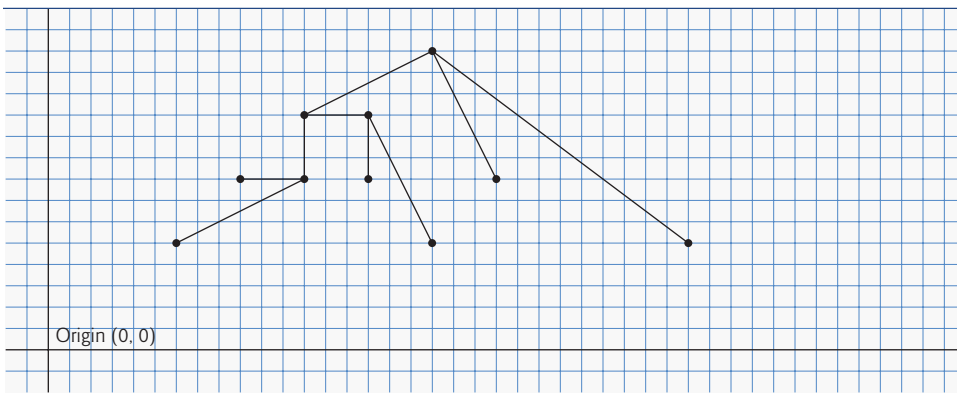

**Fig. 18.17** | “Lo fractal” at level 2.

The application in Fig. 18.18 defines the user interface for drawing this fractal (shown at the end of Fig. 18.19). The interface consists of three buttons—one for the user to change the color of the fractal, one to increase the level of recursion and one to decrease the level of recursion. A `JLabel` keeps track of the current level of recursion, which is modified by calling method `setLevel`, to be discussed shortly. Lines 15–16 specify constants `WIDTH` and `HEIGHT` to be 400 and 480, respectively, for the size of the `JFrame`. The user triggers an `ActionEvent` by clicking the **Color** button. The event handler for this button is registered in lines 37–53. The method `actionPerformed` displays a `JColorChooser`. This dialog returns the selected `Color` object or blue (if the user presses **Cancel** or closes the dialog without pressing **OK**). Line 50 calls the `setColor` method in class `FractalJPanel` to update the color.

```

1 // Fig. 18.18: Fractal.java
2 // Fractal user interface.
3 import java.awt.Color;
4 import java.awt.FlowLayout;
5 import java.awt.event.ActionEvent;

```

**Fig. 18.18** | Fractal user interface. (Part 1 of 4.)

```

6 import java.awt.event.ActionListener;
7 import javax.swing.JFrame;
8 import javax.swing.JButton;
9 import javax.swing.JLabel;
10 import javax.swing.JPanel;
11 import javax.swing.JColorChooser;
12
13 public class Fractal extends JFrame
14 {
15 private static final int WIDTH = 400; // define width of GUI
16 private static final int HEIGHT = 480; // define height of GUI
17 private static final int MIN_LEVEL = 0, MAX_LEVEL = 15;
18
19 private JButton changeColorJButton, increaseLevelJButton,
20 decreaseLevelJButton;
21 private JLabel levelJLabel;
22 private FractalJPanel drawSpace;
23 private JPanel mainJPanel, controlJPanel;
24
25 // set up GUI
26 public Fractal()
27 {
28 super("Fractal");
29
30 // set up control panel
31 controlJPanel = new JPanel();
32 controlJPanel.setLayout(new FlowLayout());
33
34 // set up color button and register listener
35 changeColorJButton = new JButton("Color");
36 controlJPanel.add(changeColorJButton);
37 changeColorJButton.addActionListener(
38 new ActionListener() // anonymous inner class
39 {
40 // process changeColorJButton event
41 public void actionPerformed(ActionEvent event)
42 {
43 Color color = JColorChooser.showDialog(
44 Fractal.this, "Choose a color", Color.BLUE);
45
46 // set default color, if no color is returned
47 if (color == null)
48 color = Color.BLUE;
49
50 drawSpace.setColor(color);
51 } // end method actionPerformed
52 } // end anonymous inner class
53); // end addActionListener
54
55 // set up decrease level button to add to control panel and
56 // register listener
57 decreaseLevelJButton = new JButton("Decrease Level");

```

**Fig. 18.18** | Fractal user interface. (Part 2 of 4.)

```

58 controlJPanel.add(decreaseLevelJButton);
59 decreaseLevelJButton.addActionListener(
60 new ActionListener() // anonymous inner class
61 {
62 // process decreaseLevelJButton event
63 public void actionPerformed((ActionEvent event)
64 {
65 int level = drawSpace.getLevel();
66 --level; // decrease level by one
67
68 // modify level if possible
69 if ((level >= MIN_LEVEL)) &&
70 (level <= MAX_LEVEL))
71 {
72 levelJLabel.setText("Level: " + level);
73 drawSpace.setLevel(level);
74 repaint();
75 } // end if
76 } // end method actionPerformed
77 } // end anonymous inner class
78); // end addActionListener
79
80 // set up increase level button to add to control panel
81 // and register listener
82 increaseLevelJButton = new JButton("Increase Level");
83 controlJPanel.add(increaseLevelJButton);
84 increaseLevelJButton.addActionListener(
85 new ActionListener() // anonymous inner class
86 {
87 // process increaseLevelJButton event
88 public void actionPerformed((ActionEvent event)
89 {
90 int level = drawSpace.getLevel();
91 ++level; // increase level by one
92
93 // modify level if possible
94 if ((level >= MIN_LEVEL)) &&
95 (level <= MAX_LEVEL))
96 {
97 levelJLabel.setText("Level: " + level);
98 drawSpace.setLevel(level);
99 repaint();
100 } // end if
101 } // end method actionPerformed
102 } // end anonymous inner class
103); // end addActionListener
104
105 // set up levelJLabel to add to controlJPanel
106 levelJLabel = new JLabel("Level: 0");
107 controlJPanel.add(levelJLabel);
108
109 drawSpace = new FractalJPanel(0);
110

```

**Fig. 18.18** | Fractal user interface. (Part 3 of 4.)

```

111 // create mainJPanel to contain controlJPanel and drawSpace
112 mainJPanel = new JPanel();
113 mainJPanel.add(controlJPanel);
114 mainJPanel.add(drawSpace);
115
116 add(mainJPanel); // add JPanel to JFrame
117
118 setSize(WIDTH, HEIGHT); // set size of JFrame
119 setVisible(true); // display JFrame
120 } // end Fractal constructor
121
122 public static void main(String[] args)
123 {
124 Fractal demo = new Fractal();
125 demo.setDefaultCloseOperation(JFrame.EXIT_ON_CLOSE);
126 } // end main
127 } // end class Fractal

```

**Fig. 18.18** | Fractal user interface. (Part 4 of 4.)

The **Decrease Level** button’s event handler is registered in lines 59–78. Method `actionPerformed` retrieves the current level of recursion and decrements it by 1 (lines 65–66). Lines 69–70 ensure that the level is greater than or equal to `MIN_LEVEL` and less than or equal to `MAX_LEVEL`—the fractal is not defined for recursion levels less than `MIN_LEVEL` and you can’t see the additional detail above `MAX_LEVEL`. You can go up to any desired level, but around level 10 and higher, the fractal rendering becomes slow due to the details to be drawn. Lines 72–74 reset the level label to reflect the change—the new level is set and the `repaint` method is called to update the image to show the fractal at the new level.

The **Increase Level** `JButton` works like the **Decrease Level** `JButton`, but the level is incremented rather than decremented to show more details of the fractal (lines 90–91). When the application is first executed, the level will be set to 0, which will display a blue line between two points that were specified in the `FractalJPanel` class.

Class `FractalJPanel` (Fig. 18.19) specifies the drawing `JPanel`’s dimensions as 400 by 400 (lines 13–14). The `FractalJPanel` constructor (lines 18–24) takes the current level as a parameter and assigns it to its instance variable `level`. Instance variable `color` is set to blue by default. Lines 22–23 change the `JPanel`’s background color to white (so the fractal is easy to see), and set the drawing `FractalJPanel`’s dimensions.

```

1 // Fig. 18.19: FractalJPanel.java
2 // Drawing the "Lo fractal" using recursion.
3 import java.awt.Graphics;
4 import java.awt.Color;
5 import java.awt.Dimension;
6 import javax.swing.JPanel;
7
8 public class FractalJPanel extends JPanel
9 {
10 private Color color; // stores color used to draw fractal
11 private int level; // stores current level of fractal

```

**Fig. 18.19** | Drawing the “Lo fractal” using recursion. (Part 1 of 4.)



```

12
13 private static final int WIDTH = 400; // defines width of JPanel
14 private static final int HEIGHT = 400; // defines height of JPanel
15
16 // set the initial fractal level to the value specified
17 // and set up JPanel specifications
18 public FractalJPanel(int currentLevel)
19 {
20 color = Color.BLUE; // initialize drawing color to blue
21 level = currentLevel; // set initial fractal level
22 setBackground(Color.WHITE);
23 setPreferredSize(new Dimension(WIDTH, HEIGHT));
24 } // end FractalJPanel constructor
25
26 // draw fractal recursively
27 public void drawFractal(int level, int xA, int yA, int xB,
28 int yB, Graphics g)
29 {
30 // base case: draw a line connecting two given points
31 if (level == 0)
32 g.drawLine(xA, yA, xB, yB);
33 else // recursion step: determine new points, draw next level
34 {
35 // calculate midpoint between (xA, yA) and (xB, yB)
36 int xC = (xA + xB) / 2;
37 int yC = (yA + yB) / 2;
38
39 // calculate the fourth point (xD, yD) which forms an
40 // isosceles right triangle between (xA, yA) and (xC, yC)
41 // where the right angle is at (xD, yD)
42 int xD = xA + (xC - xA) / 2 - (yC - yA) / 2;
43 int yD = yA + (yC - yA) / 2 + (xC - xA) / 2;
44
45 // recursively draw the Fractal
46 drawFractal(level - 1, xD, yD, xA, yA, g);
47 drawFractal(level - 1, xD, yD, xC, yC, g);
48 drawFractal(level - 1, xD, yD, xB, yB, g);
49 } // end else
50 } // end method drawFractal
51
52 // start drawing the fractal
53 public void paintComponent(Graphics g)
54 {
55 super.paintComponent(g);
56
57 // draw fractal pattern
58 g.setColor(color);
59 drawFractal(level, 100, 90, 290, 200, g);
60 } // end method paintComponent
61
62 // set the drawing color to c
63 public void setColor(Color c)
64 {

```

**Fig. 18.19** | Drawing the “Lo fractal” using recursion. (Part 2 of 4.)

```
65 color = c;
66 } // end method setColor
67
68 // set the new level of recursion
69 public void setLevel(int currentLevel)
70 {
71 level = currentLevel;
72 } // end method setLevel
73
74 // returns level of recursion
75 public int getLevel()
76 {
77 return level;
78 } // end method getLevel
79 } // end class FractalJPanel
```

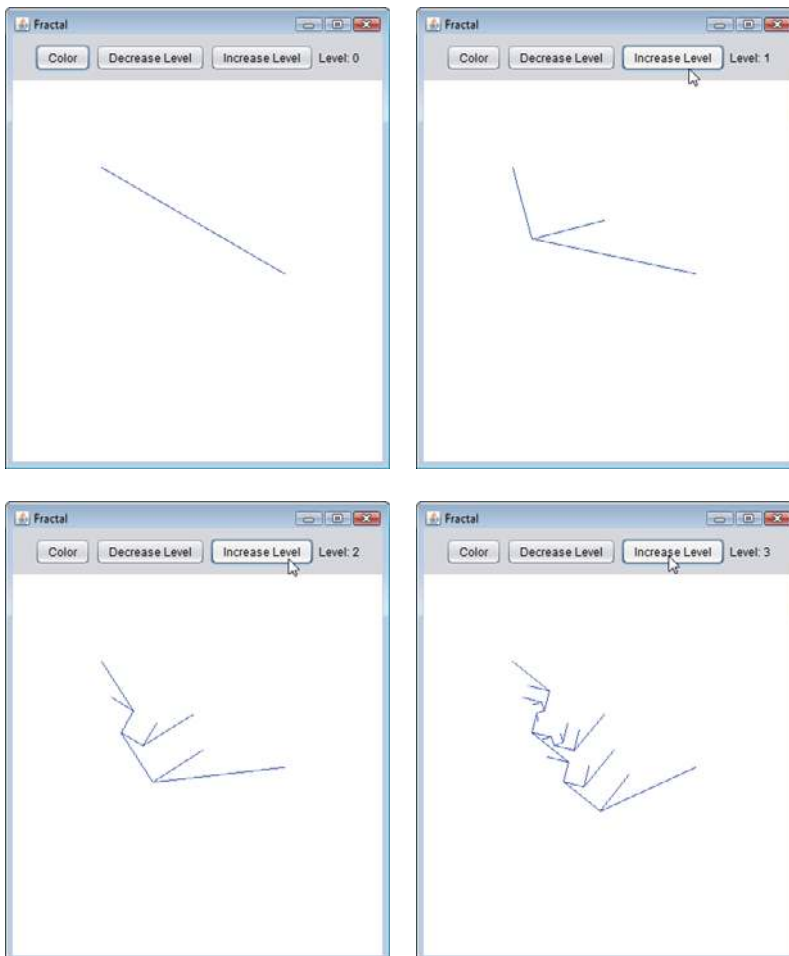

**Fig. 18.19** | Drawing the “Lo fractal” using recursion. (Part 3 of 4.)

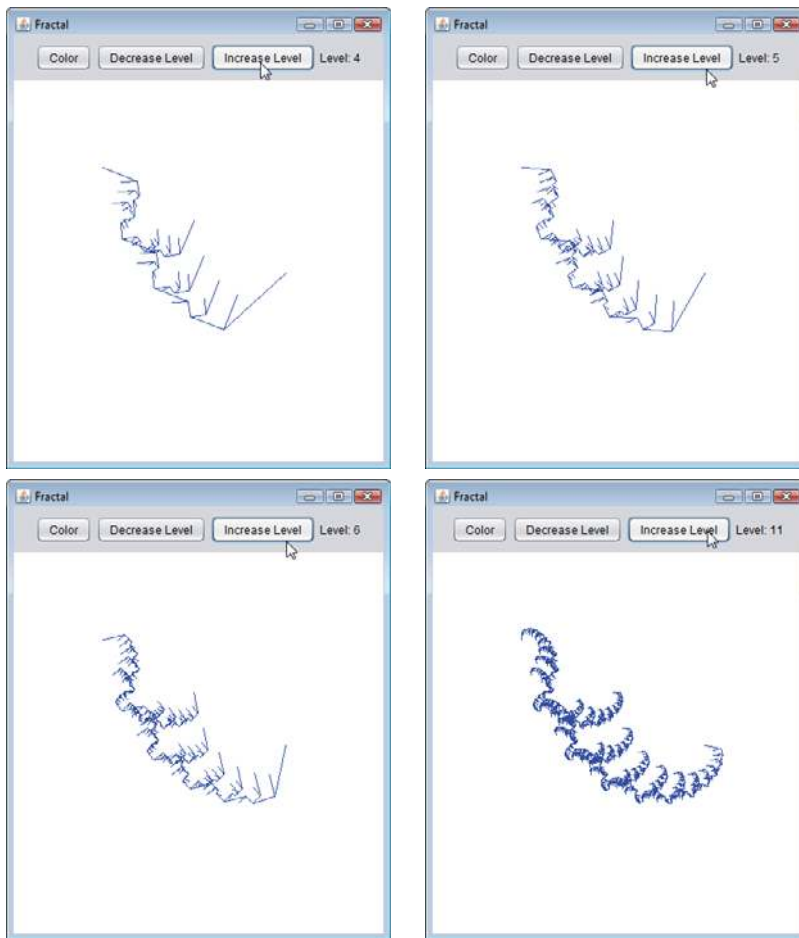

**Fig. 18.19** | Drawing the “Lo fractal” using recursion. (Part 4 of 4.)

Lines 27–50 define the recursive method that creates the fractal. This method takes six parameters: the level, four integers that specify the  $x$ - and  $y$ -coordinates of two points, and the `Graphics` object `g`. The base case for this method (line 31) occurs when `level` equals 0, at which time a line will be drawn between the two points given as parameters. Lines 36–43 calculate  $(x_C, y_C)$ , the midpoint between  $(x_A, y_A)$  and  $(x_B, y_B)$ , and  $(x_D, y_D)$ , the point that creates a right isosceles triangle with  $(x_A, y_A)$  and  $(x_C, y_C)$ . Lines 46–48 make three recursive calls on three different sets of points.

In method `paintComponent`, line 59 makes the first call to method `drawFractal` to start the drawing. This method call is not recursive, but all subsequent calls to `drawFractal` performed from the body of `drawFractal` are. Since the lines will not be drawn until the base case is reached, the distance between two points decreases on each recursive call. As the level of recursion increases, the fractal becomes smoother and more detailed. The shape of this fractal stabilizes as the level approaches 11. Fractals will stabilize at different levels based on their shape and size.

Figure 18.19 shows the development of the fractal from levels 0 to 6. The last image shows the defining shape of the fractal at level 11. If we focus on one of the arms of this fractal, it will be identical to the whole image. This property defines the fractal to be strictly self-similar. See our Recursion Resource Center at [www.deitel.com/recursion/](http://www.deitel.com/recursion/) for further resources on fractals.

## 18.9 Recursive Backtracking

Our recursive methods all have a similar architecture—if the base case is reached, return a result; if not, make one or more recursive calls. This section explores a more complex recursive technique that finds a path through a maze, returning true if there’s a possible solution. The solution involves moving through the maze one step at a time, where moves can be made by going down, right, up or left (diagonal moves are not permitted). From the current location in the maze (starting with the entry point), the following steps are taken: For each possible direction, the move is made in that direction and a recursive call is made to solve the remainder of the maze from the new location. When a dead end is reached (i.e., we cannot take any more steps forward without hitting a wall), we back up to the previous location and try to go in a different direction. If no other direction can be taken, we back up again. This process continues until we find a point in the maze where a move *can* be made in another direction. Once such a location is found, we move in the new direction and continue with another recursive call to solve the rest of the maze.

To back up to the previous location in the maze, our recursive method simply returns false, moving up the method-call chain to the previous recursive call (which references the previous location in the maze). Using recursion to return to an earlier decision point is known as **recursive backtracking**. If one set of recursive calls does not result in a solution to the problem, the program backs up to the previous decision point and makes a different decision, often resulting in another set of recursive calls. In this example, the previous decision point is the previous location in the maze, and the decision to be made is the direction that the next move should take. One direction has led to a dead end, so the search continues with a different direction. The recursive backtracking solution to the maze problem uses recursion to return only partway up the method-call chain, then try a different direction. If the backtracking reaches the entry location of the maze and the paths in all directions have been attempted, the maze does not have a solution.

The exercises ask you to implement recursive backtracking solutions to the maze problem (Exercises 18.20–18.22) and the Eight Queens problem (Exercise 18.15), which attempts to find a way to place eight queens on an empty chessboard so that no queen is “attacking” any other (i.e., no two queens are in the same row, in the same column or along the same diagonal).

## 18.10 Wrap-Up

In this chapter, you learned how to create recursive methods—i.e., methods that call themselves. You learned that recursive methods typically divide a problem into two conceptual pieces—a piece that the method knows how to do (the base case) and a piece that the method does not know how to do (the recursion step). The recursion step is a slightly smaller version of the original problem and is performed by a recursive method call. You saw some popular recursion examples, including calculating factorials and producing val-

ues in the Fibonacci series. You then learned how recursion works “under the hood,” including the order in which recursive method calls are pushed on or popped off the program-execution stack. Next, you compared recursive and iterative (nonrecursive) approaches. You learned how to use recursion to solve more complex problems—the Towers of Hanoi and displaying fractals. The chapter concluded with an introduction to recursive backtracking, a technique for solving problems that involves backing up through recursive calls to try different possible solutions. In the next chapter, you’ll learn numerous techniques for sorting lists of data and searching for an item in a list of data, and you’ll explore the circumstances under which each searching and sorting technique should be used.

## Summary

### *Section 18.1 Introduction*

- A recursive method (p. 766) calls itself directly or indirectly through another method.

### *Section 18.2 Recursion Concepts*

- When a recursive method is called (p. 767) to solve a problem, it can solve only the simplest case(s), or base case(s). If called with a base case (p. 767), the method returns a result.
- If a recursive method is called with a more complex problem than a base case, it typically divides the problem into two conceptual pieces—a piece that the method knows how to do and a piece that it does not know how to do.
- To make recursion feasible, the piece that the method does not know how to do must resemble the original problem, but be a slightly simpler or smaller version of it. Because this new problem looks like the original problem, the method calls a fresh copy of itself to work on the smaller problem—this is called the recursion step (p. 767).
- For recursion to eventually terminate, each time a method calls itself with a simpler version of the original problem, the sequence of smaller and smaller problems must converge on a base case. When, the method recognizes the base case, it returns a result to the previous copy of the method.
- A recursive call may be a call to another method, which in turn makes a call back to the original method. Such a process still results in a recursive call to the original method. This is known as an indirect recursive call or indirect recursion (p. 767).

### *Section 18.3 Example Using Recursion: Factorials*

- Either omitting the base case or writing the recursion step incorrectly so that it does not converge on the base case can cause infinite recursion (p. 769), eventually exhausting memory. This error is analogous to the problem of an infinite loop in an iterative (nonrecursive) solution.

### *Section 18.4 Example Using Recursion: Fibonacci Series*

- The Fibonacci series (p. 771) begins with 0 and 1 and has the property that each subsequent Fibonacci number is the sum of the preceding two.
- The ratio of successive Fibonacci numbers converges on a constant value of 1.618..., a number that has been called the golden ratio or the golden mean (p. 771).
- Some recursive solutions, such as Fibonacci, result in an “explosion” of method calls.

### *Section 18.5 Recursion and the Method-Call Stack*

- The executing method is always the one whose activation record is at the top of the stack, and the activation record for that method contains the values of its local variables.

**Section 18.6 Recursion vs. Iteration**

- Both iteration and recursion are based on a control statement: Iteration uses a repetition statement, recursion a selection statement.
- Both iteration and recursion involve repetition: Iteration explicitly uses a repetition statement, whereas recursion achieves repetition through repeated method calls.
- Iteration and recursion each involve a termination test: Iteration terminates when the loop-continuation condition fails, recursion when a base case is recognized.
- Iteration with counter-controlled repetition and recursion each gradually approach termination: Iteration keeps modifying a counter until the counter assumes a value that makes the loop-continuation condition fail, whereas recursion keeps producing simpler versions of the original problem until the base case is reached.
- Both iteration and recursion can occur infinitely: An infinite loop occurs with iteration if the loop-continuation test never becomes false, whereas infinite recursion occurs if the recursion step does not reduce the problem each time in a manner that converges on the base case.
- Recursion repeatedly invokes the mechanism, and consequently the overhead, of method calls.
- Any problem that can be solved recursively can also be solved iteratively.
- A recursive approach is normally preferred over an iterative approach when it more naturally mirrors the problem and results in a program that is easier to understand and debug.
- A recursive approach can often be implemented with few lines of code, but a corresponding iterative approach might take a large amount of code. Another reason to choose a recursive solution is that an iterative solution might not be apparent.

**Section 18.8 Fractals**

- A fractal (p. 779) is a geometric figure that is generated from a pattern repeated recursively an infinite number of times.
- Fractals have a self-similar property (p. 780)—subparts are reduced-size copies of the whole.

**Section 18.9 Recursive Backtracking**

- In recursive backtracking (p. 790), if one set of recursive calls does not result in a solution to the problem, the program backs up to the previous decision point and makes a different decision, often resulting in another set of recursive calls.

**Self-Review Exercises**

- 18.1** State whether each of the following is *true* or *false*. If *false*, explain why.
- A method that calls itself indirectly is not an example of recursion.
  - Recursion can be efficient in computation because of reduced memory-space usage.
  - When a recursive method is called to solve a problem, it actually is capable of solving only the simplest case(s), or base case(s).
  - To make recursion feasible, the recursion step in a recursive solution must resemble the original problem, but be a slightly larger version of it.
- 18.2** A \_\_\_\_\_ is needed to terminate recursion.
- recursion step
  - break statement
  - void return type
  - base case
- 18.3** The first call to invoke a recursive method is \_\_\_\_\_.
- not recursive

- b) recursive
  - c) the recursion step
  - d) none of the above
- 18.4** Each time a fractal's pattern is applied, the fractal is said to be at a new \_\_\_\_\_.
- a) width
  - b) height
  - c) level
  - d) volume
- 18.5** Iteration and recursion each involve a \_\_\_\_\_.
- a) repetition statement
  - b) termination test
  - c) counter variable
  - d) none of the above
- 18.6** Fill in the blanks in each of the following statements:
- a) The ratio of successive Fibonacci numbers converges on a constant value of 1.618..., a number that has been called the \_\_\_\_\_ or the \_\_\_\_\_.
  - b) Iteration normally uses a repetition statement, whereas recursion normally uses a(n) \_\_\_\_\_ statement.
  - c) Fractals have a(n) \_\_\_\_\_ property—when subdivided into parts, each is a reduced-size copy of the whole.

## Answers to Self-Review Exercises

**18.1** a) False. A method that calls itself in this manner is an example of indirect recursion. b) False. Recursion can be inefficient in computation because of multiple method calls and memory-space usage. c) True. d) False. To make recursion feasible, the recursion step in a recursive solution must resemble the original problem, but be a slightly *smaller* version of it.

**18.2** d

**18.3** a

**18.4** c

**18.5** b

**18.6** a) golden ratio, golden mean. b) selection. c) self-similar.

## Exercises

**18.7** What does the following code do?

```

1 public int mystery(int a, int b)
2 {
3 if (b == 1)
4 return a;
5 else
6 return a + mystery(a, b - 1);
7 } // end method mystery

```

**18.8** Find the error(s) in the following recursive method, and explain how to correct it (them). This method should find the sum of the values from 0 to n.

```

1 public int sum(int n)
2 {
3 if (n == 0)
4 return 0;
5 else
6 return n + sum(n);
7 } // end method sum

```

**18.9 (Recursive power Method)** Write a recursive method `power(base, exponent)` that, when called, returns

$$base^{exponent}$$

For example,  $power(3, 4) = 3 * 3 * 3 * 3$ . Assume that `exponent` is an integer greater than or equal to 1. [Hint: The recursion step should use the relationship

$$base^{exponent} = base \cdot base^{exponent-1}$$

and the terminating condition occurs when `exponent` is equal to 1, because

$$base^1 = base$$

Incorporate this method into a program that enables the user to enter the base and exponent.]

**18.10 (Visualizing Recursion)** It's interesting to watch recursion "in action." Modify the factorial method in Fig. 18.3 to print its local variable and recursive-call parameter. For each recursive call, display the outputs on a separate line and add a level of indentation. Do your utmost to make the outputs clear, interesting and meaningful. Your goal here is to design and implement an output format that makes it easier to understand recursion. You may want to add such display capabilities to other recursion examples and exercises throughout the text.

**18.11 (Greatest Common Divisor)** The greatest common divisor of integers `x` and `y` is the largest integer that evenly divides into both `x` and `y`. Write a recursive method `gcd` that returns the greatest common divisor of `x` and `y`. The `gcd` of `x` and `y` is defined recursively as follows: If `y` is equal to 0, then `gcd(x, y)` is `x`; otherwise, `gcd(x, y)` is `gcd(y, x % y)`, where `%` is the remainder operator. Use this method to replace the one you wrote in the application of Exercise 6.27.

**18.12** What does the following program do?

```

1 // Exercise 18.12 Solution: MysteryClass.java
2 public class MysteryClass
3 {
4 public static int mystery(int[] array2, int size)
5 {
6 if (size == 1)
7 return array2[0];
8 else
9 return array2[size - 1] + mystery(array2, size - 1);
10 } // end method mystery
11
12 public static void main(String[] args)
13 {
14 int[] array = { 1, 2, 3, 4, 5, 6, 7, 8, 9, 10 };
15
16 int result = mystery(array, array.length);
17 System.out.printf("Result is: %d\n", result);
18 } // end method main
19 } // end class MysteryClass

```



**18.13** What does the following program do?

```

1 // Exercise 18.13 Solution: SomeClass.java
2 public class SomeClass
3 {
4 public static String someMethod(int[] array2, int x)
5 {
6 if (x < array2.length)
7 return String.format(
8 "%s%d ", someMethod(array2, x + 1), array2[x]);
9 else
10 return "";
11 } // end method someMethod
12
13 public static void main(String[] args)
14 {
15 int[] array = { 1, 2, 3, 4, 5, 6, 7, 8, 9, 10 };
16 String results = someMethod(array, 0);
17 System.out.println(results);
18 } // end main
19 } // end class SomeClass

```

**18.14** (*Palindromes*) A palindrome is a string that is spelled the same way forward and backward. Some examples of palindromes are “radar,” “able was i ere i saw elba” and (if spaces are ignored) “a man a plan a canal panama.” Write a recursive method `testPalindrome` that returns `boolean` value `true` if the string stored in the array is a palindrome and `false` otherwise. The method should ignore spaces and punctuation in the string.

**18.15** (*Eight Queens*) A puzzler for chess buffs is the Eight Queens problem, which asks: Is it possible to place eight queens on an empty chessboard so that no queen is “attacking” any other (i.e., no two queens are in the same row, in the same column or along the same diagonal)? For instance, if a queen is placed in the upper-left corner of the board, no other queens could be placed in any of the marked squares shown in Fig. 18.20. Solve the problem recursively. [*Hint*: Your solution should begin with the first column and look for a location in that column where a queen can be placed—initially, place the queen in the first row. The solution should then recursively search the remaining columns. In the first few columns, there will be several locations where a queen may be placed. Take the first available location. If a column is reached with no possible location for a queen, the program should return to the previous column, and move the queen in that column to a new row. This continuous backing up and trying new alternatives is an example of recursive backtracking.]

**18.16** (*Print an Array*) Write a recursive method `printArray` that displays all the elements in an array of integers, separated by spaces.

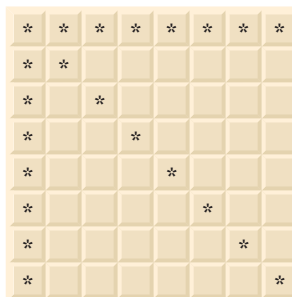
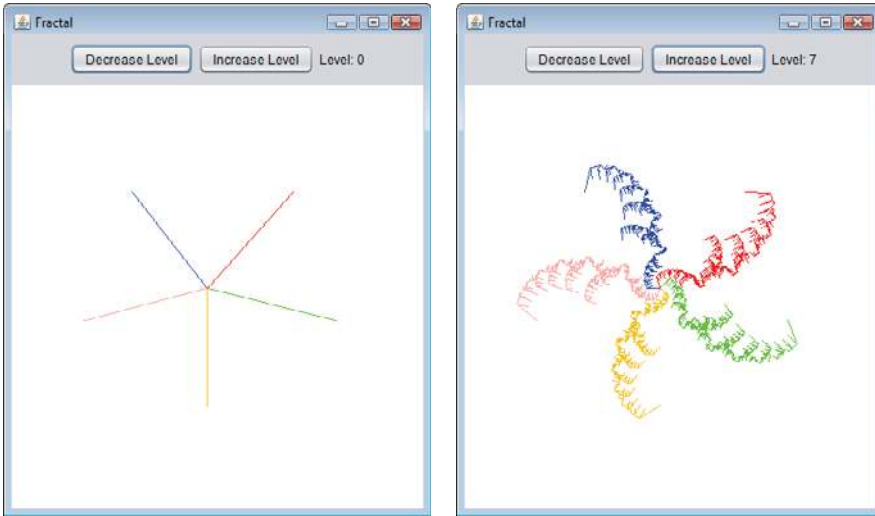

**Fig. 18.20** | Squares eliminated by placing a queen in the upper-left corner of a chessboard.

**18.17** (*Print an Array Backward*) Write a recursive method `stringReverse` that takes a character array containing a string as an argument and prints the string backward. [*Hint*: Use `String` method `toCharArray`, which takes no arguments, to get a char array containing the characters in the `String`.]

**18.18** (*Find the Minimum Value in an Array*) Write a recursive method `recursiveMinimum` that determines the smallest element in an array of integers. The method should return when it receives an array of one element.

**18.19** (*Fractals*) Repeat the fractal pattern in Section 18.8 to form a star. Begin with five lines (see Fig. 18.21) instead of one, where each line is a different arm of the star. Apply the “Lo fractal” pattern to each arm of the star.



**Fig. 18.21** | Sample outputs for Exercise 18.19.

**18.20** (*Maze Traversal Using Recursive Backtracking*) The grid of #s and dots (.) in Fig. 18.22 is a two-dimensional array representation of a maze. The #s represent the walls of the maze, and the dots represent locations in the possible paths through the maze. A move can be made only to a location in the array that contains a dot.

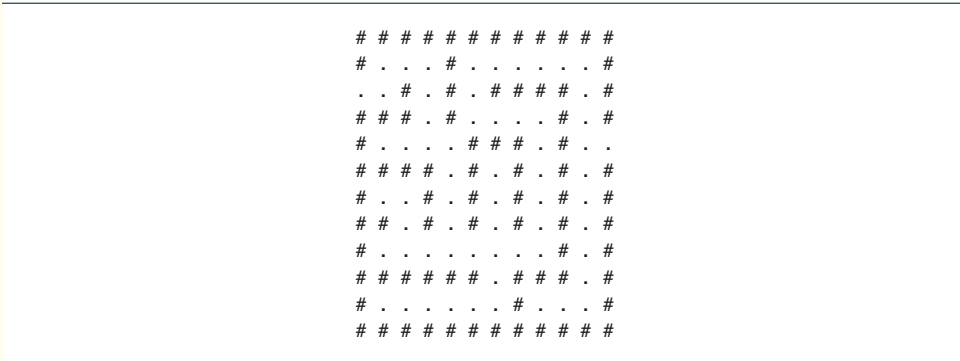

**Fig. 18.22** | Two-dimensional array representation of a maze.

Write a recursive method (`mazeTraverse1`) to walk through mazes like the one in Fig. 18.22. The method should receive as arguments a 12-by-12 character array representing the maze and the current location in the maze (the first time this method is called, the current location should be the entry point of the maze). As `mazeTraverse1` attempts to locate the exit, it should place the character `x` in each square in the path. There's a simple algorithm for walking through a maze that guarantees finding the exit (assuming there's an exit). If there's no exit, you'll arrive at the starting location again. The algorithm is as follows: From the current location in the maze, try to move one space in any of the possible directions (down, right, up or left). If it's possible to move in at least one direction, call `mazeTraverse1` recursively, passing the new spot on the maze as the current spot. If it's not possible to go in any direction, "back up" to a previous location in the maze and try a new direction for that location (this is an example of recursive backtracking). Program the method to display the maze after each move so the user can watch as the maze is solved. The final output of the maze should display only the path needed to solve the maze—if going in a particular direction results in a dead end, the `x`'s going in that direction should not be displayed. [*Hint*: To display only the final path, it may be helpful to mark off spots that result in a dead end with another character (such as 'o').]

**18.21** (*Generating Mazes Randomly*) Write a method `mazeGenerator` that takes as an argument a two-dimensional 12-by-12 character array and randomly produces a maze. The method should also provide the starting and ending locations of the maze. Test your method `mazeTraverse1` from Exercise 18.20, using several randomly generated mazes.

**18.22** (*Mazes of Any Size*) Generalize methods `mazeTraverse1` and `mazeGenerator` of Exercise 18.20 and Exercise 18.21 to process mazes of any width and height.

**18.23** (*Time to Calculate Fibonacci Numbers*) Enhance the Fibonacci program of Fig. 18.5 so that it calculates the approximate amount of time required to perform the calculation and the number of calls made to the recursive method. For this purpose, call static `System` method `currentTimeMillis`, which takes no arguments and returns the computer's current time in milliseconds. Call this method twice—once before and once after the call to `fibonacci`. Save each value and calculate the difference in the times to determine how many milliseconds were required to perform the calculation. Then, add a variable to the `FibonacciCalculator` class, and use this variable to determine the number of calls made to method `fibonacci`. Display your results.

# 19

## Searching, Sorting and Big O

*With sobs and tears he sorted out  
Those of the largest size ...*

—Lewis Carroll

*Attempt the end, and never  
stand to doubt;  
Nothing's so hard, but search  
will find it out.*

—Robert Herrick

*'Tis in my memory lock'd,  
And you yourself shall keep the  
key of it.*

—William Shakespeare

*It is an immutable law in  
business that words are words,  
explanations are explanations,  
promises are promises — but  
only performance is reality.*

—Harold S. Green

### Objectives

In this chapter you'll learn:

- To search for a given value in an array using linear search and binary search.
- To sort arrays using the iterative selection and insertion sort algorithms.
- To sort arrays using the recursive merge sort algorithm.
- To determine the efficiency of searching and sorting algorithms.

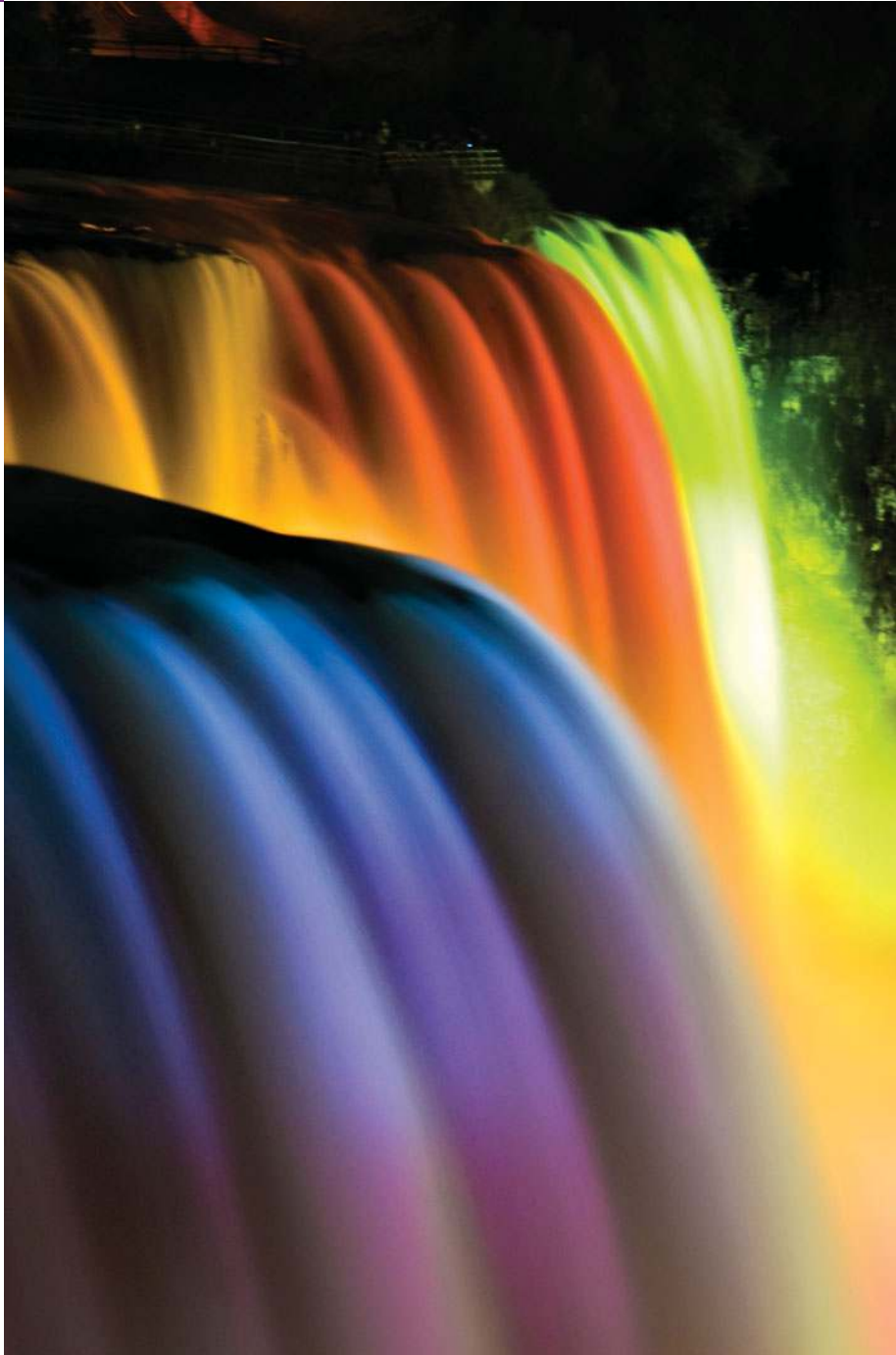

- |                                                                                                                                 |                                                                                                                                                     |
|---------------------------------------------------------------------------------------------------------------------------------|-----------------------------------------------------------------------------------------------------------------------------------------------------|
| <p><b>19.1</b> Introduction</p> <p><b>19.2</b> Searching Algorithms</p> <p>19.2.1 Linear Search</p> <p>19.2.2 Binary Search</p> | <p><b>19.3</b> Sorting Algorithms</p> <p>19.3.1 Selection Sort</p> <p>19.3.2 Insertion Sort</p> <p>19.3.3 Merge Sort</p> <p><b>19.4</b> Wrap-Up</p> |
|---------------------------------------------------------------------------------------------------------------------------------|-----------------------------------------------------------------------------------------------------------------------------------------------------|

*Summary | Self-Review Exercises | Answers to Self-Review Exercises | Exercises*

## 19.1 Introduction

**Searching** data involves determining whether a value (referred to as the **search key**) is present in the data and, if so, finding its location. Two popular search algorithms are the simple linear search and the faster but more complex binary search. **Sorting** places data in ascending or descending order, based on one or more **sort keys**. A list of names could be sorted alphabetically, bank accounts could be sorted by account number, employee payroll records could be sorted by social security number, and so on. This chapter introduces two simple sorting algorithms, the selection sort and the insertion sort, along with the more efficient but more complex merge sort. The Java Collections API (Chapter 20) provides various built-in searching and sorting capabilities. Figure 19.1 summarizes the searching and sorting algorithms discussed in the examples and exercises of this book.

| Chapter                      | Algorithm                                | Location                |
|------------------------------|------------------------------------------|-------------------------|
| <i>Searching Algorithms:</i> |                                          |                         |
| 19                           | Linear search                            | Section 19.2.1          |
|                              | Binary search                            | Section 19.2.2          |
|                              | Recursive linear search                  | Exercise 19.8           |
|                              | Recursive binary search                  | Exercise 19.9           |
| 20                           | binarySearch method of class Collections | Fig. 20.12              |
| 22                           | Linear search of a List                  | Exercise 22.21          |
|                              | Binary tree search                       | Exercise 22.23          |
| <i>Sorting Algorithms:</i>   |                                          |                         |
| 19                           | Selection sort                           | Section 19.3.1          |
|                              | Insertion sort                           | Section 19.3.2          |
|                              | Recursive merge sort                     | Section 19.3.3          |
|                              | Bubble sort                              | Exercises 19.5 and 19.6 |
|                              | Bucket sort                              | Exercise 19.7           |
|                              | Recursive quicksort                      | Exercise 19.10          |
| 20                           | sort method of class Collections         | Figs. 20.6–20.9         |
|                              | SortedSet collection                     | Fig. 20.17              |
| 22                           | Binary tree sort                         | Section 22.7            |

**Fig. 19.1** | Searching and sorting algorithms covered in this text.

## 19.2 Searching Algorithms

Looking up a phone number, finding a website via a search engine and checking the definition of a word in a dictionary all involve searching large amounts of data. The next two sections discuss two common search algorithms—one that is easy to program yet relatively inefficient and one that is relatively efficient but more complex and difficult to program.

### 19.2.1 Linear Search

The **linear search algorithm** searches each element in an array sequentially. If the search key does not match an element in the array, the algorithm tests each element, and when the end of the array is reached, informs the user that the search key is not present. If the search key is in the array, the algorithm tests each element until it finds one that matches the search key and returns the index of that element.

As an example, consider an array containing the following values

```
34 56 2 10 77 51 93 30 5 52
```

and a program that is searching for 51. Using the linear search algorithm, the program first checks whether 34 matches the search key. It does not, so the algorithm checks whether 56 matches the search key. The program continues moving through the array sequentially, testing 2, then 10, then 77. When the program tests 51, which matches the search key, the program returns the index 5, which is the location of 51 in the array. If, after checking every array element, the program determines that the search key does not match any element in the array, it returns a sentinel value (e.g., -1).

Figure 19.2 declares the `LinearArray` class. This class has two private instance variables—an array of ints named `data`, and a static `Random` object to fill the array with randomly generated ints. When an object of class `LinearArray` is instantiated, the constructor (lines 13–20) creates and initializes the array `data` with random ints in the range 10–99. If there are *duplicate* values in the array, linear search returns the index of the *first* element in the array that matches the search key.

---

```

1 // Fig. 19.2: LinearArray.java
2 // Class that contains an array of random integers and a method
3 // that will search that array sequentially.
4 import java.util.Random;
5 import java.util.Arrays;
6
7 public class LinearArray
8 {
9 private int[] data; // array of values
10 private static final Random generator = new Random();
11
12 // create array of given size and fill with random numbers
13 public LinearArray(int size)
14 {
15 data = new int[size]; // create space for array
16

```

---

**Fig. 19.2** | Class that contains an array of random integers and a method that will search that array sequentially. (Part 1 of 2.)

---

```

17 // fill array with random ints in range 10-99
18 for (int i = 0; i < size; i++)
19 data[i] = 10 + generator.nextInt(90);
20 } // end LinearArray constructor
21
22 // perform a linear search on the data
23 public int linearSearch(int searchKey)
24 {
25 // loop through array sequentially
26 for (int index = 0; index < data.length; index++)
27 if (data[index] == searchKey)
28 return index; // return index of integer
29
30 return -1; // integer was not found
31 } // end method linearSearch
32
33 // method to output values in array
34 public String toString()
35 {
36 return Arrays.toString(data);
37 } // end method toString
38 } // end class LinearArray

```

---

**Fig. 19.2** | Class that contains an array of random integers and a method that will search that array sequentially. (Part 2 of 2.)

Lines 23–31 perform the linear search. The search key is passed to parameter `searchKey`. Lines 26–28 loop through the elements in the array. Line 27 compares each with `searchKey`. If the values are equal, line 28 returns the *index* of the element. If the loop ends without finding the value, line 30 returns -1. Lines 34–37 declare method `toString`, which uses `Arrays` static method `toString` to return a `String` representation of the array.

Figure 19.3 creates a `LinearArray` object containing an array of 10 ints (line 16) and allows the user to search the array. Lines 20–22 prompt the user for and store the search key. The array holds ints from 10–99 (line 19 of Fig. 19.2). Line 28 calls method `linearSearch` to determine whether `searchInt` is in the array. If it's not, `linearSearch` returns -1 and the program notifies the user (lines 31–32). If `searchInt` is in the array, `linearSearch` returns the position of the element, which the program outputs in lines 34–35. Lines 38–40 retrieve the next integer from the user.

---

```

1 // Fig. 19.3: LinearSearchTest.java
2 // Sequentially searching an array for an item.
3 import java.util.Scanner;
4
5 public class LinearSearchTest
6 {
7 public static void main(String[] args)
8 {
9 // create Scanner object to input data
10 Scanner input = new Scanner(System.in);

```

---

**Fig. 19.3** | Sequentially searching an array for an item. (Part 1 of 2.)

```

11
12 int searchInt; // search key
13 int position; // location of search key in array
14
15 // create array and output it
16 LinearArray searchArray = new LinearArray(10);
17 System.out.println(searchArray + "\n"); // print array
18
19 // get input from user
20 System.out.print(
21 "Please enter an integer value (-1 to quit): ");
22 searchInt = input.nextInt(); // read first int from user
23
24 // repeatedly input an integer; -1 terminates the program
25 while (searchInt != -1)
26 {
27 // perform linear search
28 position = searchArray.linearSearch(searchInt);
29
30 if (position == -1) // integer was not found
31 System.out.println("The integer " + searchInt +
32 " was not found.\n");
33 else // integer was found
34 System.out.println("The integer " + searchInt +
35 " was found in position " + position + ".\n");
36
37 // get input from user
38 System.out.print(
39 "Please enter an integer value (-1 to quit): ");
40 searchInt = input.nextInt(); // read next int from user
41 } // end while
42 } // end main
43 } // end class LinearSearchTest

```

```

[59, 97, 34, 90, 79, 56, 24, 51, 30, 69]
Please enter an integer value (-1 to quit): 79
The integer 79 was found in position 4.

Please enter an integer value (-1 to quit): 61
The integer 61 was not found.

Please enter an integer value (-1 to quit): 51
The integer 51 was found in position 7.

Please enter an integer value (-1 to quit): -1

```

**Fig. 19.3** | Sequentially searching an array for an item. (Part 2 of 2.)

### *Efficiency of Linear Search*

Searching algorithms all accomplish the same goal—finding an element that matches a given search key, if such an element does, in fact, exist. There are, however, a number of things that differentiate search algorithms from one another. *The major difference is the amount of effort they require to complete the search.* One way to describe this effort is with **Big O notation**, which indicates the worst-case run time for an algorithm—that is, how



hard an algorithm may have to work to solve a problem. For searching and sorting algorithms, this depends particularly on how many data elements there are.

### *O(1) Algorithms*

Suppose an algorithm is designed to test whether the first element of an array is equal to the second. If the array has 10 elements, this algorithm requires one comparison. If the array has 1000 elements, it still requires one comparison. In fact, the algorithm is completely independent of the number of elements in the array. This algorithm is said to have a **constant run time**, which is represented in Big O notation as  $O(1)$ . An algorithm that is  $O(1)$  does not necessarily require only one comparison.  $O(1)$  just means that the number of comparisons is *constant*—it does not grow as the size of the array increases. An algorithm that tests whether the first element of an array is equal to any of the next three elements is still  $O(1)$  even though it requires three comparisons.

### *O(n) Algorithms*

An algorithm that tests whether the first array element is equal to *any* of the other array elements will require at most  $n - 1$  comparisons, where  $n$  is the number of array elements. If the array has 10 elements, this algorithm requires up to nine comparisons. If the array has 1000 elements, it requires up to 999 comparisons. As  $n$  grows larger, the  $n$  part of the expression “dominates,” and subtracting one becomes inconsequential. Big O is designed to highlight these dominant terms and ignore terms that become unimportant as  $n$  grows. For this reason, an algorithm that requires a total of  $n - 1$  comparisons (such as the one we described earlier) is said to be  $O(n)$ . An  $O(n)$  algorithm is referred to as having a **linear run time**.  $O(n)$  is often pronounced “on the order of  $n$ ” or simply “order  $n$ .”

### *O(n<sup>2</sup>) Algorithms*

Now suppose you have an algorithm that tests whether *any* element of an array is duplicated elsewhere in the array. The first element must be compared with every other element in the array. The second element must be compared with every other element except the first (it was already compared to the first). The third element must be compared with every other element except the first two. In the end, this algorithm will end up making  $(n - 1) + (n - 2) + \dots + 2 + 1$  or  $n^2/2 - n/2$  comparisons. As  $n$  increases, the  $n^2$  term dominates and the  $n$  term becomes inconsequential. Again, Big O notation highlights the  $n^2$  term, leaving  $n^2/2$ . But, as we’ll soon see, constant factors are omitted in Big O notation.

Big O is concerned with how an algorithm’s run time grows in relation to the number of items processed. Suppose an algorithm requires  $n^2$  comparisons. With four elements, the algorithm requires 16 comparisons; with eight elements, 64 comparisons. With this algorithm, *doubling* the number of elements *quadruples* the number of comparisons. Consider a similar algorithm requiring  $n^2/2$  comparisons. With four elements, the algorithm requires eight comparisons; with eight elements, 32 comparisons. Again, *doubling* the number of elements *quadruples* the number of comparisons. Both of these algorithms grow as the square of  $n$ , so Big O ignores the constant and both algorithms are considered to be  $O(n^2)$ , which is referred to as **quadratic run time** and pronounced “on the order of  $n$ -squared” or more simply “order  $n$ -squared.”

When  $n$  is small,  $O(n^2)$  algorithms (running on today’s computers) will not noticeably affect performance. But as  $n$  grows, you’ll start to notice the performance degradation. An  $O(n^2)$  algorithm running on a million-element array would require a trillion “operations”

(where each could actually require several machine instructions to execute). This could take several hours. A billion-element array would require a quintillion operations, a number so large that the algorithm could take decades!  $O(n^2)$  algorithms, unfortunately, are easy to write, as you'll see in this chapter. You'll also see algorithms with more favorable Big O measures. These efficient algorithms often take a bit more cleverness and work to create, but their superior performance can be well worth the extra effort, especially as  $n$  gets large and as algorithms are combined into larger programs.

### Big O of the Linear Search

The linear search algorithm runs in  $O(n)$  time. The worst case in this algorithm is that every element must be checked to determine whether the search item exists in the array. If the size of the array is *doubled*, the number of comparisons that the algorithm must perform is also *doubled*. Linear search can provide outstanding performance if the element matching the search key happens to be at or near the front of the array. But we seek algorithms that perform well, on average, across *all* searches, including those where the element matching the search key is near the end of the array.

Linear search is easy to program, but it can be slow compared to other search algorithms. If a program needs to perform many searches on large arrays, it's better to implement a more efficient algorithm, such as the binary search, which we present next.



#### Performance Tip 19.1

*Sometimes the simplest algorithms perform poorly. Their virtue is that they're easy to program, test and debug. Sometimes more complex algorithms are required to realize maximum performance.*

### 19.2.2 Binary Search

The **binary search algorithm** is more efficient than linear search, but it requires that the array be sorted. The first iteration of this algorithm tests the *middle* element in the array. If this matches the search key, the algorithm ends. Assuming the array is sorted in *ascending* order, then if the search key is *less than* the middle element, it cannot match any element in the second half of the array and the algorithm continues with only the first half of the array (i.e., the first element up to, but not including, the middle element). If the search key is *greater than* the middle element, it cannot match any element in the first half of the array and the algorithm continues with only the second half (i.e., the element *after* the middle element through the last element). Each iteration tests the middle value of the remaining portion of the array. If the search key does not match the element, the algorithm eliminates half of the remaining elements. The algorithm ends by either finding an element that matches the search key or reducing the subarray to zero size.

As an example consider the sorted 15-element array

2 3 5 10 27 30 34 51 56 65 77 81 82 93 99

and a search key of 65. A program implementing the binary search algorithm would first check whether 51 is the search key (because 51 is the *middle* element of the array). The search key (65) is larger than 51, so 51 is ignored along with the first half of the array (all elements smaller than 51), leaving

56 65 77 81 82 93 99

Next, the algorithm checks whether 81 (the middle element of the remainder of the array) matches the search key. The search key (65) is smaller than 81, so 81 is discarded along with the elements larger than 81. After just two tests, the algorithm has narrowed the number of values to check to only three (56, 65 and 77). It then checks 65 (which indeed matches the search key) and returns the index of the array element containing 65. This algorithm required just three comparisons to determine whether the search key matched an element of the array. Using a linear search algorithm would have required 10 comparisons. [*Note:* In this example, we've chosen to use an array with 15 elements so that there will always be an obvious middle element in the array. With an even number of elements, the middle of the array lies between two elements. We implement the algorithm to choose the higher of those two elements.]

### Binary Search Implementation

Figure 19.4 declares class `BinaryArray`. This class is similar to `LinearArray`—it has two private instance variables, a constructor, a search method (`binarySearch`), a `remainingElements` method and a `toString` method. Lines 13–22 declare the constructor. After the array has been initialized with random ints from 10–99 (lines 18–19), line 21 calls the `Arrays.sort` method on the array data. The **sort method** is a static method of class `Arrays` that sorts the elements in an array in ascending order by default; an overloaded version of this method allows you to change the sorting order. Recall that the binary search algorithm will work only on a sorted array.

---

```

1 // Fig. 19.4: BinaryArray.java
2 // Class that contains an array of random integers and a method
3 // that uses binary search to find an integer.
4 import java.util.Random;
5 import java.util.Arrays;
6
7 public class BinaryArray
8 {
9 private int[] data; // array of values
10 private static final Random generator = new Random();
11
12 // create array of given size and fill with random integers
13 public BinaryArray(int size)
14 {
15 data = new int[size]; // create space for array
16
17 // fill array with random ints in range 10-99
18 for (int i = 0; i < size; i++)
19 data[i] = 10 + generator.nextInt(90);
20
21 Arrays.sort(data);
22 } // end BinaryArray constructor
23
24 // perform a binary search on the data
25 public int binarySearch(int searchElement)
26 {

```

**Fig. 19.4** | Class that contains an array of random integers and a method that uses binary search to find an integer. (Part I of 3.)

```

27 int low = 0; // low end of the search area
28 int high = data.length - 1; // high end of the search area
29 int middle = (low + high + 1) / 2; // middle element
30 int location = -1; // return value; -1 if not found
31
32 do // loop to search for element
33 {
34 // print remaining elements of array
35 System.out.print(remainingElements(low, high));
36
37 // output spaces for alignment
38 for (int i = 0; i < middle; i++)
39 System.out.print(" ");
40 System.out.println(" * "); // indicate current middle
41
42 // if the element is found at the middle
43 if (searchElement == data[middle])
44 location = middle; // location is the current middle
45
46 // middle element is too high
47 else if (searchElement < data[middle])
48 high = middle - 1; // eliminate the higher half
49 else // middle element is too low
50 low = middle + 1; // eliminate the lower half
51
52 middle = (low + high + 1) / 2; // recalculate the middle
53 } while ((low <= high) && (location == -1));
54
55 return location; // return location of search key
56 } // end method binarySearch
57
58 // method to output certain values in array
59 public String remainingElements(int low, int high)
60 {
61 StringBuilder temporary = new StringBuilder();
62
63 // output spaces for alignment
64 for (int i = 0; i < low; i++)
65 temporary.append(" ");
66
67 // output elements left in array
68 for (int i = low; i <= high; i++)
69 temporary.append(data[i] + " ");
70
71 temporary.append("\n");
72 return temporary.toString();
73 } // end method remainingElements
74
75 // method to output values in array
76 public String toString()
77 {

```

**Fig. 19.4** | Class that contains an array of random integers and a method that uses binary search to find an integer. (Part 2 of 3.)

---

```

78 return remainingElements(0, data.length - 1);
79 } // end method toString
80 } // end class BinaryArray

```

---

**Fig. 19.4** | Class that contains an array of random integers and a method that uses binary search to find an integer. (Part 3 of 3.)

Lines 25–56 declare method `binarySearch`. The search key is passed into parameter `searchElement` (line 25). Lines 27–29 calculate the `low` end index, `high` end index and `middle` index of the portion of the array that the program is currently searching. At the beginning of the method, the `low` end is 0, the `high` end is the length of the array minus 1 and the `middle` is the average of these two values. Line 30 initializes the `location` of the element to `-1`—the value that will be returned if the element is not found. Lines 32–53 loop until `low` is greater than `high` (this occurs when the element is not found) or `location` does not equal `-1` (indicating that the search key was found). Line 43 tests whether the value in the `middle` element is equal to `searchElement`. If this is true, line 44 assigns `middle` to `location`. Then the loop terminates and `location` is returned to the caller. Each iteration of the loop tests a single value (line 43) and *eliminates half of the remaining values in the array* (line 48 or 50).

Figure 19.5 performs a binary search using the search key the user enters to determine whether it matches an element in the array. The first line of output from this program is the array of `ints`, in increasing order. When the user instructs the program to search for 23, the program first tests the middle element, which is 42 (as indicated by `*`). The search key is less than 42, so the program eliminates the second half of the array and tests the middle element from the first half. The search key is smaller than 34, so the program eliminates the second half of the array, leaving only three elements. Finally, the program checks 23 (which matches the search key) and returns the index 1.

---

```

1 // Fig. 19.5: BinarySearchTest.java
2 // Use binary search to locate an item in an array.
3 import java.util.Scanner;
4
5 public class BinarySearchTest
6 {
7 public static void main(String[] args)
8 {
9 // create Scanner object to input data
10 Scanner input = new Scanner(System.in);
11
12 int searchInt; // search key
13 int position; // location of search key in array
14
15 // create array and output it
16 BinaryArray searchArray = new BinaryArray(15);
17 System.out.println(searchArray);
18

```

---

**Fig. 19.5** | Use binary search to locate an item in an array (`*` in the output marks the middle element). (Part 1 of 3.)

```

19 // get input from user
20 System.out.print(
21 "Please enter an integer value (-1 to quit): ");
22 searchInt = input.nextInt(); // read an int from user
23 System.out.println();
24
25 // repeatedly input an integer; -1 terminates the program
26 while (searchInt != -1)
27 {
28 // use binary search to try to find integer
29 position = searchArray.binarySearch(searchInt);
30
31 // return value of -1 indicates integer was not found
32 if (position == -1)
33 System.out.println("The integer " + searchInt +
34 " was not found.\n");
35 else
36 System.out.println("The integer " + searchInt +
37 " was found in position " + position + ".\n");
38
39 // get input from user
40 System.out.print(
41 "Please enter an integer value (-1 to quit): ");
42 searchInt = input.nextInt(); // read an int from user
43 System.out.println();
44 } // end while
45 } // end main
46 } // end class BinarySearchTest

```

```

13 23 24 34 35 36 38 42 47 51 68 74 75 85 97

Please enter an integer value (-1 to quit): 23

13 23 24 34 35 36 38 42 47 51 68 74 75 85 97
 *
13 23 24 34 35 36 38
 *
13 23 24
 *
The integer 23 was found in position 1.

Please enter an integer value (-1 to quit): 75

13 23 24 34 35 36 38 42 47 51 68 74 75 85 97
 *
 47 51 68 74 75 85 97
 *
 75 85 97
 *
 75
 *
The integer 75 was found in position 12.

```

**Fig. 19.5** | Use binary search to locate an item in an array (\* in the output marks the middle element). (Part 2 of 3.)

```

Please enter an integer value (-1 to quit): 52
13 23 24 34 35 36 38 42 47 51 68 74 75 85 97
 *
 47 51 68 74 75 85 97
 *
 47 51 68
 *
 68
 *

The integer 52 was not found.

Please enter an integer value (-1 to quit): -1

```

**Fig. 19.5** | Use binary search to locate an item in an array (\* in the output marks the middle element). (Part 3 of 3.)

### *Efficiency of the Binary Search*

In the worst-case scenario, searching a *sorted* array of 1023 elements takes only 10 comparisons when using a binary search. Repeatedly dividing 1023 by 2 (because after each comparison we can eliminate half the array) and rounding down (because we also remove the middle element) yields the values 511, 255, 127, 63, 31, 15, 7, 3, 1 and 0. The number 1023 ( $2^{10} - 1$ ) is divided by 2 only 10 times to get the value 0, which indicates that there are no more elements to test. Dividing by 2 is equivalent to one comparison in the binary search algorithm. Thus, an array of 1,048,575 ( $2^{20} - 1$ ) elements takes a maximum of 20 comparisons to find the key, and an array of over one billion elements takes a maximum of 30 comparisons to find the key. This is a tremendous improvement in performance over the linear search. For a one-billion-element array, this is a difference between an average of 500 million comparisons for the linear search and a maximum of only 30 comparisons for the binary search! The maximum number of comparisons needed for the binary search of any sorted array is the exponent of the first power of 2 greater than the number of elements in the array, which is represented as  $\log_2 n$ . All logarithms grow at roughly the same rate, so in big O notation the base can be omitted. This results in a big O of  $O(\log n)$  for a binary search, which is also known as **logarithmic run time**.

## 19.3 Sorting Algorithms

Sorting data (i.e., placing the data into some particular order, such as ascending or descending) is one of the most important computing applications. A bank sorts all checks by account number so that it can prepare individual bank statements at the end of each month. Telephone companies sort their lists of accounts by last name and, further, by first name to make it easy to find phone numbers. Virtually every organization must sort some data, and often massive amounts of it. Sorting data is an intriguing, computer-intensive problem that has attracted intense research efforts.

An important item to understand about sorting is that the end result—the sorted array—will be the *same* no matter which algorithm you use to sort the array. The choice of algorithm affects only the run time and memory use of the program. The rest of this chapter introduces three common sorting algorithms. The first two—*selection sort* and *insertion sort*—are easy to program but *inefficient*. The last algorithm—merge sort—is

much *faster* than selection sort and insertion sort but *harder to program*. We focus on sorting arrays of primitive-type data, namely `ints`. It's possible to sort arrays of class objects as well. We discuss this in Section 20.7.1.

### 19.3.1 Selection Sort

**Selection sort** is a simple, but inefficient, sorting algorithm. Its first iteration selects the *smallest* element in the array and swaps it with the first element. The second iteration selects the *second-smallest* item (which is the smallest item of the remaining elements) and swaps it with the second element. The algorithm continues until the last iteration selects the *second-largest* element and swaps it with the second-to-last index, leaving the largest element in the last index. After the *i*th iteration, the smallest *i* items of the array will be sorted into increasing order in the first *i* elements of the array.

As an example, consider the array

```
34 56 4 10 77 51 93 30 5 52
```

A program that implements selection sort first determines the smallest element (4) of this array, which is contained in index 2. The program swaps 4 with 34, resulting in

```
4 56 34 10 77 51 93 30 5 52
```

The program then determines the smallest value of the remaining elements (all elements except 4), which is 5, contained in index 8. The program swaps 5 with 56, resulting in

```
4 5 34 10 77 51 93 30 56 52
```

On the third iteration, the program determines the next smallest value (10) and swaps it with 34.

```
4 5 10 34 77 51 93 30 56 52
```

The process continues until the array is fully sorted.

```
4 5 10 30 34 51 52 56 77 93
```

After the first iteration, the smallest element is in the first position. After the second iteration, the two smallest elements are in order in the first two positions. After the third iteration, the three smallest elements are in order in the first three positions.

Figure 19.6 declares the `SelectionSort` class. This class has two `private` instance variables—an array of `ints` named `data`, and a `static` `Random` object to generate random integers to fill the array. When an object of class `SelectionSort` is instantiated, the constructor (lines 13–20) creates and initializes the array `data` with random `ints` in the range 10–99.

---

```

1 // Fig. 19.6: SelectionSort.java
2 // Class that creates an array filled with random integers.
3 // Provides a method to sort the array with selection sort.
4 import java.util.Arrays;
5 import java.util.Random;
6

```

---

**Fig. 19.6** | Class that creates an array filled with random integers. Provides a method to sort the array with selection sort. (Part I of 3.)



```

7 public class SelectionSort
8 {
9 private int[] data; // array of values
10 private static final Random generator = new Random();
11
12 // create array of given size and fill with random integers
13 public SelectionSort(int size)
14 {
15 data = new int[size]; // create space for array
16
17 // fill array with random ints in range 10-99
18 for (int i = 0; i < size; i++)
19 data[i] = 10 + generator.nextInt(90);
20 } // end SelectionSort constructor
21
22 // sort array using selection sort
23 public void sort()
24 {
25 int smallest; // index of smallest element
26
27 // loop over data.length - 1 elements
28 for (int i = 0; i < data.length - 1; i++)
29 {
30 smallest = i; // first index of remaining array
31
32 // loop to find index of smallest element
33 for (int index = i + 1; index < data.length; index++)
34 if (data[index] < data[smallest])
35 smallest = index;
36
37 swap(i, smallest); // swap smallest element into position
38 printPass(i + 1, smallest); // output pass of algorithm
39 } // end outer for
40 } // end method sort
41
42 // helper method to swap values in two elements
43 public void swap(int first, int second)
44 {
45 int temporary = data[first]; // store first in temporary
46 data[first] = data[second]; // replace first with second
47 data[second] = temporary; // put temporary in second
48 } // end method swap
49
50 // print a pass of the algorithm
51 public void printPass(int pass, int index)
52 {
53 System.out.print(String.format("after pass %2d: ", pass));
54
55 // output elements till selected item
56 for (int i = 0; i < index; i++)
57 System.out.print(data[i] + " ");

```

**Fig. 19.6** | Class that creates an array filled with random integers. Provides a method to sort the array with selection sort. (Part 2 of 3.)

```

58 System.out.print(data[index] + "* "); // indicate swap
59
60 // finish outputting array
61 for (int i = index + 1; i < data.length; i++)
62 System.out.print(data[i] + " ");
63
64 System.out.print("\n "); // for alignment
65
66 // indicate amount of array that is sorted
67 for (int j = 0; j < pass; j++)
68 System.out.print("-- ");
69 System.out.println("\n"); // add newline
70 } // end method printPass
71
72 // method to output values in array
73 public String toString()
74 {
75 return Arrays.toString(data);
76 } // end method toString
77 } // end class SelectionSort

```

**Fig. 19.6** | Class that creates an array filled with random integers. Provides a method to sort the array with selection sort. (Part 3 of 3.)

Lines 23–40 declare the sort method. Line 25 declares the variable `smallest`, which will store the index of the smallest element in the remaining array. Lines 28–39 loop `data.length - 1` times. Line 30 initializes the index of the smallest element to the current item. Lines 33–35 loop over the remaining elements in the array. For each of these elements, line 34 compares its value to the value of the smallest element. If the current element is smaller than the smallest element, line 35 assigns the current element's index to `smallest`. When this loop finishes, `smallest` will contain the index of the smallest element in the remaining array. Line 36 calls method `swap` (lines 43–48) to place the smallest remaining element in the next ordered spot in the array.

Line 9 of Fig. 19.7 creates a `SelectionSort` object with 10 elements. Line 12 outputs the unsorted object. Line 14 calls method `sort` (lines 22–39 of Fig. 19.6), which sorts the elements using selection sort. Then lines 16–17 output the sorted object. The output uses dashes (lines 67–68) to indicate the portion of the array that is sorted after each pass. An asterisk is placed next to the position of the element that was swapped with the smallest element on that pass. On each pass, the element next to the asterisk (specified at line 58) and the element above the rightmost set of dashes were swapped.

```

1 // Fig. 19.7: SelectionSortTest.java
2 // Testing the selection sort class.
3
4 public class SelectionSortTest
5 {

```

**Fig. 19.7** | Testing the selection sort class. (Part 1 of 2.)

```

6 public static void main(String[] args)
7 {
8 // create object to perform selection sort
9 SelectionSort sortArray = new SelectionSort(10);
10
11 System.out.println("Unsorted array:");
12 System.out.println(sortArray + "\n"); // print unsorted array
13
14 sortArray.sort(); // sort array
15
16 System.out.println("Sorted array:");
17 System.out.println(sortArray); // print sorted array
18 } // end main
19 } // end class SelectionSortTest

```

```

Unsorted array:
[61, 87, 80, 58, 40, 50, 20, 13, 71, 45]
after pass 1: 13 87 80 58 40 50 20 61* 71 45
 --
after pass 2: 13 20 80 58 40 50 87* 61 71 45
 -- --
after pass 3: 13 20 40 58 80* 50 87 61 71 45
 -- -- --
after pass 4: 13 20 40 45 80 50 87 61 71 58*
 -- -- -- --
after pass 5: 13 20 40 45 50 80* 87 61 71 58
 -- -- -- -- --
after pass 6: 13 20 40 45 50 58 87 61 71 80*
 -- -- -- -- -- --
after pass 6: 13 20 40 45 50 58 87 61 71 80*
 -- -- -- -- -- --
after pass 7: 13 20 40 45 50 58 61 87* 71 80
 -- -- -- -- -- -- --
after pass 8: 13 20 40 45 50 58 61 71 87* 80
 -- -- -- -- -- -- --
after pass 9: 13 20 40 45 50 58 61 71 80 87*
 -- -- -- -- -- -- -- --

Sorted array:
[13, 20, 40, 45, 50, 58, 61, 71, 80, 87]

```

**Fig. 19.7** | Testing the selection sort class. (Part 2 of 2.)

### *Efficiency of the Selection Sort*

The selection sort algorithm runs in  $O(n^2)$  time. The sort method in lines 23–40 of Fig. 19.6, which implements the selection sort algorithm, contains two for loops. The outer for loop (lines 28–39) iterates over the first  $n - 1$  elements in the array, swapping the smallest remaining item into its sorted position. The inner for loop (lines 33–35) iterates over each

item in the remaining array, searching for the smallest element. This loop executes  $n - 1$  times during the first iteration of the outer loop,  $n - 2$  times during the second iteration, then  $n - 3, \dots, 3, 2, 1$ . This inner loop will iterate a total of  $n(n - 1)/2$  or  $(n^2 - n)/2$ . In Big O notation, smaller terms drop out and constants are ignored, leaving a final Big O of  $O(n^2)$ .

### 19.3.2 Insertion Sort

**Insertion sort** is another *simple, but inefficient*, sorting algorithm. The first iteration of this algorithm takes the *second element* in the array and, if it's *less than* the *first element*, *swaps it with the first element*. The second iteration looks at the third element and inserts it into the correct position with respect to the first two, so all three elements are in order. At the  $i$ th iteration of this algorithm, the first  $i$  elements in the original array will be sorted.

Consider as an example the following array. [Note: This array is identical to the one used in the discussions of selection sort and merge sort.]

```
34 56 4 10 77 51 93 30 5 52
```

A program that implements the insertion sort algorithm will first look at the first two elements of the array, 34 and 56. These are already in order, so the program continues. (If they were out of order, the program would swap them.)

In the next iteration, the program looks at the third value, 4. This value is less than 56, so the program stores 4 in a temporary variable and moves 56 one element to the right. The program then checks and determines that 4 is less than 34, so it moves 34 one element to the right. The program has now reached the beginning of the array, so it places 4 in the zeroth element. The array now is

```
4 34 56 10 77 51 93 30 5 52
```

In the next iteration, the program stores 10 in a temporary variable. Then it compares 10 to 56 and moves 56 one element to the right because it's larger than 10. The program then compares 10 to 34, moving 34 right one element. When the program compares 10 to 4, it observes that 10 is larger than 4 and places 10 in element 1. The array now is

```
4 10 34 56 77 51 93 30 5 52
```

Using this algorithm, at the  $i$ th iteration, the first  $i$  elements of the original array are sorted, but they may not be in their final locations—smaller values may be located later in the array.

Figure 19.8 declares the `InsertionSort` class. Lines 23–47 declare the `sort` method. Line 25 declares the variable `insert`, which holds the element you're going to insert while you move the other elements. Lines 28–46 loop over `data.length - 1` items in the array. In each iteration, line 31 stores in `insert` the value of the element that will be inserted into the sorted portion of the array. Line 34 declares and initializes the variable `moveItem`, which keeps track of where to insert the element. Lines 37–42 loop to locate the correct position where the element should be inserted. The loop will terminate either when the program reaches the front of the array or when it reaches an element that is less than the value to be inserted. Line 40 moves an element to the right, and line 41 decrements the position at which to insert the next element. After the loop ends, line 44 inserts the element into place. Figure 19.9 is the same as Fig. 19.7 except that it creates and uses an `InsertionSort` object. The output of this program uses dashes to indicate the portion of the array that is sorted after each pass. An asterisk is placed next to the element that was inserted into place on that pass.

```

1 // Fig. 19.8: InsertionSort.java
2 // Class that creates an array filled with random integers.
3 // Provides a method to sort the array with insertion sort.
4 import java.util.Arrays;
5 import java.util.Random;
6
7 public class InsertionSort
8 {
9 private int[] data; // array of values
10 private static final Random generator = new Random();
11
12 // create array of given size and fill with random integers
13 public InsertionSort(int size)
14 {
15 data = new int[size]; // create space for array
16
17 // fill array with random ints in range 10-99
18 for (int i = 0; i < size; i++)
19 data[i] = 10 + generator.nextInt(90);
20 } // end InsertionSort constructor
21
22 // sort array using insertion sort
23 public void sort()
24 {
25 int insert; // temporary variable to hold element to insert
26
27 // loop over data.length - 1 elements
28 for (int next = 1; next < data.length; next++)
29 {
30 // store value in current element
31 insert = data[next];
32
33 // initialize location to place element
34 int moveItem = next;
35
36 // search for place to put current element
37 while (moveItem > 0 && data[moveItem - 1] > insert)
38 {
39 // shift element right one slot
40 data[moveItem] = data[moveItem - 1];
41 moveItem--;
42 } // end while
43
44 data[moveItem] = insert; // place inserted element
45 printPass(next, moveItem); // output pass of algorithm
46 } // end for
47 } // end method sort
48
49 // print a pass of the algorithm
50 public void printPass(int pass, int index)
51 {

```

**Fig. 19.8** | Class that creates an array filled with random integers. Provides a method to sort the array with insertion sort. (Part I of 2.)

---

```

52 System.out.print(String.format("after pass %2d: ", pass));
53
54 // output elements till swapped item
55 for (int i = 0; i < index; i++)
56 System.out.print(data[i] + " ");
57
58 System.out.print(data[index] + "* "); // indicate swap
59
60 // finish outputting array
61 for (int i = index + 1; i < data.length; i++)
62 System.out.print(data[i] + " ");
63
64 System.out.print("\n "); // for alignment
65
66 // indicate amount of array that is sorted
67 for(int i = 0; i <= pass; i++)
68 System.out.print("-- ");
69 System.out.println("\n"); // add newline
70 } // end method printPass
71
72 // method to output values in array
73 public String toString()
74 {
75 return Arrays.toString(data);
76 } // end method toString
77 } // end class InsertionSort

```

---

**Fig. 19.8** | Class that creates an array filled with random integers. Provides a method to sort the array with insertion sort. (Part 2 of 2.)

---

```

1 // Fig. 19.9: InsertionSortTest.java
2 // Testing the insertion sort class.
3
4 public class InsertionSortTest
5 {
6 public static void main(String[] args)
7 {
8 // create object to perform insertion sort
9 InsertionSort sortArray = new InsertionSort(10);
10
11 System.out.println("Unsorted array:");
12 System.out.println(sortArray + "\n"); // print unsorted array
13
14 sortArray.sort(); // sort array
15
16 System.out.println("Sorted array:");
17 System.out.println(sortArray); // print sorted array
18 } // end main
19 } // end class InsertionSortTest

```

---

**Fig. 19.9** | Testing the insertion sort class. (Part 1 of 2.)

|                                          |    |     |     |     |     |     |    |    |    |     |    |
|------------------------------------------|----|-----|-----|-----|-----|-----|----|----|----|-----|----|
| Unsorted array:                          |    |     |     |     |     |     |    |    |    |     |    |
| [40, 17, 45, 82, 62, 32, 30, 44, 93, 10] |    |     |     |     |     |     |    |    |    |     |    |
| after pass                               | 1: | 17* | 40  | 45  | 82  | 62  | 32 | 30 | 44 | 93  | 10 |
|                                          |    | --  | --  |     |     |     |    |    |    |     |    |
| after pass                               | 2: | 17  | 40  | 45* | 82  | 62  | 32 | 30 | 44 | 93  | 10 |
|                                          |    | --  | --  | --  |     |     |    |    |    |     |    |
| after pass                               | 3: | 17  | 40  | 45  | 82* | 62  | 32 | 30 | 44 | 93  | 10 |
|                                          |    | --  | --  | --  | --  |     |    |    |    |     |    |
| after pass                               | 4: | 17  | 40  | 45  | 62* | 82  | 32 | 30 | 44 | 93  | 10 |
|                                          |    | --  | --  | --  | --  | --  |    |    |    |     |    |
| after pass                               | 5: | 17  | 32* | 40  | 45  | 62  | 82 | 30 | 44 | 93  | 10 |
|                                          |    | --  | --  | --  | --  | --  | -- |    |    |     |    |
| after pass                               | 6: | 17  | 30* | 32  | 40  | 45  | 62 | 82 | 44 | 93  | 10 |
|                                          |    | --  | --  | --  | --  | --  | -- | -- |    |     |    |
| after pass                               | 7: | 17  | 30  | 32  | 40  | 44* | 45 | 62 | 82 | 93  | 10 |
|                                          |    | --  | --  | --  | --  | --  | -- | -- | -- |     |    |
| after pass                               | 8: | 17  | 30  | 32  | 40  | 44  | 45 | 62 | 82 | 93* | 10 |
|                                          |    | --  | --  | --  | --  | --  | -- | -- | -- | --  |    |
| after pass                               | 9: | 10* | 17  | 30  | 32  | 40  | 44 | 45 | 62 | 82  | 93 |
|                                          |    | --  | --  | --  | --  | --  | -- | -- | -- | --  | -- |
| Sorted array:                            |    |     |     |     |     |     |    |    |    |     |    |
| [10, 17, 30, 32, 40, 44, 45, 62, 82, 93] |    |     |     |     |     |     |    |    |    |     |    |

**Fig. 19.9** | Testing the insertion sort class. (Part 2 of 2.)

### *Efficiency of the Insertion Sort*

The insertion sort algorithm also runs in  $O(n^2)$  time. Like selection sort, the implementation of insertion sort (lines 23–47 of Fig. 19.8) contains two loops. The `for` loop (lines 28–46) iterates `data.length - 1` times, inserting an element into the appropriate position in the elements sorted so far. For the purposes of this application, `data.length - 1` is equivalent to  $n - 1$  (as `data.length` is the size of the array). The `while` loop (lines 37–42) iterates over the preceding elements in the array. In the worst case, this `while` loop will require  $n - 1$  comparisons. Each individual loop runs in  $O(n)$  time. In Big O notation, nested loops mean that you must multiply the number of comparisons. For each iteration of an outer loop, there will be a certain number of iterations of the inner loop. In this algorithm, for each  $O(n)$  iterations of the outer loop, there will be  $O(n)$  iterations of the inner loop. Multiplying these values results in a Big O of  $O(n^2)$ .

### 19.3.3 Merge Sort

**Merge sort** is an *efficient* sorting algorithm but is conceptually *more complex* than selection sort and insertion sort. The merge sort algorithm sorts an array by *splitting* it into two equal-sized subarrays, *sorting* each subarray, then *merging* them into one larger array. With an odd number of elements, the algorithm creates the two subarrays such that one has one more element than the other.

The implementation of merge sort in this example is recursive. The base case is an array with one element, which is, of course, sorted, so the merge sort immediately returns in this case. The recursion step splits the array into two approximately equal pieces, recursively sorts them, then merges the two sorted arrays into one larger, sorted array.

Suppose the algorithm has already merged smaller arrays to create sorted arrays A:

```
4 10 34 56 77
```

and B:

```
5 30 51 52 93
```

Merge sort combines these two arrays into one larger, sorted array. The smallest element in A is 4 (located in the zeroth index of A). The smallest element in B is 5 (located in the zeroth index of B). In order to determine the smallest element in the larger array, the algorithm compares 4 and 5. The value from A is smaller, so 4 becomes the first element in the merged array. The algorithm continues by comparing 10 (the second element in A) to 5 (the first element in B). The value from B is smaller, so 5 becomes the second element in the larger array. The algorithm continues by comparing 10 to 30, with 10 becoming the third element in the array, and so on.

Lines 22–25 of Fig. 19.10 declare the sort method. Line 24 calls method `sortArray` with 0 and `data.length - 1` as the arguments—corresponding to the beginning and ending indices, respectively, of the array to be sorted. These values tell method `sortArray` to operate on the entire array.

Method `sortArray` is declared in lines 28–49. Line 31 tests the base case. If the size of the array is 1, the array is already sorted, so the method returns immediately. If the size of the array is greater than 1, the method splits the array in two, recursively calls method `sortArray` to sort the two subarrays, then merges them. Line 43 recursively calls method `sortArray` on the first half of the array, and line 44 recursively calls method `sortArray` on the second half. When these two method calls return, each half of the array has been sorted. Line 47 calls method `merge` (lines 52–91) on the two halves of the array to combine the two sorted arrays into one larger sorted array.

---

```

1 // Fig. 19.10: MergeSort.java
2 // Class creates an array filled with random integers.
3 // Provides a method to sort the array with merge sort.
4 import java.util.Random;
5
6 public class MergeSort
7 {
8 private int[] data; // array of values
9 private static final Random generator = new Random();
10
11 // create array of given size and fill with random integers
12 public MergeSort(int size)
13 {
14 data = new int[size]; // create space for array
15

```

---

**Fig. 19.10** | Class that creates an array filled with random integers. Provides a method to sort the array with merge sort. (Part 1 of 3.)



```

16 // fill array with random ints in range 10-99
17 for (int i = 0; i < size; i++)
18 data[i] = 10 + generator.nextInt(90);
19 } // end MergeSort constructor
20
21 // calls recursive split method to begin merge sorting
22 public void sort()
23 {
24 sortArray(0, data.length - 1); // split entire array
25 } // end method sort
26
27 // splits array, sorts subarrays and merges subarrays into sorted array
28 private void sortArray(int low, int high)
29 {
30 // test base case; size of array equals 1
31 if ((high - low) >= 1) // if not base case
32 {
33 int middle1 = (low + high) / 2; // calculate middle of array
34 int middle2 = middle1 + 1; // calculate next element over
35
36 // output split step
37 System.out.println("split: " + subarray(low, high));
38 System.out.println(" " + subarray(low, middle1));
39 System.out.println(" " + subarray(middle2, high));
40 System.out.println();
41
42 // split array in half; sort each half (recursive calls)
43 sortArray(low, middle1); // first half of array
44 sortArray(middle2, high); // second half of array
45
46 // merge two sorted arrays after split calls return
47 merge (low, middle1, middle2, high);
48 } // end if
49 } // end method sortArray
50
51 // merge two sorted subarrays into one sorted subarray
52 private void merge(int left, int middle1, int middle2, int right)
53 {
54 int leftIndex = left; // index into left subarray
55 int rightIndex = middle2; // index into right subarray
56 int combinedIndex = left; // index into temporary working array
57 int[] combined = new int[data.length]; // working array
58
59 // output two subarrays before merging
60 System.out.println("merge: " + subarray(left, middle1));
61 System.out.println(" " + subarray(middle2, right));
62
63 // merge arrays until reaching end of either
64 while (leftIndex <= middle1 && rightIndex <= right)
65 {
66 // place smaller of two current elements into result
67 // and move to next space in arrays

```

**Fig. 19.10** | Class that creates an array filled with random integers. Provides a method to sort the array with merge sort. (Part 2 of 3.)

```

68 if (data[leftIndex] <= data[rightIndex])
69 combined[combinedIndex++] = data[leftIndex++];
70 else
71 combined[combinedIndex++] = data[rightIndex++];
72 } // end while
73
74 // if left array is empty
75 if (leftIndex == middle2)
76 // copy in rest of right array
77 while (rightIndex <= right)
78 combined[combinedIndex++] = data[rightIndex++];
79 else // right array is empty
80 // copy in rest of left array
81 while (leftIndex <= middle1)
82 combined[combinedIndex++] = data[leftIndex++];
83
84 // copy values back into original array
85 for (int i = left; i <= right; i++)
86 data[i] = combined[i];
87
88 // output merged array
89 System.out.println(" " + subarray(left, right));
90 System.out.println();
91 } // end method merge
92
93 // method to output certain values in array
94 public String subarray(int low, int high)
95 {
96 StringBuilder temporary = new StringBuilder();
97
98 // output spaces for alignment
99 for (int i = 0; i < low; i++)
100 temporary.append(" ");
101
102 // output elements left in array
103 for (int i = low; i <= high; i++)
104 temporary.append(" " + data[i]);
105
106 return temporary.toString();
107 } // end method subarray
108
109 // method to output values in array
110 public String toString()
111 {
112 return subarray(0, data.length - 1);
113 } // end method toString
114 } // end class MergeSort

```

**Fig. 19.10** | Class that creates an array filled with random integers. Provides a method to sort the array with merge sort. (Part 3 of 3.)

Lines 64–72 in the merge method loop until the program reaches the end of either subarray. Line 68 tests which element at the beginning of the arrays is smaller. If the element in the left array is smaller, line 69 places it in position in the combined array. If the element

in the right array is smaller, line 71 places it in position in the combined array. When the `while` loop has completed (line 72), one entire subarray is placed in the combined array, but the other subarray still contains data. Line 75 tests whether the left array has reached the end. If so, lines 77–78 fill the combined array with the elements of the right array. If the left array has not reached the end, then the right array must have reached the end, and lines 81–82 fill the combined array with the elements of the left array. Finally, lines 85–86 copy the combined array into the original array. Figure 19.11 creates and uses a `MergeSort` object. The output from this program displays the splits and merges performed by merge sort, showing the progress of the sort at each step of the algorithm. It's well worth your time to step through these outputs to fully understand this elegant sorting algorithm.

```

1 // Figure 16.11: MergeSortTest.java
2 // Testing the merge sort class.
3
4 public class MergeSortTest
5 {
6 public static void main(String[] args)
7 {
8 // create object to perform merge sort
9 MergeSort sortArray = new MergeSort(10);
10
11 // print unsorted array
12 System.out.println("Unsorted:" + sortArray + "\n");
13
14 sortArray.sort(); // sort array
15
16 // print sorted array
17 System.out.println("Sorted: " + sortArray);
18 } // end main
19 } // end class MergeSortTest

```

```

Unsorted: 75 56 85 90 49 26 12 48 40 47
split: 75 56 85 90 49 26 12 48 40 47
 75 56 85 90 49
 26 12 48 40 47

split: 75 56 85 90 49
 75 56 85
 90 49

split: 75 56 85
 75 56
 85

split: 75 56
 75
 56

merge: 75
 56
 56 75

```

**Fig. 19.11** | Testing the merge sort class. (Part 1 of 2.)

```

merge: 56 75
 85
 56 75 85

split: 90 49
 90
 49

merge: 90
 49
 49 90

merge: 56 75 85
 49 90
 49 56 75 85 90

split: 26 12 48 40 47
 26 12 48
 40 47

split: 26 12 48
 26 12
 48

split: 26 12
 26
 12

merge: 26
 12
 12 26

merge: 12 26
 48
 12 26 48

split: 40 47
 40
 47

merge: 40
 47
 40 47

merge: 12 26 48
 40 47
 12 26 40 47 48

merge: 49 56 75 85 90
 12 26 40 47 48
 12 26 40 47 48 49 56 75 85 90

Sorted: 12 26 40 47 48 49 56 75 85 90

```

**Fig. 19.11** | Testing the merge sort class. (Part 2 of 2.)

### *Efficiency of the Merge Sort*

Merge sort is *far more efficient* than either insertion or selection sort. Consider the first (non-recursive) call to `sortArray`. This results in two recursive calls to `sortArray` with subarrays each approximately half the size of the original array, and a single call to method `merge`. This

call to merge requires, at worst,  $n - 1$  comparisons to fill the original array, which is  $O(n)$ . (Recall that each element in the array can be chosen by comparing one element from each of the subarrays.) The two calls to `sortArray` result in four more recursive calls to `sortArray`, each with a subarray approximately a quarter the size of the original array along with two calls to method `merge`. These two calls to method `merge` each require, at worst,  $n/2 - 1$  comparisons, for a total number of comparisons of  $O(n)$ . This process continues, each call to `sortArray` generating two additional calls to `sortArray` and a call to `merge`, until the algorithm has *split* the array into one-element subarrays. At each level,  $O(n)$  comparisons are required to *merge* the subarrays. Each level splits the size of the arrays in half, so doubling the array size requires one more level. Quadrupling the array size requires two more levels. This pattern is logarithmic and results in  $\log_2 n$  levels. This results in a total efficiency of  $O(n \log n)$ .

Figure 19.12 summarizes the searching and sorting algorithms covered in this chapter with the Big O for each. Figure 19.13 lists the Big O values we've covered in this chapter along with a number of values for  $n$  to highlight the differences in the growth rates.

| Algorithm                    | Location                | Big O         |
|------------------------------|-------------------------|---------------|
| <i>Searching Algorithms:</i> |                         |               |
| Linear search                | Section 19.2.1          | $O(n)$        |
| Binary search                | Section 19.2.2          | $O(\log n)$   |
| Recursive linear search      | Exercise 19.8           | $O(n)$        |
| Recursive binary search      | Exercise 19.9           | $O(\log n)$   |
| <i>Sorting Algorithms:</i>   |                         |               |
| Selection sort               | Section 19.3.1          | $O(n^2)$      |
| Insertion sort               | Section 19.3.2          | $O(n^2)$      |
| Merge sort                   | Section 19.3.3          | $O(n \log n)$ |
| Bubble sort                  | Exercises 19.5 and 19.6 | $O(n^2)$      |

**Fig. 19.12** | Searching and sorting algorithms with Big O values.

| $n =$         | $O(\log n)$ | $O(n)$        | $O(n \log n)$ | $O(n^2)$  |
|---------------|-------------|---------------|---------------|-----------|
| 1             | 0           | 1             | 0             | 1         |
| 2             | 1           | 2             | 2             | 4         |
| 3             | 1           | 3             | 3             | 9         |
| 4             | 1           | 4             | 4             | 16        |
| 5             | 1           | 5             | 5             | 25        |
| 10            | 1           | 10            | 10            | 100       |
| 100           | 2           | 100           | 200           | 10,000    |
| 1000          | 3           | 1000          | 3000          | $10^6$    |
| 1,000,000     | 6           | 1,000,000     | 6,000,000     | $10^{12}$ |
| 1,000,000,000 | 9           | 1,000,000,000 | 9,000,000,000 | $10^{18}$ |

**Fig. 19.13** | Number of comparisons for common Big O notations.

## 19.4 Wrap-Up

This chapter introduced searching and sorting. We discussed two searching algorithms—linear search and binary search—and three sorting algorithms—selection sort, insertion sort and merge sort. We introduced Big O notation, which helps you analyze the efficiency of an algorithm. The next three chapters continue our discussion of dynamic data structures that can grow or shrink at execution time. Chapter 20 presents the Java API's built-in algorithms (such as searching and sorting) and generic collections. Chapter 21 demonstrates how to use Java's generics capabilities to implement generic methods and classes. Chapter 22 discusses the details of implementing generic data structures.

### Summary

#### *Section 19.1 Introduction*

- Searching (p. 799) involves determining if a search key is in the data and, if so, finding its location.
- Sorting (p. 799) involves arranging data into order.

#### *Section 19.2 Searching Algorithms*

- The linear search algorithm (p. 800) searches each element in the array sequentially until it finds the correct element, or until it reaches the end of the array without finding the element.
- A major difference among searching algorithms is the amount of effort they require in order to return a result.
- Big O notation (p. 802) describes an algorithm's efficiency in terms of the work required to solve a problem. For searching and sorting algorithms typically it depends on the number of elements in the data.
- An algorithm that is  $O(1)$  does not necessarily require only one comparison (p. 803). It just means that the number of comparisons does not grow as the size of the array increases.
- An  $O(n)$  algorithm is referred to as having a linear run time (p. 803).
- Big O is designed to highlight dominant factors and ignore terms that become unimportant with high  $n$  values.
- Big O notation is concerned with the growth rate of algorithm run times, so constants are ignored.
- The linear search algorithm runs in  $O(n)$  time.
- The worst case in linear search is that every element must be checked to determine whether the search item exists. This occurs if the search key (p. 799) is the last element in the array or is not present.
- Binary search (p. 804) is more efficient than linear search, but it requires that the array be sorted.
- The first iteration of binary search tests the middle element in the array. If this is the search key, the algorithm returns its location. If the search key is less than the middle element, the search continues with the first half of the array. If the search key is greater than the middle element, the search continues with the second half of the array. Each iteration tests the middle value of the remaining array and, if the element is not found, eliminates half of the remaining elements.
- Binary search is a more efficient searching algorithm than linear search because each comparison eliminates from consideration half of the elements in the array.
- Binary search runs in  $O(\log n)$  time because each step removes half of the remaining elements; this is also known as logarithmic run time (p. 809).
- If the array size is doubled, binary search requires only one extra comparison.

### Section 19.3 Sorting Algorithms

- Selection sort (p. 810) is a simple, but inefficient, sorting algorithm.
- The sort begins by selecting the smallest item and swaps it with the first element. The second iteration selects the second-smallest item (which is the smallest remaining item) and swaps it with the second element. The sort continues until the last iteration selects the second-largest element and swaps it with the second-to-last element, leaving the largest element in the last index. At the  $i$ th iteration of selection sort, the smallest  $i$  items of the whole array are sorted into the first  $i$  indices.
- The selection sort algorithm runs in  $O(n^2)$  time (p. 803).
- The first iteration of insertion sort (p. 814) takes the second element in the array and, if it's less than the first element, swaps it with the first element. The second iteration looks at the third element and inserts it in the correct position with respect to the first two elements. After the  $i$ th iteration of insertion sort, the first  $i$  elements in the original array are sorted.
- The insertion sort algorithm runs in  $O(n^2)$  time.
- Merge sort (p. 817) is a sorting algorithm that is faster, but more complex to implement, than selection sort and insertion sort. The merge sort algorithm sorts an array by splitting the array into two equal-sized subarrays, sorting each subarray recursively and merging the subarrays into one larger array.
- Merge sort's base case is an array with one element. A one-element array is already sorted, so merge sort immediately returns when it's called with a one-element array. The merge part of merge sort takes two sorted arrays and combines them into one larger sorted array.
- Merge sort performs the merge by looking at the first element in each array, which is also the smallest element in the array. Merge sort takes the smallest of these and places it in the first element of the larger array. If there are still elements in the subarray, merge sort looks at the second of these (which is now the smallest element remaining) and compares it to the first element in the other subarray. Merge sort continues this process until the larger array is filled.
- In the worst case, the first call to merge sort has to make  $O(n)$  comparisons to fill the  $n$  slots in the final array.
- The merging portion of the merge sort algorithm is performed on two subarrays, each of approximately size  $n/2$ . Creating each of these subarrays requires  $n/2 - 1$  comparisons for each subarray, or  $O(n)$  comparisons total. This pattern continues as each level works on twice as many arrays, but each is half the size of the previous array.
- Similar to binary search, this halving results in  $\log n$  levels for a total efficiency of  $O(n \log n)$  (p. 823).

## Self-Review Exercises

**19.1** Fill in the blanks in each of the following statements:

- A selection sort application would take approximately \_\_\_\_\_ times as long to run on a 128-element array as on a 32-element array.
- The efficiency of merge sort is \_\_\_\_\_.

**19.2** What key aspect of both the binary search and the merge sort accounts for the logarithmic portion of their respective Big Os?

**19.3** In what sense is the insertion sort superior to the merge sort? In what sense is the merge sort superior to the insertion sort?

**19.4** In the text, we say that after the merge sort splits the array into two subarrays, it then sorts these two subarrays and merges them. Why might someone be puzzled by our statement that “it then sorts these two subarrays”?

## Answers to Self-Review Exercises

**19.1** a) 16, because an  $O(n^2)$  algorithm takes 16 times as long to sort four times as much information. b)  $O(n \log n)$ .

**19.2** Both of these algorithms incorporate “halving”—somehow reducing something by half. The binary search eliminates from consideration one-half of the array after each comparison. The merge sort splits the array in half each time it’s called.

**19.3** The insertion sort is easier to understand and to program than the merge sort. The merge sort is far more efficient [ $O(n \log n)$ ] than the insertion sort [ $O(n^2)$ ].

**19.4** In a sense, it does not really sort these two subarrays. It simply keeps splitting the original array in half until it provides a one-element subarray, which is, of course, sorted. It then builds up the original two subarrays by merging these one-element arrays to form larger subarrays, which are then merged, and so on.

## Exercises

**19.5** (*Bubble Sort*) Implement bubble sort—another simple yet inefficient sorting technique. It’s called bubble sort or sinking sort because smaller values gradually “bubble” their way to the top of the array (i.e., toward the first element) like air bubbles rising in water, while the larger values sink to the bottom (end) of the array. The technique uses nested loops to make several passes through the array. Each pass compares successive pairs of elements. If a pair is in increasing order (or the values are equal), the bubble sort leaves the values as they are. If a pair is in decreasing order, the bubble sort swaps their values in the array. The first pass compares the first two elements of the array and swaps their values if necessary. It then compares the second and third elements in the array. The end of this pass compares the last two elements in the array and swaps them if necessary. After one pass, the largest element will be in the last index. After two passes, the largest two elements will be in the last two indices. Explain why bubble sort is an  $O(n^2)$  algorithm.

**19.6** (*Enhanced Bubble Sort*) Make the following simple modifications to improve the performance of the bubble sort you developed in Exercise 19.5:

- After the first pass, the largest number is guaranteed to be in the highest-numbered array element; after the second pass, the two highest numbers are “in place”; and so on. Instead of making nine comparisons on every pass for a ten-element array, modify the bubble sort to make eight comparisons on the second pass, seven on the third pass, and so on.
- The data in the array may already be in proper or near-proper order, so why make nine passes if fewer will suffice? Modify the sort to check at the end of each pass whether any swaps have been made. If there were none, the data must already be sorted, so the program should terminate. If swaps have been made, at least one more pass is needed.

**19.7** (*Bucket Sort*) A bucket sort begins with a one-dimensional array of positive integers to be sorted and a two-dimensional array of integers with rows indexed from 0 to 9 and columns indexed from 0 to  $n - 1$ , where  $n$  is the number of values to be sorted. Each row of the two-dimensional array is referred to as a *bucket*. Write a class named `BucketSort` containing a method called `sort` that operates as follows:

- Place each value of the one-dimensional array into a row of the bucket array, based on the value’s “ones” (rightmost) digit. For example, 97 is placed in row 7, 3 is placed in row 3 and 100 is placed in row 0. This procedure is called a *distribution pass*.
- Loop through the bucket array row by row, and copy the values back to the original array. This procedure is called a *gathering pass*. The new order of the preceding values in the one-dimensional array is 100, 3 and 97.
- Repeat this process for each subsequent digit position (tens, hundreds, thousands, etc.). On the second (tens digit) pass, 100 is placed in row 0, 3 is placed in row 0 (because 3



has no tens digit) and 97 is placed in row 9. After the gathering pass, the order of the values in the one-dimensional array is 100, 3 and 97. On the third (hundreds digit) pass, 100 is placed in row 1, 3 is placed in row 0 and 97 is placed in row 0 (after the 3). After this last gathering pass, the original array is in sorted order.

The two-dimensional array of buckets is 10 times the length of the integer array being sorted. This sorting technique provides better performance than a bubble sort, but requires much more memory—the bubble sort requires space for only one additional element of data. This comparison is an example of the space/time trade-off: The bucket sort uses more memory than the bubble sort, but performs better. This version of the bucket sort requires copying all the data back to the original array on each pass. Another possibility is to create a second two-dimensional bucket array and repeatedly swap the data between the two bucket arrays.

**19.8** (*Recursive Linear Search*) Modify Fig. 19.2 to use recursive method `recursiveLinearSearch` to perform a linear search of the array. The method should receive the search key and starting index as arguments. If the search key is found, return its index in the array; otherwise, return -1. Each call to the recursive method should check one index in the array.

**19.9** (*Recursive Binary Search*) Modify Fig. 19.4 to use recursive method `recursiveBinarySearch` to perform a binary search of the array. The method should receive the search key, starting index and ending index as arguments. If the search key is found, return its index in the array. If the search key is not found, return -1.

**19.10** (*Quicksort*) The recursive sorting technique called quicksort uses the following basic algorithm for a one-dimensional array of values:

- a) *Partitioning Step*: Take the first element of the unsorted array and determine its final location in the sorted array (i.e., all values to the left of the element in the array are less than the element, and all values to the right of the element in the array are greater than the element—we show how to do this below). We now have one element in its proper location and two unsorted subarrays.
- b) *Recursive Step*: Perform *Step 1* on each unsorted subarray. Each time *Step 1* is performed on a subarray, another element is placed in its final location of the sorted array, and two unsorted subarrays are created. When a subarray consists of one element, that element is in its final location (because a one-element array is already sorted).

The basic algorithm seems simple enough, but how do we determine the final position of the first element of each subarray? As an example, consider the following set of values (the element in bold is the partitioning element—it will be placed in its final location in the sorted array):

37 2 6 4 89 8 10 12 68 45

Starting from the rightmost element of the array, compare each element with 37 until an element less than 37 is found; then swap 37 and that element. The first element less than 37 is 12, so 37 and 12 are swapped. The new array is

12 2 6 4 89 8 10 37 68 45

Element 12 is in italics to indicate that it was just swapped with 37.

Starting from the left of the array, but beginning with the element after 12, compare each element with 37 until an element greater than 37 is found—then swap 37 and that element. The first element greater than 37 is 89, so 37 and 89 are swapped. The new array is

12 2 6 4 37 8 10 89 68 45

Starting from the right, but beginning with the element before 89, compare each element with 37 until an element less than 37 is found—then swap 37 and that element. The first element less than 37 is 10, so 37 and 10 are swapped. The new array is

12 2 6 4 10 8 37 89 68 45

Starting from the left, but beginning with the element after 10, compare each element with 37 until an element greater than 37 is found—then swap 37 and that element. There are no more elements greater than 37, so when we compare 37 with itself, we know that 37 has been placed in its final location in the sorted array. Every value to the left of 37 is smaller than it, and every value to the right of 37 is larger than it.

Once the partition has been applied on the previous array, there are two unsorted subarrays. The subarray with values less than 37 contains 12, 2, 6, 4, 10 and 8. The subarray with values greater than 37 contains 89, 68 and 45. The sort continues recursively, with both subarrays being partitioned in the same manner as the original array.

Based on the preceding discussion, write recursive method `quickSortHelper` to sort a one-dimensional integer array. The method should receive as arguments a starting index and an ending index on the original array being sorted.

# Generic Collections

# 20



*I think this is the most extraordinary collection of talent, of human knowledge, that has ever been gathered together at the White House—with the possible exception of when Thomas Jefferson dined alone.*

—John F. Kennedy

*Journey over all the universe in a map.*

—Miguel de Cervantes

*Not by age but by capacity is wisdom acquired.*

—Titus Maccius Plautus

## Objectives

In this chapter you'll learn:

- What collections are.
- To use class `Arrays` for array manipulations.
- The type-wrapper classes that enable programs to process primitive data values as objects.
- To use the prebuilt generic data structures of the collections framework.
- To use iterators to “walk through” a collection.
- To use persistent hash tables manipulated with objects of class `Properties`.
- To use synchronization and modifiability wrappers.

|             |                                                                                                              |              |                                                                                |
|-------------|--------------------------------------------------------------------------------------------------------------|--------------|--------------------------------------------------------------------------------|
| <b>20.1</b> | Introduction                                                                                                 | 20.7.4       | Method <code>binarySearch</code>                                               |
| <b>20.2</b> | Collections Overview                                                                                         | 20.7.5       | Methods <code>addAll</code> , <code>frequency</code> and <code>disjoint</code> |
| <b>20.3</b> | Type-Wrapper Classes for Primitive Types                                                                     | <b>20.8</b>  | Stack Class of Package <code>java.util</code>                                  |
| <b>20.4</b> | Autoboxing and Auto-Unboxing                                                                                 | <b>20.9</b>  | Class <code>PriorityQueue</code> and Interface <code>Queue</code>              |
| <b>20.5</b> | Interface <code>Collection</code> and Class <code>Collections</code>                                         | <b>20.10</b> | Sets                                                                           |
| <b>20.6</b> | Lists                                                                                                        | <b>20.11</b> | Maps                                                                           |
| 20.6.1      | <code>ArrayList</code> and <code>Iterator</code>                                                             | <b>20.12</b> | <code>Properties</code> Class                                                  |
| 20.6.2      | <code>LinkedList</code>                                                                                      | <b>20.13</b> | Synchronized Collections                                                       |
| <b>20.7</b> | Collections Methods                                                                                          | <b>20.14</b> | Unmodifiable Collections                                                       |
| 20.7.1      | Method <code>sort</code>                                                                                     | <b>20.15</b> | Abstract Implementations                                                       |
| 20.7.2      | Method <code>shuffle</code>                                                                                  | <b>20.16</b> | Wrap-Up                                                                        |
| 20.7.3      | Methods <code>reverse</code> , <code>fill</code> , <code>copy</code> , <code>max</code> and <code>min</code> |              |                                                                                |

Summary | Self-Review Exercises | Answers to Self-Review Exercises | Exercises

## 20.1 Introduction

In Section 7.14, we introduced the generic `ArrayList` collection—a dynamically resizable array-like data structure that stores references to objects of a type that you specify when you create the `ArrayList`. In this chapter, we continue our discussion of the Java **collections framework**, which contains many other prebuilt generic data structures and various methods for manipulating them.

Because you specify the type to store in a collection at compile time, generic collections provide compile-time type safety that allows the compiler to catch attempts to use invalid types. For example, you cannot store `Employees` in a collection of `Strings`. Some examples of collections are the cards you hold in a card game, your favorite songs stored in your computer, the members of a sports team and the real-estate records in your local registry of deeds (which map book numbers and page numbers to property owners).

We discuss the collections-framework interfaces that declare the capabilities of each collection type, the implementation classes, the methods that process collection objects, and the so-called **iterators** that “walk through” collections. This chapter provides an introduction to the collections framework. For complete details, visit [download.oracle.com/javase/6/docs/technotes/guides/collections/index.html](http://download.oracle.com/javase/6/docs/technotes/guides/collections/index.html).

## 20.2 Collections Overview

A **collection** is a data structure—actually, an object—that can hold references to other objects. Usually, collections contain references to objects that are all of the same type. The collections-framework interfaces declare the operations to be performed generically on various types of collections. Figure 20.1 lists some of the interfaces of the collections framework. Several implementations of these interfaces are provided within the framework. You may also provide implementations specific to your own requirements.

| Interface  | Description                                                                                            |
|------------|--------------------------------------------------------------------------------------------------------|
| Collection | The root interface in the collections hierarchy from which interfaces Set, Queue and List are derived. |
| Set        | A collection that does not contain duplicates.                                                         |
| List       | An ordered collection that can contain duplicate elements.                                             |
| Map        | A collection that associates keys to values and cannot contain duplicate keys.                         |
| Queue      | Typically a first-in, first-out collection that models a waiting line; other orders can be specified.  |

**Fig. 20.1** | Some collections-framework interfaces.

The classes and interfaces of the collections framework are members of package `java.util`. In the next section, we begin our discussion by examining the collections-framework capabilities for array manipulation. In earlier versions of Java, the classes in the collections framework stored and manipulated `Object` references, enabling you to store *any* object in a collection. One inconvenient aspect of this approach occurs when retrieving `Object` references from a collection. A program normally needs to process specific types of objects. As a result, the `Object` references obtained from a collection typically need to be *cast* to an appropriate type to allow the program to process the objects correctly.

In Java SE 5, the collections framework was enhanced with the *generics* capabilities we introduced in Chapter 7 when discussing generic `ArrayLists`. This means that you can specify the *exact type* that will be stored in a collection. You also receive the benefits of compile-time type checking—the compiler ensures that you’re using appropriate types with your collection and, if not, issues compile-time error messages. Also, once you specify the type stored in a collection, any reference you retrieve from the collection will have the specified type. This eliminates the need for explicit type casts that can throw `ClassCastException`s if the referenced object is *not* of the appropriate type. In addition, the generic collections are *backward compatible* with Java code that was written before generics were introduced.

## 20.3 Type-Wrapper Classes for Primitive Types

Each primitive type (listed in Appendix ) has a corresponding **type-wrapper class** (in package `java.lang`). These classes are called **Boolean**, **Byte**, **Character**, **Double**, **Float**, **Integer**, **Long** and **Short**. These enable you to manipulate primitive-type values as objects. The data structures that we reuse or develop in Chapters 20–22 manipulate and share *objects*—they cannot manipulate variables of primitive types. However, they can manipulate objects of the type-wrapper classes, because every class ultimately derives from `Object`.

Each of the numeric type-wrapper classes—`Byte`, `Short`, `Integer`, `Long`, `Float` and `Double`—extends class `Number`. Also, the type-wrapper classes are `final` classes, so you cannot extend them.

Primitive types do not have methods, so the methods related to a primitive type are located in the corresponding type-wrapper class (e.g., method `parseInt`, which converts a `String` to an `int` value, is located in class `Integer`). If you need to manipulate a primitive value in your program, first refer to the documentation for the type-wrapper classes—the method you need might already be declared.

## 20.4 Autoboxing and Auto-Unboxing

Prior to Java SE 5, if you wanted to insert a primitive value into a data structure, you had to create a new object of the corresponding type-wrapper class, then insert it in the collection. Similarly, if you wanted to retrieve an object of a type-wrapper class from a collection and manipulate its primitive value, you had to invoke a method on the object to obtain its corresponding primitive-type value. For example, suppose you wanted to add an `int` to an array that stores only references to `Integer` objects. Prior to Java SE 5, you'd be required to “wrap” an `int` value in an `Integer` object before adding the integer to the array and to “unwrap” the `int` value to retrieve it from the array, as in

```
Integer[] integerArray = new Integer[5]; // create integerArray
// assign Integer 10 to integerArray[0]
integerArray[0] = new Integer(10);
// get int value of Integer
int value = integerArray[0].intValue();
```

Notice that the `int` primitive value 10 is used to initialize an `Integer` object. This achieves the desired result but requires extra code and is cumbersome. We then need to invoke method `intValue` of class `Integer` to obtain the `int` value in the `Integer` object.

Java SE 5 introduced two new conversions—the *boxing conversion* and the *unboxing conversion*—to simplify converting between primitive-type values and type-wrapper objects with no additional coding on the part of the programmer. A **boxing conversion** converts a value of a primitive type to an object of the corresponding type-wrapper class. An **unboxing conversion** converts an object of a type-wrapper class to a value of the corresponding primitive type. These conversions can be performed automatically (called **autoboxing** and **auto-unboxing**). For example, the previous statements can be rewritten as

```
Integer[] integerArray = new Integer[5]; // create integerArray
integerArray[0] = 10; // assign Integer 10 to integerArray[0]
int value = integerArray[0]; // get int value of Integer
```

In this case, *autoboxing* occurs when assigning an `int` value (10) to `integerArray[0]`, because `integerArray` stores references to `Integer` objects, not `int` values. *Auto-unboxing* occurs when assigning `integerArray[0]` to `int` variable `value`, because variable `value` stores an `int` value, not a reference to an `Integer` object. Boxing conversions also occur in conditions, which can evaluate to primitive `boolean` values or `Boolean` objects. Many of the examples in Chapters 20–22 use these conversions to store primitive values in and retrieve them from data structures.

## 20.5 Interface Collection and Class Collections

Interface **Collection** is the root interface in the collection hierarchy from which interfaces `Set`, `Queue` and `List` are derived. Interface **Set** defines a collection that does not contain duplicates. Interface **Queue** defines a collection that represents a waiting line—typically, insertions are made at the back of a queue and deletions from the front, though other orders can be specified. We discuss `Queue` and `Set` in Sections 20.9–20.10. Interface `Collection` contains **bulk operations** (i.e., operations performed on an entire collection) for operations such as adding, clearing and comparing objects (or elements) in a collection. A `Collection` can also be converted to an array. In addition, interface `Collection` provides

a method that returns an **Iterator** object, which allows a program to walk through the collection and remove elements from it during the iteration. We discuss class `Iterator` in Section 20.6.1. Other methods of interface `Collection` enable a program to determine a collection's size and whether a collection is empty.



### Software Engineering Observation 20.1

*Collection is used commonly as a parameter type in methods to allow polymorphic processing of all objects that implement interface Collection.*



### Software Engineering Observation 20.2

*Most collection implementations provide a constructor that takes a Collection argument, thereby allowing a new collection to be constructed containing the elements of the specified collection.*

Class **Collections** provides static methods that search, sort and perform other operations on collections. Section 20.7 discusses more about the methods that are available in class `Collections`. We also cover this class's **wrapper methods** that enable you to treat a collection as a *synchronized collection* (Section 20.13) or an *unmodifiable collection* (Section 20.14). Unmodifiable collections are useful when clients of a class need to view a collection's elements, but they should not be allowed to modify the collection by adding and removing elements. Synchronized collections are for use with multithreading (discussed in Chapter 26), which enables programs to perform operations in parallel. When two or more threads of a program *share* a collection, problems might occur. As an analogy, consider a traffic intersection. If all cars were allowed to access the intersection at the same time, collisions might occur. For this reason, traffic lights are provided to control access to the intersection. Similarly, we can *synchronize* access to a collection to ensure that only *one* thread manipulates the collection at a time. The synchronization wrapper methods of class `Collections` return synchronized versions of collections that can be shared among threads in a program.

## 20.6 Lists

A `List` (sometimes called a **sequence**) is an ordered `Collection` that can contain duplicate elements. Like array indices, `List` indices are zero based (i.e., the first element's index is zero). In addition to the methods inherited from `Collection`, `List` provides methods for manipulating elements via their indices, manipulating a specified range of elements, searching for elements and obtaining a **ListIterator** to access the elements.

Interface `List` is implemented by several classes, including **ArrayList**, **LinkedList** and **Vector**. *Autoboxing* occurs when you add primitive-type values to objects of these classes, because they store only *references* to objects. Class `ArrayList` and `Vector` are resizable-array implementations of `List`. Inserting an element between existing elements of an `ArrayList` or `Vector` is an *inefficient* operation—all elements after the new one must be moved out of the way, which could be an expensive operation in a collection with a large number of elements. A `LinkedList` enables efficient insertion (or removal) of elements in the middle of a collection. We discuss the architecture of linked lists in Chapter 22.

`ArrayList` and `Vector` have nearly identical behaviors. `Vectors` are synchronized by default, whereas `ArrayLists` are not. Also, class `Vector` is from Java 1.0, before the collections framework was added to Java. As such, `Vector` has some methods that are not part of

interface `List` and are not implemented in class `ArrayList` but perform identical tasks. For example, `Vector` methods `addElement` and `add` both append an element to a `Vector`, but only method `add` is specified in interface `List` and implemented by `ArrayList`. *Unsynchronized collections provide better performance than synchronized ones.* For this reason, `ArrayList` is typically preferred over `Vector` in programs that do not share a collection among threads. Separately, the Java collections API provides *synchronization wrappers* (Section 20.13) that can be used to add synchronization to the unsynchronized collections, and several powerful synchronized collections are available in the Java concurrency APIs.



### Performance Tip 20.1

*ArrayLists behave like Vectors without synchronization and therefore execute faster than Vectors, because ArrayLists do not have the overhead of thread synchronization.*



### Software Engineering Observation 20.3

*LinkedLists can be used to create stacks, queues and dequeues (double-ended queues, pronounced “decks”). The collections framework provides implementations of some of these data structures.*

The following three subsections demonstrate the `List` and `Collection` capabilities. Section 20.6.1 removes elements from an `ArrayList` with an `Iterator`. Section 20.6.2 uses `ListIterator` and several `List`- and `LinkedList`-specific methods.

## 20.6.1 ArrayList and Iterator

Figure 20.2 uses an `ArrayList` (introduced in Section 7.14) to demonstrate several capabilities of interface `Collection`. The program places two `Color` arrays in `ArrayLists` and uses an `Iterator` to remove elements in the second `ArrayList` collection from the first.

```

1 // Fig. 20.2: CollectionTest.java
2 // Collection interface demonstrated via an ArrayList object.
3 import java.util.List;
4 import java.util.ArrayList;
5 import java.util.Collection;
6 import java.util.Iterator;
7
8 public class CollectionTest
9 {
10 public static void main(String[] args)
11 {
12 // add elements in colors array to list
13 String[] colors = { "MAGENTA", "RED", "WHITE", "BLUE", "CYAN" };
14 List< String > list = new ArrayList< String >();
15
16 for (String color : colors)
17 list.add(color); // adds color to end of list
18
19 // add elements in removeColors array to removeList
20 String[] removeColors = { "RED", "WHITE", "BLUE" };

```

**Fig. 20.2** | Collection interface demonstrated via an `ArrayList` object. (Part I of 2.)



```

21 List< String > removeList = new ArrayList< String >();
22
23 for (String color : removeColors)
24 removeList.add(color);
25
26 // output list contents
27 System.out.println("ArrayList: ");
28
29 for (int count = 0; count < list.size(); count++)
30 System.out.printf("%s ", list.get(count));
31
32 // remove from list the colors contained in removeList
33 removeColors(list, removeList);
34
35 // output list contents
36 System.out.println("\n\nArrayList after calling removeColors: ");
37
38 for (String color : list)
39 System.out.printf("%s ", color);
40 } // end main
41
42 // remove colors specified in collection2 from collection1
43 private static void removeColors(Collection< String > collection1,
44 Collection< String > collection2)
45 {
46 // get iterator
47 Iterator< String > iterator = collection1.iterator();
48
49 // loop while collection has items
50 while (iterator.hasNext())
51 {
52 if (collection2.contains(iterator.next()))
53 iterator.remove(); // remove current Color
54 } // end while
55 } // end method removeColors
56 } // end class CollectionTest

```

```

ArrayList:
MAGENTA RED WHITE BLUE CYAN

```

```

ArrayList after calling removeColors:
MAGENTA CYAN

```

**Fig. 20.2** | Collection interface demonstrated via an ArrayList object. (Part 2 of 2.)

Lines 13 and 20 declare and initialize String arrays `colors` and `removeColors`. Lines 14 and 21 create `ArrayList<String>` objects and assign their references to `List<String>` variables `list` and `removeList`, respectively. Recall that `ArrayList` is a *generic* class, so we can specify a type argument (`String` in this case) to indicate the type of the elements in each list. We refer to the `ArrayLists` in this example via `List` variables. This makes our code more flexible and easier to modify. If we later decide that `LinkedLists` would be more appropriate, we'll need to modify only lines 14 and 21 where we created the `ArrayList` objects.

Lines 16–17 populate `list` with Strings stored in array `colors`, and lines 23–24 populate `removeList` with Strings stored in array `removeColors` using **List method add**. Lines 29–30 output each element of `list`. Line 29 calls **List method size** to get the number of elements in the `ArrayList`. Line 30 uses **List method get** to retrieve individual element values. Lines 29–30 also could have used the enhanced for statement (which we'll demonstrate with collections in other examples).

Line 33 calls method `removeColors` (lines 43–55), passing `list` and `removeList` as arguments. Method `removeColors` deletes the Strings in `removeList` from the Strings in `list`. Lines 38–39 print `list`'s elements after `removeColors` completes its task.

Method `removeColors` declares two `Collection<String>` parameters (lines 43–44) that allow any two `Collection`s containing strings to be passed as arguments to this method. The method accesses the elements of the first `Collection` (`collection1`) via an `Iterator`. Line 47 calls **Collection method iterator** to get an `Iterator` for the `Collection`. Interfaces `Collection` and `Iterator` are generic types. The loop-continuation condition (line 50) calls **Iterator method hasNext** to determine whether the `Collection` contains more elements. Method `hasNext` returns `true` if another element exists and `false` otherwise.

The `if` condition in line 52 calls **Iterator method next** to obtain a reference to the next element, then uses method `contains` of the second `Collection` (`collection2`) to determine whether `collection2` contains the element returned by `next`. If so, line 53 calls **Iterator method remove** to remove the element from the `Collection` `collection1`.



### Common Programming Error 20.1

*If a collection is modified by one of its methods after an iterator is created for that collection, the iterator immediately becomes invalid—operations performed with the iterator after this point throw `ConcurrentModificationExceptions`. For this reason, iterators are said to be “fail fast.”*

### New in Java SE 7: Type Inference with the `<>` Notation

Lines 14 and 21 specify the type stored in the `ArrayList` (that is, `String`) on the left and right sides of the initialization statements. Java SE 7 supports type inferencing with the `<>` notation in statements that declare and create generic type variables and objects. For example, line 14 can be written as:

```
List<String> list = new ArrayList<>();
```

In this case, Java uses the type in angle brackets on the left of the declaration (that is, `String`) as the type stored in the `ArrayList` created on the right side of the declaration.

## 20.6.2 LinkedList

Figure 20.3 demonstrates various operations on `LinkedList`s. The program creates two `LinkedList`s of Strings. The elements of one `List` are added to the other. Then all the Strings are converted to uppercase, and a range of elements is deleted.

```
1 // Fig. 20.3: ListTest.java
2 // Lists, LinkedLists and ListIterators.
3 import java.util.List;
```

**Fig. 20.3** | Lists, `LinkedList`s and `ListIterators`. (Part I of 3.)

```

4 import java.util.LinkedList;
5 import java.util.ListIterator;
6
7 public class ListTest
8 {
9 public static void main(String[] args)
10 {
11 // add colors elements to list1
12 String[] colors =
13 { "black", "yellow", "green", "blue", "violet", "silver" };
14 List< String > list1 = new LinkedList< String >();
15
16 for (String color : colors)
17 list1.add(color);
18
19 // add colors2 elements to list2
20 String[] colors2 =
21 { "gold", "white", "brown", "blue", "gray", "silver" };
22 List< String > list2 = new LinkedList< String >();
23
24 for (String color : colors2)
25 list2.add(color);
26
27 list1.addAll(list2); // concatenate lists
28 list2 = null; // release resources
29 printList(list1); // print list1 elements
30
31 convertToUppercaseStrings(list1); // convert to uppercase string
32 printList(list1); // print list1 elements
33
34 System.out.print("\nDeleting elements 4 to 6...");
35 removeItems(list1, 4, 7); // remove items 4-6 from list
36 printList(list1); // print list1 elements
37 printReversedList(list1); // print list in reverse order
38 } // end main
39
40 // output List contents
41 private static void printList(List< String > list)
42 {
43 System.out.println("\nlist: ");
44
45 for (String color : list)
46 System.out.printf("%s ", color);
47
48 System.out.println();
49 } // end method printList
50
51 // locate String objects and convert to uppercase
52 private static void convertToUppercaseStrings(List< String > list)
53 {
54 ListIterator< String > iterator = list.listIterator();
55

```

**Fig. 20.3** | Lists, LinkedLists and ListIterators. (Part 2 of 3.)

```

56 while (iterator.hasNext())
57 {
58 String color = iterator.next(); // get item
59 iterator.set(color.toUpperCase()); // convert to upper case
60 } // end while
61 } // end method convertToUpperCaseStrings
62
63 // obtain sublist and use clear method to delete sublist items
64 private static void removeItems(List< String > list,
65 int start, int end)
66 {
67 list.subList(start, end).clear(); // remove items
68 } // end method removeItems
69
70 // print reversed list
71 private static void printReversedList(List< String > list)
72 {
73 ListIterator< String > iterator = list.listIterator(list.size());
74
75 System.out.println("\nReversed List:");
76
77 // print list in reverse order
78 while (iterator.hasPrevious())
79 System.out.printf("%s ", iterator.previous());
80 } // end method printReversedList
81 } // end class ListTest

```

```

list:
black yellow green blue violet silver gold white brown blue gray silver

list:
BLACK YELLOW GREEN BLUE VIOLET SILVER GOLD WHITE BROWN BLUE GRAY SILVER

Deleting elements 4 to 6...
list:
BLACK YELLOW GREEN BLUE WHITE BROWN BLUE GRAY SILVER

Reversed List:
SILVER GRAY BLUE BROWN WHITE BLUE GREEN YELLOW BLACK

```

**Fig. 20.3** | Lists, LinkedLists and ListIterators. (Part 3 of 3.)

Lines 14 and 22 create `LinkedLists` `list1` and `list2` of type `String`. `LinkedList` is a generic class that has one type parameter for which we specify the type argument `String` in this example. Lines 16–17 and 24–25 call `List` method `add` to append elements from arrays `colors` and `colors2` to the end of `list1` and `list2`, respectively.

Line 27 calls **List method `addAll`** to append all elements of `list2` to the end of `list1`. Line 28 sets `list2` to `null`, so the `LinkedList` to which `list2` referred can be garbage collected. Line 29 calls method `printList` (lines 41–49) to output `list1`'s contents. Line 31 calls method `convertToUpperCaseStrings` (lines 52–61) to convert each `String` element to uppercase, then line 32 calls `printList` again to display the modified `Strings`. Line 35 calls method `removeItems` (lines 64–68) to remove the elements starting at index 4 up to, but not including, index 7 of the list. Line 37 calls method `printReversedList` (lines 71–80) to print the list in reverse order.

### *Method convertToUpperCaseStrings*

Method `convertToUpperCaseStrings` (lines 52–61) changes lowercase `String` elements in its `List` argument to uppercase `Strings`. Line 54 calls **List method `listIterator`** to get the `List`'s **bidirectional iterator** (i.e., one that can traverse a `List` backward or forward). `ListIterator` is also a generic class. In this example, the `ListIterator` references `String` objects, because method `listIterator` is called on a `List` of `Strings`. Line 56 calls method `hasNext` to determine whether the `List` contains another element. Line 58 gets the next `String` in the `List`. Line 59 calls **String method `toUpperCase`** to get an uppercase version of the `String` and calls **ListIterator method `set`** to replace the current `String` to which `iterator` refers with the `String` returned by method `toUpperCase`. Like method `toUpperCase`, **String method `toLowerCase`** returns a lowercase version of the `String`.

### *Method removeItems*

Method `removeItems` (lines 64–68) removes a range of items from the list. Line 67 calls **List method `subList`** to obtain a portion of the `List` (called a **sublist**). This is a so-called **range-view method**, which enables the program to view a portion of the list. The `sublist` is simply a view into the `List` on which `subList` is called. Method `subList` takes as arguments the beginning and ending index for the `sublist`. The ending index is not part of the range of the `sublist`. In this example, line 35 passes 4 for the beginning index and 7 for the ending index to `subList`. The `sublist` returned is the set of elements with indices 4 through 6. Next, the program calls **List method `clear`** on the `sublist` to remove the elements of the `sublist` from the `List`. Any changes made to a `sublist` are also made to the original `List`.

### *Method printReversedList*

Method `printReversedList` (lines 71–80) prints the list backward. Line 73 calls `List` method `listIterator` with the starting position as an argument (in our case, the last element in the list) to get a bidirectional iterator for the list. **List method `size`** returns the number of items in the `List`. The `while` condition (line 78) calls **ListIterator's `hasPrevious` method** to determine whether there are more elements while traversing the list backward. Line 79 calls **ListIterator's `previous` method** to get the previous element from the list and outputs it to the standard output stream.

### *Views into Collections and Arrays Method `asList`*

An important feature of the collections framework is the ability to manipulate the elements of one collection type (such as a set) through a different collection type (such as a list), regardless of the collection's internal implementation. The set of `public` methods through which collections are manipulated is called a **view**.

Class `Arrays` provides static method **`asList`** to view an array (sometimes called the **backing array**) as a **List** collection. A `List` view allows you to manipulate the array as if it were a list. This is useful for adding the elements in an array to a collection and for sorting array elements. The next example demonstrates how to create a `LinkedList` with a `List` view of an array, because we cannot pass the array to a `LinkedList` constructor. Sorting array elements with a `List` view is demonstrated in Fig. 20.7. Any modifications made through the `List` view change the array, and any modifications made to the array change the `List` view. The only operation permitted on the view returned by `asList` is `set`, which changes the value of the view and the backing array. Any other attempts to change the view (such as adding or removing elements) result in an **`UnsupportedOperationException`**.

*Viewing Arrays as Lists and Converting Lists to Arrays*

Figure 20.4 uses Arrays method `asList` to view an array as a List and uses **List method `toArray`** to get an array from a LinkedList collection. The program calls method `asList` to create a List view of an array, which is used to initialize a LinkedList object, then adds a series of strings to the LinkedList and calls method `toArray` to obtain an array containing references to the Strings.

```

1 // Fig. 20.4: UsingToArray.java
2 // Viewing arrays as Lists and converting Lists to arrays.
3 import java.util.LinkedList;
4 import java.util.Arrays;
5
6 public class UsingToArray
7 {
8 // creates a LinkedList, adds elements and converts to array
9 public static void main(String[] args)
10 {
11 String[] colors = { "black", "blue", "yellow" };
12
13 LinkedList< String > links =
14 new LinkedList< String >(Arrays.asList(colors));
15
16 links.addLast("red"); // add as last item
17 links.add("pink"); // add to the end
18 links.add(3, "green"); // add at 3rd index
19 links.addFirst("cyan"); // add as first item
20
21 // get LinkedList elements as an array
22 colors = links.toArray(new String[links.size()]);
23
24 System.out.println("colors: ");
25
26 for (String color : colors)
27 System.out.println(color);
28 } // end main
29 } // end class UsingToArray

```

```

colors:
cyan
black
blue
yellow
green
red
pink

```

**Fig. 20.4** | Viewing arrays as Lists and converting Lists to arrays.

Lines 13–14 construct a LinkedList of Strings containing the elements of array `colors`. Line 14 uses Arrays method `asList` to return a List view of the array, then uses that to initialize the LinkedList with its constructor that receives a Collection as an argument (a List *is a* Collection). Line 16 calls **LinkedList method `addLast`** to add "red"

to the end of links. Lines 17–18 call **LinkedList method add** to add "pink" as the last element and "green" as the element at index 3 (i.e., the fourth element). Method `addLast` (line 16) functions identically to method `add` (line 17). Line 19 calls **LinkedList method addFirst** to add "cyan" as the new first item in the `LinkedList`. The add operations are permitted because they operate on the `LinkedList` object, not the view returned by `asList`. [Note: When "cyan" is added as the first element, "green" becomes the fifth element in the `LinkedList`.]

Line 22 calls the `List` interface's `toArray` method to get a `String` array from `links`. The array is a copy of the list's elements—modifying the array's contents does *not* modify the list. The array passed to method `toArray` is of the same type that you'd like method `toArray` to return. If the number of elements in that array is greater than or equal to the number of elements in the `LinkedList`, `toArray` copies the list's elements into its array argument and returns that array. If the `LinkedList` has more elements than the number of elements in the array passed to `toArray`, `toArray` allocates a new array of the same type it receives as an argument, copies the list's elements into the new array and returns the new array.



### Common Programming Error 20.2

*Passing an array that contains data to `toArray` can cause logic errors. If the number of elements in the array is smaller than the number of elements in the list on which `toArray` is called, a new array is allocated to store the list's elements—without preserving the array argument's elements. If the number of elements in the array is greater than the number of elements in the list, the elements of the array (starting at index zero) are overwritten with the list's elements. Array elements that are not overwritten retain their values.*

## 20.7 Collections Methods

Class `Collections` provides several high-performance algorithms for manipulating collection elements. The algorithms (Fig. 20.5) are implemented as static methods. The methods `sort`, `binarySearch`, `reverse`, `shuffle`, `fill` and `copy` operate on `Lists`. Methods `min`, `max`, `addAll`, `frequency` and `disjoint` operate on `Collections`.

| Method                    | Description                                                                 |
|---------------------------|-----------------------------------------------------------------------------|
| <code>sort</code>         | Sorts the elements of a <code>List</code> .                                 |
| <code>binarySearch</code> | Locates an object in a <code>List</code> .                                  |
| <code>reverse</code>      | Reverses the elements of a <code>List</code> .                              |
| <code>shuffle</code>      | Randomly orders a <code>List</code> 's elements.                            |
| <code>fill</code>         | Sets every <code>List</code> element to refer to a specified object.        |
| <code>copy</code>         | Copies references from one <code>List</code> into another.                  |
| <code>min</code>          | Returns the smallest element in a <code>Collection</code> .                 |
| <code>max</code>          | Returns the largest element in a <code>Collection</code> .                  |
| <code>addAll</code>       | Appends all elements in an array to a <code>Collection</code> .             |
| <code>frequency</code>    | Calculates how many collection elements are equal to the specified element. |
| <code>disjoint</code>     | Determines whether two collections have no elements in common.              |

**Fig. 20.5** | Collections methods.



### Software Engineering Observation 20.4

The collections framework methods are polymorphic. That is, each can operate on objects that implement specific interfaces, regardless of the underlying implementations.

## 20.7.1 Method sort

**Method sort** sorts the elements of a `List`, which must implement the **Comparable** interface. The order is determined by the natural order of the elements' type as implemented by a `compareTo` method. Method `compareTo` is declared in interface `Comparable` and is sometimes called the **natural comparison method**. The `sort` call may specify as a second argument a **Comparator** object that determines an alternative ordering of the elements.

### Sorting in Ascending Order

Figure 20.6 uses `Collections` method `sort` to order the elements of a `List` in ascending order (line 17). Recall that `List` is a generic type and accepts one type argument that specifies the list element type—line 14 creates `list` as a `List` of `Strings`. Lines 15 and 20 each use an implicit call to the `List`'s `toString` method to output the list contents in the format shown in the output.

```

1 // Fig. 20.6: Sort1.java
2 // Collections method sort.
3 import java.util.List;
4 import java.util.Arrays;
5 import java.util.Collections;
6
7 public class Sort1
8 {
9 public static void main(String[] args)
10 {
11 String[] suits = { "Hearts", "Diamonds", "Clubs", "Spades" };
12
13 // Create and display a list containing the suits array elements
14 List< String > list = Arrays.asList(suits); // create List
15 System.out.printf("Unsorted array elements: %s\n", list);
16
17 Collections.sort(list); // sort ArrayList
18
19 // output list
20 System.out.printf("Sorted array elements: %s\n", list);
21 } // end main
22 } // end class Sort1

```

```

Unsorted array elements: [Hearts, Diamonds, Clubs, Spades]
Sorted array elements: [Clubs, Diamonds, Hearts, Spades]

```

**Fig. 20.6** | Collections method sort.

### Sorting in Descending Order

Figure 20.7 sorts the same list of strings used in Fig. 20.6 in descending order. The example introduces the `Comparator` interface, which is used for sorting a `Collection`'s elements in a different order. Line 18 calls `Collections`'s method `sort` to order the `List` in de-



scending order. The static **Collections** method **reverseOrder** returns a **Comparator** object that orders the collection's elements in reverse order.

```

1 // Fig. 20.7: Sort2.java
2 // Using a Comparator object with method sort.
3 import java.util.List;
4 import java.util.Arrays;
5 import java.util.Collections;
6
7 public class Sort2
8 {
9 public static void main(String[] args)
10 {
11 String[] suits = { "Hearts", "Diamonds", "Clubs", "Spades" };
12
13 // Create and display a list containing the suits array elements
14 List< String > list = Arrays.asList(suits); // create List
15 System.out.printf("Unsorted array elements: %s\n", list);
16
17 // sort in descending order using a comparator
18 Collections.sort(list, Collections.reverseOrder());
19
20 // output List elements
21 System.out.printf("Sorted list elements: %s\n", list);
22 } // end main
23 } // end class Sort2

```

```

Unsorted array elements: [Hearts, Diamonds, Clubs, Spades]
Sorted list elements: [Spades, Hearts, Diamonds, Clubs]

```

**Fig. 20.7** | Collections method sort with a Comparator object.

### *Sorting with a Comparator*

Figure 20.8 creates a custom Comparator class, named **TimeComparator**, that implements interface **Comparator** to compare two **Time2** objects. Class **Time2**, declared in Fig. 8.5, represents times with hours, minutes and seconds.

```

1 // Fig. 20.8: TimeComparator.java
2 // Custom Comparator class that compares two Time2 objects.
3 import java.util.Comparator;
4
5 public class TimeComparator implements Comparator< Time2 >
6 {
7 public int compare(Time2 time1, Time2 time2)
8 {
9 int hourCompare = time1.getHour() - time2.getHour(); // compare hour
10
11 // test the hour first
12 if (hourCompare != 0)
13 return hourCompare;
14 }

```

**Fig. 20.8** | Custom Comparator class that compares two Time2 objects. (Part 1 of 2.)

---

```

15 int minuteCompare =
16 time1.getMinute() - time2.getMinute(); // compare minute
17
18 // then test the minute
19 if (minuteCompare != 0)
20 return minuteCompare;
21
22 int secondCompare =
23 time1.getSecond() - time2.getSecond(); // compare second
24
25 return secondCompare; // return result of comparing seconds
26 } // end method compare
27 } // end class TimeComparator

```

---

**Fig. 20.8** | Custom Comparator class that compares two Time2 objects. (Part 2 of 2.)

Class `TimeComparator` implements interface `Comparator`, a generic type that takes one type argument (in this case `Time2`). A class that implements `Comparator` must declare a `compare` method that receives two arguments and returns a negative integer if the first argument is less than the second, 0 if the arguments are equal or a positive integer if the first argument is greater than the second. Method `compare` (lines 7–26) performs comparisons between `Time2` objects. Line 9 compares the two hours of the `Time2` objects. If the hours are different (line 12), then we return this value. If this value is positive, then the first hour is greater than the second and the first time is greater than the second. If this value is negative, then the first hour is less than the second and the first time is less than the second. If this value is zero, the hours are the same and we must test the minutes (and maybe the seconds) to determine which time is greater.

Figure 20.9 sorts a list using the custom `Comparator` class `TimeComparator`. Line 11 creates an `ArrayList` of `Time2` objects. Recall that both `ArrayList` and `List` are generic types and accept a type argument that specifies the element type of the collection. Lines 13–17 create five `Time2` objects and add them to this list. Line 23 calls method `sort`, passing it an object of our `TimeComparator` class (Fig. 20.8).

---

```

1 // Fig. 20.9: Sort3.java
2 // Collections method sort with a custom Comparator object.
3 import java.util.List;
4 import java.util.ArrayList;
5 import java.util.Collections;
6
7 public class Sort3
8 {
9 public static void main(String[] args)
10 {
11 List< Time2 > list = new ArrayList< Time2 >(); // create List
12
13 list.add(new Time2(6, 24, 34));
14 list.add(new Time2(18, 14, 58));
15 list.add(new Time2(6, 05, 34));
16 list.add(new Time2(12, 14, 58));

```

---

**Fig. 20.9** | Collections method `sort` with a custom `Comparator` object. (Part 1 of 2.)

```

17 list.add(new Time2(6, 24, 22));
18
19 // output List elements
20 System.out.printf("Unsorted array elements:\n%s\n", list);
21
22 // sort in order using a comparator
23 Collections.sort(list, new TimeComparator());
24
25 // output List elements
26 System.out.printf("Sorted list elements:\n%s\n", list);
27 } // end main
28 } // end class Sort3

```

```

Unsorted array elements:
[6:24:34 AM, 6:14:58 PM, 6:05:34 AM, 12:14:58 PM, 6:24:22 AM]
Sorted list elements:
[6:05:34 AM, 6:24:22 AM, 6:24:34 AM, 12:14:58 PM, 6:14:58 PM]

```

**Fig. 20.9** | Collections method `sort` with a custom `Comparator` object. (Part 2 of 2.)

### 20.7.2 Method `shuffle`

Method `shuffle` randomly orders a `List`'s elements. Chapter 7 presented a card shuffling and dealing simulation that shuffled a deck of cards with a loop. Figure 20.10 uses method `shuffle` to shuffle a deck of `Card` objects that might be used in a card-game simulator.

Class `Card` (lines 8–41) represents a card in a deck of cards. Each `Card` has a face and a suit. Lines 10–12 declare two enum types—`Face` and `Suit`—which represent the face and the suit of the card, respectively. Method `toString` (lines 37–40) returns a `String` containing the face and suit of the `Card` separated by the string " of ". When an enum constant is converted to a string, the constant's identifier is used as the string representation. Normally we would use all uppercase letters for enum constants. In this example, we chose to use capital letters for only the first letter of each enum constant because we want the card to be displayed with initial capital letters for the face and the suit (e.g., "Ace of Spades").

```

1 // Fig. 20.10: DeckOfCards.java
2 // Card shuffling and dealing with Collections method shuffle.
3 import java.util.List;
4 import java.util.Arrays;
5 import java.util.Collections;
6
7 // class to represent a Card in a deck of cards
8 class Card
9 {
10 public static enum Face { Ace, Deuce, Three, Four, Five, Six,
11 Seven, Eight, Nine, Ten, Jack, Queen, King };
12 public static enum Suit { Clubs, Diamonds, Hearts, Spades };
13
14 private final Face face; // face of card
15 private final Suit suit; // suit of card

```

**Fig. 20.10** | Card shuffling and dealing with `Collections` method `shuffle`. (Part 1 of 3.)

```
16
17 // two-argument constructor
18 public Card(Face cardFace, Suit cardSuit)
19 {
20 face = cardFace; // initialize face of card
21 suit = cardSuit; // initialize suit of card
22 } // end two-argument Card constructor
23
24 // return face of the card
25 public Face getFace()
26 {
27 return face;
28 } // end method getFace
29
30 // return suit of Card
31 public Suit getSuit()
32 {
33 return suit;
34 } // end method getSuit
35
36 // return String representation of Card
37 public String toString()
38 {
39 return String.format("%s of %s", face, suit);
40 } // end method toString
41 } // end class Card
42
43 // class DeckOfCards declaration
44 public class DeckOfCards
45 {
46 private List< Card > list; // declare List that will store Cards
47
48 // set up deck of Cards and shuffle
49 public DeckOfCards()
50 {
51 Card[] deck = new Card[52];
52 int count = 0; // number of cards
53
54 // populate deck with Card objects
55 for (Card.Suit suit : Card.Suit.values())
56 {
57 for (Card.Face face : Card.Face.values())
58 {
59 deck[count] = new Card(face, suit);
60 ++count;
61 } // end for
62 } // end for
63
64 list = Arrays.asList(deck); // get List
65 Collections.shuffle(list); // shuffle deck
66 } // end DeckOfCards constructor
67
```

**Fig. 20.10** | Card shuffling and dealing with Collections method shuffle. (Part 2 of 3.)

```

68 // output deck
69 public void printCards()
70 {
71 // display 52 cards in two columns
72 for (int i = 0; i < list.size(); i++)
73 System.out.printf("%-19s%s", list.get(i),
74 ((i + 1) % 4 == 0) ? "\n" : "");
75 } // end method printCards
76
77 public static void main(String[] args)
78 {
79 DeckOfCards cards = new DeckOfCards();
80 cards.printCards();
81 } // end main
82 } // end class DeckOfCards

```

|                   |                  |                   |                  |
|-------------------|------------------|-------------------|------------------|
| Deuce of Clubs    | Six of Spades    | Nine of Diamonds  | Ten of Hearts    |
| Three of Diamonds | Five of Clubs    | Deuce of Diamonds | Seven of Clubs   |
| Three of Spades   | Six of Diamonds  | King of Clubs     | Jack of Hearts   |
| Ten of Spades     | King of Diamonds | Eight of Spades   | Six of Hearts    |
| Nine of Clubs     | Ten of Diamonds  | Eight of Diamonds | Eight of Hearts  |
| Ten of Clubs      | Five of Hearts   | Ace of Clubs      | Deuce of Hearts  |
| Queen of Diamonds | Ace of Diamonds  | Four of Clubs     | Nine of Hearts   |
| Ace of Spades     | Deuce of Spades  | Ace of Hearts     | Jack of Diamonds |
| Seven of Diamonds | Three of Hearts  | Four of Spades    | Four of Diamonds |
| Seven of Spades   | King of Hearts   | Seven of Hearts   | Five of Diamonds |
| Eight of Clubs    | Three of Clubs   | Queen of Clubs    | Queen of Spades  |
| Six of Clubs      | Nine of Spades   | Four of Hearts    | Jack of Clubs    |
| Five of Spades    | King of Spades   | Jack of Spades    | Queen of Hearts  |

**Fig. 20.10** | Card shuffling and dealing with Collections method `shuffle`. (Part 3 of 3.)

Lines 55–62 populate the deck array with cards that have unique face and suit combinations. Both `Face` and `Suit` are public static enum types of class `Card`. To use these enum types outside of class `Card`, you must qualify each enum's type name with the name of the class in which it resides (i.e., `Card`) and a dot (`.`) separator. Hence, lines 55 and 57 use `Card.Suit` and `Card.Face` to declare the control variables of the `for` statements. Recall that method values of an enum type returns an array that contains all the constants of the enum type. Lines 55–62 use enhanced `for` statements to construct 52 new `Cards`.

The shuffling occurs in line 65, which calls static method `shuffle` of class `Collections` to shuffle the elements of the array. Method `shuffle` requires a `List` argument, so we must obtain a `List` view of the array before we can shuffle it. Line 64 invokes static method `asList` of class `Arrays` to get a `List` view of the deck array.

Method `printCards` (lines 69–75) displays the deck of cards in four columns. In each iteration of the loop, lines 73–74 output a card left justified in a 19-character field followed by either a newline or an empty string based on the number of cards output so far. If the number of cards is divisible by 4, a newline is output; otherwise, the empty string is output.

### 20.7.3 Methods `reverse`, `fill`, `copy`, `max` and `min`

Class `Collections` provides methods for reversing, filling and copying `Lists`. **Collection method `reverse`** reverses the order of the elements in a `List`, and **method `fill`**

overwrites elements in a `List` with a specified value. The `fill` operation is useful for re-initializing a `List`. **Method `copy`** takes two arguments—a destination `List` and a source `List`. Each source `List` element is copied to the destination `List`. The destination `List` must be at least as long as the source `List`; otherwise, an `IndexOutOfBoundsException` occurs. If the destination `List` is longer, the elements not overwritten are unchanged.

Each method we've seen so far operates on `Lists`. Methods `min` and `max` each operate on any `Collection`. Method `min` returns the smallest element in a `Collection`, and method `max` returns the largest element in a `Collection`. Both of these methods can be called with a `Comparator` object as a second argument to perform custom comparisons of objects, such as the `TimeComparator` in Fig. 20.9. Figure 20.11 demonstrates methods `reverse`, `fill`, `copy`, `max` and `min`.

---

```

1 // Fig. 20.11: Algorithms1.java
2 // Collections methods reverse, fill, copy, max and min.
3 import java.util.List;
4 import java.util.Arrays;
5 import java.util.Collections;
6
7 public class Algorithms1
8 {
9 public static void main(String[] args)
10 {
11 // create and display a List< Character >
12 Character[] letters = { 'P', 'C', 'M' };
13 List< Character > list = Arrays.asList(letters); // get List
14 System.out.println("list contains: ");
15 output(list);
16
17 // reverse and display the List< Character >
18 Collections.reverse(list); // reverse order the elements
19 System.out.println("\nAfter calling reverse, list contains: ");
20 output(list);
21
22 // create copyList from an array of 3 Characters
23 Character[] lettersCopy = new Character[3];
24 List< Character > copyList = Arrays.asList(lettersCopy);
25
26 // copy the contents of list into copyList
27 Collections.copy(copyList, list);
28 System.out.println("\nAfter copying, copyList contains: ");
29 output(copyList);
30
31 // fill list with Rs
32 Collections.fill(list, 'R');
33 System.out.println("\nAfter calling fill, list contains: ");
34 output(list);
35 } // end main
36
37 // output List information
38 private static void output(List< Character > listRef)
39 {

```

---

**Fig. 20.11** | Collections methods `reverse`, `fill`, `copy`, `max` and `min`. (Part I of 2.)

```

40 System.out.print("The list is: ");
41
42 for (Character element : listRef)
43 System.out.printf("%s ", element);
44
45 System.out.printf("\nMax: %s", Collections.max(listRef));
46 System.out.printf(" Min: %s\n", Collections.min(listRef));
47 } // end method output
48 } // end class Algorithms1

```

```

list contains:
The list is: P C M
Max: P Min: C

After calling reverse, list contains:
The list is: M C P
Max: P Min: C

After copying, copyList contains:
The list is: M C P
Max: P Min: C

After calling fill, list contains:
The list is: R R R
Max: R Min: R

```

**Fig. 20.11** | Collections methods reverse, fill, copy, max and min. (Part 2 of 2.)

Line 13 creates `List<Character>` variable `list` and initializes it with a `List` view of the `Character` array `letters`. Lines 14–15 output the current contents of the `List`. Line 18 calls `Collections` method `reverse` to reverse the order of `list`. Method `reverse` takes one `List` argument. Since `list` is a `List` view of array `letters`, the array's elements are now in reverse order. The reversed contents are output in lines 19–20. Line 27 uses `Collections` method `copy` to copy `list`'s elements into `copyList`. Changes to `copyList` do not change `letters`, because `copyList` is a separate `List` that is not a `List` view of the array `letters`. Method `copy` requires two `List` arguments—the destination `List` and the source `List`. Line 32 calls `Collections` method `fill` to place the character 'R' in each `list` element. Because `list` is a `List` view of the array `letters`, this operation changes each element in `letters` to 'R'. Method `fill` requires a `List` for the first argument and an `Object` for the second argument—in this case, the `Object` is the boxed version of the character 'R'. Lines 45–46 call `Collections` methods `max` and `min` to find the largest and the smallest element of a `Collection`, respectively. Recall that interface `List` extends interface `Collection`, so a `List` *is a* `Collection`.

### 20.7.4 Method `binarySearch`

In Section 19.2.2, we studied the high-speed binary search algorithm. This algorithm is built into the Java collections framework as a static **`Collections` method `binarySearch`**, which locates an object in a `List` (e.g., a `LinkedList` or an `ArrayList`). If the object is found, its index is returned. If the object is not found, `binarySearch` returns a negative

value. Method `binarySearch` determines this negative value by first calculating the insertion point and making its sign negative. Then, `binarySearch` subtracts 1 from the insertion point to obtain the return value, which guarantees that method `binarySearch` returns positive numbers ( $\geq 0$ ) if and only if the object is found. If multiple elements in the list match the search key, there's no guarantee which one will be located first. Figure 20.12 uses method `binarySearch` to search for a series of strings in an `ArrayList`.

---

```

1 // Fig. 20.12: BinarySearchTest.java
2 // Collections method binarySearch.
3 import java.util.List;
4 import java.util.Arrays;
5 import java.util.Collections;
6 import java.util.ArrayList;
7
8 public class BinarySearchTest
9 {
10 public static void main(String[] args)
11 {
12 // create an ArrayList< String > from the contents of colors array
13 String[] colors = { "red", "white", "blue", "black", "yellow",
14 "purple", "tan", "pink" };
15 List< String > list =
16 new ArrayList< String >(Arrays.asList(colors));
17
18 Collections.sort(list); // sort the ArrayList
19 System.out.printf("Sorted ArrayList: %s\n", list);
20
21 // search list for various values
22 printSearchResults(list, colors[3]); // first item
23 printSearchResults(list, colors[0]); // middle item
24 printSearchResults(list, colors[7]); // last item
25 printSearchResults(list, "aqua"); // below lowest
26 printSearchResults(list, "gray"); // does not exist
27 printSearchResults(list, "teal"); // does not exist
28 } // end main
29
30 // perform search and display result
31 private static void printSearchResults(
32 List< String > list, String key)
33 {
34 int result = 0;
35
36 System.out.printf("\nSearching for: %s\n", key);
37 result = Collections.binarySearch(list, key);
38
39 if (result >= 0)
40 System.out.printf("Found at index %d\n", result);
41 else
42 System.out.printf("Not Found (%d)\n", result);
43 } // end method printSearchResults
44 } // end class BinarySearchTest

```

---

**Fig. 20.12** | Collections method `binarySearch`. (Part 1 of 2.)



```
Sorted ArrayList: [black, blue, pink, purple, red, tan, white, yellow]
Searching for: black
Found at index 0

Searching for: red
Found at index 4

Searching for: pink
Found at index 2

Searching for: aqua
Not Found (-1)

Searching for: gray
Not Found (-3)

Searching for: teal
Not Found (-7)
```

**Fig. 20.12** | Collections method `binarySearch`. (Part 2 of 2.)

Lines 15–16 initialize `list` with an `ArrayList` containing a copy of the elements in array `colors`. Collections method `binarySearch` expects its `List` argument's elements to be sorted in ascending order, so line 18 uses Collections method `sort` to sort the list. If the `List` argument's elements are not sorted, the result of using `binarySearch` is undefined. Line 19 outputs the sorted list. Lines 22–27 call method `printSearchResults` (lines 31–43) to perform searches and output the results. Line 37 calls Collections method `binarySearch` to search `list` for the specified key. Method `binarySearch` takes a `List` as the first argument and an `Object` as the second argument. Lines 39–42 output the results of the search. An overloaded version of `binarySearch` takes a `Comparator` object as its third argument, which specifies how `binarySearch` should compare the search key to the `List`'s elements.

### 20.7.5 Methods `addAll`, `frequency` and `disjoint`

Class `Collections` also provides the methods `addAll`, `frequency` and `disjoint`. **Collections method `addAll`** takes two arguments—a `Collection` into which to insert the new element(s) and an array that provides elements to be inserted. **Collections method `frequency`** takes two arguments—a `Collection` to be searched and an `Object` to be searched for in the collection. Method `frequency` returns the number of times that the second argument appears in the collection. **Collections method `disjoint`** takes two `Collections` and returns `true` if they have no elements in common. Figure 20.13 demonstrates the use of methods `addAll`, `frequency` and `disjoint`.

```
1 // Fig. 20.13: Algorithms2.java
2 // Collections methods addAll, frequency and disjoint.
3 import java.util.ArrayList;
4 import java.util.List;
5 import java.util.Arrays;
6 import java.util.Collections;
```

**Fig. 20.13** | Collections methods `addAll`, `frequency` and `disjoint`. (Part 1 of 2.)

```

7
8 public class Algorithms2
9 {
10 public static void main(String[] args)
11 {
12 // initialize list1 and list2
13 String[] colors = { "red", "white", "yellow", "blue" };
14 List< String > list1 = Arrays.asList(colors);
15 ArrayList< String > list2 = new ArrayList< String >();
16
17 list2.add("black"); // add "black" to the end of list2
18 list2.add("red"); // add "red" to the end of list2
19 list2.add("green"); // add "green" to the end of list2
20
21 System.out.print("Before addAll, list2 contains: ");
22
23 // display elements in list2
24 for (String s : list2)
25 System.out.printf("%s ", s);
26
27 Collections.addAll(list2, colors); // add colors Strings to list2
28
29 System.out.print("\nAfter addAll, list2 contains: ");
30
31 // display elements in list2
32 for (String s : list2)
33 System.out.printf("%s ", s);
34
35 // get frequency of "red"
36 int frequency = Collections.frequency(list2, "red");
37 System.out.printf(
38 "\nFrequency of red in list2: %d\n", frequency);
39
40 // check whether list1 and list2 have elements in common
41 boolean disjoint = Collections.disjoint(list1, list2);
42
43 System.out.printf("list1 and list2 %s elements in common\n",
44 (disjoint ? "do not have" : "have"));
45 } // end main
46 } // end class Algorithms2

```

```

Before addAll, list2 contains: black red green
After addAll, list2 contains: black red green red white yellow blue
Frequency of red in list2: 2
list1 and list2 have elements in common

```

**Fig. 20.13** | Collections methods addAll, frequency and disjoint. (Part 2 of 2.)

Line 14 initializes `list1` with elements in array `colors`, and lines 17–19 add Strings "black", "red" and "green" to `list2`. Line 27 invokes method `addAll` to add elements in array `colors` to `list2`. Line 36 gets the frequency of String "red" in `list2` using method `frequency`. Line 41 invokes method `disjoint` to test whether Collections `list1` and `list2` have elements in common, which they do in this example.

## 20.8 Stack Class of Package java.util

We introduced the concept of a stack in Section 6.6 when we discussed the method-call stack. In Chapter 22, Custom Generic Data Structures, we'll learn how to build data structures, including linked lists, stacks, queues and trees. In a world of software reuse, rather than building data structures as we need them, we can often take advantage of existing data structures. In this section, we investigate class **Stack** in the Java utilities package (java.util).

Class Stack extends class Vector to implement a stack data structure. Because class Stack extends class Vector, the entire public interface of class Vector is available to clients of class Stack. Figure 20.14 demonstrates several Stack methods. For the details of class Stack, visit [download.oracle.com/javase/6/docs/api/java/util/Stack.html](http://download.oracle.com/javase/6/docs/api/java/util/Stack.html).



### Error-Prevention Tip 20.1

*Because Stack extends Vector, all public Vector methods can be called on Stack objects, even if the methods do not represent conventional stack operations. For example, Vector method add can be used to insert an element anywhere in a stack—an operation that could “corrupt” the stack. When manipulating a Stack, only methods push and pop should be used to add elements to and remove elements from the Stack, respectively.*

```

1 // Fig. 20.14: StackTest.java
2 // Stack class of package java.util.
3 import java.util.Stack;
4 import java.util.EmptyStackException;
5
6 public class StackTest
7 {
8 public static void main(String[] args)
9 {
10 Stack< Number > stack = new Stack< Number >(); // create a Stack
11
12 // use push method
13 stack.push(12L); // push long value 12L
14 System.out.println("Pushed 12L");
15 printStack(stack);
16 stack.push(34567); // push int value 34567
17 System.out.println("Pushed 34567");
18 printStack(stack);
19 stack.push(1.0F); // push float value 1.0F
20 System.out.println("Pushed 1.0F");
21 printStack(stack);
22 stack.push(1234.5678); // push double value 1234.5678
23 System.out.println("Pushed 1234.5678 ");
24 printStack(stack);
25
26 // remove items from stack
27 try
28 {
29 Number removedObject = null;
30

```

**Fig. 20.14** | Stack class of package java.util. (Part 1 of 2.)

```

31 // pop elements from stack
32 while (true)
33 {
34 removedObject = stack.pop(); // use pop method
35 System.out.printf("Popped %s\n", removedObject);
36 printStack(stack);
37 } // end while
38 } // end try
39 catch (EmptyStackException emptyStackException)
40 {
41 emptyStackException.printStackTrace();
42 } // end catch
43 } // end main
44
45 // display Stack contents
46 private static void printStack(Stack< Number > stack)
47 {
48 if (stack.isEmpty())
49 System.out.println("stack is empty\n"); // the stack is empty
50 else // stack is not empty
51 System.out.printf("stack contains: %s (top)\n", stack);
52 } // end method printStack
53 } // end class StackTest

```

```

Pushed 12L
stack contains: [12] (top)
Pushed 34567
stack contains: [12, 34567] (top)
Pushed 1.0F
stack contains: [12, 34567, 1.0] (top)
Pushed 1234.5678
stack contains: [12, 34567, 1.0, 1234.5678] (top)
Popped 1234.5678
stack contains: [12, 34567, 1.0] (top)
Popped 1.0
stack contains: [12, 34567] (top)
Popped 34567
stack contains: [12] (top)
Popped 12
stack is empty

java.util.EmptyStackException
 at java.util.Stack.peek(Unknown Source)
 at java.util.Stack.pop(Unknown Source)
 at StackTest.main(StackTest.java:34)

```

**Fig. 20.14** | Stack class of package `java.util`. (Part 2 of 2.)

Line 10 creates an empty Stack of Numbers. Class `Number` (in package `java.lang`) is the superclass of the type-wrapper classes for the primitive numeric types (e.g., `Integer`, `Double`). By creating a Stack of Numbers, objects of any class that extends `Number` can be pushed onto the Stack. Lines 13, 16, 19 and 22 each call Stack method **push** to add a `Number` object to the top of the stack. Note the literals `12L` (line 13) and `1.0F` (line 19). Any integer literal that has the **suffix L** is a long value. An integer literal without a suffix

is an `int` value. Similarly, any floating-point literal that has the **suffix F** is a `float` value. A floating-point literal without a suffix is a `double` value. You can learn more about numeric literals in the *Java Language Specification* at [java.sun.com/docs/books/jls/third\\_edition/html/expressions.html#15.8.1](http://java.sun.com/docs/books/jls/third_edition/html/expressions.html#15.8.1).

An infinite loop (lines 32–37) calls **Stack method pop** to remove the top element of the stack. The method returns a `Number` reference to the removed element. If there are no elements in the `Stack`, method `pop` throws an **EmptyStackException**, which terminates the loop. Class `Stack` also declares **method peek**. This method returns the top element of the stack without popping the element off the stack.

Method `printStack` (lines 46–52) displays the stack’s contents. The current top of the stack (the last value pushed onto the stack) is the first value printed. Line 48 calls **Stack method isEmpty** (inherited by `Stack` from class `Vector`) to determine whether the stack is empty. If it’s empty, the method returns `true`; otherwise, `false`.

## 20.9 Class PriorityQueue and Interface Queue

Recall that a queue is a collection that represents a waiting line—typically, insertions are made at the back of a queue and deletions are made from the front. In Section 22.6, we’ll discuss and implement a queue data structure. In this section, we investigate Java’s **Queue** interface and **PriorityQueue** class from package `java.util`. Interface `Queue` extends interface `Collection` and provides additional operations for inserting, removing and inspecting elements in a queue. `PriorityQueue`, which implements the `Queue` interface, orders elements by their natural ordering as specified by `Comparable` elements’ `compareTo` method or by a `Comparator` object that is supplied to the constructor.

Class `PriorityQueue` provides functionality that enables insertions in sorted order into the underlying data structure and deletions from the front of the underlying data structure. When adding elements to a `PriorityQueue`, the elements are inserted in priority order such that the highest-priority element (i.e., the largest value) will be the first element removed from the `PriorityQueue`.

The common `PriorityQueue` operations are **offer** to insert an element at the appropriate location based on priority order, **poll** to remove the highest-priority element of the priority queue (i.e., the head of the queue), **peek** to get a reference to the highest-priority element of the priority queue (without removing that element), **clear** to remove all elements in the priority queue and **size** to get the number of elements in the priority queue. Figure 20.15 demonstrates the `PriorityQueue` class.

---

```

1 // Fig. 20.15: PriorityQueueTest.java
2 // PriorityQueue test program.
3 import java.util.PriorityQueue;
4
5 public class PriorityQueueTest
6 {
7 public static void main(String[] args)
8 {
9 // queue of capacity 11
10 PriorityQueue< Double > queue = new PriorityQueue< Double >();

```

---

**Fig. 20.15** | `PriorityQueue` test program. (Part I of 2.)

```

11
12 // insert elements to queue
13 queue.offer(3.2);
14 queue.offer(9.8);
15 queue.offer(5.4);
16
17 System.out.print("Polling from queue: ");
18
19 // display elements in queue
20 while (queue.size() > 0)
21 {
22 System.out.printf("%.1f ", queue.peek()); // view top element
23 queue.poll(); // remove top element
24 } // end while
25 } // end main
26 } // end class PriorityQueueTest

```

```
Polling from queue: 3.2 5.4 9.8
```

**Fig. 20.15** | PriorityQueue test program. (Part 2 of 2.)

Line 10 creates a `PriorityQueue` that stores `Doubles` with an initial capacity of 11 elements and orders the elements according to the object's natural ordering (the defaults for a `PriorityQueue`). `PriorityQueue` is a generic class. Line 10 instantiates a `PriorityQueue` with a type argument `Double`. Class `PriorityQueue` provides five additional constructors. One of these takes an `int` and a `Comparator` object to create a `PriorityQueue` with the initial capacity specified by the `int` and the ordering by the `Comparator`. Lines 13–15 use method `offer` to add elements to the priority queue. Method `offer` throws a `NullPointerException` if the program attempts to add a `null` object to the queue. The loop in lines 20–24 uses method `size` to determine whether the priority queue is empty (line 20). While there are more elements, line 22 uses `PriorityQueue` method `peek` to retrieve the highest-priority element in the queue for output (without actually removing it from the queue). Line 23 removes the highest-priority element in the queue with method `poll`, which returns the removed element.

## 20.10 Sets

A **Set** is an unordered `Collection` of unique elements (i.e., no duplicate elements). The collections framework contains several `Set` implementations, including **HashSet** and **TreeSet**. `HashSet` stores its elements in a hash table, and `TreeSet` stores its elements in a tree. Hash tables are presented in Section 20.11. Trees are discussed in Section 22.7.

Figure 20.16 uses a `HashSet` to remove duplicate strings from a `List`. Recall that both `List` and `Collection` are generic types, so line 16 creates a `List` that contains `String` objects, and line 20 passes a `Collection` of `Strings` to method `printNonDuplicates`.

Method `printNonDuplicates` (lines 24–35) takes a `Collection` argument. Line 27 constructs a `HashSet<String>` from the `Collection<String>` argument. By definition, `Sets` do not contain duplicates, so when the `HashSet` is constructed, it removes any duplicates in the `Collection`. Lines 31–32 output elements in the `Set`.

```

1 // Fig. 20.16: SetTest.java
2 // HashSet used to remove duplicate values from array of strings.
3 import java.util.List;
4 import java.util.Arrays;
5 import java.util.HashSet;
6 import java.util.Set;
7 import java.util.Collection;
8
9 public class SetTest
10 {
11 public static void main(String[] args)
12 {
13 // create and display a List< String >
14 String[] colors = { "red", "white", "blue", "green", "gray",
15 "orange", "tan", "white", "cyan", "peach", "gray", "orange" };
16 List< String > list = Arrays.asList(colors);
17 System.out.printf("List: %s\n", list);
18
19 // eliminate duplicates then print the unique values
20 printNonDuplications(list);
21 } // end main
22
23 // create a Set from a Collection to eliminate duplicates
24 private static void printNonDuplications(Collection< String > values)
25 {
26 // create a HashSet
27 Set< String > set = new HashSet< String >(values);
28
29 System.out.print("\nNonduplications are: ");
30
31 for (String value : set)
32 System.out.printf("%s ", value);
33
34 System.out.println();
35 } // end method printNonDuplications
36 } // end class SetTest

```

```
List: [red, white, blue, green, gray, orange, tan, white, cyan, peach, gray, orange]
```

```
Nonduplications are: orange green white peach gray cyan red blue tan
```

**Fig. 20.16** | HashSet used to remove duplicate values from an array of strings.

### Sorted Sets

The collections framework also includes the **SortedSet interface** (which extends `Set`) for sets that maintain their elements in sorted order—either the elements’ natural order (e.g., numbers are in ascending order) or an order specified by a `Comparator`. Class `TreeSet` implements `SortedSet`. The program in Fig. 20.17 places strings into a `TreeSet`. The strings are sorted as they’re added to the `TreeSet`. This example also demonstrates range-view methods, which enable a program to view a portion of a collection.

Lines 14–15 of create a `TreeSet<String>` that contains the elements of array `colors`, then assigns the new `TreeSet<String>` to `SortedSet<String>` variable `tree`. Line 18

```

1 // Fig. 20.17: SortedSetTest.java
2 // Using SortedSets and TreeSets.
3 import java.util.Arrays;
4 import java.util.SortedSet;
5 import java.util.TreeSet;
6
7 public class SortedSetTest
8 {
9 public static void main(String[] args)
10 {
11 // create TreeSet from array colors
12 String[] colors = { "yellow", "green", "black", "tan", "grey",
13 "white", "orange", "red", "green" };
14 SortedSet< String > tree =
15 new TreeSet< String >(Arrays.asList(colors));
16
17 System.out.print("sorted set: ");
18 printSet(tree); // output contents of tree
19
20 // get headSet based on "orange"
21 System.out.print("headSet (\"orange\"): ");
22 printSet(tree.headSet("orange"));
23
24 // get tailSet based upon "orange"
25 System.out.print("tailSet (\"orange\"): ");
26 printSet(tree.tailSet("orange"));
27
28 // get first and last elements
29 System.out.printf("first: %s\n", tree.first());
30 System.out.printf("last : %s\n", tree.last());
31 } // end main
32
33 // output SortedSet using enhanced for statement
34 private static void printSet(SortedSet< String > set)
35 {
36 for (String s : set)
37 System.out.printf("%s ", s);
38
39 System.out.println();
40 } // end method printSet
41 } // end class SortedSetTest

```

```

sorted set: black green grey orange red tan white yellow
headSet ("orange"): black green grey
tailSet ("orange"): orange red tan white yellow
first: black
last : yellow

```

**Fig. 20.17** | Using SortedSets and TreeSets.

outputs the initial set of strings using method `printSet` (lines 34–40), which we discuss momentarily. Line 22 calls **TreeSet method headSet** to get a subset of the `TreeSet` in which every element is less than "orange". The view returned from `headSet` is then output



with `printSet`. If any changes are made to the subset, they'll also be made to the original `TreeSet`, because the subset returned by `headSet` is a view of the `TreeSet`.

Line 26 calls **TreeSet method `tailSet`** to get a subset in which each element is greater than or equal to "orange", then outputs the result. Any changes made through the `tailSet` view are made to the original `TreeSet`. Lines 29–30 call **SortedSet methods `first` and `last`** to get the smallest and largest elements of the set, respectively.

Method `printSet` (lines 34–40) accepts a `SortedSet` as an argument and prints it. Lines 36–37 print each element of the `SortedSet` using the enhanced `for` statement.

## 20.11 Maps

**Maps** associate keys to values. The keys in a `Map` must be unique, but the associated values need not be. If a `Map` contains both unique keys and unique values, it's said to implement a **one-to-one mapping**. If only the keys are unique, the `Map` is said to implement a **many-to-one mapping**—many keys can map to one value.

Maps differ from `Sets` in that `Maps` contain keys and values, whereas `Sets` contain only values. Three of the several classes that implement interface `Map` are **Hashtable**, **HashMap** and **TreeMap**. `Hashtables` and `HashMaps` store elements in hash tables, and `TreeMaps` store elements in trees. This section discusses hash tables and provides an example that uses a `HashMap` to store key/value pairs. **Interface `SortedMap`** extends `Map` and maintains its keys in sorted order—either the elements' natural order or an order specified by a `Comparator`. Class `TreeMap` implements `SortedMap`.

### *Map Implementation with Hash Tables*

When a program creates objects of new or existing types, it may need to store and retrieve them efficiently. Storing and retrieving information with arrays is efficient if some aspect of your data directly matches a numerical key value and if the keys are unique and tightly packed. If you have 100 employees with nine-digit social security numbers and you want to store and retrieve employee data by using the social security number as a key, the task will require an array with over 700 million elements, because nine-digit Social Security numbers must begin with 001–733 as per the Social Security Administration's website

```
www.socialsecurity.gov/employer/stateweb.htm
```

This is impractical for virtually all applications that use social security numbers as keys. A program having an array that large could achieve high performance for both storing and retrieving employee records by simply using the social security number as the array index.

Numerous applications have this problem—namely, that either the keys are of the wrong type (e.g., not positive integers that correspond to array subscripts) or they're of the right type, but sparsely spread over a huge range. What is needed is a high-speed scheme for converting keys such as social security numbers, inventory part numbers and the like into unique array indices. Then, when an application needs to store something, the scheme could convert the application's key rapidly into an index, and the record could be stored at that slot in the array. Retrieval is accomplished the same way: Once the application has a key for which it wants to retrieve a data record, the application simply applies the conversion to the key—this produces the array index where the data is stored and retrieved.

The scheme we describe here is the basis of a technique called **hashing**. Why the name? When we convert a key into an array index, we literally scramble the bits, forming

a kind of “mishmashed,” or hashed, number. The number actually has no real significance beyond its usefulness in storing and retrieving a particular data record.

A glitch in the scheme is called a **collision**—this occurs when two different keys “hash into” the same cell (or element) in the array. We cannot store two values in the same space, so we need to find an alternative home for all values beyond the first that hash to a particular array index. There are many schemes for doing this. One is to “hash again” (i.e., to apply another hashing transformation to the key to provide a next candidate cell in the array). The hashing process is designed to distribute the values throughout the table, so the assumption is that an available cell will be found with just a few hashes.

Another scheme uses one hash to locate the first candidate cell. If that cell is occupied, successive cells are searched in order until an available cell is found. Retrieval works the same way: The key is hashed once to determine the initial location and check whether it contains the desired data. If it does, the search is finished. If it does not, successive cells are searched linearly until the desired data is found.

The most popular solution to hash-table collisions is to have each cell of the table be a hash “bucket,” typically a linked list of all the key/value pairs that hash to that cell. This is the solution that Java’s `HashTable` and `HashMap` classes (from package `java.util`) implement. Both `HashTable` and `HashMap` implement the `Map` interface. The primary differences between them are that `HashMap` is unsynchronized (multiple threads should not modify a `HashMap` concurrently) and allows `null` keys and `null` values.

A hash table’s **load factor** affects the performance of hashing schemes. The load factor is the ratio of the number of occupied cells in the hash table to the total number of cells in the hash table. The closer this ratio gets to 1.0, the greater the chance of collisions.



### Performance Tip 20.2

*The load factor in a hash table is a classic example of a memory-space/execution-time trade-off: By increasing the load factor, we get better memory utilization, but the program runs slower, due to increased hashing collisions. By decreasing the load factor, we get better program speed, because of reduced hashing collisions, but we get poorer memory utilization, because a larger portion of the hash table remains empty.*

Hash tables are complex to program. Computer science students study hashing schemes in courses called “Data Structures” and “Algorithms.” Classes `HashTable` and `HashMap` enable you to use hashing without having to implement hash-table mechanisms. This concept is profoundly important in our study of object-oriented programming. As discussed in earlier chapters, classes encapsulate and hide complexity (i.e., implementation details) and offer user-friendly interfaces. Properly crafting classes to exhibit such behavior is one of the most valued skills in the field of object-oriented programming. Figure 20.18 uses a `HashMap` to count the number of occurrences of each word in a string.

```

1 // Fig. 20.18: WordTypeCount.java
2 // Program counts the number of occurrences of each word in a String.
3 import java.util.Map;
4 import java.util.HashMap;
5 import java.util.Set;
6 import java.util.TreeSet;

```

**Fig. 20.18** | Program counts the number of occurrences of each word in a `String`. (Part 1 of 3.)

```

7 import java.util.Scanner;
8
9 public class WordTypeCount
10 {
11 public static void main(String[] args)
12 {
13 // create HashMap to store String keys and Integer values
14 Map< String, Integer > myMap = new HashMap< String, Integer >();
15
16 createMap(myMap); // create map based on user input
17 displayMap(myMap); // display map content
18 } // end main
19
20 // create map from user input
21 private static void createMap(Map< String, Integer > map)
22 {
23 Scanner scanner = new Scanner(System.in); // create scanner
24 System.out.println("Enter a string:"); // prompt for user input
25 String input = scanner.nextLine();
26
27 // tokenize the input
28 String[] tokens = input.split(" ");
29
30 // processing input text
31 for (String token : tokens)
32 {
33 String word = token.toLowerCase(); // get lowercase word
34
35 // if the map contains the word
36 if (map.containsKey(word)) // is word in map
37 {
38 int count = map.get(word); // get current count
39 map.put(word, count + 1); // increment count
40 } // end if
41 else
42 map.put(word, 1); // add new word with a count of 1 to map
43 } // end for
44 } // end method createMap
45
46 // display map content
47 private static void displayMap(Map< String, Integer > map)
48 {
49 Set< String > keys = map.keySet(); // get keys
50
51 // sort keys
52 TreeSet< String > sortedKeys = new TreeSet< String >(keys);
53
54 System.out.println("\nMap contains:\nKey\t\tValue");
55
56 // generate output for each key in map
57 for (String key : sortedKeys)
58 System.out.printf("%-10s%10s\n", key, map.get(key));
59 }

```

**Fig. 20.18** | Program counts the number of occurrences of each word in a String. (Part 2 of 3.)

```

60 System.out.printf(
61 "\nsize: %d\nisEmpty: %b\n", map.size(), map.isEmpty());
62 } // end method displayMap
63 } // end class WordTypeCount

```

```

Enter a string:
this is a sample sentence with several words this is another sample
sentence with several different words

```

```

Map contains:
Key Value
a 1
another 1
different 1
is 2
sample 2
sentence 2
several 2
this 2
with 2
words 2

size: 10
isEmpty: false

```

**Fig. 20.18** | Program counts the number of occurrences of each word in a `String`. (Part 3 of 3.)

Line 14 creates an empty `HashMap` with a default initial capacity (16 elements) and a default load factor (0.75)—these defaults are built into the implementation of `HashMap`. When the number of occupied slots in the `HashMap` becomes greater than the capacity times the load factor, the capacity is doubled automatically. `HashMap` is a generic class that takes two type arguments—the type of key (i.e., `String`) and the type of value (i.e., `Integer`). Recall that the type arguments passed to a generic class must be reference types, hence the second type argument is `Integer`, not `int`.

Line 16 calls method `createMap` (lines 21–44), which uses a map to store the number of occurrences of each word in the sentence. Line 25 obtains the user input, and line 28 tokenizes it. The loop in lines 31–43 converts the next token to lowercase letters (line 33), then calls **Map method containsKey** (line 36) to determine whether the word is in the map (and thus has occurred previously in the string). If the `Map` does not contain a mapping for the word, line 42 uses **Map method put** to create a new entry in the map, with the word as the key and an `Integer` object containing 1 as the value. Autoboxing occurs when the program passes integer 1 to method `put`, because the map stores the number of occurrences of the word as an `Integer`. If the word does exist in the map, line 38 uses **Map method get** to obtain the key’s associated value (the count) in the map. Line 39 increments that value and uses `put` to replace the key’s associated value in the map. Method `put` returns the key’s prior associated value, or `null` if the key was not in the map.

Method `displayMap` (lines 47–62) displays all the entries in the map. It uses **HashMap method keySet** (line 49) to get a set of the keys. The keys have type `String` in the map, so method `keySet` returns a generic type `Set` with type parameter specified to be `String`. Line 52 creates a `TreeSet` of the keys, in which the keys are sorted. The loop in lines 57–58

accesses each key and its value in the map. Line 58 displays each key and its value using format specifier %-10s to left justify each key and format specifier %10s to right justify each value. The keys are displayed in ascending order. Line 61 calls **Map method size** to get the number of key/value pairs in the Map. Line 61 also calls **Map method isEmpty**, which returns a boolean indicating whether the Map is empty.

## 20.12 Properties Class

A **Properties** object is a persistent Hashtable that normally stores key/value pairs of strings—assuming that you use methods **setProperty** and **getProperty** to manipulate the table rather than inherited Hashtable methods put and get. By “persistent,” we mean that the Properties object can be written to an output stream (possibly a file) and read back in through an input stream. A common use of Properties objects in prior versions of Java was to maintain application-configuration data or user preferences for applications. [Note: The **Preferences API** (package **java.util.prefs**) is meant to replace this particular use of class Properties but is beyond the scope of this book. To learn more, visit [bit.ly/JavaPreferences](http://bit.ly/JavaPreferences).]

Class Properties extends class Hashtable<Object, Object>. Figure 20.19 demonstrates several methods of class Properties.

---

```

1 // Fig. 20.19: PropertiesTest.java
2 // Demonstrates class Properties of the java.util package.
3 import java.io.FileOutputStream;
4 import java.io.FileInputStream;
5 import java.io.IOException;
6 import java.util.Properties;
7 import java.util.Set;
8
9 public class PropertiesTest
10 {
11 public static void main(String[] args)
12 {
13 Properties table = new Properties(); // create Properties table
14
15 // set properties
16 table.setProperty("color", "blue");
17 table.setProperty("width", "200");
18
19 System.out.println("After setting properties");
20 listProperties(table); // display property values
21
22 // replace property value
23 table.setProperty("color", "red");
24
25 System.out.println("After replacing properties");
26 listProperties(table); // display property values
27
28 saveProperties(table); // save properties
29

```

**Fig. 20.19** | Properties class of package java.util. (Part 1 of 3.)

```

30 table.clear(); // empty table
31
32 System.out.println("After clearing properties");
33 listProperties(table); // display property values
34
35 loadProperties(table); // load properties
36
37 // get value of property color
38 Object value = table.getProperty("color");
39
40 // check if value is in table
41 if (value != null)
42 System.out.printf("Property color's value is %s\n", value);
43 else
44 System.out.println("Property color is not in table");
45 } // end main
46
47 // save properties to a file
48 private static void saveProperties(Properties props)
49 {
50 // save contents of table
51 try
52 {
53 FileOutputStream output = new FileOutputStream("props.dat");
54 props.store(output, "Sample Properties"); // save properties
55 output.close();
56 System.out.println("After saving properties");
57 listProperties(props); // display property values
58 } // end try
59 catch (IOException ioException)
60 {
61 ioException.printStackTrace();
62 } // end catch
63 } // end method saveProperties
64
65 // load properties from a file
66 private static void loadProperties(Properties props)
67 {
68 // load contents of table
69 try
70 {
71 FileInputStream input = new FileInputStream("props.dat");
72 props.load(input); // load properties
73 input.close();
74 System.out.println("After loading properties");
75 listProperties(props); // display property values
76 } // end try
77 catch (IOException ioException)
78 {
79 ioException.printStackTrace();
80 } // end catch
81 } // end method loadProperties
82

```

**Fig. 20.19** | Properties class of package java.util. (Part 2 of 3.)

```

83 // output property values
84 private static void listProperties(Properties props)
85 {
86 Set< Object > keys = props.keySet(); // get property names
87
88 // output name/value pairs
89 for (Object key : keys)
90 System.out.printf(
91 "%s\t%s\n", key, props.getProperty((String) key));
92
93 System.out.println();
94 } // end method listProperties
95 } // end class PropertiesTest

```

```

After setting properties
color blue
width 200

After replacing properties
color red
width 200

After saving properties
color red
width 200

After clearing properties

After loading properties
color red
width 200

Property color's value is red

```

**Fig. 20.19** | Properties class of package java.util. (Part 3 of 3.)

Line 13 uses the no-argument constructor to create an empty `Properties` table with no default properties. Class `Properties` also provides an overloaded constructor that receives a reference to a `Properties` object containing default property values. Lines 16 and 17 each call `Properties` method `setProperty` to store a value for the specified key. If the key does not exist in the table, `setProperty` returns `null`; otherwise, it returns the previous value for that key.

Line 38 calls `Properties` method `getProperty` to locate the value associated with the specified key. If the key is not found in this `Properties` object, `getProperty` returns `null`. An overloaded version of this method receives a second argument that specifies the default value to return if `getProperty` cannot locate the key.

Line 54 calls **Properties method store** to save the `Properties` object's contents to the `OutputStream` specified as the first argument (in this case, a `FileOutputStream`). The second argument, a `String`, is a description written into the file. **Properties method list**, which takes a `PrintStream` argument, is useful for displaying the list of properties.

Line 72 calls **Properties method load** to restore the contents of the `Properties` object from the `InputStream` specified as the first argument (in this case, a `FileInput-`

Stream). Line 86 calls `Properties` method `keySet` to obtain a `Set` of the property names. Because class `Properties` stores its contents as `Objects`, a `Set` of `Object` references is returned. Line 91 obtains the value of a property by passing a key to method `getProperty`.

## 20.13 Synchronized Collections

In Chapter 26, we discuss multithreading. Except for `Vector` and `Hashtable`, the collections in the collections framework are unsynchronized by default, so they can operate efficiently when multithreading is not required. Because they're unsynchronized, however, concurrent access to a `Collection` by multiple threads could cause indeterminate results or fatal errors. To prevent potential threading problems, **synchronization wrappers** are used for collections that might be accessed by multiple threads. A **wrapper** object receives method calls, adds thread synchronization (to prevent concurrent access to the collection) and delegates the calls to the wrapped collection object. The `Collections` API provides a set of static methods for wrapping collections as synchronized versions. Method headers for the synchronization wrappers are listed in Fig. 20.20. Details about these methods are available at [download.oracle.com/javase/6/docs/api/java/util/Collections.html](http://download.oracle.com/javase/6/docs/api/java/util/Collections.html). All these methods take a generic type and return a synchronized view of the generic type. For example, the following code creates a synchronized `List` (`list2`) that stores `String` objects:

```
List< String > list1 = new ArrayList< String >();
List< String > list2 = Collections.synchronizedList(list1);
```

### public static method headers

```
< T > Collection< T > synchronizedCollection(Collection< T > c)
< T > List< T > synchronizedList(List< T > aList)
< T > Set< T > synchronizedSet(Set< T > s)
< T > SortedSet< T > synchronizedSortedSet(SortedSet< T > s)
< K, V > Map< K, V > synchronizedMap(Map< K, V > m)
< K, V > SortedMap< K, V > synchronizedSortedMap(SortedMap< K, V > m)
```

**Fig. 20.20** | Synchronization wrapper methods.

## 20.14 Unmodifiable Collections

The `Collections` class provides a set of static methods that create **unmodifiable wrappers** for collections. Unmodifiable wrappers throw `UnsupportedOperationException`s if attempts are made to modify the collection. Headers for these methods are listed in Fig. 20.21. Details about these methods are available at [download.oracle.com/javase/6/docs/api/java/util/Collections.html](http://download.oracle.com/javase/6/docs/api/java/util/Collections.html). All these methods take a generic type and return an unmodifiable view of the generic type. For example, the following code creates an unmodifiable `List` (`list2`) that stores `String` objects:

```
List< String > list1 = new ArrayList< String >();
List< String > list2 = Collections.unmodifiableList(list1);
```



## public static method headers

```

< T > Collection< T > unmodifiableCollection(Collection< T > c)
< T > List< T > unmodifiableList(List< T > aList)
< T > Set< T > unmodifiableSet(Set< T > s)
< T > SortedSet< T > unmodifiableSortedSet(SortedSet< T > s)
< K, V > Map< K, V > unmodifiableMap(Map< K, V > m)
< K, V > SortedMap< K, V > unmodifiableSortedMap(SortedMap< K, V > m)

```

**Fig. 20.21** | Unmodifiable wrapper methods.



### Software Engineering Observation 20.5

*You can use an unmodifiable wrapper to create a collection that offers read-only access to others, while allowing read/write access to yourself. You do this simply by giving others a reference to the unmodifiable wrapper while retaining for yourself a reference to the original collection.*

## 20.15 Abstract Implementations

The collections framework provides various abstract implementations of `Collection` interfaces from which you can quickly “flesh out” complete customized implementations. These abstract implementations include a thin `Collection` implementation called an **AbstractCollection**, a `List` implementation that allows random access to its elements called an **AbstractList**, a `Map` implementation called an **AbstractMap**, a `List` implementation that allows sequential access to its elements called an **AbstractSequentialList**, a `Set` implementation called an **AbstractSet** and a `Queue` implementation called **AbstractQueue**. You can learn more about these classes at [download.oracle.com/javase/6/docs/api/java/util/package-summary.html](http://download.oracle.com/javase/6/docs/api/java/util/package-summary.html).

To write a custom implementation, you can extend the abstract implementation that best meets your needs, and implement each of the class’s abstract methods. Then, if your collection is to be modifiable, override any concrete methods that prevent modification.

## 20.16 Wrap-Up

This chapter introduced the Java collections framework. You learned the collection hierarchy and how to use the collections-framework interfaces to program with collections polymorphically. You used classes `ArrayList` and `LinkedList`, which both implement the `List` interface. We presented Java’s built-in interfaces and classes for manipulating stacks and queues. You used several predefined methods for manipulating collections. Next, you learned how to use the `Set` interface and class `HashSet` to manipulate an unordered collection of unique values. We continued our presentation of sets with the `SortedSet` interface and class `TreeSet` for manipulating a sorted collection of unique values. You then learned about Java’s interfaces and classes for manipulating key/value pairs—`Map`, `SortedMap`, `Hashtable`, `HashMap` and `TreeMap`. We discussed the specialized `Properties` class for manipulating key/value pairs of `Strings` that can be stored to a file and retrieved from a file.

Finally, we discussed the `Collections` class's static methods for obtaining unmodifiable and synchronized views of collections. Chapter 21 demonstrates how to use Java's generics capabilities to implement your own generic methods and classes.

## Summary

### *Section 20.1 Introduction*

- The Java collections framework (p. 830) provides prebuilt data structures and methods to manipulate them.

### *Section 20.2 Collections Overview*

- A collection is an object that can hold references to other objects.
- The classes and interfaces of the collections framework are in package `java.util`.

### *Section 20.3 Type-Wrapper Classes for Primitive Types*

- Type-wrapper classes (e.g., `Integer`, `Double`, `Boolean`) enable programmers to manipulate primitive-type values as objects (p. 831). Objects of these classes can be used in collections.

### *Section 20.4 Autoboxing and Auto-Unboxing*

- Boxing (p. 832) converts a primitive value to an object of the corresponding type-wrapper class. Unboxing (p. 832) converts a type-wrapper object to the corresponding primitive value.
- Java performs boxing conversions and unboxing conversions automatically.

### *Section 20.5 Interface Collection and Class Collections*

- Interfaces `Set` and `List` extend `Collection` (p. 832), which contains operations for adding, clearing, comparing and retaining objects in a collection, and method `iterator` (p. 836) to obtain a collection's `Iterator` (p. 833).
- Class `Collections` (p. 833) provides static methods for manipulating collections.

### *Section 20.6 Lists*

- A `List` (p. 839) is an ordered `Collection` that can contain duplicate elements.
- Interface `List` is implemented by classes `ArrayList`, `LinkedList` and `Vector`. `ArrayList` (p. 833) is a resizable-array implementation. `LinkedList` (p. 833) is a linkedlist implementation of a `List`.
- Java SE 7 supports type inferencing with the `<>` notation in statements that declare and create generic type variables and objects.
- `Iterator` method `hasNext` (p. 836) determines whether a `Collection` contains another element. Method `next` returns a reference to the next object in the `Collection` and advances the `Iterator`.
- Method `subList` (p. 839) returns a view into a `List`. Changes made to this view are also made to the `List`.
- Method `clear` (p. 839) removes elements from a `List`.
- Method `toArray` (p. 840) returns the contents of a collection as an array.

### *Section 20.7 Collections Methods*

- Algorithms `sort` (p. 842), `binarySearch`, `reverse` (p. 847), `shuffle` (p. 845), `fill` (p. 847), `copy`, `addAll` (p. 838), `frequency` and `disjoint` operate on `Lists`. Algorithms `min` and `max` (p. 848) operate on `Collections`.

- Algorithm `addAll` appends all the elements in an array to a collection (p. 851), `frequency` (p. 851) calculates how many elements in the collection are equal to the specified element, and `disjoint` (p. 851) determines whether two collections have elements in common.
- Algorithms `min` and `max` find the smallest and largest items in a collection.
- The `Comparator` interface (p. 842) provides a means of sorting a `Collection`'s elements in an order other than their natural order.
- `Collections` method `reverseOrder` (p. 843) returns a `Comparator` object that can be used with `sort` to sort a collection's elements in reverse order.
- Algorithm `shuffle` (p. 845) randomly orders the elements of a `List`.
- Algorithm `binarySearch` (p. 849) locates an `Object` in a sorted `List`.

### *Section 20.8 Stack Class of Package `java.util`*

- Class `Stack` (p. 853) extends `Vector`. `Stack` method `push` (p. 854) adds its argument to the top of the stack. Method `pop` (p. 855) removes the top element of the stack. Method `peek` returns a reference to the top element without removing it. `Stack` method `isEmpty` (p. 855) determines whether the stack is empty.

### *Section 20.9 Class `PriorityQueue` and Interface `Queue`*

- Interface `Queue` (p. 832) extends interface `Collection` and provides additional operations for inserting, removing and inspecting elements in a queue.
- `PriorityQueue` (p. 855) implements interface `Queue` and orders elements by their natural ordering or by a `Comparator` object that is supplied to the constructor.
- `PriorityQueue` method `offer` (p. 855) inserts an element at the appropriate location based on priority order. Method `poll` (p. 855) removes the highest-priority element of the priority queue. Method `peek` (`peek`) gets a reference to the highest-priority element of the priority queue. Method `clear` (p. 855) removes all elements in the priority queue. Method `size` (p. 855) gets the number of elements in the priority queue.

### *Section 20.10 Sets*

- A `Set` (p. 832) is an unordered `Collection` that contains no duplicate elements. `HashSet` (p. 856) stores its elements in a hash table. `TreeSet` (p. 856) stores its elements in a tree.
- Interface `SortedSet` (p. 857) extends `Set` and represents a set that maintains its elements in sorted order. Class `TreeSet` implements `SortedSet`.
- `TreeSet` method `headSet` (p. 858) gets a `TreeSet` view containing elements that are less than a specified element. Method `tailSet` (p. 859) gets a `TreeSet` view containing elements that are greater than or equal to a specified element. Any changes made to these views are made to the original `TreeSet`.

### *Section 20.11 Maps*

- `Maps` (p. 859) store key/value pairs and cannot contain duplicate keys. `HashMaps` (p. 859) and `HashTables` (p. 859) store elements in a hash table, and `TreeMaps` (p. 859) store elements in a tree.
- `HashMap` takes two type arguments—the type of key and the type of value.
- `HashMap` method `put` (p. 862) adds a key/value pair to a `HashMap`. Method `get` (p. 862) locates the value associated with the specified key. Method `isEmpty` (p. 863) determines if the map is empty.
- `HashMap` method `keySet` (p. 862) returns a set of the keys. `Map` method `size` (p. 863) returns the number of key/value pairs in the `Map`.
- Interface `SortedMap` (p. 859) extends `Map` and represents a map that maintains its keys in sorted order. Class `TreeMap` implements `SortedMap`.

**Section 20.12 Properties Class**

- A `Properties` object (p. 863) is a persistent subclass of `Hashtable`.
- The `Properties` no-argument constructor creates an empty `Properties` table. An overloaded constructor receives a `Properties` object containing default property values.
- `Properties` method `setProperty` (p. 863) specifies the value associated with its key argument. Method `getProperty` (p. 863) locates the value of the key specified as an argument. Method `store` (p. 865) saves the contents of a `Properties` object to specified `OutputStream`. Method `load` (p. 865) restores the contents of a `Properties` object from the specified `InputStream`.

**Section 20.13 Synchronized Collections**

- Collections from the collections framework are unsynchronized. Synchronization wrappers (p. 866) are provided for collections that can be accessed by multiple threads simultaneously.

**Section 20.14 Unmodifiable Collections**

- Unmodifiable collection wrappers (p. 866) throw `UnsupportedOperationException` (p. 839) if attempts are made to modify the collection.

**Section 20.15 Abstract Implementations**

- The collections framework provides various abstract implementations of collection interfaces from which you can quickly flesh out complete customized implementations.

**Self-Review Exercises**

**20.1** Fill in the blanks in each of the following statements:

- A(n) \_\_\_\_\_ is used to iterate through a collection and can remove elements from the collection during the iteration.
- An element in a `List` can be accessed by using the element's \_\_\_\_\_.
- Assuming that `myArray` contains references to `Double` objects, \_\_\_\_\_ occurs when the statement `"myArray[ 0 ] = 1.25;"` executes.
- Java classes \_\_\_\_\_ and \_\_\_\_\_ provide the capabilities of arraylike data structures that can resize themselves dynamically.
- If you do not specify a capacity increment, the system will \_\_\_\_\_ the size of the `Vector` each time additional capacity is needed.
- You can use a(n) \_\_\_\_\_ to create a collection that offers only read-only access to others while allowing read/write access to yourself.
- Assuming that `myArray` contains references to `Double` objects, \_\_\_\_\_ occurs when the statement `"double number = myArray[ 0 ];"` executes.
- `Collections` algorithm \_\_\_\_\_ determines if two collections have elements in common.

**20.2** Determine whether each statement is *true* or *false*. If *false*, explain why.

- Values of primitive types may be stored directly in a collection.
- A `Set` can contain duplicate values.
- A `Map` can contain duplicate keys.
- A `LinkedList` can contain duplicate values.
- `Collections` is an interface.
- Iterators can remove elements.
- With hashing, as the load factor increases, the chance of collisions decreases.
- A `PriorityQueue` permits null elements.

**Answers to Self-Review Exercises**

**20.1** a) `Iterator`. b) `index`. c) `autoboxing`. d) `ArrayList`, `Vector`. e) `double`. f) `unmodifiable wrapper`. g) `auto-unboxing`. h) `disjoint`.

- 20.2**
- a) False. Autoboxing occurs when adding a primitive type to a collection, which means the primitive type is converted to its corresponding type-wrapper class.
  - b) False. A Set cannot contain duplicate values.
  - c) False. A Map cannot contain duplicate keys.
  - d) True.
  - e) False. Collections is a class; Collection is an interface.
  - f) True.
  - g) False. As the load factor increases, fewer slots are available relative to the total number of slots, so the chance of a collision increases.
  - h) False. Attempting to insert a null element causes a NullPointerException.

## Exercises

- 20.3** Define each of the following terms:
- a) Collection
  - b) Collections
  - c) Comparator
  - d) List
  - e) load factor
  - f) collision
  - g) space/time trade-off in hashing
  - h) HashMap
- 20.4** Explain briefly the operation of each of the following methods of class Vector:
- a) add
  - b) set
  - c) remove
  - d) removeAllElements
  - e) removeElementAt
  - f) firstElement
  - g) lastElement
  - h) contains
  - i) indexOf
  - j) size
  - k) capacity
- 20.5** Explain why inserting additional elements into a Vector object whose current size is less than its capacity is a relatively fast operation and why inserting additional elements into a Vector object whose current size is at capacity is a relatively slow operation.
- 20.6** By extending class Vector, Java's designers were able to create class Stack quickly. What are the negative aspects of this use of inheritance, particularly for class Stack?
- 20.7** Briefly answer the following questions:
- a) What is the primary difference between a Set and a Map?
  - b) What happens when you add a primitive type (e.g., double) value to a collection?
  - c) Can you print all the elements in a collection without using an Iterator? If yes, how?
- 20.8** Explain briefly the operation of each of the following Iterator-related methods:
- a) iterator
  - b) hasNext
  - c) next
- 20.9** Explain briefly the operation of each of the following methods of class HashMap:
- a) put

- b) get
- c) isEmpty
- d) containsKey
- e) keySet

- 20.10** Determine whether each of the following statements is *true* or *false*. If *false*, explain why.
- a) Elements in a `Collection` must be sorted in ascending order before a `binarySearch` may be performed.
  - b) Method `first` gets the first element in a `TreeSet`.
  - c) A `List` created with `Arrays` method `asList` is resizable.
- 20.11** Explain the operation of each of the following methods of the `Properties` class:
- a) `load`
  - b) `store`
  - c) `getProperty`
  - d) `list`
- 20.12** Rewrite lines 16–25 in Fig. 20.3 to be more concise by using the `asList` method and the `LinkedList` constructor that takes a `Collection` argument.
- 20.13** (*Duplicate Elimination*) Write a program that reads in a series of first names and eliminates duplicates by storing them in a `Set`. Allow the user to search for a first name.
- 20.14** (*Counting Letters*) Modify the program of Fig. 20.18 to count the number of occurrences of each letter rather than of each word. For example, the string "HELLO THERE" contains two Hs, three Es, two Ls, one O, one T and one R. Display the results.
- 20.15** (*Color Chooser*) Use a `HashMap` to create a reusable class for choosing one of the 13 predefined colors in class `Color`. The names of the colors should be used as keys, and the predefined `Color` objects should be used as values. Place this class in a package that can be imported into any Java program. Use your new class in an application that allows the user to select a color and draw a shape in that color.
- 20.16** (*Counting Duplicate Words*) Write a program that determines and prints the number of duplicate words in a sentence. Treat uppercase and lowercase letters the same. Ignore punctuation.
- 20.17** (*Inserting Elements in a LinkedList in Sorted Order*) Write a program that inserts 25 random integers from 0 to 100 in order into a `LinkedList` object. The program should sort the elements, then calculate the sum of the elements and the floating-point average of the elements.
- 20.18** (*Copying and Reversing LinkedLists*) Write a program that creates a `LinkedList` object of 10 characters, then creates a second `LinkedList` object containing a copy of the first list, but in reverse order.
- 20.19** (*Prime Numbers and Prime Factors*) Write a program that takes a whole number input from a user and determines whether it's prime. If the number is not prime, display its unique prime factors. Remember that a prime number's factors are only 1 and the prime number itself. Every number that is not prime has a unique prime factorization. For example, consider the number 54. The prime factors of 54 are 2, 3, 3 and 3. When the values are multiplied together, the result is 54. For the number 54, the prime factors output should be 2 and 3. Use `Sets` as part of your solution.
- 20.20** (*Sorting Words with a TreeSet*) Write a program that uses a `String` method `split` to tokenize a line of text input by the user and places each token in a `TreeSet`. Print the elements of the `TreeSet`. [Note: This should cause the elements to be printed in ascending sorted order.]
- 20.21** (*Changing a PriorityQueue's Sort Order*) The output of Fig. 20.15 (`PriorityQueueTest`) shows that `PriorityQueue` orders `Double` elements in ascending order. Rewrite Fig. 20.15 so that it orders `Double` elements in descending order (i.e., 9.8 should be the highest-priority element rather than 3.2).

# Generic Classes and Methods

# 21



*Every man of genius sees the world at a different angle from his fellows.*

—Havelock Ellis

*... our special individuality, as distinguished from our generic humanity.*

—Oliver Wendell Holmes, Sr.

*Born under one law, to another bound.*

—Lord Brooke

## Objectives

In this chapter you'll learn:

- To create generic methods that perform identical tasks on arguments of different types.
- To create a generic `Stack` class that can be used to store objects of any class or interface type.
- To understand how to overload generic methods with nongeneric methods or with other generic methods.
- To understand raw types and how they help achieve backward compatibility.
- To use wildcards when precise type information about a parameter is not required in the method body.

- |                                                                                                              |                                                              |
|--------------------------------------------------------------------------------------------------------------|--------------------------------------------------------------|
| <b>21.1</b> Introduction                                                                                     | <b>21.5</b> Overloading Generic Methods                      |
| <b>21.2</b> Motivation for Generic Methods                                                                   | <b>21.6</b> Generic Classes                                  |
| <b>21.3</b> Generic Methods: Implementation and Compile-Time Translation                                     | <b>21.7</b> Raw Types                                        |
| <b>21.4</b> Additional Compile-Time Translation Issues: Methods That Use a Type Parameter as the Return Type | <b>21.8</b> Wildcards in Methods That Accept Type Parameters |
|                                                                                                              | <b>21.9</b> Generics and Inheritance: Notes                  |
|                                                                                                              | <b>21.10</b> Wrap-Up                                         |

Summary | Self-Review Exercises | Answers to Self-Review Exercises | Exercises

## 21.1 Introduction

You've used existing generic methods and classes in Chapters 7 and 20. In this chapter, you'll learn how to write your own. You'll also learn the relationships between generics and other Java features, such as overloading and inheritance.

It would be nice if we could write a single `sort` method to sort the elements in an `Integer` array, a `String` array or an array of any type that supports ordering (i.e., its elements can be compared). It would also be nice if we could write a single `Stack` class that could be used as a `Stack` of integers, a `Stack` of floating-point numbers, a `Stack` of `Strings` or a `Stack` of any other type. It would be even nicer if we could detect type mismatches at *compile time*—known as **compile-time type safety**. For example, if a `Stack` stores only integers, attempting to push a `String` onto that `Stack` should issue a *compile-time* error.

This chapter discusses **generics**, which provide the means to create the general models mentioned above. **Generic methods** enable you to specify, with a single method declaration, a set of related methods. **Generic classes** (and interfaces) enable you to specify, with a single class (or interface) declaration, a set of related types, respectively. Generics also provide compile-time type safety that allows you to catch invalid types at compile time.

We might write a generic method for sorting an array of objects, then invoke the generic method with `Integer` arrays, `Double` arrays, `String` arrays and so on, to sort the array elements. The compiler could perform type checking to ensure that the array passed to the sorting method contains the same type elements. We might write a single generic `Stack` class that manipulates a stack of objects, then instantiate `Stack` objects for a stack of `Integers`, a stack of `Doubles`, a stack of `Strings` and so on. The compiler could perform type checking to ensure that the `Stack` stores elements of the same type.



### Software Engineering Observation 21.1

*Generic methods and classes are among Java's most powerful capabilities for software reuse with compile-time type safety.*

## 21.2 Motivation for Generic Methods

Overloaded methods are often used to perform *similar* operations on *different* types of data. To motivate generic methods, let's begin with an example (Fig. 21.1) containing overloaded `printArray` methods (lines 21–28, 31–38 and 41–48) that print the `String` representations of the elements of an `Integer` array, a `Double` array and a `Character` array, respectively. We could have used arrays of primitive types `int`, `double` and `char`. We're



using arrays of the type-wrapper classes to set up our generic method example, because *only reference types can be used with generic methods and classes*.

---

```

1 // Fig. 21.1: OverloadedMethods.java
2 // Printing array elements using overloaded methods.
3 public class OverloadedMethods
4 {
5 public static void main(String[] args)
6 {
7 // create arrays of Integer, Double and Character
8 Integer[] integerArray = { 1, 2, 3, 4, 5, 6 };
9 Double[] doubleArray = { 1.1, 2.2, 3.3, 4.4, 5.5, 6.6, 7.7 };
10 Character[] characterArray = { 'H', 'E', 'L', 'L', 'O' };
11
12 System.out.println("Array integerArray contains:");
13 printArray(integerArray); // pass an Integer array
14 System.out.println("\nArray doubleArray contains:");
15 printArray(doubleArray); // pass a Double array
16 System.out.println("\nArray characterArray contains:");
17 printArray(characterArray); // pass a Character array
18 } // end main
19
20 // method printArray to print Integer array
21 public static void printArray(Integer[] inputArray)
22 {
23 // display array elements
24 for (Integer element : inputArray)
25 System.out.printf("%s ", element);
26
27 System.out.println();
28 } // end method printArray
29
30 // method printArray to print Double array
31 public static void printArray(Double[] inputArray)
32 {
33 // display array elements
34 for (Double element : inputArray)
35 System.out.printf("%s ", element);
36
37 System.out.println();
38 } // end method printArray
39
40 // method printArray to print Character array
41 public static void printArray(Character[] inputArray)
42 {
43 // display array elements
44 for (Character element : inputArray)
45 System.out.printf("%s ", element);
46
47 System.out.println();
48 } // end method printArray
49 } // end class OverloadedMethods

```

---

**Fig. 21.1** | Printing array elements using overloaded methods. (Part 1 of 2.)

```

Array integerArray contains:
1 2 3 4 5 6

Array doubleArray contains:
1.1 2.2 3.3 4.4 5.5 6.6 7.7

Array characterArray contains:
H E L L O

```

**Fig. 21.1** | Printing array elements using overloaded methods. (Part 2 of 2.)

The program begins by declaring and initializing three arrays—six-element `Integer` array `integerArray` (line 8), seven-element `Double` array `doubleArray` (line 9) and five-element `Character` array `characterArray` (line 10). Then lines 12–17 display the contents of each array.

When the compiler encounters a method call, it attempts to locate a method declaration with the same name and parameters that match the argument types in the call. In this example, each `printArray` call matches one of the `printArray` method declarations. For example, line 13 calls `printArray` with `integerArray` as its argument. The compiler determines the argument's type (i.e., `Integer[]`) and attempts to locate a `printArray` method that specifies an `Integer[]` parameter (lines 21–28), then sets up a call to that method. Similarly, when the compiler encounters the call at line 15, it determines the argument's type (i.e., `Double[]`), then attempts to locate a `printArray` method that specifies a `Double[]` parameter (lines 31–38), then sets up a call to that method. Finally, when the compiler encounters the call at line 17, it determines the argument's type (i.e., `Character[]`), then attempts to locate a `printArray` method that specifies a `Character[]` parameter (lines 41–48), then sets up a call to that method.

Study each `printArray` method. The array element type appears in each method's header (lines 21, 31 and 41) and `for`-statement header (lines 24, 34 and 44). If we were to replace the element types in each method with a generic name—`T` by convention—then all three methods would look like the one in Fig. 21.2. It appears that if we can replace the array element type in each of the three methods with a *single generic type*, then we should be able to declare *one* `printArray` method that can display the `String` representations of the elements of *any* array that contains objects. The method in Fig. 21.2 is similar to the generic `printArray` method declaration we discuss in Section 21.3.

```

1 public static void printArray(T[] inputArray)
2 {
3 // display array elements
4 for (T element : inputArray)
5 System.out.printf("%s ", element);
6
7 System.out.println();
8 } // end method printArray

```

**Fig. 21.2** | `printArray` method in which actual type names are replaced by convention with the generic name `T`.

## 21.3 Generic Methods: Implementation and Compile-Time Translation

If the operations performed by several overloaded methods are *identical* for each argument type, the overloaded methods can be more compactly and conveniently coded using a generic method. You can write a single generic method declaration that can be called with arguments of different types. Based on the types of the arguments passed to the generic method, the compiler handles each method call appropriately.

Figure 21.3 reimplements the application of Fig. 21.1 using a generic `printArray` method (lines 22–29). The `printArray` method calls in lines 14, 16 and 18 are identical to those of Fig. 21.1 (lines 14, 16 and 18) and the outputs of the two applications are identical. This dramatically demonstrates the expressive power of generics.

```

1 // Fig. 21.3: GenericMethodTest.java
2 // Printing array elements using generic method printArray.
3
4 public class GenericMethodTest
5 {
6 public static void main(String[] args)
7 {
8 // create arrays of Integer, Double and Character
9 Integer[] intArray = { 1, 2, 3, 4, 5 };
10 Double[] doubleArray = { 1.1, 2.2, 3.3, 4.4, 5.5, 6.6, 7.7 };
11 Character[] charArray = { 'H', 'E', 'L', 'L', 'O' };
12
13 System.out.println("Array integerArray contains:");
14 printArray(intArray); // pass an Integer array
15 System.out.println("\nArray doubleArray contains:");
16 printArray(doubleArray); // pass a Double array
17 System.out.println("\nArray characterArray contains:");
18 printArray(characterArray); // pass a Character array
19 } // end main
20
21 // generic method printArray
22 public static < T > void printArray(T[] inputArray)
23 {
24 // display array elements
25 for (T element : inputArray)
26 System.out.printf("%s ", element);
27
28 System.out.println();
29 } // end method printArray
30 } // end class GenericMethodTest

```

```

Array integerArray contains:
1 2 3 4 5 6

Array doubleArray contains:
1.1 2.2 3.3 4.4 5.5 6.6 7.7

Array characterArray contains:
H E L L O

```

**Fig. 21.3** | Printing array elements using generic method `printArray`.

Line 22 begins method `printArray`'s declaration. All generic method declarations have a **type-parameter section** delimited by **angle brackets** (< and >) that precedes the method's return type (< T > in this example). Each type-parameter section contains one or more **type parameters** (also called **formal type parameters**), separated by commas. A type parameter, also known as a **type variable**, is an identifier that specifies a generic type name. The type parameters can be used to declare the return type, parameter types and local variable types in a generic method declaration, and they act as placeholders for the types of the arguments passed to the generic method, which are known as **actual type arguments**. A generic method's body is declared like that of any other method. *Type parameters can represent only reference types*—not primitive types (like `int`, `double` and `char`). Note, too, that the type-parameter names throughout the method declaration must match those declared in the type-parameter section. For example, line 25 declares `element` as type `T`, which matches the type parameter (`T`) declared in line 22. Also, a type parameter can be declared only once in the type-parameter section but can appear more than once in the method's parameter list. For example, the type-parameter name `T` appears twice in the following method's parameter list:

```
public static < T > void printTwoArrays(T[] array1, T[] array2)
```

Type-parameter names need not be unique among different generic methods.



### Common Programming Error 21.1

*When declaring a generic method, failing to place a type-parameter section before the return type of a method is a syntax error—the compiler will not understand the type-parameter names when they're encountered in the method.*

Method `printArray`'s type-parameter section declares type parameter `T` as the *placeholder* for the array element type that `printArray` will output. `T` appears in the parameter list as the array element type (line 22). The `for`-statement header (line 25) also uses `T` as the element type. These are the same two locations where the overloaded `printArray` methods of Fig. 21.1 specified `Integer`, `Double` or `Character` as the array element type. The remainder of `printArray` is identical to the versions presented in Fig. 21.1.



### Good Programming Practice 21.1

*It's recommended that type parameters be specified as individual capital letters. Typically, a type parameter that represents an array element's type (or other collection) is named `T`.*

As in Fig. 21.1, the program begins by declaring and initializing six-element `Integer` array `integerArray` (line 9), seven-element `Double` array `doubleArray` (line 10) and five-element `Character` array `characterArray` (line 11). Then the program outputs each array by calling `printArray` (lines 14, 16 and 18)—once with argument `integerArray`, once with argument `doubleArray` and once with argument `characterArray`.

When the compiler encounters line 14, it first determines argument `integerArray`'s type (i.e., `Integer[]`) and attempts to locate a method named `printArray` that specifies a single `Integer[]` parameter. There's no such method in this example. Next, the compiler determines whether there's a generic method named `printArray` that specifies a single array parameter and uses a type parameter to represent the array element type. The compiler determines that `printArray` (lines 22–29) is a match and sets up a call to the method. The same process is repeated for the calls to method `printArray` at lines 16 and 18.



### Common Programming Error 21.2

If the compiler cannot match a method call to a nongeneric or a generic method declaration, a compilation error occurs.



### Common Programming Error 21.3

If the compiler doesn't find a method declaration that matches a method call exactly, but does find two or more methods that can satisfy the method call, a compilation error occurs.

In addition to setting up the method calls, the compiler also determines whether the operations in the method body can be applied to elements of the type stored in the array argument. The only operation performed on the array elements in this example is to output their `String` representation. Line 26 performs an *implicit toString call* on every element. *To work with generics, every element of the array must be an object of a class or interface type.* Since all objects have a `toString` method, the compiler is satisfied that line 26 performs a *valid* operation for any object in `printArray`'s array argument. The `toString` methods of classes `Integer`, `Double` and `Character` return the `String` representation of the underlying `int`, `double` or `char` value, respectively.

### Erasure at Compilation Time

When the compiler translates generic method `printArray` into Java bytecodes, it removes the type-parameter section and *replaces the type parameters with actual types.* This process is known as **erasure**. By default all generic types are replaced with type `Object`. So the compiled version of method `printArray` appears as shown in Fig. 21.4—there's only *one* copy of this code, which is used for all `printArray` calls in the example. This is quite different from other, similar mechanisms, such as C++'s templates, in which a *separate copy of the source code* is generated and compiled for *every* type passed as an argument to the method. As you'll see in Section 21.4, the translation and compilation of generics is a bit more involved than what we've discussed in this section.

By declaring `printArray` as a generic method in Fig. 21.3, we eliminated the need for the overloaded methods of Fig. 21.1, saving 19 lines of code and creating a reusable method that can output the `String` representations of the elements in any array that contains objects. However, this particular example could have simply declared the `printArray` method as shown in Fig. 21.4, using an `Object` array as the parameter. This would have yielded the same results, because any `Object` can be output as a `String`. In a generic method, the benefits become apparent when the method also uses a type parameter as the method's return type, as we demonstrate in the next section.

```
1 public static void printArray(Object[] inputArray)
2 {
3 // display array elements
4 for (Object element : inputArray)
5 System.out.printf("%s ", element);
6
7 System.out.println();
8 } // end method printArray
```

**Fig. 21.4** | Generic method `printArray` after erasure is performed by the compiler.

## 21.4 Additional Compile-Time Translation Issues: Methods That Use a Type Parameter as the Return Type

Let's consider a generic method example in which type parameters are used in the return type and in the parameter list (Fig. 21.5). The application uses a generic method `maximum` to determine and return the largest of its three arguments of the same type. Unfortunately, *the relational operator > cannot be used with reference types*. However, it's possible to compare two objects of the same class if that class implements the generic **interface Comparable<T>** (package `java.lang`). All the type-wrapper classes for primitive types implement this interface. Like generic classes, **generic interfaces** enable you to specify, with a single interface declaration, a set of related types. `Comparable<T>` objects have a **compareTo method**. For example, if we have two Integer objects, `integer1` and `integer2`, they can be compared with the expression:

```
integer1.compareTo(integer2)
```

*It's your responsibility when you declare a class that implements Comparable<T> to declare method compareTo such that it compares the contents of two objects of that class and returns the comparison results.* As specified in interface `Comparable<T>`'s documentation, `compareTo` must return 0 if the objects are equal, a negative integer if `object1` is less than `object2` or a positive integer if `object1` is greater than `object2`. For example, class `Integer`'s `compareTo` method compares the `int` values stored in two `Integer` objects. A benefit of implementing interface `Comparable<T>` is that `Comparable<T>` objects can be used with the sorting and searching methods of class `Collections` (package `java.util`). We discussed those methods in Chapter 20. In this example, we'll use method `compareTo` in method `maximum` to help determine the largest value.

---

```

1 // Fig. 21.5: MaximumTest.java
2 // Generic method maximum returns the largest of three objects.
3
4 public class MaximumTest
5 {
6 public static void main(String[] args)
7 {
8 System.out.printf("Maximum of %d, %d and %d is %d\n\n", 3, 4, 5,
9 maximum(3, 4, 5));
10 System.out.printf("Maximum of %.1f, %.1f and %.1f is %.1f\n\n",
11 6.6, 8.8, 7.7, maximum(6.6, 8.8, 7.7));
12 System.out.printf("Maximum of %s, %s and %s is %s\n", "pear",
13 "apple", "orange", maximum("pear", "apple", "orange"));
14 } // end main
15
16 // determines the largest of three Comparable objects
17 public static < T extends Comparable< T > > T maximum(T x, T y, T z)
18 {
19 T max = x; // assume x is initially the largest
20
21 if (y.compareTo(max) > 0)
22 max = y; // y is the largest so far

```

**Fig. 21.5** | Generic method `maximum` with an upper bound on its type parameter. (Part 1 of 2.)

```
23
24 if (z.compareTo(max) > 0)
25 max = z; // z is the largest
26
27 return max; // returns the largest object
28 } // end method maximum
29 } // end class MaximumTest
```

Maximum of 3, 4 and 5 is 5

Maximum of 6.6, 8.8 and 7.7 is 8.8

Maximum of pear, apple and orange is pear

**Fig. 21.5** | Generic method `maximum` with an upper bound on its type parameter. (Part 2 of 2.)

### *Generic Method `maximum`*

Generic method `maximum` (lines 17–28) uses type parameter `T` as the return type of the method (line 17), as the type of method parameters `x`, `y` and `z` (line 17), and as the type of local variable `max` (line 19). The type-parameter section specifies that `T` extends `Comparable<T>`—only objects of classes that implement interface `Comparable<T>` can be used with this method. In this case, `Comparable` is known as the **upper bound** of the type parameter. By default, `Object` is the upper bound. Type-parameter declarations that bound the parameter always use keyword `extends` regardless of whether the type parameter extends a class or implements an interface. This type parameter is more restrictive than the one specified for `printArray` in Fig. 21.3, which was able to output arrays containing any type of object. The restriction of using `Comparable<T>` objects is important, because not all objects can be compared. However, `Comparable<T>` objects are guaranteed to have a `compareTo` method.

Method `maximum` uses the same algorithm that we used in Section 6.4 to determine the largest of its three arguments. The method assumes that its first argument (`x`) is the largest and assigns it to local variable `max` (line 19). Next, the `if` statement at lines 21–22 determines whether `y` is greater than `max`. The condition invokes `y`'s `compareTo` method with the expression `y.compareTo(max)`, which returns a negative integer, 0 or a positive integer, to determine `y`'s relationship to `max`. If the return value of the `compareTo` is greater than 0, then `y` is greater and is assigned to variable `max`. Similarly, the `if` statement at lines 24–25 determines whether `z` is greater than `max`. If so, line 25 assigns `z` to `max`. Then line 27 returns `max` to the caller.

### *Calling Method `maximum`*

In `main` (lines 6–14), line 9 calls `maximum` with the integers 3, 4 and 5. When the compiler encounters this call, it first looks for a `maximum` method that takes three arguments of type `int`. There's no such method, so the compiler looks for a generic method that can be used and finds generic method `maximum`. However, recall that the arguments to a generic method must be of a *reference type*. So the compiler autoboxes the three `int` values as `Integer` objects and specifies that the three `Integer` objects will be passed to `maximum`. Class `Integer` (package `java.lang`) implements the `Comparable<Integer>` interface such that method `compareTo` compares the `int` values in two `Integer` objects. Therefore, `Integers` are valid arguments to method `maximum`. When the `Integer` representing the maximum is re-

turned, we attempt to output it with the `%d` format specifier, which outputs an `int` primitive-type value. So `maximum`'s return value is output as an `int` value.

A similar process occurs for the three `double` arguments passed to `maximum` in line 11. Each `double` is autoboxed as a `Double` object and passed to `maximum`. Again, this is allowed because class `Double` (package `java.lang`) implements the `Comparable<Double>` interface. The `Double` returned by `maximum` is output with the format specifier `%.1f`, which outputs a `double` primitive-type value. So `maximum`'s return value is auto-unboxed and output as a `double`. The call to `maximum` in line 13 receives three `String`s, which are also `Comparable<String>` objects. We intentionally placed the largest value in a different position in each method call (lines 9, 11 and 13) to show that the generic method always finds the maximum value, regardless of its position in the argument list.

### Upper Bound of a Type Parameter

When the compiler translates method `maximum` into bytecodes, it uses erasure (introduced in Section 21.3) to replace the type parameters with actual types. In Fig. 21.3, all generic types were replaced with type `Object`. Actually, all type parameters are replaced with the so-called *upper bound* of the type parameter, which is specified in the type-parameter section. To indicate the upper bound, follow the type parameter's name with the keyword `extends` and the class or interface name that represents the upper bound, or a comma-separated list of the types that represent the upper bound. The list may contain zero or one class and zero or more interfaces. For example, in method `maximum`'s type-parameter section (Fig. 21.5), we specified the upper bound of the type parameter `T` as type `Comparable<T>` as follows:

```
T extends Comparable< T >
```

Thus, only `Comparable<T>` objects can be passed as arguments to `maximum`—anything that is not a `Comparable<T>` will result in compilation errors. Unless specified otherwise, `Object` is the default upper bound. Figure 21.6 simulates the erasure of method `maximum`'s types by showing the method's source code after the type-parameter section is removed and type parameter `T` is replaced with the upper bound, `Comparable`, throughout the method declaration. The erasure of `Comparable<T>` is simply `Comparable`.

```

1 public static Comparable maximum(Comparable x, Comparable y, Comparable z)
2 {
3 Comparable max = x; // assume x is initially the largest
4
5 if (y.compareTo(max) > 0)
6 max = y; // y is the largest so far
7
8 if (z.compareTo(max) > 0)
9 max = z; // z is the largest
10
11 return max; // returns the largest object
12 } // end method maximum

```

**Fig. 21.6** | Generic method `maximum` after erasure is performed by the compiler.

After erasure, method `maximum` specifies that it returns type `Comparable`. However, the calling method does not expect to receive a `Comparable`. It expects to receive an object of the same type that was passed to `maximum` as an argument—`Integer`, `Double` or `String`



in this example. When the compiler replaces the type-parameter information with the upper-bound type in the method declaration, it also inserts *explicit cast operations* in front of each method call to ensure that the returned value is of the type expected by the caller. Thus, the call to `maximum` in line 9 (Fig. 21.5) is preceded by an `Integer` cast, as in

```
(Integer) maximum(3, 4, 5)
```

the call to `maximum` in line 11 is preceded by a `Double` cast, as in

```
(Double) maximum(6.6, 8.8, 7.7)
```

and the call to `maximum` in line 13 is preceded by a `String` cast, as in

```
(String) maximum("pear", "apple", "orange")
```

In each case, the type of the cast for the return value is *inferred* from the types of the method arguments in the particular method call, because, according to the method declaration, the return type and the argument types match.

### *Possible ClassCastException*

In this example, you cannot use a method that accepts `Objects`, because class `Object` provides only an equality comparison. Also, without generics, you'd be responsible for implementing the cast operation. Using generics ensures that the inserted cast will never throw a `ClassCastException`, assuming that generics are used throughout your code (i.e., you do not mix old code with new generics code).

## 21.5 Overloading Generic Methods

*A generic method may be overloaded.* A class can provide two or more generic methods that specify the same method name but different method parameters. For example, generic method `printArray` of Fig. 21.3 could be overloaded with another `printArray` generic method with the additional parameters `lowSubscript` and `highSubscript` to specify the portion of the array to output (see Exercise 21.5).

A generic method can also be overloaded by nongeneric methods. When the compiler encounters a method call, it searches for the method declaration that most precisely matches the method name and the argument types specified in the call. For example, generic method `printArray` of Fig. 21.3 could be overloaded with a version that's specific to `Strings`, which outputs the `Strings` in neat, tabular format (see Exercise 21.6).

When the compiler encounters a method call, it performs a matching process to determine which method to invoke. The compiler tries to find and use a precise match in which the method name and argument types of the method call match those of a specific method declaration. If there's no such method, the compiler attempts to find a method with compatible types or a matching generic method.

## 21.6 Generic Classes

The concept of a data structure, such as a stack, can be understood *independently* of the element type it manipulates. Generic classes provide a means for describing the concept of a stack (or any other class) in a type-independent manner. We can then instantiate type-specific objects of the generic class. This capability provides a wonderful opportunity for software reusability.

Once you have a generic class, you can use a simple, concise notation to indicate the type(s) that should be used in place of the class's type parameter(s). At compilation time, the compiler ensures the *type safety* of your code and uses the *erasure* techniques described in Sections 21.3–21.4 to enable your client code to interact with the generic class.

One generic Stack class, for example, could be the basis for creating many logical Stack classes (e.g., “Stack of Double,” “Stack of Integer,” “Stack of Character,” “Stack of Employee”). These classes are known as **parameterized classes** or **parameterized types** because they accept one or more type parameters. Recall that type parameters represent only *reference types*, which means the Stack generic class cannot be instantiated with primitive types. However, we can instantiate a Stack that stores objects of Java's type-wrapper classes and allow Java to use *autoboxing* to convert the primitive values into objects. Recall that autoboxing occurs when a value of a primitive type (e.g., int) is pushed onto a Stack that contains wrapper-class objects (e.g., Integer). *Auto-unboxing* occurs when an object of the wrapper class is popped off the Stack and assigned to a primitive-type variable.

### Implementing a Generic Stack Class

Figure 21.7 presents a generic Stack class declaration. A generic class declaration looks like a nongeneric one, but the class name is followed by a *type-parameter section* (line 5). In this case, type parameter T represents the element type the Stack will manipulate. As with generic methods, the type-parameter section of a generic class can have one or more type parameters separated by commas. (You'll create a generic class with two type parameters in Exercise 21.8.) Type parameter T is used throughout the Stack class declaration to represent the element type. This example implements a Stack as an ArrayList.

---

```

1 // Fig. 21.7: Stack.java
2 // Stack generic class declaration.
3 import java.util.ArrayList;
4
5 public class Stack< T >
6 {
7 private ArrayList< T > elements; // ArrayList stores stack elements
8
9 // no-argument constructor creates a stack of the default size
10 public Stack()
11 {
12 this(10); // default stack size
13 } // end no-argument Stack constructor
14
15 // constructor creates a stack of the specified number of elements
16 public Stack(int capacity)
17 {
18 int initCapacity = capacity > 0 ? capacity : 10; // validate
19 elements = new ArrayList< T >(initCapacity); // create ArrayList
20 } // end one-argument Stack constructor
21
22 // push element onto stack
23 public void push(T pushValue)
24 {

```

**Fig. 21.7** | Stack generic class declaration. (Part I of 2.)

```

25 elements.add(pushValue); // place pushValue on Stack
26 } // end method push
27
28 // return the top element if not empty; else throw EmptyStackException
29 public T pop()
30 {
31 if (elements.isEmpty()) // if stack is empty
32 throw new EmptyStackException("Stack is empty, cannot pop");
33
34 // remove and return top element of Stack
35 return elements.remove(elements.size() - 1);
36 } // end method pop
37 } // end class Stack< T >

```

**Fig. 21.7** | Stack generic class declaration. (Part 2 of 2.)

Class `Stack` declares variable `elements` as an `ArrayList<T>` (line 7). This `ArrayList` will store the `Stack`'s elements. As you know, an `ArrayList` can grow dynamically, so objects of our `Stack` class can also grow dynamically. The `Stack` class's no-argument constructor (lines 10–13) invokes the one-argument constructor (lines 16–20) to create a `Stack` in which the underlying `ArrayList` has a capacity of 10 elements. The one-argument constructor can also be called directly to create a `Stack` with a specified initial capacity. Line 18 validates the constructor's argument. Line 19 creates the `ArrayList` of the specified capacity (or 10 if the capacity was invalid).

Method `push` (lines 23–26) uses `ArrayList` method `add` to append the pushed item to the end of the `ArrayList` `elements`. The last element in the `ArrayList` represents the *top* of the stack.

Method `pop` (lines 29–36) first determines whether an attempt is being made to pop an element from an empty `Stack`. If so, line 32 throws an `EmptyStackException` (declared in Fig. 21.8). Otherwise, line 35 returns the top element of the `Stack` by removing the last element in the underlying `ArrayList`.

Class `EmptyStackException` (Fig. 21.8) provides a no-argument constructor and a one-argument constructor. The no-argument constructor sets the default error message, and the one-argument constructor sets a custom error message.

```

1 // Fig. 21.8: EmptyStackException.java
2 // EmptyStackException class declaration.
3 public class EmptyStackException extends RuntimeException
4 {
5 // no-argument constructor
6 public EmptyStackException()
7 {
8 this("Stack is empty");
9 } // end no-argument EmptyStackException constructor
10
11 // one-argument constructor
12 public EmptyStackException(String message)
13 {

```

**Fig. 21.8** | `EmptyStackException` class declaration. (Part 1 of 2.)

---

```

14 super(message);
15 } // end one-argument EmptyStackException constructor
16 } // end class EmptyStackException

```

---

**Fig. 21.8** | EmptyStackException class declaration. (Part 2 of 2.)

As with generic methods, when a generic class is compiled, the compiler performs *erasure* on the class's type parameters and replaces them with their upper bounds. For class Stack (Fig. 21.7), no upper bound is specified, so the default upper bound, Object, is used. The scope of a generic class's type parameter is the entire class. However, type parameters *cannot* be used in a class's static variable declarations.

### Testing the Generic Stack Class of Fig. 21.7

Now, let's consider the application (Fig. 21.9) that uses the Stack generic class (Fig. 21.7). Lines 12–13 create and initialize variables of type Stack<Double> (pronounced “Stack of Double”) and Stack<Integer> (pronounced “Stack of Integer”). The types Double and Integer are known as the Stack's **type arguments**. The compiler uses them to replace the type parameters so that it can perform type checking and insert cast operations as necessary. We'll discuss the cast operations in more detail shortly. Lines 12–13 instantiate doubleStack with a capacity of 5 and integerStack with a capacity of 10 (the default). Lines 16–17 and 20–21 call methods testPushDouble (lines 25–36), testPopDouble (lines 39–59), testPushInteger (lines 62–73) and testPopInteger (lines 76–96), respectively, to demonstrate the two Stacks in this example.

---

```

1 // Fig. 21.9: StackTest.java
2 // Stack generic class test program.
3
4 public class StackTest
5 {
6 public static void main(String[] args)
7 {
8 double[] doubleElements = { 1.1, 2.2, 3.3, 4.4, 5.5 };
9 int[] integerElements = { 1, 2, 3, 4, 5, 6, 7, 8, 9, 10 };
10
11 // Create a Stack< Double > and a Stack< Integer >
12 Stack< Double > doubleStack = new Stack< Double >(5);
13 Stack< Integer > integerStack = new Stack< Integer >();
14
15 // push elements of doubleElements onto doubleStack
16 testPushDouble(doubleStack, doubleElements);
17 testPopDouble(doubleStack); // pop from doubleStack
18
19 // push elements of integerElements onto integerStack
20 testPushInteger(integerStack, integerElements);
21 testPopInteger(integerStack); // pop from integerStack
22 } // end main
23

```

---

**Fig. 21.9** | Stack generic class test program. (Part 1 of 3.)

```
24 // test push method with double stack
25 private static void testPushDouble(
26 Stack< Double > stack, double[] values)
27 {
28 System.out.println("\nPushing elements onto doubleStack");
29
30 // push elements to Stack
31 for (double value : values)
32 {
33 System.out.printf("%.1f ", value);
34 stack.push(value); // push onto doubleStack
35 } // end for
36 } // end method testPushDouble
37
38 // test pop method with double stack
39 private static void testPopDouble(Stack< Double > stack)
40 {
41 // pop elements from stack
42 try
43 {
44 System.out.println("\nPopping elements from doubleStack");
45 double popValue; // store element removed from stack
46
47 // remove all elements from Stack
48 while (true)
49 {
50 popValue = stack.pop(); // pop from doubleStack
51 System.out.printf("%.1f ", popValue);
52 } // end while
53 } // end try
54 catch(EmptyStackException emptyStackException)
55 {
56 System.err.println();
57 emptyStackException.printStackTrace();
58 } // end catch EmptyStackException
59 } // end method testPopDouble
60
61 // test push method with integer stack
62 private static void testPushInteger(
63 Stack< Integer > stack, int[] values)
64 {
65 System.out.println("\nPushing elements onto integerStack");
66
67 // push elements to Stack
68 for (int value : values)
69 {
70 System.out.printf("%d ", value);
71 stack.push(value); // push onto integerStack
72 } // end for
73 } // end method testPushInteger
74
```

**Fig. 21.9** | Stack generic class test program. (Part 2 of 3.)

```

75 // test pop method with integer stack
76 private static void testPopInteger(Stack< Integer > stack)
77 {
78 // pop elements from stack
79 try
80 {
81 System.out.println("\nPopping elements from integerStack");
82 int popValue; // store element removed from stack
83
84 // remove all elements from Stack
85 while (true)
86 {
87 popValue = stack.pop(); // pop from intStack
88 System.out.printf("%d ", popValue);
89 } // end while
90 } // end try
91 catch(EmptyStackException emptyStackException)
92 {
93 System.err.println();
94 emptyStackException.printStackTrace();
95 } // end catch EmptyStackException
96 } // end method testPopInteger
97 } // end class StackTest

```

```

Pushing elements onto doubleStack
1.1 2.2 3.3 4.4 5.5
Popping elements from doubleStack
5.5 4.4 3.3 2.2 1.1
EmptyStackException: Stack is empty, cannot pop
 at Stack.pop(Stack.java:32)
 at StackTest.testPopDouble(StackTest.java:50)
 at StackTest.main(StackTest.java:17)

Pushing elements onto integerStack
1 2 3 4 5 6 7 8 9 10
Popping elements from integerStack
10 9 8 7 6 5 4 3 2 1
EmptyStackException: Stack is empty, cannot pop
 at Stack.pop(Stack.java:32)
 at StackTest.testPopInteger(StackTest.java:87)
 at StackTest.main(StackTest.java:21)

```

**Fig. 21.9** | Stack generic class test program. (Part 3 of 3.)

### **Methods `testPushDouble` and `testPopDouble`**

Method `testPushDouble` (lines 25–36) invokes method `push` (line 34) to place the `double` values 1.1, 2.2, 3.3, 4.4 and 5.5 from array `doubleElements` onto `doubleStack`. *Autoboxing* occurs in line 34 when the program tries to push a primitive `double` value onto the `doubleStack`, which stores only references to `Double` objects.

Method `testPopDouble` (lines 39–59) invokes `Stack` method `pop` (line 50) in an infinite `while` loop (lines 48–52) to remove all the values from the stack. Note in the output that the values indeed pop off in last-in, first-out order (the defining characteristic of stacks). When the loop attempts to pop a sixth value, the `doubleStack` is empty, so the pop

throws an `EmptyStackException`, which causes the program to proceed to the catch block (lines 54–58) to handle the exception. The stack trace indicates the exception that occurred and shows that `Stack` method `pop` generated the exception at line 32 of the file `Stack.java` (Fig. 21.7). The trace also shows that method `pop` was called by `StackTest` method `testPopDouble` at line 50 of `StackTest.java` and that method `testPopDouble` was called from method `main` at line 17 of `StackTest.java`. This information enables you to determine the methods that were on the method-call stack at the time that the exception occurred. Because the program catches the exception, the exception is considered to have been handled and the program can continue executing.

*Auto-unboxing* occurs in line 50 when the program assigns the `Double` object popped from the stack to a `double` primitive variable. Recall from Section 21.4 that the compiler inserts casts to ensure that the proper types are returned from generic methods. After erasure, `Stack` method `pop` returns type `Object`, but the client code in `testPopDouble` expects to receive a `double` when method `pop` returns. So the compiler inserts a `Double` cast, as in

```
popValue = (Double) stack.pop();
```

The value assigned to `popValue` will be *unboxed* from the `Double` object returned by `pop`.

#### Methods `testPushInteger` and `testPopInteger`

Method `testPushInteger` (lines 62–73) invokes `Stack` method `push` to place values onto `integerStack` until it's full. Method `testPopInteger` (lines 76–96) invokes `Stack` method `pop` to remove values from `integerStack`. Once again, the values are popped in last-in, first-out order. During *erasure*, the compiler recognizes that the client code in method `testPopInteger` expects to receive an `int` when method `pop` returns. So the compiler inserts an `Integer` cast, as in

```
popValue = (Integer) stack.pop();
```

The value assigned to `popValue` will be unboxed from the `Integer` object returned by `pop`.

#### Creating Generic Methods to Test Class `Stack<T>`

The code in methods `testPushDouble` and `testPushInteger` is *almost identical* for pushing values onto a `Stack<Double>` or a `Stack<Integer>`, respectively, and the code in methods `testPopDouble` and `testPopInteger` is almost identical for popping values from a `Stack<Double>` or a `Stack<Integer>`, respectively. This presents another opportunity to use generic methods. Figure 21.10 declares generic method `testPush` (lines 24–35) to perform the same tasks as `testPushDouble` and `testPushInteger` in Fig. 21.9—that is, push values onto a `Stack<T>`. Similarly, generic method `testPop` (lines 38–58) performs the same tasks as `testPopDouble` and `testPopInteger` in Fig. 21.9—that is, pop values off a `Stack<T>`. The output of Fig. 21.10 precisely matches that of Fig. 21.9.

---

```

1 // Fig. 21.10: StackTest2.java
2 // Passing generic Stack objects to generic methods.
3 public class StackTest2
4 {
5 public static void main(String[] args)
6 {
```

---

**Fig. 21.10** | Passing generic `Stack` objects to generic methods. (Part 1 of 3.)

```

7 Double[] doubleElements = { 1.1, 2.2, 3.3, 4.4, 5.5 };
8 Integer[] integerElements = { 1, 2, 3, 4, 5, 6, 7, 8, 9, 10 };
9
10 // Create a Stack< Double > and a Stack< Integer >
11 Stack< Double > doubleStack = new Stack< Double >(5);
12 Stack< Integer > integerStack = new Stack< Integer >();
13
14 // push elements of doubleElements onto doubleStack
15 testPush("doubleStack", doubleStack, doubleElements);
16 testPop("doubleStack", doubleStack); // pop from doubleStack
17
18 // push elements of integerElements onto integerStack
19 testPush("integerStack", integerStack, integerElements);
20 testPop("integerStack", integerStack); // pop from integerStack
21 } // end main
22
23 // generic method testPush pushes elements onto a Stack
24 public static < T > void testPush(String name , Stack< T > stack,
25 T[] elements)
26 {
27 System.out.printf("\nPushing elements onto %s\n", name);
28
29 // push elements onto Stack
30 for (T element : elements)
31 {
32 System.out.printf("%s ", element);
33 stack.push(element); // push element onto stack
34 } // end for
35 } // end method testPush
36
37 // generic method testPop pops elements from a Stack
38 public static < T > void testPop(String name, Stack< T > stack)
39 {
40 // pop elements from stack
41 try
42 {
43 System.out.printf("\nPopping elements from %s\n", name);
44 T popValue; // store element removed from stack
45
46 // remove all elements from Stack
47 while (true)
48 {
49 popValue = stack.pop();
50 System.out.printf("%s ", popValue);
51 } // end while
52 } // end try
53 catch(EmptyStackException emptyStackException)
54 {
55 System.out.println();
56 emptyStackException.printStackTrace();
57 } // end catch EmptyStackException
58 } // end method testPop
59 } // end class StackTest2

```

**Fig. 21.10** | Passing generic Stack objects to generic methods. (Part 2 of 3.)



```

Pushing elements onto doubleStack
1.1 2.2 3.3 4.4 5.5
Popping elements from doubleStack
5.5 4.4 3.3 2.2 1.1
EmptyStackException: Stack is empty, cannot pop
 at Stack.pop(Stack.java:32)
 at StackTest2.testPop(StackTest2.java:50)
 at StackTest2.main(StackTest2.java:17)

Pushing elements onto integerStack
1 2 3 4 5 6 7 8 9 10
Popping elements from integerStack
10 9 8 7 6 5 4 3 2 1
EmptyStackException: Stack is empty, cannot pop
 at Stack.pop(Stack.java:32)
 at StackTest2.testPop(StackTest2.java:50)
 at StackTest2.main(StackTest2.java:21)

```

**Fig. 21.10** | Passing generic Stack objects to generic methods. (Part 3 of 3.)

Lines 11–12 create the `Stack<Double>` and `Stack<Integer>` objects, respectively. Lines 15–16 and 19–20 invoke generic methods `testPush` and `testPop` to test the Stack objects. Because type parameters can represent only reference types, to be able to pass arrays `doubleElements` and `integerElements` to generic method `testPush`, the arrays declared in lines 7–8 must be declared with the wrapper types `Double` and `Integer`. When these arrays are initialized with primitive values, the compiler *autoboxes* each primitive value.

Generic method `testPush` (lines 24–35) uses type parameter `T` (specified at line 24) to represent the data type stored in the `Stack<T>`. The generic method takes three arguments—a `String` that represents the name of the `Stack<T>` object for output purposes, a reference to an object of type `Stack<T>` and an array of type `T`—the type of elements that will be pushed onto `Stack<T>`. The compiler enforces *consistency* between the type of the Stack and the elements that will be pushed onto the Stack when `push` is invoked, which is the real value of the generic method call. Generic method `testPop` (lines 38–58) takes two arguments—a `String` that represents the name of the `Stack<T>` object for output purposes and a reference to an object of type `Stack<T>`.

## 21.7 Raw Types

The test programs for generic class `Stack` in Section 21.6 instantiate Stacks with type arguments `Double` and `Integer`. It's also possible to instantiate generic class `Stack` without specifying a type argument, as follows:

```
Stack objectStack = new Stack(5); // no type-argument specified
```

In this case, the `objectStack` is said to have a **raw type**, which means that the compiler implicitly uses type `Object` throughout the generic class for each type argument. Thus the preceding statement creates a `Stack` that can store objects of any type. This is important for *backward compatibility* with prior versions of Java. For example, the data structures of the Java Collections Framework (see Chapter 20) all stored references to `Objects`, but are now implemented as generic types.

A raw-type `Stack` variable can be assigned a `Stack` that specifies a type argument, such as a `Stack<Double>` object, as follows:

```
Stack rawTypeStack2 = new Stack< Double >(5);
```

because type `Double` is a subclass of `Object`. This assignment is allowed because the elements in a `Stack<Double>` (i.e., `Double` objects) are certainly objects—class `Double` is an indirect subclass of `Object`.

Similarly, a `Stack` variable that specifies a type argument in its declaration can be assigned a raw-type `Stack` object, as in:

```
Stack< Integer > integerStack = new Stack(10);
```

Although this assignment is permitted, it's *unsafe*, because a `Stack` of raw type might store types other than `Integer`. In this case, the compiler issues a warning message which indicates the unsafe assignment.

### Using Raw Types with Generic Class Stack

The test program of Fig. 21.11 uses the notion of raw type. Line 11 instantiates generic class `Stack` with raw type, which indicates that `rawTypeStack1` can hold objects of any type. Line 14 assigns a `Stack<Double>` to variable `rawTypeStack2`, which is declared as a `Stack` of raw type. Line 17 assigns a `Stack` of raw type to `Stack<Integer>` variable, which is legal but causes the compiler to issue a warning message (Fig. 21.12) indicating a *potentially unsafe assignment*—again, this occurs because a `Stack` of raw type might store types other than `Integer`. Also, the calls to generic methods `testPush` and `testPop` in lines 19–22 result in compiler warning messages (Fig. 21.12). These occur because `rawTypeStack1` and `rawTypeStack2` are declared as `Stacks` of raw type, but methods `testPush` and `testPop` each expect a second argument that is a `Stack` with a specific type argument. The warnings indicate that the compiler cannot guarantee the types manipulated by the stacks to be the correct types, since we did not supply a variable declared with a type argument. Methods `testPush` (lines 28–39) and `testPop` (lines 42–62) are the same as in Fig. 21.10.

Figure 21.12 shows the warning messages generated by the compiler when the file `RawTypeTest.java` (Fig. 21.11) is compiled with the `-Xlint:unchecked` option, which provides more information about potentially unsafe operations in code that uses generics. The first warning is generated for line 17, which assigned a raw-type `Stack` to a `Stack<Integer>` variable—the compiler cannot ensure that all objects in the `Stack` will be `Integer` objects. The next warning occurs at line 19. The compiler determines method `testPush`'s type argument from the `Double` array passed as the third argument, because the second method argument is a raw-type `Stack` variable. In this case, `Double` is the type argument, so the compiler expects a `Stack<Double>` as the second argument. The warning occurs because the compiler cannot ensure that a raw-type `Stack` contains only `Doubles`. The warning at line 21 occurs for the same reason, even though the actual `Stack` that `rawTypeStack2` references is a `Stack<Double>`. The compiler cannot guarantee that the variable will always refer to the same `Stack` object, so it must use the variable's declared type to perform all type checking. Lines 20 and 22 each generate warnings because method `testPop` expects as an argument a `Stack` for which a type argument has been specified. However, in each call to `testPop`, we pass a raw-type `Stack` variable. Thus, the compiler indicates a warning because it cannot check the types used in the body of the method. In general, you should avoid using raw types.

```

1 // Fig. 21.11: RawTypeTest.java
2 // Raw type test program.
3 public class RawTypeTest
4 {
5 public static void main(String[] args)
6 {
7 Double[] doubleElements = { 1.1, 2.2, 3.3, 4.4, 5.5 };
8 Integer[] integerElements = { 1, 2, 3, 4, 5, 6, 7, 8, 9, 10 };
9
10 // Stack of raw types assigned to Stack of raw types variable
11 Stack rawTypeStack1 = new Stack(5);
12
13 // Stack< Double > assigned to Stack of raw types variable
14 Stack rawTypeStack2 = new Stack< Double >(5);
15
16 // Stack of raw types assigned to Stack< Integer > variable
17 Stack< Integer > integerStack = new Stack(10);
18
19 testPush("rawTypeStack1", rawTypeStack1, doubleElements);
20 testPop("rawTypeStack1", rawTypeStack1);
21 testPush("rawTypeStack2", rawTypeStack2, doubleElements);
22 testPop("rawTypeStack2", rawTypeStack2);
23 testPush("integerStack", integerStack, integerElements);
24 testPop("integerStack", integerStack);
25 } // end main
26
27 // generic method pushes elements onto stack
28 public static < T > void testPush(String name, Stack< T > stack,
29 T[] elements)
30 {
31 System.out.printf("\nPushing elements onto %s\n", name);
32
33 // push elements onto Stack
34 for (T element : elements)
35 {
36 System.out.printf("%s ", element);
37 stack.push(element); // push element onto stack
38 } // end for
39 } // end method testPush
40
41 // generic method testPop pops elements from stack
42 public static < T > void testPop(String name, Stack< T > stack)
43 {
44 // pop elements from stack
45 try
46 {
47 System.out.printf("\nPopping elements from %s\n", name);
48 T popValue; // store element removed from stack
49
50 // remove elements from Stack
51 while (true)
52 {
53 popValue = stack.pop(); // pop from stack

```

**Fig. 21.11** | Raw-type test program. (Part 1 of 2.)

```

54 System.out.printf("%s ", popValue);
55 } // end while
56 } // end try
57 catch(EmptyStackException emptyStackException)
58 {
59 System.out.println();
60 emptyStackException.printStackTrace();
61 } // end catch EmptyStackException
62 } // end method testPop
63 } // end class RawTypeTest

```

```

Pushing elements onto rawTypeStack1
1.1 2.2 3.3 4.4 5.5
Popping elements from rawTypeStack1
5.5 4.4 3.3 2.2 1.1
EmptyStackException: Stack is empty, cannot pop
 at Stack.pop(Stack.java:32)
 at RawTypeTest.testPop(RawTypeTest.java:53)
 at RawTypeTest.main(RawTypeTest.java:20)

Pushing elements onto rawTypeStack2
1.1 2.2 3.3 4.4 5.5
Popping elements from rawTypeStack2
5.5 4.4 3.3 2.2 1.1
EmptyStackException: Stack is empty, cannot pop
 at Stack.pop(Stack.java:32)
 at RawTypeTest.testPop(RawTypeTest.java:53)
 at RawTypeTest.main(RawTypeTest.java:22)

Pushing elements onto integerStack
1 2 3 4 5 6 7 8 9 10
Popping elements from integerStack
10 9 8 7 6 5 4 3 2 1
EmptyStackException: Stack is empty, cannot pop
 at Stack.pop(Stack.java:32)
 at RawTypeTest.testPop(RawTypeTest.java:53)
 at RawTypeTest.main(RawTypeTest.java:24)

```

**Fig. 21.11** | Raw-type test program. (Part 2 of 2.)

```

RawTypeTest.java:17: warning: [unchecked] unchecked conversion
found : Stack
required: Stack<java.lang.Integer>
 Stack< Integer > integerStack = new Stack(10);
 ^

RawTypeTest.java:19: warning: [unchecked] unchecked conversion
found : Stack
required: Stack<java.lang.Double>
 testPush("rawTypeStack1", rawTypeStack1, doubleElements);
 ^

```

**Fig. 21.12** | Warning messages from the compiler. (Part 1 of 2.)

```

RawTypeTest.java:19: warning: [unchecked] unchecked method invocation:
<T>testPush(java.lang.String,Stack<T>,T[]) in RawTypeTest is applied to
(java.lang.String,Stack,java.lang.Double[])
 testPush("rawTypeStack1", rawTypeStack1, doubleElements);
 ^
RawTypeTest.java:20: warning: [unchecked] unchecked conversion
found : Stack
required: Stack<T>
 testPop("rawTypeStack1", rawTypeStack1);
 ^
RawTypeTest.java:20: warning: [unchecked] unchecked method invocation:
<T>testPop(java.lang.String,Stack<T>) in RawTypeTest is applied to
(java.lang.String,Stack)
 testPop("rawTypeStack1", rawTypeStack1);
 ^
RawTypeTest.java:21: warning: [unchecked] unchecked conversion
found : Stack
required: Stack<java.lang.Double>
 testPush("rawTypeStack2", rawTypeStack2, doubleElements);
 ^
RawTypeTest.java:21: warning: [unchecked] unchecked method invocation:
<T>testPush(java.lang.String,Stack<T>,T[]) in RawTypeTest is applied to
(java.lang.String,Stack,java.lang.Double[])
 testPush("rawTypeStack2", rawTypeStack2, doubleElements);
 ^
RawTypeTest.java:22: warning: [unchecked] unchecked conversion
found : Stack
required: Stack<T>
 testPop("rawTypeStack2", rawTypeStack2);
 ^
RawTypeTest.java:22: warning: [unchecked] unchecked method invocation:
<T>testPop(java.lang.String,Stack<T>) in RawTypeTest is applied to
(java.lang.String,Stack)
 testPop("rawTypeStack2", rawTypeStack2);
 ^
9 warnings

```

**Fig. 21.12** | Warning messages from the compiler. (Part 2 of 2.)

## 21.8 Wildcards in Methods That Accept Type Parameters

In this section, we introduce a powerful generics concept known as **wildcards**. For this purpose, we'll also introduce a new data structure from package `java.util`. In Chapter 20, we discussed the Java Collections Framework, which provides many generic data structures and algorithms that manipulate the elements of those data structures. Perhaps the simplest of these data structures is class `ArrayList`—a dynamically resizable, arraylike data structure. As part of this discussion, you'll learn how to create an `ArrayList`, add elements to it and traverse those elements using an enhanced `for` statement.

Let's consider an example that motivates wildcards. Suppose that you'd like to implement a generic method `sum` that totals the numbers in a collection, such as an `ArrayList`. You'd begin by inserting the numbers in the collection. Because generic classes can be used only with class or interface types, the numbers would be *autoboxed* as objects of the type-

wrapper classes. For example, any `int` value would be *autoboxed* as an `Integer` object, and any `double` value would be *autoboxed* as a `Double` object. We'd like to be able to total all the numbers in the `ArrayList` regardless of their type. For this reason, we'll declare the `ArrayList` with the type argument `Number`, which is the superclass of both `Integer` and `Double`. In addition, method `sum` will receive a parameter of type `ArrayList<Number>` and total its elements. Figure 21.13 demonstrates totaling the elements of an `ArrayList` of `Numbers`.

```

1 // Fig. 21.13: TotalNumbers.java
2 // Totaling the numbers in an ArrayList<Number>.
3 import java.util.ArrayList;
4
5 public class TotalNumbers
6 {
7 public static void main(String[] args)
8 {
9 // create, initialize and output ArrayList of Numbers containing
10 // both Integers and Doubles, then display total of the elements
11 Number[] numbers = { 1, 2.4, 3, 4.1 }; // Integers and Doubles
12 ArrayList< Number > numberList = new ArrayList< Number >();
13
14 for (Number element : numbers)
15 numberList.add(element); // place each number in numberList
16
17 System.out.printf("numberList contains: %s\n", numberList);
18 System.out.printf("Total of the elements in numberList: %.1f\n",
19 sum(numberList));
20 } // end main
21
22 // calculate total of ArrayList elements
23 public static double sum(ArrayList< Number > list)
24 {
25 double total = 0; // initialize total
26
27 // calculate sum
28 for (Number element : list)
29 total += element.doubleValue();
30
31 return total;
32 } // end method sum
33 } // end class TotalNumbers

```

```

numberList contains: [1, 2.4, 3, 4.1]
Total of the elements in numberList: 10.5

```

**Fig. 21.13** | Totaling the numbers in an `ArrayList<Number>`.

Line 11 declares and initializes an array of `Numbers`. Because the initializers are primitive values, Java *autoboxes* each primitive value as an object of its corresponding wrapper type. The `int` values 1 and 3 are *autoboxed* as `Integer` objects, and the `double` values 2.4 and 4.1 are *autoboxed* as `Double` objects. Line 12 declares and creates an `ArrayList` object that stores `Numbers` and assigns it to variable `numberList`. We do not have to specify the size of the `ArrayList` because it will grow automatically as we insert objects.

Lines 14–15 traverse array `numbers` and place each element in `numberList`. Line 17 outputs the contents of the `ArrayList` as a `String`. This statement implicitly invokes the `ArrayList`'s `toString` method, which returns a `String` of the form "`[elements]`" in which *elements* is a comma-separated list of the elements' `String` representations. Lines 18–19 display the sum of the elements that is returned by the call to method `sum`.

Method `sum` (lines 23–32) receives an `ArrayList` of `Numbers` and calculates the total of the `Numbers` in the collection. The method uses `double` values to perform the calculations and returns the result as a `double`. Lines 28–29 use the enhanced `for` statement, which is designed to work with both arrays and the collections of the `Collections Framework`, to total the elements of the `ArrayList`. The `for` statement assigns each `Number` in the `ArrayList` to variable `element`, then uses **Number method `doubleValue`** to obtain the `Number`'s underlying primitive value as a `double` value. The result is added to `total`. When the loop terminates, the method returns the `total`.

### *Implementing Method `sum` With a Wildcard Type Argument in Its Parameter*

Recall that the purpose of method `sum` in Fig. 21.13 was to total any type of `Numbers` stored in an `ArrayList`. We created an `ArrayList` of `Numbers` that contained both `Integer` and `Double` objects. The output of Fig. 21.13 demonstrates that method `sum` worked properly. Given that method `sum` can total the elements of an `ArrayList` of `Numbers`, you might expect that the method would also work for `ArrayList`s that contain elements of only one numeric type, such as `ArrayList<Integer>`. So we modified class `TotalNumbers` to create an `ArrayList` of `Integers` and pass it to method `sum`. When we compile the program, the compiler issues the following error message:

```
sum(java.util.ArrayList<java.lang.Number>) in TotalNumbersErrors
cannot be applied to (java.util.ArrayList<java.lang.Integer>)
```

Although `Number` is the superclass of `Integer`, the compiler does not consider the parameterized type `ArrayList<Number>` to be a superclass of `ArrayList<Integer>`. If it were, then every operation we could perform on `ArrayList<Number>` would also work on an `ArrayList<Integer>`. Consider the fact that you can add a `Double` object to an `ArrayList<Number>` because a `Double` *is a* `Number`, but you cannot add a `Double` object to an `ArrayList<Integer>` because a `Double` *is not an* `Integer`. Thus, the subtype relationship does not hold.

How do we create a more flexible version of the `sum` method that can total the elements of any `ArrayList` containing elements of any subclass of `Number`? This is where **wildcard type arguments** are important. Wildcards enable you to specify method parameters, return values, variables or fields, and so on, that act as supertypes or subtypes of parameterized types. In Fig. 21.14, method `sum`'s parameter is declared in line 50 with the type:

```
ArrayList< ? extends Number >
```

A wildcard type argument is denoted by a question mark (`?`), which by itself represents an “unknown type.” In this case, the wildcard extends class `Number`, which means that the wildcard has an upper bound of `Number`. Thus, the unknown-type argument must be either `Number` or a subclass of `Number`. With the parameter type shown here, method `sum` can receive an `ArrayList` argument that contains any type of `Number`, such as `ArrayList<Integer>` (line 20), `ArrayList<Double>` (line 33) or `ArrayList<Number>` (line 46).

```

1 // Fig. 21.14: WildcardTest.java
2 // Wildcard test program.
3 import java.util.ArrayList;
4
5 public class WildcardTest
6 {
7 public static void main(String[] args)
8 {
9 // create, initialize and output ArrayList of Integers, then
10 // display total of the elements
11 Integer[] integers = { 1, 2, 3, 4, 5 };
12 ArrayList< Integer > integerList = new ArrayList< Integer >();
13
14 // insert elements in integerList
15 for (Integer element : integers)
16 integerList.add(element);
17
18 System.out.printf("integerList contains: %s\n", integerList);
19 System.out.printf("Total of the elements in integerList: %.0f\n\n",
20 sum(integerList));
21
22 // create, initialize and output ArrayList of Doubles, then
23 // display total of the elements
24 Double[] doubles = { 1.1, 3.3, 5.5 };
25 ArrayList< Double > doubleList = new ArrayList< Double >();
26
27 // insert elements in doubleList
28 for (Double element : doubles)
29 doubleList.add(element);
30
31 System.out.printf("doubleList contains: %s\n", doubleList);
32 System.out.printf("Total of the elements in doubleList: %.1f\n\n",
33 sum(doubleList));
34
35 // create, initialize and output ArrayList of Numbers containing
36 // both Integers and Doubles, then display total of the elements
37 Number[] numbers = { 1, 2.4, 3, 4.1 }; // Integers and Doubles
38 ArrayList< Number > numberList = new ArrayList< Number >();
39
40 // insert elements in numberList
41 for (Number element : numbers)
42 numberList.add(element);
43
44 System.out.printf("numberList contains: %s\n", numberList);
45 System.out.printf("Total of the elements in numberList: %.1f\n",
46 sum(numberList));
47 } // end main
48
49 // total the elements; using a wildcard in the ArrayList parameter
50 public static double sum(ArrayList< ? extends Number > list)
51 {
52 double total = 0; // initialize total
53

```

**Fig. 21.14** | Generic wildcard test program. (Part I of 2.)



```

54 // calculate sum
55 for (Number element : list)
56 total += element.doubleValue();
57
58 return total;
59 } // end method sum
60 } // end class WildcardTest

```

```

integerList contains: [1, 2, 3, 4, 5]
Total of the elements in integerList: 15

doubleList contains: [1.1, 3.3, 5.5]
Total of the elements in doubleList: 9.9

numberList contains: [1, 2.4, 3, 4.1]
Total of the elements in numberList: 10.5

```

**Fig. 21.14** | Generic wildcard test program. (Part 2 of 2.)

Lines 11–20 create and initialize an `ArrayList<Integer>`, output its elements and total them by calling method `sum` (line 20). Lines 24–33 perform the same operations for an `ArrayList<Double>`. Lines 37–46 perform the same operations for an `ArrayList<Number>` that contains `Integers` and `Doubles`.

In method `sum` (lines 50–59), although the `ArrayList` argument’s element types are not directly known by the method, they’re known to be at least of type `Number`, because the wildcard was specified with the upper bound `Number`. For this reason line 56 is allowed, because all `Number` objects have a `doubleValue` method.

Although wildcards provide flexibility when passing parameterized types to a method, they also have some disadvantages. Because the wildcard (?) in the method’s header (line 50) does not specify a type-parameter name, you cannot use it as a type name throughout the method’s body (i.e., you cannot replace `Number` with ? in line 55). You could, however, declare method `sum` as follows:

```
public static <T extends Number> double sum(ArrayList< T > list)
```

which allows the method to receive an `ArrayList` that contains elements of any `Number` subclass. You could then use the type parameter `T` throughout the method body.

If the wildcard is specified without an upper bound, then only the methods of type `Object` can be invoked on values of the wildcard type. Also, methods that use wildcards in their parameter’s type arguments cannot be used to add elements to a collection referenced by the parameter.



#### Common Programming Error 21.4

*Using a wildcard in a method’s type-parameter section or using a wildcard as an explicit type of a variable in the method body is a syntax error.*

## 21.9 Generics and Inheritance: Notes

Generics can be used with inheritance in several ways:

- A generic class can be derived from a nongeneric class. For example, the `Object` class is a direct or indirect superclass of every generic class.

- A generic class can be derived from another generic class. For example, generic class `Stack` (in package `java.util`) is a subclass of generic class `Vector` (in package `java.util`). We discussed these classes in Chapter 20.
- A nongeneric class can be derived from a generic class. For example, nongeneric class `Properties` (in package `java.util`) is a subclass of generic class `Hashtable` (in package `java.util`). We also discussed these classes in Chapter 20.
- Finally, a generic method in a subclass can override a generic method in a superclass if both methods have the same signatures.

## 21.10 Wrap-Up

This chapter introduced generics. You learned how to declare generic methods and classes. We discussed how backward compatibility is achieved via raw types. You also learned how to use wildcards in a generic method or a generic class. In Chapter 22, you'll learn how to implement your own custom dynamic data structures that can grow or shrink at execution time. In particular, you'll implement these data structures using the generics capabilities you learned in this chapter. For more information on generics, please visit our Java Resource Center at [www.deitel.com/Java/](http://www.deitel.com/Java/) and click the topic **Java Generics** under the heading **Resource Center Contents**.

## Summary

### *Section 21.1 Introduction*

- Generic methods enable you to specify, with one method declaration, a set of related methods.
- Generic classes and interfaces enable you to specify sets of related types.

### *Section 21.2 Motivation for Generic Methods*

- Overloaded methods are often used to perform similar operations on different types of data.
- When the compiler encounters a method call, it attempts to locate a method declaration with a name and parameters that are compatible with the argument types in the method call.

### *Section 21.3 Generic Methods: Implementation and Compile-Time Translation*

- If the operations performed by several overloaded methods are identical for each argument type, they can be more compactly and conveniently coded using a generic method. A single generic method declaration can be called with arguments of different data types. Based on the types of the arguments passed to a generic method, the compiler handles each method call appropriately.
- All generic method declarations have a type-parameter section (p. 878) delimited by angle brackets (< and >) that precedes the method's return type (p. 878).
- A type-parameter section contains one or more type parameters separated by commas.
- A type parameter (p. 878) is an identifier that specifies a generic type name. Type parameters can be used as the return type, parameter types and local variable types in a generic method declaration, and they act as placeholders for the types of the arguments passed to the generic method, which are known as actual type arguments (p. 878). Type parameters can represent only reference types.
- Type-parameter names used throughout a method declaration must match those declared in the type-parameter section. A type-parameter name can be declared only once in the type-parameter section but can appear more than once in the method's parameter list.

- When the compiler encounters a method call, it determines the argument types and attempts to locate a method with the same name and parameters that match the argument types. If there's no such method, the compiler searches for methods with the same name and compatible parameters and for matching generic methods.
- Objects of a class that implements generic interface `Comparable` (`Comparable`) can be compared with method `compareTo` (p. 880), which returns 0 if the objects are equal, a negative integer if the first object is less than the second or a positive integer if the first object is greater than the second.
- All the type-wrapper classes for primitive types implement `Comparable`.
- `Comparable` objects can be used with the sorting and searching methods of class `Collections`.
- When a generic method is compiled, the compiler performs erasure (p. 879) to remove the type-parameter section and replace the type parameters with actual types. By default each type parameter is replaced with its upper bound (p. 881), which is `Object` unless specified otherwise.

#### *Section 21.4 Additional Compile-Time Translation Issues: Methods That Use a Type Parameter as the Return Type*

- When erasure is performed on a method that returns a type variable (p. 878), explicit casts are inserted in front of each method call to ensure that the returned value has the type expected by the caller.

#### *Section 21.5 Overloading Generic Methods*

- A generic method may be overloaded with other generic methods or with nongeneric methods.

#### *Section 21.6 Generic Classes*

- Generic classes provide a means for describing a class in a type-independent manner. We can then instantiate type-specific objects of the generic class.
- A generic class declaration looks like a nongeneric class declaration, except that the class name is followed by a type-parameter section. The type-parameter section of a generic class can have one or more type parameters separated by commas.
- When a generic class is compiled, the compiler performs erasure on the class's type parameters and replaces them with their upper bounds.
- Type parameters cannot be used in a class's `static` declarations.
- When instantiating an object of a generic class, the types specified in angle brackets after the class name are known as type arguments (p. 886). The compiler uses them to replace the type parameters so that it can perform type checking and insert cast operations as necessary.

#### *Section 21.7 Raw Types*

- It's possible to instantiate a generic class without specifying a type argument. In this case, the new object of the class is said to have a raw type (p. 891)—the compiler implicitly uses type `Object` (or the type parameter's upper bound) throughout the generic class for each type argument.

#### *Section 21.8 Wildcards in Methods That Accept Type Parameters*

- Class `Number` is the superclass of both `Integer` and `Double`.
- `Number` method `doubleValue` (p. 897) obtains the `Number`'s underlying primitive value as a `double` value.
- Wildcard type arguments enable you to specify method parameters, return values, variables, and so on, that act as supertypes of parameterized types. A wildcard-type argument is denoted by `?` (p. 897), which represents an “unknown type.” A wildcard can also have an upper bound.

- Because a wildcard (?) is not a type-parameter name, you cannot use it as a type name throughout a method's body.
- If a wildcard is specified without an upper bound, then only the methods of type `Object` can be invoked on values of the wildcard type.
- Methods that use wildcards as type arguments (p. 897) cannot be used to add elements to a collection referenced by the parameter.

### Section 21.9 Generics and Inheritance: Notes

- A generic class can be derived from a nongeneric class. For example, `Object` is a direct or indirect superclass of every generic class.
- A generic class can be derived from another generic class.
- A nongeneric class can be derived from a generic class.
- A generic method in a subclass can override a generic method in a superclass if both methods have the same signatures.

## Self-Review Exercises

**21.1** (*True or False*) State whether each of the following is *true* or *false*. If *false*, explain why.

- A generic method cannot have the same method name as a nongeneric method.
- All generic method declarations have a type-parameter section that immediately precedes the method name.
- A generic method can be overloaded by another generic method with the same method name but different method parameters.
- A type parameter can be declared only once in the type-parameter section but can appear more than once in the method's parameter list.
- Type-parameter names among different generic methods must be unique.
- The scope of a generic class's type parameter is the entire class except its static members.

**21.2** (*Fill in the Blanks*) Fill in the blanks in each of the following:

- \_\_\_\_\_ and \_\_\_\_\_ enable you to specify, with a single method declaration, a set of related methods, or with a single class declaration, a set of related types, respectively.
- A type-parameter section is delimited by \_\_\_\_\_.
- A generic method's \_\_\_\_\_ can be used to specify the method's argument types, to specify the method's return type and to declare variables within the method.
- The statement `"Stack objectStack = new Stack();"` indicates that `objectStack` stores \_\_\_\_\_.
- In a generic class declaration, the class name is followed by a(n) \_\_\_\_\_.
- The syntax \_\_\_\_\_ specifies that the upper bound of a wildcard is type `T`.

## Answers to Self-Review Exercises

**21.1** a) False. Generic and nongeneric methods can have the same method name. A generic method can overload another generic method with the same method name but different method parameters. A generic method also can be overloaded by providing nongeneric methods with the same method name and number of arguments. b) False. All generic method declarations have a type-parameter section that immediately precedes the method's return type. c) True. d) True. e) False. Type-parameter names among different generic methods need not be unique. f) True.

**21.2** a) Generic methods, generic classes. b) angle brackets (< and >). c) type parameters. d) a raw type. e) type-parameter section. f) ? extends `T`.

## Exercises

**21.3** (*Explain Notation*) Explain the use of the following notation in a Java program:

```
public class Array< T > { }
```

**21.4** (*Generic Method `selectionSort`*) Write a generic method `selectionSort` based on the sort program of Figs. 19.6–19.7. Write a test program that inputs, sorts and outputs an `Integer` array and a `Float` array. [Hint: Use `<T extends Comparable<T>>` in the type-parameter section for method `selectionSort`, so that you can use method `compareTo` to compare the objects of the type that `T` represents.]

**21.5** (*Overloaded Generic Method `printArray`*) Overload generic method `printArray` of Fig. 21.3 so that it takes two additional integer arguments, `lowSubscript` and `highSubscript`. A call to this method prints only the designated portion of the array. Validate `lowSubscript` and `highSubscript`. If either is out of range, the overloaded `printArray` method should throw an `InvalidSubscriptException`; otherwise, `printArray` should return the number of elements printed. Then modify `main` to exercise both versions of `printArray` on arrays `integerArray`, `doubleArray` and `characterArray`. Test all capabilities of both versions of `printArray`.

**21.6** (*Overloading a Generic Method with a Nongeneric Method*) Overload generic method `printArray` of Fig. 21.3 with a nongeneric version that specifically prints an array of `Strings` in neat, tabular format, as shown in the sample output that follows:

```
Array stringArray contains:
one two three four
five six seven eight
```

**21.7** (*Generic `isEqualTo` Method*) Write a simple generic version of method `isEqualTo` that compares its two arguments with the `equals` method and returns `true` if they're equal and `false` otherwise. Use this generic method in a program that calls `isEqualTo` with a variety of built-in types, such as `Object` or `Integer`. What result do you get when you attempt to run this program?

**21.8** (*Generic Class `Pair`*) Write a generic class `Pair` which has two type parameters—`F` and `S`—each representing the type of the first and second element of the pair, respectively. Add `get` and `set` methods for the first and second elements of the pair. [Hint: The class header should be `public class Pair<F, S>`.]

**21.9** (*Overloading Generic Methods*) How can generic methods be overloaded?

**21.10** (*Overload Resolution*) The compiler performs a matching process to determine which method to call when a method is invoked. Under what circumstances does an attempt to make a match result in a compile-time error?

**21.11** (*What Does this Statement Do?*) Explain why a Java program might use the statement

```
ArrayList< Employee > workerList = new ArrayList< Employee >();
```

# 22

## Custom Generic Data Structures

*Much that I bound, I could not free;  
Much that I freed returned to me.*

—Lee Wilson Dodd

*‘Will you walk a little faster?’  
said a whiting to a snail,  
‘There’s a porpoise close behind us,  
and he’s treading on my tail.’*

—Lewis Carroll

*There is always room at the top.*

—Daniel Webster

*Push on—keep moving.*

—Thomas Morton

*I’ll turn over a new leaf.*

—Miguel de Cervantes

### Objectives

In this chapter you’ll learn:

- To form linked data structures using references, self-referential classes, recursion and generics.
- To create and manipulate dynamic data structures, such as linked lists, queues, stacks and binary trees.
- Various important applications of linked data structures.
- How to create reusable data structures with classes, inheritance and composition.

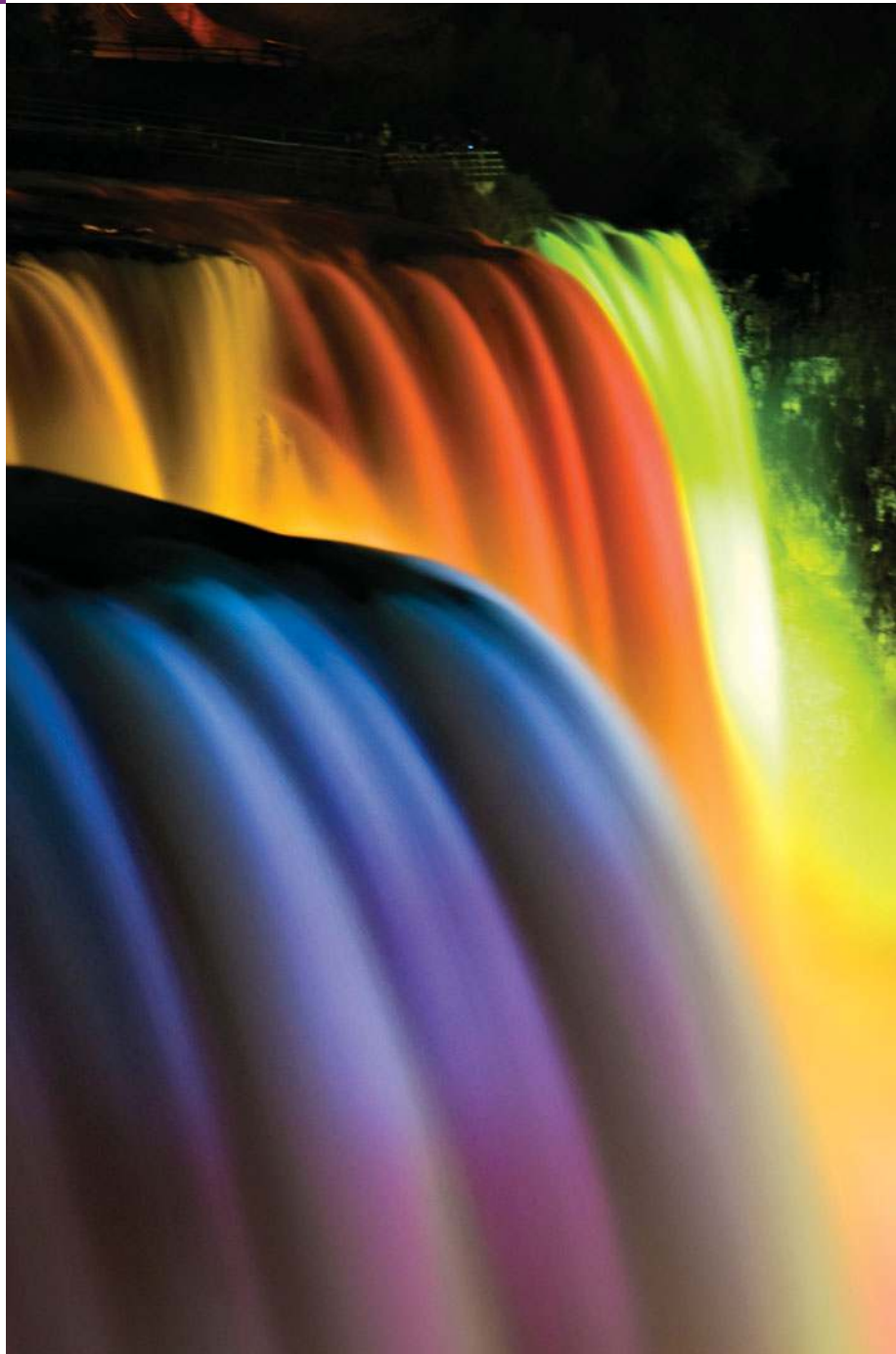

|                                       |                     |
|---------------------------------------|---------------------|
| <b>22.1</b> Introduction              | <b>22.5</b> Stacks  |
| <b>22.2</b> Self-Referential Classes  | <b>22.6</b> Queues  |
| <b>22.3</b> Dynamic Memory Allocation | <b>22.7</b> Trees   |
| <b>22.4</b> Linked Lists              | <b>22.8</b> Wrap-Up |

Summary | Self-Review Exercises | Answers to Self-Review Exercises | Exercises |  
Special Section: Building Your Own Compiler

## 22.1 Introduction

This chapter shows how to build **dynamic data structures** that grow and shrink at execution time. **Linked lists** are collections of data items “linked up in a chain”; insertions and deletions can be made anywhere in a linked list. **Stacks** are important in compilers and operating systems; insertions and deletions are made only at one end of a stack—its **top**. **Queues** represent waiting lines; insertions are made at the back (also referred to as the **tail**) of a queue and deletions are made from the front (also referred to as the **head**). **Binary trees** facilitate high-speed searching and sorting of data, eliminating duplicate data items efficiently, representing file-system directories, compiling expressions into machine language and many other interesting applications.

We discuss each of these major data-structure types and implement programs that create and manipulate them. We use classes, inheritance and composition to create and package them for reusability and maintainability. In general, you’d use one of the pre-defined collection classes that we discussed in Chapter 20. However, the techniques we present here can be used if you ever need to build your own *custom* collections.

For simplicity, this chapter’s examples manipulate primitive values. However, the data-structure implementations we develop here can store objects of most types.

If you feel ambitious, you might want to attempt the major project described in the special section entitled Building Your Own Compiler, which we’ve posted online at [www.deitel.com/books/jhttp9/](http://www.deitel.com/books/jhttp9/). You’ve been using a Java compiler to translate your Java programs to bytecodes so that you could execute these programs. In this project, you’ll actually build your own compiler. It will read statements written in a simple, yet powerful high-level language similar to early versions of the popular language BASIC and translate these statements into Simpletron Machine Language (SML) instructions—SML is the language you learned in the Chapter 7 special section, Building Your Own Computer. Your Simpletron Simulator program will then execute the SML program produced by your compiler! Implementing this project by using an object-oriented approach will give you an opportunity to exercise most of what you’ve learned in this book. The special section carefully walks you through the specifications of the high-level language and describes the algorithms you’ll need to convert each high-level language statement into machine-language instructions. If you enjoy being challenged, you might attempt the enhancements to both the compiler and the Simpletron Simulator suggested in the exercises.

## 22.2 Self-Referential Classes

A **self-referential class** contains an instance variable that refers to another object of the same class type. For example, the generic Node class declaration

```

class Node< T >
{
 private T data;
 private Node< T > nextNode; // reference to next linked node
 public Node(T data) { /* constructor body */ }
 public void setData(T data) { /* method body */ }
 public T getData() { /* method body */ }
 public void setNext(Node< T > next) { /* method body */ }
 public Node< T > getNext() { /* method body */ }
} // end class Node< T >

```

has two private instance variables—`data` (of the generic type `T`) and `Node<T>` variable `nextNode`. Variable `nextNode` references a `Node<T>` object, an object of the same class being declared here—hence the term “self-referential class.” Field `nextNode` is a **link**—it “links” an object of type `Node<T>` to another object of the same type. Type `Node<T>` also has five methods: a constructor that receives a value to initialize `data`, a `setData` method to set the value of `data`, a `getData` method to return the value of `data`, a `setNext` method to set the value of `nextNode` and a `getNext` method to return a reference to the next node.

Programs can link self-referential objects together to form such useful data structures as lists, queues, stacks and trees. Figure 22.1 illustrates two self-referential objects linked together to form a list. A backslash—representing a `null` reference—is placed in the link member of the second self-referential object to indicate that the link does *not* refer to another object. The backslash is illustrative; it does not correspond to the backslash character in Java. We use the `null` reference to indicate the end of a data structure.



**Fig. 22.1** | Self-referential-class objects linked together.

## 22.3 Dynamic Memory Allocation

Creating and maintaining dynamic data structures requires **dynamic memory allocation**—allowing a program to obtain more memory space at execution time to hold new nodes and to release space no longer needed. Remember that Java programs do not explicitly release dynamically allocated memory. Rather, Java performs automatic *garbage collection* of objects that are no longer referenced in a program.

The limit for dynamic memory allocation can be as large as the amount of available physical memory in the computer or the amount of available disk space in a virtual-memory system. Often the limits are much smaller, because the computer’s available memory must be shared among many applications.

The declaration and class-instance-creation expression

```

// 10 is nodeToAdd's data
Node< Integer > nodeToAdd = new Node< Integer >(10);

```

allocates a `Node<Integer>` object and returns a reference to it, which is assigned to `nodeToAdd`. If *insufficient memory* is available, the expression throws an `OutOfMemoryError`. The sections that follow discuss lists, stacks, queues and trees—all of which use dynamic memory allocation and self-referential classes to create dynamic data structures.



## 22.4 Linked Lists

A linked list is a linear collection (i.e., a sequence) of self-referential-class objects, called **nodes**, connected by reference links—hence, the term “linked” list. Typically, a program accesses a linked list via a reference to its first node. The program accesses each subsequent node via the link reference stored in the previous node. By convention, the link reference in the last node of the list is set to `null`. Data is stored in a linked list dynamically—the program creates each node as necessary. Stacks and queues are also linear data structures and, as we’ll see, are constrained versions of linked lists. Trees are *nonlinear* data structures.

Lists of data can be stored in arrays, but linked lists provide several advantages. A linked list is appropriate when the number of data elements to be represented in the data structure is *unpredictable*. Linked lists are dynamic, so the length of a list can increase or decrease as necessary, whereas the size of a “conventional” Java array cannot be altered—it’s fixed when the program creates the array. “Conventional” arrays can become full. Linked lists become full only when the system has *insufficient memory* to satisfy dynamic storage allocation requests. Package `java.util` contains class `LinkedList` (discussed in Chapter 20) for implementing and manipulating linked lists that grow and shrink during program execution.



### Performance Tip 22.1

*An array can be declared to contain more elements than the number of items expected, but this wastes memory. In these situations, linked lists provide better memory utilization, allowing the program to adapt to storage needs at runtime.*



### Performance Tip 22.2

*Insertion into a linked list is fast—only two references have to be modified (after locating the insertion point). All existing node objects remain at their current locations in memory.*

Linked lists can be maintained in sorted order simply by inserting each new element at the proper point in the list. (It does, of course, take time to *locate* the proper insertion point.) *Existing list elements do not need to be moved.*



### Performance Tip 22.3

*Insertion and deletion in a sorted array can be time consuming—all the elements following the inserted or deleted element must be shifted appropriately.*

### Singly Linked Lists

Linked list nodes normally are *not stored contiguously* in memory. Rather, they’re logically contiguous. Figure 22.2 illustrates a linked list with several nodes. This diagram presents a **singly linked list**—each node contains one reference to the next node in the list. Often, linked lists are implemented as *doubly linked lists*—each node contains a reference to the next node in the list *and* a reference to the preceding one.



### Performance Tip 22.4

*Normally, the elements of an array are contiguous in memory. This allows immediate access to any array element, because its address can be calculated directly as its offset from the beginning of the array. Linked lists do not afford such immediate access—an element can be accessed only by traversing the list from the front (or the back in a doubly linked list).*

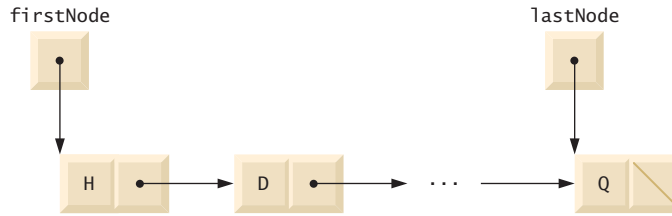

**Fig. 22.2** | Linked-list graphical representation.

### Implementing a Generic List Class

The program of Figs. 22.3–22.5 uses an object of our generic List class to manipulate a list of miscellaneous objects. The program consists of four classes—ListNode (Fig. 22.3, lines 6–37), List (Fig. 22.3, lines 40–147), EmptyListException (Fig. 22.4) and ListTest (Fig. 22.5). The List, ListNode and EmptyListException classes are placed in package `com.deitel.ch22`, so that they can be reused throughout this chapter. Encapsulated in each List object is a linked list of ListNode objects. [Note: Many of the classes in this chapter are declared in the package `com.deitel.ch22`. Each such class should be compiled with the `-d` command-line option to `javac`. When compiling the classes that are not in this package and when running the programs, be sure to use the option `-classpath` with `javac` and `java`, respectively.]

```

1 // Fig. 22.3: List.java
2 // ListNode and List class declarations.
3 package com.deitel.ch22;
4
5 // class to represent one node in a list
6 class ListNode< T >
7 {
8 // package access members; List can access these directly
9 T data; // data for this node
10 ListNode< T > nextNode; // reference to the next node in the list
11
12 // constructor creates a ListNode that refers to object
13 ListNode(T object)
14 {
15 this(object, null);
16 } // end ListNode one-argument constructor
17
18 // constructor creates ListNode that refers to the specified
19 // object and to the next ListNode
20 ListNode(T object, ListNode< T > node)
21 {
22 data = object;
23 nextNode = node;
24 } // end ListNode two-argument constructor

```

**Fig. 22.3** | ListNode and List class declarations. (Part 1 of 4.)

```

25
26 // return reference to data in node
27 T getData()
28 {
29 return data; // return item in this node
30 } // end method getData
31
32 // return reference to next node in list
33 ListNode< T > getNext()
34 {
35 return nextNode; // get next node
36 } // end method getNext
37 } // end class ListNode< T >
38
39 // class List definition
40 public class List< T >
41 {
42 private ListNode< T > firstNode;
43 private ListNode< T > lastNode;
44 private String name; // string like "list" used in printing
45
46 // constructor creates empty List with "list" as the name
47 public List()
48 {
49 this("list");
50 } // end List no-argument constructor
51
52 // constructor creates an empty List with a name
53 public List(String listName)
54 {
55 name = listName;
56 firstNode = lastNode = null;
57 } // end List one-argument constructor
58
59 // insert item at front of List
60 public void insertAtFront(T insertItem)
61 {
62 if (isEmpty()) // firstNode and lastNode refer to same object
63 firstNode = lastNode = new ListNode< T >(insertItem);
64 else // firstNode refers to new node
65 firstNode = new ListNode< T >(insertItem, firstNode);
66 } // end method insertAtFront
67
68 // insert item at end of List
69 public void insertAtBack(T insertItem)
70 {
71 if (isEmpty()) // firstNode and lastNode refer to same object
72 firstNode = lastNode = new ListNode< T >(insertItem);
73 else // lastNode's nextNode refers to new node
74 lastNode = lastNode.nextNode = new ListNode< T >(insertItem);
75 } // end method insertAtBack
76

```

**Fig. 22.3** | ListNode and List class declarations. (Part 2 of 4.)

```

77 // remove first node from List
78 public T removeFromFront() throws EmptyListException
79 {
80 if (isEmpty()) // throw exception if List is empty
81 throw new EmptyListException(name);
82
83 T removedItem = firstNode.data; // retrieve data being removed
84
85 // update references firstNode and lastNode
86 if (firstNode == lastNode)
87 firstNode = lastNode = null;
88 else
89 firstNode = firstNode.nextNode;
90
91 return removedItem; // return removed node data
92 } // end method removeFromFront
93
94 // remove last node from List
95 public T removeFromBack() throws EmptyListException
96 {
97 if (isEmpty()) // throw exception if List is empty
98 throw new EmptyListException(name);
99
100 T removedItem = lastNode.data; // retrieve data being removed
101
102 // update references firstNode and lastNode
103 if (firstNode == lastNode)
104 firstNode = lastNode = null;
105 else // locate new last node
106 {
107 ListNode< T > current = firstNode;
108
109 // loop while current node does not refer to lastNode
110 while (current.nextNode != lastNode)
111 current = current.nextNode;
112
113 lastNode = current; // current is new lastNode
114 current.nextNode = null;
115 } // end else
116
117 return removedItem; // return removed node data
118 } // end method removeFromBack
119
120 // determine whether list is empty
121 public boolean isEmpty()
122 {
123 return firstNode == null; // return true if list is empty
124 } // end method isEmpty
125
126 // output list contents
127 public void print()
128 {

```

**Fig. 22.3** | ListNode and List class declarations. (Part 3 of 4.)

```

129 if (isEmpty())
130 {
131 System.out.printf("Empty %s\n", name);
132 return;
133 } // end if
134
135 System.out.printf("The %s is: ", name);
136 ListNode< T > current = firstNode;
137
138 // while not at end of list, output current node's data
139 while (current != null)
140 {
141 System.out.printf("%s ", current.data);
142 current = current.nextNode;
143 } // end while
144
145 System.out.println("\n");
146 } // end method print
147 } // end class List< T >

```

**Fig. 22.3** | ListNode and List class declarations. (Part 4 of 4.)

```

1 // Fig. 22.4: EmptyListException.java
2 // Class EmptyListException declaration.
3 package com.deitel.ch22;
4
5 public class EmptyListException extends RuntimeException
6 {
7 // no-argument constructor
8 public EmptyListException()
9 {
10 this("List"); // call other EmptyListException constructor
11 } // end EmptyListException no-argument constructor
12
13 // one-argument constructor
14 public EmptyListException(String name)
15 {
16 super(name + " is empty"); // call superclass constructor
17 } // end EmptyListException one-argument constructor
18 } // end class EmptyListException

```

**Fig. 22.4** | EmptyListException class declaration.

```

1 // Fig. 22.5: ListTest.java
2 // ListTest class to demonstrate List capabilities.
3 import com.deitel.ch22.List;
4 import com.deitel.ch22.EmptyListException;
5
6 public class ListTest
7 {

```

**Fig. 22.5** | ListTest class to demonstrate List capabilities. (Part 1 of 2.)

```

8 public static void main(String[] args)
9 {
10 List< Integer > list = new List< Integer >(); // create a List
11
12 // insert integers in list
13 list.insertAtFront(-1);
14 list.print();
15 list.insertAtFront(0);
16 list.print();
17 list.insertAtBack(1);
18 list.print();
19 list.insertAtBack(5);
20 list.print();
21
22 // remove objects from list; print after each removal
23 try
24 {
25 int removedItem = list.removeFromFront();
26 System.out.printf("\n%d removed\n", removedItem);
27 list.print();
28
29 removedItem = list.removeFromFront();
30 System.out.printf("\n%d removed\n", removedItem);
31 list.print();
32
33 removedItem = list.removeFromBack();
34 System.out.printf("\n%d removed\n", removedItem);
35 list.print();
36
37 removedItem = list.removeFromBack();
38 System.out.printf("\n%d removed\n", removedItem);
39 list.print();
40 } // end try
41 catch (EmptyListException emptyListException)
42 {
43 emptyListException.printStackTrace();
44 } // end catch
45 } // end main
46 } // end class ListTest

```

```

The list is: -1
The list is: 0 -1
The list is: 0 -1 1
The list is: 0 -1 1 5

0 removed
The list is: -1 1 5

-1 removed
The list is: 1 5

5 removed
The list is: 1

1 removed
Empty list

```

**Fig. 22.5** | ListTest class to demonstrate List capabilities. (Part 2 of 2.)

### Generic Classes `ListNode` and `List`

Generic class `ListNode` (Fig. 22.3, lines 6–37) declares package-access fields `data` and `nextNode`. The `data` field is a reference of type `T`, so its type will be determined when the client code creates the corresponding `List` object. Variable `nextNode` stores a reference to the next `ListNode` object in the linked list (or `null` if the node is the last one in the list).

Lines 42–43 of class `List` (Fig. 22.3, lines 40–47) declare references to the first and last `ListNodes` in a `List` (`firstNode` and `lastNode`, respectively). The constructors (lines 47–50 and 53–57) initialize both references to `null`. The most important methods of class `List` are `insertAtFront` (lines 60–66), `insertAtBack` (lines 69–75), `removeFromFront` (lines 78–92) and `removeFromBack` (lines 95–118). Method `isEmpty` (lines 121–124) is a *predicate method* that determines whether the list is empty (i.e., the reference to the first node of the list is `null`). Predicate methods typically test a condition and do not modify the object on which they’re called. If the list is empty, method `isEmpty` returns `true`; otherwise, it returns `false`. Method `print` (lines 127–146) displays the list’s contents. We discuss class `List`’s methods in more detail after we discuss class `ListTest`.

### Class `ListTest`

Method `main` of class `ListTest` (Fig. 22.5) creates a `List<Integer>` object (line 10), then inserts objects at the beginning of the list using method `insertAtFront`, inserts objects at the end of the list using method `insertAtBack`, deletes objects from the front of the list using method `removeFromFront` and deletes objects from the end of the list using method `removeFromBack`. After each insert and remove operation, `ListTest` calls `List` method `print` to display the current list contents. If an attempt is made to remove an item from an empty list, an `EmptyListException` (Fig. 22.4) is thrown, so the method calls to `removeFromFront` and `removeFromBack` are placed in a try block that’s followed by an appropriate exception handler. Notice in lines 13, 15, 17 and 19 that the application passes literal primitive `int` values to methods `insertAtFront` and `insertAtBack`. Each of these methods was declared with a parameter of the generic type `T` (Fig. 22.3, lines 60 and 69). Since this example manipulates a `List<Integer>`, the type `T` represents the type-wrapper class `Integer`. In this case, the JVM *autoboxes* each literal value in an `Integer` object, and that object is actually inserted into the list.

### `List` Method `insertAtFront`

Now we discuss each method of class `List` (Fig. 22.3) in detail and provide diagrams showing the reference manipulations performed by methods `insertAtFront`, `insertAtBack`, `removeFromFront` and `removeFromBack`. Method `insertAtFront` (lines 60–66 of Fig. 22.3) places a new node at the front of the list. The steps are:

1. Call `isEmpty` to determine whether the list is empty (line 62).
2. If the list is empty, assign to `firstNode` and `lastNode` the new `ListNode` that was initialized with `insertItem` (line 63). (Recall that assignment operators evaluate right to left.) The `ListNode` constructor at lines 13–16 calls the `ListNode` constructor at lines 20–24 to set instance variable `data` to refer to the `insertItem` passed as an argument and to set reference `nextNode` to `null`, because this is the first and last node in the list.

3. If the list is not empty, the new node is “linked” into the list by setting `firstNode` to a new `ListNode` object and initializing that object with `insertItem` and `firstNode` (line 65). When the `ListNode` constructor (lines 20–24) executes, it sets instance variable `data` to refer to the `insertItem` passed as an argument and performs the insertion by setting the `nextNode` reference of the new node to the `ListNode` passed as an argument, which previously was the first node.

In Fig. 22.6, part (a) shows a list and a new node during the `insertAtFront` operation and before the program links the new node into the list. The dotted arrows in part (b) illustrate *Step 3* of the `insertAtFront` operation that enables the node containing 12 to become the new first node in the list.

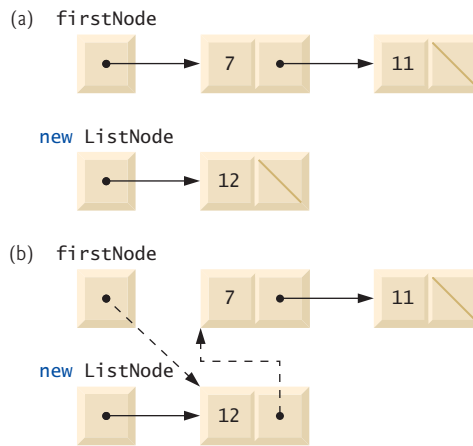

**Fig. 22.6** | Graphical representation of operation `insertAtFront`.

### List Method `insertAtBack`

Method `insertAtBack` (lines 69–75 of Fig. 22.3) places a new node at the back of the list. The steps are:

1. Call `isEmpty` to determine whether the list is empty (line 71).
2. If the list is empty, assign to `firstNode` and `lastNode` the new `ListNode` that was initialized with `insertItem` (line 72). The `ListNode` constructor at lines 13–16 calls the constructor at lines 20–24 to set instance variable `data` to refer to the `insertItem` passed as an argument and to set reference `nextNode` to `null`.
3. If the list is not empty, line 74 links the new node into the list by assigning to `lastNode` and `lastNode.nextNode` the reference to the new `ListNode` that was initialized with `insertItem`. `ListNode`'s constructor (lines 13–16) sets instance variable `data` to refer to the `insertItem` passed as an argument and sets reference `nextNode` to `null`, because this is the last node in the list.

In Fig. 22.7, part (a) shows a list and a new node during the `insertAtBack` operation and before linking the new node into the list. The dotted arrows in part (b) illustrate *Step 3* of method `insertAtBack`, which adds the new node to the end of a list that's not empty.



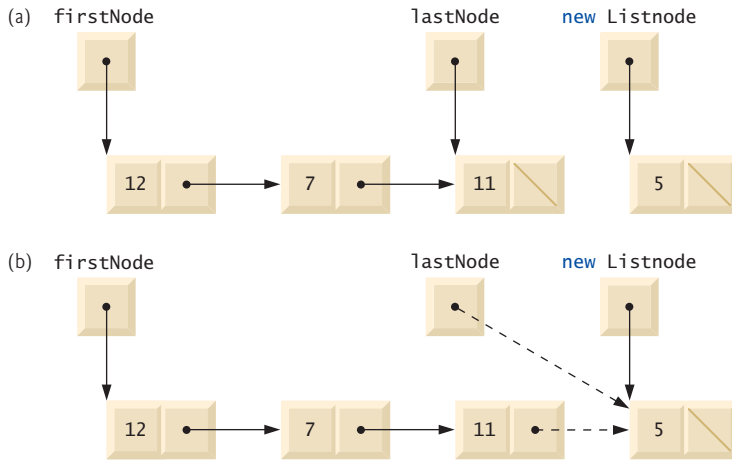

**Fig. 22.7** | Graphical representation of operation `insertAtBack`.

#### **List Method `removeFromFront`**

Method `removeFromFront` (lines 78–92 of Fig. 22.3) removes the first node of the list and returns a reference to the removed data. If the list is empty when the program calls this method, the method throws an `EmptyListException` (lines 80–81). Otherwise, the method returns a reference to the removed data. The steps are:

1. Assign `firstNode.data` (the data being removed) to `removedItem` (line 83).
2. If `firstNode` and `lastNode` refer to the same object (line 86), the list has only one element at this time. So, the method sets `firstNode` and `lastNode` to `null` (line 87) to remove the node from the list (leaving the list empty).
3. If the list has more than one node, then the method leaves reference `lastNode` as is and assigns the value of `firstNode.nextNode` to `firstNode` (line 89). Thus, `firstNode` references the node that was previously the second node in the list.
4. Return the `removedItem` reference (line 91).

In Fig. 22.8, part (a) illustrates the list before the removal operation. The dashed lines and arrows in part (b) show the reference manipulations.

#### **List Method `removeFromBack`**

Method `removeFromBack` (lines 95–118 of Fig. 22.3) removes the last node of a list and returns a reference to the removed data. The method throws an `EmptyListException` (lines 97–98) if the list is empty when the program calls this method. The steps are:

1. Assign `lastNode.data` (the data being removed from the list) to `removedItem` (line 100).
2. If the `firstNode` and `lastNode` refer to the same object (line 103), the list has only one element at this time. So, line 104 sets `firstNode` and `lastNode` to `null` to remove that node from the list (leaving the list empty).

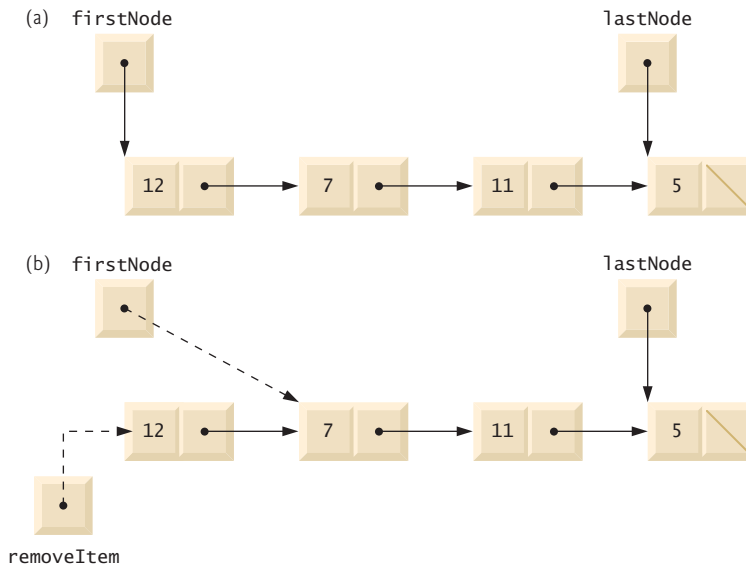

**Fig. 22.8** | Graphical representation of operation `removeFromFront`.

3. If the list has more than one node, create the `ListNode` reference `current` and assign it `firstNode` (line 107).
4. Now “walk the list” with `current` until it references the node before the last node. The `while` loop (lines 110–111) assigns `current.nextNode` to `current` as long as `current.nextNode` (the next node in the list) is not `lastNode`.
5. After locating the second-to-last node, assign `current` to `lastNode` (line 113) to update which node is last in the list.
6. Set the `current.nextNode` to `null` (line 114) to remove the last node from the list and terminate the list at the `current` node.
7. Return the `removeItem` reference (line 117).

In Fig. 22.9, part (a) illustrates the list before the removal operation. The dashed lines and arrows in part (b) show the reference manipulations.

### List Method `print`

Method `print` (lines 127–146) first determines whether the list is empty (lines 129–133). If so, `print` displays a message indicating that the list is empty and returns control to the calling method. Otherwise, `print` outputs the list’s data. Line 136 creates `ListNode` `current` and initializes it with `firstNode`. While `current` is not `null`, there are more items in the list. Therefore, line 141 outputs a string representation of `current.data`. Line 142 moves to the next node in the list by assigning the value of reference `current.nextNode` to `current`. This printing algorithm is identical for linked lists, stacks and queues.

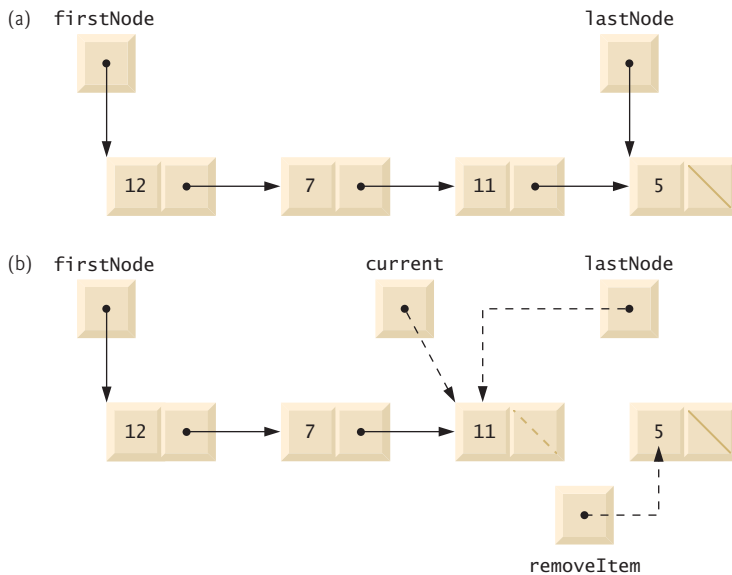

**Fig. 22.9** | Graphical representation of operation `removeFromBack`.

## 22.5 Stacks

A stack is a constrained version of a list—*new nodes can be added to and removed from a stack only at the top*. For this reason, a stack is referred to as a **last-in, first-out (LIFO)** data structure. The link member in the bottom node is set to null to indicate the bottom of the stack. A stack is not required to be implemented as a linked list—it can also be implemented using an array.

The primary methods for manipulating a stack are **push** and **pop**, which add a new node to the top of the stack and remove a node from the top of the stack, respectively. Method `pop` also returns the data from the popped node.

Stacks have many interesting applications. For example, when a program calls a method, the called method must know how to return to its caller, so the return address of the calling method is pushed onto the program-execution stack (discussed in Section 6.6). If a series of method calls occurs, the successive return addresses are pushed onto the stack in last-in, first-out order so that each method can return to its caller. Stacks support recursive method calls in the *same* manner as they do conventional nonrecursive method calls.

The program-execution stack also contains the memory for local variables on each invocation of a method during a program's execution. When the method returns to its caller, the memory for that method's local variables is popped off the stack, and those variables are no longer known to the program. If the local variable is a reference and the object to which it referred has no other variables referring to it, the object can be garbage collected.

Compilers use stacks to evaluate arithmetic expressions and generate machine-language code to process them. The exercises in this chapter explore several applications of stacks, including using them to develop a complete working compiler. Also, package

java.util contains class Stack (see Chapter 20) for implementing and manipulating stacks that can grow and shrink during program execution.

In this section, we take advantage of the close relationship between lists and stacks to implement a stack class by reusing the List<T> class of Fig. 22.3. We demonstrate two different forms of reusability. First, we implement the stack class by extending class List. Then we implement an identically performing stack class through *composition* by including a reference to a List object as a private instance variable. The list, stack and queue data structures in this chapter are implemented to store references to objects of any type to encourage further reusability.

### Stack Class That Inherits from List<T>

Figures 22.10 and 22.11 create and manipulate a stack class that extends the List<T> class of Fig. 22.3. We want the stack to have methods push, pop, isEmpty and print. Essentially, these are the List<T> methods insertAtFront, removeFromFront, isEmpty and print. Of course, class List<T> contains other methods (such as insertAtBack and removeFromBack) that we would rather not make accessible through the public interface to the stack class. It's important to remember that all methods in List<T>'s public interface class also are public methods of the subclass StackInheritance<T> (Fig. 22.10). Each method of StackInheritance<T> calls the appropriate List<T> method—for example, method push calls insertAtFront and method pop calls removeFromFront. StackInheritance<T> clients can call methods isEmpty and print because they're inherited from List<T>. Class StackInheritance<T> is declared in package com.deitel.ch22 (line 3) for reuse. StackInheritance<T> does not import List<T>—the classes are in the same package.

---

```

1 // Fig. 22.10: StackInheritance.java
2 // StackInheritance extends class List.
3 package com.deitel.ch22;
4
5 public class StackInheritance< T > extends List< T >
6 {
7 // no-argument constructor
8 public StackInheritance()
9 {
10 super("stack");
11 } // end StackInheritance no-argument constructor
12
13 // add object to stack
14 public void push(T object)
15 {
16 insertAtFront(object);
17 } // end method push
18
19 // remove object from stack
20 public T pop() throws EmptyListException
21 {
22 return removeFromFront();
23 } // end method pop
24 } // end class StackInheritance

```

---

**Fig. 22.10** | StackInheritance extends class List.

Class `StackInheritanceTest`'s method `main` (Fig. 22.11) creates an object of class `StackInheritance<T>` called `stack` (lines 10–11). The program pushes integers onto the stack (lines 14, 16, 18 and 20). *Autoboxing* is used here to insert `Integer` objects into the data structure. Lines 28–33 pop the objects from the stack in an infinite `while` loop. If method `pop` is invoked on an empty stack, the method throws an `EmptyListException`. In this case, the program displays the exception's stack trace, which shows the methods on the program-execution stack at the time the exception occurred. The program uses method `print` (inherited from `List`) to output the contents of the stack.

---

```

1 // Fig. 22.11: StackInheritanceTest.java
2 // Stack manipulation program.
3 import com.deitel.ch22.StackInheritance;
4 import com.deitel.ch22.EmptyListException;
5
6 public class StackInheritanceTest
7 {
8 public static void main(String[] args)
9 {
10 StackInheritance< Integer > stack =
11 new StackInheritance< Integer >();
12
13 // use push method
14 stack.push(-1);
15 stack.print();
16 stack.push(0);
17 stack.print();
18 stack.push(1);
19 stack.print();
20 stack.push(5);
21 stack.print();
22
23 // remove items from stack
24 try
25 {
26 int removedItem;
27
28 while (true)
29 {
30 removedItem = stack.pop(); // use pop method
31 System.out.printf("\n%d popped\n", removedItem);
32 stack.print();
33 } // end while
34 } // end try
35 catch (EmptyListException emptyListException)
36 {
37 emptyListException.printStackTrace();
38 } // end catch
39 } // end main
40 } // end class StackInheritanceTest

```

---

**Fig. 22.11** | Stack manipulation program. (Part I of 2.)

```

The stack is: -1
The stack is: 0 -1

The stack is: 1 0 -1
The stack is: 5 1 0 -1

5 popped
The stack is: 1 0 -1

1 popped
The stack is: 0 -1

0 popped
The stack is: -1

-1 popped
Empty stack
com.deitel.ch22.EmptyListException: stack is empty
 at com.deitel.ch22.List.removeFromFront(List.java:81)
 at com.deitel.ch22.StackInheritance.pop(StackInheritance.java:22)
 at StackInheritanceTest.main(StackInheritanceTest.java:30)

```

**Fig. 22.11** | Stack manipulation program. (Part 2 of 2.)

### *Stack Class That Contains a Reference to a List*

You can also implement a class by reusing a list class through composition. Figure 22.12 uses a private `List<T>` (line 7) in class `StackComposition<T>`'s declaration. Composition enables us to hide the `List<T>` methods that should not be in our stack's public interface. We provide public interface methods that use only the required `List<T>` methods. Implementing each stack method as a call to a `List<T>` method is called **delegation**—the stack method invoked delegates the call to the appropriate `List<T>` method. In particular, `StackComposition<T>` delegates calls to `List<T>` methods `insertAtFront`, `removeFromFront`, `isEmpty` and `print`. In this example, we do not show class `StackCompositionTest`, because the only difference is that we change the type of the stack from `StackInheritance` to `StackComposition` (lines 3 and 10–11 of Fig. 22.11).

```

1 // Fig. 22.12: StackComposition.java
2 // StackComposition uses a composed List object.
3 package com.deitel.ch22;
4
5 public class StackComposition< T >
6 {
7 private List< T > stackList;
8
9 // no-argument constructor
10 public StackComposition()
11 {
12 stackList = new List< T >("stack");
13 } // end StackComposition no-argument constructor
14

```

**Fig. 22.12** | `StackComposition` uses a composed `List` object. (Part 1 of 2.)

---

```

15 // add object to stack
16 public void push(T object)
17 {
18 stackList.insertAtFront(object);
19 } // end method push
20
21 // remove object from stack
22 public T pop() throws EmptyListException
23 {
24 return stackList.removeFromFront();
25 } // end method pop
26
27 // determine if stack is empty
28 public boolean isEmpty()
29 {
30 return stackList.isEmpty();
31 } // end method isEmpty
32
33 // output stack contents
34 public void print()
35 {
36 stackList.print();
37 } // end method print
38 } // end class StackComposition

```

---

**Fig. 22.12** | StackComposition uses a composed List object. (Part 2 of 2.)

## 22.6 Queues

Another commonly used data structure is the queue. A queue is similar to a checkout line in a supermarket—the cashier services the person at the *beginning* of the line *first*. Other customers enter the line only at the end and wait for service. *Queue nodes are removed only from the head (or front) of the queue and are inserted only at the tail (or end)*. For this reason, a queue is a **first-in, first-out (FIFO)** data structure. The insert and remove operations are known as **enqueue** and **dequeue**.

Queues have many uses in computer systems. Each CPU in a computer can service only one application at a time. Each application requiring processor time is placed in a queue. The application at the front of the queue is the next to receive service. Each application gradually advances to the front as the applications before it receive service.

Queues are also used to support **print spooling**. For example, a single printer might be shared by all users of a network. Many users can send print jobs to the printer, even when the printer is already busy. These print jobs are placed in a queue until the printer becomes available. A program called a **spooler** manages the queue to ensure that, as each print job completes, the next one is sent to the printer.

Information packets also *wait* in queues in computer networks. Each time a packet arrives at a network node, it must be routed to the next node along the path to the packet's final destination. The routing node routes one packet at a time, so additional packets are enqueued until the router can route them.

A file server in a computer network handles file-access requests from many clients throughout the network. Servers have a limited capacity to service requests from clients. When that capacity is exceeded, client requests *wait* in queues.

Figure 22.13 creates a `Queue<T>` class that contains a `List<T>` (Fig. 22.3) object and provides methods `enqueue`, `dequeue`, `isEmpty` and `print`. Class `List<T>` contains some methods (e.g., `insertAtFront` and `removeFromBack`) that we'd rather not make accessible through `Queue<T>`'s public interface. Using composition enables us to hide class `List<T>`'s other public methods from clients of class `Queue<T>`. Each `Queue<T>` method calls an appropriate `List<T>` method—method `enqueue` calls `List<T>` method `insertAtBack`, method `dequeue` calls `List<T>` method `removeFromFront`, method `isEmpty` calls `List<T>` method `isEmpty` and method `print` calls `List<T>` method `print`. For reuse, class `Queue<T>` is declared in package `com.deitel.ch22`.

Class `QueueTest`'s (Fig. 22.14) `main` method creates and initializes `Queue<T>` variable `queue` (line 10). Lines 13, 15, 17 and 19 enqueue four integers, taking advantage of *auto-*

---

```

1 // Fig. 22.13: Queue.java
2 // Queue uses class List.
3 package com.deitel.ch22;
4
5 public class Queue
6 {
7 private List< T > queueList;
8
9 // no-argument constructor
10 public Queue()
11 {
12 queueList = new List< T >("queue");
13 } // end Queue no-argument constructor
14
15 // add object to queue
16 public void enqueue(T object)
17 {
18 queueList.insertAtBack(object);
19 } // end method enqueue
20
21 // remove object from queue
22 public T dequeue() throws EmptyListException
23 {
24 return queueList.removeFromFront();
25 } // end method dequeue
26
27 // determine if queue is empty
28 public boolean isEmpty()
29 {
30 return queueList.isEmpty();
31 } // end method isEmpty
32
33 // output queue contents
34 public void print()
35 {
36 queueList.print();
37 } // end method print
38 } // end class Queue

```

---

**Fig. 22.13** | Queue uses class List.



*boxing* to insert Integer objects into the queue. Lines 27–32 use an infinite loop to dequeue the objects in first-in, first-out order. When the queue is empty, method `dequeue` throws an `EmptyListException`, and the program displays the exception's stack trace.

```

1 // Fig. 22.14: QueueTest.java
2 // Class QueueTest.
3 import com.deitel.ch22.Queue;
4 import com.deitel.ch22.EmptyListException;
5
6 public class QueueTest
7 {
8 public static void main(String[] args)
9 {
10 Queue< Integer > queue = new Queue< Integer >();
11
12 // use enqueue method
13 queue.enqueue(-1);
14 queue.print();
15 queue.enqueue(0);
16 queue.print();
17 queue.enqueue(1);
18 queue.print();
19 queue.enqueue(5);
20 queue.print();
21
22 // remove objects from queue
23 try
24 {
25 int removedItem;
26
27 while (true)
28 {
29 removedItem = queue.dequeue(); // use dequeue method
30 System.out.printf("\n%d dequeued\n", removedItem);
31 queue.print();
32 } // end while
33 } // end try
34 catch (EmptyListException emptyListException)
35 {
36 emptyListException.printStackTrace();
37 } // end catch
38 } // end main
39 } // end class QueueTest

```

```

The queue is: -1
The queue is: -1 0
The queue is: -1 0 1
The queue is: -1 0 1 5

-1 dequeued
The queue is: 0 1 5

```

**Fig. 22.14** | Queue processing program. (Part I of 2.)

```

0 dequeued
The queue is: 1 5

1 dequeued
The queue is: 5

5 dequeued
Empty queue
com.deitel.ch22.EmptyListException: queue is empty
 at com.deitel.ch22.List.removeFromFront(List.java:81)
 at com.deitel.ch22.Queue.dequeue(Queue.java:24)
 at QueueTest.main(QueueTest.java:29)

```

**Fig. 22.14** | Queue processing program. (Part 2 of 2.)

## 22.7 Trees

Lists, stacks and queues are **linear data structures** (i.e., **sequences**). A tree is a nonlinear, two-dimensional data structure with special properties. Tree nodes contain two or more links. This section discusses binary trees (Fig. 22.15)—trees whose nodes each contain two links (one or both of which may be null). The **root node** is the first node in a tree. Each link in the root node refers to a **child**. The **left child** is the first node in the **left subtree** (also known as the root node of the left subtree), and the **right child** is the first node in the **right subtree** (also known as the root node of the right subtree). The children of a specific node are called **siblings**. A node with no children is called a **leaf node**. Computer scientists normally draw trees from the root node down—the opposite of the way most trees grow in nature.

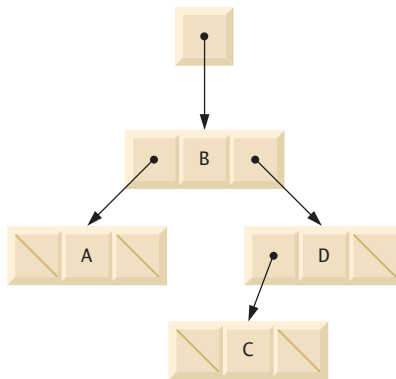
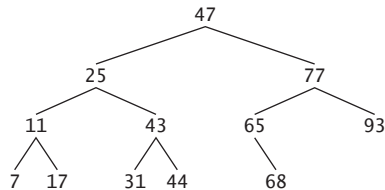

**Fig. 22.15** | Binary tree graphical representation.

In our example, we create a special binary tree called a **binary search tree**. A binary search tree (with no duplicate node values) has the characteristic that the values in any left subtree are less than the value in that subtree's parent node, and the values in any right subtree are greater than the value in that subtree's parent node. Figure 22.16 illustrates a binary search tree with 12 integer values. The shape of the binary search tree that corre-

sponds to a set of data can vary, depending on the order in which the values are inserted into the tree.

Figures 22.17 and 22.18 create a generic binary search tree class and use it to manipulate a tree of integers. The application in Fig. 22.18 *traverses* the tree (i.e., walks through all its nodes) three ways—using recursive **inorder**, **preorder** and **postorder traversals**. The program generates 10 random numbers and inserts each into the tree. Class `Tree<T>` is declared in package `com.deitel.ch22` for reuse.



**Fig. 22.16** | Binary search tree containing 12 values.

```

1 // Fig. 22.17: Tree.java
2 // TreeNode and Tree class declarations for a binary search tree.
3 package com.deitel.ch22;
4
5 // class TreeNode definition
6 class TreeNode< T extends Comparable< T > >
7 {
8 // package access members
9 TreeNode< T > leftNode; // left node
10 T data; // node value
11 TreeNode< T > rightNode; // right node
12
13 // constructor initializes data and makes this a leaf node
14 public TreeNode(T nodeData)
15 {
16 data = nodeData;
17 leftNode = rightNode = null; // node has no children
18 } // end TreeNode constructor
19
20 // locate insertion point and insert new node; ignore duplicate values
21 public void insert(T insertValue)
22 {
23 // insert in left subtree
24 if (insertValue.compareTo(data) < 0)
25 {
26 // insert new TreeNode
27 if (leftNode == null)
28 leftNode = new TreeNode< T >(insertValue);
29 else // continue traversing left subtree recursively
30 leftNode.insert(insertValue);
31 } // end if

```

**Fig. 22.17** | `TreeNode` and `Tree` class declarations for a binary search tree. (Part I of 3.)

```

32 // insert in right subtree
33 else if (insertValue.compareTo(data) > 0)
34 {
35 // insert new TreeNode
36 if (rightNode == null)
37 rightNode = new TreeNode< T >(insertValue);
38 else // continue traversing right subtree recursively
39 rightNode.insert(insertValue);
40 } // end else if
41 } // end method insert
42 } // end class TreeNode
43
44 // class Tree definition
45 public class Tree< T extends Comparable< T > >
46 {
47 private TreeNode< T > root;
48
49 // constructor initializes an empty Tree of integers
50 public Tree()
51 {
52 root = null;
53 } // end Tree no-argument constructor
54
55 // insert a new node in the binary search tree
56 public void insertNode(T insertValue)
57 {
58 if (root == null)
59 root = new TreeNode< T >(insertValue); // create root node
60 else
61 root.insert(insertValue); // call the insert method
62 } // end method insertNode
63
64 // begin preorder traversal
65 public void preorderTraversal()
66 {
67 preorderHelper(root);
68 } // end method preorderTraversal
69
70 // recursive method to perform preorder traversal
71 private void preorderHelper(TreeNode< T > node)
72 {
73 if (node == null)
74 return;
75
76 System.out.printf("%s ", node.data); // output node data
77 preorderHelper(node.leftNode); // traverse left subtree
78 preorderHelper(node.rightNode); // traverse right subtree
79 } // end method preorderHelper
80
81 // begin inorder traversal
82 public void inorderTraversal()
83 {

```

**Fig. 22.17** | `TreeNode` and `Tree` class declarations for a binary search tree. (Part 2 of 3.)

```

84 inorderHelper(root);
85 } // end method inorderTraversal
86
87 // recursive method to perform inorder traversal
88 private void inorderHelper(TreeNode< T > node)
89 {
90 if (node == null)
91 return;
92
93 inorderHelper(node.leftNode); // traverse left subtree
94 System.out.printf("%s ", node.data); // output node data
95 inorderHelper(node.rightNode); // traverse right subtree
96 } // end method inorderHelper
97
98 // begin postorder traversal
99 public void postorderTraversal()
100 {
101 postorderHelper(root);
102 } // end method postorderTraversal
103
104 // recursive method to perform postorder traversal
105 private void postorderHelper(TreeNode< T > node)
106 {
107 if (node == null)
108 return;
109
110 postorderHelper(node.leftNode); // traverse left subtree
111 postorderHelper(node.rightNode); // traverse right subtree
112 System.out.printf("%s ", node.data); // output node data
113 } // end method postorderHelper
114 } // end class Tree

```

**Fig. 22.17** | `TreeNode` and `Tree` class declarations for a binary search tree. (Part 3 of 3.)

```

1 // Fig. 22.18: TreeTest.java
2 // Binary tree test program.
3 import java.util.Random;
4 import com.deitel.ch22.Tree;
5
6 public class TreeTest
7 {
8 public static void main(String[] args)
9 {
10 Tree< Integer > tree = new Tree< Integer >();
11 int value;
12 Random randomNumber = new Random();
13
14 System.out.println("Inserting the following values: ");
15
16 // insert 10 random integers from 0-99 in tree
17 for (int i = 1; i <= 10; i++)
18 {

```

**Fig. 22.18** | Binary tree test program. (Part 1 of 2.)

```

19 value = randomNumber.nextInt(100);
20 System.out.printf("%d ", value);
21 tree.insertNode(value);
22 } // end for
23
24 System.out.println ("\n\nPreorder traversal");
25 tree.preorderTraversal(); // perform preorder traversal of tree
26
27 System.out.println ("\n\nInorder traversal");
28 tree.inorderTraversal(); // perform inorder traversal of tree
29
30 System.out.println ("\n\nPostorder traversal");
31 tree.postorderTraversal(); // perform postorder traversal of tree
32 System.out.println();
33 } // end main
34 } // end class TreeTest

```

```

Inserting the following values:
49 64 14 34 85 64 46 14 37 55

Preorder traversal
49 14 34 46 37 64 55 85

Inorder traversal
14 34 37 46 49 55 64 85

Postorder traversal
37 46 34 14 55 85 64 49

```

**Fig. 22.18** | Binary tree test program. (Part 2 of 2.)

Let's walk through the binary tree program. Method `main` of class `TreeTest` (Fig. 22.18) begins by instantiating an empty `Tree<T>` object and assigning its reference to variable `tree` (line 10). Lines 17–22 randomly generate 10 integers, each of which is inserted into the binary tree by calling method `insertNode` (line 21). The program then performs preorder, inorder and postorder traversals (these will be explained shortly) of `tree` (lines 25, 28 and 31, respectively).

### Overview of Class `Tree`

Class `Tree` (Fig. 22.17, lines 45–114) requires its type argument to implement interface `Comparable`, so that each value inserted in the tree can be *compared* with the existing values to find the insertion point. The class has private field `root` (line 47)—a `TreeNode` reference to the root node of the tree. `Tree`'s constructor (lines 50–53) initializes `root` to `null` to indicate that the tree is *empty*. The class contains method `insertNode` (lines 56–62) to insert a new node in the tree and methods `preorderTraversal` (lines 65–68), `inorderTraversal` (lines 82–85) and `postorderTraversal` (lines 99–102) to begin traversals of the tree. Each of these methods calls a recursive utility method to perform the traversal operations on the internal representation of the tree.

### Tree Method `insertNode`

Class `Tree`'s method `insertNode` (lines 56–62) first determines whether the tree is empty. If so, line 59 allocates a new `TreeNode`, initializes the node with the value being inserted

in the tree and assigns the new node to reference `root`. If the tree is not empty, line 61 calls `TreeNode` method `insert` (lines 21–41). This method uses recursion to determine the location for the new node in the tree and inserts the node at that location. A node can be inserted only as a leaf node in a binary search tree.

### **TreeNode Method insert**

`TreeNode` method `insert` compares the value to insert with the data value in the root node. If the insert value is less than the root node data (line 24), the program determines whether the left subtree is empty (line 27). If so, line 28 allocates a new `TreeNode`, initializes it with the value being inserted and assigns the new node to reference `leftNode`. Otherwise, line 30 recursively calls `insert` for the left subtree to insert the value into the left subtree. If the insert value is greater than the root node data (line 33), the program determines whether the right subtree is empty (line 36). If so, line 37 allocates a new `TreeNode`, initializes it with the value being inserted and assigns the new node to reference `rightNode`. Otherwise, line 39 recursively calls `insert` for the right subtree to insert the value in the right subtree. If the `insertValue` is already in the tree, it's simply ignored.

### **Tree Methods inorderTraversal, preorderTraversal and postorderTraversal**

Methods `inorderTraversal`, `preorderTraversal` and `postorderTraversal` call `Tree` helper methods `inorderHelper` (lines 88–96), `preorderHelper` (lines 71–79) and `postorderHelper` (lines 105–113), respectively, to traverse the tree and print the node values. The helper methods in class `Tree` enable you to start a traversal without having to pass the root node to the method. Reference `root` is an *implementation detail* that a programmer should not be able to access. Methods `inorderTraversal`, `preorderTraversal` and `postorderTraversal` simply take the private `root` reference and pass it to the appropriate helper method to initiate a traversal of the tree. The base case for each helper method determines whether the reference it receives is `null` and, if so, returns immediately.

Method `inorderHelper` (lines 88–96) defines the steps for an inorder traversal:

1. Traverse the left subtree with a call to `inorderHelper` (line 93).
2. Process the value in the node (line 94).
3. Traverse the right subtree with a call to `inorderHelper` (line 95).

*The inorder traversal does not process the value in a node until the values in that node's left subtree are processed.* The inorder traversal of the tree in Fig. 22.19 is

```
6 13 17 27 33 42 48
```

The inorder traversal of a binary search tree prints the node values in *ascending order*. The process of creating a binary search tree actually sorts the data; thus, it's called the **binary tree sort**.

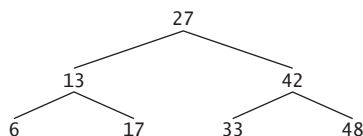

**Fig. 22.19** | Binary search tree with seven values.

Method `preorderHelper` (lines 71–79) defines the steps for a preorder traversal:

1. Process the value in the node (line 76).
2. Traverse the left subtree with a call to `preorderHelper` (line 77).
3. Traverse the right subtree with a call to `preorderHelper` (line 78).

*The preorder traversal processes the value in each node as the node is visited.* After processing the value in a particular node, it processes the values in the left subtree, then processes the values in the right subtree. The preorder traversal of the tree in Fig. 22.19 is

```
27 13 6 17 42 33 48
```

Method `postorderHelper` (lines 105–113) defines the steps for a postorder traversal:

1. Traverse the left subtree with a call to `postorderHelper` (line 110).
2. Traverse the right subtree with a call to `postorderHelper` (line 111).
3. Process the value in the node (line 112).

*The postorder traversal processes the value in each node after the values of all that node's children are processed.* The `postorderTraversal` of the tree in Fig. 22.19 is

```
6 17 13 33 48 42 27
```

The binary search tree facilitates **duplicate elimination**. While building a tree, the insertion operation recognizes attempts to insert a duplicate value, because a duplicate follows the same “go left” or “go right” decisions on each comparison as the original value did. Thus, the insertion operation eventually compares the duplicate with a node containing the same value. At this point, the insertion operation can decide to *discard* the duplicate value (as we do in this example).

Searching a binary tree for a value that matches a key value is fast, especially for **tightly packed** (or **balanced**) **trees**. In a tightly packed tree, each level contains about twice as many elements as the previous level. Figure 22.19 is a tightly packed binary tree. A tightly packed binary search tree with  $n$  elements has  $\log_2 n$  levels. Thus, at most  $\log_2 n$  comparisons are required either to find a match or to determine that no match exists. Searching a (tightly packed) 1000-element binary search tree requires at most 10 comparisons, because  $2^{10} > 1000$ . Searching a (tightly packed) 1,000,000-element binary search tree requires at most 20 comparisons, because  $2^{20} > 1,000,000$ .

The chapter exercises present algorithms for several other binary tree operations, such as deleting an item from a binary tree, printing a binary tree in a two-dimensional tree format and performing a **level-order traversal of a binary tree**. The level-order traversal visits the nodes of the tree row by row, starting at the root node level. On each level of the tree, a level-order traversal visits the nodes from left to right. Other binary tree exercises include allowing a binary search tree to contain duplicate values, inserting string values in a binary tree and determining how many levels are contained in a binary tree.

## 22.8 Wrap-Up

This chapter completes our presentation of data structures. We began in Chapter 20 with an introduction to the built-in collections of the Java Collections Framework and continued in Chapter 21 by showing you how to implement generic methods and collections. In this chapter, you learned to build generic dynamic data structures that grow and shrink at



execution time. You learned that linked lists are collections of data items that are “linked up in a chain.” You also saw that an application can perform insertions and deletions at the beginning and end of a linked list. You learned that the stack and queue data structures are constrained versions of lists. For stacks, you saw that insertions and deletions are made only at the top. For queues that represent waiting lines, you saw that insertions are made at the tail and deletions are made from the head. You also learned the binary tree data structure. You saw a binary search tree that facilitated high-speed searching and sorting of data and eliminating duplicate data items efficiently. Throughout the chapter, you learned how to create and package these data structures for reusability and maintainability.

Next, we introduce Java applets—Java programs that typically execute in a browser. We overview the JDK’s sample applets, then show you how to write and execute your own applets. We then introduce the Java Web Start capabilities for launching an applet and installing a desktop shortcut to relaunch the applet in the future without having to revisit the applet’s website.

## Summary

### *Section 22.1 Introduction*

- Dynamic data structures (p. 905) can grow and shrink at execution time.
- Linked lists (p. 905) are collections of data items “linked up in a chain”—insertions and deletions can be made anywhere in a linked list.
- Stacks (p. 905) are important in compilers and operating systems—insertions and deletions are made only at the top (p. 905) of a stack.
- In a queue, insertions are made at the tail (p. 905) and deletions are made from the head (p. 905).
- Binary trees (p. 905) facilitate high-speed searching and sorting, eliminating duplicate data items efficiently, representing file-system directories and compiling expressions into machine language.

### *Section 22.2 Self-Referential Classes*

- A self-referential class (p. 905) contains a reference that refers to another object of the same class type. Self-referential objects can be linked together to form dynamic data structures.

### *Section 22.3 Dynamic Memory Allocation*

- The limit for dynamic memory allocation (p. 906) can be as large as the available physical memory in the computer or the available disk space in a virtual-memory system. Often the limits are much smaller, because the computer’s available memory must be shared among many users.
- If no memory is available, an `OutOfMemoryError` is thrown.

### *Section 22.4 Linked Lists*

- A linked list is accessed via a reference to the first node of the list. Each subsequent node is accessed via the link-reference member stored in the previous node.
- By convention, the link reference in the last node of a list is set to `null` to mark the end of the list.
- A node can contain data of any type, including objects of other classes.
- A linked list is appropriate when the number of data elements to be stored is unpredictable. Linked lists are dynamic, so the length of a list can increase or decrease as necessary.
- The size of a “conventional” Java array cannot be altered—it’s fixed at creation time.
- List nodes normally are not stored in contiguous memory. Rather, they’re logically contiguous.

### Section 22.5 Stacks

- A stack is a last-in, first-out (LIFO) data structure (p. 917). The primary methods used to manipulate a stack are `push` (p. 917) and `pop` (p. 917), which add a new node to the stack's top and remove a node from the top, respectively. Method `pop` returns the removed node's data.
- When a method call is made, the called method must know how to return to its caller, so the return address is pushed onto the program-execution stack. If a series of method calls occurs, the successive return values are pushed onto the stack in last-in, first-out order.
- The program-execution stack contains the space created for local variables on each invocation of a method. When the method returns to its caller, the space for that method's local variables is popped off the stack, and those variables are no longer available to the program.
- Stacks are used by compilers to evaluate arithmetic expressions and generate machine-language code to process the expressions.
- The technique of implementing each stack method as a call to a `List` method is called delegation—the stack method invoked delegates (p. 920) the call to the appropriate `List` method.

### Section 22.6 Queues

- A queue (p. 905) is similar to a checkout line in a supermarket—the first person in line is serviced first, and other customers enter the line only at the end and wait to be serviced.
- Queue nodes are removed only from the head (p. 905) of the queue and are inserted only at the tail. For this reason, a queue is referred to as a first-in, first-out FIFO data structure.
- The insert and remove operations for a queue are known as `enqueue` (p. 921) and `dequeue` (p. 921).
- Queues have many uses in computer systems. Most computers have only a single processor, so only one application at a time can be serviced. Entries for the other applications are placed in a queue. The entry at the front of the queue is the next to receive service. Each entry gradually advances to the front of the queue as applications receive service.

### Section 22.7 Trees

- A tree is a nonlinear, two-dimensional data structure. Tree nodes contain two or more links.
- A binary tree (p. 905) is a tree whose nodes all contain two links. The root node (p. 924) is the first node in a tree.
- Each link in the root node refers to a child (p. 924). The left child (p. 924) is the first node in the left subtree (p. 924), and the right child (p. 924) is the first node in the right subtree (p. 924).
- The children of a node are called siblings (p. 924). A node with no children is a leaf node (p. 924).
- In a binary search tree (p. 924) with no duplicate values, the values in any left subtree are less than the value in the subtree's parent node, and the values in any right subtree are greater than the value in the subtree's parent node. A node can be inserted only as a leaf node in a binary search tree.
- An inorder traversal (p. 925) of a binary search tree processes the node values in ascending order.
- In a preorder traversal (p. 925), the value in each node is processed as the node is visited. Then the values in the left subtree are processed, then the values in the right subtree.
- In a postorder traversal (p. 925), the value in each node is processed after the values of its children.
- The binary search tree facilitates duplicate elimination (p. 930). As the tree is created, attempts to insert a duplicate value are recognized, because a duplicate follows the same “go left” or “go right” decisions on each comparison as the original value did. Thus, the duplicate eventually is compared with a node containing the same value. The duplicate value can be discarded at this point.

- In a tightly packed tree (p. 930), each level contains about twice as many elements as the previous one. So a tightly packed binary search tree with  $n$  elements has  $\log_2 n$  levels, and thus at most  $\log_2 n$  comparisons would have to be made either to find a match or to determine that no match exists. Searching a (tightly packed) 1000-element binary search tree requires at most 10 comparisons, because  $2^{10} > 1000$ . Searching a (tightly packed) 1,000,000-element binary search tree requires at most 20 comparisons, because  $2^{20} > 1,000,000$ .

## Self-Review Exercises

**22.1** Fill in the blanks in each of the following statements:

- A self-\_\_\_\_\_ class is used to form dynamic data structures that can grow and shrink at execution time.
- A(n) \_\_\_\_\_ is a constrained version of a linked list in which nodes can be inserted and deleted only from the start of the list.
- A method that does not alter a linked list, but simply looks at it to determine whether it's empty, is referred to as a(n) \_\_\_\_\_ method.
- A queue is referred to as a(n) \_\_\_\_\_ data structure because the first nodes inserted are the first ones removed.
- The reference to the next node in a linked list is referred to as a(n) \_\_\_\_\_.
- Automatically reclaiming dynamically allocated memory in Java is called \_\_\_\_\_.
- A(n) \_\_\_\_\_ is a constrained version of a linked list in which nodes can be inserted only at the end of the list and deleted only from the start of the list.
- A(n) \_\_\_\_\_ is a nonlinear, two-dimensional data structure that contains nodes with two or more links.
- A stack is referred to as a(n) \_\_\_\_\_ data structure because the last node inserted is the first node removed.
- The nodes of a(n) \_\_\_\_\_ tree contain two link members.
- The first node of a tree is the \_\_\_\_\_ node.
- Each link in a tree node refers to a(n) \_\_\_\_\_ or \_\_\_\_\_ of that node.
- A tree node that has no children is called a(n) \_\_\_\_\_ node.
- The three traversal algorithms we mentioned in the text for binary search trees are \_\_\_\_\_, \_\_\_\_\_ and \_\_\_\_\_.

**22.2** What are the differences between a linked list and a stack?

**22.3** What are the differences between a stack and a queue?

**22.4** Comment on how each of the following entities or concepts contributes to the reusability of data structures:

- classes
- inheritance
- composition

**22.5** Provide the inorder, preorder and postorder traversals of the binary search tree of Fig. 22.20.

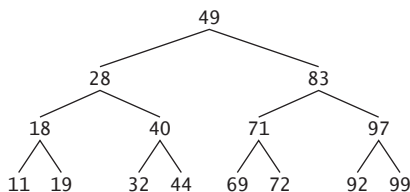

**Fig. 22.20** | Binary search tree with 15 nodes.

## Answers to Self-Review Exercises

**22.1** a) referential. b) stack. c) predicate. d) first-in, first-out (FIFO). e) link. f) garbage collection. g) queue. h) tree i) last-in, first-out (LIFO). j) binary. k) root. l) child or subtree. m) leaf. n) inorder, preorder, postorder.

**22.2** It's possible to insert a node anywhere in a linked list and remove a node from anywhere in a linked list. Nodes in a stack may be inserted only at the top of the stack and removed only from the top.

**22.3** A queue is a FIFO data structure that has references to both its head and its tail, so that nodes may be inserted at the tail and deleted from the head. A stack is a LIFO data structure that has a single reference to the stack's top, where both insertion and deletion of nodes are performed.

**22.4** a) Classes allow us to create as many data structure objects as we wish.  
 b) Inheritance enables a subclass to reuse the functionality from a superclass. Public and protected superclass methods can be accessed through a subclass to eliminate duplicate logic.  
 c) Composition enables a class to reuse code by storing a reference to an instance of another class in a field. Public methods of the instance can be called by methods in the class that contains the reference.

**22.5** The inorder traversal is

11 18 19 28 32 40 44 49 69 71 72 83 92 97 99

The preorder traversal is

49 28 18 11 19 40 32 44 83 71 69 72 97 92 99

The postorder traversal is

11 19 18 32 44 40 28 69 72 71 92 99 97 83 49

## Exercises

**22.6** (*Concatenating Lists*) Write a program that concatenates two linked list objects of characters. Class `ListConcatenate` should include a static method `concatenate` that takes references to both list objects as arguments and concatenates the second list to the first list.

**22.7** (*Inserting into an Ordered List*) Write a program that inserts 25 random integers from 0 to 100 in order into a linked-list object. For this exercise, you'll need to modify the `List<T>` class (Fig. 22.3) to maintain an ordered list. Name the new version of the class `SortedList`.

**22.8** (*Merging Ordered Lists*) Modify the `SortedList` class from Exercise 22.7 to include a merge method that can merge the `SortedList` it receives as an argument with the `SortedList` that calls the method. Write an application to test method `merge`.

**22.9** (*Copying a List Backward*) Write a static method `reverseCopy` that receives a `List<T>` as an argument and returns a copy of that `List<T>` with its elements reversed. Test this method in an application.

**22.10** (*Printing a Sentence in Reverse Using a Stack*) Write a program that inputs a line of text and uses a stack to display the words of the line in reverse order.

**22.11** (*Palindrome Tester*) Write a program that uses a stack to determine whether a string is a palindrome (i.e., the string is spelled identically backward and forward). The program should ignore spaces and punctuation.

**22.12** (*Infix-to-Postfix Converter*) Stacks are used by compilers to help in the process of evaluating expressions and generating machine-language code. In this and the next exercise, we investigate how compilers evaluate arithmetic expressions consisting only of constants, operators and parentheses.

Humans generally write expressions like  $3 + 4$  and  $7 / 9$  in which the operator (+ or / here) is written between its operands—this is called *infix notation*. Computers “prefer” *postfix notation*, in

which the operator is written to the right of its two operands. The preceding infix expressions would appear in postfix notation as  $3\ 4\ +$  and  $7\ 9\ /$ , respectively.

To evaluate a complex infix expression, a compiler would first convert the expression to postfix notation and evaluate the postfix version. Each of these algorithms requires only a single left-to-right pass of the expression. Each algorithm uses a stack object in support of its operation, but each uses the stack for a different purpose.

In this exercise, you'll write a Java version of the infix-to-postfix conversion algorithm. In the next exercise, you'll write a Java version of the postfix expression evaluation algorithm. In a later exercise, you'll discover that code you write in this exercise can help you implement a complete working compiler.

Write class `InfixToPostfixConverter` to convert an ordinary infix arithmetic expression (assume a valid expression is entered) with single-digit integers such as

$$(6 + 2) * 5 - 8 / 4$$

to a postfix expression. The postfix version (no parentheses are needed) of the this infix expression is

$$6\ 2\ +\ 5\ *\ 8\ 4\ /\ -$$

The program should read the expression into `StringBuffer infix` and use one of the stack classes implemented in this chapter to help create the postfix expression in `StringBuffer postfix`. The algorithm for creating a postfix expression is as follows:

- a) Push a left parenthesis '(' onto the stack.
- b) Append a right parenthesis ')' to the end of `infix`.
- c) While the stack is not empty, read `infix` from left to right and do the following:
  - If the current character in `infix` is a digit, append it to `postfix`.
  - If the current character in `infix` is a left parenthesis, push it onto the stack.
  - If the current character in `infix` is an operator:
    - Pop operators (if there are any) at the top of the stack while they have equal or higher precedence than the current operator, and append the popped operators to `postfix`.
    - Push the current character in `infix` onto the stack.
  - If the current character in `infix` is a right parenthesis:
    - Pop operators from the top of the stack and append them to `postfix` until a left parenthesis is at the top of the stack.
    - Pop (and discard) the left parenthesis from the stack.

The following arithmetic operations are allowed in an expression:

- + addition
- subtraction
- \* multiplication
- / division
- ^ exponentiation
- % remainder

The stack should be maintained with stack nodes that each contain an instance variable and a reference to the next stack node. Some methods you may want to provide are as follows:

- a) Method `convertToPostfix`, which converts the infix expression to postfix notation.
- b) Method `isOperator`, which determines whether `c` is an operator.
- c) Method `precedence`, which determines whether the precedence of `operator1` (from the infix expression) is less than, equal to or greater than that of `operator2` (from the stack). The method returns `true` if `operator1` has lower precedence than `operator2`. Otherwise, `false` is returned.
- d) Method `peek` (this should be added to the stack class), which returns the top value of the stack without popping the stack.

**22.13 (Postfix Evaluator)** Write class `PostfixEvaluator` that evaluates a postfix expression such as  
`6 2 + 5 * 8 4 / -`

The program should read a postfix expression consisting of digits and operators into a `StringBuffer`. Using modified versions of the stack methods implemented earlier in this chapter, the program should scan the expression and evaluate it (assume it's valid). The algorithm is as follows:

- a) Append a right parenthesis ')' to the end of the postfix expression. When the right-parenthesis character is encountered, no further processing is necessary.
- b) Until the right parenthesis is encountered, read the expression from left to right.
  - If the current character is a digit, do the following:
    - Push its integer value onto the stack (the integer value of a digit character is its value in the Unicode character set minus the value of '0' in Unicode).
  - Otherwise, if the current character is an *operator*:
    - Pop the two top elements of the stack into variables `x` and `y`.
    - Calculate `y operator x`.
    - Push the result of the calculation onto the stack.
- c) When the right parenthesis is encountered in the expression, pop the top value of the stack. This is the result of the postfix expression.

[*Note:* In b) above (based on the sample expression at the beginning of this exercise), if the operator is '/', the top of the stack is 4 and the next element in the stack is 40, then pop 4 into `x`, pop 40 into `y`, evaluate `40 / 4` and push the result, 10, back on the stack. This note also applies to operator '-'.] The arithmetic operations allowed in an expression are: + (addition), - (subtraction), \* (multiplication), / (division), ^ (exponentiation) and % (remainder).

The stack should be maintained with one of the stack classes introduced in this chapter. You may want to provide the following methods:

- a) Method `evaluatePostfixExpression`, which evaluates the postfix expression.
- b) Method `calculate`, which evaluates the expression `op1 operator op2`.

**22.14 (Postfix Evaluator Modification)** Modify the postfix evaluator program of Exercise 22.13 so that it can process integer operands larger than 9.

**22.15 (Supermarket Simulation)** Write a program that simulates a checkout line at a supermarket. The line is a queue object. Customers (i.e., customer objects) arrive in random integer intervals of from 1 to 4 minutes. Also, each customer is serviced in random integer intervals of from 1 to 4 minutes. Obviously, the rates need to be balanced. If the average arrival rate is larger than the average service rate, the queue will grow infinitely. Even with "balanced" rates, randomness can still cause long lines. Run the supermarket simulation for a 12-hour day (720 minutes), using the following algorithm:

- a) Choose a random integer between 1 and 4 to determine the minute at which the first customer arrives.
- b) At the first customer's arrival time, do the following:
  - Determine customer's service time (random integer from 1 to 4).
  - Begin servicing the customer.
  - Schedule arrival time of next customer (random integer 1 to 4 added to the current time).
- c) For each simulated minute of the day, consider the following:
  - If the next customer arrives, proceed as follows:
    - Say so.
    - Enqueue the customer.
    - Schedule the arrival time of the next customer.
  - If service was completed for the last customer, do the following:
    - Say so.
    - Dequeue next customer to be serviced.
    - Determine customer's service completion time (random integer from 1 to 4 added to the current time).

Now run your simulation for 720 minutes and answer each of the following:

- a) What is the maximum number of customers in the queue at any time?
- b) What is the longest wait any one customer experiences?
- c) What happens if the arrival interval is changed from 1 to 4 minutes to 1 to 3 minutes?

**22.16** (*Allowing Duplicates in a Binary Tree*) Modify Figs. 22.17 and 22.18 to allow the binary tree to contain duplicates.

**22.17** (*Processing a Binary Search Tree of Strings*) Write a program based on the program of Figs. 22.17 and 22.18 that inputs a line of text, tokenizes it into separate words, inserts the words in a binary search tree and prints the inorder, preorder and postorder traversals of the tree.

**22.18** (*Duplicate Elimination*) In this chapter, we saw that duplicate elimination is straightforward when creating a binary search tree. Describe how you'd perform duplicate elimination when using only a one-dimensional array. Compare the performance of array-based duplicate elimination with the performance of binary-search-tree-based duplicate elimination.

**22.19** (*Depth of a Binary Tree*) Modify Figs. 22.17 and 22.18 so the `Tree` class provides a method `getDepth` that determines how many levels are in the tree. Test the method in an application that inserts 20 random integers in a `Tree`.

**22.20** (*Recursively Print a List Backward*) Modify the `List<T>` class of Fig. 22.3 to include method `printListBackward` that recursively outputs the items in a linked-list object in reverse order. Write a test program that creates a list of integers and prints the list in reverse order.

**22.21** (*Recursively Search a List*) Modify the `List<T>` class of Fig. 22.3 to include method `search` that recursively searches a linked-list object for a specified value. The method should return a reference to the value if it's found; otherwise, it should return `null`. Use your method in a test program that creates a list of integers. The program should prompt the user for a value to locate in the list.

**22.22** (*Binary Tree Delete*) In this exercise, we discuss deleting items from binary search trees. The deletion algorithm is not as straightforward as the insertion algorithm. Three cases are encountered when deleting an item—the item is contained in a leaf node (i.e., it has no children), or in a node that has one child or in a node that has two children.

If the item to be deleted is contained in a leaf node, the node is deleted and the reference in the parent node is set to null.

If the item to be deleted is contained in a node with one child, the reference in the parent node is set to reference the child node and the node containing the data item is deleted. This causes the child node to take the place of the deleted node in the tree.

The last case is the most difficult. When a node with two children is deleted, another node in the tree must take its place. However, the reference in the parent node cannot simply be assigned to reference one of the children of the node to be deleted. In most cases, the resulting binary search tree would not embody the following characteristic of binary search trees (with no duplicate values): *The values in any left subtree are less than the value in the parent node, and the values in any right subtree are greater than the value in the parent node.*

Which node is used as a *replacement node* to maintain this characteristic? It's either the node containing the largest value in the tree less than the value in the node being deleted, or the node containing the smallest value in the tree greater than the value in the node being deleted. Let's consider the node with the smaller value. In a binary search tree, the largest value less than a parent's value is located in the left subtree of the parent node and is guaranteed to be contained in the right-most node of the subtree. This node is located by walking down the left subtree to the right until the reference to the right child of the current node is null. We're now referencing the replacement node, which is either a leaf node or a node with one child to its left. If the replacement node is a leaf node, the steps to perform the deletion are as follows:

- a) Store the reference to the node to be deleted in a temporary reference variable.

- b) Set the reference in the parent of the node being deleted to reference the replacement node.
- c) Set the reference in the parent of the replacement node to null.
- d) Set the reference to the right subtree in the replacement node to reference the right subtree of the node to be deleted.
- e) Set the reference to the left subtree in the replacement node to reference the left subtree of the node to be deleted.

The deletion steps for a replacement node with a left child are similar to those for a replacement node with no children, but the algorithm also must move the child into the replacement node's position in the tree. If the replacement node is a node with a left child, the steps to perform the deletion are as follows:

- a) Store the reference to the node to be deleted in a temporary reference variable.
- b) Set the reference in the parent of the node being deleted to refer to the replacement node.
- c) Set the reference in the parent of the replacement node to reference the left child of the replacement node.
- d) Set the reference to the right subtree in the replacement node to reference the right subtree of the node to be deleted.
- e) Set the reference to the left subtree in the replacement node to reference the left subtree of the node to be deleted.

Write method `deleteNode`, which takes as its argument the value to delete. Method `deleteNode` should locate in the tree the node containing the value to delete and use the algorithms discussed here to delete the node. If the value is not found in the tree, the method should display a message saying so. Modify the program of Figs. 22.17 and 22.18 to use this method. After deleting an item, call the methods `inorderTraversal`, `preorderTraversal` and `postorderTraversal` to confirm that the delete operation was performed correctly.

**22.23** (*Binary Tree Search*) Modify class `Tree` of Fig. 22.17 to include method `contains`, which attempts to locate a specified value in a binary-search-tree object. The method should take as an argument a search key to locate. If the node containing the search key is found, the method should return a reference to that node's data; otherwise, it should return null.

**22.24** (*Level-Order Binary Tree Traversal*) The program of Figs. 22.17 and 22.18 illustrated three recursive methods of traversing a binary tree—inorder, preorder and postorder traversals. This exercise presents the *level-order traversal* of a binary tree, in which the node values are printed level by level, starting at the root node level. The nodes on each level are printed from left to right. The level-order traversal is not a recursive algorithm. It uses a queue object to control the output of the nodes. The algorithm is as follows:

- a) Insert the root node in the queue.
- b) While there are nodes left in the queue, do the following:
  - Get the next node in the queue.
  - Print the node's value.
  - If the reference to the left child of the node is not null:
    - Insert the left child node in the queue.
  - If the reference to the right child of the node is not null:
    - Insert the right child node in the queue.

Write method `levelOrder` to perform a level-order traversal of a binary tree object. Modify the program of Figs. 22.17 and 22.18 to use this method. [*Note:* You'll also need to use the queue-processing methods of Fig. 22.13 in this program.]

**22.25** (*Printing Trees*) Modify class `Tree` of Fig. 22.17 to include a recursive `outputTree` method to display a binary tree object. The method should output the tree row by row, with the top of the tree at the left of the screen and the bottom of the tree toward the right. Each row is output vertically. For example, the binary tree illustrated in Fig. 22.20 is output as shown in Fig. 22.21.



The rightmost leaf node appears at the top of the output in the rightmost column and the root node appears at the left of the output. Each column starts five spaces to the right of the preceding column. Method `outputTree` should receive an argument `totalSpaces` representing the number of spaces preceding the value to be output. (This variable should start at zero so that the root node is output at the left of the screen.) The method uses a modified inorder traversal to output the tree—it starts at the rightmost node in the tree and works back to the left. The algorithm is as follows:

```

 99
 97 92
 83 72
 49 71 69
 40 44
 28 32
 19
 18 11

```

**Fig. 22.21** | Sample output of recursive method `outputTree`.

While the reference to the current node is not null, perform the following:

- Recursively call `outputTree` with the right subtree of the current node and `totalSpaces + 5`.
- Use a `for` statement to count from 1 to `totalSpaces` and output spaces.
- Output the value in the current node.
- Set the reference to the current node to refer to the left subtree of the current node.
- Increment `totalSpaces` by 5.

**22.26** (*Insert/Delete Anywhere in a Linked List*) Our linked list class allowed insertions and deletions at only the front and the back of the linked list. These capabilities were convenient for us when we used inheritance or composition to produce a stack class and a queue class with a minimal amount of code simply by reusing the list class. Linked lists are normally more general than those we provided. Modify the linked list class we developed in this chapter to handle insertions and deletions anywhere in the list.

**22.27** (*Lists and Queues without Tail References*) Our linked-list implementation (Fig. 22.3) used both a `firstNode` and a `lastNode`. The `lastNode` was useful for the `insertAtBack` and `removeFromBack` methods of the `List` class. The `insertAtBack` method corresponds to the `enqueue` method of the `Queue` class. Rewrite the `List` class so that it does not use a `lastNode`. Thus, any operations on the tail of a list must begin searching the list from the front. Does this affect our implementation of the `Queue` class (Fig. 22.13)?

**22.28** (*Performance of Binary Tree Sorting and Searching*) One problem with the binary tree sort is that the order in which the data is inserted affects the shape of the tree—for the same collection of data, different orderings can yield binary trees of dramatically different shapes. The performance of the binary tree sorting and searching algorithms is sensitive to the shape of the binary tree. What shape would a binary tree have if its data were inserted in increasing order? in decreasing order? What shape should the tree have to achieve maximal searching performance?

**22.29** (*Indexed Lists*) As presented in the text, linked lists must be searched sequentially. For large lists, this can result in poor performance. A common technique for improving list-searching performance is to create and maintain an index to the list. An index is a set of references to key places in the

list. For example, an application that searches a large list of names could improve performance by creating an index with 26 entries—one for each letter of the alphabet. A search operation for a last name beginning with ‘Y’ would then first search the index to determine where the ‘Y’ entries began, then “jump into” the list at that point and search linearly until the desired name was found. This would be much faster than searching the linked list from the beginning. Use the `List` class of Fig. 22.3 as the basis of an `IndexedList` class. Write a program that demonstrates the operation of indexed lists. Be sure to include methods `insertInIndexedList`, `searchIndexedList` and `deleteFromIndexedList`.

**22.30** (*Queue Class that Inherits from a List Class*) In Section 22.5, we created a stack class from class `List` with inheritance (Fig. 22.10) and with composition (Fig. 22.12). In Section 22.6 we created a queue class from class `List` with composition (Fig. 22.13). Create a queue class by inheriting from class `List`. What are the differences between this class and the one we created with composition?

## Special Section: Building Your Own Compiler

In Exercises 7.35–7.37, we introduced Simpletron Machine Language (SML), and you implemented a Simpletron computer simulator to execute SML programs. In Exercises 22.31–22.35, we build a compiler that converts programs written in a high-level programming language to SML. This section “ties” together the entire programming process. You’ll write programs in this new high-level language, compile them on the compiler you build and run them on the simulator you built in Exercise 7.36. You should make every effort to implement your compiler in an object-oriented manner. [*Note:* Due to the size of the descriptions for Exercises 22.31–22.35, we’ve posted them in a PDF document located at [www.deitel.com/books/jhtp9/](http://www.deitel.com/books/jhtp9/).]

# Applets and Java Web Start

# 23



*Observe due measure, for right timing is in all things the most important factor.*

—Hesiod

*Painting is only a bridge linking the painter's mind with that of the viewer.*

—Eugene Delacroix

*The direction in which education starts a man will determine his future in life.*

—Plato

## Objectives

In this chapter you'll learn:

- What applets are and how they're used in web pages.
- To observe some of Java's exciting capabilities through the JDK's demonstration applets.
- To write simple applets.
- To write a simple HyperText Markup Language (HTML) document to load an applet into an applet container and execute the applet.
- Applet life-cycle methods.
- About the sandbox security model for running downloaded code safely.
- What Java Web Start is and how to use it to download, install and run applets outside of the web browser.

|                                                                              |                                                                               |
|------------------------------------------------------------------------------|-------------------------------------------------------------------------------|
| <b>23.1</b> Introduction                                                     | <b>23.5</b> Initialization with Method <code>init</code>                      |
| <b>23.2</b> Sample Applets Provided with the JDK                             | <b>23.6</b> Sandbox Security Model                                            |
| <b>23.3</b> Simple Java Applet: Drawing a String                             | <b>23.7</b> Java Web Start and the Java Network Launch Protocol (JNLP)        |
| 23.3.1 Executing <code>WelcomeApplet</code> in the <code>appletviewer</code> | 23.7.1 Packaging the <code>DrawTest</code> Applet for Use with Java Web Start |
| 23.3.2 Executing an Applet in a Web Browser                                  | 23.7.2 JNLP Document for the <code>DrawTest</code> Applet                     |
| <b>23.4</b> Applet Life-Cycle Methods                                        | <b>23.8</b> Wrap-Up                                                           |

Summary | Self-Review Exercise | Answers to Self-Review Exercise | Exercises

## 23.1 Introduction

[*Note:* This chapter is intentionally small and simple for readers who wish to study applets after reading only the book's first few chapters. We present more complex applets in Chapter 24, Multimedia: Applets and Applications, and Chapter 27, Networking. Also, the examples in this chapter require some knowledge of HTML to create a web page that loads an applet. With each example we supply sample HTML documents that you can modify for your own purposes.

This chapter introduces **applets**—Java programs that are typically embedded in **HTML (HyperText Markup Language) documents**—also called web pages. When a Java-enabled web browser loads a web page containing an applet, the applet downloads into the browser and executes.

### *Applet Containers*

The application in which an applet executes is known as the **applet container**. It's the applet container's responsibility to load the applet's class(es), create an instance of the applet and manage its life cycle (which we discuss in more detail in Section 23.4). The Java Development Kit (JDK) includes one called the **appletviewer** for testing applets as you develop them and before you embed them in web pages. We demonstrate applets using both the `appletviewer` and web browsers, which execute Java applets via the **Java Plug-In**. Some browsers don't come with the plug-in by default. You can visit [java.com](http://java.com) to determine whether your browser is ready to execute Java applets. If not, you can click the **Free Java Download** button to install Java for your browser. Several popular browsers are supported. We tested our applets in Mozilla's Firefox 3.6, Microsoft's Internet Explorer 8, Google's Chrome, Opera 11 and Apple's Safari 5.

### *Java Web Start and the Java Network Launch Protocol (JNLP)*

This chapter concludes with an introduction to Java Web Start and the Java Network Launch Protocol (JNLP). Together, these enable you to package your applets and applications so that they can be installed onto the user's desktop. As you'll learn in Chapter 24, Java Web Start also enables you to give the user control over whether an applet or application downloaded from the web can have limited access to resources on the local file system. For example, if you create a downloadable text-editor program in Java, users would probably want to store their documents on their own computers.

## 23.2 Sample Applets Provided with the JDK

Before we discuss our own applets, let's consider several demonstration applets provided with the JDK. Each sample applet comes with its source code.

The demonstration programs provided with the JDK are located in a directory called `demo`. For Windows, the default location of the JDK 6.0's `demo` directory is

```
C:\Program Files\Java\jdk1.6.0_##\demo
```

where `_##` represents the JDK update number. On UNIX/Linux, the default location is the directory in which you install the JDK followed by `jdk1.6.0_##/demo`—for example,

```
/usr/local/jdk1.6.0_##/demo
```

Other platforms use a similar directory (or folder) structure. You may need to update the locations specified here to reflect your chosen installation directory and disk drive, or a different version of the JDK. The demonstration programs are also available on JDK 7.

If you're using a Java development tool that does not come with the Java demos, you can download the current JDK from [www.oracle.com/technetwork/java/javase/downloads/index.html](http://www.oracle.com/technetwork/java/javase/downloads/index.html). Mac OS X users should visit [developer.apple.com/java](http://developer.apple.com/java) for information about Java SE 6 on the Mac, or use virtualization software to run the Windows or Linux versions of Java in a virtual machine. Apple recently joined the OpenJDK project ([openjdk.java.net](http://openjdk.java.net)). Eventually a Mac OS X version of the JDK for Java SE 7 will be available from this project's website.

### *Overview of the Demonstration Applets*

Open a command window and use the `cd` command to change directories to the JDK's `demo` directory. The `demo` directory contains several subdirectories. You can list them by issuing the `dir` command on Windows or the `ls` command on UNIX/Linux/Mac OS X. We discuss sample programs in the `applets` and `jfc` subdirectories. The `applets` directory contains demonstration applets. The `jfc` (Java Foundation Classes) directory contains applets and applications that demonstrate Java's powerful graphics and GUI capabilities.

Change to the `applets` directory and list its contents to see the directory names for the demonstration applets. Figure 23.1 provides a brief description of each. If your browser supports Java, you can test an applet by opening the HTML document for it in the applet's directory. We'll demonstrate three of these applets by using the `appletviewer` command in a command window.

| Example  | Description                                                                                                   |
|----------|---------------------------------------------------------------------------------------------------------------|
| Animator | Performs one of four separate animations.                                                                     |
| ArcTest  | Demonstrates drawing arcs. You can interact with the applet to change attributes of the arc that's displayed. |
| BarChart | Draws a simple bar chart.                                                                                     |
| Blink    | Displays blinking text in different colors.                                                                   |
| CardTest | Demonstrates several GUI components and layouts.                                                              |

**Fig. 23.1** | The examples from the `applets` directory. (Part 1 of 2.)

| Example        | Description                                                                                                                                                                                                                                                                                                                                                                   |
|----------------|-------------------------------------------------------------------------------------------------------------------------------------------------------------------------------------------------------------------------------------------------------------------------------------------------------------------------------------------------------------------------------|
| Clock          | Draws a clock with rotating hands, the current date and the current time. The clock updates once per second.                                                                                                                                                                                                                                                                  |
| DitherTest     | Demonstrates drawing with a graphics technique known as <i>dithering</i> that allows gradual transformation from one color to another.                                                                                                                                                                                                                                        |
| DrawTest       | Allows the user to draw lines and points in different colors by dragging the mouse.                                                                                                                                                                                                                                                                                           |
| Fractal        | Draws a fractal. Fractals typically require complex calculations to determine how they're displayed. We discuss fractals in Section 18.8.                                                                                                                                                                                                                                     |
| GraphicsTest   | Draws shapes to illustrate graphics capabilities.                                                                                                                                                                                                                                                                                                                             |
| GraphLayout    | Draws a graph consisting of many nodes (represented as rectangles) connected by lines. Drag a node to see the other nodes in the graph adjust on the screen and demonstrate complex graphical interactions.                                                                                                                                                                   |
| JumpingBox     | Moves a rectangle randomly around the screen. Try to catch it by clicking it with the mouse!                                                                                                                                                                                                                                                                                  |
| MoleculeViewer | Presents a three-dimensional view of several chemical molecules. Drag the mouse to view the molecule from different angles.                                                                                                                                                                                                                                                   |
| NervousText    | Draws text that jumps around the applet.                                                                                                                                                                                                                                                                                                                                      |
| SimpleGraph    | Draws a complex curve.                                                                                                                                                                                                                                                                                                                                                        |
| SortDemo       | Compares three sorting techniques. Sorting (described in Chapter 19) arranges information in order—like alphabetizing words. When you execute this example with the <code>appletviewer</code> , three windows appear. When you execute it in a browser, the three demos appear side by side. Click in each demo to start the sort. The sorts all operate at different speeds. |
| SpreadSheet    | Demonstrates a simple spreadsheet of rows and columns.                                                                                                                                                                                                                                                                                                                        |
| TicTacToe      | Allows the user to play Tic-Tac-Toe against the computer.                                                                                                                                                                                                                                                                                                                     |
| WireFrame      | Draws a three-dimensional shape as a wire frame. Drag the mouse to view the shape from different angles.                                                                                                                                                                                                                                                                      |

**Fig. 23.1** | The examples from the `applets` directory. (Part 2 of 2.)

### *TicTacToe Applet*

This `TicTacToe` demonstration applet allows you to play Tic-Tac-Toe against the computer. Change directories to subdirectory `TicTacToe`, where you'll find the file `example1.html` that loads the applet. In the command window, type the command

```
appletviewer example1.html
```

and press *Enter*. This executes the `appletviewer` applet container, which loads the HTML document `example1.html` specified as its command-line argument. The `appletviewer` determines from the document which applet to load and executes it. Figure 23.2 shows several screen captures of playing Tic-Tac-Toe with this applet. You can open the HTML document in your browser to execute the applet in the browser.

You are player **X**. To interact with the applet, point the mouse at the square where you want to place an **X** and click the mouse button. The applet plays a sound and places an **X**

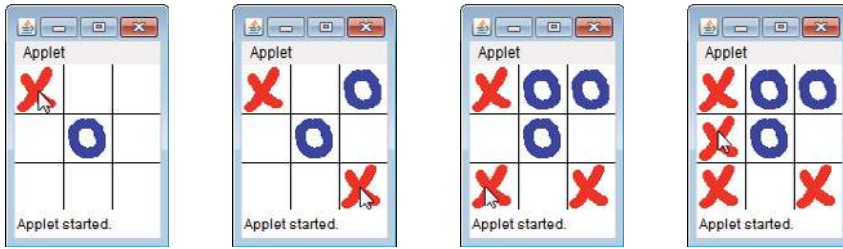

**Fig. 23.2** | TicTacToe applet sample execution.

in the square if it's open. If the square is occupied, this is an invalid move, and the applet plays a different sound, indicating that you cannot make the specified move. After you make a valid move, the applet responds by making its own move.

To play again, click the appletviewer's **Applet** menu and select the **Reload** menu item (Fig. 23.3), or click the applet again when the game is over. To terminate the appletviewer, click the appletviewer's **Applet** menu and select the **Quit** menu item.

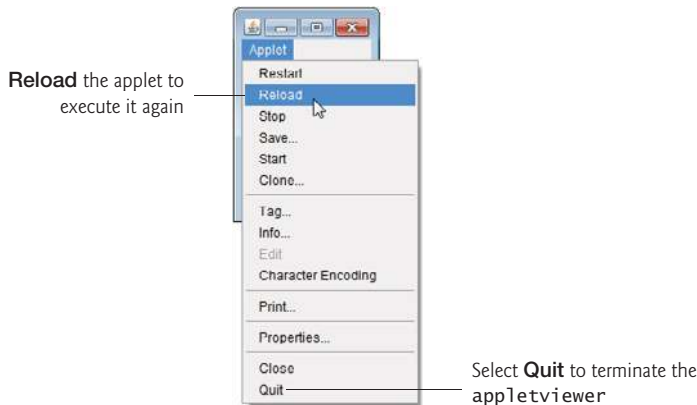

**Fig. 23.3** | Applet menu in the appletviewer.

### *DrawTest Applet*

The DrawTest applet allows you to draw lines and points in different colors. In the command window, change directories to directory `applets`, then to subdirectory `DrawTest`. You can move up the directory tree incrementally toward `demo` by issuing the command `cd ..` in the command window. The DrawTest directory contains the `example1.html` document that's used to execute the applet. In the command window, type the command

```
appletviewer example1.html
```

and press *Enter*. The appletviewer loads `example1.html`, determines from the document which applet to load and executes it. Figure 23.4 shows a screen capture after some lines and points have been drawn.

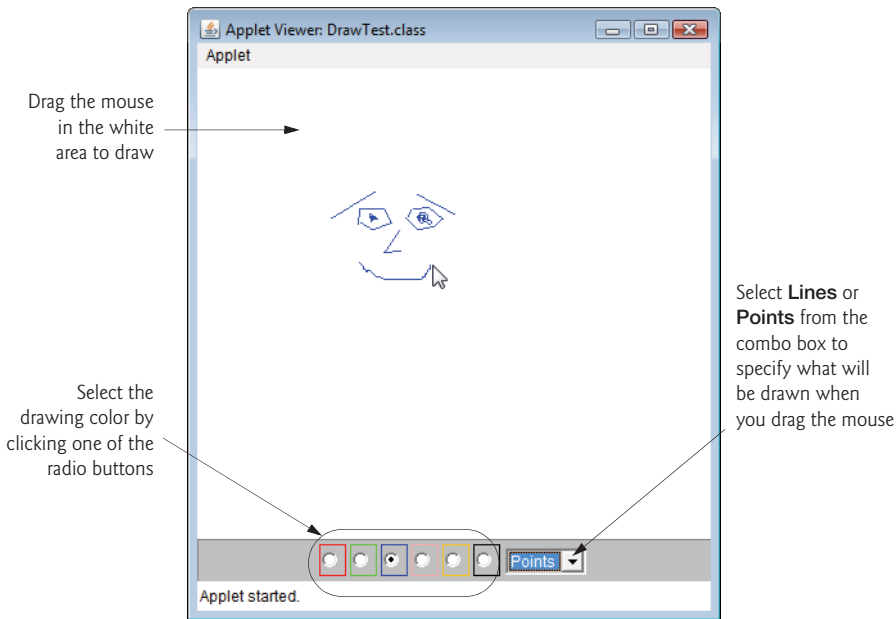

**Fig. 23.4** | DrawTest applet sample execution.

By default the applet allows you to draw black lines by dragging the mouse across the applet. When you drag the mouse, the line's start point always remains in the same place and its endpoint follows the mouse pointer around the applet. The line is not permanent until you release the mouse button.

Select a color by clicking one of the radio buttons at the bottom of the applet. You can select from red, green, blue, pink, orange and black. Change the shape to draw from **Lines** to **Points** by selecting **Points** from the combo box. To start a new drawing, select **Reload** from the appletviewer's **Applet** menu.

### Java2D Applet

The Java2D applet demonstrates many features of the Java 2D API, which we introduced in Chapter 15. This demo can also be found at [java.sun.com/products/java-media/2D/samples/index.html](http://java.sun.com/products/java-media/2D/samples/index.html). Change directories to the `jfc` directory in the JDK's demo directory, then change to the Java2D directory. In the command window, type the command

```
appletviewer Java2Demo.html
```

and press *Enter*. The appletviewer loads `Java2Demo.html`, determines from the document which applet to load and executes it. Figure 23.5 shows a screen capture of one of this applet's many demonstrations of Java's two-dimensional graphics capabilities.

At the top of the applet are tabs that look like file folders in a filing cabinet. This demo provides 12 tabs, each demonstrating Java 2D API features. To change to a different part of the demo, simply click a different tab. Also, try changing the options in the upper-right corner of the applet. Some of these affect the speed with which the applet draws the graphics. For example, click the checkbox to the left of the word **Anti-Aliasing** to turn off



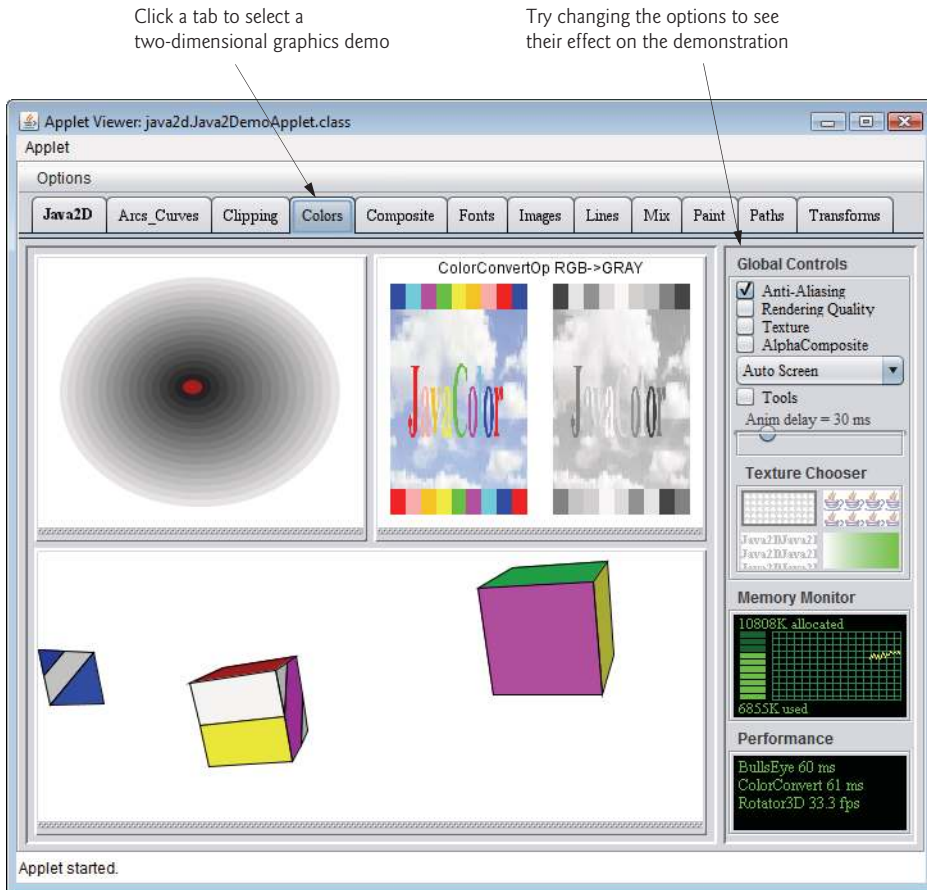

**Fig. 23.5** | Java2D applet sample execution.

*antialiasing* (a graphics technique for producing smoother on-screen graphics in which the edges are blurred). Shapes that are not antialiased are less complex to draw. Accordingly, when the antialiasing feature is turned off, the animation speed increases for the animated shapes at the bottom of the demo (Fig. 23.5).

### 23.3 Simple Java Applet: Drawing a String

Every Java applet is a graphical user interface on which you can place GUI components using the techniques introduced in Chapter 14 or draw using the techniques demonstrated in Chapter 15. In this chapter, we'll demonstrate drawing on an applet. Examples in Chapters 24 and 27 demonstrate building an applet's graphical user interface.

Now let's build an applet of our own. We begin with a simple applet (Fig. 23.6) that draws "Welcome to Java Programming!" on the applet. We show this applet executing in two applet containers—the appletviewer and the Mozilla Firefox web browser. At the end of this section, you'll learn how to execute the applet in a web browser.

```

1 // Fig. 23.6: WelcomeApplet.java
2 // Applet that draws a String.
3 import java.awt.Graphics; // program uses class Graphics
4 import javax.swing.JApplet; // program uses class JApplet
5
6 public class WelcomeApplet extends JApplet
7 {
8 // draw text on applet's background
9 public void paint(Graphics g)
10 {
11 // call superclass version of method paint
12 super.paint(g);
13
14 // draw a String at x-coordinate 25 and y-coordinate 25
15 g.drawString("Welcome to Java Programming!", 25, 25);
16 } // end method paint
17 } // end class WelcomeApplet

```

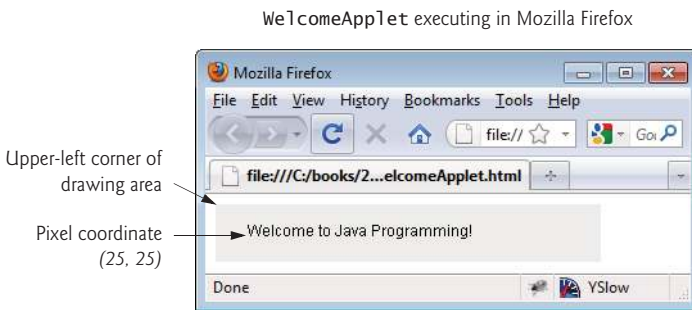
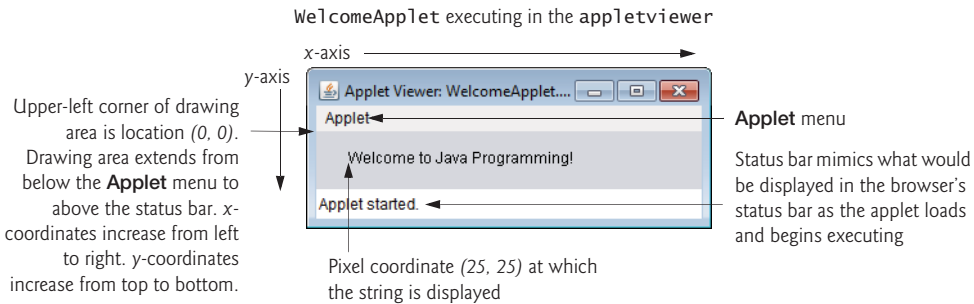

**Fig. 23.6** | Applet that draws a String.

### Creating the Applet Class

Line 3 imports class `Graphics` to enable the applet to draw graphics, such as lines, rectangles, ovals and strings of characters. Class `JApplet` (imported at line 4) from package `javax.swing` is used to create applets. As with applications, every Java applet contains at least one `public` class declaration. An applet container can create only objects of classes that are `public` and extend `JApplet` (or its superclass `Applet`). For this reason, class `WelcomeApplet` (lines 6–17) extends `JApplet`.

An applet container expects every Java applet to have methods named **init**, **start**, **paint**, **stop** and **destroy**, each of which is declared in class `JApplet`. Each new applet class you create inherits default implementations of these methods from class `JApplet`. These methods can be overridden (redefined) to perform tasks that are specific to your applet. Section 23.4 discusses each method in more detail.

When an applet container loads class `WelcomeApplet`, the container creates a `WelcomeApplet` object, then calls its methods `init`, `start` and `paint` in sequence. If you do not declare these methods in your applet, the applet container calls the inherited versions. The superclass methods `init` and `start` have empty bodies, so they do not perform any tasks. The superclass method `paint` does not draw anything on the applet.

You might wonder why it's necessary to inherit methods `init`, `start` and `paint` if their default implementations do not perform tasks. Some applets do not use all three of these methods. However, the applet container does not know that. Thus, it expects every applet to have these methods, so that it can provide a consistent start-up sequence. This is similar to applications' always starting execution with `main`. Inheriting the "default" versions of these methods guarantees that the applet container can execute each applet uniformly. Also, inheriting default implementations of these methods allows you to concentrate on defining only the methods required for a particular applet.

### *Overriding Method `paint` for Drawing*

To enable our applet to draw, class `WelcomeApplet` overrides method `paint` (lines 9–16) by placing statements in the body of `paint` that draw a message on the screen. Method `paint` receives a parameter of type `Graphics` (called `g` by convention), which is used to draw graphics on the applet. You do not call method `paint` explicitly in an applet. Rather, the applet container calls `paint` to tell the applet when to draw, and the applet container is responsible for passing a `Graphics` object as an argument.

Line 12 calls the superclass version of method `paint` that was inherited from `JApplet`. This should be the first statement in every applet's `paint` method. Omitting it can cause subtle drawing errors in applets that combine drawing and GUI components.

Line 15 uses `Graphics` method `drawString` to draw `Welcome to Java Programming!` on the applet. The method receives as arguments the `String` to draw and the  $x$ - $y$  coordinates at which the bottom-left corner of the `String` should appear in the drawing area. When line 15 executes, it draws the `String` on the applet at the coordinates 25 and 25.

### 23.3.1 Executing `WelcomeApplet` in the `appletviewer`

After creating class `WelcomeApplet` and saving it in the file `WelcomeApplet.java`, open a command window, change to the directory in which you saved the applet class declaration and compile class `WelcomeApplet`.

Recall that applets are embedded in web pages for execution in an applet container (`appletviewer` or a browser). Before you can execute the applet, you must create an HTML document that specifies which applet to execute in the applet container. Typically, an HTML document ends with an `.html` or `.htm` file-name extension. Figure 23.7 shows a simple HTML document—`WelcomeApplet.html`—that loads the applet defined in Fig. 23.6 into an applet container.

Most HTML elements are delimited by pairs of **tags**—e.g., lines 1 and 6 delimit the HTML document's beginning and end, respectively. Each tag is enclosed in angle brackets

```

1 <html>
2 <body>
3 <applet code = "WelcomeApplet.class" width = "300" height = "45">
4 </applet>
5 </body>
6 </html>

```

**Fig. 23.7** | WelcomeApplet.html loads WelcomeApplet (Fig. 23.6) into an applet container.

(< and >). Lines 2–5 specify the **body element** element of the document—this represents the elements that will be displayed in the web page. Lines 3–4 specify an **applet element** that tells the applet container to load a specific applet and defines the size of its display area (its width and height in pixels) in the applet container.

The applet and its corresponding HTML document are normally stored in the same directory on disk. Typically, a browser loads an HTML document from a computer (other than your own) connected to the Internet. However, HTML documents also can reside on your computer (as in Section 23.2). When an applet container encounters an applet element in an HTML document, it loads the applet's .class file (or files) from the same location that contains the HTML document.

The applet element has several **attributes**. The first attribute in line 3, code = "WelcomeApplet.class", indicates that the file WelcomeApplet.class contains the compiled applet class. The second and third attributes in line 3 indicate the **width** (300) and the **height** (45) of the applet in pixels. The </applet> tag (line 4) terminates the applet element that began at line 2. The </html> tag (line 6) terminates the HTML document.



### Common Programming Error 23.1

*Forgetting the ending </applet> tag prevents the applet from executing in some applet containers. The appletviewer terminates without indicating an error. Some web browsers simply ignore the incomplete applet element.*



### Error-Prevention Tip 23.1

*If you receive a MissingResourceException error message when loading an applet into the appletviewer or a browser, check the <applet> tag in the HTML document carefully for syntax errors, such as commas (,) between the attributes.*

The appletviewer understands only the <applet> and </applet> HTML tags and ignores all other tags in the document. The appletviewer is an ideal place to test an applet and ensure that it executes properly. Once the applet's execution is verified, you can add its HTML tags to a web page that others can view in their web browsers.

To execute WelcomeApplet in the appletviewer, open a command window, change to the directory containing your applet and HTML document, then type

```
appletviewer WelcomeApplet.html
```



### Error-Prevention Tip 23.2

*Test your applets in the appletviewer before executing them in a web browser. Browsers often save a copy of an applet in memory until all the browser's windows are closed. If you change an applet, recompile it, then reload it in your browser, the browser may still execute the original version of the applet.*



### Error-Prevention Tip 23.3

*Test your applets in every web browser in which they'll execute to ensure that they operate correctly.*

## 23.3.2 Executing an Applet in a Web Browser

The sample program executions in Fig. 23.6 demonstrate `WelcomeApplet` executing in the `appletviewer` and in the Mozilla Firefox web browser. To execute an applet in Firefox, perform the following steps:

1. Select **Open File...** from the **File** menu.
2. In the dialog box that appears, locate the directory containing the HTML document for the applet you wish to execute.
3. Select the HTML document.
4. Click the **Open** button.

The steps for executing applets in other web browsers are similar. In most browsers, you can simply type `<Ctrl> O` to open a dialog that enables you to select an HTML document from your local computer.



### Error-Prevention Tip 23.4

*If your applet executes in the `appletviewer` but not in your web browser, Java may not be installed and configured for your browser. In this case, visit the website [java.com](http://java.com) and click the **Free Java Download** button to install Java for your browser.*

## 23.4 Applet Life-Cycle Methods

Now that you've created an applet, let's consider the five applet methods that are called by the applet container from the time the applet is loaded into the browser to the time it's terminated by the browser. These methods correspond to various aspects of an applet's life cycle. Figure 23.8 lists these methods, which are inherited into your applet classes from class `JApplet`. The table specifies when each method gets called and explains its purpose. Other than method `paint`, these methods have empty bodies by default. If you'd like to declare any of them in your applets and have the applet container call them, you must use the method headers shown in Fig. 23.8.

| Method                          | Description                                                                                                                                                                                                                                                                                                      |
|---------------------------------|------------------------------------------------------------------------------------------------------------------------------------------------------------------------------------------------------------------------------------------------------------------------------------------------------------------|
| <code>public void init()</code> | Called <i>once</i> by the applet container when an applet is loaded for execution. This method initializes an applet. Typical actions performed here are initializing fields, creating GUI components, loading sounds to play, loading images to display (see Chapter 24) and creating threads (see Chapter 26). |

**Fig. 23.8** | `JApplet` life-cycle methods that are called by an applet container during an applet's execution. (Part 1 of 2.)

| Method                                       | Description                                                                                                                                                                                                                                                                                                                                                                                                                                                                                                    |
|----------------------------------------------|----------------------------------------------------------------------------------------------------------------------------------------------------------------------------------------------------------------------------------------------------------------------------------------------------------------------------------------------------------------------------------------------------------------------------------------------------------------------------------------------------------------|
| <code>public void start()</code>             | Called by the applet container after method <code>init</code> completes execution. In addition, if the user browses to another website and later returns to the applet's HTML page, method <code>start</code> is called again. The method performs any tasks that must be completed when the applet is loaded for the first time and that must be performed every time the applet's HTML page is revisited. Actions performed here might include starting an animation or starting other threads of execution. |
| <code>public void paint( Graphics g )</code> | Called by the applet container after methods <code>init</code> and <code>start</code> . Method <code>paint</code> is also called when the applet needs to be repainted. For example, if the user covers the applet with another open window on the screen and later uncovers it, the <code>paint</code> method is called. Typical actions performed here involve drawing with the <code>Graphics</code> object <code>g</code> that's passed to the <code>paint</code> method by the applet container.          |
| <code>public void stop()</code>              | This method is called by the applet container when the user leaves the applet's web page by browsing to another web page. Since it's possible that the user might return to the web page containing the applet, method <code>stop</code> performs tasks that might be required to suspend the applet's execution, so that the applet does not use computer processing time when it's not displayed on the screen. Typical actions performed here would stop the execution of animations and threads.           |
| <code>public void destroy()</code>           | This method is called by the applet container when the applet is being removed from memory. This occurs when the user exits the browsing session by closing all the browser windows and may also occur at the browser's discretion when the user has browsed to other web pages. The method performs any tasks that are required to clean up resources allocated to the applet.                                                                                                                                |

**Fig. 23.8** | JApplet life-cycle methods that are called by an applet container during an applet's execution. (Part 2 of 2.)



### Common Programming Error 23.2

*Declaring methods `init`, `start`, `paint`, `stop` or `destroy` with method headers that differ from those shown in Fig. 23.8 results in methods that will not be called by the applet container. The code specified in your versions of the methods will not execute. The `@Override` annotation can be applied to each method to prevent this problem.*

## 23.5 Initialization with Method `init`

Our next applet (Fig. 23.9) computes the sum of two values entered into input dialogs by the user and displays the result by drawing a `String` inside a rectangle on the applet. The sum is stored in an instance variable of the `AdditionApplet` class, so it can be used in both the `init` method and the `paint` method. The HTML document that you can use to load this applet into an applet container (i.e., the `appletviewer` or a web browser) is shown in Fig. 23.10.

```

1 // Fig. 23.9: AdditionApplet.java
2 // Applet that adds two double values entered via input dialogs.
3 import java.awt.Graphics; // program uses class Graphics
4 import javax.swing.JApplet; // program uses class JApplet
5 import javax.swing.JOptionPane; // program uses class JOptionPane
6
7 public class AdditionApplet extends JApplet
8 {
9 private double sum; // sum of values entered by user
10
11 // initialize applet by obtaining values from user
12 public void init()
13 {
14 // obtain first number from user
15 String firstNumber = JOptionPane.showInputDialog(
16 "Enter first floating-point value");
17
18 // obtain second number from user
19 String secondNumber = JOptionPane.showInputDialog(
20 "Enter second floating-point value");
21
22 // convert numbers from type String to type double
23 double number1 = Double.parseDouble(firstNumber);
24 double number2 = Double.parseDouble(secondNumber);
25
26 sum = number1 + number2; // add numbers
27 } // end method init
28
29 // draw results in a rectangle on applet's background
30 public void paint(Graphics g)
31 {
32 super.paint(g); // call superclass version of method paint
33
34 // draw rectangle starting from (15, 10) that is 270
35 // pixels wide and 20 pixels tall
36 g.drawRect(15, 10, 270, 20);
37
38 // draw results as a String at (25, 25)
39 g.drawString("The sum is " + sum, 25, 25);
40 } // end method paint
41 } // end class AdditionApplet

```



**Fig. 23.9** | Applet that adds two double values entered via input dialogs. (Part I of 2.)

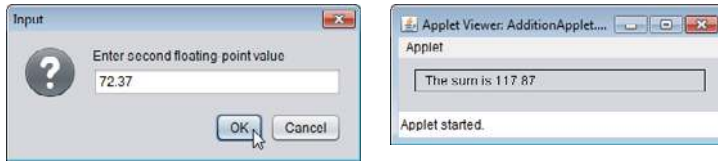

**Fig. 23.9** | Applet that adds two double values entered via input dialogs. (Part 2 of 2.)

```

1 <html>
2 <body>
3 <applet code = "AdditionApplet.class" width = "300" height = "50">
4 </applet>
5 </body>
6 </html>

```

**Fig. 23.10** | AdditionApplet.html loads class AdditionApplet of Fig. 23.9 into an applet container.

The applet requests that the user enter two floating-point numbers. In Fig. 23.9, line 9 declares instance variable `sum` of type `double`. The applet contains two methods—`init` (lines 12–27) and `paint` (lines 30–40). When an applet container loads this applet, the container creates an instance of class `AdditionApplet` and calls its `init` method—this occurs only *once* during an applet’s execution. Method `init` normally initializes the applet’s fields (if they need to be initialized to values other than their defaults) and performs other tasks that should occur only once when the applet begins execution. The first line of `init` always appears as shown in line 12, which indicates that `init` is a public method that receives no arguments and returns no information when it completes.

Lines 15–24 declare variables to store the values entered by the user, obtain the user input and convert the `Strings` entered by the user to `double` values. Line 26 adds the values stored in variables `number1` and `number2`, and assigns the result to instance variable `sum`. At this point, the applet’s `init` method returns program control to the applet container, which then calls the applet’s `start` method. We did not declare `start` in this applet, so the one inherited from class `JApplet` is called here.

Next, the applet container calls the applet’s `paint` method, which draws a rectangle (line 36) where the addition result will appear. Line 39 calls the `Graphics` object’s `drawString` method to display the results. The statement concatenates the value of instance variable `sum` to the `String` "The sum is " and displays the concatenated `String`.



### Software Engineering Observation 23.1

*The only statements that should be placed in an applet’s `init` method are those that should execute only once when the applet is initialized.*

## 23.6 Sandbox Security Model

For security reasons, it’s generally considered dangerous to allow applets or any other program that you execute from a web browser to access your local computer. So, you must



decide whether *you trust the source*. For example, if you choose to download a new version of the Firefox web browser from Mozilla's `firefox.com` website, you must decide whether you trust Mozilla. After all, their installer program is going to modify your system and place the files to execute Firefox on your computer. Once it's installed, Firefox will be able to access files and other local resources. Most of what you do with your web browsers—such as shopping, browsing the web and downloading software—requires you to trust the sites you visit and to trust the organizations that maintain those sites. If you're not careful, a malicious downloaded program could gain control of your computer, access personal information stored there, corrupt your data and possibly even be used to attack other computers on the Internet—as so often happens with computer viruses today.

### *Preventing Malicious Applets*

Applets are typically downloaded from the Internet. What would happen if you downloaded a malicious applet? Consider the fact that a browser downloads and executes a Java applet automatically—the user *is not asked for approval*. In fact, an applet typically downloads *without the user's knowledge*—it's just another element of the web page the user happens to be visiting.

The designers of Java considered this issue thoroughly, since Java was intended for use in networked environments. To combat malicious code, the Java platform uses a so-called **sandbox security model** that provides a mechanism for executing downloaded code safely. Such code executes in the “sandbox” and is not allowed to “play outside the sandbox.” *By default, downloaded code cannot access local system resources, and an applet can interact only with the server from which the applet was downloaded.*

### *Digitally Signed Applets*

Unfortunately, executing in a sandbox makes it difficult for applets to perform useful tasks. It's possible, however, for an organization that wishes to create applets with access to the local system to obtain a security certificate (also called a digital certificate) from one of several certificate authorities (see [en.wikipedia.org/wiki/Certificate\\_Authority](http://en.wikipedia.org/wiki/Certificate_Authority) for a list of authorities and more information about certificate authorities). The organization can then use tools provided with the JDK to *digitally sign* an applet that requires access to local system resources. When a user downloads a digitally signed applet, a dialog prompts the user asking whether he or she trusts the applet's source. In that dialog, the user can view the organization's security certificate and see which certificate authority issued it. If the user indicates that he/she trusts the source, only then will the applet be able to access to the local computer's resources.

In the next section, we introduce Java Web Start and the Java Network Launch Protocol (JNLP). These technologies enable applets or applications to interact with the user to request access to specific local system resources. With the user's permission, this enables Java programmers to *extend the sandbox*, but it does *not* give their programs access to all of the user's local resources—so the sandbox principles are still in effect. For example, it would be useful for a downloadable text editor program to store the user's files in a folder on the user's computer. The text editor can prompt the user to ask for permission to do this. If the user grants permission for a specific directory on disk, the program can then access *only* that local directory and its subdirectories.

For more information on digitally signed applets, visit [java.sun.com/developer/onlineTraining/Programming/JDCBook/signed.html](http://java.sun.com/developer/onlineTraining/Programming/JDCBook/signed.html). For information on the Java Plat-

form security model, visit [download.oracle.com/javase/6/docs/technotes/guides/security/](http://download.oracle.com/javase/6/docs/technotes/guides/security/).

## 23.7 Java Web Start and the Java Network Launch Protocol (JNLP)

**Java Web Start** is a framework for running downloaded applets and applications outside the browser. Typically, such programs are stored on a web server for access via the Internet, but they can also be stored on an organization's network for internal distribution, or even on CDs, DVDs or other media. As you'll learn in Chapter 24, Java Web Start enables you to ask the user if a downloaded program can have access to the resources of the user's computer.

### *Java Web Start Features*

Some key Java Web Start features include:

- **Desktop integration:** Users can launch robust applets and applications by clicking a hyperlink in a web page, and can quickly and easily install the programs on their computers. *Java Web Start can be configured to ask the user if a desktop icon should be created so the user can launch the program directly from the desktop.* Downloaded programs can also have an “offline mode” for execution when the computer is not connected to the Internet.
- **Automatic updating:** When you execute a program via Java Web Start, the program is downloaded and cached (stored) on the user's computer. The next time the user executes that program, Java Web Start launches it from the cache. If the program has been updated since it was last launched, Java Web Start can automatically download the updates, so a user always has the most up-to-date version. This makes installing and updating software simple and seamless to the user.
- **Draggable applets:** With a small change to the applet element that invokes an applet from an HTML document, you can allow users to execute an applet in its own window by holding the *Alt* key and dragging the applet out of the web browser. The applet continues to execute even after the web browser closes.

### *Java Network Launch Protocol (JNLP)*

A **Java Network Launch Protocol (JNLP)** document provides the information that Java Web Start needs in order to download and run a program. Also, you must package your program in one or more *Java archive (JAR) files* that contain the program's code and resources (e.g., images, media files, text files).

By default, programs launched via Java Web Start execute using the sandbox security model. If the user gives permission, such programs *can* access the local file system, the clipboard and other services via the JNLP APIs of package `javax.jnlp`. We discuss some of these features in Chapter 24. *Digitally signed programs can gain greater access to the local system if the user trusts the source.*

#### 23.7.1 Packaging the DrawTest Applet for Use with Java Web Start

Let's package the JDK's DrawTest demonstration applet (discussed in Section 23.2) so that you can execute it via Java Web Start. To do so, you must first wrap the applet's `.class` files and the resources it uses (if any) into a Java archive (JAR) file. In a command

window, change to the DrawTest directory, as you did in Section 23.2. Once in that folder, execute the following command:

```
jar cvf DrawTest.jar *.class
```

which creates in the current directory a JAR file named DrawTest.jar containing the applet's .class files—DrawControls.class, DrawPanel.class and DrawTest.class. If the program had other resources, you'd simply add the file names or the folder names in which those resources are stored to the end of the preceding command. The letters cvf are command-line options to the **jar command**. The **c option** indicates that the command should create a new JAR file. The **v option** indicates that the command should produce verbose output so you can see the list of files and directories being included in the JAR file. The **f option** indicates that the next argument in the command line (DrawTest.jar) is the new JAR file's name. Figure 23.11 shows the preceding command's verbose output, which shows the files that were placed into the JAR.

```
added manifest
adding: DrawControls.class(in = 2611) (out= 1488)(deflated 43%)
adding: DrawPanel.class(in = 2703) (out= 1406)(deflated 47%)
adding: DrawTest.class(in = 1170) (out= 706)(deflated 39%)
```

**Fig. 23.11** | Output of the jar command.

### 23.7.2 JNLP Document for the DrawTest Applet

Next, you must create a JNLP document that describes the contents of the JAR file and specifies which file in the JAR is the so-called **main-class** that begins the program's execution. For an applet, the **main-class** is the one that extends JApplet (i.e., DrawTest in this example). For an application, the **main-class** is the one that contains the **main** method. A basic JNLP document for the DrawTest applet is shown in Fig. 23.12. We describe this document's elements momentarily.

```

1 <?xml version="1.0" encoding="UTF-8"?>
2 <jnlp
3 codebase=PathToJNLPFile
4 href="DrawTest.jnlp">
5
6 <information>
7 <title>DrawTest Applet</title>
8 <vendor>Oracle Corporation</vendor>
9 <shortcut>
10 <desktop/>
11 </shortcut>
12 <offline-allowed/>
13 </information>
14
15 <resources>
16 <java version="1.6+"/>
17 <jar href="DrawTest.jar" main="true"/>
18 </resources>
```

**Fig. 23.12** | DrawTest.jnlp document for launching the DrawTest applet. (Part 1 of 2.)

```

19
20 <applet-desc
21 name="DrawTest"
22 main-class="DrawTest"
23 width="400"
24 height="400">
25 </applet-desc>
26 </jnlp>

```

**Fig. 23.12** | DrawTest.jnlp document for launching the DrawTest applet. (Part 2 of 2.)

### Overview of XML

JNLP documents are written in **Extensible Markup Language (XML)**—a widely supported standard for describing data. XML is commonly used to exchange data between applications over the Internet, and many applications now use XML to specify configuration information as well—as is the case with JNLP documents for Java Web Start. XML permits you to create markup for virtually any type of information. This enables you to create entirely new markup languages for describing any type of data, such as mathematical formulas, software-configuration instructions, chemical molecular structures, music, news, recipes and financial reports. XML describes data in a way that both humans and computers can understand. JNLP is a so-called XML vocabulary that describes the information Java Web Start needs to launch a program.

XML documents contain **elements** that specify the document's structure, such as `title` (line 7), and text that represents content (i.e., data), such as `DrawTest Applet` (line 7). XML documents delimit elements with **start tags** and **end tags**. A start tag consists of the element name in **angle brackets** (e.g., `<title>` and `<vendor>` in lines 7 and 8). Start tags may also contain attributes of the form `name=value`—for example, the `jnlp` start tag contains the attribute `href="DrawTest.jnlp"`. An end tag consists of the element name preceded by a **forward slash (/)** in angle brackets (e.g., `</title>` and `</vendor>` in lines 7 and 8). An element's start and end tags enclose text that represents a piece of data (e.g., the vendor of the program—Oracle Corporation—in line 8, which is enclosed by the `<vendor>` start tag and `</vendor>` end tag) or other elements (e.g., the `title`, `vendor`, `shortcut` and `offline-allowed` elements in the `information` element of lines 6–13). Every XML document must have exactly one **root element** that contains all the other elements. In Fig. 23.12, the **jnlp element** (lines 2–26) is the root element.

### JNLP Document: jnlp Element

The `jnlp` element's start tag (lines 2–4) has two attributes—`codebase` and `href`. The `codebase` attribute's value is a URL that specifies the path where the JNLP document and the JAR file are stored—this is specified in Fig. 23.12 as `PathToJNLPFile`, since this value depends on the location from which the applet is loaded. The `href` attribute specifies the JNLP file that launches the program. We saved the JNLP file and the JAR file in the `DrawTest` demonstration applet's directory within the JDK's directory structure. We used the following local file system URL as the `codebase`:

```
file:.
```

which indicates that the code is in the current directory (`.`). Typically, the `codebase` references a directory on a web server with an `http://` URL. If you'd like to serve your applet

or application from a web server so users can access it online, you'll need to configure your web server correctly, as described at [java.sun.com/javase/6/docs/technotes/guides/javaws/developersguide/setup.html](http://java.sun.com/javase/6/docs/technotes/guides/javaws/developersguide/setup.html).

#### *JNLP Document: information Element*

The **information element** (lines 6–13) provides details about the program. The **title element** specifies a title for the program. The **vendor element** specifies who created the program. The values of these elements appear in Java Web Start's security warnings and errors that are presented to the user. The **title**'s value also appears in the title bar of the window in which the program executes.

The **desktop element** that's nested in the **shortcut element** (lines 9–11) tells Java Web Start to ask whether the user wishes to install a desktop shortcut. If the user accepts, an icon will appear on the desktop. The user can then launch the program in its own window by double-clicking the desktop icon. Note the syntax of the `<desktop/>` element—a so-called empty XML element. When nothing appears between an element's start and end tags, the element can be written using one tag that ends with `/>`.

The **offline-allowed element** (line 12) indicates that once the program is installed on the user's computer, it can be launched via Java Web Start—even when the computer is not connected to the Internet. This is particularly useful for any program that can be used with files stored on the user's computer.

#### *JNLP Document: resources Element*

The **resources element** (lines 15–18) contains two nested elements. The **java element** lists the minimum version of Java required to execute the program (line 16) and the **jar element** (line 17) specifies the location of the JAR file that contains the program and whether that JAR file contains the class that launches the program. There can be multiple jar elements, as you'll see in the next chapter.

#### *JNLP Document: applet-desc Element*

The **applet-desc element** (lines 20–25) is similar to the `applet` element in HTML. The `name` attribute specifies the applet's name. The `main-class` attribute specifies the main applet class (the one that extends `JApplet`). The `width` and `height` attributes specify the width and height in pixels, respectively, of the window in which the applet will execute. Chapter 24 discusses a similar element for applications—`application-desc`.

#### *Launching the Applet with Java Web Start*

You're now ready to launch the applet via Java Web Start. There are several ways to do this. You can use the **javaws command** in a command window from the folder that contains the JNLP document, as in

```
javaws DrawTest.jnlp
```

You can also use your operating system's file manager to locate the JNLP on your computer and double click its file name. Normally, the JNLP file is referenced from a web page via a hyperlink. The `DrawTestWebPage.html` document in Fig. 23.13 (which was saved in the same directory as the JNLP file) contains an anchor (`a`) element (line 4), which links to the `DrawTest.jnlp` file. Clicking this hyperlink in the web page downloads the JNLP file (in this case, it's loaded from the local file system) and executes the corresponding applet.

```

1 <html>
2 <head><title>DrawTest Launcher Page</title></head>
3 <body>
4 Launch DrawTest via Java Web Start
5 </body>
6 </html>

```



**Fig. 23.13** | HTML document that launches the DrawTest applet when the user clicks the link.

When you run the applet via Java Web Start the first time, you'll be presented with the dialog in Fig. 23.14. This dialog enables the user to decide if a desktop icon will be installed. If the user clicks **OK**, a new icon labeled with the title specified in the JNLP document appears on the user's desktop. The applet is also cached for future use. After the user clicks **OK** or **Skip** in this dialog, the program executes (Fig. 23.15).

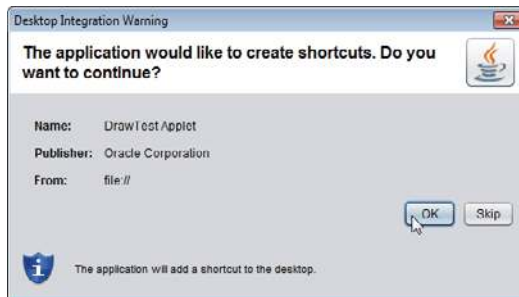

**Fig. 23.14** | Dialog asking whether the user wishes to install a desktop shortcut.

### *Viewing the Installed Java Web Start Programs*

You can view the installed Java Web Start programs in the **Java Cache Viewer** by typing the following command in a command window:

```
javaws -viewer
```

This displays the window in Fig. 23.16. The **Java Cache Viewer** enables you to manage the Java Web Start programs on your system. You can run a selected program, create a desktop shortcut for a program (if there isn't one already), delete installed programs, and more.

For more information on Java Web Start, visit [download.oracle.com/javase/6/docs/technotes/guides/javaws/](http://download.oracle.com/javase/6/docs/technotes/guides/javaws/). This site provides an overview of Java Web Start and includes links to the Developer's Guide, an FAQ, the JNLP Specification and the API documentation for the `javaws.jnlp` package.

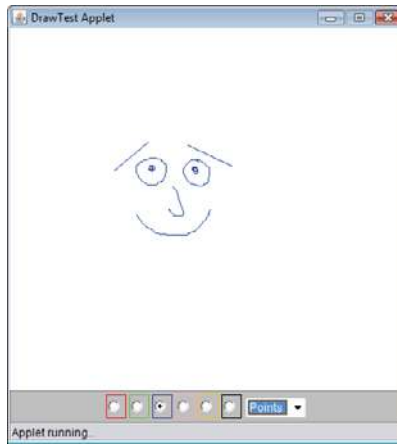

**Fig. 23.15** | DrawTest applet running with Java Web Start.

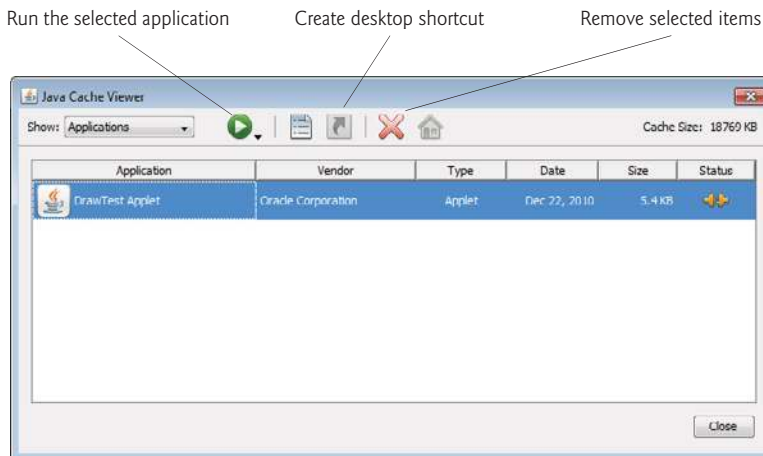

**Fig. 23.16** | Viewing installed Java Web Start programs in the **Java Cache Viewer**.

## 23.8 Wrap-Up

In this chapter, you learned the fundamentals of Java applets and Java Web Start. You learned HTML concepts for embedding an applet in a web page and executing it in an applet container such as the `appletviewer` or a web browser. You learned the five methods that are called automatically by the applet container during an applet's life cycle. We discussed Java's sandbox security model for executing downloaded code. Then we introduced Java Web Start and the Java Network Launch Protocol (JNLP). You packaged a program into a JAR file so that it could be executed via Java Web Start. We also discussed the basic elements of a JNLP document. Next, you'll see additional applets as we present basic multimedia capabilities. You'll also learn more features of Java Web Start and JNLP.

## Summary

### Section 23.1 Introduction

- Applets (p. 942) are Java programs that are typically embedded in HTML (Extensible HyperText Markup Language) documents—also called web pages. When a Java-enabled web browser loads a web page containing an applet, the applet downloads into the browser and executes.
- The application in which an applet executes is known as the applet container (p. 942). It's the applet container's responsibility to load the applet's class(es), create an instance of the applet and manage its life cycle. The JDK includes an applet container called the `appletviewer` (p. 942) for testing applets as you develop them and before you embed them in web pages.
- Web browsers execute Java applets via the Java Plug-In (p. 942).

### Section 23.2 Sample Applets Provided with the JDK

- To re-execute an applet in the `appletviewer`, click the `appletviewer`'s **Applet** menu and select the **Reload** menu item.
- To terminate the `appletviewer`, select **Quit** from the `appletviewer`'s **Applet** menu.

### Section 23.3 Simple Java Applet: Drawing a String

- Every Java applet is a graphical user interface on which you can place GUI components or draw.
- Class `JApplet` (p. 948) from package `javax.swing` is used to create applets.
- An applet container can create only objects of classes that are `public` and extend `JApplet` (or the `Applet` class from early versions of Java).
- An applet container expects every Java applet to have methods named `init`, `start`, `paint`, `stop` and `destroy` (p. 949), each of which is declared in class `JApplet`. Each new applet class you create inherits default implementations of these methods from class `JApplet`.
- When an applet container loads an applet, it creates an object of the applet's type, then calls the applet's `init`, `start` and `paint` methods.
- To enable an applet to draw, override its `paint` method (p. 949). The applet container calls `paint` to tell the applet when to draw.
- The first statement in method `paint` should be a call to the superclass method `paint`.
- Before you can execute an applet, you must create an HTML (Extensible HyperText Markup Language) document that specifies which applet to execute in the applet container. Typically, an HTML document ends with an `.html` or `.htm` file-name extension.
- An `applet` element tells the applet container to load a specific applet and defines the size of its display area (its width and height in pixels) in the applet container.
- Normally, an applet and its corresponding HTML document are stored in the same directory.
- When an applet container encounters an HTML document that contains an applet, the container automatically loads the applet's `.class` file(s) from the same location as the HTML document.
- The `appletviewer` understands only the `<applet>` and `</applet>` HTML tags (p. 950) and ignores all other tags in the document.

### Section 23.4 Applet Life-Cycle Methods

- Method `init` (p. 949) is called once by the applet container to initialize an applet when it's loaded.
- Method `start` (p. 949) is called by the applet container after method `init` completes execution. In addition, if the user browses to another website and later returns to the applet's HTML page, method `start` is called again.
- Method `paint` is called by the applet container after methods `init` and `start`.



- Method `stop` (p. 949) is called by the applet container when the user leaves the applet's web page by browsing to another web page.
- Method `destroy` (p. 949) is called by the applet container when the applet is being removed from memory. This occurs when the user exits the browsing session by closing all the browser windows and may also occur at the browser's discretion when the user has browsed to other web pages.

### *Section 23.5 Initialization with Method `init`*

- Graphics method `drawString` draws a `String` at a specified location.
- Graphics method `drawRect` draws a rectangle at the specified upper-left corner, width and height.

### *Section 23.6 Sandbox Security Model*

- A browser downloads an applet *without the user's knowledge*—it's just another element of the web page the user happens to be visiting.
- To combat malicious code, the Java platform uses a sandbox security model (p. 955) that provides a mechanism for executing downloaded code safely. Downloaded code cannot access local system resources, and an applet can interact only with the server from which it was downloaded.
- You can “digitally sign” an applet that requires access to local system resources. If the user indicates that he/she trusts the applet's source, only then will the applet be able to access the local computer's resources.

### *Section 23.7 Java Web Start and the Java Network Launch Protocol (JNLP)*

- Java Web Start (p. 956) is a framework for running downloaded programs outside the browser.
- Users can launch robust applets and applications by clicking a hyperlink in a web page, and can quickly and easily install the programs on their computers.
- Java Web Start can be configured to ask the user if a desktop icon should be created so the user can launch the program directly from the desktop. Downloaded programs can also have an “offline mode” for execution when the computer is not connected to the Internet.
- When you execute a program via Java Web Start, the program is downloaded and cached (stored) on the user's computer. The next time the user executes that program, Java Web Start launches it from the cache.
- If the program has been updated since it was last launched, Java Web Start can automatically download the new version, so a user always has the most up-to-date version.
- A Java Network Launch Protocol (JNLP; p. 956) document provides the information that Java Web Start needs to download and run a program.
- Programs launched via Java Web Start execute using the sandbox security model. The user can permit access to the local file system, the clipboard and other services via the JNLP APIs.

#### *Section 23.7.1 Packaging the `DrawTest` Applet for Use with Java Web Start*

- The `jar` command (p. 957) is used to create JAR files. Option `c` indicates that the command should create a new JAR file (p. 957). Option `v` indicates that the command should produce verbose output (p. 957). Option `f` indicates that the next argument in the command line is the new JAR file's name (p. 957).

#### *Section 23.7.2 JNLP Document for the `DrawTest` Applet*

- A JNLP document describes the contents of the JAR file and specifies which file in the JAR is the so-called `main-class` (p. 957) that begins the program's execution.
- JNLP documents are written in Extensible Markup Language (XML)—a widely supported standard for describing data (p. 957).

- JNLP is a so-called XML vocabulary that describes the information Java Web Start needs to launch a program.
- The `jnlp` element's (p. 958) `codebase` attribute specifies the path where the JNLP document and the JAR file are stored. The `href` attribute specifies the JNLP file that launches the program.
- Typically, the `codebase` references a directory on a web server with an `http://` URL.
- The `information` element (p. 959) provides details about the program.
- The `title` element (p. 959) specifies a title for the program.
- The `vendor` element (p. 959) specifies who created the program.
- The `desktop` element nested in the `shortcut` element (p. 959) tells Java Web Start to ask users whether they wish to install a desktop shortcut.
- The `offline-allowed` (p. 959) element indicates that a program can be launched via Java Web Start even when the computer is not connected to the Internet.
- The `resources` element (p. 959) contains a `java` element (p. 959) that lists the minimum version of Java required to execute the program and a `jar` element (p. 959) that specifies the location of the JAR file.
- The `applet-desc` (p. 959) element's `name` attribute specifies the applet's name. The `main-class` attribute specifies the main applet class. The `width` and `height` (p. 950) attributes specify the width and height in pixels, respectively, of the window in which the applet will execute.
- To launch the applet via Java Web Start you can use the `javaws` command (p. 959). You can also use your operating system's file manager to locate the JNLP on your computer and double click its file name. Normally, a JNLP file is referenced from a web page via a hyperlink.
- When you run an applet via Java Web Start the first time and the JNLP document specifies that a desktop icon should be installed, you'll be presented with a dialog that enables you to decide whether to install the desktop icon. If you click **OK**, a new icon labeled with the title specified in the JNLP document appears on the desktop.
- You can view the installed Java Web Start programs in the **Java Cache Viewer** by typing the command `javaws -viewer` in a command window.
- The **Java Cache Viewer** enables you to manage the installed Java Web Start programs. You can run a selected program, create a desktop shortcut, delete installed programs, and more.

## Self-Review Exercise

**23.1** Fill in the blanks in each of the following:

- Java applets begin execution with a series of three method calls: \_\_\_\_\_, \_\_\_\_\_ and \_\_\_\_\_.
- The \_\_\_\_\_ method is invoked for an applet each time a browser's user leaves an HTML page on which the applet resides.
- Every applet should extend class \_\_\_\_\_.
- The \_\_\_\_\_ or a browser can be used to execute a Java applet.
- The \_\_\_\_\_ method is called each time the user of a browser revisits the HTML page on which an applet resides.
- To load an applet into a browser, you must first define a(n) \_\_\_\_\_ file.
- Method \_\_\_\_\_ is called once when an applet begins execution.
- Method \_\_\_\_\_ is invoked to draw on an applet.
- Method \_\_\_\_\_ is invoked for an applet when the browser removes it from memory.
- The \_\_\_\_\_ and \_\_\_\_\_ HTML tags specify that an applet should be loaded into an applet container and executed.

- k) \_\_\_\_\_ is a framework for running downloaded programs outside the browser.
- l) A(n) \_\_\_\_\_ document provides the information that Java Web Start needs to download and run a program.
- m) The \_\_\_\_\_ enables you to manage the Java Web Start programs on your system.

## Answers to Self-Review Exercise

**23.1** a) init, start, paint. b) stop. c) JApplet (or Applet). d) appletviewer. e) start. f) HTML. g) init. h) paint. i) destroy. j) <applet>, </applet>. k) Java Web Start. l) Java Network Launch Protocol (JNLP). m) **Java Cache Viewer**.

## Exercises

**23.2** (*Arithmetic*) Write an applet that asks the user to enter two floating-point numbers, obtains the two numbers from the user and draws their sum, product (multiplication), difference and quotient (division). Use the techniques shown in Fig. 23.9.

**23.3** (*Comparing Numbers*) Write an applet that asks the user to enter two floating-point numbers, obtains the numbers from the user and displays the two numbers, then displays the larger number followed by the words "is larger" as a string on the applet. If the numbers are equal, the applet should print the message "These numbers are equal." Use the techniques shown in Fig. 23.9.

**23.4** (*Arithmetic and Numeric Comparisons*) Write an applet that inputs three floating-point numbers from the user and displays the sum, average, product, smallest and largest of these numbers as strings on the applet. Use the techniques shown in Fig. 23.9.

**23.5** (*Diameter, Circumference and Area of a Circle*) Write an applet that asks the user to input the radius of a circle as a floating-point number and draws the circle's diameter, circumference and area. Use the value 3.14159 for  $\pi$ . Use the techniques shown in Fig. 23.9. [*Note:* You may also use the predefined constant `Math.PI` for the value of  $\pi$ . This constant is more precise than the value 3.14159. Class `Math` is defined in the `java.lang` package, so you do not need to `import` it.] Use the following formulas ( $r$  is the radius):

$$\begin{aligned} \text{diameter} &= 2r \\ \text{circumference} &= 2\pi r \\ \text{area} &= \pi r^2 \end{aligned}$$

**23.6** (*Largest and Smallest*) Write an applet that reads five integers, determines which are the largest and smallest integers in the group and prints them. Draw the results on the applet.

**23.7** (*Draw a Checkerboard Pattern*) Write an applet that draws a checkerboard pattern as follows:

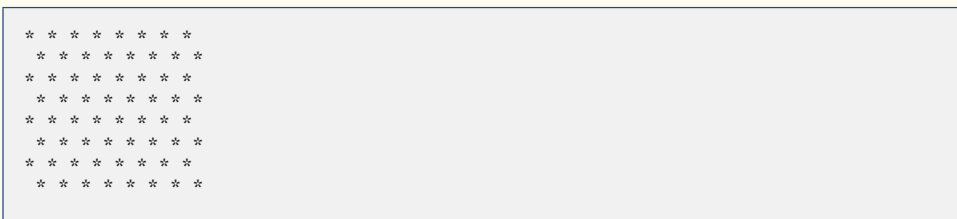

**23.8** (*Drawing Rectangles*) Write an applet that draws rectangles of different sizes and locations.

**23.9** (*Drawing Rectangles Based on User Input*) Write an applet that allows the user to input values for the arguments required by method `drawRect`, then draws a rectangle using the four input values.

**23.10** (*Drawing Ovals and Rectangles*) Class `Graphics` contains method `drawOval`, which takes as arguments the same four arguments as method `drawRect`. The arguments for method `drawOval` specify the “bounding box” for the oval—the sides of the bounding box are the boundaries of the oval. Write a Java applet that draws an oval and a rectangle with the same four arguments. The oval will touch the rectangle at the center of each side.

**23.11** (*Drawing Ovals and Rectangles*) Modify the solution to Exercise 23.10 to output ovals of different shapes and sizes.

**23.12** (*Drawing Ovals Based on User Input*) Write an applet that allows the user to input the four arguments required by method `drawOval`, then draws an oval using the four input values.

**23.13** (*TicTacToe Demonstration Applet with Java Web Start*) Package the `TicTacToe` demonstration applet from the JDK (discussed in Section 23.2) for use with Java Web Start, then copy the JNLP document in Fig. 23.12 and modify it so that it launches the `TicTacToe` applet.

# Multimedia: Applets and Applications

# 24



*The wheel that squeaks the loudest ... gets the grease.*

—John Billings (Henry Wheeler Shaw)

*We'll use a signal I have tried and found far-reaching and easy to yell. Waa-hoo!*

—Zane Grey

*There is a natural hootchy-kootchy motion to a goldfish.*

—Walt Disney

*Between the motion and the act falls the shadow.*

—Thomas Stearns Eliot

## Objectives

In this chapter you'll learn:

- How to get, display and scale images.
- How to create animations from sequences of images.
- How to create image maps that can sense when the cursor is over them.
- How to get, play, loop and stop sounds using an `AudioClip`.
- How to play video using interface `Player`.

|                                                    |                                                                     |
|----------------------------------------------------|---------------------------------------------------------------------|
| <b>24.1</b> Introduction                           | <b>24.5</b> Loading and Playing Audio Clips                         |
| <b>24.2</b> Loading, Displaying and Scaling Images | <b>24.6</b> Playing Video and Other Media with Java Media Framework |
| <b>24.3</b> Animating a Series of Images           | <b>24.7</b> Wrap-Up                                                 |
| <b>24.4</b> Image Maps                             | <b>24.8</b> Web Resources                                           |

*Summary | Self-Review Exercises | Answers to Self-Review Exercises | Exercises  
Special Section: Challenging Multimedia Projects | Making a Difference*

## 24.1 Introduction

**Multimedia**—using sound, images, graphics, animation and video—makes applications “come alive.” Although most multimedia in Java applications is two-dimensional, you can use the **Java 3D API** to create 3D graphics applications ([www.oracle.com/technetwork/java/javase/tech/index-jsp-138252.html](http://www.oracle.com/technetwork/java/javase/tech/index-jsp-138252.html)).

Most new computers sold today are “multimedia ready,” with DVD drives and audio and video capabilities. Economical desktop computers, laptops and smartphones are so powerful that they can store and play DVD-quality (and often, HD-quality) sound and video.

Among users who want graphics, many now want three-dimensional, high-resolution, color graphics. True three-dimensional imaging is already available. We expect high-resolution, “theater-in-the-round,” three-dimensional television to eventually become common. Sporting and entertainment events will seem to take place on your living room floor! Medical students worldwide will see operations being performed thousands of miles away, as if they were occurring in the same room. People will learn how to drive with incredibly realistic driving simulators in their homes before they get behind the wheel. The possibilities are endless and exciting.

Multimedia demands extraordinary computing power. Today’s ultrapowerful processors make effective multimedia economical. Users are eager to own faster processors, larger memories and wider communications channels that support demanding multimedia applications. Ironically, these enhanced capabilities may not cost more—fierce competition keeps driving prices down.

The Java APIs provide multimedia facilities that enable you to start developing powerful multimedia applications immediately. This chapter presents several examples, including:

1. the basics of manipulating images
2. creating smooth animations
3. playing audio files with the `AudioClip` interface
4. creating image maps that can sense when the cursor is over them, even without a mouse click
5. playing video files using the `Player` interface

We introduce additional JNLP features that, with the user’s permission, enable an applet or application to access files on the user’s local computer. The exercises suggest dozens of challenging and interesting projects. Multimedia leverages creativity in ways that we did not experience with “conventional” computer capabilities. [*Note:* Java’s multimedia

capabilities go far beyond those presented in this chapter. They include the **Java Media Framework (JMF) API** (for adding audio and video media to an application), **Java Sound API** (for playing, recording and modifying audio), Java 3D API (for creating and modifying 3D graphics), **Java Advanced Imaging API** (for image-processing capabilities, such as cropping and scaling), **Java Speech API** (for inputting speech from the user and converting it to text, or outputting text to the user as speech), Java 2D API (for creating and modifying 2D graphics, covered in Chapter 15) and **Java Image I/O API** (for reading images from and outputting images to files). Section 24.8 provides web links for these APIs.]

## 24.2 Loading, Displaying and Scaling Images

We begin our discussion with images. We'll use several different images in this chapter. You can create your own images with software such as Adobe® Photoshop®, Corel® Paint Shop Pro®, Microsoft® Paint and G.I.M.P. (gimp.org).

The applet of Fig. 24.1 uses Java Web Start and the JNLP **FileOpenService** (package `javax.jnlp`) to allow the user to select an image, then displays that image and allows the user to scale it. After the user selects an image, the applet gets the bytes from the file, then passes them to the `ImageIcon` (package `javax.swing`) constructor to create the image that will be displayed. Class `ImageIcon`'s constructors can receive arguments of several different formats, including a byte array containing the bytes of an image, an **Image** (package `java.awt`) already loaded in memory, or a `String` or a URL representing the image's location. Java supports various image formats, including **Graphics Interchange Format (GIF)**, **Joint Photographic Experts Group (JPEG)** and **Portable Network Graphics (PNG)**. File names for these types typically end with **.gif**, **.jpg** (or **.jpeg**) and **.png**, respectively.

---

```

1 // Fig. 24.1: LoadImageAndScale.java
2 // Loading, displaying and scaling an image in an applet
3 import java.awt.BorderLayout;
4 import java.awt.Graphics;
5 import java.awt.event.ActionEvent;
6 import java.awt.event.ActionListener;
7 import javax.jnlp.FileContents;
8 import javax.jnlp.FileOpenService;
9 import javax.jnlp.ServiceManager;
10 import javax.swing.ImageIcon;
11 import javax.swing.JApplet;
12 import javax.swing.JButton;
13 import javax.swing.JFrame;
14 import javax.swing.JLabel;
15 import javax.swing.JOptionPane;
16 import javax.swing.JPanel;
17 import javax.swing.JTextField;
18
19 public class LoadImageAndScale extends JApplet
20 {
21 private ImageIcon image; // references image to display
22 private JPanel scaleJPanel; // JPanel containing the scale-selector

```

---

**Fig. 24.1** | Loading, displaying and scaling an image in an applet. (Part I of 4.)

```

23 private JLabel percentJLabel; // label for JTextField
24 private JTextField scaleInputJTextField; // obtains user's input
25 private JButton scaleChangeJButton; // initiates scaling of image
26 private double scaleValue = 1.0; //scale percentage for image
27
28 // load image when applet is loaded
29 public void init()
30 {
31 scaleJPanel = new JPanel();
32 percentJLabel = new JLabel("scale percent:");
33 scaleInputJTextField = new JTextField("100");
34 scaleChangeJButton = new JButton("Set Scale");
35
36 // add components and place scaleJPanel in applet's NORTH region
37 scaleJPanel.add(percentJLabel);
38 scaleJPanel.add(scaleInputJTextField);
39 scaleJPanel.add(scaleChangeJButton);
40 add(scaleJPanel, BorderLayout.NORTH);
41
42 // register event handler for scaleChangeJButton
43 scaleChangeJButton.addActionListener(
44 new ActionListener()
45 {
46 // when the JButton is pressed, set scaleValue and repaint
47 public void actionPerformed(ActionEvent e)
48 {
49 scaleValue = Double.parseDouble(
50 scaleInputJTextField.getText()) / 100.0;
51 repaint(); // causes image to be redisplayed at new scale
52 } // end method actionPerformed
53 } // end anonymous inner class
54); // end call to addActionListener
55
56 // use JNLP services to open an image file that the user selects
57 try
58 {
59 // get a reference to the FileOpenService
60 FileOpenService fileOpenService =
61 (FileOpenService) ServiceManager.lookup(
62 "javax.jnlp.FileOpenService");
63
64 // get file's contents from the FileOpenService
65 FileContents contents =
66 fileOpenService.openFileDialog(null, null);
67
68 // byte array to store image's data
69 byte[] imageData = new byte[(int) contents.getLength()];
70 contents.getInputStream().read(imageData); // read image bytes
71 image = new ImageIcon(imageData); // create the image
72
73 // if image successfully loaded, create and add DrawJPanel
74 add(new DrawJPanel(), BorderLayout.CENTER);
75 } // end try

```

**Fig. 24.1** | Loading, displaying and scaling an image in an applet. (Part 2 of 4.)



```

76 catch(Exception e)
77 {
78 e.printStackTrace();
79 } // end catch
80 } // end method init
81
82 // DrawJPanel used to display loaded image
83 private class DrawJPanel extends JPanel
84 {
85 // display image
86 public void paintComponent(Graphics g)
87 {
88 super.paintComponent(g);
89
90 // the following values are used to center the image
91 double spareWidth =
92 getWidth() - scaleValue * image.getIconWidth();
93 double spareHeight =
94 getHeight() - scaleValue * image.getIconHeight();
95
96 // draw image with scaled width and height
97 g.drawImage(image.getImage(),
98 (int) (spareWidth) / 2, (int) (spareHeight) / 2,
99 (int) (image.getIconWidth() * scaleValue),
100 (int) (image.getIconHeight() * scaleValue), this);
101 } // end method paint
102 } // end class DrawJPanel
103 } // end class LoadImageAndScale

```

(a) Java Web Start security dialog that appears because this applet is requesting access to a file on the local computer

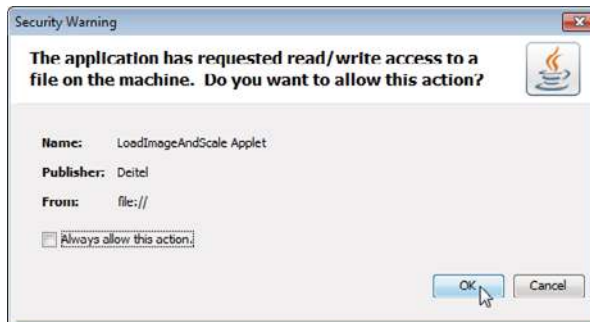

(b) Open dialog that appears if the user clicks **OK** in the security dialog

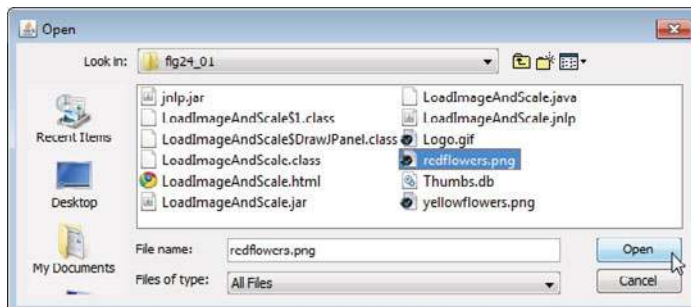

**Fig. 24.1** | Loading, displaying and scaling an image in an applet. (Part 3 of 4.)

(c) Scaling the image

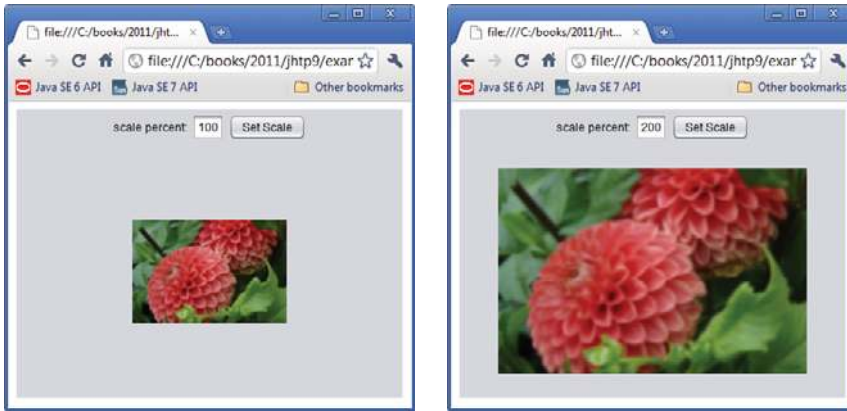

**Fig. 24.1** | Loading, displaying and scaling an image in an applet. (Part 4 of 4.)

### *Configuring the GUI and the JButton's Event Handler*

The applet's `init` method (lines 29–80) configures the GUI and an event handler. It also uses JNLP services to enable the user to select an image to display from the local computer. Line 31 creates the `JPanel` that will contain the `JLabel`, `JTextField` and `JButton` created in lines 32–34. Lines 37–39 add these components to the `JPanel`'s default `FlowLayout`. Line 40 places this `JPanel` in the NORTH region of the `JApplet`'s default `BorderLayout`.

Lines 43–54 create the event handler for the `scaleChangeJButton`. When the user clicks this `JButton`, lines 49–50 obtain the user's input from the `scaleInputJTextField`, divide it by 100.0 to calculate the scale percentage and assign the result to `scaleValue`. This value will be used in later calculations to scale the image. For example, if the user enters 50, the scale value will be 0.5 and the image will be displayed at half its original size. Line 51 then repaints the applet to display the image at its new scale.

### *Opening the Image File Using JNLP's FileOpenService*

As we mentioned in Section 23.7, with the user's permission, Java Web Start programs can access the local file system via the JNLP APIs of package `javax.jnlp`. In this example, we'd like the user to select an image from the local computer to display in the applet. (We've provided two images in this example's directory with the source code.) You can use JNLP's `FileOpenService` to request limited access to the local file system.

Lines 7–9 import the interfaces and class we need to use the `FileOpenService`. Lines 60–62 use the JNLP `ServiceManager` class's static `lookup` method to obtain a reference to the `FileOpenService`. JNLP provides several services, so this method returns an `Object` that you must cast to the appropriate type. Lines 65–66 use the `FileOpenService`'s `openFileDialog` method to display a file-selection dialog. Java Web Start prompts the user (Fig. 24.1(a)) to approve the applet's request for local file-system access. If the user gives permission, the `Open` dialog (Fig. 24.1(b)) is displayed. Method `openFileDialog`'s parameters are a `String` to suggest a directory to open and a `String` array of acceptable file extensions (such as `"png"` and `"jpg"`). For simplicity, we passed `null` for each, which displays an open dialog showing the user's default directory and allows any file type to be selected.

When the user selects an image file and clicks the **Open** button in the dialog, method `openFileDialog` returns a `FileContents` object, which for security reasons does not give the program access to the file's exact location on disk. Instead, the program can get an `InputStream` and read the file's bytes. Line 69 creates a byte array in which the image's data will be stored. `FileContents` method `getLength` returns the number of bytes (as a `long`) in the file. Line 70 obtains the `InputStream`, then invokes its `read` method to fill the `imageData` byte array. Line 71 creates an `ImageIcon` using the byte array as the source of the image's data. Finally, line 74 adds a new `DrawJPanel` to the `CENTER` of the applet's `BorderLayout`. When the applet is displayed, its components' `paintComponent` methods are called, which causes the `DrawJPanel` to display the image. You can learn more about the JNLP APIs at [download.oracle.com/javase/6/docs/jre/api/javaws/jnlp/](http://download.oracle.com/javase/6/docs/jre/api/javaws/jnlp/).

### *Displaying the Image with Class `DrawJPanel`'s `paintComponent` Method*

To separate the GUI from the area in which the image is displayed, we use a subclass of `JPanel` named `DrawJPanel` (lines 83–102). Its `paintComponent` method (lines 86–101) displays the image. We'd like to center the image in the `DrawJPanel`, so lines 91–94 calculate the difference between the width of the `DrawJPanel` and that of the scaled image, then the height of the `DrawJPanel` and that of the scaled image. `DrawJPanel`'s `getWidth` and `getHeight` methods (inherited indirectly from class `Component`) return the `DrawJPanel`'s width and height, respectively. The `ImageIcon`'s `getIconWidth` and `getIconHeight` methods return the image's width and height, respectively. The `scaleValue` is set to 1.0 by default (line 26), and is changed when the user clicks the `Set Scale` `JButton`.

Lines 97–100 use `Graphics`'s method `drawImage` to display a scaled `ImageIcon`. The first argument invokes the `ImageIcon`'s `getImage` method to obtain the `Image` to draw. The second and third arguments represent the image's *upper-left* corner coordinates with respect to the `DrawJPanel`'s upper-left corner. The fourth and fifth arguments specify the image's scaled width and height, respectively. Line 99 scales the image's width by invoking the `ImageIcon`'s `getIconWidth` method and multiplying its return value by `scaleValue`. Similarly, line 100 scales the image's height. The last argument is an **ImageObserver**—an interface implemented by class `Component`. Since class `DrawJPanel` indirectly extends `Component`, a `DrawJPanel` *is an* `ImageObserver`. This argument is important when displaying large images that require a long time to load (or download from the Internet). It's possible that a program will attempt to display the image before it has completely loaded (or downloaded). As the `Image` loads, the `ImageObserver` receives notifications and updates the image on the screen as necessary. In this example, the images are being loaded from the user's computer, so it's likely that entire image will be displayed immediately.

### *Compiling the Applet*

Compiling and running this applet requires the `jnlp.jar` file that contains the JNLP APIs. This file can be found in your JDK installation directory under the directories

```
sample
 jnlp
 servlet
```

To compile the applet, use the following command:

```
javac -classpath PathToJnlpJarFile LoadImageAndScale.java
```

where *PathToJnlpJarFile* includes both the path and the file name `jnlp.jar`. For example, on our Windows Vista computer, the *PathToJnlpJarFile* is

```
"C:\Program Files\Java\jdk1.6.0_11\sample\jnlp\servlet\jnlp.jar"
```

### *Packaging the Applet for Use with Java Web Start*

To package the applet for use with Java Web Start, you must create a JAR file that contains the applet's code and the `jnlp.jar` file. To do so, use the command

```
jar cvf LoadImageAndScale.jar *.class PathToJnlpJarFile
```

where *PathToJnlpJarFile* includes both the path and the file name `jnlp.jar`. This will place all the `.class` files for the applet and a copy of the `jnlp.jar` file in the new JAR file `LoadImageAndScale.jar`.

### *JNLP Document for LoadImageAndScale Applet*

The JNLP document in Fig. 24.2 is similar to the one introduced in Fig. 23.12. The only new feature in this document is that the `resources` element (lines 10–14) contains a second `jar` element (line 13) that references the `jnlp.jar` file, which is embedded in the file `LoadImageAndScale.jar`.

---

```

1 <?xml version="1.0" encoding="UTF-8"?>
2 <jnlp codebase="file:." href="LoadImageAndScale.jnlp">
3
4 <information>
5 <title>LoadImageAndScale Applet</title>
6 <vendor>Deitel</vendor>
7 <offline-allowed/>
8 </information>
9
10 <resources>
11 <java version="1.6+"/>
12 <jar href="LoadImageAndScale.jar" main="true"/>
13 <jar href="jnlp.jar"/>
14 </resources>
15
16 <applet-desc
17 name="LoadImageAndScale"
18 main-class="LoadImageAndScale"
19 width="400"
20 height="300">
21 </applet-desc>
22 </jnlp>

```

---

**Fig. 24.2** | JNLP document for the `LoadImageAndScale` applet.

### *Making the Applet Draggable Outside the Browser Window*

The HTML document in Fig. 24.3 loads the applet into a web browser. In this example, we use an `applet` element to specify the applet's class and provide two `param` elements between the `applet` element's tags. The first (line 4) specifies that this applet should be **draggable**. That is, the user can hold the *Alt* key and use the mouse to drag the applet outside the browser window. The applet will then continue executing, even if the browser is

closed. Clicking the close box on the applet when it's executing outside the browser causes the applet to move back into the browser window if it's still open, or to terminate otherwise. The second param element shows an alternate way to specify the JNLP file that launches an applet. We discuss applet parameters in more detail in Section 27.2.

```

1 <html>
2 <body>
3 <applet code="LoadImageAndScale.class" width="400" height="300">
4 <param name="draggable" value="true">
5 <param name="jnlp_href" value="LoadImageAndScale.jnlp">
6 </applet>
7 </body>
8 </html>

```

**Fig. 24.3** | HTML document to load the `LoadImageAndScale` applet and make it draggable outside the browser window.

## 24.3 Animating a Series of Images

Next, we animate a series of images stored in an array of `ImageIcons`. In this example, we use the JNLP `FileOpenService` to enable the user to choose a group of images that will be animated by displaying one image at a time at 50-millisecond intervals. The animation presented in Figs. 24.4–24.5 is implemented using a subclass of `JPanel` called `LogoAnimatorJPanel` (Fig. 24.4) that can be attached to an application window or a `JApplet`. Class `LogoAnimator` (Fig. 24.5) declares a `main` method (lines 8–20 of Fig. 24.5) to execute the animation as an application. Method `main` declares an instance of class `JFrame` and attaches a `LogoAnimatorJPanel` object to the `JFrame` to display the animation.

```

1 // Fig. 24.4: LogoAnimatorJPanel.java
2 // Animating a series of images.
3 import java.awt.Dimension;
4 import java.awt.event.ActionEvent;
5 import java.awt.event.ActionListener;
6 import java.awt.Graphics;
7 import javax.jnlp.FileContents;
8 import javax.jnlp.FileOpenService;
9 import javax.jnlp.ServiceManager;
10 import javax.swing.ImageIcon;
11 import javax.swing.JPanel;
12 import javax.swing.Timer;
13
14 public class LogoAnimatorJPanel extends JPanel
15 {
16 protected ImageIcon images[]; // array of images
17 private int currentImage = 0; // current image index
18 private final int ANIMATION_DELAY = 50; // millisecond delay
19 private int width; // image width
20 private int height; // image height
21

```

**Fig. 24.4** | Animating a series of images. (Part 1 of 3.)

```

22 private Timer animationTimer; // Timer drives animation
23
24 // constructor initializes LogoAnimatorJPanel by loading images
25 public LogoAnimatorJPanel()
26 {
27 try
28 {
29 // get reference to FileOpenService
30 FileOpenService fileOpenService =
31 (FileOpenService) ServiceManager.lookup(
32 "javax.jnlp.FileOpenService");
33
34 // display dialog that allows user to select multiple files
35 FileContents[] contents =
36 fileOpenService.openMultiFileDialog(null, null);
37
38 // create array to store ImageIcon references
39 images = new ImageIcon[contents.length];
40
41 // load the selected images
42 for (int count = 0; count < images.length; count++)
43 {
44 // create byte array to store an image's data
45 byte[] imageData =
46 new byte[(int) contents[count].getLength()];
47
48 // get image's data and create image
49 contents[count].getInputStream().read(imageData);
50 images[count] = new ImageIcon(imageData);
51 } // end for
52
53 // this example assumes all images have the same width and height
54 width = images[0].getIconWidth(); // get icon width
55 height = images[0].getIconHeight(); // get icon height
56 } // end try
57 catch(Exception e)
58 {
59 e.printStackTrace();
60 } // end catch
61 } // end LogoAnimatorJPanel constructor
62
63 // display current image
64 public void paintComponent(Graphics g)
65 {
66 super.paintComponent(g); // call superclass paintComponent
67
68 images[currentImage].paintIcon(this, g, 0, 0);
69
70 // set next image to be drawn only if Timer is running
71 if (animationTimer.isRunning())
72 currentImage = (currentImage + 1) % images.length;
73 } // end method paintComponent

```

**Fig. 24.4** | Animating a series of images. (Part 2 of 3.)

```

74
75 // start animation, or restart if window is redisplayed
76 public void startAnimation()
77 {
78 if (animationTimer == null)
79 {
80 currentImage = 0; // display first image
81
82 // create timer
83 animationTimer =
84 new Timer(ANIMATION_DELAY, new TimerHandler());
85
86 animationTimer.start(); // start Timer
87 } // end if
88 else // animationTimer already exists, restart animation
89 {
90 if (! animationTimer.isRunning())
91 animationTimer.restart();
92 } // end else
93 } // end method startAnimation
94
95 // stop animation Timer
96 public void stopAnimation()
97 {
98 animationTimer.stop();
99 } // end method stopAnimation
100
101 // return minimum size of animation
102 public Dimension getMinimumSize()
103 {
104 return getPreferredSize();
105 } // end method getMinimumSize
106
107 // return preferred size of animation
108 public Dimension getPreferredSize()
109 {
110 return new Dimension(width, height);
111 } // end method getPreferredSize
112
113 // inner class to handle action events from Timer
114 private class TimerHandler implements ActionListener
115 {
116 // respond to Timer's event
117 public void actionPerformed(ActionEvent actionEvent)
118 {
119 repaint(); // repaint animator
120 } // end method actionPerformed
121 } // end class TimerHandler
122 } // end class LogoAnimatorJPanel

```

**Fig. 24.4** | Animating a series of images. (Part 3 of 3.)

```

1 // Fig. 24.5: LogoAnimator.java
2 // Displaying animated images on a JFrame.
3 import javax.swing.JFrame;
4
5 public class LogoAnimator
6 {
7 // execute animation in a JFrame
8 public static void main(String args[])
9 {
10 LogoAnimatorJPanel animation = new LogoAnimatorJPanel();
11
12 JFrame window = new JFrame("Animator test"); // set up window
13 window.setDefaultCloseOperation(JFrame.EXIT_ON_CLOSE);
14 window.add(animation); // add panel to frame
15
16 window.pack(); // make window just large enough for its GUI
17 window.setVisible(true); // display window
18
19 animation.startAnimation(); // begin animation
20 } // end main
21 } // end class LogoAnimator

```



**Fig. 24.5** | Displaying animated images on a JFrame.

### *Class LogoAnimatorPanel*

Class `LogoAnimatorJPanel` (Fig. 24.4) maintains an array of `ImageIcons` (declared at line 16) that are loaded in the constructor (lines 25–61). The constructor begins by using the `JNLP FileOpenService`'s `openMultiFileDialog` method to display a file-selection dialog that allows the user to select multiple files at once. We named our sample images such that they all have the same base name (“deitel”) followed by a two-digit number from 00–29. This ensures that our images are in the proper order for the animation. As in this chapter’s first example, first the user is prompted to give permission, then the `Open` dialog appears if permission is granted. `FileOpenService` method `openMultiFileDialog` takes the same arguments as method `openFileDialog` but returns an array of `FileContents` objects representing the set of files selected by the user. When you run this application, navigate to a folder containing the images you wish to use and select the images. If you wish, you can use the 30 images we provide in this example’s subdirectory named `images`.

Line 39 creates the array of `ImageIcons`, then lines 42–51 populate the array by creating a byte array (lines 45–46) for the current image’s data, reading the bytes of the image into the array (line 49) and creating an `ImageIcon` object from the byte array. Lines 54–55 determine the width and height of the animation from the size of the first image in array `images`—we assume that all the images have the same width and height.



### *Method startAnimation*

After the `LogoAnimatorJPanel` constructor loads the images, method `main` of Fig. 24.5 sets up the window in which the animation will appear (lines 12–17), and line 19 calls the `LogoAnimatorJPanel`'s `startAnimation` method (declared at lines 76–93 of Fig. 24.4). This method starts the program's animation for the first time or restarts the animation that the program stopped previously. The animation is driven by an instance of class `Timer` (from package `javax.swing`).

When the program is first run, method `startAnimation` is called to begin the animation. Although we provide the functionality for this method to restart the animation if it has been stopped, the example does not call the method for this purpose. We've added the functionality, however, should the reader choose to add GUI components that enable the user to start and stop the animation.

A `Timer` generates `ActionEvents` at a fixed interval in milliseconds (normally specified as an argument to the `Timer`'s constructor) and notifies all its `ActionListeners` each time an `ActionEvent` occurs. Line 78 determines whether the `Timer` reference `animationTimer` is `null`. If it is, method `startAnimation` is being called for the first time, and a `Timer` needs to be created so that the animation can begin. Line 80 sets `currentImage` to 0, which indicates that the animation should begin with the first element of array `images`. Lines 83–84 assign a new `Timer` object to `animationTimer`. The `Timer` constructor receives two arguments—the delay in milliseconds (`ANIMATION_DELAY` is 50, as specified in line 18) and the `ActionListener` that will respond to the `Timer`'s `ActionEvents`. For the second argument, an object of class `TimerHandler` is created. This class, which implements `ActionListener`, is declared in lines 114–121. Line 86 calls the `Timer` object's `start` method to start the `Timer`. Once started, `animationTimer` will generate an `ActionEvent` every 50 milliseconds and call the `Timer`'s event handler `actionPerformed` (lines 117–120). Line 119 calls `LogoAnimatorJPanel`'s `repaint` method to schedule a call to `LogoAnimatorJPanel`'s `paintComponent` method (lines 64–73). Remember that any subclass of `JComponent` that draws should do so in its `paintComponent` method. Recall that the first statement in any `paintComponent` method should be a call to the superclass's `paintComponent` method, to ensure that `Swing` components are displayed correctly.

If the animation started earlier, then our `Timer` was created and the condition in line 78 evaluates to `false`. The program continues with lines 90–91, which restarts the animation that the program stopped previously. The `if` condition at line 90 uses `Timer` method `isRunning` to determine whether the `Timer` is running (i.e., generating events). If it's not running, line 91 calls `Timer` method `restart` to indicate that the `Timer` should start generating events again. Once this occurs, method `actionPerformed` (the `Timer`'s event handler) is again called at regular intervals.

### *Method paintComponent*

Line 68 calls the `ImageIcon`'s `paintIcon` method to display the image stored at element `currentImage` in the array. The arguments represent the `Component` on which to draw (`this`), the `Graphics` object that performs the drawing (`g`) and the coordinates of the image's upper-left corner. Lines 71–72 determine whether the `animationTimer` is running and, if so, prepare for the next image to be displayed by incrementing `currentImage` by 1. The remainder calculation ensures that the value of `currentImage` is set to 0 (to repeat the animation sequence) when it's incremented past the last element index in the array. The

if statement ensures that the same image will be displayed if `paintComponent` is called while the `Timer` is stopped. This can be useful if a GUI is provided that enables the user to start and stop the animation. For example, if the animation is stopped and the user covers it with another window, then uncovers it, method `paintComponent` will be called. In this case, we do not want the animation to show the next image (because the animation has been stopped). We simply want the window to display the same image until the animation is restarted.

### Method `stopAnimation`

Method `stopAnimation` (lines 96–99) stops the animation by calling `Timer` method `stop` to indicate that the `Timer` should stop generating events. This prevents `actionPerformed` from calling `repaint` to initiate the painting of the next image in the array. Just as with restarting the animation, this example defines but does not use method `stopAnimation`. We've provided this method for demonstration purposes, or to allow the user to modify this example to stop and restart the animation.



### Software Engineering Observation 24.1

*When creating an animation for use in an applet, provide a mechanism for disabling the animation when the user browses a new web page different from the one on which the animation applet resides.*

### Methods `getPreferredSize` and `getMinimumSize`

By extending class `JPanel`, we're creating a new GUI component. So, we must ensure that it works like other components for layout purposes. Layout managers often use a component's `getPreferredSize` method (inherited from class `java.awt.Component`) to determine the component's preferred width and height. If a new component has a preferred width and height, it should override method `getPreferredSize` (lines 108–111) to return that width and height as an object of class `Dimension` (package `java.awt`). The `Dimension` class represents the width and height of a GUI component. In this example, the images we provide are 160 pixels wide and 80 pixels tall, so method `getPreferredSize` would return a `Dimension` object containing the numbers 160 and 80 (if you use these images).



### Look-and-Feel Observation 24.1

*The default size of a `JPanel` object is 10 pixels wide and 10 pixels tall.*



### Look-and-Feel Observation 24.2

*When subclassing `JPanel` (or any other `JComponent`), override method `getPreferredSize` if the new component is to have a specific preferred width and height.*

Lines 102–105 override method `getMinimumSize`. This method determines the minimum width and height of the component. As with method `getPreferredSize`, new components should override method `getMinimumSize` (also inherited from class `Component`). Method `getMinimumSize` simply calls `getPreferredSize` (a common programming practice) to indicate that the minimum size and preferred size are the same. Some layout managers ignore the dimensions specified by these methods. For example, a `BorderLayout`'s NORTH and SOUTH regions use only the component's preferred height.



### Look-and-Feel Observation 24.3

If a new GUI component has a minimum width and height (i.e., smaller dimensions would render the component ineffective on the display), override method `getMinimumSize` to return the minimum width and height as an instance of class `Dimension`.



### Look-and-Feel Observation 24.4

For many GUI components, method `getMinimumSize` is implemented to return the result of a call to the component's `getPreferredSize` method.

## Compiling the Application

Compiling and running this application requires the `jnlp.jar` file that contains the JNLP APIs. To compile the application use the following command:

```
javac -classpath PathToJnlpJarFile *.java
```

where `PathToJnlpJarFile` includes both the path and the file name `jnlp.jar`.

## Packaging the Application for Use with Java Web Start

To package the application for use with Java Web Start, you must create a JAR file that contains the applet's code and the `jnlp.jar` file. To do so, use the command

```
jar cvf LogoAnimator.jar *.class PathToJnlpJarFile
```

where `PathToJnlpJarFile` includes both the path and the file name `jnlp.jar`.

## JNLP Document for LoadImageAndScale Applet

The JNLP document in Fig. 24.6 is similar to the one in Fig. 24.2. The only new feature in this document is the `application-desc` element (lines 16–19), which specifies the name of the application and its main class. To run this application, use the command

```
javaws LogoAnimator.jnlp
```

Recall that you can also run Java Web Start applications via a link in a web page, as we showed in Fig. 23.13.

```

1 <?xml version="1.0" encoding="UTF-8"?>
2 <jnlp codebase="file:." href="LogoAnimator.jnlp">
3
4 <information>
5 <title>LogoAnimator</title>
6 <vendor>Deitel</vendor>
7 <offline-allowed/>
8 </information>
9
10 <resources>
11 <java version="1.6+"/>
12 <jar href="LogoAnimator.jar" main="true"/>
13 <jar href="jnlp.jar"/>
14 </resources>
15

```

**Fig. 24.6** | JNLP document for the `LoadImageAndScale` applet. (Part 1 of 2.)

```

16 <application-desc
17 name="LogoAnimator"
18 main-class="LogoAnimator">
19 </application-desc>
20 </jnlp>

```

**Fig. 24.6** | JNLP document for the LoadImageAndScale applet. (Part 2 of 2.)

## 24.4 Image Maps

**Image maps** are commonly used to create interactive web pages. An image map is an image with **hot areas** that the user can click to accomplish a task, such as loading a different web page into a browser. When the user positions the mouse pointer over a hot area, normally a descriptive message appears in the status area of the browser or in a tool tip.

Figure 24.7 loads an image containing several of the programming-tip icons used in this book. The program allows the user to position the mouse pointer over an icon to display a descriptive message associated with it. Event handler `mouseMoved` (lines 39–43) takes the mouse coordinates and passes them to method `translateLocation` (lines 58–69). Method `translateLocation` tests the coordinates to determine the icon over which the mouse was positioned when the `mouseMoved` event occurred—the method then returns a message indicating what the icon represents. This message is displayed in the applet container’s status bar using method `showStatus` of class `Applet`.

```

1 // Fig. 24.7: ImageMap.java
2 // Image map.
3 import java.awt.event.MouseAdapter;
4 import java.awt.event.MouseEvent;
5 import java.awt.event.MouseMotionAdapter;
6 import java.awt.Graphics;
7 import javax.swing.ImageIcon;
8 import javax.swing.JApplet;
9
10 public class ImageMap extends JApplet
11 {
12 private ImageIcon mapImage;
13
14 private static final String captions[] = { "Common Programming Error",
15 "Good Programming Practice", "Look-and-Feel Observation",
16 "Performance Tip", "Portability Tip",
17 "Software Engineering Observation", "Error-Prevention Tip" };
18
19 // sets up mouse listeners
20 public void init()
21 {
22 addMouseListener(
23
24 new MouseAdapter() // anonymous inner class
25 {

```

**Fig. 24.7** | Image map. (Part 1 of 3.)

```

26 // indicate when mouse pointer exits applet area
27 public void mouseExited(MouseEvent event)
28 {
29 showStatus("Pointer outside applet");
30 } // end method mouseExited
31 } // end anonymous inner class
32); // end call to addMouseListener
33
34 addMouseMotionListener(
35
36 new MouseMotionAdapter() // anonymous inner class
37 {
38 // determine icon over which mouse appears
39 public void mouseMoved(MouseEvent event)
40 {
41 showStatus(translateLocation(
42 event.getX(), event.getY()));
43 } // end method mouseMoved
44 } // end anonymous inner class
45); // end call to addMouseMotionListener
46
47 mapImage = new ImageIcon("icons.png"); // get image
48 } // end method init
49
50 // display mapImage
51 public void paint(Graphics g)
52 {
53 super.paint(g);
54 mapImage.paintIcon(this, g, 0, 0);
55 } // end method paint
56
57 // return tip caption based on mouse coordinates
58 public String translateLocation(int x, int y)
59 {
60 // if coordinates outside image, return immediately
61 if (x >= mapImage.getIconWidth() || y >= mapImage.getIconHeight())
62 return "";
63
64 // determine icon number (0 - 6)
65 double iconWidth = (double) mapImage.getIconWidth() / 7.0;
66 int iconNumber = (int)((double) x / iconWidth);
67
68 return captions[iconNumber]; // return appropriate icon caption
69 } // end method translateLocation
70 } // end class ImageMap

```



**Fig. 24.7** | Image map. (Part 2 of 3.)



**Fig. 24.7** | Image map. (Part 3 of 3.)

Clicking in the applet of Fig. 24.7 will not cause any action. In Chapter 27, we discuss the techniques for loading another web page into a browser via URLs and the `AppletCon-`

text interface. Using those techniques, this applet could associate each icon with a URL that the browser would display when the user clicks the icon.

## 24.5 Loading and Playing Audio Clips

Java programs can manipulate and play **audio clips**. Users can capture their own audio clips, and many clips are available in software products and over the Internet. Your system needs to be equipped with audio hardware (speakers and a sound card) to be able to play the audio clips.

Java provides several mechanisms for playing sounds in an applet. The two simplest are the Applet's **play** method and the **play** method of the **AudioClip** interface. Additional audio capabilities are available in the Java Media Framework and Java Sound APIs. If you'd like to play a sound once in a program, the Applet method `play` loads the sound and plays it once, then the sound can be garbage collected. The Applet method `play` has two versions:

```
public void play(URL location, String soundFileName);
public void play(URL soundURL);
```

The first version loads the audio clip stored in file `soundFileName` from `location` and plays the sound. The first argument is normally a call to the applet's `getDocumentBase` or `getCodeBase` method. Method `getDocumentBase` returns the location of the HTML file that loaded the applet. (If the applet is in a package, the method returns the location of the package or the JAR file containing the package.) Method `getCodeBase` indicates the location of the applet's `.class` file. The second version of method `play` takes a URL that contains the location and the file name of the audio clip. The statement

```
play(getDocumentBase(), "hi.au");
```

loads the audio clip in file `hi.au` and plays it once.

The **sound engine** that plays the audio clips supports several audio file formats, including **Sun Audio file format** (`.au` extension), **Windows Wave file format** (`.wav` extension), **Macintosh AIFF file format** (`.aif` or `.aiff` extensions) and **Musical Instrument Digital Interface (MIDI) file format** (`.mid` or `.rmi` extensions). The Java Media Framework (JMF) and Java Sound APIs support additional formats.

The program of Fig. 24.8 demonstrates loading and playing an `AudioClip` (package `java.applet`). This technique is more flexible than Applet method `play`. An applet can use an `AudioClip` to store audio for repeated use throughout a program's execution. Applet method `getAudioClip` has two forms that take the same arguments as method `play` described previously. Method `getAudioClip` returns a reference to an `AudioClip`. An `AudioClip` has three methods—`play`, `loop` and `stop`. As mentioned earlier, method `play` plays the audio clip once. Method `loop` continuously loops through the audio clip in the background. Method `stop` terminates an audio clip that is currently playing. In the program, each of these methods is associated with a button on the applet.

---

```
1 // Fig. 24.8: LoadAudioAndPlay.java
2 // Loading and playing an AudioClip.
3 import java.applet.AudioClip;
4 import java.awt.event.ItemListener;
```

---

**Fig. 24.8** | Loading and playing an `AudioClip`. (Part 1 of 3.)

```
5 import java.awt.event.ItemEvent;
6 import java.awt.event.ActionListener;
7 import java.awt.event.ActionEvent;
8 import java.awt.FlowLayout;
9 import javax.swing.JApplet;
10 import javax.swing.JButton;
11 import javax.swing.JComboBox;
12
13 public class LoadAudioAndPlay extends JApplet
14 {
15 private AudioClip sound1, sound2, currentSound;
16 private JButton playJButton, loopJButton, stopJButton;
17 private JComboBox soundJComboBox;
18
19 // load the audio when the applet begins executing
20 public void init()
21 {
22 setLayout(new FlowLayout());
23
24 String choices[] = { "Welcome", "Hi" };
25 soundJComboBox = new JComboBox(choices); // create JComboBox
26
27 soundJComboBox.addItemListener(
28
29 new ItemListener() // anonymous inner class
30 {
31 // stop sound and change sound to user's selection
32 public void itemStateChanged(ItemEvent e)
33 {
34 currentSound.stop();
35 currentSound = soundJComboBox.getSelectedIndex() == 0 ?
36 sound1 : sound2;
37 } // end method itemStateChanged
38 } // end anonymous inner class
39); // end addItemListener method call
40
41 add(soundJComboBox); // add JComboBox to applet
42
43 // set up button event handler and buttons
44 ButtonHandler handler = new ButtonHandler();
45
46 // create Play JButton
47 playJButton = new JButton("Play");
48 playJButton.addActionListener(handler);
49 add(playJButton);
50
51 // create Loop JButton
52 loopJButton = new JButton("Loop");
53 loopJButton.addActionListener(handler);
54 add(loopJButton);
55
56 // create Stop JButton
57 stopJButton = new JButton("Stop");
```

**Fig. 24.8** | Loading and playing an AudioClip. (Part 2 of 3.)



```

58 stopJButton.addActionListener(handler);
59 add(stopJButton);
60
61 // load sounds and set currentSound
62 sound1 = getAudioClip(getDocumentBase(), "welcome.wav");
63 sound2 = getAudioClip(getDocumentBase(), "hi.au");
64 currentSound = sound1;
65 } // end method init
66
67 // stop the sound when the user switches web pages
68 public void stop()
69 {
70 currentSound.stop(); // stop AudioClip
71 } // end method stop
72
73 // private inner class to handle button events
74 private class ButtonHandler implements ActionListener
75 {
76 // process play, loop and stop button events
77 public void actionPerformed((ActionEvent actionEvent)
78 {
79 if (actionEvent.getSource() == playJButton)
80 currentSound.play(); // play AudioClip once
81 else if (actionEvent.getSource() == loopJButton)
82 currentSound.loop(); // play AudioClip continuously
83 else if (actionEvent.getSource() == stopJButton)
84 currentSound.stop(); // stop AudioClip
85 } // end method actionPerformed
86 } // end class ButtonHandler
87 } // end class LoadAudioAndPlay

```



**Fig. 24.8** | Loading and playing an AudioClip. (Part 3 of 3.)

Lines 62–63 in the applet’s `init` method use `getAudioClip` to load two audio files—a Windows Wave file (`welcome.wav`) and a Sun Audio file (`hi.au`). The user can select which audio clip to play from the `JComboBox` `soundJComboBox`. The applet’s `stop` method is overridden at lines 68–71. When the user switches web pages, the applet container calls the applet’s `stop` method. This enables the applet to stop playing the audio clip. Otherwise, it continues to play in the background—even if the applet is not displayed in the browser. This is not necessarily a problem, but it can be annoying to the user if the audio clip is looping. The `stop` method is provided here as a convenience to the user.



### Look-and-Feel Observation 24.5

*When playing audio clips in an applet or application, provide a mechanism for the user to disable the audio.*

## 24.6 Playing Video and Other Media with Java Media Framework

A simple video can concisely and effectively convey a great deal of information. Using the Java Media Framework (JMF) API, you can create Java applications that play, edit, stream and capture many popular media types. This section briefly introduces some popular media formats and demonstrates playing video using the JMF API.

JMF 2.1.1e supports media file types such as **Microsoft Audio/Video Interleave** (**.avi**), **Macromedia Flash movies** (**.swf**), **Future Splash** (**.sp1**), **MPEG Layer 3 Audio** (**.mp3**), Musical Instrument Digital Interface (MIDI; **.mid** or **.rmi** extensions), **MPEG-1 videos** (**.mpeg**, **.mpg**), **QuickTime** (**.mov**), Sun Audio file format (**.au** extension), and Macintosh AIFF file format (**.aif** or **.aiff** extensions). You've already seen some of these file types.

Currently, JMF is available as an extension separate from the JDK. The most recent JMF implementation (2.1.1e) can be downloaded from:

```
www.oracle.com/technetwork/java/javase/download-142937.html
```

[*Note:* Keep track of where you install the Java Media Framework on your computer. To compile and run this application, you must include in the class path the `jmf.jar` file that is installed with the Java Media Framework. Recall that you can specify the class path with both the `javac` and `java` commands via the `-classpath` command-line option.]

The JMF website provides versions of the JMF that take advantage of the performance features of certain platforms. For example, the JMF Windows Performance Pack provides extensive media and device support for Java programs running on Microsoft Windows platforms. The JMF's website ([www.oracle.com/technetwork/java/javase/tech/index-jsp-140239.html](http://www.oracle.com/technetwork/java/javase/tech/index-jsp-140239.html)) provides information and resources for JMF programmers.

### *Creating a Simple Media Player*

JMF offers several mechanisms for playing media. The simplest is using objects that implement interface **Player** declared in package **javax.media**. Package `javax.media` and its subpackages contain the classes that compose the Java Media Framework. To play a media clip, you must first create a URL object that refers to it. Then pass the URL as an argument to static method **createRealizedPlayer** of class **Manager** to obtain a **Player** for the media clip. Class **Manager** declares utility methods for accessing system resources to play and to manipulate media. Figure 24.9 declares a `JPanel` that demonstrates some of these methods.

---

```

1 // Fig. 24.9: MediaPlayer.java
2 // JPanel that plays a media file from a URL.
3 import java.awt.BorderLayout;
4 import java.awt.Component;
5 import java.io.IOException;
6 import java.net.URL;
7 import javax.media.CannotRealizeException;
8 import javax.media.Manager;
9 import javax.media.NoPlayerException;
```

**Fig. 24.9** | `JPanel` that plays a media file from a URL. (Part 1 of 2.)

```
10 import javax.media.Player;
11 import javax.swing.JPanel;
12
13 public class MediaPlayer extends JPanel
14 {
15 public MediaPlayer(URL mediaURL)
16 {
17 setLayout(new BorderLayout()); // use a BorderLayout
18
19 // Use lightweight components for Swing compatibility
20 Manager.setHint(Manager.LIGHTWEIGHT_RENDERER, true);
21
22 try
23 {
24 // create a player to play the media specified in the URL
25 Player mediaPlayer = Manager.createRealizedPlayer(mediaURL);
26
27 // get the components for the video and the playback controls
28 Component video = mediaPlayer.getVisualComponent();
29 Component controls = mediaPlayer.getControlPanelComponent();
30
31 if (video != null)
32 add(video, BorderLayout.CENTER); // add video component
33
34 if (controls != null)
35 add(controls, BorderLayout.SOUTH); // add controls
36
37 mediaPlayer.start(); // start playing the media clip
38 } // end try
39 catch (NoPlayerException noPlayerException)
40 {
41 System.err.println("No media player found");
42 } // end catch
43 catch (CannotRealizeException cannotRealizeException)
44 {
45 System.err.println("Could not realize media player");
46 } // end catch
47 catch (IOException iOException)
48 {
49 System.err.println("Error reading from the source");
50 } // end catch
51 } // end MediaPlayer constructor
52 } // end class MediaPlayer
```

**Fig. 24.9** | JPanel that plays a media file from a URL. (Part 2 of 2.)

The constructor (lines 15–51) sets up the JPanel to play the media file specified by the constructor's URL parameter. MediaPlayer uses a BorderLayout (line 17). Line 20 invokes static method `setHint` to set the flag `Manager.LIGHTWEIGHT_RENDERER` to true. This instructs the Manager to use a lightweight renderer that is compatible with lightweight Swing components, as opposed to the default heavyweight renderer. Inside the try block (lines 22–38), line 25 invokes static method `createRealizedPlayer` of class Manager to create and realize a Player that plays the media file. When a Player realizes, it identifies

the system resources it needs to play the media. Depending on the file, realizing can be a resource-consuming and time-consuming process. Method `createRealizedPlayer` throws three checked exceptions, `NoPlayerException`, `CannotRealizeException` and `IOException`. A `NoPlayerException` indicates that the system could not find a player that can play the file format. A `CannotRealizeException` indicates that the system could not properly identify the resources a media file needs. An `IOException` indicates that there was an error while reading the file. These exceptions are handled in the catch block in lines 39–50.

Line 28 invokes method `getVisualComponent` of `Player` to get a `Component` that displays the visual (generally video) aspect of the media file. Line 29 invokes method `getControlPanelComponent` of `Player` to get a `Component` that provides playback and media controls. These components are assigned to local variables `video` and `controls`, respectively. The `if` statements in lines 31–32 and lines 34–35 add the `video` and the `controls` if they exist. The `video` `Component` is added to the `CENTER` region (line 32), so it fills any available space on the `JPanel`. The `controls` `Component`, which is added to the `SOUTH` region, typically provides the following controls:

1. A *positioning slider* to jump to certain points in the media clip
2. A *pause button*
3. A *volume button* that provides volume control by right clicking and a mute function by left clicking
4. A *media properties button* that provides detailed media information by left clicking and frame-rate control by right clicking

Line 37 calls `Player` method `start` to begin playing the media file. Lines 39–50 handle the various exceptions that `createRealizedPlayer` throws.

The application in Fig. 24.10 displays a `JFileChooser` dialog for the user to choose a media file. It then creates a `MediaPanel` that plays the selected file and creates a `JFrame` to display the `MediaPanel`.

---

```

1 // Fig. 24.10: MediaTest.java
2 // Test application that creates a MediaPanel from a user-selected file.
3 import java.io.File;
4 import java.net.MalformedURLException;
5 import java.net.URL;
6 import javax.swing.JFileChooser;
7 import javax.swing.JFrame;
8
9 public class MediaTest
10 {
11 // launch the application
12 public static void main(String args[])
13 {
14 // create a file chooser
15 JFileChooser fileChooser = new JFileChooser();
16
17 // show open file dialog
18 int result = fileChooser.showOpenDialog(null);

```

---

**Fig. 24.10** | Test application that creates a `MediaPanel` from a user-selected file. (Part 1 of 2.)

```

19
20 if (result == JFileChooser.APPROVE_OPTION) // user chose a file
21 {
22 URL mediaURL = null;
23
24 try
25 {
26 // get the file as URL
27 mediaURL = fileChooser.getSelectedFile().toURI().toURL();
28 } // end try
29 catch (MalformedURLException malformedURLException)
30 {
31 System.err.println("Could not create URL for the file");
32 } // end catch
33
34 if (mediaURL != null) // only display if there is a valid URL
35 {
36 JFrame mediaTest = new JFrame("Media Tester");
37 mediaTest.setDefaultCloseOperation(JFrame.EXIT_ON_CLOSE);
38
39 MediaPanel mediaPanel = new MediaPanel(mediaURL);
40 mediaTest.add(mediaPanel);
41
42 mediaTest.setSize(300, 300);
43 mediaTest.setVisible(true);
44 } // end inner if
45 } // end outer if
46 } // end main
47 } // end class MediaTest

```

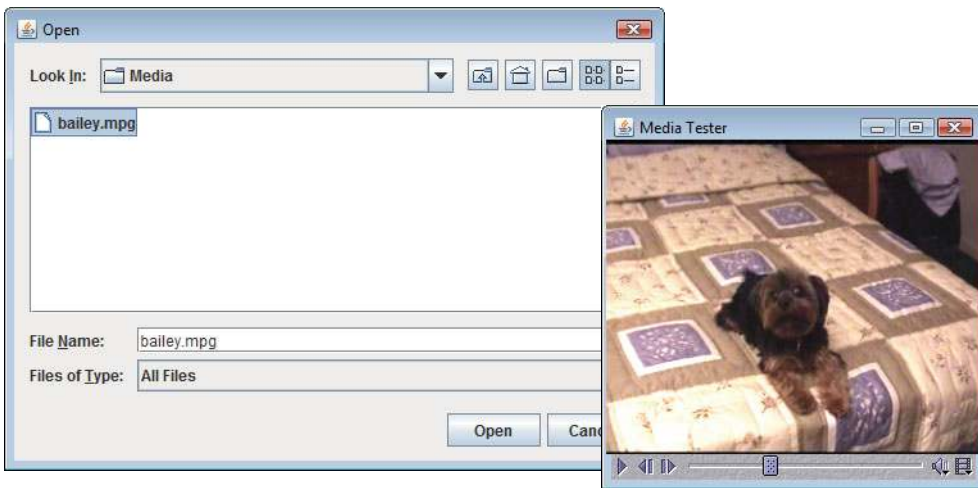

**Fig. 24.10** | Test application that creates a MediaPanel from a user-selected file. (Part 2 of 2.)

Method `main` (lines 12–46) assigns a new `JFileChooser` to local variable `fileChooser` (line 15), shows an open-file dialog (line 18) and assigns the return value to `result`. Line 20 checks `result` to determine whether the user chose a file. To create a

Player to play the selected media file, you must convert the `File` object returned by `JFileChooser` to a `URL` object. Method `toURI` of class `File` returns a `URI` that points to the `File` on the system. We then invoke method `toURL` of class `URI` to get the file's `URL`. The `try` statement (lines 24–32) creates a `URL` for the selected file and assigns it to `mediaURL`. The `if` statement in lines 34–44 checks that `mediaURL` is not `null` and creates the GUI components to play the media.

## 24.7 Wrap-Up

In this chapter, you learned how to build multimedia-rich applications with sound, images, graphics and video. We introduced Java's multimedia capabilities, including the Java Media Framework API and Java Sound API. You used class `ImageIcon` to display and manipulate images stored in files, and you learned about the different image formats supported by Java. You used the `JNLPFileOpenService` to enable the user of a Java Web Start application to select files from the local file system, then used streams to load the contents of those files for use in your programs. You created an animation by displaying a series of images in a specific order. You used image maps to make an application more interactive. You learned how to load audio clips and how to play them either once or in a continuous loop. The chapter concluded with a demonstration of loading and playing video. In the next chapter, you'll continue your study of GUI concepts, building on the techniques you learned in Chapter 14.

## 24.8 Web Resources

[www.nasa.gov/multimedia/index.html](http://www.nasa.gov/multimedia/index.html)

The *NASA Multimedia Gallery* contains a wide variety of images, audio clips and video clips that you can download and use to test your Java multimedia programs.

[commons.wikimedia.org/wiki/Main\\_Page](http://commons.wikimedia.org/wiki/Main_Page)

The *Wikimedia Commons* site provides access to millions of media files.

[www.anbg.gov.au/gardens/index.html](http://www.anbg.gov.au/gardens/index.html)

The *Australian National Botanic Gardens* website provides links to the sounds of many animals. Try, for example, the *Common Birds* link under the “Animals in the Gardens” section.

[www.thefreesite.com](http://www.thefreesite.com)

This site has links to free sounds and clip art.

[www.soundcentral.com](http://www.soundcentral.com)

*SoundCentral* provides audio clips in WAV, AU, AIFF and MIDI formats.

[www.animationfactory.com](http://www.animationfactory.com)

The *Animation Factory* provides thousands of free GIF animations for personal use.

[www.clipart.com](http://www.clipart.com)

This site is a subscription-based service for images and sounds.

[java.sun.com/developer/techDocs/hi/repository/](http://java.sun.com/developer/techDocs/hi/repository/)

The *Java look-and-feel Graphics Repository* provides images designed for use in a Swing GUI, including toolbar button images.

[www.freebyte.com/graphicprograms/](http://www.freebyte.com/graphicprograms/)

This guide contains links to several free graphics software programs. The software can be used to modify images and draw graphics.

[graphicssoft.about.com/od/pixelbasedfreewin/](http://graphicssoft.about.com/od/pixelbasedfreewin/)

This site provides links to free graphics programs designed for use on Windows machines.

### *Java Multimedia API References*

[www.oracle.com/technetwork/java/javase/tech/media-141984.html](http://www.oracle.com/technetwork/java/javase/tech/media-141984.html)

The online home of the Java Media APIs.

[www.oracle.com/technetwork/java/index-139508.html](http://www.oracle.com/technetwork/java/index-139508.html)

The *Java Sound API* home page. Java Sound provides capabilities for playing and recording audio.

[java3d.dev.java.net/](http://java3d.dev.java.net/)

The *Java 3D API* home page. This API can be used to produce three-dimensional images typical of today's video games.

[java.sun.com/products/java-media/speech/](http://java.sun.com/products/java-media/speech/)

The *Java Speech API* enables programs to perform speech synthesis and speech recognition.

[freetts.sourceforge.net/docs/index.php](http://freetts.sourceforge.net/docs/index.php)

*FreeTTS* is an implementation of the Java Speech API.

## Summary

### *Section 24.2 Loading, Displaying and Scaling Images*

- Class `ImageIcon`'s constructors can receive arguments of several different formats, including a byte array containing the bytes of an image, an `Image` (package `java.awt`) already loaded in memory, or a `String` or a URL representing the image's location.
- Java supports several image formats, including Graphics Interchange Format (GIF), Joint Photographic Experts Group (JPEG) and Portable Network Graphics (PNG). The file names for these types typically end with `.gif`, `.jpg` (or `.jpeg`) and `.png`, respectively.
- Java Web Start programs can access the local file system via the JNLP APIs (package `javax.jnlp`). You can use JNLP's `FileOpenService` (p. 969) to request limited access to the local file system.
- The JNLP `ServiceManager` class's static `lookup` (p. 972) method obtains a reference to the `FileOpenService` (p. 969). Since other services are provided by JNLP, this method returns an `Object` reference, which you must cast to the appropriate type.
- `FileOpenService` method `openFileDialog` method (p. 972) displays a file-selection dialog. Java Web Start prompts the user to approve the program's request local file-system access. If the user gives permission, the **Open** dialog is displayed. The `openFileDialog` method has two parameters—a `String` to suggest a directory to open and a `String` array of acceptable file extensions.
- Method `openFileDialog` returns a `FileContents` object, which for security reasons does not give the program access to the file's exact location on disk. Instead, the program can get an `InputStream` and read the file's bytes.
- `FileContents` method `getLength` (p. 973) returns the number of bytes in the file.
- Component methods `getWidth` and `getHeight` (p. 973) return the width and height of a `Component`.
- `ImageIcon` methods `getIconWidth` and `getIconHeight` (p. 973) return the width and height of an image, respectively.
- Class `Graphics` provides overloaded `drawImage` methods (p. 973), one of which displays a scaled version of an `Image` (p. 969). The first argument is the `Image` to draw. The second and third arguments represent the upper-left corner coordinates of the `Image`. The fourth and fifth arguments specify the `Image`'s scaled width and height, respectively. The last argument is a reference to an `ImageObserver` (p. 973)—an interface implemented by class `Component`.
- As an `Image` loads, its `ImageObserver` receives notifications and updates the image on the screen as necessary.

- A draggable applet (p. 974) can be dragged outside the browser window by holding the *Alt* key and dragging the applet with the mouse. The applet will then continue executing, even if the browser is closed. Clicking the close box on the applet when it's executing outside the browser causes the applet to move back into the browser window if it's still open, or to terminate otherwise.

### Section 24.3 Animating a Series of Images

- The `FileOpenService`'s `openMultiFileDialog` method (p. 978) displays a file-selection dialog that allows the user to select multiple files at once. `FileOpenService` method `openMultiFileDialog` takes the same arguments as method `openFileDialog`, but returns an array of `FileContents` objects representing the set of files selected by the user.
- `Timer` objects generate `ActionEvents` at fixed millisecond intervals (`Timer`). The `Timer` constructor receives a delay in milliseconds and an `ActionListener`. `Timer` method `start` (p. 979) starts the `Timer`. Method `stop` indicates that the `Timer` should stop generating events. Method `restart` (p. 979) indicates that the `Timer` should start generating events again.
- `ImageIcon` method `paintIcon` (p. 979) displays the `ImageIcon`'s image. Its four arguments are a reference to the `Component` on which the image will be displayed, a reference to the `Graphics` object used to render the image, the *x*-coordinate of the upper-left corner of the image and the *y*-coordinate of the upper-left corner of the image.

### Section 24.4 Image Maps

- An image map (image map) is an image that has hot areas (p. 982) that the user can click to accomplish a task, such as loading a different web page into a browser.

### Section 24.5 Loading and Playing Audio Clips

- `Applet` method `play` (p. 985) has two forms:

```
public void play(URL location, String soundFileName);
public void play(URL soundURL);
```

One version loads the audio clip (p. 985) stored in file `soundFileName` from `location` and plays the sound. The other takes a `URL` that contains the location and the file name of the audio clip.

- `Applet` method `getDocumentBase` indicates the location of the HTML file that loaded the applet. Method `getCodeBase` (p. 985) indicates where the `.class` file for an applet is located.
- The sound engine (p. 985) that plays audio clips supports several audio file formats, including Sun Audio file format (`.au` extension), Windows Wave file format (`.wav` extension), Macintosh AIFF file format (`.aif` or `.aiff` extensions) and Musical Instrument Digital Interface (MIDI) file format (`.mid` or `.rmi` extensions). The Java Media Framework (JMF; p. 969) supports additional formats.
- `Applet` method `getAudioClip` (p. 985) has two forms that take the same arguments as the `play` method. Method `getAudioClip` returns a reference to an `AudioClip` (p. 985). `AudioClips` have three methods—`play`, `loop` and `stop`. Method `play` plays the audio clip once (p. 985). Method `loop` (p. 985) continuously loops the audio clip. Method `stop` terminates an audio clip that is currently playing.

### Section 24.6 Playing Video and Other Media with Java Media Framework

- Package `javax.media` and its subpackages contain the Java Media Framework classes.
- `ClassManager` (p. 988) declares methods for accessing system resources to play and to manipulate media.
- Method `toURI` of class `File` (p. 992) returns a `URI` that points to the `File` on the system.



## Self-Review Exercises

- 24.1** Fill in the blanks in each of the following statements:
- Graphics method \_\_\_\_\_ displays an image on an applet.
  - Java provides two mechanisms for playing sounds in an applet—the Applet’s `play` method and the `play` method of the \_\_\_\_\_ interface.
  - A(n) \_\_\_\_\_ is an image that has hot areas that the user can click to accomplish a task such as loading a web page.
  - Method \_\_\_\_\_ of class `ImageIcon` displays the `ImageIcon`’s image.
  - Java supports several image formats, including \_\_\_\_\_, \_\_\_\_\_ and \_\_\_\_\_.
  - The `JNLP` \_\_\_\_\_ class’s static `lookup` method obtains a reference to the `FileOpenService`.
- 24.2** Determine whether each of the following statements is *true* or *false*. If *false*, explain why.
- A sound is marked for garbage collection after it plays via the `play` method of class `Applet`.
  - Class `ImageIcon` provides constructors that allow an `ImageIcon` object to be initialized only with an image from the local computer.
  - Method `play` of class `AudioClip` continuously loops an audio clip.
  - The Java Image I/O API is used for adding 3D graphics to a Java application.
  - `Applet` method `getDocumentBase` returns, as an object of class `URL`, the location on the Internet of the HTML file that invoked the applet.
  - `FileOpenService` methods `openFileDialog` and `openMultiFileDialog` return a `FileContents` object and an array of `FileContents` objects, respectively.

## Answers to Self-Review Exercises

- 24.1** a) `drawImage`. b) `AudioClip`. c) image map. d) `paintIcon`. e) Graphics Interchange Format (GIF), Joint Photographic Experts Group (JPEG), Portable Network Graphics (PNG). f) `ServiceManager`.
- 24.2** a) True. b) False. `ImageIcon` can load images from the Internet as well. c) False. Method `play` of class `AudioClip` plays an audio clip once. Method `loop` of class `AudioClip` continuously loops an audio clip. d) False. The Java 3D API is used for creating and modifying 3D graphics. The Java Image I/O API is used for reading from and outputting images to files. e) True. f) True.

## Exercises

- 24.3** (*“Browser-Friendly” Animation*) Describe how to make an animation “browser friendly.”
- 24.4** (*Audio Clips*) Describe the Java methods for playing and manipulating audio clips.
- 24.5** (*Image Maps*) Explain how image maps are used. List several examples of their use.
- 24.6** (*Randomly Erasing an Image*) Suppose an image is displayed in a rectangular screen area. One way to erase the image is simply to set every pixel to the same color immediately, but the visual effect is dull. Write a Java program that displays an image, then erases it by using random-number generation to select individual pixels to erase. After most of the image is erased, erase all the remaining pixels at once. You can draw individual pixels as a line that starts and ends at the same coordinates. You might try several variants of this problem. For example, you might display lines randomly or display shapes randomly to erase regions of the screen.
- 24.7** (*Text Flasher*) Create a Java program that repeatedly flashes text on the screen. Do this by alternating the text with a plain background-color image. Allow the user to control the “blink speed” and the background color or pattern. You’ll need to use methods `getDelay` and `setDelay` of class

Timer. These methods are used to retrieve and set the interval in milliseconds between Action-Events, respectively

**24.8** (*Image Flasher*) Create a Java program that repeatedly flashes an image on the screen. Do this by alternating the image with a plain background-color image.

**24.9** (*Digital Clock*) Implement a program that displays a digital clock on the screen.

**24.10** (*Calling Attention to an Image*) If you want to emphasize an image, you might place a row of simulated light bulbs around it. You can let the light bulbs flash in unison or fire on and off in sequence one after the other.

**24.11** (*Image Zooming*) Create a program that enables you to zoom in on or out from an image.

**24.12** (*LoadImageAndScale Modification*) Modify applet `LoadImageAndScale` (Fig. 24.1) to provide a second button that enables the user to choose a new image. The button's event handler should use the `JNLP FileOpenService` to display an `Open` dialog, so that the user can select a new image.

**24.13** (*Image Viewer*) Using the JNLP techniques you learned in Sections 24.2–24.3, create an image viewer application that enables the user to select a group of images to display. The application should display a `JList` containing the names of the selected files. You can obtain the name of the file represented by a `FileContents` object by calling its `getName` method. When the user clicks the name of an image in the `JList`, the application should display the image in the window.

## Special Section: Challenging Multimedia Projects

The preceding exercises are keyed to the text and designed to test your understanding of fundamental multimedia concepts. This section includes a collection of advanced multimedia projects. You should find these problems challenging, yet entertaining. The problems vary in difficulty. Some require an hour or two of program writing and implementation. Others are useful for lab assignments that might require two or three weeks of study and implementation. Some are challenging term projects. [*Note to Instructors:* Solutions are *not* provided for these exercises.]

**24.14** (*Animation*) Create a general-purpose Java animation program. It should allow the user to specify the sequence of frames to be displayed, the speed at which the images are displayed, audios to be played while the animation is running and so on.

**24.15** (*Limericks*) Modify the limerick-writing program you wrote in Exercise 16.6 to sing the limericks your program creates.

**24.16** (*Random Interimage Transition*) This provides a nice visual effect. If you're displaying one image in a given area on the screen and you'd like to transition to another image in the same area, store the new screen image in an off-screen buffer and randomly copy pixels from it to the display area, overlaying the pixels already at those locations. When the vast majority of the pixels have been copied, copy the entire new image to the display area to be sure you're displaying the complete new image. To implement this program, you may need to use the `PixelGrabber` and `MemoryImageSource` classes (see the Java API documentation for descriptions of these classes). You might try several variants of this problem. For example, select all the pixels in a randomly chosen straight line or shape in the new image and overlay them above the corresponding positions of the old image.

**24.17** (*Background Audio*) Add background audio to one of your favorite applications by using the `loop` method of class `AudioClip` to play the sound in the background while you interact with your application in the normal way.

**24.18** (*Scrolling Marquee Sign*) Create a program that scrolls dotted characters from right to left (or from left to right if that is appropriate for your language) across a marquee-like display sign. As an option, display the text in a continuous loop, so that after the text disappears at one end, it reappears at the other.

- 24.19** (*Scrolling Image Marquee*) Create a program that scrolls an image across a marquee screen.
- 24.20** (*Analog Clock*) Create a program that displays an analog clock with hour, minute and second hands that move appropriately as the time changes.
- 24.21** (*Dynamic Audio and Graphical Kaleidoscope*) Write a kaleidoscope program that displays reflected graphics to simulate the popular children’s toy. Incorporate audio effects that “mirror” your program’s dynamically changing graphics.
- 24.22** (*Automatic Jigsaw Puzzle Generator*) Create a jigsaw puzzle generator and manipulator. The user specifies an image. Your program loads and displays the image, then breaks it into randomly selected shapes and shuffles them. The user then uses the mouse to move the pieces around to solve the puzzle. Add appropriate audio sounds as the pieces are moved around and snapped back into place. You might keep tabs on each piece and where it really belongs—then use audio effects to help the user get the pieces into the correct positions.
- 24.23** (*Maze Generator and Walker*) Develop a multimedia-based maze generator and traverser program based on the maze programs you wrote in Exercises 18.20–18.22. Let the user customize the maze by specifying the number of rows and columns and by indicating the level of difficulty. Have an animated mouse walk the maze. Use audio to dramatize the movement of your mouse character.
- 24.24** (*One-Armed Bandit*) Develop a multimedia simulation of a “one-armed bandit.” Have three spinning wheels. Place symbols and images of various fruits on each wheel. Use random-number generation to simulate the spinning of each wheel and the stopping of each wheel on a symbol.
- 24.25** (*Horse Race*) Create a simulation of a horse race. Have multiple contenders. Use audios for a race announcer. Play the appropriate audios to indicate the correct status of each contender throughout the race. Use audios to announce the final results. You might try to simulate the kinds of horse-racing games that are often played at carnivals. The players take turns at the mouse and have to perform some skill-oriented manipulation with it to advance their horses.
- 24.26** (*Shuffleboard*) Develop a multimedia-based simulation of the game of shuffleboard. Use appropriate audio and visual effects.
- 24.27** (*Game of Pool*) Create a multimedia-based simulation of the game of pool. Each player takes turns using the mouse to position a pool cue and hit it against the ball at the appropriate angle to try to make other balls fall into the pockets. Your program should keep score.
- 24.28** (*Artist*) Design an art program that will give an artist a great variety of capabilities to draw, use images and use animations to create a dynamic multimedia art display.
- 24.29** (*Fireworks Designer*) Create a Java program that someone might use to create a fireworks display. Create a variety of fireworks demonstrations. Then orchestrate the firing of the fireworks for maximum effect.
- 24.30** (*Floor Planner*) Develop a program that will help someone arrange furniture in a home. Add features that enable the person to achieve the best possible arrangement.
- 24.31** (*Crossword*) Crossword puzzles are among the most popular pastimes. Develop a multimedia-based crossword-puzzle program. Your program should enable the player to place and erase words easily. Tie your program to a large computerized dictionary. Your program also should be able to suggest words on which letters have already been filled in. Provide other features that will make the crossword-puzzle enthusiast’s job easier.
- 24.32** (*15 Puzzle*) Write a multimedia-based program that enables the user to play the game of 15. The game is played on a 4-by-4 board having a total of 16 slots. One slot is empty, the others are occupied by 15 tiles numbered 1 through 15. The user can move any tile next to the currently empty slot into that slot by clicking on the tile. Your program should create the board with the tiles in random order. The goal is to arrange the tiles into sequential order, row by row.

**24.33** (*Reaction Time/Reaction Precision Tester*) Create a program that moves a randomly created shape around the screen. The user moves the mouse to catch and click on the shape. The shape's speed and size can be varied. Keep statistics on how long the user typically takes to catch a shape of a given size. The user will probably have more difficulty catching faster-moving, smaller shapes.

**24.34** (*Calendar/Tickler File*) Using both audio and images, create a general-purpose calendar and "tickler" file. For example, the program should sing "Happy Birthday" when you use it on your birthday. Have the program display images and play audios associated with important events. Also, have it remind you in advance of these important events. It would be nice, for example, to have the program give you a week's notice so you can pick up an appropriate greeting card for that special person.

**24.35** (*Rotating Images*) Create a program that lets you rotate an image through some number of degrees (out of a maximum of 360 degrees). The program should let you specify that you want to spin the image continuously. It should let you adjust the spin speed dynamically.

**24.36** (*Coloring Black-and-White Photographs and Images*) Create a program that lets you paint a black-and-white photograph with color. Provide a color palette for selecting colors. Your program should let you apply different colors to different regions of the image.

**24.37** (*Multimedia-Based Simpletron Simulator*) Modify the Simpletron simulator that you developed in Exercises 7.35–7.37 to include multimedia features. Add computer-like sounds to indicate that the Simpletron is executing instructions. Add a breaking-glass sound when a fatal error occurs. Use flashing lights to indicate which cells of memory or which registers are currently being manipulated. Use other multimedia techniques, as appropriate, to make your Simpletron simulator more valuable to its users as an educational tool.

## Making a Difference

**24.38** (*Accessibility Project: Speech Synthesis*) Computers can help people who are blind or have low vision by speaking web pages, e-mails and other documents using text-to-speech (TTS) or speech-synthesis "engines." Similarly, to help people who have difficulty interacting with a computer via the mouse and keyboard, speech-recognition engines enable computers to recognize spoken commands. With speech synthesis and speech recognition, users can "talk" with computers. In this exercise, you'll research and explore speech synthesis with the Java Speech API ([java.sun.com/products/java-media/speech/](http://java.sun.com/products/java-media/speech/)). Download and install the open-source FreeTTS speech synthesizer ([freetts.sourceforge.net/docs/index.php](http://freetts.sourceforge.net/docs/index.php)). Explore the FreeTTS documentation, then implement an application in which the user can enter text in a `JTextArea`. When the user clicks a `Speak` `JButton`, the program should use FreeTTS to speak the text aloud.

**24.39** (*Accessibility Project: Speech Recognition*) In this exercise, you'll research and explore speech recognition with the Java Speech API. Download and install the open-source Sphinx-4 speech-recognition engine ([cmusphinx.sourceforge.net/sphinx4/](http://cmusphinx.sourceforge.net/sphinx4/)). Write a program that enables a user to speak to the computer. Use the speech-recognition capabilities to display what the user says in a `JTextArea`. Enable the user to save the contents of the `JTextArea` to a file on disk by speaking the command "save".

**24.40** (*Project: Simbad Robotics Simulator*) Robotics holds tremendous promise for handling jobs that are dangerous for humans, such as mining coal, mining and farming the depths of the ocean and exploring deep space. Simbad ([simbad.sourceforge.net](http://simbad.sourceforge.net)) is an open-source Java-based 3D robotics simulator. According to the project's web page, it supports single- and multi-robot simulations; vision, range and contact sensors; and more. You can download Simbad from [simbad.sourceforge.net/index.php#download](http://simbad.sourceforge.net/index.php#download). You'll also need to download and install Java 3D — instructions are provided on this site for Mac OS X, Windows and Linux.

Once you've downloaded Simbad and installed Java 3D, you can try the simple example provided at [simbad.sourceforge.net/example1.php](http://simbad.sourceforge.net/example1.php). After getting this running, read the Simbad Programming Guide at [simbad.sourceforge.net/guide.php](http://simbad.sourceforge.net/guide.php) and try modifying the simple example to perform some different tasks. If you're interested in exploring robotics further, study the API documentation at [simbad.sourceforge.net/doc/](http://simbad.sourceforge.net/doc/) and create your own robot simulation program using Simbad. For example, create a simulation of a robot vacuum cleaner that travels in the direction it's facing until it encounters an obstacle, then randomly chooses another direction.

# 25

## GUI Components: Part 2

*An actor entering through the door, you've got nothing. But if he enters through the window, you've got a situation.*

—Billy Wilder

*...the force of events wakes slumberous talents.*

—Edward Hoagland

*You and I would see more interesting photography if they would stop worrying, and instead, apply horse-sense to the problem of recording the look and feel of their own era.*

—Jessie Tarbox Beals

### Objectives

In this chapter you'll learn:

- To create and manipulate sliders, menus, pop-up menus and windows.
- To programmatically change the look-and-feel of a GUI, using Swing's pluggable look-and-feel.
- To create a multiple-document interface with `JDesktopPane` and `JInternalFrame`.
- To use additional layout managers.

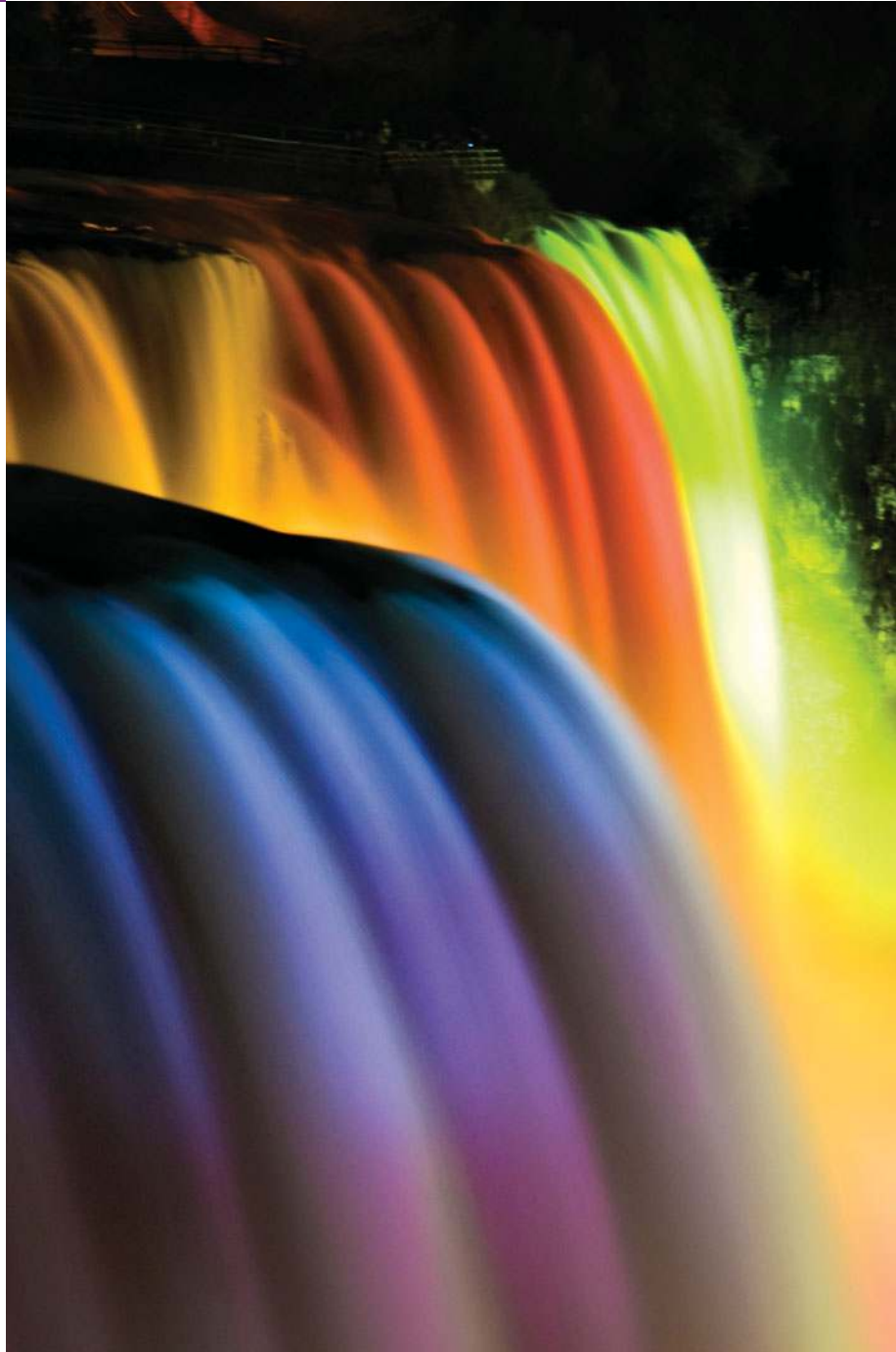

|                                       |                                                                |
|---------------------------------------|----------------------------------------------------------------|
| <b>25.1</b> Introduction              | <b>25.7</b> JDesktopPane and<br>JInternalFrame                 |
| <b>25.2</b> JSlider                   | <b>25.8</b> JTabbedPane                                        |
| <b>25.3</b> Windows: Additional Notes | <b>25.9</b> Layout Managers: BorderLayout and<br>GridBagLayout |
| <b>25.4</b> Using Menus with Frames   | <b>25.10</b> Wrap-Up                                           |
| <b>25.5</b> JPopupMenu                |                                                                |
| <b>25.6</b> Pluggable Look-and-Feel   |                                                                |

Summary | Self-Review Exercises | Answers to Self-Review Exercises | Exercises

## 25.1 Introduction

In this chapter, we continue our study of GUIs. We discuss additional components and layout managers and lay the groundwork for building more complex GUIs.

We begin our discussion with sliders that enable you to select from a range of integer values. Next, we discuss some additional details of windows. You'll learn to use menus that enable the user to effectively perform tasks in the program. The look-and-feel of a Swing GUI can be uniform across all platforms on which a Java program executes, or the GUI can be customized by using Swing's **pluggable look-and-feel (PLAF)**. We provide an example that illustrates how to change between Swing's default metal look-and-feel (which looks and behaves the same across platforms), the Nimbus look-and-feel (introduced in Chapter 14), a look-and-feel that simulates **Motif** (a popular UNIX look-and-feel) and one that simulates Microsoft's Windows look-and-feel.

Many of today's applications use a multiple-document interface (MDI)—a main window (often called the *parent window*) containing other windows (often called *child windows*) to manage several open documents in parallel. For example, many e-mail programs allow you to have several e-mail windows open at the same time so that you can compose or read multiple e-mail messages. We demonstrate Swing's classes for creating multiple-document interfaces. The chapter finishes with a series of examples discussing additional layout managers for organizing graphical user interfaces.

Swing is a large and complex topic. There are many more GUI components and capabilities than can be presented here. Several more Swing GUI components are introduced in the remaining chapters of this book as they're needed.

## 25.2 JSlider

**JSliders** enable a user to select from a range of integer values. Class `JSlider` inherits from `JComponent`. Figure 25.1 shows a horizontal `JSlider` with **tick marks** and the **thumb** that allows a user to select a value. `JSliders` can be customized to display *major tick marks*, *minor tick marks* and labels for the tick marks. They also support **snap-to ticks**, which cause the *thumb*, when positioned between two tick marks, to snap to the closest one.



**Fig. 25.1** | `JSlider` component with horizontal orientation.

Most Swing GUI components support user interactions through the mouse and the keyboard. For example, if a `JSlider` has the focus (i.e., it's the currently selected GUI component in the user interface), the left arrow key and right arrow key cause the thumb of the `JSlider` to decrease or increase by 1, respectively. The down arrow key and up arrow key also cause the thumb to decrease or increase by 1 tick, respectively. The *PgDn* (page down) *key* and *PgUp* (page up) *key* cause the thumb to decrease or increase by **block increments** of one-tenth of the range of values, respectively. The *Home key* moves the thumb to the minimum value of the `JSlider`, and the *End key* moves the thumb to the maximum value of the `JSlider`.

`JSliders` have either a horizontal or a vertical orientation. For a horizontal `JSlider`, the minimum value is at the left end and the maximum is at the right end. For a vertical `JSlider`, the minimum value is at the bottom and the maximum is at the top. The minimum and maximum value positions on a `JSlider` can be reversed by invoking `JSlider` method `setInverted` with boolean argument `true`. The relative position of the thumb indicates the current value of the `JSlider`.

The program in Figs. 25.2–25.4 allows the user to size a circle drawn on a subclass of `JPanel` called `OvalPanel` (Fig. 25.2). The user specifies the circle's diameter with a horizontal `JSlider`. Class `OvalPanel` knows how to draw a circle on itself, using its own instance variable `diameter` to determine the diameter of the circle—the `diameter` is used as the width and height of the bounding box in which the circle is displayed. The `diameter` value is set when the user interacts with the `JSlider`. The event handler calls method `setDiameter` in class `OvalPanel` to set the `diameter` and calls `repaint` to draw the new circle. The `repaint` call results in a call to `OvalPanel`'s `paintComponent` method.

---

```

1 // Fig. 25.2: OvalPanel.java
2 // A customized JPanel class.
3 import java.awt.Graphics;
4 import java.awt.Dimension;
5 import javax.swing.JPanel;
6
7 public class OvalPanel extends JPanel
8 {
9 private int diameter = 10; // default diameter of 10
10
11 // draw an oval of the specified diameter
12 public void paintComponent(Graphics g)
13 {
14 super.paintComponent(g);
15
16 g.fillOval(10, 10, diameter, diameter); // draw circle
17 } // end method paintComponent
18
19 // validate and set diameter, then repaint
20 public void setDiameter(int newDiameter)
21 {
22 // if diameter invalid, default to 10
23 diameter = (newDiameter >= 0 ? newDiameter : 10);

```

---

**Fig. 25.2** | `JPanel` subclass for drawing circles of a specified diameter. (Part I of 2.)



```

24 repaint(); // repaint panel
25 } // end method setDiameter
26
27 // used by layout manager to determine preferred size
28 public Dimension getPreferredSize()
29 {
30 return new Dimension(200, 200);
31 } // end method getPreferredSize
32
33 // used by layout manager to determine minimum size
34 public Dimension getMinimumSize()
35 {
36 return getPreferredSize();
37 } // end method getMinimumSize
38 } // end class OvalPanel

```

**Fig. 25.2** | JPanel subclass for drawing circles of a specified diameter. (Part 2 of 2.)

```

1 // Fig. 25.3: SliderFrame.java
2 // Using JSliders to size an oval.
3 import java.awt.BorderLayout;
4 import java.awt.Color;
5 import javax.swing.JFrame;
6 import javax.swing.JSlider;
7 import javax.swing.SwingConstants;
8 import javax.swing.event.ChangeListener;
9 import javax.swing.event.ChangeEvent;
10
11 public class SliderFrame extends JFrame
12 {
13 private JSlider diameterJSlider; // slider to select diameter
14 private OvalPanel myPanel; // panel to draw circle
15
16 // no-argument constructor
17 public SliderFrame()
18 {
19 super("Slider Demo");
20
21 myPanel = new OvalPanel(); // create panel to draw circle
22 myPanel.setBackground(Color.YELLOW); // set background to yellow
23
24 // set up JSlider to control diameter value
25 diameterJSlider =
26 new JSlider(SwingConstants.HORIZONTAL, 0, 200, 10);
27 diameterJSlider.setMajorTickSpacing(10); // create tick every 10
28 diameterJSlider.setPaintTicks(true); // paint ticks on slider
29
30 // register JSlider event listener
31 diameterJSlider.addChangeListener(
32
33 new ChangeListener() // anonymous inner class
34 {

```

**Fig. 25.3** | JSlider value used to determine the diameter of a circle. (Part 1 of 2.)

```

35 // handle change in slider value
36 public void stateChanged(ChangeEvent e)
37 {
38 myPanel.setDiameter(diameterJSlider.getValue());
39 } // end method stateChanged
40 } // end anonymous inner class
41); // end call to addChangeListener
42
43 add(diameterJSlider, BorderLayout.SOUTH); // add slider to frame
44 add(myPanel, BorderLayout.CENTER); // add panel to frame
45 } // end SliderFrame constructor
46 } // end class SliderFrame

```

**Fig. 25.3** | JSlider value used to determine the diameter of a circle. (Part 2 of 2.)

```

1 // Fig. 25.4: SliderDemo.java
2 // Testing SliderFrame.
3 import javax.swing.JFrame;
4
5 public class SliderDemo
6 {
7 public static void main(String[] args)
8 {
9 SliderFrame sliderFrame = new SliderFrame();
10 sliderFrame.setDefaultCloseOperation(JFrame.EXIT_ON_CLOSE);
11 sliderFrame.setSize(220, 270); // set frame size
12 sliderFrame.setVisible(true); // display frame
13 } // end main
14 } // end class SliderDemo

```

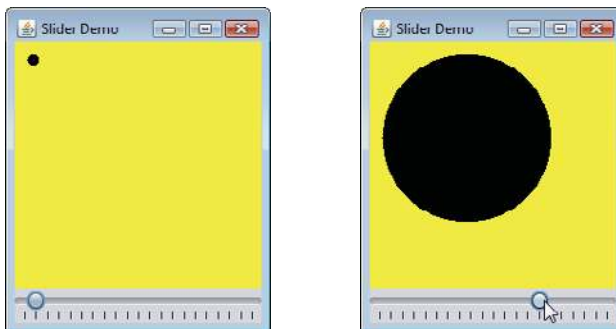

**Fig. 25.4** | Test class for SliderFrame.

Class `OvalPanel` (Fig. 25.2) contains a `paintComponent` method (lines 12–17) that draws a filled oval (a circle in this example), a `setDiameter` method (lines 20–25) that changes the circle’s diameter and repaints the `OvalPanel`, a `getPreferredSize` method (lines 28–31) that returns the preferred width and height of an `OvalPanel` and a `getMinimumSize` method (lines 34–37) that returns an `OvalPanel`’s minimum width and height. Section 24.3 introduced `getPreferredSize` and `getMinimumSize`, which are used by some layout managers to determine the size of a component.

Class `SliderFrame` (Fig. 25.3) creates the `JSlider` that controls the diameter of the circle. Class `SliderFrame`'s constructor (lines 17–45) creates `OvalPanel` object `myPanel` (line 21) and sets its background color (line 22). Lines 25–26 create `JSlider` object `diameterSlider` to control the diameter of the circle drawn on the `OvalPanel`. The `JSlider` constructor takes four arguments. The first argument specifies the orientation of `diameterSlider`, which is `HORIZONTAL` (a constant in interface `SwingConstants`). The second and third arguments indicate the minimum and maximum integer values in the range of values for this `JSlider`. The last argument indicates that the initial value of the `JSlider` (i.e., where the thumb is displayed) should be 10.

Lines 27–28 customize the appearance of the `JSlider`. Method **`setMajorTickSpacing`** indicates that each major tick mark represents 10 values in the range of values supported by the `JSlider`. Method **`setPaintTicks`** with a `true` argument indicates that the tick marks should be displayed (they aren't displayed by default). For other methods that are used to customize a `JSlider`'s appearance, see the `JSlider` on-line documentation ([download.oracle.com/javase/6/docs/api/javaw/swing/JSlider.html](http://download.oracle.com/javase/6/docs/api/javaw/swing/JSlider.html)).

`JSliders` generate **`ChangeEvent`**s (package `javax.swing.event`) in response to user interactions. An object of a class that implements interface **`ChangeListener`** (package `javax.swing.event`) and declares method **`stateChanged`** can respond to `ChangeEvent`s. Lines 31–41 register a `ChangeListener` to handle `diameterSlider`'s events. When method `stateChanged` (lines 36–39) is called in response to a user interaction, line 38 calls `myPanel`'s `setDiameter` method and passes the current value of the `JSlider` as an argument. `JSlider` method **`getValue`** returns the current thumb position.

## 25.3 Windows: Additional Notes

A `JFrame` is a **window** with a **title bar** and a **border**. Class `JFrame` is a subclass of `Frame` (package `java.awt`), which is a subclass of `Window` (package `java.awt`). As such, `JFrame` is one of the *heavyweight* Swing GUI components. When you display a window from a Java program, the window is provided by the local platform's windowing toolkit, and therefore the window will look like every other window displayed on that platform. When a Java application executes on a Macintosh and displays a window, the window's title bar and borders will look like those of other Macintosh applications. When a Java application executes on a Microsoft Windows system and displays a window, the window's title bar and borders will look like those of other Microsoft Windows applications. And when a Java application executes on a UNIX platform and displays a window, the window's title bar and borders will look like other UNIX applications on that platform.

By default, when the user closes a `JFrame` window, it's hidden (i.e., removed from the screen), but you can control this with `JFrame` method **`setDefaultCloseOperation`**. Interface **`WindowConstants`** (package `javax.swing`), which class `JFrame` implements, declares three constants—`DISPOSE_ON_CLOSE`, `DO_NOTHING_ON_CLOSE` and `HIDE_ON_CLOSE` (the default)—for use with this method. Some platforms allow only a limited number of windows to be displayed on the screen. Thus, a window is a valuable resource that should be given back to the system when it's no longer needed. Class `Window` (an indirect superclass of `JFrame`) declares method **`dispose`** for this purpose. When a window is no longer needed in an application, you should explicitly dispose of it. This can be done by calling the `Window`'s `dispose` method or by calling method `setDefaultCloseOperation` with the argument `WindowConstants.DISPOSE_ON_CLOSE`. Terminating an application also returns

window resources to the system. Using `DO_NOTHING_ON_CLOSE` indicates that the program will determine what to do when the user attempts to close the window. For example, the program might want to ask whether to save a file's changes before closing a window.



### Performance Tip 25.1

*A window is an expensive system resource. Return it to the system by calling its `dispose` method when the window is no longer needed.*

By default, a window is not displayed on the screen until the program invokes the window's `setVisible` method (inherited from class `java.awt.Component`) with a `true` argument. A window's size should be set with a call to method `setSize` (inherited from class `java.awt.Component`). The position of a window when it appears on the screen is specified with method `setLocation` (inherited from class `java.awt.Component`).



### Common Programming Error 25.1

*Forgetting to call method `setVisible` on a window is a runtime logic error—the window is not displayed.*



### Common Programming Error 25.2

*Forgetting to call the `setSize` method on a window is a runtime logic error—only the title bar appears.*

When the user manipulates the window, this action generates **window events**. Event listeners are registered for window events with `Window` method `addWindowListener`. Interface `WindowListener` provides seven window-event-handling methods—`windowActivated` (called when the user makes a window the active window), `windowClosed` (called after the window is closed), `windowClosing` (called when the user initiates closing of the window), `windowDeactivated` (called when the user makes another window the active window), `windowDeiconified` (called when the user restores a window from being minimized), `windowIconified` (called when the user minimizes a window) and `windowOpened` (called when a program first displays a window on the screen).

## 25.4 Using Menus with Frames

**Menus** are an integral part of GUIs. They allow the user to perform actions without unnecessarily cluttering a GUI with extra components. In Swing GUIs, menus can be attached only to objects of the classes that provide method `setJMenuBar`. Two such classes are `JFrame` and `JApplet`. The classes used to declare menus are `JMenuBar`, `JMenu`, `JMenuItem`, `JCheckBoxMenuItem` and class `JRadioButtonMenuItem`.



### Look-and-Feel Observation 25.1

*Menus simplify GUIs because components can be hidden within them. These components will be visible only when the user looks for them by selecting the menu.*

### Overview of Several Menu-Related Components

Class `JMenuBar` (a subclass of `JComponent`) contains the methods necessary to manage a **menu bar**, which is a container for menus. Class `JMenu` (a subclass of `javax.swing.JMenuItem`) contains the methods necessary for managing menus. Menus contain menu items

and are added to menu bars or to other menus as submenus. When a menu is clicked, it expands to show its list of menu items.

Class **JMenuItem** (a subclass of `javax.swing.AbstractButton`) contains the methods necessary to manage **menu items**. A menu item is a GUI component inside a menu that, when selected, causes an action event. A menu item can be used to initiate an action, or it can be a **submenu** that provides more menu items from which the user can select. Submenus are useful for grouping related menu items in a menu.

Class **JCheckBoxMenuItem** (a subclass of `javax.swing.JMenuItem`) contains the methods necessary to manage menu items that can be toggled on or off. When a `JCheckBoxMenuItem` is selected, a check appears to the left of the menu item. When the `JCheckBoxMenuItem` is selected again, the check is removed.

Class **JRadioButtonMenuItem** (a subclass of `javax.swing.JMenuItem`) contains the methods necessary to manage menu items that can be toggled on or off like `JCheckBoxMenuItem`s. When multiple `JRadioButtonMenuItem`s are maintained as part of a `ButtonGroup`, only one item in the group can be selected at a given time. When a `JRadioButtonMenuItem` is selected, a filled circle appears to the left of the menu item. When another `JRadioButtonMenuItem` is selected, the filled circle of the previously selected menu item is removed.

### *Using Menus in an Application*

Figures 25.5–25.6 demonstrate various menu items and how to specify special characters called **mnemonics** that can provide quick access to a menu or menu item from the keyboard. Mnemonics can be used with all subclasses of `javax.swing.AbstractButton`. Class `MenuFrame` (Fig. 25.5) creates the GUI and handles the menu-item events. Most of the code in this application appears in the class's constructor (lines 34–151).

---

```

1 // Fig. 25.5: MenuFrame.java
2 // Demonstrating menus.
3 import java.awt.Color;
4 import java.awt.Font;
5 import java.awt.BorderLayout;
6 import java.awt.event.ActionListener;
7 import java.awt.event.ActionEvent;
8 import java.awt.event.ItemListener;
9 import java.awt.event.ItemEvent;
10 import javax.swing.JFrame;
11 import javax.swing.JRadioButtonMenuItem;
12 import javax.swing.JCheckBoxMenuItem;
13 import javax.swing.JOptionPane;
14 import javax.swing.JLabel;
15 import javax.swing.SwingConstants;
16 import javax.swing.ButtonGroup;
17 import javax.swing.JMenu;
18 import javax.swing.JMenuItem;
19 import javax.swing.JMenuBar;
20
21 public class MenuFrame extends JFrame
22 {
```

**Fig. 25.5** | JMenus and mnemonics. (Part I of 5.)

```

23 private final Color[] colorValues =
24 { Color.BLACK, Color.BLUE, Color.RED, Color.GREEN };
25 private JRadioButtonMenuItem[] colorItems; // color menu items
26 private JRadioButtonMenuItem[] fonts; // font menu items
27 private JCheckBoxMenuItem[] styleItems; // font style menu items
28 private JLabel displayJLabel; // displays sample text
29 private ButtonGroup fontButtonGroup; // manages font menu items
30 private ButtonGroup colorButtonGroup; // manages color menu items
31 private int style; // used to create style for font
32
33 // no-argument constructor set up GUI
34 public MenuFrame()
35 {
36 super("Using JMenus");
37
38 JMenu fileMenu = new JMenu("File"); // create file menu
39 fileMenu.setMnemonic('F'); // set mnemonic to F
40
41 // create About... menu item
42 JMenuItem aboutItem = new JMenuItem("About...");
43 aboutItem.setMnemonic('A'); // set mnemonic to A
44 fileMenu.add(aboutItem); // add about item to file menu
45 aboutItem.addActionListener(
46
47 new ActionListener() // anonymous inner class
48 {
49 // display message dialog when user selects About...
50 public void actionPerformed((ActionEvent event))
51 {
52 JOptionPane.showMessageDialog(MenuFrame.this,
53 "This is an example\nof using menus",
54 "About", JOptionPane.PLAIN_MESSAGE);
55 } // end method actionPerformed
56 } // end anonymous inner class
57); // end call to addActionListener
58
59 JMenuItem exitItem = new JMenuItem("Exit"); // create exit item
60 exitItem.setMnemonic('x'); // set mnemonic to x
61 fileMenu.add(exitItem); // add exit item to file menu
62 exitItem.addActionListener(
63
64 new ActionListener() // anonymous inner class
65 {
66 // terminate application when user clicks exitItem
67 public void actionPerformed((ActionEvent event))
68 {
69 System.exit(0); // exit application
70 } // end method actionPerformed
71 } // end anonymous inner class
72); // end call to addActionListener
73
74 JMenuBar bar = new JMenuBar(); // create menu bar
75 setJMenuBar(bar); // add menu bar to application

```

**Fig. 25.5** | JMenus and mnemonics. (Part 2 of 5.)

```

76 bar.add(fileMenu); // add file menu to menu bar
77
78 JMenu formatMenu = new JMenu("Format"); // create format menu
79 formatMenu.setMnemonic('r'); // set mnemonic to r
80
81 // array listing string colors
82 String[] colors = { "Black", "Blue", "Red", "Green" };
83
84 JMenu colorMenu = new JMenu("Color"); // create color menu
85 colorMenu.setMnemonic('C'); // set mnemonic to C
86
87 // create radio button menu items for colors
88 colorItems = new JRadioButtonMenuItem[colors.length];
89 colorButtonGroup = new ButtonGroup(); // manages colors
90 ItemHandler itemHandler = new ItemHandler(); // handler for colors
91
92 // create color radio button menu items
93 for (int count = 0; count < colors.length; count++)
94 {
95 colorItems[count] =
96 new JRadioButtonMenuItem(colors[count]); // create item
97 colorMenu.add(colorItems[count]); // add item to color menu
98 colorButtonGroup.add(colorItems[count]); // add to group
99 colorItems[count].addActionListener(itemHandler);
100 } // end for
101
102 colorItems[0].setSelected(true); // select first Color item
103
104 formatMenu.add(colorMenu); // add color menu to format menu
105 formatMenu.addSeparator(); // add separator in menu
106
107 // array listing font names
108 String[] fontNames = { "Serif", "Monospaced", "SansSerif" };
109 JMenu fontMenu = new JMenu("Font"); // create font menu
110 fontMenu.setMnemonic('n'); // set mnemonic to n
111
112 // create radio button menu items for font names
113 fonts = new JRadioButtonMenuItem[fontNames.length];
114 fontButtonGroup = new ButtonGroup(); // manages font names
115
116 // create Font radio button menu items
117 for (int count = 0; count < fonts.length; count++)
118 {
119 fonts[count] = new JRadioButtonMenuItem(fontNames[count]);
120 fontMenu.add(fonts[count]); // add font to font menu
121 fontButtonGroup.add(fonts[count]); // add to button group
122 fonts[count].addActionListener(itemHandler); // add handler
123 } // end for
124
125 fonts[0].setSelected(true); // select first Font menu item
126 fontMenu.addSeparator(); // add separator bar to font menu
127
128 String[] styleNames = { "Bold", "Italic" }; // names of styles

```

**Fig. 25.5** | JMenus and mnemonics. (Part 3 of 5.)

```

129 styleItems = new JCheckBoxMenuItem[styleNames.length];
130 StyleHandler styleHandler = new StyleHandler(); // style handler
131
132 // create style checkbox menu items
133 for (int count = 0; count < styleNames.length; count++)
134 {
135 styleItems[count] =
136 new JCheckBoxMenuItem(styleNames[count]); // for style
137 fontMenu.add(styleItems[count]); // add to font menu
138 styleItems[count].addItemListener(styleHandler); // handler
139 } // end for
140
141 formatMenu.add(fontMenu); // add Font menu to Format menu
142 bar.add(formatMenu); // add Format menu to menu bar
143
144 // set up label to display text
145 displayJLabel = new JLabel("Sample Text", SwingConstants.CENTER);
146 displayJLabel.setForeground(colorValues[0]);
147 displayJLabel.setFont(new Font("Serif", Font.PLAIN, 72));
148
149 getContentPane().setBackground(Color.CYAN); // set background
150 add(displayJLabel, BorderLayout.CENTER); // add displayJLabel
151 } // end MenuFrame constructor
152
153 // inner class to handle action events from menu items
154 private class ItemHandler implements ActionListener
155 {
156 // process color and font selections
157 public void actionPerformed(ActionEvent event)
158 {
159 // process color selection
160 for (int count = 0; count < colorItems.length; count++)
161 {
162 if (colorItems[count].isSelected())
163 {
164 displayJLabel.setForeground(colorValues[count]);
165 break;
166 } // end if
167 } // end for
168
169 // process font selection
170 for (int count = 0; count < fonts.length; count++)
171 {
172 if (event.getSource() == fonts[count])
173 {
174 displayJLabel.setFont(
175 new Font(fonts[count].getText(), style, 72));
176 } // end if
177 } // end for
178
179 repaint(); // redraw application
180 } // end method actionPerformed
181 } // end class ItemHandler

```

**Fig. 25.5** | JMenus and mnemonics. (Part 4 of 5.)



```

182
183 // inner class to handle item events from checkbox menu items
184 private class StyleHandler implements ItemListener
185 {
186 // process font style selections
187 public void itemStateChanged(ItemEvent e)
188 {
189 String name = displayJLabel.getFont().getName(); // current Font
190 Font font; // new font based on user selections
191
192 // determine which items are checked and create Font
193 if (styleItems[0].isSelected() &&
194 styleItems[1].isSelected())
195 font = new Font(name, Font.BOLD + Font.ITALIC, 72);
196 else if (styleItems[0].isSelected())
197 font = new Font(name, Font.BOLD, 72);
198 else if (styleItems[1].isSelected())
199 font = new Font(name, Font.ITALIC, 72);
200 else
201 font = new Font(name, Font.PLAIN, 72);
202
203 displayJLabel.setFont(font);
204 repaint(); // redraw application
205 } // end method itemStateChanged
206 } // end class StyleHandler
207 } // end class MenuFrame

```

**Fig. 25.5** | JMenus and mnemonics. (Part 5 of 5.)

```

1 // Fig. 25.6: MenuTest.java
2 // Testing MenuFrame.
3 import javax.swing.JFrame;
4
5 public class MenuTest
6 {
7 public static void main(String[] args)
8 {
9 MenuFrame menuFrame = new MenuFrame(); // create MenuFrame
10 menuFrame.setDefaultCloseOperation(JFrame.EXIT_ON_CLOSE);
11 menuFrame.setSize(500, 200); // set frame size
12 menuFrame.setVisible(true); // display frame
13 } // end main
14 } // end class MenuTest

```

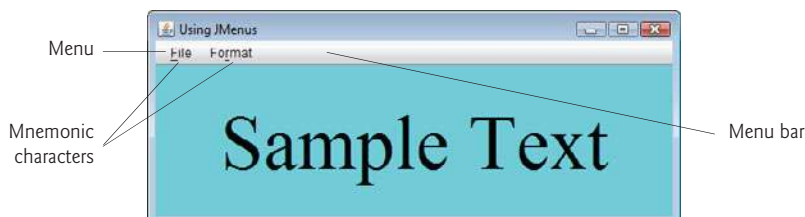

**Fig. 25.6** | Test class for MenuFrame. (Part 1 of 2.)

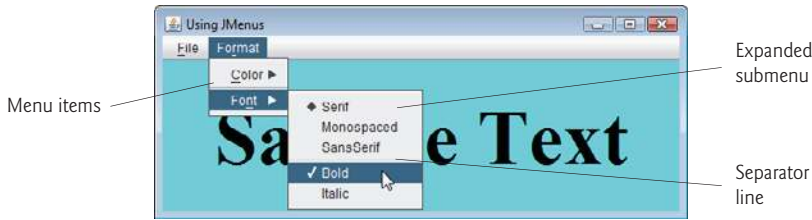

**Fig. 25.6** | Test class for MenuFrame. (Part 2 of 2.)

### Setting Up the File Menu

Lines 38–76 set up the **File** menu and attach it to the menu bar. The **File** menu contains an **About...** menu item that displays a message dialog when the menu item is selected and an **Exit** menu item that can be selected to terminate the application.

Line 38 creates a `JMenu` and passes to the constructor the string "File" as the name of the menu. Line 39 uses `JMenu` method `setMnemonic` (inherited from class `AbstractButton`) to indicate that `F` is the mnemonic for this menu. Pressing the `Alt` key and the letter `F` opens the menu, just as clicking the menu name with the mouse would. In the GUI, the mnemonic character in the menu's name is displayed with an underline. (See the screen captures in Fig. 25.6.)



#### Look-and-Feel Observation 25.2

*Mnemonics provide quick access to menu commands and button commands through the keyboard.*



#### Look-and-Feel Observation 25.3

*Different mnemonics should be used for each button or menu item. Normally, the first letter in the label on the menu item or button is used as the mnemonic. If several buttons or menu items start with the same letter, choose the next most prominent letter in the name (e.g., `x` is commonly chosen for an **Exit** button or menu item). Mnemonics are case insensitive.*

Lines 42–43 create `JMenuItem` `aboutItem` with the text "About. . ." and set its mnemonic to the letter `A`. This menu item is added to `fileMenu` at line 44 with `JMenu` method `add`. To access the **About...** menu item through the keyboard, press the `Alt` key and letter `F` to open the **File** menu, then press `A` to select the **About...** menu item. Lines 47–56 create an `ActionListener` to process `aboutItem`'s action event. Lines 52–54 display a message dialog box. In most prior uses of `showMessageDialog`, the first argument was `null`. The purpose of the first argument is to specify the **parent window** that helps determine where the dialog box will be displayed. If the parent window is specified as `null`, the dialog box appears in the center of the screen. Otherwise, it appears centered over the specified parent window. In this example, the program specifies the parent window with `MenuFrame.this`—the `this` reference of the `MenuFrame` object. When using the `this` reference in an inner class, specifying `this` by itself refers to the inner-class object. To reference the outer-class object's `this` reference, qualify `this` with the outer-class name and a dot (`.`).

Dialog boxes are typically modal. A modal dialog box does not allow any other window in the application to be accessed until the dialog box is dismissed. The dialogs dis-

played with class `JOptionPane` are modal dialogs. Class `JDialog` can be used to create your own modal or nonmodal dialogs.

Lines 59–72 create menu item `exitItem`, set its mnemonic to `x`, add it to `fileMenu` and register an `ActionListener` that terminates the program when the user selects `exitItem`.

Lines 74–76 create the `JMenuBar`, attach it to the window with `JFrame` method `setMenuBar` and use `JMenuBar` method `add` to attach the `fileMenu` to the `JMenuBar`.



### Common Programming Error 25.3

*Forgetting to set the menu bar with `JFrame` method `setMenuBar` prevents the menu bar from displaying in the `JFrame`.*



### Look-and-Feel Observation 25.4

*Menus appear left to right in the order they're added to a `JMenuBar`.*

### Setting Up the Format Menu

Lines 78–79 create menu `formatMenu` and set its mnemonic to `r`. (`F` is not used because that is the `File` menu's mnemonic.)

Lines 84–85 create menu `colorMenu` (this will be a submenu in the `Format` menu) and set its mnemonic to `C`. Line 88 creates `JRadioButtonMenuItem` array `colorItems`, which refers to the menu items in `colorMenu`. Line 89 creates `ButtonGroup` `colorButtonGroup`, which will ensure that only one of the menu items in the `Color` submenu is selected at a time. Line 90 creates an instance of inner class `ItemHandler` (declared at lines 154–181) that responds to selections from the `Color` and `Font` submenus (discussed shortly). The for statement at lines 93–100 creates each `JRadioButtonMenuItem` in array `colorItems`, adds each menu item to `colorMenu` and to `colorButtonGroup` and registers the `ActionListener` for each menu item.

Line 102 invokes `AbstractButton` method `setSelected` to select the first element in array `colorItems`. Line 104 adds `colorMenu` as a submenu of `formatMenu`. Line 105 invokes `JMenu` method `addSeparator` to add a horizontal `separator` line to the menu.



### Look-and-Feel Observation 25.5

*A submenu is created by adding a menu as a menu item in another menu. When the mouse is positioned over a submenu (or the submenu's mnemonic is pressed), the submenu expands to show its menu items.*



### Look-and-Feel Observation 25.6

*Separators can be added to a menu to group menu items logically.*



### Look-and-Feel Observation 25.7

*Any lightweight GUI component (i.e., a component that is a subclass of `JComponent`) can be added to a `JMenu` or to a `JMenuBar`.*

Lines 108–126 create the `Font` submenu and several `JRadioButtonMenuItem`s and select the first element of `JRadioButtonMenuItem` array `fonts`. Line 129 creates a `JCheck-`

BoxMenuItem array to represent the menu items for specifying bold and italic styles for the fonts. Line 130 creates an instance of inner class `StyleHandler` (declared at lines 184–206) to respond to the `JCheckBoxMenuItem` events. The `for` statement at lines 133–139 creates each `JCheckBoxMenuItem`, adds it to `fontMenu` and registers its `ItemListener`. Line 141 adds `fontMenu` as a submenu of `formatMenu`. Line 142 adds the `formatMenu` to `bar` (the menu bar).

### *Creating the Rest of the GUI and Defining the Event Handlers*

Lines 145–147 create a `JLabel` for which the **Format** menu items control the font, font color and font style. The initial foreground color is set to the first element of array `colorValues` (`Color.BLACK`) by invoking `JComponent` method **setForeground**. The initial font is set to `Serif` with `PLAIN` style and 72-point size. Line 149 sets the background color of the window's content pane to cyan, and line 150 attaches the `JLabel` to the `CENTER` of the content pane's `BorderLayout`.

`ItemHandler` method `actionPerformed` (lines 157–180) uses two `for` statements to determine which font or color menu item generated the event and sets the font or color of the `JLabel` `displayLabel`, respectively. The `if` condition at line 162 uses `AbstractButton` method **isSelected** to determine the selected `JRadioButtonMenuItem`. The `if` condition at line 172 invokes the event object's `getSource` method to get a reference to the `JRadioButtonMenuItem` that generated the event. Line 175 invokes `AbstractButton` method `getText` to obtain the name of the font from the menu item.

`StyleHandler` method `itemStateChanged` (lines 187–205) is called if the user selects a `JCheckBoxMenuItem` in the `fontMenu`. Lines 193–201 determine which `JCheckBoxMenuItem`s are selected and use their combined state to determine the new font style.

## 25.5 JPopupMenu

Many of today's computer applications provide so-called **context-sensitive pop-up menus**. In Swing, such menus are created with class **JPopupMenu** (a subclass of `JComponent`). These menus provide options that are specific to the component for which the **pop-up trigger event** was generated. On most systems, the pop-up trigger event occurs when the user presses and releases the right mouse button.



### Look-and-Feel Observation 25.8

*The pop-up trigger event is platform specific. On most platforms that use a mouse with multiple buttons, the pop-up trigger event occurs when the user clicks the right mouse button on a component that supports a pop-up menu.*

The application in Figs. 25.7–25.8 creates a `JPopupMenu` that allows the user to select one of three colors and change the background color of the window. When the user clicks the right mouse button on the `PopupFrame` window's background, a `JPopupMenu` containing colors appears. If the user clicks a `JRadioButtonMenuItem` for a color, `ItemHandler` method `actionPerformed` changes the background color of the window's content pane.

Line 25 of the `PopupFrame` constructor (Fig. 25.7, lines 21–69) creates an instance of class `ItemHandler` (declared in lines 72–87) that will process the item events from the menu items in the pop-up menu. Line 29 creates the `JPopupMenu`. The `for` statement (lines 33–39) creates a `JRadioButtonMenuItem` object (line 35), adds it to `popupMenu` (line 36), adds it to `ButtonGroup` `colorGroup` (line 37) to maintain one selected `JRadioButton`

MenuItem at a time and registers its ActionListener (line 38). Line 41 sets the initial background to white by invoking method setBackground.

```

1 // Fig. 25.7: PopupFrame.java
2 // Demonstrating JPopupMenu.
3 import java.awt.Color;
4 import java.awt.event.MouseAdapter;
5 import java.awt.event.MouseEvent;
6 import java.awt.event.ActionListener;
7 import java.awt.event.ActionEvent;
8 import javax.swing.JFrame;
9 import javax.swing.JRadioButtonMenuItem;
10 import javax.swing.JPopupMenu;
11 import javax.swing.ButtonGroup;
12
13 public class PopupFrame extends JFrame
14 {
15 private JRadioButtonMenuItem[] items; // holds items for colors
16 private final Color[] colorValues =
17 { Color.BLUE, Color.YELLOW, Color.RED }; // colors to be used
18 private JPopupMenu popupMenu; // allows user to select color
19
20 // no-argument constructor sets up GUI
21 public PopupFrame()
22 {
23 super("Using JPopupMenu");
24
25 ItemHandler handler = new ItemHandler(); // handler for menu items
26 String[] colors = { "Blue", "Yellow", "Red" }; // array of colors
27
28 ButtonGroup colorGroup = new ButtonGroup(); // manages color items
29 popupMenu = new JPopupMenu(); // create pop-up menu
30 items = new JRadioButtonMenuItem[colors.length]; // color items
31
32 // construct menu item, add to pop-up menu, enable event handling
33 for (int count = 0; count < items.length; count++)
34 {
35 items[count] = new JRadioButtonMenuItem(colors[count]);
36 popupMenu.add(items[count]); // add item to pop-up menu
37 colorGroup.add(items[count]); // add item to button group
38 items[count].addActionListener(handler); // add handler
39 } // end for
40
41 setBackground(Color.WHITE); // set background to white
42
43 // declare a MouseListener for the window to display pop-up menu
44 addMouseListener(
45
46 new MouseAdapter() // anonymous inner class
47 {
48 // handle mouse press event
49 public void mousePressed(MouseEvent event)
50 {

```

**Fig. 25.7** | JPopupMenu for selecting colors. (Part 1 of 2.)

```

51 checkForTriggerEvent(event); // check for trigger
52 } // end method mousePressed
53
54 // handle mouse release event
55 public void mouseReleased(MouseEvent event)
56 {
57 checkForTriggerEvent(event); // check for trigger
58 } // end method mouseReleased
59
60 // determine whether event should trigger pop-up menu
61 private void checkForTriggerEvent(MouseEvent event)
62 {
63 if (event.isPopupTrigger())
64 popupMenu.show(
65 event.getComponent(), event.getX(), event.getY());
66 } // end method checkForTriggerEvent
67 } // end anonymous inner class
68); // end call to addMouseListener
69 } // end PopupFrame constructor
70
71 // private inner class to handle menu item events
72 private class ItemHandler implements ActionListener
73 {
74 // process menu item selections
75 public void actionPerformed(ActionEvent event)
76 {
77 // determine which menu item was selected
78 for (int i = 0; i < items.length; i++)
79 {
80 if (event.getSource() == items[i])
81 {
82 getContentPane().setBackground(colorValues[i]);
83 return;
84 } // end if
85 } // end for
86 } // end method actionPerformed
87 } // end private inner class ItemHandler
88 } // end class PopupFrame

```

**Fig. 25.7** | JPopupMenu for selecting colors. (Part 2 of 2.)

```

1 // Fig. 25.8: PopupTest.java
2 // Testing PopupFrame.
3 import javax.swing.JFrame;
4
5 public class PopupTest
6 {
7 public static void main(String[] args)
8 {
9 PopupFrame popupFrame = new PopupFrame(); // create PopupFrame
10 popupFrame.setDefaultCloseOperation(JFrame.EXIT_ON_CLOSE);

```

**Fig. 25.8** | Test class for PopupFrame. (Part 1 of 2.)

```

11 popupFrame.setSize(300, 200); // set frame size
12 popupFrame.setVisible(true); // display frame
13 } // end main
14 } // end class PopupTest

```

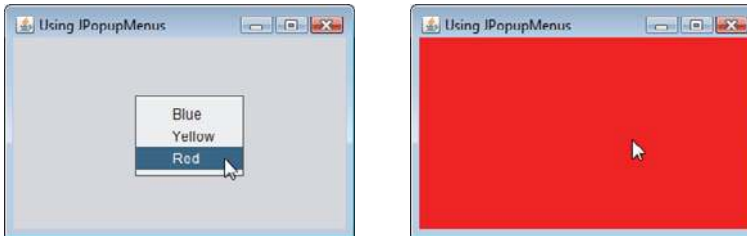

**Fig. 25.8** | Test class for PopupFrame. (Part 2 of 2.)

Lines 44–68 register a `MouseListener` to handle the mouse events of the application window. Methods `mousePressed` (lines 49–52) and `mouseReleased` (lines 55–58) check for the pop-up trigger event. Each method calls private utility method `checkForTriggerEvent` (lines 61–66) to determine whether the pop-up trigger event occurred. If it did, `MouseEvent` method `isPopupTrigger` returns `true`, and `JPopupMenu` method `show` displays the `JPopupMenu`. The first argument to method `show` specifies the **origin component**, whose position helps determine where the `JPopupMenu` will appear on the screen. The last two arguments are the  $x$ - $y$  coordinates (measured from the origin component’s upper-left corner) at which the `JPopupMenu` is to appear.



### Look-and-Feel Observation 25.9

*Displaying a `JPopupMenu` for the pop-up trigger event of multiple GUI components requires registering mouse-event handlers for each of those GUI components.*

When the user selects a menu item from the pop-up menu, class `ItemHandler`’s method `actionPerformed` (lines 75–86) determines which `JRadioButtonMenuItem` the user selected and sets the background color of the window’s content pane.

## 25.6 Pluggable Look-and-Feel

A program that uses Java’s AWT GUI components (package `java.awt`) takes on the look-and-feel of the platform on which the program executes. A Java application running on a Mac OS X looks like other Mac OS X applications. One running on Microsoft Windows looks like other Windows applications. One running on a Linux platform looks like other applications on that Linux platform. This is sometimes desirable, because it allows users of the application on each platform to use GUI components with which they’re already familiar. However, it also introduces interesting portability issues.



### Portability Tip 25.1

*GUI components look different on different platforms and may require different amounts of space to display. This could change their layout and alignments.*



### Portability Tip 25.2

*GUI components on different platforms have different default functionality (e.g., some platforms allow a button with the focus to be “pressed” with the space bar, and some don’t).*

Swing’s lightweight GUI components eliminate many of these issues by providing uniform functionality across platforms and by defining a uniform cross-platform look-and-feel. Recent versions of Java SE 6 and the upcoming Java SE 7 include the *Nimbus* look-and-feel that we discussed in Section 14.2. Earlier versions of Java used the **metal look-and-feel**, which is still the default. Swing also provides the flexibility to customize the look-and-feel to appear as a Microsoft Windows-style look-and-feel (only on Windows systems), a Motif-style (UNIX) look-and-feel (across all platforms) or a Macintosh look-and-feel (only on Mac systems).

Figures 25.9–25.10 demonstrate a way to change the look-and-feel of a Swing GUI. It creates several GUI components, so you can see the change in their look-and-feel at the same time. The output windows show the Metal, Nimbus, CDE/Motif, Windows and Windows Classic look-and-feels that are available on Windows systems. The installed look-and-feels will vary by platform.

```

1 // Fig. 25.9: LookAndFeelFrame.java
2 // Changing the look-and-feel.
3 import java.awt.GridLayout;
4 import java.awt.BorderLayout;
5 import java.awt.event.ItemListener;
6 import java.awt.event.ItemEvent;
7 import javax.swing.JFrame;
8 import javax.swing.UIManager;
9 import javax.swing.JRadioButton;
10 import javax.swing.ButtonGroup;
11 import javax.swing.JButton;
12 import javax.swing.JLabel;
13 import javax.swing.JComboBox;
14 import javax.swing.JPanel;
15 import javax.swing.SwingConstants;
16 import javax.swing.SwingUtilities;
17
18 public class LookAndFeelFrame extends JFrame
19 {
20 private UIManager.LookAndFeelInfo[] looks; // look and feels
21 private String[] lookNames; // names of look and feels
22 private JRadioButton[] radio; // radio buttons to select look-and-feel
23 private ButtonGroup group; // group for radio buttons
24 private JButton button; // displays look of button
25 private JLabel label; // displays look of label
26 private JComboBox comboBox; // displays look of combo box
27
28 // set up GUI
29 public LookAndFeelFrame()
30 {

```

**Fig. 25.9** | Look-and-feel of a Swing-based GUI. (Part 1 of 3.)



```
31 super("Look and Feel Demo");
32
33 // get installed look-and-feel information
34 looks = UIManager.getInstalledLookAndFeels();
35 lookNames = new String[looks.length];
36
37 // get names of installed look-and-feels
38 for (int i = 0; i < looks.length; i++)
39 lookNames[i] = looks[i].getName();
40
41 JPanel northPanel = new JPanel(); // create north panel
42 northPanel.setLayout(new GridLayout(3, 1, 0, 5));
43
44 label = new JLabel("This is a " + lookNames[0] + " look-and-feel",
45 SwingConstants.CENTER); // create label
46 northPanel.add(label); // add label to panel
47
48 button = new JButton("JButton"); // create button
49 northPanel.add(button); // add button to panel
50
51 comboBox = new JComboBox(lookNames); // create combobox
52 northPanel.add(comboBox); // add combobox to panel
53
54 // create array for radio buttons
55 radio = new JRadioButton[looks.length];
56
57 JPanel southPanel = new JPanel(); // create south panel
58
59 // use a GridLayout with 3 buttons in each row
60 int rows = (int) Math.ceil(radio.length / 3.0);
61 southPanel.setLayout(new GridLayout(rows, 3));
62
63 group = new ButtonGroup(); // button group for looks-and-feels
64 ItemHandler handler = new ItemHandler(); // look-and-feel handler
65
66 for (int count = 0; count < radio.length; count++)
67 {
68 radio[count] = new JRadioButton(lookNames[count]);
69 radio[count].addItemListener(handler); // add handler
70 group.add(radio[count]); // add radio button to group
71 southPanel.add(radio[count]); // add radio button to panel
72 } // end for
73
74 add(northPanel, BorderLayout.NORTH); // add north panel
75 add(southPanel, BorderLayout.SOUTH); // add south panel
76
77 radio[0].setSelected(true); // set default selection
78 } // end LookAndFeelFrame constructor
79
80 // use UIManager to change look-and-feel of GUI
81 private void changeTheLookAndFeel(int value)
82 {
```

**Fig. 25.9** | Look-and-feel of a Swing-based GUI. (Part 2 of 3.)

```

83 try // change look-and-feel
84 {
85 // set look-and-feel for this application
86 UIManager.setLookAndFeel(looks[value].getClassName());
87
88 // update components in this application
89 SwingUtilities.updateComponentTreeUI(this);
90 } // end try
91 catch (Exception exception)
92 {
93 exception.printStackTrace();
94 } // end catch
95 } // end method changeTheLookAndFeel
96
97 // private inner class to handle radio button events
98 private class ItemHandler implements ItemListener
99 {
100 // process user's look-and-feel selection
101 public void itemStateChanged(ItemEvent event)
102 {
103 for (int count = 0; count < radio.length; count++)
104 {
105 if (radio[count].isSelected())
106 {
107 label.setText(String.format(
108 "This is a %s look-and-feel", lookNames[count]));
109 comboBox.setSelectedIndex(count); // set combobox index
110 changeTheLookAndFeel(count); // change look-and-feel
111 } // end if
112 } // end for
113 } // end method itemStateChanged
114 } // end private inner class ItemHandler
115 } // end class LookAndFeelFrame

```

**Fig. 25.9** | Look-and-feel of a Swing-based GUI. (Part 3 of 3.)

```

1 // Fig. 25.10: LookAndFeelDemo.java
2 // Changing the look-and-feel.
3 import javax.swing.JFrame;
4
5 public class LookAndFeelDemo
6 {
7 public static void main(String[] args)
8 {
9 LookAndFeelFrame lookAndFeelFrame = new LookAndFeelFrame();
10 lookAndFeelFrame.setDefaultCloseOperation(JFrame.EXIT_ON_CLOSE);
11 lookAndFeelFrame.setSize(400, 220); // set frame size
12 lookAndFeelFrame.setVisible(true); // display frame
13 } // end main
14 } // end class LookAndFeelDemo

```

**Fig. 25.10** | Test class for LookAndFeelFrame. (Part 1 of 2.)

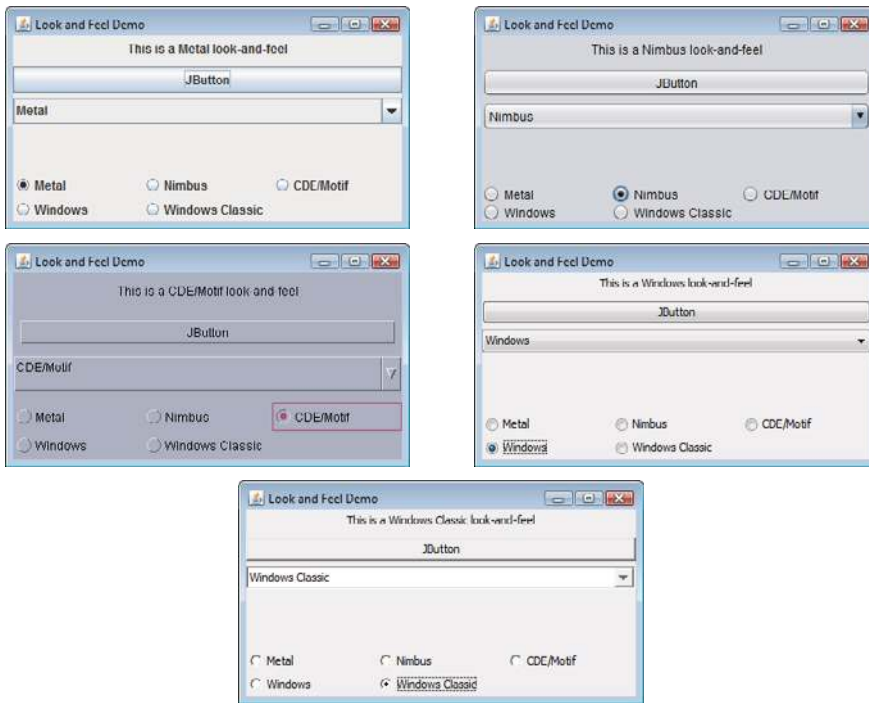

**Fig. 25.10** | Test class for LookAndFeelFrame. (Part 2 of 2.)

We've covered the GUI components and event-handling concepts in this example previously, so we focus here on the mechanism for changing the look-and-feel. Class **UIManager** (package `javax.swing`) contains nested class **LookAndFeelInfo** (a public static class) that maintains information about a look-and-feel. Line 20 declares an array of type `UIManager.LookAndFeelInfo` (note the syntax used to identify the static inner class `LookAndFeelInfo`). Line 34 uses `UIManager` static method **getInstalledLookAndFeels** to get the array of `UIManager.LookAndFeelInfo` objects that describe each look-and-feel available on your system.



### Performance Tip 25.2

*Each look-and-feel is represented by a Java class. `UIManager` method `getInstalledLookAndFeels` does not load each class. Rather, it provides the names of the available look-and-feel classes so that a choice can be made (presumably once at program start-up). This reduces the overhead of having to load all the look-and-feel classes even if the program will not use some of them.*

Our utility method `changeTheLookAndFeel` (lines 81–95) is called by the event handler for the `JRadioButtons` at the bottom of the user interface. The event handler (declared in private inner class `ItemHandler` at lines 98–114) passes an integer representing the element in array `looks` that should be used to change the look-and-feel. Line 86 invokes static method **setLookAndFeel** of `UIManager` to change the look-and-feel. Method **getClassName** of class `UIManager.LookAndFeelInfo` determines the name of the look-and-

feel class that corresponds to the `UIManager.LookAndFeelInfo` object. If the look-and-feel class is not already loaded, it will be loaded as part of the call to `setLookAndFeel`. Line 89 invokes static method `updateComponentTreeUI` of class `SwingUtilities` (package `javax.swing`) to change the look-and-feel of every GUI component attached to its argument (this instance of our application class `LookAndFeelFrame`) to the new look-and-feel.

## 25.7 JDesktopPane and JInternalFrame

Many of today's applications use a **multiple-document interface (MDI)**—a main window (called the **parent window**) containing other windows (called **child windows**), to manage several open documents that are being processed in parallel. For example, many e-mail programs allow you to have several windows open at the same time, so you can compose or read multiple e-mail messages simultaneously. Similarly, many word processors allow the user to open multiple documents in separate windows within a main window, making it possible to switch between them without having to close one to open another. The application in Figs. 25.11–25.12 demonstrates Swing's `JDesktopPane` and `JInternalFrame` classes for implementing multiple-document interfaces.

---

```

1 // Fig. 25.11: DesktopFrame.java
2 // Demonstrating JDesktopPane.
3 import java.awt.BorderLayout;
4 import java.awt.Dimension;
5 import java.awt.Graphics;
6 import java.awt.event.ActionListener;
7 import java.awt.event.ActionEvent;
8 import java.util.Random;
9 import javax.swing.JFrame;
10 import javax.swing.JDesktopPane;
11 import javax.swing.JMenuBar;
12 import javax.swing.JMenu;
13 import javax.swing.JMenuItem;
14 import javax.swing.JInternalFrame;
15 import javax.swing.JPanel;
16 import javax.swing.ImageIcon;
17
18 public class DesktopFrame extends JFrame
19 {
20 private JDesktopPane theDesktop;
21
22 // set up GUI
23 public DesktopFrame()
24 {
25 super("Using a JDesktopPane");
26
27 JMenuBar bar = new JMenuBar(); // create menu bar
28 JMenu addMenu = new JMenu("Add"); // create Add menu
29 JMenuItem newFrame = new JMenuItem("Internal Frame");
30
31 addMenu.add(newFrame); // add new frame item to Add menu
32 bar.add(addMenu); // add Add menu to menu bar

```

---

**Fig. 25.11** | Multiple-document interface. (Part 1 of 3.)

```

33 setJMenuBar(bar); // set menu bar for this application
34
35 theDesktop = new JDesktopPane(); // create desktop pane
36 add(theDesktop); // add desktop pane to frame
37
38 // set up listener for newFrame menu item
39 newFrame.addActionListener(
40
41 new ActionListener() // anonymous inner class
42 {
43 // display new internal window
44 public void actionPerformed((ActionEvent event))
45 {
46 // create internal frame
47 JInternalFrame frame = new JInternalFrame(
48 "Internal Frame", true, true, true, true);
49
50 MyJPanel panel = new MyJPanel(); // create new panel
51 frame.add(panel, BorderLayout.CENTER); // add panel
52 frame.pack(); // set internal frame to size of contents
53
54 theDesktop.add(frame); // attach internal frame
55 frame.setVisible(true); // show internal frame
56 } // end method actionPerformed
57 } // end anonymous inner class
58); // end call to addActionListener
59 } // end DesktopFrame constructor
60 } // end class DesktopFrame
61
62 // class to display an ImageIcon on a panel
63 class MyJPanel extends JPanel
64 {
65 private static Random generator = new Random();
66 private ImageIcon picture; // image to be displayed
67 private final static String[] images = { "yellowflowers.png",
68 "purpleflowers.png", "redflowers.png", "redflowers2.png",
69 "lavenderflowers.png" };
70
71 // load image
72 public MyJPanel()
73 {
74 int randomNumber = generator.nextInt(images.length);
75 picture = new ImageIcon(images[randomNumber]); // set icon
76 } // end MyJPanel constructor
77
78 // display ImageIcon on panel
79 public void paintComponent(Graphics g)
80 {
81 super.paintComponent(g);
82 picture.paintIcon(this, g, 0, 0); // display icon
83 } // end method paintComponent
84

```

**Fig. 25.11** | Multiple-document interface. (Part 2 of 3.)

---

```

85 // return image dimensions
86 public Dimension getPreferredSize()
87 {
88 return new Dimension(picture.getIconWidth(),
89 picture.getIconHeight());
90 } // end method getPreferredSize
91 } // end class MyJPanel

```

---

**Fig. 25.11** | Multiple-document interface. (Part 3 of 3.)

Lines 27–33 create a `JMenuBar`, a `JMenu` and a `JMenuItem`, add the `JMenuItem` to the `JMenu`, add the `JMenu` to the `JMenuBar` and set the `JMenuBar` for the application window. When the user selects the `JMenuItem` `newFrame`, the application creates and displays a new `JInternalFrame` object containing an image.

Line 35 assigns `JDesktopPane` (package `javax.swing`) variable `theDesktop` a new `JDesktopPane` object that will be used to manage the `JInternalFrame` child windows. Line 36 adds the `JDesktopPane` to the `JFrame`. By default, the `JDesktopPane` is added to the center of the content pane's `BorderLayout`, so the `JDesktopPane` expands to fill the entire application window.

Lines 39–58 register an `ActionListener` to handle the event when the user selects the `newFrame` menu item. When the event occurs, method `actionPerformed` (lines 44–56) creates a `JInternalFrame` object in lines 47–48. The `JInternalFrame` constructor used here takes five arguments—a `String` for the title bar of the internal window, a `boolean` indicating whether the internal frame can be resized by the user, a `boolean` indicating whether the internal frame can be closed by the user, a `boolean` indicating whether the internal frame can be maximized by the user and a `boolean` indicating whether the internal frame can be minimized by the user. For each of the `boolean` arguments, a `true` value indicates that the operation should be allowed (as is the case here).

As with `JFrames` and `JApplets`, a `JInternalFrame` has a content pane to which GUI components can be attached. Line 50 (Fig. 25.11) creates an instance of our class `MyJPanel` (declared at lines 63–91) that is added to the `JInternalFrame` at line 51.

---

```

1 // Fig. 25.12: DesktopTest.java
2 // Demonstrating JDesktopPane.
3 import javax.swing.JFrame;
4
5 public class DesktopTest
6 {
7 public static void main(String[] args)
8 {
9 DesktopFrame desktopFrame = new DesktopFrame();
10 desktopFrame.setDefaultCloseOperation(JFrame.EXIT_ON_CLOSE);
11 desktopFrame.setSize(600, 480); // set frame size
12 desktopFrame.setVisible(true); // display frame
13 } // end main
14 } // end class DesktopTest

```

---

**Fig. 25.12** | Test class for `DeskTopFrame`. (Part 1 of 2.)

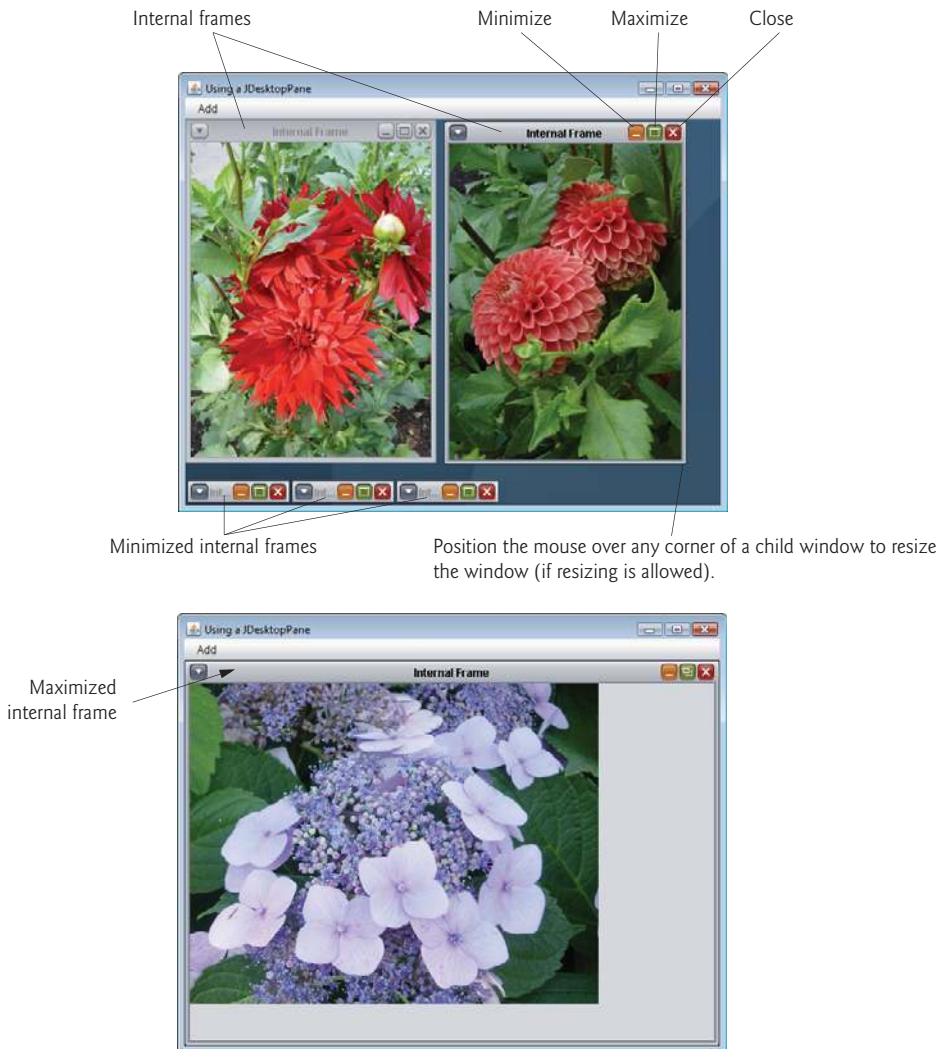

**Fig. 25.12** | Test class for DeskTopFrame. (Part 2 of 2.)

Line 52 uses `JInternalFrame` method **pack** to set the size of the child window. Method `pack` uses the preferred sizes of the components to determine the window's size. Class `MyJPanel` declares method `getPreferredSize` (lines 86–90) to specify the panel's preferred size for use by the `pack` method. Line 54 adds the `JInternalFrame` to the `JDesktopPane`, and line 55 displays the `JInternalFrame`.

Classes `JInternalFrame` and `JDesktopPane` provide many methods for managing child windows. See the `JInternalFrame` and `JDesktopPane` online API documentation for complete lists of these methods:

[download.oracle.com/javase/6/docs/api/javafx/swing/JInternalFrame.html](http://download.oracle.com/javase/6/docs/api/javafx/swing/JInternalFrame.html)  
[download.oracle.com/javase/6/docs/api/javafx/swing/JDesktopPane.html](http://download.oracle.com/javase/6/docs/api/javafx/swing/JDesktopPane.html)

## 25.8 JTabbedPane

A **JTabbedPane** arranges GUI components into layers, of which only one is visible at a time. Users access each layer via a tab—similar to folders in a file cabinet. When the user clicks a tab, the appropriate layer is displayed. The tabs appear at the top by default but also can be positioned at the left, right or bottom of the JTabbedPane. Any component can be placed on a tab. If the component is a container, such as a panel, it can use any layout manager to lay out several components on the tab. Class JTabbedPane is a subclass of JComponent. The application in Figs. 25.13–25.14 creates one tabbed pane with three tabs. Each tab displays one of the JPanels—pane11, pane12 or pane13.

---

```

1 // Fig. 25.13: JTabbedPaneFrame.java
2 // Demonstrating JTabbedPane.
3 import java.awt.BorderLayout;
4 import java.awt.Color;
5 import javax.swing.JFrame;
6 import javax.swing.JTabbedPane;
7 import javax.swing.JLabel;
8 import javax.swing.JPanel;
9 import javax.swing.JButton;
10 import javax.swing.SwingConstants;
11
12 public class JTabbedPaneFrame extends JFrame
13 {
14 // set up GUI
15 public JTabbedPaneFrame()
16 {
17 super("JTabbedPane Demo ");
18
19 JTabbedPane tabbedPane = new JTabbedPane(); // create JTabbedPane
20
21 // set up pane11 and add it to JTabbedPane
22 JLabel label11 = new JLabel("panel one", SwingConstants.CENTER);
23 JPanel pane11 = new JPanel(); // create first panel
24 pane11.add(label11); // add label to panel
25 tabbedPane.addTab("Tab One", null, pane11, "First Panel");
26
27 // set up pane12 and add it to JTabbedPane
28 JLabel label12 = new JLabel("panel two", SwingConstants.CENTER);
29 JPanel pane12 = new JPanel(); // create second panel
30 pane12.setBackground(Color.YELLOW); // set background to yellow
31 pane12.add(label12); // add label to panel
32 tabbedPane.addTab("Tab Two", null, pane12, "Second Panel");
33
34 // set up pane13 and add it to JTabbedPane
35 JLabel label13 = new JLabel("panel three");
36 JPanel pane13 = new JPanel(); // create third panel
37 pane13.setLayout(new BorderLayout()); // use BorderLayout
38 pane13.add(new JButton("North"), BorderLayout.NORTH);
39 pane13.add(new JButton("West"), BorderLayout.WEST);
40 pane13.add(new JButton("East"), BorderLayout.EAST);

```

**Fig. 25.13** | JTabbedPane used to organize GUI components. (Part I of 2.)



```

41 pane13.add(new JButton("South"), BorderLayout.SOUTH);
42 pane13.add(labe13, BorderLayout.CENTER);
43 tabbedPane.addTab("Tab Three", null, pane13, "Third Panel");
44
45 add(tabbedPane); // add JTabbedPane to frame
46 } // end JTabbedPaneFrame constructor
47 } // end class JTabbedPaneFrame

```

**Fig. 25.13** | JTabbedPane used to organize GUI components. (Part 2 of 2.)

```

1 // Fig. 25.14: JTabbedPaneDemo.java
2 // Demonstrating JTabbedPane.
3 import javax.swing.JFrame;
4
5 public class JTabbedPaneDemo
6 {
7 public static void main(String[] args)
8 {
9 JTabbedPaneFrame tabbedPaneFrame = new JTabbedPaneFrame();
10 tabbedPaneFrame.setDefaultCloseOperation(JFrame.EXIT_ON_CLOSE);
11 tabbedPaneFrame.setSize(250, 200); // set frame size
12 tabbedPaneFrame.setVisible(true); // display frame
13 } // end main
14 } // end class JTabbedPaneDemo

```

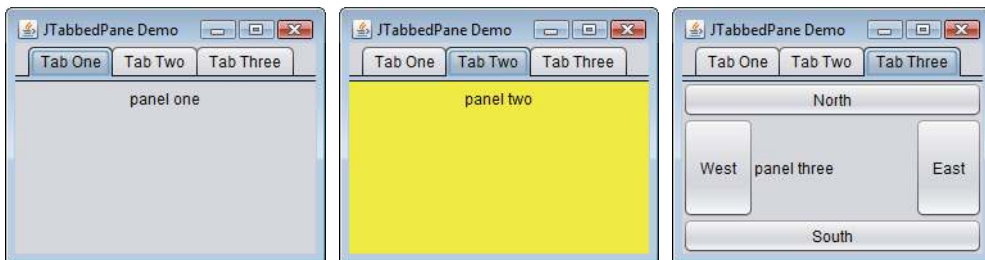

**Fig. 25.14** | Test class for JTabbedPaneFrame.

The constructor (lines 15–46) builds the GUI. Line 19 creates an empty `JTabbedPane` with default settings—that is, tabs across the top. If the tabs do not fit on one line, they’ll wrap to form additional lines of tabs. Next the constructor creates the `JPanels` `pane11`, `pane12` and `pane13` and their GUI components. As we set up each panel, we add it to `tabbedPane`, using `JTabbedPane` method `addTab` with four arguments. The first argument is a `String` that specifies the title of the tab. The second argument is an `Icon` reference that specifies an icon to display on the tab. If the `Icon` is a `null` reference, no image is displayed. The third argument is a `Component` reference that represents the GUI component to display when the user clicks the tab. The last argument is a `String` that specifies the tool tip for the tab. For example, line 25 adds `JPanel` `pane11` to `tabbedPane` with title “Tab One” and the tool tip “First Panel”. `JPanels` `pane12` and `pane13` are added to `tabbedPane` at lines 32 and 43. To view a tab, click it with the mouse or use the arrow keys to cycle through the tabs.

## 25.9 Layout Managers: BorderLayout and GridBagLayout

In Chapter 14, we introduced three layout managers—FlowLayout, BorderLayout and GridLayout. This section presents two additional layout managers (summarized in Fig. 25.15). We discuss them in the examples that follow. We also discuss the extremely flexible GroupLayout in Appendix I.

| Layout manager | Description                                                                                                                                                                                                                                                                |
|----------------|----------------------------------------------------------------------------------------------------------------------------------------------------------------------------------------------------------------------------------------------------------------------------|
| BoxLayout      | A layout manager that allows GUI components to be arranged left-to-right or top-to-bottom in a container. Class Box declares a container with BoxLayout as its default layout manager and provides static methods to create a Box with a horizontal or vertical BoxLayout. |
| GridBagLayout  | A layout manager similar to GridLayout, but the components can vary in size and can be added in any order.                                                                                                                                                                 |

**Fig. 25.15** | Additional layout managers.

### *BoxLayout Layout Manager*

The BoxLayout layout manager (in package javax.swing) arranges GUI components horizontally along a container's  $x$ -axis or vertically along its  $y$ -axis. The application in Figs. 25.16–25.17 demonstrates BoxLayout and the container class Box that uses BoxLayout as its default layout manager.

```

1 // Fig. 25.16: BoxLayoutFrame.java
2 // Demonstrating BoxLayout.
3 import java.awt.Dimension;
4 import javax.swing.JFrame;
5 import javax.swing.Box;
6 import javax.swing.JButton;
7 import javax.swing.BoxLayout;
8 import javax.swing.JPanel;
9 import javax.swing.JTabbedPane;
10
11 public class BoxLayoutFrame extends JFrame
12 {
13 // set up GUI
14 public BoxLayoutFrame()
15 {
16 super("Demonstrating BoxLayout");
17
18 // create Box containers with BoxLayout
19 Box horizontal1 = Box.createHorizontalBox();
20 Box vertical1 = Box.createVerticalBox();
21 Box horizontal2 = Box.createHorizontalBox();
22 Box vertical2 = Box.createVerticalBox();
23
24 final int SIZE = 3; // number of buttons on each Box
25

```

**Fig. 25.16** | BoxLayout layout manager. (Part 1 of 2.)

```

26 // add buttons to Box horizontal1
27 for (int count = 0; count < SIZE; count++)
28 horizontal1.add(new JButton("Button " + count));
29
30 // create strut and add buttons to Box vertical1
31 for (int count = 0; count < SIZE; count++)
32 {
33 vertical1.add(Box.createVerticalStrut(25));
34 vertical1.add(new JButton("Button " + count));
35 } // end for
36
37 // create horizontal glue and add buttons to Box horizontal2
38 for (int count = 0; count < SIZE; count++)
39 {
40 horizontal2.add(Box.createHorizontalGlue());
41 horizontal2.add(new JButton("Button " + count));
42 } // end for
43
44 // create rigid area and add buttons to Box vertical2
45 for (int count = 0; count < SIZE; count++)
46 {
47 vertical2.add(Box.createRigidArea(new Dimension(12, 8)));
48 vertical2.add(new JButton("Button " + count));
49 } // end for
50
51 // create vertical glue and add buttons to panel
52 JPanel panel = new JPanel();
53 panel.setLayout(new BorderLayout(panel, BorderLayout.Y_AXIS));
54
55 for (int count = 0; count < SIZE; count++)
56 {
57 panel.add(Box.createGlue());
58 panel.add(new JButton("Button " + count));
59 } // end for
60
61 // create a JTabbedPane
62 JTabbedPane tabs = new JTabbedPane(
63 JTabbedPane.TOP, JTabbedPane.SCROLL_TAB_LAYOUT);
64
65 // place each container on tabbed pane
66 tabs.addTab("Horizontal Box", horizontal1);
67 tabs.addTab("Vertical Box with Struts", vertical1);
68 tabs.addTab("Horizontal Box with Glue", horizontal2);
69 tabs.addTab("Vertical Box with Rigid Areas", vertical2);
70 tabs.addTab("Vertical Box with Glue", panel);
71
72 add(tabs); // place tabbed pane on frame
73 } // end BorderLayoutFrame constructor
74 } // end class BorderLayoutFrame

```

**Fig. 25.16** | BorderLayout layout manager. (Part 2 of 2.)

Lines 19–22 create Box containers. References `horizontal1` and `horizontal2` are initialized with static Box method `createHorizontalBox`, which returns a Box container

```

1 // Fig. 25.17: BoxLayoutDemo.java
2 // Demonstrating BoxLayout.
3 import javax.swing.JFrame;
4
5 public class BoxLayoutDemo
6 {
7 public static void main(String[] args)
8 {
9 BoxLayoutFrame boxLayoutFrame = new BoxLayoutFrame();
10 boxLayoutFrame.setDefaultCloseOperation(JFrame.EXIT_ON_CLOSE);
11 boxLayoutFrame.setSize(400, 220); // set frame size
12 boxLayoutFrame.setVisible(true); // display frame
13 } // end main
14 } // end class BoxLayoutDemo

```



**Fig. 25.17** | Test class for BoxLayoutFrame.

with a horizontal `BoxLayout` in which GUI components are arranged left-to-right. Variables `vertical1` and `vertical2` are initialized with static `Box` method `createVerticalBox`, which returns references to `Box` containers with a vertical `BoxLayout` in which GUI components are arranged top-to-bottom.

The loop at lines 27–28 adds three `JButtons` to `horizontal1`. The `for` statement at lines 31–35 adds three `JButtons` to `vertical1`. Before adding each button, line 33 adds a **vertical strut** to the container with static `Box` method `createVerticalStrut`. A vertical strut is an invisible GUI component that has a fixed pixel height and is used to guarantee a fixed amount of space between GUI components. The `int` argument to method `createVerticalStrut` determines the height of the strut in pixels. When the container is resized,

the distance between GUI components separated by struts does not change. Class `Box` also declares method `createHorizontalStrut` for horizontal `BoxLayout`s.

The `for` statement at lines 38–42 adds three `JButtons` to `horizontal12`. Before adding each button, line 40 adds **horizontal glue** to the container with static `Box` method `createHorizontalGlue`. Horizontal glue is an invisible GUI component that can be used between fixed-size GUI components to occupy additional space. Normally, extra space appears to the right of the last horizontal GUI component or below the last vertical one in a `BoxLayout`. Glue allows the extra space to be placed between GUI components. When the container is resized, components separated by glue components remain the same size, but the glue stretches or contracts to occupy the space between them. Class `Box` also declares method `createVerticalGlue` for vertical `BoxLayout`s.

The `for` statement at lines 45–49 adds three `JButtons` to `vertical12`. Before each button is added, line 47 adds a **rigid area** to the container with static `Box` method `createRigidArea`. A rigid area is an invisible GUI component that always has a fixed pixel width and height. The argument to method `createRigidArea` is a `Dimension` object that specifies the area's width and height.

Lines 52–53 create a `JPanel` object and set its layout to a `BoxLayout` in the conventional manner, using `Container` method `setLayout`. The `BoxLayout` constructor receives a reference to the container for which it controls the layout and a constant indicating whether the layout is horizontal (`BoxLayout.X_AXIS`) or vertical (`BoxLayout.Y_AXIS`).

The `for` statement at lines 55–59 adds three `JButtons` to `panel`. Before adding each button, line 57 adds a glue component to the container with static `Box` method `createGlue`. This component expands or contracts based on the size of the `Box`.

Lines 62–63 create a `JTabbedPane` to display the five containers in this program. The argument `JTabbedPane.TOP` sent to the constructor indicates that the tabs should appear at the top of the `JTabbedPane`. The argument `JTabbedPane.SCROLL_TAB_LAYOUT` specifies that the tabs should wrap to a new line if there are too many to fit on one line.

The `Box` containers and the `JPanel` are attached to the `JTabbedPane` at lines 66–70. Try executing the application. When the window appears, resize the window to see how the glue components, strut components and rigid area affect the layout on each tab.

### *GridBagLayout Layout Manager*

One of the most powerful predefined layout managers is `GridBagLayout` (in package `java.awt`). This layout is similar to `GridLayout` in that it arranges components in a grid, but it's more flexible. The components can vary in size (i.e., they can occupy multiple rows and columns) and can be added in any order.

The first step in using `GridBagLayout` is determining the appearance of the GUI. For this step you need only a piece of paper. Draw the GUI, then draw a grid over it, dividing the components into rows and columns. The initial row and column numbers should be 0, so that the `GridBagLayout` layout manager can use the row and column numbers to properly place the components in the grid. Figure 25.18 demonstrates drawing the lines for the rows and columns over a GUI.

A `GridBagConstraints` object describes how a component is placed in a `GridBagLayout`. Several `GridBagConstraints` fields are summarized in Fig. 25.19.

`GridBagConstraints` field `anchor` specifies the relative position of the component in an area that it does not fill. The variable `anchor` is assigned one of the following `GridBag-`

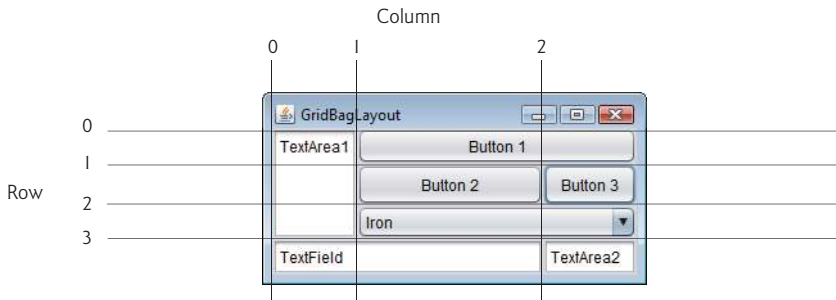

**Fig. 25.18** | Designing a GUI that will use GridBagLayout.

| Field      | Description                                                                                                                                                       |
|------------|-------------------------------------------------------------------------------------------------------------------------------------------------------------------|
| anchor     | Specifies the relative position (NORTH, NORTHEAST, EAST, SOUTHEAST, SOUTH, SOUTHWEST, WEST, NORTHWEST, CENTER) of the component in an area that it does not fill. |
| fill       | Resizes the component in the specified direction (NONE, HORIZONTAL, VERTICAL, BOTH) when the display area is larger than the component.                           |
| gridx      | The column in which the component will be placed.                                                                                                                 |
| gridy      | The row in which the component will be placed.                                                                                                                    |
| gridwidth  | The number of columns the component occupies.                                                                                                                     |
| gridheight | The number of rows the component occupies.                                                                                                                        |
| weightx    | The amount of extra space to allocate horizontally. The grid slot can become wider when extra space is available.                                                 |
| weighty    | The amount of extra space to allocate vertically. The grid slot can become taller when extra space is available.                                                  |

**Fig. 25.19** | GridBagConstraints fields.

Constraints constants: **NORTH, NORTHEAST, EAST, SOUTHEAST, SOUTH, SOUTHWEST, WEST, NORTHWEST** or **CENTER**. The default value is **CENTER**.

GridBagConstraints field **fill** defines how the component grows if the area in which it can be displayed is larger than the component. The variable **fill** is assigned one of the following GridBagConstraints constants: **NONE, VERTICAL, HORIZONTAL** or **BOTH**. The default value is **NONE**, which indicates that the component will not grow in either direction. **VERTICAL** indicates that it will grow vertically. **HORIZONTAL** indicates that it will grow horizontally. **BOTH** indicates that it will grow in both directions.

Variables **gridx** and **gridy** specify where the upper-left corner of the component is placed in the grid. Variable **gridx** corresponds to the column, and variable **gridy** corresponds to the row. In Fig. 25.18, the JComboBox (displaying “Iron”) has a **gridx** value of 1 and a **gridy** value of 2.

Variable **gridwidth** specifies the number of columns a component occupies. The JComboBox occupies two columns. Variable **gridheight** specifies the number of rows a component occupies. The JTextArea on the left side of Fig. 25.18 occupies three rows.

Variable **weightx** specifies how to distribute extra horizontal space to grid slots in a GridBagLayout when the container is resized. A zero value indicates that the grid slot does not grow horizontally on its own. However, if the component spans a column containing a component with nonzero **weightx** value, the component with zero **weightx** value will grow horizontally in the same proportion as the other component(s) in that column. This is because each component must be maintained in the same row and column in which it was originally placed.

Variable **weighty** specifies how to distribute extra vertical space to grid slots in a GridBagLayout when the container is resized. A zero value indicates that the grid slot does not grow vertically on its own. However, if the component spans a row containing a component with nonzero **weighty** value, the component with zero **weighty** value grows vertically in the same proportion as the other component(s) in the same row.

In Fig. 25.18, the effects of **weighty** and **weightx** cannot easily be seen until the container is resized and additional space becomes available. Components with larger **weight** values occupy more of the additional space than those with smaller **weight** values.

Components should be given nonzero positive **weight** values—otherwise they'll “huddle” together in the middle of the container. Figure 25.20 shows the GUI of Fig. 25.18 with all **weights** set to zero.

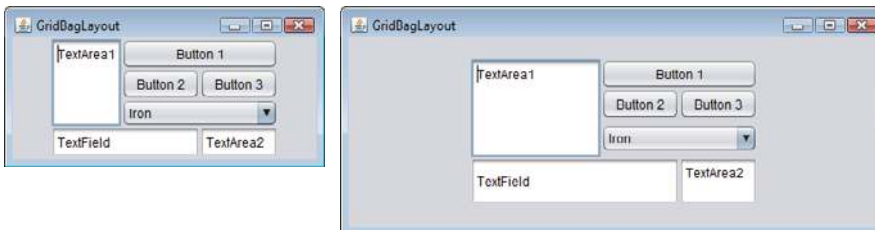

**Fig. 25.20** | GridBagLayout with the weights set to zero.

The application in Figs. 25.21–25.22 uses the GridBagLayout layout manager to arrange the components of the GUI in Fig. 25.18. The application does nothing except demonstrate how to use GridBagLayout.

```

1 // Fig. 25.21: GridBagFrame.java
2 // Demonstrating GridBagLayout.
3 import java.awt.GridBagLayout;
4 import java.awt.GridBagConstraints;
5 import java.awt.Component;
6 import javax.swing.JFrame;
7 import javax.swing.JTextArea;
8 import javax.swing.JTextField;

```

**Fig. 25.21** | GridBagLayout layout manager. (Part 1 of 3.)

```
9 import javax.swing.JButton;
10 import javax.swing.JComboBox;
11
12 public class GridBagFrame extends JFrame
13 {
14 private GridBagLayout layout; // layout of this frame
15 private GridBagConstraints constraints; // constraints of this layout
16
17 // set up GUI
18 public GridBagFrame()
19 {
20 super("GridBagLayout");
21 layout = new GridBagLayout();
22 setLayout(layout); // set frame layout
23 constraints = new GridBagConstraints(); // instantiate constraints
24
25 // create GUI components
26 JTextArea textArea1 = new JTextArea("TextArea1", 5, 10);
27 JTextArea textArea2 = new JTextArea("TextArea2", 2, 2);
28
29 String[] names = { "Iron", "Steel", "Brass" };
30 JComboBox comboBox = new JComboBox(names);
31
32 JTextField textField = new JTextField("TextField");
33 JButton button1 = new JButton("Button 1");
34 JButton button2 = new JButton("Button 2");
35 JButton button3 = new JButton("Button 3");
36
37 // weightx and weighty for textArea1 are both 0: the default
38 // anchor for all components is CENTER: the default
39 constraints.fill = GridBagConstraints.BOTH;
40 addComponent(textArea1, 0, 0, 1, 3);
41
42 // weightx and weighty for button1 are both 0: the default
43 constraints.fill = GridBagConstraints.HORIZONTAL;
44 addComponent(button1, 0, 1, 2, 1);
45
46 // weightx and weighty for comboBox are both 0: the default
47 // fill is HORIZONTAL
48 addComponent(comboBox, 2, 1, 2, 1);
49
50 // button2
51 constraints.weightx = 1000; // can grow wider
52 constraints.weighty = 1; // can grow taller
53 constraints.fill = GridBagConstraints.BOTH;
54 addComponent(button2, 1, 1, 1, 1);
55
56 // fill is BOTH for button3
57 constraints.weightx = 0;
58 constraints.weighty = 0;
59 addComponent(button3, 1, 2, 1, 1);
60
```

**Fig. 25.21** | GridBagLayout layout manager. (Part 2 of 3.)



```

61 // weightx and weighty for textField are both 0, fill is BOTH
62 addComponent(textField, 3, 0, 2, 1);
63
64 // weightx and weighty for textArea2 are both 0, fill is BOTH
65 addComponent(textArea2, 3, 2, 1, 1);
66 } // end GridBagFrame constructor
67
68 // method to set constraints on
69 private void addComponent(Component component,
70 int row, int column, int width, int height)
71 {
72 constraints.gridx = column; // set gridx
73 constraints.gridy = row; // set gridy
74 constraints.gridwidth = width; // set gridwidth
75 constraints.gridheight = height; // set gridheight
76 layout.setConstraints(component, constraints); // set constraints
77 add(component); // add component
78 } // end method addComponent
79 } // end class GridBagFrame

```

**Fig. 25.21** | GridBagLayout layout manager. (Part 3 of 3.)

```

1 // Fig. 25.22: GridBagDemo.java
2 // Demonstrating GridBagLayout.
3 import javax.swing.JFrame;
4
5 public class GridBagDemo
6 {
7 public static void main(String[] args)
8 {
9 GridBagFrame gridBagFrame = new GridBagFrame();
10 gridBagFrame.setDefaultCloseOperation(JFrame.EXIT_ON_CLOSE);
11 gridBagFrame.setSize(300, 150); // set frame size
12 gridBagFrame.setVisible(true); // display frame
13 } // end main
14 } // end class GridBagDemo

```

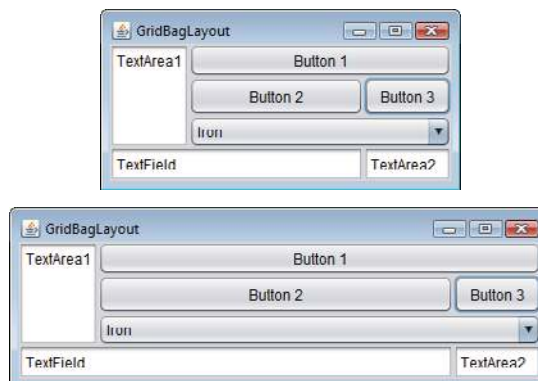

**Fig. 25.22** | Test class for GridBagFrame. (Part 1 of 2.)

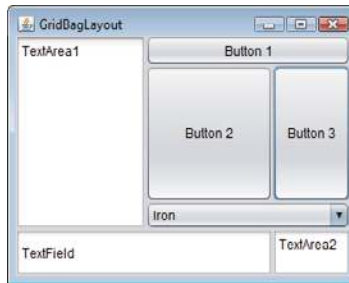

**Fig. 25.22** | Test class for GridBagFrame. (Part 2 of 2.)

The GUI contains three `JButtons`, two `JTextAreas`, a `JComboBox` and a `JTextField`. The layout manager is `GridBagLayout`. Lines 21–22 create the `GridBagLayout` object and set the layout manager for the `JFrame` to `layout`. Line 23 creates the `GridBagConstraints` object used to determine the location and size of each component in the grid. Lines 26–35 create each GUI component that will be added to the content pane.

Lines 39–40 configure `JTextArea` `textArea1` and add it to the content pane. The values for `weightx` and `weighty` values are not specified in constraints, so each has the value zero by default. Thus, the `JTextArea` will not resize itself even if space is available. However, it spans multiple rows, so the vertical size is subject to the `weighty` values of `JButtons` `button2` and `button3`. When either button is resized vertically based on its `weighty` value, the `JTextArea` is also resized.

Line 39 sets variable `fill` in constraints to `GridBagConstraints.BOTH`, causing the `JTextArea` to always fill its entire allocated area in the grid. An anchor value is not specified in constraints, so the default `CENTER` is used. We do not use variable anchor in this application, so all the components will use the default. Line 40 calls our utility method `addComponent` (declared at lines 69–78). The `JTextArea` object, the row, the column, the number of columns to span and the number of rows to span are passed as arguments.

`JButton` `button1` is the next component added (lines 43–44). By default, the `weightx` and `weighty` values are still zero. The `fill` variable is set to `HORIZONTAL`—the component will always fill its area in the horizontal direction. The vertical direction is not filled. The `weighty` value is zero, so the button will become taller only if another component in the same row has a nonzero `weighty` value. `JButton` `button1` is located at row 0, column 1. One row and two columns are occupied.

`JComboBox` `comboBox` is the next component added (line 48). By default, the `weightx` and `weighty` values are zero, and the `fill` variable is set to `HORIZONTAL`. The `JComboBox` button will grow only in the horizontal direction. The `weightx`, `weighty` and `fill` variables retain the values set in constraints until they're changed. The `JComboBox` button is placed at row 2, column 1. One row and two columns are occupied.

`JButton` `button2` is the next component added (lines 51–54). It's given a `weightx` value of 1000 and a `weighty` value of 1. The area occupied by the button is capable of growing in the vertical and horizontal directions. The `fill` variable is set to `BOTH`, which specifies that the button will always fill the entire area. When the window is resized, `button2` will grow. The button is placed at row 1, column 1. One row and one column are occupied.

JButton `button3` is added next (lines 57–59). Both the `weightx` value and `weighty` value are set to zero, and the value of `fill` is `BOTH`. JButton `button3` will grow if the window is resized—it's affected by the weight values of `button2`. The `weightx` value for `button2` is much larger than that for `button3`. When resizing occurs, `button2` will occupy a larger percentage of the new space. The button is placed at row 1, column 2. One row and one column are occupied.

Both the JTextField `textField` (line 62) and JTextArea `textArea2` (line 65) have a `weightx` value of 0 and a `weighty` value of 0. The value of `fill` is `BOTH`. The JTextField is placed at row 3, column 0, and the JTextArea at row 3, column 2. The JTextField occupies one row and two columns, the JTextArea one row and one column.

Method `addComponent`'s parameters are a Component reference component and integers `row`, `column`, `width` and `height`. Lines 72–73 set the GridBagConstraints variables `gridx` and `gridy`. The `gridx` variable is assigned the column in which the Component will be placed, and the `gridy` value is assigned the row in which the Component will be placed. Lines 74–75 set the GridBagConstraints variables `gridwidth` and `gridheight`. The `gridwidth` variable specifies the number of columns the Component will span in the grid, and the `gridheight` variable specifies the number of rows the Component will span in the grid. Line 76 sets the GridBagConstraints for a component in the GridBagLayout. Method `setConstraints` of class GridBagLayout takes a Component argument and a GridBagConstraints argument. Line 77 adds the component to the JFrame.

When you execute this application, try resizing the window to see how the constraints for each GUI component affect its position and size in the window.

### *GridBagConstraints Constants RELATIVE and REMAINDER*

Instead of `gridx` and `gridy`, a variation of GridBagLayout uses GridBagConstraints constants **RELATIVE** and **REMAINDER**. **RELATIVE** specifies that the next-to-last component in a particular row should be placed to the right of the previous component in the row. **REMAINDER** specifies that a component is the last component in a row. Any component that is not the second-to-last or last component on a row must specify values for GridBagConstraints variables `gridwidth` and `gridheight`. The application in Figs. 25.23–25.24 arranges components in GridBagLayout, using these constants.

---

```
1 // Fig. 25.23: GridBagFrame2.java
2 // Demonstrating GridBagLayout constants.
3 import java.awt.GridBagLayout;
4 import java.awt.GridBagConstraints;
5 import java.awt.Component;
6 import javax.swing.JFrame;
7 import javax.swing.JComboBox;
8 import javax.swing.JTextField;
9 import javax.swing.JList;
10 import javax.swing.JButton;
11
12 public class GridBagFrame2 extends JFrame
13 {
14 private GridBagLayout layout; // layout of this frame
15 private GridBagConstraints constraints; // constraints of this layout
```

---

**Fig. 25.23** | GridBagConstraints constants RELATIVE and REMAINDER. (Part 1 of 3.)

```
16
17 // set up GUI
18 public GridBagFrame2()
19 {
20 super("GridBagLayout");
21 layout = new GridBagLayout();
22 setLayout(layout); // set frame layout
23 constraints = new GridBagConstraints(); // instantiate constraints
24
25 // create GUI components
26 String[] metals = { "Copper", "Aluminum", "Silver" };
27 JComboBox comboBox = new JComboBox(metals);
28
29 JTextField textField = new JTextField("TextField");
30
31 String[] fonts = { "Serif", "Monospaced" };
32 JList list = new JList(fonts);
33
34 String[] names = { "zero", "one", "two", "three", "four" };
35 JButton[] buttons = new JButton[names.length];
36
37 for (int count = 0; count < buttons.length; count++)
38 buttons[count] = new JButton(names[count]);
39
40 // define GUI component constraints for textField
41 constraints.weightx = 1;
42 constraints.weighty = 1;
43 constraints.fill = GridBagConstraints.BOTH;
44 constraints.gridwidth = GridBagConstraints.REMAINDER;
45 addComponent(textField);
46
47 // buttons[0] -- weightx and weighty are 1: fill is BOTH
48 constraints.gridwidth = 1;
49 addComponent(buttons[0]);
50
51 // buttons[1] -- weightx and weighty are 1: fill is BOTH
52 constraints.gridwidth = GridBagConstraints.RELATIVE;
53 addComponent(buttons[1]);
54
55 // buttons[2] -- weightx and weighty are 1: fill is BOTH
56 constraints.gridwidth = GridBagConstraints.REMAINDER;
57 addComponent(buttons[2]);
58
59 // comboBox -- weightx is 1: fill is BOTH
60 constraints.weighty = 0;
61 constraints.gridwidth = GridBagConstraints.REMAINDER;
62 addComponent(comboBox);
63
64 // buttons[3] -- weightx is 1: fill is BOTH
65 constraints.weighty = 1;
66 constraints.gridwidth = GridBagConstraints.REMAINDER;
67 addComponent(buttons[3]);
68
```

**Fig. 25.23** | GridBagConstraints constants RELATIVE and REMAINDER. (Part 2 of 3.)

```

69 // buttons[4] -- weightx and weighty are 1: fill is BOTH
70 constraints.gridwidth = GridBagConstraints.RELATIVE;
71 addComponent(buttons[4]);
72
73 // list -- weightx and weighty are 1: fill is BOTH
74 constraints.gridwidth = GridBagConstraints.REMAINDER;
75 addComponent(list);
76 } // end GridBagFrame2 constructor
77
78 // add a component to the container
79 private void addComponent(Component component)
80 {
81 layout.setConstraints(component, constraints);
82 add(component); // add component
83 } // end method addComponent
84 } // end class GridBagFrame2

```

**Fig. 25.23** | GridBagConstraints constants RELATIVE and REMAINDER. (Part 3 of 3.)

```

1 // Fig. 25.24: GridBagDemo2.java
2 // Demonstrating GridBagLayout constants.
3 import javax.swing.JFrame;
4
5 public class GridBagDemo2
6 {
7 public static void main(String[] args)
8 {
9 GridBagFrame2 gridBagFrame = new GridBagFrame2();
10 gridBagFrame.setDefaultCloseOperation(JFrame.EXIT_ON_CLOSE);
11 gridBagFrame.setSize(300, 200); // set frame size
12 gridBagFrame.setVisible(true); // display frame
13 } // end main
14 } // end class GridBagDemo2

```

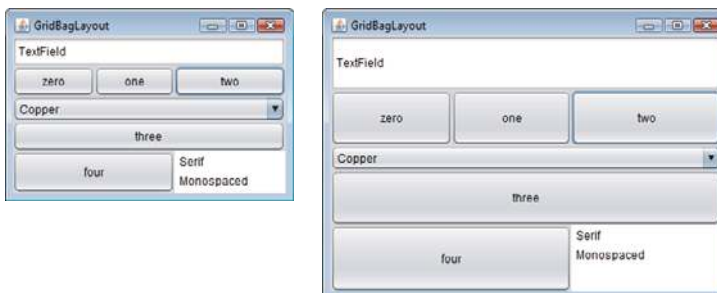

**Fig. 25.24** | Test class for GridBagDemo2.

Lines 21–22 create a GridBagLayout and use it to set the JFrame’s layout manager. The components that are placed in GridBagLayout are created in lines 27–38—they are a JComboBox, a JTextField, a JList and five JButtons.

The JTextField is added first (lines 41–45). The weightx and weighty values are set to 1. The fill variable is set to BOTH. Line 44 specifies that the JTextField is the last com-

ponent on the line. The `JTextField` is added to the content pane with a call to our utility method `addComponent` (declared at lines 79–83). Method `addComponent` takes a `Component` argument and uses `GridBagLayout` method `setConstraints` to set the constraints for the `Component`. Method `add` attaches the component to the content pane.

`JButton buttons[ 0 ]` (lines 48–49) has `weightx` and `weighty` values of 1. The `fill` variable is `BOTH`. Because `buttons[ 0 ]` is not one of the last two components on the row, it's given a `gridwidth` of 1 and so will occupy one column. The `JButton` is added to the content pane with a call to utility method `addComponent`.

`JButton buttons[ 1 ]` (lines 52–53) has `weightx` and `weighty` values of 1. The `fill` variable is `BOTH`. Line 52 specifies that the `JButton` is to be placed relative to the previous component. The `Button` is added to the `JFrame` with a call to `addComponent`.

`JButton buttons[ 2 ]` (lines 56–57) has `weightx` and `weighty` values of 1. The `fill` variable is `BOTH`. This `JButton` is the last component on the line, so `REMAINDER` is used. The `JButton` is added to the content pane with a call to `addComponent`.

The `JComboBox` (lines 60–62) has a `weightx` of 1 and a `weighty` of 0. The `JComboBox` will not grow vertically. The `JComboBox` is the only component on the line, so `REMAINDER` is used. The `JComboBox` is added to the content pane with a call to `addComponent`.

`JButton buttons[ 3 ]` (lines 65–67) has `weightx` and `weighty` values of 1. The `fill` variable is `BOTH`. This `JButton` is the only component on the line, so `REMAINDER` is used. The `JButton` is added to the content pane with a call to `addComponent`.

`JButton buttons[ 4 ]` (lines 70–71) has `weightx` and `weighty` values of 1. The `fill` variable is `BOTH`. This `JButton` is the next-to-last component on the line, so `RELATIVE` is used. The `JButton` is added to the content pane with a call to `addComponent`.

The `JList` (lines 74–75) has `weightx` and `weighty` values of 1. The `fill` variable is `BOTH`. The `JList` is added to the content pane with a call to `addComponent`.

## 25.10 Wrap-Up

This chapter completes our introduction to GUIs. In this chapter, we discussed additional GUI topics, such as menus, sliders, pop-up menus, multiple-document interfaces, tabbed panes and Java's pluggable look-and-feel. All these components can be added to existing applications to make them easier to use and understand. We also presented additional layout managers for organizing and sizing GUI components. In the next chapter, you'll learn about multithreading, which allows you to specify that an application should perform multiple tasks at once.

## Summary

### Section 25.2 `JSlider`

- `JSliders` enable you to select from a range of integer values. They can display major and minor tick marks, and labels for the tick marks (p. 1001). They also support snap-to ticks (p. 1001)—positioning the thumb (p. 1001) between two tick marks causes snaps it to the closest tick mark.
- `JSliders` (p. 1001) have either horizontal or vertical orientation. For a horizontal `JSlider`, the minimum value is at the extreme left and the maximum value at the extreme right. For a vertical `JSlider`, the minimum value is at the extreme bottom and the maximum value at the extreme top. The position of the thumb indicates the current value of the `JSlider`. Method `getValue` (p. 1005) of class `JSlider` returns the current thumb position.

- `JSlider` method `setMajorTickSpacing()` sets the spacing for tick marks on a `JSlider`. Method `setPaintTicks()` (p. 1005) with a `true` argument indicates that the tick marks should be displayed.
- `JSliders` generate `ChangeEvent`s when the user interacts with a `JSlider`. A `ChangeListener` (p. 1005) declares method `stateChanged()` (p. 1005) that can respond to `ChangeEvent`s.

### Section 25.3 Windows: Additional Notes

- A window's (p. 1005) events can be handled by a `WindowListener` (p. 1006), which provides seven window-event-handling methods—`windowActivated`, `windowClosed`, `windowClosing`, `windowDeactivated`, `windowDeiconified`, `windowIconified` and `windowOpened`.

### Section 25.4 Using Menus with Frames

- Menus neatly organize commands in a GUI. In Swing GUIs, menus can be attached only to objects of classes with method `setJMenuBar()` (p. 1006).
- A `JMenuBar` (p. 1006) is a container for menus. A `JMenuItem` appears in a menu. A `JMenu` (p. 1006) contains menu items (p. 1007) and can be added to a `JMenuBar` or to other `JMenus` as submenus.
- When a menu is clicked, it expands to show its list of menu items.
- When a `JCheckBoxMenuItem` (p. 1007) is selected, a check appears to the left of the menu item. When the `JCheckBoxMenuItem` is selected again, the check is removed.
- In a `ButtonGroup`, only one `JRadioButtonMenuItem` (p. 1007) can be selected at a time.
- `AbstractButton` method `setMnemonic()` (p. 1012) specifies the mnemonic (p. 1007) for a button. Mnemonic characters are normally displayed with an underline.
- A modal dialog box (p. 1012) does not allow access to any other window in the application until the dialog is dismissed. The dialogs displayed with class `JOptionPane` are modal dialogs. Class `JDialog` (p. 1013) can be used to create your own modal or nonmodal dialogs.

### Section 25.5 JPopupMenu

- Context-sensitive pop-up menus (p. 1014) are created with class `JPopupMenu` (p. 1014). The pop-up trigger event (p. 1014) occurs normally when the user presses and releases the right mouse button. `MouseEvent` method `isPopupTrigger()` (p. 1017) returns `true` if the pop-up trigger event occurred.
- `JPopupMenu` method `show()` (p. 1017) displays a `JPopupMenu`. The first argument specifies the origin component (p. 1017), which helps determine where the `JPopupMenu` will appear. The last two arguments are the coordinates from the origin component's upper-left corner, at which the `JPopupMenu` appears.

### Section 25.6 Pluggable Look-and-Feel

- Class `UIManager.LookAndFeelInfo` (p. 1021) maintains information about a look-and-feel.
- `UIManager` (p. 1021) static method `getInstalledLookAndFeels()` (p. 1021) returns an array of `UIManager.LookAndFeelInfo` objects that describe the available look-and-feels.
- `UIManager` static method `setLookAndFeel()` (p. 1021) changes the look-and-feel. `SwingUtilities` (p. 1022) static method `updateComponentTreeUI()` (p. 1022) changes the look-and-feel of every component attached to its `Component` argument to the new look-and-feel.

### Section 25.7 JDesktopPane and JInternalFrame

- Many of today's applications use a multiple-document interface (MDI; p. 1022) to manage several open documents that are being processed in parallel. Swing's `JDesktopPane` (p. 1022) and `JInternalFrame` (p. 1022) classes provide support for creating multiple-document interfaces.

**Section 25.8 JTabbedPane**

- A `JTabbedPane` (p. 1026) arranges GUI components into layers, of which only one is visible at a time. Users access each layer by clicking its tab.

**Section 25.9 Layout Managers: `BoxLayout` and `GridBagLayout`**

- `BoxLayout` arranges GUI components left-to-right or top-to-bottom in a container.
- Class `Box` represents a container with `BoxLayout` as its default layout manager and provides static methods to create a `Box` with a horizontal or vertical `BoxLayout`.
- `GridBagLayout` (p. 1031) is similar to `GridLayout`, but each component size can vary.
- A `GridBagConstraints` object (p. 1031) specifies how a component is placed in a `GridBagLayout`.

**Self-Review Exercises**

- 25.1** Fill in the blanks in each of the following statements:
- The \_\_\_\_\_ class is used to create a menu object.
  - The \_\_\_\_\_ method of class `JMenu` places a separator bar in a menu.
  - `JSlider` events are handled by the \_\_\_\_\_ method of interface \_\_\_\_\_.
  - The `GridBagConstraints` instance variable \_\_\_\_\_ is set to `CENTER` by default.
- 25.2** State whether each of the following is *true* or *false*. If *false*, explain why.
- When the programmer creates a `JFrame`, a minimum of one menu must be created and added to the `JFrame`.
  - The variable `fill` belongs to the `GridBagLayout` class.
  - Drawing on a GUI component is performed with respect to the (0, 0) upper-left corner coordinate of the component.
  - The default layout for a `Box` is `BoxLayout`.
- 25.3** Find the error(s) in each of the following and explain how to correct the error(s).
- `JMenuBar b`;
  - `mySlider = JSlider( 1000, 222, 100, 450 );`
  - `gbc.fill = GridBagConstraints.NORTHWEST; // set fill`
  - `// override to paint on a customized Swing component`  

```
public void paintComponent(Graphics g)
{
 g.drawString("HELLO", 50, 50);
} // end method paintComponent
```
  - `// create a JFrame and display it`  

```
JFrame f = new JFrame("A Window");
f.setVisible(true);
```

**Answers to Self-Review Exercises**

- 25.1** a) `JMenu`. b) `addSeparator`. c) `stateChanged`, `ChangeListener`. d) `anchor`.
- 25.2** a) *False*. A `JFrame` does not require any menus.  
b) *False*. The variable `fill` belongs to the `GridBagConstraints` class.  
c) *True*.  
d) *True*.
- 25.3** a) `JMenuBar` should be `JMenuBar`.  
b) The first argument to the constructor should be `SwingConstants.HORIZONTAL` or `SwingConstants.VERTICAL`, and the keyword `new` must be used after the `=` operator. Also, the minimum value should be less than the maximum and the initial value should be in range.



- c) The constant should be either BOTH, HORIZONTAL, VERTICAL or NONE.
- d) `paintComponent` should be `paintComponent`, and the method should call `super.paintComponent( g )` as its first statement.
- e) The `JFrame`'s `setSize` method must also be called to establish the size of the window.

## Exercises

**25.4** (*Fill-in-the-Blanks*) Fill in the blanks in each of the following statements:

- a) A `JMenuItem` that is a `JMenu` is called a(n) \_\_\_\_\_.
- b) Method \_\_\_\_\_ attaches a `JMenuBar` to a `JFrame`.
- c) Container class \_\_\_\_\_ has a default `BoxLayout`.
- d) A(n) \_\_\_\_\_ manages a set of child windows declared with class `JInternalFrame`.

**25.5** (*True or False*) State whether each of the following is *true* or *false*. If *false*, explain why.

- a) Menus require a `JMenuBar` object so they can be attached to a `JFrame`.
- b) `BoxLayout` is the default layout manager for a `JFrame`.
- c) `JApplets` can contain menus.

**25.6** (*Find the Code Errors*) Find the error(s) in each of the following. Explain how to correct the error(s).

- a) `x.add( new JMenuItem( "Submenu Color" ) ); // create submenu`
- b) `container.setLayout( new GridbagLayout() );`

**25.7** (*Display a Circle and its Attributes*) Write a program that displays a circle of random size and calculates and displays the area, radius, diameter and circumference. Use the following equations:  $diameter = 2 \times radius$ ,  $area = \pi \times radius^2$ ,  $circumference = 2 \times \pi \times radius$ . Use the constant `Math.PI` for  $\pi$  ( $\pi$ ). All drawing should be done on a subclass of `JPanel`, and the results of the calculations should be displayed in a read-only `JTextArea`.

**25.8** (*Using a JSlider*) Enhance the program in Exercise 25.7 by allowing the user to alter the radius with a `JSlider`. The program should work for all radii in the range from 100 to 200. As the radius changes, the diameter, area and circumference should be updated and displayed. The initial radius should be 150. Use the equations from Exercise 25.7. All drawing should be done on a subclass of `JPanel`, and the results of the calculations should be displayed in a read-only `JTextArea`.

**25.9** (*Varying weightx and weighty*) Explore the effects of varying the `weightx` and `weighty` values of the program in Fig. 25.21. What happens when a slot has a nonzero weight but is not allowed to fill the whole area (i.e., the `fill` value is not BOTH)?

**25.10** (*Synchronizing a JSlider and a JTextField*) Write a program that uses the `paintComponent` method to draw the current value of a `JSlider` on a subclass of `JPanel`. In addition, provide a `JTextField` where a specific value can be entered. The `JTextField` should display the current value of the `JSlider` at all times. Changing the value in the `JTextField` should also update the `JSlider`. A `JLabel` should be used to identify the `JTextField`. The `JSlider` methods `setValue` and `getValue` should be used. [Note: The `setValue` method is a `public` method that does not return a value and takes one integer argument, the `JSlider` value, which determines the position of the thumb.]

**25.11** (*Creating a Color Chooser*) Declare a subclass of `JPanel` called `MyColorChooser` that provides three `JSlider` objects and three `JTextField` objects. Each `JSlider` represents the values from 0 to 255 for the red, green and blue parts of a color. Use these values as the arguments to the `Color` constructor to create a new `Color` object. Display the current value of each `JSlider` in the corresponding `JTextField`. When the user changes the value of the `JSlider`, the `JTextField` should be changed accordingly. Use your new GUI component as part of an application that displays the current `Color` value by drawing a filled rectangle.

**25.12** (*Creating a Color Chooser: Modification*) Modify the `MyColorChooser` class of Exercise 25.11 to allow the user to enter an integer value into a `JTextField` to set the red, green or blue value. When the user presses *Enter* in the `JTextField`, the corresponding `JSlider` should be set to the appropriate value.

**25.13** (*Creating a Color Chooser: Modification*) Modify the application in Exercise 25.12 to draw the current color as a rectangle on an instance of a subclass of `JPanel` which provides its own `paintComponent` method to draw the rectangle and provides *set* methods to set the red, green and blue values for the current color. When any *set* method is invoked, the drawing panel should automatically repaint itself.

**25.14** (*Drawing Application*) Modify the application in Exercise 25.13 to allow the user to drag the mouse across the drawing panel (a subclass of `JPanel`) to draw a shape in the current color. Enable the user to choose what shape to draw.

**25.15** (*Drawing Application Modification*) Modify the application in Exercise 25.14 to provide the user with the ability to terminate the application by clicking the close box on the window that is displayed and by selecting `Exit` from a `File` menu. Use the techniques shown in Fig. 25.5.

**25.16** (*Complete Drawing Application*) Using the techniques developed in this chapter and Chapter 14, create a complete drawing application. The program should use the GUI components from Chapter 14 and Chapter 25 to enable the user to select the shape, color and fill characteristics. Each shape should be stored in an array of `MyShape` objects, where `MyShape` is the superclass in your hierarchy of shape classes. Use a `JDesktopPane` and `JInternalFrames` to allow the user to create multiple separate drawings in separate child windows. Create the user interface as a separate child window containing all the GUI components that allow the user to determine the characteristics of the shape to be drawn. The user can then click in any `JInternalFrame` to draw the shape.

# Multithreading

# 26



*The most general definition of beauty... Multeity in Unity.*

—Samuel Taylor Coleridge

*Do not block the way of inquiry.*

—Charles Sanders Peirce

*A person with one watch knows what time it is; a person with two watches is never sure.*

—Proverb

*Learn to labor and to wait.*

—Henry Wadsworth Longfellow

*The world is moving so fast these days that the man who says it can't be done is generally interrupted by someone doing it.*

—Elbert Hubbard

## Objectives

In this chapter you'll learn:

- What threads are and why they're useful.
- How threads enable you to manage concurrent activities.
- The life cycle of a thread.
- To create and execute `Runnable`s.
- Thread synchronization.
- What producer/consumer relationships are and how they're implemented with multithreading.
- To enable multiple threads to update Swing GUI components in a thread-safe manner.

- 26.1 Introduction
- 26.2 Thread States: Life Cycle of a Thread
- 26.3 Creating and Executing Threads with Executor Framework
- 26.4 Thread Synchronization
  - 26.4.1 Unsynchronized Data Sharing
  - 26.4.2 Synchronized Data Sharing—Making Operations Atomic
- 26.5 Producer/Consumer Relationship without Synchronization
- 26.6 Producer/Consumer Relationship: ArrayBlockingQueue
- 26.7 Producer/Consumer Relationship with Synchronization
- 26.8 Producer/Consumer Relationship: Bounded Buffers
- 26.9 Producer/Consumer Relationship: The Lock and Condition Interfaces
- 26.10 Concurrent Collections Overview
- 26.11 Multithreading with GUI
  - 26.11.1 Performing Computations in a Worker Thread
  - 26.11.2 Processing Intermediate Results with SwingWorker
- 26.12 Interfaces Callable and Future
- 26.13 Java SE 7: Fork/Join Framework
- 26.14 Wrap-Up

Summary | Self-Review Exercises | Answers to Self-Review Exercises | Exercises

## 26.1 Introduction

It would be nice if we could focus our attention on performing only one action at a time and performing it well, but that's usually difficult to do. The human body performs a great variety of operations *in parallel*—or, as we'll say throughout this chapter, **concurrently**. Respiration, blood circulation, digestion, thinking and walking, for example, can occur concurrently, as can all the senses—sight, touch, smell, taste and hearing.

Computers, too, can perform operations concurrently. It's common for personal computers to compile a program, send a file to a printer and receive electronic mail messages over a network concurrently. Only computers that have multiple processors can truly execute multiple instructions concurrently. Operating systems on single-processor computers create the illusion of concurrent execution by rapidly switching between activities, but on such computers only a single instruction can execute at once. Today's multicore computers have multiple processors that enable computers to perform tasks truly concurrently. Multicore smartphones are starting to appear.

Historically, concurrency has been implemented with operating system primitives available only to experienced systems programmers. The Ada programming language—developed by the United States Department of Defense—made concurrency primitives widely available to defense contractors building military command-and-control systems. However, Ada has not been widely used in academia and industry.

### *Java Concurrency*

Java makes concurrency available to you through the language and APIs. Java programs can have multiple **threads of execution**, where each thread has its own method-call stack and program counter, allowing it to execute concurrently with other threads while sharing with them application-wide resources such as memory. This capability is called **multithreading**.



### Performance Tip 26.1

*A problem with single-threaded applications that can lead to poor responsiveness is that lengthy activities must complete before others can begin. In a multithreaded application, threads can be distributed across multiple processors (if available) so that multiple tasks execute truly concurrently and the application can operate more efficiently. Multithreading can also increase performance on single-processor systems that simulate concurrency—when one thread cannot proceed (because, for example, it's waiting for the result of an I/O operation), another can use the processor.*

### Concurrent Programming Uses

We'll discuss many applications of **concurrent programming**. For example, when downloading a large file (e.g., an image, an audio clip or a video clip) over the Internet, the user may not want to wait until the entire clip downloads before starting the playback. To solve this problem, multiple threads can be used—one to download the clip, and another to play it. These activities proceed concurrently. To avoid choppy playback, the threads are **synchronized** (that is, their actions are coordinated) so that the player thread doesn't begin until there's a sufficient amount of the clip in memory to keep the player thread busy. The Java Virtual Machine (JVM) creates threads to run programs and threads to perform housekeeping tasks such as garbage collection.

### Concurrent Programming Is Difficult

Writing multithreaded programs can be tricky. Although the human mind can perform functions concurrently, people find it difficult to jump between parallel trains of thought. To see why multithreaded programs can be difficult to write and understand, try the following experiment: Open three books to page 1, and try reading the books concurrently. Read a few words from the first book, then a few from the second, then a few from the third, then loop back and read the next few words from the first book, and so on. After this experiment, you'll appreciate many of the challenges of multithreading—switching between the books, reading briefly, remembering your place in each book, moving the book you're reading closer so that you can see it and pushing the books you're not reading aside—and, amid all this chaos, trying to comprehend the content of the books!

### Use the Prebuilt Classes of the Concurrency APIs Whenever Possible

Programming concurrent applications is difficult and error prone. If you must use synchronization in a program, you should follow some simple guidelines. *Use existing classes from the Concurrency APIs (such as the `ArrayBlockingQueue` class we discuss in Section 26.6) that manage synchronization for you.* These classes are written by experts, have been thoroughly tested and debugged, operate efficiently and help you avoid common traps and pitfalls.

If you need even more complex capabilities, use interfaces `Lock` and `Condition` that we introduce in Section 26.9. These interfaces should be used only by advanced programmers who are familiar with concurrent programming's common traps and pitfalls. We explain these topics in this chapter for several reasons:

- They provide a solid basis for understanding how concurrent applications synchronize access to shared memory.
- The concepts are important to understand, even if an application does not use these tools explicitly.

- By showing you the complexity involved in using these low-level features, we hope to impress upon you the importance of *using prebuilt concurrency capabilities whenever possible*.

Section 26.10 provides an overview of Java’s pre-built concurrent collections.

## 26.2 Thread States: Life Cycle of a Thread

At any time, a thread is said to be in one of several **thread states**—illustrated in the UML state diagram in Fig. 26.1. Several of the terms in the diagram are defined in later sections. We include this discussion to help you understand what’s going on “under the hood” in a Java multithreaded environment. Java hides most of this detail from you, greatly simplifying the task of developing multithreaded applications.

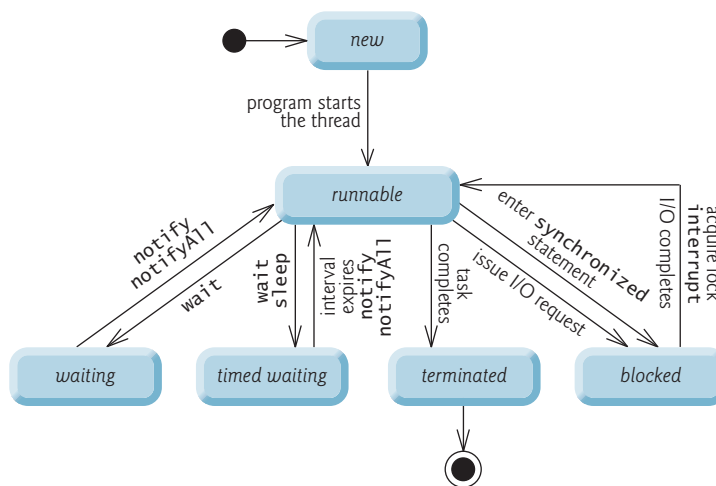

**Fig. 26.1** | Thread life-cycle UML state diagram.

### New and Runnable States

A new thread begins its life cycle in the **new** state. It remains in this state until the program starts the thread, which places it in the **runnable** state. A thread in the **runnable** state is considered to be executing its task.

### Waiting State

Sometimes a **runnable** thread transitions to the **waiting** state while it waits for another thread to perform a task. A **waiting** thread transitions back to the **runnable** state only when another thread notifies it to continue executing.

### Timed Waiting State

A **runnable** thread can enter the **timed waiting** state for a specified interval of time. It transitions back to the **runnable** state when that time interval expires or when the event it’s waiting for occurs. **Timed waiting** and **waiting** threads cannot use a processor, even if one

is available. A *runnable* thread can transition to the *timed waiting* state if it provides an optional wait interval when it's waiting for another thread to perform a task. Such a thread returns to the *runnable* state when it's notified by another thread or when the timed interval expires—whichever comes first. Another way to place a thread in the *timed waiting* state is to put a *runnable* thread to sleep. A **sleeping thread** remains in the *timed waiting* state for a designated period of time (called a **sleep interval**), after which it returns to the *runnable* state. Threads sleep when they momentarily do not have work to perform. For example, a word processor may contain a thread that periodically backs up (i.e., writes a copy of) the current document to disk for recovery purposes. If the thread did not sleep between successive backups, it would require a loop in which it continually tested whether it should write a copy of the document to disk. This loop would consume processor time without performing productive work, thus reducing system performance. In this case, it's more efficient for the thread to specify a sleep interval (equal to the period between successive backups) and enter the *timed waiting* state. This thread is returned to the *runnable* state when its sleep interval expires, at which point it writes a copy of the document to disk and reenters the *timed waiting* state.

### Blocked State

A *runnable* thread transitions to the *blocked* state when it attempts to perform a task that cannot be completed immediately and it must temporarily wait until that task completes. For example, when a thread issues an input/output request, the operating system blocks the thread from executing until that I/O request completes—at that point, the *blocked* thread transitions to the *runnable* state, so it can resume execution. A *blocked* thread cannot use a processor, even if one is available.

### Terminated State

A *runnable* thread enters the *terminated* state (sometimes called the *dead* state) when it successfully completes its task or otherwise terminates (perhaps due to an error). In the UML state diagram of Fig. 26.1, the *terminated* state is followed by the UML final state (the bull's-eye symbol) to indicate the end of the state transitions.

### Operating-System View of the Runnable State

At the operating system level, Java's *runnable* state typically encompasses *two separate* states (Fig. 26.2). The operating system hides these states from the Java Virtual Machine (JVM), which sees only the *runnable* state. When a thread first transitions to the *runnable* state from the *new* state, it's in the *ready* state. A *ready* thread enters the *running* state (i.e., begins executing) when the operating system assigns it to a processor—also known as **dispatching the thread**. In most operating systems, each thread is given a small amount of processor time—called a **quantum** or **timeslice**—with which to perform its task. Deciding how large the quantum should be is a key topic in operating systems courses. When its quantum expires, the thread returns to the *ready* state, and the operating system assigns another thread to the processor. Transitions between the *ready* and *running* states are handled solely by the operating system. The JVM does not “see” the transitions—it simply views the thread as being *runnable* and leaves it up to the operating system to transition the thread between *ready* and *running*. The process that an operating system uses to determine which thread to dispatch is called **thread scheduling** and is dependent on thread priorities.

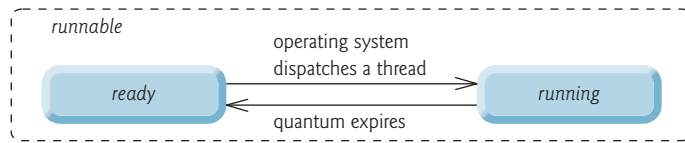

**Fig. 26.2** | Operating system's internal view of Java's *runnable* state.

### Thread Priorities and Thread Scheduling

Every Java thread has a **thread priority** that helps determine the order in which threads are scheduled. Each new thread inherits the priority of the thread that created it. Informally, higher-priority threads are more important to a program and should be allocated processor time before lower-priority threads. *Nevertheless, thread priorities cannot guarantee the order in which threads execute.*

*It's recommended that you do not explicitly create and use Thread objects to implement concurrency, but rather use the Executor interface (which is described in Section 26.3).* The Thread class does contain some useful static methods, which you *will* use later in the chapter.

Most operating systems support timeslicing, which enables threads of equal priority to share a processor. Without timeslicing, each thread in a set of equal-priority threads runs to completion (unless it leaves the *runnable* state and enters the *waiting* or *timed waiting* state, or gets interrupted by a higher-priority thread) before other threads of equal priority get a chance to execute. With timeslicing, even if a thread has *not* finished executing when its quantum expires, the processor is taken away from the thread and given to the next thread of equal priority, if one is available.

An *operating system's thread scheduler* determines which thread runs next. One simple thread-scheduler implementation keeps the highest-priority thread *running* at all times and, if there's more than one highest-priority thread, ensures that all such threads execute for a quantum each in **round-robin** fashion. This process continues until all threads run to completion.

When a higher-priority thread enters the *ready* state, the operating system generally preempts the currently *running* thread (an operation known as **preemptive scheduling**). Depending on the operating system, higher-priority threads could postpone—possibly indefinitely—the execution of lower-priority threads. Such **indefinite postponement** is sometimes referred to more colorfully as **starvation**. Operating systems employ a technique called *aging* to prevent starvation—as a thread waits in the *ready* state, the operating system gradually increases the thread's priority, thus ensuring that the thread will eventually run.

*Java provides higher-level concurrency utilities to hide much of this complexity and make multithreaded programming less error prone. Thread priorities are used behind the scenes to interact with the operating system, but most programmers who use Java multithreading will not be concerned with setting and adjusting thread priorities.*



#### Portability Tip 26.1

*Thread scheduling is platform dependent—the behavior of a multithreaded program could vary across different Java implementations.*



## 26.3 Creating and Executing Threads with Executor Framework

This section demonstrates how to perform concurrent tasks in an application by using Executors and Runnable objects.

### *Creating Concurrent Tasks with the Runnable Interface*

You implement the **Runnable** interface (of package `java.lang`) to specify a task that can execute concurrently with other tasks. The Runnable interface declares the single method **run**, which contains the code that defines the task that a Runnable object should perform.

### *Executing Runnable Objects with an Executor*

To allow a Runnable to perform its task, you must execute it. An **Executor** object executes Runnables. An Executor does this by creating and managing a group of threads called a **thread pool**. When an Executor begins executing a Runnable, the Executor calls the Runnable object's `run` method, which executes in the new thread.

The Executor interface declares a single method named **execute** which accepts a Runnable as an argument. The Executor assigns every Runnable passed to its `execute` method to one of the available threads in the thread pool. If there are no available threads, the Executor creates a new thread or waits for a thread to become available and assigns that thread the Runnable that was passed to method `execute`.

Using an Executor has many advantages over creating threads yourself. Executors can *reuse existing threads* to eliminate the overhead of creating a new thread for each task and can improve performance by *optimizing the number of threads* to ensure that the processor stays busy, without creating so many threads that the application runs out of resources.



### **Software Engineering Observation 26.1**

*Though it's possible to create threads explicitly, it's recommended that you use the Executor interface to manage the execution of Runnable objects.*

### *Using Class Executors to Obtain an ExecutorService*

The **ExecutorService** interface (of package `java.util.concurrent`) *extends* Executor and declares various methods for managing the life cycle of an Executor. An object that implements the ExecutorService interface can be created using static methods declared in class **Executors** (of package `java.util.concurrent`). We use interface ExecutorService and a method of class Executors in our example, which executes three tasks.

### *Implementing the Runnable Interface*

Class `PrintTask` (Fig. 26.3) implements Runnable (line 5), *so that multiple PrintTasks can execute concurrently*. Variable `sleepTime` (line 7) stores a random integer value from 0 to 5 seconds created in the `PrintTask` constructor (line 17). Each thread running a `PrintTask` sleeps for the amount of time specified by `sleepTime`, then outputs its task's name and a message indicating that it's done sleeping.

A `PrintTask` executes when a thread calls the `PrintTask`'s `run` method. Lines 25–26 display a message indicating the name of the currently executing task and that the task is going to sleep for `sleepTime` milliseconds. Line 27 invokes static method **sleep** of class `Thread` to place the thread in the *timed waiting* state for the specified amount of time. At this point, the thread loses the processor, and the system allows another thread to execute.

---

```

1 // Fig. 26.3: PrintTask.java
2 // PrintTask class sleeps for a random time from 0 to 5 seconds
3 import java.util.Random;
4
5 public class PrintTask implements Runnable
6 {
7 private final int sleepTime; // random sleep time for thread
8 private final String taskName; // name of task
9 private final static Random generator = new Random();
10
11 // constructor
12 public PrintTask(String name)
13 {
14 taskName = name; // set task name
15
16 // pick random sleep time between 0 and 5 seconds
17 sleepTime = generator.nextInt(5000); // milliseconds
18 } // end PrintTask constructor
19
20 // method run contains the code that a thread will execute
21 public void run()
22 {
23 try // put thread to sleep for sleepTime amount of time
24 {
25 System.out.printf("%s going to sleep for %d milliseconds.\n",
26 taskName, sleepTime);
27 Thread.sleep(sleepTime); // put thread to sleep
28 } // end try
29 catch (InterruptedException exception)
30 {
31 System.out.printf("%s %s\n", taskName,
32 "terminated prematurely due to interruption");
33 } // end catch
34
35 // print task name
36 System.out.printf("%s done sleeping\n", taskName);
37 } // end method run
38 } // end class PrintTask

```

---

**Fig. 26.3** | PrintTask class sleeps for a random time from 0 to 5 seconds.

When the thread awakens, it reenters the *runnable* state. When the PrintTask is assigned to a processor again, line 36 outputs a message indicating that the task is done sleeping, then method run terminates. The catch at lines 29–33 is required because method sleep might throw a *checked* exception of type **InterruptedException** if a sleeping thread's **interrupt** method is called.

### *Using the ExecutorService to Manage Threads that Execute PrintTasks*

Figure 26.4 uses an ExecutorService object to manage threads that execute PrintTasks (as defined in Fig. 26.3). Lines 11–13 create and name three PrintTasks to execute. Line 18 uses Executors method **newCachedThreadPool** to obtain an ExecutorService that's capable of creating new threads as they're needed by the application. These threads are used by ExecutorService (threadExecutor) to execute the Runnables.

```
1 // Fig. 26.4: TaskExecutor.java
2 // Using an ExecutorService to execute Runnable's.
3 import java.util.concurrent.Executors;
4 import java.util.concurrent.ExecutorService;
5
6 public class TaskExecutor
7 {
8 public static void main(String[] args)
9 {
10 // create and name each runnable
11 PrintTask task1 = new PrintTask("task1");
12 PrintTask task2 = new PrintTask("task2");
13 PrintTask task3 = new PrintTask("task3");
14
15 System.out.println("Starting Executor");
16
17 // create ExecutorService to manage threads
18 ExecutorService threadExecutor = Executors.newCachedThreadPool();
19
20 // start threads and place in runnable state
21 threadExecutor.execute(task1); // start task1
22 threadExecutor.execute(task2); // start task2
23 threadExecutor.execute(task3); // start task3
24
25 // shut down worker threads when their tasks complete
26 threadExecutor.shutdown();
27
28 System.out.println("Tasks started, main ends.\n");
29 } // end main
30 } // end class TaskExecutor
```

```
Starting Executor
Tasks started, main ends
```

```
task1 going to sleep for 4806 milliseconds
task2 going to sleep for 2513 milliseconds
task3 going to sleep for 1132 milliseconds
task3 done sleeping
task2 done sleeping
task1 done sleeping
```

```
Starting Executor
task1 going to sleep for 3161 milliseconds.
task3 going to sleep for 532 milliseconds.
task2 going to sleep for 3440 milliseconds.
Tasks started, main ends.
```

```
task3 done sleeping
task1 done sleeping
task2 done sleeping
```

**Fig. 26.4** | Using an ExecutorService to execute Runnable's.

Lines 21–23 each invoke the `ExecutorService`'s `execute` method, which executes the `Runnable` passed to it as an argument (in this case a `PrintTask`) some time in the future. The specified task may execute in one of the threads in the `ExecutorService`'s thread pool, in a new thread created to execute it, or in the thread that called the `execute` method—the `ExecutorService` manages these details. Method `execute` returns immediately from each invocation—the program does *not* wait for each `PrintTask` to finish. Line 26 calls `ExecutorService` method `shutdown`, which notifies the `ExecutorService` to *stop accepting new tasks, but continues executing tasks that have already been submitted*. Once all of the previously submitted `Runnable`s have completed, the `ThreadExecutor` terminates. Line 28 outputs a message indicating that the tasks were started and the `main` thread is finishing its execution.

The code in `main` executes in the **main thread**, a thread created by the JVM. The code in the `run` method of `PrintTask` (lines 21–37 of Fig. 26.3) executes whenever the `ExecutorService` starts each `PrintTask`—again, this is sometime after they're passed to the `ExecutorService`'s `execute` method (Fig. 26.4, lines 21–23). When `main` terminates, the program itself continues running because there are still tasks that must finish executing. The program will not terminate until these tasks complete.

The sample outputs show each task's name and sleep time as the thread goes to sleep. The thread with the shortest sleep time *normally* awakens first, indicates that it's done sleeping and terminates. In Section 26.8, we discuss multithreading issues that could prevent the thread with the shortest sleep time from awakening first. In the first output, the `main` thread terminates *before* any of the `PrintTasks` output their names and sleep times. This shows that the `main` thread runs to completion before any of the `PrintTasks` gets a chance to run. In the second output, all of the `PrintTasks` output their names and sleep times *before* the `main` thread terminates. This shows that the `PrintTasks` started executing before the `main` thread terminated. Also, notice in the second example output, `task3` goes to sleep before `task2` last, even though we passed `task2` to the `ExecutorService`'s `execute` method before `task3`. This illustrates the fact that *we cannot predict the order in which the tasks will start executing, even if we know the order in which they were created and started*.

## 26.4 Thread Synchronization

When multiple threads share an object and it's modified by one or more of them, indeterminate results may occur (as we'll see in the examples) unless access to the shared object is managed properly. If one thread is in the process of updating a shared object and another thread also tries to update it, it's unclear which thread's update takes effect. When this happens, the program's behavior cannot be trusted—sometimes the program will produce the correct results, and sometimes it won't. In either case, there'll be no indication that the shared object was manipulated incorrectly.

The problem can be solved by giving only one thread at a time *exclusive access* to code that manipulates the shared object. During that time, other threads desiring to manipulate the object are kept waiting. When the thread with exclusive access to the object finishes manipulating it, one of the threads that was waiting is allowed to proceed. This process, called **thread synchronization**, coordinates access to shared data by multiple concurrent threads. By synchronizing threads in this manner, you can ensure that each thread accessing a shared object excludes all other threads from doing so simultaneously—this is called **mutual exclusion**.

### Monitors

A common way to perform synchronization is to use Java's built-in **monitors**. Every object has a monitor and a **monitor lock** (or **intrinsic lock**). The monitor ensures that its object's monitor lock is held by a maximum of only one thread at any time. Monitors and monitor locks can thus be used to enforce mutual exclusion. If an operation requires the executing thread to hold a lock while the operation is performed, a thread must acquire the lock before proceeding with the operation. Other threads attempting to perform an operation that requires the same lock will be *blocked* until the first thread releases the lock, at which point the *blocked* threads may attempt to acquire the lock and proceed with the operation.

To specify that a thread must hold a monitor lock to execute a block of code, the code should be placed in a **synchronized statement**. Such code is said to be **guarded** by the monitor lock; a thread must **acquire the lock** to execute the guarded statements. The monitor allows only one thread at a time to execute statements within synchronized statements that lock on the same object, as only one thread at a time can hold the monitor lock. The synchronized statements are declared using the **synchronized keyword**:

```
synchronized (object)
{
 statements
} // end synchronized statement
```

where *object* is the object whose monitor lock will be acquired; *object* is normally `this` if it's the object in which the synchronized statement appears. If several synchronized statements are trying to execute on an object at the same time, only one of them may be active on the object—all the other threads attempting to enter a synchronized statement on the same object are placed in the *blocked* state.

When a synchronized statement finishes executing, the object's monitor lock is released and one of the *blocked* threads attempting to enter a synchronized statement can be allowed to acquire the lock to proceed. Java also allows **synchronized methods**. Before executing, a non-static synchronized method must acquire the lock on the object that's used to call the method. Similarly, a static synchronized method must acquire the lock on the class that's used to call the method.

#### 26.4.1 Unsynchronized Data Sharing

First, we illustrate the dangers of sharing an object across threads without proper synchronization. In this example, two `Runnable`s maintain references to a single integer array. Each `Runnable` writes three values to the array, then terminates. This may seem harmless, but we'll see that it can result in errors if the array is manipulated without synchronization.

##### *Class SimpleArray*

A `SimpleArray` object (Fig. 26.5) will be *shared* across multiple threads. `SimpleArray` will enable those threads to place `int` values into array (declared at line 8). Line 9 initializes variable `writeIndex`, which will be used to determine the array element that should be written to next. The constructor (lines 13–16) creates an integer array of the desired size.

Method `add` (lines 19–40) allows new values to be inserted at the end of the array. Line 21 stores the current `writeIndex` value. Line 26 puts the thread that invokes `add` to sleep for a random interval from 0 to 499 milliseconds. This is done to make the problems associated with *unsynchronized access to shared data* more obvious. After the thread is done

---

```

1 // Fig. 26.5: SimpleArray.java
2 // Class that manages an integer array to be shared by multiple threads.
3 import java.util.Arrays;
4 import java.util.Random;
5
6 public class SimpleArray // CAUTION: NOT THREAD SAFE!
7 {
8 private final int[] array; // the shared integer array
9 private int writeIndex = 0; // index of next element to be written
10 private final static Random generator = new Random();
11
12 // construct a SimpleArray of a given size
13 public SimpleArray(int size)
14 {
15 array = new int[size];
16 } // end constructor
17
18 // add a value to the shared array
19 public void add(int value)
20 {
21 int position = writeIndex; // store the write index
22
23 try
24 {
25 // put thread to sleep for 0-499 milliseconds
26 Thread.sleep(generator.nextInt(500));
27 } // end try
28 catch (InterruptedException ex)
29 {
30 ex.printStackTrace();
31 } // end catch
32
33 // put value in the appropriate element
34 array[position] = value;
35 System.out.printf("%s wrote %2d to element %d.\n",
36 Thread.currentThread().getName(), value, position);
37
38 ++writeIndex; // increment index of element to be written next
39 System.out.printf("Next write index: %d\n", writeIndex);
40 } // end method add
41
42 // used for outputting the contents of the shared integer array
43 public String toString()
44 {
45 return "\nContents of SimpleArray:\n" + Arrays.toString(array);
46 } // end method toString
47 } // end class SimpleArray

```

---

**Fig. 26.5** | Class that manages an integer array to be shared by multiple threads.

sleeping, line 34 inserts the value passed to `add` into the array at the element specified by `position`. Lines 35–36 output a message indicating the executing thread’s name, the value that was inserted in the array and where it was inserted. The expression `Thread.currentThread().getName()` (line 36) first obtains a reference to the currently executing `Thread`,

then uses that Thread's `getName` method to obtain its name. Line 38 increments `writeIndex` so that the next call to `add` will insert a value in the array's next element. Lines 43–46 override method `toString` to create a `String` representation of the array's contents.

### Class `ArrayWriter`

Class `ArrayWriter` (Fig. 26.6) implements the interface `Runnable` to define a task for inserting values in a `SimpleArray` object. The constructor (lines 10–14) takes two arguments—an integer value, which is the first value this task will insert in the `SimpleArray` object, and a reference to the `SimpleArray` object. Line 20 invokes method `add` on the `SimpleArray` object. The task completes after three consecutive integers beginning with `startValue` are added to the `SimpleArray` object.

---

```

1 // Fig. 26.6: ArrayWriter.java
2 // Adds integers to an array shared with other Runnables
3 import java.lang.Runnable;
4
5 public class ArrayWriter implements Runnable
6 {
7 private final SimpleArray sharedSimpleArray;
8 private final int startValue;
9
10 public ArrayWriter(int value, SimpleArray array)
11 {
12 startValue = value;
13 sharedSimpleArray = array;
14 } // end constructor
15
16 public void run()
17 {
18 for (int i = startValue; i < startValue + 3; i++)
19 {
20 sharedSimpleArray.add(i); // add an element to the shared array
21 } // end for
22 } // end method run
23 } // end class ArrayWriter

```

---

**Fig. 26.6** | Adds integers to an array shared with other `Runnables`.

### Class `SharedArrayTest`

Class `SharedArrayTest` (Fig. 26.7) executes two `ArrayWriter` tasks that add values to a single `SimpleArray` object. Line 12 constructs a six-element `SimpleArray` object. Lines 15–16 create two new `ArrayWriter` tasks, one that places the values 1–3 in the `SimpleArray` object, and one that places the values 11–13. Lines 19–21 create an `ExecutorService` and execute the two `ArrayWriters`. Line 23 invokes the `ExecutorService`'s `shutdown` method to *prevent additional tasks from starting* and to enable the application to terminate when the currently executing tasks complete execution.

Recall that `ExecutorService` method `shutdown` returns immediately. Thus any code that appears *after* the call to `ExecutorService` method `shutdown` in line 23 *will continue executing as long as the main thread is still assigned to a processor*. We'd like to output the `SimpleArray` object to show you the results *after* the threads complete their tasks. So, we

need the program to wait for the threads to complete before `main` outputs the `SimpleArray` object's contents. Interface `ExecutorService` provides the `awaitTermination` method for this purpose. This method returns control to its caller either when all tasks executing in the `ExecutorService` complete or when the specified timeout elapses. If all tasks are completed before `awaitTermination` times out, this method returns `true`; otherwise it returns `false`. The two arguments to `awaitTermination` represent a timeout value and a unit of measure specified with a constant from class `TimeUnit` (in this case, `TimeUnit.MINUTES`).

---

```

1 // Fig 26.7: SharedArrayTest.java
2 // Executes two Runnable's to add elements to a shared SimpleArray.
3 import java.util.concurrent.Executors;
4 import java.util.concurrent.ExecutorService;
5 import java.util.concurrent.TimeUnit;
6
7 public class SharedArrayTest
8 {
9 public static void main(String[] arg)
10 {
11 // construct the shared object
12 SimpleArray sharedSimpleArray = new SimpleArray(6);
13
14 // create two tasks to write to the shared SimpleArray
15 ArrayWriter writer1 = new ArrayWriter(1, sharedSimpleArray);
16 ArrayWriter writer2 = new ArrayWriter(11, sharedSimpleArray);
17
18 // execute the tasks with an ExecutorService
19 ExecutorService executor = Executors.newCachedThreadPool();
20 executor.execute(writer1);
21 executor.execute(writer2);
22
23 executor.shutdown();
24
25 try
26 {
27 // wait 1 minute for both writers to finish executing
28 boolean tasksEnded = executor.awaitTermination(
29 1, TimeUnit.MINUTES);
30
31 if (tasksEnded)
32 System.out.println(sharedSimpleArray); // print contents
33 else
34 System.out.println(
35 "Timed out while waiting for tasks to finish.");
36 } // end try
37 catch (InterruptedException ex)
38 {
39 System.out.println(
40 "Interrupted while waiting for tasks to finish.");
41 } // end catch
42 } // end main
43 } // end class SharedArrayTest

```

---

**Fig. 26.7** | Executes two `Runnable`s to insert values in a shared array. (Part 1 of 2.)



```

pool-1-thread-1 wrote 1 to element 0.
Next write index: 1
pool-1-thread-1 wrote 2 to element 1.
Next write index: 2
pool-1-thread-1 wrote 3 to element 2.
Next write index: 3
pool-1-thread-2 wrote 11 to element 0.
Next write index: 4
pool-1-thread-2 wrote 12 to element 4.
Next write index: 5
pool-1-thread-2 wrote 13 to element 5.
Next write index: 6

Contents of SimpleArray:
[11, 2, 3, 0, 12, 13]

```

First pool-1-thread-1 wrote the value 1 to element 0. Later pool-1-thread-2 wrote the value 11 to element 0, thus overwriting the previously stored value.

**Fig. 26.7** | Executes two `Runnable`s to insert values in a shared array. (Part 2 of 2.)

In this example, if *both* tasks complete before `awaitTermination` times out, line 32 displays the `SimpleArray` object's contents. Otherwise, lines 34–35 print a message indicating that the tasks did not finish executing before `awaitTermination` timed out.

The output in Fig. 26.7 demonstrates the problems (highlighted in the output) that can be *caused by failure to synchronize access to shared data*. The value 1 was written to element 0, then *overwritten* later by the value 11. Also, when `writeIndex` was incremented to 3, *nothing was written to that element*, as indicated by the 0 in that element of the printed array.

Recall that we added calls to `Thread` method `sleep` between operations on the shared data to emphasize the *unpredictability of thread scheduling* and increase the likelihood of producing erroneous output. Even if these operations were allowed to proceed at their normal pace, you could still see errors in the program's output. However, modern processors can handle the simple operations of the `SimpleArray` method `add` so quickly that you might not see the errors caused by the two threads executing this method concurrently, even if you tested the program dozens of times. *One of the challenges of multithreaded programming is spotting the errors—they may occur so infrequently that a broken program does not produce incorrect results during testing, creating the illusion that the program is correct.*

### 26.4.2 Synchronized Data Sharing—Making Operations Atomic

The output errors of Fig. 26.7 can be attributed to the fact that the shared object, `SimpleArray`, is not **thread safe**—`SimpleArray` is susceptible to errors if it's *accessed concurrently by multiple threads*. The problem lies in method `add`, which stores the value of `writeIndex`, places a new value in that element, then increments `writeIndex`. Such a method would present no problem in a single-threaded program. However, if one thread obtains the value of `writeIndex`, there's no guarantee that another thread cannot come along and increment `writeIndex` *before* the first thread has had a chance to place a value in the array. If this happens, the first thread will be writing to the array based on a **stale value** of `writeIndex`—a value that's no longer valid. Another possibility is that one thread might obtain the value of `writeIndex` *after* another thread adds an element to the array but *before* `writeIndex` is incremented. In this case, too, the first thread would write to the array based on an invalid value for `writeIndex`.

`SimpleArray` is *not thread safe* because it allows any number of threads to read and modify shared data concurrently, which can cause errors. To make `SimpleArray` thread safe, we must ensure that no two threads can access it at the same time. We also must ensure that while one thread is in the process of storing `writeIndex`, adding a value to the array, and incrementing `writeIndex`, no other thread may read or change the value of `writeIndex` or modify the contents of the array at any point during these three operations. In other words, we want these three operations—storing `writeIndex`, writing to the array, incrementing `writeIndex`—to be an **atomic operation**, which cannot be divided into smaller suboperations. We can simulate atomicity by ensuring that only one thread carries out the three operations at a time. Any other threads that need to perform the operation must *wait* until the first thread has finished the add operation in its entirety.

Atomicity can be achieved using the `synchronized` keyword. By placing our three suboperations in a `synchronized` statement or `synchronized` method, we allow only one thread at a time to acquire the lock and perform the operations. When that thread has completed all of the operations in the `synchronized` block and releases the lock, another thread may acquire the lock and begin executing the operations. This ensures that a thread executing the operations will see the actual values of the shared data and that *these values will not change unexpectedly in the middle of the operations as a result of another thread's modifying them*.



### Software Engineering Observation 26.2

Place all accesses to mutable data that may be shared by multiple threads inside `synchronized` statements or `synchronized` methods that synchronize on the same lock. When performing multiple operations on shared data, hold the lock for the entirety of the operation to ensure that the operation is effectively atomic.

### Class `SimpleArray` with Synchronization

Figure 26.8 displays class `SimpleArray` with the proper synchronization. Notice that it's identical to the `SimpleArray` class of Fig. 26.5, except that `add` is now a `synchronized` method (line 20). So, only one thread at a time can execute this method. We reuse classes `ArrayWriter` (Fig. 26.6) and `SharedArrayTest` (Fig. 26.7) from the previous example.

```

1 // Fig. 26.8: SimpleArray.java
2 // Class that manages an integer array to be shared by multiple
3 // threads with synchronization.
4 import java.util.Arrays;
5 import java.util.Random;
6
7 public class SimpleArray
8 {
9 private final int[] array; // the shared integer array
10 private int writeIndex = 0; // index of next element to be written
11 private final static Random generator = new Random();
12

```

**Fig. 26.8** | Class that manages an integer array to be shared by multiple threads with synchronization. (Part 1 of 2.)

```

13 // construct a SimpleArray of a given size
14 public SimpleArray(int size)
15 {
16 array = new int[size];
17 } // end constructor
18
19 // add a value to the shared array
20 public synchronized void add(int value)
21 {
22 int position = writeIndex; // store the write index
23
24 try
25 {
26 // put thread to sleep for 0-499 milliseconds
27 Thread.sleep(generator.nextInt(500));
28 } // end try
29 catch (InterruptedException ex)
30 {
31 ex.printStackTrace();
32 } // end catch
33
34 // put value in the appropriate element
35 array[position] = value;
36 System.out.printf("%s wrote %2d to element %d.\n",
37 Thread.currentThread().getName(), value, position);
38
39 ++writeIndex; // increment index of element to be written next
40 System.out.printf("Next write index: %d\n", writeIndex);
41 } // end method add
42
43 // used for outputting the contents of the shared integer array
44 public String toString()
45 {
46 return "\nContents of SimpleArray:\n" + Arrays.toString(array);
47 } // end method toString
48 } // end class SimpleArray

```

```

pool-1-thread-1 wrote 1 to element 0.
Next write index: 1
pool-1-thread-2 wrote 11 to element 1.
Next write index: 2
pool-1-thread-2 wrote 12 to element 2.
Next write index: 3
pool-1-thread-2 wrote 13 to element 3.
Next write index: 4
pool-1-thread-1 wrote 2 to element 4.
Next write index: 5
pool-1-thread-1 wrote 3 to element 5.
Next write index: 6

```

```

Contents of SimpleArray:
1 11 12 13 2 3

```

**Fig. 26.8** | Class that manages an integer array to be shared by multiple threads with synchronization. (Part 2 of 2.)

Line 20 declares method as synchronized, making all of the operations in this method behave as a single, atomic operation. Line 22 performs the first suboperation—storing the value of `writeIndex`. Line 35 defines the second suboperation, writing an element to the element at the index position. Line 39 increments `writeIndex`. When the method finishes executing at line 41, the executing thread implicitly releases the `SimpleArray` lock, making it possible for another thread to begin executing the `add` method.

In the synchronized `add` method, we print messages to the console indicating the progress of threads as they execute this method, in addition to performing the actual operations required to insert a value in the array. We do this so that the messages will be printed in the correct order, allowing us to see whether the method is properly synchronized by comparing these outputs with those of the previous, unsynchronized example. We continue to output messages from synchronized blocks in later examples for demonstration purposes only; typically, however, I/O *should not* be performed in synchronized blocks, because it's important to minimize the amount of time that an object is “locked.” Also, line 27 in this example calls `Thread` method `sleep` to emphasize the *unpredictability of thread scheduling*. *You should never call `sleep` while holding a lock in a real application.*



### Performance Tip 26.2

*Keep the duration of synchronized statements as short as possible while maintaining the needed synchronization. This minimizes the wait time for blocked threads. Avoid performing I/O, lengthy calculations and operations that do not require synchronization while holding a lock.*

Another note on thread safety: We've said that it's necessary to synchronize access to all data that may be shared across multiple threads. Actually, this synchronization is necessary only for **mutable data**, or data that may *change* in its lifetime. If the shared data will not change in a multithreaded program, then it's not possible for a thread to see old or incorrect values as a result of another thread's manipulating that data.

When you share immutable data across threads, declare the corresponding data fields `final` to indicate that the values of the variables will *not* change after they're initialized. This prevents accidental modification of the shared data later in a program, which could compromise thread safety. *Labeling object references as `final` indicates that the reference will not change, but it does not guarantee that the object itself is immutable—this depends entirely on the object's properties.* However, it's still good practice to mark references that will not change as `final`, as doing so forces the object's constructor to be atomic—the object will be fully constructed with all its fields initialized before the program accesses it.



### Good Programming Practice 26.1

*Always declare data fields that you do not expect to change as `final`. Primitive variables that are declared as `final` can safely be shared across threads. An object reference that's declared as `final` ensures that the object it refers to will be fully constructed and initialized before it's used by the program, and prevents the reference from pointing to another object.*

## 26.5 Producer/Consumer Relationship without Synchronization

In a **producer/consumer relationship**, the **producer** portion of an application generates data and *stores it in a shared object*, and the **consumer** portion of the application *reads data*

from the shared object. The producer/consumer relationship separates the task of identifying work to be done from the tasks involved in actually carrying out the work. One example of a common producer/consumer relationship is **print spooling**. Although a printer might not be available when you want to print from an application (i.e., the producer), you can still “complete” the print task, as the data is temporarily placed on disk until the printer becomes available. Similarly, when the printer (i.e., a consumer) is available, it doesn’t have to wait until a current user wants to print. The spooled print jobs can be printed as soon as the printer becomes available. Another example of the producer/consumer relationship is an application that copies data onto DVDs by placing data in a fixed-size buffer, which is emptied as the DVD drive “burns” the data onto the DVD.

In a multithreaded producer/consumer relationship, a **producer thread** generates data and places it in a shared object called a **buffer**. A **consumer thread** reads data from the buffer. This relationship requires *synchronization* to ensure that values are produced and consumed properly. All operations on mutable data that’s shared by multiple threads (e.g., the data in the buffer) must be guarded with a lock to prevent corruption, as discussed in Section 26.4. Operations on the buffer data shared by a producer and consumer thread are also **state dependent**—the operations should proceed only if the buffer is in the correct state. If the buffer is in a *not-full state*, the producer may produce; if the buffer is in a *not-empty state*, the consumer may consume. All operations that access the buffer must use synchronization to ensure that data is written to the buffer or read from the buffer only if the buffer is in the proper state. If the producer attempting to put the next data into the buffer determines that it’s full, the producer thread must *wait* until there’s space to write a new value. If a consumer thread finds the buffer empty or finds that the previous data has already been read, the consumer must also *wait* for new data to become available.

Consider how logic errors can arise if we do not synchronize access among multiple threads manipulating shared data. Our next example (Fig. 26.9–Fig. 26.13) implements a producer/consumer relationship without the proper synchronization. A producer thread writes the numbers 1 through 10 into a shared buffer—a single memory location shared between two threads (a single `int` variable called `buffer` in line 6 of Fig. 26.12 in this example). The consumer thread reads this data from the shared buffer and displays the data. The program’s output shows the values that the producer writes (produces) into the shared buffer and the values that the consumer reads (consumes) from the shared buffer.

Each value the producer thread writes to the shared buffer must be consumed *exactly once* by the consumer thread. However, the threads in this example are not synchronized. Therefore, *data can be lost or garbled if the producer places new data into the shared buffer before the consumer reads the previous data*. Also, data can be incorrectly *duplicated* if the consumer consumes data again before the producer produces the next value. To show these possibilities, the consumer thread in the following example keeps a total of all the values it reads. The producer thread produces values from 1 through 10. If the consumer reads each value produced once and only once, the total will be 55. However, if you execute this program several times, you’ll see that the total is not always 55 (as shown in the outputs in Fig. 26.13). To emphasize the point, the producer and consumer threads in the example each sleep for random intervals of up to three seconds between performing their tasks. Thus, we do not know when the producer thread will attempt to write a new value, or when the consumer thread will attempt to read a value.

*Implementing the Producer/Consumer Relationship*

The program consists of interface `Buffer` (Fig. 26.9) and classes `Producer` (Fig. 26.10), `Consumer` (Fig. 26.11), `UnsynchronizedBuffer` (Fig. 26.12) and `SharedBufferTest` (Fig. 26.13). Interface `Buffer` (Fig. 26.9) declares methods `set` (line 6) and `get` (line 9) that a `Buffer` (such as `UnsynchronizedBuffer`) must implement to enable the `Producer` thread to place a value in the `Buffer` and the `Consumer` thread to retrieve a value from the `Buffer`, respectively. In subsequent examples, methods `set` and `get` will call methods that throw `InterruptedExceptions`. We declare each method with a `throws` clause here so that we don't have to modify this interface for the later examples.

---

```

1 // Fig. 26.9: Buffer.java
2 // Buffer interface specifies methods called by Producer and Consumer.
3 public interface Buffer
4 {
5 // place int value into Buffer
6 public void set(int value) throws InterruptedException;
7
8 // return int value from Buffer
9 public int get() throws InterruptedException;
10 } // end interface Buffer

```

---

**Fig. 26.9** | Buffer interface specifies methods called by Producer and Consumer.

Class `Producer` (Fig. 26.10) implements the `Runnable` interface, allowing it to be executed as a task in a separate thread. The constructor (lines 11–14) initializes the `Buffer` reference `sharedLocation` with an object created in `main` (line 14 of Fig. 26.13) and passed to the constructor. As we'll see, this is an `UnsynchronizedBuffer` object that implements interface `Buffer` *without synchronizing access to the shared object*. The `Producer` thread in this program executes the tasks specified in the method `run` (lines 17–39). Each iteration of the loop (lines 21–35) invokes `Thread` method `sleep` (line 25) to place the `Producer` thread into the *timed waiting* state for a random time interval between 0 and 3 seconds. When the thread awakens, line 26 passes the value of control variable `count` to the `Buffer` object's `set` method to set the shared buffer's value. Lines 27–28 keep a total of all the values produced so far and output that value. When the loop completes, lines 37–38 display a message indicating that the `Producer` has finished producing data and is terminating. Next, method `run` terminates, which indicates that the `Producer` completed its task. Any method called from a `Runnable`'s `run` method (e.g., `Buffer` method `set`) executes as part of that task's thread of execution. This fact becomes important in Sections 26.6–26.8 when we add synchronization to the producer/consumer relationship.

---

```

1 // Fig. 26.10: Producer.java
2 // Producer with a run method that inserts the values 1 to 10 in buffer.
3 import java.util.Random;
4
5 public class Producer implements Runnable
6 {

```

---

**Fig. 26.10** | Producer with a run method that inserts the values 1 to 10 in buffer. (Part 1 of 2.)

```
7 private final static Random generator = new Random();
8 private final Buffer sharedLocation; // reference to shared object
9
10 // constructor
11 public Producer(Buffer shared)
12 {
13 sharedLocation = shared;
14 } // end Producer constructor
15
16 // store values from 1 to 10 in sharedLocation
17 public void run()
18 {
19 int sum = 0;
20
21 for (int count = 1; count <= 10; count++)
22 {
23 try // sleep 0 to 3 seconds, then place value in Buffer
24 {
25 Thread.sleep(generator.nextInt(3000)); // random sleep
26 sharedLocation.set(count); // set value in buffer
27 sum += count; // increment sum of values
28 System.out.printf("\t%2d\n", sum);
29 } // end try
30 // if lines 25 or 26 get interrupted, print stack trace
31 catch (InterruptedException exception)
32 {
33 exception.printStackTrace();
34 } // end catch
35 } // end for
36
37 System.out.println(
38 "Producer done producing\nTerminating Producer");
39 } // end method run
40 } // end class Producer
```

**Fig. 26.10** | Producer with a run method that inserts the values 1 to 10 in buffer. (Part 2 of 2.)

Class Consumer (Fig. 26.11) also implements interface `Runnable`, allowing the Consumer to execute concurrently with the Producer. Lines 11–14 initialize Buffer reference `sharedLocation` with an object that implements the Buffer interface (created in main, Fig. 26.13) and passed to the constructor as the parameter `shared`. As we'll see, this is the same `UnsyncronizedBuffer` object that's used to initialize the Producer object—thus, the two threads share the same object. The Consumer thread in this program performs the tasks specified in method `run` (lines 17–39). Lines 21–35 iterate 10 times. Each iteration invokes `Thread` method `sleep` (line 26) to put the Consumer thread into the *timed waiting* state for up to 3 seconds. Next, line 27 uses the Buffer's `get` method to retrieve the value in the shared buffer, then adds the value to variable `sum`. Line 28 displays the total of all the values consumed so far. When the loop completes, lines 37–38 display a line indicating the sum of the consumed values. Then method `run` terminates, which indicates that the Consumer completed its task. Once both threads enter the *terminated* state, the program ends.

```

1 // Fig. 26.11: Consumer.java
2 // Consumer with a run method that loops, reading 10 values from buffer.
3 import java.util.Random;
4
5 public class Consumer implements Runnable
6 {
7 private final static Random generator = new Random();
8 private final Buffer sharedLocation; // reference to shared object
9
10 // constructor
11 public Consumer(Buffer shared)
12 {
13 sharedLocation = shared;
14 } // end Consumer constructor
15
16 // read sharedLocation's value 10 times and sum the values
17 public void run()
18 {
19 int sum = 0;
20
21 for (int count = 1; count <= 10; count++)
22 {
23 // sleep 0 to 3 seconds, read value from buffer and add to sum
24 try
25 {
26 Thread.sleep(generator.nextInt(3000));
27 sum += sharedLocation.get();
28 System.out.printf("\t\t\t%2d\n", sum);
29 } // end try
30 // if lines 26 or 27 get interrupted, print stack trace
31 catch (InterruptedException exception)
32 {
33 exception.printStackTrace();
34 } // end catch
35 } // end for
36
37 System.out.printf("\n%s %d\n%s\n",
38 "Consumer read values totaling", sum, "Terminating Consumer");
39 } // end method run
40 } // end class Consumer

```

**Fig. 26.11** | Consumer with a run method that loops, reading 10 values from buffer.

[*Note:* We call method `sleep` in method `run` of the `Producer` and `Consumer` classes to emphasize the fact that, *in multithreaded applications, it's unpredictable when each thread will perform its task and for how long it will perform the task when it has a processor.* Normally, these thread scheduling issues are beyond the control of the Java developer. In this program, our thread's tasks are quite simple—the `Producer` writes the values 1 to 10 to the buffer, and the `Consumer` reads 10 values from the buffer and adds each value to variable `sum`. Without the `sleep` method call, and if the `Producer` executes first, given today's phenomenally fast processors, the `Producer` would likely complete its task before the `Consumer` got a chance to execute. If the `Consumer` executed first, it would likely consume garbage data ten times, then terminate before the `Producer` could produce the first real value.]



Class `UnsynchronizedBuffer` (Fig. 26.12) implements interface `Buffer` (line 4). An object of this class is shared between the `Producer` and the `Consumer`. Line 6 declares instance variable `buffer` and initializes it with the value `-1`. This value is used to demonstrate the case in which the `Consumer` attempts to consume a value *before* the `Producer` ever places a value in `buffer`. Methods `set` (lines 9–13) and `get` (lines 16–20) do *not* synchronize access to the field `buffer`. Method `set` simply assigns its argument to `buffer` (line 12), and method `get` simply returns the value of `buffer` (line 19).

---

```
1 // Fig. 26.12: UnsynchronizedBuffer.java
2 // UnsynchronizedBuffer maintains the shared integer that is accessed by
3 // a producer thread and a consumer thread via methods set and get.
4 public class UnsynchronizedBuffer implements Buffer
5 {
6 private int buffer = -1; // shared by producer and consumer threads
7
8 // place value into buffer
9 public void set(int value) throws InterruptedException
10 {
11 System.out.printf("Producer writes\t%d", value);
12 buffer = value;
13 } // end method set
14
15 // return value from buffer
16 public int get() throws InterruptedException
17 {
18 System.out.printf("Consumer reads\t%d", buffer);
19 return buffer;
20 } // end method get
21 } // end class UnsynchronizedBuffer
```

---

**Fig. 26.12** | `UnsynchronizedBuffer` maintains the shared integer that is accessed by a producer thread and a consumer thread via methods `set` and `get`.

In class `SharedBufferTest` (Fig. 26.13), line 11 creates an `ExecutorService` to execute the `Producer` and `Consumer` `Runnable`s. Line 14 creates an `UnsynchronizedBuffer` object and assigns it to `Buffer` variable `sharedLocation`. This object stores the data that the `Producer` and `Consumer` threads will share. Lines 23–24 create and execute the `Producer` and `Consumer`. The `Producer` and `Consumer` constructors are each passed the same `Buffer` object (`sharedLocation`), so each object is initialized with a reference to the same `Buffer`. These lines also implicitly launch the threads and call each `Runnable`'s `run` method. Finally, line 26 calls method `shutdown` so that the application can terminate when the threads executing the `Producer` and `Consumer` complete their tasks. When `main` terminates (line 27), the `main` thread of execution enters the *terminated* state.

---

```
1 // Fig. 26.13: SharedBufferTest.java
2 // Application with two threads manipulating an unsynchronized buffer.
3 import java.util.concurrent.ExecutorService;
4 import java.util.concurrent.Executors;
```

---

**Fig. 26.13** | Application with two threads manipulating an unsynchronized buffer. (Part 1 of 3.)

```

5
6 public class SharedBufferTest
7 {
8 public static void main(String[] args)
9 {
10 // create new thread pool with two threads
11 ExecutorService application = Executors.newCachedThreadPool();
12
13 // create UnsynchronizedBuffer to store ints
14 Buffer sharedLocation = new UnsynchronizedBuffer();
15
16 System.out.println(
17 "Action\t\tValue\tSum of Produced\tSum of Consumed");
18 System.out.println(
19 "-----\t\t\t-----\t\t-----\t\t-----\n");
20
21 // execute the Producer and Consumer, giving each of them access
22 // to sharedLocation
23 application.execute(new Producer(sharedLocation));
24 application.execute(new Consumer(sharedLocation));
25
26 application.shutdown(); // terminate application when tasks complete
27 } // end main
28 } // end class SharedBufferTest

```

| Action                           | Value | Sum of Produced | Sum of Consumed     |
|----------------------------------|-------|-----------------|---------------------|
| -----                            | ----- | -----           | -----               |
| Producer writes                  | 1     | 1               |                     |
| Producer writes                  | 2     | 3               | —— 1 is lost        |
| Producer writes                  | 3     | 6               | —— 2 is lost        |
| Consumer reads                   | 3     |                 | 3                   |
| Producer writes                  | 4     | 10              |                     |
| Consumer reads                   | 4     |                 | 7                   |
| Producer writes                  | 5     | 15              |                     |
| Producer writes                  | 6     | 21              | —— 5 is lost        |
| Producer writes                  | 7     | 28              | —— 6 is lost        |
| Consumer reads                   | 7     |                 | 14                  |
| Consumer reads                   | 7     |                 | 21 —— 7 read again  |
| Producer writes                  | 8     | 36              |                     |
| Consumer reads                   | 8     |                 | 29                  |
| Consumer reads                   | 8     |                 | 37 —— 8 read again  |
| Producer writes                  | 9     | 45              |                     |
| Producer writes                  | 10    | 55              | —— 9 is lost        |
| Producer done producing          |       |                 |                     |
| Terminating Producer             |       |                 |                     |
| Consumer reads                   | 10    |                 | 47                  |
| Consumer reads                   | 10    |                 | 57 —— 10 read again |
| Consumer reads                   | 10    |                 | 67 —— 10 read again |
| Consumer reads                   | 10    |                 | 77 —— 10 read again |
| Consumer read values totaling 77 |       |                 |                     |
| Terminating Consumer             |       |                 |                     |

**Fig. 26.13** | Application with two threads manipulating an unsynchronized buffer. (Part 2 of 3.)

| Action                           | Value | Sum of Produced | Sum of Consumed |                   |
|----------------------------------|-------|-----------------|-----------------|-------------------|
| Consumer reads                   | -1    |                 | -1              | reads -1 bad data |
| Producer writes                  | 1     | 1               |                 |                   |
| Consumer reads                   | 1     |                 | 0               |                   |
| Consumer reads                   | 1     |                 | 1               | 1 read again      |
| Consumer reads                   | 1     |                 | 2               | 1 read again      |
| Consumer reads                   | 1     |                 | 3               | 1 read again      |
| Consumer reads                   | 1     |                 | 4               | 1 read again      |
| Producer writes                  | 2     | 3               |                 |                   |
| Consumer reads                   | 2     |                 | 6               |                   |
| Producer writes                  | 3     | 6               |                 |                   |
| Consumer reads                   | 3     |                 | 9               |                   |
| Producer writes                  | 4     | 10              |                 |                   |
| Consumer reads                   | 4     |                 | 13              |                   |
| Producer writes                  | 5     | 15              |                 |                   |
| Producer writes                  | 6     | 21              |                 | 5 is lost         |
| Consumer reads                   | 6     |                 | 19              |                   |
| Consumer read values totaling 19 |       |                 |                 |                   |
| Terminating Consumer             |       |                 |                 |                   |
| Producer writes                  | 7     | 28              |                 | 7 never read      |
| Producer writes                  | 8     | 36              |                 | 8 never read      |
| Producer writes                  | 9     | 45              |                 | 9 never read      |
| Producer writes                  | 10    | 55              |                 | 10 never read     |
| Producer done producing          |       |                 |                 |                   |
| Terminating Producer             |       |                 |                 |                   |

**Fig. 26.13** | Application with two threads manipulating an unsynchronized buffer. (Part 3 of 3.)

Recall from the overview of this example that we would like the Producer to execute first and every value produced by the Producer to be consumed exactly once by the Consumer. However, when we study the first output of Fig. 26.13, we see that the Producer writes the values 1, 2 and 3 before the Consumer reads its first value (3). Therefore, the values 1 and 2 are lost. Later, the values 5, 6 and 9 are lost, while 7 and 8 are read twice and 10 is read four times. So the first output produces an incorrect total of 77, instead of the correct total of 55. In the second output, the Consumer reads the value -1 before the Producer ever writes a value. The Consumer reads the value 1 five times before the Producer writes the value 2. Meanwhile, the values 5, 7, 8, 9 and 10 are all lost—the last four because the Consumer terminates before the Producer. An incorrect consumer total of 19 is displayed. (Lines in the output where the Producer or Consumer has acted out of order are highlighted.)



### Error-Prevention Tip 26.1

*Access to a shared object by concurrent threads must be controlled carefully or a program may produce incorrect results.*

To solve the problems of lost and duplicated data, Section 26.6 presents an example in which we use an `ArrayBlockingQueue` (from package `java.util.concurrent`) to synchronize access to the shared object, guaranteeing that each and every value will be processed once and only once.

## 26.6 Producer/Consumer Relationship: ArrayBlockingQueue

One way to synchronize producer and consumer threads is to use classes from Java's concurrency package that *encapsulate the synchronization for you*. Java includes the class **ArrayBlockingQueue** (from package `java.util.concurrent`)—a fully implemented, *thread-safe buffer class* that implements interface **BlockingQueue**. This interface extends the `Queue` interface discussed in Chapter 20 and declares methods **put** and **take**, the blocking equivalents of `Queue` methods `offer` and `poll`, respectively. Method `put` places an element at the end of the `BlockingQueue`, waiting if the queue is full. Method `take` removes an element from the head of the `BlockingQueue`, waiting if the queue is empty. These methods make class `ArrayBlockingQueue` a good choice for implementing a shared buffer. Because method `put` blocks until there's room in the buffer to write data, and method `take` blocks until there's new data to read, the producer must produce a value first, the consumer correctly consumes only after the producer writes a value and the producer correctly produces the next value (after the first) only after the consumer reads the previous (or first) value. `ArrayBlockingQueue` stores the shared data in an array. The array's size is specified as an argument to the `ArrayBlockingQueue` constructor. Once created, an `ArrayBlockingQueue` is fixed in size and will not expand to accommodate extra elements.

Figures 26.14–26.15 demonstrate a Producer and a Consumer accessing an `ArrayBlockingQueue`. Class `BlockingBuffer` (Fig. 26.14) uses an `ArrayBlockingQueue` object that stores an `Integer` (line 7). Line 11 creates the `ArrayBlockingQueue` and passes 1 to the constructor so that the object holds a single value, as we did with the `UnsyncronizedBuffer` of Fig. 26.12. Lines 7 and 11 use generics, which we discussed in Chapters 20–21. We discuss multiple-element buffers in Section 26.8. Because our `BlockingBuffer` class uses the thread-safe `ArrayBlockingQueue` class to manage access to the shared buffer, `BlockingBuffer` is itself *thread safe*, even though we have not implemented the synchronization ourselves.

---

```

1 // Fig. 26.14: BlockingBuffer.java
2 // Creating a synchronized buffer using an ArrayBlockingQueue.
3 import java.util.concurrent.ArrayBlockingQueue;
4
5 public class BlockingBuffer implements Buffer
6 {
7 private final ArrayBlockingQueue<Integer> buffer; // shared buffer
8
9 public BlockingBuffer()
10 {
11 buffer = new ArrayBlockingQueue<Integer>(1);
12 } // end BlockingBuffer constructor
13
14 // place value into buffer
15 public void set(int value) throws InterruptedException
16 {
17 buffer.put(value); // place value in buffer

```

---

**Fig. 26.14** | Creating a synchronized buffer using an `ArrayBlockingQueue`. (Part I of 2.)

```

18 System.out.printf("%s%d\t%s%d\n", "Producer writes ", value,
19 "Buffer cells occupied: ", buffer.size());
20 } // end method set
21
22 // return value from buffer
23 public int get() throws InterruptedException
24 {
25 int readValue = buffer.take(); // remove value from buffer
26 System.out.printf("%s %d\t%s%d\n", "Consumer reads ",
27 readValue, "Buffer cells occupied: ", buffer.size());
28
29 return readValue;
30 } // end method get
31 } // end class BlockingBuffer

```

**Fig. 26.14** | Creating a synchronized buffer using an ArrayBlockingQueue. (Part 2 of 2.)

BlockingBuffer implements interface Buffer (Fig. 26.9) and uses classes Producer (Fig. 26.10 modified to remove line 28) and Consumer (Fig. 26.11 modified to remove line 28) from the example in Section 26.5. This approach demonstrates that *the threads accessing the shared object are unaware that their buffer accesses are now synchronized*. The synchronization is handled entirely in the set and get methods of BlockingBuffer by calling the synchronized ArrayBlockingQueue methods put and take, respectively. Thus, the Producer and Consumer Runnable's are properly synchronized simply by calling the shared object's set and get methods.

Line 17 in method set (Fig. 26.14, lines 15–20) calls the ArrayBlockingQueue object's put method. This method call blocks if necessary until there's room in the buffer to place the value. Method get (lines 23–30) calls the ArrayBlockingQueue object's take method (line 25). This method call blocks if necessary until there's an element in the buffer to remove. Lines 18–19 and 26–27 use the ArrayBlockingQueue object's **size** method to display the total number of elements currently in the ArrayBlockingQueue.

Class BlockingBufferTest (Fig. 26.15) contains the main method that launches the application. Line 12 creates an ExecutorService, and line 15 creates a BlockingBuffer object and assigns its reference to the Buffer variable sharedLocation. Lines 17–18 execute the Producer and Consumer Runnable's. Line 19 calls method shutdown to end the application when the threads finish executing the Producer and Consumer tasks.

```

1 // Fig. 26.15: BlockingBufferTest.java
2 // Two threads manipulating a blocking buffer that properly
3 // implements the producer/consumer relationship.
4 import java.util.concurrent.ExecutorService;
5 import java.util.concurrent.Executors;
6
7 public class BlockingBufferTest
8 {
9 public static void main(String[] args)
10 {

```

**Fig. 26.15** | Two threads manipulating a blocking buffer that properly implements the producer/consumer relationship. (Part 1 of 2.)

```

11 // create new thread pool with two threads
12 ExecutorService application = Executors.newCachedThreadPool();
13
14 // create BlockingBuffer to store ints
15 Buffer sharedLocation = new BlockingBuffer();
16
17 application.execute(new Producer(sharedLocation));
18 application.execute(new Consumer(sharedLocation));
19
20 application.shutdown();
21 } // end main
22 } // end class BlockingBufferTest

```

```

Producer writes 1 Buffer cells occupied: 1
Consumer reads 1 Buffer cells occupied: 0
Producer writes 2 Buffer cells occupied: 1
Consumer reads 2 Buffer cells occupied: 0
Producer writes 3 Buffer cells occupied: 1
Consumer reads 3 Buffer cells occupied: 0
Producer writes 4 Buffer cells occupied: 1
Consumer reads 4 Buffer cells occupied: 0
Producer writes 5 Buffer cells occupied: 1
Consumer reads 5 Buffer cells occupied: 0
Producer writes 6 Buffer cells occupied: 1
Consumer reads 6 Buffer cells occupied: 0
Producer writes 7 Buffer cells occupied: 1
Consumer reads 7 Buffer cells occupied: 0
Producer writes 8 Buffer cells occupied: 1
Consumer reads 8 Buffer cells occupied: 0
Producer writes 9 Buffer cells occupied: 1
Consumer reads 9 Buffer cells occupied: 0
Producer writes 10 Buffer cells occupied: 1

Producer done producing
Terminating Producer
Consumer reads 10 Buffer cells occupied: 0

Consumer read values totaling 55
Terminating Consumer

```

**Fig. 26.15** | Two threads manipulating a blocking buffer that properly implements the producer/consumer relationship. (Part 2 of 2.)

While methods `put` and `take` of `ArrayBlockingQueue` are properly synchronized, `BlockingBuffer` methods `set` and `get` (Fig. 26.14) are not declared to be synchronized. Thus, the statements performed in method `set`—the `put` operation (line 17) and the output (lines 18–19)—are *not atomic*; nor are the statements in method `get`—the `take` operation (line 25) and the output (lines 26–27). So there’s no guarantee that each output will occur immediately after the corresponding `put` or `take` operation, and the outputs may appear out of order. Even if they do, the `ArrayBlockingQueue` object is properly synchronizing access to the data, as evidenced by the fact that the sum of values read by the consumer is always correct.

## 26.7 Producer/Consumer Relationship with Synchronization

The previous example showed how multiple threads can share a single-element buffer in a thread-safe manner by using the `ArrayBlockingQueue` class that encapsulates the synchronization necessary to protect the shared data. For educational purposes, we now explain how you can implement a shared buffer yourself using the `synchronized` keyword and methods of class `Object`. Using an `ArrayBlockingQueue` will result in more-maintainable and better-performing code.

The first step in synchronizing access to the buffer is to implement methods `get` and `set` as synchronized methods. This requires that a thread obtain the *monitor lock* on the `Buffer` object before attempting to access the buffer data, but it does not automatically ensure that threads proceed with an operation only if the buffer is in the proper state. We need a way to allow our threads to wait, depending on whether certain conditions are true. In the case of placing a new item in the buffer, the condition that allows the operation to proceed is that the *buffer is not full*. In the case of fetching an item from the buffer, the condition that allows the operation to proceed is that the *buffer is not empty*. If the condition in question is true, the operation may proceed; if it's false, the thread must wait until it becomes true. When a thread is waiting on a condition, it's removed from contention for the processor and placed into the *waiting* state and the lock it holds is released.

### *Methods wait, notify and notifyAll*

`Object` methods `wait`, `notify` and `notifyAll`, which are inherited by all other classes, can be used with conditions to make threads *wait* when they cannot perform their tasks. If a thread obtains the *monitor lock* on an object, then determines that it cannot continue with its task on that object until some condition is satisfied, the thread can call `Object` method `wait` on the synchronized object; this releases the monitor lock on the object, and the thread waits in the *waiting* state while the other threads try to enter the object's synchronized statement(s) or method(s). When a thread executing a synchronized statement (or method) completes or satisfies the condition on which another thread may be waiting, it can call `Object` method `notify` on the synchronized object to allow a waiting thread to transition to the *runnable* state again. At this point, the thread that was transitioned from the *waiting* state to the *runnable* state can attempt to reacquire the monitor lock on the object. Even if the thread is able to reacquire the monitor lock, it still might not be able to perform its task at this time—in which case the thread will reenter the *waiting* state and implicitly release the monitor lock. If a thread calls `notifyAll` on the synchronized object, then *all* the threads waiting for the monitor lock become eligible to reacquire the lock (that is, they all transition to the *runnable* state).

Remember that only one thread at a time can obtain the monitor lock on the object—other threads that attempt to acquire the same monitor lock will be *blocked* until the monitor lock becomes available again (i.e., until no other thread is executing in a synchronized statement on that object).



### Common Programming Error 26.1

*It's an error if a thread issues a `wait`, a `notify` or a `notifyAll` on an object without having acquired a lock for it. This causes an `IllegalMonitorStateException`.*

**Error-Prevention Tip 26.2**

*It's a good practice to use `notifyAll` to notify waiting threads to become runnable. Doing so avoids the possibility that your program would forget about waiting threads, which would otherwise starve.*

The application in Fig. 26.16 and Fig. 26.17 demonstrates a Producer and a Consumer accessing a shared buffer with synchronization. In this case, the Producer always produces a value *first*, the Consumer correctly consumes only *after* the Producer produces a value and the Producer correctly produces the next value only after the Consumer consumes the previous (or first) value. We reuse interface `Buffer` and classes `Producer` and `Consumer` from the example in Section 26.5, except that line 28 is removed from class `Producer` and class `Consumer`. The synchronization is handled in the `set` and `get` methods of class `SynchronizedBuffer` (Fig. 26.16), which implements interface `Buffer` (line 4). Thus, the Producer's and Consumer's `run` methods simply call the shared object's synchronized `set` and `get` methods.

```

1 // Fig. 26.16: SynchronizedBuffer.java
2 // Synchronizing access to shared data using Object
3 // methods wait and notifyAll.
4 public class SynchronizedBuffer implements Buffer
5 {
6 private int buffer = -1; // shared by producer and consumer threads
7 private boolean occupied = false; // whether the buffer is occupied
8
9 // place value into buffer
10 public synchronized void set(int value) throws InterruptedException
11 {
12 // while there are no empty locations, place thread in waiting state
13 while (occupied)
14 {
15 // output thread information and buffer information, then wait
16 System.out.println("Producer tries to write.");
17 displayState("Buffer full. Producer waits.");
18 wait();
19 } // end while
20
21 buffer = value; // set new buffer value
22
23 // indicate producer cannot store another value
24 // until consumer retrieves current buffer value
25 occupied = true;
26
27 displayState("Producer writes " + buffer);
28
29 notifyAll(); // tell waiting thread(s) to enter runnable state
30 } // end method set; releases lock on SynchronizedBuffer
31

```

**Fig. 26.16** | Synchronizing access to shared data using `Object` methods `wait` and `notifyAll`.  
(Part 1 of 2.)



```

32 // return value from buffer
33 public synchronized int get() throws InterruptedException
34 {
35 // while no data to read, place thread in waiting state
36 while (!occupied)
37 {
38 // output thread information and buffer information, then wait
39 System.out.println("Consumer tries to read.");
40 displayState("Buffer empty. Consumer waits.");
41 wait();
42 } // end while
43
44 // indicate that producer can store another value
45 // because consumer just retrieved buffer value
46 occupied = false;
47
48 displayState("Consumer reads " + buffer);
49
50 notifyAll(); // tell waiting thread(s) to enter runnable state
51
52 return buffer;
53 } // end method get; releases lock on SynchronizedBuffer
54
55 // display current operation and buffer state
56 public void displayState(String operation)
57 {
58 System.out.printf("%-40s%d\t\t%b\n\n", operation, buffer,
59 occupied);
60 } // end method displayState
61 } // end class SynchronizedBuffer

```

**Fig. 26.16** | Synchronizing access to shared data using Object methods `wait` and `notifyAll`. (Part 2 of 2.)

### *Fields and Methods of Class SynchronizedBuffer*

Class `SynchronizedBuffer` contains fields `buffer` (line 6) and `occupied` (line 7). Methods `set` (lines 10–30) and `get` (lines 33–53) are declared as `synchronized`—only one thread can call either of these methods at a time on a particular `SynchronizedBuffer` object. Field `occupied` is used to determine whether it's the Producer's or the Consumer's turn to perform a task. This field is used in conditional expressions in both the `set` and `get` methods. If `occupied` is `false`, then `buffer` is empty, so the Consumer cannot read the value of `buffer`, but the Producer can place a value into `buffer`. If `occupied` is `true`, the Consumer can read a value from `buffer`, but the Producer cannot place a value into `buffer`.

### *Method set and the Producer Thread*

When the Producer thread's `run` method invokes `synchronized` method `set`, the thread implicitly attempts to acquire the `SynchronizedBuffer` object's monitor lock. If the monitor lock is available, the Producer thread implicitly acquires the lock. Then the loop at lines 13–19 first determines whether `occupied` is `true`. If so, `buffer` is full, so line 16 outputs a message indicating that the Producer thread is trying to write a value, and line 17 invokes method `displayState` (lines 56–60) to output another message indicating that `buffer` is

full and that the Producer thread is waiting until there's space. Line 18 invokes method `wait` (inherited from `Object` by `SynchronizedBuffer`) to place the thread that called method `set` (i.e., the Producer thread) in the *waiting* state for the `SynchronizedBuffer` object. The call to `wait` causes the calling thread to *implicitly* release the lock on the `SynchronizedBuffer` object. This is important because the thread cannot currently perform its task and because other threads (in this case, the Consumer) should be allowed to access the object to allow the condition (occupied) to change. Now another thread can attempt to acquire the `SynchronizedBuffer` object's lock and invoke the object's `set` or `get` method.

The Producer thread remains in the *waiting* state until another thread notifies the Producer that it may proceed—at which point the Producer returns to the *runnable* state and attempts to implicitly reacquire the lock on the `SynchronizedBuffer` object. If the lock is available, the Producer thread reacquires it, and method `set` continues executing with the next statement after the `wait` call. Because `wait` is called in a loop, the loop-continuation condition is tested again to determine whether the thread can proceed. If not, then `wait` is invoked again—otherwise, method `set` continues with the next statement after the loop.

Line 21 in method `set` assigns the value to the buffer. Line 25 sets `occupied` to `true` to indicate that the buffer now contains a value (i.e., a consumer can read the value, but a Producer cannot yet put another value there). Line 27 invokes method `displayState` to output a message indicating that the Producer is writing a new value into the buffer. Line 29 invokes method `notifyAll` (inherited from `Object`). If any threads are waiting on the `SynchronizedBuffer` object's monitor lock, those threads enter the *runnable* state and can now attempt to reacquire the lock. Method `notifyAll` returns immediately, and method `set` then returns to the caller (i.e., the Producer's `run` method). When method `set` returns, it implicitly releases the monitor lock on the `SynchronizedBuffer` object.

### *Method get and the Consumer Thread*

Methods `get` and `set` are implemented similarly. When the Consumer thread's `run` method invokes synchronized method `get`, the thread attempts to acquire the *monitor lock* on the `SynchronizedBuffer` object. If the lock is available, the Consumer thread acquires it. Then the `while` loop at lines 36–42 determines whether `occupied` is `false`. If so, the buffer is empty, so line 39 outputs a message indicating that the Consumer thread is trying to read a value, and line 40 invokes method `displayState` to output a message indicating that the buffer is empty and that the Consumer thread is waiting. Line 41 invokes method `wait` to place the thread that called method `get` (i.e., the Consumer) in the *waiting* state for the `SynchronizedBuffer` object. Again, the call to `wait` causes the calling thread to implicitly release the lock on the `SynchronizedBuffer` object, so another thread can attempt to acquire the `SynchronizedBuffer` object's lock and invoke the object's `set` or `get` method. If the lock on the `SynchronizedBuffer` is not available (e.g., if the Producer has not yet returned from method `set`), the Consumer is blocked until the lock becomes available.

The Consumer thread remains in the *waiting* state until it's notified by another thread that it may proceed—at which point the Consumer thread returns to the *runnable* state and attempts to implicitly reacquire the lock on the `SynchronizedBuffer` object. If the lock is available, the Consumer reacquires it, and method `get` continues executing with the next statement after `wait`. Because `wait` is called in a loop, the loop-continuation condition is tested again to determine whether the thread can proceed with its execution. If not, `wait` is invoked again—otherwise, method `get` continues with the next statement after the loop.

Line 46 sets `occupied` to `false` to indicate that buffer is now empty (i.e., a Consumer cannot read the value, but a Producer can place another value in buffer), line 48 calls method `displayState` to indicate that the consumer is reading and line 50 invokes method `notifyAll`. If any threads are in the *waiting* state for the lock on this `SynchronizedBuffer` object, they enter the *runnable* state and can now attempt to reacquire the lock. Method `notifyAll` returns immediately, then method `get` returns the value of buffer to its caller. When method `get` returns, the lock on the `SynchronizedBuffer` object is implicitly released.



### Error-Prevention Tip 26.3

*Always invoke method `wait` in a loop that tests the condition the task is waiting on. It's possible that a thread will reenter the *runnable* state (via a timed wait or another thread calling `notifyAll`) before the condition is satisfied. Testing the condition again ensures that the thread will not erroneously execute if it was notified early.*

### Testing Class `SynchronizedBuffer`

Class `SharedBufferTest2` (Fig. 26.17) is similar to class `SharedBufferTest` (Fig. 26.13). `SharedBufferTest2` contains method `main` (lines 8–24), which launches the application. Line 11 creates an `ExecutorService` to run the Producer and Consumer tasks. Line 14 creates a `SynchronizedBuffer` object and assigns its reference to `Buffer` variable `sharedLocation`. This object stores the data that will be shared between the Producer and Consumer. Lines 16–17 display the column heads for the output. Lines 20–21 execute a Producer and a Consumer. Finally, line 23 calls method `shutdown` to end the application when the Producer and Consumer complete their tasks. When method `main` ends (line 24), the main thread of execution terminates.

```

1 // Fig. 26.17: SharedBufferTest2.java
2 // Two threads correctly manipulating a synchronized buffer.
3 import java.util.concurrent.ExecutorService;
4 import java.util.concurrent.Executors;
5
6 public class SharedBufferTest2
7 {
8 public static void main(String[] args)
9 {
10 // create a newCachedThreadPool
11 ExecutorService application = Executors.newCachedThreadPool();
12
13 // create SynchronizedBuffer to store ints
14 Buffer sharedLocation = new SynchronizedBuffer();
15
16 System.out.printf("%-40s%\t\t%s\n%-40s%\n", "Operation",
17 "Buffer", "Occupied", "-----", "-----\t\t-----");
18
19 // execute the Producer and Consumer tasks
20 application.execute(new Producer(sharedLocation));
21 application.execute(new Consumer(sharedLocation));
22

```

**Fig. 26.17** | Two threads correctly manipulating a synchronized buffer. (Part I of 3.)

```

23 application.shutdown();
24 } // end main
25 } // end class SharedBufferTest2

```

| Operation<br>-----                                       | Buffer<br>----- | Occupied<br>----- |
|----------------------------------------------------------|-----------------|-------------------|
| Consumer tries to read.<br>Buffer empty. Consumer waits. | -1              | false             |
| Producer writes 1                                        | 1               | true              |
| Consumer reads 1                                         | 1               | false             |
| Consumer tries to read.<br>Buffer empty. Consumer waits. | 1               | false             |
| Producer writes 2                                        | 2               | true              |
| Consumer reads 2                                         | 2               | false             |
| Producer writes 3                                        | 3               | true              |
| Consumer reads 3                                         | 3               | false             |
| Producer writes 4                                        | 4               | true              |
| Producer tries to write.<br>Buffer full. Producer waits. | 4               | true              |
| Consumer reads 4                                         | 4               | false             |
| Producer writes 5                                        | 5               | true              |
| Consumer reads 5                                         | 5               | false             |
| Producer writes 6                                        | 6               | true              |
| Producer tries to write.<br>Buffer full. Producer waits. | 6               | true              |
| Consumer reads 6                                         | 6               | false             |
| Producer writes 7                                        | 7               | true              |
| Producer tries to write.<br>Buffer full. Producer waits. | 7               | true              |
| Consumer reads 7                                         | 7               | false             |
| Producer writes 8                                        | 8               | true              |
| Consumer reads 8                                         | 8               | false             |
| Consumer tries to read.<br>Buffer empty. Consumer waits. | 8               | false             |

**Fig. 26.17** | Two threads correctly manipulating a synchronized buffer. (Part 2 of 3.)

|                                                          |    |       |
|----------------------------------------------------------|----|-------|
| Producer writes 9                                        | 9  | true  |
| Consumer reads 9                                         | 9  | false |
| Consumer tries to read.<br>Buffer empty. Consumer waits. | 9  | false |
| Producer writes 10                                       | 10 | true  |
| Consumer reads 10                                        | 10 | false |
| Producer done producing<br>Terminating Producer          |    |       |
| Consumer read values totaling 55<br>Terminating Consumer |    |       |

**Fig. 26.17** | Two threads correctly manipulating a synchronized buffer. (Part 3 of 3.)

Study the outputs in Fig. 26.17. Observe that *every integer produced is consumed exactly once—no values are lost, and no values are consumed more than once*. The synchronization ensures that the Producer produces a value only when the buffer is empty and the Consumer consumes only when the buffer is full. The Producer always goes first, the Consumer waits if the Producer has not produced since the Consumer last consumed, and the Producer waits if the Consumer has not yet consumed the value that the Producer most recently produced. Execute this program several times to confirm that every integer produced is consumed exactly once. In the sample output, note the highlighted lines indicating when the Producer and Consumer must wait to perform their respective tasks.

## 26.8 Producer/Consumer Relationship: Bounded Buffers

The program in Section 26.7 uses thread synchronization to guarantee that two threads manipulate data in a shared buffer correctly. However, the application may not perform optimally. If the two threads operate at different speeds, one them will spend more (or most) of its time waiting. For example, in the program in Section 26.7 we shared a single integer variable between the two threads. If the Producer thread produces values faster than the Consumer can consume them, then the Producer thread *waits* for the Consumer, because there are no other locations in the buffer in which to place the next value. Similarly, if the Consumer consumes values faster than the Producer produces them, the Consumer *waits* until the Producer places the next value in the shared buffer. Even when we have threads that operate at the same relative speeds, those threads may occasionally become “out of sync” over a period of time, causing one of them to wait for the other. *We cannot make assumptions about the relative speeds of concurrent threads*—interactions that occur with the operating system, the network, the user and other components can cause the threads to operate at different and ever-changing speeds. When this happens, threads wait. When threads wait excessively, programs become less efficient, interactive programs become less responsive and applications suffer longer delays.

### Bounded Buffers

To minimize the amount of waiting time for threads that share resources and operate at the same average speeds, we can implement a **bounded buffer** that provides a fixed number of buffer cells into which the Producer can place values, and from which the Consumer can retrieve those values. (In fact, we've already done this with the `ArrayBlockingQueue` class in Section 26.6.) If the Producer temporarily produces values faster than the Consumer can consume them, the Producer can write additional values into the extra buffer cells, if any are available. This capability enables the Producer to perform its task even though the Consumer is not ready to retrieve the current value being produced. Similarly, if the Consumer consumes faster than the Producer produces new values, the Consumer can read additional values (if there are any) from the buffer. This enables the Consumer to keep busy even though the Producer is not ready to produce additional values.

Even a *bounded buffer* is inappropriate if the Producer and the Consumer operate consistently at different speeds. If the Consumer always executes faster than the Producer, then a buffer containing one location is enough. Additional locations would simply waste memory. If the Producer always executes faster, only a buffer with an “infinite” number of locations would be able to absorb the extra production. However, if the Producer and Consumer execute at about the same average speed, a bounded buffer helps to smooth the effects of any occasional speeding up or slowing down in either thread's execution.

The key to using a *bounded buffer* with a Producer and Consumer that operate at about the same speed is to provide the buffer with enough locations to handle the anticipated “extra” production. If, over a period of time, we determine that the Producer often produces as many as three more values than the Consumer can consume, we can provide a buffer of at least three cells to handle the extra production. Making the buffer too small would cause threads to wait longer; making the buffer too large would waste memory.



#### Performance Tip 26.3

*Even when using a bounded buffer, it's possible that a producer thread could fill the buffer, which would force the producer to wait until a consumer consumed a value to free an element in the buffer. Similarly, if the buffer is empty at any given time, a consumer thread must wait until the producer produces another value. The key to using a bounded buffer is to optimize the buffer size to minimize the amount of thread wait time, while not wasting space.*

### Bounded Buffers Using `ArrayBlockingQueue`

The simplest way to implement a bounded buffer is to use an `ArrayBlockingQueue` for the buffer so that *all of the synchronization details are handled for you*. This can be done by modifying the example from Section 26.6 to pass the desired size for the bounded buffer into the `ArrayBlockingQueue` constructor. Rather than repeat our previous `ArrayBlockingQueue` example with a different size, we instead present an example that illustrates how you can build a bounded buffer yourself. Again, using an `ArrayBlockingQueue` will result in more-maintainable and better-performing code. In Exercise 26.11, we ask you to reimplement this section's example, using the Java Concurrency API techniques presented in Section 26.9.

### Implementing Your Own Bounded Buffer as a Circular Buffer

The program in Fig. 26.18 and Fig. 26.19 demonstrates a Producer and a Consumer accessing a *bounded buffer with synchronization*. Again, we reuse interface `Buffer` and classes

Producer and Consumer from the example in Section 26.5, except that line 28 is removed from class `Producer` and class `Consumer`. We implement the bounded buffer in class `CircularBuffer` (Fig. 26.18) as a **circular buffer** that uses a shared array of three elements. A circular buffer writes into and reads from the array elements in order, beginning at the first cell and moving toward the last. When a `Producer` or `Consumer` reaches the last element, it returns to the first and begins writing or reading, respectively, from there. In this version of the producer/consumer relationship, the `Consumer` consumes a value only when the array is not empty and the `Producer` produces a value only when the array is not full. The statements that created and started the thread objects in the main method of class `SharedBufferTest2` (Fig. 26.17) now appear in class `CircularBufferTest` (Fig. 26.19).

```
1 // Fig. 26.18: CircularBuffer.java
2 // Synchronizing access to a shared three-element bounded buffer.
3 public class CircularBuffer implements Buffer
4 {
5 private final int[] buffer = { -1, -1, -1 }; // shared buffer
6
7 private int occupiedCells = 0; // count number of buffers used
8 private int writeIndex = 0; // index of next element to write to
9 private int readIndex = 0; // index of next element to read
10
11 // place value into buffer
12 public synchronized void set(int value) throws InterruptedException
13 {
14 // wait until buffer has space available, then write value;
15 // while no empty locations, place thread in blocked state
16 while (occupiedCells == buffer.length)
17 {
18 System.out.printf("Buffer is full. Producer waits.\n");
19 wait(); // wait until a buffer cell is free
20 } // end while
21
22 buffer[writeIndex] = value; // set new buffer value
23
24 // update circular write index
25 writeIndex = (writeIndex + 1) % buffer.length;
26
27 ++occupiedCells; // one more buffer cell is full
28 displayState("Producer writes " + value);
29 notifyAll(); // notify threads waiting to read from buffer
30 } // end method set
31
32 // return value from buffer
33 public synchronized int get() throws InterruptedException
34 {
35 // wait until buffer has data, then read value;
36 // while no data to read, place thread in waiting state
37 while (occupiedCells == 0)
38 {
39 System.out.printf("Buffer is empty. Consumer waits.\n");
```

**Fig. 26.18** | Synchronizing access to a shared three-element bounded buffer. (Part 1 of 2.)

```

40 wait(); // wait until a buffer cell is filled
41 } // end while
42
43 int readValue = buffer[readIndex]; // read value from buffer
44
45 // update circular read index
46 readIndex = (readIndex + 1) % buffer.length;
47
48 --occupiedCells; // one fewer buffer cells are occupied
49 displayState("Consumer reads " + readValue);
50 notifyAll(); // notify threads waiting to write to buffer
51
52 return readValue;
53 } // end method get
54
55 // display current operation and buffer state
56 public void displayState(String operation)
57 {
58 // output operation and number of occupied buffer cells
59 System.out.printf("%s%d\n%s", operation,
60 " (buffer cells occupied: ", occupiedCells, "buffer cells: ");
61
62 for (int value : buffer)
63 System.out.printf(" %2d ", value); // output values in buffer
64
65 System.out.print("\n ");
66
67 for (int i = 0; i < buffer.length; i++)
68 System.out.print("---- ");
69
70 System.out.print("\n ");
71
72 for (int i = 0; i < buffer.length; i++)
73 {
74 if (i == writeIndex && i == readIndex)
75 System.out.print(" WR"); // both write and read index
76 else if (i == writeIndex)
77 System.out.print(" W "); // just write index
78 else if (i == readIndex)
79 System.out.print(" R "); // just read index
80 else
81 System.out.print(" "); // neither index
82 } // end for
83
84 System.out.println("\n");
85 } // end method displayState
86 } // end class CircularBuffer

```

**Fig. 26.18** | Synchronizing access to a shared three-element bounded buffer. (Part 2 of 2.)

Line 5 initializes array `buffer` as a three-element `int` array that represents the circular buffer. Variable `occupiedCells` (line 7) counts the number of elements in `buffer` that contain data to be read. When `occupiedCells` is 0, there's no data in the circular buffer and the Consumer must wait—when `occupiedCells` is 3 (the size of the circular buffer),



the circular buffer is full and the Producer must wait. Variable `writeIndex` (line 8) indicates the next location in which a value can be placed by a Producer. Variable `readIndex` (line 9) indicates the position from which the next value can be read by a Consumer.

### ***CircularBuffer Method set***

`CircularBuffer` method `set` (lines 12–30) performs the same tasks as in Fig. 26.16, with a few modifications. The loop at lines 16–20 determines whether the Producer must wait (i.e., all buffer cells are full). If so, line 18 indicates that the Producer is waiting to perform its task. Then line 19 invokes method `wait`, causing the Producer thread to release the `CircularBuffer`'s lock and wait until there's space for a new value to be written into the buffer. When execution continues at line 22 after the `while` loop, the value written by the Producer is placed in the circular buffer at location `writeIndex`. Then line 25 updates `writeIndex` for the next call to `CircularBuffer` method `set`. This line is the key to the buffer's *circularity*. When `writeIndex` is incremented past the end of the buffer, the line sets it to 0. Line 27 increments `occupiedCells`, because there's now one more value in the buffer that the Consumer can read. Next, line 28 invokes method `displayState` (lines 56–85) to update the output with the value produced, the number of occupied buffer cells, the contents of the buffer cells and the current `writeIndex` and `readIndex`. Line 29 invokes method `notifyAll` to transition *waiting* threads to the *runnable* state, so that a waiting Consumer thread (if there is one) can now try again to read a value from the buffer.

### ***CircularBuffer Method get***

`CircularBuffer` method `get` (lines 33–53) also performs the same tasks as it did in Fig. 26.16, with a few minor modifications. The loop at lines 37–41 determines whether the Consumer must wait (i.e., all buffer cells are empty). If the Consumer must wait, line 39 updates the output to indicate that the Consumer is waiting to perform its task. Then line 40 invokes method `wait`, causing the current thread to release the lock on the `CircularBuffer` and wait until data is available to read. When execution eventually continues at line 43 after a `notifyAll` call from the Producer, `readValue` is assigned the value at location `readIndex` in the circular buffer. Then line 46 updates `readIndex` for the next call to `CircularBuffer` method `get`. This line and line 25 implement the *circularity* of the buffer. Line 48 decrements `occupiedCells`, because there's now one more position in the buffer in which the Producer thread can place a value. Line 49 invokes method `displayState` to update the output with the consumed value, the number of occupied buffer cells, the contents of the buffer cells and the current `writeIndex` and `readIndex`. Line 50 invokes method `notifyAll` to allow any Producer threads waiting to write into the `CircularBuffer` object to attempt to write again. Then line 52 returns the consumed value to the caller.

### ***CircularBuffer Method displayState***

Method `displayState` (lines 56–85) outputs the application's state. Lines 62–63 output the values of the buffer cells. Line 63 uses method `printf` with a "%2d" format specifier to print the contents of each buffer with a leading space if it's a single digit. Lines 70–82 output the current `writeIndex` and `readIndex` with the letters `W` and `R`, respectively.

### ***Testing Class CircularBuffer***

Class `CircularBufferTest` (Fig. 26.19) contains the `main` method that launches the application. Line 11 creates the `ExecutorService`, and line 14 creates a `CircularBuffer` ob-

ject and assigns its reference to `CircularBuffer` variable `sharedLocation`. Line 17 invokes the `CircularBuffer`'s `displayState` method to show the initial state of the buffer. Lines 20–21 execute the `Producer` and `Consumer` tasks. Line 23 calls method `shutdown` to end the application when the threads complete the `Producer` and `Consumer` tasks.

Each time the `Producer` writes a value or the `Consumer` reads a value, the program outputs a message indicating the action performed (a read or a write), the contents of buffer, and the location of `writeIndex` and `readIndex`. In the output of Fig. 26.19, the `Producer` first writes the value 1. The buffer then contains the value 1 in the first cell and the value -1 (the default value that we use for output purposes) in the other two cells. The write index is updated to the second cell, while the read index stays at the first cell. Next, the `Consumer` reads 1. The buffer contains the same values, but the read index has been updated to the second cell. The `Consumer` then tries to read again, but the buffer is empty and the `Consumer` is forced to wait. Only once in this execution of the program was it necessary for either thread to wait.

```

1 // Fig. 26.19: CircularBufferTest.java
2 // Producer and Consumer threads manipulating a circular buffer.
3 import java.util.concurrent.ExecutorService;
4 import java.util.concurrent.Executors;
5
6 public class CircularBufferTest
7 {
8 public static void main(String[] args)
9 {
10 // create new thread pool with two threads
11 ExecutorService application = Executors.newCachedThreadPool();
12
13 // create CircularBuffer to store ints
14 CircularBuffer sharedLocation = new CircularBuffer();
15
16 // display the initial state of the CircularBuffer
17 sharedLocation.displayState("Initial State");
18
19 // execute the Producer and Consumer tasks
20 application.execute(new Producer(sharedLocation));
21 application.execute(new Consumer(sharedLocation));
22
23 application.shutdown();
24 } // end main
25 } // end class CircularBufferTest

```

```

Initial State (buffer cells occupied: 0)
buffer cells: -1 -1 -1

 WR

Producer writes 1 (buffer cells occupied: 1)
buffer cells: 1 -1 -1

 R W

```

**Fig. 26.19** | Producer and Consumer threads manipulating a circular buffer. (Part I of 3.)

```

Consumer reads 1 (buffer cells occupied: 0)
buffer cells: 1 -1 -1

 WR

Buffer is empty. Consumer waits.
Producer writes 2 (buffer cells occupied: 1)
buffer cells: 1 2 -1

 R W

Consumer reads 2 (buffer cells occupied: 0)
buffer cells: 1 2 -1

 WR

Producer writes 3 (buffer cells occupied: 1)
buffer cells: 1 2 3

 W R

Consumer reads 3 (buffer cells occupied: 0)
buffer cells: 1 2 3

 WR

Producer writes 4 (buffer cells occupied: 1)
buffer cells: 4 2 3

 R W

Producer writes 5 (buffer cells occupied: 2)
buffer cells: 4 5 3

 R W

Consumer reads 4 (buffer cells occupied: 1)
buffer cells: 4 5 3

 R W

Producer writes 6 (buffer cells occupied: 2)
buffer cells: 4 5 6

 W R

Producer writes 7 (buffer cells occupied: 3)
buffer cells: 7 5 6

 WR

Consumer reads 5 (buffer cells occupied: 2)
buffer cells: 7 5 6

 W R

Producer writes 8 (buffer cells occupied: 3)
buffer cells: 7 8 6

 WR

```

**Fig. 26.19** | Producer and Consumer threads manipulating a circular buffer. (Part 2 of 3.)

```

Consumer reads 6 (buffer cells occupied: 2)
buffer cells: 7 8 6

 R W

Consumer reads 7 (buffer cells occupied: 1)
buffer cells: 7 8 6

 R W

Producer writes 9 (buffer cells occupied: 2)
buffer cells: 7 8 9

 W R

Consumer reads 8 (buffer cells occupied: 1)
buffer cells: 7 8 9

 W R

Consumer reads 9 (buffer cells occupied: 0)
buffer cells: 7 8 9

 WR

Producer writes 10 (buffer cells occupied: 1)
buffer cells: 10 8 9

 R W

Producer done producing
Terminating Producer
Consumer reads 10 (buffer cells occupied: 0)
buffer cells: 10 8 9

 WR

Consumer read values totaling: 55
Terminating Consumer

```

**Fig. 26.19** | Producer and Consumer threads manipulating a circular buffer. (Part 3 of 3.)

## 26.9 Producer/Consumer Relationship: The Lock and Condition Interfaces

Though the `synchronized` keyword provides for most basic thread-synchronization needs, Java provides other tools to assist in developing concurrent programs. In this section, we discuss the `Lock` and `Condition` interfaces. These interfaces give you more precise control over thread synchronization, but are more complicated to use.

### *Interface `Lock` and Class `ReentrantLock`*

Any object can contain a reference to an object that implements the `Lock` interface (of package `java.util.concurrent.locks`). A thread calls the `Lock`'s `lock` method (analogous to entering a `synchronized` block) to acquire the lock. Once a `Lock` has been obtained by one thread, the `Lock` object will not allow another thread to obtain the `Lock` until the first thread releases the `Lock` (by calling the `Lock`'s `unlock` method—analogueous to ex-

iting a synchronized block). If several threads are trying to call method `lock` on the same `Lock` object at the same time, only one of these threads can obtain the lock—all the others are placed in the *waiting* state for that lock. When a thread calls method `unlock`, the lock on the object is released and a waiting thread attempting to lock the object proceeds.

Class **ReentrantLock** (of package `java.util.concurrent.locks`) is a basic implementation of the `Lock` interface. The constructor for a `ReentrantLock` takes a `boolean` argument that specifies whether the lock has a **fairness policy**. If the argument is `true`, the `ReentrantLock`'s fairness policy is “the longest-waiting thread will acquire the lock when it's available.” Such a fairness policy guarantees that *indefinite postponement* (also called *starvation*) cannot occur. If the fairness policy argument is set to `false`, there's no guarantee as to which waiting thread will acquire the lock when it's available.



### Software Engineering Observation 26.3

Using a `ReentrantLock` with a fairness policy avoids indefinite postponement.



### Performance Tip 26.4

Using a `ReentrantLock` with a fairness policy can decrease program performance.

## Condition Objects and Interface Condition

If a thread that owns a `Lock` determines that it cannot continue with its task until some condition is satisfied, the thread can wait on a **condition object**. Using `Lock` objects allows you to explicitly declare the condition objects on which a thread may need to wait. For example, in the producer/consumer relationship, producers can wait on *one* object and consumers can wait on *another*. This is not possible when using the synchronized keywords and an object's built-in monitor lock. Condition objects are associated with a specific `Lock` and are created by calling a `Lock`'s **newCondition** method, which returns an object that implements the **Condition** interface (of package `java.util.concurrent.locks`). To wait on a condition object, the thread can call the `Condition`'s **await** method (analogous to `Object` method `wait`). This immediately releases the associated `Lock` and places the thread in the *waiting* state for that `Condition`. Other threads can then try to obtain the `Lock`. When a *runnable* thread completes a task and determines that the *waiting* thread can now continue, the *runnable* thread can call `Condition` method **signal** (analogous to `Object` method `notify`) to allow a thread in that `Condition`'s *waiting* state to return to the *runnable* state. At this point, the thread that transitioned from the *waiting* state to the *runnable* state can attempt to reacquire the `Lock`. Even if it's able to reacquire the `Lock`, the thread still might not be able to perform its task at this time—in which case the thread can call the `Condition`'s `await` method to release the `Lock` and reenter the *waiting* state. If multiple threads are in a `Condition`'s *waiting* state when `signal` is called, the default implementation of `Condition` signals the longest-waiting thread to transition to the *runnable* state. If a thread calls `Condition` method **signalAll** (analogous to `Object` method `notifyAll`), then all the threads waiting for that condition transition to the *runnable* state and become eligible to reacquire the `Lock`. Only one of those threads can obtain the `Lock` on the object—the others will wait until the `Lock` becomes available again. If the `Lock` has a *fairness policy*, the longest-waiting thread acquires the `Lock`. When a thread is finished with a shared object, it must call method `unlock` to release the `Lock`.



### Common Programming Error 26.2

*Deadlock* occurs when a waiting thread (let's call this thread1) cannot proceed because it's waiting (either directly or indirectly) for another thread (let's call this thread2) to proceed, while simultaneously thread2 cannot proceed because it's waiting (either directly or indirectly) for thread1 to proceed. The two threads are waiting for each other, so the actions that would enable each thread to continue execution can never occur.



### Error-Prevention Tip 26.4

When multiple threads manipulate a shared object using locks, ensure that if one thread calls method `await` to enter the waiting state for a condition object, a separate thread eventually will call Condition method `signal` to transition the thread waiting on the condition object back to the runnable state. If multiple threads may be waiting on the condition object, a separate thread can call Condition method `signalAll` as a safeguard to ensure that all the waiting threads have another opportunity to perform their tasks. If this is not done, starvation might occur.



### Common Programming Error 26.3

An `IllegalMonitorStateException` occurs if a thread issues an `await`, a `signal`, or a `signalAll` on a Condition object that was created from a `ReentrantLock` without having acquired the lock for that Condition object.

## Lock and Condition vs. the synchronized Keyword

In some applications, using `Lock` and `Condition` objects may be preferable to using the `synchronized` keyword. Locks allow you to *interrupt* waiting threads or to specify a *timeout* for waiting to acquire a lock, which is not possible using the `synchronized` keyword. Also, a `Lock` is *not* constrained to be acquired and released in the *same* block of code, which is the case with the `synchronized` keyword. `Condition` objects allow you to specify multiple conditions on which threads may wait. Thus, it's possible to indicate to waiting threads that a specific condition object is now true by calling `signal` or `signalAll` on that `Condition` object. With `synchronized`, there's no way to explicitly state the condition on which threads are waiting, and thus there's no way to notify threads waiting on one condition that they may proceed without also signaling threads waiting on any other conditions. There are other possible advantages to using `Lock` and `Condition` objects, but generally it's best to use the `synchronized` keyword unless your application requires advanced synchronization capabilities.



### Error-Prevention Tip 26.5

Using interfaces `Lock` and `Condition` is error prone—`unlock` is not guaranteed to be called, whereas the monitor in a `synchronized` statement will always be released when the statement completes execution.

## Using Locks and Conditions to Implement Synchronization

To illustrate how to use the `Lock` and `Condition` interfaces, we now implement the producer/consumer relationship using `Lock` and `Condition` objects to coordinate access to a shared single-element buffer (Fig. 26.20 and Fig. 26.21). In this case, each produced value is correctly consumed exactly once. Again, we reuse interface `Buffer` and classes `Producer` and `Consumer` from the example in Section 26.5, except that line 28 is removed from class `Producer` and class `Consumer`.

Class `SynchronizedBuffer` (Fig. 26.20) contains five fields. Line 11 creates a new object of type `ReentrantLock` and assigns its reference to Lock variable `accessLock`. The `ReentrantLock` is created without the *fairness policy* because at any time only a single Producer or Consumer will be waiting to acquire the Lock in this example. Lines 14–15 create two Conditions using Lock method `newCondition`. Condition `canWrite` contains a queue for a Producer thread waiting while the buffer is full (i.e., there's data in the buffer that the Consumer has not read yet). If the buffer is full, the Producer calls method `await` on this Condition. When the Consumer reads data from a full buffer, it calls method `signal` on this Condition. Condition `canRead` contains a queue for a Consumer thread waiting while the buffer is empty (i.e., there's no data in the buffer for the Consumer to read). If the buffer is empty, the Consumer calls method `await` on this Condition. When the Producer writes to the empty buffer, it calls method `signal` on this Condition. The `int` variable `buffer` (line 17) holds the shared data. The `boolean` variable `occupied` (line 18) keeps track of whether the buffer currently holds data (that the Consumer should read).

---

```

1 // Fig. 26.20: SynchronizedBuffer.java
2 // Synchronizing access to a shared integer using the Lock and Condition
3 // interfaces
4 import java.util.concurrent.locks.Lock;
5 import java.util.concurrent.locks.ReentrantLock;
6 import java.util.concurrent.locks.Condition;
7
8 public class SynchronizedBuffer implements Buffer
9 {
10 // Lock to control synchronization with this buffer
11 private final Lock accessLock = new ReentrantLock();
12
13 // conditions to control reading and writing
14 private final Condition canWrite = accessLock.newCondition();
15 private final Condition canRead = accessLock.newCondition();
16
17 private int buffer = -1; // shared by producer and consumer threads
18 private boolean occupied = false; // whether buffer is occupied
19
20 // place int value into buffer
21 public void set(int value) throws InterruptedException
22 {
23 accessLock.lock(); // lock this object
24
25 // output thread information and buffer information, then wait
26 try
27 {
28 // while buffer is not empty, place thread in waiting state
29 while (occupied)
30 {
31 System.out.println("Producer tries to write.");
32 displayState("Buffer full. Producer waits.");
33 canWrite.await(); // wait until buffer is empty
34 } // end while

```

---

**Fig. 26.20** | Synchronizing access to a shared integer using the Lock and Condition interfaces. (Part I of 3.)

```

35
36 buffer = value; // set new buffer value
37
38 // indicate producer cannot store another value
39 // until consumer retrieves current buffer value
40 occupied = true;
41
42 displayState("Producer writes " + buffer);
43
44 // signal any threads waiting to read from buffer
45 canRead.signalAll();
46 } // end try
47 finally
48 {
49 accessLock.unlock(); // unlock this object
50 } // end finally
51 } // end method set
52
53 // return value from buffer
54 public int get() throws InterruptedException
55 {
56 int readValue = 0; // initialize value read from buffer
57 accessLock.lock(); // lock this object
58
59 // output thread information and buffer information, then wait
60 try
61 {
62 // if there is no data to read, place thread in waiting state
63 while (!occupied)
64 {
65 System.out.println("Consumer tries to read.");
66 displayState("Buffer empty. Consumer waits.");
67 canRead.await(); // wait until buffer is full
68 } // end while
69
70 // indicate that producer can store another value
71 // because consumer just retrieved buffer value
72 occupied = false;
73
74 readValue = buffer; // retrieve value from buffer
75 displayState("Consumer reads " + readValue);
76
77 // signal any threads waiting for buffer to be empty
78 canWrite.signalAll();
79 } // end try
80 finally
81 {
82 accessLock.unlock(); // unlock this object
83 } // end finally
84
85 return readValue;
86 } // end method get

```

**Fig. 26.20** | Synchronizing access to a shared integer using the Lock and Condition interfaces. (Part 2 of 3.)



```

87
88 // display current operation and buffer state
89 public void displayState(String operation)
90 {
91 System.out.printf("%-40s%d\t\t%b\n\n", operation, buffer,
92 occupied);
93 } // end method displayState
94 } // end class SynchronizedBuffer

```

**Fig. 26.20** | Synchronizing access to a shared integer using the Lock and Condition interfaces. (Part 3 of 3.)

Line 23 in method `set` calls method `lock` on the `SynchronizedBuffer`'s `accessLock`. If the lock is available (i.e., no other thread has acquired it), this thread now owns the lock and the thread continues. If the lock is unavailable (i.e., it's held by another thread), method `lock` waits until the lock is released. After the lock is acquired, lines 26–46 execute. Line 29 tests `occupied` to determine whether buffer is full. If it is, lines 31–32 display a message indicating that the thread will wait. Line 33 calls `Condition` method `await` on the `canWrite` condition object, which temporarily releases the `SynchronizedBuffer`'s `Lock` and waits for a signal from the `Consumer` that buffer is available for writing. When buffer is available, the method proceeds, writing to buffer (line 36), setting `occupied` to `true` (line 40) and displaying a message indicating that the producer wrote a value (line 42). Line 45 calls `Condition` method `signal` on condition object `canRead` to notify the waiting `Consumer` (if there is one) that the buffer has new data to be read. Line 49 calls method `unlock` from a `finally` block to release the lock and allow the `Consumer` to proceed.



#### Error-Prevention Tip 26.6

*Place calls to `Lock` method `unlock` in a `finally` block. If an exception is thrown, `unlock` must still be called or deadlock could occur.*

Line 57 of method `get` (lines 54–86) calls method `lock` to acquire the `Lock`. This method waits until the `Lock` is available. Once the `Lock` is acquired, line 63 tests whether `occupied` is `false`, indicating that the buffer is empty. If so, line 67 calls method `await` on condition object `canRead`. Recall that method `signal` is called on variable `canRead` in the `set` method (line 45). When the `Condition` object is signaled, the `get` method continues. Line 72–74 set `occupied` to `false`, store the value of buffer in `readValue` and output the `readValue`. Then line 78 signals the condition object `canWrite`. This awakens the `Producer` if it's indeed waiting for the buffer to be emptied. Line 82 calls method `unlock` from a `finally` block to release the lock, and line 85 returns `readValue` to the caller.



#### Common Programming Error 26.4

*Forgetting to `signal` a waiting thread is a logic error. The thread will remain in the waiting state, which will prevent it from proceeding. Such waiting can lead to indefinite postponement or deadlock.*

Class `SharedBufferTest2` (Fig. 26.21) is identical to that of Fig. 26.17. Study the outputs in Fig. 26.21. *Observe that every integer produced is consumed exactly once—no values are lost, and no values are consumed more than once.* The `Lock` and `Condition` objects ensure that the `Producer` and `Consumer` cannot perform their tasks unless it's their turn.

The Producer must go first, the Consumer must wait if the Producer has not produced since the Consumer last consumed and the Producer must wait if the Consumer has not yet consumed the value that the Producer most recently produced. Execute this program several times to confirm that every integer produced is consumed exactly once. In the sample output, note the highlighted lines indicating when the Producer and Consumer must wait to perform their respective tasks.

```

1 // Fig. 26.21: SharedBufferTest2.java
2 // Two threads manipulating a synchronized buffer.
3 import java.util.concurrent.ExecutorService;
4 import java.util.concurrent.Executors;
5
6 public class SharedBufferTest2
7 {
8 public static void main(String[] args)
9 {
10 // create new thread pool with two threads
11 ExecutorService application = Executors.newCachedThreadPool();
12
13 // create SynchronizedBuffer to store ints
14 Buffer sharedLocation = new SynchronizedBuffer();
15
16 System.out.printf("%-40s%s\t\t%s\n%-40s%s\n", "Operation",
17 "Buffer", "Occupied", "-----", "-----\t\t-----");
18
19 // execute the Producer and Consumer tasks
20 application.execute(new Producer(sharedLocation));
21 application.execute(new Consumer(sharedLocation));
22
23 application.shutdown();
24 } // end main
25 } // end class SharedBufferTest2

```

| Operation<br>-----                                       | Buffer<br>----- | Occupied<br>----- |
|----------------------------------------------------------|-----------------|-------------------|
| Producer writes 1                                        | 1               | true              |
| Producer tries to write.<br>Buffer full. Producer waits. | 1               | true              |
| Consumer reads 1                                         | 1               | false             |
| Producer writes 2                                        | 2               | true              |
| Producer tries to write.<br>Buffer full. Producer waits. | 2               | true              |
| Consumer reads 2                                         | 2               | false             |
| Producer writes 3                                        | 3               | true              |
| Consumer reads 3                                         | 3               | false             |

**Fig. 26.21** | Two threads manipulating a synchronized buffer. (Part I of 2.)

|                                                          |    |       |
|----------------------------------------------------------|----|-------|
| Producer writes 4                                        | 4  | true  |
| Consumer reads 4                                         | 4  | false |
| Consumer tries to read.<br>Buffer empty. Consumer waits. | 4  | false |
| Producer writes 5                                        | 5  | true  |
| Consumer reads 5                                         | 5  | false |
| Consumer tries to read.<br>Buffer empty. Consumer waits. | 5  | false |
| Producer writes 6                                        | 6  | true  |
| Consumer reads 6                                         | 6  | false |
| Producer writes 7                                        | 7  | true  |
| Consumer reads 7                                         | 7  | false |
| Producer writes 8                                        | 8  | true  |
| Consumer reads 8                                         | 8  | false |
| Producer writes 9                                        | 9  | true  |
| Consumer reads 9                                         | 9  | false |
| Producer writes 10                                       | 10 | true  |
| Producer done producing<br>Terminating Producer          |    |       |
| Consumer reads 10                                        | 10 | false |
| Consumer read values totaling 55<br>Terminating Consumer |    |       |

**Fig. 26.21** | Two threads manipulating a synchronized buffer. (Part 2 of 2.)

## 26.10 Concurrent Collections Overview

In Chapter 20, we introduced various collections from the Java Collections API. We also mentioned that you can obtain synchronized versions of those collections to allow only one thread at a time to access a collection that might be shared among several threads. The collections from the `java.util.concurrent` package are specifically designed and optimized for use in programs that share collections among multiple threads.

Figure 26.22 lists the many concurrent collections in package `java.util.concurrent`. For more information on these collections, visit

[download.oracle.com/javase/6/docs/api/java/util/concurrent/package-summary.html](http://download.oracle.com/javase/6/docs/api/java/util/concurrent/package-summary.html)

For information on the additional concurrent collections that are new in Java SE 7, visit

[download.java.net/jdk7/docs/api/java/util/concurrent/package-summary.html](http://download.java.net/jdk7/docs/api/java/util/concurrent/package-summary.html)

| Collection                                       | Description                                                                                                                                                                                                                                                                                                                                                                                                                                                                                                                                                                                       |
|--------------------------------------------------|---------------------------------------------------------------------------------------------------------------------------------------------------------------------------------------------------------------------------------------------------------------------------------------------------------------------------------------------------------------------------------------------------------------------------------------------------------------------------------------------------------------------------------------------------------------------------------------------------|
| <code>ArrayBlockingQueue</code>                  | A fixed-size queue that supports the producer/consumer relationship—possibly with many producers and consumers.                                                                                                                                                                                                                                                                                                                                                                                                                                                                                   |
| <code>ConcurrentHashMap</code>                   | A hash-based map that allows an arbitrary number of reader threads and a limited number of writer threads.                                                                                                                                                                                                                                                                                                                                                                                                                                                                                        |
| <code>ConcurrentLinkedQueue</code>               | A concurrent linked-list implementation of a queue that can grow dynamically.                                                                                                                                                                                                                                                                                                                                                                                                                                                                                                                     |
| <code>ConcurrentSkipListMap</code>               | A concurrent map that is sorted by its keys.                                                                                                                                                                                                                                                                                                                                                                                                                                                                                                                                                      |
| <code>ConcurrentSkipListSet</code>               | A sorted concurrent set.                                                                                                                                                                                                                                                                                                                                                                                                                                                                                                                                                                          |
| <code>CopyOnWriteArrayList</code>                | A thread-safe <code>ArrayList</code> . Each operation that modifies the collection first creates a new copy of the contents. Used when the collection is traversed much more frequently than the collection's contents are modified.                                                                                                                                                                                                                                                                                                                                                              |
| <code>CopyOnWriteArraySet</code>                 | A set that's implemented using <code>CopyOnWriteArrayList</code> .                                                                                                                                                                                                                                                                                                                                                                                                                                                                                                                                |
| <code>DelayQueue</code>                          | A variable-size queue containing <code>Delayed</code> objects. An object can be removed only after its delay has expired.                                                                                                                                                                                                                                                                                                                                                                                                                                                                         |
| <code>LinkedBlockingDeque</code>                 | A double-ended blocking queue implemented as a linked list that can optionally be fixed in size.                                                                                                                                                                                                                                                                                                                                                                                                                                                                                                  |
| <code>LinkedBlockingQueue</code>                 | A blocking queue implemented as a linked list that can optionally be fixed in size.                                                                                                                                                                                                                                                                                                                                                                                                                                                                                                               |
| <code>PriorityBlockingQueue</code>               | A variable-length priority-based blocking queue (like a <code>PriorityQueue</code> ).                                                                                                                                                                                                                                                                                                                                                                                                                                                                                                             |
| <code>SynchronousQueue</code>                    | A blocking queue implementation that does not have an internal capacity. Each insert operation by one thread must wait for a remove operation from another thread and vice versa.                                                                                                                                                                                                                                                                                                                                                                                                                 |
| <i>Concurrent Collections Added in Java SE 7</i> |                                                                                                                                                                                                                                                                                                                                                                                                                                                                                                                                                                                                   |
| <code>ConcurrentLinkedDeque</code>               | A concurrent linked-list implementation of a double-ended queue.                                                                                                                                                                                                                                                                                                                                                                                                                                                                                                                                  |
| <code>LinkedTransferQueue</code>                 | A linked-list implementation of interface <code>TransferQueue</code> . Each producer has the option of waiting for a consumer to take an element being inserted (via method <code>transfer</code> ) or simply placing the element into the queue (via method <code>put</code> ). Also provides overloaded method <code>tryTransfer</code> to immediately transfer an element to a waiting consumer or to do so within a specified timeout period. If the transfer cannot be completed, the element is not placed in the queue. Typically used in applications that pass messages between threads. |

**Fig. 26.22** | Concurrent collections summary (package `java.util.concurrent`).

## 26.11 Multithreading with GUI

Swing applications present a unique set of challenges for multithreaded programming. All Swing applications have a single thread, called the **event dispatch thread**, to handle interactions with the application's GUI components. Typical interactions include *updating GUI components* or *processing user actions* such as mouse clicks. All tasks that require interaction with an application's GUI are placed in an *event queue* and are executed sequentially by the event dispatch thread.

*Swing GUI components are not thread safe*—they cannot be manipulated by multiple threads without the risk of incorrect results. Unlike the other examples presented in this chapter, thread safety in GUI applications is achieved not by synchronizing thread actions, but by *ensuring that Swing components are accessed from only a single thread*—the event dispatch thread. This technique is called **thread confinement**. Allowing just one thread to access non-thread-safe objects eliminates the possibility of corruption due to multiple threads accessing these objects concurrently.

Usually it's sufficient to perform simple calculations on the event dispatch thread in sequence with GUI component manipulations. If an application must perform a lengthy computation in response to a user interface interaction, the event dispatch thread cannot attend to other tasks in the event queue while the thread is tied up in that computation. This causes the GUI components to become unresponsive. It's preferable to handle a long-running computation in a separate thread, freeing the event dispatch thread to continue managing other GUI interactions. Of course, to update the GUI based on the computation's results, you must update the GUI from the event dispatch thread, rather than from the worker thread that performed the computation.

### Class *SwingWorker*

Class **SwingWorker** (in package `javax.swing`) perform long-running computations in a worker thread and to update Swing components from the event dispatch thread based on the computations' results. `SwingWorker` implements the `Runnable` interface, meaning that *a SwingWorker object can be scheduled to execute in a separate thread*. The `SwingWorker` class provides several methods to simplify performing computations in a worker thread and making the results available for display in a GUI. Some common `SwingWorker` methods are described in Fig. 26.23.

| Method                      | Description                                                                                                                                            |
|-----------------------------|--------------------------------------------------------------------------------------------------------------------------------------------------------|
| <code>doInBackground</code> | Defines a long computation and is called in a worker thread.                                                                                           |
| <code>done</code>           | Executes on the event dispatch thread when <code>doInBackground</code> returns.                                                                        |
| <code>execute</code>        | Schedules the <code>SwingWorker</code> object to be executed in a worker thread.                                                                       |
| <code>get</code>            | Waits for the computation to complete, then returns the result of the computation (i.e., the return value of <code>doInBackground</code> ).            |
| <code>publish</code>        | Sends intermediate results from the <code>doInBackground</code> method to the <code>process</code> method for processing on the event dispatch thread. |

**Fig. 26.23** | Commonly used `SwingWorker` methods. (Part 1 of 2.)

| Method                   | Description                                                                                                                  |
|--------------------------|------------------------------------------------------------------------------------------------------------------------------|
| <code>process</code>     | Receives intermediate results from the <code>publish</code> method and processes these results on the event dispatch thread. |
| <code>setProgress</code> | Sets the progress property to notify any property change listeners on the event dispatch thread of progress bar updates.     |

**Fig. 26.23** | Commonly used `SwingWorker` methods. (Part 2 of 2.)

### 26.11.1 Performing Computations in a Worker Thread

In the next example, the user enters a number  $n$  and the program gets the  $n$ th Fibonacci number, which we calculate using the recursive algorithm discussed in Section 18.4. Since the algorithm is time consuming for large values, we use a `SwingWorker` object to perform the calculation in a worker thread. The GUI also provides a separate set of components that get the next Fibonacci number in the sequence with each click of a button, beginning with `fibonacci(1)`. This set of components performs its short computation directly in the event dispatch thread. This program is capable of producing up to the 92nd Fibonacci number—subsequent values are outside the range that can be represented by a `long`. Recall that you can use class `BigInteger` to represent arbitrarily large integer values.

Class `BackgroundCalculator` (Fig. 26.24) performs the recursive Fibonacci calculation in a *worker thread*. This class extends `SwingWorker` (line 8), overriding the methods `doInBackground` and `done`. Method `doInBackground` (lines 21–24) computes the  $n$ th Fibonacci number in a worker thread and returns the result. Method `done` (lines 27–43) displays the result in a `JLabel`.

---

```

1 // Fig. 26.24: BackgroundCalculator.java
2 // SwingWorker subclass for calculating Fibonacci numbers
3 // in a background thread.
4 import javax.swing.SwingWorker;
5 import javax.swing.JLabel;
6 import java.util.concurrent.ExecutionException;
7
8 public class BackgroundCalculator extends SwingWorker< Long, Object >
9 {
10 private final int n; // Fibonacci number to calculate
11 private final JLabel resultJLabel; // JLabel to display the result
12
13 // constructor
14 public BackgroundCalculator(int number, JLabel label)
15 {
16 n = number;
17 resultJLabel = label;
18 } // end BackgroundCalculator constructor

```

---

**Fig. 26.24** | `SwingWorker` subclass for calculating Fibonacci numbers in a background thread. (Part 1 of 2.)

```

19
20 // long-running code to be run in a worker thread
21 public Long doInBackground()
22 {
23 return nthFib = fibonacci(n);
24 } // end method doInBackground
25
26 // code to run on the event dispatch thread when doInBackground returns
27 protected void done()
28 {
29 try
30 {
31 // get the result of doInBackground and display it
32 resultJLabel.setText(get().toString());
33 } // end try
34 catch (InterruptedException ex)
35 {
36 resultJLabel.setText("Interrupted while waiting for results.");
37 } // end catch
38 catch (ExecutionException ex)
39 {
40 resultJLabel.setText(
41 "Error encountered while performing calculation.");
42 } // end catch
43 } // end method done
44
45 // recursive method fibonacci; calculates nth Fibonacci number
46 public long fibonacci(long number)
47 {
48 if (number == 0 || number == 1)
49 return number;
50 else
51 return fibonacci(number - 1) + fibonacci(number - 2);
52 } // end method fibonacci
53 } // end class BackgroundCalculator

```

**Fig. 26.24** | SwingWorker subclass for calculating Fibonacci numbers in a background thread. (Part 2 of 2.)

SwingWorker is a *generic class*. In line 8, the first type parameter is Long and the second is Object. The first type parameter indicates the type returned by the doInBackground method; the second indicates the type that's passed between the publish and process methods to handle intermediate results. Since we do not use publish and process in this example, we simply use Object as the second type parameter. We discuss publish and process in Section 26.11.2.

A BackgroundCalculator object can be instantiated from a class that controls a GUI. A BackgroundCalculator maintains instance variables for an integer that represents the Fibonacci number to be calculated and a JLabel that displays the results of the calculation (lines 10–11). The BackgroundCalculator constructor (lines 14–18) initializes these instance variables with the arguments that are passed to the constructor.



### Software Engineering Observation 26.4

*Any GUI components that will be manipulated by `SwingWorker` methods, such as components that will be updated from methods `process` or `done`, should be passed to the `SwingWorker` subclass's constructor and stored in the subclass object. This gives these methods access to the GUI components they'll manipulate.*

When method `execute` is called on a `BackgroundCalculator` object, the object is scheduled for execution in a worker thread. Method `doInBackground` is called from the worker thread and invokes the `fibonacci` method (lines 46–52), passing instance variable `n` as an argument (line 23). Method `fibonacci` uses recursion to compute the Fibonacci of `n`. When `fibonacci` returns, method `doInBackground` returns the result.

After `doInBackground` returns, method `done` is called from the event dispatch thread. This method attempts to set the result `JLabel` to the return value of `doInBackground` by calling method `get` to retrieve this return value (line 32). Method `get` waits for the result to be ready if necessary, but since we call it from method `done`, the computation will be complete before `get` is called. Lines 34–37 catch `InterruptedException` if the current thread is interrupted while waiting for `get` to return. This exception will not occur in this example since the calculation will have already completed by the time `get` is called. Lines 38–42 catch `ExecutionException`, which is thrown if an exception occurs during the computation.

### Class `FibonacciNumbers`

Class `FibonacciNumbers` (Fig. 26.25) displays a window containing two sets of GUI components—one set to compute a Fibonacci number in a worker thread and another to get the next Fibonacci number in response to the user's clicking a `JButton`. The constructor (lines 38–109) places these components in separate titled `JPanels`. Lines 46–47 and 78–79 add two `JLabels`, a `JTextField` and a `JButton` to the worker `JPanel` to allow the user to enter an integer whose Fibonacci number will be calculated by the `BackgroundWorker`. Lines 84–85 and 103 add two `JLabels` and a `JButton` to the event dispatch thread panel to allow the user to get the next Fibonacci number in the sequence. Instance variables `n1` and `n2` contain the previous two Fibonacci numbers in the sequence and are initialized to 0 and 1, respectively (lines 29–30). Instance variable `count` stores the most recently computed sequence number and is initialized to 1 (line 31). The two `JLabels` display `count` and `n2` initially, so that the user will see the text `Fibonacci of 1: 1` in the eventThread-`JPanel` when the GUI starts.

---

```

1 // Fig. 26.25: FibonacciNumbers.java
2 // Using SwingWorker to perform a long calculation with
3 // results displayed in a GUI.
4 import java.awt.GridLayout;
5 import java.awt.event.ActionEvent;
6 import java.awt.event.ActionListener;
7 import javax.swing.JButton;
8 import javax.swing.JFrame;
9 import javax.swing.JPanel;

```

---

**Fig. 26.25** | Using `SwingWorker` to perform a long calculation with results displayed in a GUI. (Part 1 of 4.)



```

10 import javax.swing.JLabel;
11 import javax.swing.JTextField;
12 import javax.swing.border.TitledBorder;
13 import javax.swing.border.LineBorder;
14 import java.awt.Color;
15 import java.util.concurrent.ExecutionException;
16
17 public class FibonacciNumbers extends JFrame
18 {
19 // components for calculating the Fibonacci of a user-entered number
20 private final JPanel workerJPanel =
21 new JPanel(new GridLayout(2, 2, 5, 5));
22 private final JTextField numberJTextField = new JTextField();
23 private final JButton goJButton = new JButton("Go");
24 private final JLabel fibonacciJLabel = new JLabel();
25
26 // components and variables for getting the next Fibonacci number
27 private final JPanel eventThreadJPanel =
28 new JPanel(new GridLayout(2, 2, 5, 5));
29 private long n1 = 0; // initialize with first Fibonacci number
30 private long n2 = 1; // initialize with second Fibonacci number
31 private int count = 1; // current Fibonacci number to display
32 private final JLabel nJLabel = new JLabel("Fibonacci of 1: ");
33 private final JLabel nFibonacciJLabel =
34 new JLabel(String.valueOf(n2));
35 private final JButton nextNumberJButton = new JButton("Next Number");
36
37 // constructor
38 public FibonacciNumbers()
39 {
40 super("Fibonacci Numbers");
41 setLayout(new GridLayout(2, 1, 10, 10));
42
43 // add GUI components to the SwingWorker panel
44 workerJPanel.setBorder(new TitledBorder(
45 new LineBorder(Color.BLACK), "With SwingWorker"));
46 workerJPanel.add(new JLabel("Get Fibonacci of:"));
47 workerJPanel.add(numberJTextField);
48 goJButton.addActionListener(
49 new ActionListener()
50 {
51 public void actionPerformed((ActionEvent event)
52 {
53 int n;
54
55 try
56 {
57 // retrieve user's input as an integer
58 n = Integer.parseInt(numberJTextField.getText());
59 } // end try
60 catch(NumberFormatException ex)
61 {

```

**Fig. 26.25** | Using SwingWorker to perform a long calculation with results displayed in a GUI.  
(Part 2 of 4.)

```

62 // display an error message if the user did not
63 // enter an integer
64 fibonacciJLabel.setText("Enter an integer.");
65 return;
66 } // end catch
67
68 // indicate that the calculation has begun
69 fibonacciJLabel.setText("Calculating...");
70
71 // create a task to perform calculation in background
72 BackgroundCalculator task =
73 new BackgroundCalculator(n, fibonacciJLabel);
74 task.execute(); // execute the task
75 } // end method actionPerformed
76 } // end anonymous inner class
77); // end call to addActionListener
78 workerJPanel.add(goJButton);
79 workerJPanel.add(fibonacciJLabel);
80
81 // add GUI components to the event-dispatching thread panel
82 eventThreadJPanel.setBorder(new TitledBorder(
83 new LineBorder(Color.BLACK), "Without SwingWorker"));
84 eventThreadJPanel.add(nJLabel);
85 eventThreadJPanel.add(nFibonacciJLabel);
86 nextNumberJButton.addActionListener(
87 new ActionListener()
88 {
89 public void actionPerformed(ActionEvent event)
90 {
91 // calculate the Fibonacci number after n2
92 long temp = n1 + n2;
93 n1 = n2;
94 n2 = temp;
95 ++count;
96
97 // display the next Fibonacci number
98 nJLabel.setText("Fibonacci of " + count + ": ");
99 nFibonacciJLabel.setText(String.valueOf(n2));
100 } // end method actionPerformed
101 } // end anonymous inner class
102); // end call to addActionListener
103 eventThreadJPanel.add(nextNumberJButton);
104
105 add(workerJPanel);
106 add(eventThreadJPanel);
107 setSize(275, 200);
108 setVisible(true);
109 } // end constructor
110
111 // main method begins program execution
112 public static void main(String[] args)
113 {

```

**Fig. 26.25** | Using `SwingWorker` to perform a long calculation with results displayed in a GUI.  
(Part 3 of 4.)

```

114 FibonacciNumbers application = new FibonacciNumbers();
115 application.setDefaultCloseOperation(EXIT_ON_CLOSE);
116 } // end main
117 } // end class FibonacciNumbers

```

a) Begin calculating Fibonacci of 40 in the background

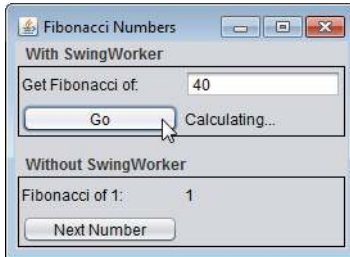

b) Calculating other Fibonacci values while Fibonacci of 40 continues calculating

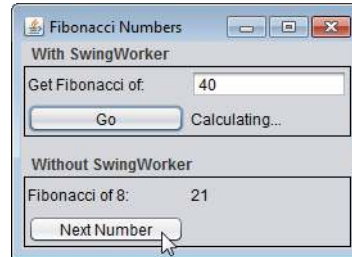

c) Fibonacci of 40 calculation finishes

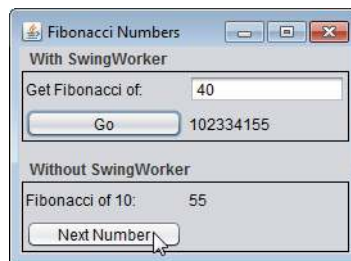

**Fig. 26.25** | Using SwingWorker to perform a long calculation with results displayed in a GUI. (Part 4 of 4.)

Lines 48–77 register the event handler for the `goJButton`. If the user clicks this `JButton`, line 58 gets the value entered in the `numberJTextField` and attempts to parse it as an integer. Lines 72–73 create a new `BackgroundCalculator` object, passing in the user-entered value and the `fibonacciJLabel` that’s used to display the calculation’s results. Line 74 calls method `execute` on the `BackgroundCalculator`, scheduling it for execution in a separate worker thread. Method `execute` does not wait for the `BackgroundCalculator` to finish executing. It returns immediately, allowing the GUI to continue processing other events while the computation is performed.

If the user clicks the `nextNumberJButton` in the `eventThreadJPanel`, the event handler registered in lines 86–102 executes. Lines 92–95 add the previous two Fibonacci numbers stored in `n1` and `n2` to determine the next number in the sequence, update `n1` and `n2` to their new values and increment `count`. Then lines 98–99 update the GUI to display the next number. The code for these calculations is in method `actionPerformed`, so they’re performed on the *event dispatch thread*. Handling such short computations in the event dispatch thread does not cause the GUI to become unresponsive, as with the recursive algorithm for calculating the Fibonacci of a large number. Because the longer Fibonacci computation is performed in a separate worker thread using the `SwingWorker`, it’s possible to get the next Fibonacci number while the recursive computation is still in progress.

### 26.11.2 Processing Intermediate Results with SwingWorker

We've presented an example that uses the `SwingWorker` class to execute a long process in a *background thread* and update the GUI when the process is finished. We now present an example of updating the GUI with intermediate results before the long process completes. Figure 26.26 presents class `PrimeCalculator`, which extends `SwingWorker` to compute the first  $n$  prime numbers in a *worker thread*. In addition to the `doInBackground` and `done` methods used in the previous example, this class uses `SwingWorker` methods `publish`, `process` and `setProgress`. In this example, method `publish` sends prime numbers to method `process` as they're found, method `process` displays these primes in a GUI component and method `setProgress` updates the progress property. We later show how to use this property to update a `JProgressBar`.

---

```

1 // Fig. 26.26: PrimeCalculator.java
2 // Calculates the first n primes, displaying them as they are found.
3 import javax.swing.JTextArea;
4 import javax.swing.JLabel;
5 import javax.swing.JButton;
6 import javax.swing.SwingWorker;
7 import java.util.Arrays;
8 import java.util.Random;
9 import java.util.List;
10 import java.util.concurrent.CancellationException;
11 import java.util.concurrent.ExecutionException;
12
13 public class PrimeCalculator extends SwingWorker< Integer, Integer >
14 {
15 private final Random generator = new Random();
16 private final JTextArea intermediateJTextArea; // displays found primes
17 private final JButton getPrimesJButton;
18 private final JButton cancelJButton;
19 private final JLabel statusJLabel; // displays status of calculation
20 private final boolean[] primes; // boolean array for finding primes
21
22 // constructor
23 public PrimeCalculator(int max, JTextArea intermediate, JLabel status,
24 JButton getPrimes, JButton cancel)
25 {
26 intermediateJTextArea = intermediate;
27 statusJLabel = status;
28 getPrimesJButton = getPrimes;
29 cancelJButton = cancel;
30 primes = new boolean[max];
31
32 // initialize all prime array values to true
33 Arrays.fill(primes, true);
34 } // end constructor
35
36 // finds all primes up to max using the Sieve of Eratosthenes
37 public Integer doInBackground()
38 {

```

---

**Fig. 26.26** | Calculates the first  $n$  primes, displaying them as they are found. (Part 1 of 3.)

```

39 int count = 0; // the number of primes found
40
41 // starting at the third value, cycle through the array and put
42 // false as the value of any greater number that is a multiple
43 for (int i = 2; i < primes.length; i++)
44 {
45 if (isCancelled()) // if calculation has been canceled
46 return count;
47 else
48 {
49 setProgress(100 * (i + 1) / primes.length);
50
51 try
52 {
53 Thread.sleep(generator.nextInt(5));
54 } // end try
55 catch (InterruptedException ex)
56 {
57 statusJLabel.setText("Worker thread interrupted");
58 return count;
59 } // end catch
60
61 if (primes[i]) // i is prime
62 {
63 publish(i); // make i available for display in prime list
64 ++count;
65
66 for (int j = i + i; j < primes.length; j += i)
67 primes[j] = false; // i is not prime
68 } // end if
69 } // end else
70 } // end for
71
72 return count;
73 } // end method doInBackground
74
75 // displays published values in primes list
76 protected void process(List< Integer > publishedVals)
77 {
78 for (int i = 0; i < publishedVals.size(); i++)
79 intermediateJTextArea.append(publishedVals.get(i) + "\n");
80 } // end method process
81
82 // code to execute when doInBackground completes
83 protected void done()
84 {
85 getPrimesJButton.setEnabled(true); // enable Get Primes button
86 cancelJButton.setEnabled(false); // disable Cancel button
87
88 int numPrimes;
89
90 try
91 {

```

**Fig. 26.26** | Calculates the first  $n$  primes, displaying them as they are found. (Part 2 of 3.)

```

92 numPrimes = get(); // retrieve doInBackground return value
93 } // end try
94 catch (InterruptedException ex)
95 {
96 statusJLabel.setText("Interrupted while waiting for results.");
97 return;
98 } // end catch
99 catch (ExecutionException ex)
100 {
101 statusJLabel.setText("Error performing computation.");
102 return;
103 } // end catch
104 catch (CancellationException ex)
105 {
106 statusJLabel.setText("Cancelled.");
107 return;
108 } // end catch
109
110 statusJLabel.setText("Found " + numPrimes + " primes.");
111 } // end method done
112 } // end class PrimeCalculator

```

**Fig. 26.26** | Calculates the first  $n$  primes, displaying them as they are found. (Part 3 of 3.)

Class `PrimeCalculator` extends `SwingWorker` (line 13), with the first type parameter indicating the return type of method `doInBackground` and the second indicating the type of intermediate results passed between methods `publish` and `process`. In this case, both type parameters are `Integer`s. The constructor (lines 23–34) takes as arguments an integer that indicates the upper limit of the prime numbers to locate, a `JTextArea` used to display primes in the GUI, one  `JButton`  for initiating a calculation and one for canceling it, and a  `JLabel`  used to display the status of the calculation.

### *Sieve of Eratosthenes*

Line 33 initializes the elements of the boolean array `primes` to true with `Arrays` method `fill`. `PrimeCalculator` uses this array and the **Sieve of Eratosthenes** algorithm (described in Exercise 7.27) to find all primes less than `max`. The Sieve of Eratosthenes takes a list of integers and, beginning with the first prime number, filters out all multiples of that prime. It then moves to the next prime, which will be the next number that's not yet filtered out, and eliminates all of its multiples. It continues until the end of the list is reached and all nonprimes have been filtered out. Algorithmically, we begin with element 2 of the boolean array and set the cells corresponding to all values that are multiples of 2 to `false` to indicate that they're divisible by 2 and thus not prime. We then move to the next array element, check whether it's true, and if so set all of its multiples to `false` to indicate that they're divisible by the current index. When the whole array has been traversed in this way, all indices that contain true are prime, as they have no divisors.

### *Method doInBackground*

In method `doInBackground` (lines 37–73), the control variable `i` for the loop (lines 43–70) controls the current index for implementing the Sieve of Eratosthenes. Line 45 calls the inherited `SwingWorker` method `isCancelled` to determine whether the user has

clicked the **Cancel** button. If `isCancelled` returns `true`, method `doInBackground` returns the number of primes found so far (line 46) without finishing the computation.

If the calculation isn't canceled, line 49 calls `setProgress` to update the percentage of the array that's been traversed so far. Line 53 puts the currently executing thread to sleep for up to 4 milliseconds. We discuss the reason for this shortly. Line 61 tests whether the element of array `primes` at the current index is `true` (and thus prime). If so, line 63 passes the index to method `publish` so that it can be displayed as an intermediate result in the GUI and line 64 increments the number of primes found. Lines 66–67 set all multiples of the current index to `false` to indicate that they're not prime. When the entire array has been traversed, line 72 returns the number of primes found.

### *Method process*

Lines 76–80 declare method `process`, which executes in the event dispatch thread and receives its argument `publishedVals` from method `publish`. The passing of values between `publish` in the worker thread and `process` in the event dispatch thread is asynchronous; `process` might not be invoked for every call to `publish`. All `Integers` published since the last call to `process` are received as a `List` by method `process`. Lines 78–79 iterate through this list and display the published values in a `JTextArea`. Because the computation in method `doInBackground` progresses quickly, publishing values often, updates to the `JTextArea` can pile up on the event dispatch thread, causing the GUI to become sluggish. In fact, when searching for a large number of primes, the *event dispatch thread* may receive so many requests in quick succession to update the `JTextArea` that it *runs out of memory in its event queue*. This is why we put the worker thread to sleep for a few milliseconds between calls to `publish`. The calculation is slowed just enough to allow the event dispatch thread to keep up with requests to update the `JTextArea` with new primes, enabling the GUI to update smoothly and remain responsive.

### *Method done*

Lines 83–111 define method `done`. When the calculation is finished or canceled, method `done` enables the **Get Primes** button and disables the **Cancel** button (lines 85–86). Line 92 gets the return value—the number of primes found—from method `doInBackground`. Lines 94–108 catch the exceptions thrown by method `get` and display an appropriate message in the `statusJLabel`. If no exceptions occur, line 110 sets the `statusJLabel` to indicate the number of primes found.

### *Class FindPrimes*

Class `FindPrimes` (Fig. 26.27) displays a `JTextField` that allows the user to enter a number, a `JButton` to begin finding all primes less than that number and a `JTextArea` to display the primes. A `JButton` allows the user to cancel the calculation, and a `JProgressBar` indicates the calculation's progress. The `FindPrimes` constructor (lines 32–125) sets up the application's GUI.

Lines 42–94 register the event handler for the `getPrimesJButton`. When the user clicks this `JButton`, lines 47–49 reset the `JProgressBar` and clear the `displayPrimesJTextArea` and the `statusJLabel`. Lines 53–63 parse the value in the `JTextField` and display an error message if the value is not an integer. Lines 66–68 construct a new `PrimeCalculator` object, passing as arguments the integer the user entered, the `displayPrimesJTextArea` for displaying the primes, the `statusJLabel` and the two `JButtons`.

```

1 // Fig 26.27: FindPrimes.java
2 // Using a SwingWorker to display prime numbers and update a JProgressBar
3 // while the prime numbers are being calculated.
4 import javax.swing.JFrame;
5 import javax.swing.JTextField;
6 import javax.swing.JTextArea;
7 import javax.swing.JButton;
8 import javax.swing.JProgressBar;
9 import javax.swing.JLabel;
10 import javax.swing.JPanel;
11 import javax.swing.JScrollPane;
12 import javax.swing.ScrollPaneConstants;
13 import java.awt.BorderLayout;
14 import java.awt.GridLayout;
15 import java.awt.event.ActionListener;
16 import java.awt.event.ActionEvent;
17 import java.util.concurrent.ExecutionException;
18 import java.beans.PropertyChangeListener;
19 import java.beans.PropertyChangeEvent;
20
21 public class FindPrimes extends JFrame
22 {
23 private final JTextField highestPrimeJTextField = new JTextField();
24 private final JButton getPrimesJButton = new JButton("Get Primes");
25 private final JTextArea displayPrimesJTextArea = new JTextArea();
26 private final JButton cancelJButton = new JButton("Cancel");
27 private final JProgressBar progressJProgressBar = new JProgressBar();
28 private final JLabel statusJLabel = new JLabel();
29 private PrimeCalculator calculator;
30
31 // constructor
32 public FindPrimes()
33 {
34 super("Finding Primes with SwingWorker");
35 setLayout(new BorderLayout());
36
37 // initialize panel to get a number from the user
38 JPanel northJPanel = new JPanel();
39 northJPanel.add(new JLabel("Find primes less than: "));
40 highestPrimeJTextField.setColumns(5);
41 northJPanel.add(highestPrimeJTextField);
42 getPrimesJButton.addActionListener(
43 new ActionListener()
44 {
45 public void actionPerformed(ActionEvent e)
46 {
47 progressJProgressBar.setValue(0); // reset JProgressBar
48 displayPrimesJTextArea.setText(""); // clear JTextArea
49 statusJLabel.setText(""); // clear JLabel
50
51 int number; // search for primes up through this value

```

**Fig. 26.27** | Using a `SwingWorker` to display prime numbers and update a `JProgressBar` while the prime numbers are being calculated. (Part 1 of 3.)



```

52
53 try
54 {
55 // get user input
56 number = Integer.parseInt(
57 highestPrimeJTextField.getText());
58 } // end try
59 catch (NumberFormatException ex)
60 {
61 statusJLabel.setText("Enter an integer.");
62 return;
63 } // end catch
64
65 // construct a new PrimeCalculator object
66 calculator = new PrimeCalculator(number,
67 displayPrimesJTextArea, statusJLabel, getPrimesJButton,
68 cancelJButton);
69
70 // listen for progress bar property changes
71 calculator.addPropertyChangeListener(
72 new PropertyChangeListener()
73 {
74 public void propertyChange(PropertyChangeEvent e)
75 {
76 // if the changed property is progress,
77 // update the progress bar
78 if (e.getPropertyName().equals("progress"))
79 {
80 int newValue = (Integer) e.getNewValue();
81 progressJProgressBar.setValue(newValue);
82 } // end if
83 } // end method propertyChange
84 } // end anonymous inner class
85); // end call to addPropertyChangeListener
86
87 // disable Get Primes button and enable Cancel button
88 getPrimesJButton.setEnabled(false);
89 cancelJButton.setEnabled(true);
90
91 calculator.execute(); // execute the PrimeCalculator object
92 } // end method actionPerformed
93 } // end anonymous inner class
94); // end call to addActionListener
95 northJPanel.add(getPrimesJButton);
96
97 // add a scrollable JList to display results of calculation
98 displayPrimesJTextArea.setEditable(false);
99 add(new JScrollPane(displayPrimesJTextArea,
100 ScrollPaneConstants.VERTICAL_SCROLLBAR_ALWAYS,
101 ScrollPaneConstants.HORIZONTAL_SCROLLBAR_NEVER));
102

```

**Fig. 26.27** | Using a `SwingWorker` to display prime numbers and update a `JProgressBar` while the prime numbers are being calculated. (Part 2 of 3.)

```

103 // initialize a panel to display cancelJButton,
104 // progressJProgressBar, and statusJLabel
105 JPanel southJPanel = new JPanel(new GridLayout(1, 3, 10, 10));
106 cancelJButton.setEnabled(false);
107 cancelJButton.addActionListener(
108 new ActionListener()
109 {
110 public void actionPerformed(ActionEvent e)
111 {
112 calculator.cancel(true); // cancel the calculation
113 } // end method actionPerformed
114 } // end anonymous inner class
115); // end call to addActionListener
116 southJPanel.add(cancelJButton);
117 progressJProgressBar.setStringPainted(true);
118 southJPanel.add(progressJProgressBar);
119 southJPanel.add(statusJLabel);
120
121 add(northJPanel, BorderLayout.NORTH);
122 add(southJPanel, BorderLayout.SOUTH);
123 setSize(350, 300);
124 setVisible(true);
125 } // end constructor
126
127 // main method begins program execution
128 public static void main(String[] args)
129 {
130 FindPrimes application = new FindPrimes();
131 application.setDefaultCloseOperation(EXIT_ON_CLOSE);
132 } // end main
133 } // end class FindPrimes

```

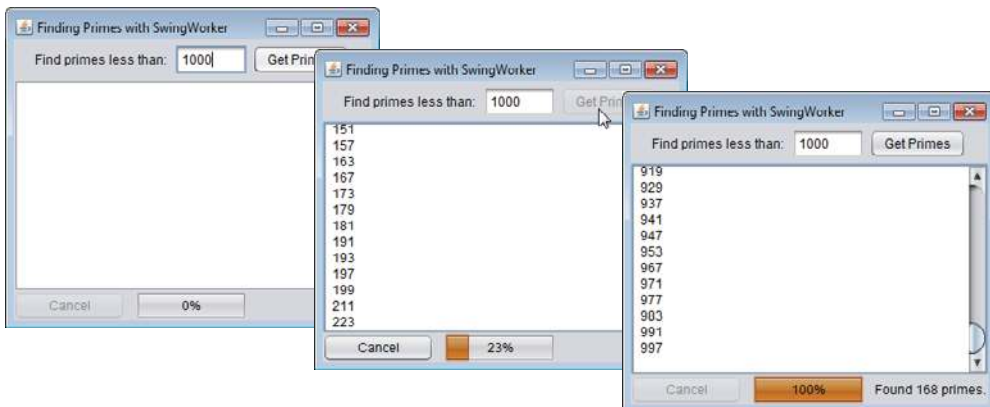

**Fig. 26.27** | Using a SwingWorker to display prime numbers and update a JProgressBar while the prime numbers are being calculated. (Part 3 of 3.)

Lines 71–85 register a `PropertyChangeListener` for the `PrimeCalculator` object. **PropertyChangeListener** is an interface from package `java.beans` that defines a single method, `propertyChange`. Every time method `setProgress` is invoked on a `PrimeCalcu-`

lator, the `PrimeCalculator` generates a `PropertyChangeEvent` to indicate that the progress property has changed. Method `propertyChange` listens for these events. Line 78 tests whether a given `PropertyChangeEvent` indicates a change to the progress property. If so, line 80 gets the new value of the property and line 81 updates the `JProgressBar` with the new progress property value.

The `Get Primes` `JButton` is disabled (line 88) so only one calculation that updates the GUI can execute at a time, and the `Cancel` `JButton` is enabled (line 89) to allow the user to stop the computation before it completes. Line 91 executes the `PrimesCalculator` to begin finding primes. If the user clicks the `cancel` `JButton`, the event handler registered at lines 107–115 calls `PrimeCalculator`'s method `cancel` (line 112), which is inherited from class `SwingWorker`, and the calculation returns early. The argument `true` to method `cancel` indicates that the thread performing the task should be interrupted in an attempt to cancel the task.

## 26.12 Interfaces Callable and Future

Interface `Runnable` provides only the most basic functionality for multithreaded programming. In fact, this interface has several limitations. Suppose a `Runnable` encounters a problem and tries to throw a *checked* exception. The `run` method is not declared to throw any exceptions, so the problem must be handled within the `Runnable`—the exception *cannot* be passed to the calling thread. Now suppose a `Runnable` is performing a long calculation and the application wants to retrieve the result of that calculation. The `run` method cannot return a value, so the application must use shared data to pass the value back to the calling thread. This also involves the overhead of synchronizing access to the data. The developers of the concurrency APIs recognized these limitations and created a new interface to fix them. The `Callable` interface (of package `java.util.concurrent`) declares a single method named `call`. This interface is designed to be similar to the `Runnable` interface—allowing an action to be performed concurrently in a separate thread—but the `call` method allows the thread to return a value or to throw a *checked* exception.

An application that creates a `Callable` likely wants to run it concurrently with other `Runnable`s and `Callable`s. The `ExecutorService` interface provides method `submit`, which will execute a `Callable` passed in as its argument. The `submit` method returns an object of type `Future` (of package `java.util.concurrent`), which is an interface that represents the executing `Callable`. The `Future` interface declares method `get` to return the result of the `Callable` and provides other methods to manage a `Callable`'s execution.

## 26.13 Java SE 7: Fork/Join Framework

Java SE 7's concurrency APIs include the new fork/join framework, which helps programmers parallelize algorithms. The framework is beyond the scope of this book. Experts tell us that most Java programmers will benefit by this framework being used “behind the scenes” in the Java API and other third party libraries.

The fork/join framework is particularly well suited to divide-and-conquer-style algorithms, such as the merge sort that we implemented in Section 19.3.3. Recall that the recursive algorithm sorts an array by *splitting* it into two equal-sized subarrays, *sorting* each subarray, then *merging* them into one larger array. Each subarray is sorted by performing the same algorithm on the subarray. For algorithms like merge sort, the fork/join frame-

work can be used to create parallel tasks so that they can be distributed across multiple processors and be truly performed in parallel—the details of assigning the parallel tasks to different processors are handled for you by the framework.

To learn more about the fork/join framework and Java multithreading in general, please visit the sites listed in our Java Multithreading Resource Center at

[www.deitel.com/JavaMultithreading](http://www.deitel.com/JavaMultithreading)

## 26.14 Wrap-Up

In this chapter, you learned that concurrency has historically been implemented with operating-system primitives available only to experienced systems programmers, but that Java makes concurrency available to you through the language and APIs. You also learned that the JVM itself creates threads to run a program, and that it also can create threads to perform housekeeping tasks such as garbage collection.

We discussed the life cycle of a thread and the states that a thread may occupy during its lifetime. Next, we presented the interface `Runnable`, which is used to specify a task that can execute concurrently with other tasks. This interface's `run` method is invoked by the thread executing the task. We showed how to execute a `Runnable` object by associating it with an object of class `Thread`. Then we showed how to use the `Executor` interface to manage the execution of `Runnable` objects via thread pools, which can reuse existing threads to eliminate the overhead of creating a new thread for each task and can improve performance by optimizing the number of threads to ensure that the processor stays busy.

You learned that when multiple threads share an object and one or more of them modify that object, indeterminate results may occur unless access to the shared object is managed properly. We showed you how to solve this problem via thread synchronization, which coordinates access to shared data by multiple concurrent threads. You learned several techniques for performing synchronization—first with the built-in class `ArrayBlockingQueue` (which handles *all* the synchronization details for you), then with Java's built-in monitors and the `synchronized` keyword, and finally with interfaces `Lock` and `Condition`.

We discussed the fact that Swing GUIs are not thread safe, so all interactions with and modifications to the GUI must be performed in the event dispatch thread. We also discussed the problems associated with performing long-running calculations in the event dispatch thread. Then we showed how you can use the `SwingWorker` class to perform long-running calculations in worker threads. You learned how to display the results of a `SwingWorker` in a GUI when the calculation completed and how to display intermediate results while the calculation was still in process.

Finally, we discussed the `Callable` and `Future` interfaces, which enable you to execute tasks that return results and to obtain those results, respectively. We use the multithreading techniques introduced in this chapter again in Chapter 27, Networking, to help build multithreaded servers that can interact with multiple clients concurrently.

## Summary

### Section 26.1 Introduction

- Historically, concurrency (p. 1046) has been implemented with operating-system primitives available only to experienced systems programmers.

- The Ada programming language made concurrency primitives widely available.
- Java makes concurrency available to you through the language and APIs.
- The JVM creates threads to run a program and for housekeeping tasks such as garbage collection.

### Section 26.2 Thread States: Life Cycle of a Thread

- A new thread begins its life cycle in the *new* state (p. 1048). When the program starts the thread, it's placed in the *runnable* state. A thread in the *runnable* state is considered to be executing its task.
- A *runnable* thread transitions to the *waiting* state (p. 1048) to wait for another thread to perform a task. A *waiting* thread transitions to *runnable* when another thread notifies it to continue executing.
- A *runnable* thread can enter the *timed waiting* state (p. 1048) for a specified interval of time, transitioning back to *runnable* when that time interval expires or when the event it's waiting for occurs.
- A *runnable* thread can transition to the *timed waiting* state if it provides an optional wait interval when it's waiting for another thread to perform a task. Such a thread will return to the *runnable* state when it's notified by another thread or when the timed interval expires.
- A sleeping thread (p. 1049) remains in the *timed waiting* state for a designated period of time, after which it returns to the *runnable* state.
- A *runnable* thread transitions to the *blocked* state (p. 1049) when it attempts to perform a task that cannot be completed immediately and the thread must temporarily wait until that task completes. At that point, the *blocked* thread transitions to the *runnable* state, so it can resume execution.
- A *runnable* thread enters the *terminated* state (p. 1049) when it successfully completes its task or otherwise terminates (perhaps due to an error).
- At the operating-system level, the *runnable* state (p. 1048) encompasses two separate states. When a thread first transitions to the *runnable* state from the *new* state, it's in the *ready* state (p. 1049). A *ready* thread enters the *running* state (p. 1049) when the operating system dispatches it.
- Most operating systems allot a quantum (p. 1049) or timeslice in which a thread performs its task. When this expires, the thread returns to the *ready* state and another thread is assigned to the processor.
- Thread scheduling determines which thread to dispatch based on thread priorities.
- The job of an operating system's thread scheduler (p. 1050) is to determine which thread runs next.
- When a higher-priority thread enters the *ready* state, the operating system generally preempts the currently *running* thread (an operation known as preemptive scheduling; p. 1050).
- Depending on the operating system, higher-priority threads could postpone—possibly indefinitely (p. 1050)—the execution of lower-priority threads.

### Section 26.3 Creating and Executing Threads with Executor Framework

- A `Runnable` (p. 1051) object represents a task that can execute concurrently with other tasks.
- Interface `Runnable` declares method `run` (p. 1051) in which you place the code that defines the task to perform. The thread executing a `Runnable` calls method `run` to perform the task.
- A program will not terminate until its last thread completes execution.
- You cannot predict the order in which threads will be scheduled, even if you know the order in which they were created and started.
- It's recommended that you use the `Executor` interface (p. 1051) to manage the execution of `Runnable` objects. An `Executor` object typically creates and manages a group of threads—called a thread pool (p. 1051).
- Executors (p. 1051) can reuse existing threads and can improve performance by optimizing the number of threads to ensure that the processor stays busy.

- Executor method `execute` (p. 1051) receives a `Runnable` and assigns it to an available thread in a thread pool. If there are none, the Executor creates a new thread or waits for one to become available.
- Interface `ExecutorService` (of package `java.util.concurrent`; p. 1051) extends interface `Executor` and declares other methods for managing the life cycle of an Executor.
- An object that implements the `ExecutorService` interface can be created using static methods declared in class `Executors` (of package `java.util.concurrent`).
- `Executors` method `newCachedThreadPool` (p. 1052) returns an `ExecutorService` that creates new threads as they're needed by the application.
- `ExecutorService` method `execute` executes its `Runnable` sometime in the future. The method returns immediately from each invocation—the program does not wait for each task to finish.
- `ExecutorService` method `shutdown` (p. 1054) notifies the `ExecutorService` to stop accepting new tasks, but continues executing existing tasks and terminates when those tasks complete execution.

### Section 26.4 Thread Synchronization

- Thread synchronization (p. 1054) coordinates access to shared data by multiple concurrent threads.
- By synchronizing threads, you can ensure that each thread accessing a shared object excludes all other threads from doing so simultaneously—this is called mutual exclusion (p. 1054).
- A common way to perform synchronization is to use Java's built-in monitors. Every object has a monitor and a monitor lock (p. 1055). The monitor ensures that its object's monitor lock is held by a maximum of only one thread at any time, and thus can be used to enforce mutual exclusion.
- If an operation requires the executing thread to hold a lock while the operation is performed, a thread must acquire the lock (p. 1055) before it can proceed with the operation. Any other threads attempting to perform an operation that requires the same lock will be *blocked* until the first thread releases the lock, at which point the *blocked* threads may attempt to acquire the lock.
- To specify that a thread must hold a monitor lock to execute a block of code, the code should be placed in a synchronized statement (p. 1055). Such code is said to be guarded by the monitor lock (p. 1055).
- The synchronized statements are declared using the synchronized keyword:

```
synchronized (object)
{
 statements
} // end synchronized statement
```

where *object* is the object whose monitor lock will be acquired; *object* is normally `this` if it's the object in which the synchronized statement appears.

- Java also allows synchronized methods (p. 1055). Before executing, a non-static synchronized method must acquire the lock on the object that's used to call the method. Similarly, a static synchronized method must acquire the lock on the class that's used to call the method.
- `ExecutorService` method `awaitTermination` (p. 1058) forces a program to wait for threads to terminate. It returns control to its caller either when all tasks executing in the `ExecutorService` complete or when the specified timeout elapses. If all tasks complete before the timeout elapses, the method returns `true`; otherwise, it returns `false`.
- You can simulate atomicity (p. 1060) by ensuring that only one thread performs a set of operations at a time. Atomicity can be achieved with synchronized statements or synchronized methods.
- When you share immutable data across threads, you should declare the corresponding data fields `final` to indicate that variables' values will not change after they're initialized.

### *Section 26.5 Producer/Consumer Relationship without Synchronization*

- In a multithreaded producer/consumer relationship (p. 1062), a producer thread generates data and places it in a shared object called a buffer. A consumer thread reads data from the buffer.
- Operations on a buffer data shared by a producer and a consumer should proceed only if the buffer is in the correct state. If the buffer is not full, the producer may produce; if the buffer is not empty, the consumer may consume. If the buffer is full when the producer attempts to write into it, the producer must wait until there's space. If the buffer is empty or the previous value was already read, the consumer must wait for new data to become available.

### *Section 26.6 Producer/Consumer Relationship: ArrayBlockingQueue*

- `ArrayBlockingQueue` (p. 1070) is a fully implemented buffer class from package `java.util.concurrent` that implements the `BlockingQueue` interface.
- An `ArrayBlockingQueue` can implement a shared buffer in a producer/consumer relationship. Method `put` (p. 1070) places an element at the end of the `BlockingQueue`, waiting if the queue is full. Method `take` (p. 1070) removes an element from the head of the `BlockingQueue`, waiting if the queue is empty.
- `ArrayBlockingQueue` stores shared data in an array that's sized with an argument passed to the constructor. Once created, an `ArrayBlockingQueue` is fixed in size.

### *Section 26.7 Producer/Consumer Relationship with Synchronization*

- You can implement a shared buffer yourself using the `synchronized` keyword and `Object` methods `wait` (p. 1073), `notify` and `notifyAll`.
- A thread can call `Object` method `wait` to release an object's monitor lock, and wait in the *waiting* state while the other threads try to enter the object's synchronized statement(s) or method(s).
- When a thread executing a synchronized statement (or method) completes or satisfies the condition on which another thread may be waiting, it can call `Object` method `notify` (p. 1073) to allow a waiting thread to transition to the *runnable* state. At this point, the thread that was transitioned can attempt to reacquire the monitor lock on the object.
- If a thread calls `notifyAll` (p. 1073), then all the threads waiting for the monitor lock become eligible to reacquire the lock (that is, they all transition to the *runnable* state).

### *Section 26.8 Producer/Consumer Relationship: Bounded Buffers*

- You cannot make assumptions about the relative speeds of concurrent threads.
- A bounded buffer (p. 1080) can be used to minimize the amount of waiting time for threads that share resources and operate at the same average speeds. If the producer temporarily produces values faster than the consumer can consume them, the producer can write additional values into the extra buffer space (if any are available). If the consumer consumes faster than the producer produces new values, the consumer can read additional values (if there are any) from the buffer.
- The key to using a bounded buffer with a producer and consumer that operate at about the same speed is to provide the buffer with enough locations to handle the anticipated "extra" production.
- The simplest way to implement a bounded buffer is to use an `ArrayBlockingQueue` for the buffer so that all of the synchronization details are handled for you.

### *Section 26.9 Producer/Consumer Relationship: The Lock and Condition Interfaces*

- The `Lock` and `Condition` interfaces (p. 1087) give programmers more precise control over thread synchronization, but are more complicated to use.
- Any object can contain a reference to an object that implements the `Lock` interface (of package `java.util.concurrent.locks`). A thread calls the `Lock`'s `lock` method (p. 1086) to acquire the

lock. Once a Lock has been obtained by one thread, the Lock object will not allow another thread to obtain the Lock until the first thread releases the Lock (by calling the Lock's `unlock` method; p. 1086).

- If several threads are trying to call method `lock` on the same Lock object at the same time, only one thread can obtain the lock—the others are placed in the *waiting* state. When a thread calls `unlock`, the object's lock is released and a waiting thread attempting to lock the object proceeds.
- Class `ReentrantLock` (p. 1087) is a basic implementation of the Lock interface.
- The `ReentrantLock` constructor takes a `boolean` that specifies whether the lock has a fairness policy (p. 1087). If `true`, the `ReentrantLock`'s fairness policy is “the longest-waiting thread will acquire the lock when it's available”—this prevents indefinite postponement. If the argument is set to `false`, there's no guarantee as to which waiting thread will acquire the lock when it's available.
- If a thread that owns a Lock determines that it cannot continue with its task until some condition is satisfied, the thread can wait on a condition object (p. 1087). Using Lock objects allows you to explicitly declare the condition objects on which a thread may need to wait.
- `Condition` (p. 1087) objects are associated with a specific Lock and are created by calling Lock method `newCondition`, which returns a `Condition` object. To wait on a `Condition`, the thread can call the `Condition`'s `await` method. This immediately releases the associated Lock and places the thread in the *waiting* state for that `Condition`. Other threads can then try to obtain the Lock.
- When a *runnable* thread completes a task and determines that a *waiting* thread can now continue, the *runnable* thread can call `Condition` method `signal` to allow a thread in that `Condition`'s *waiting* state to return to the *runnable* state. At this point, the thread that transitioned from the *waiting* state to the *runnable* state can attempt to reacquire the Lock.
- If multiple threads are in a `Condition`'s *waiting* state when `signal` is called, the default implementation of `Condition` signals the longest-waiting thread to transition to the *runnable* state.
- If a thread calls `Condition` method `signalAll`, then all the threads waiting for that condition transition to the *runnable* state and become eligible to reacquire the Lock.
- When a thread is finished with a shared object, it must call method `unlock` to release the Lock.
- Locks allow you to interrupt waiting threads or to specify a timeout for waiting to acquire a lock—not possible with `synchronized`. Also, a Lock object is not constrained to be acquired and released in the same block of code, which is the case with the `synchronized` keyword.
- `Condition` objects allow you to specify multiple conditions on which threads may wait. Thus, it's possible to indicate to waiting threads that a specific condition object is now true by calling that `Condition` object's `signal` or `signalAll` methods (p. 1087). With `synchronized`, there's no way to explicitly state the condition on which threads are waiting.

### Section 26.11 Multithreading with GUI

- The event dispatch thread (p. 1095) handles interactions with the application's GUI components. All tasks that interact with the GUI are placed in an event queue and executed sequentially by this thread.
- Swing GUI components are not thread safe. Thread safety is achieved by ensuring that Swing components are accessed from only the event dispatch thread.
- Performing a lengthy computation in response to a user interface interaction ties up the event dispatch thread, preventing it from attending to other tasks and causing the GUI components to become unresponsive. Long-running computations should be handled in separate threads.
- You can extend generic class `SwingWorker` (p. 1095; package `javax.swing`), which implements `Runnable`, to perform long-running computations in a worker thread and to update Swing components from the event dispatch thread based on the computations' results. You override its



`doInBackground` and `done` methods. Method `doInBackground` performs the computation and returns the result. Method `done` displays the results in the GUI.

- Class `SwingWorker`'s first type parameter indicates the type returned by the `doInBackground` method; the second indicates the type that's passed between the `publish` and `process` methods to handle intermediate results.
- Method `doInBackground` is called from a worker thread. After `doInBackground` returns, method `done` is called from the event dispatch thread to display the results.
- An `ExecutionException` is thrown if an exception occurs during the computation.
- `SwingWorker` method `publish` repeatedly sends intermediate results to method `process`, which displays the results in a GUI component. Method `setProgress` updates the `progress` property.
- Method `process` executes in the event dispatch thread and receives data from method `publish`. The passing of values between `publish` in the worker thread and `process` in the event dispatch thread is asynchronous; `process` is not necessarily invoked for every call to `publish`.
- `PropertyChangeListener` (p. 1108) is an interface from package `java.beans` that defines a single method, `propertyChange`. Every time method `setProgress` is invoked, a `PropertyChangeEvent` is generated to indicate that the `progress` property has changed.

### Section 26.12 Interfaces `Callable` and `Future`

- The `Callable` (p. 1109) interface (of package `java.util.concurrent`) declares a single method named `call` that allows the thread to return a value or to throw a checked exception.
- `ExecutorService` method `submit` (p. 1109) executes a `Callable` passed in as its argument.
- Method `submit` returns an object of type `Future` (of package `java.util.concurrent`) that represents the executing `Callable`. Interface `Future` (p. 1109) declares method `get` to return the result of the `Callable` and provides other methods to manage a `Callable`'s execution.

### Section 26.13 Java SE 7: Fork/Join Framework

- Java SE 7's concurrency APIs include the new fork/join framework, which helps programmers parallelize algorithms. The fork/join framework particularly well suited to divide-and-conquer-style algorithms, like the merge sort.

## Self-Review Exercises

- 26.1** Fill in the blanks in each of the following statements:
- A thread enters the *terminated* state when \_\_\_\_\_.
  - To pause for a designated number of milliseconds and resume execution, a thread should call method \_\_\_\_\_ of class \_\_\_\_\_.
  - Method \_\_\_\_\_ of class `Condition` moves a single thread in an object's *waiting* state to the *runnable* state.
  - Method \_\_\_\_\_ of class `Condition` moves every thread in an object's *waiting* state to the *runnable* state.
  - A(n) \_\_\_\_\_ thread enters the \_\_\_\_\_ state when it completes its task or otherwise terminates.
  - A *runnable* thread can enter the \_\_\_\_\_ state for a specified interval of time.
  - At the operating-system level, the *runnable* state actually encompasses two separate states, \_\_\_\_\_ and \_\_\_\_\_.
  - `Runnable`s are executed using a class that implements the \_\_\_\_\_ interface.
  - `ExecutorService` method \_\_\_\_\_ ends each thread in an `ExecutorService` as soon as it finishes executing its current `Runnable`, if any.

- j) A thread can call method \_\_\_\_\_ on a Condition object to release the associated Lock and place that thread in the \_\_\_\_\_ state.
- k) In a(n) \_\_\_\_\_ relationship, the \_\_\_\_\_ generates data and stores it in a shared object, and the \_\_\_\_\_ reads data from the shared object.
- l) Class \_\_\_\_\_ implements the BlockingQueue interface using an array.
- m) Keyword \_\_\_\_\_ indicates that only one thread at a time should execute on an object.

**26.2** State whether each of the following is *true* or *false*. If *false*, explain why.

- a) A thread is not *runnable* if it has terminated.
- b) Some operating systems use timeslicing with threads. Therefore, they can enable threads to preempt threads of the same priority.
- c) When the thread's quantum expires, the thread returns to the *running* state as the operating system assigns it to a processor.
- d) On a single-processor system without timeslicing, each thread in a set of equal-priority threads (with no other threads present) runs to completion before other threads of equal priority get a chance to execute.

## Answers to Self-Review Exercises

**26.1** a) its run method ends. b) sleep, Thread. c) signal. d) signalAll. e) *runnable, terminated*. f) *timed waiting*. g) *ready, running*. h) Executor. i) shutdown. j) await, *waiting*. k) producer/consumer, producer, consumer. l) ArrayBlockingQueue. m) synchronized.

**26.2** a) True. b) False. Timeslicing allows a thread to execute until its timeslice (or quantum) expires. Then other threads of equal priority can execute. c) False. When a thread's quantum expires, the thread returns to the *ready* state and the operating system assigns to the processor another thread. d) True.

## Exercises

**26.3** (*True or False*) State whether each of the following is *true* or *false*. If *false*, explain why.

- a) Method sleep does not consume processor time while a thread sleeps.
- b) Declaring a method synchronized guarantees that deadlock cannot occur.
- c) Once a ReentrantLock has been obtained by a thread, the ReentrantLock object will not allow another thread to obtain the lock until the first thread releases it.
- d) Swing components are thread safe.

**26.4** (*Multithreading Terms*) Define each of the following terms.

- a) thread
- b) multithreading
- c) *runnable* state
- d) *timed waiting* state
- e) preemptive scheduling
- f) Runnable interface
- g) notifyAll method
- h) producer/consumer relationship
- i) quantum

**26.5** (*Multithreading Terms*) Discuss each of the following terms in the context of Java's threading mechanisms:

- a) synchronized
- b) producer
- c) consumer

- d) wait
- e) notify
- f) Lock
- g) Condition

**26.6** (*Blocked State*) List the reasons for entering the *blocked* state. For each of these, describe how the program will normally leave the *blocked* state and enter the *runnable* state.

**26.7** (*Deadlock and Indefinite Postponement*) Two problems that can occur in systems that allow threads to wait are deadlock, in which one or more threads will wait forever for an event that cannot occur, and indefinite postponement, in which one or more threads will be delayed for some unpredictably long time. Give an example of how each of these problems can occur in multithreaded Java programs.

**26.8** (*Bouncing Ball*) Write a program that bounces a blue ball inside a `JPanel`. The ball should begin moving with a `mousePressed` event. When the ball hits the edge of the `JPanel`, it should bounce off the edge and continue in the opposite direction. The ball should be updated using a `Runnable`.

**26.9** (*Bouncing Balls*) Modify the program in Exercise 26.8 to add a new ball each time the user clicks the mouse. Provide for a minimum of 20 balls. Randomly choose the color for each new ball.

**26.10** (*Bouncing Balls with Shadows*) Modify the program in Exercise 26.9 to add shadows. As a ball moves, draw a solid black oval at the bottom of the `JPanel`. You may consider adding a 3-D effect by increasing or decreasing the size of each ball when it hits the edge of the `JPanel`.

**26.11** (*Circular Buffer with Locks and Conditions*) Reimplement the example in Section 26.8 using the `Lock` and `Condition` concepts presented in Section 26.9.

# 27

## Networking

*If the presence of electricity can be made visible in any part of a circuit, I see no reason why intelligence may not be transmitted instantaneously by electricity.*

—Samuel F. B. Morse

*Protocol is everything.*

—Francois Giuliani

*What networks of railroads, highways and canals were in another age, the networks of telecommunications, information and computerization ... are today.*

—Bruno Kreisky

*The port is near, the bells I hear, the people all exulting.*

—Walt Whitman

### Objectives

In this chapter you'll learn:

- Java networking with URLs, sockets and datagrams.
- To implement Java networking applications by using sockets and datagrams.
- To implement Java clients and servers that communicate with one another.
- To implement network-based collaborative applications.
- To construct a simple multithreaded server.

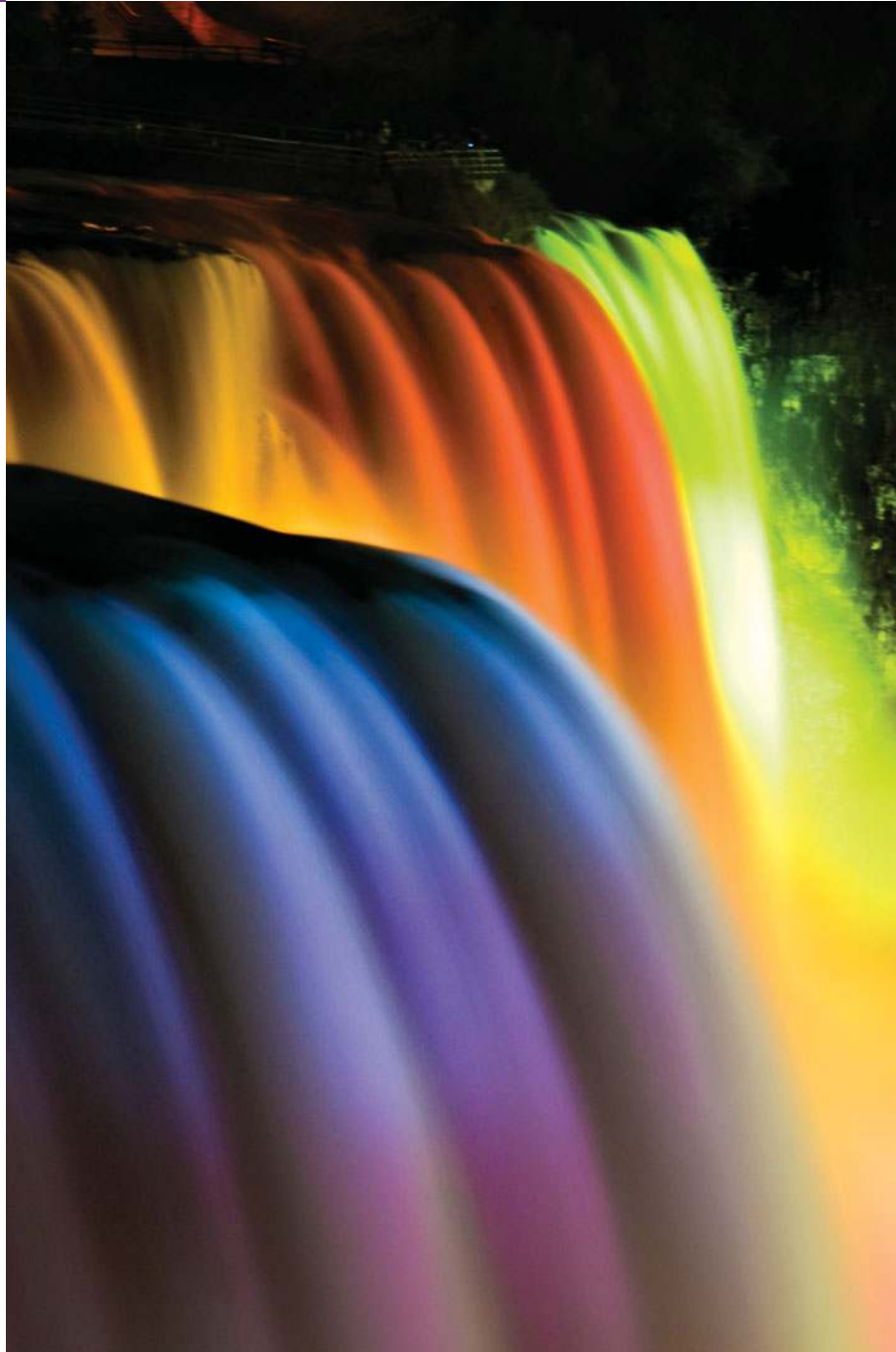

- |                                                                                                                                                                                                                                                                                                                                                         |                                                                                                                                                                                                                                                              |
|---------------------------------------------------------------------------------------------------------------------------------------------------------------------------------------------------------------------------------------------------------------------------------------------------------------------------------------------------------|--------------------------------------------------------------------------------------------------------------------------------------------------------------------------------------------------------------------------------------------------------------|
| <ul style="list-style-type: none"> <li>27.1 Introduction</li> <li>27.2 Manipulating URLs</li> <li>27.3 Reading a File on a Web Server</li> <li>27.4 Establishing a Simple Server Using Stream Sockets</li> <li>27.5 Establishing a Simple Client Using Stream Sockets</li> <li>27.6 Client/Server Interaction with Stream Socket Connections</li> </ul> | <ul style="list-style-type: none"> <li>27.7 Datagrams: Connectionless Client/Server Interaction</li> <li>27.8 Client/Server Tic-Tac-Toe Using a Multithreaded Server</li> <li>27.9 [Web Bonus] Case Study: DeiteIMessenger</li> <li>27.10 Wrap-Up</li> </ul> |
|---------------------------------------------------------------------------------------------------------------------------------------------------------------------------------------------------------------------------------------------------------------------------------------------------------------------------------------------------------|--------------------------------------------------------------------------------------------------------------------------------------------------------------------------------------------------------------------------------------------------------------|

*Summary | Self-Review Exercises | Answers to Self-Review Exercises | Exercises*

## 27.1 Introduction

Java provides a number of built-in networking capabilities that make it easy to develop Internet-based and web-based applications. Java can enable programs to search the world for information and to collaborate with programs running on other computers internationally, nationally or just within an organization (subject to security constraints).

Java's fundamental networking capabilities are declared by the classes and interfaces of package **java.net**, through which Java offers **stream-based communications** that enable applications to view networking as streams of data. The classes and interfaces of package **java.net** also offer **packet-based communications** for transmitting individual **packets** of information—commonly used to transmit data images, audio and video over the Internet. In this chapter, we show how to communicate with packets and streams of data.

We focus on both sides of the **client/server relationship**. The **client** *requests* that some action be performed, and the **server** performs the action and *responds* to the client. A common implementation of the *request-response model* is between web browsers and web servers. When a user selects a website to browse through a browser (the client application), a request is sent to the appropriate web server (the server application). The server normally responds to the client by sending an appropriate web page to be rendered by the browser.

We introduce Java's **socket-based communications**, which enable applications to view networking as if it were *file I/O*—a program can read from a **socket** or write to a socket as simply as reading from a file or writing to a file. The socket is simply a software construct that represents one endpoint of a connection. We show how to create and manipulate *stream sockets* and *datagram sockets*.

With **stream sockets**, a process establishes a **connection** to another process. While the connection is in place, data flows between the processes in continuous **streams**. Stream sockets are said to provide a **connection-oriented service**. The protocol used for transmission is the popular **TCP (Transmission Control Protocol)**.

With **datagram sockets**, individual **packets** of information are transmitted. The protocol used—**UDP, the User Datagram Protocol**—is a **connectionless service** and does *not* guarantee that packets arrive in any particular *order*. With UDP, packets can even be *lost* or *duplicated*. Significant extra programming is required on your part to deal with these problems (if you choose to do so). UDP is most appropriate for network applications that

do not require the error checking and reliability of TCP. Stream sockets and the TCP protocol will be more desirable for the vast majority of Java networking applications.



### Performance Tip 27.1

*Connectionless services generally offer greater performance but less reliability than connection-oriented services.*



### Portability Tip 27.1

*TCP, UDP and related protocols enable heterogeneous computer systems (i.e., those with different processors and different operating systems) to intercommunicate.*

On the web at [www.deitel.com/books/jhttp9/](http://www.deitel.com/books/jhttp9/), we present a case study that implements a client/server chat application similar to popular instant-messaging services. The application introduces **multicasting**, in which a server can publish information and *many* clients can *subscribe* to it. When the server publishes information, *all* subscribers receive it.

## 27.2 Manipulating URLs

The Internet offers many protocols. The **HyperText Transfer Protocol (HTTP)**, which forms the basis of the web, uses **URIs (Uniform Resource Identifiers)** to identify data on the Internet. URIs that specify the locations of websites and web pages are called **URLs (Uniform Resource Locators)**. Common URLs refer to files or directories and can reference objects that perform complex tasks, such as database lookups and Internet searches. If you know the URL of a publicly available web page, you can access it through HTTP.

Java makes it easy to manipulate URLs. When you use a URL that refers to the exact location of a resource (e.g., a web page) as an argument to the **showDocument** method of interface **AppletContext**, the browser in which the applet is executing will access and display that resource. The applet in Figs. 27.1–27.2 demonstrates simple networking capabilities. It enables the user to select a web page from a `JList` and causes the browser to display the corresponding page. In this example, the networking is performed by the browser.

### Processing Applet Parameters

This applet takes advantage of **applet parameters** specified in the HTML document that invokes the applet. When browsing the web, you'll often come across applets that are in the public domain—you can use them free of charge on your own web pages (normally in exchange for crediting the applet's creator). Many applets can be customized via parameters supplied from the HTML file that invokes the applet. For example, Fig. 27.1 contains the HTML that invokes the applet `SiteSelector` in Fig. 27.2.

```

1 <html>
2 <head>
3 <title>Site Selector</title>
4 </head>
5 <body>
6 <applet code = "SiteSelector.class" width = "300" height = "75">
7 <param name = "title0" value = "Java Home Page">
8 <param name = "location0">

```

**Fig. 27.1** | HTML document to load `SiteSelector` applet. (Part 1 of 2.)

```

9 value = "http://www.oracle.com/technetwork/java/">
10 <param name = "title1" value = "Deitel">
11 <param name = "location1" value = "http://www.deitel.com/">
12 <param name = "title2" value = "JGuru">
13 <param name = "location2" value = "http://www.jGuru.com/">
14 <param name = "title3" value = "JavaWorld">
15 <param name = "location3" value = "http://www.javaworld.com/">
16 </applet>
17 </body>
18 </html>

```

**Fig. 27.1** | HTML document to load SiteSelector applet. (Part 2 of 2.)

The HTML document contains eight parameters specified with the **param element**—these lines must appear between the starting and ending `applet` tags. The applet can read these values and use them to customize itself. Any number of `param` elements can appear between the starting and ending `applet` tags. Each parameter has a unique **name** and a **value**. Applet method `getParameter` returns the value associated with a specific parameter name as a `String`. The argument passed to `getParameter` is a `String` containing the name of the parameter in the `param` element. In this example, parameters represent the title and location of each website the user can select. Parameters specified for this applet are named `title#`, where the value of `#` starts at 0 and increments by 1 for each new title. Each title should have a corresponding location parameter of the form `location#`, where the value of `#` starts at 0 and increments by 1 for each new location. The statement

```
String title = getParameter("title0");
```

gets the value associated with parameter `"title0"` and assigns it to reference `title`. If there's no `param` tag containing the specified parameter, `getParameter` returns `null`.

### *Storing the Website Names and URLs*

The applet (Fig. 27.2) obtains from the HTML document (Fig. 27.1) the choices that will be displayed in the applet's `JList`. Class `SiteSelector` uses a `HashMap` (package `java.util`) to store the website names and URLs. In this example, the *key* is the `String` in the `JList` that represents the website name, and the *value* is a `URL` object that stores the location of the website to display in the browser.

```

1 // Fig. 27.2: SiteSelector.java
2 // Loading a document from a URL into a browser.
3 import java.net.MalformedURLException;
4 import java.net.URL;
5 import java.util.HashMap;
6 import java.util.ArrayList;
7 import java.awt.BorderLayout;
8 import java.applet.AppletContext;
9 import javax.swing.JApplet;
10 import javax.swing.JLabel;
11 import javax.swing.JList;
12 import javax.swing.JScrollPane;

```

**Fig. 27.2** | Loading a document from a URL into a browser. (Part 1 of 3.)

```

13 import javax.swing.event.ListSelectionEvent;
14 import javax.swing.event.ListSelectionListener;
15
16 public class SiteSelector extends JApplet
17 {
18 private HashMap< String, URL > sites; // site names and URLs
19 private ArrayList< String > siteNames; // site names
20 private JList siteChooser; // list of sites to choose from
21
22 // read parameters and set up GUI
23 public void init()
24 {
25 sites = new HashMap< String, URL >(); // create HashMap
26 siteNames = new ArrayList< String >(); // create ArrayList
27
28 // obtain parameters from HTML document
29 getSitesFromHTMLParameters();
30
31 // create GUI components and lay out interface
32 add(new JLabel("Choose a site to browse"), BorderLayout.NORTH);
33
34 siteChooser = new JList(siteNames.toArray()); // populate JList
35 siteChooser.addListSelectionListener(
36 new ListSelectionListener() // anonymous inner class
37 {
38 // go to site user selected
39 public void valueChanged(ListSelectionEvent event)
40 {
41 // get selected site name
42 Object object = siteChooser.getSelectedValue();
43
44 // use site name to locate corresponding URL
45 URL newDocument = sites.get(object);
46
47 // get applet container
48 AppletContext browser = getAppletContext();
49
50 // tell applet container to change pages
51 browser.showDocument(newDocument);
52 } // end method valueChanged
53 } // end anonymous inner class
54); // end call to addListSelectionListener
55
56 add(new JScrollPane(siteChooser), BorderLayout.CENTER);
57 } // end method init
58
59 // obtain parameters from HTML document
60 private void getSitesFromHTMLParameters()
61 {
62 String title; // site title
63 String location; // location of site
64 URL url; // URL of location
65 int counter = 0; // count number of sites

```

**Fig. 27.2** | Loading a document from a URL into a browser. (Part 2 of 3.)



```

66
67 title = getParameter("title" + counter); // get first site title
68
69 // loop until no more parameters in HTML document
70 while (title != null)
71 {
72 // obtain site location
73 location = getParameter("location" + counter);
74
75 try // place title/URL in HashMap and title in ArrayList
76 {
77 url = new URL(location); // convert location to URL
78 sites.put(title, url); // put title/URL in HashMap
79 siteNames.add(title); // put title in ArrayList
80 } // end try
81 catch (MalformedURLException urlException)
82 {
83 urlException.printStackTrace();
84 } // end catch
85
86 ++counter;
87 title = getParameter("title" + counter); // get next site title
88 } // end while
89 } // end method getSitesFromHTMLParameters
90 } // end class SiteSelector

```

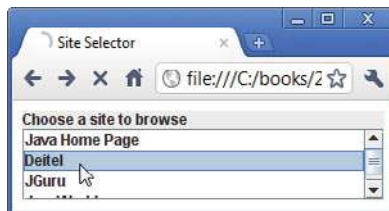

**Fig. 27.2** | Loading a document from a URL into a browser. (Part 3 of 3.)

Class `SiteSelector` also contains an `ArrayList` (package `java.util`) in which the site names are placed so that they can be used to initialize the `JList` (one version of the `JList` constructor receives an array of `Objects` which is returned by `ArrayList`'s `toArray` method). An `ArrayList` is a dynamically resizable array of references. Class `ArrayList` provides method `add` to add a new element to the end of the `ArrayList`. (`ArrayList` and `HashMap` were discussed in Chapter 20.)

Lines 25–26 in the applet’s `init` method (lines 23–57) create a `HashMap` object and an `ArrayList` object. Line 29 calls our utility method `getSitesFromHTMLParameters` (declared at lines 60–89) to obtain the HTML parameters from the HTML document that invoked the applet.

Method `getSitesFromHTMLParameters` uses `Applet` method `getParameter` (line 67) to obtain a website title. If the `title` is not `null`, lines 73–87 execute. Line 73 uses `Applet` method `getParameter` to obtain the website location. Line 77 uses the `location` as the value of a new `URL` object. The `URL` constructor determines whether its argument represents a valid `URL`. If not, the `URL` constructor throws a **`MalformedURLException`**. The `URL` constructor must be called in a `try` block. If the `URL` constructor generates a `MalformedURLException`, the call to `printStackTrace` (line 83) causes the program to output a stack trace to the Java console. On Windows machines, the Java console can be viewed by right clicking the Java icon in the notification area of the taskbar. On a Mac, go to **Applications > Utilities** and launch the **Java Preferences** app. Then on the **Advanced** tab under **Java console**, select **Show console**. On other platforms, this is typically accessible through a desktop icon. Then the program attempts to obtain the next website title. The program does not add the site for the invalid `URL` to the `HashMap`, so the title will not be displayed in the `JList`.

For a proper `URL`, line 78 places the `title` and `URL` into the `HashMap`, and line 79 adds the `title` to the `ArrayList`. Line 87 gets the next title from the HTML document. When the call to `getParameter` at line 87 returns `null`, the loop terminates.

### *Building the Applet’s GUI*

When method `getSitesFromHTMLParameters` returns to `init`, lines 32–56 construct the applet’s GUI. Line 32 adds the `JLabel` “Choose a site to browse” to the NORTH of the `JApplet`’s `BorderLayout`. Line 34 creates `JList` `siteChooser` to allow the user to select a web page to view. Lines 35–54 register a `ListSelectionListener` to handle the `JList`’s events. Line 56 adds `siteChooser` to the CENTER of the `JFrame`’s `BorderLayout`.

### *Processing a User Selection*

When the user selects a website in `siteChooser`, the program calls method `valueChanged` (lines 39–52). Line 42 obtains the selected site name from the `JList`. Line 45 passes the selected site name (the *key*) to `HashMap` method `get`, which locates and returns a reference to the corresponding `URL` object (the *value*) that’s assigned to reference `newDocument`.

Line 48 uses `Applet` method **`getAppletContext`** to get a reference to an `AppletContext` object that represents the applet container. Line 51 uses this reference to invoke method `showDocument`, which receives a `URL` object as an argument and passes it to the `AppletContext` (i.e., the browser). The browser displays in the current browser window the resource associated with that `URL`. In this example, all the resources are HTML documents.

### *Specifying the Target Frame for Method `showDocument`*

A second version of `AppletContext` method `showDocument` enables an applet to specify the **target frame** in which to display the web resource. This takes as arguments a `URL` object specifying the resource to display and a `String` representing the target frame. There are some special target frames that can be used as the second argument. The target frame **`_blank`** results in a new web browser window to display the content from the specified `URL`. The target frame **`_self`** specifies that the content from the specified `URL` should be displayed in the same frame as the applet (the applet’s HTML page is replaced in this case).

The target frame `_top` specifies that the browser should remove the current frames in the browser window, then display the content from the specified URL in the current window.



### Error-Prevention Tip 27.1

The applet in Fig. 27.2 must be run from a web browser to show the results of displaying another web page. The `appletviewer` is capable only of executing applets—it ignores all other HTML tags. If the websites in the program contained Java applets, only those applets would appear in the `appletviewer` when the user selected a website. Each applet would execute in a separate `appletviewer` window.

## 27.3 Reading a File on a Web Server

The application in Fig. 27.3 uses Swing GUI component `JEditorPane` (from package `javax.swing`) to display the contents of a file on a web server. The user enters a URL in the `JTextField` at the top of the window, and the application displays the corresponding document (if it exists) in the `JEditorPane`. Class `JEditorPane` is able to render both plain text and basic HTML-formatted text, as illustrated in the two screen captures (Fig. 27.4), so this application acts as a simple web browser. The application also demonstrates how to process `HyperlinkEvents` when the user clicks a hyperlink in the HTML document. The techniques shown in this example can also be used in applets. However, an applet is allowed to read files only on the server from which it was downloaded. [Note: This program might not work if your web browser must access the web through a proxy server. If you create a JNLP document for this program and use Java Web Start to launch it, Java Web Start will use the proxy server settings from your default web browser. See Chapters 23–24 for more information on Java Web Start.]

```

1 // Fig. 27.3: ReadServerFile.java
2 // Reading a file by opening a connection through a URL.
3 import java.awt.BorderLayout;
4 import java.awt.event.ActionEvent;
5 import java.awt.event.ActionListener;
6 import java.io.IOException;
7 import javax.swing.JEditorPane;
8 import javax.swing.JFrame;
9 import javax.swing.JOptionPane;
10 import javax.swing.JScrollPane;
11 import javax.swing.JTextField;
12 import javax.swing.event.HyperlinkEvent;
13 import javax.swing.event.HyperlinkListener;
14
15 public class ReadServerFile extends JFrame
16 {
17 private JTextField enterField; // JTextField to enter site name
18 private JEditorPane contentsArea; // to display website
19
20 // set up GUI
21 public ReadServerFile()
22 {

```

**Fig. 27.3** | Reading a file by opening a connection through a URL. (Part 1 of 2.)

```

23 super("Simple Web Browser");
24
25 // create enterField and register its listener
26 enterField = new JTextField("Enter file URL here");
27 enterField.addActionListener(
28 new ActionListener()
29 {
30 // get document specified by user
31 public void actionPerformed(ActionEvent event)
32 {
33 getPage(event.getActionCommand());
34 } // end method actionPerformed
35 } // end inner class
36); // end call to addActionListener
37
38 add(enterField, BorderLayout.NORTH);
39
40 contentsArea = new JEditorPane(); // create contentsArea
41 contentsArea.setEditable(false);
42 contentsArea.addHyperlinkListener(
43 new HyperlinkListener()
44 {
45 // if user clicked hyperlink, go to specified page
46 public void hyperlinkUpdate(HyperlinkEvent event)
47 {
48 if (event.getEventType() ==
49 HyperlinkEvent.EventType.ACTIVATED)
50 getPage(event.getURL().toString());
51 } // end method hyperlinkUpdate
52 } // end inner class
53); // end call to addHyperlinkListener
54
55 add(new JScrollPane(contentsArea), BorderLayout.CENTER);
56 setSize(400, 300); // set size of window
57 setVisible(true); // show window
58 } // end ReadServerFile constructor
59
60 // load document
61 private void getPage(String location)
62 {
63 try // load document and display location
64 {
65 contentsArea.setPage(location); // set the page
66 enterField.setText(location); // set the text
67 } // end try
68 catch (IOException ioException)
69 {
70 JOptionPane.showMessageDialog(this,
71 "Error retrieving specified URL", "Bad URL",
72 JOptionPane.ERROR_MESSAGE);
73 } // end catch
74 } // end method getPage
75 } // end class ReadServerFile

```

**Fig. 27.3** | Reading a file by opening a connection through a URL. (Part 2 of 2.)

```

1 // Fig. 27.4: ReadServerFileTest.java
2 // Create and start a ReadServerFile.
3 import javax.swing.JFrame;
4
5 public class ReadServerFileTest
6 {
7 public static void main(String[] args)
8 {
9 ReadServerFile application = new ReadServerFile();
10 application.setDefaultCloseOperation(JFrame.EXIT_ON_CLOSE);
11 } // end main
12 } // end class ReadServerFileTest

```



**Fig. 27.4** | Test class for ReadServerFile.

The application class `ReadServerFile` contains `JTextField` `enterField`, in which the user enters the URL of the file to read and `JEditorPane` `contentsArea` to display the file's contents. When the user presses the *Enter* key in `enterField`, the application calls method `actionPerformed` (lines 31–34). Line 33 uses `ActionEvent` method `getActionCommand` to get the `String` the user input in the `JTextField` and passes the `String` to utility method `getPage` (lines 61–74).

Line 65 invokes `JEditorPane` method `setPage` to download the document specified by `location` and display it in the `JEditorPane`. If there's an error downloading the document, method `setPage` throws an `IOException`. Also, if an invalid URL is specified, a `MalformedURLException` (a subclass of `IOException`) occurs. If the document loads successfully, line 66 displays the current location in `enterField`.

Typically, an HTML document contains **hyperlinks** that, when clicked, provide quick access to another document on the web. If a `JEditorPane` contains an HTML document and the user clicks a hyperlink, the `JEditorPane` generates a **HyperlinkEvent** (package `javax.swing.event`) and notifies all registered **HyperlinkListeners** (package `javax.swing.event`) of that event. Lines 42–53 register a `HyperlinkListener` to handle `HyperlinkEvents`. When a `HyperlinkEvent` occurs, the program calls method **hyperlinkUpdate** (lines 46–51). Lines 48–49 use `HyperlinkEvent` method `getEventType` to determine the type of the `HyperlinkEvent`. Class `HyperlinkEvent` contains a public nested class called **EventType** that declares three static `EventType` objects, which represent the hyperlink event types. **ACTIVATED** indicates that the user clicked a hyperlink to change web pages, **ENTERED** indicates that the user moved the mouse over a hyperlink and **EXITED** indicates that the user moved the mouse away from a hyperlink. If a hyperlink was **ACTIVATED**, line 50 uses `HyperlinkEvent` method `getURL` to obtain the URL represented by the hyperlink. Method `toString` converts the returned URL to a `String` that can be passed to utility method `getPage`.



### Look-and-Feel Observation 27.1

*A JEditorPane generates HyperLinkEvents only if it's uneditable.*

## 27.4 Establishing a Simple Server Using Stream Sockets

The two examples discussed so far use *high-level* Java networking capabilities to communicate between applications. In the examples, it was not your responsibility to establish the connection between a client and a server. The first program relied on the web browser to communicate with a web server. The second program relied on a JEditorPane to perform the connection. This section begins our discussion of creating your own applications that can communicate with one another.

### Step 1: Create a ServerSocket

Establishing a simple server in Java requires five steps. *Step 1* is to create a **ServerSocket** object. A call to the ServerSocket constructor, such as

```
ServerSocket server = new ServerSocket(portNumber, queueLength);
```

**registers** an available TCP **port number** and specifies the maximum number of clients that can wait to connect to the server (i.e., the **queue length**). The port number is used by clients to locate the server application on the server computer. This is often called the **handshake point**. If the queue is full, the server refuses client connections. The constructor establishes the port where the server waits for connections from clients—a process known as **binding the server to the port**. Each client will ask to connect to the server on this **port**. Only one application at a time can be bound to a specific port on the server.



### Software Engineering Observation 27.1

*Port numbers can be between 0 and 65,535. Most operating systems reserve port numbers below 1024 for system services (e.g., e-mail and World Wide Web servers). Generally, these ports should not be specified as connection ports in user programs. In fact, some operating systems require special access privileges to bind to port numbers below 1024.*

### Step 2: Wait for a Connection

Programs manage each client connection with a **Socket** object. In *Step 2*, the server listens indefinitely (or **blocks**) for an attempt by a client to connect. To listen for a client connection, the program calls ServerSocket method **accept**, as in

```
Socket connection = server.accept();
```

which returns a Socket when a connection with a client is established. The Socket allows the server to interact with the client. The interactions with the client actually occur at a different server port from the *handshake point*. This allows the port specified in *Step 1* to be used again in a multithreaded server to accept another client connection. We demonstrate this concept in Section 27.8.

### Step 3: Get the Socket's I/O Streams

*Step 3* is to get the OutputStream and InputStream objects that enable the server to communicate with the client by sending and receiving bytes. The server sends information to

the client via an `OutputStream` and receives information from the client via an `InputStream`. The server invokes method `getOutputStream` on the `Socket` to get a reference to the `Socket`'s `OutputStream` and invokes method `getInputStream` on the `Socket` to get a reference to the `Socket`'s `InputStream`.

The stream objects can be used to send or receive individual bytes or sequences of bytes with the `OutputStream`'s method `write` and the `InputStream`'s method `read`, respectively. Often it's useful to send or receive values of primitive types (e.g., `int` and `double`) or `Serializable` objects (e.g., `Strings` or other serializable types) rather than sending bytes. In this case, we can use the techniques discussed in Chapter 17 to wrap other stream types (e.g., `ObjectOutputStream` and `ObjectInputStream`) around the `OutputStream` and `InputStream` associated with the `Socket`. For example,

```
ObjectInputStream input =
 new ObjectInputStream(connection.getInputStream());
ObjectOutputStream output =
 new ObjectOutputStream(connection.getOutputStream());
```

The beauty of establishing these relationships is that whatever the server writes to the `ObjectOutputStream` is sent via the `OutputStream` and is available at the client's `InputStream`, and whatever the client writes to its `OutputStream` (with a corresponding `ObjectOutputStream`) is available via the server's `InputStream`. The transmission of the data over the network is seamless and is handled completely by Java.

#### *Step 4: Perform the Processing*

*Step 4* is the *processing* phase, in which the server and the client communicate via the `OutputStream` and `InputStream` objects.

#### *Step 5: Close the Connection*

In *Step 5*, when the transmission is complete, the server closes the connection by invoking the `close` method on the streams and on the `Socket`.



#### **Software Engineering Observation 27.2**

*With sockets, network I/O appears to Java programs to be similar to sequential file I/O. Sockets hide much of the complexity of network programming.*



#### **Software Engineering Observation 27.3**

*A multithreaded server can take the `Socket` returned by each call to `accept` and create a new thread that manages network I/O across that `Socket`. Alternatively, a multithreaded server can maintain a pool of threads (a set of already existing threads) ready to manage network I/O across the new `Sockets` as they're created. These techniques enable multithreaded servers to manage many simultaneous client connections.*



#### **Performance Tip 27.2**

*In high-performance systems in which memory is abundant, a multithreaded server can create a pool of threads that can be assigned quickly to handle network I/O for new `Sockets` as they're created. Thus, when the server receives a connection, it need not incur thread-creation overhead. When the connection is closed, the thread is returned to the pool for reuse.*

## 27.5 Establishing a Simple Client Using Stream Sockets

Establishing a simple client in Java requires four steps.

### *Step 1: Create a Socket to Connect to the sServer*

In *Step 1*, we create a `Socket` to connect to the server. The `Socket` constructor establishes the connection. For example, the statement

```
Socket connection = new Socket(serverAddress, port);
```

uses the `Socket` constructor with two arguments—the server's address (`serverAddress`) and the `port` number. If the connection attempt is successful, this statement returns a `Socket`. A connection attempt that fails throws an instance of a subclass of `IOException`, so many programs simply catch `IOException`. An **UnknownHostException** occurs specifically when the system is unable to resolve the server name specified in the call to the `Socket` constructor to a corresponding IP address.

### *Step 2: Get the Socket's I/O Streams*

In *Step 2*, the client uses `Socket` methods `getInputStream` and `getOutputStream` to obtain references to the `Socket`'s `InputStream` and `OutputStream`. As we mentioned in the preceding section, we can use the techniques of Chapter 17 to wrap other stream types around the `InputStream` and `OutputStream` associated with the `Socket`. If the server is sending information in the form of actual types, the client should receive the information in the same format. Thus, if the server sends values with an `ObjectOutputStream`, the client should read those values with an `ObjectInputStream`.

### *Step 3: Perform the Processing*

*Step 3* is the processing phase in which the client and the server communicate via the `InputStream` and `OutputStream` objects.

### *Step 4: Close the Connection*

In *Step 4*, the client closes the connection when the transmission is complete by invoking the `close` method on the streams and on the `Socket`. The client must determine when the server is finished sending information so that it can call `close` to close the `Socket` connection. For example, the `InputStream` method `read` returns the value `-1` when it detects end-of-stream (also called EOF—end-of-file). If an `ObjectInputStream` reads information from the server, an `EOFException` occurs when the client attempts to read a value from a stream on which end-of-stream is detected.

## 27.6 Client/Server Interaction with Stream Socket Connections

Figures 27.5 and 27.7 use stream sockets, `ObjectInputStream` and `ObjectOutputStream` to demonstrate a simple **client/server chat application**. The server waits for a client connection attempt. When a client connects to the server, the server application sends the client a `String` object (recall that `Strings` are `Serializable` objects) indicating that the connection was successful. Then the client displays the message. The client and server applications each provide text fields that allow the user to type a message and send it to the other application. When the client or the server sends the `String` "TERMINATE", the con-



nection terminates. Then the server waits for the next client to connect. The declaration of class `Server` appears in Fig. 27.5. The declaration of class `Client` appears in Fig. 27.7. The screen captures showing the execution between the client and the server are shown in Fig. 27.8.

### *Server Class*

`Server`'s constructor (Fig. 27.5, lines 30–55) creates the server's GUI, which contains a `JTextField` and a `JTextArea`. `Server` displays its output in the `JTextArea`. When the main method (lines 6–11 of Fig. 27.6) executes, it creates a `Server` object, specifies the window's default close operation and calls method `runServer` (Fig. 27.5, lines 57–86).

---

```
1 // Fig. 27.5: Server.java
2 // Server portion of a client/server stream-socket connection.
3 import java.io.EOFException;
4 import java.io.IOException;
5 import java.io.ObjectInputStream;
6 import java.io.ObjectOutputStream;
7 import java.net.ServerSocket;
8 import java.net.Socket;
9 import java.awt.BorderLayout;
10 import java.awt.event.ActionEvent;
11 import java.awt.event.ActionListener;
12 import javax.swing.JFrame;
13 import javax.swing.JScrollPane;
14 import javax.swing.JTextArea;
15 import javax.swing.JTextField;
16 import javax.swing.SwingUtilities;
17
18 public class Server extends JFrame
19 {
20 private JTextField enterField; // inputs message from user
21 private JTextArea displayArea; // display information to user
22 private ObjectOutputStream output; // output stream to client
23 private ObjectInputStream input; // input stream from client
24 private ServerSocket server; // server socket
25 private Socket connection; // connection to client
26 private int counter = 1; // counter of number of connections
27
28 // set up GUI
29 public Server()
30 {
31 super("Server");
32
33 enterField = new JTextField(); // create enterField
34 enterField.setEditable(false);
35 enterField.addActionListener(
36 new ActionListener()
37 {
38 // send message to client
39 public void actionPerformed(ActionEvent event)
40 {
```

**Fig. 27.5** | Server portion of a client/server stream-socket connection. (Part I of 4.)

```

41 sendData(event.getActionCommand());
42 enterField.setText("");
43 } // end method actionPerformed
44 } // end anonymous inner class
45); // end call to addActionListener
46
47 add(enterField, BorderLayout.NORTH);
48
49 displayArea = new JTextArea(); // create displayArea
50 add(new JScrollPane(displayArea), BorderLayout.CENTER);
51
52 setSize(300, 150); // set size of window
53 setVisible(true); // show window
54 } // end Server constructor
55
56 // set up and run server
57 public void runServer()
58 {
59 try // set up server to receive connections; process connections
60 {
61 server = new ServerSocket(12345, 100); // create ServerSocket
62
63 while (true)
64 {
65 try
66 {
67 waitForConnection(); // wait for a connection
68 getStreams(); // get input & output streams
69 processConnection(); // process connection
70 } // end try
71 catch (EOFException eofException)
72 {
73 displayMessage("\nServer terminated connection");
74 } // end catch
75 finally
76 {
77 closeConnection(); // close connection
78 ++counter;
79 } // end finally
80 } // end while
81 } // end try
82 catch (IOException ioException)
83 {
84 ioException.printStackTrace();
85 } // end catch
86 } // end method runServer
87
88 // wait for connection to arrive, then display connection info
89 private void waitForConnection() throws IOException
90 {
91 displayMessage("Waiting for connection\n");
92 connection = server.accept(); // allow server to accept connection

```

**Fig. 27.5** | Server portion of a client/server stream-socket connection. (Part 2 of 4.)

```
93 displayMessage("Connection " + counter + " received from: " +
94 connection.getInetAddress().getHostName());
95 } // end method waitForConnection
96
97 // get streams to send and receive data
98 private void getStreams() throws IOException
99 {
100 // set up output stream for objects
101 output = new ObjectOutputStream(connection.getOutputStream());
102 output.flush(); // flush output buffer to send header information
103
104 // set up input stream for objects
105 input = new ObjectInputStream(connection.getInputStream());
106
107 displayMessage("\nGot I/O streams\n");
108 } // end method getStreams
109
110 // process connection with client
111 private void processConnection() throws IOException
112 {
113 String message = "Connection successful";
114 sendData(message); // send connection successful message
115
116 // enable enterField so server user can send messages
117 setTextFieldEditable(true);
118
119 do // process messages sent from client
120 {
121 try // read message and display it
122 {
123 message = (String) input.readObject(); // read new message
124 displayMessage("\n" + message); // display message
125 } // end try
126 catch (ClassNotFoundException classNotFoundException)
127 {
128 displayMessage("\nUnknown object type received");
129 } // end catch
130
131 } while (!message.equals("CLIENT>>> TERMINATE"));
132 } // end method processConnection
133
134 // close streams and socket
135 private void closeConnection()
136 {
137 displayMessage("\nTerminating connection\n");
138 setTextFieldEditable(false); // disable enterField
139
140 try
141 {
142 output.close(); // close output stream
143 input.close(); // close input stream
144 connection.close(); // close socket
145 } // end try
```

**Fig. 27.5** | Server portion of a client/server stream-socket connection. (Part 3 of 4.)

```

146 catch (IOException ioException)
147 {
148 ioException.printStackTrace();
149 } // end catch
150 } // end method closeConnection
151
152 // send message to client
153 private void sendData(String message)
154 {
155 try // send object to client
156 {
157 output.writeObject("SERVER>>> " + message);
158 output.flush(); // flush output to client
159 displayMessage("\nSERVER>>> " + message);
160 } // end try
161 catch (IOException ioException)
162 {
163 displayArea.append("\nError writing object");
164 } // end catch
165 } // end method sendData
166
167 // manipulates displayArea in the event-dispatch thread
168 private void displayMessage(final String messageToDisplay)
169 {
170 SwingUtilities.invokeLater(
171 new Runnable()
172 {
173 public void run() // updates displayArea
174 {
175 displayArea.append(messageToDisplay); // append message
176 } // end method run
177 } // end anonymous inner class
178); // end call to SwingUtilities.invokeLater
179 } // end method displayMessage
180
181 // manipulates enterField in the event-dispatch thread
182 private void setTextFieldEditable(final boolean editable)
183 {
184 SwingUtilities.invokeLater(
185 new Runnable()
186 {
187 public void run() // sets enterField's editability
188 {
189 enterField.setEditable(editable);
190 } // end method run
191 } // end inner class
192); // end call to SwingUtilities.invokeLater
193 } // end method setTextFieldEditable
194 } // end class Server

```

**Fig. 27.5** | Server portion of a client/server stream-socket connection. (Part 4 of 4.)

```
1 // Fig. 27.6: ServerTest.java
2 // Test the Server application.
3 import javax.swing.JFrame;
4
5 public class ServerTest
6 {
7 public static void main(String[] args)
8 {
9 Server application = new Server(); // create server
10 application.setDefaultCloseOperation(JFrame.EXIT_ON_CLOSE);
11 application.runServer(); // run server application
12 } // end main
13 } // end class ServerTest
```

**Fig. 27.6** | Test class for Server.

### *Method runServer*

Method `runServer` (Fig. 27.5, lines 57–86) sets up the server to receive a connection and processes one connection at a time. Line 61 creates a `ServerSocket` called `server` to wait for connections. The `ServerSocket` listens for a connection from a client at port 12345. The second argument to the constructor is the number of connections that can wait in a queue to connect to the server (100 in this example). If the queue is full when a client attempts to connect, the server refuses the connection.



### **Common Programming Error 27.1**

*Specifying a port that's already in use or specifying an invalid port number when creating a `ServerSocket` results in a `BindException`.*

Line 67 calls method `waitForConnection` (declared at lines 89–95) to wait for a client connection. After the connection is established, line 68 calls method `getStreams` (declared at lines 98–108) to obtain references to the connection's streams. Line 69 calls method `processConnection` (declared at lines 111–132) to send the initial connection message to the client and to process all messages received from the client. The `finally` block (lines 75–79) terminates the client connection by calling method `closeConnection` (lines 135–150), even if an exception occurs. These methods call `displayMessage` (lines 168–179), which uses the event-dispatch thread to display messages in the application's `JTextArea`. **SwingUtilities** method `invokeLater` receives a `Runnable` object as its argument and places it into the event-dispatch thread for execution. This ensures that we don't modify a GUI component from a thread other than the event-dispatch thread, which is important since *Swing GUI components are not thread safe*. We use a similar technique in method `setTextFieldEditable` (lines 182–193), to set the editability of `enterField`. For more information on interface `Runnable`, see Chapter 26.

### *Method waitForConnection*

Method `waitForConnection` (lines 89–95) uses `ServerSocket` method `accept` (line 92) to wait for a connection from a client. When a connection occurs, the resulting `Socket` is assigned to `connection`. Method `accept` blocks until a connection is received (i.e., the thread in which `accept` is called stops executing until a client connects). Lines 93–94 output the host name of the computer that made the connection. `Socket` method `getInet-`

**Address** returns an **InetAddress** (package `java.net`) containing information about the client computer. `InetAddress` method **getHostName** returns the host name of the client computer. For example, a special IP address (**127.0.0.1**) and host name (**localhost**) are useful for testing networking applications on your local computer (this is also known as the **loopback address**). If `getHostName` is called on an `InetAddress` containing `127.0.0.1`, the corresponding host name returned by the method will be `localhost`.

### Method `getStreams`

Method `getStreams` (lines 98–108) obtains the `Socket`'s streams and uses them to initialize an `ObjectOutputStream` (line 101) and an `ObjectInputStream` (line 105), respectively. Note the call to `ObjectOutputStream` method **flush** at line 102. This statement causes the `ObjectOutputStream` on the server to send a **stream header** to the corresponding client's `ObjectInputStream`. The stream header contains such information as the version of object serialization being used to send objects. This information is required by the `ObjectInputStream` so that it can prepare to receive those objects correctly.



### Software Engineering Observation 27.4

*When using `ObjectOutputStream` and `ObjectInputStream` to send and receive data over a network connection, always create the `ObjectOutputStream` first and `flush` the stream so that the client's `ObjectInputStream` can prepare to receive the data. This is required for networking applications that communicate using `ObjectOutputStream` and `ObjectInputStream`.*



### Performance Tip 27.3

*A computer's I/O components are typically much slower than its memory. Output buffers are used to increase the efficiency of an application by sending larger amounts of data fewer times, reducing the number of times an application accesses the computer's I/O components.*

### Method `processConnection`

Line 114 of method `processConnection` (lines 111–132) calls method `sendData` to send "SERVER>>> Connection successful" as a `String` to the client. The loop at lines 119–131 executes until the server receives the message "CLIENT>>> TERMINATE". Line 123 uses `ObjectInputStream` method `readObject` to read a `String` from the client. Line 124 invokes method `displayMessage` to append the message to the `JTextArea`.

### Method `closeConnection`

When the transmission is complete, method `processConnection` returns, and the program calls method `closeConnection` (lines 135–150) to close the streams associated with the `Socket` and close the `Socket`. Then the server waits for the next connection attempt from a client by continuing with line 67 at the beginning of the `while` loop.

Server receives a connection, processes it, closes it and waits for the next connection. A more likely scenario would be a `Server` that receives a connection, sets it up to be processed as a separate thread of execution, then immediately waits for new connections. The separate threads that process existing connections can continue to execute while the `Server` concentrates on new connection requests. This makes the server more efficient, because multiple client requests can be processed concurrently. We demonstrate a *multi-threaded server* in Section 27.8.

### Processing User Interactions

When the user of the server application enters a `String` in the text field and presses the *Enter* key, the program calls method `actionPerformed` (lines 39–43), which reads the `String` from the text field and calls utility method `sendData` (lines 153–165) to send the `String` to the client. Method `sendData` writes the object, flushes the output buffer and appends the same `String` to the text area in the server window. It's not necessary to invoke `displayMessage` to modify the text area here, because method `sendData` is called from an event handler—thus, `sendData` executes as part of the *event-dispatch thread*.

### Client Class

Like class `Server`, class `Client`'s constructor (Fig. 27.7, lines 29–56) creates the GUI of the application (a `JTextField` and a `JTextArea`). `Client` displays its output in the text area. When method `main` (lines 7–19 of Fig. 27.8) executes, it creates an instance of class `Client`, specifies the window's default close operation and calls method `runClient` (Fig. 27.7, lines 59–79). In this example, you can execute the client from any computer on the Internet and specify the IP address or host name of the server computer as a command-line argument to the program. For example, the command

```
java Client 192.168.1.15
```

attempts to connect to the `Server` on the computer with IP address `192.168.1.15`.

---

```
1 // Fig. 27.7: Client.java
2 // Client portion of a stream-socket connection between client and server.
3 import java.io.EOFException;
4 import java.io.IOException;
5 import java.io.ObjectInputStream;
6 import java.io.ObjectOutputStream;
7 import java.net.InetAddress;
8 import java.net.Socket;
9 import java.awt.BorderLayout;
10 import java.awt.event.ActionEvent;
11 import java.awt.event.ActionListener;
12 import javax.swing.JFrame;
13 import javax.swing.JScrollPane;
14 import javax.swing.JTextArea;
15 import javax.swing.JTextField;
16 import javax.swing.SwingUtilities;
17
18 public class Client extends JFrame
19 {
20 private JTextField enterField; // enters information from user
21 private JTextArea displayArea; // display information to user
22 private ObjectOutputStream output; // output stream to server
23 private ObjectInputStream input; // input stream from server
24 private String message = ""; // message from server
25 private String chatServer; // host server for this application
26 private Socket client; // socket to communicate with server
27
```

**Fig. 27.7** | Client portion of a stream-socket connection between client and server. (Part 1 of 5.)

```

28 // initialize chatServer and set up GUI
29 public Client(String host)
30 {
31 super("Client");
32
33 chatServer = host; // set server to which this client connects
34
35 enterField = new JTextField(); // create enterField
36 enterField.setEditable(false);
37 enterField.addActionListener(
38 new ActionListener()
39 {
40 // send message to server
41 public void actionPerformed((ActionEvent event))
42 {
43 sendData(event.getActionCommand());
44 enterField.setText("");
45 } // end method actionPerformed
46 } // end anonymous inner class
47); // end call to addActionListener
48
49 add(enterField, BorderLayout.NORTH);
50
51 displayArea = new JTextArea(); // create displayArea
52 add(new JScrollPane(displayArea), BorderLayout.CENTER);
53
54 setSize(300, 150); // set size of window
55 setVisible(true); // show window
56 } // end Client constructor
57
58 // connect to server and process messages from server
59 public void runClient()
60 {
61 try // connect to server, get streams, process connection
62 {
63 connectToServer(); // create a Socket to make connection
64 getStreams(); // get the input and output streams
65 processConnection(); // process connection
66 } // end try
67 catch (EOFException eofException)
68 {
69 displayMessage("\nClient terminated connection");
70 } // end catch
71 catch (IOException ioException)
72 {
73 ioException.printStackTrace();
74 } // end catch
75 finally
76 {
77 closeConnection(); // close connection
78 } // end finally
79 } // end method runClient

```

**Fig. 27.7** | Client portion of a stream-socket connection between client and server. (Part 2 of 5.)



```
80
81 // connect to server
82 private void connectToServer() throws IOException
83 {
84 displayMessage("Attempting connection\n");
85
86 // create Socket to make connection to server
87 client = new Socket(InetAddress.getByName(chatServer), 12345);
88
89 // display connection information
90 displayMessage("Connected to: " +
91 client.getInetAddress().getHostName());
92 } // end method connectToServer
93
94 // get streams to send and receive data
95 private void getStreams() throws IOException
96 {
97 // set up output stream for objects
98 output = new ObjectOutputStream(client.getOutputStream());
99 output.flush(); // flush output buffer to send header information
100
101 // set up input stream for objects
102 input = new ObjectInputStream(client.getInputStream());
103
104 displayMessage("\nGot I/O streams\n");
105 } // end method getStreams
106
107 // process connection with server
108 private void processConnection() throws IOException
109 {
110 // enable enterField so client user can send messages
111 setTextFieldEditable(true);
112
113 do // process messages sent from server
114 {
115 try // read message and display it
116 {
117 message = (String) input.readObject(); // read new message
118 displayMessage("\n" + message); // display message
119 } // end try
120 catch (ClassNotFoundException classNotFoundException)
121 {
122 displayMessage("\nUnknown object type received");
123 } // end catch
124
125 } while (!message.equals("SERVER>>> TERMINATE"));
126 } // end method processConnection
127
128 // close streams and socket
129 private void closeConnection()
130 {
131 displayMessage("\nClosing connection");
132 setTextFieldEditable(false); // disable enterField
```

**Fig. 27.7** | Client portion of a stream-socket connection between client and server. (Part 3 of 5.)

```

133
134 try
135 {
136 output.close(); // close output stream
137 input.close(); // close input stream 1
138 client.close(); // close socket
139 } // end try
140 catch (IOException ioException)
141 {
142 ioException.printStackTrace();
143 } // end catch
144 } // end method closeConnection
145
146 // send message to server
147 private void sendData(String message)
148 {
149 try // send object to server
150 {
151 output.writeObject("CLIENT>>> " + message);
152 output.flush(); // flush data to output
153 displayMessage("\nCLIENT>>> " + message);
154 } // end try
155 catch (IOException ioException)
156 {
157 displayArea.append("\nError writing object");
158 } // end catch
159 } // end method sendData
160
161 // manipulates displayArea in the event-dispatch thread
162 private void displayMessage(final String messageToDisplay)
163 {
164 SwingUtilities.invokeLater(
165 new Runnable()
166 {
167 public void run() // updates displayArea
168 {
169 displayArea.append(messageToDisplay);
170 } // end method run
171 } // end anonymous inner class
172); // end call to SwingUtilities.invokeLater
173 } // end method displayMessage
174
175 // manipulates enterField in the event-dispatch thread
176 private void setTextFieldEditable(final boolean editable)
177 {
178 SwingUtilities.invokeLater(
179 new Runnable()
180 {
181 public void run() // sets enterField's editability
182 {
183 enterField.setEditable(editable);
184 } // end method run
185 } // end anonymous inner class

```

**Fig. 27.7** | Client portion of a stream-socket connection between client and server. (Part 4 of 5.)

```

186); // end call to SwingUtilities.invokeLater
187 } // end method setTextFieldEditable
188 } // end class Client

```

**Fig. 27.7** | Client portion of a stream-socket connection between client and server. (Part 5 of 5.)

```

1 // Fig. 27.8: ClientTest.java
2 // Class that tests the Client.
3 import javax.swing.JFrame;
4
5 public class ClientTest
6 {
7 public static void main(String[] args)
8 {
9 Client application; // declare client application
10
11 // if no command line args
12 if (args.length == 0)
13 application = new Client("127.0.0.1"); // connect to localhost
14 else
15 application = new Client(args[0]); // use args to connect
16
17 application.setDefaultCloseOperation(JFrame.EXIT_ON_CLOSE);
18 application.runClient(); // run client application
19 } // end main
20 } // end class ClientTest

```

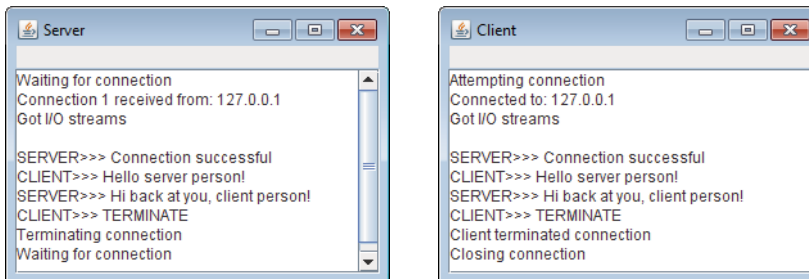

**Fig. 27.8** | Class that tests the Client.

### *Method runClient*

Client method `runClient` (Fig. 27.7, lines 59–79) sets up the connection to the server, processes messages received from the server and closes the connection when communication is complete. Line 63 calls method `connectToServer` (declared at lines 82–92) to perform the connection. After connecting, line 64 calls method `getStreams` (declared at lines 95–105) to obtain references to the `Socket`'s stream objects. Then line 65 calls method `processConnection` (declared at lines 108–126) to receive and display messages sent from the server. The `finally` block (lines 75–78) calls `closeConnection` (lines 129–144) to close the streams and the `Socket` even if an exception occurred. Method `displayMessage` (lines 162–173) is called from these methods to use the event-dispatch thread to display messages in the application's text area.

**Method `connectToServer`**

Method `connectToServer` (lines 82–92) creates a `Socket` called `client` (line 87) to establish a connection. The arguments to the `Socket` constructor are the IP address of the server computer and the port number (12345) where the server application is awaiting client connections. In the first argument, `InetAddress` static method `getByName` returns an `InetAddress` object containing the IP address specified as a command-line argument to the application (or `127.0.0.1` if none was specified). Method `getByName` can receive a `String` containing either the actual IP address or the host name of the server. The first argument also could have been written other ways. For the `localhost` address `127.0.0.1`, the first argument could be specified with either of the following expressions:

```
InetAddress.getByName("localhost")
InetAddress.getLocalHost()
```

Other versions of the `Socket` constructor receive the IP address or host name as a `String`. The first argument could have been specified as the IP address `"127.0.0.1"` or the host name `"localhost"`. We chose to demonstrate the client/server relationship by connecting between applications on the same computer (`localhost`). Normally, this first argument would be the IP address of another computer. The `InetAddress` object for another computer can be obtained by specifying the computer's IP address or host name as the argument to `InetAddress` method `getByName`. The `Socket` constructor's second argument is the server port number. This *must* match the port number at which the server is waiting for connections (called the *handshake point*). Once the connection is made, lines 90–91 display a message in the text area indicating the name of the server computer to which the client has connected.

The `Client` uses an `ObjectOutputStream` to send data to the server and an `ObjectInputStream` to receive data from the server. Method `getStreams` (lines 95–105) creates the `ObjectOutputStream` and `ObjectInputStream` objects that use the streams associated with the `client` socket.

**Methods `processConnection` and `closeConnection`**

Method `processConnection` (lines 108–126) contains a loop that executes until the client receives the message `"SERVER>>> TERMINATE"`. Line 117 reads a `String` object from the server. Line 118 invokes `displayMessage` to append the message to the text area. When the transmission is complete, method `closeConnection` (lines 129–144) closes the streams and the `Socket`.

**Processing User Interactions**

When the client application user enters a `String` in the text field and presses *Enter*, the program calls method `actionPerformed` (lines 41–45) to read the `String`, then invokes utility method `sendData` (147–159) to send the `String` to the server. Method `sendData` writes the object, flushes the output buffer and appends the same `String` to the client window's `JTextArea`. Once again, it's not necessary to invoke utility method `displayMessage` to modify the text area here, because method `sendData` is called from an event handler.

**27.7 Datagrams: Connectionless Client/Server Interaction**

We've been discussing connection-oriented, streams-based transmission. Now we consider **connectionless transmission with datagrams**.

Connection-oriented transmission is like the telephone system in which you dial and are given a connection to the telephone of the person with whom you wish to communicate. The connection is maintained for your phone call, *even when you're not talking*.

Connectionless transmission with datagrams is more like the way mail is carried via the postal service. If a large message will not fit in one envelope, you break it into separate pieces that you place in sequentially numbered envelopes. All of the letters are then mailed at once. The letters could arrive *in order, out of order or not at all* (the last case is rare). The person at the receiving end *reassembles* the pieces into sequential order before attempting to make sense of the message.

If your message is small enough to fit in one envelope, you need not worry about the “out-of-sequence” problem, but it’s still possible that your message might not arrive. One advantage of datagrams over postal mail is that duplicates of datagrams can arrive at the receiving computer.

Figures 27.9–27.12 use datagrams to send packets of information via the User Datagram Protocol (UDP) between a client application and a server application. In the Client application (Fig. 27.11), the user types a message into a text field and presses *Enter*. The program converts the message into a byte array and places it in a datagram packet that’s sent to the server. The Server (Figs. 27.9–27.10) receives the packet and displays the information in it, then **echoes** the packet back to the client. Upon receiving the packet, the client displays the information it contains.

### Server Class

Class Server (Fig. 27.9) declares two **DatagramPackets** that the server uses to send and receive information and one **DatagramSocket** that sends and receives the packets. The constructor (lines 19–37), which is called from `main` (Fig. 27.10, lines 7–12), creates the GUI in which the packets of information will be displayed. Line 30 creates the `DatagramSocket` in a `try` block. Line 30 in Fig. 27.9 uses the `DatagramSocket` constructor that takes an integer port-number argument (5000 in this example) to bind the server to a port where it can receive packets from clients. Clients sending packets to this Server specify the same port number in the packets they send. A **SocketException** is thrown if the `DatagramSocket` constructor fails to bind the `DatagramSocket` to the specified port.



### Common Programming Error 27.2

*Specifying a port that’s already in use or specifying an invalid port number when creating a `DatagramSocket` results in a `SocketException`.*

```
1 // Fig. 27.9: Server.java
2 // Server side of connectionless client/server computing with datagrams.
3 import java.io.IOException;
4 import java.net.DatagramPacket;
5 import java.net.DatagramSocket;
6 import java.net.SocketException;
7 import java.awt.BorderLayout;
8 import javax.swing.JFrame;
9 import javax.swing.JScrollPane;
10 import javax.swing.JTextArea;
```

**Fig. 27.9** | Server side of connectionless client/server computing with datagrams. (Part 1 of 3.)

```

11 import javax.swing.SwingUtilities;
12
13 public class Server extends JFrame
14 {
15 private JTextArea displayArea; // displays packets received
16 private DatagramSocket socket; // socket to connect to client
17
18 // set up GUI and DatagramSocket
19 public Server()
20 {
21 super("Server");
22
23 displayArea = new JTextArea(); // create displayArea
24 add(new JScrollPane(displayArea), BorderLayout.CENTER);
25 setSize(400, 300); // set size of window
26 setVisible(true); // show window
27
28 try // create DatagramSocket for sending and receiving packets
29 {
30 socket = new DatagramSocket(5000);
31 } // end try
32 catch (SocketException socketException)
33 {
34 socketException.printStackTrace();
35 System.exit(1);
36 } // end catch
37 } // end Server constructor
38
39 // wait for packets to arrive, display data and echo packet to client
40 public void waitForPackets()
41 {
42 while (true)
43 {
44 try // receive packet, display contents, return copy to client
45 {
46 byte[] data = new byte[100]; // set up packet
47 DatagramPacket receivePacket =
48 new DatagramPacket(data, data.length);
49
50 socket.receive(receivePacket); // wait to receive packet
51
52 // display information from received packet
53 displayMessage("\nPacket received:" +
54 "\nFrom host: " + receivePacket.getAddress() +
55 "\nHost port: " + receivePacket.getPort() +
56 "\nLength: " + receivePacket.getLength() +
57 "\nContaining:\n\t" + new String(receivePacket.getData(),
58 0, receivePacket.getLength()));
59
60 sendPacketToClient(receivePacket); // send packet to client
61 } // end try
62 catch (IOException ioException)
63 {

```

**Fig. 27.9** | Server side of connectionless client/server computing with datagrams. (Part 2 of 3.)

```

64 displayMessage(ioException + "\n");
65 ioException.printStackTrace();
66 } // end catch
67 } // end while
68 } // end method waitForPackets
69
70 // echo packet to client
71 private void sendPacketToClient(DatagramPacket receivePacket)
72 throws IOException
73 {
74 displayMessage("\n\nEcho data to client...");
75
76 // create packet to send
77 DatagramPacket sendPacket = new DatagramPacket(
78 receivePacket.getData(), receivePacket.getLength(),
79 receivePacket.getAddress(), receivePacket.getPort());
80
81 socket.send(sendPacket); // send packet to client
82 displayMessage("Packet sent\n");
83 } // end method sendPacketToClient
84
85 // manipulates displayArea in the event-dispatch thread
86 private void displayMessage(final String messageToDisplay)
87 {
88 SwingUtilities.invokeLater(
89 new Runnable()
90 {
91 public void run() // updates displayArea
92 {
93 displayArea.append(messageToDisplay); // display message
94 } // end method run
95 } // end anonymous inner class
96); // end call to SwingUtilities.invokeLater
97 } // end method displayMessage
98 } // end class Server

```

**Fig. 27.9** | Server side of connectionless client/server computing with datagrams. (Part 3 of 3.)

```

1 // Fig. 27.10: ServerTest.java
2 // Class that tests the Server.
3 import javax.swing.JFrame;
4
5 public class ServerTest
6 {
7 public static void main(String[] args)
8 {
9 Server application = new Server(); // create server
10 application.setDefaultCloseOperation(JFrame.EXIT_ON_CLOSE);
11 application.waitForPackets(); // run server application
12 } // end main
13 } // end class ServerTest

```

**Fig. 27.10** | Class that tests the Server. (Part 1 of 2.)

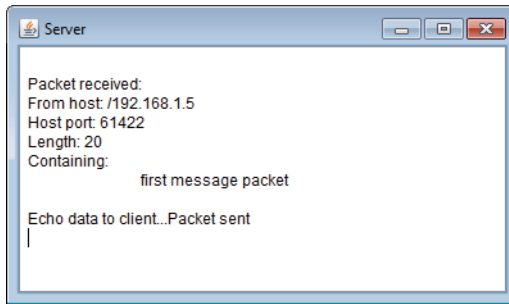

Server window after packet of data is received from Client

**Fig. 27.10** | Class that tests the Server. (Part 2 of 2.)

### *Method waitForPackets*

Server method `waitForPackets` (Fig. 27.9, lines 40–68) uses an infinite loop to wait for packets to arrive at the Server. Lines 47–48 create a `DatagramPacket` in which a received packet of information can be stored. The `DatagramPacket` constructor for this purpose receives two arguments—a byte array in which the data will be stored and the length of the array. Line 50 uses `DatagramSocket` method `receive` to wait for a packet to arrive at the Server. Method `receive` blocks until a packet arrives, then stores the packet in its `DatagramPacket` argument. The method throws an `IOException` if an error occurs while receiving a packet.

### *Method displayMessage*

When a packet arrives, lines 53–58 call method `displayMessage` (declared at lines 86–97) to append the packet’s contents to the text area. `DatagramPacket` method `getAddress` (line 54) returns an `InetAddress` object containing the IP address of the computer from which the packet was sent. Method `getPort` (line 55) returns an integer specifying the port number through which the client computer sent the packet. Method `getLength` (line 56) returns an integer representing the number of bytes of data received. Method `getData` (line 57) returns a byte array containing the data. Lines 57–58 initialize a `String` object using a three-argument constructor that takes a byte array, the offset and the length. This `String` is then appended to the text to display.

### *Method sendPacketToClient*

After displaying a packet, line 60 calls method `sendPacketToClient` (declared at lines 71–83) to create a new packet and send it to the client. Lines 77–79 create a `DatagramPacket` and pass four arguments to its constructor. The first argument specifies the byte array to send. The second argument specifies the number of bytes to send. The third argument specifies the client computer’s IP address, to which the packet will be sent. The fourth argument specifies the port where the client is waiting to receive packets. Line 81 sends the packet over the network. Method `send` of `DatagramSocket` throws an `IOException` if an error occurs while sending a packet.

### *Client Class*

The `Client` (Figs. 27.11–27.12) works similarly to class `Server`, except that the `Client` sends packets only when the user types a message in a text field and presses the *Enter* key.



When this occurs, the program calls method `actionPerformed` (Fig. 27.11, lines 32–57), which converts the `String` the user entered into a byte array (line 41). Lines 44–45 create a `DatagramPacket` and initialize it with the byte array, the length of the `String` that was entered by the user, the IP address to which the packet is to be sent (`InetAddress.getLocalHost()` in this example) and the port number at which the Server is waiting for packets (5000 in this example). Line 47 sends the packet. The client in this example must know that the server is receiving packets at port 5000—otherwise, the server will *not* receive the packets.

The `DatagramSocket` constructor call (Fig. 27.11, line 71) in this application does not specify any arguments. This no-argument constructor allows the computer to select the next available port number for the `DatagramSocket`. The client does not need a specific port number, because the server receives the client's port number as part of each `DatagramPacket` sent by the client. Thus, the server can send packets back to the same computer and port number from which it receives a packet of information.

---

```

1 // Fig. 27.11: Client.java
2 // Client side of connectionless client/server computing with datagrams.
3 import java.io.IOException;
4 import java.net.DatagramPacket;
5 import java.net.DatagramSocket;
6 import java.net.InetAddress;
7 import java.net.SocketException;
8 import java.awt.BorderLayout;
9 import java.awt.event.ActionEvent;
10 import java.awt.event.ActionListener;
11 import javax.swing.JFrame;
12 import javax.swing.JScrollPane;
13 import javax.swing.JTextArea;
14 import javax.swing.JTextField;
15 import javax.swing.SwingUtilities;
16
17 public class Client extends JFrame
18 {
19 private JTextField enterField; // for entering messages
20 private JTextArea displayArea; // for displaying messages
21 private DatagramSocket socket; // socket to connect to server
22
23 // set up GUI and DatagramSocket
24 public Client()
25 {
26 super("Client");
27
28 enterField = new JTextField("Type message here");
29 enterField.addActionListener(
30 new ActionListener()
31 {
32 public void actionPerformed(ActionEvent event)
33 {
34 try // create and send packet
35 {

```

---

**Fig. 27.11** | Client side of connectionless client/server computing with datagrams. (Part 1 of 3.)

```

36 // get message from textfield
37 String message = event.getActionCommand();
38 displayArea.append("\nSending packet containing: " +
39 message + "\n");
40
41 byte[] data = message.getBytes(); // convert to bytes
42
43 // create sendPacket
44 DatagramPacket sendPacket = new DatagramPacket(data,
45 data.length, InetAddress.getLocalHost(), 5000);
46
47 socket.send(sendPacket); // send packet
48 displayArea.append("Packet sent\n");
49 displayArea.setCaretPosition(
50 displayArea.getText().length());
51 } // end try
52 catch (IOException ioException)
53 {
54 displayMessage(ioException + "\n");
55 ioException.printStackTrace();
56 } // end catch
57 } // end actionPerformed
58 } // end inner class
59); // end call to addActionListener
60
61 add(enterField, BorderLayout.NORTH);
62
63 displayArea = new JTextArea();
64 add(new JScrollPane(displayArea), BorderLayout.CENTER);
65
66 setSize(400, 300); // set window size
67 setVisible(true); // show window
68
69 try // create DatagramSocket for sending and receiving packets
70 {
71 socket = new DatagramSocket();
72 } // end try
73 catch (SocketException socketException)
74 {
75 socketException.printStackTrace();
76 System.exit(1);
77 } // end catch
78 } // end Client constructor
79
80 // wait for packets to arrive from Server, display packet contents
81 public void waitForPackets()
82 {
83 while (true)
84 {
85 try // receive packet and display contents
86 {
87 byte[] data = new byte[100]; // set up packet

```

**Fig. 27.11** | Client side of connectionless client/server computing with datagrams. (Part 2 of 3.)

```

88 DatagramPacket receivePacket = new DatagramPacket(
89 data, data.length);
90
91 socket.receive(receivePacket); // wait for packet
92
93 // display packet contents
94 displayMessage("\nPacket received:" +
95 "\nFrom host: " + receivePacket.getAddress() +
96 "\nHost port: " + receivePacket.getPort() +
97 "\nLength: " + receivePacket.getLength() +
98 "\nContaining:\n\t" + new String(receivePacket.getData(),
99 0, receivePacket.getLength()));
100 } // end try
101 catch (IOException exception)
102 {
103 displayMessage(exception + "\n");
104 exception.printStackTrace();
105 } // end catch
106 } // end while
107 } // end method waitForPackets
108
109 // manipulates displayArea in the event-dispatch thread
110 private void displayMessage(final String messageToDisplay)
111 {
112 SwingUtilities.invokeLater(
113 new Runnable()
114 {
115 public void run() // updates displayArea
116 {
117 displayArea.append(messageToDisplay);
118 } // end method run
119 } // end inner class
120); // end call to SwingUtilities.invokeLater
121 } // end method displayMessage
122 } // end class Client

```

**Fig. 27.11** | Client side of connectionless client/server computing with datagrams. (Part 3 of 3.)

```

1 // Fig. 27.12: ClientTest.java
2 // Tests the Client class.
3 import javax.swing.JFrame;
4
5 public class ClientTest
6 {
7 public static void main(String[] args)
8 {
9 Client application = new Client(); // create client
10 application.setDefaultCloseOperation(JFrame.EXIT_ON_CLOSE);
11 application.waitForPackets(); // run client application
12 } // end main
13 } // end class ClientTest

```

**Fig. 27.12** | Class that tests the Client. (Part 1 of 2.)



Client window after sending packet to Server and receiving packet back from Server

**Fig. 27.12** | Class that tests the Client. (Part 2 of 2.)

### Method `waitForPackets`

Client method `waitForPackets` (lines 81–107) uses an infinite loop to wait for packets from the server. Line 91 blocks until a packet arrives. This does not prevent the user from sending a packet, because the *GUI events are handled in the event-dispatch thread*. It only prevents the while loop from continuing until a packet arrives at the Client. When a packet arrives, line 91 stores it in `receivePacket`, and lines 94–99 call method `displayMessage` (declared at lines 110–121) to display the packet’s contents in the text area.

## 27.8 Client/Server Tic-Tac-Toe Using a Multithreaded Server

This section presents the popular game Tic-Tac-Toe implemented by using client/server techniques with stream sockets. The program consists of a `TicTacToeServer` application (Figs. 27.13–27.14) that allows two `TicTacToeClient` applications (Figs. 27.15–27.16) to connect to the server and play Tic-Tac-Toe. Sample outputs are shown in Fig. 27.17.

### `TicTacToeServer` Class

As the `TicTacToeServer` receives each client connection, it creates an instance of inner-class `Player` (Fig. 27.13, lines 182–304) to process the client in a *separate thread*. These threads enable the clients to play the game independently. The first client to connect to the server is player X and the second is player O. Player X makes the first move. The server maintains the information about the board so it can determine if a player’s move is valid.

```

1 // Fig. 27.13: TicTacToeServer.java
2 // Server side of client/server Tic-Tac-Toe program.
3 import java.awt.BorderLayout;
4 import java.net.ServerSocket;
5 import java.net.Socket;
6 import java.io.IOException;
7 import java.util.Formatter;
8 import java.util.Scanner;
9 import java.util.concurrent.ExecutorService;
10 import java.util.concurrent.Executors;

```

**Fig. 27.13** | Server side of client/server Tic-Tac-Toe program. (Part 1 of 7.)

```

11 import java.util.concurrent.locks.Lock;
12 import java.util.concurrent.locks.ReentrantLock;
13 import java.util.concurrent.locks.Condition;
14 import javax.swing.JFrame;
15 import javax.swing.JTextArea;
16 import javax.swing.SwingUtilities;
17
18 public class TicTacToeServer extends JFrame
19 {
20 private String[] board = new String[9]; // tic-tac-toe board
21 private JTextArea outputArea; // for outputting moves
22 private Player[] players; // array of Players
23 private ServerSocket server; // server socket to connect with clients
24 private int currentPlayer; // keeps track of player with current move
25 private final static int PLAYER_X = 0; // constant for first player
26 private final static int PLAYER_O = 1; // constant for second player
27 private final static String[] MARKS = { "X", "O" }; // array of marks
28 private ExecutorService runGame; // will run players
29 private Lock gameLock; // to lock game for synchronization
30 private Condition otherPlayerConnected; // to wait for other player
31 private Condition otherPlayerTurn; // to wait for other player's turn
32
33 // set up tic-tac-toe server and GUI that displays messages
34 public TicTacToeServer()
35 {
36 super("Tic-Tac-Toe Server"); // set title of window
37
38 // create ExecutorService with a thread for each player
39 runGame = Executors.newFixedThreadPool(2);
40 gameLock = new ReentrantLock(); // create lock for game
41
42 // condition variable for both players being connected
43 otherPlayerConnected = gameLock.newCondition();
44
45 // condition variable for the other player's turn
46 otherPlayerTurn = gameLock.newCondition();
47
48 for (int i = 0; i < 9; i++)
49 board[i] = new String(""); // create tic-tac-toe board
50 players = new Player[2]; // create array of players
51 currentPlayer = PLAYER_X; // set current player to first player
52
53 try
54 {
55 server = new ServerSocket(12345, 2); // set up ServerSocket
56 } // end try
57 catch (IOException ioException)
58 {
59 ioException.printStackTrace();
60 System.exit(1);
61 } // end catch
62
63 outputArea = new JTextArea(); // create JTextArea for output

```

**Fig. 27.13** | Server side of client/server Tic-Tac-Toe program. (Part 2 of 7.)

```

64 add(outputArea, BorderLayout.CENTER);
65 outputArea.setText("Server awaiting connections\n");
66
67 setSize(300, 300); // set size of window
68 setVisible(true); // show window
69 } // end TicTacToeServer constructor
70
71 // wait for two connections so game can be played
72 public void execute()
73 {
74 // wait for each client to connect
75 for (int i = 0; i < players.length; i++)
76 {
77 try // wait for connection, create Player, start runnable
78 {
79 players[i] = new Player(server.accept(), i);
80 runGame.execute(players[i]); // execute player runnable
81 } // end try
82 catch (IOException ioException)
83 {
84 ioException.printStackTrace();
85 System.exit(1);
86 } // end catch
87 } // end for
88
89 gameLock.lock(); // lock game to signal player X's thread
90
91 try
92 {
93 players[PLAYER_X].setSuspended(false); // resume player X
94 otherPlayerConnected.signal(); // wake up player X's thread
95 } // end try
96 finally
97 {
98 gameLock.unlock(); // unlock game after signalling player X
99 } // end finally
100 } // end method execute
101
102 // display message in outputArea
103 private void displayMessage(final String messageToDisplay)
104 {
105 // display message from event-dispatch thread of execution
106 SwingUtilities.invokeLater(
107 new Runnable()
108 {
109 public void run() // updates outputArea
110 {
111 outputArea.append(messageToDisplay); // add message
112 } // end method run
113 } // end inner class
114); // end call to SwingUtilities.invokeLater
115 } // end method displayMessage

```

**Fig. 27.13** | Server side of client/server Tic-Tac-Toe program. (Part 3 of 7.)

```
116
117 // determine if move is valid
118 public boolean validateAndMove(int location, int player)
119 {
120 // while not current player, must wait for turn
121 while (player != currentPlayer)
122 {
123 gameLock.lock(); // lock game to wait for other player to go
124
125 try
126 {
127 otherPlayerTurn.await(); // wait for player's turn
128 } // end try
129 catch (InterruptedException exception)
130 {
131 exception.printStackTrace();
132 } // end catch
133 finally
134 {
135 gameLock.unlock(); // unlock game after waiting
136 } // end finally
137 } // end while
138
139 // if location not occupied, make move
140 if (!isOccupied(location))
141 {
142 board[location] = MARKS[currentPlayer]; // set move on board
143 currentPlayer = (currentPlayer + 1) % 2; // change player
144
145 // let new current player know that move occurred
146 players[currentPlayer].otherPlayerMoved(location);
147
148 gameLock.lock(); // lock game to signal other player to go
149
150 try
151 {
152 otherPlayerTurn.signal(); // signal other player to continue
153 } // end try
154 finally
155 {
156 gameLock.unlock(); // unlock game after signaling
157 } // end finally
158
159 return true; // notify player that move was valid
160 } // end if
161 else // move was not valid
162 return false; // notify player that move was invalid
163 } // end method validateAndMove
164
165 // determine whether location is occupied
166 public boolean isOccupied(int location)
167 {
```

**Fig. 27.13** | Server side of client/server Tic-Tac-Toe program. (Part 4 of 7.)

```

168 if (board[location].equals(MARKS[PLAYER_X]) ||
169 board [location].equals(MARKS[PLAYER_O]))
170 return true; // location is occupied
171 else
172 return false; // location is not occupied
173 } // end method isOccupied
174
175 // place code in this method to determine whether game over
176 public boolean isGameOver()
177 {
178 return false; // this is left as an exercise
179 } // end method isGameOver
180
181 // private inner class Player manages each Player as a runnable
182 private class Player implements Runnable
183 {
184 private Socket connection; // connection to client
185 private Scanner input; // input from client
186 private Formatter output; // output to client
187 private int playerNumber; // tracks which player this is
188 private String mark; // mark for this player
189 private boolean suspended = true; // whether thread is suspended
190
191 // set up Player thread
192 public Player(Socket socket, int number)
193 {
194 playerNumber = number; // store this player's number
195 mark = MARKS[playerNumber]; // specify player's mark
196 connection = socket; // store socket for client
197
198 try // obtain streams from Socket
199 {
200 input = new Scanner(connection.getInputStream());
201 output = new Formatter(connection.getOutputStream());
202 } // end try
203 catch (IOException ioException)
204 {
205 ioException.printStackTrace();
206 System.exit(1);
207 } // end catch
208 } // end Player constructor
209
210 // send message that other player moved
211 public void otherPlayerMoved(int location)
212 {
213 output.format("Opponent moved\n");
214 output.format("%d\n", location); // send location of move
215 output.flush(); // flush output
216 } // end method otherPlayerMoved
217

```

**Fig. 27.13** | Server side of client/server Tic-Tac-Toe program. (Part 5 of 7.)



```

218 // control thread's execution
219 public void run()
220 {
221 // send client its mark (X or O), process messages from client
222 try
223 {
224 displayMessage("Player " + mark + " connected\n");
225 output.format("%s\n", mark); // send player's mark
226 output.flush(); // flush output
227
228 // if player X, wait for another player to arrive
229 if (playerNumber == PLAYER_X)
230 {
231 output.format("%s\n%s", "Player X connected",
232 "Waiting for another player\n");
233 output.flush(); // flush output
234
235 gameLock.lock(); // lock game to wait for second player
236
237 try
238 {
239 while(suspended)
240 {
241 otherPlayerConnected.await(); // wait for player O
242 } // end while
243 } // end try
244 catch (InterruptedException exception)
245 {
246 exception.printStackTrace();
247 } // end catch
248 finally
249 {
250 gameLock.unlock(); // unlock game after second player
251 } // end finally
252
253 // send message that other player connected
254 output.format("Other player connected. Your move.\n");
255 output.flush(); // flush output
256 } // end if
257 else
258 {
259 output.format("Player O connected, please wait\n");
260 output.flush(); // flush output
261 } // end else
262
263 // while game not over
264 while (!isGameOver())
265 {
266 int location = 0; // initialize move location
267
268 if (input.hasNext())
269 location = input.nextInt(); // get move location
270

```

**Fig. 27.13** | Server side of client/server Tic-Tac-Toe program. (Part 6 of 7.)

```

271 // check for valid move
272 if (validateAndMove(location, playerNumber))
273 {
274 displayMessage("\nlocation: " + location);
275 output.format("Valid move.\n"); // notify client
276 output.flush(); // flush output
277 } // end if
278 else // move was invalid
279 {
280 output.format("Invalid move, try again\n");
281 output.flush(); // flush output
282 } // end else
283 } // end while
284 } // end try
285 finally
286 {
287 try
288 {
289 connection.close(); // close connection to client
290 } // end try
291 catch (IOException ioException)
292 {
293 ioException.printStackTrace();
294 System.exit(1);
295 } // end catch
296 } // end finally
297 } // end method run
298
299 // set whether or not thread is suspended
300 public void setSuspended(boolean status)
301 {
302 suspended = status; // set value of suspended
303 } // end method setSuspended
304 } // end class Player
305 } // end class TicTacToeServer

```

**Fig. 27.13** | Server side of client/server Tic-Tac-Toe program. (Part 7 of 7.)

```

1 // Fig. 27.14: TicTacToeServerTest.java
2 // Class that tests Tic-Tac-Toe server.
3 import javax.swing.JFrame;
4
5 public class TicTacToeServerTest
6 {
7 public static void main(String[] args)
8 {
9 TicTacToeServer application = new TicTacToeServer();
10 application.setDefaultCloseOperation(JFrame.EXIT_ON_CLOSE);
11 application.execute();
12 } // end main
13 } // end class TicTacToeServerTest

```

**Fig. 27.14** | Class that tests Tic-Tac-Toe server. (Part 1 of 2.)

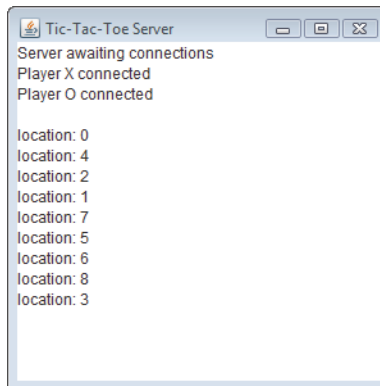

**Fig. 27.14** | Class that tests Tic-Tac-Toe server. (Part 2 of 2.)

We begin with a discussion of the server side of the Tic-Tac-Toe game. When the `TicTacToeServer` application executes, the `main` method (lines 7–12 of Fig. 27.14) creates a `TicTacToeServer` object called `application`. The constructor (Fig. 27.13, lines 34–69) attempts to set up a `ServerSocket`. If successful, the program displays the server window, then `main` invokes the `TicTacToeServer` method `execute` (lines 72–100). Method `execute` loops twice, blocking at line 79 each time while waiting for a client connection. When a client connects, line 79 creates a new `Player` object to manage the connection as a separate thread, and line 80 executes the `Player` in the `runGame` thread pool.

When the `TicTacToeServer` creates a `Player`, the `Player` constructor (lines 192–208) receives the `Socket` object representing the connection to the client and gets the associated input and output streams. Line 201 creates a `Formatter` (see Chapter 17) by wrapping it around the output stream of the socket. The `Player`'s `run` method (lines 219–297) controls the information that's sent to and received from the client. First, it passes to the client the character that the client will place on the board when a move is made (line 225). Line 226 calls `Formatter` method `flush` to force this output to the client. Line 241 suspends player X's thread as it starts executing, because player X can move only after player O connects.

When player O connects, the game can be played, and the `run` method begins executing its `while` statement (lines 264–283). Each iteration of this loop reads an integer (line 269) representing the location where the client wants to place a mark (blocking to wait for input, if necessary), and line 272 invokes the `TicTacToeServer` method `validateAndMove` (declared at lines 118–163) to check the move. If the move is valid, line 275 sends a message to the client to this effect. If not, line 280 sends a message indicating that the move was invalid. The program maintains board locations as numbers from 0 to 8 (0 through 2 for the first row, 3 through 5 for the second row and 6 through 8 for the third row).

Method `validateAndMove` (lines 118–163 in class `TicTacToeServer`) allows only one player at a time to move, thereby preventing them from modifying the state information of the game simultaneously. If the `Player` attempting to validate a move is *not* the current player (i.e., the one allowed to make a move), it's placed in a *wait* state until its turn to move. If the position for the move being validated is already occupied on the board,

`validMove` returns `false`. Otherwise, the server places a mark for the player in its local representation of the board (line 142), notifies the other `Player` object (line 146) that a move has been made (so that the client can be sent a message), invokes method `signal` (line 152) so that the waiting `Player` (if there is one) can validate a move and returns `true` (line 159) to indicate that the move is valid.

### *TicTacToeClient Class*

Each `TicTacToeClient` application (Figs. 27.15–27.16; sample outputs in Fig. 27.17) maintains its own GUI version of the Tic-Tac-Toe board on which it displays the state of the game. The clients can place a mark only in an empty square. Inner class `Square` (Fig. 27.15, lines 205–261) implements each of the nine squares on the board. When a `TicTacToeClient` begins execution, it creates a `JTextArea` in which messages from the server and a representation of the board using nine `Square` objects are displayed. The `startClient` method (lines 80–100) opens a connection to the server and gets the associated input and output streams from the `Socket` object. Lines 85–86 make a connection to the server. Class `TicTacToeClient` implements interface `Runnable` so that a separate thread can read messages from the server. This approach enables the user to interact with the board (in the event-dispatch thread) while waiting for messages from the server. After establishing the connection to the server, line 99 executes the client with the worker `ExecutorService`. The `run` method (lines 103–126) controls the separate thread of execution. The method first reads the mark character (X or O) from the server (line 105), then loops continuously (lines 121–125) and reads messages from the server (line 124). Each message is passed to the `processMessage` method (lines 129–156) for processing.

---

```

1 // Fig. 27.15: TicTacToeClient.java
2 // Client side of client/server Tic-Tac-Toe program.
3 import java.awt.BorderLayout;
4 import java.awt.Dimension;
5 import java.awt.Graphics;
6 import java.awt.GridLayout;
7 import java.awt.event.MouseAdapter;
8 import java.awt.event.MouseEvent;
9 import java.net.Socket;
10 import java.net.InetAddress;
11 import java.io.IOException;
12 import javax.swing.JFrame;
13 import javax.swing.JPanel;
14 import javax.swing.JScrollPane;
15 import javax.swing.JTextArea;
16 import javax.swing.JTextField;
17 import javax.swing.SwingUtilities;
18 import java.util.Formatter;
19 import java.util.Scanner;
20 import java.util.concurrent.Executors;
21 import java.util.concurrent.ExecutorService;
22
23 public class TicTacToeClient extends JFrame implements Runnable
24 {

```

**Fig. 27.15** | Client side of client/server Tic-Tac-Toe program. (Part I of 6.)

```

25 private JTextField idField; // textfield to display player's mark
26 private JTextArea displayArea; // JTextArea to display output
27 private JPanel boardPanel; // panel for tic-tac-toe board
28 private JPanel panel2; // panel to hold board
29 private Square[][] board; // tic-tac-toe board
30 private Square currentSquare; // current square
31 private Socket connection; // connection to server
32 private Scanner input; // input from server
33 private Formatter output; // output to server
34 private String ticTacToeHost; // host name for server
35 private String myMark; // this client's mark
36 private boolean myTurn; // determines which client's turn it is
37 private final String X_MARK = "X"; // mark for first client
38 private final String O_MARK = "O"; // mark for second client
39
40 // set up user-interface and board
41 public TicTacToeClient(String host)
42 {
43 ticTacToeHost = host; // set name of server
44 displayArea = new JTextArea(4, 30); // set up JTextArea
45 displayArea.setEditable(false);
46 add(new JScrollPane(displayArea), BorderLayout.SOUTH);
47
48 boardPanel = new JPanel(); // set up panel for squares in board
49 boardPanel.setLayout(new GridLayout(3, 3, 0, 0));
50
51 board = new Square[3][3]; // create board
52
53 // loop over the rows in the board
54 for (int row = 0; row < board.length; row++)
55 {
56 // loop over the columns in the board
57 for (int column = 0; column < board[row].length; column++)
58 {
59 // create square
60 board[row][column] = new Square(' ', row * 3 + column);
61 boardPanel.add(board[row][column]); // add square
62 } // end inner for
63 } // end outer for
64
65 idField = new JTextField(); // set up textfield
66 idField.setEditable(false);
67 add(idField, BorderLayout.NORTH);
68
69 panel2 = new JPanel(); // set up panel to contain boardPanel
70 panel2.add(boardPanel, BorderLayout.CENTER); // add board panel
71 add(panel2, BorderLayout.CENTER); // add container panel
72
73 setSize(300, 225); // set size of window
74 setVisible(true); // show window
75
76 startClient();
77 } // end TicTacToeClient constructor

```

**Fig. 27.15** | Client side of client/server Tic-Tac-Toe program. (Part 2 of 6.)

```

78
79 // start the client thread
80 public void startClient()
81 {
82 try // connect to server and get streams
83 {
84 // make connection to server
85 connection = new Socket(
86 InetAddress.getByName(ticTacToeHost), 12345);
87
88 // get streams for input and output
89 input = new Scanner(connection.getInputStream());
90 output = new Formatter(connection.getOutputStream());
91 } // end try
92 catch (IOException ioException)
93 {
94 ioException.printStackTrace();
95 } // end catch
96
97 // create and start worker thread for this client
98 ExecutorService worker = Executors.newFixedThreadPool(1);
99 worker.execute(this); // execute client
100 } // end method startClient
101
102 // control thread that allows continuous update of displayArea
103 public void run()
104 {
105 myMark = input.nextLine(); // get player's mark (X or O)
106
107 SwingUtilities.invokeLater(
108 new Runnable()
109 {
110 public void run()
111 {
112 // display player's mark
113 idField.setText("You are player \"\" + myMark + "\"\");
114 } // end method run
115 } // end anonymous inner class
116); // end call to SwingUtilities.invokeLater
117
118 myTurn = (myMark.equals(X_MARK)); // determine if client's turn
119
120 // receive messages sent to client and output them
121 while (true)
122 {
123 if (input.hasNextLine())
124 processMessage(input.nextLine());
125 } // end while
126 } // end method run
127
128 // process messages received by client
129 private void processMessage(String message)
130 {

```

**Fig. 27.15** | Client side of client/server Tic-Tac-Toe program. (Part 3 of 6.)

```

131 // valid move occurred
132 if (message.equals("Valid move."))
133 {
134 displayMessage("Valid move, please wait.\n");
135 setMark(currentSquare, myMark); // set mark in square
136 } // end if
137 else if (message.equals("Invalid move, try again"))
138 {
139 displayMessage(message + "\n"); // display invalid move
140 myTurn = true; // still this client's turn
141 } // end else if
142 else if (message.equals("Opponent moved"))
143 {
144 int location = input.nextInt(); // get move location
145 input.nextLine(); // skip newline after int location
146 int row = location / 3; // calculate row
147 int column = location % 3; // calculate column
148
149 setMark(board[row][column],
150 (myMark.equals(X_MARK) ? O_MARK : X_MARK)); // mark move
151 displayMessage("Opponent moved. Your turn.\n");
152 myTurn = true; // now this client's turn
153 } // end else if
154 else
155 displayMessage(message + "\n"); // display the message
156 } // end method processMessage
157
158 // manipulate displayArea in event-dispatch thread
159 private void displayMessage(final String messageToDisplay)
160 {
161 SwingUtilities.invokeLater(
162 new Runnable()
163 {
164 public void run()
165 {
166 displayArea.append(messageToDisplay); // updates output
167 } // end method run
168 } // end inner class
169); // end call to SwingUtilities.invokeLater
170 } // end method displayMessage
171
172 // utility method to set mark on board in event-dispatch thread
173 private void setMark(final Square squareToMark, final String mark)
174 {
175 SwingUtilities.invokeLater(
176 new Runnable()
177 {
178 public void run()
179 {
180 squareToMark.setMark(mark); // set mark in square
181 } // end method run

```

**Fig. 27.15** | Client side of client/server Tic-Tac-Toe program. (Part 4 of 6.)

```

182 } // end anonymous inner class
183); // end call to SwingUtilities.invokeLater
184 } // end method setMark
185
186 // send message to server indicating clicked square
187 public void sendClickedSquare(int location)
188 {
189 // if it is my turn
190 if (myTurn)
191 {
192 output.format("%d\n", location); // send location to server
193 output.flush();
194 myTurn = false; // not my turn any more
195 } // end if
196 } // end method sendClickedSquare
197
198 // set current Square
199 public void setCurrentSquare(Square square)
200 {
201 currentSquare = square; // set current square to argument
202 } // end method setCurrentSquare
203
204 // private inner class for the squares on the board
205 private class Square extends JPanel
206 {
207 private String mark; // mark to be drawn in this square
208 private int location; // location of square
209
210 public Square(String squareMark, int squareLocation)
211 {
212 mark = squareMark; // set mark for this square
213 location = squareLocation; // set location of this square
214
215 addMouseListener(
216 new MouseAdapter()
217 {
218 public void mouseReleased(MouseEvent e)
219 {
220 setCurrentSquare(Square.this); // set current square
221
222 // send location of this square
223 sendClickedSquare(getSquareLocation());
224 } // end method mouseReleased
225 } // end anonymous inner class
226); // end call to addMouseListener
227 } // end Square constructor
228
229 // return preferred size of Square
230 public Dimension getPreferredSize()
231 {
232 return new Dimension(30, 30); // return preferred size
233 } // end method getPreferredSize

```

**Fig. 27.15** | Client side of client/server Tic-Tac-Toe program. (Part 5 of 6.)



```

234
235 // return minimum size of Square
236 public Dimension getMinimumSize()
237 {
238 return getPreferredSize(); // return preferred size
239 } // end method getMinimumSize
240
241 // set mark for Square
242 public void setMark(String newMark)
243 {
244 mark = newMark; // set mark of square
245 repaint(); // repaint square
246 } // end method setMark
247
248 // return Square location
249 public int getSquareLocation()
250 {
251 return location; // return location of square
252 } // end method getSquareLocation
253
254 // draw Square
255 public void paintComponent(Graphics g)
256 {
257 super.paintComponent(g);
258
259 g.drawRect(0, 0, 29, 29); // draw square
260 g.drawString(mark, 11, 20); // draw mark
261 } // end method paintComponent
262 } // end inner-class Square
263 } // end class TicTacToeClient

```

**Fig. 27.15** | Client side of client/server Tic-Tac-Toe program. (Part 6 of 6.)

```

1 // Fig. 27.16: TicTacToeClientTest.java
2 // Test class for Tic-Tac-Toe client.
3 import javax.swing.JFrame;
4
5 public class TicTacToeClientTest
6 {
7 public static void main(String[] args)
8 {
9 TicTacToeClient application; // declare client application
10
11 // if no command line args
12 if (args.length == 0)
13 application = new TicTacToeClient("127.0.0.1"); // localhost
14 else
15 application = new TicTacToeClient(args[0]); // use args
16
17 application.setDefaultCloseOperation(JFrame.EXIT_ON_CLOSE);
18 } // end main
19 } // end class TicTacToeClientTest

```

**Fig. 27.16** | Test class for Tic-Tac-Toe client.

If the message received is "Valid move.", lines 134–135 display the message "Valid move, please wait." and call method `setMark` (lines 173–184) to set the client's mark in the current square (the one in which the user clicked), using `SwingUtilities` method `invokeLater` to ensure that the GUI updates occur in the event-dispatch thread. If the message received is "Invalid move, try again.", line 139 displays the message so that the user can click a different square. If the message received is "Opponent moved.", line 144 reads an integer from the server indicating where the opponent moved, and lines 149–150 place a mark in that square of the board (again using `SwingUtilities` method `invokeLater` to ensure that the GUI updates occur in the event-dispatch thread). If any other message is received, line 155 simply displays the message.

a) Player X connected to server.

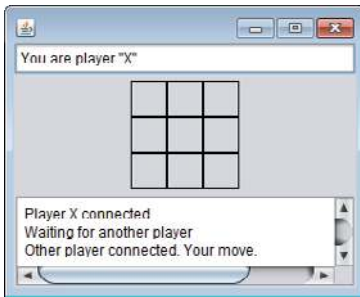

b) Player O connected to server.

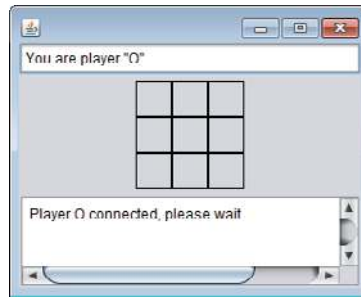

c) Player X moved.

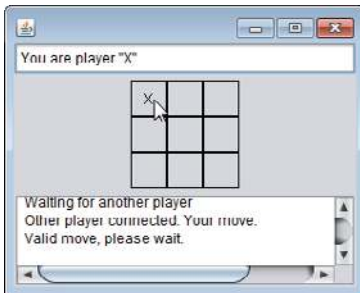

d) Player O sees Player X's move.

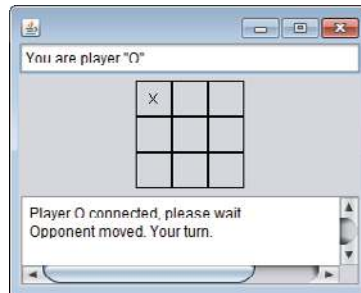

e) Player O moved.

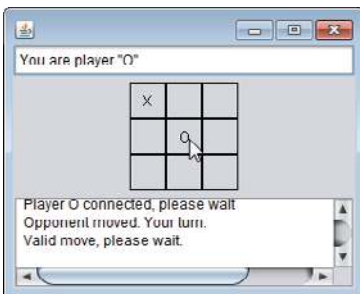

f) Player X sees Player O's move.

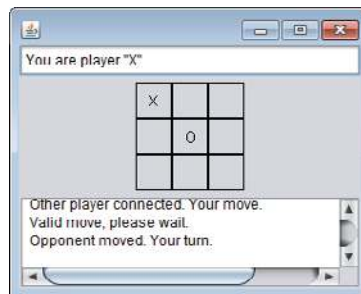
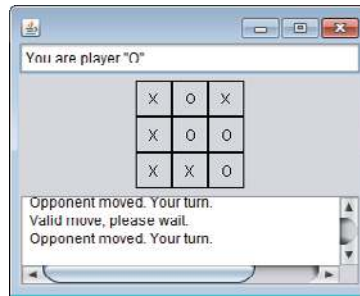

**Fig. 27.17** | Sample outputs from the client/server Tic-Tac-Toe program. (Part 1 of 2.)

g) Player X moved.



h) Player O sees Player X's last move.



**Fig. 27.17** | Sample outputs from the client/server Tic-Tac-Toe program. (Part 2 of 2.)

## 27.9 [Web Bonus] Case Study: DeitelMessenger

This case study is available at [www.deitel.com/books/jhttp9/](http://www.deitel.com/books/jhttp9/). Chat rooms provide a central location where users can chat with each other via short text messages. Each participant can see all the messages that the other users post, and each user can post messages. This case study integrates many of the Java networking, multithreading and Swing GUI features you've learned thus far to build an online chat system. We also introduce **multicasting**, which enables an application to send `DatagramPackets` to *groups* of clients.

The DeitelMessenger case study is a significant application that uses many intermediate Java features, such as networking with `Sockets`, `DatagramPackets` and `MulticastSockets`, multithreading and Swing GUI. The case study also demonstrates good software engineering practices by separating interface from implementation and enabling developers to support different network protocols and provide different user interfaces. After reading this case study, you'll be able to build more significant networking applications.

### 27.10 Wrap-Up

In this chapter, you learned the basics of network programming in Java. We began with a simple applet and application in which Java performed the networking for you. You then learned two different methods of sending data over a network—streams-based networking using TCP/IP and datagrams-based networking using UDP. We showed how to build simple client/server chat programs using both streams-based and datagram-based networking. You then saw a client/server Tic-Tac-Toe game that enables two clients to play by interacting with a multithreaded server that maintains the game's state and logic. In the next chapter, you'll learn basic database concepts, how to interact with data in a database using SQL and how to use JDBC to allow Java applications to manipulate database data.

## Summary

### Section 27.1 Introduction

- Java provides stream sockets and datagram sockets (p. 1119). With stream sockets (p. 1119), a process establishes a connection (p. 1119) to another process. While the connection is in place, data flows between the processes in streams. Stream sockets are said to provide a connection-ori-

ented service (p. 1119). The protocol used for transmission is the popular TCP (Transmission Control Protocol; p. 1119).

- With datagram sockets (datagram socket), individual packets of information are transmitted. UDP (User Datagram Protocol; p. 1119) is a connectionless service that does not guarantee that packets will not be lost, duplicated or arrive out of sequence.

### *Section 27.2 Manipulating URLs*

- The HTTP protocol (p. 1120) uses URIs (p. 1120) to locate data on the Internet. Common URIs represent files or directories and can represent complex tasks such as database lookups and Internet searches. A URI that represents a website or web page is called a URL (p. 1120).
- Applet method `getAppletContext` (p. 1124) returns an `AppletContext` (p. 1120) that represents the browser in which the applet is executing. `AppletContext` method `showDocument` (p. 1120) receives a URL and passes it to the `AppletContext`, which displays the corresponding web resource. A second version of `showDocument` enables an applet to specify the target frame (p. 1124) in which to display a web resource.

### *Section 27.3 Reading a File on a Web Server*

- `JEditorPane` (p. 1125) method `setPage` (p. 1127) downloads the document specified by its argument and displays it.
- Typically, an HTML document contains hyperlinks that link to other documents on the web. If an HTML document is displayed in an uneditable `JEditorPane` and the user clicks a hyperlink (p. 1127), a `HyperlinkEvent` (p. 1125) occurs and the `HyperlinkListeners` are notified.
- `HyperlinkEvent` method `getEventType` (p. 1127) determines the event type. `HyperlinkEvent` contains nested class `EventType` (p. 1127), which declares event types `ACTIVATED`, `ENTERED` and `EXITED`. `HyperlinkEvent` method `getURL` (p. 1127) obtains the URL represented by the hyperlink.

### *Section 27.4 Establishing a Simple Server Using Stream Sockets*

- Stream-based connections (p. 1119) are managed with `Socket` objects (p. 1128).
- A `ServerSocket` object (p. 1128) establishes the port (p. 1128) where a server (p. 1119) waits for connections from clients (p. 1119). `ServerSocket` method `accept` (p. 1128) waits indefinitely for a connection from a client and returns a `Socket` object when a connection is established.
- `Socket` methods `getOutputStream` and `getInputStream` (p. 1129) get references to a `Socket`'s `OutputStream` and `InputStream`, respectively. Method `close` (p. 1129) terminates a connection.

### *Section 27.5 Establishing a Simple Client Using Stream Sockets*

- A server name and port number (p. 1128) are specified when creating a `Socket` object to enable it to connect a client to the server. A failed connection attempt throws an `IOException`.
- `InetAddress` method `getByName` (p. 1142) returns an `InetAddress` object (p. 1136) containing the IP address of the specified computer. `InetAddress` method `getLocalHost` (p. 1142) returns an `InetAddress` object containing the IP address of the local computer executing the program.

### *Section 27.7 Datagrams: Connectionless Client/Server Interaction*

- Connection-oriented transmission is like the telephone system—you dial and are given a connection to the telephone of the person with whom you wish to communicate. The connection is maintained for the duration of your phone call, even when you aren't talking.
- Connectionless transmission (p. 1142) with datagrams is similar to mail carried via the postal service. A large message that will not fit in one envelope can be broken into separate message pieces that are placed in separate, sequentially numbered envelopes. All the letters are then mailed at once. They could arrive in order, out of order or not at all.

- DatagramPacket objects store packets of data that are to be sent or that are received by an application. DatagramSockets send and receive DatagramPackets.
- The DatagramSocket constructor that takes no arguments binds the DatagramSocket to a port chosen by the computer executing the program. The one that takes an integer port-number argument binds the DatagramSocket to the specified port. If a DatagramSocket constructor fails to bind the DatagramSocket to a port, a SocketException occurs (p. 1143). DatagramSocket method receive (p. 1146) blocks (waits) until a packet arrives, then stores the packet in its argument.
- DatagramPacket method getAddress (p. 1146) returns an InetAddress object containing information about the computer from or to which the packet was sent. Method getPort (p. 1146) returns an integer specifying the port number (p. 1128) through which the DatagramPacket was sent or received. Method getLength (getLength) returns the number of bytes of data in a DatagramPacket. Method getData (p. 1146) returns a byte array containing the data.
- The DatagramPacket constructor for a packet to be sent takes four arguments—the byte array to be sent, the number of bytes to be sent, the client address to which the packet will be sent and the port number where the client is waiting to receive packets.
- DatagramSocket method send (p. 1146) sends a DatagramPacket out over the network.
- If an error occurs when receiving or sending a DatagramPacket, an IOException occurs.

## Self-Review Exercises

- 27.1** Fill in the blanks in each of the following statements:
- Exception \_\_\_\_\_ occurs when an input/output error occurs when closing a socket.
  - Exception \_\_\_\_\_ occurs when a hostname indicated by a client cannot be resolved to an address.
  - If a DatagramSocket constructor fails to set up a DatagramSocket properly, an exception of type \_\_\_\_\_ occurs.
  - Many of Java's networking classes are contained in package \_\_\_\_\_.
  - Class \_\_\_\_\_ binds the application to a port for datagram transmission.
  - An object of class \_\_\_\_\_ contains an IP address.
  - The two types of sockets we discussed in this chapter are \_\_\_\_\_ and \_\_\_\_\_.
  - The acronym URL stands for \_\_\_\_\_.
  - The acronym URI stands for \_\_\_\_\_.
  - The key protocol that forms the basis of the World Wide Web is \_\_\_\_\_.
  - AppletContext method \_\_\_\_\_ receives a URL object as an argument and displays in a browser the World Wide Web resource associated with that URL.
  - Method getLocalHost returns a(n) \_\_\_\_\_ object containing the local IP address of the computer on which the program is executing.
  - The URL constructor determines whether its String argument is a valid URL. If so, the URL object is initialized with that location. If not, a(n) \_\_\_\_\_ exception occurs.
- 27.2** State whether each of the following is *true* or *false*. If *false*, explain why.
- UDP is a connection-oriented protocol.
  - With stream sockets a process establishes a connection to another process.
  - A server waits at a port for connections from a client.
  - Datagram packet transmission over a network is reliable—packets are guaranteed to arrive in sequence.

## Answers to Self-Review Exercises

- 27.1** a) IOException. b) UnknownHostException. c) SocketException. d) java.net. e) DatagramSocket. f) InetAddress. g) stream sockets, datagram sockets. h) Uniform Resource Locator.

i) Uniform Resource Identifier. j) HTTP. k) `showDocument`. l) `InetAddress`. m) `MalformedURLException`.

**27.2** a) False; UDP is a connectionless protocol and TCP is a connection-oriented protocol.  
b) True. c) True. d) False; packets can be lost, arrive out of order or be duplicated.

## Exercises

**27.3** Distinguish between connection-oriented and connectionless network services.

**27.4** How does a client determine the hostname of the client computer?

**27.5** Under what circumstances would a `SocketException` be thrown?

**27.6** How can a client get a line of text from a server?

**27.7** Describe how a client connects to a server.

**27.8** Describe how a server sends data to a client.

**27.9** Describe how to prepare a server to receive a stream-based connection from a single client.

**27.10** How does a server listen for streams-based socket connections at a port?

**27.11** What determines how many connect requests from clients can wait in a queue to connect to a server?

**27.12** As described in the text, what reasons might cause a server to refuse a connection request from a client?

**27.13** Use a socket connection to allow a client to specify a file name of a text file and have the server send the contents of the file or indicate that the file does not exist.

**27.14** Modify Exercise 27.13 to allow the client to modify the contents of the file and send the file back to the server for storage. The user can edit the file in a `JTextArea`, then click a *save changes* button to send the file back to the server.

**27.15** Modify the program in Fig. 27.2 to allow users to add their own sites to the list and remove sites from the list.

**27.16** (*Multithreaded Server*) Multithreaded servers are quite popular today, especially because of the increasing use of multicore servers. Modify the simple server application presented in Section 27.6 to be a multithreaded server. Then use several client applications and have each of them connect to the server simultaneously. Use an `ArrayList` to store the client threads. `ArrayList` provides several methods to use in this exercise. Method `size` determines the number of elements in an `ArrayList`. Method `get` returns the element in the location specified by its argument. Method `add` places its argument at the end of the `ArrayList`. Method `remove` deletes its argument from the `ArrayList`.

**27.17** (*Checkers Game*) In the text, we presented a Tic-Tac-Toe program controlled by a multithreaded server. Develop a checkers program modeled after the Tic-Tac-Toe program. The two users should alternate making moves. Your program should mediate the players' moves, determining whose turn it is and allowing only valid moves. The players themselves will determine when the game is over.

**27.18** (*Chess Game*) Develop a chess-playing program modeled after Exercise 27.17.

**27.19** (*Blackjack Game*) Develop a blackjack card game program in which the server application deals cards to each of the clients. The server should deal additional cards (per the rules of the game) to each player as requested.

**27.20** (*Poker Game*) Develop a poker game in which the server application deals cards to each client. The server should deal additional cards (per the rules of the game) to each player as requested.

**27.21** (*Modifications to the Multithreaded Tic-Tac-Toe Program*) The programs in Figs. 27.13 and 27.15 implemented a multithreaded, client/server version of the game of Tic-Tac-Toe. Our goal in developing this game was to demonstrate a multithreaded server that could process multiple connections from clients at the same time. The server in the example is really a mediator between

the two client applets—it makes sure that each move is valid and that each client moves in the proper order. The server does not determine who won or lost or whether there was a draw. Also, there's no capability to allow a new game to be played or to terminate an existing game.

The following is a list of suggested modifications to Figs. 27.13 and 27.15:

- a) Modify the `TicTacToeServer` class to test for a win, loss or draw after each move. Send a message to each client that indicates the result of the game when the game is over.
- b) Modify the `TicTacToeClient` class to display a button that when clicked allows the client to play another game. The button should be enabled only when a game completes. Both class `TicTacToeClient` and class `TicTacToeServer` must be modified to reset the board and all state information. Also, the other `TicTacToeClient` should be notified that a new game is about to begin so that its board and state can be reset.
- c) Modify the `TicTacToeClient` class to provide a button that allows a client to terminate the program at any time. When the user clicks the button, the server and the other client should be notified. The server should then wait for a connection from another client so that a new game can begin.
- d) Modify the `TicTacToeClient` class and the `TicTacToeServer` class so that the winner of a game can choose game piece X or O for the next game. Remember: X always goes first.
- e) If you'd like to be ambitious, allow a client to play against the server while the server waits for a connection from another client.

**27.22** (*3-D Multithreaded Tic-Tac-Toe*) Modify the multithreaded, client/server Tic-Tac-Toe program to implement a three-dimensional 4-by-4-by-4 version of the game. Implement the server application to mediate between the two clients. Display the three-dimensional board as four boards containing four rows and four columns each. If you're ambitious, try the following modifications:

- a) Draw the board in a three-dimensional manner.
- b) Allow the server to test for a win, loss or draw. Beware! There are many possible ways to win on a 4-by-4-by-4 board!

**27.23** (*Networked Morse Code*) Perhaps the most famous of all coding schemes is the Morse code, developed by Samuel Morse in 1832 for use with the telegraph system. The Morse code assigns a series of dots and dashes to each letter of the alphabet, each digit, and a few special characters (e.g., period, comma, colon and semicolon). In sound-oriented systems, the dot represents a short sound and the dash a long sound. Other representations of dots and dashes are used with light-oriented systems and signal-flag systems. Separation between words is indicated by a space or, simply, the absence of a dot or dash. In a sound-oriented system, a space is indicated by a short time during which no sound is transmitted. The international version of the Morse code appears in Fig. 27.18.

| Character | Code | Character | Code   | Character | Code  | Character | Code   |
|-----------|------|-----------|--------|-----------|-------|-----------|--------|
| A         | .-   | J         | .-.-.- | S         | ...   | 1         | .-.-.- |
| B         | -... | K         | -.-    | T         | -     | 2         | ..-.-  |
| C         | -.-. | L         | .-..   | U         | ..-   | 3         | ...--  |
| D         | -..  | M         | --     | V         | ...-  | 4         | ....-  |
| E         | .    | N         | -.     | W         | .-.-  | 5         | .....  |
| F         | ...- | O         | ---    | X         | -.-.  | 6         | -..... |
| G         | --.  | P         | ..-.   | Y         | -.--  | 7         | --.... |
| H         | .... | Q         | ---.   | Z         | ---.. | 8         | ----.. |
| I         | ..   | R         | .-.    |           |       | 9         | -----  |
|           |      |           |        |           |       | 0         | -----  |

**Fig. 27.18** | Letters and digits in international Morse code.

Write a client/server application in which two clients can send Morse-code messages to each other through a multithreaded server application. The client application should allow the user to type English-language phrases in a `JTextArea`. When the user sends the message, the client application encodes the text into Morse code and sends the coded message through the server to the other client. Use one blank between each Morse-coded letter and three blanks between each Morse-coded word. When messages are received, they should be decoded and displayed as normal characters and as Morse code. The client should have one `JTextField` for typing and one `JTextArea` for displaying the other client's messages.



# Accessing Databases with JDBC

# 28



*It is a capital mistake to theorize before one has data.*

—Arthur Conan Doyle

*Now go, write it before them in a table, and note it in a book, that it may be for the time to come for ever and ever.*

—The Holy Bible, Isaiah 30:8

*Get your facts first, and then you can distort them as much as you please.*

—Mark Twain

*I like two kinds of men: domestic and foreign.*

—Mae West

## Objectives

In this chapter you'll learn:

- Relational database concepts.
- To use Structured Query Language (SQL) to retrieve data from and manipulate data in a database.
- To use the JDBC™ API to access databases.
- To use the RowSet interface from package `javax.sql` to manipulate databases.
- To use JDBC 4's automatic JDBC driver discovery.
- To create precompiled SQL statements with parameters via `PreparedStatement`.
- How transaction processing makes database applications more robust.

- |                                                                                                                                                                                                                                                                                                                                                                                                                                                                                                                                                                                                                         |                                                                                                                                                                                                                                                                                                                                                                                                                                                                                                                                                                                                                                                             |
|-------------------------------------------------------------------------------------------------------------------------------------------------------------------------------------------------------------------------------------------------------------------------------------------------------------------------------------------------------------------------------------------------------------------------------------------------------------------------------------------------------------------------------------------------------------------------------------------------------------------------|-------------------------------------------------------------------------------------------------------------------------------------------------------------------------------------------------------------------------------------------------------------------------------------------------------------------------------------------------------------------------------------------------------------------------------------------------------------------------------------------------------------------------------------------------------------------------------------------------------------------------------------------------------------|
| <ul style="list-style-type: none"> <li><b>28.1</b> Introduction</li> <li><b>28.2</b> Relational Databases</li> <li><b>28.3</b> Relational Database Overview:<br/>The books Database</li> <li><b>28.4</b> SQL <ul style="list-style-type: none"> <li>28.4.1 Basic SELECT Query</li> <li>28.4.2 WHERE Clause</li> <li>28.4.3 ORDER BY Clause</li> <li>28.4.4 Merging Data from Multiple<br/>Tables: INNER JOIN</li> <li>28.4.5 INSERT Statement</li> <li>28.4.6 UPDATE Statement</li> <li>28.4.7 DELETE Statement</li> </ul> </li> <li><b>28.5</b> Instructions for Installing MySQL<br/>and MySQL Connector/J</li> </ul> | <ul style="list-style-type: none"> <li><b>28.6</b> Instructions for Setting Up a MySQL<br/>User Account</li> <li><b>28.7</b> Creating Database books in MySQL</li> <li><b>28.8</b> Manipulating Databases with JDBC <ul style="list-style-type: none"> <li>28.8.1 Connecting to and Querying a Database</li> <li>28.8.2 Querying the books Database</li> </ul> </li> <li><b>28.9</b> RowSet Interface</li> <li><b>28.10</b> Java DB/Apache Derby</li> <li><b>28.11</b> PreparedStatements</li> <li><b>28.12</b> Stored Procedures</li> <li><b>28.13</b> Transaction Processing</li> <li><b>28.14</b> Wrap-Up</li> <li><b>28.15</b> Web Resources</li> </ul> |
|-------------------------------------------------------------------------------------------------------------------------------------------------------------------------------------------------------------------------------------------------------------------------------------------------------------------------------------------------------------------------------------------------------------------------------------------------------------------------------------------------------------------------------------------------------------------------------------------------------------------------|-------------------------------------------------------------------------------------------------------------------------------------------------------------------------------------------------------------------------------------------------------------------------------------------------------------------------------------------------------------------------------------------------------------------------------------------------------------------------------------------------------------------------------------------------------------------------------------------------------------------------------------------------------------|

*Summary | Self-Review Exercise | Answers to Self-Review Exercise | Exercises*

## 28.1 Introduction<sup>1</sup>

A **database** is an organized collection of data. There are many different strategies for organizing data to facilitate easy access and manipulation. A **database management system (DBMS)** provides mechanisms for storing, organizing, retrieving and modifying data for many users. Database management systems allow for the access and storage of data without concern for the internal representation of data.

Today’s most popular database systems are *relational databases* (Section 28.2). A language called **SQL**—pronounced “sequel,” or as its individual letters—is the international standard language used almost universally with relational databases to perform **queries** (i.e., to request information that satisfies given criteria) and to manipulate data. [*Note: As you learn about SQL, you’ll see some authors writing “a SQL statement” (which assumes the pronunciation “sequel”) and others writing “an SQL statement” (which assumes that the individual letters are pronounced). In this book we pronounce SQL as “sequel.”*]

Some popular **relational database management systems (RDBMSs)** are Microsoft SQL Server, Oracle, Sybase, IBM DB2, Informix, PostgreSQL and MySQL. The JDK now comes with a pure-Java RDBMS called Java DB—Oracle’s version of Apache Derby. In this chapter, we present examples using MySQL and Java DB.

Java programs communicate with databases and manipulate their data using the **Java Database Connectivity (JDBC™) API**. A **JDBC driver** enables Java applications to connect to a database in a particular DBMS and allows you to manipulate that database using the JDBC API.



### Software Engineering Observation 28.1

*Using the JDBC API enables developers to change the underlying DBMS (for example, from Java DB to MySQL) without modifying the Java code that accesses the database.*

1. Before using this chapter, please review the Before You Begin section of the book.

Most popular database management systems now provide JDBC drivers. There are also many third-party JDBC drivers available. In this chapter, we introduce JDBC and use it to manipulate MySQL and Java DB databases. The techniques demonstrated here can also be used to manipulate other databases that have JDBC drivers. Check your DBMS's documentation to determine whether your DBMS comes with a JDBC driver. If not, third-party vendors provide JDBC drivers for many DBMSs.



### Software Engineering Observation 28.2

*Most major database vendors provide their own JDBC database drivers, and many third-party vendors provide JDBC drivers as well.*

For more information on JDBC, visit

[www.oracle.com/technetwork/java/javase/tech/index-jsp-136101.html](http://www.oracle.com/technetwork/java/javase/tech/index-jsp-136101.html)

which contains JDBC information including the JDBC specification, FAQs, a learning resource center and software downloads.

## 28.2 Relational Databases

A **relational database** is a logical representation of data that allows the data to be accessed without consideration of its physical structure. A relational database stores data in **tables**. Figure 28.1 illustrates a sample table that might be used in a personnel system. The table name is `Employee`, and its primary purpose is to store the attributes of employees. Tables are composed of **rows**, and rows are composed of **columns** in which values are stored. This table consists of six rows. The `Number` column of each row is the table's **primary key**—a column (or group of columns) with a *unique* value that cannot be duplicated in other rows. This guarantees that each row can be identified by its primary key. Good examples of primary-key columns are a social security number, an employee ID number and a part number in an inventory system, as values in each of these columns are guaranteed to be unique. The rows in Fig. 28.1 are displayed in order by primary key. In this case, the rows are listed in increasing order, but we could also use decreasing order.

Rows in tables are not guaranteed to be stored in any particular order. As we'll demonstrate in an upcoming example, programs can specify ordering criteria when requesting data from a database.

|     | Number | Name     | Department | Salary | Location    |
|-----|--------|----------|------------|--------|-------------|
|     | 23603  | Jones    | 413        | 1100   | New Jersey  |
|     | 24568  | Kerwin   | 413        | 2000   | New Jersey  |
| Row | 34589  | Larson   | 642        | 1800   | Los Angeles |
|     | 35761  | Myers    | 611        | 1400   | Orlando     |
|     | 47132  | Neumann  | 413        | 9000   | New Jersey  |
|     | 78321  | Stephens | 611        | 8500   | Orlando     |

Primary key
Column

**Fig. 28.1** | `Employee` table sample data.

Each column represents a different data attribute. Rows are normally unique (by primary key) within a table, but particular column values may be duplicated between rows. For example, three different rows in the `Employee` table's `Department` column contain number 413.

Different users of a database are often interested in different data and different relationships among the data. Most users require only subsets of the rows and columns. Queries specify which subsets of the data to select from a table. You use SQL to define queries. For example, you might select data from the `Employee` table to create a result that shows where each department is located, presenting the data sorted in increasing order by department number. This result is shown in Fig. 28.2. SQL is discussed in Section 28.4.

| Department | Location    |
|------------|-------------|
| 413        | New Jersey  |
| 611        | Orlando     |
| 642        | Los Angeles |

**Fig. 28.2** | Result of selecting distinct `Department` and `Location` data from table `Employee`.

## 28.3 Relational Database Overview: The books Database

We now overview relational databases in the context of a sample books database we created for this chapter. Before we discuss SQL, we discuss the *tables* of the books database. We use this database to introduce various database concepts, including how to use SQL to obtain information from the database and to manipulate the data. We provide a script to create the database. You can find the script in the `examples` directory for this chapter. Section 28.7 explains how to use this script. The database consists of three tables: `Authors`, `AuthorISBN` and `Titles`.

### *Authors Table*

The `Authors` table (described in Fig. 28.3) consists of three columns that maintain each author's unique ID number, first name and last name. Figure 28.4 contains sample data from the `Authors` table of the books database.

| Column                 | Description                                                                                                                                                                                                                                                                                                                            |
|------------------------|----------------------------------------------------------------------------------------------------------------------------------------------------------------------------------------------------------------------------------------------------------------------------------------------------------------------------------------|
| <code>AuthorID</code>  | Author's ID number in the database. In the books database, this integer column is defined as <b>autoincremented</b> —for each row inserted in this table, the <code>AuthorID</code> value is increased by 1 automatically to ensure that each row has a unique <code>AuthorID</code> . This column represents the table's primary key. |
| <code>FirstName</code> | Author's first name (a string).                                                                                                                                                                                                                                                                                                        |
| <code>LastName</code>  | Author's last name (a string).                                                                                                                                                                                                                                                                                                         |

**Fig. 28.3** | `Authors` table from the books database.

| AuthorID | FirstName | LastName |
|----------|-----------|----------|
| 1        | Paul      | Deitel   |
| 2        | Harvey    | Deitel   |
| 3        | Abbey     | Deitel   |
| 4        | Michael   | Morgano  |
| 5        | Eric      | Kern     |

**Fig. 28.4** | Sample data from the Authors table.

### AuthorISBN Table

The AuthorISBN table (described in Fig. 28.5) consists of two columns that maintain each ISBN and the corresponding author's ID number. This table associates authors with their books. Both columns are foreign keys that represent the relationship between the tables Authors and Titles—one row in table Authors may be associated with many rows in table Titles, and vice versa. The combined columns of the AuthorISBN table represent the table's *primary key*—thus, each row in this table must be a *unique* combination of an AuthorID and an ISBN. Figure 28.6 contains sample data from the AuthorISBN table of the books database. [Note: To save space, we have split the contents of this table into two columns, each containing the AuthorID and ISBN columns.] The AuthorID column is a **foreign key**—a column in this table that matches the primary-key column in another table (i.e., AuthorID in the Authors table). Foreign keys are specified when creating a table. The foreign key helps maintain the **Rule of Referential Integrity**—every foreign-key value must appear as another table's primary-key value. This enables the DBMS to determine whether the AuthorID value for a particular book is *valid*. Foreign keys also allow related data in multiple tables to be selected from those tables for analytic purposes—this is known as **joining** the data.

| Column   | Description                                                 |
|----------|-------------------------------------------------------------|
| AuthorID | The author's ID number, a foreign key to the Authors table. |
| ISBN     | The ISBN for a book, a foreign key to the Titles table.     |

**Fig. 28.5** | AuthorISBN table from the books database.

| AuthorID | ISBN       | AuthorID | ISBN       |
|----------|------------|----------|------------|
| 1        | 0132152134 | 2        | 0132575663 |
| 2        | 0132152134 | 1        | 0132662361 |
| 1        | 0132151421 | 2        | 0132662361 |
| 2        | 0132151421 | 1        | 0132404168 |
| 1        | 0132575663 | 2        | 0132404168 |

**Fig. 28.6** | Sample data from the AuthorISBN table of books. (Part I of 2.)

| AuthorID | ISBN       | AuthorID | ISBN       |
|----------|------------|----------|------------|
| 1        | 013705842X | 1        | 0132121360 |
| 2        | 013705842X | 2        | 0132121360 |
| 3        | 013705842X | 3        | 0132121360 |
| 4        | 013705842X | 4        | 0132121360 |
| 5        | 013705842X |          |            |

**Fig. 28.6** | Sample data from the AuthorISBN table of books. (Part 2 of 2.)

### Titles Table

The `Titles` table described in Fig. 28.7 consists of four columns that stand for the ISBN, the title, the edition number and the copyright year. The table is in Fig. 28.8.

| Column        | Description                                                                                                                                                                                                      |
|---------------|------------------------------------------------------------------------------------------------------------------------------------------------------------------------------------------------------------------|
| ISBN          | ISBN of the book (a string). The table's primary key. ISBN is an abbreviation for "International Standard Book Number"—a numbering scheme that publishers use to give every book a unique identification number. |
| Title         | Title of the book (a string).                                                                                                                                                                                    |
| EditionNumber | Edition number of the book (an integer).                                                                                                                                                                         |
| Copyright     | Copyright year of the book (a string).                                                                                                                                                                           |

**Fig. 28.7** | `Titles` table from the books database.

| ISBN       | Title                                           | EditionNumber | Copyright |
|------------|-------------------------------------------------|---------------|-----------|
| 0132152134 | Visual Basic 2010 How to Program                | 5             | 2011      |
| 0132151421 | Visual C# 2010 How to Program                   | 4             | 2011      |
| 0132575663 | Java How to Program                             | 9             | 2012      |
| 0132662361 | C++ How to Program                              | 8             | 2012      |
| 0132404168 | C How to Program                                | 6             | 2010      |
| 013705842X | iPhone for Programmers: An App-Driven Approach  | 1             | 2010      |
| 0132121360 | Android for Programmers: An App-Driven Approach | 1             | 2012      |

**Fig. 28.8** | Sample data from the `Titles` table of the books database .

### Entity-Relationship (ER) Diagram

There's a one-to-many relationship between a primary key and a corresponding foreign key (e.g., one author can write many books). A foreign key can appear many times in its own table, but only once (as the primary key) in another table. Figure 28.9 is an **entity-**

**relationship (ER) diagram** for the books database. This diagram shows the *database tables* and the *relationships* among them. The first compartment in each box contains the table's name and the remaining compartments contain the table's columns. The names in italic are primary keys. A table's primary key uniquely identifies each row in the table. Every row must have a primary-key value, and that value must be unique in the table. This is known as the **Rule of Entity Integrity**. Again, for the AuthorISBN table, the primary key is the combination of both columns.

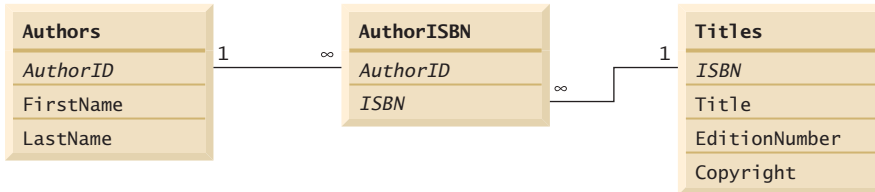

**Fig. 28.9** | Table relationships in the books database.



### Common Programming Error 28.1

*Not providing a value for every column in a primary key breaks the Rule of Entity Integrity and causes the DBMS to report an error.*



### Common Programming Error 28.2

*Providing the same primary-key value in multiple rows causes the DBMS to report an error.*

The lines connecting the tables (Fig. 28.9) represent the relationships between the tables. Consider the line between the AuthorISBN and Authors tables. On the Authors end of the line is a 1, and on the AuthorISBN end is an infinity symbol ( $\infty$ ), indicating a **one-to-many relationship** in which every author in the Authors table can have an arbitrary number of books in the AuthorISBN table. The relationship line links the AuthorID column in Authors (i.e., its primary key) to the AuthorID column in AuthorISBN (i.e., its foreign key). The AuthorID column in the AuthorISBN table is a foreign key.



### Common Programming Error 28.3

*Providing a foreign-key value that does not appear as a primary-key value in another table breaks the Rule of Referential Integrity and causes the DBMS to report an error.*

The line between Titles and AuthorISBN illustrates another *one-to-many relationship*; a title can be written by any number of authors. In fact, the sole purpose of the AuthorISBN table is to provide a *many-to-many relationship* between Authors and Titles—an author can write many books and a book can have many authors.

## 28.4 SQL

We now overview SQL in the context of our books database. You'll be able to use the SQL discussed here in the examples later in the chapter and in examples in Chapters 30–31.

The next several subsections discuss the SQL keywords listed in Fig. 28.10 in the context of SQL queries and statements. Other SQL keywords are beyond this text's scope. To

learn other keywords, refer to the SQL reference guide supplied by the vendor of the RDBMS you're using.

| SQL keyword | Description                                                                                                                     |
|-------------|---------------------------------------------------------------------------------------------------------------------------------|
| SELECT      | Retrieves data from one or more tables.                                                                                         |
| FROM        | Tables involved in the query. Required in every SELECT.                                                                         |
| WHERE       | Criteria for selection that determine the rows to be retrieved, deleted or updated. Optional in a SQL query or a SQL statement. |
| GROUP BY    | Criteria for grouping rows. Optional in a SELECT query.                                                                         |
| ORDER BY    | Criteria for ordering rows. Optional in a SELECT query.                                                                         |
| INNER JOIN  | Merge rows from multiple tables.                                                                                                |
| INSERT      | Insert rows into a specified table.                                                                                             |
| UPDATE      | Update rows in a specified table.                                                                                               |
| DELETE      | Delete rows from a specified table.                                                                                             |

**Fig. 28.10** | SQL query keywords.

### 28.4.1 Basic SELECT Query

Let us consider several SQL queries that extract information from database books. A SQL query “selects” rows and columns from one or more tables in a database. Such selections are performed by queries with the **SELECT** keyword. The basic form of a SELECT query is

```
SELECT * FROM tableName
```

in which the **asterisk (\*) wildcard character** indicates that all columns from the *tableName* table should be retrieved. For example, to retrieve all the data in the Authors table, use

```
SELECT * FROM Authors
```

Most programs do not require all the data in a table. To retrieve only specific columns, replace the \* with a comma-separated list of column names. For example, to retrieve only the columns AuthorID and LastName for all rows in the Authors table, use the query

```
SELECT AuthorID, LastName FROM Authors
```

This query returns the data listed in Fig. 28.11.

| AuthorID | LastName |
|----------|----------|
| 1        | Deitel   |
| 2        | Deitel   |
| 3        | Deitel   |
| 4        | Morgano  |
| 5        | Kern     |

**Fig. 28.11** | Sample AuthorID and LastName data from the Authors table.





### Software Engineering Observation 28.3

In general, you process results by knowing in advance the order of the columns in the result—for example, selecting `AuthorID` and `LastName` from table `Authors` ensures that the columns will appear in the result with `AuthorID` as the first column and `LastName` as the second column. Programs typically process result columns by specifying the column number in the result (starting from number 1 for the first column). Selecting columns by name avoids returning unneeded columns and protects against changes in the actual order of the columns in the table(s) by returning the columns in the exact order specified.



### Common Programming Error 28.4

If you assume that the columns are always returned in the same order from a query that uses the asterisk (\*), the program may process the results incorrectly. If the column order in the table(s) changes or if additional columns are added at a later time, the order of the columns in the result will change accordingly.

## 28.4.2 WHERE Clause

In most cases, it's necessary to locate rows in a database that satisfy certain **selection criteria**. Only rows that satisfy the selection criteria (formally called **predicates**) are selected. SQL uses the optional **WHERE clause** in a query to specify the selection criteria for the query. The basic form of a query with selection criteria is

```
SELECT columnName1, columnName2, ... FROM tableName WHERE criteria
```

For example, to select the `Title`, `EditionNumber` and `Copyright` columns from table `Titles` for which the `Copyright` date is greater than 2010, use the query

```
SELECT Title, EditionNumber, Copyright
FROM Titles
WHERE Copyright > '2010'
```

Strings in SQL are delimited by single (') rather than double (") quotes. Figure 28.12 shows the result of the preceding query.

| Title                                           | EditionNumber | Copyright |
|-------------------------------------------------|---------------|-----------|
| Visual Basic 2010 How to Program                | 5             | 2011      |
| Visual C# 2010 How to Program                   | 4             | 2011      |
| Java How to Program                             | 9             | 2012      |
| C++ How to Program                              | 8             | 2012      |
| Android for Programmers: An App-Driven Approach | 1             | 2012      |

**Fig. 28.12** | Sampling of titles with copyrights after 2005 from table `Titles`.

### Pattern Matching: Zero or More Characters

The `WHERE` clause criteria can contain the operators `<`, `>`, `<=`, `>=`, `=`, `<>` and `LIKE`. Operator **LIKE** is used for **pattern matching** with wildcard characters **percent (%)** and **underscore (\_)**. Pattern matching allows SQL to search for strings that match a given pattern.

A pattern that contains a percent character (%) searches for strings that have zero or more characters at the percent character's position in the pattern. For example, the next query locates the rows of all the authors whose last name starts with the letter D:

```
SELECT AuthorID, FirstName, LastName
FROM Authors
WHERE LastName LIKE 'D%'
```

This query selects the two rows shown in Fig. 28.13—three of the five authors have a last name starting with the letter D (followed by zero or more characters). The % symbol in the WHERE clause's LIKE pattern indicates that any number of characters can appear after the letter D in the LastName. The pattern string is surrounded by single-quote characters.

| AuthorID | FirstName | LastName |
|----------|-----------|----------|
| 1        | Paul      | Deitel   |
| 2        | Harvey    | Deitel   |
| 3        | Abbey     | Deitel   |

**Fig. 28.13** | Authors whose last name starts with D from the Authors table.



### Portability Tip 28.1

See the documentation for your database system to determine whether SQL is case sensitive on your system and to determine the syntax for SQL keywords.



### Portability Tip 28.2

Read your database system's documentation carefully to determine whether it supports the LIKE operator as discussed here.

### Pattern Matching: Any Character

An underscore ( \_ ) in the pattern string indicates a single wildcard character at that position in the pattern. For example, the following query locates the rows of all the authors whose last names start with any character (specified by \_), followed by the letter o, followed by any number of additional characters (specified by %):

```
SELECT AuthorID, FirstName, LastName
FROM Authors
WHERE LastName LIKE '_o%'
```

The preceding query produces the row shown in Fig. 28.14, because only one author in our database has a last name that contains the letter o as its second letter.

| AuthorID | FirstName | LastName |
|----------|-----------|----------|
| 4        | Michael   | Morgano  |

**Fig. 28.14** | The only author from the Authors table whose last name contains o as the second letter.

### 28.4.3 ORDER BY Clause

The rows in the result of a query can be sorted into ascending or descending order by using the optional **ORDER BY clause**. The basic form of a query with an ORDER BY clause is

```
SELECT columnName1, columnName2, ... FROM tableName ORDER BY column ASC
SELECT columnName1, columnName2, ... FROM tableName ORDER BY column DESC
```

where ASC specifies ascending order (lowest to highest), DESC specifies descending order (highest to lowest) and *column* specifies the column on which the sort is based. For example, to obtain the list of authors in ascending order by last name (Fig. 28.15), use the query

```
SELECT AuthorID, FirstName, LastName
FROM Authors
ORDER BY LastName ASC
```

| AuthorID | FirstName | LastName |
|----------|-----------|----------|
| 1        | Paul      | Deitel   |
| 2        | Harvey    | Deitel   |
| 3        | Abbey     | Deitel   |
| 5        | Eric      | Kern     |
| 4        | Michael   | Morgano  |

**Fig. 28.15** | Sample data from table Authors in ascending order by LastName.

#### *Sorting in Descending Order*

The default sorting order is ascending, so ASC is optional. To obtain the same list of authors in descending order by last name (Fig. 28.16), use the query

```
SELECT AuthorID, FirstName, LastName
FROM Authors
ORDER BY LastName DESC
```

| AuthorID | FirstName | LastName |
|----------|-----------|----------|
| 4        | Michael   | Morgano  |
| 5        | Eric      | Kern     |
| 1        | Paul      | Deitel   |
| 2        | Harvey    | Deitel   |
| 3        | Abbey     | Deitel   |

**Fig. 28.16** | Sample data from table Authors in descending order by LastName.

#### *Sorting By Multiple Columns*

Multiple columns can be used for sorting with an ORDER BY clause of the form

```
ORDER BY column1 sortingOrder, column2 sortingOrder, ...
```

where *sortingOrder* is either ASC or DESC. The *sortingOrder* does not have to be identical for each column. The query

```
SELECT AuthorID, FirstName, LastName
FROM Authors
ORDER BY LastName, FirstName
```

sorts all the rows in ascending order by last name, then by first name. If any rows have the same last-name value, they're returned sorted by first name (Fig. 28.17).

| AuthorID | FirstName | LastName |
|----------|-----------|----------|
| 3        | Abbey     | Deitel   |
| 2        | Harvey    | Deitel   |
| 1        | Paul      | Deitel   |
| 5        | Eric      | Kern     |
| 4        | Michael   | Morgano  |

**Fig. 28.17** | Sample data from Authors in ascending order by LastName and FirstName.

### Combining the WHERE and ORDER BY Clauses

The WHERE and ORDER BY clauses can be combined in one query, as in

```
SELECT ISBN, Title, EditionNumber, Copyright
FROM Titles
WHERE Title LIKE '%How to Program'
ORDER BY Title ASC
```

which returns the ISBN, Title, EditionNumber and Copyright of each book in the Titles table that has a Title ending with "How to Program" and sorts them in ascending order by Title. The query results are shown in Fig. 28.18.

| ISBN       | Title                            | Edition-<br>Number | Copy-<br>right |
|------------|----------------------------------|--------------------|----------------|
| 0132404168 | C How to Program                 | 6                  | 2010           |
| 0132662361 | C++ How to Program               | 8                  | 2012           |
| 0132575663 | Java How to Program              | 9                  | 2012           |
| 0132152134 | Visual Basic 2005 How to Program | 5                  | 2011           |
| 0132151421 | Visual C# 2005 How to Program    | 4                  | 2011           |

**Fig. 28.18** | Sampling of books from table Titles whose titles end with How to Program in ascending order by Title.

## 28.4.4 Merging Data from Multiple Tables: INNER JOIN

Database designers often split related data into separate tables to ensure that a database does not store data redundantly. For example, in the books database, we use an AuthorISBN table to store the relationship data between authors and their corresponding titles. If we did

not separate this information into individual tables, we'd need to include author information with each entry in the `TITLES` table. This would result in the database's storing *duplicate* author information for authors who wrote multiple books. Often, it's necessary to merge data from multiple tables into a single result. Referred to as joining the tables, this is specified by an **INNER JOIN** operator, which merges rows from two tables by matching values in columns that are common to the tables. The basic form of an **INNER JOIN** is:

```
SELECT columnName1, columnName2, ...
FROM table1
INNER JOIN table2
ON table1.columnName = table2.columnName
```

The **ON clause** of the **INNER JOIN** specifies the columns from each table that are compared to determine which rows are merged. For example, the following query produces a list of authors accompanied by the ISBNs for books written by each author:

```
SELECT FirstName, LastName, ISBN
FROM Authors
INNER JOIN AuthorISBN
ON Authors.AuthorID = AuthorISBN.AuthorID
ORDER BY LastName, FirstName
```

The query merges the `FirstName` and `LastName` columns from table `Authors` with the `ISBN` column from table `AuthorISBN`, sorting the result in ascending order by `LastName` and `FirstName`. Note the use of the syntax `tableName.columnName` in the **ON** clause. This syntax, called a **qualified name**, specifies the columns from each table that should be compared to join the tables. The “`tableName.`” syntax is required if the columns have the same name in both tables. The same syntax can be used in any SQL statement to distinguish columns in different tables that have the same name. In some systems, table names qualified with the database name can be used to perform cross-database queries. As always, the query can contain an **ORDER BY** clause. Figure 28.19 shows the results of the preceding query, ordered by `LastName` and `FirstName`. [*Note:* To save space, we split the result of the query into two columns, each containing the `FirstName`, `LastName` and `ISBN` columns.]

| FirstName | LastName | ISBN       | FirstName | LastName | ISBN       |
|-----------|----------|------------|-----------|----------|------------|
| Abbey     | Deitel   | 013705842X | Paul      | Deitel   | 0132151421 |
| Abbey     | Deitel   | 0132121360 | Paul      | Deitel   | 0132575663 |
| Harvey    | Deitel   | 0132152134 | Paul      | Deitel   | 0132662361 |
| Harvey    | Deitel   | 0132151421 | Paul      | Deitel   | 0132404168 |
| Harvey    | Deitel   | 0132575663 | Paul      | Deitel   | 013705842X |
| Harvey    | Deitel   | 0132662361 | Paul      | Deitel   | 0132121360 |
| Harvey    | Deitel   | 0132404168 | Eric      | Kern     | 013705842X |
| Harvey    | Deitel   | 013705842X | Michael   | Morgano  | 013705842X |
| Harvey    | Deitel   | 0132121360 | Michael   | Morgano  | 0132121360 |
| Paul      | Deitel   | 0132152134 |           |          |            |

**Fig. 28.19** | Sampling of authors and ISBNs for the books they have written in ascending order by `LastName` and `FirstName`.



### Software Engineering Observation 28.4

If a SQL statement includes columns with the same name from multiple tables, the statement must precede those column names with their table names and a dot (e.g., `Authors.AuthorID`).



### Common Programming Error 28.5

Failure to qualify names for columns that have the same name in two or more tables is an error.

## 28.4.5 INSERT Statement

The **INSERT** statement inserts a row into a table. The basic form of this statement is

```
INSERT INTO tableName (columnName1, columnName2, ..., columnNameN)
VALUES (value1, value2, ..., valueN)
```

where *tableName* is the table in which to insert the row. The *tableName* is followed by a comma-separated list of column names in parentheses (this list is not required if the **INSERT** operation specifies a value for every column of the table in the correct order). The list of column names is followed by the SQL keyword **VALUES** and a comma-separated list of values in parentheses. The values specified here must match the columns specified after the table name in both order and type (e.g., if *columnName1* is supposed to be the `FirstName` column, then *value1* should be a string in single quotes representing the first name). Always explicitly list the columns when inserting rows. If the table's column order changes or a new column is added, using only **VALUES** may cause an error. The **INSERT** statement

```
INSERT INTO Authors (FirstName, LastName)
VALUES ('Sue', 'Red')
```

inserts a row into the `Authors` table. The statement indicates that values are provided for the `FirstName` and `LastName` columns. The corresponding values are 'Sue' and 'Smith'. We do not specify an `AuthorID` in this example because `AuthorID` is an autoincremented column in the `Authors` table. For every row added to this table, the DBMS assigns a unique `AuthorID` value that is the next value in the autoincremented sequence (i.e., 1, 2, 3 and so on). In this case, Sue Red would be assigned `AuthorID` number 6. Figure 28.20 shows the `Authors` table after the **INSERT** operation. [Note: Not every database management system supports autoincremented columns. Check the documentation for your DBMS for alternatives to autoincremented columns.]

| AuthorID | FirstName | LastName |
|----------|-----------|----------|
| 1        | Paul      | Deitel   |
| 2        | Harvey    | Deitel   |
| 3        | Abbey     | Deitel   |
| 4        | Michael   | Morgano  |
| 5        | Eric      | Kern     |
| 6        | Sue       | Red      |

**Fig. 28.20** | Sample data from table `Authors` after an **INSERT** operation.

**Common Programming Error 28.6**

*It's normally an error to specify a value for an autoincrement column.*

**Common Programming Error 28.7**

*SQL delimits strings with single quotes ('). A string containing a single quote (e.g., O'Malley) must have two single quotes in the position where the single quote appears (e.g., 'O' 'Ma11ey'). The first acts as an escape character for the second. Not escaping single-quote characters in a string that's part of a SQL statement is a SQL syntax error.*

### 28.4.6 UPDATE Statement

An **UPDATE** statement modifies data in a table. Its basic form is

```
UPDATE tableName
SET columnName1 = value1, columnName2 = value2, ..., columnNameN = valueN
WHERE criteria
```

where *tableName* is the table to update. The *tableName* is followed by keyword **SET** and a comma-separated list of column name/value pairs in the format *columnName = value*. The optional **WHERE** clause provides criteria that determine which rows to update. Though not required, the **WHERE** clause is typically used, unless a change is to be made to every row. The **UPDATE** statement

```
UPDATE Authors
SET LastName = 'Black'
WHERE LastName = 'Red' AND FirstName = 'Sue'
```

updates a row in the **Authors** table. The statement indicates that **LastName** will be assigned the value **Black** for the row in which **LastName** is equal to **Red** and **FirstName** is equal to **Sue**. [Note: If there are multiple rows with the first name “Sue” and the last name “Red,” this statement will modify all such rows to have the last name “Black.”] If we know the **AuthorID** in advance of the **UPDATE** operation (possibly because we searched for it previously), the **WHERE** clause can be simplified as follows:

```
WHERE AuthorID = 6
```

Figure 28.21 shows the **Authors** table after the **UPDATE** operation has taken place.

| AuthorID | FirstName | LastName |
|----------|-----------|----------|
| 1        | Paul      | Deitel   |
| 2        | Harvey    | Deitel   |
| 3        | Abbey     | Deitel   |
| 4        | Michael   | Morgano  |
| 5        | Eric      | Kern     |
| 6        | Sue       | Black    |

**Fig. 28.21** | Sample data from table **Authors** after an **UPDATE** operation.

### 28.4.7 DELETE Statement

A SQL **DELETE** statement removes rows from a table. Its basic form is

```
DELETE FROM tableName WHERE criteria
```

where *tableName* is the table from which to delete. The optional WHERE clause specifies the criteria used to determine which rows to delete. If this clause is omitted, all the table's rows are deleted. The DELETE statement

```
DELETE FROM Authors
WHERE LastName = 'Black' AND FirstName = 'Sue'
```

deletes the row for Sue Black in the Authors table. If we know the AuthorID in advance of the DELETE operation, the WHERE clause can be simplified as follows:

```
WHERE AuthorID = 5
```

Figure 28.22 shows the Authors table after the DELETE operation has taken place.

| AuthorID | FirstName | LastName |
|----------|-----------|----------|
| 1        | Paul      | Deitel   |
| 2        | Harvey    | Deitel   |
| 3        | Abbey     | Deitel   |
| 4        | Michael   | Morgano  |
| 5        | Eric      | Kern     |

**Fig. 28.22** | Sample data from table Authors after a DELETE operation.

## 28.5 Instructions for Installing MySQL and MySQL Connector/J

**MySQL Community Edition** is an open-source database management system that executes on many platforms, including Windows, Linux, and Mac OS X. Complete information about MySQL is available from [www.mysql.com](http://www.mysql.com). The examples in Sections 28.8–28.9 manipulate MySQL databases using MySQL 5.5.8—the latest release at the time of this writing.

### *Installing MySQL*

To install MySQL Community Edition on Windows, Linux or Mac OS X, see the installation overview for your platform at:

- Windows: [dev.mysql.com/doc/refman/5.5/en/windows-installation.html](http://dev.mysql.com/doc/refman/5.5/en/windows-installation.html)
- Linux: [dev.mysql.com/doc/refman/5.5/en/linux-installation-rpm.html](http://dev.mysql.com/doc/refman/5.5/en/linux-installation-rpm.html)
- Mac OS X: [dev.mysql.com/doc/refman/5.5/en/macosx-installation.html](http://dev.mysql.com/doc/refman/5.5/en/macosx-installation.html)

Carefully follow the instructions for downloading and installing the software on your platform. The downloads are available from:

```
dev.mysql.com/downloads/mysql/
```



For the following steps, we assume that you're installing MySQL on Windows. When you execute the installer, the **MySQL Server 5.5 Setup Wizard** window will appear. Perform the following steps:

1. Click the **Next** button.
2. Read the license agreement, then check the **I accept the terms in the License Agreement** checkbox and click the **Next** button. [*Note:* If you do not accept the license terms, you will not be able to install MySQL.]
3. Click the **Typical** button in the **Choose Setup Type** screen then click **Install**.
4. When the installation completes, click **Next >** twice.
5. In the **Completed the MySQL Server 5.5 Setup Wizard** screen, ensure that the **Launch the MySQL Instance Configuration Wizard** checkbox is checked, then click **Finish** to begin configuring the server.

The **MySQL Instance Configuration Wizard** window appears. To configure the server:

1. Click **Next >**, then select **Standard Configuration** and click **Next >** again.
2. You have the option of installing MySQL as a Windows service, which enables the MySQL server to begin executing automatically each time your system starts. For our examples, this is unnecessary, so you can uncheck **Install as a Windows Service** if you wish. Check **Include Bin Directory in Windows PATH**. This will enable you to use the MySQL commands in the Windows Command Prompt. Click **Next >**, then click **Execute** to perform the server configuration.
3. Click **Finish** to close the wizard.

You've now completed the MySQL installation.

### *Installing MySQL Connector/J*

To use MySQL with JDBC, you also need to install **MySQL Connector/J** (the J stands for Java)—a JDBC driver that allows programs to use JDBC to interact with MySQL. MySQL Connector/J can be downloaded from

`dev.mysql.com/downloads/connector/j/`

The documentation for Connector/J is located at

`dev.mysql.com/doc/refman/5.5/en/connector-j.html`

At the time of this writing, the current generally available release of MySQL Connector/J is 5.1.14. To install MySQL Connector/J, carefully follow the installation instructions at:

`dev.mysql.com/doc/refman/5.5/en/connector-j-installing.html`

We *do not* recommend modifying your system's CLASSPATH environment variable, which is discussed in the installation instructions. Instead, we'll show you how use MySQL Connector/J by specifying it as a command-line option when you execute your applications.

## 28.6 Instructions for Setting Up a MySQL User Account

For the MySQL examples to execute correctly, you need to set up a user account that allows users to create, delete and modify a database. After MySQL is installed, follow the

steps below to set up a user account (these steps assume MySQL is installed in its default installation directory):

1. Open a Command Prompt and start the database server by executing the command `mysqld.exe`. This command has no output—it simply starts the MySQL server. Do not close this window—doing so terminates the server.
1. Next, you'll start the MySQL monitor so you can set up a user account, open another Command Prompt and execute the command

```
mysql -h localhost -u root
```

The `-h` option indicates the host (i.e., computer) on which the MySQL server is running—in this case your local computer (`localhost`). The `-u` option indicates the user account that will be used to log in to the server—`root` is the default user account that is created during installation to allow you to configure the server. Once you've logged in, you'll see a `mysql>` prompt at which you can type commands to interact with the MySQL server.

1. At the `mysql>` prompt, type

```
USE mysql;
```

and press *Enter* to select the built-in database named `mysql`, which stores server information, such as user accounts and their privileges for interacting with the server. Each command must end with a semicolon. To confirm the command, MySQL issues the message “Database changed.”

1. Next, you'll add the `deitel` user account to the `mysql` built-in database. The `mysql` database contains a table called `user` with columns that represent the user's name, password and various privileges. To create the `deitel` user account with the password `deitel`, execute the following commands from the `mysql>` prompt:

```
create user 'deitel'@'localhost' identified by 'deitel';
grant select, insert, update, delete, create, drop, references,
execute on *.* to 'deitel'@'localhost';
```

This creates the `deitel` user with the privileges needed to create the databases used in this chapter and manipulate them.

1. Type the command

```
exit;
```

to terminate the MySQL monitor.

## 28.7 Creating Database books in MySQL

For each MySQL database we discuss, we provide a SQL script in a `.sql` file that sets up the database and its tables. You can execute these scripts in the MySQL monitor. In this chapter's examples directory, you'll find the script `books.sql` to create the `books` database. For the following steps, we assume that the MySQL server (`mysqld.exe`) is still running. To execute the `books.sql` script:

1. Open a Command Prompt and use the `cd` command to change directories to the location that contains the `books.sql` script.

2. Start the MySQL monitor by typing

```
mysql -h localhost -u deitel -p
```

The `-p` option prompts you for the password for the `deitel` user account. When prompted, enter the password `deitel`.

3. Execute the script by typing

```
source books.sql;
```

This creates a new directory named `books` in the server's data directory—located by default on Windows at `C:\ProgramData\MySQL\MySQL Server 5.5\data`. This new directory contains the `books` database.

4. Type the command

```
exit;
```

to terminate the MySQL monitor. You're now ready to proceed to the first JDBC example.

## 28.8 Manipulating Databases with JDBC

This section presents two examples. The first introduces how to connect to a database and query it. The second demonstrates how to display the result of the query in a `JTable`.

### 28.8.1 Connecting to and Querying a Database

The example of Fig. 28.23 performs a simple query on the `books` database that retrieves the entire `Authors` table and displays the data. The program illustrates connecting to the database, querying the database and processing the result. The discussion that follows presents the key JDBC aspects of the program. [*Note:* Sections 28.5–28.7 demonstrate how to start the MySQL server, configure a user account and create the `books` database. These steps *must* be performed before executing the program of Fig. 28.23.]

---

```

1 // Fig. 28.23: DisplayAuthors.java
2 // Displaying the contents of the Authors table.
3 import java.sql.Connection;
4 import java.sql.Statement;
5 import java.sql.DriverManager;
6 import java.sql.ResultSet;
7 import java.sql.ResultSetMetaData;
8 import java.sql.SQLException;
9
10 public class DisplayAuthors
11 {
12 // database URL
13 static final String DATABASE_URL = "jdbc:mysql://localhost/books";
14
15 // launch the application
16 public static void main(String args[])
17 {
```

**Fig. 28.23** | Displaying the contents of the `Authors` table. (Part 1 of 3.)

```

18 Connection connection = null; // manages connection
19 Statement statement = null; // query statement
20 ResultSet resultSet = null; // manages results
21
22 // connect to database books and query database
23 try
24 {
25 // establish connection to database
26 connection = DriverManager.getConnection(
27 DATABASE_URL, "deitel", "deitel");
28
29 // create Statement for querying database
30 statement = connection.createStatement();
31
32 // query database
33 resultSet = statement.executeQuery(
34 "SELECT AuthorID, FirstName, LastName FROM Authors");
35
36 // process query results
37 ResultSetMetaData metaData = resultSet.getMetaData();
38 int numberOfColumns = metaData.getColumnCount();
39 System.out.println("Authors Table of Books Database:\n");
40
41 for (int i = 1; i <= numberOfColumns; i++)
42 System.out.printf("%-8s\t", metaData.getColumnName(i));
43 System.out.println();
44
45 while (resultSet.next())
46 {
47 for (int i = 1; i <= numberOfColumns; i++)
48 System.out.printf("%-8s\t", resultSet.getObject(i));
49 System.out.println();
50 } // end while
51 } // end try
52 catch (SQLException sqlException)
53 {
54 sqlException.printStackTrace();
55 } // end catch
56 finally // ensure resultSet, statement and connection are closed
57 {
58 try
59 {
60 resultSet.close();
61 statement.close();
62 connection.close();
63 } // end try
64 catch (Exception exception)
65 {
66 exception.printStackTrace();
67 } // end catch
68 } // end finally
69 } // end main
70 } // end class DisplayAuthors

```

**Fig. 28.23** | Displaying the contents of the Authors table. (Part 2 of 3.)

| Authors Table of Books Database: |           |          |
|----------------------------------|-----------|----------|
| AuthorID                         | FirstName | LastName |
| 1                                | Harvey    | Deitel   |
| 2                                | Paul      | Deitel   |
| 3                                | Andrew    | Goldberg |
| 4                                | David     | Choffnes |

**Fig. 28.23** | Displaying the contents of the Authors table. (Part 3 of 3.)

Lines 3–8 import the JDBC interfaces and classes from package `java.sql` used in this program. Line 13 declares a string constant for the database URL. This identifies the name of the database to connect to, as well as information about the protocol used by the JDBC driver (discussed shortly). Method `main` (lines 16–69) connects to the books database, queries the database, displays the result of the query and closes the database connection.

In past versions of Java, programs were required to load an appropriate database driver before connecting to a database. JDBC 4.0 and higher support **automatic driver discovery**—you’re no longer required to load the database driver in advance. To ensure that the program can locate the database driver class, you must include the class’s location in the program’s classpath when you execute the program. For MySQL, you include the file `mysql-connector-java-5.1.14-bin.jar` (in the `C:\mysql-connector-java-5.1.14` directory) in your program’s classpath, as in:

```
java -classpath .;c:\mysql-connector-java-5.1.14\mysql-connector-
java-5.1.14-bin.jar DisplayAuthors
```

If the period (`.`) at the beginning of the classpath information is missing, the JVM will not look for classes in the current directory and thus will not find the `DisplayAuthors` class file. You may also copy the `mysql-connector-java-5.1.14-bin.jar` file to your JDK’s `\jre\lib\ext` folder. After doing so, you can run the application simply using the command

```
java DisplayAuthors
```

### *Connecting to the Database*

Lines 26–27 of Fig. 28.23 create a **Connection** object (package `java.sql`) referenced by `connection`. An object that implements interface `Connection` manages the connection between the Java program and the database. `Connection` objects enable programs to create SQL statements that manipulate databases. The program initializes `connection` with the result of a call to static method **`getConnection`** of class **`DriverManager`** (package `java.sql`), which attempts to connect to the database specified by its URL. Method `getConnection` takes three arguments—a `String` that specifies the database URL, a `String` that specifies the username and a `String` that specifies the password. The username and password are set in Section 28.6. If you used a different username and password, you need to replace the username (second argument) and password (third argument) passed to method `getConnection` in line 27. The URL locates the database (possibly on a network or in the local file system of the computer). The URL `jdbc:mysql://localhost/books` specifies the protocol for communication (`jdbc`), the **subprotocol** for communication (`mysql`) and the location of the database (`//localhost/books`, where `localhost` is the host running the MySQL server and `books` is the database name). The subprotocol `mysql`

indicates that the program uses a MySQL-specific subprotocol to connect to the MySQL database. If the `DriverManager` cannot connect to the database, method `getConnection` throws a **`SQLException`** (package `java.sql`). Figure 28.24 lists the JDBC driver names and database URL formats of several popular RDBMSs.

| RDBMS                | Database URL format                                                                                                     |
|----------------------|-------------------------------------------------------------------------------------------------------------------------|
| MySQL                | <code>jdbc:mysql://hostname:portNumber/databaseName</code>                                                              |
| ORACLE               | <code>jdbc:oracle:thin:@hostname:portNumber:databaseName</code>                                                         |
| DB2                  | <code>jdbc:db2:hostname:portNumber/databaseName</code>                                                                  |
| PostgreSQL           | <code>jdbc:postgresql://hostname:portNumber/databaseName</code>                                                         |
| Java DB/Apache Derby | <code>jdbc:derby:databaseName</code> (embedded)<br><code>jdbc:derby://hostname:portNumber/databaseName</code> (network) |
| Microsoft SQL Server | <code>jdbc:sqlserver://hostname:portNumber;databaseName=databaseName</code>                                             |
| Sybase               | <code>jdbc:sybase:Tds:hostname:portNumber/databaseName</code>                                                           |

**Fig. 28.24** | Popular JDBC database URL formats.



### Software Engineering Observation 28.5

Most database management systems require the user to log in before accessing the database contents. `DriverManager` method `getConnection` is overloaded with versions that enable the program to supply the user name and password to gain access.

### Creating a Statement for Executing Queries

Line 30 invokes `Connection` method **`createStatement`** to obtain an object that implements interface `Statement` (package `java.sql`). The program uses the **`Statement`** object to submit SQL statements to the database.

### Executing a Query

Lines 33–34 use the `Statement` object's **`executeQuery`** method to submit a query that selects all the author information from table `Authors`. This method returns an object that implements interface **`ResultSet`** and contains the query results. The `ResultSet` methods enable the program to manipulate the query result.

### Processing a Query's ResultSet

Lines 37–50 process the `ResultSet`. Line 37 obtains the metadata for the `ResultSet` as a **`ResultSetMetaData`** (package `java.sql`) object. The **`metadata`** describes the `ResultSet`'s contents. Programs can use metadata programmatically to obtain information about the `ResultSet`'s column names and types. Line 38 uses `ResultSetMetaData` method **`getColumnCount`** to retrieve the number of columns in the `ResultSet`. Lines 41–42 display the column names.



### Software Engineering Observation 28.6

Metadata enables programs to process `ResultSet` contents dynamically when detailed information about the `ResultSet` is not known in advance.

Lines 45–50 display the data in each `ResultSet` row. First, the program positions the `ResultSet` cursor (which points to the row being processed) to the first row in the `ResultSet` with method `next` (line 45). Method `next` returns boolean value `true` if it's able to position to the next row; otherwise, the method returns `false`.



### Common Programming Error 28.8

*Initially, a `ResultSet` cursor is positioned before the first row. A `SQLException` occurs if you attempt to access a `ResultSet`'s contents before positioning the `ResultSet` cursor to the first row with method `next`.*

If there are rows in the `ResultSet`, lines 47–48 extract and display the contents of each column in the current row. When a `ResultSet` is processed, each column can be extracted as a specific Java type. In fact, `ResultSetMetaData` method `getColumnType` returns a constant integer from class `Types` (package `java.sql`) indicating the type of a specified column. Programs can use these values in a `switch` statement to invoke `ResultSet` methods that return the column values as appropriate Java types. If the type of a column is `Types.INTEGER`, `ResultSet` method `getInt` returns the column value as an `int`. `ResultSet` `get` methods typically receive as an argument either a column number (as an `int`) or a column name (as a `String`) indicating which column's value to obtain. Visit

[java.sun.com/javase/6/docs/technotes/guides/jdbc/getstart/GettingStartedTOC.fm.html](http://java.sun.com/javase/6/docs/technotes/guides/jdbc/getstart/GettingStartedTOC.fm.html)

for detailed mappings of SQL data types to Java types and to determine the appropriate `ResultSet` method to call for each SQL data type.



### Performance Tip 28.1

*If a query specifies the exact columns to select from the database, the `ResultSet` contains the columns in the specified order. In this case, using the column number to obtain the column's value is more efficient than using the column name. The column number provides direct access to the specified column. Using the column name requires a search of the column names to locate the appropriate column.*



### Error-Prevention Tip 28.1

*Using column names to obtain values from a `ResultSet` produces code that is less error prone than obtaining values by column number—you don't need to remember the column order. Also, if the column order changes, your code does not have to change.*

For simplicity, this example treats each value as an `Object`. We retrieve each column value with `ResultSet` method `getObject` (line 48) then print the `Object`'s `String` representation. Unlike array indices, `ResultSet` *column numbers start at 1*. The `finally` block (lines 56–68) closes the `ResultSet`, the `Statement` and the database `Connection`. [*Note*: Lines 60–62 will throw `NullPointerExceptions` if the `ResultSet`, `Statement` or `Connection` objects were not created properly. For code used in industry, you should check the variables that refer to these objects to see if they're `null` before you call `close`.]



### Common Programming Error 28.9

*Specifying column 0 when obtaining values from a `ResultSet` causes a `SQLException`.*



### Common Programming Error 28.10

A `SQLException` occurs if you attempt to manipulate a `ResultSet` after closing the `Statement` that created it. The `ResultSet` is discarded when the `Statement` is closed.



### Software Engineering Observation 28.7

Each `Statement` object can open only one `ResultSet` object at a time. When a `Statement` returns a new `ResultSet`, the `Statement` closes the prior `ResultSet`. To use multiple `ResultSet`s in parallel, separate `Statement` objects must return the `ResultSet`s.

## Java SE 7: Automatically Closing Connections, Statements and ResultSets

As of Java SE 7, the interfaces `Connection`, `Statement` and `ResultSet` each extend the `AutoCloseable` interface, so you can use objects that implement these interfaces with the new try-with-resources statement, which was introduced in Section 11.13. In the folder for the example of Fig. 28.23, the subfolder `JavaSE7Version` contains a version of the example that uses the try-with-resources statement to allocate the `Connection`, `Statement` and `ResultSet` objects. These objects are automatically closed at the end of the try block or if an exception occurs while executing the code in the try block.

## 28.8.2 Querying the books Database

The next example (Fig. 28.25 and Fig. 28.28) allows the user to enter any query into the program. The example displays the result of a query in a `JTable`, using a `TableModel` object to provide the `ResultSet` data to the `JTable`. A `JTable` is a swing GUI component that can be bound to a database to display the results of a query. Class `ResultSetTableModel` (Fig. 28.25) performs the connection to the database via a `TableModel` and maintains the `ResultSet`. Class `DisplayQueryResults` (Fig. 28.28) creates the GUI and specifies an instance of class `ResultSetTableModel` to provide data for the `JTable`.

### ResultSetTableModel Class

Class `ResultSetTableModel` (Fig. 28.25) extends class `AbstractTableModel` (package `javax.swing.table`), which implements interface `TableModel`. `ResultSetTableModel` overrides `TableModel` methods `getColumnClass`, `getColumnCount`, `columnName`, `getRowCount` and `getValueAt`. The default implementations of `TableModel` methods `isCellEditable` and `setValueAt` (provided by `AbstractTableModel`) are not overridden, because this example does not support editing the `JTable` cells. The default implementations of `TableModel` methods `addTableModelListener` and `removeTableModelListener` (provided by `AbstractTableModel`) are not overridden, because the implementations of these methods in `AbstractTableModel` properly add and remove event listeners.

```

1 // Fig. 28.25: ResultSetTableModel.java
2 // A TableModel that supplies ResultSet data to a JTable.
3 import java.sql.Connection;
4 import java.sql.Statement;
5 import java.sql.DriverManager;
6 import java.sql.ResultSet;
7 import java.sql.ResultSetMetaData;

```

**Fig. 28.25** | A `TableModel` that supplies `ResultSet` data to a `JTable`. (Part I of 5.)



```

8 import java.sql.SQLException;
9 import javax.swing.table.AbstractTableModel;
10
11 // ResultSet rows and columns are counted from 1 and JTable
12 // rows and columns are counted from 0. When processing
13 // ResultSet rows or columns for use in a JTable, it is
14 // necessary to add 1 to the row or column number to manipulate
15 // the appropriate ResultSet column (i.e., JTable column 0 is
16 // ResultSet column 1 and JTable row 0 is ResultSet row 1).
17 public class ResultSetTableModel extends AbstractTableModel
18 {
19 private Connection connection;
20 private Statement statement;
21 private ResultSet resultSet;
22 private ResultSetMetaData metaData;
23 private int numberOfRows;
24
25 // keep track of database connection status
26 private boolean connectedToDatabase = false;
27
28 // constructor initializes resultSet and obtains its meta data object;
29 // determines number of rows
30 public ResultSetTableModel(String url, String username,
31 String password, String query) throws SQLException
32 {
33 // connect to database
34 connection = DriverManager.getConnection(url, username, password);
35
36 // create Statement to query database
37 statement = connection.createStatement(
38 ResultSet.TYPE_SCROLL_INSENSITIVE,
39 ResultSet.CONCUR_READ_ONLY);
40
41 // update database connection status
42 connectedToDatabase = true;
43
44 // set query and execute it
45 setQuery(query);
46 } // end constructor ResultSetTableModel
47
48 // get class that represents column type
49 public Class getColumnClass(int column) throws IllegalStateException
50 {
51 // ensure database connection is available
52 if (!connectedToDatabase)
53 throw new IllegalStateException("Not Connected to Database");
54
55 // determine Java class of column
56 try
57 {
58 String className = metaData.getColumnClassName(column + 1);
59

```

**Fig. 28.25** | A TableModel that supplies ResultSet data to a JTable. (Part 2 of 5.)

```

60 // return Class object that represents className
61 return Class.forName(className);
62 } // end try
63 catch (Exception exception)
64 {
65 exception.printStackTrace();
66 } // end catch
67
68 return Object.class; // if problems occur above, assume type Object
69 } // end method getColumnClass
70
71 // get number of columns in ResultSet
72 public int getColumnCount() throws IllegalStateException
73 {
74 // ensure database connection is available
75 if (!connectedToDatabase)
76 throw new IllegalStateException("Not Connected to Database");
77
78 // determine number of columns
79 try
80 {
81 return metaData.getColumnCount();
82 } // end try
83 catch (SQLException sqlException)
84 {
85 sqlException.printStackTrace();
86 } // end catch
87
88 return 0; // if problems occur above, return 0 for number of columns
89 } // end method getColumnCount
90
91 // get name of a particular column in ResultSet
92 public String getColumnName(int column) throws IllegalStateException
93 {
94 // ensure database connection is available
95 if (!connectedToDatabase)
96 throw new IllegalStateException("Not Connected to Database");
97
98 // determine column name
99 try
100 {
101 return metaData.getColumnName(column + 1);
102 } // end try
103 catch (SQLException sqlException)
104 {
105 sqlException.printStackTrace();
106 } // end catch
107
108 return ""; // if problems, return empty string for column name
109 } // end method getColumnName
110

```

**Fig. 28.25** | A TableModel that supplies ResultSet data to a JTable. (Part 3 of 5.)

```

111 // return number of rows in ResultSet
112 public int getRowCount() throws IllegalStateException
113 {
114 // ensure database connection is available
115 if (!connectedToDatabase)
116 throw new IllegalStateException("Not Connected to Database");
117
118 return numberOfRows;
119 } // end method getRowCount
120
121 // obtain value in particular row and column
122 public Object getValueAt(int row, int column)
123 throws IllegalStateException
124 {
125 // ensure database connection is available
126 if (!connectedToDatabase)
127 throw new IllegalStateException("Not Connected to Database");
128
129 // obtain a value at specified ResultSet row and column
130 try
131 {
132 resultSet.absolute(row + 1);
133 return resultSet.getObject(column + 1);
134 } // end try
135 catch (SQLException sqlException)
136 {
137 sqlException.printStackTrace();
138 } // end catch
139
140 return ""; // if problems, return empty string object
141 } // end method getValueAt
142
143 // set new database query string
144 public void setQuery(String query)
145 throws SQLException, IllegalStateException
146 {
147 // ensure database connection is available
148 if (!connectedToDatabase)
149 throw new IllegalStateException("Not Connected to Database");
150
151 // specify query and execute it
152 resultSet = statement.executeQuery(query);
153
154 // obtain meta data for ResultSet
155 metaData = resultSet.getMetaData();
156
157 // determine number of rows in ResultSet
158 resultSet.last(); // move to last row
159 numberOfRows = resultSet.getRow(); // get row number
160
161 // notify JTable that model has changed
162 fireTableStructureChanged();
163 } // end method setQuery

```

**Fig. 28.25** | A TableModel that supplies ResultSet data to a JTable. (Part 4 of 5.)

```

164
165 // close Statement and Connection
166 public void disconnectFromDatabase()
167 {
168 if (connectedToDatabase)
169 {
170 // close Statement and Connection
171 try
172 {
173 resultSet.close();
174 statement.close();
175 connection.close();
176 } // end try
177 catch (SQLException sqlException)
178 {
179 sqlException.printStackTrace();
180 } // end catch
181 finally // update database connection status
182 {
183 connectedToDatabase = false;
184 } // end finally
185 } // end if
186 } // end method disconnectFromDatabase
187 } // end class ResultSetTableModel

```

**Fig. 28.25** | A `TableModel` that supplies `ResultSet` data to a `JTable`. (Part 5 of 5.)

### *ResultSetTableModel Constructor*

The `ResultSetTableModel` constructor (lines 30–46) accepts four `String` arguments—the URL of the database, the username, the password and the default query to perform. The constructor throws any exceptions that occur in its body back to the application that created the `ResultSetTableModel` object, so that the application can determine how to handle the exception (e.g., report an error and terminate the application). Line 34 establishes a connection to the database. Lines 37–39 invoke `Connection` method `createStatement` to create a `Statement` object. This example uses a version of method `createStatement` that takes two arguments—the result set type and the result set concurrency. The **result set type** (Fig. 28.26) specifies whether the `ResultSet`'s cursor is able to scroll in both directions or forward only and whether the `ResultSet` is sensitive to changes made to the underlying data.

| ResultSet constant                   | Description                                                                                                                                                                                                                                                               |
|--------------------------------------|---------------------------------------------------------------------------------------------------------------------------------------------------------------------------------------------------------------------------------------------------------------------------|
| <code>TYPE_FORWARD_ONLY</code>       | Specifies that a <code>ResultSet</code> 's cursor can move only in the forward direction (i.e., from the first to the last row in the <code>ResultSet</code> ).                                                                                                           |
| <code>TYPE_SCROLL_INSENSITIVE</code> | Specifies that a <code>ResultSet</code> 's cursor can scroll in either direction and that the changes made to the underlying data during <code>ResultSet</code> processing are not reflected in the <code>ResultSet</code> unless the program queries the database again. |

**Fig. 28.26** | `ResultSet` constants for specifying `ResultSet` type. (Part 1 of 2.)

| ResultSet constant    | Description                                                                                                                                                                                 |
|-----------------------|---------------------------------------------------------------------------------------------------------------------------------------------------------------------------------------------|
| TYPE_SCROLL_SENSITIVE | Specifies that a ResultSet's cursor can scroll in either direction and that the changes made to the underlying data during ResultSet processing are reflected immediately in the ResultSet. |

**Fig. 28.26** | ResultSet constants for specifying ResultSet type. (Part 2 of 2.)



### Portability Tip 28.3

*Some JDBC drivers do not support scrollable ResultSets. In such cases, the driver typically returns a ResultSet in which the cursor can move only forward. For more information, see your database driver documentation.*



### Common Programming Error 28.11

*Attempting to move the cursor backward through a ResultSet when the database driver does not support backward scrolling causes a `SQLFeatureNotSupportedException`.*

ResultSets that are sensitive to changes reflect those changes immediately after they're made with methods of interface `ResultSet`. If a ResultSet is insensitive to changes, the query that produced the ResultSet must be executed again to reflect any changes made. The **result set concurrency** (Fig. 28.27) specifies whether the ResultSet can be updated with ResultSet's update methods.

| ResultSet static concurrency constant | Description                                                                                                                                                 |
|---------------------------------------|-------------------------------------------------------------------------------------------------------------------------------------------------------------|
| CONCUR_READ_ONLY                      | Specifies that a ResultSet cannot be updated (i.e., changes to the ResultSet contents cannot be reflected in the database with ResultSet's update methods). |
| CONCUR_UPDATABLE                      | Specifies that a ResultSet can be updated (i.e., changes to its contents can be reflected in the database with ResultSet's update methods).                 |

**Fig. 28.27** | ResultSet constants for specifying result properties.



### Portability Tip 28.4

*Some JDBC drivers do not support updatable ResultSets. In such cases, the driver typically returns a read-only ResultSet. For more information, see your database driver documentation.*



### Common Programming Error 28.12

*Attempting to update a ResultSet when the database driver does not support updatable ResultSets causes `SQLFeatureNotSupportedException`.*

This example uses a ResultSet that is scrollable, insensitive to changes and read only. Line 45 invokes our method `setQuery` (lines 144–163) to perform the default query.

**ResultSetTableModel Method getColumnClass**

Method `getColumnClass` (lines 49–69) returns a `Class` object that represents the superclass of all objects in a particular column. The `JTable` uses this information to configure the default cell renderer and cell editor for that column in the `JTable`. Line 58 uses `ResultSetMetaData` method `getColumnClassName` to obtain the fully qualified class name for the specified column. Line 61 loads the class and returns the corresponding `Class` object. If an exception occurs, the catch in lines 63–66 prints a stack trace and line 68 returns `Object.class`—the `Class` instance that represents class `Object`—as the default type. [Note: Line 58 uses the argument `column + 1`. Like arrays, `JTable` row and column numbers are counted from 0. However, `ResultSet` row and column numbers are counted from 1. Thus, when processing `ResultSet` rows or columns for use in a `JTable`, it's necessary to add 1 to the row or column number to manipulate the appropriate `ResultSet` row or column.]

**ResultSetTableModel Method getColumnCount**

Method `getColumnCount` (lines 72–89) returns the number of columns in the model's underlying `ResultSet`. Line 81 uses `ResultSetMetaData` method `getColumnCount` to obtain the number of columns in the `ResultSet`. If an exception occurs, the catch in lines 83–86 prints a stack trace and line 88 returns 0 as the default number of columns.

**ResultSetTableModel Method getColumnName**

Method `getColumnName` (lines 92–109) returns the name of the column in the model's underlying `ResultSet`. Line 101 uses `ResultSetMetaData` method `getColumnName` to obtain the column name from the `ResultSet`. If an exception occurs, the catch in lines 103–106 prints a stack trace and line 108 returns the empty string as the default column name.

**ResultSetTableModel Method getRowCount**

Method `getRowCount` (lines 112–119) returns the number of rows in the model's underlying `ResultSet`. When method `setQuery` (lines 144–163) performs a query, it stores the number of rows in variable `numberOfRows`.

**ResultSetTableModel Method getValueAt**

Method `getValueAt` (lines 122–141) returns the `Object` in a particular row and column of the model's underlying `ResultSet`. Line 132 uses `ResultSet` method `absolute` to position the `ResultSet` cursor at a specific row. Line 133 uses `ResultSet` method `getObject` to obtain the `Object` in a specific column of the current row. If an exception occurs, the catch in lines 135–138 prints a stack trace and line 140 returns an empty string as the default value.

**ResultSetTableModel Method setQuery**

Method `setQuery` (lines 144–163) executes the query it receives as an argument to obtain a new `ResultSet` (line 152). Line 155 gets the `ResultSetMetaData` for the new `ResultSet`. Line 158 uses `ResultSet` method `last` to position the `ResultSet` cursor at the last row in the `ResultSet`. [Note: This can be slow if the table contains many rows.] Line 159 uses `ResultSet` method `getRow` to obtain the row number for the current row in the `ResultSet`. Line 162 invokes method `fireTableStructureChanged` (inherited from class `AbstractTableModel`) to notify any `JTable` using this `ResultSetTableModel` object as its model that the structure of the model has changed. This causes the `JTable` to repopulate its rows and columns with the new `ResultSet` data. Method `setQuery` throws any exceptions that occur in its body back to the application that invoked `setQuery`.

**ResultSetTableModel Method disconnectFromDatabase**

Method `disconnectFromDatabase` (lines 166–186) implements an appropriate termination method for class `ResultSetTableModel`. A class designer should provide a public method that clients of the class must invoke explicitly to free resources that an object has used. In this case, method `disconnectFromDatabase` closes the `ResultSet`, `Statement` and `Connection` (lines 173–175), which are considered limited resources. Clients of the `ResultSetTableModel` class should always invoke this method when the instance of this class is no longer needed. Before releasing resources, line 168 verifies whether the connection is already terminated. If not, the method proceeds. The other methods in class `ResultSetTableModel` each throw an `IllegalStateException` if `connectedToDatabase` is false. Method `disconnectFromDatabase` sets `connectedToDatabase` to false (line 183) to ensure that clients do not use an instance of `ResultSetTableModel` after that instance has already been terminated. `IllegalStateException` is an exception from the Java libraries that is appropriate for indicating this error condition.

**DisplayQueryResults Class**

Class `DisplayQueryResults` (Fig. 28.28) implements the application's GUI and interacts with the `ResultSetTableModel` via a `JTable` object. This application also demonstrates the `JTable` sorting and filtering capabilities.

---

```

1 // Fig. 28.28: DisplayQueryResults.java
2 // Display the contents of the Authors table in the books database.
3 import java.awt.BorderLayout;
4 import java.awt.event.ActionListener;
5 import java.awt.event.ActionEvent;
6 import java.awt.event.WindowAdapter;
7 import java.awt.event.WindowEvent;
8 import java.sql.SQLException;
9 import java.util.regex.PatternSyntaxException;
10 import javax.swing.JFrame;
11 import javax.swing.JTextArea;
12 import javax.swing.JScrollPane;
13 import javax.swing.ScrollPaneConstants;
14 import javax.swing.JTable;
15 import javax.swing.JOptionPane;
16 import javax.swing.JButton;
17 import javax.swing.Box;
18 import javax.swing.JLabel;
19 import javax.swing.JTextField;
20 import javax.swing.RowFilter;
21 import javax.swing.table.TableRowSorter;
22 import javax.swing.table.TableModel;
23
24 public class DisplayQueryResults extends JFrame
25 {
26 // database URL, username and password
27 static final String DATABASE_URL = "jdbc:mysql://localhost/books";
28 static final String USERNAME = "deitel";
29 static final String PASSWORD = "deitel";

```

**Fig. 28.28** | Displays contents of the database books. (Part I of 5.)

```

30
31 // default query retrieves all data from Authors table
32 static final String DEFAULT_QUERY = "SELECT * FROM Authors";
33
34 private ResultSetTableModel tableModel;
35 private JTextArea queryArea;
36
37 // create ResultSetTableModel and GUI
38 public DisplayQueryResults()
39 {
40 super("Displaying Query Results");
41
42 // create ResultSetTableModel and display database table
43 try
44 {
45 // create TableModel for results of query SELECT * FROM Authors
46 tableModel = new ResultSetTableModel(DATABASE_URL,
47 USERNAME, PASSWORD, DEFAULT_QUERY);
48
49 // set up JTextArea in which user types queries
50 queryArea = new JTextArea(DEFAULT_QUERY, 3, 100);
51 queryArea.setWrapStyleWord(true);
52 queryArea.setLineWrap(true);
53
54 JScrollPane scrollPane = new JScrollPane(queryArea,
55 ScrollPaneConstants.VERTICAL_SCROLLBAR_AS_NEEDED,
56 ScrollPaneConstants.HORIZONTAL_SCROLLBAR_NEVER);
57
58 // set up JButton for submitting queries
59 JButton submitButton = new JButton("Submit Query");
60
61 // create Box to manage placement of queryArea and
62 // submitButton in GUI
63 Box boxNorth = Box.createHorizontalBox();
64 boxNorth.add(scrollPane);
65 boxNorth.add(submitButton);
66
67 // create JTable based on the tableModel
68 JTable resultTable = new JTable(tableModel);
69
70 JLabel filterLabel = new JLabel("Filter:");
71 final JTextField filterText = new JTextField();
72 JButton filterButton = new JButton("Apply Filter");
73 Box boxSouth = Box.createHorizontalBox();
74
75 boxSouth.add(filterLabel);
76 boxSouth.add(filterText);
77 boxSouth.add(filterButton);
78
79 // place GUI components on content pane
80 add(boxNorth, BorderLayout.NORTH);
81 add(new JScrollPane(resultTable), BorderLayout.CENTER);
82 add(boxSouth, BorderLayout.SOUTH);

```

**Fig. 28.28** | Displays contents of the database books. (Part 2 of 5.)



```

83
84 // create event listener for submitButton
85 submitButton.addActionListener(
86
87 new ActionListener()
88 {
89 // pass query to table model
90 public void actionPerformed(ActionEvent event)
91 {
92 // perform a new query
93 try
94 {
95 tableModel.setQuery(queryArea.getText());
96 } // end try
97 catch (SQLException sqlException)
98 {
99 JOptionPane.showMessageDialog(null,
100 sqlException.getMessage(), "Database error",
101 JOptionPane.ERROR_MESSAGE);
102
103 // try to recover from invalid user query
104 // by executing default query
105 try
106 {
107 tableModel.setQuery(DEFAULT_QUERY);
108 queryArea.setText(DEFAULT_QUERY);
109 } // end try
110 catch (SQLException sqlException2)
111 {
112 JOptionPane.showMessageDialog(null,
113 sqlException2.getMessage(), "Database error",
114 JOptionPane.ERROR_MESSAGE);
115
116 // ensure database connection is closed
117 tableModel.disconnectFromDatabase();
118
119 System.exit(1); // terminate application
120 } // end inner catch
121 } // end outer catch
122 } // end actionPerformed
123 } // end ActionListener inner class
124); // end call to addActionListener
125
126 final TableRowSorter< TableModel > sorter =
127 new TableRowSorter< TableModel >(tableModel);
128 resultTable.setRowSorter(sorter);
129 setSize(500, 250); // set window size
130 setVisible(true); // display window
131
132 // create listener for filterButton
133 filterButton.addActionListener(
134 new ActionListener()
135 {

```

**Fig. 28.28** | Displays contents of the database books. (Part 3 of 5.)

```

136 // pass filter text to listener
137 public void actionPerformed(ActionEvent e)
138 {
139 String text = filterText.getText();
140
141 if (text.length() == 0)
142 sorter.setRowFilter(null);
143 else
144 {
145 try
146 {
147 sorter.setRowFilter(
148 RowFilter.regexFilter(text));
149 } // end try
150 catch (PatternSyntaxException pse)
151 {
152 JOptionPane.showMessageDialog(null,
153 "Bad regex pattern", "Bad regex pattern",
154 JOptionPane.ERROR_MESSAGE);
155 } // end catch
156 } // end else
157 } // end method actionPerformed
158 } // end anonymous inner class
159); // end call to addActionListener
160 } // end try
161 catch (SQLException sqlException)
162 {
163 JOptionPane.showMessageDialog(null, sqlException.getMessage(),
164 "Database error", JOptionPane.ERROR_MESSAGE);
165
166 // ensure database connection is closed
167 tableModel.disconnectFromDatabase();
168
169 System.exit(1); // terminate application
170 } // end catch
171
172 // dispose of window when user quits application (this overrides
173 // the default of HIDE_ON_CLOSE)
174 setDefaultCloseOperation(DISPOSE_ON_CLOSE);
175
176 // ensure database connection is closed when user quits application
177 addWindowListener(
178
179 new WindowAdapter()
180 {
181 // disconnect from database and exit when window has closed
182 public void windowClosed(WindowEvent event)
183 {
184 tableModel.disconnectFromDatabase();
185 System.exit(0);
186 } // end method windowClosed
187 } // end WindowAdapter inner class

```

**Fig. 28.28** | Displays contents of the database books. (Part 4 of 5.)

```

188); // end call to addWindowListener
189 } // end DisplayQueryResults constructor
190
191 // execute application
192 public static void main(String args[])
193 {
194 new DisplayQueryResults();
195 } // end main
196 } // end class DisplayQueryResults

```

a) Displaying all authors from the Authors table

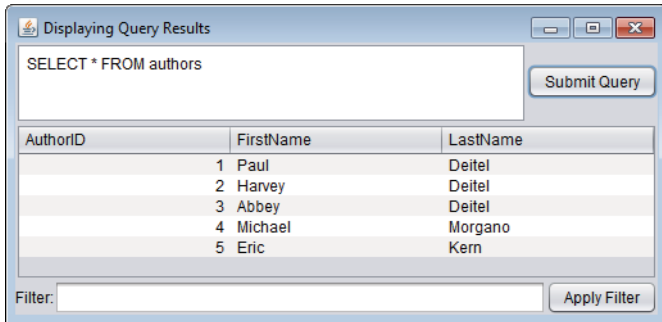

b) Displaying the the authors' first and last names joined with the titles and edition numbers of the books they've authored

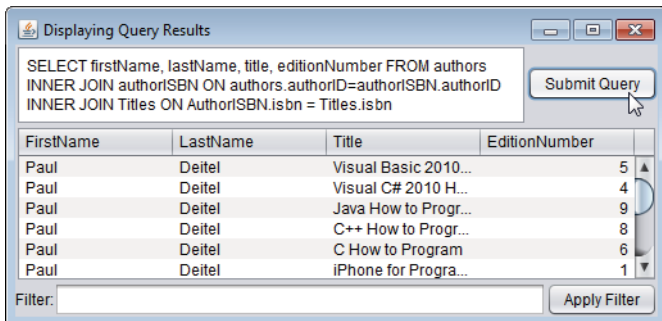

c) Filtering the results of the previous query to show only the books with Java in the title

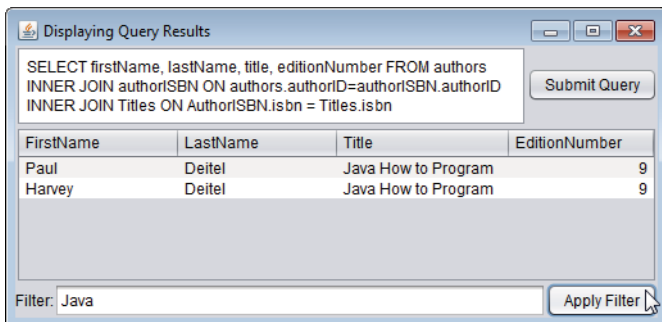

**Fig. 28.28** | Displays contents of the database books. (Part 5 of 5.)

Lines 27–29 and 32 declare the URL, username, password and default query that are passed to the `ResultSetTableModel` constructor to make the initial connection to the

database and perform the default query. The `DisplayQueryResults` constructor (lines 38–189) creates a `ResultSetTableModel` object and the GUI for the application. Line 68 creates the `JTable` object and passes a `ResultSetTableModel` object to the `JTable` constructor, which then registers the `JTable` as a listener for `TableModelEvents` generated by the `ResultSetTableModel`.

The local variables `filterText` (line 71) and `sorter` (lines 126–127) are declared `final`. These are both used from an event handler that is implemented as an anonymous inner class (lines 134–158). Any local variable that will be used in an anonymous inner class *must* be declared `final`; otherwise, a compilation error occurs.

Lines 85–124 register an event handler for the `submitButton` that the user clicks to submit a query to the database. When the user clicks the button, method `actionPerformed` (lines 90–122) invokes method `setQuery` from the class `ResultSetTableModel` to execute the new query (line 95). If the user’s query fails (e.g., because of a syntax error in the user’s input), lines 107–108 execute the default query. If the default query also fails, there could be a more serious error, so line 117 ensures that the database connection is closed and line 119 exits the program. The screen captures in Fig. 28.28 show the results of two queries. The first screen capture shows the default query that retrieves all the data from table `Authors` of database books. The second screen capture shows a query that selects each author’s first name and last name from the `Authors` table and combines that information with the title and edition number from the `Titles` table. Try entering your own queries in the text area and clicking the **Submit Query** button to execute the query.

Lines 177–188 register a `WindowListener` for the `windowClosed` event, which occurs when the user closes the window. Since `WindowListeners` can handle several window events, we extend class `WindowAdapter` and override only the `windowClosed` event handler.

### *Sorting Rows in a JTable*

`JTables` allow users to sort rows by the data in a specific column. Lines 126–127 use the `TableRowSorter` class (from package `javax.swing.table`) to create an object that uses our `ResultSetTableModel` to sort rows in the `JTable` that displays query results. When the user clicks the title of a particular `JTable` column, the `TableRowSorter` interacts with the underlying `TableModel` to reorder the rows based on the data in that column. Line 128 uses `JTable` method `setRowSorter` to specify the `TableRowSorter` for `resultTable`.

### *Filtering Rows in a JTable*

`JTables` can now show subsets of the data from the underlying `TableModel`. This is known as filtering the data. Lines 133–159 register an event handler for the `filterButton` that the user clicks to filter the data. In method `actionPerformed` (lines 137–157), line 139 obtains the filter text. If the user did not specify filter text, line 142 uses `JTable` method `setRowFilter` to remove any prior filter by setting the filter to `null`. Otherwise, lines 147–148 use `setRowFilter` to specify a `RowFilter` (from package `javax.swing`) based on the user’s input. Class `RowFilter` provides several methods for creating filters. The static method `regexFilter` receives a `String` containing a regular expression pattern as its argument and an optional set of indices that specify which columns to filter. If no indices are specified, then all the columns are searched. In this example, the regular expression pattern is the text the user typed. Once the filter is set, the data displayed in the `JTable` is updated based on the filtered `TableModel`.

## 28.9 RowSet Interface

In the preceding examples, you learned how to query a database by explicitly establishing a `Connection` to the database, preparing a `Statement` for querying the database and executing the query. In this section, we demonstrate the **RowSet interface**, which configures the database connection and prepares query statements automatically. The interface `RowSet` provides several *set* methods that allow you to specify the properties needed to establish a connection (such as the database URL, user name and password of the database) and create a `Statement` (such as a query). `RowSet` also provides several *get* methods that return these properties.

### *Connected and Disconnected RowSets*

There are two types of `RowSet` objects—connected and disconnected. A **connected RowSet** object connects to the database once and remains connected while the object is in use. A **disconnected RowSet** object connects to the database, executes a query to retrieve the data from the database and then closes the connection. A program may change the data in a disconnected `RowSet` while it's disconnected. Modified data can be updated in the database after a disconnected `RowSet` reestablishes the connection with the database.

Package `javax.sql.rowset` contains two subinterfaces of `RowSet`—`JdbcRowSet` and `CachedRowSet`. **`JdbcRowSet`**, a connected `RowSet`, acts as a wrapper around a `ResultSet` object and allows you to scroll through and update the rows in the `ResultSet`. Recall that by default, a `ResultSet` object is nonscrollable and read only—you must explicitly set the result set type constant to `TYPE_SCROLL_INSENSITIVE` and set the result set concurrency constant to `CONCUR_UPDATABLE` to make a `ResultSet` object scrollable and updatable. A `JdbcRowSet` object is scrollable and updatable by default. **`CachedRowSet`**, a disconnected `RowSet`, caches the data of a `ResultSet` in memory and disconnects from the database. Like `JdbcRowSet`, a `CachedRowSet` object is scrollable and updatable by default. A `CachedRowSet` object is also *serializable*, so it can be passed between Java applications through a network, such as the Internet. However, `CachedRowSet` has a limitation—the amount of data that can be stored in memory is limited. Package `javax.sql.rowset` contains three other subinterfaces of `RowSet`.



### Portability Tip 28.5

A `RowSet` can provide scrolling capability for drivers that do not support scrollable `ResultSet`s.

### *Using a RowSet*

Figure 28.29 reimplements the example of Fig. 28.23 using a `RowSet`. Rather than establish the connection and create a `Statement` explicitly, Fig. 28.29 uses a `JdbcRowSet` object to create a `Connection` and a `Statement` automatically.

```

1 // Fig. 28.29: JdbcRowSetTest.java
2 // Displaying the contents of the Authors table using JdbcRowSet.
3 import java.sql.ResultSetMetaData;
4 import java.sql.SQLException;

```

**Fig. 28.29** | Displaying the Authors table using `JdbcRowSet`. (Part 1 of 3.)

```

5 import javax.sql.rowset.JdbcRowSet;
6 import com.sun.rowset.JdbcRowSetImpl; // Sun's JdbcRowSet implementation
7
8 public class JdbcRowSetTest
9 {
10 // JDBC driver name and database URL
11 static final String DATABASE_URL = "jdbc:mysql://localhost/books";
12 static final String USERNAME = "deitel";
13 static final String PASSWORD = "deitel";
14
15 // constructor connects to database, queries database, processes
16 // results and displays results in window
17 public JdbcRowSetTest()
18 {
19 // connect to database books and query database
20 try
21 {
22 // specify properties of JdbcRowSet
23 JdbcRowSet rowSet = new JdbcRowSetImpl();
24 rowSet.setUrl(DATABASE_URL); // set database URL
25 rowSet.setUsername(USERNAME); // set username
26 rowSet.setPassword(PASSWORD); // set password
27 rowSet.setCommand("SELECT * FROM Authors"); // set query
28 rowSet.execute(); // execute query
29
30 // process query results
31 ResultSetMetaData metaData = rowSet.getMetaData();
32 int numberOfColumns = metaData.getColumnCount();
33 System.out.println("Authors Table of Books Database:\n");
34
35 // display rowset header
36 for (int i = 1; i <= numberOfColumns; i++)
37 System.out.printf("%-8s\t", metaData.getColumnName(i));
38 System.out.println();
39
40 // display each row
41 while (rowSet.next())
42 {
43 for (int i = 1; i <= numberOfColumns; i++)
44 System.out.printf("%-8s\t", rowSet.getObject(i));
45 System.out.println();
46 } // end while
47
48 // close the underlying ResultSet, Statement and Connection
49 rowSet.close();
50 } // end try
51 catch (SQLException sqlException)
52 {
53 sqlException.printStackTrace();
54 System.exit(1);
55 } // end catch
56 } // end DisplayAuthors constructor
57

```

**Fig. 28.29** | Displaying the Authors table using JdbcRowSet. (Part 2 of 3.)

```

58 // launch the application
59 public static void main(String args[])
60 {
61 JdbcRowSetTest application = new JdbcRowSetTest();
62 } // end main
63 } // end class JdbcRowSetTest

```

Authors Table of Books Database:

| AuthorID | FirstName | LastName |
|----------|-----------|----------|
| 1        | Paul      | Deitel   |
| 2        | Harvey    | Deitel   |
| 3        | Abbey     | Deitel   |
| 4        | Michael   | Morgano  |
| 5        | Eric      | Kern     |

**Fig. 28.29** | Displaying the Authors table using JdbcRowSet. (Part 3 of 3.)

The package **com.sun.rowset** provides Oracle's reference implementations of the interfaces in package `javax.sql.rowset`. Line 23 uses Sun's reference implementation of the JdbcRowSet interface—**JdbcRowSetImpl**—to create a JdbcRowSet object. We used class JdbcRowSetImpl here to demonstrate the capability of the JdbcRowSet interface. Other databases may provide their own RowSet implementations.

Lines 24–26 set the RowSet properties that the DriverManager uses to establish a database connection. Line 24 invokes JdbcRowSet method **setUrl** to specify the database URL. Line 25 invokes JdbcRowSet method **setUsername** to specify the username. Line 26 invokes JdbcRowSet method **setPassword** to specify the password. Line 27 invokes JdbcRowSet method **setCommand** to specify the SQL query that will be used to populate the RowSet. Line 28 invokes JdbcRowSet method **execute** to execute the SQL query. Method execute performs four actions—it establishes a Connection to the database, prepares the query Statement, executes the query and stores the ResultSet returned by query. The Connection, Statement and ResultSet are encapsulated in the JdbcRowSet object.

The remaining code is almost identical to Fig. 28.23, except that line 31 obtains a ResultSetMetaData object from the JdbcRowSet, line 41 uses the JdbcRowSet's next method to get the next row of the result and line 44 uses the JdbcRowSet's getObject method to obtain a column's value. Line 49 invokes JdbcRowSet method **close**, which closes the RowSet's encapsulated ResultSet, Statement and Connection. In a CachedRowSet, invoking close also releases the resources held by that RowSet. The output of this application is the same as that of Fig. 28.23.

## 28.10 Java DB/Apache Derby

In this section and Section 28.11, we use Oracle's pure Java database **Java DB**. Please refer to the Before You Begin section after the Preface for information on installing Java DB. Section 28.11 uses the embedded version of Java DB. There's also a network version that executes similarly to the MySQL DBMS introduced earlier in the chapter.

Before you can execute the application in Section 28.11, you must set up the AddressBook database in Java DB. For the purpose of the following steps, we assume

you're running Microsoft Windows with Java installed in its default location. Mac OS X and Linux will need to perform similar steps.

1. Java DB comes with several batch files to configure and run it. Before executing these batch files from a command prompt, you must set the environment variable `JAVA_HOME` to refer to the JDK's installation directory—for example, `C:\Program Files\Java\jdk1.6.0_23`. Be sure to use the exact installation directory of the JDK on your computer.
2. Open the batch file `setEmbeddedCP.bat` (typically located in `C:\Program Files\Sun\JavaDB\bin`) in a text editor such as Notepad. Locate the line

```
@rem set DERBY_INSTALL=
```

and change it to

```
@set DERBY_INSTALL=C:\Program Files\Sun\JavaDB
```

Save your changes and close this file. [*Note:* You might need to run Notepad as an Administrator to edit this file. To do so, open the Start menu and type Notepad in the **Search programs and files** field. Then, right click **Notepad** at the top of the menu and select **Run as administrator**.]

3. Open a Command Prompt as an administrator (as you did for Notepad in the previous step) and change directories to

```
C:\Program Files\Sun\JavaDB\bin
```

Then, type `setEmbeddedCP.bat` and press *Enter* to set the environment variables required by Java DB.

4. An embedded Java DB database must reside in the same location as the application that manipulates the database. For this reason, change to the directory that contains the code for Figs. 28.30–28.32. This directory contains a SQL script `address.sql` that builds the `AddressBook` database.
5. Execute the command

```
"C:\Program Files\Sun\JavaDB\bin\ij"
```

to start the command-line tool for interacting with Java DB. The double quotes are necessary because the path contains a space. This will display the `ij>` prompt.

6. At the `ij>` prompt type

```
connect 'jdbc:derby:AddressBook;create=true;user=deitel';
password=deitel';
```

and press *Enter* to create the `AddressBook` database in the current directory and to create the user `deitel` with the password `deitel` for accessing the database.

7. To create the database table and insert sample data in it, we've provided the file `address.sql` in this example's directory. To execute this SQL script, type

```
run 'address.sql';
```

8. To terminate the Java DB command-line tool, type

```
exit;
```



You're now ready to execute the AddressBook application in Section 28.11. MySQL or any other database that supports JDBC PreparedStatement could also be used.

## 28.11 PreparedStatement

A **PreparedStatement** enables you to create compiled SQL statements that execute more efficiently than Statements. PreparedStatement can also specify parameters, making them more flexible than Statements—you can execute the same query repeatedly with different parameter values. For example, in the books database, you might want to locate all book titles for an author with a specific last and first name, and you might want to execute that query for several authors. With a PreparedStatement, that query is defined as follows:

```
PreparedStatement authorBooks = connection.prepareStatement(
 "SELECT LastName, FirstName, Title " +
 "FROM Authors INNER JOIN AuthorISBN " +
 "ON Authors.AuthorID=AuthorISBN.AuthorID " +
 "INNER JOIN Titles " +
 "ON AuthorISBN.ISBN=Titles.ISBN " +
 "WHERE LastName = ? AND FirstName = ?");
```

The two question marks (?) in the the preceding SQL statement's last line are placeholders for values that will be passed as part of the query to the database. Before executing a PreparedStatement, the program must specify the parameter values by using the PreparedStatement interface's *set* methods.

For the preceding query, both parameters are strings that can be set with PreparedStatement method **setString** as follows:

```
authorBooks.setString(1, "Deitel");
authorBooks.setString(2, "Paul");
```

Method `setString`'s first argument represents the parameter number being set, and the second argument is that parameter's value. Parameter numbers are *counted from 1*, starting with the first question mark (?). When the program executes the preceding PreparedStatement with the parameter values set above, the SQL passed to the database is

```
SELECT LastName, FirstName, Title
FROM Authors INNER JOIN AuthorISBN
ON Authors.AuthorID=AuthorISBN.AuthorID
INNER JOIN Titles
ON AuthorISBN.ISBN=Titles.ISBN
WHERE LastName = 'Deitel' AND FirstName = 'Paul'
```

Method `setString` automatically escapes String parameter values as necessary. For example, if the last name is O'Brien, the statement

```
authorBooks.setString(1, "O'Brien");
```

escapes the ' character in O'Brien by replacing it with two single-quote characters, so that the ' appears correctly in the database.



### Performance Tip 28.2

*PreparedStatement* are more efficient than Statements when executing SQL statements multiple times and with different parameter values.



### Error-Prevention Tip 28.2

Use `PreparedStatement` with parameters for queries that receive `String` values as arguments to ensure that the `Strings` are quoted properly in the `SQL` statement.

Interface `PreparedStatement` provides *set* methods for each supported `SQL` type. It's important to use the *set* method that is appropriate for the parameter's `SQL` type in the database—`SQLExceptions` occur when a program attempts to convert a parameter value to an incorrect type.

### Address Book Application that Uses `PreparedStatement`s

We now present an address book application that enables you to browse existing entries, add new entries and search for entries with a specific last name. Our `AddressBook` Java DB database contains an `Addresses` table with the columns `addressID`, `FirstName`, `LastName`, `Email` and `PhoneNumber`. The column `addressID` is a so-called *identity column*. This is the `SQL` standard way to represent an *autoincremented column*. The `SQL` script we provide for this database uses the `SQL IDENTITY` keyword to mark the `addressID` column as an identity column. For more information on using the `IDENTITY` keyword and creating databases, see the Java DB Developer's Guide at [download.oracle.com/javadb/10.6.1.0/devguide/devguide-single.html](http://download.oracle.com/javadb/10.6.1.0/devguide/devguide-single.html).

### Class `Person`

Our address book application consists of three classes—`Person` (Fig. 28.30), `PersonQueues` (Fig. 28.31) and `AddressBookDisplay` (Fig. 28.32). Class `Person` is a simple class that represents one person in the address book. The class contains fields for the address ID, first name, last name, email address and phone number, as well as *set* and *get* methods for manipulating these fields.

---

```

1 // Fig. 28.30: Person.java
2 // Person class that represents an entry in an address book.
3 public class Person
4 {
5 private int addressID;
6 private String firstName;
7 private String lastName;
8 private String email;
9 private String phoneNumber;
10
11 // no-argument constructor
12 public Person()
13 {
14 } // end no-argument Person constructor
15
16 // constructor
17 public Person(int id, String first, String last,
18 String emailAddress, String phone)
19 {
20 setAddressID(id);
21 setFirstName(first);

```

**Fig. 28.30** | `Person` class that represents an entry in an `AddressBook`. (Part 1 of 3.)

```
22 setLastName(last);
23 setEmail(emailAddress);
24 setPhoneNumber(phone);
25 } // end five-argument Person constructor
26
27 // sets the addressID
28 public void setAddressID(int id)
29 {
30 addressID = id;
31 } // end method setAddressID
32
33 // returns the addressID
34 public int getAddressID()
35 {
36 return addressID;
37 } // end method getAddressID
38
39 // sets the firstName
40 public void setFirstName(String first)
41 {
42 firstName = first;
43 } // end method setFirstName
44
45 // returns the first name
46 public String getFirstName()
47 {
48 return firstName;
49 } // end method getFirstName
50
51 // sets the lastName
52 public void setLastName(String last)
53 {
54 lastName = last;
55 } // end method setLastName
56
57 // returns the last name
58 public String getLastName()
59 {
60 return lastName;
61 } // end method getLastName
62
63 // sets the email address
64 public void setEmail(String emailAddress)
65 {
66 email = emailAddress;
67 } // end method setEmail
68
69 // returns the email address
70 public String getEmail()
71 {
72 return email;
73 } // end method getEmail
74
```

**Fig. 28.30** | Person class that represents an entry in an AddressBook. (Part 2 of 3.)

```

75 // sets the phone number
76 public void setPhoneNumber(String phone)
77 {
78 phoneNumber = phone;
79 } // end method setPhoneNumber
80
81 // returns the phone number
82 public String getPhoneNumber()
83 {
84 return phoneNumber;
85 } // end method getPhoneNumber
86 } // end class Person

```

**Fig. 28.30** | Person class that represents an entry in an AddressBook. (Part 3 of 3.)

### *Class PersonQueries*

Class `PersonQueries` (Fig. 28.31) manages the address book application's database connection and creates the `PreparedStatement`s that the application uses to interact with the database. Lines 18–20 declare three `PreparedStatement` variables. The constructor (lines 23–49) connects to the database at lines 27–28.

```

1 // Fig. 28.31: PersonQueries.java
2 // PreparedStatement used by the Address Book application.
3 import java.sql.Connection;
4 import java.sql.DriverManager;
5 import java.sql.PreparedStatement;
6 import java.sql.ResultSet;
7 import java.sql.SQLException;
8 import java.util.List;
9 import java.util.ArrayList;
10
11 public class PersonQueries
12 {
13 private static final String URL = "jdbc:derby:AddressBook";
14 private static final String USERNAME = "deitel";
15 private static final String PASSWORD = "deitel";
16
17 private Connection connection = null; // manages connection
18 private PreparedStatement selectAllPeople = null;
19 private PreparedStatement selectPeopleByLastName = null;
20 private PreparedStatement insertNewPerson = null;
21
22 // constructor
23 public PersonQueries()
24 {
25 try
26 {
27 connection =
28 DriverManager.getConnection(URL, USERNAME, PASSWORD);
29

```

**Fig. 28.31** | PreparedStatement used by the Address Book application. (Part 1 of 4.)

```

30 // create query that selects all entries in the AddressBook
31 selectAllPeople =
32 connection.prepareStatement("SELECT * FROM Addresses");
33
34 // create query that selects entries with a specific last name
35 selectPeopleByLastName = connection.prepareStatement(
36 "SELECT * FROM Addresses WHERE LastName = ?");
37
38 // create insert that adds a new entry into the database
39 insertNewPerson = connection.prepareStatement(
40 "INSERT INTO Addresses " +
41 "(FirstName, LastName, Email, PhoneNumber) " +
42 "VALUES (?, ?, ?, ?)");
43 } // end try
44 catch (SQLException sqlException)
45 {
46 sqlException.printStackTrace();
47 System.exit(1);
48 } // end catch
49 } // end PersonQueries constructor
50
51 // select all of the addresses in the database
52 public List< Person > getAllPeople()
53 {
54 List< Person > results = null;
55 ResultSet resultSet = null;
56
57 try
58 {
59 // executeQuery returns ResultSet containing matching entries
60 resultSet = selectAllPeople.executeQuery();
61 results = new ArrayList< Person >();
62
63 while (resultSet.next())
64 {
65 results.add(new Person(
66 resultSet.getInt("addressID"),
67 resultSet.getString("FirstName"),
68 resultSet.getString("LastName"),
69 resultSet.getString("Email"),
70 resultSet.getString("PhoneNumber")));
71 } // end while
72 } // end try
73 catch (SQLException sqlException)
74 {
75 sqlException.printStackTrace();
76 } // end catch
77 finally
78 {
79 try
80 {
81 resultSet.close();
82 } // end try

```

**Fig. 28.31** | PreparedStatement used by the Address Book application. (Part 2 of 4.)

```

83 catch (SQLException sqlException)
84 {
85 sqlException.printStackTrace();
86 close();
87 } // end catch
88 } // end finally
89
90 return results;
91 } // end method getAllPeople
92
93 // select person by last name
94 public List< Person > getPeopleByLastName(String name)
95 {
96 List< Person > results = null;
97 ResultSet resultSet = null;
98
99 try
100 {
101 selectPeopleByLastName.setString(1, name); // specify last name
102
103 // executeQuery returns ResultSet containing matching entries
104 resultSet = selectPeopleByLastName.executeQuery();
105
106 results = new ArrayList< Person >();
107
108 while (resultSet.next())
109 {
110 results.add(new Person(resultSet.getInt("addressID"),
111 resultSet.getString("FirstName"),
112 resultSet.getString("LastName"),
113 resultSet.getString("Email"),
114 resultSet.getString("PhoneNumber")));
115 } // end while
116 } // end try
117 catch (SQLException sqlException)
118 {
119 sqlException.printStackTrace();
120 } // end catch
121 finally
122 {
123 try
124 {
125 resultSet.close();
126 } // end try
127 catch (SQLException sqlException)
128 {
129 sqlException.printStackTrace();
130 close();
131 } // end catch
132 } // end finally
133
134 return results;
135 } // end method getPeopleByName

```

**Fig. 28.31** | PreparedStatements used by the Address Book application. (Part 3 of 4.)

```

136
137 // add an entry
138 public int addPerson(
139 String fname, String lname, String email, String num)
140 {
141 int result = 0;
142
143 // set parameters, then execute insertNewPerson
144 try
145 {
146 insertNewPerson.setString(1, fname);
147 insertNewPerson.setString(2, lname);
148 insertNewPerson.setString(3, email);
149 insertNewPerson.setString(4, num);
150
151 // insert the new entry; returns # of rows updated
152 result = insertNewPerson.executeUpdate();
153 } // end try
154 catch (SQLException sqlException)
155 {
156 sqlException.printStackTrace();
157 close();
158 } // end catch
159
160 return result;
161 } // end method addPerson
162
163 // close the database connection
164 public void close()
165 {
166 try
167 {
168 connection.close();
169 } // end try
170 catch (SQLException sqlException)
171 {
172 sqlException.printStackTrace();
173 } // end catch
174 } // end method close
175 } // end class PersonQueries

```

**Fig. 28.31** | PreparedStatement used by the Address Book application. (Part 4 of 4.)

### *Creating PreparedStatement*

Lines 31–32 invoke Connection method **prepareStatement** to create the PreparedStatement named `selectAllPeople` that selects all the rows in the `Addresses` table. Lines 35–36 create the PreparedStatement named `selectPeopleByLastName` with a parameter. This statement selects all the rows in the `Addresses` table that match a particular last name. Notice the `?` character that’s used to specify the last-name parameter. Lines 39–42 create the PreparedStatement named `insertNewPerson` with four parameters that represent the first name, last name, email address and phone number for a new entry. Again, notice the `?` characters used to represent these parameters.

**PersonQueries Method getAllPeople**

Method `getAllPeople` (lines 52–91) executes `PreparedStatement selectAllPeople` (line 60) by calling method `executeQuery`, which returns a `ResultSet` containing the rows that match the query (in this case, all the rows in the `Addresses` table). Lines 61–71 place the query results in an `ArrayList` of `Person` objects, which is returned to the caller at line 90. Method `getPeopleByLastName` (lines 94–135) uses `PreparedStatement` method `setString` to set the parameter to `selectPeopleByLastName` (line 101). Then, line 104 executes the query and lines 106–115 place the query results in an `ArrayList` of `Person` objects. Line 134 returns the `ArrayList` to the caller.

**PersonQueries Methods addPerson and Close**

Method `addPerson` (lines 138–161) uses `PreparedStatement` method `setString` (lines 146–149) to set the parameters for the `insertNewPerson` `PreparedStatement`. Line 152 uses `PreparedStatement` method `executeUpdate` to insert the new record. This method returns an integer indicating the number of rows that were updated (or inserted) in the database. Method `close` (lines 164–174) simply closes the database connection.

**Class AddressBookDisplay**

The `AddressBookDisplay` (Fig. 28.32) application uses a `PersonQueries` object to interact with the database. Line 59 creates the `PersonQueries` object. When the user presses the **Browse All Entries** `JButton`, the `browseButtonActionPerformed` handler (lines 309–335) is called. Line 313 calls the method `getAllPeople` on the `PersonQueries` object to obtain all the entries in the database. The user can then scroll through the entries using the **Previous** and **Next** `JButtons`. When the user presses the **Find** `JButton`, the `queryButtonActionPerformed` handler (lines 265–287) is called. Lines 267–268 call method `getPeopleByLastName` on the `PersonQueries` object to obtain the entries in the database that match the specified last name. If there are several such entries, the user can then scroll through them using the **Previous** and **Next** `JButtons`.

---

```

1 // Fig. 28.32: AddressBookDisplay.java
2 // A simple address book
3 import java.awt.event.ActionEvent;
4 import java.awt.event.ActionListener;
5 import java.awt.event.WindowAdapter;
6 import java.awt.event.WindowEvent;
7 import java.awt.FlowLayout;
8 import java.awt.GridLayout;
9 import java.util.List;
10 import javax.swing.JButton;
11 import javax.swing.Box;
12 import javax.swing.JFrame;
13 import javax.swing.JLabel;
14 import javax.swing.JPanel;
15 import javax.swing.JTextField;
16 import javax.swing.WindowConstants;
17 import javax.swing.BoxLayout;
18 import javax.swing.BorderFactory;
19 import javax.swing.JOptionPane;

```

---

**Fig. 28.32** | A simple address book. (Part I of 9.)



```

20
21 public class AddressBookDisplay extends JFrame
22 {
23 private Person currentEntry;
24 private PersonQueries personQueries;
25 private List< Person > results;
26 private int numberOfEntries = 0;
27 private int currentEntryIndex;
28
29 private JButton browseButton;
30 private JLabel emailLabel;
31 private JTextField emailTextField;
32 private JLabel firstNameLabel;
33 private JTextField firstNameTextField;
34 private JLabel idLabel;
35 private JTextField idTextField;
36 private JTextField indexTextField;
37 private JLabel lastNameLabel;
38 private JTextField lastNameTextField;
39 private JTextField maxTextField;
40 private JButton nextButton;
41 private JLabel ofLabel;
42 private JLabel phoneLabel;
43 private JTextField phoneTextField;
44 private JButton previousButton;
45 private JButton queryButton;
46 private JLabel queryLabel;
47 private JPanel queryPanel;
48 private JPanel navigatePanel;
49 private JPanel displayPanel;
50 private JTextField queryTextField;
51 private JButton insertButton;
52
53 // no-argument constructor
54 public AddressBookDisplay()
55 {
56 super("Address Book");
57
58 // establish database connection and set up PreparedStatement
59 personQueries = new PersonQueries();
60
61 // create GUI
62 navigatePanel = new JPanel();
63 previousButton = new JButton();
64 indexTextField = new JTextField(2);
65 ofLabel = new JLabel();
66 maxTextField = new JTextField(2);
67 nextButton = new JButton();
68 displayPanel = new JPanel();
69 idLabel = new JLabel();
70 idTextField = new JTextField(10);
71 firstNameLabel = new JLabel();
72 firstNameTextField = new JTextField(10);

```

**Fig. 28.32** | A simple address book. (Part 2 of 9.)

```

73 lastNameLabel = new JLabel();
74 lastNameTextField = new JTextField(10);
75 emailLabel = new JLabel();
76 emailTextField = new JTextField(10);
77 phoneLabel = new JLabel();
78 phoneTextField = new JTextField(10);
79 queryPanel = new JPanel();
80 queryLabel = new JLabel();
81 queryTextField = new JTextField(10);
82 queryButton = new JButton();
83 browseButton = new JButton();
84 insertButton = new JButton();
85
86 setLayout(new FlowLayout(FlowLayout.CENTER, 10, 10));
87 setSize(400, 300);
88 setResizable(false);
89
90 navigatePanel.setLayout(
91 new BoxLayout(navigatePanel, BoxLayout.X_AXIS));
92
93 previousButton.setText("Previous");
94 previousButton.setEnabled(false);
95 previousButton.addActionListener(
96 new ActionListener()
97 {
98 public void actionPerformed(ActionEvent evt)
99 {
100 previousButtonActionPerformed(evt);
101 } // end method actionPerformed
102 } // end anonymous inner class
103); // end call to addActionListener
104
105 navigatePanel.add(previousButton);
106 navigatePanel.add(Box.createHorizontalStrut(10));
107
108 indexTextField.setHorizontalAlignment(
109 JTextField.CENTER);
110 indexTextField.addActionListener(
111 new ActionListener()
112 {
113 public void actionPerformed(ActionEvent evt)
114 {
115 indexTextFieldActionPerformed(evt);
116 } // end method actionPerformed
117 } // end anonymous inner class
118); // end call to addActionListener
119
120 navigatePanel.add(indexTextField);
121 navigatePanel.add(Box.createHorizontalStrut(10));
122
123 ofLabel.setText("of");
124 navigatePanel.add(ofLabel);
125 navigatePanel.add(Box.createHorizontalStrut(10));

```

**Fig. 28.32** | A simple address book. (Part 3 of 9.)

```

126
127 maxTextField.setHorizontalAlignment(
128 JTextField.CENTER);
129 maxTextField.setEditable(false);
130 navigatePanel.add(maxTextField);
131 navigatePanel.add(Box.createHorizontalStrut(10));
132
133 nextButton.setText("Next");
134 nextButton.setEnabled(false);
135 nextButton.addActionListener(
136 new ActionListener()
137 {
138 public void actionPerformed((ActionEvent evt))
139 {
140 nextButtonActionPerformed(evt);
141 } // end method actionPerformed
142 } // end anonymous inner class
143); // end call to addActionListener
144
145 navigatePanel.add(nextButton);
146 add(navigatePanel);
147
148 displayPanel.setLayout(new GridLayout(5, 2, 4, 4));
149
150 idLabel.setText("Address ID:");
151 displayPanel.add(idLabel);
152
153 idTextField.setEditable(false);
154 displayPanel.add(idTextField);
155
156 firstNameLabel.setText("First Name:");
157 displayPanel.add(firstNameLabel);
158 displayPanel.add(firstNameTextField);
159
160 lastNameLabel.setText("Last Name:");
161 displayPanel.add(lastNameLabel);
162 displayPanel.add(lastNameTextField);
163
164 emailLabel.setText("Email:");
165 displayPanel.add(emailLabel);
166 displayPanel.add(emailTextField);
167
168 phoneLabel.setText("Phone Number:");
169 displayPanel.add(phoneLabel);
170 displayPanel.add(phoneTextField);
171 add(displayPanel);
172
173 queryPanel.setLayout(
174 new BoxLayout(queryPanel, BoxLayout.X_AXIS));
175
176 queryPanel.setBorder(BorderFactory.createTitledBorder(
177 "Find an entry by last name"));
178 queryLabel.setText("Last Name:");

```

**Fig. 28.32** | A simple address book. (Part 4 of 9.)

```
179 queryPanel.add(Box.createHorizontalStrut(5));
180 queryPanel.add(queryLabel);
181 queryPanel.add(Box.createHorizontalStrut(10));
182 queryPanel.add(queryTextField);
183 queryPanel.add(Box.createHorizontalStrut(10));
184
185 queryButton.setText("Find");
186 queryButton.addActionListener(
187 new ActionListener()
188 {
189 public void actionPerformed(ActionEvent evt)
190 {
191 queryButtonActionPerformed(evt);
192 } // end method actionPerformed
193 } // end anonymous inner class
194); // end call to addActionListener
195
196 queryPanel.add(queryButton);
197 queryPanel.add(Box.createHorizontalStrut(5));
198 add(queryPanel);
199
200 browseButton.setText("Browse All Entries");
201 browseButton.addActionListener(
202 new ActionListener()
203 {
204 public void actionPerformed(ActionEvent evt)
205 {
206 browseButtonActionPerformed(evt);
207 } // end method actionPerformed
208 } // end anonymous inner class
209); // end call to addActionListener
210
211 add(browseButton);
212
213 insertButton.setText("Insert New Entry");
214 insertButton.addActionListener(
215 new ActionListener()
216 {
217 public void actionPerformed(ActionEvent evt)
218 {
219 insertButtonActionPerformed(evt);
220 } // end method actionPerformed
221 } // end anonymous inner class
222); // end call to addActionListener
223
224 add(insertButton);
225
226 addWindowListener(
227 new WindowAdapter()
228 {
229 public void windowClosing(WindowEvent evt)
230 {
231 personQueries.close(); // close database connection
```

**Fig. 28.32** | A simple address book. (Part 5 of 9.)

```

232 System.exit(0);
233 } // end method windowClosing
234 } // end anonymous inner class
235); // end call to addWindowListener
236
237 setVisible(true);
238 } // end no-argument constructor
239
240 // handles call when previousButton is clicked
241 private void previousButtonActionPerformed((ActionEvent evt)
242 {
243 currentEntryIndex--;
244
245 if (currentEntryIndex < 0)
246 currentEntryIndex = numberOfEntries - 1;
247
248 indexTextField.setText("" + (currentEntryIndex + 1));
249 indexTextFieldActionPerformed(evt);
250 } // end method previousButtonActionPerformed
251
252 // handles call when nextButton is clicked
253 private void nextButtonActionPerformed((ActionEvent evt)
254 {
255 currentEntryIndex++;
256
257 if (currentEntryIndex >= numberOfEntries)
258 currentEntryIndex = 0;
259
260 indexTextField.setText("" + (currentEntryIndex + 1));
261 indexTextFieldActionPerformed(evt);
262 } // end method nextButtonActionPerformed
263
264 // handles call when queryButton is clicked
265 private void queryButtonActionPerformed((ActionEvent evt)
266 {
267 results =
268 personQueries.getPeopleByLastName(queryTextField.getText());
269 numberOfEntries = results.size();
270
271 if (numberOfEntries != 0)
272 {
273 currentEntryIndex = 0;
274 currentEntry = results.get(currentEntryIndex);
275 idTextField.setText("" + currentEntry.getAddressID());
276 firstNameTextField.setText(currentEntry.getFirstName());
277 lastNameTextField.setText(currentEntry.getLastName());
278 emailTextField.setText(currentEntry.getEmail());
279 phoneTextField.setText(currentEntry.getPhoneNumber());
280 maxTextField.setText("" + numberOfEntries);
281 indexTextField.setText("" + (currentEntryIndex + 1));
282 nextButton.setEnabled(true);
283 previousButton.setEnabled(true);
284 } // end if

```

**Fig. 28.32** | A simple address book. (Part 6 of 9.)

```

285 else
286 browseButtonActionPerformed(evt);
287 } // end method queryButtonActionPerformed
288
289 // handles call when a new value is entered in indexTextField
290 private void indexTextFieldActionPerformed(ActionEvent evt)
291 {
292 currentEntryIndex =
293 (Integer.parseInt(indexTextField.getText()) - 1);
294
295 if (numberOfEntries != 0 && currentEntryIndex < numberOfEntries)
296 {
297 currentEntry = results.get(currentEntryIndex);
298 idTextField.setText("" + currentEntry.getAddressID());
299 firstNameTextField.setText(currentEntry.getFirstName());
300 lastNameTextField.setText(currentEntry.getLastName());
301 emailTextField.setText(currentEntry.getEmail());
302 phoneTextField.setText(currentEntry.getPhoneNumber());
303 maxTextField.setText("" + numberOfEntries);
304 indexTextField.setText("" + (currentEntryIndex + 1));
305 } // end if
306 } // end method indexTextFieldActionPerformed
307
308 // handles call when browseButton is clicked
309 private void browseButtonActionPerformed(ActionEvent evt)
310 {
311 try
312 {
313 results = personQueries.getAllPeople();
314 numberOfEntries = results.size();
315
316 if (numberOfEntries != 0)
317 {
318 currentEntryIndex = 0;
319 currentEntry = results.get(currentEntryIndex);
320 idTextField.setText("" + currentEntry.getAddressID());
321 firstNameTextField.setText(currentEntry.getFirstName());
322 lastNameTextField.setText(currentEntry.getLastName());
323 emailTextField.setText(currentEntry.getEmail());
324 phoneTextField.setText(currentEntry.getPhoneNumber());
325 maxTextField.setText("" + numberOfEntries);
326 indexTextField.setText("" + (currentEntryIndex + 1));
327 nextButton.setEnabled(true);
328 previousButton.setEnabled(true);
329 } // end if
330 } // end try
331 catch (Exception e)
332 {
333 e.printStackTrace();
334 } // end catch
335 } // end method browseButtonActionPerformed
336

```

**Fig. 28.32** | A simple address book. (Part 7 of 9.)

```

337 // handles call when insertButton is clicked
338 private void insertButtonActionPerformed(ActionEvent evt)
339 {
340 int result = personQueries.addPerson(firstNameTextField.getText(),
341 lastNameTextField.getText(), emailTextField.getText(),
342 phoneTextField.getText());
343
344 if (result == 1)
345 JOptionPane.showMessageDialog(this, "Person added!",
346 "Person added", JOptionPane.PLAIN_MESSAGE);
347 else
348 JOptionPane.showMessageDialog(this, "Person not added!",
349 "Error", JOptionPane.PLAIN_MESSAGE);
350
351 browseButtonActionPerformed(evt);
352 } // end method insertButtonActionPerformed
353
354 // main method
355 public static void main(String args[])
356 {
357 new AddressBookDisplay();
358 } // end method main
359 } // end class AddressBookDisplay

```

a) Initial **Address Book** screen.



b) Results of clicking **Browse All Entries**.



c) Browsing to the next entry.



d) Finding entries with the last name Green.



**Fig. 28.32** | A simple address book. (Part 8 of 9.)

e) After adding a new entry and browsing to it.



**Fig. 28.32** | A simple address book. (Part 9 of 9.)

To add a new entry into the AddressBook database, the user can enter the first name, last name, email and phone number (the AddressID will *autoincrement*) in the JTextFields and press the **Insert New Entry** JButton. The `insertButtonActionPerformed` handler (lines 338–352) is called. Lines 340–342 call the method `addPerson` on the `PersonQueries` object to add a new entry to the database. Line 351 calls `browseButtonActionPerformed` to obtain the updated set of people in the address book and update the GUI accordingly.

The user can then view different entries by pressing the **Previous** JButton or **Next** JButton, which results in calls to methods `previousButtonActionPerformed` (lines 241–250) or `nextButtonActionPerformed` (lines 253–262), respectively. Alternatively, the user can enter a number in the `indexTextField` and press *Enter* to view a particular entry. This results in a call to method `indexTextFieldActionPerformed` (lines 290–306) to display the specified record.

## 28.12 Stored Procedures

Many database management systems can store individual or sets of SQL statements in a database, so that programs accessing that database can invoke them. Such named collections of SQL statements are called **stored procedures**. JDBC enables programs to invoke stored procedures using objects that implement the interface **CallableStatement**. `CallableStatements` can receive arguments specified with the methods inherited from interface `PreparedStatement`. In addition, `CallableStatements` can specify **output parameters** in which a stored procedure can place return values. Interface `CallableStatement` includes methods to specify which parameters in a stored procedure are output parameters. The interface also includes methods to obtain the values of output parameters returned from a stored procedure.



### Portability Tip 28.6

*Although the syntax for creating stored procedures differs across database management systems, the interface `CallableStatement` provides a uniform interface for specifying input and output parameters for stored procedures and for invoking stored procedures.*





### Portability Tip 28.7

According to the Java API documentation for interface `CallableStatement`, for maximum portability between database systems, programs should process the update counts (which indicate how many rows were updated) or `ResultSet`s returned from a `CallableStatement` before obtaining the values of any output parameters.

## 28.13 Transaction Processing

Many database applications require guarantees that a series of database insertions, updates and deletions executes properly before the application continues processing the next database operation. For example, when you transfer money electronically between bank accounts, several factors determine if the transaction is successful. You begin by specifying the source account and the amount you wish to transfer from that account to a destination account. Next, you specify the destination account. The bank checks the source account to determine whether its funds are sufficient to complete the transfer. If so, the bank withdraws the specified amount and, if all goes well, deposits it into the destination account to complete the transfer. What happens if the transfer fails after the bank withdraws the money from the source account? In a proper banking system, the bank redeposits the money in the source account. How would you feel if the money was subtracted from your source account and the bank *did not* deposit the money in the destination account?

**Transaction processing** enables a program that interacts with a database to *treat a database operation (or set of operations) as a single operation*. Such an operation also is known as an **atomic operation** or a **transaction**. At the end of a transaction, a decision can be made either to **commit the transaction** or **roll back the transaction**. Committing the transaction finalizes the database operation(s); all insertions, updates and deletions performed as part of the transaction cannot be reversed without performing a new database operation. Rolling back the transaction leaves the database in its state prior to the database operation. This is useful when a portion of a transaction fails to complete properly. In our bank-account-transfer discussion, the transaction would be rolled back if the deposit could not be made into the destination account.

Java provides transaction processing via methods of interface `Connection`. Method `setAutoCommit` specifies whether each SQL statement commits after it completes (a `true` argument) or whether several SQL statements should be grouped as a transaction (a `false` argument). If the argument to `setAutoCommit` is `false`, the program must follow the last SQL statement in the transaction with a call to `Connection` method `commit` (to commit the changes to the database) or `Connection` method `rollback` (to return the database to its state prior to the transaction). Interface `Connection` also provides method `getAutoCommit` to determine the autocommit state for the `Connection`.

## 28.14 Wrap-Up

In this chapter, you learned basic database concepts, how to query and manipulate data in a database using SQL and how to use JDBC to allow Java applications to interact with MySQL and Java DB databases. You learned about the SQL commands `SELECT`, `INSERT`, `UPDATE` and `DELETE`, as well as clauses such as `WHERE`, `ORDER BY` and `INNER JOIN`. You learned the steps for obtaining a `Connection` to the database, creating a `Statement` to interact with the database's data, executing the statement and processing the results. Then you used a

RowSet to simplify the process of connecting to a database and creating statements. You used PreparedStatement to create precompiled SQL statements. You also learned how to create and configure databases in both MySQL and Java DB by using predefined SQL scripts. We also provided overviews of CallableStatements and transaction processing. In the next chapter, you'll learn about web application development with JavaServer Faces.

## 28.15 Web Resources

[www.oracle.com/technetwork/java/javadb/overview/index.html](http://www.oracle.com/technetwork/java/javadb/overview/index.html)

Oracle Java DB home page.

[db.apache.org/derby/papers/DerbyTut/index.html](http://db.apache.org/derby/papers/DerbyTut/index.html)

Apache Derby tutorial. Includes Linux installation instructions.

[download.oracle.com/javase/tutorial/jdbc/index.html](http://download.oracle.com/javase/tutorial/jdbc/index.html)

*The Java Tutorial's* JDBC track.

[www.sql.org](http://www.sql.org)

This SQL portal provides links to many resources, including SQL syntax, tips, tutorials, books, magazines, discussion groups, companies with SQL services, SQL consultants and free software.

[download.oracle.com/javase/6/docs/technotes/guides/jdbc/index.html](http://download.oracle.com/javase/6/docs/technotes/guides/jdbc/index.html)

Oracle JDBC API documentation.

[www.mysql.com](http://www.mysql.com)

This site is the MySQL database home page. You can download the latest versions of MySQL and MySQL Connector/J and access their online documentation.

[dev.mysql.com/doc/refman/5.5/en/index.html](http://dev.mysql.com/doc/refman/5.5/en/index.html)

MySQL reference manual.

[download.oracle.com/javase/6/docs/technotes/guides/jdbc/getstart/rowsetImpl.html](http://download.oracle.com/javase/6/docs/technotes/guides/jdbc/getstart/rowsetImpl.html)

Overviews the RowSet interface and its subinterfaces. This site also discusses the reference implementations of these interfaces from Sun and their usage.

## Summary

### Section 28.1 Introduction

- A database (p. 1172) is an integrated collection of data. A database management system (DBMS; p. 1172) provides mechanisms for storing, organizing, retrieving and modifying data.
- Today's most popular database management systems are relational database (p. 1173) systems.
- SQL (p. 1172) is the international standard language used to query (p. 1172) and manipulate relational data.
- Programs connect to, and interact with, relational databases via an interface—software that facilitates communications between a database management system and a program.
- A JDBC driver (p. 1172) enables Java applications to connect to a database in a particular DBMS and allows you to retrieve and manipulate database data.

### Section 28.2 Relational Databases

- A relational database (p. 1173) stores data in tables (p. 1173). Tables are composed of rows (p. 1173), and rows are composed of columns in which values are stored.
- A table's primary key (p. 1173) provides a unique value that cannot be duplicated among rows.
- Each column (p. 1173) of a table represents a different attribute.

- The primary key can be composed of more than one column.
- Every column in a primary key must have a value, and the value of the primary key must be unique. This is known as the Rule of Entity Integrity (p. 1177).
- A one-to-many relationship (p. 1177) between tables indicates that a row in one table can have many related rows in a separate table.
- A foreign key (p. 1175) is a column in a table that must match the primary-key column in another table. This is known as the Rule of Referential Integrity (p. 1175).
- Foreign keys enable information from multiple tables to be joined together. There's a one-to-many relationship between a primary key and its corresponding foreign key.

### Section 28.4.1 Basic SELECT Query

- The basic form of a query (p. 1172) is

```
* FROM tableName
```

where the asterisk (\*) (p. 1178) indicates that all columns from *tableName* should be selected, and *tableName* specifies the table in the database from which rows will be retrieved.

- To retrieve specific columns, replace the \* with a comma-separated list of column names.

### Section 28.4.2 WHERE Clause

- The optional WHERE clause (p. 1179) in a query specifies the selection criteria for the query. The basic form of a query with selection criteria (p. 1178) is

```
SELECT columnName1, columnName2, ... FROM tableName WHERE criteria
```

- The WHERE clause can contain operators <, >, <=, >=, =, <> and LIKE. LIKE (p. 1179) is used for string pattern matching (p. 1179) with wildcard characters percent (%) and underscore (\_).
- A percent character (%) (p. 1179) in a pattern indicates that a string matching the pattern can have zero or more characters at the percent character's location in the pattern.
- An underscore (\_ ; p. 1179) in the pattern string indicates a single character at that position in the pattern.

### Section 28.4.3 ORDER BY Clause

- A query's result can be sorted with the ORDER BY clause (p. 1181). The simplest form of an ORDER BY clause is

```
SELECT columnName1, columnName2, ... FROM tableName ORDER BY column ASC
SELECT columnName1, columnName2, ... FROM tableName ORDER BY column DESC
```

where ASC specifies ascending order, DESC specifies descending order and *column* specifies the column on which the sort is based. The default sorting order is ascending, so ASC is optional.

- Multiple columns can be used for ordering purposes with an ORDER BY clause of the form
- ```
ORDER BY column1 sortingOrder, column2 sortingOrder, ...
```
- The WHERE and ORDER BY clauses can be combined in one query. If used, ORDER BY must be the last clause in the query.

Section 28.4.4 Merging Data from Multiple Tables: INNER JOIN

- An INNER JOIN (p. 1183) merges rows from two tables by matching values in columns that are common to the tables. The basic form for the INNER JOIN operator is:

```
SELECT columnName1, columnName2, ...
FROM table1
INNER JOIN table2
ON table1.columnName = table2.columnName
```

The ON clause (p. 1183) specifies the columns from each table that are compared to determine which rows are joined. If a SQL statement uses columns with the same name from multiple tables, the column names must be fully qualified (p. 1183) by prefixing them with their table names and a dot (.).

Section 28.4.5 INSERT Statement

- An INSERT statement (p. 1184) inserts a new row into a table. The basic form of this statement is

```
INSERT INTO tableName ( columnName1, columnName2, ..., columnNameN )
VALUES ( value1, value2, ..., valueN )
```

where *tableName* is the table in which to insert the row. The *tableName* is followed by a comma-separated list of column names in parentheses. The list of column names is followed by the SQL keyword VALUES (p. 1184) and a comma-separated list of values in parentheses.

- SQL uses single quotes (') to delimit strings. To specify a string containing a single quote in SQL, escape the single quote with another single quote (i.e., '').

Section 28.4.6 UPDATE Statement

- An UPDATE statement (p. 1185) modifies data in a table. The basic form of an UPDATE statement is

```
UPDATE tableName
SET columnName1 = value1, columnName2 = value2, ..., columnNameN = valueN
WHERE criteria
```

where *tableName* is the table to update. Keyword SET (p. 1185) is followed by a comma-separated list of *columnName = value* pairs. The optional WHERE clause determines which rows to update.

Section 28.4.7 DELETE Statement

- A DELETE statement (p. 1186) removes rows from a table. The simplest form for a DELETE statement is

```
DELETE FROM tableName WHERE criteria
```

where *tableName* is the table from which to delete a row (or rows). The optional WHERE *criteria* determines which rows to delete. If this clause is omitted, all the table's rows are deleted.

Section 28.8.1 Connecting to and Querying a Database

- Package `java.sql` contains classes and interfaces for accessing relational databases in Java.
- A `Connection` object (p. 1191) manages the connection between a Java program and a database. `Connection` objects enable programs to create SQL statements that access data.
- `DriverManager` (p. 1191) method `getConnection` (p. 1191) attempts to connect to a database at a URL that specifies the protocol for communication, the subprotocol (p. 1191) for communication and the database name.
- `Connection` method `createStatement` (p. 1192) creates a `Statement` object (p. 1192), which can be used to submit SQL statements to the database.
- `Statement` method `executeQuery` (p. 1192) executes a query and returns a `ResultSet` object (p. 1192). `ResultSet` methods enable a program to manipulate query results.
- A `ResultSetMetaData` object (p. 1192) describes a `ResultSet`'s contents. Programs can use metadata programmatically to obtain information about the `ResultSet` column names and types.
- `ResultSetMetaData` method `getColumnCount` (p. 1192) retrieves the number of `ResultSet` columns.
- `ResultSet` method `next` (p. 1193) positions the `ResultSet` cursor to the next row and returns `true` if the row exists; otherwise, it returns `false`. This method must be called to begin processing a `ResultSet` because the cursor is initially positioned before the first row.

- It's possible to extract each `ResultSet` column as a specific Java type. `ResultSetMetaData` method `getColumnType` (p. 1193) returns a `Types` (p. 1193) constant (package `java.sql`) indicating the column's type.
- `ResultSet` *get* methods typically receive as an argument either a column number (as an `int`) or a column name (as a `String`) indicating which column's value to obtain.
- `ResultSet` row and column numbers start at 1.
- Each `Statement` object can open only one `ResultSet` at a time. When a `Statement` returns a new `ResultSet`, the `Statement` closes the prior `ResultSet`.
- `Connection` method `createStatement` has an overloaded version that receives the result type and concurrency. The result type specifies whether the `ResultSet`'s cursor is able to scroll in both directions or forward only and whether the `ResultSet` is sensitive to changes. The result concurrency (p. 1199) specifies whether the `ResultSet` can be updated.
- Some JDBC drivers (p. 1172) do not support scrollable or updatable `ResultSet`s.

Section 28.8.2 Querying the books Database

- `TableModel` (p. 1194) method `getColumnClass` (p. 1194) returns a `Class` object that represents the superclass of all objects in a particular column. A `JTable` (p. 1194) uses this information to set up the default cell renderer and cell editor for that column in a `JTable`.
- `ResultSetMetaData` method `getColumnClassName` (p. 1200) obtains a column's fully qualified class name (p. 1183).
- `TableModel` method `getColumnCount` (p. 1194) returns the number of columns in the `ResultSet`.
- `TableModel` method `columnName` (p. 1194) returns the column name in the `ResultSet`.
- `ResultSetMetaData` method `columnName` (p. 1200) obtains a column's name from the `ResultSet`.
- `TableModel` method `rowCount` (p. 1194) returns the number of rows in the model's `ResultSet`.
- `TableModel` method `getValueAt` (p. 1194) returns the `Object` at a particular row and column of the model's underlying `ResultSet`.
- `ResultSet` method `absolute` (p. 1200) positions the `ResultSet` cursor at a specific row.
- `AbstractTableModel` (p. 1194) method `fireTableStructureChanged` (p. 1200) notifies any `JTable` using a particular `TableModel` object as its model that the data in the model has changed.

Section 28.9 RowSet Interface

- `Interface RowSet` (p. 1207) configures a database connection and executes a query automatically.
- A connected `RowSet` (p. 1207) remains connected to the database while the object is in use. A disconnected `RowSet` (p. 1207) connects, executes a query, then closes the connection.
- `JdbcRowSet` (p. 1207), a connected `RowSet`, wraps a `ResultSet` object and allows you to scroll and update its rows. Unlike a `ResultSet` object, a `JdbcRowSet` object is scrollable and updatable by default.
- `CachedRowSet` (p. 1207), a disconnected `RowSet`, caches a `ResultSet`'s data in memory. A `CachedRowSet` is scrollable and updatable. A `CachedRowSet` is also serializable.

Section 28.10 Java DB/Apache Derby

- `Java DB` (p. 1209) has both an embedded version and a network version.

Section 28.11 PreparedStatements

- `PreparedStatements` (p. 1211) are compiled, so they execute more efficiently than `Statements`.

- PreparedStatements can have parameters, so the same query can execute with different arguments.
- A parameter is specified with a question mark (?) in the SQL statement. Before executing a PreparedStatement, you must use PreparedStatement's *set* methods to specify the arguments.
- PreparedStatement method *setString*'s (p. 1211) first argument represents the parameter number being set and the second argument is that parameter's value.
- Parameter numbers are counted from 1, starting with the first question mark (?).
- Method *setString* automatically escapes String parameter values as necessary.
- Interface PreparedStatement provides *set* methods for each supported SQL type.
- An identity column is the SQL standard way to represent an autoincremented (p. 1174) column. The SQL *IDENTITY* keyword (p. 1212) marks a column as an identity column.

Section 28.12 Stored Procedures

- JDBC enables programs to invoke stored procedures (p. 1226) using CallableStatement (p. 1226) objects.
- CallableStatement can specify input parameters. CallableStatement can specify output parameters (p. 1226) in which a stored procedure can place return values.

Section 28.13 Transaction Processing

- Transaction processing (p. 1227) enables a program that interacts with a database to treat a database operation (or set of operations) as a single operation—known as an atomic operation (p. 1227) or a transaction (p. 1227).
- At the end of a transaction, a decision can be made to either commit or roll back the transaction.
- Committing a transaction (p. 1227) finalizes the database operation(s)—inserts, updates and deletes cannot be reversed without performing a new database operation.
- Rolling back a transaction (p. 1227) leaves the database in its state prior to the database operation.
- Java provides transaction processing via methods of interface Connection.
- Method *setAutoCommit* (p. 1227) specifies whether each SQL statement commits after it completes (a true argument) or whether several SQL statements should be grouped as a transaction.
- When autocommit is disabled, the program must follow the last SQL statement in the transaction with a call to Connection method *commit* (to commit the changes to the database; p. 1227) or Connection method *rollback* (to return the database to its state prior to the transaction; p. 1227).
- Method *getAutoCommit* (p. 1227) determines the autocommit state for the Connection.

Self-Review Exercise

- 28.1** Fill in the blanks in each of the following statements:
- The international standard database language is _____.
 - A table in a database consists of _____ and _____.
 - Statement objects return SQL query results as _____ objects.
 - The _____ uniquely identifies each row in a table.
 - SQL keyword _____ is followed by the selection criteria that specify the rows to select in a query.
 - SQL keywords _____ specify the order in which rows are sorted in a query.
 - Merging rows from multiple database tables is called _____ the tables.
 - A(n) _____ is an organized collection of data.
 - A(n) _____ is a set of columns whose values match the primary-key values of another table.

- j) _____ method _____ is used to obtain a Connection to a database.
- k) Interface _____ helps manage the connection between a Java program and a database.
- l) A(n) _____ object is used to submit a query to a database.
- m) Unlike a ResultSet object, _____ and _____ objects are scrollable and updatable by default.
- n) _____, a disconnected RowSet, caches the data of a ResultSet in memory.

Answers to Self-Review Exercise

28.1 a) SQL. b) rows, columns. c) ResultSet. d) primary key. e) WHERE. f) ORDER BY. g) joining. h) database. i) foreign key. j) DriverManager, getConnection. k) Connection. l) Statement. m) JdbcRowSet, CachedRowSet n) CachedRowSet.

Exercises

28.2 (*Query Application for the books Database*) Using the techniques shown in this chapter, define a complete query application for the books database. Provide the following predefined queries:

- a) Select all authors from the Authors table.
- b) Select a specific author and list all books for that author. Include each book's title, year and ISBN. Order the information alphabetically by the author's last then first name.
- c) Select a specific title and list all authors for that title. Order the authors alphabetically by last name then by first name.
- d) Provide any other queries you feel are appropriate.

Display a JComboBox with appropriate names for each predefined query. Also allow users to supply their own queries.

28.3 (*Data Manipulation Application for the books Database*) Define a data-manipulation application for the books database. The user should be able to edit existing data and add new data to the database (obeying referential and entity integrity constraints). Allow the user to edit the database in the following ways:

- a) Add a new author.
- b) Edit the existing information for an author.
- c) Add a new title for an author. (Remember that the book must have an entry in the AuthorISBN table.).
- d) Add a new entry in the AuthorISBN table to link authors with titles.

28.4 (*Employee Database*) In Section 10.7, we introduced an employee-payroll hierarchy to calculate each employee's payroll. In this exercise, we provide a database of employees that corresponds to the employee-payroll hierarchy. (A SQL script to create the employees MySQL database is provided with the examples for this chapter.) Write an application that allows the user to:

- a) Add employees to the employee table.
- b) Add payroll information to the appropriate table for each new employee. For example, for a salaried employee add the payroll information to the salariedEmployees table.

Figure 28.33 is the entity-relationship diagram for the employees database.

28.5 (*Employee Database Query Application*) Modify Exercise 28.4 to provide a JComboBox and a JTextArea to allow the user to perform a query that is either selected from the JComboBox or defined in the JTextArea. Sample predefined queries are:

- a) Select all employees working in Department SALES.
- b) Select hourly employees working over 30 hours.
- c) Select all commission employees in descending order of the commission rate.

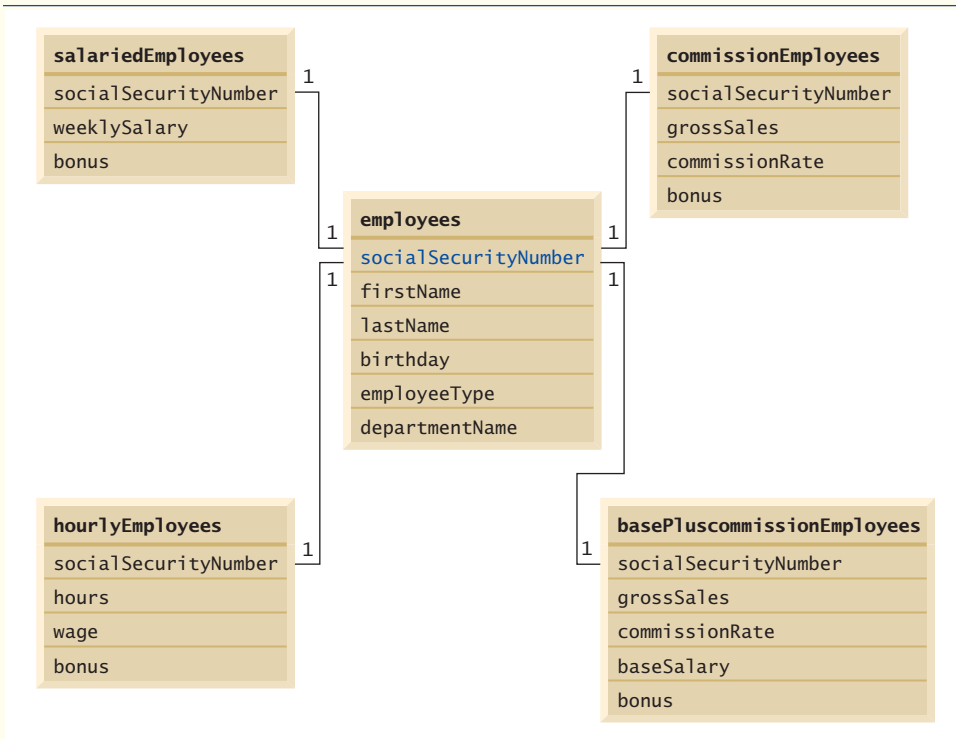

Fig. 28.33 | Table relationships in the employees database.

28.6 (*Employee Database Data Manipulation Application*) Modify Exercise 28.5 to perform the following tasks:

- Increase base salary by 10% for all base-plus-commission employees.
- If the employee's birthday is in the current month, add a \$100 bonus.
- For all commission employees with gross sales over \$10,000, add a \$100 bonus.

28.7 (*Address Book Modification: Update an Existing Entry*) Modify the program in Figs. 28.30–28.32 to provide a JButton that allows the user to call a method named `updatePerson` in `PersonQueries` class to update the current entry in the `AddressBook` database.

28.8 (*Address Book Modification: Delete an Existing Entry*) Modify the program of Exercise 28.7 to provide a JButton that allows the user to call a method named `deletePerson` in `PersonQueries` class to delete the current entry in the `AddressBook` database.

28.9 (*Project: ATM Case Study with a Database*) Modify the ATM Case Study (Chapters 12–13) to use an actual database to store the account information. We provide a SQL script to create a MySQL `BankDatabase`, which has a single table consisting of four columns—`AccountNumber` (an `int`), `PIN` (an `int`), `AvailableBalance` (a `double`) and `TotalBalance` (a `double`).

JavaServer™ Faces Web Apps: Part I

29

If any man will draw up his case, and put his name at the foot of the first page, I will give him an immediate reply. Where he compels me to turn over the sheet, he must wait my leisure.

—Lord Sandwich

Rule One:

Our client is always right.

Rule Two: If you think our client is wrong, see Rule One.

—Anonymous

A fair question should be followed by a deed in silence.

—Dante Alighieri

You will come here and get books that will open your eyes, and your ears, and your curiosity, and turn you inside out or outside in.

—Ralph Waldo Emerson

Objectives

In this chapter you'll learn:

- To create JavaServer Faces web apps.
- To create web apps consisting of multiple pages.
- To validate user input on a web page.
- To maintain user-specific state information throughout a web app with session tracking.

- | | |
|--|---|
| <ul style="list-style-type: none"> 29.1 Introduction 29.2 HyperText Transfer Protocol (HTTP) Transactions 29.3 Multitier Application Architecture 29.4 Your First JSF Web App <ul style="list-style-type: none"> 29.4.1 The Default <code>index.xhtml</code> Document: Introducing Facelets 29.4.2 Examining the <code>WebTimeBean</code> Class 29.4.3 Building the <code>WebTime</code> JSF Web App in NetBeans | <ul style="list-style-type: none"> 29.5 Model-View-Controller Architecture of JSF Apps 29.6 Common JSF Components 29.7 Validation Using JSF Standard Validators 29.8 Session Tracking <ul style="list-style-type: none"> 29.8.1 Cookies 29.8.2 Session Tracking with <code>@SessionScoped</code> Beans 29.9 Wrap-Up |
|--|---|

Summary | Self-Review Exercises | Answers to Self-Review Exercises | Exercises

29.1 Introduction

In this chapter, we introduce web app development in Java with JavaServer Faces (JSF). Web-based apps create content for web browser clients. This content includes eXtensible HyperText Markup Language (XHTML), JavaScript client-side scripting, Cascading Style Sheets (CSS), images and binary data. XHTML is an XML (eXtensible Markup Language) vocabulary that is based on HTML (HyperText Markup Language). We discuss only the features of these technologies that are required to understand the examples in this chapter. If you'd like more information on XHTML, XML, JavaScript and CSS, please visit our Resource Centers on each of these topics at

www.deitel.com/ResourceCenters.html

where you'll find links to introductions, tutorials and other valuable resources.

This chapter begins with an overview of how interactions between a web browser and web server work. We then present several web apps implemented with JSF. We continue this discussion in Chapter 30 with more advanced web applications.

Java multitier applications are typically implemented using Java Enterprise Edition (Java EE). The technologies we use to develop web apps here and in Chapter 30 are part of Java EE 6 (www.oracle.com/technetwork/java/javaee/overview/index.html). After you study this chapter and the next, you can learn more about JavaServer Faces 2.0 in Oracle's extensive Java EE 6 tutorial at download.oracle.com/javaee/6/tutorial/doc/.

We focus on the JavaServer Faces 2.0¹ subset of Java EE. JavaServer Faces is a **web-application framework** that enables you to build multitier web apps by extending the framework with your application-specific capabilities. The framework handles the details of receiving client requests and returning responses for you so that you can focus on your application's functionality.

Required Software for This Chapter

To work with and implement the examples in this chapter and Chapters 30–31, you must install the **NetBeans 6.9.1** IDE and the **GlassFish 3.0.1** open-source application server. Both are available in a bundle from netbeans.org/downloads/index.html. You're prob-

1. The JavaServer Faces Specification: <http://bit.ly/JSF20Spec>.

ably using a computer with the Windows, Linux or Mac OS X operating system—installers are provided for each of these platforms. Download and execute the installer for the **Java** or **All** version—both include the required **Java Web and EE** and **Glassfish Server Open Source Edition** options. We assume you use the default installation options for your platform. Once you’ve installed NetBeans, run it. Then, use the **Help** menu’s **Check for Updates** option to make sure you have the most up-to-date components.

29.2 HyperText Transfer Protocol (HTTP) Transactions

To learn how JSF web apps work, it’s important to understand the basics of what occurs behind the scenes when a user requests a web page in a web browser. If you’re already familiar with this and with multitier application architecture, you can skip to Section 29.4.

XHTML Documents

In its simplest form, a web page is nothing more than an XHTML document (also called an XHTML page) that describes content to display in a web browser. HTML documents normally contain *hyperlinks* that link to different pages or to other parts of the same page. When the user clicks a hyperlink, the requested web page loads into the user’s web browser. Similarly, the user can type the address of a page into the browser’s address field.

URLs

Computers that run **web-server** software make resources available, such as web pages, images, PDF documents and even objects that perform complex tasks such as database look-ups and web searches. The HyperText Transfer Protocol (HTTP) is used by web browsers to communicate with web servers, so they can exchange information in a uniform and reliable manner. URLs (Uniform Resource Locators) identify the locations on the Internet of resources, such as those mentioned above. If you know the URL of a publicly available web resource, you can access it through HTTP.

Parts of a URL

When you enter a URL into a web browser, the browser uses the information in the URL to locate the web server that contains the resource and to request that resource from the server. Let’s examine the components of the URL

```
http://www.deitel.com/books/downloads.html
```

The `http://` indicates that the resource is to be obtained using the HTTP protocol. The next portion, `www.deitel.com`, is the server’s fully qualified **hostname**—the name of the *server* on which the *resource* resides. The computer that houses and maintains resources is usually referred to as the **host**. The hostname `www.deitel.com` is translated into an **IP (Internet Protocol) address**—a unique numerical value that identifies the server, much as a telephone number uniquely defines a particular phone line. This translation is performed by a **domain-name system (DNS) server**—a computer that maintains a database of hostnames and their corresponding IP addresses—and the process is called a **DNS lookup**. To test web apps, you’ll often use your computer as the host. This host is referred to using the reserved domain name `localhost`, which translates to the IP address `127.0.0.1`. The fully qualified hostname can be followed by a colon (`:`) and a port number. Web servers typically await requests on port 80 by default; however, many development web servers use a different port number, such as 8080—as you’ll see in Section 29.4.3.

The remainder of the URL (i.e., `/books/downloads.html`) specifies both the name of the requested resource (the HTML document `downloads.html`) and its path, or location (`/books`), on the web server. The path could specify the location of an actual directory on the web server's file system. For security reasons, however, the path normally specifies the location of a **virtual directory**. The server translates the virtual directory into a real location on the server (or on another computer on the server's network), thus hiding the resource's true location. Some resources are created dynamically using other information, such as data from a database.

Making a Request and Receiving a Response

When given a URL, a web browser performs an HTTP transaction to retrieve and display the web page at that address. Figure 29.1 illustrates the transaction, showing the interaction between the web browser (the client) and the web server (the server).

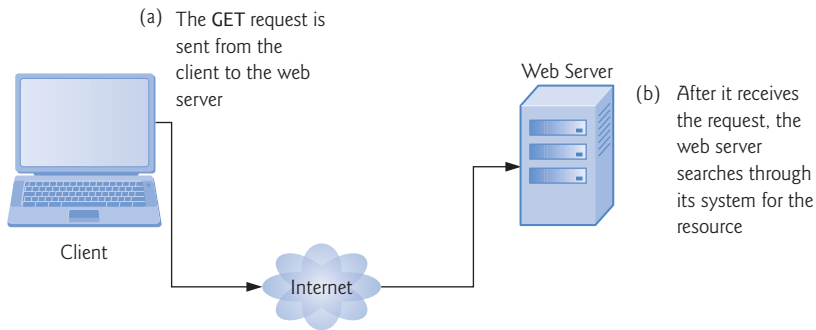

Fig. 29.1 | Client interacting with the web server. *Step 1: The GET request.*

In Fig. 29.1, the web browser sends an HTTP request to the server. Underneath the hood, the request (in its simplest form) is

```
GET /books/downloads.html HTTP/1.1
```

The word **GET** is an **HTTP method** indicating that the client wishes to obtain a resource from the server. The remainder of the request provides the path name of the resource (e.g., an HTML document) and the protocol's name and version number (HTTP/1.1). As part of the client request, the browser also sends other required and optional information, such as the `Host` (which identifies the server computer) or the `User-Agent` (which identifies the web browser type and version number).

Any server that understands HTTP (version 1.1) can translate this request and respond appropriately. Figure 29.2 depicts the server responding to a request.

The server first responds by sending a line of text that indicates the HTTP version, followed by a numeric code and a phrase describing the status of the transaction. For example,

```
HTTP/1.1 200 OK
```

indicates success, whereas

```
HTTP/1.1 404 Not found
```

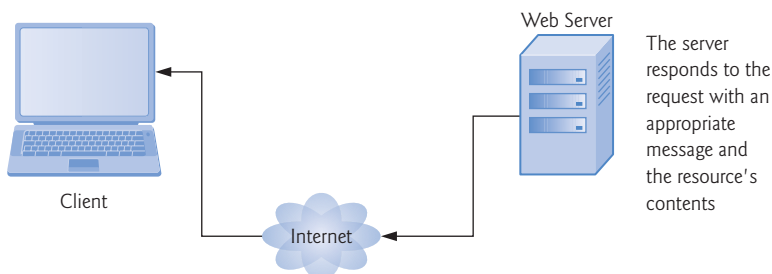

Fig. 29.2 | Client interacting with the web server. Step 2: The HTTP response.

informs the client that the web server could not locate the requested resource. On a successful request, the server appends the requested resource to the HTTP response. A complete list of numeric codes indicating the status of an HTTP transaction can be found at www.w3.org/Protocols/rfc2616/rfc2616-sec10.html.

HTTP Headers

The server then sends one or more **HTTP headers**, which provide additional information about the data that will be sent. If the server is sending an HTML text document, one HTTP header would read:

```
Content-type: text/html
```

The information provided in this header specifies the **Multipurpose Internet Mail Extensions (MIME)** type of the content that the server is transmitting to the browser. MIME is an Internet standard that specifies *data formats* so that programs can interpret data correctly. For example, the MIME type `text/plain` indicates that the sent information is text that can be displayed directly, without any interpretation of the content as HTML markup. Similarly, the MIME type `image/jpeg` indicates that the content is a JPEG image. When the browser receives this MIME type, it attempts to display the image. For a list of available MIME types, visit www.w3schools.com/media/media_mimeref.asp.

The header or set of headers is followed by a blank line, which indicates to the client browser that the server is finished sending HTTP headers. The server then sends the contents of the requested resource (such as, `downloads.html`). In the case of an HTML document, the web browser parses the HTML markup it receives and **renders** (or displays) the results.

HTTP GET and POST Requests

The two most common **HTTP request types** (also known as **request methods**) are GET and POST. A GET request typically asks for a resource on a server. Common uses of GET requests are to retrieve an HTML document or an image or to fetch search results from a search engine based on a user-submitted search term. A **POST** request typically sends data to a server. Common uses of POST requests are to send form data or documents to a server.

When a web page contains an HTML form in which the user can enter data, an HTTP request typically posts that data to a **server-side form handler** for processing. For example, when a user performs a search or participates in a web-based survey, the web server receives the information specified in the form as part of the request.

GET requests and POST requests can both send form data to a web server, yet each request type sends the information differently. A GET request sends information to the server in the URL, as in `www.google.com/search?q=deitel`. Here, `search` is the name of Google's server-side form handler, `q` is the name of a variable in Google's search form and `deitel` is the search term. A `?` separates the **query string** from the rest of the URL in a request. A *name/value* pair is passed to the server with the *name* and the *value* separated by an equals sign (`=`). If more than one *name/value* pair is submitted, each is separated from the next by an ampersand (`&`). The server uses data passed in a query string to retrieve an appropriate resource. The server then sends a **response** to the client. A GET request may be initiated by submitting an HTML form whose `method` attribute is set to `"get"`, by typing the URL (possibly containing a query string) directly into the browser's address bar or through a hyperlink when the user clicks the link.

A POST request sends form data as part of the HTTP message, not as part of the URL. The specification for GET requests does not limit the query string's number of characters, but some web browsers do—for example, Internet Explorer restricts the length to 2083 characters), so it's often necessary to send large pieces of information using POST. Sometimes POST is preferred because it hides the submitted data from the user by embedding it in an HTTP message.



Software Engineering Observation 29.1

The data sent in a POST request is not part of the URL, and the user can't see the data by default. However, tools are available that expose this data, so you should not assume that the data is secure just because a POST request is used.

Client-Side Caching

Browsers often **cache** (save on disk) web pages for quick reloading. If there are no changes between the version stored in the cache and the current version on the web, the browser uses the cached copy to speed up your browsing experience. An HTTP response can indicate the length of time for which the content remains “fresh.” If this amount of time has not been reached, the browser can avoid another request to the server. Otherwise, the browser requests the document from the server. Thus, the browser minimizes the amount of data that must be downloaded for you to view a web page. Browsers typically do not cache the server's response to a POST request, because the next POST might not return the same result. For example, in a survey, many users could visit the same web page and answer a question. The survey results could then be displayed for the user. Each new answer changes the survey results.

When you use a web-based search engine, the browser normally supplies the information you specify in an HTML form to the search engine with a GET request. The search engine performs the search, then returns the results to you as a web page. Such pages are sometimes cached by the browser in case you perform the same search again.

29.3 Multitier Application Architecture

Web apps are **multitier applications** (sometimes referred to as *n-tier applications*). Multitier applications divide functionality into separate **tiers** (i.e., logical groupings of functionality). Although tiers can be located on the same computer, the tiers of web apps often reside on separate computers. Figure 29.3 presents the basic structure of a three-tier web app.

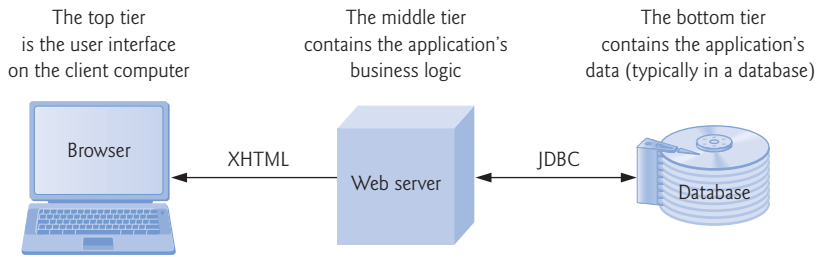

Fig. 29.3 | Three-tier architecture.

The **information tier** (also called the **data tier** or the **bottom tier**) maintains data pertaining to the application. This tier typically stores data in a *relational database management system (RDBMS)*. We discussed RDBMSs in Chapter 28. For example, a retail store might have a database for storing product information, such as descriptions, prices and quantities in stock. The same database also might contain customer information, such as user names, billing addresses and credit card numbers. This tier can contain multiple databases, which together comprise the data needed for our application.

The **middle tier** implements **business logic**, **controller logic** and **presentation logic** to control interactions between the application's clients and the application's data. The middle tier acts as an intermediary between data in the information tier and the application's clients. The middle-tier controller logic processes client requests (such as requests to view a product catalog) and retrieves data from the database. The middle-tier presentation logic then processes data from the information tier and presents the content to the client. Web apps typically present data to clients as HTML documents.

Business logic in the middle tier enforces **business rules** and ensures that data is reliable before the server application updates the database or presents the data to users. Business rules dictate how clients can and cannot access application data, and how applications process data. For example, a business rule in the middle tier of a retail store's web app might ensure that all product quantities remain positive. A client request to set a negative quantity in the bottom tier's product-information database would be rejected by the middle tier's business logic.

The **client tier**, or **top tier**, is the application's user interface, which gathers input and displays output. Users interact directly with the application through the user interface (typically viewed in a web browser), keyboard and mouse. In response to user actions (e.g., clicking a hyperlink), the client tier interacts with the middle tier to make requests and to retrieve data from the information tier. The client tier then displays the data retrieved from the middle tier to the user. The client tier never directly interacts with the information tier.

29.4 Your First JSF Web App

Let's begin with a simple example. Figure 29.4 shows the output of our WebTime app. When you invoke this app from a web browser, the browser requests the app's default JSF page. The web server receives this request and passes it to the **JSF web-application framework** for processing. This framework is available in any Java EE 6-compliant application server (such as the GlassFish application server used in this chapter) or any JavaServer

Faces 2.0-compliant container (such as Apache Tomcat). The framework includes the **Faces servlet**—a software component running on the server that processes each requested JSF page so that the server can eventually return a response to the client. In this example, the Faces servlet processes the JSF document in Fig. 29.5 and forms a response containing the text "Current time on the web server:" followed by the web server's local time. We demonstrate this chapter's examples on the GlassFish server that you installed with NetBeans locally on your computer.



Fig. 29.4 | Sample output of the WebTime app.

Executing the WebTime App

To run this example on your own computer, perform the following steps:

1. Open the NetBeans IDE.
2. Select **File > Open Project...** to display the **Open Project** dialog.
3. Navigate to the `ch29` folder in the book's examples and select `WebTime`.
4. Click the **Open Project** button.
5. Right click the project's name in the **Projects** tab (in the upper-left corner of the IDE, below the toolbar) and select **Run** from the pop-up menu.

This launches the GlassFish application server (if isn't already running), installs the web app onto the server, then opens your computer's default web browser which requests the WebTime app's default JSF page. The browser should display a web page similar to that in Fig. 29.4.

29.4.1 The Default `index.xhtml` Document: Introducing Facelets

This app contains a single web page and consists of two related files—a JSF document named `index.xhtml` (Fig. 29.5) and a supporting Java source-code file (Fig. 29.6), which we discuss in Section 29.4.2. First we discuss the markup in `index.xhtml` and the supporting source code, then we provide step-by-step instructions for creating this web app in Section 29.4.3. Most of the markup in Fig. 29.5 was generated by NetBeans. We've reformatted the generated code to match our coding conventions used throughout the book.

```

1 <?xml version='1.0' encoding='UTF-8' ?>
2
3 <!-- index.xhtml -->
4 <!-- JSF page that displays the current time on the web server -->

```

Fig. 29.5 | JSF page that displays the current time on the web server. (Part I of 2.)

```
5 <!DOCTYPE html PUBLIC "-//W3C//DTD XHTML 1.0 Transitional//EN"
6 "http://www.w3.org/TR/xhtml1/DTD/xhtml1-transitional.dtd">
7 <html xmlns="http://www.w3.org/1999/xhtml"
8     xmlns:h="http://java.sun.com/jsf/html">
9     <h:head>
10        <title>WebTime: A Simple Example</title>
11        <meta http-equiv="refresh" content="60" />
12    </h:head>
13    <h:body>
14        <h1>Current time on the web server: #{webTimeBean.time}</h1>
15    </h:body>
16 </html>
```

Fig. 29.5 | JSF page that displays the current time on the web server. (Part 2 of 2.)

Facelets: XHTML and JSF Markup

You present your web app's content in JSF using **Facelets**—a combination of XHTML markup and JSF markup. **XHTML**—the **Extensible HyperText Markup Language**—specifies the content of a web page that is displayed in a web browser. XHTML separates the **presentation** of a document (that is, the document's appearance when rendered by a browser) from the **structure** of the document's data. A document's presentation might specify where the browser should place an element in a web page or what fonts and colors should be used to display an element. The XHTML 1.0 Strict Recommendation allows only a document's structure to appear in a valid XHTML document, and not its presentation. Presentation is specified with Cascading Style Sheets (CSS). JSF uses the XHTML 1.0 Transitional Recommendation by default. Transitional markup may include some non-CSS formatting, but this is not recommended.

XML Declaration, Comments and the DOCTYPE Declaration

With the exception of lines 3–4, 10–11 and 14, the code shown in Fig. 29.5 was generated by NetBeans. Line 1 is an XML declaration, indicating that the JSF document is expressed in XML 1.0 syntax. Lines 3–4 are comments that we added to the document to indicate its file name and purpose. Lines 5–6 are a DOCTYPE declaration indicating the version of XHTML used in the markup. This can be used by a web browser to validate the syntax of the document.

Specifying the XML Namespaces Used in the Document

Line 7 begins the document's root `html` element, which spans lines 7–16. Each element typically consists of a starting and ending tag. The starting `<html>` tag (lines 7–8) may contain one or more `xmlns` attributes. Each `xmlns` attribute has a **name** and a **value** separated by an equal sign (=), and specifies an XML namespace of elements that are used in the document. Just as Java packages can be used to differentiate class names, XML namespaces can be used to differentiate sets of elements. When there's a naming conflict, fully qualified tag names can be used to resolve the conflict.

Line 7 specifies a required `xmlns` attribute and its value (`http://www.w3.org/1999/xhtml`) for the `html` element. This indicates that the `html` element and any other unqualified element names are part of the default XML namespace that's used in this document.

The `xmlns:h` attribute (line 8) specifies a prefix and a URL for JSF's **HTML Tag Library**, allowing the document to use JSF's elements from that library. A tag library defines

a set of elements that can be inserted into the XHTML markup. The elements in the HTML Tag Library generate XHTML elements. Based on line 7, each element we use from the HTML Tag Library must be preceded by the `h:` prefix. This tag library is one of several supported by JSF that can be used to create Facelets pages. We'll discuss others as we use them. For a complete list of JSF tag libraries and their elements and attributes, visit

```
javaserverfaces.java.net/nonav/docs/2.0/pd1docs/facelets/
```

The `h:head` and `h:body` Elements

The `h:head` element (lines 9–12) defines the XHTML page's head element. In this example the head contains an HTML `title` element and a `meta` element. The document's `title` (line 10) typically appears in the browser window's title bar, or a browser tab if you have multiple web pages open in the browser at once. The `title` is also used when search engines index your web pages. The `meta` element (line 11) tells the browser to refresh the page every 60 seconds. This forces the browser to re-request the page once per minute.

The `h:body` element (lines 13–15) represents the page's content. In this example, it contains a XHTML `h1` header element (line 14) that represents the text to display when this document is rendered in the web browser. The `h1` element contains some literal text (Current time on the web server:) that's simply placed into the response to the client and a **JSF Expression Language (EL)** expression that obtains a value dynamically and inserts it into the response. The expression

```
{webTimeBean.time}
```

indicates that the web app has an object named `webTimeBean` which contains a property named `time`. The property's value replaces the expression in the response that's sent to the client. We'll discuss this EL expression in more detail shortly.

29.4.2 Examining the `WebTimeBean` Class

JSF documents typically interact with one or more Java objects to perform the app's tasks. As you saw, this example obtains the time on the server and sends it as part of the response.

JavaBeans

JavaBeans objects are instances of classes that follow certain conventions for class design. Each JavaBean class typically contains data and methods. A JavaBean exposes its data to a JSF document as **properties**. Depending on their use, these properties can be read/write, read-only or write-only. To define a read/write property, a JavaBean class provides *set* and *get* methods for that property. For example, to create a String property `firstName`, the class would provide methods with the following first lines:

```
public String getFirstName()
public void setFirstName( String name )
```

The fact that both method names contain “`FirstName`” with an uppercase “`F`” indicates that the class exposes a `firstName` property with a lowercase “`f`.” This naming convention is part of the JavaBeans Specification (available at bit.ly/JavaBeansSpecification). A read-only property would have only a *get* method and a write-only property only a *set* method. The JavaBeans used in JSF are also **POJOs (plain old Java objects)**, meaning that—unlike prior versions of JSF—you do *not* need to extend a special class to create the beans used in JSF applications. Instead various annotations are used to “inject” function-

ality into your beans so they can be used easily in JSF applications. The JSF framework is responsible for creating and managing objects of your JavaBean classes for you—you’ll see how to enable this momentarily.

Class *WebTimeBean*

Figure 29.6 presents the `WebTimeBean` class that allows the JSF document to obtain the web server’s time. You can name your bean classes like any other class. We chose to end the class name with “Bean” to indicate that the class represents a JavaBean. The class contains just a `getTime` method (lines 13–17), which defines the read-only `time` property of the class. Recall that we access this property at line 14 of Fig. 29.5. Lines 15–16 create a `Date` object, then format and return the time as a `String`.

```

1 // WebTimeBean.java
2 // Bean that enables the JSF page to retrieve the time from the server
3 package webtime;
4
5 import java.text.DateFormat;
6 import java.util.Date;
7 import javax.faces.bean.ManagedBean;
8
9 @ManagedBean( name="webTimeBean" )
10 public class WebTimeBean
11 {
12     // return the time on the server at which the request was received
13     public String getTime()
14     {
15         return DateFormat.getTimeInstance( DateFormat.LONG ).format(
16             new Date() );
17     } // end method getTime
18 } // end class WebTimeBean

```

Fig. 29.6 | Bean that enables the JSF page to retrieve the time from the server.

The *@ManagedBean* Annotation

Line 9 uses the **@ManagedBean** annotation (from the package `javax.faces.bean`) to indicate that the JSF framework should create and manage the `WebTimeBean` object(s) used in the application. The parentheses following the annotation contain the optional **name attribute**—in this case, indicating that the bean object created by the JSF framework should be called `webTimeBean`. If you specify the annotation without the parentheses and the name attribute, the JSF framework will use the class name with a lowercase first letter (that is, `webTimeBean`) as the default bean name.

Processing the EL Expression

When the Faces servlet encounters an EL expression that accesses a bean property, it automatically invokes the property’s *set* or *get* method based on the context in which the property is used. In line 14 of Fig. 29.5, accessing the property `webTimeBean.time` results in a call to the bean’s `getTime` method, which returns the web server’s time. If this bean object does not yet exist, the JSF framework instantiates it, then calls the `getTime` method on the bean object. The framework can also discard beans that are no longer being used. [Note: We discuss only the EL expressions that we use in this chapter. For more EL details,

see Chapter 6 of the Java EE 6 tutorial at download.oracle.com/javasee/6/tutorial/doc/ and Chapter 5 of the JSF 2.0 specification at bit.ly/JSF20Spec.]

29.4.3 Building the WebTime JSF Web App in NetBeans

We'll now build the WebTime app from scratch using NetBeans.

Creating the JSF Web Application Project

Begin by opening the NetBeans IDE and performing the following steps:

1. Select **File > New Project...** to display the **New Project** dialog. Select **Java Web** in the **Categories** pane, **Web Application** in the **Projects** pane and click **Next >**.
2. In the dialog's **Name and Location** step, specify **WebTime** as the **Project Name**. In the **Project Location** field, specify where you'd like to store the project (or keep the default location). These settings will create a **WebTime** directory to store the project's files in the parent directory you specified. Keep the other default settings and click **Next >**.
3. In the dialog's **Server and Settings** step, specify **GlassFish Server 3** as the **Server** and **Java EE 6 Web** as the **Java EE Version** (these may be the default). Keep the default **Context Path** and click **Next >**.
4. In the dialog's **Frameworks** step, select **JavaServer Faces**, then click **Finish** to create the web application project.

Examining the NetBeans Projects Window

Figure 29.7 displays the **Projects** window, which appears in the upper-left corner of the IDE. This window displays the contents of the project. The app's XHTML documents are placed in the **Web Pages** node. NetBeans supplies the default web page `index.xhtml` that will be displayed when a user requests this web app from a browser. When you add Java source code to the project, it will be placed in the **Source Packages** node.

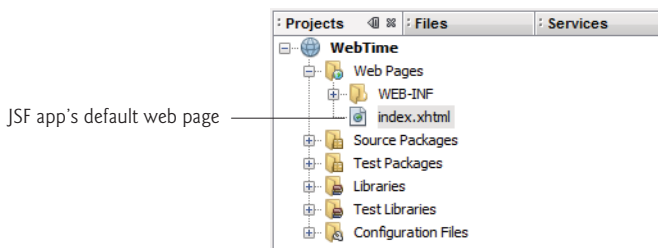

Fig. 29.7 | Projects window for the WebTime project.

Examining the Default index.xhtml Page

Figure 29.8 displays `index.xhtml`—the default page that will be displayed when a user requests this web app. We reformatted the code to match our coding conventions. When this file is first created, it contains elements for setting up the page, including linking to the page's style sheet and declaring the JSF libraries that will be used. By default, NetBeans

does not show line numbers in the source-code editor. To view the line numbers, select **View > Show Line Numbers**.

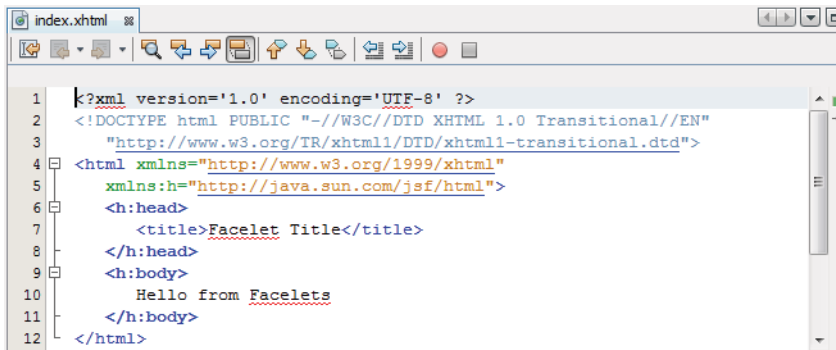

Fig. 29.8 | Default index.xhtml page generated by NetBeans for the web app.

Editing the h:head Element's Contents

Modify line 7 of Fig. 29.8 by changing the title element's content from "Facelet Title" to "Web Time: A Simple Example". After the closing `</title>` tag, press *Enter*, then insert the meta element

```
<meta http-equiv="refresh" content="60" />
```

which will cause the browser to refresh this page once per minute. As you type, notice that NetBeans provides a code-completion window to help you write your code. For example, after typing "`<meta`" and a space, the IDE displays the code-completion window in Fig. 29.9, which shows the list of valid attributes for the starting tag of a meta element. You can then double click an item in the list to insert it into your code. Code-completion support is provided for XHTML elements, JSF elements and Java code.

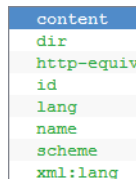

Fig. 29.9 | NetBeans code-completion window.

Editing the h:body Element's Contents

In the `h:body` element, replace "Hello from Facelets" with the `h1` header element

```
<h1>Current time on the web server: </h1>
```

Don't insert the expression `{webTimeBean.time}` yet. After we define the `WebTimeBean` class, we'll come back to this file and insert this expression to demonstrate that the IDE provides code-completion support for the Java classes you define in your project.

Defining the Page's Logic: Class WebTimeBean

We'll now create the `WebTimeBean` class—the `@ManagedBean` class that will allow the JSF page to obtain the web server's time. To create the class, perform the following steps:

1. In the NetBeans **Projects** tab, right click the `WebTime` project's **Source Packages** node and select **New > Other...** to display the **New File** dialog.
2. In the **Categories** list, select **JavaServer Faces**, then in the **File Types** list select **JSF Managed Bean**. Click **Next >**.
3. In the **Name and Location** step, specify `WebTimeBean` as the **Class Name** and `webtime` as the **Package**, then click **Finish**.

NetBeans creates the `WebTimeBean.java` file and places it within the `webtime` package in the project's **Source Packages** node. Figure 29.10 shows this file's default source code displayed in the IDE. At line 16, notice that NetBeans added the **@RequestScoped** annotation to the class—this indicates that an object of this class exists only for the duration of the request that's being processed. (We'll discuss `@RequestScoped` and other bean scopes in more detail in Section 29.8.) We did not include this annotation in Fig. 29.6, because all JSF beans are request scoped by default. Replace the code in Fig. 29.10 with the code in Fig. 29.6.

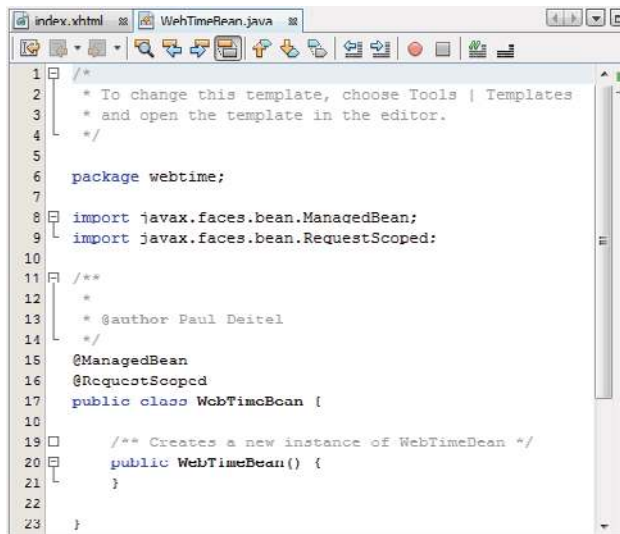

Fig. 29.10 | Default source code for the `WebTimeBean` class.

Adding the EL Expression to the index.xhtml Page

Now that you've created the `WebTimeBean`, let's go back to the `index.xhtml` file and add the EL expression that will obtain the time. In the `index.xhtml` file, modify the line

```
<h1>Current time on the web server: </h1>
```

by inserting the expression `#{webTimeBean.time}` before the `h1` element's closing tag. After you type the characters `#` and `{`, the IDE automatically inserts the closing `}`, inserts the

cursor between the braces and displays the code-completion window. This shows various items that could be placed in the braces of the EL expression, including the `webTimeBean` object (of type `WebTimeBean`). To insert `webTimeBean` in the code, you can type the object's name or double click it in the code-completion window. As you type, the list of items in the code-completion window is filtered by what you've typed so far.

When you type the dot (`.`) after `webTimeBean`, the code-completion window reappears, showing you the `WebTimeBean` methods and properties that can be used in this context (Fig. 29.11). In this list, you can double click the `time` property, or you can simply type its name.

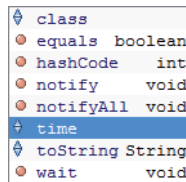

Fig. 29.11 | NetBeans code-completion window for the `webTimeBean` object.

Running the Application

You've now completed the `WebTime` app. To test it, right click the project's name in the **Projects** tab and select **Run** from the pop-up menu. The IDE will compile the code and deploy (that is, install) the `WebTime` app on the GlassFish application server running on your local machine. Then, the IDE will launch your default web browser and request the `WebTime` app's default web page (`index.xhtml`). Because GlassFish is installed on your local computer, the URL displayed in the browser's address bar will be

```
http://localhost:8080/WebTime/
```

where 8080 is the port number on which the GlassFish server runs by default. Depending on your web browser, the `http://` may not be displayed (Fig. 29.5).

Debugging the Application

If there's a problem with your web app's logic, you can press `<Ctrl> F5` to build the application and run it in debug mode—the NetBeans built-in debugger can help you troubleshoot applications. If you press `F6`, the program executes without debugging enabled.

Testing the Application from Other Web Browsers

After deploying your project, you can test it from another web browser on your computer by entering the app's URL into the other browser's address field. Since your application resides on the local file system, GlassFish must be running. If you've already executed the application using one of the techniques above and have not closed NetBeans, GlassFish will still be running. Otherwise, you can start the server from the IDE by opening the **Services** tab (located in the same panel as the **Projects**), expanding the **Servers** node, right clicking **GlassFish Server 3** and selecting **Start**. Then you can type the URL in the browser to execute the application.

29.5 Model-View-Controller Architecture of JSF Apps

JSF applications adhere to the **Model-View-Controller (MVC) architecture**, which separates an application's data (contained in the **model**) from the graphical presentation (the **view**) and the processing logic (the **controller**). Figure 29.12 shows the relationships between components in MVC.

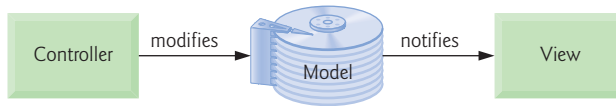

Fig. 29.12 | Model-View-Controller architecture.

In JSF, the controller is the JSF framework and is responsible for coordinating interactions between the view and the model. The model contains the application's data (typically in a database), and the view presents the data stored in the model (typically as web pages). When a user interacts with a JSF web app's view, the framework interacts with the model to store and/or retrieve data. When the model changes, the view is updated with the changed data.

29.6 Common JSF Components

As mentioned in Section 29.4, JSF supports several tag libraries. In this section, we introduce several of the JSF HTML Tag Library's elements and one element from the **JSF Core Tag Library**. Figure 29.13 summarizes elements discussed in this section.

JSF component	Description
<code>h:form</code>	Inserts an XHTML form element into a page.
<code>h:commandButton</code>	Displays a button that triggers an event when clicked. Typically, such a button is used to submit a form's user input to the server for processing.
<code>h:graphicImage</code>	Displays an image (e.g., GIF and JPG).
<code>h:inputText</code>	Displays a text box in which the user can enter input.
<code>h:outputLink</code>	Displays a hyperlink.
<code>h:panelGrid</code>	Displays an XHTML table element.
<code>h:selectOneMenu</code>	Displays a drop-down list of choices from which the user can make a selection.
<code>h:selectOneRadio</code>	Displays a set of radio buttons.
<code>f:selectItem</code>	Specifies an item in an <code>h:selectOneMenu</code> or <code>h:selectOneRadio</code> (and other similar components).

Fig. 29.13 | Commonly used JSF components.

All of these elements are mapped by JSF framework to a combination of XHTML elements and JavaScript code that enables the browser to render the page. JavaScript is a scripting language that's interpreted in all of today's popular web browsers. It can be used to perform tasks that manipulate web-page elements in a web browser and provide interactivity with the user. You can learn more about JavaScript in our JavaScript Resource Center at www.deitel.com/JavaScript/.

Figure 29.14 displays a form for gathering user input. [Note: To create this application from scratch, review the steps in Section 29.4.3 and name the application WebComponents.] The `h:form` element (lines 14–55) contains the components with which a user interacts to provide data, such as registration or login information, to a JSF app. This example uses the components summarized in Fig. 29.13. This example does not perform a task when the user clicks the **Register** button. Later, we demonstrate how to add functionality to many of these components.

```

1  <?xml version='1.0' encoding='UTF-8' ?>
2
3  <!-- index.xhtml -->
4  <!-- Registration form that demonstrates various JSF components -->
5  <!DOCTYPE html PUBLIC "-//W3C//DTD XHTML 1.0 Transitional//EN"
6     "http://www.w3.org/TR/xhtml1/DTD/xhtml1-transitional.dtd">
7  <html xmlns="http://www.w3.org/1999/xhtml"
8       xmlns:h="http://java.sun.com/jsf/html"
9       xmlns:f="http://java.sun.com/jsf/core">
10     <h:head>
11         <title>Sample Registration Form</title>
12     </h:head>
13     <h:body>
14         <h:form>
15             <h1>Registration Form</h1>
16             <p>Please fill in all fields and click Register</p>
17             <h:panelGrid columns="4" style="height: 96px; width:456px;">
18                 <h:graphicImage name="fname.png" library="images"/>
19                 <h:inputText id="firstNameInputText"/>
20                 <h:graphicImage name="lname.png" library="images"/>
21                 <h:inputText id="lastNameInputText"/>
22                 <h:graphicImage name="email.png" library="images"/>
23                 <h:inputText id="emailInputText"/>
24                 <h:graphicImage name="phone.png" library="images"/>
25                 <h:inputText id="phoneInputText"/>
26             </h:panelGrid>
27             <p><h:graphicImage name="publications.png" library="images"/>
28                 <br/>Which book would you like information about?</p>
29             <h:selectOneMenu id="booksSelectOneMenu">
30                 <f:selectItem itemValue="CHTP"
31                     itemLabel="C How to Program" />
32                 <f:selectItem itemValue="CPPHTP"
33                     itemLabel="C++ How to Program" />
34                 <f:selectItem itemValue="IW3HTP"
35                     itemLabel="Internet & World Wide Web How to Program" />

```

Fig. 29.14 | Registration form that demonstrates various JSF components. (Part 1 of 2.)

```

36         <f:selectItem itemValue="JHTP"
37             itemLabel="Java How to Program" />
38         <f:selectItem itemValue="VBHTP"
39             itemLabel="Visual Basic How to Program" />
40         <f:selectItem itemValue="VCSHTP"
41             itemLabel="Visual C# How to Program" />
42     </h:selectOneMenu>
43     <p><h:outputLink value="http://www.deitel.com">
44         Click here to learn more about our books
45     </h:outputLink></p>
46     <h:graphicImage name="os.png" library="images"/>
47     <h:selectOneRadio id="osSelectOneRadio">
48         <f:selectItem itemValue="WinVista" itemLabel="Windows Vista"/>
49         <f:selectItem itemValue="Win7" itemLabel="Windows 7"/>
50         <f:selectItem itemValue="OSX" itemLabel="Mac OS X"/>
51         <f:selectItem itemValue="Linux" itemLabel="Linux"/>
52         <f:selectItem itemValue="Other" itemLabel="Other"/>
53     </h:selectOneRadio>
54     <h:commandButton value="Register"/>
55 </h:form>
56 </h:body>
57 </html>

```

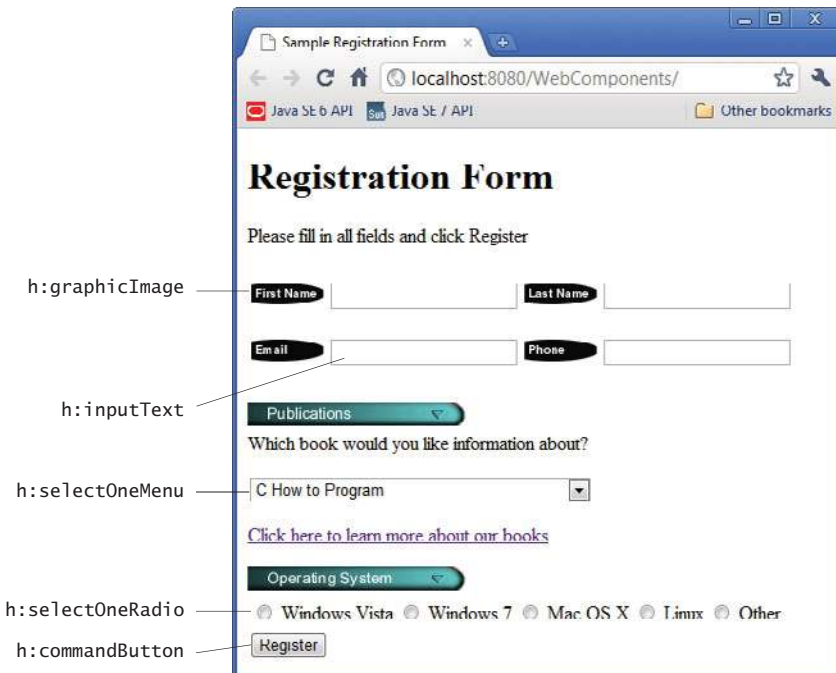

Fig. 29.14 | Registration form that demonstrates various JSF components. (Part 2 of 2.)

h:panelGrid Element

Lines 17–26 define an **h:panelGrid** element for organizing elements in the page. This element inserts an XHTML table in the page. The **h:** prefix indicates that panelGrid is

from the JSF HTML Tag Library. The **columns attribute** specifies the number of columns in the table. The elements between the `h:panelGrid`'s start tag (line 17) and end tag (line 26) are automatically placed into the table's columns from left to right in the order they appear in the JSF page. When the number of elements in a row exceeds the number of columns, the `h:panelGrid` creates a new row. We use the `h:panelGrid` to control the positions of the `h:graphicImage` and `h:inputText` elements in the user information section of the page. In this case, there are eight elements in the `h:panelGrid`, so the first four (lines 18–21) are placed in the table's first row and the last four are placed in the second row. The `h:panelGrid`'s **style attribute** specifies the CSS formatting for the table. We use the CSS attributes `width` and `height` to specify the width and height of the table in pixels (px). The `h:panelGrid` contains pairs of `h:graphicImage` and `h:inputText` elements.

h:graphicImage Element and Resource Libraries

Each **h:graphicImage** displays an image in the page. For example, line 18 inserts the image `fname.png`—as specified by the **name attribute**. As of JSF 2.0, you add resources that are used throughout your app—such as images, CSS files, JavaScript files—to your web apps by placing them in the app's **resources folder** within your project's **Web Pages** node. Each subfolder of resources represents a **resource library**. Typically, images are placed in an `images` library and CSS files in a `css` library. In line 18, we specify that the image is located in the `images` library with the **library attribute**. JSF knows that the value of this attribute represents a folder within the resources folder.

You can create any library you like in the resources folder. To create this folder:

1. Expand your app's node in the NetBeans **Projects** tab.
2. Right click the **Web Pages** node and select **New > Folder...** to display the **New Folder** dialog. [*Note:* If the **Folder...** option is not available in the popup menu, select **Other...**, then in the **Categories** pane select **Other** and in the **File Types** pane select **Folder** and click **Next >**.
3. Specify resources as the *Folder Name* and press *Finish*.

Next, right click the resources folder you just created and create an `images` subfolder. You can then drag the images from your file system onto the `images` folder to add them as resources. The images in this example are located in the `images` directory with the chapter's examples.

The `h:graphicImage` in line 18 is a so-called **empty element**—an element that does not have content between its start and end tags. In such an element, data is typically specified as attributes in the start tag, such as the `name` and `library` attributes in line 18. You can close an empty element either by placing a slash immediately preceding the start tag's right angle bracket, as shown in line 18, or by explicitly writing an end tag.

h:inputText Element

Line 19 defines an **h:inputText element** in which the user can enter text or the app can display text. For any element that might be accessed by other elements of the page or that might be used in server-side code, you should specify an **id attribute**. We specified these attributes in this example, even though the app does not provide any functionality. We'll use the `id` attribute starting with the next example.

h:selectOneMenu Element

Lines 29–42 define an **h:selectOneMenu element**, which is typically rendered in a web page as a drop-down list. When a user clicks the drop-down list, it expands and displays a list from which the user can make a selection. Each item to display appears between the start and end tags of this element as an **f:selectItem element** (lines 30–41). This element is part of the JSF Core Tag Library. The XML namespace for this tag library is specified in the `html` element's start tag at line 9. Each `f:selectItem` has `itemValue` and `itemLabel` attributes. The `itemLabel` is the string that the user will see in the browser, and the `itemValue` is the value that's returned when you programmatically retrieve the user's selection from the drop-down list (as you'll see in a later example).

h:outputLink Element

The **h:outputLink element** (lines 43–45) inserts a hyperlink in a web page. Its **value attribute** specifies the resource (`http://www.deitel.com` in this case) that's requested when a user clicks the hyperlink. By default, `h:outputLink` elements cause pages to open in the same browser window, but you can set the element's `target` attribute to change this behavior.

h:selectOneMenu Element

Lines 47–53 define an **h:selectOneRadio element**, which provides a series of radio buttons from which the user can select only one. Like an `h:selectOneMenu`, an `h:selectOneRadio` displays items that are specified with `f:selectItem` elements.

h:commandButton Element

Lines 54 defines an **h:commandButton element** that triggers an action when clicked—in this example, we don't specify the action to trigger, so the default action occurs (re-requesting the same page from the server) when the user clicks this button. An `h:commandButton` typically maps to an XHTML input element with its `type` attribute set to `"submit"`. Such elements are often used to submit a form's user input values to the server for processing.

29.7 Validation Using JSF Standard Validators

Validating input is an important step in collecting information from users. **Validation** helps prevent processing errors due to incomplete, incorrect or improperly formatted user input. For example, you may perform validation to ensure that all required fields contain data or that a zip-code field has the correct number of digits. The JSF Core Tag Library provides several standard validator components and allows you to create your own custom validators. Multiple validators can be specified for each input element. The validators are:

- **f:validateLength**—determines whether a field contains an acceptable number of characters.
- **f:validateDoubleRange** and **f:validateLongRange**—determine whether numeric input falls within acceptable ranges of `double` or `long` values, respectively.
- **f:validateRequired**—determines whether a field contains a value.
- **f:validateRegex**—determines whether a field contains a string that matches a specified regular expression pattern.
- **f:validateBean**—allows you to invoke a bean method that performs custom validation.

Validating Form Data in a Web Application

[*Note:* To create this application from scratch, review the steps in Section 29.4.3 and name the application `Validation`.] The example in this section prompts the user to enter a name, e-mail address and phone number in a form. When the user enters any data and presses the **Submit** button to submit the form's contents to the web server, validation ensures that the user entered a value in each field, that the entered name does not exceed 30 characters, and that the e-mail address and phone-number values are in an acceptable format. In this example, (555) 123-4567, 555-123-4567 and 123-4567 are all considered valid phone numbers. Once valid data is submitted, the JSF framework stores the submitted values in a bean object of class `ValidationBean` (Fig. 29.15), then sends a response back to the web browser. We simply display the validated data in the page to demonstrate that the server received the data. A real business application would typically store the submitted data in a database or in a file on the server.

Class `ValidationBean`

Class `ValidationBean` (Fig. 29.15) provides the read/write properties `name`, `email` and `phone`, and the read-only property `result`. Each read/write property has an instance variable (lines 11–13) and corresponding *set/get* methods (lines 16–25, 28–37 and 40–49) for manipulating the instance variables. The read-only property response has only a `getResult` method (lines 52–60), which returns a paragraph (`p`) element containing the validated data. (You can create the `ValidationBean` managed bean class by using the steps presented in Fig. 29.4.3.)

```
1 // ValidationBean.java
2 // Validating user input.
3 package validation;
4
5 import java.io.Serializable;
6 import javax.faces.bean.ManagedBean;
7
8 @ManagedBean( name="validationBean" )
9 public class ValidationBean implements Serializable
10 {
11     private String name;
12     private String email;
13     private String phone;
14
15     // return the name String
16     public String getName()
17     {
18         return name;
19     } // end method getName
20
21     // set the name String
22     public void setName( String name )
23     {
24         this.name = name;
25     } // end method setName
```

Fig. 29.15 | `ValidationBean` stores the validated data, which is then used as part of the response to the client. (Part 1 of 2.)

```

26
27 // return the email String
28 public String getEmail()
29 {
30     return email;
31 } // end method getEmail
32
33 // set the email String
34 public void setEmail( String email )
35 {
36     this.email = email;
37 } // end method setEmail
38
39 // return the phone String
40 public String getPhone()
41 {
42     return phone;
43 } // end method getPhone
44
45 // set the phone String
46 public void setPhone( String phone )
47 {
48     this.phone = phone;
49 } // end method setPhone
50
51 // returns result for rendering on the client
52 public String getResult()
53 {
54     if ( name != null && email != null && phone != null )
55         return "<p style=\"background-color:yellow;width:200px;\" +
56             \"padding:5px\">Name: " + getName() + "<br/>E-Mail: " +
57             getEmail() + "<br/>Phone: " + getPhone() + "</p>";
58     else
59         return ""; // request has not yet been made
60 } // end method getResult
61 } // end class ValidationBean

```

Fig. 29.15 | `ValidationBean` stores the validated data, which is then used as part of the response to the client. (Part 2 of 2.)

index.xhtml

Figure 29.16 shows this app's `index.xhtml` file. The initial request to this web app displays the page shown in Fig. 29.16(a). When this app is initially requested, the beginning of the **JSF application lifecycle** uses this `index.xhtml` document to build the app's facelets view and sends it as the response to the client browser, which displays the form for user input. During this initial request, the EL expressions (lines 22, 30, 39 and 49) are evaluated to obtain the values that should be displayed in various parts of the page. Nothing is displayed initially as a result of these four EL expressions being evaluated, because no default values are specified for the bean's properties. The page's `h:form` element contains an `h:panelGrid` (lines 18–45) with three columns and an `h:commandButton` (line 46), which by default submits the contents of the form's fields to the server.

```

1  <?xml version='1.0' encoding='UTF-8' ?>
2
3  <!-- index.xhtml -->
4  <!-- Validating user input -->
5  <!DOCTYPE html PUBLIC "-//W3C//DTD XHTML 1.0 Transitional//EN"
6     "http://www.w3.org/TR/xhtml1/DTD/xhtml1-transitional.dtd">
7  <html xmlns="http://www.w3.org/1999/xhtml"
8     xmlns:h="http://java.sun.com/jsf/html"
9     xmlns:f="http://java.sun.com/jsf/core">
10 <h:head>
11     <title>Validating Form Data</title>
12     <h:outputStylesheet name="style.css" library="css"/>
13 </h:head>
14 <h:body>
15     <h:form>
16         <h1>Please fill out the following form:</h1>
17         <p>All fields are required and must contain valid information</p>
18         <h:panelGrid columns="3">
19             <h:outputText value="Name:"/>
20             <h:inputText id="nameInputText" required="true"
21                 requiredMessage="Please enter your name"
22                 value="#{validationBean.name}"
23                 validatorMessage="Name must be fewer than 30 characters">
24                 <f:validateLength maximum="30" />
25             </h:inputText>
26             <h:message for="nameInputText" styleClass="error"/>
27             <h:outputText value="E-mail:"/>
28             <h:inputText id="emailInputText" required="true"
29                 requiredMessage="Please enter a valid e-mail address"
30                 value="#{validationBean.email}"
31                 validatorMessage="Invalid e-mail address format">
32                 <f:validateRegex pattern=
33                     "\w+([-+.']\w+)*@\w+([-.\w+)*\.\w+([-.\w+)*" />
34             </h:inputText>
35             <h:message for="emailInputText" styleClass="error"/>
36             <h:outputText value="Phone:"/>
37             <h:inputText id="phoneInputText" required="true"
38                 requiredMessage="Please enter a valid phone number"
39                 value="#{validationBean.phone}"
40                 validatorMessage="Invalid phone number format">
41                 <f:validateRegex pattern=
42                     "((\d{3}\d{3})?|\d{3}-)?\d{3}-\d{4}" />
43             </h:inputText>
44             <h:message for="phoneInputText" styleClass="error"/>
45         </h:panelGrid>
46         <h:commandButton value="Submit"/>
47         <h:outputText escape="false" value="#{validationBean.response}"/>
48     </h:form>
49 </h:body>
50 </html>

```

Fig. 29.16 | Form to demonstrate validating user input. (Part I of 3.)

a) Submitting the form before entering any information



b) Error messages displayed after submitting the empty form



c) Error messages displayed after submitting invalid information



Fig. 29.16 | Form to demonstrate validating user input. (Part 2 of 3.)

d) Successfully submitted form

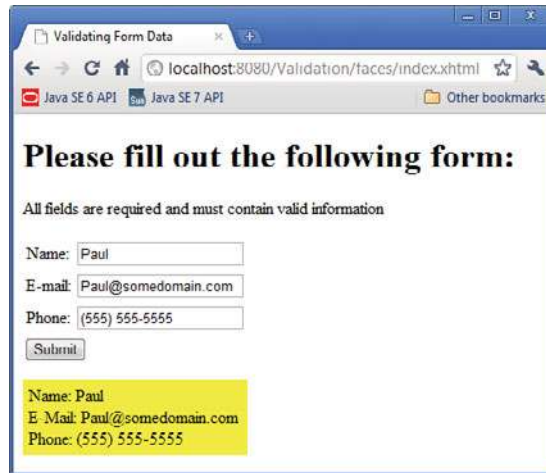

Fig. 29.16 | Form to demonstrate validating user input. (Part 3 of 3.)

First Row of the h:panelGrid

In this application, we demonstrate several new elements and attributes. The first new element is the **h:outputText element** (line 19; from the JSF HTML Tag Library), which inserts text in the page. In this case, we insert a literal string ("Name: ") that is specified with the element's `value` attribute.

The `h:inputText` element (lines 20–25) displays a text box in which the user can enter a name. We've specified several attributes for this element:

- `id`—This enables other elements or server-side code to reference this element.
- **required**—Ensuring that the user has made a selection or entered some text in a required input element is a basic type of validation. When set to "true", this attribute specifies that the element *must* contain a value.
- **requiredMessage**—This specifies the message that should be displayed if the user submits the form without first providing a value for this required element.
- `value`—This specifies the value to display in the field or to be saved into a bean on the server. In this case, the EL expression indicates the bean property that's associated with this field.
- **validatorMessage**—This specifies the message to display if a validator is associated with this `h:inputText` and the data the user enters is invalid.

The messages specified by the `requiredMessage` and `validatorMessage` attributes are displayed in an associated **h:message element** (line 26) when validation fails. The element's **for attribute** specifies the `id` of the specific element for which messages will be displayed (`nameInputText`), and the **styleClass attribute** specifies the name of a CSS style class that will format the message. For this example, we defined a CSS style sheet, which was inserted into the document's head element at line 12 using the **h:outputStylesheet**

element. We placed the style sheet in the `css` library within the `resources` folder. The style sheet contains the following CSS rule:

```
.error
{
    color:red;
}
```

which creates a style class named `error` (the dot indicates that it's a style class) and specifies that any text to which this is applied, such as the error messages, should be red. We use this CSS style for all the `h:message` elements in this example.

Validating the nameInputText Element's Contents

If the user submits the form without a value in the `nameInputText`, the `requiredMessage` "Please enter your name" is displayed in the corresponding `h:message` element. If the user specifies a value for the `nameInputText`, the JSF framework executes the `f:validateLength` validator that's nested in the `h:inputText` element. Here, we check that the name contains no more than 30 characters—as specified by the validator's **maximum attribute**. This might be useful to ensure that a value will fit within a particular database field.

Users can type as much text in the `nameInputText` as they wish. If the name is too long, the `validatorMessage` is displayed in the `h:message` element after the user submits the form. It's also possible to limit the length of user input in an `h:inputText` without using validation by setting its **maxLength attribute**, in which case the element's cursor will not advance beyond the maximum allowable number of characters. This would prevent the user from submitting data that exceeds the length limit.

Second and Third Rows of the h:panelGrid

The next two rows of the `h:panelGrid` have elements similar to those in the first row. In addition to being required elements, the `h:inputText` elements at lines 28–34 and 37–43 are each validated by `h:validateRegex` validators as described next.

Validating the e-Mail Address

The `h:validateRegex` element at lines 32–33 uses the regular expression

```
\w+([-+.']\w+)*@\w+([-.\w+)*\.\w+([-.\w+)*
```

which indicates that an e-mail address is valid if the part before the `@` symbol contains one or more word characters (that is, alphanumeric characters or underscores), followed by zero or more strings comprised of a hyphen, plus sign, period or apostrophe and additional word characters. After the `@` symbol, a valid e-mail address must contain one or more groups of word characters potentially separated by hyphens or periods, followed by a required period and another group of one or more word characters potentially separated by hyphens or periods. For example, `bob's-personal.email@white.email.com`, `bob-white@my-email.com` and `bob.white@email.com` are all valid e-mail addresses. If the address the user enters has an invalid format, the `validatorMessage` (line 31) will be displayed in the corresponding `h:message` element (line 35).

Validating the Phone Number

The `h:validateRegex` element at lines 41–42 uses the regular expression

```
((\{\d{3}\} )?|(\{\d{3}-\})?\d{3}-\d{4}
```

which indicates that a phone number can contain a three-digit area code either in parentheses and followed by an optional space or without parentheses and followed by a required hyphen. After an optional area code, a phone number must contain three digits, a hyphen and another four digits. For example, (555) 123-4567, 555-123-4567 and 123-4567 are all valid phone numbers. If the phone number the user enters has an invalid format, the `validatorMessage` (line 40) will be displayed in the corresponding `h:message` element (line 44).

Submitting the Form—More Details of the JSF Lifecycle

As we mentioned earlier in this section, when the app receives the initial request, it returns the page shown in Fig. 29.16(a). When a request does not contain any request values, such as those the user enters in a form, the JSF framework simply creates the view and returns it as the response.

The user submits the form to the server by pressing the **Submit** `h:commandButton` (defined at line 46). Since we did not specify an `action` attribute for this `h:commandButton`, the `action` is configured by default to perform a **postback**—the browser re-requests the page `index.xhtml` and sends the values of the form's fields to the server for processing. Next, the JSF framework performs the validations of all the form elements. If any of the elements is invalid, the framework renders the appropriate error message as part of the response.

If the values of all the elements are valid, the framework uses the values of the elements to set the properties of the `validateBean`—as specified in the EL expressions in lines 22, 30 and 39. Each property's `set` method is invoked, passing the value of the corresponding element as an argument. The framework then formulates the response to the client. In the response, the form elements are populated with the values of the `validateBean`'s properties (by calling their `get` methods), and the `h:outputText` element at line 47 is populated with the value of the read-only `result` property. The value of this property is determined by the `getResult` method (lines 52–60 of Fig. 29.15), which uses the submitted form data in the string that it returns.

When you execute this app, try submitting the form with no data (Fig. 29.16(b)), with invalid data (Fig. 29.16(c)) and with valid data (Fig. 29.16(d)).

29.8 Session Tracking

Originally, critics accused the Internet and e-business of failing to provide the customized service typically experienced in “brick-and-mortar” stores. To address this problem, businesses established mechanisms by which they could *personalize* users' browsing experiences, tailoring content to individual users. They tracked each customer's movement through the Internet and combined the collected data with information the consumer provided, including billing information, personal preferences, interests and hobbies.

Personalization

Personalization enables businesses to communicate effectively with their customers and also helps users locate desired products and services. Companies that provide content of particular interest to users can establish relationships with customers and build on those relationships over time. Furthermore, by targeting consumers with personal offers, recommendations, advertisements, promotions and services, businesses create customer loyalty.

Websites can use sophisticated technology to allow visitors to customize home pages to suit their individual needs and preferences. Similarly, online shopping sites often store personal information for customers, tailoring notifications and special offers to their interests. Such services encourage customers to visit sites more frequently and make purchases more regularly.

Privacy

A trade-off exists between personalized business service and protection of privacy. Some consumers embrace tailored content, but others fear the possible adverse consequences if the info they provide to businesses is released or collected by tracking technologies. Consumers and privacy advocates ask: What if the business to which we give personal data sells or gives that information to another organization without our knowledge? What if we do not want our actions on the Internet—a supposedly anonymous medium—to be tracked and recorded by unknown parties? What if unauthorized parties gain access to sensitive private data, such as credit-card numbers or medical history? These are questions that must be addressed by programmers, consumers, businesses and lawmakers alike.

Recognizing Clients

To provide personalized services, businesses must be able to recognize clients when they request information from a site. As we have discussed, the request/response system on which the web operates is facilitated by HTTP. Unfortunately, HTTP is a *stateless protocol*—it *does not* provide information that would enable web servers to maintain state information regarding particular clients. This means that web servers cannot determine whether a request comes from a particular client or whether the same or different clients generate a series of requests.

To circumvent this problem, sites can provide mechanisms by which they identify individual clients. A session represents a unique client on a website. If the client leaves a site and then returns later, the client will still be recognized as the same user. When the user closes the browser, the session typically ends. To help the server distinguish among clients, each client must identify itself to the server. Tracking individual clients is known as **session tracking**. One popular session-tracking technique uses cookies (discussed in Section 29.8.1); another uses beans that are marked with the `@SessionScoped` **annotation** (used in Section 29.8.2). Additional session-tracking techniques are beyond this book's scope.

29.8.1 Cookies

Cookies provide you with a tool for personalizing web pages. A cookie is a piece of data stored by web browsers in a small text file on the user's computer. A cookie maintains information about the client during and between browser sessions. The first time a user visits the website, the user's computer might receive a cookie from the server; this cookie is then reactivated each time the user revisits that site. The collected information is intended to be an anonymous record containing data that is used to personalize the user's future visits to the site. For example, cookies in a shopping application might store unique identifiers for users. When a user adds items to an online shopping cart or performs another task resulting in a request to the web server, the server receives a cookie containing the user's unique identifier. The server then uses the unique identifier to locate the shopping cart and perform any necessary processing.

In addition to identifying users, cookies also can indicate users' shopping preferences. When a Web Form receives a request from a client, the Web Form can examine the cookie(s) it sent to the client during previous communications, identify the user's preferences and immediately display products of interest to the client.

Every HTTP-based interaction between a client and a server includes a header containing information either about the request (when the communication is from the client to the server) or about the response (when the communication is from the server to the client). When a Web Form receives a request, the header includes information such as the request type and any cookies that have been sent previously from the server to be stored on the client machine. When the server formulates its response, the header information contains any cookies the server wants to store on the client computer and other information, such as the MIME type of the response.

The **expiration date** of a cookie determines how long the cookie remains on the client's computer. If you do not set an expiration date for a cookie, the web browser maintains the cookie for the duration of the browsing session. Otherwise, the web browser maintains the cookie until the expiration date occurs. Cookies are deleted by the web browser when they **expire**.



Portability Tip 29.1

Users may disable cookies in their web browsers to help ensure their privacy. Such users will experience difficulty using web applications that depend on cookies to maintain state information.

29.8.2 Session Tracking with @SessionScoped Beans

The previous web applications used @RequestScoped beans by default—the beans existed only for the duration of each request. In the next application, we use a @SessionScoped bean to maintain selections throughout the user's session. Such a bean is created when a session begins and exists throughout the entire session. A @SessionScoped bean can be accessed by all of the app's pages during the session, and the app server maintains a separate @SessionScoped bean for each user. By default a session expires after 30 minutes of inactivity or when the user closes the browser that was used to begin the session. When the session expires, the server discards the bean associated with that session.



Software Engineering Observation 29.2

@SessionScoped beans should implement the Serializable interface. Websites with heavy traffic often use groups of servers (sometimes hundreds or thousands of them) to respond to requests. Such groups are known as server farms. Server farms often balance the number of requests being handled on each server by moving some sessions to other servers. Making a bean Serializable enables the session to be moved properly among servers.

Test-Driving the App

This example consists of a SelectionsBean class that is @SessionScoped and two pages (index.xhtml and recommendations.xhtml) that store data in and retrieve data from a SelectionsBean object. To understand how these pieces fit together, let's walk through a sample execution of the app. When you first execute the app, the index.xhtml page is displayed. The user selects a topic from a group of radio buttons and submits the form (Fig. 29.17).

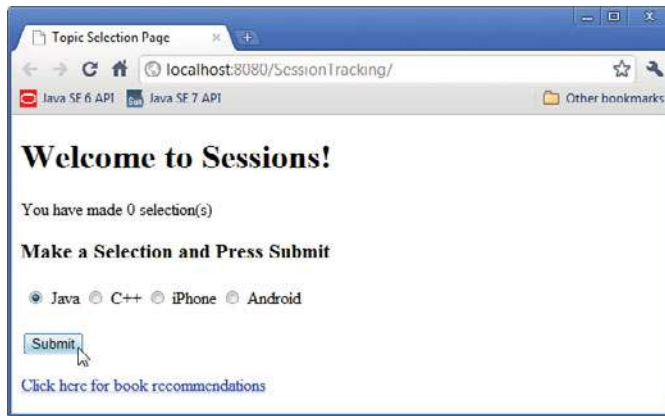

Fig. 29.17 | `index.xhtml` after the user has made a selection and is about to submit the form for the first time.

When the form is submitted, the JSF framework creates a `SelectionsBean` object that is specific to this user, stores the selected topic in the bean and returns the `index.xhtml` page. The page now shows how many selections have been made (1) and allows the user to make another selection (Fig. 29.18).

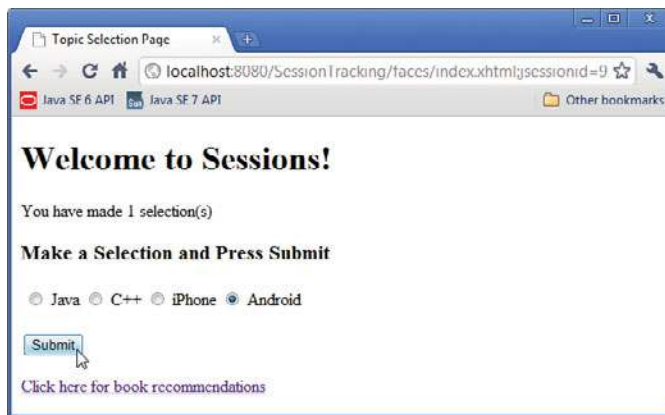

Fig. 29.18 | `index.xhtml` after the user has submitted the form the first time, made another selection and is about to submit the form again.

The user makes a second topic selection and submits the form again. The app stores the selection in this user's existing `SelectionsBean` object and returns the `index.xhtml` page (Fig. 29.19), which shows how many selections have been made so far (2).

At any time, the user can click the link at the bottom of the `index.xhtml` page to open `recommendations.xhtml`, which obtains the information from this user's `SelectionsBean` object and creates a recommended books list (Fig. 29.20) for the user's selected topics.



Fig. 29.19 | `index.xhtml` after the user has submitted the form the second time and is about to click the link to the `recommendations.xhtml` page.

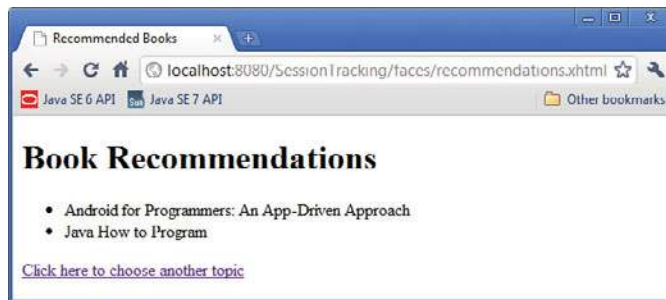

Fig. 29.20 | `recommendations.xhtml` showing book recommendations for the topic selections made by the user in Figs. 29.18 and 29.19.

@SessionScoped Class SelectionsBean

Class `SelectionsBean` (Fig. 29.21) uses the `@SessionScoped` annotation (line 13) to indicate that the server should maintain separate instances of this class for each user session. The class maintains a static `HashMap` (created at lines 17–18) of topics and their corresponding book titles. We made this object `static`, because its values can be shared among all `SelectionsBean` objects. The static initializer block (lines 23–28) specifies the `HashMap`'s key/value pairs. Class `SelectionsBean` maintains each user's selections in a `Set<String>` (line 32), which allows only unique keys, so selecting the same topic multiple times does not increase the number of selections.

```

1 // SelectionsBean.java
2 // Manages a user's topic selections
3 package sessiontracking;
```

Fig. 29.21 | `@SessionScoped SelectionsBean` class. (Part 1 of 3.)

```
4
5 import java.io.Serializable;
6 import java.util.HashMap;
7 import java.util.Set;
8 import java.util.TreeSet;
9 import javax.faces.bean.ManagedBean;
10 import javax.faces.bean.SessionScoped;
11
12 @ManagedBean( name="selectionsBean" )
13 @SessionScoped
14 public class SelectionsBean implements Serializable
15 {
16     // map of topics to book titles
17     private static final HashMap< String, String > booksMap =
18         new HashMap< String, String >();
19
20     // initialize booksMap
21     static
22     {
23         booksMap.put( "java", "Java How to Program" );
24         booksMap.put( "cpp", "C++ How to Program" );
25         booksMap.put( "iphone",
26             "iPhone for Programmers: An App-Driven Approach" );
27         booksMap.put( "android",
28             "Android for Programmers: An App-Driven Approach" );
29     } // end static initializer block
30
31     // stores individual user's selections
32     private Set< String > selections = new TreeSet< String >();
33     private String selection; // stores the current selection
34
35     // return number of selections
36     public int getNumberOfSelections()
37     {
38         return selections.size();
39     } // end method getNumberOfSelections
40
41     // returns the current selection
42     public String getSelection()
43     {
44         return selection;
45     } // end method getSelection
46
47     // store user's selection
48     public void setSelection( String topic )
49     {
50         selection = booksMap.get( topic );
51         selections.add( selection );
52     } // end method setSelection
53
54     // return the Set of selections
55     public String[] getSelections()
56     {
```

Fig. 29.21 | @SessionScoped SelectionsBean class. (Part 2 of 3.)

```

57     return selections.toArray( new String[ selections.size() ] );
58   } // end method getSelections
59 } // end class SelectionsBean

```

Fig. 29.21 | @SessionScoped SelectionsBean class. (Part 3 of 3.)

Methods of Class SelectionsBean

Method `getNumberOfSelections` (lines 36–39) returns the number of topics the user has selected and represents the read-only property `numberOfSelections`. We use this property in the `index.xhtml` document to display the number of selections the user has made so far.

Methods `getSelection` (lines 42–45) and `setSelection` (lines 48–52) represent the read/write selection property. When a user makes a selection in `index.xhtml` and submits the form, method `setSelection` looks up the corresponding book title in the `booksMap` (line 50), then stores that title in `selections` (line 51).

Method `getSelections` (lines 55–58) represents the read-only property `selections`, which returns an array of `Strings` containing the book titles for the topics selected by the user so far. When the `recommendations.xhtml` page is requested, it uses the `selections` property to get the list of book titles and display them in the page.

index.xhtml

The `index.xhtml` document (Fig. 29.22) contains an `h:selectOneRadio` element (lines 19–26) with the options **Java**, **C++**, **iPhone** and **Android**. The user selects a topic by clicking a radio button, then pressing **Submit** to send the selection. As the user makes each selection and submits the form, the `selectionsBean` object's `selection` property is updated and this document is returned. The EL expression at line 15 inserts the number of selections that have been made so far into the page. When the user clicks the `h:outputLink` (lines 29–31) the `recommendations.xhtml` page is requested. The `value` attribute specifies only `recommendations.xhtml`, so the browser assumes that this page is on the same server and at the same location as `index.xhtml`.

```

1  <?xml version='1.0' encoding='UTF-8' ?>
2
3  <!-- index.xhtml -->
4  <!-- Allow the user to select a topic -->
5  <!DOCTYPE html PUBLIC "-//W3C//DTD XHTML 1.0 Transitional//EN"
6     "http://www.w3.org/TR/xhtml1/DTD/xhtml1-transitional.dtd">
7  <html xmlns="http://www.w3.org/1999/xhtml"
8     xmlns:h="http://java.sun.com/jsf/html"
9     xmlns:f="http://java.sun.com/jsf/core">
10   <h:head>
11     <title>Topic Selection Page</title>
12   </h:head>
13   <h:body>
14     <h1>Welcome to Sessions!</h1>
15     <p>You have made #{selectionsBean.numberOfSelections} selection(s)
16     </p>
17     <h3>Make a Selection and Press Submit</h3>

```

Fig. 29.22 | `index.xhtml` allows the user to select a topic. (Part 1 of 2.)

```

18     <h:form>
19         <h:selectOneRadio id="topicSelectOneRadio" required="true"
20             requiredMessage="Please choose a topic, then press Submit"
21             value="#{selectionsBean.selection}">
22             <f:selectItem itemValue="java" itemLabel="Java"/>
23             <f:selectItem itemValue="cpp" itemLabel="C++"/>
24             <f:selectItem itemValue="iphone" itemLabel="iPhone"/>
25             <f:selectItem itemValue="android" itemLabel="Android"/>
26         </h:selectOneRadio>
27         <p><h:commandButton value="Submit"/></p>
28     </h:form>
29     <p><h:outputLink value="recommendations.xhtml">
30         Click here for book recommendations
31     </h:outputLink></p>
32 </h:body>
33 </html>

```

Fig. 29.22 | `index.xhtml` allows the user to select a topic. (Part 2 of 2.)

recommendations.xhtml

When the user clicks the `h:outputLink` in the `index.xhtml` page, the browser requests the `recommendations.xhtml` (Fig. 29.23), which displays book recommendations in an XHTML unordered (bulleted) list (lines 15–19). The `h:outputLink` (lines 20–22) allows the user to return to `index.xhtml` to select additional topics.

```

1  <?xml version='1.0' encoding='UTF-8' ?>
2
3  <!-- recommendations.xhtml -->
4  <!-- Display recommended books based on the user's selected topics -->
5  <!DOCTYPE html PUBLIC "-//W3C//DTD XHTML 1.0 Transitional//EN"
6     "http://www.w3.org/TR/xhtml1/DTD/xhtml1-transitional.dtd">
7  <html xmlns="http://www.w3.org/1999/xhtml"
8     xmlns:h="http://java.sun.com/jsf/html"
9     xmlns:ui="http://java.sun.com/jsf/facelets">
10 <h:head>
11     <title>Recommended Books</title>
12 </h:head>
13 <h:body>
14     <h1>Book Recommendations</h1>
15     <ul>
16         <ui:repeat value="#{selectionsBean.selections}" var="book">
17             <li>#{book}</li>
18         </ui:repeat>
19     </ul>
20     <p><h:outputLink value="index.xhtml">
21         Click here to choose another topic
22     </h:outputLink></p>
23 </h:body>
24 </html>

```

Fig. 29.23 | `recommendations.xhtml` displays book recommendations based on the user's selections.

Iterating Through the List of Books

Line 9 enables us to use elements from the **JSF Facelets Tag Library**. This library includes the **ui:repeat element** (lines 16–18), which can be thought of as an enhanced for loop that iterates through collections JSF Expression Language. The element inserts its nested element(s) once for each element in a collection. The collection is specified by the **value attribute**'s EL expression, which *must* return an array, a `List`, a `java.sql.ResultSet` or an `Object`. If the EL expression does not return an array, a `List` or a `ResultSet`, the `ui:repeat` element inserts its nested element(s) only once for the returned `Object`. In this example, the `ui:repeat` element renders the items returned by the `selectionsBean`'s `selections` property.

The `ui:repeat` element's **var attribute** creates a variable named `book` to which each item in the collection is assigned in sequence. You can use this variable in EL expressions in the nested elements. For example, the expression `#{book}` in line 17 inserts between the `` and `` tags the `String` representation of one item in the collection. You can also use the variable to invoke methods on, or access properties of, the referenced object.

29.9 Wrap-Up

In this chapter, we introduced web application development using JavaServer Faces in NetBeans. We began by discussing the simple HTTP transactions that take place when you request and receive a web page through a web browser. We then discussed the three tiers (i.e., the client or top tier, the business logic or middle tier and the information or bottom tier) that comprise most web applications.

You learned how to use NetBeans and the GlassFish Application Server to create, compile and execute web applications. We demonstrated several common JSF components. We also showed how to use validators to ensure that user input satisfies the requirements of an application.

We discussed the benefits of maintaining user information across multiple pages of a website. We then demonstrated how you can include such functionality in a web application using `@SessionScoped` beans.

In Chapter 30, we continue our discussion of Java web application development with more advanced concepts. You'll learn how to access a database from a JSF web application and how to use AJAX to help web-based applications provide the interactivity and responsiveness that users typically expect of *desktop* applications.

Summary

Section 29.1 Introduction

- Web-based apps create content for web browser clients. This content includes eXtensible Hyper-Text Markup Language (XHTML), JavaScript client-side scripting, Cascading Style Sheets (CSS), images and binary data.
- XHTML is an XML (eXtensible Markup Language) vocabulary that is based on HTML (Hyper-Text Markup Language).
- Java multitier applications are typically implemented using the features of Java Enterprise Edition (Java EE).

- The JavaServer Faces subset of Java EE is a web-application framework (p. 1236) for building multitier web apps by extending the framework with your application-specific capabilities. The framework handles the details of receiving client requests and returning responses for you.

Section 29.2 HyperText Transfer Protocol (HTTP) Transactions

- In its simplest form, a web page is nothing more than an XHTML document that describes to a web browser how to display and format the document's information.
- XHTML documents normally contain hyperlinks that link to different pages or to other parts of the same page. When the user clicks a hyperlink, the requested web page loads into the browser.
- Computers that run web-server software (p. 1237) make resources available, such as web pages, images, PDF documents and even objects that perform complex tasks.
- The HTTP protocol allows clients and servers to interact and exchange information.
- HTTP uses URLs (Uniform Resource Locators) to locate resources on the Internet.
- A URL contains information that directs a browser to the resource that the user wishes to access.
- The computer that houses and maintains resources is usually referred to as the host (p. 1237).
- Host names are translated into IP addresses by domain-name system (DNS) servers (p. 1237).
- The path in a URL typically specifies a virtual directory on the server. The server translates the this into a real location, thus hiding a resource's true location.
- When given a URL, a web browser performs an HTTP transaction to retrieve and display the web page at that address.
- HTTP headers (p. 1239) provide additional information about the data that will be sent.
- Multipurpose Internet Mail Extensions (MIME; p. 1239) is an Internet standard that specifies data formats so that programs can interpret data correctly.
- The two most common HTTP request types are GET and POST (p. 1239). A GET request typically asks for a specific resource on a server. A POST request typically posts (or sends) data to a server.
- GET requests and POST requests can both be used to send form data to a web server, yet each request type sends the information differently. A GET request sends information to the server in the URL's query string (p. 1240). A POST request sends form data as part of the HTTP message.
- Browsers often cache (p. 1240) web pages for quick reloading. If there are no changes between the cached version and the current version on the web, this speeds up your browsing experience.
- An HTTP response can indicate the length of time for which the content remains "fresh." If this amount of time has not been reached, the browser can avoid another request to the server.
- Browsers typically do not cache the server's response to a POST request, because the next POST might not return the same result.

Section 29.3 Multitier Application Architecture

- Web-based applications are multitier (*n*-tier) applications (p. 1240) that divide functionality into separate tiers (i.e., logical groupings of functionality). Although tiers can be located on the same computer, the tiers of web-based applications often reside on separate computers.
- The information tier (p. 1241) maintains data pertaining to the application.
- The middle tier (p. 1241) implements business logic, controller logic and presentation logic to control interactions between the application's clients and the application's data. Business logic in the middle tier enforces business rules and ensures that data is reliable before the server application updates the database or presents the data to users. Business rules dictate how clients can and cannot access application data, and how applications process data.

- The client tier (p. 1241) is the application's user interface, which gathers input and displays output. Users interact directly with the application through the user interface. In response to user actions (e.g., clicking a hyperlink), the client tier interacts with the middle tier to make requests and to retrieve data from the information tier.

Section 29.4 Your First JSF Web App

- The JSF web-application framework's Faces servlet (p. 1242) processes each requested JSF page so that the server can eventually return a response to the client.

Section 29.4.1 The Default `index.xhtml` Document: Introducing Facelets

- You present your web app's content in JSF using Facelets (p. 1243)—a combination of XHTML markup and JSF markup.
- XHTML (p. 1243) specifies the content of a web page that is displayed in a web browser. XHTML separates the presentation of a document from the structure of the document's data.
- Presentation is specified with Cascading Style Sheets (CSS).
- JSF uses the XHTML 1.0 Transitional Recommendation by default. Transitional markup may include some non-CSS formatting, but this is not recommended.
- The starting `<html>` tag may contain one or more `xmlns` attributes (p. 1243). Each has a name and a value separated by an equal sign (`=`), and specifies an XML namespace of elements that are used in the document.
- The attribute `xmlns:h="http://java.sun.com/jsf/html"` specifies a prefix and a URL for JSF's HTML Tag Library (p. 1243), allowing the document to use JSF's elements from that library.
- A tag library defines a set of elements that can be inserted into the XHTML markup.
- The elements in the HTML Tag Library generate XHTML elements.
- The `h:head` element (p. 1244) defines the XHTML page's head element.
- The document's `title` typically appears in the browser window's title bar, or a browser tab if you have multiple web pages open in the browser at once.
- The `h:body` (p. 1244) element represents the page's content.
- A JSF Expression Language (EL; p. 1244) expression can interact with a JavaBean to obtain data.

Section 29.4.2 Examining the `WebTimeBean` Class

- JSF documents typically interact with one or more Java objects to perform the app's tasks.
- JavaBeans objects (p. 1244) are instances of classes that follow certain conventions for class design. A JavaBean exposes its data as properties (p. 1244). Properties can be read/write, read-only or write-only. To define a read/write property, a JavaBean class provides `set` and `get` methods for that property. A read-only property would have only a `get` method and a write-only property only a `set` method.
- The JavaBeans used in JSF are also POJOs (plain old Java objects; p. 1244)
- The JSF framework creates and manages objects of your JavaBean classes for you.
- The `@ManagedBean` annotation (from the package `javax.faces.bean`; p. 1245) indicates that the JSF framework should create and manage instances of the class. The parentheses following the annotation contain the optional `name` attribute. If you specify the annotation without the parentheses and the `name` attribute, the JSF framework will use the class name with a lowercase first letter as the default bean name.
- When the Faces servlet encounters an EL expression that accesses a bean property, it automatically invokes the property's `set` or `get` method based on the context in which the property is used.

Section 29.5 Model-View-Controller Architecture of JSF Apps

- JSF applications adhere to the Model-View-Controller (MVC; p. 1250) architecture, which separates an application's data (contained in the model) from the graphical presentation (the view) and the processing logic (the controller).
- In JSF, the controller is the JSF framework and is responsible for coordinating interactions between the view and the model. The model contains the application's data (typically in a database), and the view presents the data stored in the model (typically as web pages).

Section 29.6 Common JSF Components

- Elements from the JSF HTML Tag Library are mapped by the JSF framework to a combination of XHTML elements and JavaScript code that enables the browser to render the page.
- The `h:form` element (p. 1251) contains the components with which a user interacts to provide data, such as registration or login information, to a JSF app.
- An `h:panelGrid` element (p. 1252) organizes elements in an XHTML table. The `columns` attribute specifies the number of columns in the table. The `style` attribute specifies the CSS formatting for the table.
- A `h:graphicImage` (p. 1253) displays an image (specified by the `name` attribute) in the page.
- As of JSF 2.0, you add resources (p. 1253) that are used throughout your app—such as images, CSS files, JavaScript files—to your web apps by placing them in the app's `resources` folder within your project's **Web Pages** node. Each subfolder of resources represents a resource library (p. 1253).
- An empty element (p. 1253) does not have content between its start and end tags. In such an element, data can be specified as attributes in the start tag. You can close an empty element either by placing a slash immediately preceding the start tag's right angle bracket or by explicitly writing an end tag.
- An `h:selectOneMenu` element (p. 1254) is typically rendered in a web page as a drop-down list. Each item to display appears between the start and end tags of this element as an `f:selectItem` element (from the JSF Core Tag Library; p. 1254). An `f:selectItem`'s `itemLabel` is the string that the user will see in the browser, and its `itemValue` is the value that's returned when you programmatically retrieve the user's selection from the drop-down list.
- An `h:outputLink` element (p. 1254) inserts a hyperlink in a web page. Its `value` attribute specifies the resource that's requested when a user clicks the hyperlink.
- An `h:selectOneRadio` element (p. 1254) provides a series of radio buttons from which the user can select only one.
- An `h:commandButton` element (p. 1254) triggers an action when clicked. An `h:commandButton` typically maps to an XHTML `input` element with its `type` attribute set to "submit". Such elements are often used to submit a form's user input values to the server for processing.

Section 29.7 Validation Using JSF Standard Validators

- Form validation (p. 1254) helps prevent processing errors due to incomplete or improperly formatted user input.
- An `f:validateLength` validator (p. 1254) determines whether a field contains an acceptable number of characters.
- `f:validateDoubleRange` and `f:validateLongRange` validators (p. 1254) determine whether numeric input falls within acceptable ranges.
- An `f:validateRequired` validator (p. 1254) determines whether a field contains a value.
- An `f:validateRegex` validator (p. 1254) determines whether a field contains a string that matches a specified regular expression pattern.

- An `f:validateBean` validator (p. 1254) invokes a bean method that performs custom validation.
- An `h:outputText` element (p. 1259) inserts text in a page.
- An input element's `required` attribute (when set to "true"; p. 1259) ensures that the user has made a selection or entered some text in a required input element is a basic type of validation.
- An input element's `requiredMessage` attribute (p. 1259) specifies the message that should be displayed if the user submits the form without first providing a value for the required element.
- An input element's `validatorMessage` attribute (p. 1259) specifies the message to display if a validator is associated with the element and the data the user enters is invalid.
- The messages specified by the `requiredMessage` and `validatorMessage` attributes are displayed in an associated `h:message` element (p. 1259) when validation fails.
- To limit the length of user input in an `h:inputText`, set its `maxLength` attribute (p. 1260)—the element's cursor will not advance beyond the maximum allowable number of characters.
- In a postback (p. 1261), the browser re-requests the page and sends the values of the form's fields to the server for processing.

Section 29.8 Session Tracking

- Personalization (p. 1261) makes it possible for e-businesses to communicate effectively with their customers and also improves the user's ability to locate desired products and services.
- A trade-off exists between personalized e-business service and protection of privacy. Some consumers embrace the idea of tailored content, but others fear the possible adverse consequences if the information they provide to e-businesses is released or collected by tracking technologies.
- HTTP is a stateless protocol—it does not provide information that would enable web servers to maintain state information regarding particular clients.
- To help the server distinguish among clients, each client must identify itself to the server. Tracking individual clients, known as session tracking, can be achieved in a number of ways. One popular technique uses cookies; another uses the `@SessionScoped` annotation.

Section 29.8.1 Cookies

- A cookie (p. 1262) is a piece of data stored in a small text file on the user's computer. A cookie maintains information about the client during and between browser sessions.
- The expiration date (p. 1263) of a cookie determines how long the cookie remains on the client's computer. If you do not set an expiration date for a cookie, the web browser maintains the cookie for the duration of the browsing session.

Section 29.8.2 Session Tracking with @SessionScoped Beans

- A `@SessionScoped` bean (p. 1263) can maintain a user's selections throughout the user's session. Such a bean is created when a session begins and exists throughout the entire session.
- A `@SessionScoped` bean can be accessed by all of the app's pages, and the app server maintains a separate `@SessionScoped` bean for each user.
- By default a session expires after 30 minutes of inactivity or when the user closes the browser that was used to begin the session. When the session expires, the server discards the bean that was associated with that session.
- The `ui:repeat` element (from the JSF Facelets Tag Library; p. 1269) inserts its nested element(s) once for each element in a collection. The collection is specified by the `value` attribute's EL expression, which must return an array, a `List`, a `java.sql.ResultSet` or an `Object`.
- The `ui:repeat` element's `var` attribute creates a variable named `book` to which each item in the collection is assigned in sequence.

Self-Review Exercises

- 29.1** State whether each of the following is *true* or *false*. If *false*, explain why.
- A URL contains information that directs a browser to the resource that the user wishes to access.
 - Host names are translated into IP addresses by web servers.
 - The path in a URL typically specifies a resource's exact location on the server.
 - GET requests and POST requests can both be used to send form data to a web server.
 - Browsers typically cache the server's response to a POST request.
 - A tag library defines a set of elements that can be inserted into the XHTML markup.
 - You must create and manage the JavaBean objects that are used in your JSF web applications.
 - When the Faces servlet encounters an EL expression that accesses a bean property, it automatically invokes the property's *set* or *get* method based on the context in which the property is used.
 - An `h:panelGrid` element organizes elements in an XHTML table.
 - An `h:selectOneMenu` element is typically rendered in a web page as a set of radio buttons.
 - The messages specified by an element's `requiredMessage` and `validatorMessage` attributes are displayed in an associated `h:message` element when validation fails.
 - The HTTP protocol provides information that enables web servers to maintain state information regarding particular clients.
 - The `ui:repeat` element inserts its nested element(s) once for each element in a collection. The collection can be any `Iterable` type.
- 29.2** Fill in the blanks in each of the following statements:
- Java multitier applications are typically implemented using the features of _____.
 - Computers that run _____ software make resources available, such as web pages, images, PDF documents and even objects that perform complex tasks.
 - The JSF web-application framework's _____ processes each requested JSF page.
 - A(n) _____ exposes its data as *read/write*, *read-only* or *write-only* properties.
 - The _____ annotation indicates that the JSF framework should create and manage instances of the class.
 - A(n) _____ element contains the components with which a user interacts to provide data, such as registration or login information, to a JSF app.
 - A(n) _____ element triggers an action when clicked.
 - A(n) _____ validator determines whether a field contains an acceptable number of characters.
 - A(n) _____ validator determines whether a field contains a string that matches a specified regular expression pattern.
 - In a(n) _____, the browser re-requests the page and sends the values of the form's fields to the server for processing.
 - A(n) _____ bean is created when a session begins and exists throughout the entire session.

Answers to Self-Review Exercises

- 29.1** a) True. b) False. Host names are translated into IP addresses by DNS servers. c) False. The server translates a virtual directory into a real location, thus hiding a resource's true location. d) True. e) False. Browsers typically do not cache the server's response to a POST request, because the next POST might not return the same result. f) True. g) False. The JSF framework creates and manages objects of your JavaBean classes for you. h) True. i) True. j) False. An `h:selectOneRadio` ele-

ment is rendered as a set of radio buttons. An `h:selectOneMenu` is rendered as a drop-down list. k) True. l) False. HTTP is a stateless protocol that does not provide information that enables web servers to maintain state information regarding particular clients—a separate tracking technology must be used. m) False. A `ui:repeat` element can iterate over only arrays, `Lists` and `ResultSets`. For any other object, the elements in a `ui:repeat` element will be inserted once.

29.2 a) Java Enterprise Edition (Java EE). b) web-server. c) Faces servlet. d) JavaBean. e) `@ManagedBean`. f) `h:form`. g) `h:commandButton`. h) `f:validateLength`. i) `f:validateRegex`. j) `postback`. k) `@SessionScoped`.

Exercises

29.3 (*Registration Form Modification*) Modify the `WebComponents` application to add functionality to the **Register** button. When the user clicks **Register**, validate all input fields to make sure the user has filled out the form completely and entered a valid email address and phone number. Then, display a message indicating successful registration and show the user's registration information at the bottom of the page. (This is similar to the example in Section 29.7.) You'll need to create an appropriate bean class to store the user's registration information.

29.4 (*Shopping Cart Application*) Using the techniques you learned in Section 29.8.2, create a simple shopping cart application. Display a list of books as an `h:selectOneRadio` element. When the user submits the form, store the user's selection in a `@SessionScoped` managed bean. Allow the user to return to the list of books and make additional selections. Provide a link to view the shopping cart. On the shopping cart page, display the list of selections the user made, the price of each book and the total of all books in the cart.

29.5 (*Guestbook Application*) In Section 29.8.2, you used an `@SessionScoped` managed bean to maintain an individual user's selections. JSF also provides the `@ApplicationScoped` annotation for managed beans that should be shared among all users of a JSF app. For this exercise, create an `@ApplicationScoped` `GuestbookBean` that maintains a `List` of `GuestbookEntry` objects. The application should provide a form, similar to the one in Fig. 29.16 that enables a user to enter a name, an email address and a message. When the user submits the form, the `GuestbookBean` should create a `GuestbookEntry` object containing the submitted values and insert it at the beginning of the `List` of `GuestbookEntry` objects—this places the most recent entry first. The `GuestbookBean` should also provide a read-only property that returns the `List` of `GuestbookEntry` objects. The page should use a `ui:repeat` element to display all of the items in the `List` so the user can see all the guestbook entries so far. [*Note:* In the next chapter, you'll implement a similar exercise that stores this information in a database.]

30

JavaServer™ Faces Web Apps: Part 2

Whatever is in any way beautiful hath its source of beauty in itself, and is complete in itself; praise forms no part of it.

—Marcus Aurelius Antoninus

There is something in a face, An air, and a peculiar grace, Which boldest painters cannot trace.

—William Somerville

Cato said the best way to keep good acts in memory was to refresh them with new.

—Francis Bacon

I never forget a face, but in your case I'll make an exception.

—Groucho Marx

Objectives

In this chapter you'll learn:

- To access databases from JSF applications.
- The basic principles and advantages of Ajax technology.
- To use Ajax in a JSF web app.

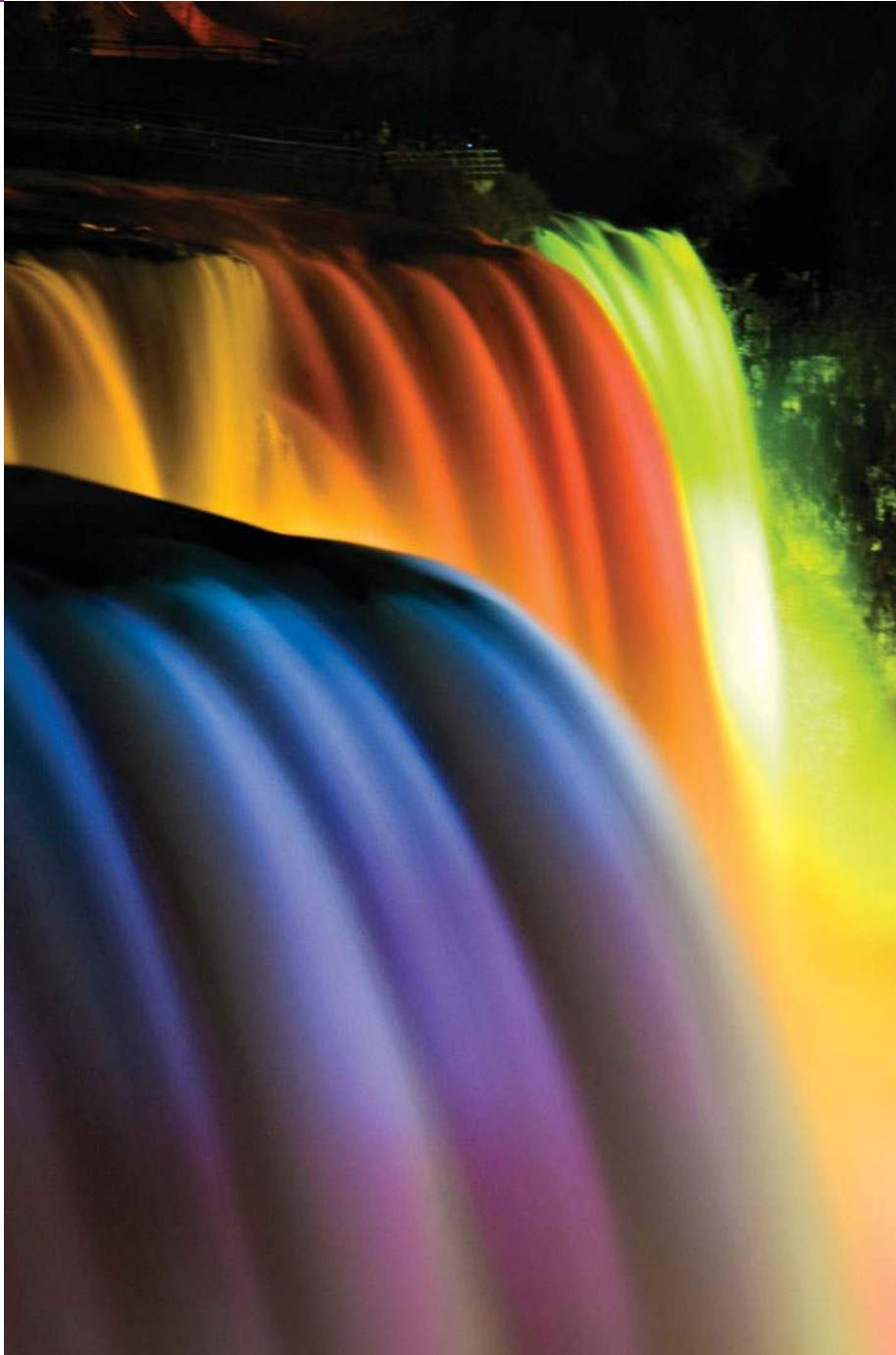

- | | |
|---|---|
| 30.1 Introduction | 30.3 Ajax |
| 30.2 Accessing Databases in Web Apps | 30.4 Adding Ajax Functionality to the Validation App |
| 30.2.1 Setting Up the Database | 30.5 Wrap-Up |
| 30.2.2 @ManagedBean Class AddressBean | |
| 30.2.3 index.xhtml Facelets Page | |
| 30.2.4 addentry.xhtml Facelets Page | |

Summary | Self-Review Exercise | Answers to Self-Review Exercise | Exercises

30.1 Introduction

This chapter continues our discussion of JSF web application development with two additional examples. In the first, we present a simple address book app that retrieves data from and inserts data into a Java DB database. The app allows users to view the existing contacts in the address book and to add new contacts. In the second example, we add so-called *Ajax* capabilities to the *Validation* example from Section 29.7. As you'll learn, Ajax improves application performance and responsiveness. This chapter's examples, like those in Chapter 29, were developed in NetBeans.

30.2 Accessing Databases in Web Apps

Many web apps access databases to store and retrieve persistent data. In this section, we build an address book web app that uses a Java DB database display contacts from the address book on a web page and to store contacts in the address book. Figure 30.1 shows sample interactions with the *AddressBook* app.

a) Table of addresses displayed when the *AddressBook* app is first requested

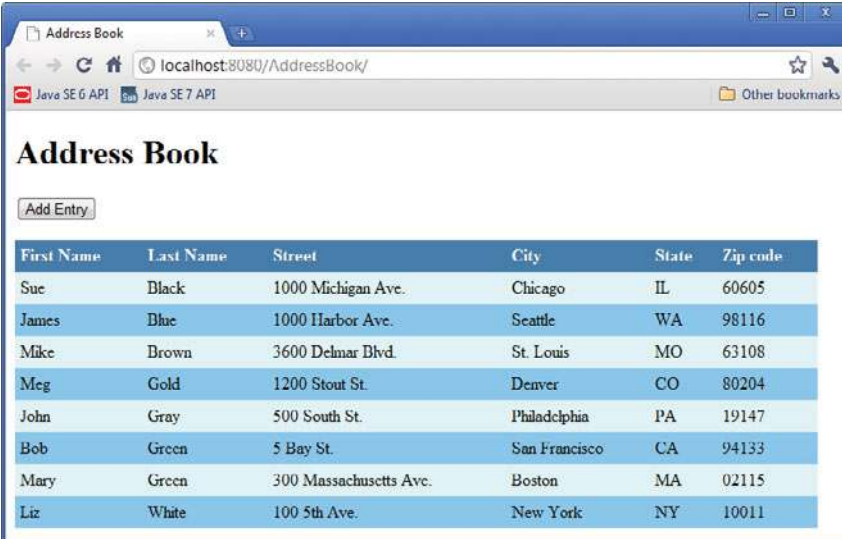

First Name	Last Name	Street	City	State	Zip code
Sue	Black	1000 Michigan Ave.	Chicago	IL	60605
James	Blue	1000 Harbor Ave.	Seattle	WA	98116
Mike	Brown	3600 Delmar Blvd.	St. Louis	MO	63108
Meg	Gold	1200 Stout St.	Denver	CO	80204
John	Gray	500 South St.	Philadelphia	PA	19147
Bob	Green	5 Bay St.	San Francisco	CA	94133
Mary	Green	300 Massachusetts Ave.	Boston	MA	02115
Liz	White	100 5th Ave.	New York	NY	10011

Fig. 30.1 | Sample outputs from the *AddressBook* app. (Part 1 of 2.)

b) Form for adding an entry

Address Book: Add Entry

First name:

Last name:

Street:

City:

State:

Zipcode:

c) Table of addresses updated with the new entry added in Part (b)

Address Book

First Name	Last Name	Street	City	State	Zip code
Sue	Black	1000 Michigan Ave.	Chicago	IL	60605
James	Blue	1000 Harbor Ave.	Seattle	WA	98116
Mike	Brown	3600 Delmar Blvd.	St. Louis	MO	63108
Meg	Gold	1200 Stout St.	Denver	CO	80204
John	Gray	500 South St.	Philadelphia	PA	19147
Bob	Green	5 Day St.	San Francisco	CA	94133
Mary	Green	300 Massachusetts Ave.	Boston	MA	02115
Jessica	Magenta	1 Main Street	SomeCity	FL	12345
Liz	White	100 5th Ave.	New York	NY	10011

Fig. 30.1 | Sample outputs from the AddressBook app. (Part 2 of 2.)

If the app's database already contains addresses, the initial request to the app displays those addresses as shown in Fig. 30.1(a). We populated the database with the sample addresses shown. When the user clicks **Add Entry**, the `addentry.xhtml` page is displayed (Fig. 30.1(b)). When the user clicks **Save Address**, the form's fields are validated. If the validations are successful, the address is added to the database and the app returns to the `index.xhtml` page to show the updated list of addresses (Fig. 30.1(c)). This example also introduces the `h:dataTable` element for displaying data in tabular format.

The next several sections explain how to build the AddressBook application. First, we set up the database (Section 30.2.1). Next, we present class AddressBean (Section 30.2.2), which enables the app's Facelets pages to interact with the database. Finally, we present the `index.xhtml` (Section 30.2.3) and `addentry.xhtml` (Section 30.2.4) Facelets pages.

30.2.1 Setting Up the Database

You'll now create a *data source* that enables the app to interact with the database. As part of this process, you'll create the addressbook database and populate it with sample data.

Open NetBeans and Ensure that Java DB and GlassFish Are Running

Before you can create the data source in NetBeans, the IDE must be open and the Java DB and GlassFish servers must be running. Perform the following steps:

1. Open the NetBeans IDE.
2. On the **Services** tab, expand the **Databases** node then right click **Java DB**. If **Java DB** is not already running the **Start Server** option will be enabled. In this case, **Select Start** server to launch the Java DB server.
3. On the **Services** tab, expand the **Servers** node then right click **GlassFish Server 3**. If **GlassFish Server 3** is not already running the **Start** option will be enabled. In this case, **Start** server to launch GlassFish.

You may need to wait a few moments for the servers to begin executing.

Creating a Connection Pool

In web apps that receive many requests, it's inefficient to create separate database connections for each request. Instead, you should set up a **connection pool** to allow the server to manage a limited number of database connections and share them among requests. To create a connection pool for this app, perform the following steps:

1. On the **Services** tab, expand the **Servers** node, right click **GlassFish Server 3** and select **View Admin Console**. This opens your default web browser and displays a web page for configuring the GlassFish server.
2. In the left column of the page under **Common Tasks**, expand the **Resources** node, then expand its **JDBC** node to show the **JDBC Resources** and **Connection Pools** nodes (Fig. 30.2).

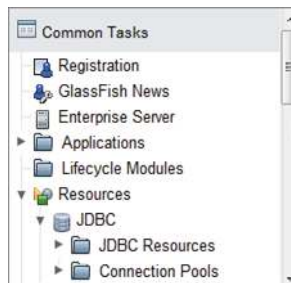

Fig. 30.2 | Common Tasks window in the GlassFish server configuration web page.

3. Click the **Connection Pools** node to display the list of existing connection pools, then click the **New...** button above the list to create a new connection pool.
4. In the **New JDBC Connection Pool (Step 1 of 2)** page (Fig. 30.3), specify `AddressBookPool` for the **Name**, select `javax.sql.DataSource` for the **Resource Type** and select `JavaDB` for the **Database Vendor**, then click **Next**.
5. In the **New JDBC Connection Pool (Step 2 of 2)** page (Fig. 30.4), scroll to the **Additional Properties** table and specify the following values (leave the other entries in the table unchanged):
 - **ConnectionAttributes:** `;create=true` (specifies that the database should be created when the connection pool is created)
 - **DatabaseName:** `addressbook` (specifies the name of the database to create)
 - **Password:** `APP` (specifies the password for the database—the **User** name is already specified as `APP` in the **Additional Properties** table; you can specify any **User** name and **Password** you like)

Fig. 30.3 | New JDBC Connection Pool (Step 1 of 2) page.

Name	Value
ConnectionAttributes	.create=true
CreateDatabase	
DataSourceName	
DatabaseName	addressbook
Description	
LoginTimeout	0
Password	APP
PortNumber	1527
RetrieveMessageText	true
SecurityMechanism	4
ServerName	localhost
ShutdownDatabase	
Sql	off
TraceDirectory	
TraceFile	
TraceFileAppend	false
TraceLevel	-1
User	APP

Fig. 30.4 | New JDBC Connection Pool (Step 2 of 2) page.

6. Click **Finish** to create the connection pool and return to the connection pools list.
7. Click `AddressBookPool` in the connection pools list to display the **Edit JDBC Connection Pool** page, then click **Ping** in that page to test the database connection and ensure that you set it up correctly.

Creating a Data Source Name

To connect to the database from the web app, you must configure a **data source name** that will be used to locate the database. The data source name must be associated with the connection pool that manages the connections to the database. Perform the following steps:

1. In the left column of the GlassFish configuration web page, click the **JDBC Resources** node to display the list of data source names, then click the **New...** button to display the **New JDBC Resource** page (Fig. 30.5).
2. Specify `jdbc/addressbook` as the **JNDI Name** and select `AddressBookPool` as the **Pool Name**. Then click **OK**. JNDI (Java Naming and Directory Interface) is a technology for locating application components (such as databases) in a distributed application (such as a multitier web application). You can now close the GlassFish configuration web page.



Fig. 30.5 | New JDBC Resource page.

Populate the addressbook Database with Sample Data

You'll now populate the database with sample data using the `AddressBook.sql` SQL script that's provided with this chapter's examples. To do so, you must create a connection to the new addressbook database from NetBeans. Perform the following steps:

1. On the NetBeans **Services** tab, right click the **Databases** node and select **New Connection....**
2. In the **New Database Connection** dialog, specify `localhost` as the **Host**, `1527` as the **Port**, `addressbook` as the **Database**, `APP` as the **User Name** and `APP` as the **Password**, then select the **Remember password** checkbox and click **OK**.

The preceding steps create a new entry in the **Databases** node showing the database's URL (`jdbc:derby://localhost:1527/addressbook`). The database server that provides access to this database resides on the local machine and accepts connections on port 1527.

NetBeans must be connected to the database to execute SQL statements. If NetBeans is already connected to the database, the icon  is displayed next to the database's URL; otherwise, the icon  is displayed. In this case, right click the icon and select **Connect...**

To populate the database with sample data, perform the following steps:

1. Click the + next to `jdbc:derby://localhost:1527/addressbook` node to expand it, then expand the database's **APP** node.
2. Right click the **Tables** node and select **Execute Command...** to open a **SQL Command** editor tab in NetBeans. In a text editor, open the file `AddressBook.sql` from this chapter's examples folder, then copy the SQL statements and paste them into the **SQL Command** editor in NetBeans. Next, right click in the **SQL Command** editor and select **Run File**. This will create the `Addresses` table with the sample data in Fig. 30.1(a). [*Note:* The SQL script attempts to remove the database's `Addresses` table if it already exists. If it doesn't exist, you'll receive an error message, but the table will still be created properly.] Expand the **Tables** node to see the new table. You can view the table's data by right clicking **ADDRESSES** and selecting **View Data...** Notice that we named the columns with all capital letters. We'll be using these names in Section 30.2.3.

30.2.2 @ManagedBean Class AddressBean

[*Note:* To build this app from scratch, use the techniques you learned in Chapter 29 to create a JSF web application named `AddressBook` and add a second Facelets page named `addentry.xhtml` to the app.] Class `AddressBean` (Fig. 30.6) enables the `AddressBook` app to interact with the `addressbook` database. The class provides properties that represent the first name, last name, street, city, state and zip code for an entry in the database. These are used by the `addentry.xhtml` page when adding a new entry to the database. In addition, this class declares a `DataSource` (lines 26–27) for interacting with the database method `getAddresses` (lines 102–130) for obtaining the list of addresses from the database and method `save` (lines 133–169) for saving a new address into the database. These methods use various JDBC techniques you learned in Chapter 28.

```

1 // AddressBean.java
2 // Bean for interacting with the AddressBook database
3 package addressbook;
4
5 import java.sql.Connection;
6 import java.sql.PreparedStatement;
7 import java.sql.ResultSet;
8 import java.sql.SQLException;
9 import javax.annotation.Resource;
10 import javax.faces.bean.ManagedBean;
11 import javax.sql.DataSource;
12 import javax.sql.rowset.CachedRowSet;
13
14 @ManagedBean( name="addressBean" )
15 public class AddressBean
16 {

```

Fig. 30.6 | `AddressBean` interacts with a database to store and retrieve addresses. (Part 1 of 4.)

```
17 // instance variables that represent one address
18 private String firstName;
19 private String lastName;
20 private String street;
21 private String city;
22 private String state;
23 private String zipcode;
24
25 // allow the server to inject the DataSource
26 @Resource( name="jdbc/addressbook" )
27 DataSource dataSource;
28
29 // get the first name
30 public String getFirstName()
31 {
32     return firstName;
33 } // end method getFirstName
34
35 // set the first name
36 public void setFirstName( String firstName )
37 {
38     this.firstName = firstName;
39 } // end method setFirstName
40
41 // get the last name
42 public String getLastName()
43 {
44     return lastName;
45 } // end method getLastName
46
47 // set the last name
48 public void setLastName( String lastName )
49 {
50     this.lastName = lastName;
51 } // end method setLastName
52
53 // get the street
54 public String getStreet()
55 {
56     return street;
57 } // end method getStreet
58
59 // set the street
60 public void setStreet( String street )
61 {
62     this.street = street;
63 } // end method setStreet
64
65 // get the city
66 public String getCity()
67 {
68     return city;
69 } // end method getCity
```

Fig. 30.6 | AddressBean interacts with a database to store and retrieve addresses. (Part 2 of 4.)

```
70
71 // set the city
72 public void setCity( String city )
73 {
74     this.city = city;
75 } // end method setCity
76
77 // get the state
78 public String getState()
79 {
80     return state;
81 } // end method getState
82
83 // set the state
84 public void setState( String state )
85 {
86     this.state = state;
87 } // end method setState
88
89 // get the zipcode
90 public String getZipcode()
91 {
92     return zipcode;
93 } // end method getZipcode
94
95 // set the zipcode
96 public void setZipcode( String zipcode )
97 {
98     this.zipcode = zipcode;
99 } // end method setZipcode
100
101 // return a ResultSet of entries
102 public ResultSet getAddresses() throws SQLException
103 {
104     // check whether dataSource was injected by the server
105     if ( dataSource == null )
106         throw new SQLException( "Unable to obtain DataSource" );
107
108     // obtain a connection from the connection pool
109     Connection connection = dataSource.getConnection();
110
111     // check whether connection was successful
112     if ( connection == null )
113         throw new SQLException( "Unable to connect to DataSource" );
114
115     try
116     {
117         // create a PreparedStatement to insert a new address book entry
118         PreparedStatement getAddresses = connection.prepareStatement(
119             "SELECT FIRSTNAME, LASTNAME, STREET, CITY, STATE, ZIP " +
120             "FROM ADDRESSES ORDER BY LASTNAME, FIRSTNAME" );
121
122         CachedRowSet rowSet = new com.sun.rowset.CachedRowSetImpl();
```

Fig. 30.6 | AddressBean interacts with a database to store and retrieve addresses. (Part 3 of 4.)

```

123         rowSet.populate( getAddresses.executeQuery() );
124         return rowSet;
125     } // end try
126     finally
127     {
128         connection.close(); // return this connection to pool
129     } // end finally
130 } // end method getAddresses
131
132 // save a new address book entry
133 public String save() throws SQLException
134 {
135     // check whether dataSource was injected by the server
136     if ( dataSource == null )
137         throw new SQLException( "Unable to obtain DataSource" );
138
139     // obtain a connection from the connection pool
140     Connection connection = dataSource.getConnection();
141
142     // check whether connection was successful
143     if ( connection == null )
144         throw new SQLException( "Unable to connect to DataSource" );
145
146     try
147     {
148         // create a PreparedStatement to insert a new address book entry
149         PreparedStatement addEntry =
150             connection.prepareStatement( "INSERT INTO ADDRESSES " +
151                 "(FIRSTNAME, LASTNAME, STREET, CITY, STATE, ZIP)" +
152                 "VALUES ( ?, ?, ?, ?, ?, ? )" );
153
154         // specify the PreparedStatement's arguments
155         addEntry.setString( 1, getFirstName() );
156         addEntry.setString( 2, getLastName() );
157         addEntry.setString( 3, getStreet() );
158         addEntry.setString( 4, getCity() );
159         addEntry.setString( 5, getState() );
160         addEntry.setString( 6, getZipcode() );
161
162         addEntry.executeUpdate(); // insert the entry
163         return "index"; // go back to index.xhtml page
164     } // end try
165     finally
166     {
167         connection.close(); // return this connection to pool
168     } // end finally
169 } // end method save
170 } // end class AddressBean

```

Fig. 30.6 | AddressBean interacts with a database to store and retrieve addresses. (Part 4 of 4.)

Injecting the DataSource into Class AddressBean

A **DataSource** (package `javax.sql`) enables a web application to obtain a `Connection` to a database. Lines 26–27 use annotation **@Resource** to inject a `DataSource` object into the

`AddressBean`. The annotation's name attribute specifies `java/addressbook`—the JNDI name from the *Creating a Data Source Name* step of Section 30.2.1. The `@Resource` annotation enables the server (GlassFish in our case) to hide all the complex details of locating the connection pool that we set up for interacting with the `addressbook` database. The server creates a `DataSource` for you that's configured to use that connection pool and assigns the `DataSource` object to the annotated variable declared at line 27. You can now trivially obtain a `Connection` for interacting with the database.

AddressBean Method getAddresses

Method `getAddresses` (lines 102–130) is called when the `index.xhtml` page is requested. The method returns a list of addresses for display in the page (Section 30.2.3). First, we check whether variable `dataSource` is `null` (lines 105–106), which would indicate that the server was unable to create the `DataSource` object. If the `DataSource` was created successfully, we use it to obtain a `Connection` to the database (line 109). Next, we check whether variable `connection` is `null` (lines 112–113), which would indicate that we were unable to connect. If the connection was successful, lines 118–124 get the set of addresses from the database and return them.

The `PreparedStatement` at lines 118–120 obtains all the addresses. Because database connections are a limited resources, you should use and close them quickly in your web apps. For this reason, we create a `CachedRowSet` and populate it with the `ResultSet` returned by the `PreparedStatement`'s `executeQuery` method (lines 122–123). We then return the `CachedRowSet` (a disconnected `RowSet`) for use in the `index.xhtml` page (line 124) and close the `connection` object (line 128) in the `finally` block.

AddressBean Method save

Method `save` (lines 133–169) stores a new address in the database (Section 30.2.4). This occurs when the user submits the `addentry.xhtml` form—assuming the form's fields validate successfully. As in `getAddresses`, we ensure that the `DataSource` is not `null`, then obtain the `Connection` object and ensure that its not `null`. Lines 149–152 create a `PreparedStatement` for inserting a new record in the database. Lines 155–160 specify the values for each of the parameters in the `PreparedStatement`. Line 162 then executes the `PreparedStatement` to insert the new record. Line 163 returns the string `"index"`, which as you'll see in Section 30.2.4 causes the app to display the `index.xhtml` page again.

30.2.3 `index.xhtml` Facelets Page

`index.xhtml` (Fig. 30.7) is the default web page for the `AddressBook` app. When this page is requested, it obtains the list of addresses from the `AddressBean` and displays them in tabular format using an **`h:dataTable` element**. The user can click the **Add Entry** button (line 17) to view the `addentry.xhtml` page. Recall that the default action for an `h:commandButton` is to submit a form. In this case, we specify the button's **action attribute** with the value `"addentry"`. The JSF framework assumes this is a page in the app, appends `.xhtml` extension to the `action` attribute's value and returns the `addentry.xhtml` page to the client browser.

The `h:dataTable` Element

The `h:dataTable` element (lines 19–46) inserts tabular data into a page. We discuss only the attributes and nested elements that we use here. For more details on this element, its attributes and other JSF tag library elements, visit bit.ly/JSF2TagLibraryReference.

```

1  <?xml version='1.0' encoding='UTF-8' ?>
2
3  <!-- index.html -->
4  <!-- Displays an h:dataTable of the addresses in the address book -->
5  <!DOCTYPE html PUBLIC "-//W3C//DTD XHTML 1.0 Transitional//EN"
6     "http://www.w3.org/TR/xhtml1/DTD/xhtml1-transitional.dtd">
7  <html xmlns="http://www.w3.org/1999/xhtml"
8     xmlns:h="http://java.sun.com/jsf/html"
9     xmlns:f="http://java.sun.com/jsf/core">
10   <h:head>
11     <title>Address Book</title>
12     <h:outputStylesheet name="style.css" library="css"/>
13   </h:head>
14   <h:body>
15     <h1>Address Book</h1>
16     <h:form>
17       <p><h:commandButton value="Add Entry" action="addentry"/></p>
18     </h:form>
19     <h:dataTable value="#{addressBean.addresses}" var="address"
20       rowClasses="oddRows,evenRows" headerClass="header"
21       styleClass="table" cellpadding="5" cellspacing="0">
22       <h:column>
23         <f:facet name="header">First Name</f:facet>
24         #{address.FIRSTNAME}
25       </h:column>
26       <h:column>
27         <f:facet name="header">Last Name</f:facet>
28         #{address.LASTNAME}
29       </h:column>
30       <h:column>
31         <f:facet name="header">Street</f:facet>
32         #{address.STREET}
33       </h:column>
34       <h:column>
35         <f:facet name="header">City</f:facet>
36         #{address.CITY}
37       </h:column>
38       <h:column>
39         <f:facet name="header">State</f:facet>
40         #{address.STATE}
41       </h:column>
42       <h:column>
43         <f:facet name="header">Zip code</f:facet>
44         #{address.ZIP}
45       </h:column>
46     </h:dataTable>
47   </h:body>
48 </html>

```

Fig. 30.7 | Displays an `h:dataTable` of the addresses in the address book.

The `h:dataTable` element's **value attribute** (line 19) specifies the collection of data you wish to display. In this case, we use `AddressBean`'s `addresses` property, which calls

the `getAddresses` method (Fig. 30.6). The collection returned by this method is a `CachedRowSet`, which is a type of `ResultSet`.

The `h:dataTable` iterates over its `value` collection and, one at a time, assigns each element to the variable specified by the **var attribute**. This variable is used in the `h:dataTable`'s nested elements to access each element of the collection—each element in this case represents one row (i.e., address) in the `CachedRowSet`.

The **rowClasses attribute** (line 20) is a space-separated list of CSS style class names that are used to style the rows in the tabular output. These style classes are defined in the app's `styles.css` file in the `css` library (which is inserted into the document at line 12). You can open this file to view the various style class definitions. We specified two style classes— all the odd numbered rows will have the first style (`oddRows`) and all the even numbered rows the second style (`evenRows`). You can specify as many styles as you like—they'll be applied in the order you list them one row at a time until all the styles have been applied, then the `h:DataTable` will automatically cycle through the styles again for the next set of rows. The **columnClasses attribute** works similarly for columns in the table.

The **headerClass attribute** (line 20) specifies the column header CSS style. Headers are defined with `f:facet` elements nested in `h:column` elements (discussed momentarily). The **footerClass attribute** works similarly for column footers in the table.

The **styleClass attribute** (line 21) specifies the CSS styles for the entire table. The **cellpadding** and **cellspacing** attributes (line 21) specify the number of pixels around each table cell's contents and the number of pixels between table cells, respectively.

The h:column Elements

Lines 22–45 define the table's columns with six nested **h:column elements**. We focus here on the one at lines 22–25. When the `CachedRowSet` is populated in the `AddressBean` class, it automatically uses the database's column names as property names for each row object in the `CachedRowSet`. Line 28 inserts into the column the `FIRSTNAME` property of the `CachedRowSet`'s current row. To display a column header above the column, you define an **f:facet element** (line 23) and set its `name` attribute to "header". Similarly, to display a column footer, use an `f:facet` with its `name` attribute set to "footer". The header is formatted with the CSS style specified in the `h:dataTable`'s `headerClass` attribute (line 20). The remaining `h:column` elements perform similar tasks for the current row's `LASTNAME`, `STREET`, `CITY`, `STATE` and `ZIP` properties.

30.2.4 addentry.xhtml Facelets Page

When the user clicks **Add Entry** in the `index.xhtml` page, `addentry.xhtml` (Fig. 30.8) is displayed. Each `h:inputText` in this page has its `required` attribute set to "true" and includes a `maxLength` attribute that restricts the user's input to the maximum length of the corresponding database field. When the user clicks **Save** (lines 48–49), the input element's values are validated and (if successful) assigned to the properties of the `addressBean` managed object. In addition, the button specifies as its `action` the EL expression

```
#{addressBean.save}
```

which invokes the `addressBean` object's `save` method to store the new address in the database. When you call a method with the `action` attribute, if the method returns a value (in

this case, it returns the string "index"), that value is used to request the corresponding page from the app. If the method does not return a value, the current page is re-requested.

```

1 <?xml version='1.0' encoding='UTF-8' ?>
2
3 <!-- addentry.html -->
4 <!-- Form for adding an entry to an address book -->
5 <!DOCTYPE html PUBLIC "-//W3C//DTD XHTML 1.0 Transitional//EN"
6   "http://www.w3.org/TR/xhtml1/DTD/xhtml1-transitional.dtd">
7 <html xmlns="http://www.w3.org/1999/xhtml"
8   xmlns:h="http://java.sun.com/jsf/html">
9   <h:head>
10    <title>Address Book: Add Entry</title>
11    <h:outputStylesheet name="style.css" library="css"/>
12  </h:head>
13  <h:body>
14    <h1>Address Book: Add Entry</h1>
15    <h:form>
16      <h:panelGrid columns="3">
17        <h:outputText value="First name:"/>
18        <h:inputText id="firstNameInputText" required="true"
19          requiredMessage="Please enter first name"
20          value="#{addressBean.firstName}" maxLength="30"/>
21        <h:message for="firstNameInputText" styleClass="error"/>
22        <h:outputText value="Last name:"/>
23        <h:inputText id="lastNameInputText" required="true"
24          requiredMessage="Please enter last name"
25          value="#{addressBean.lastName}" maxLength="30"/>
26        <h:message for="lastNameInputText" styleClass="error"/>
27        <h:outputText value="Street:"/>
28        <h:inputText id="streetInputText" required="true"
29          requiredMessage="Please enter the street address"
30          value="#{addressBean.street}" maxLength="150"/>
31        <h:message for="streetInputText" styleClass="error"/>
32        <h:outputText value="City:"/>
33        <h:inputText id="cityInputText" required="true"
34          requiredMessage="Please enter the city"
35          value="#{addressBean.city}" maxLength="30"/>
36        <h:message for="cityInputText" styleClass="error"/>
37        <h:outputText value="State:"/>
38        <h:inputText id="stateInputText" required="true"
39          requiredMessage="Please enter state"
40          value="#{addressBean.state}" maxLength="2"/>
41        <h:message for="stateInputText" styleClass="error"/>
42        <h:outputText value="Zipcode:"/>
43        <h:inputText id="zipcodeInputText" required="true"
44          requiredMessage="Please enter zipcode"
45          value="#{addressBean.zipcode}" maxLength="5"/>
46        <h:message for="zipcodeInputText" styleClass="error"/>
47      </h:panelGrid>
48      <h:commandButton value="Save Address"
49        action="#{addressBean.save}"/>
50    </h:form>

```

Fig. 30.8 | Form for adding an entry to an address book. (Part I of 2.)

```

51         <h:outputLink value="index.xhtml">Return to Addresses</h:outputLink>
52     </h:body>
53 </html>

```

Fig. 30.8 | Form for adding an entry to an address book. (Part 2 of 2.)

30.3 Ajax

The term **Ajax**—short for **Asynchronous JavaScript and XML**—was coined by Jesse James Garrett of Adaptive Path, Inc., in 2005 to describe a range of technologies for developing highly responsive, dynamic web applications. Ajax applications include Google Maps, Yahoo’s Flickr and many more. Ajax separates the *user interaction* portion of an application from its *server interaction*, enabling both to proceed *in parallel*. This enables Ajax web-based applications to perform at speeds approaching those of desktop applications, reducing or even eliminating the performance advantage that desktop applications have traditionally had over web-based applications. This has huge ramifications for the desktop applications industry—the applications platform of choice is shifting from the desktop to the web. Many people believe that the web—especially in the context of abundant open-source software, inexpensive computers and exploding Internet bandwidth—will create the next major growth phase for Internet companies.

Ajax makes **asynchronous** calls to the server to exchange small amounts of data with each call. *Where normally the entire page would be submitted and reloaded with every user interaction on a web page, Ajax allows only the necessary portions of the page to reload, saving time and resources.*

Ajax applications typically make use of client-side scripting technologies such as JavaScript to interact with page elements. They use the browser’s **XMLHttpRequest object** to perform the asynchronous exchanges with the web server that make Ajax applications so responsive. This object can be used by most scripting languages to pass XML data from the client to the server and to process XML data sent from the server back to the client.

Using Ajax technologies in web applications can dramatically improve performance, but programming Ajax directly is complex and error prone. It requires page designers to know both scripting and markup languages. As you’ll soon see, JSF 2.0 makes adding Ajax capabilities to your web apps fairly simple.

Traditional Web Applications

Figure 30.9 presents the typical interactions between the client and the server in a traditional web application, such as one that uses a user registration form. The user first fills in the form’s fields, then *submits* the form (Fig. 30.9, *Step 1*). The browser generates a request to the server, which receives the request and processes it (*Step 2*). The server generates and sends a response containing the exact page that the browser will render (*Step 3*), which causes the browser to load the new page (*Step 4*) and temporarily makes the browser window blank. The client *waits* for the server to respond and *reloads the entire page* with the data from the response (*Step 4*). While such a **synchronous request** is being processed on the server, *the user cannot interact with the client web page*. If the user interacts with and submits another form, the process begins again (*Steps 5–8*).

This model was originally designed for a web of *hypertext documents*—what some people call the “brochure web.” As the web evolved into a full-scale applications platform,

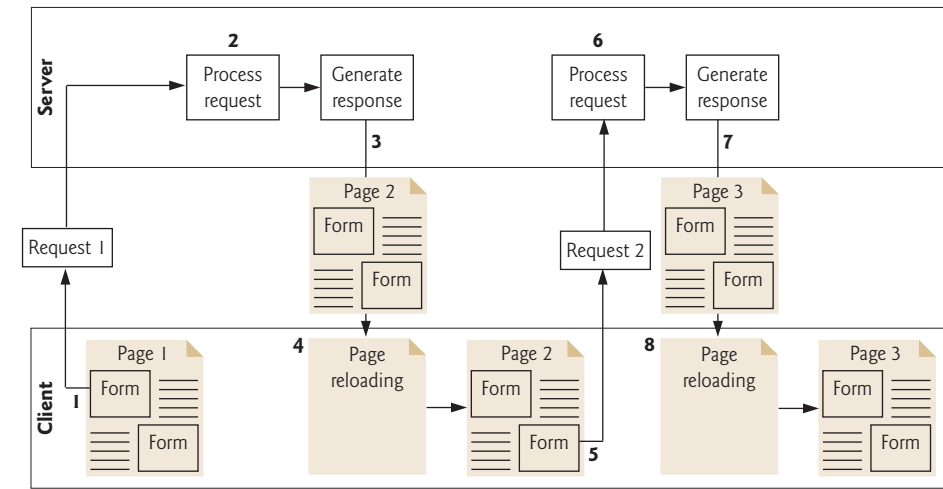

Fig. 30.9 | Classic web application reloading the page for every user interaction.

the model shown in Fig. 30.9 yielded “choppy” application performance. Every full-page refresh required users to reestablish their understanding of the full-page contents. Users began to demand a model that would yield the responsiveness of desktop applications.

Ajax Web Applications

Ajax applications add a layer between the client and the server to manage communication between the two (Fig. 30.10). When the user interacts with the page, the client creates an

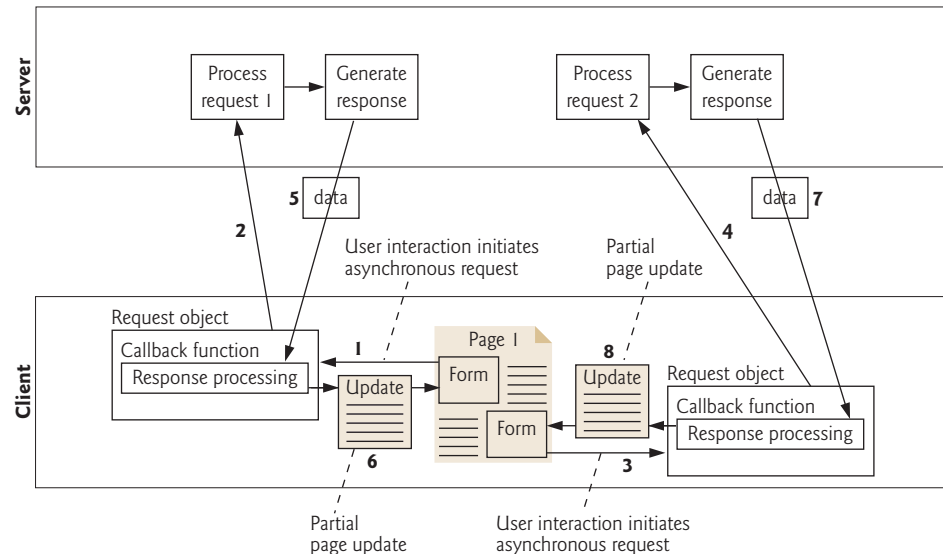

Fig. 30.10 | Ajax-enabled web application interacting with the server asynchronously.

XMLHttpRequest object to manage a request (*Step 1*). This object sends the request to the server (*Step 2*) and awaits the response. The requests are asynchronous, so the user can continue interacting with the application on the client side while the server processes the earlier request concurrently. Other user interactions could result in additional requests to the server (*Steps 3 and 4*). Once the server responds to the original request (*Step 5*), the XMLHttpRequest object that issued the request calls a client-side function to process the data returned by the server. This function—known as a **callback function**—uses **partial page updates** (*Step 6*) to display the data in the existing web page *without reloading the entire page*. At the same time, the server may be responding to the second request (*Step 7*) and the client side may be starting to do another partial page update (*Step 8*). The callback function updates only a designated part of the page. Such partial page updates help make web applications more responsive, making them feel more like desktop applications. The web application does not load a new page while the user interacts with it.

30.4 Adding Ajax Functionality to the Validation App

The example in this section adds Ajax capabilities to the Validation app that we presented in Section 29.7. Figure 30.11 shows the sample outputs from the ValidationAjax version of the app that we'll build momentarily. Part (a) shows the initial form that's displayed when this app first executes. Parts (b) and (c) show validation errors that are displayed when the user submits an empty form and invalid data, respectively. Part (d) shows the page after the form is submitted successfully.

As you can see, the app has the same functionality as the version in Section 29.7; however, you'll notice a couple of changes in how the app works. First, the URL displayed in the web browser always reads localhost:8080/ValidationAjax/, whereas the URL in the Section 29.7 changes after the form is submitted the first time. Also, in the non-Ajax version of the app, the page refreshes each time you press the **Submit** button. In the Ajax version, only the parts of the page that need updating actually change.

a) Submitting the form before entering any information



Fig. 30.11 | JSP that demonstrates validation of user input. (Part 1 of 2.)

b) Error messages displayed after submitting the empty form



Validating Form Data

localhost:8080/ValidationAjax/

Java SE 6 API Java SE 7 API

Please fill out the following form:

All fields are required and must contain valid information

Name: Please enter your name

E-mail: Please enter a valid e-mail address

Phone: Please enter a valid phone number

Submit

c) Error messages displayed after submitting invalid information



Validating Form Data

localhost:8080/ValidationAjax/

Java SE 6 API Java SE 7 API

Please fill out the following form:

All fields are required and must contain valid information

Name: Paul plus a bunch of other Name must be fewer than 30 characters

E-mail: not a valid email Invalid e-mail address format

Phone: 55 1234 Invalid phone number format

Submit

d) Successfully submitted form



Validating Form Data

localhost:8080/ValidationAjax/

Java SE 6 API Java SE 7 API

Please fill out the following form:

All fields are required and must contain valid information

Name: Paul

E-mail: paul@somedomain.com

Phone: (555) 555-5555

Submit

Name: Paul
E-Mail: paul@somedomain.com
Phone: (555) 555-5555

Fig. 30.11 | JSP that demonstrates validation of user input. (Part 2 of 2.)

index.xhtml

The changes required to add Ajax functionality to this app are minimal. All of the changes are in the `index.xhtml` file (Fig. 30.12) and are highlighted. The `ValidationBean` class is identical to the version in Section 29.7, so we don't show it here.

```

1  <?xml version='1.0' encoding='UTF-8' ?>
2
3  <!-- index.xhtml -->
4  <!-- Validating user input -->
5  <!DOCTYPE html PUBLIC "-//W3C//DTD XHTML 1.0 Transitional//EN"
6     "http://www.w3.org/TR/xhtml1/DTD/xhtml1-transitional.dtd">
7  <html xmlns="http://www.w3.org/1999/xhtml"
8     xmlns:h="http://java.sun.com/jsf/html"
9     xmlns:f="http://java.sun.com/jsf/core">
10   <h:head>
11     <title>Validating Form Data</title>
12     <h:outputStylesheet name="style.css" library="css"/>
13   </h:head>
14   <h:body>
15     <h:form>
16       <h1>Please fill out the following form:</h1>
17       <p>All fields are required and must contain valid information</p>
18       <h:panelGrid columns="3">
19         <h:outputText value="Name:"/>
20         <h:inputText id="nameInputText" required="true"
21           requiredMessage="Please enter your name"
22           value="#{validationBean.name}"
23           validatorMessage="Name must be fewer than 30 characters">
24           <f:validateLength maximum="30" />
25         </h:inputText>
26         <h:message id="nameMessage" for="nameInputText"
27           styleClass="error"/>
28         <h:outputText value="E-mail:"/>
29         <h:inputText id="emailInputText" required="true"
30           requiredMessage="Please enter a valid e-mail address"
31           value="#{validationBean.email}"
32           validatorMessage="Invalid e-mail address format">
33           <f:validateRegex pattern=
34             "\w+([-+.']\w+)*@\w+([-.\w+)*\.\w+([-.\w+)*" />
35         </h:inputText>
36         <h:message id="emailMessage" for="emailInputText"
37           styleClass="error"/>
38         <h:outputText value="Phone:"/>
39         <h:inputText id="phoneInputText" required="true"
40           requiredMessage="Please enter a valid phone number"
41           value="#{validationBean.phone}"
42           validatorMessage="Invalid phone number format">
43           <f:validateRegex pattern=
44             "((\d{3}\d{3})|(\d{3}-))?\d{3}-\d{4}" />
45         </h:inputText>
46         <h:message id="phoneMessage" for="phoneInputText"
47           styleClass="error"/>
48       </h:panelGrid>

```

Fig. 30.12 | Ajax enabling the Validation app. (Part 1 of 2.)

```

49     <h:commandButton value="Submit">
50         <f:ajax execute="nameInputText emailInputText phoneInputText"
51             render=
52                 "nameMessage emailMessage phoneMessage resultOutputText"/>
53     </h:commandButton>
54     <h:outputText id="resultOutputText" escape="false"
55         value="#{validationBean.response}"/>
56 </h:form>
57 </h:body>
58 </html>

```

Fig. 30.12 | Ajax enabling the Validation app. (Part 2 of 2.)

Adding id Attributes to Elements

The Facelets elements that will be submitted as part of an Ajax request and the Facelets elements that will participate in the partial page updates must have `id` attributes. The `h:inputText` elements in the original `Validation` example already had `id` attributes. These elements will be submitted to the server as part of an Ajax request. We'd like the `h:Message` elements that show validation errors and the `h:outputText` element that displays the result to be updated with partial page updates. For this reason, we've added `id` attributes to these elements.

f:ajax Element

The other key change to this page is at lines 49–53 where the `h:commandButton` now contains an **f:ajax element**, which intercepts the form submission when the user clicks the button and makes an Ajax request instead. The `f:ajax` element's **execute attribute** specifies a space-separated list of element `ids`—the values of these elements are submitted as part of the Ajax request. The `f:ajax` element's **render attribute** specifies a space-separated list of element `ids` for the elements that should be updated via partial page updates.

30.5 Wrap-Up

In this chapter, we built an `AddressBook` application that allowed a user to add and view contacts. You learned how to insert user input into a Java DB database and how to display the contents of a database on a web page using an `h:dataTable` JSF element. We also demonstrated how to add Ajax capabilities to JSF web apps by enhancing the `Validation` app from Section 29.7. In Chapter 31, you'll use NetBeans to create web services and consume them from desktop and web applications.

Summary

Section 30.2.1 Setting Up the Database

- A data source enables a web app to interact with a database.
- In web apps that receive many requests, it's inefficient to create separate database connections for each request. Instead, you should set up a connection pool (p. 1279) to allow the server to manage a limited number of database connections and share them among requests.

- To connect to the database from a web app, you configure a data source name (p. 1281) that will be used to locate the database. The data source name is associated with a connection pool that manages the connections to the database.
- JNDI (Java Naming and Directory Interface) is a technology for locating application components (such as databases) in a distributed application (such as a multitier web application).

Section 30.2.2 @ManagedBean Class AddressBean

- A `DataSource` (p. 1285; package `javax.sql`) enables a web application to obtain a `Connection` to a database.
- The annotation `@Resource` (p. 1285) can be used to inject a `DataSource` object into a managed bean. The annotation's `name` attribute specifies the JNDI name of a data source.
- The `@Resource` annotation enables the server to hide all the complex details of locating a connection pool. The server creates a `DataSource` for you that's configured to use a connection pool and assigns the `DataSource` object to the annotated variable. You can then trivially obtain a `Connection` for interacting with the database.
- Database connections are limited resources, so you should use and close them quickly in your web apps. You can use a `CachedRowSet` to store the results of a query for use later.

Section 30.2.3 `index.xhtml` Facelets Page

- You can use an `h:dataTable` element (p. 1286) to display a collection of objects, such as the rows in a `CachedRowSet`, in tabular format.
- If you specify an `h:commandButton`'s `action` attribute (p. 1286) with a value that is the name of a web page (without the file name extension), the JSF framework assumes this is a page in the app, appends `.xhtml` extension to the `action` attribute's value and returns the page to the client browser.
- The `h:dataTable` element's `value` attribute (p. 1287) specifies the collection of data you wish to display. The `h:dataTable` iterates over its `value` collection and, one at a time, assigns each element to the variable specified by the `var` attribute (p. 1288). This variable is used in the `h:dataTable`'s nested elements to access each element of the collection.
- The `h:dataTable` `rowClasses` attribute (p. 1288) is a space-separated list of CSS style class names that are used to style the rows in the tabular output. You can specify as many styles as you like—they'll be applied in the order you list them one row at a time until all the styles have been applied, then the `h:dataTable` will automatically cycle through the styles again for the next set of rows. The `columnClasses` attribute works similarly for columns in the table.
- The `headerClass` attribute (p. 1288) specifies the column header CSS style. The `footerClass` attribute (p. 1288) works similarly for column footers in the table.
- The `styleClass` attribute (p. 1288) specifies the CSS styles for the entire table. The `cellpadding` and `cellspacing` attributes (p. 1288) specify the number of pixels around each table cell's contents and the number of pixels between table cells, respectively.
- An `h:column` element (p. 1288) defines a column in an `h:dataTable`.
- To display a column header above a column, define an `f:facet` element (p. 1288) and set its `name` attribute to "header". Similarly, to display a column footer, use an `f:facet` with its `name` attribute set to "footer".

Section 30.2.4 `addentry.xhtml` Facelets Page

- You can call a managed bean's methods in EL expressions.
- When you call a managed bean method with the `action` attribute, if the method returns a value, that value is used to request the corresponding page from the app. If the method does not return a value, the current page is re-requested.

Section 30.3 Ajax

- The term Ajax—short for Asynchronous JavaScript and XML—was coined by Jesse James Garrett of Adaptive Path, Inc., in February 2005 to describe a range of technologies for developing highly responsive, dynamic web applications.
- Ajax separates the user interaction portion of an application from its server interaction, enabling both to proceed asynchronously in parallel. This enables Ajax web-based applications to perform at speeds approaching those of desktop applications.
- Ajax makes asynchronous calls to the server to exchange small amounts of data with each call. Where normally the entire page would be submitted and reloaded with every user interaction on a web page, Ajax reloads only the necessary portions of the page, saving time and resources.
- Ajax applications typically make use of client-side scripting technologies such as JavaScript to interact with page elements. They use the browser's XMLHttpRequest object to perform the asynchronous exchanges with the web server that make Ajax applications so responsive.
- In a traditional web application, the user fills in a form's fields, then submits the form. The browser generates a request to the server, which receives the request and processes it. The server generates and sends a response containing the exact page that the browser will render. The browser loads the new page, temporarily making the browser window blank. The client waits for the server to respond and reloads the entire page with the data from the response. While such a synchronous request is being processed on the server, the user cannot interact with the web page. This model yields “choppy” application performance.
- In an Ajax application, when the user interacts with the page, the client creates an XMLHttpRequest object to manage a request. This object sends the request to the server and awaits the response. The requests are asynchronous, so the user can interact with the application on the client side while the server processes the earlier request concurrently. Other user interactions could result in additional requests to the server. Once the server responds to the original request, the XMLHttpRequest object that issued the request calls a client-side function to process the data returned by the server. This callback function uses partial page updates to display the data in the existing web page without reloading the entire page. At the same time, the server may be responding to the second request and the client side may be starting to do another partial page update.
- Partial page updates help make web applications more responsive, making them feel more like desktop applications.

Section 30.4 Adding Ajax Functionality to the Validation App

- The Facelets elements that will be submitted as part of an Ajax request and the Facelets elements that will participate in the partial page updates must have id attributes.
- When you nest an f:ajax element (p. 1295) in an h:commandButton element, the f:ajax element intercepts the form submission and makes an Ajax request instead.
- The f:ajax element's execute attribute (p. 1295) specifies a space-separated list of element ids—the values of these elements are submitted as part of the Ajax request.
- The f:ajax element's render attribute (p. 1295) specifies a space-separated list of element ids for the elements that should be updated via partial page updates.

Self-Review Exercise

- 30.1** Fill in the blanks in each of the following statements.
- Ajax is an acronym for _____.
 - A(n) _____ allows the server to manage a limited number of database connections and share them among requests.

- c) is a technology for locating application components (such as databases) in a distributed application.
- d) A(n) _____ enables a web application to obtain a `Connection` to a database.
- e) The annotation _____ can be used to inject a `DataSource` object into a managed bean.
- f) A(n) _____ element displays a collection of objects in tabular format.
- g) An `h:commandButton`'s _____ attribute can specify the name of another page in the web app that should be returned to the client.
- h) To specify headers or footers for the columns in `h:dataTables`, use _____ elements nested with their name attributes set to _____ and _____, respectively.
- i) _____ separates the user interaction portion of an application from its server interaction, enabling both to proceed asynchronously in parallel.
- j) _____ help make web applications more responsive, making them feel more like desktop applications.
- k) The `f:ajax` element's _____ attribute specifies a space-separated list of element `ids`—the values of these elements are submitted as part of the Ajax request.
- l) The `f:ajax` element's _____ attribute specifies a space-separated list of element `ids` for the elements that should be updated via partial page updates.

Answers to Self-Review Exercise

30.1 a) Asynchronous JavaScript and XML. b) connection pool. c) JNDI (Java Naming and Directory Interface). d) `DataSource`. e) `@Resource`. f) `h:dataTable`. g) `action`. h) `f:facet`, "header", "footer". i) Ajax. j) partial page updates. k) `execute`. l) `render`.

Exercises

30.2 (*Guestbook Application*) Create a JSF web app that allows users to sign and view a guestbook. Use the Guestbook database to store guestbook entries. [*Note:* A SQL script to create the Guestbook database is provided in the examples directory for this chapter.] The Guestbook database has a single table, `Messages`, which has four columns: `Date`, `Name`, `Email` and `Message`. The database already contains a few sample entries. Using the `AddressBook` app in Section 30.2 as your guide, create two Facelets pages and a managed bean. The `index.xhtml` page should show the Guestbook entries in tabular format and should provide a button to add an entry to the Guestbook. When the user clicks this button, display an `addentry.xhtml` page. Provide `h:inputText` elements for the user's name and email address, an `h:inputTextarea` for the message and a **Sign Guestbook** button to submit the form. When the form is submitted, you should store in the Guestbook database a new entry containing the user's input and the date of the entry.

30.3 (*AddressBook Application Modification: Ajax*) Combine the two Facelets pages of the `AddressBook` application (Section 30.2) into a single page. Use Ajax capabilities to submit the new address book entry and to perform a partial page update that rerenders `h:dataTable` with the updated list of addresses.

30.4 (*AddressBook Application Modification*) Modify your solution to Exercise 30.3 to add a search capability that allows the user to search by last name. When the user presses the **Search** button, use Ajax to submit the search key and perform a partial page update that displays only the matching addresses in the `h:dataTable`.



A client is to me a mere unit, a factor in a problem.

—Sir Arthur Conan Doyle

They also serve who only stand and wait.

—John Milton

...if the simplest things of nature have a message that you understand, rejoice, for your soul is alive.

—Eleonora Duse

Protocol is everything.

—Francoise Giuliani

Objectives

In this chapter you will learn:

- What a web service is.
- How to publish and consume web services in NetBeans.
- How XML, JSON, XML-Based Simple Object Access Protocol (SOAP) and Representational State Transfer (REST) Architecture enable Java web services.
- How to create client desktop and web applications that consume web services.
- How to use session tracking in web services to maintain client state information.
- How to connect to databases from web services.
- How to pass objects of user-defined types to and return them from a web service.

- 31.1** Introduction
- 31.2** Web Service Basics
- 31.3** Simple Object Access Protocol (SOAP)
- 31.4** Representational State Transfer (REST)
- 31.5** JavaScript Object Notation (JSON)
- 31.6** Publishing and Consuming SOAP-Based Web Services
 - 31.6.1 Creating a Web Application Project and Adding a Web Service Class in NetBeans
 - 31.6.2 Defining the `WelcomeSOAP` Web Service in NetBeans
 - 31.6.3 Publishing the `WelcomeSOAP` Web Service from NetBeans
 - 31.6.4 Testing the `WelcomeSOAP` Web Service with GlassFish Application Server's Tester Web Page
 - 31.6.5 Describing a Web Service with the Web Service Description Language (WSDL)
 - 31.6.6 Creating a Client to Consume the `WelcomeSOAP` Web Service
 - 31.6.7 Consuming the `WelcomeSOAP` Web Service
- 31.7** Publishing and Consuming REST-Based XML Web Services
 - 31.7.1 Creating a REST-Based XML Web Service
 - 31.7.2 Consuming a REST-Based XML Web Service
- 31.8** Publishing and Consuming REST-Based JSON Web Services
 - 31.8.1 Creating a REST-Based JSON Web Service
 - 31.8.2 Consuming a REST-Based JSON Web Service
- 31.9** Session Tracking in a SOAP Web Service
 - 31.9.1 Creating a `Blackjack` Web Service
 - 31.9.2 Consuming the `Blackjack` Web Service
- 31.10** Consuming a Database-Driven SOAP Web Service
 - 31.10.1 Creating the `Reservation` Database
 - 31.10.2 Creating a Web Application to Interact with the `Reservation` Service
- 31.11** Equation Generator: Returning User-Defined Types
 - 31.11.1 Creating the `EquationGeneratorXML` Web Service
 - 31.11.2 Consuming the `EquationGeneratorXML` Web Service
 - 31.11.3 Creating the `EquationGeneratorJSON` Web Service
 - 31.11.4 Consuming the `EquationGeneratorJSON` Web Service
- 31.12** Wrap-Up

Summary | Self-Review Exercises | Answers to Self-Review Exercises | Exercises | Making a Difference

31.1 Introduction

This chapter introduces web services, which promote software portability and reusability in applications that operate over the Internet. A **web service** is a software component stored on one computer that can be accessed by an application (or other software component) on another computer over a network. Web services communicate using such technologies as XML, JSON and HTTP. In this chapter, we use two Java APIs that facilitate web services. The first, **JAX-WS**, is based on the **Simple Object Access Protocol (SOAP)**—an XML-based protocol that allows web services and clients to communicate, even if the client and the web service are written in different languages. The second, **JAX-RS**, uses **Representational State Transfer (REST)**—a network architecture that uses the web's traditional request/response mechanisms such as GET and POST requests. For more information on SOAP-based and REST-based web services, visit our Web Services Resource Centers:

www.deitel.com/WebServices/
www.deitel.com/RESTWebServices/

These Resource Centers include information about designing and implementing web services in many languages and about web services offered by companies such as Google, Amazon and eBay. You'll also find many additional tools for publishing and consuming web services. For more information about REST-based Java web services, check out the Jersey project:

```
jersey.java.net/
```

The XML used in this chapter is created and manipulated for you by the APIs, so you need not know the details of XML to use it here. To learn more about XML, read the following tutorials:

```
www.deitel.com/articles/xml_tutorials/20060401/XMLBasics/  
www.deitel.com/articles/xml_tutorials/20060401/XMLStructuringData/
```

and visit our XML Resource Center:

```
www.deitel.com/XML/
```

Business-to-Business Transactions

Rather than relying on proprietary applications, businesses can conduct transactions via standardized, widely available web services. This has important implications for **business-to-business (B2B) transactions**. Web services are platform and language independent, enabling companies to collaborate without worrying about the compatibility of their hardware, software and communications technologies. Companies such as Amazon, Google, eBay, PayPal and many others are benefiting by making their server-side applications available to partners via web services.

By purchasing some web services and using other free ones that are relevant to their businesses, companies can spend less time developing applications and can create new ones that are more innovative. E-businesses for example, can provide their customers with enhanced shopping experiences. Consider an online music store. The store's website links to information about various CDs, enabling users to purchase them, to learn about the artists, to find more titles by those artists, to find other artists' music they may enjoy, and more. The store's website may also link to the site of a company that sells concert tickets and provides a web service that displays upcoming concert dates for various artists, allowing users to buy tickets. By consuming the concert-ticket web service on its site, the online music store can provide an additional service to its customers, increase its site traffic and perhaps earn a commission on concert-ticket sales. The company that sells concert tickets also benefits from the business relationship by selling more tickets and possibly by receiving revenue from the online music store for the use of the web service.

Any Java programmer with a knowledge of web services can write applications that "consume" web services. The resulting applications would invoke web services running on servers that could be thousands of miles away.

NetBeans

NetBeans is one of many tools that enable you to *publish* and/or *consume* web services. We demonstrate how to use NetBeans to implement web services using the JAX-WS and JAX-RS APIs and how to invoke them from client applications. For each example, we provide the web service's code, then present a client application that uses the web service. Our first examples build simple web services and client applications in NetBeans. Then we demon-

strate web services that use more sophisticated features, such as manipulating databases with JDBC and manipulating class objects. For information on downloading and installing the NetBeans and the GlassFish server, see Section 29.1.

31.2 Web Service Basics

The machine on which a web service resides is referred to as a **web service host**. The client application sends a request over a network to the web service host, which processes the request and returns a response over the network to the application. This kind of distributed computing benefits systems in various ways. For example, an application without direct access to data on another system might be able to retrieve the data via a web service. Similarly, an application lacking the processing power to perform specific computations could use a web service to take advantage of another system's superior resources.

In Java, a web service is implemented as a class that resides on a server—it's not part of the client application. Making a web service available to receive client requests is known as **publishing a web service**; using a web service from a client application is known as **consuming a web service**.

31.3 Simple Object Access Protocol (SOAP)

The Simple Object Access Protocol (SOAP) is a platform-independent protocol that uses XML to interact with web services, typically over HTTP. You can view the SOAP specification at www.w3.org/TR/soap/. Each request and response is packaged in a **SOAP message**—XML markup containing the information that a web service requires to process the message. SOAP messages are written in XML so that they're computer readable, human readable and platform independent. Most **firewalls**—security barriers that restrict communication among networks—allow HTTP traffic to pass through, so that clients can browse the web by sending requests to and receiving responses from web servers. Thus, SOAP-based services can send and receive SOAP messages over HTTP connections with few limitations.

SOAP supports an extensive set of types, including the primitive types (e.g., `int`), as well as `Date`, `Time`, `XmlNode` and others. SOAP can also transmit arrays of these types. When a program invokes a method of a SOAP web service, the request and all relevant information are packaged in a SOAP message enclosed in a **SOAP envelope** and sent to the server on which the web service resides. When the web service receives this SOAP message, it parses the XML representing the message, then processes the message's contents. The message specifies the *method* that the client wishes to execute and the *arguments* the client passed to that method. Next, the web service calls the method with the specified arguments (if any) and sends the response back to the client in another SOAP message. The client parses the response to retrieve the method's result. In Section 31.6, you'll build and consume a basic SOAP web service.

31.4 Representational State Transfer (REST)

Representational State Transfer (REST) refers to an architectural style for implementing web services. Such web services are often called **RESTful web services**. Though REST itself is not a standard, RESTful web services are implemented using web standards. Each method in a

RESTful web service is identified by a unique URL. Thus, when the server receives a request, it immediately knows what operation to perform. Such web services can be used in a program or directly from a web browser. The results of a particular operation may be cached locally by the browser when the service is invoked with a GET request. This can make subsequent requests for the same operation faster by loading the result directly from the browser's cache. Amazon's web services (aws.amazon.com) are RESTful, as are many others.

RESTful web services are alternatives to those implemented with SOAP. Unlike SOAP-based web services, the request and response of REST services are not wrapped in envelopes. REST is also not limited to returning data in XML format. It can use a variety of formats, such as XML, JSON, HTML, plain text and media files. In Sections 31.7–31.8, you'll build and consume basic RESTful web services.

31.5 JavaScript Object Notation (JSON)

JavaScript Object Notation (JSON) is an alternative to XML for representing data. JSON is a text-based data-interchange format used to represent objects in JavaScript as collections of name/value pairs represented as Strings. It's commonly used in Ajax applications. JSON is a simple format that makes objects easy to read, create and parse and, because it's much less verbose than XML, allows programs to transmit data efficiently across the Internet. Each JSON object is represented as a list of property names and values contained in curly braces, in the following format:

```
{ propertyName1 : value1, propertyName2 : value2 }
```

Arrays are represented in JSON with square brackets in the following format:

```
[ value1, value2, value3 ]
```

Each value in an array can be a string, a number, a JSON object, true, false or null. To appreciate the simplicity of JSON data, examine this representation of an array of address-book entries:

```
[ { first: 'Cheryl', last: 'Black' },
  { first: 'James', last: 'Blue' },
  { first: 'Mike', last: 'Brown' },
  { first: 'Meg', last: 'Gold' } ]
```

Many programming languages now support the JSON data format. An extensive list of JSON libraries sorted by language can be found at www.json.org.

31.6 Publishing and Consuming SOAP-Based Web Services

This section presents our first example of publishing (enabling for client access) and consuming (using) a web service. We begin with a SOAP-based web service.

31.6.1 Creating a Web Application Project and Adding a Web Service Class in NetBeans

When you create a web service in NetBeans, you focus on its logic and let the IDE and server handle its infrastructure. First you create a **Web Application project**. NetBeans uses this project type for web services that are invoked by other applications.

Creating a Web Application Project in NetBeans

To create a web application, perform the following steps:

1. Select **File > New Project...** to open the **New Project** dialog.
2. Select **Java Web** from the dialog's **Categories** list, then select **Web Application** from the **Projects** list. Click **Next >**.
3. Specify the name of your project (WelcomeSOAP) in the **Project Name** field and specify where you'd like to store the project in the **Project Location** field. You can click the **Browse** button to select the location. Click **Next >**.
4. Select **GlassFish Server 3** from the **Server** drop-down list and **Java EE 6 Web** from the **Java EE Version** drop-down list.
5. Click **Finish** to create the project.

This creates a web application that will run in a web browser, similar to the projects used in Chapters 29 and 30.

Adding a Web Service Class to a Web Application Project

Perform the following steps to add a web service class to the project:

1. In the **Projects** tab in NetBeans, right click the **WelcomeSOAP** project's node and select **New > Web Service...** to open the **New Web Service** dialog.
2. Specify **WelcomeSOAP** in the **Web Service Name** field.
3. Specify **com.deitel.welcomesoap** in the **Package** field.
4. Click **Finish** to create the web service class.

The IDE generates a sample web service class with the name from *Step 2* in the package from *Step 3*. You can find this class in your project's **Web Services** node. In this class, you'll define the methods that your web service makes available to client applications. When you eventually build your application, the IDE will generate other supporting files for your web service.

31.6.2 Defining the WelcomeSOAP Web Service in NetBeans

Figure 31.1 contains the completed `WelcomeSOAPService` code (reformatted to match the coding conventions we use in this book). First we discuss this code, then show how to use the NetBeans web service design view to add the `welcome` method to the class.

```

1 // Fig. 31.1: WelcomeSOAP.java
2 // Web service that returns a welcome message via SOAP.
3 package com.deitel.welcomesoap;
4
5 import javax.jws.WebService; // program uses the annotation @WebService
6 import javax.jws.WebMethod; // program uses the annotation @WebMethod
7 import javax.jws.WebParam; // program uses the annotation @WebParam
8
9 @WebService() // annotates the class as a web service
10 public class WelcomeSOAP
11 {

```

Fig. 31.1 | Web service that returns a welcome message via SOAP. (Part 1 of 2.)

```
12 // WebMethod that returns welcome message
13 @WebMethod( operationName = "welcome" )
14 public String welcome( @WebParam( name = "name" ) String name )
15 {
16     return "Welcome to JAX-WS web services with SOAP, " + name + "!";
17 } // end method welcome
18 } // end class WelcomeSOAP
```

Fig. 31.1 | Web service that returns a welcome message via SOAP. (Part 2 of 2.)

Annotation import Declarations

Lines 5–7 import the annotations used in this example. By default, each new web service class created with the JAX-WS APIs is a POJO (plain old Java object), so you do *not* need to extend a class or implement an interface to create a web service.

@WebService Annotation

Line 9 contains a **@WebService annotation** (imported at line 5) which indicates that class `WelcomeSOAP` implements a web service. The annotation is followed by parentheses that may contain optional annotation attributes. The optional **name attribute** specifies the name of the service endpoint interface class that will be generated for the client. A **service endpoint interface (SEI)** class (sometimes called a **proxy class**) is used to interact with the web service—a client application consumes the web service by invoking methods on the service endpoint interface object. The optional **serviceName attribute** specifies the service name, which is also the name of the class that the client uses to obtain a service endpoint interface object. If the `serviceName` attribute is not specified, the web service's name is assumed to be the Java class name followed by the word `Service`. NetBeans places the `@WebService` annotation at the beginning of each new web service class you create. You can then add the `name` and `serviceName` properties in the parentheses following the annotation.

When you deploy a web application containing a class that uses the `@WebService` annotation, the server (GlassFish in our case) recognizes that the class implements a web service and creates all the **server-side artifacts** that support the web service—that is, the framework that allows the web service to wait for client requests and respond to those requests once it's deployed on an application server. Some popular open-source application servers that support Java web services include GlassFish (glassfish.dev.java.net), Apache Tomcat (tomcat.apache.org) and JBoss Application Server (www.jboss.com/products/platforms/application).

WelcomeSOAP Service's welcome Method

The `WelcomeSOAP` service has only one method, `welcome` (lines 13–17), which takes the user's name as a `String` and returns a `String` containing a welcome message. This method is tagged with the **@WebMethod annotation** to indicate that it can be called remotely. Any methods that are not tagged with `@WebMethod` are *not* accessible to clients that consume the web service. Such methods are typically utility methods within the web service class. The `@WebMethod` annotation uses the **operationName** attribute to specify the method name that is exposed to the web service's client. If the `operationName` is not specified, it's set to the actual Java method's name.



Common Programming Error 31.1

Failing to expose a method as a web method by declaring it with the `@WebMethod` annotation prevents clients of the web service from accessing the method. There's one exception—if none of the class's methods are declared with the `@WebMethod` annotation, then all the `public` methods of the class will be exposed as web methods.



Common Programming Error 31.2

Methods with the `@WebMethod` annotation cannot be `static`. An object of the web service class must exist for a client to access the service's web methods.

The name parameter to `welcome` is annotated with the **@WebParam** annotation (line 14). The optional `@WebParam` attribute **name** indicates the parameter name that is exposed to the web service's clients. If you don't specify the name, the actual parameter name is used.

Completing the Web Service's Code

NetBeans provides a web service design view in which you can define the method(s) and parameter(s) for your web services. To define the `WelcomeSOAP` class's `welcome` method, perform the following steps:

1. In the project's **Web Services** node, double click `WelcomeSOAP` to open the file `WelcomeSOAPService.java` in the code editor.
2. Click the **Design** button at the top of the code editor to show the web service design view (Fig. 31.2).

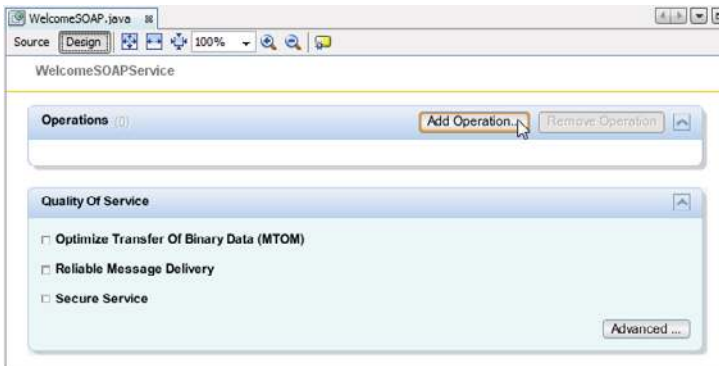

Fig. 31.2 | Web service design view.

3. Click the **Add Operation...** button to display the **Add Operation...** dialog (Fig. 31.3).
4. Specify the method name `welcome` in the **Name** field. The default **Return Type** (`String`) is correct for this example.
5. Add the method's name parameter by clicking the **Add** button to the right of the **Parameters** tab then entering name in the **Name** field. The parameter's default **Type** (`String`) is correct for this example.

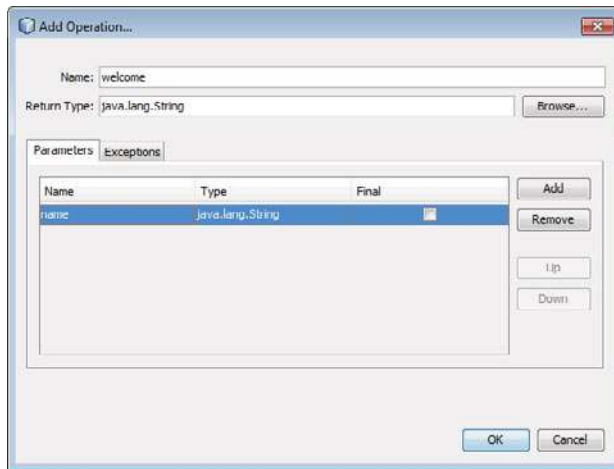

Fig. 31.3 | Adding an operation to a web service.

6. Click **OK** to create the `welcome` method. The design view should now appear as shown in Fig. 31.3.
7. At the top of the design view, click the **Source** button to display the class's source code and add the code line 18 of Fig. 31.1 to the body of method `welcome`.

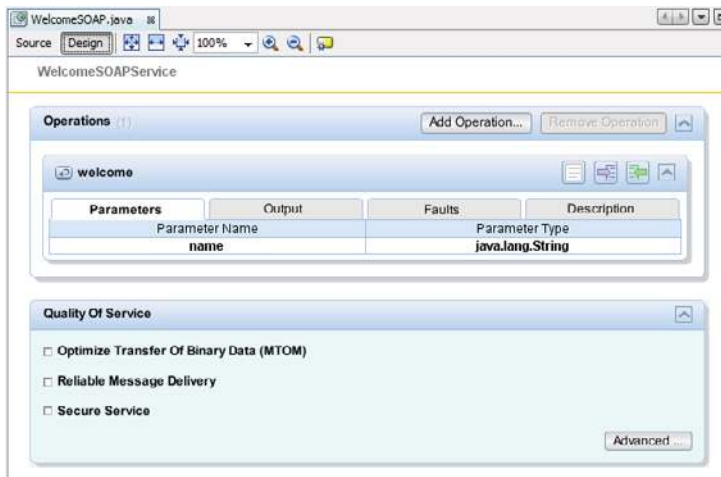

Fig. 31.4 | Web service design view after new operation is added.

31.6.3 Publishing the `WelcomeSOAP` Web Service from NetBeans

Now that you've created the `WelcomeSOAP` web service class, you'll use NetBeans to build and *publish* (that is, deploy) the web service so that clients can consume its services. NetBeans handles all the details of building and deploying a web service for you. This includes

creating the framework required to support the web service. Right click the project name `WelcomeSOAP` in the **Projects** tab and select **Deploy** to build and deploy the web application to the GlassFish server.

31.6.4 Testing the `WelcomeSOAP` Web Service with GlassFish Application Server's Tester Web Page

Next, you'll test the `WelcomeSOAP` web service. We previously selected the GlassFish application server to execute this web application. This server can dynamically create a web page that allows you to test a web service's methods from a web browser. To use this capability:

1. Expand the project's **Web Services** in the NetBeans **Projects** tab.
2. Right click the web service class name (`WelcomeSOAP`) and select **Test Web Service**.

The GlassFish application server builds the Tester web page and loads it into your web browser. Figure 31.5 shows the Tester web page for the `WelcomeSOAP` web service. The web service's name is automatically the class name followed by `Service`.



Fig. 31.5 | Tester web page created by GlassFish for the `WelcomeSOAP` web service.

Once you've deployed the web service, you can also type the URL

```
http://localhost:8080/WelcomeSOAP/WelcomeSOAPService?Tester
```

in your web browser to view the Tester web page. `WelcomeSOAPService` is the name (specified in line 11 of Fig. 31.1) that clients use to access the web service.

To test `WelcomeSOAP`'s `welcome` web method, type your name in the text field to the right of the `welcome` button and click the button to invoke the method. Figure 31.6 shows the results of invoking `WelcomeSOAP`'s `welcome` method with the value `Paul`.

Application Server Note

You can access the web service only when the application server is running. If NetBeans launches GlassFish for you, it will automatically shut it down when you close NetBeans. To keep it up and running, you can launch it independently of NetBeans before you deploy or run web applications. The GlassFish Quick Start Guide at glassfish.java.net/downloads/quickstart/index.html shows how to manually start and stop the server.



Fig. 31.6 | Testing WelcomeSOAP's welcome method.

Testing the WelcomeSOAP Web Service from Another Computer

If your computer is connected to a network and allows HTTP requests, then you can test the web service from another computer on the network by typing the following URL (where *host* is the hostname or IP address of the computer on which the web service is deployed) into a browser on another computer:

```
http://host:8080/WelcomeSOAP/WelcomeSOAPService?Tester
```

31.6.5 Describing a Web Service with the Web Service Description Language (WSDL)

To consume a web service, a client must determine its functionality and how to use it. For this purpose, web services normally contain a **service description**. This is an XML document that conforms to the **Web Service Description Language (WSDL)**—an XML vocabulary that defines the methods a web service makes available and how clients interact with them. The WSDL document also specifies lower-level information that clients might need, such as the required formats for requests and responses.

WSDL documents help applications determine how to interact with the web services described in the documents. You do not need to understand WSDL to take advantage of it—the GlassFish application server generates a web service's WSDL dynamically for you, and client tools can parse the WSDL to help create the client-side service endpoint interface class that a client uses to access the web service. Since GlassFish (and most other servers) generate the WSDL dynamically, clients always receive a deployed web service's most up-to-date description. To access the WelcomeSOAP web service, the client code will need the following WSDL URL:

```
http://localhost:8080/WelcomeSOAP/WelcomeSOAPService?WSDL
```

Accessing the WelcomeSOAP Web Service's WSDL from Another Computer

Eventually, you'll want clients on other computers to use your web service. Such clients need the web service's WSDL, which they would access with the following URL:

```
http://host:8080/WelcomeSOAP/WelcomeSOAPService?WSDL
```

where *host* is the hostname or IP address of the server that hosts the web service. As we discussed in Section 31.6.4, this works only if your computer allows HTTP connections from other computers—as is the case for publicly accessible web and application servers.

31.6.6 Creating a Client to Consume the WelcomeSOAP Web Service

Now you'll consume the web service from a client application. A web service client can be any type of application or even another web service. You enable a client application to consume a web service by **adding a web service reference** to the application.

Service Endpoint Interface (SEI)

An application that consumes a web service consists of an object of a service endpoint interface (SEI) class (sometimes called a *proxy class*) that's used to interact with the web service and a client application that consumes the web service by invoking methods on the service endpoint interface object. The client code invokes methods on the service endpoint interface object, which handles the details of passing method arguments to and receiving return values from the web service on the client's behalf. This communication can occur over a local network, over the Internet or even with a web service on the same computer. The web service performs the corresponding task and returns the results to the service endpoint interface object, which then returns the results to the client code. Figure 31.7 depicts the interactions among the client code, the SEI object and the web service. As you'll soon see, NetBeans creates these service endpoint interface classes for you.

Requests to and responses from web services created with JAX-WS (one of many different web service frameworks) are typically transmitted via SOAP. Any client capable of generating and processing SOAP messages can interact with a web service, regardless of the language in which the web service is written.

We now use NetBeans to create a client Java desktop GUI application. Then you'll add a web service reference to the project so the client can access the web service. When you add the reference, the IDE creates and compiles the **client-side artifacts**—the framework of Java code that supports the client-side service endpoint interface class. The client then calls methods on an object of the service endpoint interface class, which uses the rest of the artifacts to interact with the web service.

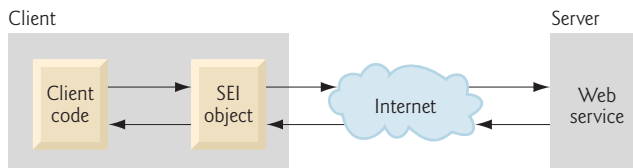

Fig. 31.7 | Interaction between a web service client and a web service.

Creating a Desktop Application Project in NetBeans

Before performing the steps in this section, ensure that the WelcomeSOAP web service has been deployed and that the GlassFish application server is running (see Section 31.6.3). Perform the following steps to create a client Java desktop application in NetBeans:

1. Select **File > New Project...** to open the **New Project** dialog.
2. Select **Java** from the **Categories** list and **Java Application** from the **Projects** list, then click **Next >**.
3. Specify the name `WelcomeSOAPClient` in the **Project Name** field and uncheck the **Create Main Class** checkbox. Later, you'll add a subclass of `JFrame` that contains a main method.
4. Click **Finish** to create the project.

Step 2: Adding a Web Service Reference to an Application

Next, you'll add a web service reference to your application so that it can interact with the `WelcomeSOAP` web service. To add a web service reference, perform the following steps.

1. Right click the project name (`WelcomeSOAPClient`) in the NetBeans **Projects** tab and select **New > Web Service Client...** from the pop-up menu to display the **New Web Service Client** dialog.
2. In the **WSDL URL** field, specify the URL `http://localhost:8080/WelcomeSOAP/WelcomeSOAPService?WSDL` (Fig. 31.8). This URL tells the IDE where to find the web service's WSDL description. [*Note:* If the GlassFish application server is located on a different computer, replace `localhost` with the hostname or IP address of that computer.] The IDE uses this WSDL description to generate the client-side artifacts that compose and support the service endpoint interface.

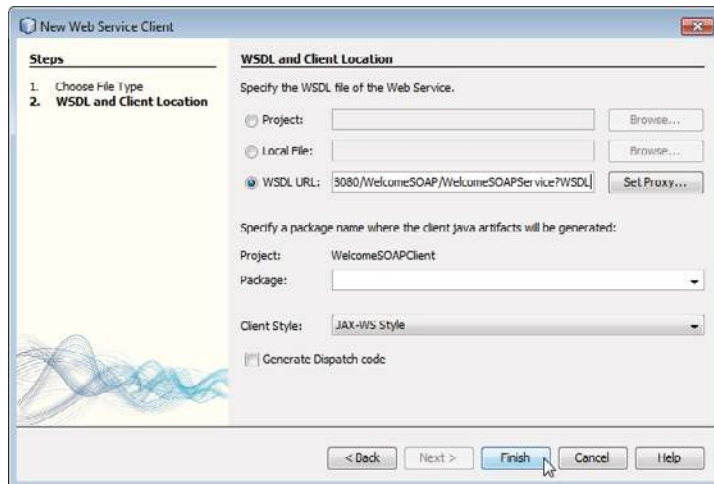

Fig. 31.8 | **New Web Service Client** dialog.

3. For the other options, leave the default settings, then click **Finish** to create the web service reference and dismiss the **New Web Service Client** dialog.

In the NetBeans **Projects** tab, the `WelcomeSOAPClient` project now contains a **Web Service References** folder with the `WelcomeSOAP` web service's service endpoint interface (Fig. 31.9). The service endpoint interface's name is listed as `WelcomeSOAPService`.

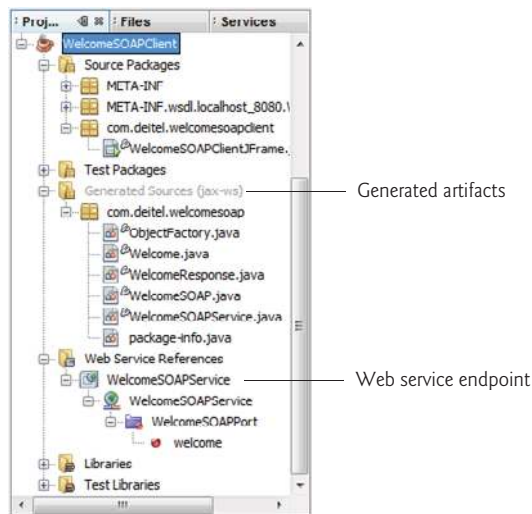

Fig. 31.9 | NetBeans **Project** tab after adding a web service reference to the project.

When you specify the web service you want to consume, NetBeans accesses and copies its WSDL information to a file in your project (named `WelcomeSOAPService.wsdl` in this example). You can view this file by double clicking the `WelcomeSOAPService` node in the project's **Web Service References** folder. If the web service changes, the client-side artifacts and the client's copy of the WSDL file can be regenerated by right clicking the `WelcomeSOAPService` node shown in Fig. 31.9 and selecting **Refresh...** Figure 31.9 also shows the IDE-generated client-side artifacts, which appear in the **Generated Sources (jax-ws)** folder.

31.6.7 Consuming the WelcomeSOAP Web Service

For this example, we use a GUI application¹ to interact with the `WelcomeSOAP` web service. To build the client application's GUI, add a subclass of `JFrame` to the project by performing the following steps:

1. Right click the project name (`WelcomeSOAPClient`) in the NetBeans **Project** tab and select **New > JFrame Form...** to display the **New JFrame Form** dialog.
2. Specify `WelcomeSOAPClientJFrame` in the **Class Name** field.
3. Specify `com.deitel.welcomesoapclient` in the **Package** field.
4. Click **Finish** to close the **New JFrame Form** dialog.

Next, use the NetBeans GUI design tools to build the GUI shown in the sample screen captures at the end of Fig. 31.10. The GUI consists of a **Label**, a **Text Field** and a **Button**.

The application in Fig. 31.10 uses the `WelcomeSOAP` web service to display a welcome message to the user. To save space, we do not show the NetBeans autogenerated `initComponents` method, which contains the code that creates the GUI components, positions

1. We assume you're already familiar with using the NetBeans GUI designer. If not, see Appendix I.

them and registers their event handlers. To view the complete source code, open the `WelcomeSOAPClientJFrame.java` file in this example's folder under `src\java\com\deitel\welcomesoapclient`. NetBeans places the GUI component instance-variable declarations at the end of the class (lines 114–116). Java allows instance variables to be declared anywhere in a class's body as long as they're placed outside the class's methods. We continue to declare our own instance variables at the top of the class.

```

1 // Fig. 31.10: WelcomeSOAPClientJFrame.java
2 // Client desktop application for the WelcomeSOAP web service.
3 package com.deitel.welcomesoapclient;
4
5 import com.deitel.welcomesoap.WelcomeSOAP;
6 import com.deitel.welcomesoap.WelcomeSOAPService;
7 import javax.swing.JOptionPane;
8
9 public class WelcomeSOAPClientJFrame extends javax.swing.JFrame
10 {
11     // references the service endpoint interface object (i.e., the proxy)
12     private WelcomeSOAP welcomeSOAPProxy;
13
14     // no-argument constructor
15     public WelcomeSOAPClientJFrame()
16     {
17         initComponents();
18
19         try
20         {
21             // create the objects for accessing the WelcomeSOAP web service
22             WelcomeSOAPService service = new WelcomeSOAPService();
23             welcomeSOAPProxy = service.getWelcomeSOAPPort();
24         } // end try
25         catch ( Exception exception )
26         {
27             exception.printStackTrace();
28             System.exit( 1 );
29         } // end catch
30     } // end WelcomeSOAPClientJFrame constructor
31
32     // The initComponents method is autogenerated by NetBeans and is called
33     // from the constructor to initialize the GUI. This method is not shown
34     // here to save space. Open WelcomeSOAPClientJFrame.java in this
35     // example's folder to view the complete generated code.
36
37     // call the web service with the supplied name and display the message
38     private void submitJButtonActionPerformed(
39         java.awt.event.ActionEvent evt )
40     {
41         String name = nameJTextField.getText(); // get name from JTextField
42
43         // retrieve the welcome string from the web service
44         String message = welcomeSOAPProxy.welcome( name );

```

Fig. 31.10 | Client desktop application for the WelcomeSOAP web service. (Part I of 2.)

```

95     JOptionPane.showMessageDialog( this, message,
96         "Welcome", JOptionPane.INFORMATION_MESSAGE );
97 } // end method submitJButtonActionPerformed
98
99 // main method begins execution
100 public static void main( String args[] )
101 {
102     java.awt.EventQueue.invokeLater(
103         new Runnable()
104         {
105             public void run()
106             {
107                 new WelcomeSOAPClientJFrame().setVisible( true );
108             } // end method run
109         } // end anonymous inner class
110     ); // end call to java.awt.EventQueue.invokeLater
111 } // end main
112
113 // Variables declaration - do not modify
114 private javax.swing.JLabel nameJLabel;
115 private javax.swing.JTextField nameJTextField;
116 private javax.swing.JButton submitJButton;
117 // End of variables declaration
118 } // end class WelcomeSOAPClientJFrame

```



Fig. 31.10 | Client desktop application for the WelcomeSOAP web service. (Part 2 of 2.)

Lines 5–6 import the classes `WelcomeSOAP` and `WelcomeSOAPService` that enable the client application to interact with the web service. Notice that we do not have import declarations for most of the GUI components used in this example. When you create a GUI in NetBeans, it uses fully qualified class names (such as `javax.swing.JFrame` in line 9), so import declarations are unnecessary.

Line 12 declares a variable of type `WelcomeSOAP` that will refer to the service endpoint interface object. Line 22 in the constructor creates an object of type `WelcomeSOAPService`. Line 23 uses this object's `getWelcomeSOAPPort` method to obtain the `WelcomeSOAP` service endpoint interface object that the application uses to invoke the web service's methods.

The event handler for the **Submit** button (lines 88–97) first retrieves the name the user entered from `nameJTextField`. It then calls the `welcome` method on the service endpoint interface object (line 94) to retrieve the welcome message from the web service. This object communicates with the web service on the client's behalf. Once the message has been retrieved, lines 95–96 display it in a message box by calling `JOptionPane`'s `showMessageDialog` method.

31.7 Publishing and Consuming REST-Based XML Web Services

The previous section used a service endpoint interface (proxy) object to pass data to and from a Java web service using the SOAP protocol. Now, we access a Java web service using the REST architecture. We recreate the `WelcomeSOAP` example to return data in plain XML format. You can create a **Web Application** project as you did in Section 31.6 to begin. Name the project `WelcomeRESTXML`.

31.7.1 Creating a REST-Based XML Web Service

NetBeans provides various templates for creating RESTful web services, including ones that can interact with databases on the client's behalf. In this chapter, we focus on simple RESTful web services. To create a RESTful web service:

1. Right-click the `WelcomeRESTXML` node in the **Projects** tab, and select **New > Other...** to display the **New File** dialog.
2. Select **Web Services** under **Categories**, then select **RESTful Web Services** from **Patterns** and click **Next >**.
3. Under **Select Pattern**, ensure **Simple Root Resource** is selected, and click **Next >**.
4. Set the **Resource Package** to `com.deitel.welcomerestxml`, the **Path** to `welcome` and the **Class Name** to `WelcomeRESTXMLResource`. Leave the **MIME Type** and **Representation Class** set to `application/xml` and `java.lang.String`, respectively. The correct configuration is shown in Fig. 31.11.
5. Click **Finish** to create the web service.

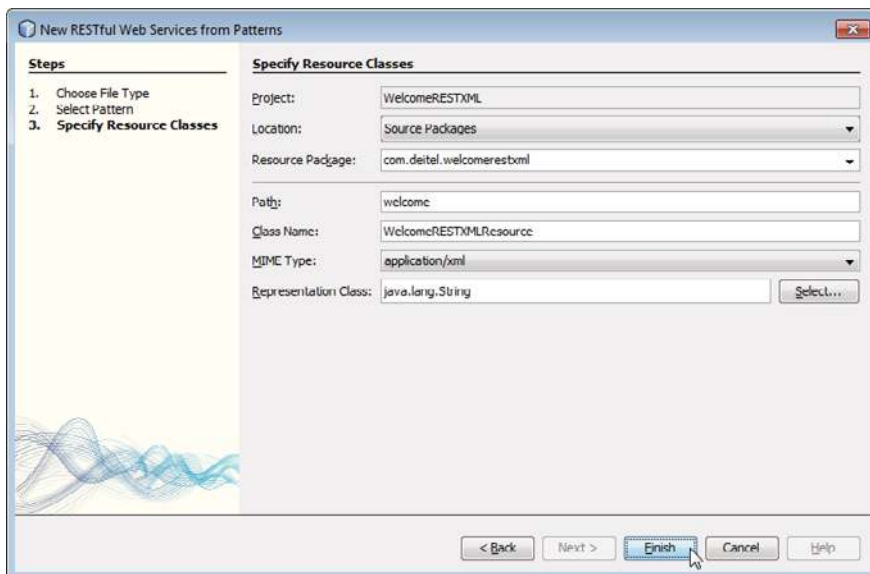

Fig. 31.11 | Creating the `WelcomeRESTXML` RESTful web service.

NetBeans generates the class and sets up the proper annotations. The class is placed in the project's **RESTful Web Services** folder. The code for the completed service is shown in Fig. 31.12. You'll notice that the completed code does not include some of the code generated by NetBeans. We removed the pieces that were unnecessary for this simple web service. The autogenerated `putXml` method is not necessary, because this example does not modify state on the server. The `UriInfo` instance variable is not needed, because we do not use HTTP query parameters. We also removed the autogenerated constructor, because we have no code to place in it.

```

1 // Fig. 31.12: WelcomeRESTXMLResource.java
2 // REST web service that returns a welcome message as XML.
3 package com.deitel.welcomerestxml;
4
5 import java.io.StringWriter;
6 import javax.ws.rs.GET; // annotation to indicate method uses HTTP GET
7 import javax.ws.rs.Path; // annotation to specify path of resource
8 import javax.ws.rs.PathParam; // annotation to get parameters from URI
9 import javax.ws.rs.Produces; // annotation to specify type of data
10 import javax.xml.bind.JAXB; // utility class for common JAXB operations
11
12 @Path( "welcome" ) // URI used to access the resource
13 public class WelcomeRESTXMLResource
14 {
15     // retrieve welcome message
16     @GET // handles HTTP GET requests
17     @Path( "{name}" ) // URI component containing parameter
18     @Produces( "application/xml" ) // response formatted as XML
19     public String getXml( @PathParam( "name" ) String name )
20     {
21         String message = "Welcome to JAX-RS web services with REST and " +
22             "XML, " + name + "!"; // our welcome message
23         StringWriter writer = new StringWriter();
24         JAXB.marshal( message, writer ); // marshal String as XML
25         return writer.toString(); // return XML as String
26     } // end method getXml
27 } // end class WelcomeRESTXMLResource

```

Fig. 31.12 | REST web service that returns a welcome message as XML.

Lines 6–9 contain the imports for the JAX-RS annotations that help define the RESTful web service. The **@Path annotation** on the `WelcomeRESTXMLResource` class (line 12) indicates the URI for accessing the web service. This URI is appended to the web application project's URL to invoke the service. Methods of the class can also use the `@Path` annotation (line 17). Parts of the path specified in curly braces indicate parameters—they're placeholders for values that are passed to the web service as part of the path. The base path for the service is the project's resources directory. For example, to get a welcome message for someone named John, the complete URL is

```
http://localhost:8080/WelcomeRESTXML/resources/welcome/John
```

Arguments in a URL can be used as arguments to a web service method. To do so, you bind the parameters specified in the `@Path` specification to parameters of the web service

method with the **@PathParam** annotation, as shown in line 19. When the request is received, the server passes the argument(s) in the URL to the appropriate parameter(s) in the web service method.

The **@GET** annotation denotes that this method is accessed via an HTTP GET request. The `putXml` method the IDE created for us had an **@PUT** annotation, which indicates that the method is accessed using the HTTP PUT method. Similar annotations exist for HTTP POST, DELETE and HEAD requests.

The **@Produces** annotation denotes the content type returned to the client. It's possible to have multiple methods with the same HTTP method and path but different **@Produces** annotations, and JAX-RS will call the method matching the content type requested by the client. Standard Java method overloading rules apply, so such methods must have different names. The **@Consumes** annotation for the autogenerated `putXml` method (which we deleted) restricts the content type that the web service will accept from a PUT operation.

Line 10 imports the **JAXB** class from package `javax.xml.bind`. **JAXB (Java Architecture for XML Binding)** is a set of classes for converting POJOs to and from XML. There are many related classes in the same package that implement the serializations we perform, but the JAXB class contains easy-to-use wrappers for common operations. After creating the welcome message (lines 21–22), we create a `StringWriter` (line 23) to which JAXB will output the XML. Line 24 calls the JAXB class's static method **marshal** to convert the `String` containing our message to XML format. Line 25 calls `StringWriter`'s `toString` method to retrieve the XML text to return to the client.

Testing RESTful Web Services

Section 31.6.4 demonstrated testing a SOAP service using GlassFish's Tester page. GlassFish does not provide a testing facility for RESTful services, but NetBeans automatically generates a test page that can be accessed by right clicking the **WelcomeRESTXML** node in the **Projects** tab and selecting **Test RESTful Web Services**. This will compile and deploy the web service, if you have not yet done so, then open the test page. Your browser will probably require you to acknowledge a potential security issue before allowing the test page to perform its tasks. The test page is loaded from your computer's local file system, *not* the GlassFish server. Browsers consider the local file system and GlassFish as two different servers, even though they're both on the local computer. For security reasons, browsers do not allow so-called cross-site scripting in which a web page tries to interact with a server other than the one that served the page.

On the test page (Fig. 31.13), expand the **welcome** element in the left column and select **{name}**. The form on the right side of the page allows you to choose the MIME type of the data (`application/xml` by default) and lets you enter the name parameter's value. Click the **Test** button to invoke the web service and display the returned XML.



Error-Prevention Tip 31.1

At the time of this writing, the test page did not work in Google's Chrome web browser. If this is your default web browser, copy the test page's URL from Chrome's address field and paste it into another web browser's address field. Fig. 31.13 shows the test page in Mozilla Firefox.

The test page shows several tabs containing the results and various other information. The **Raw View** tab shows the actual XML response. The **Headers** tab shows the HTTP

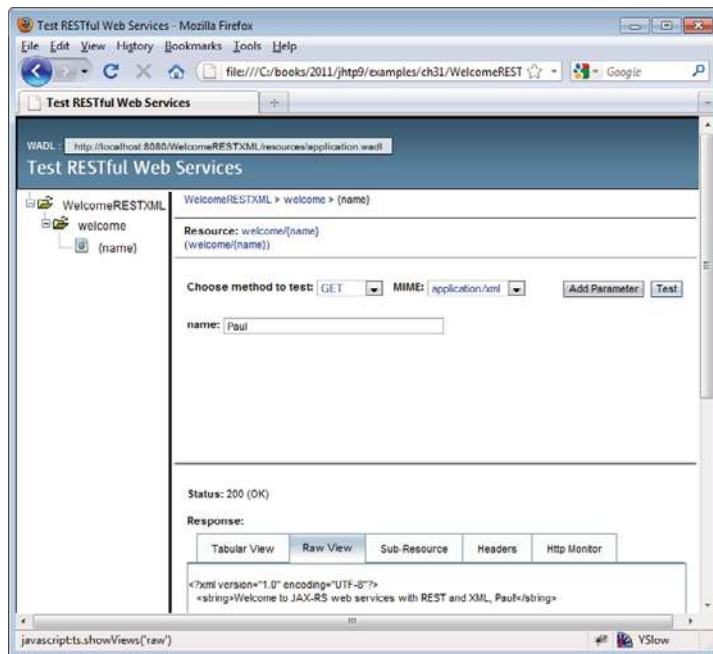

Fig. 31.13 | Test page for the WelcomeRESTXML web service.

headers returned by the server. The **Http Monitor** tab shows a log of the HTTP transactions that took place to complete the request and response. The **Sub-Resource** tab shows the actual URL that was used to invoke the web service

```
http://localhost:8080/WelcomeRESTXML/resources/welcome/Paul
```

You can enter this URL in any browser on your computer to invoke the web service with the value Paul.

The test page provides its functionality by reading a WADL file from the server—you can see the URL of the WADL file in the upper-left corner of the test page. **WADL (Web Application Description Language)** has similar design goals to WSDL, but describes RESTful services instead of SOAP services.

31.7.2 Consuming a REST-Based XML Web Service

As we did with SOAP, we create a Java application that retrieves the welcome message from the web service and displays it to the user. First, create a Java application with the name `WelcomeRESTXMLClient`. RESTful web services do *not* require web service references, so you can begin building the GUI immediately by creating a `JFrame` form called `WelcomeRESTXMLClientJFrame` and placing it in the `com.deitel.welcomerestxmlclient` package. The GUI is identical to the one in Fig. 31.10, including the names of the GUI elements. To create the GUI quickly, you can simply copy and paste the GUI from the **Design** view of the `WelcomeSOAPClientJFrame` class and paste it into the **Design** view of the `WelcomeRESTXMLClientJFrame` class. Figure 31.14 contains the completed code.

```
1 // Fig. 31.14: WelcomeRESTXMLClientJFrame.java
2 // Client that consumes the WelcomeRESTXML service.
3 package com.deitel.welcomerestxmlclient;
4
5 import javax.swing.JOptionPane;
6 import javax.xml.bind.JAXB; // utility class for common JAXB operations
7
8 public class WelcomeRESTXMLClientJFrame extends javax.swing.JFrame
9 {
10     // no-argument constructor
11     public WelcomeRESTXMLClientJFrame()
12     {
13         initComponents();
14     } // end constructor
15
16     // The initComponents method is autogenerated by NetBeans and is called
17     // from the constructor to initialize the GUI. This method is not shown
18     // here to save space. Open WelcomeRESTXMLClientJFrame.java in this
19     // example's folder to view the complete generated code.
20
21     // call the web service with the supplied name and display the message
22     private void submitJButtonActionPerformed(
23         java.awt.event.ActionEvent evt)
24     {
25         String name = nameJTextField.getText(); // get name from JTextField
26
27         // the URL for the REST service
28         String url =
29             "http://localhost:8080/WelcomeRESTXML/resources/welcome/" + name;
30
31         // read from URL and convert from XML to Java String
32         String message = JAXB.unmarshal( url, String.class );
33
34         // display the message to the user
35         JOptionPane.showMessageDialog( this, message,
36             "Welcome", JOptionPane.INFORMATION_MESSAGE );
37     } // end method submitJButtonActionPerformed
38
39     // main method begins execution
40     public static void main( String args[] )
41     {
42         java.awt.EventQueue.invokeLater(
43             new Runnable()
44             {
45                 public void run()
46                 {
47                     new WelcomeRESTXMLClientJFrame().setVisible( true );
48                 } // end method run
49             } // end anonymous inner class
50         ); // end call to java.awt.EventQueue.invokeLater
51     } // end main
52
```

Fig. 31.14 | Client that consumes the WelcomeRESTXML service. (Part 1 of 2.)

```

103 // Variables declaration - do not modify
104 private javax.swing.JLabel nameJLabel;
105 private javax.swing.JTextField nameJTextField;
106 private javax.swing.JButton submitJButton;
107 // End of variables declaration
108 } // end class WelcomeRESTXMLClientJFrame

```



Fig. 31.14 | Client that consumes the `WelcomeRESTXML` service. (Part 2 of 2.)

You can access a RESTful web service with classes from Java API. As in the RESTful XML web service, we use the JAXB library. The JAXB class (imported on line 6) has a static `unmarshal` method that takes as arguments a file name or URL as a `String`, and a `Class<T>` object indicating the Java class to which the XML will be converted (line 82). In this example, the XML contains a `String` object, so we use the Java compiler shortcut `String.class` to create the `Class<String>` object we need as the second argument. The `String` returned from the call to the `unmarshal` method is then displayed to the user via `JOptionPane`'s `showMessageDialog` method (lines 85–86), as it was with the SOAP service. The URL used in this example to extract data from the web service matches the URL used by the test page.

31.8 Publishing and Consuming REST-Based JSON Web Services

While XML was designed primarily as a document interchange format, JSON is designed as a *data* exchange format. Data structures in most programming languages do not map directly to XML constructs—for example, the distinction between elements and attributes is not present in programming-language data structures. JSON is a subset of the JavaScript programming language, and its components—objects, arrays, strings, numbers—can be easily mapped to constructs in Java and other programming languages.

The standard Java libraries do not currently provide capabilities for working with JSON, but there are many open-source JSON libraries for Java and other languages; you can find a list of them at json.org. We chose the Gson library from code.google.com/p/google-gson/, which provides a simple way to convert POJOs to and from JSON.

31.8.1 Creating a REST-Based JSON Web Service

To begin, create a `WelcomeRESTJSON` web application, then create the web service by following the steps in Section 31.7.1. In *Step 4*, change the **Resource Package** to `com.deitel.welcomestjson`, the **Class Name** to `WelcomeRESTJSONResource` and the **MIME Type** to `application/json`. Additionally, you must download the Gson library's

JAR file, then add it to the project as a library. To do so, right click your project's **Libraries** folder, select **Add JAR/Folder...** locate the downloaded Gson JAR file and click **Open**. The complete code for the service is shown in Fig. 31.15.

```

1 // Fig. 31.15: WelcomeRESTJSONResource.java
2 // REST web service that returns a welcome message as JSON.
3 package com.deitel.welcomerestjson;
4
5 import com.google.gson.Gson; // converts POJO to JSON and back again
6 import javax.ws.rs.GET; // annotation to indicate method uses HTTP GET
7 import javax.ws.rs.Path; // annotation to specify path of resource
8 import javax.ws.rs.PathParam; // annotation to get parameters from URI
9 import javax.ws.rs.Produces; // annotation to specify type of data
10
11 @Path( "welcome" ) // path used to access the resource
12 public class WelcomeRESTJSONResource
13 {
14     // retrieve welcome message
15     @GET // handles HTTP GET requests
16     @Path( "{name}" ) // takes name as a path parameter
17     @Produces( "application/json" ) // response formatted as JSON
18     public String getJson( @PathParam( "name" ) String name )
19     {
20         // add welcome message to field of TextMessage object
21         TextMessage message = new TextMessage(); // create wrapper object
22         message.setMessage( String.format( "%s, %s!",
23             "Welcome to JAX-RS web services with REST and JSON", name ) );
24
25         return new Gson().toJson( message ); // return JSON-wrapped message
26     } // end method getJson
27 } // end class WelcomeRESTJSONResource
28
29 // private class that contains the message we wish to send
30 class TextMessage
31 {
32     private String message; // message we're sending
33
34     // returns the message
35     public String getMessage()
36     {
37         return message;
38     } // end method getMessage
39
40     // sets the message
41     public void setMessage( String value )
42     {
43         message = value;
44     } // end method setMessage
45 } // end class TextMessage

```

Fig. 31.15 | REST web service that returns a welcome message as JSON.

All the annotations and the basic structure of the `WelcomeRESTJSONResource` class are the same as REST XML example. The argument to the `@Produces` attribute (line 17) is

"application/json". The `TextMessage` class (lines 30–45) addresses a difference between JSON and XML. JSON does not permit strings or numbers to stand on their own—they must be encapsulated in a composite data type. So, we created class `TextMessage` to encapsulate the `String` representing the message.

When a client invokes this web service, line 21 creates the `TextMessage` object, then lines 22–23 set its contained message. Next, line 25 creates a `Gson` object (from package `com.google.gson.Gson`) and calls its `toJson` method to convert the `TextMessage` into its JSON `String` representation. We return this `String`, which is then sent back to the client in the web service's response. There are multiple overloads of the `toJson` method, such as one that sends its output to a `Writer` instead of returning a `String`.

RESTful services returning JSON can be tested in the same way as those returning XML. Follow the procedure outlined in Section 31.7.1, but be sure to change the MIME type to `application/json` in the test web page; otherwise, the web service will return an error stating that it cannot produce the desired response.

31.8.2 Consuming a REST-Based JSON Web Service

We now create a Java application that retrieves the welcome message from the web service and displays it to the user. First, create a Java application with the name `WelcomeRESTJSONClient`. Then, create a `JFrame` form called `WelcomeRESTXMLClientJFrame` and place it in the `com.deitel.welcomerestjsonclient` package. The GUI is identical to the one in Fig. 31.10. To create the GUI quickly, copy it from the **Design** view of the `WelcomeSOAPClientJFrame` class and paste it into the **Design** view of the `WelcomeRESTJSONClientJFrame` class. Figure 31.16 contains the completed code.

```

1 // Fig. 31.16: WelcomeRESTJSONClientJFrame.java
2 // Client that consumes the WelcomeRESTJSON service.
3 package com.deitel.welcomerestjsonclient;
4
5 import com.google.gson.Gson; // converts POJO to JSON and back again
6 import java.io.InputStreamReader;
7 import java.net.URL;
8 import javax.swing.JOptionPane;
9
10 public class WelcomeRESTJSONClientJFrame extends javax.swing.JFrame
11 {
12     // no-argument constructor
13     public WelcomeRESTJSONClientJFrame()
14     {
15         initComponents();
16     } // end constructor
17
18     // The initComponents method is autogenerated by NetBeans and is called
19     // from the constructor to initialize the GUI. This method is not shown
20     // here to save space. Open WelcomeRESTJSONClientJFrame.java in this
21     // example's folder to view the complete generated code.
22

```

Fig. 31.16 | Client that consumes the `WelcomeRESTJSON` service. (Part 1 of 3.)

```

23 // call the web service with the supplied name and display the message
24 private void submitJButtonActionPerformed(
25     java.awt.event.ActionEvent evt )
26 {
27     String name = nameJTextField.getText(); // get name from JTextField
28
29     // retrieve the welcome string from the web service
30     try
31     {
32         // the URL of the web service
33         String url = "http://localhost:8080/WelcomeRESTJSON/" +
34             "resources/welcome/" + name;
35
36         // open URL, using a Reader to convert bytes to chars
37         InputStreamReader reader =
38             new InputStreamReader( new URL( url ).openStream() );
39
40         // parse the JSON back into a TextMessage
41         TextMessage message =
42             new Gson().fromJson( reader, TextMessage.class );
43
44         // display message to the user
45         JOptionPane.showMessageDialog( this, message.getMessage(),
46             "Welcome", JOptionPane.INFORMATION_MESSAGE );
47     } // end try
48     catch ( Exception exception )
49     {
50         exception.printStackTrace(); // show exception details
51     } // end catch
52 } // end method submitJButtonActionPerformed
53
54 // main method begin execution
55 public static void main( String args[] )
56 {
57     java.awt.EventQueue.invokeLater(
58         new Runnable()
59         {
60             public void run()
61             {
62                 new WelcomeRESTJSONClientJFrame().setVisible( true );
63             } // end method run
64         } // end anonymous inner class
65     ); // end call to java.awt.EventQueue.invokeLater
66 } // end main
67
68 // Variables declaration - do not modify
69 private javax.swing.JLabel nameJLabel;
70 private javax.swing.JTextField nameJTextField;
71 private javax.swing.JButton submitJButton;
72 // End of variables declaration
73 } // end class WelcomeRESTJSONClientJFrame
74

```

Fig. 31.16 | Client that consumes the WelcomeRESTJSON service. (Part 2 of 3.)

```
75 // private class that contains the message we are receiving
76 class TextMessage
77 {
78     private String message; // message we're receiving
79
80     // returns the message
81     public String getMessage()
82     {
83         return message;
84     } // end method getMessage
85
86     // sets the message
87     public void setMessage( String value )
88     {
89         message = value;
90     } // end method setMessage
91 } // end class TextMessage
```

Fig. 31.16 | Client that consumes the WelcomeRESTJSON service. (Part 3 of 3.)

Lines 83–84 create the URL String that is used to invoke the web service. Lines 87–88 create a URL object using this String, then call the URL’s `openStream` method to invoke the web service and obtain an `InputStream` from which the client can read the response. The `InputStream` is wrapped in an `InputStreamReader` so it can be passed as the first argument to the `Gson` class’s `fromJson` method. This method is overloaded. The version we use takes as arguments a `Reader` from which to read a JSON String and a `Class<T>` object indicating the Java class to which the JSON String will be converted (line 92). In this example, the JSON String contains a `TextMessage` object, so we use the Java compiler shortcut `TextMessage.class` to create the `Class<TextMessage>` object we need as the second argument. Lines 95–96 display the message in the `TextMessage` object.

The `TextMessage` classes in the web service and client are unrelated. Technically, the client can be written in any programming language, so the manner in which a response is processed can vary greatly. Since our client is written in Java, we duplicated the `TextMessage` class in the client so we could easily convert the JSON object back to Java.

31.9 Session Tracking in a SOAP Web Service

Section 29.8 described the advantages of using session tracking to maintain client-state information so you can personalize the users’ browsing experiences. Now we’ll incorporate *session tracking* into a web service. Suppose a client application needs to call several methods from the same web service, possibly several times each. In such a case, it can be beneficial for the web service to maintain state information for the client, thus eliminating the need for client information to be passed between the client and the web service multiple times. For example, a web service that provides local restaurant reviews could store the client user’s street address during the initial request, then use it to return personalized, localized results in subsequent requests. Storing session information also enables a web service to distinguish between clients.

31.9.1 Creating a Blackjack Web Service

Our next example is a web service that assists you in developing a blackjack card game. The `Blackjack` web service (Fig. 31.17) provides web methods to shuffle a deck of cards, deal a card from the deck and evaluate a hand of cards. After presenting the web service, we use it to serve as the dealer for a game of blackjack (Fig. 31.18). The `Blackjack` web service uses an `HttpSession` object to maintain a unique deck of cards for each client application. Several clients can use the service at the same time, but web method calls made by a specific client use only the deck of cards stored in that client's session. Our example uses the following blackjack rules:

Two cards each are dealt to the dealer and the player. The player's cards are dealt face up. Only the first of the dealer's cards is dealt face up. Each card has a value. A card numbered 2 through 10 is worth its face value. Jacks, queens and kings each count as 10. Aces can count as 1 or 11—whichever value is more beneficial to the player (as we'll soon see). If the sum of the player's two initial cards is 21 (i.e., the player was dealt a card valued at 10 and an ace, which counts as 11 in this situation), the player has "blackjack" and immediately wins the game—if the dealer does not also have blackjack (which would result in a "push"—i.e., a tie). Otherwise, the player can begin taking additional cards one at a time. These cards are dealt face up, and the player decides when to stop taking cards. If the player "busts" (i.e., the sum of the player's cards exceeds 21), the game is over, and the player loses. When the player is satisfied with the current set of cards, the player "stands" (i.e., stops taking cards), and the dealer's hidden card is revealed. If the dealer's total is 16 or less, the dealer must take another card; otherwise, the dealer must stand. The dealer must continue taking cards until the sum of the dealer's cards is greater than or equal to 17. If the dealer exceeds 21, the player wins. Otherwise, the hand with the higher point total wins. If the dealer and the player have the same point total, the game is a "push," and no one wins. The value of an ace for a dealer depends on the dealer's other card(s) and the casino's house rules. A dealer typically must hit for totals of 16 or less and must stand for totals of 17 or more. However, for a "soft 17"—a hand with a total of 17 with one ace counted as 11—some casinos require the dealer to hit and some require the dealer to stand (we require the dealer to stand). Such a hand is known as a "soft 17" because taking another card cannot bust the hand.

The web service (Fig. 31.17) stores each card as a `String` consisting of a number, 1–13, representing the card's face (ace through king, respectively), followed by a space and a digit, 0–3, representing the card's suit (hearts, diamonds, clubs or spades, respectively). For example, the jack of clubs is represented as "11 2" and the two of hearts as "2 0". To create and deploy this web service, follow the steps that we presented in Sections 31.6.2–31.6.3 for the `WelcomeSOAP` service.

```
1 // Fig. 31.17: Blackjack.java
2 // Blackjack web service that deals cards and evaluates hands
3 package com.deitel.blackjack;
4
5 import com.sun.xml.ws.developer.servlet.HttpSessionScope;
6 import java.util.ArrayList;
7 import java.util.Random;
```

Fig. 31.17 | Blackjack web service that deals cards and evaluates hands. (Part 1 of 3.)

```

8 import javax.jws.WebMethod;
9 import javax.jws.WebParam;
10 import javax.jws.WebService;
11
12 @HttpSessionScope // enable web service to maintain session state
13 @WebService()
14 public class Blackjack
15 {
16     private ArrayList< String > deck; // deck of cards for one user session
17     private static final Random randomObject = new Random();
18
19     // deal one card
20     @WebMethod( operationName = "dealCard" )
21     public String dealCard()
22     {
23         String card = "";
24         card = deck.get( 0 ); // get top card of deck
25         deck.remove( 0 ); // remove top card of deck
26         return card;
27     } // end WebMethod dealCard
28
29     // shuffle the deck
30     @WebMethod( operationName = "shuffle" )
31     public void shuffle()
32     {
33         // create new deck when shuffle is called
34         deck = new ArrayList< String >();
35
36         // populate deck of cards
37         for ( int face = 1; face <= 13; face++ ) // loop through faces
38             for ( int suit = 0; suit <= 3; suit++ ) // loop through suits
39                 deck.add( face + " " + suit ); // add each card to deck
40
41         String tempCard; // holds card temporarily during swapping
42         int index; // index of randomly selected card
43
44         for ( int i = 0; i < deck.size(); i++ ) // shuffle
45         {
46             index = randomObject.nextInt( deck.size() - 1 );
47
48             // swap card at position i with randomly selected card
49             tempCard = deck.get( i );
50             deck.set( i, deck.get( index ) );
51             deck.set( index, tempCard );
52         } // end for
53     } // end WebMethod shuffle
54
55     // determine a hand's value
56     @WebMethod( operationName = "getHandValue" )
57     public int getHandValue( @WebParam( name = "hand" ) String hand )
58     {
59         // split hand into cards
60         String[] cards = hand.split( "\\t" );

```

Fig. 31.17 | Blackjack web service that deals cards and evaluates hands. (Part 2 of 3.)

```

61     int total = 0; // total value of cards in hand
62     int face; // face of current card
63     int aceCount = 0; // number of aces in hand
64
65     for ( int i = 0; i < cards.length; i++ )
66     {
67         // parse string and get first int in String
68         face = Integer.parseInt(
69             cards[ i ].substring( 0, cards[ i ].indexOf( " " ) ) );
70
71         switch ( face )
72         {
73             case 1: // if ace, increment aceCount
74                 ++aceCount;
75                 break;
76             case 11: // jack
77             case 12: // queen
78             case 13: // king
79                 total += 10;
80                 break;
81             default: // otherwise, add face
82                 total += face;
83                 break;
84         } // end switch
85     } // end for
86
87     // calculate optimal use of aces
88     if ( aceCount > 0 )
89     {
90         // if possible, count one ace as 11
91         if ( total + 11 + aceCount - 1 <= 21 )
92             total += 11 + aceCount - 1;
93         else // otherwise, count all aces as 1
94             total += aceCount;
95     } // end if
96
97     return total;
98 } // end WebMethod getHandValue
99 } // end class Blackjack

```

Fig. 31.17 | Blackjack web service that deals cards and evaluates hands. (Part 3 of 3.)

Session Tracking in Web Services: @HttpSessionScope Annotation

In JAX-WS 2.2, it's easy to enable session tracking in a web service. You simply precede your web service class with the **@HttpSessionScope** annotation. This annotation is located in package `com.sun.xml.ws.developer.servlet`. To use this package you must add the JAX-WS 2.2 library to your project. To do so, right click the **Libraries** node in your Blackjack web application project and select **Add Library...** Then, in the dialog that appears, locate and select **JAX-WS 2.2**, then click **Add Library**. Once a web service is annotated with `@HttpSessionScope`, the server automatically maintains a separate instance of the class for each client session. Thus, the deck instance variable (line 16) will be maintained separately for each client.

Client Interactions with the Blackjack Web Service

A client first calls the `Blackjack` web service's `shuffle` web method (lines 30–53) to create a new deck of cards (line 34), populate it (lines 37–39) and shuffle it (lines 41–52). Lines 37–39 generate `String`s in the form "*face suit*" to represent each possible card in the deck.

Lines 20–27 define the `dealCard` web method. Method `shuffle` *must* be called before method `dealCard` is called the first time for a client—otherwise, `deck` could be `null`. The method gets the top card from the deck (line 24), removes it from the deck (line 25) and returns the card's value as a `String` (line 26). Without using session tracking, the deck of cards would need to be passed back and forth with each method call. Session tracking makes the `dealCard` method easy to call (it requires no arguments) and eliminates the overhead of sending the deck over the network multiple times.

Method `getHandValue` (lines 56–98) determines the total value of the cards in a hand by trying to attain the highest score possible without going over 21. Recall that an ace can be counted as either 1 or 11, and all face cards count as 10. This method does not use the `session` object, because the deck of cards is not used in this method.

As you'll soon see, the client application maintains a hand of cards as a `String` in which each card is separated by a tab character. Line 60 splits the hand of cards (represented by `hand`) into individual cards by calling `String` method `split` and passing to it a `String` containing the delimiter characters (in this case, just a tab). Method `split` uses the delimiter characters to separate tokens in the `String`. Lines 65–85 count the value of each card. Lines 68–69 retrieve the first integer—the face—and use that value in the `switch` statement (lines 71–84). If the card is an ace, the method increments variable `aceCount`. We discuss how this variable is used shortly. If the card is an 11, 12 or 13 (jack, queen or king), the method adds 10 to the total value of the hand (line 79). If the card is anything else, the method increases the total by that value (line 82).

Because an ace can have either of two values, additional logic is required to process aces. Lines 88–95 process the aces after all the other cards. If a hand contains several aces, only one ace can be counted as 11. The condition in line 91 determines whether counting one ace as 11 and the rest as 1 will result in a total that does not exceed 21. If this is possible, line 92 adjusts the total accordingly. Otherwise, line 94 adjusts the total, counting each ace as 1.

Method `getHandValue` maximizes the value of the current cards without exceeding 21. Imagine, for example, that the dealer has a 7 and receives an ace. The new total could be either 8 or 18. However, `getHandValue` always maximizes the value of the cards without going over 21, so the new total is 18.

31.9.2 Consuming the Blackjack Web Service

The blackjack application in Fig. 31.18 keeps track of the player's and dealer's cards, and the web service tracks the cards that have been dealt. The constructor (lines 34–83) sets up the GUI (line 36), changes the window's background color (line 40) and creates the `Blackjack` web service's service endpoint interface object (lines 46–47). In the GUI, each player has 11 `JLabels`—the maximum number of cards that can be dealt without automatically exceeding 21 (i.e., four aces, four twos and three threes). These `JLabels` are placed in an `ArrayList` of `JLabels` (lines 59–82), so we can index the `ArrayList` during the game to determine the `JLabel` that will display a particular card image.

```
1 // Fig. 31.18: BlackjackGameJFrame.java
2 // Blackjack game that uses the Blackjack Web Service.
3 package com.deitel.blackjackclient;
4
5 import com.deitel.blackjack.Blackjack;
6 import com.deitel.blackjack.BlackjackService;
7 import java.awt.Color;
8 import java.util.ArrayList;
9 import javax.swing.ImageIcon;
10 import javax.swing.JLabel;
11 import javax.swing.JOptionPane;
12 import javax.xml.ws.BindingProvider;
13
14 public class BlackjackGameJFrame extends javax.swing.JFrame
15 {
16     private String playerCards;
17     private String dealerCards;
18     private ArrayList<JLabel> cardboxes; // list of card image JLabels
19     private int currentPlayerCard; // player's current card number
20     private int currentDealerCard; // blackjackProxy's current card number
21     private BlackjackService blackjackService; // used to obtain proxy
22     private Blackjack blackjackProxy; // used to access the web service
23
24     // enumeration of game states
25     private enum GameState
26     {
27         PUSH, // game ends in a tie
28         LOSE, // player loses
29         WIN, // player wins
30         BLACKJACK // player has blackjack
31     } // end enum GameState
32
33     // no-argument constructor
34     public BlackjackGameJFrame()
35     {
36         initComponents();
37
38         // due to a bug in NetBeans, we must change the JFrame's background
39         // color here rather than in the designer
40         getContentPane().setBackground( new Color( 0, 180, 0 ) );
41
42         // initialize the blackjack proxy
43         try
44         {
45             // create the objects for accessing the Blackjack web service
46             blackjackService = new BlackjackService();
47             blackjackProxy = blackjackService.getBlackjackPort();
48
49             // enable session tracking
50             ( (BindingProvider) blackjackProxy ).getRequestContext().put(
51                 BindingProvider.SESSION_MAINTAIN_PROPERTY, true );
52         } // end try
```

Fig. 31.18 | Blackjack game that uses the Blackjack web service. (Part I of 10.)

```

53     catch ( Exception e )
54     {
55         e.printStackTrace();
56     } // end catch
57
58     // add JLabels to cardBoxes ArrayList for programmatic manipulation
59     cardboxes = new ArrayList<JLabel>();
60
61     cardboxes.add( dealerCard1JLabel );
62     cardboxes.add( dealerCard2JLabel );
63     cardboxes.add( dealerCard3JLabel );
64     cardboxes.add( dealerCard4JLabel );
65     cardboxes.add( dealerCard5JLabel );
66     cardboxes.add( dealerCard6JLabel );
67     cardboxes.add( dealerCard7JLabel );
68     cardboxes.add( dealerCard8JLabel );
69     cardboxes.add( dealerCard9JLabel );
70     cardboxes.add( dealerCard10JLabel );
71     cardboxes.add( dealerCard11JLabel );
72     cardboxes.add( playerCard1JLabel );
73     cardboxes.add( playerCard2JLabel );
74     cardboxes.add( playerCard3JLabel );
75     cardboxes.add( playerCard4JLabel );
76     cardboxes.add( playerCard5JLabel );
77     cardboxes.add( playerCard6JLabel );
78     cardboxes.add( playerCard7JLabel );
79     cardboxes.add( playerCard8JLabel );
80     cardboxes.add( playerCard9JLabel );
81     cardboxes.add( playerCard10JLabel );
82     cardboxes.add( playerCard11JLabel );
83 } // end constructor
84
85 // play the dealer's hand
86 private void dealerPlay()
87 {
88     try
89     {
90         // while the value of the dealers's hand is below 17
91         // the dealer must continue to take cards
92         String[] cards = dealerCards.split( "\\t" );
93
94         // display dealer's cards
95         for ( int i = 0; i < cards.length; i++ )
96         {
97             displayCard( i, cards[i] );
98         }
99
100        while ( blackjackProxy.getHandValue( dealerCards ) < 17 )
101        {
102            String newCard = blackjackProxy.dealCard(); // deal new card
103            dealerCards += "\\t" + newCard; // deal new card
104            displayCard( currentDealerCard, newCard );

```

Fig. 31.18 | Blackjack game that uses the BBlackjack web service. (Part 2 of 10.)

```
105         ++currentDealerCard;
106         JOptionPane.showMessageDialog( this, "Dealer takes a card",
107             "Dealer's turn", JOptionPane.PLAIN_MESSAGE );
108     } // end while
109
110     int dealersTotal = blackjackProxy.getHandValue( dealerCards );
111     int playersTotal = blackjackProxy.getHandValue( playerCards );
112
113     // if dealer busted, player wins
114     if ( dealersTotal > 21 )
115     {
116         gameOver( GameState.WIN );
117         return;
118     } // end if
119
120     // if dealer and player are below 21
121     // higher score wins, equal scores is a push
122     if ( dealersTotal > playersTotal )
123     {
124         gameOver( GameState.LOSE );
125     }
126     else if ( dealersTotal < playersTotal )
127     {
128         gameOver( GameState.WIN );
129     }
130     else
131     {
132         gameOver( GameState.PUSH );
133     }
134 } // end try
135 catch ( Exception e )
136 {
137     e.printStackTrace();
138 } // end catch
139 } // end method dealerPlay
140
141 // displays the card represented by cardValue in specified JLabel
142 private void displayCard( int card, String cardValue )
143 {
144     try
145     {
146         // retrieve correct JLabel from cardBoxes
147         JLabel displayLabel = cardboxes.get( card );
148
149         // if string representing card is empty, display back of card
150         if ( cardValue.equals( "" ) )
151         {
152             displayLabel.setIcon( new ImageIcon( getClass().getResource(
153                 "/com/deitel/java/blackjackclient/" +
154                 "blackjack_images/cardback.png" ) ) );
155             return;
156         } // end if
```

Fig. 31.18 | Blackjack game that uses the B1ackjack web service. (Part 3 of 10.)

```

157
158 // retrieve the face value of the card
159 String face = cardValue.substring( 0, cardValue.indexOf( " " ) );
160
161 // retrieve the suit of the card
162 String suit =
163     cardValue.substring( cardValue.indexOf( " " ) + 1 );
164
165 char suitLetter; // suit letter used to form image file
166
167 switch ( Integer.parseInt( suit ) )
168 {
169     case 0: // hearts
170         suitLetter = 'h';
171         break;
172     case 1: // diamonds
173         suitLetter = 'd';
174         break;
175     case 2: // clubs
176         suitLetter = 'c';
177         break;
178     default: // spades
179         suitLetter = 's';
180         break;
181 } // end switch
182
183 // set image for displayLabel
184 displayLabel.setIcon( new ImageIcon( getClass().getResource(
185     "/com/deitel/java/blackjackclient/blackjack_images/" +
186     face + suitLetter + ".png" ) ) );
187 } // end try
188 catch ( Exception e )
189 {
190     e.printStackTrace();
191 } // end catch
192 } // end method displayCard
193
194 // displays all player cards and shows appropriate message
195 private void gameOver( GameState winner )
196 {
197     String[] cards = dealerCards.split( "\\t" );
198
199     // display blackjackProxy's cards
200     for ( int i = 0; i < cards.length; i++ )
201     {
202         displayCard( i, cards[i] );
203     }
204
205     // display appropriate status image
206     if ( winner == GameState.WIN )
207     {
208         statusJLabel.setText( "You win!" );
209     }

```

Fig. 31.18 | Blackjack game that uses the BBlackjack web service. (Part 4 of 10.)

```

210     else if ( winner == GameStatus.LOSE )
211     {
212         statusJLabel.setText( "You lose." );
213     }
214     else if ( winner == GameStatus.PUSH )
215     {
216         statusJLabel.setText( "It's a push." );
217     }
218     else // blackjack
219     {
220         statusJLabel.setText( "Blackjack!" );
221     }
222
223     // display final scores
224     int dealersTotal = blackjackProxy.getHandValue( dealerCards );
225     int playersTotal = blackjackProxy.getHandValue( playerCards );
226     dealerTotalJLabel.setText( "Dealer: " + dealersTotal );
227     playerTotalJLabel.setText( "Player: " + playersTotal );
228
229     // reset for new game
230     standJButton.setEnabled( false );
231     hitJButton.setEnabled( false );
232     dealJButton.setEnabled( true );
233 } // end method gameOver
234
235 // The initComponents method is autogenerated by NetBeans and is called
236 // from the constructor to initialize the GUI. This method is not shown
237 // here to save space. Open BlackjackGameJFrame.java in this
238 // example's folder to view the complete generated code
239
542 // handles dealJButton click
543 private void dealJButtonActionPerformed(
544     java.awt.event.ActionEvent evt )
545 {
546     String card; // stores a card temporarily until it's added to a hand
547
548     // clear card images
549     for ( int i = 0; i < cardboxes.size(); i++ )
550     {
551         cardboxes.get( i ).setIcon( null );
552     }
553
554     statusJLabel.setText( "" );
555     dealerTotalJLabel.setText( "" );
556     playerTotalJLabel.setText( "" );
557
558     // create a new, shuffled deck on remote machine
559     blackjackProxy.shuffle();
560
561     // deal two cards to player
562     playerCards = blackjackProxy.dealCard(); // add first card to hand
563     displayCard( 11, playerCards ); // display first card
564     card = blackjackProxy.dealCard(); // deal second card

```

Fig. 31.18 | Blackjack game that uses the B1ackjack web service. (Part 5 of 10.)

```

565     displayCard( 12, card ); // display second card
566     playerCards += "\t" + card; // add second card to hand
567
568     // deal two cards to blackjackProxy, but only show first
569     dealerCards = blackjackProxy.dealCard(); // add first card to hand
570     displayCard( 0, dealerCards ); // display first card
571     card = blackjackProxy.dealCard(); // deal second card
572     displayCard( 1, "" ); // display back of card
573     dealerCards += "\t" + card; // add second card to hand
574
575     standJButton.setEnabled( true );
576     hitJButton.setEnabled( true );
577     dealJButton.setEnabled( false );
578
579     // determine the value of the two hands
580     int dealersTotal = blackjackProxy.getHandValue( dealerCards );
581     int playersTotal = blackjackProxy.getHandValue( playerCards );
582
583     // if hands both equal 21, it is a push
584     if ( playersTotal == dealersTotal && playersTotal == 21 )
585     {
586         gameOver( GameState.PUSH );
587     }
588     else if ( dealersTotal == 21 ) // blackjackProxy has blackjack
589     {
590         gameOver( GameState.LOSE );
591     }
592     else if ( playersTotal == 21 ) // blackjack
593     {
594         gameOver( GameState.BLACKJACK );
595     }
596
597     // next card for blackjackProxy has index 2
598     currentDealerCard = 2;
599
600     // next card for player has index 13
601     currentPlayerCard = 13;
602 } // end method dealJButtonActionPerformed
603
604 // handles standJButton click
605 private void hitJButtonActionPerformed(
606     java.awt.event.ActionEvent evt )
607 {
608     // get player another card
609     String card = blackjackProxy.dealCard(); // deal new card
610     playerCards += "\t" + card; // add card to hand
611
612     // update GUI to display new card
613     displayCard( currentPlayerCard, card );
614     ++currentPlayerCard;
615
616     // determine new value of player's hand
617     int total = blackjackProxy.getHandValue( playerCards );

```

Fig. 31.18 | Blackjack game that uses the B1ackjack web service. (Part 6 of 10.)

```

618
619     if ( total > 21 ) // player busts
620     {
621         gameOver( GameStatus.LOSE );
622     }
623     else if ( total == 21 ) // player cannot take any more cards
624     {
625         hitJButton.setEnabled( false );
626         dealerPlay();
627     } // end if
628 } // end method hitJButtonActionPerformed
629
630 // handles standJButton click
631 private void standJButtonActionPerformed(
632     java.awt.event.ActionEvent evt )
633 {
634     standJButton.setEnabled( false );
635     hitJButton.setEnabled( false );
636     dealJButton.setEnabled( true );
637     dealerPlay();
638 } // end method standJButtonActionPerformed
639
640 // begins application execution
641 public static void main( String args[] )
642 {
643     java.awt.EventQueue.invokeLater(
644         new Runnable()
645         {
646             public void run()
647             {
648                 new BlackjackGameJFrame().setVisible( true );
649             }
650         }
651     ); // end call to java.awt.EventQueue.invokeLater
652 } // end main
653
654 // Variables declaration - do not modify
655 private javax.swing.JButton dealJButton;
656 private javax.swing.JLabel dealerCard10JLabel;
657 private javax.swing.JLabel dealerCard11JLabel;
658 private javax.swing.JLabel dealerCard1JLabel;
659 private javax.swing.JLabel dealerCard2JLabel;
660 private javax.swing.JLabel dealerCard3JLabel;
661 private javax.swing.JLabel dealerCard4JLabel;
662 private javax.swing.JLabel dealerCard5JLabel;
663 private javax.swing.JLabel dealerCard6JLabel;
664 private javax.swing.JLabel dealerCard7JLabel;
665 private javax.swing.JLabel dealerCard8JLabel;
666 private javax.swing.JLabel dealerCard9JLabel;
667 private javax.swing.JLabel dealerJLabel;
668 private javax.swing.JLabel dealerTotalJLabel;
669 private javax.swing.JButton hitJButton;
670 private javax.swing.JLabel playerCard10JLabel;

```

Fig. 31.18 | Blackjack game that uses the B1ackjack web service. (Part 7 of 10.)

```

671 private javax.swing.JLabel playerCard1JLabel;
672 private javax.swing.JLabel playerCard1JLabel;
673 private javax.swing.JLabel playerCard2JLabel;
674 private javax.swing.JLabel playerCard3JLabel;
675 private javax.swing.JLabel playerCard4JLabel;
676 private javax.swing.JLabel playerCard5JLabel;
677 private javax.swing.JLabel playerCard6JLabel;
678 private javax.swing.JLabel playerCard7JLabel;
679 private javax.swing.JLabel playerCard8JLabel;
680 private javax.swing.JLabel playerCard9JLabel;
681 private javax.swing.JLabel playerJLabel;
682 private javax.swing.JLabel playerTotalJLabel;
683 private javax.swing.JButton standJButton;
684 private javax.swing.JLabel statusJLabel;
685 // End of variables declaration
686 } // end class BlackjackGameJFrame

```

a) Dealer and player hands after the user clicks the **Deal** JButton



b) Dealer and player hands after the user clicks **Stand**. In this case, the result is a push

Fig. 31.18 | Blackjack game that uses the B1ackjack web service. (Part 8 of 10.)

c) Dealer and player hands after the user clicks **Hit** and draws 21. In this case, the player wins



d) Dealer and player hands after the player is dealt blackjack



Fig. 31.18 | Blackjack game that uses the B1ackjack web service. (Part 9 of 10.)

e) Dealer and player hands after the dealer is dealt blackjack



Fig. 31.18 | Blackjack game that uses the B1ackjack web service. (Part 10 of 10.)

Configuring the Client for Session Tracking

When interacting with a JAX-WS web service that performs session tracking, the client application must indicate whether it wants to allow the web service to maintain session information. Lines 50–51 in the constructor perform this task. We first cast the service endpoint interface object to interface type `BindingProvider`. A **BindingProvider** enables the client to manipulate the request information that will be sent to the server. This information is stored in an object that implements interface **RequestContext**. The `BindingProvider` and `RequestContext` are part of the framework that is created by the IDE when you add a web service client to the application. Next, we invoke the `BindingProvider`'s **getRequestContext** method to obtain the `RequestContext` object. Then we call the `RequestContext`'s **put** method to set the property

```
BindingProvider.SESSION_MAINTAIN_PROPERTY
```

to `true`. This enables the client side of the session-tracking mechanism, so that the web service knows which client is invoking the service's web methods.

Method gameOver

Method `gameOver` (lines 195–233) displays all the dealer's cards, shows the appropriate message in `statusJLabel` and displays the final point totals of both the dealer and the player. Method `gameOver` receives as an argument a member of the `GameStatus` enumeration (defined in lines 25–31). The enumeration represents whether the player tied, lost or won the game; its four members are `PUSH`, `LOSE`, `WIN` and `BLACKJACK`.

Method dealJButtonActionPerformed

When the player clicks the **Deal** JButton, method `dealJButtonActionPerformed` (lines 543–602) clears all of the JLabels that display cards or game status information. Next, the deck is shuffled (line 559), and the player and dealer receive two cards each (lines 562–573). Lines 580–581 then total each hand. If the player and the dealer both obtain scores of 21, the program calls method `gameOver`, passing `GameStatus.PUSH` (line 586). If only the dealer has 21, the program passes `GameStatus.LOSE` to method `gameOver` (line 590). If only the player has 21 after the first two cards are dealt, the program passes `GameStatus.BLACKJACK` to method `gameOver` (line 594).

Method hitJButtonActionPerformed

If `dealJButtonActionPerformed` does not call `gameOver`, the player can take more cards by clicking the **Hit** JButton, which calls `hitJButtonActionPerformed` in lines 605–628. Each time a player clicks **Hit**, the program deals the player one more card (line 609) and displays it in the GUI (line 613). If the player exceeds 21, the game is over and the player loses (line 621). If the player has exactly 21, the player is not allowed to take any more cards (line 625), and method `dealerPlay` is called (line 626).

Method dealerPlay

Method `dealerPlay` (lines 86–139) displays the dealer's cards, then deals cards to the dealer until the dealer's hand has a value of 17 or more (lines 100–108). If the dealer exceeds 21, the player wins (line 116); otherwise, the values of the hands are compared, and `gameOver` is called with the appropriate argument (lines 122–133).

Method standJButtonActionPerformed

Clicking the **Stand** JButton indicates that a player does not want to be dealt another card. Method `standJButtonActionPerformed` (lines 631–638) disables the **Hit** and **Stand** buttons, enables the **Deal** button, then calls method `dealerPlay`.

Method displayCard

Method `displayCard` (lines 142–192) updates the GUI to display a newly dealt card. The method takes as arguments an integer index for the JLabel in the ArrayList that must have its image set and a String representing the card. An empty String indicates that we wish to display the card face down. If method `displayCard` receives a String that's not empty, the program extracts the face and suit from the String and uses this information to display the correct image. The switch statement (lines 167–181) converts the number representing the suit to an integer and assigns the appropriate character to variable `suitLetter` (h for hearts, d for diamonds, c for clubs and s for spades). The character in `suitLetter` is used to complete the image's file name (lines 184–186). *You must add the folder `blackjack_images` to your project so that lines 152–154 and 184–186 can access the images properly.* To do so, copy the folder `blackjack_images` from this chapter's examples folder and paste it into the project's `src\com\deitel\java\blackjackclient` folder.

31.10 Consuming a Database-Driven SOAP Web Service

Our prior examples accessed web services from desktop applications created in NetBeans. However, we can just as easily use them in web applications created with NetBeans. In fact, because web-based businesses are becoming increasingly popular, it's common for

web applications to consume web services. In this section, we present an airline reservation web service that receives information regarding the type of seat a customer wishes to reserve and makes a reservation if such a seat is available. Later in the section, we present a web application that allows a customer to specify a reservation request, then uses the airline reservation web service to attempt to execute the request.

31.10.1 Creating the Reservation Database

Our web service uses a reservation database containing a single table named `Seats` to locate a seat matching a client's request. Review the steps presented in Section 30.2.1 for configuring a data source and the `addressbook` database. Then perform those steps for the reservation database used in this example. Create a data source named `jdbc/reservation`. This chapter's examples directory contains the `Seats.sql` SQL script to create the `seats` table and populate it with sample data. The sample data is shown in Fig. 31.19.

number	location	class	taken
1	Aisle	Economy	0
2	Aisle	Economy	0
3	Aisle	First	0
4	Middle	Economy	0
5	Middle	Economy	0
6	Middle	First	0
7	Window	Economy	0
8	Window	Economy	0
9	Window	First	0
10	Window	First	0

Fig. 31.19 | Data from the `seats` table.

Creating the Reservation Web Service

You can now create a web service that uses the Reservation database (Fig. 31.20). The airline reservation web service has a single web method—`reserve` (lines 23–78)—which searches the `Seats` table to locate a seat matching a user's request. The method takes two arguments—a `String` representing the desired seat type (i.e., "Window", "Middle" or "Aisle") and a `String` representing the desired class type (i.e., "Economy" or "First"). If it finds an appropriate seat, method `reserve` updates the database to make the reservation and returns `true`; otherwise, no reservation is made, and the method returns `false`. The statements at lines 34–39 and lines 45–48 that query and update the database use objects of JDBC types `ResultSet` and `PreparedStatement`.



Software Engineering Observation 31.1

Using `PreparedStatement`s to create SQL statements is highly recommended to secure against so-called SQL injection attacks in which executable code is inserted into SQL code. The site www.owasp.org/index.php/Preventing_SQL_Injection_in_Java provides a summary of SQL injection attacks and ways to mitigate against them.

```

1 // Fig. 31.20: Reservation.java
2 // Airline reservation web service.
3 package com.deitel.reservation;
4
5 import java.sql.Connection;
6 import java.sql.PreparedStatement;
7 import java.sql.ResultSet;
8 import java.sql.SQLException;
9 import javax.annotation.Resource;
10 import javax.jws.WebMethod;
11 import javax.jws.WebParam;
12 import javax.jws.WebService;
13 import javax.sql.DataSource;
14
15 @WebService()
16 public class Reservation
17 {
18     // allow the server to inject the DataSource
19     @Resource( name="jdbc/reservation" )
20     DataSource dataSource;
21
22     // a WebMethod that can reserve a seat
23     @WebMethod( operationName = "reserve" )
24     public boolean reserve( @WebParam( name = "seatType" ) String seatType,
25         @WebParam( name = "classType" ) String classType )
26     {
27         Connection connection = null;
28         PreparedStatement lookupSeat = null;
29         PreparedStatement reserveSeat = null;
30
31         try
32         {
33             connection = DriverManager.getConnection(
34                 DATABASE_URL, USERNAME, PASSWORD );
35             lookupSeat = connection.prepareStatement(
36                 "SELECT \"number\" FROM \"seats\" WHERE (\"taken\" = 0) " +
37                 "AND (\"location\" = ?) AND (\"class\" = ?)" );
38             lookupSeat.setString( 1, seatType );
39             lookupSeat.setString( 2, classType );
40             ResultSet resultSet = lookupSeat.executeQuery();
41
42             // if requested seat is available, reserve it
43             if ( resultSet.next() )
44             {
45                 int seat = resultSet.getInt( 1 );
46                 reserveSeat = connection.prepareStatement(
47                     "UPDATE \"seats\" SET \"taken\"=1 WHERE \"number\"=?" );
48                 reserveSeat.setInt( 1, seat );
49                 reserveSeat.executeUpdate();
50                 return true;
51             } // end if
52

```

Fig. 31.20 | Airline reservation web service. (Part I of 2.)

```

53         return false;
54     } // end try
55     catch ( SQLException e )
56     {
57         e.printStackTrace();
58         return false;
59     } // end catch
60     catch ( Exception e )
61     {
62         e.printStackTrace();
63         return false;
64     } // end catch
65     finally
66     {
67         try
68         {
69             lookupSeat.close();
70             reserveSeat.close();
71             connection.close();
72         } // end try
73         catch ( Exception e )
74         {
75             e.printStackTrace();
76             return false;
77         } // end catch
78     } // end finally
79 } // end WebMethod reserve
80 } // end class Reservation

```

Fig. 31.20 | Airline reservation web service. (Part 2 of 2.)

Our database contains four columns—the seat number (i.e., 1–10), the seat type (i.e., Window, Middle or Aisle), the class type (i.e., Economy or First) and a column containing either 1 (true) or 0 (false) to indicate whether the seat is taken. Lines 34–39 retrieve the seat numbers of any available seats matching the requested seat and class type. This statement fills the `resultSet` with the results of the query

```

SELECT number
FROM seats
WHERE (taken = 0) AND (type = type) AND (class = class)

```

The parameters *type* and *class* in the query are replaced with values of method `reserve`'s `seatType` and `classType` parameters.

If `resultSet` is not empty (i.e., at least one seat is available that matches the selected criteria), the condition in line 42 is true and the web service reserves the first matching seat number. Recall that `ResultSet` method `next` returns true if a nonempty row exists, and positions the cursor on that row. We obtain the seat number (line 44) by accessing `resultSet`'s first column (i.e., `resultSet.getInt(1)`—the first column in the row). Then lines 45–48 configure a `PreparedStatement` and execute the SQL:

```

UPDATE seats
SET taken = 1
WHERE (number = number)

```

which marks the seat as taken in the database. The parameter *number* is replaced with the value of *seat*. Method *reserve* returns *true* (line 49) to indicate that the reservation was successful. If there are no matching seats, or if an exception occurred, method *reserve* returns *false* (lines 52, 57, 62 and 75) to indicate that no seats matched the user's request.

31.10.2 Creating a Web Application to Interact with the Reservation Service

This section presents a *ReservationClient* JSF web application that consumes the *Reservation* web service. The application allows users to select "Aisle", "Middle" or "Window" seats in "Economy" or "First" class, then submit their requests to the web service. If the database request is not successful, the application instructs the user to modify the request and try again. The application presented here was built using the techniques presented in Chapters 29–30. We assume that you've already read those chapters and thus know how to build a Facelets page and a corresponding *JavaBean*.

index.xhtml

index.xhtml (Fig. 31.21) defines two *h:selectOneMenus* and an *h:commandButton*. The *h:selectOneMenu* at lines 16–20) displays all the seat types from which users can select. The one at lines 21–24) provides choices for the class type. The values of these are stored in the *seatType* and *classType* properties of the *reservationBean* (Fig. 31.22). Users click the **Reserve** button (lines 25–26) to submit requests after making selections from the *h:selectOneMenus*. Clicking the button calls the *reservationBean*'s *reserveSeat* method. The page displays the result of each attempt to reserve a seat in line 28.

```

1  <?xml version='1.0' encoding='UTF-8' ?>
2
3  <!-- Fig. 31.21: index.xhtml -->
4  <!-- Facelets page that allows a user to select a seat -->
5  <!DOCTYPE html PUBLIC "-//W3C//DTD XHTML 1.0 Transitional/EN"
6     "http://www.w3.org/TR/xhtml1/DTD/xhtml1-transitional.dtd">
7  <html xmlns="http://www.w3.org/1999/xhtml"
8     xmlns:h="http://java.sun.com/jsf/html"
9     xmlns:f="http://java.sun.com/jsf/core">
10   <h:head>
11     <title>Airline Reservations</title>
12   </h:head>
13   <h:body>
14     <h:form>
15       <h3>Please select the seat type and class to reserve:</h3>
16       <h:selectOneMenu value="#{reservationBean.seatType}">
17         <f:selectItem itemValue="Aisle" itemLabel="Aisle" />
18         <f:selectItem itemValue="Middle" itemLabel="Middle" />
19         <f:selectItem itemValue="Window" itemLabel="Window" />
20       </h:selectOneMenu>
21       <h:selectOneMenu value="#{reservationBean.classType}">
22         <f:selectItem itemValue="Economy" itemLabel="Economy" />
23         <f:selectItem itemValue="First" itemLabel="First" />
24       </h:selectOneMenu>

```

Fig. 31.21 | Facelets page that allows a user to select a seat. (Part 1 of 2.)

```

25         <h:commandButton value="Reserve"
26             action="#{reservationBean.reserveSeat}"/>
27     </h:form>
28     <h3>#{reservationBean.result}</h3>
29 </h:body>
30 </html>

```

a) Selecting
a seat

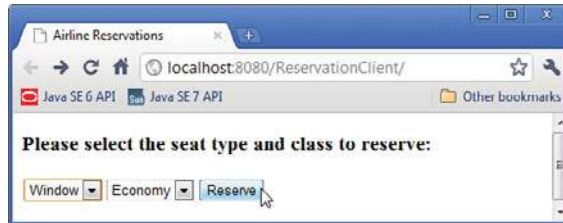

b) Seat reserved
successfully



c) Attempting to
reserve another
window seat in
economy when
there are no such
seats available

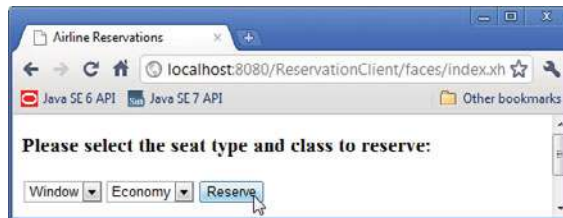

d) No seats
match the
requested seat
type and class



Fig. 31.21 | Facelets page that allows a user to select a seat. (Part 2 of 2.)

ReservationBean.java

Class `ReservationBean` (Fig. 31.22) defines the `seatType`, `classType` and `result` properties and the `reserveSeat` method that are used in the `index.xhtml` page. When the user clicks the **Reserve** button in `index.xhtml`, method `reserveSeat` (lines 57–74) executes. Lines 61–62 use the service endpoint interface object (created in lines 22–23) to invoke

the web service's reserve method, passing the selected seat type and class type as arguments. If reserve returns true, line 65 sets result to a message thanking the user for making a reservation; otherwise, lines 67–68 set result to a message notifying the user that the requested seat type is not available and instructing the user to try again.

```

1 // Fig. 31.22: ReservationBean.java
2 // Bean for seat reservation client.
3 package reservationclient;
4
5 import com.deitel.reservation.Reservation;
6 import com.deitel.reservation.ReservationService;
7 import javax.faces.bean.ManagedBean;
8
9 @ManagedBean( name = "reservationBean" )
10 public class ReservationBean
11 {
12     // references the service endpoint interface object (i.e., the proxy)
13     private Reservation reservationServiceProxy; // reference to proxy
14     private String seatType; // type of seat to reserve
15     private String classType; // class of seat to reserve
16     private String result; // result of reservation attempt
17
18     // no-argument constructor
19     public ReservationBean()
20     {
21         // get service endpoint interface
22         ReservationService reservationService = new ReservationService();
23         reservationServiceProxy = reservationService.getReservationPort();
24     } // end constructor
25
26     // return classType
27     public String getClassType()
28     {
29         return classType;
30     } // end method getClassType
31
32     // set classType
33     public void setClassType( String classType )
34     {
35         this.classType = classType;
36     } // end method setClassType
37
38     // return seatType
39     public String getSeatType()
40     {
41         return seatType;
42     } // end method getSeatType
43
44     // set seatType
45     public void setSeatType( String seatType )
46     {

```

Fig. 31.22 | Page bean for seat reservation client. (Part 1 of 2.)

```

47     this.seatType = seatType;
48 } // end method setSeatType
49
50 // return result
51 public String getResult()
52 {
53     return result;
54 } // end method getResult
55
56 // invoke the web service when the user clicks Reserve button
57 public void reserveSeat()
58 {
59     try
60     {
61         boolean reserved = reservationServiceProxy.reserve(
62             getSeatType(), getClassType() );
63
64         if ( reserved )
65             result = "Your reservation has been made. Thank you!";
66         else
67             result = "This type of seat is not available. " +
68                 "Please modify your request and try again.";
69     } // end try
70     catch ( Exception e )
71     {
72         e.printStackTrace();
73     } // end catch
74 } // end method reserveSeat
75 } // end class ReservationBean

```

Fig. 31.22 | Page bean for seat reservation client. (Part 2 of 2.)

31.11 Equation Generator: Returning User-Defined Types

Most of the web services we've demonstrated received and returned primitive-type instances. It's also possible to process instances of class types in a web service. These types can be passed to or returned from web service methods.

This section presents a RESTful `EquationGenerator` web service that generates random arithmetic equations of type `Equation`. The client is a math-tutoring application that accepts information about the mathematical question that the user wishes to attempt (addition, subtraction or multiplication) and the skill level of the user (1 specifies equations using numbers from 1 through 9, 2 specifies equations involving numbers from 10 through 99, and 3 specifies equations containing numbers from 100 through 999). The web service then generates an equation consisting of random numbers in the proper range. The client application receives the `Equation` and displays the sample question to the user.

Defining Class Equation

We define class `Equation` in Fig. 31.23. All the programs in this section have a copy of this class in their corresponding package. Except for the package name, the class is identical in each project, so we show it only once. Like the `TextMessage` class used earlier, the server-

side and client-side copies of class `Equation` are unrelated to each other. The only requirement for *serialization* and *deserialization* to work with the JAXB and Gson classes is that class `Equation` must have the same public properties on both the server and the client. Such properties can be public instance variables or private instance variables that have corresponding *set* and *get* methods.

```
1 // Fig. 31.23: Equation.java
2 // Equation class that contains information about an equation.
3 package com.deitel.equationgeneratorxml;
4
5 public class Equation
6 {
7     private int leftOperand;
8     private int rightOperand;
9     private int result;
10    private String operationType;
11
12    // required no-argument constructor
13    public Equation()
14    {
15        this( 0, 0, "add" );
16    } // end no-argument constructor
17
18    // constructor that receives the operands and operation type
19    public Equation( int leftValue, int rightValue, String type )
20    {
21        leftOperand = leftValue;
22        rightOperand = rightValue;
23
24        // determine result
25        if ( type.equals( "add" ) ) // addition
26        {
27            result = leftOperand + rightOperand;
28            operationType = "+";
29        } // end if
30        else if ( type.equals( "subtract" ) ) // subtraction
31        {
32            result = leftOperand - rightOperand;
33            operationType = "-";
34        } // end if
35        else // multiplication
36        {
37            result = leftOperand * rightOperand;
38            operationType = "*";
39        } // end else
40    } // end three argument constructor
41
42    // gets the leftOperand
43    public int getLeftOperand()
44    {
45        return leftOperand;
46    } // end method getLeftOperand
```

Fig. 31.23 | Equation class that contains information about an equation. (Part I of 3.)

```
47
48 // required setter
49 public void setLeftOperand( int value )
50 {
51     leftOperand = value;
52 } // end method setLeftOperand
53
54 // gets the rightOperand
55 public int getRightOperand()
56 {
57     return rightOperand;
58 } // end method getRightOperand
59
60 // required setter
61 public void setRightOperand( int value )
62 {
63     rightOperand = value;
64 } // end method setRightOperand
65
66 // gets the resultValue
67 public int getResult()
68 {
69     return result;
70 } // end method getResult
71
72 // required setter
73 public void setResult( int value )
74 {
75     result = value;
76 } // end method setResult
77
78 // gets the operationType
79 public String getOperationType()
80 {
81     return operationType;
82 } // end method getOperationType
83
84 // required setter
85 public void setOperationType( String value )
86 {
87     operationType = value;
88 } // end method setOperationType
89
90 // returns the left hand side of the equation as a String
91 public String getLeftHandSide()
92 {
93     return leftOperand + " " + operationType + " " + rightOperand;
94 } // end method getLeftHandSide
95
96 // returns the right hand side of the equation as a String
97 public String getRightHandSide()
98 {
```

Fig. 31.23 | Equation class that contains information about an equation. (Part 2 of 3.)

```

99     return "" + result;
100  } // end method getRightHandSide
101
102  // returns a String representation of an Equation
103  public String toString()
104  {
105      return getLeftHandSide() + " = " + getRightHandSide();
106  } // end method toString
107 } // end class Equation

```

Fig. 31.23 | Equation class that contains information about an equation. (Part 3 of 3.)

Lines 19–40 define a constructor that takes two `ints` representing the left and right operands, and a `String` representing the arithmetic operation. The constructor stores this information, then calculates the result. The parameterless constructor (lines 13–16) calls the three-argument constructor (lines 19–40) and passes default values.

Class `Equation` defines *get* and *set* methods for instance variables `leftOperand` (lines 43–52), `rightOperand` (lines 55–64), `result` (line 67–76) and `operationType` (lines 79–88). It also provides *get* methods for the left-hand and right-hand sides of the equation and a `toString` method that returns the entire equation as a `String`. An instance variable can be serialized only if it has both a *get* and a *set* method. Because the different sides of the equation and the result of `toString` can be generated from the other instance variables, there’s no need to send them across the wire. The client in this case study does not use the `getRightHandSide` method, but we included it in case future clients choose to use it.

31.11.1 Creating the EquationGeneratorXML Web Service

Figure 31.24 presents the `EquationGeneratorXML` web service’s class for creating randomly generated Equations. Method `getXml` (lines 19–38) takes two parameters—a `String` representing the mathematical operation ("add", "subtract" or "multiply") and an `int` representing the difficulty level. JAX-RS automatically converts the arguments to the correct type and will return a “not found” error to the client if the argument cannot be converted from a `String` to the destination type. Supported types for conversion include integer types, floating-point types, `boolean` and the corresponding *type-wrapper classes*.

```

1  // Fig. 31.24: EquationGeneratorXMLResource.java
2  // RESTful equation generator that returns XML.
3  package com.deitel.equationgeneratorxml;
4
5  import java.io.StringWriter;
6  import java.util.Random;
7  import javax.ws.rs.PathParam;
8  import javax.ws.rs.Path;
9  import javax.ws.rs.GET;
10 import javax.ws.rs.Produces;
11 import javax.xml.bind.JAXB; // utility class for common JAXB operations
12

```

Fig. 31.24 | RESTful equation generator that returns XML. (Part 1 of 2.)

```

13 @Path( "equation" )
14 public class EquationGeneratorXMLResource
15 {
16     private static Random randomObject = new Random();
17
18     // retrieve an equation formatted as XML
19     @GET
20     @Path( "{operation}/{level}" )
21     @Produces( "application/xml" )
22     public String getXml( @PathParam( "operation" ) String operation,
23                          @PathParam( "level" ) int level )
24     {
25         // compute minimum and maximum values for the numbers
26         int minimum = ( int ) Math.pow( 10, level - 1 );
27         int maximum = ( int ) Math.pow( 10, level );
28
29         // create the numbers on the left-hand side of the equation
30         int first = randomObject.nextInt( maximum - minimum ) + minimum;
31         int second = randomObject.nextInt( maximum - minimum ) + minimum;
32
33         // create Equation object and marshal it into XML
34         Equation equation = new Equation( first, second, operation );
35         StringWriter writer = new StringWriter(); // XML output here
36         JAXB.marshal( equation, writer ); // write Equation to StringWriter
37         return writer.toString(); // return XML string
38     } // end method getXml
39 } // end class EquationGeneratorXMLResource

```

Fig. 31.24 | RESTful equation generator that returns XML. (Part 2 of 2.)

The `getXml` method first determines the minimum (inclusive) and maximum (exclusive) values for the numbers in the equation it will return (lines 26–27). It then uses a static member of the `Random` class (line 16) to generate two random numbers in that range (lines 30–31). Line 34 creates an `Equation` object, passing these two numbers and the requested operation to the constructor. The `getXml` method then uses `JAXB` to convert the `Equation` object to XML (line 36), which is output to the `StringWriter` created on line 35. Finally, it retrieves the data that was written to the `StringWriter` and returns it to the client. [Note: We'll reimplement this web service with JSON in Section 31.11.3.]

31.11.2 Consuming the EquationGeneratorXML Web Service

The `EquationGeneratorXMLClient` application (Fig. 31.25) retrieves an XML-formatted `Equation` object from the `EquationGeneratorXML` web service. The application then displays the `Equation`'s left-hand side and waits for user to submit an answer.

```

1 // Fig. 31.25: EquationGeneratorXMLClientJFrame.java
2 // Math-tutoring program using REST and XML to generate equations.
3 package com.deitel.equationgeneratorxmlclient;
4
5 import javax.swing.JOptionPane;

```

Fig. 31.25 | Math-tutoring program using REST and XML to generate equations. (Part 1 of 4.)

```

6 import javax.xml.bind.JAXB; // utility class for common JAXB operations
7
8 public class EquationGeneratorXMLClientJFrame extends javax.swing.JFrame
9 {
10     private String operation = "add"; // operation user is tested on
11     private int difficulty = 1; // 1, 2, or 3 digits in each number
12     private int answer; // correct answer to the question
13
14     // no-argument constructor
15     public EquationGeneratorXMLClientJFrame()
16     {
17         initComponents();
18     } // end no-argument constructor
19
20     // The initComponents method is autogenerated by NetBeans and is called
21     // from the constructor to initialize the GUI. This method is not shown
22     // here to save space. Open EquationGeneratorXMLClientJFrame.java in
23     // this example's folder to view the complete generated code.
24
143    // determine if the user answered correctly
144    private void checkAnswerJButtonActionPerformed(
145        java.awt.event.ActionEvent evt)
146    {
147        if ( answerJTextField.getText().equals( "" ) )
148        {
149            JOptionPane.showMessageDialog(
150                this, "Please enter your answer." );
151        } // end if
152
153        int userAnswer = Integer.parseInt( answerJTextField.getText() );
154
155        if ( userAnswer == answer )
156        {
157            equationJLabel.setText( "" ); // clear label
158            answerJTextField.setText( "" ); // clear text field
159            checkAnswerJButton.setEnabled( false );
160            JOptionPane.showMessageDialog( this, "Correct! Good Job!",
161                "Correct", JOptionPane.PLAIN_MESSAGE );
162        } // end if
163        else
164        {
165            JOptionPane.showMessageDialog( this, "Incorrect. Try again.",
166                "Incorrect", JOptionPane.PLAIN_MESSAGE );
167        } // end else
168    } // end method checkAnswerJButtonActionPerformed
169
170    // retrieve equation from web service and display left side to user
171    private void generateJButtonActionPerformed(
172        java.awt.event.ActionEvent evt)
173    {
174        try
175    {

```

Fig. 31.25 | Math-tutoring program using REST and XML to generate equations. (Part 2 of 4.)

```

176     String url = String.format( "http://localhost:8080/" +
177         "EquationGeneratorXML/resources/equation/%s/%d",
178         operation, difficulty );
179
180     // convert XML back to an Equation object
181     Equation equation = JAXB.unmarshal( url, Equation.class );
182
183     answer = equation.getResult();
184     equationJLabel.setText( equation.getLeftHandSide() + " =" );
185     checkAnswerJButton.setEnabled( true );
186 } // end try
187 catch ( Exception exception )
188 {
189     exception.printStackTrace();
190 } // end catch
191 } // end method generateJButtonActionPerformed
192
193 // obtains the mathematical operation selected by the user
194 private void operationJComboBoxItemStateChanged(
195     java.awt.event.ItemEvent evt)
196 {
197     String item = ( String ) operationJComboBox.getSelectedItem();
198
199     if ( item.equals( "Addition" ) )
200         operation = "add"; // user selected addition
201     else if ( item.equals( "Subtraction" ) )
202         operation = "subtract"; // user selected subtraction
203     else
204         operation = "multiply"; // user selected multiplication
205 } // end method operationJComboBoxItemStateChanged
206
207 // obtains the difficulty level selected by the user
208 private void levelJComboBoxItemStateChanged(
209     java.awt.event.ItemEvent evt)
210 {
211     // indices start at 0, so add 1 to get the difficulty level
212     difficulty = levelJComboBox.getSelectedIndex() + 1;
213 } // end method levelJComboBoxItemStateChanged
214
215 // main method begins execution
216 public static void main( String args[] )
217 {
218     java.awt.EventQueue.invokeLater(
219         new Runnable()
220         {
221             public void run()
222             {
223                 new EquationGeneratorXMLClientJFrame().setVisible( true );
224             } // end method run
225         } // end anonymous inner class
226     ); // end call to java.awt.EventQueue.invokeLater
227 } // end main
228

```

Fig. 31.25 | Math-tutoring program using REST and XML to generate equations. (Part 3 of 4.)

```

229 // Variables declaration - do not modify
230 private javax.swing.JLabel answerJLabel;
231 private javax.swing.JTextField answerJTextField;
232 private javax.swing.JButton checkAnswerJButton;
233 private javax.swing.JLabel equationJLabel;
234 private javax.swing.JButton generateJButton;
235 private javax.swing.JComboBox levelJComboBox;
236 private javax.swing.JLabel levelJLabel;
237 private javax.swing.JComboBox operationJComboBox;
238 private javax.swing.JLabel operationJLabel;
239 private javax.swing.JLabel questionJLabel;
240 // End of variables declaration
241 } // end class EquationGeneratorXMLClientJFrame

```

a) Generating a simple equation.

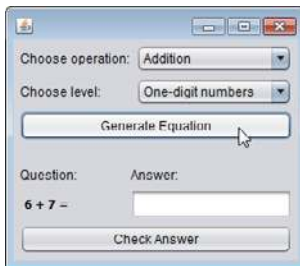

b) Submitting the answer.

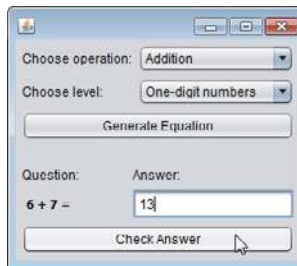

c) Dialog indicating correct answer.



Fig. 31.25 | Math-tutoring program using REST and XML to generate equations. (Part 4 of 4.)

The default setting for the difficulty level is 1, but the user can change this by choosing a level from the **Choose level** JComboBox. Changing the selected value invokes the `levelJComboBoxItemStateChanged` event handler (lines 208–213), which sets the `difficulty` instance variable to the level selected by the user. Although the default setting for the question type is **Addition**, the user also can change this by choosing from the **Choose operation** JComboBox. This invokes the `operationJComboBoxItemStateChanged` event handler in lines 194–205, which assigns to instance variable `operation` the String corresponding to the user's selection.

The event handler for `generateJButton` (lines 171–191) constructs the URL to invoke the web service, then passes this URL to the `unmarshal` method, along with an instance of `Class<Equation>`, so that JAXB can convert the XML into an `Equation` object (line 181). Once the XML has been converted back into an `Equation`, lines 183–184 retrieve the correct answer and display the left-hand side of the equation. The **Check Answer** button is then enabled (line 185), and the user must solve the problem and enter the answer.

When the user enters a value and clicks **Check Answer**, the `checkAnswerJButtonActionPerformed` event handler (lines 144–168) retrieves the user's answer from the dialog box (line 153) and compares it to the correct answer that was stored earlier (line 155). If they match, lines 157–161 reset the GUI elements so the user can generate another equation and tell the user that the answer was correct. If they do not match, a message box asking the user to try again is displayed (lines 165–166).

31.11.3 Creating the EquationGeneratorJSON Web Service

As you saw in Section 31.8, RESTful web services can return data formatted as JSON as well. Figure 31.26 is a reimplementaion of the EquationGeneratorXML service that returns an Equation in JSON format.

```

1 // Fig. 31.26: EquationGeneratorJSONResource.java
2 // RESTful equation generator that returns JSON.
3 package com.deitel.equationgeneratorjson;
4
5 import com.google.gson.Gson; // converts POJO to JSON and back again
6 import java.util.Random;
7 import javax.ws.rs.GET;
8 import javax.ws.rs.Path;
9 import javax.ws.rs.PathParam;
10 import javax.ws.rs.Produces;
11
12 @Path( "equation" )
13 public class EquationGeneratorJSONResource
14 {
15     static Random randomObject = new Random(); // random number generator
16
17     // retrieve an equation formatted as JSON
18     @GET
19     @Path( "{operation}/{level}" )
20     @Produces( "application/json" )
21     public String getJson( @PathParam( "operation" ) String operation,
22                          @PathParam( "level" ) int level )
23     {
24         // compute minimum and maximum values for the numbers
25         int minimum = ( int ) Math.pow( 10, level - 1 );
26         int maximum = ( int ) Math.pow( 10, level );
27
28         // create the numbers on the left-hand side of the equation
29         int first = randomObject.nextInt( maximum - minimum ) + minimum;
30         int second = randomObject.nextInt( maximum - minimum ) + minimum;
31
32         // create Equation object and return result
33         Equation equation = new Equation( first, second, operation );
34         return new Gson().toJson( equation ); // convert to JSON and return
35     } // end method getJson
36 } // end class EquationGeneratorJSONResource

```

Fig. 31.26 | RESTful equation generator that returns JSON.

The logic implemented here is the same as the XML version except for the last line (line 34), which uses `Gson` to convert the `Equation` object into JSON instead of using `JAXB` to convert it into XML. The `@Produces` annotation (line 20) has also changed to reflect the JSON data format.

31.11.4 Consuming the EquationGeneratorJSON Web Service

The program in Fig. 31.27 consumes the `EquationGeneratorJSON` service and performs the same function as `EquationGeneratorXMLClient`—the only difference is in how the

Equation object is retrieved from the web service. Lines 181–183 construct the URL that is used to invoke the EquationGeneratorJSON service. As in the WelcomeRESTJSONClient example, we use the URL class and an InputStreamReader to invoke the web service and read the response (lines 186–187). The retrieved JSON is *deserialized* using Gson (line 191) and converted back into an Equation object. As before, we use the getResult method (line 194) of the deserialized object to obtain the answer and the getLeftHandSide method (line 195) to display the left side of the equation.

```

1 // Fig. 31.27: EquationGeneratorJSONClientJFrame.java
2 // Math-tutoring program using REST and JSON to generate equations.
3 package com.deitel.equationgeneratorjsonclient;
4
5 import com.google.gson.Gson; // converts POJO to JSON and back again
6 import java.io.InputStreamReader;
7 import java.net.URL;
8 import javax.swing.JOptionPane;
9
10 public class EquationGeneratorJSONClientJFrame extends javax.swing.JFrame
11 {
12     private String operation = "add"; // operation user is tested on
13     private int difficulty = 1; // 1, 2, or 3 digits in each number
14     private int answer; // correct answer to the question
15
16     // no-argument constructor
17     public EquationGeneratorJSONClientJFrame()
18     {
19         initComponents();
20     } // end no-argument constructor
21
22     // The initComponents method is autogenerated by NetBeans and is called
23     // from the constructor to initialize the GUI. This method is not shown
24     // here to save space. Open EquationGeneratorJSONClientJFrame.java in
25     // this example's folder to view the complete generated code.
26
27     // determine if the user answered correctly
28     private void checkAnswerJButtonActionPerformed(
29         java.awt.event.ActionEvent evt)
30     {
31         if ( answerJTextField.getText().equals( "" ) )
32         {
33             JOptionPane.showMessageDialog(
34                 this, "Please enter your answer." );
35         } // end if
36
37         int userAnswer = Integer.parseInt( answerJTextField.getText() );
38
39         if ( userAnswer == answer )
40         {
41             equationJLabel.setText( "" ); // clear label
42             answerJTextField.setText( "" ); // clear text field
43             checkAnswerJButton.setEnabled( false );

```

Fig. 31.27 | Math-tutoring program using REST and JSON to generate equations. (Part 1 of 3.)

```

164         JOptionPane.showMessageDialog( this, "Correct! Good Job!",
165             "Correct", JOptionPane.PLAIN_MESSAGE );
166     } // end if
167     else
168     {
169         JOptionPane.showMessageDialog( this, "Incorrect. Try again.",
170             "Incorrect", JOptionPane.PLAIN_MESSAGE );
171     } // end else
172 } // end method checkAnswerJButtonActionPerformed
173
174 // retrieve equation from web service and display left side to user
175 private void generateJButtonActionPerformed(
176     java.awt.event.ActionEvent evt)
177 {
178     try
179     {
180         // URL of the EquationGeneratorJSON service, with parameters
181         String url = String.format( "http://localhost:8080/" +
182             "EquationGeneratorJSON/resources/equation/%s/%d",
183             operation, difficulty );
184
185         // open URL and create a Reader to read the data
186         InputStreamReader reader =
187             new InputStreamReader( new URL( url ).openStream() );
188
189         // convert the JSON back into an Equation object
190         Equation equation =
191             new Gson().fromJson( reader, Equation.class );
192
193         // update the internal state and GUI to reflect the equation
194         answer = equation.getResult();
195         equationJLabel.setText( equation.getLeftHandSide() + " = " );
196         checkAnswerJButton.setEnabled( true );
197     } // end try
198     catch ( Exception exception )
199     {
200         exception.printStackTrace();
201     } // end catch
202 } // end method generateJButtonActionPerformed
203
204 // obtains the mathematical operation selected by the user
205 private void operationJComboBoxItemStateChanged(
206     java.awt.event.ItemEvent evt)
207 {
208     String item = ( String ) operationJComboBox.getSelectedItem();
209
210     if ( item.equals( "Addition" ) )
211         operation = "add"; // user selected addition
212     else if ( item.equals( "Subtraction" ) )
213         operation = "subtract"; // user selected subtraction
214     else
215         operation = "multiply"; // user selected multiplication
216 } // end method operationJComboBoxItemStateChanged

```

Fig. 31.27 | Math-tutoring program using REST and JSON to generate equations. (Part 2 of 3.)

```

217
218 // obtains the difficulty level selected by the user
219 private void levelJComboBoxItemStateChanged(
220     java.awt.event.ItemEvent evt)
221 {
222     // indices start at 0, so add 1 to get the difficulty level
223     difficulty = levelJComboBox.getSelectedIndex() + 1;
224 } // end method levelJComboBoxItemStateChanged
225
226 // main method begins execution
227 public static void main( String args[] )
228 {
229     java.awt.EventQueue.invokeLater(
230         new Runnable()
231         {
232             public void run()
233             {
234                 new EquationGeneratorJSONClientJFrame().setVisible( true );
235             } // end method run
236         } // end anonymous inner class
237     ); // end call to java.awt.EventQueue.invokeLater
238 } // end main
239
240 // Variables declaration - do not modify
241 private javax.swing.JLabel answerJLabel;
242 private javax.swing.JTextField answerJTextField;
243 private javax.swing.JButton checkAnswerJButton;
244 private javax.swing.JLabel equationJLabel;
245 private javax.swing.JButton generateJButton;
246 private javax.swing.JComboBox levelJComboBox;
247 private javax.swing.JLabel levelJLabel;
248 private javax.swing.JComboBox operationJComboBox;
249 private javax.swing.JLabel operationJLabel;
250 private javax.swing.JLabel questionJLabel;
251 // End of variables declaration
252 } // end class EquationGeneratorJSONClientJFrame

```

Fig. 31.27 | Math-tutoring program using REST and JSON to generate equations. (Part 3 of 3.)

31.12 Wrap-Up

This chapter introduced web services—a set of technologies for building distributed systems in which system components communicate with one another over networks. In particular, we presented JAX-WS SOAP-based web services and JAX-RS REST-based web services. You learned that a web service is a class that allows client software to call the web service’s methods remotely via common data formats and protocols, such as XML, JSON, HTTP, SOAP and REST. We also benefits of distributed computing with web services.

We explained how NetBeans and the JAX-WS and JAX-RS APIs facilitate publishing and consuming web services. You learned how to define web services and methods using both SOAP protocol and REST architecture, and how to return data in both XML and JSON formats. You consumed SOAP-based web services using proxy classes to call the web service’s methods. You also consumed REST-based web services by using class URL to

invoke the services and open `InputStreams` from which the clients could read the services' responses. You learned how to define web services and web methods, as well as how to consume them both from Java desktop applications and from web applications. After explaining the mechanics of web services through our `Welcome` examples, we demonstrated more sophisticated web services that use session tracking, database access and user-defined types. We also explained XML and JSON serialization and showed how to retrieve objects of user-defined types from web services.

Summary

Section 31.1 Introduction

- A web service (p. 1300) is a software component stored on one computer that can be accessed by an application (or other software component) on another computer over a network.
- Web services communicate using such technologies as XML, JSON and HTTP.
- JAX-WS (p. 1300) is based on the Simple Object Access Protocol (SOAP; p. 1300)—an XML-based protocol that allows web services and clients to communicate.
- JAX-RS (p. 1300) uses Representational State Transfer (REST; p. 1300)—a network architecture that uses the web's traditional request/response mechanisms such as GET and POST requests.
- Web services enable businesses to conduct transactions via standardized, widely available web services rather than relying on proprietary applications.
- Web services are platform and language independent, so companies can collaborate via web services without hardware, software and communications compatibility issues.
- NetBeans is one of the many tools that enable you to publish and/or consume web services.

Section 31.2 Web Service Basics

- The machine on which a web service resides is referred to as a web service host.
- A client application that accesses the web service sends a method call over a network to the web service host, which processes the call and returns a response over the network to the application.
- In Java, a web service is implemented as a class. The class that represents the web service resides on a server—it's not part of the client application.
- Making a web service available to receive client requests is known as publishing a web service (p. 1302); using a web service from a client application is known as consuming a web service (p. 1302).

Section 31.3 Simple Object Access Protocol (SOAP)

- SOAP is a platform-independent protocol that uses XML to make remote procedure calls, typically over HTTP. Each request and response is packaged in a SOAP message (p. 1302)—an XML message containing the information that a web service requires to process the message.
- SOAP messages are written in XML so that they're computer readable, human readable and platform independent.
- SOAP supports an extensive set of types—the primitive types, as well as `Date`, `Time` and `XmlNode` and others. SOAP can also transmit arrays of these types.
- When a program invokes a method of a SOAP web service, the request and all relevant information are packaged in a SOAP message, enclosed in a SOAP envelope (p. 1302) and sent to the server on which the web service resides.

- When a web service receives a SOAP message, it parses the XML representing the message, then processes the message's contents. The message specifies the method that the client wishes to execute and the arguments the client passed to that method.
- After a web service parses a SOAP message, it calls the appropriate method with the specified arguments (if any) and sends the response back to the client in another SOAP message. The client parses the response to retrieve the method's result.

Section 31.4 Representational State Transfer (REST)

- Representational State Transfer (REST) refers to an architectural style for implementing web services. Such web services are often called RESTful web services (p. 1302). Though REST itself is not a standard, RESTful web services are implemented using web standards.
- Each operation in a RESTful web service is identified by a unique URL.
- REST can return data in many formats, including XML and JSON.

Section 31.5 JavaScript Object Notation (JSON)

- JavaScript Object Notation (JSON; p. 1303) is an alternative to XML for representing data.
- JSON is a text-based data-interchange format used to represent objects in JavaScript as collections of name/value pairs represented as Strings.
- JSON is a simple format that makes objects easy to read, create and parse and allows programs to transmit data efficiently across the Internet, because it's much less verbose than XML.
- Each value in a JSON array can be a string, a number, a JSON object, true, false or null.

Section 31.6.1 Creating a Web Application Project and Adding a Web Service Class in NetBeans

- When you create a web service in NetBeans, you focus on the web service's logic and let the IDE handle the web service's infrastructure.
- To create a web service in NetBeans, you first create a **Web Application** project (p. 1303).

Section 31.6.2 Defining the WelcomeSOAP Web Service in NetBeans

- By default, each new web service class created with the JAX-WS APIs is a POJO (plain old Java object)—you do not need to extend a class or implement an interface to create a web service.
- When you deploy a web application containing a JAX-WS web service, the server creates the server-side artifacts that support the web service.
- The `@WebService` annotation (p. 1305) indicates that a class represents a web service. The optional `name` attribute (p. 1305) specifies the service endpoint interface (SEI; p. 1305) class's name. The optional `serviceName` attribute (p. 1305) specifies the name of the class that the client uses to obtain an SEI object.
- Methods that are tagged with the `@WebMethod` annotation (p. 1305) can be called remotely.
- The `@WebMethod` annotation's optional `operationName` attribute (p. 1305) specifies the method name that is exposed to the web service's clients.
- Web method parameters are annotated with the `@WebParam` annotation (p. 1306). The optional `name` attribute (p. 1306) indicates the parameter name that is exposed to the web service's clients.

Section 31.6.3 Publishing the WelcomeSOAP Web Service from NetBeans

- NetBeans handles all the details of building and deploying a web service for you. This includes creating the framework required to support the web service.

Section 31.6.4 Testing the WelcomeSOAP Web Service with GlassFish Application Server's Tester Web Page

- GlassFish can dynamically create a web page for testing a web service's methods from a web browser. To open the test page, expand the project's **Web Services** node in the NetBeans **Projects** tab, then right click the web service class name and select **Test Web Service**.
- A client can access a web service only when the application server is running. If NetBeans launches the application server for you, the server will shut down when you close NetBeans. To keep the application server up and running, you can launch it independently of NetBeans.

Section 31.6.5 Describing a Web Service with the Web Service Description Language (WSDL)

- To consume a web service, a client must know where to find it and must be provided with the web service's description.
- JAX-WS uses the Web Service Description Language (WSDL; p. 1309)—a standard XML vocabulary for describing web services in a platform-independent manner.
- The server generates a web service's WSDL dynamically for you, and client tools can parse the WSDL to help create the client-side proxy class that a client uses to access the web service.

Section 31.6.6 Creating a Client to Consume the WelcomeSOAP Web Service

- A web service reference (p. 1310) defines the service endpoint interface class so that a client can access the a service.
- An application that consumes a SOAP-based web service invokes methods on a service endpoint interface (SEI) object that interact with the web service on the client's behalf.
- The service endpoint interface object handles the details of passing method arguments to and receiving return values from the web service. This communication can occur over a local network, over the Internet or even with a web service on the same computer.
- NetBeans creates these service endpoint interface classes for you.
- When you add the web service reference, the IDE creates and compiles the client-side artifacts—the framework of Java code that supports the client-side service endpoint interface class. The service endpoint interface class uses the rest of the artifacts to interact with the web service.
- A web service reference is added by giving NetBeans the URL of the web service's WSDL file.

Section 31.6.7 Consuming the WelcomeSOAP Web Service

- To consume a JAX-WS web service, you must obtain an SEI object. You then invoke the web service's methods through the SEI object.

Section 31.7.1 Creating a REST-Based XML Web Service

- The **RESTful Web Services** plug-in for NetBeans provides various templates for creating RESTful web services, including ones that can interact with databases on the client's behalf.
- The `@Path` annotation (p. 1316) on a JAX-RS web service class indicates the URI for accessing the web service. This is appended to the web application project's URL to invoke the service. Methods of the class can also use the `@Path` annotation.
- Parts of the path specified in curly braces indicate parameters—they're placeholders for arguments that are passed to the web service as part of the path. The base path for the service is the project's `resources` directory.
- Arguments in a URL can be used as arguments to a web service method. To do so, you bind the parameters specified in the `@Path` specification to parameters of a web service method with the

- `@PathParam` annotation (p. 1317). When the request is received, the server passes the argument(s) in the URL to the appropriate parameter(s) in the web service method.
- The `@GET` annotation (p. 1317) denotes that a method is accessed via an HTTP GET request. Similar annotations exist for HTTP PUT, POST, DELETE and HEAD requests.
 - The `@Produces` annotation (p. 1317) denotes the content type returned to the client. It's possible to have multiple methods with the same HTTP method and path but different `@Produces` annotations, and JAX-RS will call the method matching the content type requested by the client.
 - The `@Consumes` annotation (p. 1317) restricts the content type that a web service accepts from a PUT request.
 - JAXB (Java Architecture for XML Binding; p. 1317) is a set of classes for converting POJOs to and from XML. Class `JAXB` (package `javax.xml.bind`) contains static methods for common operations.
 - Class `JAXB`'s static method `marshal` (p. 1317) converts a Java object to XML format.
 - GlassFish does not provide test pages for RESTful services, but NetBeans generates a test page that can be accessed by right clicking the project's node in the **Projects** tab and selecting **Test RESTful Web Services**.
 - On the test page, select a method element in the left column. The right side of the page displays a form that allows you to choose the MIME type of the data and lets you enter the method's arguments. Click the **Test** button to invoke the web service and display the returned data.
 - WADL (Web Application Description Language; p. 1318) has similar design goals to WSDL, but describes RESTful services instead of SOAP services.

Section 31.7.2 Consuming a REST-Based XML Web Service

- Clients of RESTful web services do not require web service references.
- The JAXB class has a static `unmarshal` method that takes as arguments a file name or URL as a `String`, and a `Class<T>` object indicating the Java class to which the XML will be converted.

Section 31.8 Publishing and Consuming REST-Based JSON Web Services

- JSON components—objects, arrays, strings, numbers—can be easily mapped to constructs in Java and other programming languages.
- There are many open-source JSON libraries for Java and other languages. The Gson library from code.google.com/p/google-gson/ provides a simple way to convert POJOs to and from JSON.

Section 31.8.1 Creating a REST-Based JSON Web Service

- To add a JAR file as a library in NetBeans, right click your project's **Libraries** folder, select **Add JAR/Folder...**, locate the JAR file and click **Open**.
- For a web service method that returns JSON text, the argument to the `@Produces` attribute must be `"application/json"`.
- In JSON, all data must be encapsulated in a composite data type.
- Create a Gson object (from package `com.google.gson`) and call its `toJson` method to convert an object into its JSON `String` representation.

Section 31.8.2 Consuming a REST-Based JSON Web Service

- To read JSON data from a URL, create a `URL` object and call its `openStream` method (p. 1324). This invokes the web service and returns an `InputStream` from which the client can read the response. Wrap the `InputStream` in an `InputStreamReader` so it can be passed as the first argument to the Gson class's `fromJson` method (p. 1324).

Section 31.9 Session Tracking in a SOAP Web Service

- It can be beneficial for a web service to maintain client state information, thus eliminating the need to pass client information between the client and the web service multiple times. Storing session information also enables a web service to distinguish between clients.

Section 31.9.1 Creating a Blackjack Web Service

- In JAX-WS 2.2, to enable session tracking in a web service, you simply precede your web service class with the `@HttpSessionScope` annotation (p. 1327) from package `com.sun.xml.ws.developer.servlet`. To use this package you must add the JAX-WS 2.2 library to your project.
- Once a web service is annotated with `@HttpSessionScope`, the server automatically maintains a separate instance of the class for each client session.

Section 31.9.2 Consuming the Blackjack Web Service

- In the JAX-WS framework, the client must indicate whether it wants to allow the web service to maintain session information. To do this, first cast the proxy object to interface type `BindingProvider`. A `BindingProvider` enables the client to manipulate the request information that will be sent to the server. This information is stored in an object that implements interface `RequestContext`. The `BindingProvider` and `RequestContext` are part of the framework that is created by the IDE when you add a web service client to the application.
- Next, invoke the `BindingProvider`'s `getRequestContext` method to obtain the `RequestContext` object. Then call the `RequestContext`'s `put` method to set the property `BindingProvider.SESSION_MAINTAIN_PROPERTY` to `true`, which enables session tracking from the client side so that the web service knows which client is invoking the service's web methods.

Section 31.11 Equation Generator: Returning User-Defined Types

- It's also possible to process instances of class types in a web service. These types can be passed to or returned from web service methods.
- An instance variable can be serialized only if it's `public` or has both a `get` and a `set` method.
- Properties that can be generated from the values of other properties should not be serialized to prevent redundancy.
- JAX-RS automatically converts arguments from an `@Path` annotation to the correct type, and it will return a "not found" error to the client if the argument cannot be converted from the `String` passed as part of the URL to the destination type. Supported types for conversion include integer types, floating-point types, `boolean` and the corresponding type-wrapper classes.

Self-Review Exercises

- 31.1** State whether each of the following is *true* or *false*. If *false*, explain why.
- All methods of a web service class can be invoked by clients of that web service.
 - When consuming a web service in a client application created in NetBeans, you must create the proxy class that enables the client to communicate with the web service.
 - A proxy class communicating with a web service normally uses SOAP to send and receive messages.
 - Session tracking is automatically enabled in a client of a web service.
 - Web methods cannot be declared `static`.
 - A user-defined type used in a web service must define both `get` and `set` methods for any property that will be serialized.
 - Operations in a REST web service are defined by their own unique URLs.
 - A SOAP-based web service can return data in JSON format.

31.2 Fill in the blanks for each of the following statements:

- a) A key difference between SOAP and REST is that SOAP messages have data wrapped in a(n) _____.
- b) A web service in Java is a(n) _____—it does not need to implement any interfaces or extend any classes.
- c) Web service requests are typically transported over the Internet via the _____ protocol.
- d) To set the exposed name of a web method, use the _____ element of the `@WebMethod` annotation.
- e) _____ transforms an object into a format that can be sent between a web service and a client.
- f) To return data in JSON format from a method of a REST-based web service, the `@Produces` annotation is set to _____.
- g) To return data in XML format from a method of a REST-based web service, the `@Produces` annotation is set to _____.

Answers to Self-Review Exercises

31.1 a) False. Only methods declared with the `@WebMethod` annotation can be invoked by a web service's clients. b) False. The proxy class is created by NetBeans when you add a web service client to the application. c) True. d) False. In the JAX-WS framework, the client must indicate whether it wants to allow the web service to maintain session information. First, you must cast the proxy object to interface type `BindingProvider`, then use the `BindingProvider`'s `getRequestContext` method to obtain the `RequestContext` object. Finally, you must use the `RequestContext`'s `put` method to set the property `BindingProvider.SESSION_MAINTAIN_PROPERTY` to `true`. e) True. f) True. g) True. h) False. A SOAP web service implicitly returns data in XML format.

31.2 a) SOAP message or SOAP envelope. b) POJO (plain old Java object) c) HTTP. d) `operationName`. e) serialization. f) `"application/json"`. g) `"application/xml"`.

Exercises

31.3 (*Phone Book Web Service*) Create a RESTful web service that stores phone book entries in the database `PhoneBookDB` and a web client application that consumes this service. The web service should output XML. Use the steps in Section 30.2.1 to create the `PhoneBook` database and a data source name for accessing it. The database contains one table—`PhoneBook`—with three columns—`LastName`, `FirstName` and `PhoneNumber`. The `LastName` and `FirstName` columns store up to 30 characters. The `PhoneNumber` column supports phone numbers of the form (800) 555-1212 that contain 14 characters. Use the `PhoneBookDB.sql` script provided in the examples folder to create the `PhoneBook` table.

Give the client user the capability to enter a new contact (web method `addEntry`) and to find contacts by last name (web method `getEntries`). Pass only `Strings` as arguments to the web service. The `getEntries` web method should return an array of `Strings` that contains the matching phone book entries. Each `String` in the array should consist of the last name, first name and phone number for one phone book entry. These values should be separated by commas.

The `SELECT` query that will find a `PhoneBook` entry by last name should be:

```
SELECT LastName, FirstName, PhoneNumber
FROM PhoneBook
WHERE (LastName = LastName)
```

The `INSERT` statement that inserts a new entry into the `PhoneBook` database should be:

```
INSERT INTO PhoneBook (LastName, FirstName, PhoneNumber)
VALUES (LastName, FirstName, PhoneNumber)
```

31.4 (*Phone Book Web Service Modification*) Modify Exercise 31.3 so that it uses a class named `PhoneBookEntry` to represent a row in the database. The web service should return objects of type `PhoneBookEntry` in XML format for the `getEntries` method, and the client application should use the JAXB method `unmarshal` to retrieve the `PhoneBookEntry` objects.

31.5 (*Phone-Book Web Service with JSON*) Modify Exercise 31.4 so that the `PhoneBookEntry` class is passed to and from the web service as a JSON object. Use serialization to convert the JSON object into an object of type `PhoneBookEntry`.

31.6 (*Blackjack Web Service Modification*) Modify the `Blackjack` web service example in Section 31.9 to include class `Card`. Modify web method `dealCard` so that it returns an object of type `Card` and modify web method `getHandValue` so that it receives an array of `Card` objects from the client. Also modify the client application to keep track of what cards have been dealt by using `ArrayLists` of `Card` objects. The proxy class created by NetBeans will treat a web method's array parameter as a `List`, so you can pass these `ArrayLists` of `Card` objects directly to the `getHandValue` method. Your `Card` class should include *set* and *get* methods for the face and suit of the card.

31.7 (*Project: Airline Reservation Web-Service Modification*) Modify the airline reservation web service in Section 31.10 so that it contains two separate methods—one that allows users to view all available seats, and another that allows users to reserve a particular seat that is currently available. Use an object of type `Ticket` to pass information to and from the web service. The web service must be able to handle cases in which two users view available seats, one reserves a seat and the second user tries to reserve the same seat, not knowing that it's now taken. The names of the methods that execute should be `reserve` and `getAllAvailableSeats`.

31.8 (*Project: Morse Code Web Service*) In Exercise 16.22, you learned about Morse Code and wrote applications that could translate English phrases into Morse Code and vice versa. Create a SOAP-based web service that provides two methods—one that translates an English phrase into Morse Code and one that translates Morse Code into English. Next, build a Morse Code translator GUI application that invokes the web service to perform these translations.

Making a Difference

31.9 (*Project: Spam Scanner Web Service*) In Exercise 16.27, you created a spam scanner application that scanned an e-mail and gave it a point rating based on the occurrence of certain words and phrases that commonly appear in spam e-mails and how many times the words and phrases occurred in the e-mail. Create a SOAP-based Spam scanner web service. Next, modify the GUI application you created in Exercise 16.27 to use the web service to scan an e-mail. Then display the point rating returned by the web service.

31.10 (*Project: SMS Web Service*) In Exercise 16.28, you created an SMS message-translator application. Create a SOAP-based web service with three methods:

- a) one that receives an SMS abbreviation and returns the corresponding English word or phrase,
- b) one that receives an entire SMS message and returns the corresponding English text, and
- c) one that translates English text into an SMS message.

Use the web service from a GUI application that displays the web service's responses.

31.11 (*Project: Gender-Neutrality Web Service*) In Exercise 1.12, you researched eliminating sexism in all forms of communication. You then described the algorithm you'd use to read through a paragraph of text and replace gender-specific words with gender-neutral equivalents. Create a SOAP-based web service that receives a paragraph of text, then replaces gender-specific words with gender-neutral ones. Use the web service from a GUI application that displays the resulting gender-neutral text.



Operator Precedence Chart

Operators are shown in decreasing order of precedence from top to bottom (Fig. A.1).

Operator	Description	Associativity
++ --	unary postfix increment unary postfix decrement	right to left
++ -- + - ! ~ (<i>type</i>)	unary prefix increment unary prefix decrement unary plus unary minus unary logical negation unary bitwise complement unary cast	right to left
* / %	multiplication division remainder	left to right
+ -	addition or string concatenation subtraction	left to right
<< >> >>>	left shift signed right shift unsigned right shift	left to right
< <= > >= instanceof	less than less than or equal to greater than greater than or equal to type comparison	left to right
== !=	is equal to is not equal to	left to right
&	bitwise AND boolean logical AND	left to right
^	bitwise exclusive OR boolean logical exclusive OR	left to right

Fig. A.1 | Operator precedence chart. (Part 1 of 2.)

Operator	Description	Associativity
	bitwise inclusive OR boolean logical inclusive OR	left to right
&&	conditional AND	left to right
	conditional OR	left to right
?:	conditional	right to left
=	assignment	right to left
+=	addition assignment	
-=	subtraction assignment	
*=	multiplication assignment	
/=	division assignment	
%=	remainder assignment	
&=	bitwise AND assignment	
^=	bitwise exclusive OR assignment	
=	bitwise inclusive OR assignment	
<<=	bitwise left-shift assignment	
>>=	bitwise signed-right-shift assignment	
>>>=	bitwise unsigned-right-shift assignment	

Fig. A.1 | Operator precedence chart. (Part 2 of 2.)

B

ASCII Character Set

	0	1	2	3	4	5	6	7	8	9
0	nul	soh	stx	etx	eot	enq	ack	bel	bs	ht
1	n1	vt	ff	cr	so	si	d1e	dc1	dc2	dc3
2	dc4	nak	syn	etb	can	em	sub	esc	fs	gs
3	rs	us	sp	!	"	#	\$	%	&	'
4	()	*	+	,	-	.	/	0	1
5	2	3	4	5	6	7	8	9	:	;
6	<	=	>	?	@	A	B	C	D	E
7	F	G	H	I	J	K	L	M	N	O
8	P	Q	R	S	T	U	V	W	X	Y
9	Z	[\]	^	_	'	a	b	c
10	d	e	f	g	h	i	j	k	l	m
11	n	o	p	q	r	s	t	u	v	w
12	x	y	z	{		}	~	del		

Fig. B.1 | ASCII character set.

The digits at the left of the table are the left digits of the decimal equivalents (0–127) of the character codes, and the digits at the top of the table are the right digits of the character codes. For example, the character code for “F” is 70, and the character code for “&” is 38.

Most users of this book are interested in the ASCII character set used to represent English characters on many computers. The ASCII character set is a subset of the Unicode character set used by Java to represent characters from most of the world’s languages. For more information on the Unicode character set, see the web bonus Appendix N.

C

Keywords and Reserved Words

Java Keywords				
abstract	assert	boolean	break	byte
case	catch	char	class	continue
default	do	double	else	enum
extends	final	finally	float	for
if	implements	import	instanceof	int
interface	long	native	new	package
private	protected	public	return	short
static	strictfp	super	switch	synchronized
this	throw	throws	transient	try
void	volatile	while		
<i>Keywords that are not currently used</i>				
const	goto			

Fig. C.1 | Java keywords.

Java also contains the reserved words `true` and `false`, which are boolean literals, and `null`, which is the literal that represents a reference to nothing. Like keywords, these reserved words cannot be used as identifiers.

D

Primitive Types

Type	Size in bits	Values	Standard
<code>boolean</code>		true or false [<i>Note: A boolean's representation is specific to the Java Virtual Machine on each platform.</i>]	
<code>char</code>	16	'\u0000' to '\uFFFF' (0 to 65535)	(ISO Unicode character set)
<code>byte</code>	8	-128 to +127 (-2^7 to $2^7 - 1$)	
<code>short</code>	16	-32,768 to +32,767 (-2^{15} to $2^{15} - 1$)	
<code>int</code>	32	-2,147,483,648 to +2,147,483,647 (-2^{31} to $2^{31} - 1$)	
<code>long</code>	64	-9,223,372,036,854,775,808 to +9,223,372,036,854,775,807 (-2^{63} to $2^{63} - 1$)	
<code>float</code>	32	<i>Negative range:</i> -3.4028234663852886E+38 to -1.40129846432481707e-45 <i>Positive range:</i> 1.40129846432481707e-45 to 3.4028234663852886E+38	(IEEE 754 floating point)
<code>double</code>	64	<i>Negative range:</i> -1.7976931348623157E+308 to -4.94065645841246544e-324 <i>Positive range:</i> 4.94065645841246544e-324 to 1.7976931348623157E+308	(IEEE 754 floating point)

Fig. D.1 | Java primitive types.

For more information on IEEE 754 visit grouper.ieee.org/groups/754/. For more information on Unicode, see Appendix N.

E

Using the Java API Documentation

E.1 Introduction

The Java class library contains thousands of predefined classes and interfaces that programmers can use to write their own applications. These classes are grouped into packages based on their functionality. For example, the classes and interfaces used for file processing are grouped into the `java.io` package, and the classes and interfaces for networking applications are grouped into the `java.net` package. The **Java API documentation** lists the public and protected members of each class and the public members of each interface in the Java class library. The documentation overviews all the classes and interfaces, summarizes their members (i.e., the fields, constructors and methods of classes, and the fields and methods of interfaces) and provides detailed descriptions of each member. Most Java programmers rely on this documentation when writing programs. Normally, programmers would search the API to find the following:

1. The package that contains a particular class or interface.
2. Relationships between a particular class or interface and other classes and interfaces.
3. Class or interface constants—normally declared as `public static final` fields.
4. Constructors to determine how an object of the class can be initialized.
5. The methods of a class to determine whether they're `static` or `non-static`, the number and types of the arguments you need to pass, the return types and any exceptions that might be thrown from the method.

In addition, programmers often rely on the documentation to discover classes and interfaces that they have not used before. For this reason, we demonstrate the documentation with classes you know and classes you may not have studied yet. We show how to use the documentation to locate the information you need to use a class or interface effectively.

E.2 Navigating the Java API

The Java API documentation can be downloaded to your local hard disk or viewed online. To download the Java API documentation, go to www.oracle.com/technetwork/java/javase/downloads/index.html scroll down to the **Additional Resources** section and click the **Download Zip** button to the right of **Java SE 6 Documentation**. You'll be asked to accept a license agreement. To do this, click **Accept**, then click **Continue**. Click the link to

the ZIP file to begin downloading it. After downloading the file, you can use a program such as WinZip (www.winzip.com) to extract the files. If you're using Windows, extract the contents to your JDK's installation directory. To view the API documentation on your local hard disk in Microsoft Windows, open `C:\Program Files\Java\YourJDKVersion\docs\api\index.html` page in your browser. To view the API documentation online, go to download.oracle.com/javase/6/docs/api/ (Fig. E.1).

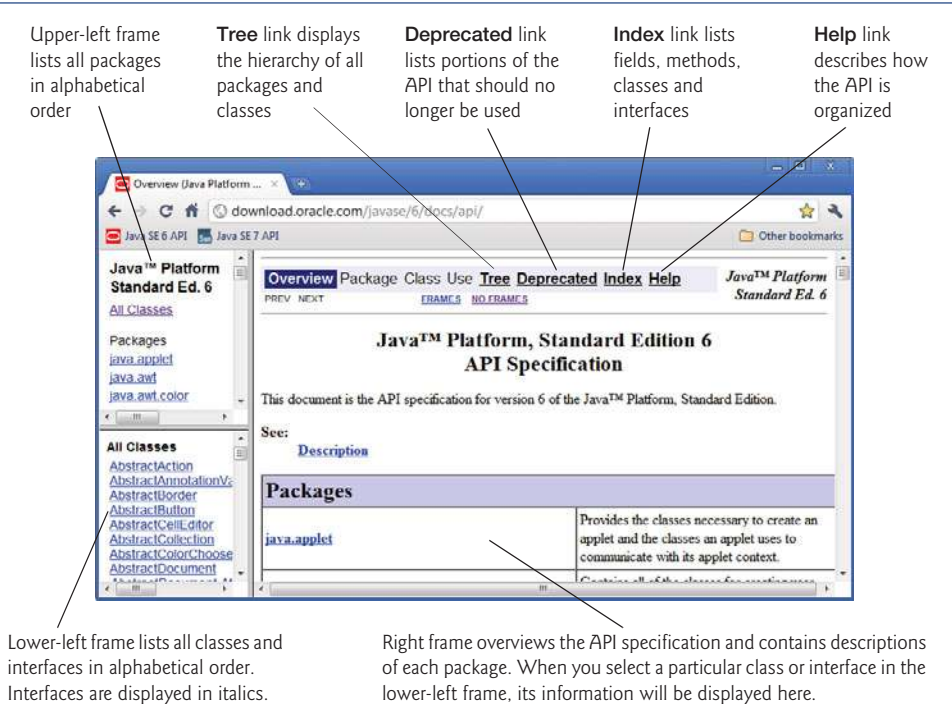

Fig. E.1 | Java API overview. (Courtesy of Oracle Corporation)

Frames in the API Documentation's `index.html` Page

The API documentation is divided into three frames (see Fig. E.1). The upper-left frame lists all of the Java API's packages in alphabetical order. The lower-left frame initially lists the Java API's classes and interfaces in alphabetical order. Interface names are displayed in italic. When you click a specific package in the upper-left frame, the lower-left frame lists the classes and interfaces of the selected package. The right frame initially provides a brief description of each package of the Java API specification—read this overview to become familiar with the general capabilities of the Java APIs. If you select a class or interface in the lower-left frame, the right frame displays information about that class or interface.

Important Links in the `index.html` Page

At the top of the right frame (Fig. E.1), there are four links—**Tree**, **Deprecated**, **Index** and **Help**. The **Tree** link displays the hierarchy of all packages, classes and interfaces in a tree structure. The **Deprecated** link displays interfaces, classes, exceptions, fields, constructors and methods that should no longer be used. The **Index** link displays classes, interfaces,

fields, constructors and methods in alphabetical order. The **Help** link describes how the API documentation is organized. You should probably begin by reading the **Help** page.

Viewing the Index Page

If you do not know the name of the class you're looking for, but you do know the name of a method or field, you can use the documentation's index to locate the class. The **Index** link is located near the upper-right corner of the right frame. The index page (Fig. E.2) displays fields, constructors, methods, interfaces and classes in alphabetical order. For example, if you're looking for Scanner method `hasNextInt`, but do not know the class name, you can click the **H** link to go to the alphabetical listing of all items in the Java API that begin with "h". Scroll to method `hasNextInt` (Fig. E.3). Once there, each method named `hasNextInt` is listed with the package name and class to which the method belongs. From there, you can click the class name to view the class's complete details, or you can click the method name to view the method's details.

Classes, interfaces and their members are listed in alphabetical order. Click a letter to view all fields, constructors, methods, interfaces and classes that start with that letter.

Click the **Index** link to display the documentation's index



Fig. E.2 | Viewing the **Index** page. (Courtesy of Oracle Corporation.)

Viewing a Specific Package

When you click the package name in the upper-left frame, all classes and interfaces from that package are displayed in the lower-left frame and are divided into five subsections—**Interfaces**, **Classes**, **Enums**, **Exceptions** and **Errors**—each listed alphabetically. For example, the contents of package `javax.swing` are displayed in the lower-left frame (Fig. E.4) when you click `javax.swing` in the upper-left frame. You can click the package name in the lower-left frame to get an overview of the package. If you think that a package contains several classes that could be useful in your application, the package overview can be especially helpful.

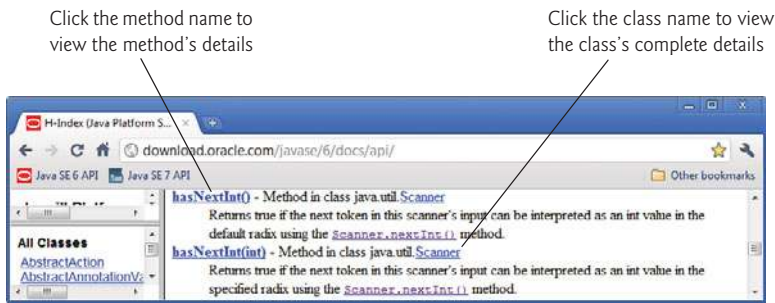

Fig. E.3 | Scroll to method `hasNextInt`. (Courtesy of Oracle Corporation)

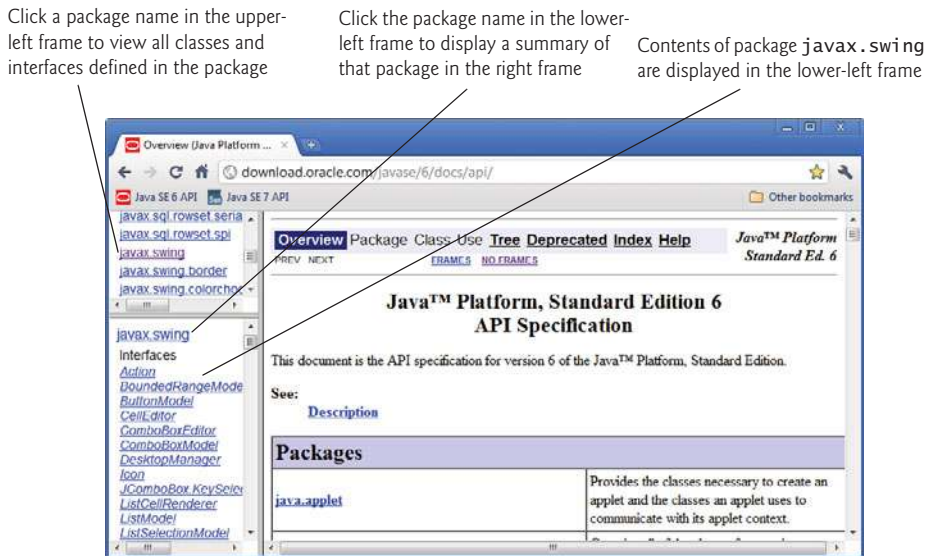

Fig. E.4 | Clicking a package name in the upper-left frame to view all classes and interfaces declared in this package. (Courtesy of Oracle Corporation)

Viewing the Details of a Class

When you click a class name or interface name in the lower-left frame, the right frame displays the details of that class or interface. First you'll see the class's package name followed by a hierarchy that shows the class's relationship to other classes. You'll also see a list of the interfaces implemented by the class and the class's known subclasses. Figure E.5 shows the beginning of the documentation page for class `JButton` from the `javax.swing` package. The page first shows the package name in which the class appears. This is followed by the class hierarchy that leads to class `JButton`, the interfaces class `JButton` implements and the subclasses of class `JButton`. The bottom of the right frame shows the beginning of class `JButton`'s description. When you look at the documentation for an interface, the right frame does not display a hierarchy for that interface. Instead, the right frame lists the interface's superinterfaces, known subinterfaces and known implementing classes.

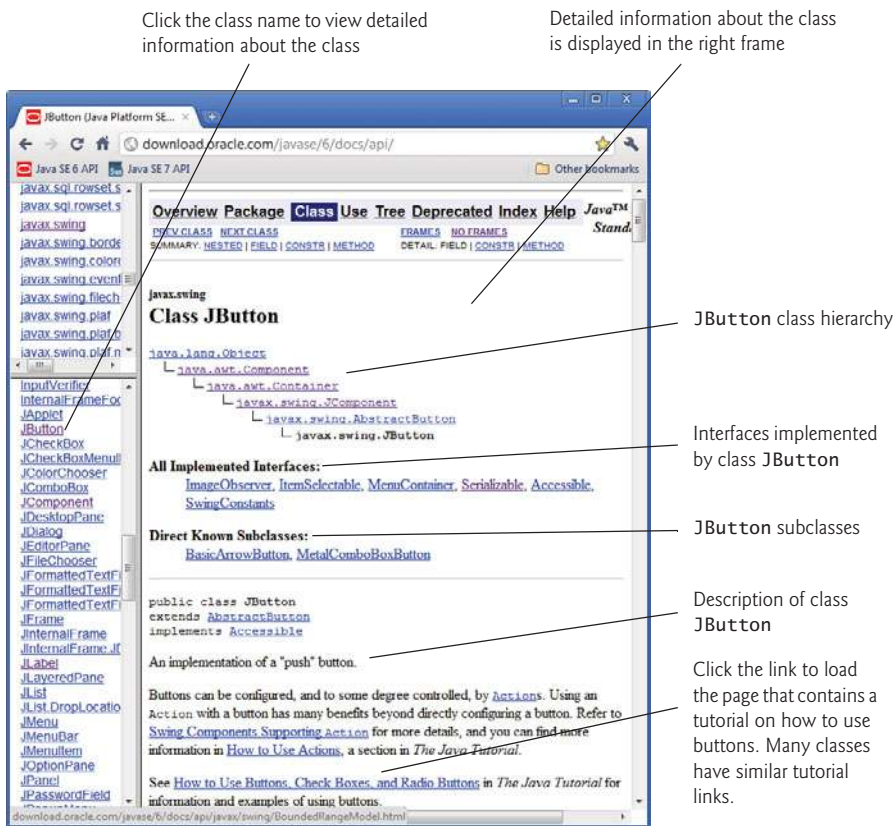

Fig. E.5 | Clicking a class name to view detailed information about the class. (Courtesy of Oracle Corporation)

Summary Sections in a Class's Documentation Page

Other parts of each API page are listed below. Each part is presented only if the class contains or inherits the items specified. Class members shown in the summary sections are `public` unless they're explicitly marked as `protected`. A class's `private` members are not shown in the documentation, because they cannot be used directly in your programs.

1. The **Nested Class Summary** section summarizes the class's `public` and `protected` nested classes—i.e., classes that are defined inside the class. Unless explicitly specified, these classes are `public` and `non-static`.
2. The **Field Summary** section summarizes the class's `public` and `protected` fields. Unless explicitly specified, these fields are `public` and `non-static`. Figure E.6 shows the **Field Summary** section of class `Color`.
3. The **Constructor Summary** section summarizes the class's constructors. Constructors are not inherited, so this section appears in the documentation for a class only if the class declares one or more constructors. Figure E.7 shows the **Constructor Summary** section of class `JButton`.

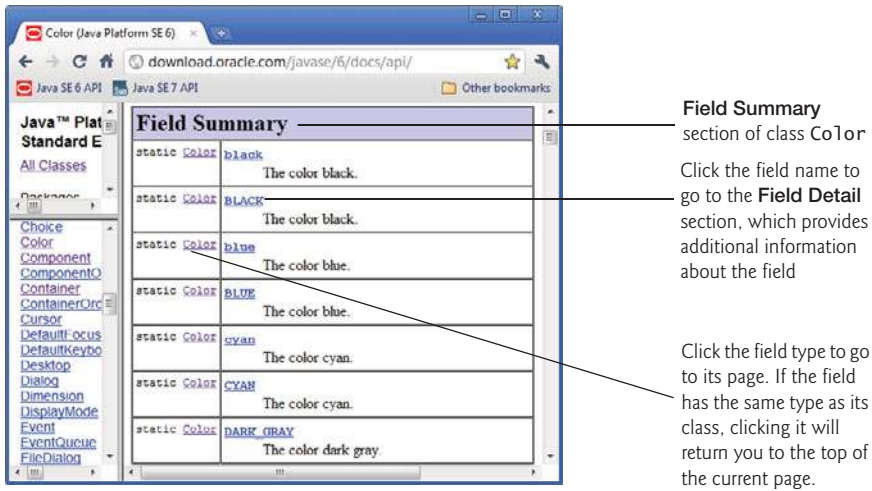

Fig. E.6 | Field Summary section of class `Color`. (Courtesy of Oracle Corporation)

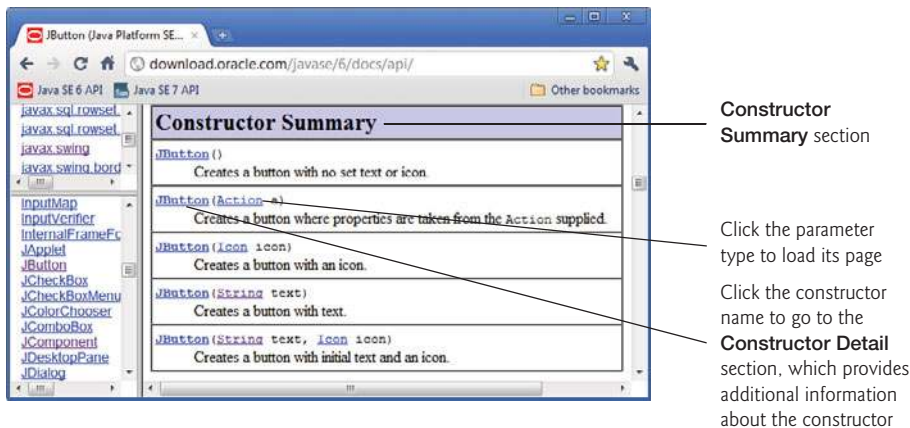

Fig. E.7 | Constructor Summary section of class `JButton`. (Courtesy of Oracle Corporation)

- The **Method Summary** section summarizes the class's public and protected methods. Unless explicitly specified, these methods are public and non-static. Figure E.8 shows the **Method Summary** section of class `BufferedInputStream`.

The summary sections typically provide only a one-sentence description of a class member. Additional details are presented in the detail sections discussed next.

Detail Sections in a Class's Documentation Page

After the summary sections are detail sections that normally provide more discussion of particular class members. There isn't a detail section for nested classes. When you click the



Fig. E.8 | Method Summary section of class `BufferedInputStream`. (Courtesy of Oracle Corporation)

link in the **Nested Class Summary** for a particular nested class, a documentation page describing that nested class is displayed. The detail sections are described below.

1. The **Field Detail** section provides the declaration of each field. It also discusses each field, including the field's modifiers and meaning. Figure E.9 shows the **Field Detail** section of class `Color`.
2. The **Constructor Detail** section provides the first line of each constructor's declaration and discusses the constructors. The discussion includes the modifiers of each constructor, a description of each constructor, each constructor's parameters and any exceptions thrown by each constructor. Figure E.10 shows the **Constructor Detail** section of class `JButton`.
3. The **Method Detail** section provides the first line of each method. The discussion of each method includes its modifiers, a more complete method description, the method's parameters, the method's return type and any exceptions thrown by the method. Figure E.11 shows class `BufferedInputStream`'s **Method Detail** section.

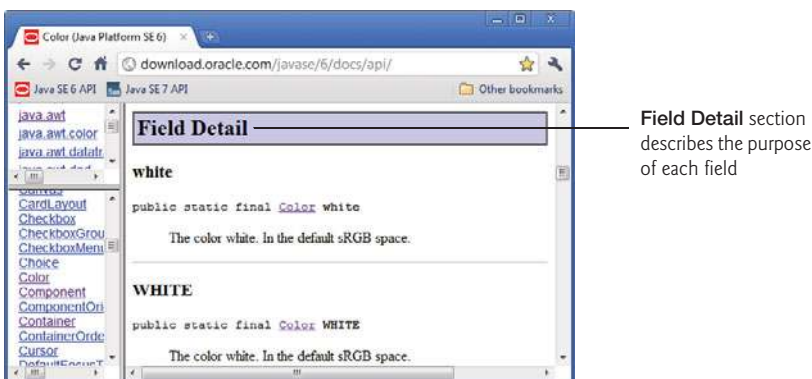

Fig. E.9 | Field Detail section of class `Color`. (Courtesy of Oracle Corporation)



Fig. E.10 | Constructor Detail section of class `JButton`. (Courtesy of Oracle Corporation)

The method details show you other methods that might be of interest (labeled as **See Also**). If the method overrides a method of the superclass, the name of the superclass method and the name of the superclass are provided so you can link to the method or superclass for more information.

Method `read` throws `IOException`. Click `IOException` to load the `IOException` class information page and learn more about the exception type (e.g., why such an exception might be thrown)

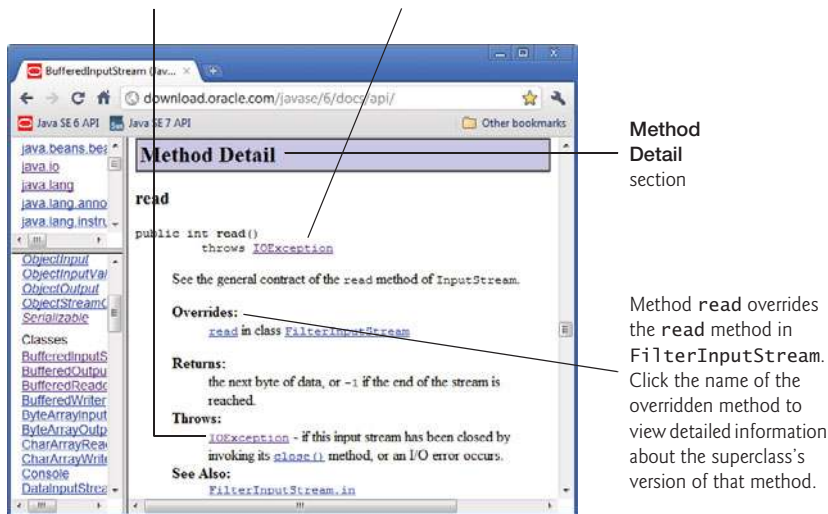

Fig. E.11 | Method Detail section of class `BufferedInputStream`. (Courtesy of Oracle Corporation)

As you look through the documentation, you'll notice that there are often links to other fields, methods, nested-classes and top-level classes. These links enable you to jump from the class you're looking at to another relevant portion of the documentation.

F

Using the Debugger

And so shall I catch the fly.

—William Shakespeare

*We are built to make mistakes,
coded for error.*

—Lewis Thomas

*What we anticipate seldom
occurs; what we least expect
generally happens.*

—Benjamin Disraeli

Objectives

In this appendix you'll learn:

- To set breakpoints to debug applications.
- To use the `run` command to run an application through the debugger.
- To use the `stop` command to set a breakpoint.
- To use the `cont` command to continue execution.
- To use the `print` command to evaluate expressions.
- To use the `set` command to change variable values during program execution.
- To use the `step`, `step up` and `next` commands to control execution.
- To use the `watch` command to see how a field is modified during program execution.
- To use the `clear` command to list breakpoints or remove a breakpoint.

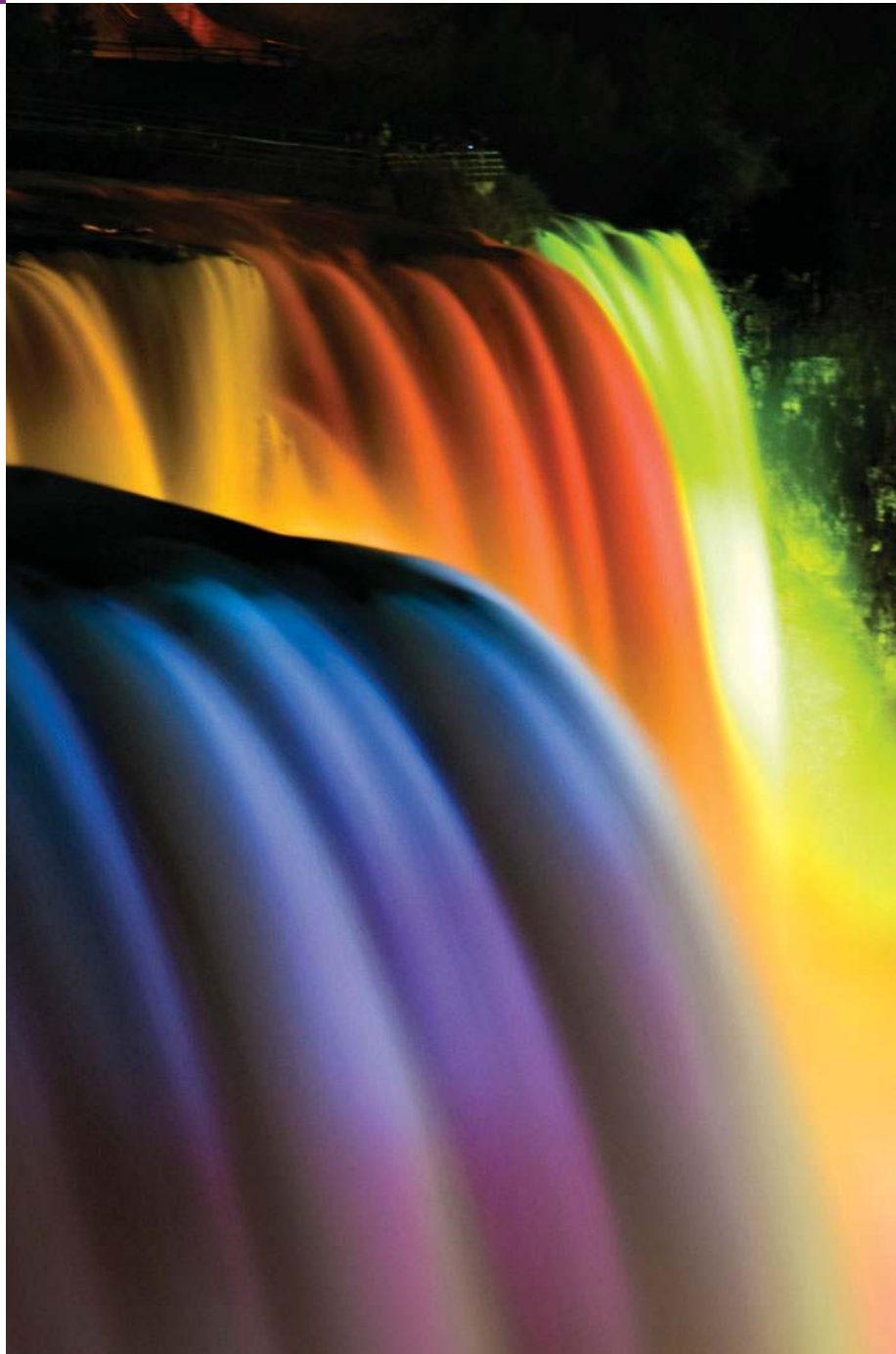

- | | |
|--|------------------------------|
| F.1 Introduction | F.5 The watch Command |
| F.2 Breakpoints and the run, stop, cont and print Commands | F.6 The clear Command |
| F.3 The print and set Commands | F.7 Wrap-Up |
| F.4 Controlling Execution Using the step, step up and next Commands | |

Self-Review Exercises | Answers to Self-Review Exercises

F.1 Introduction

In Chapter 2, you learned that there are two types of errors—syntax errors and logic errors—and you learned how to eliminate syntax errors from your code. Logic errors do not prevent the application from compiling successfully, but they do cause an application to produce erroneous results when it runs. The JDK includes software called a **debugger** that allows you to monitor the execution of your applications so you can locate and remove logic errors. The debugger will be one of your most important application development tools. Many IDEs provide their own debuggers similar to the one included in the JDK or provide a graphical user interface to the JDK’s debugger.

This appendix demonstrates key features of the JDK’s debugger using command-line applications that receive no input from the user. The same debugger features discussed here can be used to debug applications that take user input, but debugging such applications requires a slightly more complex setup. To focus on the debugger features, we’ve opted to demonstrate the debugger with simple command-line applications involving no user input. For more information on the Java debugger visit download.oracle.com/javase/6/docs/technotes/tools/windows/jdb.html.

F.2 Breakpoints and the run, stop, cont and print Commands

We begin our study of the debugger by investigating **breakpoints**, which are markers that can be set at any executable line of code. When application execution reaches a breakpoint, execution pauses, allowing you to examine the values of variables to help determine whether logic errors exist. For example, you can examine the value of a variable that stores the result of a calculation to determine whether the calculation was performed correctly. Setting a breakpoint at a line of code that is not executable (such as a comment) causes the debugger to display an error message.

To illustrate the features of the debugger, we use application `AccountTest` (Fig. F.1), which creates and manipulates an object of class `Account` (Fig. 3.13). Execution of `AccountTest` begins in `main` (lines 7–24). Line 9 creates an `Account` object with an initial balance of \$50.00. Recall that `Account`’s constructor accepts one argument, which specifies the `Account`’s initial balance. Lines 12–13 output the initial account balance using `Account` method `getBalance`. Line 15 declares and initializes a local variable `depositAmount`. Lines 17–19 then print `depositAmount` and add it to the `Account`’s balance using

its credit method. Finally, lines 22–23 display the new balance. [Note: The Appendix F examples directory contains a copy of `Account.java` identical to the one in Fig. 3.13.]

```

1 // Fig. F.1: AccountTest.java
2 // Create and manipulate an Account object.
3
4 public class AccountTest
5 {
6     // main method begins execution
7     public static void main( String[] args )
8     {
9         Account account = new Account( 50.00 ); // create Account object
10
11        // display initial balance of Account object
12        System.out.printf( "initial account balance: %.2f\n",
13            account.getBalance() );
14
15        double depositAmount = 25.0; // deposit amount
16
17        System.out.printf( "\nadding %.2f to account balance\n\n",
18            depositAmount );
19        account.credit( depositAmount ); // add to account balance
20
21        // display new balance
22        System.out.printf( "new account balance: %.2f\n",
23            account.getBalance() );
24    } // end main
25
26 } // end class AccountTest

```

```

initial account balance: $50.00
adding 25.00 to account balance
new account balance: $75.00

```

Fig. F.1 | `AccountTest` class creates and manipulates an `Account` object.

In the following steps, you'll use breakpoints and various debugger commands to examine the value of the variable `depositAmount` declared in `AccountTest` (Fig. F.1).

1. *Opening the Command Prompt window and changing directories.* Open the Command Prompt window by selecting **Start > Programs > Accessories > Command Prompt**. Change to the directory containing the Appendix F examples by typing `cd C:\examples\debugger` [Note: If your examples are in a different directory, use that directory here.]
2. *Compiling the application for debugging.* The Java debugger works only with `.class` files that were compiled with the `-g` compiler option, which generates information that is used by the debugger to help you debug your applications. Compile the application with the `-g` command-line option by typing `javac -g AccountTest.java Account.java`. Recall from Chapter 3 that this command compiles both `AccountTest.java` and `Account.java`. The command `java -g *.java` compiles all of the working directory's `.java` files for debugging.

3. *Starting the debugger.* In the **Command Prompt**, type **jdb** (Fig. F.2). This command will start the Java debugger and enable you to use its features. [Note: We modified the colors of our **Command Prompt** window for readability.]

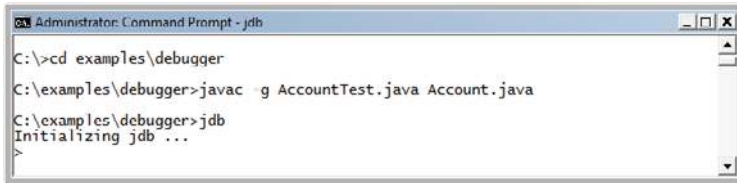

```
Administrator: Command Prompt - jdb
C:\>cd examples\debugger
C:\examples\debugger>javac -g AccountTest.java Account.java
C:\examples\debugger>jdb
Initializing jdb ...
>
```

Fig. F.2 | Starting the Java debugger.

4. *Running an application in the debugger.* Run the **AccountTest** application through the debugger by typing **run AccountTest** (Fig. F.3). If you do not set any breakpoints before running your application in the debugger, the application will run just as it would using the **java** command.

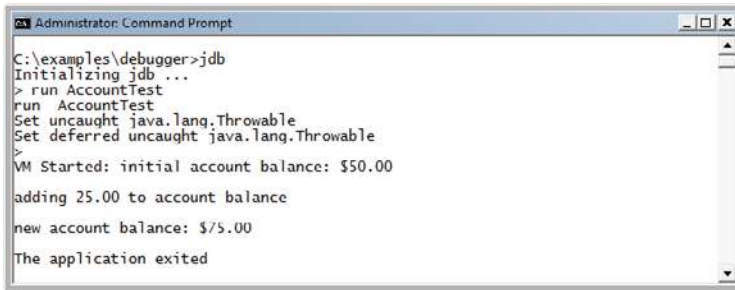

```
Administrator: Command Prompt
C:\examples\debugger>jdb
Initializing jdb ...
> run AccountTest
run AccountTest
Set uncaught java.lang.Throwable
Set deferred uncaught java.lang.Throwable
VM Started: initial account balance: $50.00
adding 25.00 to account balance
new account balance: $75.00
The application exited
```

Fig. F.3 | Running the **AccountTest** application through the debugger.

5. *Restarting the debugger.* To make proper use of the debugger, you must set at least one breakpoint before running the application. Restart the debugger by typing **jdb**.
6. *Inserting breakpoints in Java.* You set a breakpoint at a specific line of code in your application. The line numbers used in these steps are from the source code in Fig. F.1. Set a breakpoint at line 12 in the source code by typing **stop at AccountTest:12** (Fig. F.4). The **stop command** inserts a breakpoint at the line number specified after the command. You can set as many breakpoints as necessary. Set another breakpoint at line 19 by typing **stop at AccountTest:19** (Fig. F.4). When the application runs, it suspends execution at any line that contains a breakpoint. The application is said to be in **break mode** when the debugger pauses the application's execution. Breakpoints can be set even after the debugging process has begun. The debugger command **stop in**, followed by a class name, a period and a method name (e.g., **stop in Account.credit**) instructs the debugger to set a breakpoint at the first executable statement in the specified method. The debugger pauses execution when program control enters the method.

```

Administrator: Command Prompt - jdb
C:\examples\debugger>jdb
Initializing jdb ...
> stop_at AccountTest:12
Deferring breakpoint AccountTest:12.
It will be set after the class is loaded.
> stop_at AccountTest:19
Deferring breakpoint AccountTest:19.
It will be set after the class is loaded.
>

```

Fig. F.4 | Setting breakpoints at lines 12 and 19.

7. *Running the application and beginning the debugging process.* Type `run` `AccountTest` to execute the application and begin the debugging process (Fig. F.5). The debugger prints text indicating that breakpoints were set at lines 12 and 19. It calls each breakpoint a “deferred breakpoint” because each was set before the application began running in the debugger. The application pauses when execution reaches the breakpoint on line 12. At this point, the debugger notifies you that a breakpoint has been reached and it displays the source code at that line (12). That line of code is the next statement that will execute.

```

Administrator: Command Prompt - jdb
It will be set after the class is loaded.
> run AccountTest
run AccountTest
Set uncaught java.lang.Throwable
Set deferred uncaught java.lang.Throwable
>
VM Started: Set deferred breakpoint AccountTest:19
Set deferred breakpoint AccountTest:12
Breakpoint hit: "thread=main", AccountTest.main(), line=12 bci=11
12 System.out.printf("initial account balance: %$.2f\n",
main[1]

```

Next line of code to execute Breakpoint is reached

Fig. F.5 | Restarting the `AccountTest` application.

8. *Using the `cont` command to resume execution.* Type `cont`. The **cont** command causes the application to continue running until the next breakpoint is reached (line 19), at which point the debugger notifies you (Fig. F.6). `AccountTest`’s normal output appears between messages from the debugger.

Another breakpoint is reached

```

Administrator: Command Prompt - jdb
main[1] cont
> initial account balance: $50.00
adding 25.00 to account balance
Breakpoint hit: "thread=main", AccountTest.main(), line=19 bci=58
19 account.credit( depositAmount ); // add to account balance
main[1]

```

Fig. F.6 | Execution reaches the second breakpoint.

9. *Examining a variable's value.* Type `print depositAmount` to display the current value stored in the `depositAmount` variable (Fig. F.7). The **print command** allows you to peek inside the computer at the value of one of your variables. This command will help you find and eliminate logic errors in your code. The value displayed is 25.0—the value assigned to `depositAmount` in line 15 of Fig. F.1.



```
Administrator: Command Prompt - jdb
main[1] print depositAmount
depositAmount = 25.0
main[1]
```

Fig. F.7 | Examining the value of variable `depositAmount`.

10. *Continuing application execution.* Type `cont` to continue the application's execution. There are no more breakpoints, so the application is no longer in break mode. The application continues executing and eventually terminates (Fig. F.8). The debugger will stop when the application ends.



```
Administrator: Command Prompt
depositAmount = 25.0
main[1] cont
> new account balance: $75.00
The application exited
C:\examples\debugger>
```

Fig. F.8 | Continuing application execution and exiting the debugger.

F.3 The print and set Commands

In the preceding section, you learned how to use the debugger's `print` command to examine the value of a variable during program execution. In this section, you'll learn how to use the `print` command to examine the value of more complex expressions. You'll also learn the **set command**, which allows the programmer to assign new values to variables.

For this section, we assume that you've followed *Step 1* and *Step 2* in Section F.2 to open the **Command Prompt** window, change to the directory containing the Appendix F examples (e.g., `C:\examples\debugger`) and compile the `AccountTest` application (and class `Account`) for debugging.

1. *Starting debugging.* In the **Command Prompt**, type `jdb` to start the Java debugger.
2. *Inserting a breakpoint.* Set a breakpoint at line 19 in the source code by typing `stop at AccountTest:19`.
3. *Running the application and reaching a breakpoint.* Type `run AccountTest` to begin the debugging process (Fig. F.9). This will cause `AccountTest`'s `main` to execute until the breakpoint at line 19 is reached. This suspends application execution and switches the application into break mode. At this point, the statements in lines 9–13 created an `Account` object and printed the initial balance of the `Ac-`

count obtained by calling its `getBalance` method. The statement in line 15 (Fig. F.1) declared and initialized local variable `depositAmount` to 25.0. The statement in line 19 is the next statement that will execute.

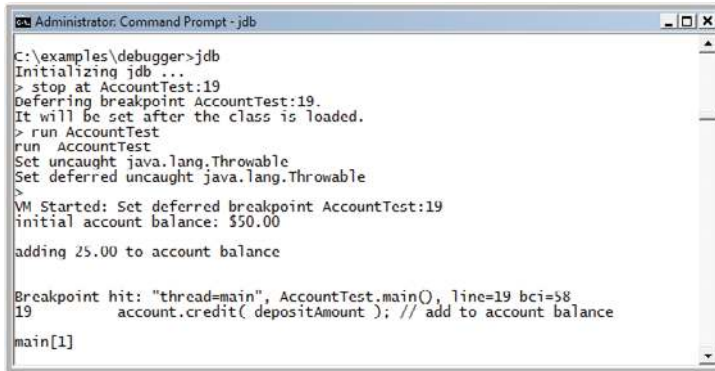

```
Administrator: Command Prompt - jdb
C:\examples\debugger>jdb
Initializing jdb...
> stop at AccountTest:19
Deferring breakpoint AccountTest:19.
It will be set after the class is loaded.
> run AccountTest
run AccountTest
Set uncaught java.lang.Throwable
Set deferred uncaught java.lang.Throwable
>
VM Started: Set deferred breakpoint AccountTest:19
initial account balance: $50.00

adding 25.00 to account balance

Breakpoint hit: "thread=main", AccountTest.main(), line=19 bci=58
19      account.credit( depositAmount ); // add to account balance
main[1]
```

Fig. F.9 | Application execution suspended when debugger reaches the breakpoint at line 19.

4. *Evaluating arithmetic and boolean expressions.* Recall from Section F.2 that once the application has entered break mode, you can explore the values of the application's variables using the debugger's `print` command. You can also use the `print` command to evaluate arithmetic and boolean expressions. In the **Command Prompt** window, type `print depositAmount - 2.0`. The `print` command returns the value 23.0 (Fig. F.10). However, this command does not actually change the value of `depositAmount`. In the **Command Prompt** window, type `print depositAmount == 23.0`. Expressions containing the `==` symbol are treated as boolean expressions. The value returned is `false` (Fig. F.10) because `depositAmount` does not currently contain the value 23.0—`depositAmount` is still 25.0.



```
Administrator: Command Prompt - jdb
main[1] print depositAmount - 2.0
depositAmount - 2.0 = 23.0
main[1] print depositAmount == 23.0
depositAmount == 23.0 = false
main[1]
```

Fig. F.10 | Examining the values of an arithmetic and boolean expression.

5. *Modifying values.* The debugger allows you to change the values of variables during the application's execution. This can be valuable for experimenting with different values and for locating logic errors in applications. You can use the debugger's `set` command to change the value of a variable. Type `set depositAmount = 75.0`. The debugger changes the value of `depositAmount` and displays its new value (Fig. F.11).



```
Administrator: Command Prompt - jdb
depositAmount == 23.0 = false
main[1] set depositAmount = 75.0
depositAmount = 75.0 = 75.0
main[1]
```

Fig. F.11 | Modifying values.

6. *Viewing the application result.* Type `cont` to continue application execution. Line 19 of `AccountTest` (Fig. F.1) executes, passing `depositAmount` to `Account` method `credit`. Method `main` then displays the new balance. The result is \$125.00 (Fig. F.12). This shows that the preceding step changed the value of `depositAmount` from its initial value (25.0) to 75.0.



```
Select Administrator: Command Prompt
depositAmount = 75.0 = 75.0
main[1] cont
> new account balance: $125.00
The application exited
C:\examples\debugger>
```

New account balance based on altered value
of variable `depositAmount`

Fig. F.12 | Output displayed after the debugging process.

F.4 Controlling Execution Using the `step`, `step up` and `next` Commands

Sometimes you'll need to execute an application line by line to find and fix errors. Walking through a portion of your application this way can help you verify that a method's code executes correctly. In this section, you'll learn how to use the debugger for this task. The commands you learn in this section allow you to execute a method line by line, execute all the statements of a method at once or execute only the remaining statements of a method (if you've already executed some statements within the method).

Once again, we assume you're working in the directory containing the Appendix F examples and have compiled for debugging with the `-g` compiler option.

1. *Starting the debugger.* Start the debugger by typing `jdb`.
2. *Setting a breakpoint.* Type `stop at AccountTest:19` to set a breakpoint at line 19.
3. *Running the application.* Run the application by typing `run AccountTest`. After the application displays its two output messages, the debugger indicates that the breakpoint has been reached and displays the code at line 19 (Fig. F.13). The debugger and application then pause and wait for the next command to be entered.
4. *Using the `step` command.* The **step command** executes the next statement in the application. If the next statement to execute is a method call, control transfers to the called method. The `step` command enables you to enter a method and study

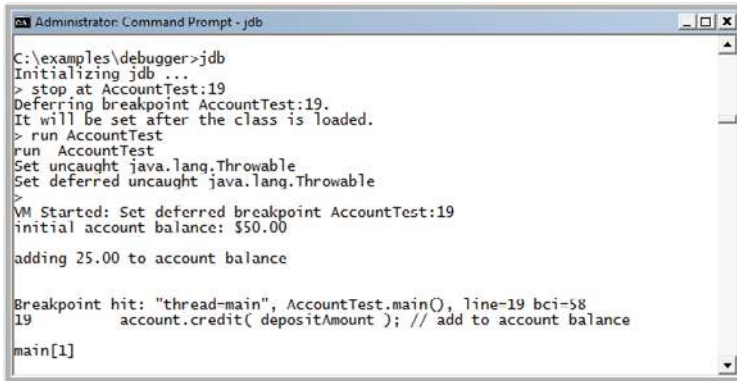

```

Administrator: Command Prompt - jdb
C:\examples\debugger>jdb
Initializing jdb ...
> stop at AccountTest:19
Deferring breakpoint AccountTest:19.
It will be set after the class is loaded.
> run AccountTest
run AccountTest
Set uncaught java.lang.Throwable
Set deferred uncaught java.lang.Throwable
>
VM Started: Set deferred breakpoint AccountTest:19
initial account balance: $50.00

adding 25.00 to account balance

Breakpoint hit: "thread=main", AccountTest.main(), line=19 bci=58
19      account.credit( depositAmount ); // add to account balance
main[1]

```

Fig. F.13 | Reaching the breakpoint in the AccountTest application.

the individual statements of that method. For instance, you can use the print and set commands to view and modify the variables within the method. You'll now use the step command to enter the credit method of class Account (Fig. 3.13) by typing step (Fig. F.14). The debugger indicates that the step has been completed and displays the next executable statement—in this case, line 21 of class Account (Fig. 3.13).

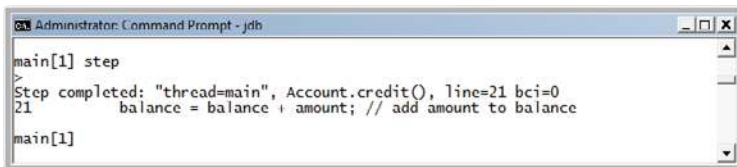

```

Administrator: Command Prompt - jdb
main[1] step
>
Step completed: "thread=main", Account.credit(), line=21 bci=0
21      balance = balance + amount; // add amount to balance
main[1]

```

Fig. F.14 | Stepping into the credit method.

5. *Using the **step up** command.* After you've stepped into the credit method, type **step up**. This command executes the remaining statements in the method and returns control to the place where the method was called. The credit method contains only one statement to add the method's parameter amount to instance variable balance. The step up command executes this statement, then pauses before line 22 in AccountTest. Thus, the next action to occur will be to print the new account balance (Fig. F.15). In lengthy methods, you may want to look at a few key lines of code, then continue debugging the caller's code. The step up command is useful for situations in which you do not want to continue stepping through the entire method line by line.
6. *Using the **cont** command to continue execution.* Enter the cont command (Fig. F.16) to continue execution. The statement at lines 22–23 executes, displaying the new balance, then the application and the debugger terminate.
7. *Restarting the debugger.* Restart the debugger by typing jdb.

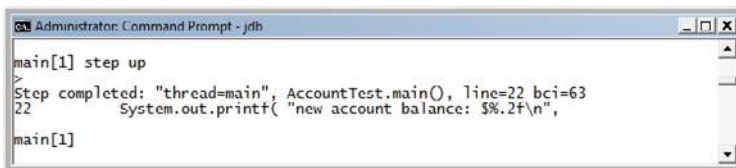

```
Administrator: Command Prompt - jdb
main[1] step up
>
Step completed: "thread=main", AccountTest.main(), line=22 bci=63
22     System.out.printf( "new account balance: $%.2f\n",
main[1]
```

Fig. F.15 | Stepping out of a method.



```
Administrator: Command Prompt
main[1] cont
> new account balance: $75.00
The application exited
C:\examples\debugger>
```

Fig. F.16 | Continuing execution of the `AccountTest` application.

8. *Setting a breakpoint.* Breakpoints persist only until the end of the debugging session in which they're set—once the debugger exits, all breakpoints are removed. (In Section F.6, you'll learn how to manually clear a breakpoint before the end of the debugging session.) Thus, the breakpoint set for line 19 in *Step 2* no longer exists upon restarting the debugger in *Step 7*. To reset the breakpoint at line 19, once again type `stop at AccountTest:19`.
9. *Running the application.* Type `run AccountTest` to run the application. As in *Step 3*, `AccountTest` runs until the breakpoint at line 19 is reached, then the debugger pauses and waits for the next command (Fig. F.17).

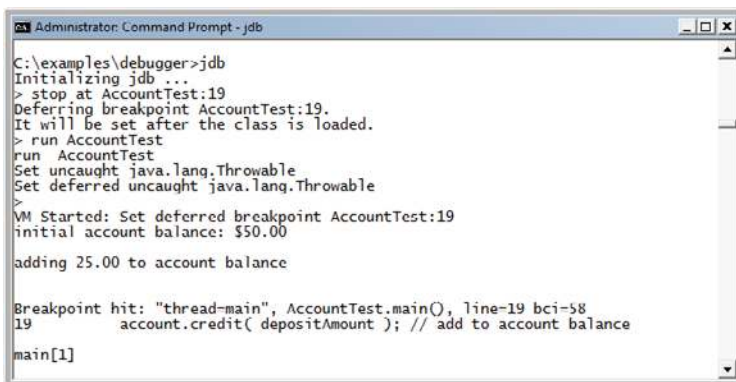

```
Administrator: Command Prompt - jdb
C:\examples\debugger>jdb
Initializing jdb ...
> stop at AccountTest:19
Deferring breakpoint AccountTest:19.
It will be set after the class is loaded.
> run AccountTest
run AccountTest
Set uncaught java.lang.Throwable
Set deferred uncaught java.lang.Throwable
>
VM Started: Set deferred breakpoint AccountTest:19
initial account balance: $50.00
adding 25.00 to account balance

Breakpoint hit: "thread=main", AccountTest.main(), line=19 bci=58
19     account.credit( depositAmount ); // add to account balance
main[1]
```

Fig. F.17 | Reaching the breakpoint in the `AccountTest` application.

10. *Using the next command.* Type `next`. This command behaves like the `step` command, except when the next statement to execute contains a method call. In that case, the called method executes in its entirety and the application advances to the

next executable line after the method call (Fig. F.18). Recall from *Step 4* that the step command would enter the called method. In this example, the next command causes Account method `credit` to execute, then the debugger pauses at line 22 in `AccountTest`.

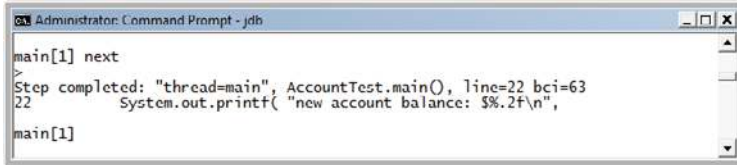

```
Administrator: Command Prompt - jdb
main[1] next
>
Step completed: "thread=main", AccountTest.main(), line=22 bci=63
22 System.out.printf( "new account balance: $%.2f\n",
main[1]
```

Fig. F.18 | Stepping over a method call.

11. *Using the `exit` command.* Use the **exit command** to end the debugging session (Fig. F.19). This command causes the `AccountTest` application to immediately terminate rather than execute the remaining statements in `main`. When debugging some types of applications (e.g., GUI applications), the application continues to execute even after the debugging session ends.



```
Administrator: Command Prompt
main[1] exit
>
C:\examples\debugger>
```

Fig. F.19 | Exiting the debugger.

F.5 The watch Command

In this section, we present the **watch command**, which tells the debugger to watch a field. When that field is about to change, the debugger will notify you. In this section, you'll learn how to use the watch command to see how the `Account` object's field `balance` is modified during the execution of the `AccountTest` application.

As in the preceding two sections, we assume that you've followed *Step 1* and *Step 2* in Section F.2 to open the **Command Prompt**, change to the correct examples directory and compile classes `AccountTest` and `Account` for debugging (i.e., with the `-g` compiler option).

1. *Starting the debugger.* Start the debugger by typing `jdb`.
2. *Watching a class's field.* Set a watch on `Account`'s `balance` field by typing `watch Account.balance` (Fig. F.20). You can set a watch on any field during execution of the debugger. Whenever the value in a field is about to change, the debugger enters break mode and notifies you that the value will change. Watches can be placed only on fields, not on local variables.
3. *Running the application.* Run the application with the command `run AccountTest`. The debugger will now notify you that field `balance`'s value will change



```
Administrator: Command Prompt - jdb
C:\examples\debugger>jdb
Initializing jdb ...
> watch Account.balance
Deferring watch modification of Account.balance.
It will be set after the class is loaded.
>
```

Fig. F.20 | Setting a watch on Account's balance field.

(Fig. F.21). When the application begins, an instance of Account is created with an initial balance of \$50.00 and a reference to the Account object is assigned to the local variable `account` (line 9, Fig. F.1). Recall from Fig. 3.13 that when the constructor for this object runs, if parameter `initialBalance` is greater than 0.0, instance variable `balance` is assigned the value of parameter `initialBalance`. The debugger notifies you that the value of `balance` will be set to 50.0.

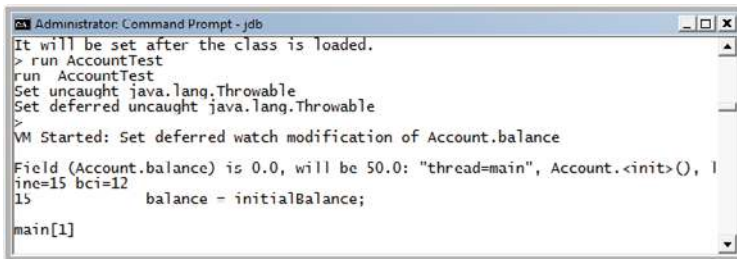

```
Administrator: Command Prompt - jdb
It will be set after the class is loaded.
> run AccountTest
run AccountTest
Set uncaught java.lang.Throwable
Set deferred uncaught java.lang.Throwable
>
VM Started: Set deferred watch modification of Account.balance

Field (Account.balance) is 0.0, will be 50.0: "thread=main", Account.<init>(), l
ine=15 bci=12
15     balance = initialBalance;
main[1]
```

Fig. F.21 | AccountTest application stops when `account` is created and its `balance` field will be modified.

4. *Adding money to the account.* Type `cont` to continue executing the application. The application executes normally before reaching the code on line 19 of Fig. F.1 that calls Account method `credit` to raise the Account object's balance by a specified amount. The debugger notifies you that instance variable `balance` will change (Fig. F.22). Although line 19 of class `AccountTest` calls method `credit`, line 21 in Account's method `credit` actually changes the value of `balance`.

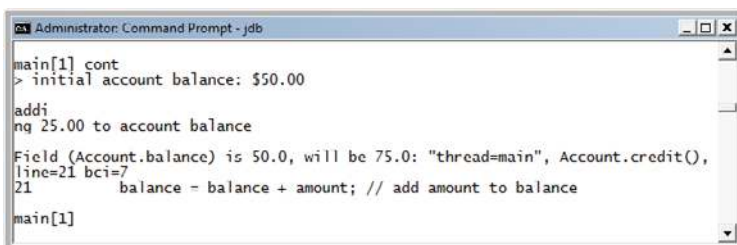

```
Administrator: Command Prompt - jdb
main[1] cont
> initial account balance: $50.00

addi
nq 25.00 to account balance

Field (Account.balance) is 50.0, will be 75.0: "thread=main", Account.credit(),
line=21 bci=7
21     balance = balance + amount; // add amount to balance
main[1]
```

Fig. F.22 | Changing the value of `balance` by calling Account method `credit`.

5. *Continuing execution.* Type `cont`—the application will finish executing because the application does not attempt any additional changes to `balance` (Fig. F.23).



```
Administrator: Command Prompt
main[1] cont
> new account balance: $75.00
The application exited
C:\examples\debugger>
```

Fig. F.23 | Continuing execution of `AccountTest`.

6. *Restarting the debugger and resetting the watch on the variable.* Type `jdb` to restart the debugger. Once again, set a watch on the `Account` instance variable `balance` by typing the watch `Account.balance`, then type `run AccountTest` to run the application (Fig. F.24).

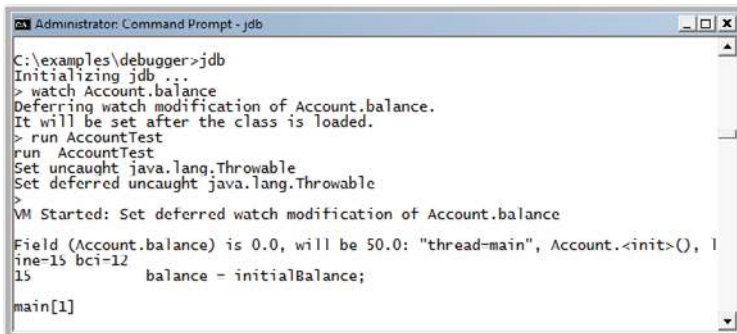

```
Administrator: Command Prompt - jdb
C:\examples\debugger>jdb
Initializing jdb ...
> watch Account.balance
Deferring watch modification of Account.balance.
It will be set after the class is loaded.
> run AccountTest
run AccountTest
Set uncaught java.lang.Throwable
Set deferred uncaught java.lang.Throwable
>
VM Started: Set deferred watch modification of Account.balance
Field (Account.balance) is 0.0, will be 50.0: "thread-main", Account.<init>(), l
ine-15 bci-12
15      balance = initialBalance;
main[1]
```

Fig. F.24 | Restarting the debugger and resetting the watch on the variable `balance`.

7. *Removing the watch on the field.* Suppose you want to watch a field for only part of a program's execution. You can remove the debugger's watch on variable `balance` by typing `unwatch Account.balance` (Fig. F.25). Type `cont`—the application will finish executing without reentering break mode.



```
Administrator: Command Prompt
main[1] unwatch Account.balance
Removed: watch modification of Account.balance
main[1] cont
> initial account balance: $50.00
adding 25.00 to account balance
new account balance: $75.00
The application exited
C:\examples\debugger>
```

Fig. F.25 | Removing the watch on variable `balance`.

8. *Closing the Command Prompt window.* Close the **Command Prompt** window by clicking its close button.

F.6 The `clear` Command

In the preceding section, you learned to use the `unwatch` command to remove a watch on a field. The debugger also provides the `clear` command to remove a breakpoint from an application. You'll often need to debug applications containing repetitive actions, such as a loop. You may want to examine the values of variables during several, but possibly not all, of the loop's iterations. If you set a breakpoint in the body of a loop, the debugger will pause before each execution of the line containing a breakpoint. After determining that the loop is working properly, you may want to remove the breakpoint and allow the remaining iterations to proceed normally. In this section, we use the compound interest application in Fig. 5.6 to demonstrate how the debugger behaves when you set a breakpoint in the body of a `for` statement and how to remove a breakpoint in the middle of a debugging session.

1. *Opening the Command Prompt window, changing directories and compiling the application for debugging.* Open the **Command Prompt** window, then change to the directory containing the Appendix F examples. For your convenience, we've provided a copy of the `Interest.java` file in this directory. Compile the application for debugging by typing `javac -g Interest.java`.
2. *Starting the debugger and setting breakpoints.* Start the debugger by typing `jdb`. Set breakpoints at lines 13 and 22 of class `Interest` by typing `stop at Interest:13`, then `stop at Interest:22` (Fig. F.26).

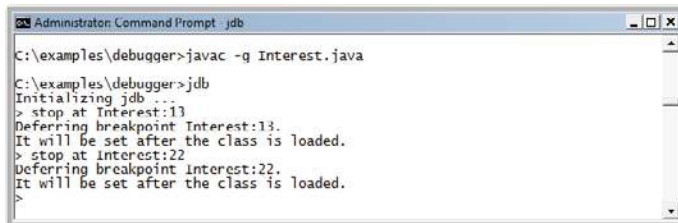

```
Administrator: Command Prompt - jdb
C:\examples\debugger>javac -g Interest.java
C:\examples\debugger>jdb
Initializing jdb ...
> stop at Interest:13
Deferring breakpoint Interest:13.
It will be set after the class is loaded.
> stop at Interest:22
Deferring breakpoint Interest:22.
It will be set after the class is loaded.
>
```

Fig. F.26 | Setting breakpoints in the `Interest` application.

3. *Running the application.* Run the application by typing `run Interest`. The application executes until reaching the breakpoint at line 13 (Fig. F.27).
4. *Continuing execution.* Type `cont` to continue—the application executes line 13, printing the column headings "Year" and "Amount on deposit". Line 13 appears before the `for` statement at lines 16–23 in `Interest` (Fig. 5.6) and thus executes only once. Execution continues past line 13 until the breakpoint at line 22 is reached during the first iteration of the `for` statement (Fig. F.28).
5. *Examining variable values.* Type `print year` to examine the current value of variable `year` (i.e., the `for`'s control variable). Print the value of variable `amount` too (Fig. F.29).

```

Administrator: Command Prompt - jdb
It will be set after the class is loaded.
> run Interest
run Interest
Set uncaught java.lang.Throwable
Set deferred uncaught java.lang.Throwable
>
VM Started: Set deferred breakpoint Interest:22
Set deferred breakpoint Interest:13
Breakpoint hit: "thread=main", Interest.main(), line=13 bci=9
13      System.out.printf( "%s%20s\n", "Year", "Amount on deposit" );
main[1]

```

Fig. F.27 | Reaching the breakpoint at line 13 in the Interest application.

```

Administrator: Command Prompt - jdb
main[1] cont
> Year      Amount on deposit
Breakpoint hit: "thread=main", Interest.main(), line=22 bci=55
22      System.out.printf( "%4d%,20.2f\n", year, amount );
main[1]

```

Fig. F.28 | Reaching the breakpoint at line 22 in the Interest application.

```

Administrator: Command Prompt - jdb
main[1] print year
year = 1
main[1] print amount
amount = 1050.0
main[1]

```

Fig. F.29 | Printing year and amount during the first iteration of Interest's for.

6. **Continuing execution.** Type `cont` to continue execution. Line 22 executes and prints the current values of `year` and `amount`. After the `for` enters its second iteration, the debugger notifies you that the breakpoint at line 22 has been reached a second time. The debugger pauses each time a line where a breakpoint has been set is about to execute—when the breakpoint appears in a loop, the debugger pauses during each iteration. Print the values of variables `year` and `amount` again to see how the values have changed since the first iteration of the `for` (Fig. F.30).

```

Administrator: Command Prompt - jdb
> 1      1,050.00
Breakpoint hit: "thread=main", Interest.main(), line=22 bci=55
22      System.out.printf( "%4d%,20.2f\n", year, amount );
main[1] print year
year = 2
main[1] print amount
amount = 1102.5
main[1]

```

Fig. F.30 | Printing year and amount during the second iteration of Interest's for.

7. **Removing a breakpoint.** You can display a list of all of the breakpoints in the application by typing `clear` (Fig. F.31). Suppose you're satisfied that the Interest

application's for statement is working properly, so you want to remove the breakpoint at line 22 and allow the remaining iterations of the loop to proceed normally. You can remove the breakpoint at line 22 by typing `clear Interest:22`. Now type `clear` to list the remaining breakpoints in the application. The debugger should indicate that only the breakpoint at line 13 remains (Fig. F.31). This breakpoint has already been reached and thus will no longer affect execution.

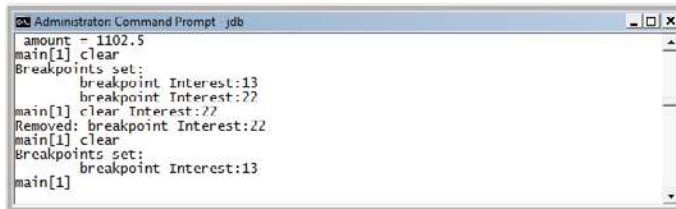

```
Administrator: Command Prompt - jdb
amount = 1102.5
main[1] clear
Breakpoints set:
    breakpoint Interest:13
    breakpoint Interest:22
main[1] clear Interest:22
Removed: breakpoint Interest:22
main[1] clear
Breakpoints set:
    breakpoint Interest:13
main[1]
```

Fig. F.31 | Removing the breakpoint at line 22.

8. *Continuing execution after removing a breakpoint.* Type `cont` to continue execution. Recall that execution last paused before the `printf` statement in line 22. If the breakpoint at line 22 was removed successfully, continuing the application will produce the correct output for the current and remaining iterations of the for statement without the application halting (Fig. F.32).

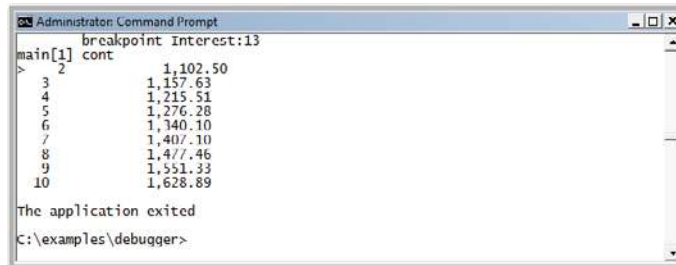

```
Administrator: Command Prompt
    breakpoint Interest:13
main[1] cont
>
3      1,102.50
4      1,157.63
5      1,215.51
6      1,276.28
7      1,340.10
8      1,407.10
9      1,477.46
10     1,551.33
10     1,628.89

The application exited
C:\examples\debugger>
```

Fig. F.32 | Application executes without a breakpoint set at line 22.

F.7 Wrap-Up

In this appendix, you learned how to insert and remove breakpoints in the debugger. Breakpoints allow you to pause application execution so you can examine variable values with the debugger's `print` command. This capability will help you locate and fix logic errors in your applications. You saw how to use the `print` command to examine the value of an expression and how to use the `set` command to change the value of a variable. You also learned debugger commands (including the `step`, `step up` and `next` commands) that can be used to determine whether a method is executing correctly. You learned how to use the `watch` command to keep track of a field throughout the life of an application. Finally, you learned how to use the `clear` command to list all the breakpoints set for an application or remove individual breakpoints to continue execution without breakpoints.

Self-Review Exercises

- F.1** Fill in the blanks in each of the following statements:
- A breakpoint cannot be set at a(n) _____.
 - You can examine the value of an expression by using the debugger's _____ command.
 - You can modify the value of a variable by using the debugger's _____ command.
 - During debugging, the _____ command executes the remaining statements in the current method and returns program control to the place where the method was called.
 - The debugger's _____ command behaves like the step command when the next statement to execute does not contain a method call.
 - The watch debugger command allows you to view all changes to a(n) _____.
- F.2** State whether each of the following is *true* or *false*. If *false*, explain why.
- When application execution suspends at a breakpoint, the next statement to be executed is the statement after the breakpoint.
 - Watches can be removed using the debugger's `clear` command.
 - The `-g` compiler option must be used when compiling classes for debugging.
 - When a breakpoint appears in a loop, the debugger pauses only the first time that the breakpoint is encountered.

Answers to Self-Review Exercises

- F.1** a) comment. b) print. c) set. d) step up. e) next. f) field.
- F.2** a) False. When application execution suspends at a breakpoint, the next statement to be executed is the statement at the breakpoint. b) False. Watches can be removed using the debugger's `unwatch` command. c) True. d) False. When a breakpoint appears in a loop, the debugger pauses during each iteration.

Formatted Output

G



All the news that's fit to print.

—Adolph S. Ochs

What mad pursuit? What struggle to escape?

—John Keats

Remove not the landmark on the boundary of the fields.

—Amenehope

Objectives

In this appendix you'll learn:

- To understand input and output streams.
- To use `printf` formatting.
- To print with field widths and precisions.
- To use formatting flags in the `printf` format string.
- To print with an argument index.
- To output literals and escape sequences.
- To format output with class `Formatter`.

- G.1** Introduction
- G.2** Streams
- G.3** Formatting Output with `printf`
- G.4** Printing Integers
- G.5** Printing Floating-Point Numbers
- G.6** Printing Strings and Characters
- G.7** Printing Dates and Times
- G.8** Other Conversion Characters
- G.9** Printing with Field Widths and Precisions
- G.10** Using Flags in the `printf` Format String
- G.11** Printing with Argument Indices
- G.12** Printing Literals and Escape Sequences
- G.13** Formatting Output with Class `Formatter`
- G.14** Wrap-Up

Summary | Self-Review Exercises | Answers to Self-Review Exercises | Exercises

G.1 Introduction

In this appendix, we discuss the formatting features of method `printf` and class `Formatter` (package `java.util`). Class **`Formatter`** formats and outputs data to a specified destination, such as a string or a file output stream. Many features of `printf` were discussed earlier in the text. This appendix summarizes those features and introduces others, such as displaying date and time data in various formats, reordering output based on the index of the argument and displaying numbers and strings with various flags.

G.2 Streams

Input and output are usually performed with streams, which are sequences of bytes. In input operations, the bytes flow from a device (e.g., a keyboard, a disk drive, a network connection) to main memory. In output operations, bytes flow from main memory to a device (e.g., a display screen, a printer, a disk drive, a network connection).

When program execution begins, three streams are created. The standard input stream typically reads bytes from the keyboard, and the standard output stream typically outputs characters to a command window. A third stream, the **standard error stream** (`System.err`), typically outputs characters to a command window and is used to output error messages so they can be viewed immediately. Operating systems typically allow these streams to be redirected to other devices. Streams are discussed in detail in Chapter 17, Files, Streams and Object Serialization, and Chapter 27, Networking.

G.3 Formatting Output with `printf`

Precise output formatting is accomplished with `printf`. Java borrowed (and enhanced) this feature from the C programming language. Method `printf` can perform the following formatting capabilities, each of which is discussed in this appendix:

1. Rounding floating-point values to an indicated number of decimal places.
2. Aligning a column of numbers with decimal points appearing one above the other.
3. Right justification and left justification of outputs.

4. Inserting literal characters at precise locations in a line of output.
5. Representing floating-point numbers in exponential format.
6. Representing integers in octal and hexadecimal format.
7. Displaying all types of data with fixed-size field widths and precisions.
8. Displaying dates and times in various formats.

Every call to `printf` supplies as the first argument a **format string** that describes the output format. The format string may consist of **fixed text** and **format specifiers**. Fixed text is output by `printf` just as it would be output by `System.out` methods `print` or `println`. Each format specifier is a placeholder for a value and specifies the type of data to output. Format specifiers also may include optional formatting information.

In the simplest form, each format specifier begins with a percent sign (%) and is followed by a **conversion character** that represents the data type of the value to output. For example, the format specifier `%s` is a placeholder for a string, and the format specifier `%d` is a placeholder for an `int` value. The optional formatting information, such as an argument index, flags, field width and precision, is specified between the percent sign and the conversion character. We demonstrate each of these capabilities.

G.4 Printing Integers

Figure G.1 describes the **integer conversion characters**. (See Appendix H for an overview of the binary, octal, decimal and hexadecimal number systems.) Figure G.2 uses each to print an integer. In lines 9–10, the plus sign is not displayed by default, but the minus sign is. Later in this appendix (Fig. G.14) we'll see how to force plus signs to print.

Conversion character	Description
d	Display a decimal (base 10) integer.
o	Display an octal (base 8) integer.
x or X	Display a hexadecimal (base 16) integer. X uses uppercase letters.

Fig. G.1 | Integer conversion characters.

```

1 // Fig. G.2: IntegerConversionTest.java
2 // Using the integer conversion characters.
3
4 public class IntegerConversionTest
5 {
6     public static void main( String[] args )
7     {
8         System.out.printf( "%d\n", 26 );
9         System.out.printf( "%d\n", +26 );
10        System.out.printf( "%d\n", -26 );
11        System.out.printf( "%o\n", 26 );
12        System.out.printf( "%x\n", 26 );

```

Fig. G.2 | Using the integer conversion characters. (Part 1 of 2.)

```

13     System.out.printf( "%X\n", 26 );
14   } // end main
15 } // end class IntegerConversionTest

```

```

26
26
-26
32
1a
1A

```

Fig. G.2 | Using the integer conversion characters. (Part 2 of 2.)

The `printf` method has the form

```
printf( format-string, argument-list );
```

where *format-string* describes the output format, and the optional *argument-list* contains the values that correspond to each format specifier in *format-string*. There can be many format specifiers in one format string.

Each format string in lines 8–10 specifies that `printf` should output a decimal integer (`%d`) followed by a newline character. At the format specifier’s position, `printf` substitutes the value of the first argument after the format string. If the format string contains multiple format specifiers, at each subsequent format specifier’s position `printf` substitutes the value of the next argument in the argument list. The `%o` format specifier in line 11 outputs the integer in octal format. The `%x` format specifier in line 12 outputs the integer in hexadecimal format. The `%X` format specifier in line 13 outputs the integer in hexadecimal format with capital letters.

G.5 Printing Floating-Point Numbers

Figure G.3 describes the floating-point conversions. The **conversion characters e and E** display floating-point values in **computerized scientific notation** (also called **exponential notation**). Exponential notation is the computer equivalent of the scientific notation used in mathematics. For example, the value 150.4582 is represented in scientific notation in mathematics as

$$1.504582 \times 10^2$$

and is represented in exponential notation as

$$1.504582e+02$$

in Java. This notation indicates that 1.504582 is multiplied by 10 raised to the second power (`e+02`). The `e` stands for “exponent.”

Values printed with the conversion characters `e`, `E` and `f` are output with six digits of precision to the right of the decimal point by default (e.g., 1.045921)—other precisions must be specified explicitly. For values printed with the conversion character `g`, the precision represents the total number of digits displayed, excluding the exponent. The default is six digits (e.g., 12345678.9 is displayed as 1.23457e+07). **Conversion character f** always prints at least one digit to the left of the decimal point. Conversion characters `e` and `E` print

Conversion character	Description
e or E	Display a floating-point value in exponential notation. Conversion character E displays the output in uppercase letters.
f	Display a floating-point value in decimal format.
g or G	Display a floating-point value in either the floating-point format f or the exponential format e based on the magnitude of the value. If the magnitude is less than 10^{-3} , or greater than or equal to 10^7 , the floating-point value is printed with e (or E). Otherwise, the value is printed in format f. When conversion character G is used, the output is displayed in uppercase letters.
a or A	Display a floating-point number in hexadecimal format. Conversion character A displays the output in uppercase letters.

Fig. G.3 | Floating-point conversion characters.

lowercase e and uppercase E preceding the exponent and always print exactly one digit to the left of the decimal point. Rounding occurs if the value being formatted has more significant digits than the precision.

Conversion character g (or **G**) prints in either e (E) or f format, depending on the floating-point value. For example, the values 0.0000875, 8750000.0, 8.75, 87.50 and 875.0 are printed as 8.750000e-05, 8.750000e+07, 8.750000, 87.500000 and 875.000000 with the conversion character g. The value 0.0000875 uses e notation because the magnitude is less than 10^{-3} . The value 8750000.0 uses e notation because the magnitude is greater than 10^7 . Figure G.4 demonstrates the floating-point conversion characters.

```

1 // Fig. G.4: FloatingNumberTest.java
2 // Using floating-point conversion characters.
3
4 public class FloatingNumberTest
5 {
6     public static void main( String[] args )
7     {
8         System.out.printf( "%e\n", 12345678.9 );
9         System.out.printf( "%e\n", +12345678.9 );
10        System.out.printf( "%e\n", -12345678.9 );
11        System.out.printf( "%E\n", 12345678.9 );
12        System.out.printf( "%f\n", 12345678.9 );
13        System.out.printf( "%g\n", 12345678.9 );
14        System.out.printf( "%G\n", 12345678.9 );
15    } // end main
16 } // end class FloatingNumberTest

```

```

1.234568e+07
1.234568e+07
-1.234568e+07

```

Fig. G.4 | Using floating-point conversion characters. (Part I of 2.)

```
1.234568E+07
12345678.900000
1.23457e+07
1.23457E+07
```

Fig. G.4 | Using floating-point conversion characters. (Part 2 of 2.)

G.6 Printing Strings and Characters

The `c` and `s` conversion characters print individual characters and strings, respectively. **Conversion characters `c` and `C`** require a `char` argument. **Conversion characters `s` and `S`** can take a `String` or any `Object` as an argument. When conversion characters `C` and `S` are used, the output is displayed in uppercase letters. Figure G.5 displays characters, strings and objects with conversion characters `c` and `s`. Autoboxing occurs at line 9 when an `int` constant is assigned to an `Integer` object. Line 15 outputs an `Integer` argument with the conversion character `s`, which implicitly invokes the `toString` method to get the integer value. You can also output an `Integer` object using the `%d` format specifier. In this case, the `int` value in the `Integer` object will be unboxed and output.



Common Programming Error G.1

Using `%c` to print a `String` causes an `IllegalFormatConversionException`—a `String` cannot be converted to a character.

```
1 // Fig. G.5: CharStringConversion.java
2 // Using character and string conversion characters.
3 public class CharStringConversion
4 {
5     public static void main( String[] args )
6     {
7         char character = 'A'; // initialize char
8         String string = "This is also a string"; // String object
9         Integer integer = 1234; // initialize integer (autoboxing)
10
11         System.out.printf( "%c\n", character );
12         System.out.printf( "%s\n", "This is a string" );
13         System.out.printf( "%s\n", string );
14         System.out.printf( "%S\n", string );
15         System.out.printf( "%s\n", integer ); // implicit call to toString
16     } // end main
17 } // end class CharStringConversion
```

```
A
This is a string
This is also a string
THIS IS ALSO A STRING
1234
```

Fig. G.5 | Using character and string conversion characters.

G.7 Printing Dates and Times

The **conversion character t** (or **T**) is used to print dates and times in various formats. It's always followed by a **conversion suffix character** that specifies the date and/or time format. When conversion character T is used, the output is displayed in uppercase letters. Figure G.6 lists the common conversion suffix characters for formatting **date and time compositions** that display both the date and the time. Figure G.7 lists the common conversion suffix characters for formatting dates. Figure G.8 lists the common conversion suffix characters for formatting times. For the complete list of conversion suffix characters, visit java.sun.com/javase/6/docs/api/java/util/Formatter.html.

Conversion suffix character	Description
c	Display date and time formatted as <code>day month date hour:minute:second time-zone year</code> with three characters for day and month, two digits for date, hour, minute and second and four digits for year—for example, <code>Wed Mar 03 16:30:25 GMT-05:00 2004</code> . The 24-hour clock is used. GMT-05:00 is the time zone.
F	Display date formatted as <code>year-month-date</code> with four digits for the year and two digits each for the month and date (e.g., <code>2004-05-04</code>).
D	Display date formatted as <code>month/day/year</code> with two digits each for the month, day and year (e.g., <code>03/03/04</code>).
r	Display time in 12-hour format as <code>hour:minute:second AM PM</code> with two digits each for the hour, minute and second (e.g., <code>04:30:25 PM</code>).
R	Display time formatted as <code>hour:minute</code> with two digits each for the hour and minute (e.g., <code>16:30</code>). The 24-hour clock is used.
T	Display time as <code>hour:minute:second</code> with two digits for the hour, minute and second (e.g., <code>16:30:25</code>). The 24-hour clock is used.

Fig. G.6 | Date and time composition conversion suffix characters.

Conversion suffix character	Description
A	Display full name of the day of the week (e.g., <code>Wednesday</code>).
a	Display the three-character name of the day of the week (e.g., <code>Wed</code>).
B	Display full name of the month (e.g., <code>March</code>).
b	Display the three-character short name of the month (e.g., <code>Mar</code>).
d	Display the day of the month with two digits, padding with leading zeros as necessary (e.g., <code>03</code>).
m	Display the month with two digits, padding with leading zeros as necessary (e.g., <code>07</code>).

Fig. G.7 | Date formatting conversion suffix characters. (Part I of 2.)

Conversion suffix character	Description
e	Display the day of month without leading zeros (e.g., 3).
Y	Display the year with four digits (e.g., 2004).
y	Display the last two digits of the year with leading zeros (e.g., 04).
j	Display the day of the year with three digits, padding with leading zeros as necessary (e.g., 016).

Fig. G.7 | Date formatting conversion suffix characters. (Part 2 of 2.)

Conversion suffix character	Description
H	Display hour in 24-hour clock with a leading zero as necessary (e.g., 16).
I	Display hour in 12-hour clock with a leading zero as necessary (e.g., 04).
k	Display hour in 24-hour clock without leading zeros (e.g., 16).
l	Display hour in 12-hour clock without leading zeros (e.g., 4).
M	Display minute with a leading zero as necessary (e.g., 06).
S	Display second with a leading zero as necessary (e.g., 05).
Z	Display the abbreviation for the time zone (e.g., EST, stands for Eastern Standard Time, which is 5 hours behind Greenwich Mean Time).
p	Display morning or afternoon marker in lowercase (e.g., pm).
P	Display morning or afternoon marker in uppercase (e.g., PM).

Fig. G.8 | Time formatting conversion suffix characters.

Figure G.9 uses the conversion characters `t` and `T` with the conversion suffix characters to display dates and times in various formats. Conversion character `t` requires the corresponding argument to be a date or time of type `long`, `Long`, `Calendar` (package `java.util`) or `Date` (package `java.util`)—objects of each of these classes can represent dates and times. Class `Calendar` is preferred for this purpose because some constructors

```

1 // Fig. G.9: DateTimeTest.java
2 // Formatting dates and times with conversion characters t and T.
3 import java.util.Calendar;
4
5 public class DateTimeTest
6 {
7     public static void main( String[] args )
8     {
9         // get current date and time
10        Calendar dateTime = Calendar.getInstance();

```

Fig. G.9 | Formatting dates and times with conversion characters `t` and `T`. (Part 1 of 2.)

```

11
12 // printing with conversion characters for date/time compositions
13 System.out.printf( "%tc\n", dateTime );
14 System.out.printf( "%tF\n", dateTime );
15 System.out.printf( "%tD\n", dateTime );
16 System.out.printf( "%tr\n", dateTime );
17 System.out.printf( "%tT\n", dateTime );
18
19 // printing with conversion characters for date
20 System.out.printf( "%1$tA, %1$tB %1$tD, %1$tY\n", dateTime );
21 System.out.printf( "%1$TA, %1$TB %1$TD, %1$TY\n", dateTime );
22 System.out.printf( "%1$ta, %1$tb %1$te, %1$ty\n", dateTime );
23
24 // printing with conversion characters for time
25 System.out.printf( "%1$tH:%1$tM:%1$tS\n", dateTime );
26 System.out.printf( "%1$tZ %1$tI:%1$tM:%1$tS %tP", dateTime );
27 } // end main
28 } // end class DateTimeTest

```

```

Wed Feb 25 15:00:22 EST 2009
2009-02-25
02/25/09
03:00:22 PM
15:00:22
Wednesday, February 25, 2009
WEDNESDAY, FEBRUARY 25, 2009
Wed, Feb 25, 09
15:00:22
EST 03:00:22 PM

```

Fig. G.9 | Formatting dates and times with conversion characters `t` and `T`. (Part 2 of 2.)

and methods in class `Date` are replaced by those in class `Calendar`. Line 10 invokes static method `getInstance` of `Calendar` to obtain a calendar with the current date and time. Lines 13–17, 20–22 and 25–26 use this `Calendar` object in `printf` statements as the value to be formatted with conversion character `t`. Lines 20–22 and 25–26 use the optional **argument index** ("`1$`") to indicate that all format specifiers in the format string use the first argument after the format string in the argument list. You'll learn more about argument indices in Section G.11. Using the argument index eliminates the need to repeatedly list the same argument.

G.8 Other Conversion Characters

The remaining conversion characters are **b**, **B**, **h**, **H**, **%** and **n**. These are described in Fig. G.10. Lines 9–10 of Fig. G.11 use `%b` to print the value of `boolean` (or `Boolean`) values `false` and `true`. Line 11 associates a `String` to `%b`, which returns `true` because it's not `null`. Line 12 associates a `null` object to `%B`, which displays `FALSE` because `test` is `null`. Lines 13–14 use `%h` to print the string representations of the hash-code values for strings `"hello"` and `"Hello"`. These values could be used to store or locate the strings in a `Hashtable` or `HashMap` (both discussed in Chapter 20, `Generic Collections`). The hash-code values for these two strings differ, because one string starts with a lowercase letter and

the other with an uppercase letter. Line 15 uses %H to print null in uppercase letters. The last two printf statements (lines 16–17) use %% to print the % character in a string and \n to print a platform-specific line separator.

Conversion character	Description
b or B	Print "true" or "false" for the value of a boolean or Boolean. These conversion characters can also format the value of any reference. If the reference is non-null, "true" is output; otherwise, "false". When conversion character B is used, the output is displayed in uppercase letters.
h or H	Print the string representation of an object's hash-code value in hexadecimal format. If the corresponding argument is null, "null" is printed. When conversion character H is used, the output is displayed in uppercase letters.
%	Print the percent character.
n	Print the platform-specific line separator (e.g., \r\n on Windows or \n on UNIX/LINUX).

Fig. G.10 | Other conversion characters.

```

1 // Fig. G.11: OtherConversion.java
2 // Using the b, B, h, H, % and n conversion characters.
3
4 public class OtherConversion
5 {
6     public static void main( String[] args )
7     {
8         Object test = null;
9         System.out.printf( "%b\n", false );
10        System.out.printf( "%b\n", true );
11        System.out.printf( "%b\n", "Test" );
12        System.out.printf( "%B\n", test );
13        System.out.printf( "Hashcode of \"hello\" is %h\n", "hello" );
14        System.out.printf( "Hashcode of \"Hello\" is %h\n", "Hello" );
15        System.out.printf( "Hashcode of null is %H\n", test );
16        System.out.printf( "Printing a %% in a format string\n" );
17        System.out.printf( "Printing a new line %nnext line starts here" );
18    } // end main
19 } // end class OtherConversion

```

```

false
true
true
FALSE
Hashcode of "hello" is 5e918d2

```

Fig. G.11 | Using the b, B, h, H, % and n conversion characters. (Part I of 2.)

```

Hashcode of "Hello" is 42628b2
Hashcode of null is NULL
Printing a % in a format string
Printing a new line
next line starts here

```

Fig. G.11 | Using the b, B, h, H, % and n conversion characters. (Part 2 of 2.)



Common Programming Error G.2

Trying to print a literal percent character using % rather than %% in the format string might cause a difficult-to-detect logic error. When % appears in a format string, it must be followed by a conversion character in the string. The single percent could accidentally be followed by a legitimate conversion character, thus causing a logic error.

G.9 Printing with Field Widths and Precisions

The size of a field in which data is printed is specified by a **field width**. If the field width is larger than the data being printed, the data is right justified in that field by default. We discuss left justification in Section G.10. You insert an integer representing the field width between the % and the conversion character (e.g., %4d) in the format specifier. Figure G.12 prints two groups of five numbers each, right justifying those numbers that contain fewer digits than the field width. The field width is increased to print values wider than the field and that the minus sign for a negative value uses one character position in the field. Also, if no field width is specified, the data prints in exactly as many positions as it needs. Field widths can be used with all format specifiers except the line separator (%n).

```

1 // Fig. G.12: FieldWidthTest.java
2 // Right justifying integers in fields.
3
4 public class FieldWidthTest
5 {
6     public static void main( String[] args )
7     {
8         System.out.printf( "%4d\n", 1 );
9         System.out.printf( "%4d\n", 12 );
10        System.out.printf( "%4d\n", 123 );
11        System.out.printf( "%4d\n", 1234 );
12        System.out.printf( "%4d\n\n", 12345 ); // data too large
13
14        System.out.printf( "%4d\n", -1 );
15        System.out.printf( "%4d\n", -12 );
16        System.out.printf( "%4d\n", -123 );
17        System.out.printf( "%4d\n", -1234 ); // data too large
18        System.out.printf( "%4d\n", -12345 ); // data too large
19    } // end main
20 } // end class RightJustifyTest

```

Fig. G.12 | Right justifying integers in fields. (Part 1 of 2.)

```

1
12
123
1234
12345

-1
-12
-123
-1234
-12345

```

Fig. G.12 | Right justifying integers in fields. (Part 2 of 2.)



Common Programming Error G.3

Not providing a sufficiently large field width to handle a value to be printed can offset other data being printed and produce confusing outputs. Know your data!

Method `printf` also provides the ability to specify the precision with which data is printed. Precision has different meanings for different types. When used with floating-point conversion characters `e` and `f`, the precision is the number of digits that appear after the decimal point. When used with conversion characters `g`, `a` or `A`, the precision is the maximum number of significant digits to be printed. When used with conversion character `s`, the precision is the maximum number of characters to be written from the string. To use precision, place between the percent sign and the conversion specifier a decimal point (`.`) followed by an integer representing the precision. Figure G.13 demonstrates the use of precision in format strings. When a floating-point value is printed with a precision smaller than the original number of decimal places in the value, the value is rounded. Also, the format specifier `%.3g` indicates that the total number of digits used to display the floating-point value is 3. Because the value has three digits to the left of the decimal point, the value is rounded to the ones position.

The field width and the precision can be combined by placing the field width, followed by a decimal point, followed by a precision between the percent sign and the conversion character, as in the statement

```
printf( "%9.3f", 123.456789 );
```

which displays 123.457 with three digits to the right of the decimal point right justified in a nine-digit field—this number will be preceded in its field by two blanks.

```

1 // Fig. G.13: PrecisionTest.java
2 // Using precision for floating-point numbers and strings.
3 public class PrecisionTest
4 {
5     public static void main( String[] args )
6     {
7         double f = 123.94536;
8         String s = "Happy Birthday";

```

Fig. G.13 | Using precision for floating-point numbers and strings. (Part 1 of 2.)

```

9
10     System.out.printf( "Using precision for floating-point numbers\n" );
11     System.out.printf( "\t%.3f\n\t%.3e\n\t%.3g\n\n", f, f, f );
12
13     System.out.printf( "Using precision for strings\n" );
14     System.out.printf( "\t%.11s\n", s );
15 } // end main
16 } // end class PrecisionTest

```

```

Using precision for floating-point numbers
    123.945
    1.239e+02
    124

Using precision for strings
    Happy Birth

```

Fig. G.13 | Using precision for floating-point numbers and strings. (Part 2 of 2.)

G.10 Using Flags in the printf Format String

Various flags may be used with method `printf` to supplement its output formatting capabilities. Seven flags are available for use in format strings (Fig. G.14).

Flag	Description
- (minus sign)	Left justify the output within the specified field.
+ (plus sign)	Display a plus sign preceding positive values and a minus sign preceding negative values.
<i>space</i>	Print a space before a positive value not printed with the + flag.
#	Prefix 0 to the output value when used with the octal conversion character <code>o</code> . Prefix <code>0x</code> to the output value when used with the hexadecimal conversion character <code>x</code> .
0 (zero)	Pad a field with leading zeros.
, (comma)	Use the locale-specific thousands separator (i.e., ',' for U.S. locale) to display decimal and floating-point numbers.
(Enclose negative numbers in parentheses.

Fig. G.14 | Format string flags.

To use a flag in a format string, place it immediately to the right of the percent sign. Several flags may be used in the same format specifier. Figure G.15 demonstrates right justification and left justification of a string, an integer, a character and a floating-point number. Line 9 serves as a counting mechanism for the screen output.

Figure G.16 prints a positive number and a negative number, each with and without the **+ flag**. The minus sign is displayed in both cases, the plus sign only when the + flag is used.

```

1 // Fig. G.15: MinusFlagTest.java
2 // Right justifying and left justifying values.
3
4 public class MinusFlagTest
5 {
6     public static void main( String[] args )
7     {
8         System.out.println( "Columns:" );
9         System.out.println( "0123456789012345678901234567890123456789\n" );
10        System.out.printf( "%10s%10d%10c%10f\n", "hello", 7, 'a', 1.23 );
11        System.out.printf(
12            "%-10s%-10d%-10c%-10f\n", "hello", 7, 'a', 1.23 );
13    } // end main
14 } // end class MinusFlagTest

```

```

Columns:
0123456789012345678901234567890123456789
      hello          7          a  1.230000
hello      7          a          1.230000

```

Fig. G.15 | Right justifying and left justifying values.

```

1 // Fig. G.16: PlusFlagTest.java
2 // Printing numbers with and without the + flag.
3
4 public class PlusFlagTest
5 {
6     public static void main( String[] args )
7     {
8         System.out.printf( "%d\t%d\n", 786, -786 );
9         System.out.printf( "%+d\t%+d\n", 786, -786 );
10    } // end main
11 } // end class PlusFlagTest

```

```

786    -786
+786  -786

```

Fig. G.16 | Printing numbers with and without the + flag.

Figure G.17 prefixes a space to the positive number with the **space flag**. This is useful for aligning positive and negative numbers with the same number of digits. The value -547 is not preceded by a space in the output because of its minus sign. Figure G.18 uses the **# flag** to prefix 0 to the octal value and 0x to the hexadecimal value.

```

1 // Fig. G.17: SpaceFlagTest.java
2 // Printing a space before non-negative values.
3

```

Fig. G.17 | Printing a space before nonnegative values. (Part I of 2.)

```

4 public class SpaceFlagTest
5 {
6     public static void main( String[] args )
7     {
8         System.out.printf( "% d\n% d\n", 547, -547 );
9     } // end main
10 } // end class SpaceFlagTest

```

```

547
-547

```

Fig. G.17 | Printing a space before nonnegative values. (Part 2 of 2.)

```

1 // Fig. G.18: PoundFlagTest.java
2 // Using the # flag with conversion characters o and x.
3
4 public class PoundFlagTest
5 {
6     public static void main( String[] args )
7     {
8         int c = 31; // initialize c
9
10        System.out.printf( "%#o\n", c );
11        System.out.printf( "%#x\n", c );
12    } // end main
13 } // end class PoundFlagTest

```

```

037
0x1f

```

Fig. G.18 | Using the # flag with conversion characters o and x.

Figure G.19 combines the + flag the **0 flag** and the space flag to print 452 in a field of width 9 with a + sign and leading zeros, next prints 452 in a field of width 9 using only the 0 flag, then prints 452 in a field of width 9 using only the space flag.

```

1 // Fig. G.19: ZeroFlagTest.java
2 // Printing with the 0 (zero) flag fills in leading zeros.
3
4 public class ZeroFlagTest
5 {
6     public static void main( String[] args )
7     {
8         System.out.printf( "%+09d\n", 452 );
9         System.out.printf( "%09d\n", 452 );
10        System.out.printf( "% 9d\n", 452 );
11    } // end main
12 } // end class ZeroFlagTest

```

Fig. G.19 | Printing with the 0 (zero) flag fills in leading zeros. (Part I of 2.)

```
+00000452
00000452
 452
```

Fig. G.19 | Printing with the 0 (zero) flag fills in leading zeros. (Part 2 of 2.)

Figure G.20 uses the comma (,) flag to display a decimal and a floating-point number with the thousands separator. Figure G.21 encloses negative numbers in parentheses using the (flag. The value 50 is not enclosed in parentheses in the output because it's a positive number.

```
1 // Fig. G.20: CommaFlagTest.java
2 // Using the comma (,) flag to display numbers with thousands separator.
3
4 public class CommaFlagTest
5 {
6     public static void main( String[] args )
7     {
8         System.out.printf( "%,d\n", 58625 );
9         System.out.printf( "%,.2f", 58625.21 );
10        System.out.printf( "%,.2f", 12345678.9 );
11    } // end main
12 } // end class CommaFlagTest
```

```
58,625
58,625.21
12,345,678.90
```

Fig. G.20 | Using the comma (,) flag to display numbers with the thousands separator.

```
1 // Fig. G.21: ParenthesesFlagTest.java
2 // Using the ( flag to place parentheses around negative numbers.
3
4 public class ParenthesesFlagTest
5 {
6     public static void main( String[] args )
7     {
8         System.out.printf( "(%d\n", 50 );
9         System.out.printf( "(%d\n", -50 );
10        System.out.printf( "(%.1e\n", -50.0 );
11    } // end main
12 } // end class ParenthesesFlagTest
```

```
50
(50)
(5.0e+01)
```

Fig. G.21 | Using the (flag to place parentheses around negative numbers.

G.11 Printing with Argument Indices

An **argument index** is an optional integer followed by a \$ sign that indicates the argument's position in the argument list. For example, lines 20–22 and 25–26 in Fig. G.9 use argument index "1\$" to indicate that all format specifiers use the first argument in the argument list. Argument indices enable programmers to reorder the output so that the arguments in the argument list are not necessarily in the order of their corresponding format specifiers. Argument indices also help avoid duplicating arguments. Figure G.22 prints arguments in the argument list in reverse order using the argument index.

```

1 // Fig. G.22: ArgumentIndexTest
2 // Reordering output with argument indices.
3
4 public class ArgumentIndexTest
5 {
6     public static void main( String[] args )
7     {
8         System.out.printf(
9             "Parameter list without reordering: %s %s %s %s\n",
10            "first", "second", "third", "fourth" );
11        System.out.printf(
12            "Parameter list after reordering: %4$s %3$s %2$s %1$s\n",
13            "first", "second", "third", "fourth" );
14    } // end main
15 } // end class ArgumentIndexTest

```

```

Parameter list without reordering: first second third fourth
Parameter list after reordering: fourth third second first

```

Fig. G.22 | Reordering output with argument indices.

G.12 Printing Literals and Escape Sequences

Most literal characters to be printed in a `printf` statement can simply be included in the format string. However, there are several “problem” characters, such as the quotation mark (") that delimits the format string itself. Various control characters, such as newline and tab, must be represented by escape sequences. An escape sequence is represented by a backslash (\), followed by an escape character. Figure G.23 lists the escape sequences and the actions they cause.

Escape sequence	Description
\' (single quote)	Output the single quote (') character.
\" (double quote)	Output the double quote (") character.
\\ (backslash)	Output the backslash (\) character.
\b (backspace)	Move the cursor back one position on the current line.

Fig. G.23 | Escape sequences. (Part I of 2.)

Escape sequence	Description
\f (new page or form feed)	Move the cursor to the start of the next logical page.
\n (newline)	Move the cursor to the beginning of the next line.
\r (carriage return)	Move the cursor to the beginning of the current line.
\t (horizontal tab)	Move the cursor to the next horizontal tab position.

Fig. G.23 | Escape sequences. (Part 2 of 2.)



Common Programming Error G.4

Attempting to print as literal data in a printf statement a double quote or backslash character without preceding that character with a backslash to form a proper escape sequence might result in a syntax error.

G.13 Formatting Output with Class Formatter

So far, we've discussed displaying formatted output to the standard output stream. What should we do if we want to send formatted outputs to other output streams or devices, such as a JTextArea or a file? The solution relies on class `Formatter` (in package `java.util`), which provides the same formatting capabilities as `printf`. `Formatter` is a utility class that enables programmers to output formatted data to a specified destination, such as a file on disk. By default, a `Formatter` creates a string in memory. Figure G.24 demonstrates how to use a `Formatter` to build a formatted string, which is then displayed in a message dialog.

Line 11 creates a `Formatter` object using the default constructor, so this object will build a string in memory. Other constructors are provided to allow you to specify the destination to which the formatted data should be output. For details, see java.sun.com/javase/6/docs/api/java/util/Formatter.html.

```

1 // Fig. Fig. G.24: FormatterTest.java
2 // Formatting output with class Formatter.
3 import java.util.Formatter;
4 import javax.swing.JOptionPane;
5
6 public class FormatterTest
7 {
8     public static void main( String[] args )
9     {
10         // create Formatter and format output
11         Formatter formatter = new Formatter();
12         formatter.format( "%d = %#o = %#X", 10, 10, 10 );
13
14         // display output in JOptionPane
15         JOptionPane.showMessageDialog( null, formatter.toString() );
16     } // end main
17 } // end class FormatterTest

```

Fig. G.24 | Formatting output with class `Formatter`. (Part 1 of 2.)

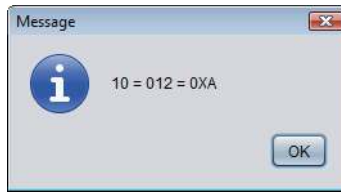

Fig. G.24 | Formatting output with class `Formatter`. (Part 2 of 2.)

Line 12 invokes method **format** to format the output. Like `printf`, method `format` takes a format string and an argument list. The difference is that `printf` sends the formatted output directly to the standard output stream, while `format` sends the formatted output to the destination specified by its constructor (a string in memory in this program). Line 15 invokes the `Formatter`'s `toString` method to get the formatted data as a string, which is then displayed in a message dialog.

Class `String` also provides a static convenience method named `format` that enables you to create a string in memory without the need to first create a `Formatter` object. Lines 11–12 and line 15 in Fig. G.24 could have been replaced by

```
String s = String.format( "%d = %#o = %#x", 10, 10, 10 );
JOptionPane.showMessageDialog( null, s );
```

G.14 Wrap-Up

This appendix summarized how to display formatted output with various format characters and flags. We displayed decimal numbers using format characters `d`, `o`, `x` and `X`; floating-point numbers using format characters `e`, `E`, `f`, `g` and `G`; and dates and times in various format using format characters `t` and `T` and their conversion suffix characters. You learned how to display output with field widths and precisions. We introduced the flags `+`, `-`, `space`, `#`, `0`, `comma` and `(` that are used together with the format characters to produce output. We also demonstrated how to format output with class `Formatter`.

Summary

Section G.2 Streams

- Input and output are usually performed with streams, which are sequences of bytes.
- Normally, the standard input stream is connected to the keyboard, and the standard output stream is connected to the computer screen.

Section G.3 Formatting Output with `printf`

- The `printf` format string describes the formats in which the output values appear. The format specifier consists of argument index, flags, field widths, precisions and conversion characters.

Section G.4 Printing Integers

- Integers are printed with the conversion characters `d` for decimal integers, `o` for integers in octal form and `x` (or `X`) for integers in hexadecimal form. `X` displays uppercase letters.

Section G.5 Printing Floating-Point Numbers

- Floating-point values are printed with the conversion characters `e` (or `E`) for exponential notation, `f` for regular floating-point notation, and `g` (or `G`) for either `e` (or `E`) notation or `f` notation. For the `g` conversion specifier, the `e` conversion character is used if the value is less than 10^{-3} or greater than or equal to 10^7 ; otherwise, the `f` conversion character is used.

Section G.6 Printing Strings and Characters

- The conversion character `c` prints a character.
- The conversion character `s` (or `S`) prints a string of characters. Conversion character `S` displays the output in uppercase letters.

Section G.7 Printing Dates and Times

- The conversion character `t` (or `T`) followed by a conversion suffix character prints the date and time in various forms. Conversion character `T` displays the output in uppercase letters.
- Conversion character `t` (or `T`) requires the argument to be of type `long`, `Long`, `Calendar` or `Date`.

Section G.8 Other Conversion Characters

- Conversion character `b` (or `B`) outputs the string representation of a `boolean` or `Boolean`. These conversion characters also output `"true"` for non-`null` references and `"false"` for `null` references. Conversion character `B` outputs uppercase letters.
- Conversion character `h` (or `H`) returns `null` for a `null` reference and a `String` representation of the hash-code value (in base 16) of an object `.` Hash codes are used to store and retrieve objects in `HashMaps` and `HashTables`. Conversion character `H` outputs uppercase letters.
- The conversion character `n` prints the platform-specific line separator.
- The conversion character `%` is used to display a literal `%`.

Section G.9 Printing with Field Widths and Precisions

- If the field width is larger than the object being printed, the object is right justified in the field.
- Field widths can be used with all conversion characters except the line-separator conversion.
- Precision used with floating-point conversion characters `e` and `f` indicates the number of digits that appear after the decimal point. Precision used with floating-point conversion character `g` indicates the number of significant digits to appear.
- Precision used with conversion character `s` indicates the number of characters to be printed.
- The field width and the precision can be combined by placing the field width, followed by a decimal point, followed by the precision between the percent sign and the conversion character.

Section G.10 Using Flags in the `printf` Format String

- The `-` flag left justifies its argument in a field.
- The `+` flag prints a plus sign for positive values and a minus sign for negative values.
- The space flag prints a space preceding a positive value. The space flag and the `+` flag cannot be used together in an integer conversion character.
- The `#` flag prefixes `0` to octal values and `0x` to hexadecimal values.
- The `0` flag prints leading zeros for a value that does not occupy its entire field.
- The comma (`,`) flag uses the locale-specific thousands separator to display integer and floating-point numbers.
- The `(` flag encloses a negative number in parentheses.

Section G.11 Printing with Argument Indices

- An argument index is an optional decimal integer followed by a \$ sign that indicates the position of the argument in the argument list.
- Argument indices enable programmers to reorder the output so that the arguments in the argument list are not necessarily in the order of their corresponding format specifiers. Argument indices also help avoid duplicating arguments.

Section G.13 Formatting Output with Class Formatter

- Class `Formatter` (in package `java.util`) provides the same formatting capabilities as `printf`. `Formatter` is a utility class that enables programmers to print formatted output to various destinations, including GUI components, files and other output streams.
- `Formatter` method `format` outputs formatted data to the destination specified by the `Formatter` constructor.
- `String` static method `format` formats data and returns the formatted data as a `String`.

Self-Review Exercises

- G.1** Fill in the blanks in each of the following:
- All input and output is dealt with in the form of _____.
 - The _____ stream is normally connected to the keyboard.
 - The _____ stream is normally connected to the computer screen.
 - `System.out`'s _____ method can be used to format text that is displayed on the standard output.
 - The conversion character _____ may be used to output a decimal integer.
 - The conversion characters _____ and _____ are used to display integers in octal and hexadecimal form, respectively.
 - The conversion character _____ is used to display a floating-point value in exponential notation.
 - The conversion characters `e` and `f` are displayed with _____ digits of precision to the right of the decimal point if no precision is specified.
 - The conversion characters _____ and _____ are used to print strings and characters, respectively.
 - The conversion character _____ and conversion suffix character _____ are used to print time for the 24-hour clock as `hour:minute:second`.
 - The _____ flag causes output to be left justified in a field.
 - The _____ flag causes values to be displayed with either a plus sign or a minus sign.
 - The argument index _____ corresponds to the second argument in the argument list.
 - Class _____ has the same capability as `printf`, but allows programmers to print formatted output to various destinations besides the standard output stream.
- G.2** Find the error in each of the following and explain how it can be corrected.
- The following statement should print the character 'c'.
`System.out.printf("%c\n", "c");`
 - The following statement should print 9.375%.
`System.out.printf("%.3f%", 9.375);`
 - The following statement should print the third argument in the argument list.
`System.out.printf("%2$s\n", "Mon", "Tue", "Wed", "Thu", "Fri");`
 - `System.out.printf(""A string in quotes"");`
 - `System.out.printf(%d%d, 12, 20);`
 - `System.out.printf("%s\n", 'Richard');`

- G.3** Write a statement for each of the following:
- Print 1234 right justified in a 10-digit field.
 - Print 123.456789 in exponential notation with a sign (+ or -) and 3 digits of precision.
 - Print 100 in octal form preceded by 0.
 - Given a `Calendar` object `calendar`, print a date formatted as month/day/year (each with two digits).
 - Given a `Calendar` object `calendar`, print a time for the 24-hour clock as hour:minute:second (each with two digits) using argument index and conversion suffix characters for formatting time.
 - Print 3.333333 with a sign (+ or -) in a field of 20 characters with a precision of 3.

Answers to Self-Review Exercises

G.1 a) Streams. b) Standard input. c) Standard output. d) `printf`. e) d. f) o, x or X. g) e or E. h) 6. i) s or S, c or C. j) t, T. k) - (minus). l) + (plus). m) 2\$. n) Formatter.

- G.2**
- Error: Conversion character `c` expects an argument of primitive type `char`.
Correction: To print the character `'c'`, change `"c"` to `'c'`.
 - Error: Trying to print the literal character `%` without using the format specifier `%%`.
Correction: Use `%%` to print a literal `%` character.
 - Error: Argument index does not start with 0; e.g., the first argument is 1\$.
Correction: To print the third argument use 3\$.
 - Error: Trying to print the literal character `"` without using the `\` escape sequence.
Correction: Replace each quote in the inner set of quotes with `\`.
 - Error: The format string is not enclosed in double quotes.
Correction: Enclose `%d %d` in double quotes.
 - Error: The string to be printed is enclosed in single quotes.
Correction: Use double quotes instead of single quotes to represent a string.

- G.3**
- `System.out.printf("%10d\n", 1234);`
 - `System.out.printf("%.3e\n", 123.456789);`
 - `System.out.printf("%#o\n", 100);`
 - `System.out.printf("%tD\n", calendar);`
 - `System.out.printf("%1$tH:%1$tM:%1$tS\n", calendar);`
 - `System.out.printf("%+20.3f\n", 3.333333);`

Exercises

- G.4** Write statement(s) for each of the following:
- Print integer 40000 right justified in a 15-digit field.
 - Print 200 with and without a sign.
 - Print 100 in hexadecimal form preceded by 0x.
 - Print 1.234 with three digits of precision in a 9-digit field with preceding zeros.
- G.5** Show what is printed by each of the following statements. If a statement is incorrect, indicate why.
- `System.out.printf("%-10d\n", 10000);`
 - `System.out.printf("%c\n", "This is a string");`
 - `System.out.printf("%8.3f\n", 1024.987654);`
 - `System.out.printf("%#o\n%#X\n", 17, 17);`
 - `System.out.printf("% d\n%+d\n", 1000000, 1000000);`
 - `System.out.printf("%10.2e\n", 444.93738);`
 - `System.out.printf("%d\n", 10.987);`

G.6 Find the error(s) in each of the following program segments. Show the corrected statement.

- a) `System.out.printf("%s\n", 'Happy Birthday');`
- b) `System.out.printf("%c\n", 'Hello');`
- c) `System.out.printf("%c\n", "This is a string");`
- d) The following statement should print "Bon Voyage" with the double quotes:
`System.out.printf("%s", "Bon Voyage");`
- e) The following statement should print "Today is Friday":
`System.out.printf("Today is %s\n", "Monday", "Friday");`
- f) `System.out.printf('Enter your name: ');`
- g) `System.out.printf(%f, 123.456);`
- h) The following statement should print the current time in the format "hh:mm:ss":
`Calendar dateTime = Calendar.getInstance();`
`System.out.printf("%1$tK:1$tL:1$tS\n", dateTime);`

G.7 (*Printing Dates and Times*) Write a program that prints dates and times in the following forms:

```
GMT-05:00 04/30/04 09:55:09 AM
GMT-05:00 April 30 2004 09:55:09
2004-04-30 day-of-the-month:30
2004-04-30 day-of-the-year:121
Fri Apr 30 09:55:09 GMT-05:00 2004
```

[*Note:* Depending on your location, you may get a time zone other than GMT-05:00.]

G.8 Write a program to test the results of printing the integer value 12345 and the floating-point value 1.2345 in fields of various sizes.

G.9 (*Rounding Numbers*) Write a program that prints the value 100.453627 rounded to the nearest digit, tenth, hundredth, thousandth and ten-thousandth.

G.10 Write a program that inputs a word from the keyboard and determines its length. Print the word using twice the length as the field width.

G.11 (*Converting Fahrenheit Temperature to Celsius*) Write a program that converts integer Fahrenheit temperatures from 0 to 212 degrees to floating-point Celsius temperatures with three digits of precision. Use the formula

$$\text{celsius} = 5.0 / 9.0 * (\text{fahrenheit} - 32);$$

to perform the calculation. The output should be printed in two right-justified columns of 10 characters each, and the Celsius temperatures should be preceded by a sign for both positive and negative values.

G.12 Write a program to test all the escape sequences in Fig. G.23. For those that move the cursor, print a character before and after the escape sequence so that it's clear where the cursor has moved.

G.13 Write a program that uses the conversion character g to output the value 9876.12345. Print the value with precisions ranging from 1 to 9.

H

Number Systems

Objectives

In this appendix you'll learn:

- To understand basic number systems concepts, such as base, positional value and symbol value.
- To understand how to work with numbers represented in the binary, octal and hexadecimal number systems.
- To abbreviate binary numbers as octal numbers or hexadecimal numbers.
- To convert octal numbers and hexadecimal numbers to binary numbers.
- To convert back and forth between decimal numbers and their binary, octal and hexadecimal equivalents.
- To understand binary arithmetic and how negative binary numbers are represented using two's complement notation.

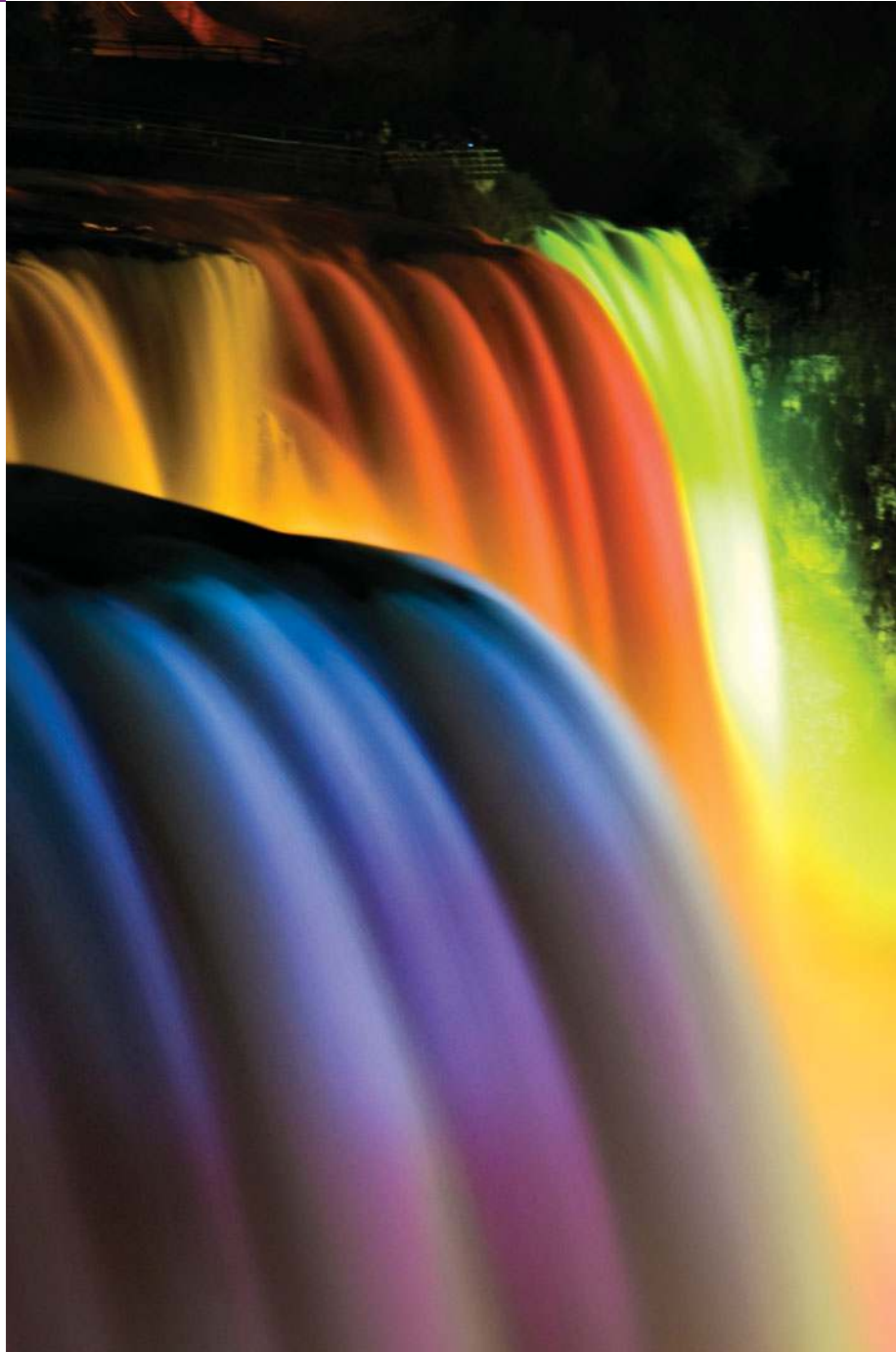

- | | |
|---|--|
| H.1 Introduction | H.5 Converting from Decimal to Binary, Octal or Hexadecimal |
| H.2 Abbreviating Binary Numbers as Octal and Hexadecimal Numbers | H.6 Negative Binary Numbers: Two's Complement Notation |
| H.3 Converting Octal and Hexadecimal Numbers to Binary Numbers | |
| H.4 Converting from Binary, Octal or Hexadecimal to Decimal | |

Summary | Self-Review Exercises | Answers to Self-Review Exercises | Exercises

H.1 Introduction

In this appendix, we introduce the key number systems that Java programmers use, especially when they're working on software projects that require close interaction with machine-level hardware. Projects like this include operating systems, computer networking software, compilers, database systems and applications requiring high performance.

When we write an integer such as 227 or -63 in a Java program, the number is assumed to be in the decimal (base 10) number system. The digits in the decimal number system are 0, 1, 2, 3, 4, 5, 6, 7, 8 and 9. The lowest digit is 0 and the highest digit is 9—one less than the base of 10. Internally, computers use the binary (base 2) number system. The binary number system has only two digits, namely 0 and 1. Its lowest digit is 0 and its highest digit is 1—one less than the base of 2.

As we'll see, binary numbers tend to be much longer than their decimal equivalents. Programmers who work in assembly languages and in high-level languages like Java that enable programmers to reach down to the machine level find it cumbersome to work with binary numbers. So two other number systems—the octal number system (base 8) and the hexadecimal number system (base 16)—are popular primarily because they make it convenient to abbreviate binary numbers.

In the octal number system, the digits range from 0 to 7. Because both the binary number system and the octal number system have fewer digits than the decimal number system, their digits are the same as the corresponding digits in decimal.

The hexadecimal number system poses a problem because it requires 16 digits—a lowest digit of 0 and a highest digit with a value equivalent to decimal 15 (one less than the base of 16). By convention, we use the letters A through F to represent the hexadecimal digits corresponding to decimal values 10 through 15. Thus in hexadecimal we can have numbers like 876 consisting solely of decimal-like digits, numbers like 8A55F consisting of digits and letters and numbers like FFE consisting solely of letters. Occasionally, a hexadecimal number spells a common word such as FACE or FEED—this can appear strange to programmers accustomed to working with numbers. The digits of the binary, octal, decimal and hexadecimal number systems are summarized in Fig. H.1 and Fig. H.2.

Each of these number systems uses positional notation—each position in which a digit is written has a different positional value. For example, in the decimal number 937 (the 9, the 3 and the 7 are referred to as symbol values), we say that the 7 is written in the ones position, the 3 is written in the tens position and the 9 is written in the hundreds position. Each of these positions is a power of the base (base 10) and that these powers begin at 0 and increase by 1 as we move left in the number (Fig. H.3).

Binary digit	Octal digit	Decimal digit	Hexadecimal digit
0	0	0	0
1	1	1	1
	2	2	2
	3	3	3
	4	4	4
	5	5	5
	6	6	6
	7	7	7
		8	8
		9	9
			A (decimal value of 10)
			B (decimal value of 11)
			C (decimal value of 12)
			D (decimal value of 13)
			E (decimal value of 14)
			F (decimal value of 15)

Fig. H.1 | Digits of the binary, octal, decimal and hexadecimal number systems.

Attribute	Binary	Octal	Decimal	Hexadecimal
Base	2	8	10	16
Lowest digit	0	0	0	0
Highest digit	1	7	9	F

Fig. H.2 | Comparing the binary, octal, decimal and hexadecimal number systems.

Positional values in the decimal number system			
Decimal digit	9	3	7
Position name	Hundreds	Tens	Ones
Positional value	100	10	1
Positional value as a power of the base (10)	10^2	10^1	10^0

Fig. H.3 | Positional values in the decimal number system.

For longer decimal numbers, the next positions to the left would be the thousands position (10 to the 3rd power), the ten-thousands position (10 to the 4th power), the hundred-thousands position (10 to the 5th power), the millions position (10 to the 6th power), the ten-millions position (10 to the 7th power) and so on.

In the binary number 101, the rightmost 1 is written in the ones position, the 0 is written in the twos position and the leftmost 1 is written in the fours position. Each position is a power of the base (base 2) and that these powers begin at 0 and increase by 1 as we move left in the number (Fig. H.4). So, $101 = 2^2 + 2^0 = 4 + 1 = 5$.

Positional values in the binary number system			
Binary digit	1	0	1
Position name	Fours	Twos	Ones
Positional value	4	2	1
Positional value as a power of the base (2)	2^2	2^1	2^0

Fig. H.4 | Positional values in the binary number system.

For longer binary numbers, the next positions to the left would be the eights position (2 to the 3rd power), the sixteens position (2 to the 4th power), the thirty-twos position (2 to the 5th power), the sixty-fours position (2 to the 6th power) and so on.

In the octal number 425, we say that the 5 is written in the ones position, the 2 is written in the eights position and the 4 is written in the sixty-fours position. Each of these positions is a power of the base (base 8) and that these powers begin at 0 and increase by 1 as we move left in the number (Fig. H.5).

Positional values in the octal number system			
Decimal digit	4	2	5
Position name	Sixty-fours	Eights	Ones
Positional value	64	8	1
Positional value as a power of the base (8)	8^2	8^1	8^0

Fig. H.5 | Positional values in the octal number system.

For longer octal numbers, the next positions to the left would be the five-hundred-and-twelves position (8 to the 3rd power), the four-thousand-and-ninety-sixes position (8 to the 4th power), the thirty-two-thousand-seven-hundred-and-sixty-eights position (8 to the 5th power) and so on.

In the hexadecimal number 3DA, we say that the A is written in the ones position, the D is written in the sixteens position and the 3 is written in the two-hundred-and-fifty-sixes position. Each of these positions is a power of the base (base 16) and that these powers begin at 0 and increase by 1 as we move left in the number (Fig. H.6).

For longer hexadecimal numbers, the next positions to the left would be the four-thousand-and-ninety-sixes position (16 to the 3rd power), the sixty-five-thousand-five-hundred-and-thirty-sixes position (16 to the 4th power) and so on.

Positional values in the hexadecimal number system			
Decimal digit	3	D	A
Position name	Two-hundred-and-fifty-sixes	Sixteens	Ones
Positional value	256	16	1
Positional value as a power of the base (16)	16^2	16^1	16^0

Fig. H.6 | Positional values in the hexadecimal number system.

H.2 Abbreviating Binary Numbers as Octal and Hexadecimal Numbers

The main use for octal and hexadecimal numbers in computing is for abbreviating lengthy binary representations. Figure H.7 highlights the fact that lengthy binary numbers can be expressed concisely in number systems with higher bases than the binary number system.

Decimal number	Binary representation	Octal representation	Hexadecimal representation
0	0	0	0
1	1	1	1
2	10	2	2
3	11	3	3
4	100	4	4
5	101	5	5
6	110	6	6
7	111	7	7
8	1000	10	8
9	1001	11	9
10	1010	12	A
11	1011	13	B
12	1100	14	C
13	1101	15	D
14	1110	16	E
15	1111	17	F
16	10000	20	10

Fig. H.7 | Decimal, binary, octal and hexadecimal equivalents.

A particularly important relationship that both the octal number system and the hexadecimal number system have to the binary system is that the bases of octal and hexadec-

imal (8 and 16 respectively) are powers of the base of the binary number system (base 2). Consider the following 12-digit binary number and its octal and hexadecimal equivalents. See if you can determine how this relationship makes it convenient to abbreviate binary numbers in octal or hexadecimal. The answer follows the numbers.

Binary number	Octal equivalent	Hexadecimal equivalent
100011010001	4321	8D1

To see how the binary number converts easily to octal, simply break the 12-digit binary number into groups of three consecutive bits each and write those groups over the corresponding digits of the octal number as follows:

100	011	010	001
4	3	2	1

The octal digit you've written under each group of three bits corresponds precisely to the octal equivalent of that 3-digit binary number, as shown in Fig. H.7.

The same kind of relationship can be observed in converting from binary to hexadecimal. Break the 12-digit binary number into groups of four consecutive bits each and write those groups over the corresponding digits of the hexadecimal number as follows:

1000	1101	0001
8	D	1

Notice that the hexadecimal digit you wrote under each group of four bits corresponds precisely to the hexadecimal equivalent of that 4-digit binary number as shown in Fig. H.7.

H.3 Converting Octal and Hexadecimal Numbers to Binary Numbers

In the previous section, we saw how to convert binary numbers to their octal and hexadecimal equivalents by forming groups of binary digits and simply rewriting them as their equivalent octal digit values or hexadecimal digit values. This process may be used in reverse to produce the binary equivalent of a given octal or hexadecimal number.

For example, the octal number 653 is converted to binary simply by writing the 6 as its 3-digit binary equivalent 110, the 5 as its 3-digit binary equivalent 101 and the 3 as its 3-digit binary equivalent 011 to form the 9-digit binary number 110101011.

The hexadecimal number FAD5 is converted to binary simply by writing the F as its 4-digit binary equivalent 1111, the A as its 4-digit binary equivalent 1010, the D as its 4-digit binary equivalent 1101 and the 5 as its 4-digit binary equivalent 0101 to form the 16-digit 1111101011010101.

H.4 Converting from Binary, Octal or Hexadecimal to Decimal

We're accustomed to working in decimal, and therefore it's often convenient to convert a binary, octal, or hexadecimal number to decimal to get a sense of what the number is "really" worth. Our diagrams in Section H.1 express the positional values in decimal. To convert a number to decimal from another base, multiply the decimal equivalent of each digit

by its positional value and sum these products. For example, the binary number 110101 is converted to decimal 53, as shown in Fig. H.8.

Converting a binary number to decimal						
Positional values:	32	16	8	4	2	1
Symbol values:	1	1	0	1	0	1
Products:	$1*32=32$	$1*16=16$	$0*8=0$	$1*4=4$	$0*2=0$	$1*1=1$
Sum:	$= 32 + 16 + 0 + 4 + 0 + 1 = 53$					

Fig. H.8 | Converting a binary number to decimal.

To convert octal 7614 to decimal 3980, we use the same technique, this time using appropriate octal positional values, as shown in Fig. H.9.

Converting an octal number to decimal				
Positional values:	512	64	8	1
Symbol values:	7	6	1	4
Products	$7*512=3584$	$6*64=384$	$1*8=8$	$4*1=4$
Sum:	$= 3584 + 384 + 8 + 4 = 3980$			

Fig. H.9 | Converting an octal number to decimal.

To convert hexadecimal AD3B to decimal 44347, we use the same technique, this time using appropriate hexadecimal positional values, as shown in Fig. H.10.

Converting a hexadecimal number to decimal				
Positional values:	4096	256	16	1
Symbol values:	A	D	3	B
Products	$A*4096=4096$	$D*256=3328$	$3*16=48$	$B*1=11$
Sum:	$= 4096 + 3328 + 48 + 11 = 44347$			

Fig. H.10 | Converting a hexadecimal number to decimal.

H.5 Converting from Decimal to Binary, Octal or Hexadecimal

The conversions in Section H.4 follow naturally from the positional notation conventions. Converting from decimal to binary, octal, or hexadecimal also follows these conventions.

Suppose we wish to convert decimal 57 to binary. We begin by writing the positional values of the columns right to left until we reach a column whose positional value is greater than the decimal number. We don't need that column, so we discard it. Thus, we first write:

Positional values:	64	32	16	8	4	2	1
--------------------	----	----	----	---	---	---	---

Then we discard the column with positional value 64, leaving:

Positional values:	32	16	8	4	2	1
--------------------	----	----	---	---	---	---

Next we work from the leftmost column to the right. We divide 32 into 57 and observe that there's one 32 in 57 with a remainder of 25, so we write 1 in the 32 column. We divide 16 into 25 and observe that there's one 16 in 25 with a remainder of 9 and write 1 in the 16 column. We divide 8 into 9 and observe that there's one 8 in 9 with a remainder of 1. The next two columns each produce quotients of 0 when their positional values are divided into 1, so we write 0s in the 4 and 2 columns. Finally, 1 into 1 is 1, so we write 1 in the 1 column. This yields:

Positional values:	32	16	8	4	2	1
Symbol values:	1	1	1	0	0	1

and thus decimal 57 is equivalent to binary 111001.

To convert decimal 103 to octal, we begin by writing the positional values of the columns until we reach a column whose positional value is greater than the decimal number. We do not need that column, so we discard it. Thus, we first write:

Positional values:	512	64	8	1
--------------------	-----	----	---	---

Then we discard the column with positional value 512, yielding:

Positional values:	64	8	1
--------------------	----	---	---

Next we work from the leftmost column to the right. We divide 64 into 103 and observe that there's one 64 in 103 with a remainder of 39, so we write 1 in the 64 column. We divide 8 into 39 and observe that there are four 8s in 39 with a remainder of 7 and write 4 in the 8 column. Finally, we divide 1 into 7 and observe that there are seven 1s in 7 with no remainder, so we write 7 in the 1 column. This yields:

Positional values:	64	8	1
Symbol values:	1	4	7

and thus decimal 103 is equivalent to octal 147.

To convert decimal 375 to hexadecimal, we begin by writing the positional values of the columns until we reach a column whose positional value is greater than the decimal number. We do not need that column, so we discard it. Thus, we first write:

Positional values:	4096	256	16	1
--------------------	------	-----	----	---

Then we discard the column with positional value 4096, yielding:

Positional values:	256	16	1
--------------------	-----	----	---

Next we work from the leftmost column to the right. We divide 256 into 375 and observe that there's one 256 in 375 with a remainder of 119, so we write 1 in the 256 column. We divide 16 into 119 and observe that there are seven 16s in 119 with a

remainder of 7 and write 7 in the 16 column. Finally, we divide 1 into 7 and observe that there are seven 1s in 7 with no remainder, so we write 7 in the 1 column. This yields:

Positional values:	256	16	1
Symbol values:	1	7	7

and thus decimal 375 is equivalent to hexadecimal 177.

H.6 Negative Binary Numbers: Two's Complement Notation

The discussion so far in this appendix has focused on positive numbers. In this section, we explain how computers represent negative numbers using *two's complement notation*. First we explain how the two's complement of a binary number is formed, then we show why it represents the negative value of the given binary number.

Consider a machine with 32-bit integers. Suppose

```
int value = 13;
```

The 32-bit representation of `value` is

```
00000000 00000000 00000000 00001101
```

To form the negative of `value` we first form its *one's complement* by applying Java's bitwise complement operator (`~`):

```
onesComplementOfValue = ~value;
```

Internally, `~value` is now `value` with each of its bits reversed—ones become zeros and zeros become ones, as follows:

```
value:
00000000 00000000 00000000 00001101
~value (i.e., value's ones complement):
11111111 11111111 11111111 11110010
```

To form the two's complement of `value`, we simply add 1 to `value`'s one's complement. Thus

```
Two's complement of value:
11111111 11111111 11111111 11110011
```

Now if this is in fact equal to -13 , we should be able to add it to binary 13 and obtain a result of 0. Let's try this:

```

00000000 00000000 00000000 00001101
+11111111 11111111 11111111 11110011
-----
00000000 00000000 00000000 00000000
```

The carry bit coming out of the leftmost column is discarded and we indeed get 0 as a result. If we add the one's complement of a number to the number, the result would be all 1s. The key to getting a result of all zeros is that the two's complement is one more than the one's complement. The addition of 1 causes each column to add to 0 with a carry of 1. The carry keeps moving leftward until it's discarded from the leftmost bit, and thus the resulting number is all zeros.

Computers actually perform a subtraction, such as

$$x = a - \text{value};$$

by adding the two's complement of `value` to `a`, as follows:

$$x = a + (\sim\text{value} + 1);$$

Suppose `a` is 27 and `value` is 13 as before. If the two's complement of `value` is actually the negative of `value`, then adding the two's complement of `value` to `a` should produce the result 14. Let's try this:

a (i.e., 27)	00000000	00000000	00000000	00011011
+ (~value + 1)	+11111111	11111111	11111111	11110011

	00000000	00000000	00000000	00001110

which is indeed equal to 14.

Summary

- An integer such as 19 or 227 or -63 in a Java program is assumed to be in the decimal (base 10) number system. The digits in the decimal number system are 0, 1, 2, 3, 4, 5, 6, 7, 8 and 9. The lowest digit is 0 and the highest digit is 9—one less than the base of 10.
- Computers use the binary (base 2) number system. The binary number system has only two digits, namely 0 and 1. Its lowest digit is 0 and its highest digit is 1—one less than the base of 2.
- The octal number system (base 8) and the hexadecimal number system (base 16) are popular primarily because they make it convenient to abbreviate binary numbers.
- The digits of the octal number system range from 0 to 7.
- The hexadecimal number system poses a problem because it requires 16 digits—a lowest digit of 0 and a highest digit with a value equivalent to decimal 15 (one less than the base of 16). By convention, we use the letters A through F to represent the hexadecimal digits corresponding to decimal values 10 through 15.
- Each number system uses positional notation—each position in which a digit is written has a different positional value.
- A particularly important relationship of both the octal number system and the hexadecimal number system to the binary system is that the bases of octal and hexadecimal (8 and 16 respectively) are powers of the base of the binary number system (base 2).
- To convert an octal to a binary number, replace each octal digit with its three-digit binary equivalent.
- To convert a hexadecimal number to a binary number, simply replace each hexadecimal digit with its four-digit binary equivalent.
- Because we're accustomed to working in decimal, it's convenient to convert a binary, octal or hexadecimal number to decimal to get a sense of the number's "real" worth.
- To convert a number to decimal from another base, multiply the decimal equivalent of each digit by its positional value and sum the products.
- Computers represent negative numbers using two's complement notation.
- To form the negative of a value in binary, first form its one's complement by applying Java's bitwise complement operator (`~`). This reverses the bits of the value. To form the two's complement of a value, simply add one to the value's one's complement.

Self-Review Exercises

- H.1** The bases of the decimal, binary, octal and hexadecimal number systems are _____, _____, _____ and _____ respectively.
- H.2** In general, the decimal, octal and hexadecimal representations of a given binary number contain (more/fewer) digits than the binary number contains.
- H.3** (*True/False*) A popular reason for using the decimal number system is that it forms a convenient notation for abbreviating binary numbers simply by substituting one decimal digit per group of four binary bits.
- H.4** The (octal / hexadecimal / decimal) representation of a large binary value is the most concise (of the given alternatives).
- H.5** (*True/False*) The highest digit in any base is one more than the base.
- H.6** (*True/False*) The lowest digit in any base is one less than the base.
- H.7** The positional value of the rightmost digit of any number in either binary, octal, decimal or hexadecimal is always _____.
- H.8** The positional value of the digit to the left of the rightmost digit of any number in binary, octal, decimal or hexadecimal is always equal to _____.
- H.9** Fill in the missing values in this chart of positional values for the rightmost four positions in each of the indicated number systems:
- | | | | | |
|-------------|------|-----|-----|-----|
| decimal | 1000 | 100 | 10 | 1 |
| hexadecimal | ... | 256 | ... | ... |
| binary | ... | ... | ... | ... |
| octal | 512 | ... | 8 | ... |
- H.10** Convert binary 110101011000 to octal and to hexadecimal.
- H.11** Convert hexadecimal FACE to binary.
- H.12** Convert octal 7316 to binary.
- H.13** Convert hexadecimal 4FEC to octal. (*Hint*: First convert 4FEC to binary, then convert that binary number to octal.)
- H.14** Convert binary 1101110 to decimal.
- H.15** Convert octal 317 to decimal.
- H.16** Convert hexadecimal EFD4 to decimal.
- H.17** Convert decimal 177 to binary, to octal and to hexadecimal.
- H.18** Show the binary representation of decimal 417. Then show the one's complement of 417 and the two's complement of 417.
- H.19** What is the result when a number and its two's complement are added to each other?

Answers to Self-Review Exercises

- H.1** 10, 2, 8, 16.
- H.2** Fewer.
- H.3** False. Hexadecimal does this.
- H.4** Hexadecimal.
- H.5** False. The highest digit in any base is one less than the base.

H.6 False. The lowest digit in any base is zero.

H.7 1 (the base raised to the zero power).

H.8 The base of the number system.

H.9 See below:

decimal	1000	100	10	1
hexadecimal	4096	256	16	1
binary	8	4	2	1
octal	512	64	8	1

H.10 Octal 6530; hexadecimal D58.

H.11 Binary 1111 1010 1100 1110.

H.12 Binary 111 011 001 110.

H.13 Binary 0 100 111 111 101 100; Octal 47754.

H.14 Decimal $2+4+8+32+64=110$.

H.15 Decimal $7+1*8+3*64=7+8+192=207$.

H.16 Decimal $4+13*16+15*256+14*4096=61396$.

H.17 Decimal 177

to binary:

$$\begin{array}{r} 256 \ 128 \ 64 \ 32 \ 16 \ 8 \ 4 \ 2 \ 1 \\ 128 \ 64 \ 32 \ 16 \ 8 \ 4 \ 2 \ 1 \\ (1*128)+(0*64)+(1*32)+(1*16)+(0*8)+(0*4)+(0*2)+(1*1) \\ 10110001 \end{array}$$

to octal:

$$\begin{array}{r} 512 \ 64 \ 8 \ 1 \\ 64 \ 8 \ 1 \\ (2*64)+(6*8)+(1*1) \\ 261 \end{array}$$

to hexadecimal:

$$\begin{array}{r} 256 \ 16 \ 1 \\ 16 \ 1 \\ (11*16)+(1*1) \\ (B*16)+(1*1) \\ B1 \end{array}$$

H.18 Binary:

$$\begin{array}{r} 512 \ 256 \ 128 \ 64 \ 32 \ 16 \ 8 \ 4 \ 2 \ 1 \\ 256 \ 128 \ 64 \ 32 \ 16 \ 8 \ 4 \ 2 \ 1 \\ (1*256)+(1*128)+(0*64)+(1*32)+(0*16)+(0*8)+(0*4)+(0*2)+(1*1) \\ 110100001 \end{array}$$

One's complement: 001011110

Two's complement: 001011111

Check: Original binary number + its two's complement

$$\begin{array}{r} 110100001 \\ 001011111 \\ \hline 000000000 \end{array}$$

H.19 Zero.

Exercises

H.20 Some people argue that many of our calculations would be easier in the base 12 number system because 12 is divisible by so many more numbers than 10 (for base 10). What is the lowest digit in base 12? What would be the highest symbol for the digit in base 12? What are the positional values of the rightmost four positions of any number in the base 12 number system?

H.21 Complete the following chart of positional values for the rightmost four positions in each of the indicated number systems:

decimal	1000	100	10	1
base 6	6	...
base 13	...	169
base 3	27

H.22 Convert binary 100101111010 to octal and to hexadecimal.

H.23 Convert hexadecimal 3A7D to binary.

H.24 Convert hexadecimal 765F to octal. (*Hint:* First convert 765F to binary, then convert that binary number to octal.)

H.25 Convert binary 1011110 to decimal.

H.26 Convert octal 426 to decimal.

H.27 Convert hexadecimal FFFF to decimal.

H.28 Convert decimal 299 to binary, to octal and to hexadecimal.

H.29 Show the binary representation of decimal 779. Then show the one's complement of 779 and the two's complement of 779.

H.30 Show the two's complement of integer value -1 on a machine with 32-bit integers.

GroupLayout

I.1 Introduction

Java SE 6 includes a powerful layout manager called **GroupLayout**, which is the default layout manager in the NetBeans IDE (www.netbeans.org). In this appendix, we overview GroupLayout, then demonstrate how to use the NetBeans IDE's **Matisse GUI designer** to create a GUI using GroupLayout to position the components. NetBeans generates the GroupLayout code for you automatically. Though you can write GroupLayout code by hand, in most cases you'll use a GUI design tool like the one provided by NetBeans to take advantage of GroupLayout's power. For more details on GroupLayout, see the list of web resources at the end of this appendix.

I.2 GroupLayout Basics

Chapters 14 and 25 presented several layout managers that provide basic GUI layout capabilities. We also discussed how to combine layout managers and multiple containers to create more complex layouts. Most layout managers do not give you precise control over the positioning of components. In Chapter 25, we discussed the `GridBagLayout`, which provides more precise control over the position and size of your GUI components. It allows you to specify the horizontal and vertical position of each component, the number of rows and columns each component occupies in the grid, and how components grow and shrink as the size of the container changes. This is all specified at once with a `GridBagConstraints` object. Class `GroupLayout` is the next step in layout management. `GroupLayout` is more flexible, because you can specify the horizontal and vertical layouts of your components independently.

Sequential and Parallel Arrangements

Components are arranged either sequentially or in parallel. The three `JButtons` in Fig. I.1 are arranged with **sequential horizontal orientation**—they appear left to right in sequence. Vertically, the components are arranged in parallel, so, in a sense, they “occupy the same vertical space.” Components can also be arranged sequentially in the vertical direction and in parallel in the horizontal direction, as you'll see in Section I.3. To prevent overlapping components, components with parallel vertical orientation are normally arranged with sequential horizontal orientation (and vice versa).

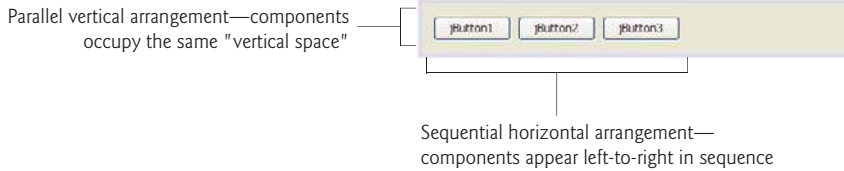

Fig. I.1 | JButtons arranged sequentially for their horizontal orientation and in parallel for their vertical orientation.

Groups and Alignment

To create more complex user interfaces, GroupLayout allows you to create **groups** that contain sequential or parallel elements. Within a group you can have GUI components, other groups and gaps. Placing a group within another group is similar to building a GUI using nested containers, such as a JPanel that contains other JPanels, which in turn contain GUI components.

When you create a group, you can specify the **alignment** of the group's elements. Class GroupLayout contains four constants for this purpose—LEADING, TRAILING, CENTER and BASELINE. The constant BASELINE applies only to vertical orientations. In horizontal orientation, the constants LEADING, TRAILING and CENTER represent left justified, right justified and centered, respectively. In vertical orientation, LEADING, TRAILING and CENTER align the components at their tops, bottoms or vertical centers, respectively. Aligning components with BASELINE indicates they should be aligned using the baseline of the font for the components' text. For more information about font baselines, see Section 15.4.

Spacing

GroupLayout by default uses the recommended GUI design guidelines of the underlying platform for spacing between components. The **addGap** method of GroupLayout nested classes **GroupLayout.Group**, **GroupLayout.SequentialGroup** and **GroupLayout.ParallelGroup** allows you to control the spacing between components.

Sizing Components

By default, GroupLayout uses each component's `getMinimumSize`, `getMaximumSize` and `getPreferredSize` methods to help determine the component's size. You can override the default settings.

I.3 Building a ColorChooser

We now present a ColorChooser application to demonstrate the GroupLayout layout manager. The application consists of three JSlider objects, each representing the values from 0 to 255 for specifying the red, green and blue values of a color. The selected values for each JSlider will be used to display a filled rectangle of the specified color. We build the application using NetBeans. For an more detailed introduction to developing GUI applications in the NetBeans IDE, see www.netbeans.org/kb/trails/matisse.html.

Creating a New Project

Begin by opening a new NetBeans project. Select **File > New Project...** In the **New Project** dialog, choose **Java** from the **Categories** list and **Java Application** from the **Projects** list then click **Next >**. Specify **ColorChooser** as the project name and uncheck the **Create Main Class** checkbox. You can also specify the location of your project in the **Project Location** field. Click **Finish** to create the project.

Adding a New Subclass of JFrame to the Project

In the IDE's **Projects** tab just below the **File** menu and toolbar (Fig. I.2), expand the **Source Packages** node. Right-click the **<default package>** node that appears and select **New > JFrame Form**. In the **New JFrame Form** dialog, specify **ColorChooser** as the class name and click **Finish**. This subclass of **JFrame** will display the application's GUI components. The NetBeans window should now appear similar to Fig. I.3 with the **ColorChooser** class shown in **Design** view. The **Source** and **Design** buttons at the top of the **ColorChooser.java** window allow you to switch between editing the source code and designing the GUI.

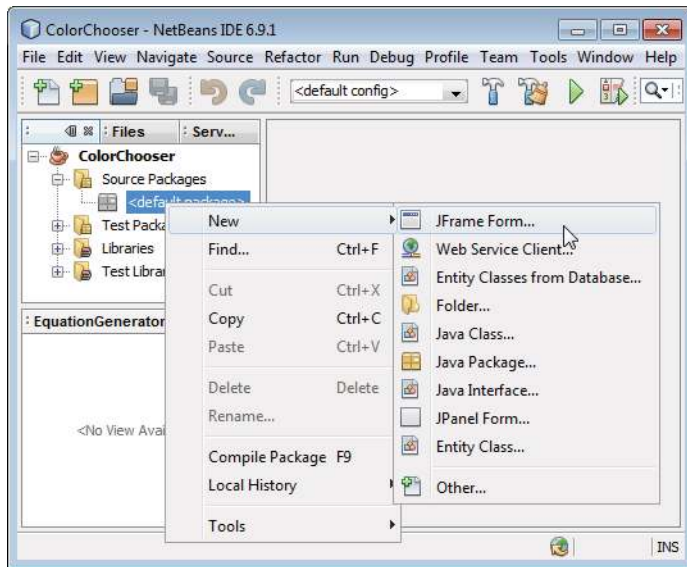

Fig. I.2 | Adding a new **JFrame Form** to the **ColorChooser** project.

Design view shows only the **ColorChooser**'s client area (i.e., the area that will appear inside the window's borders). To build a GUI visually, you can drag GUI components from the **Palette** window onto the client area. You can configure the properties of each component by selecting it, then modifying the property values that appear in the **Properties** window (Fig. I.3). When you select a component, the **Properties** window displays three buttons—**Properties**, **Bindings**, **Events**, **Code** (see Fig. I.4)—that enable you to configure various aspects of the component.

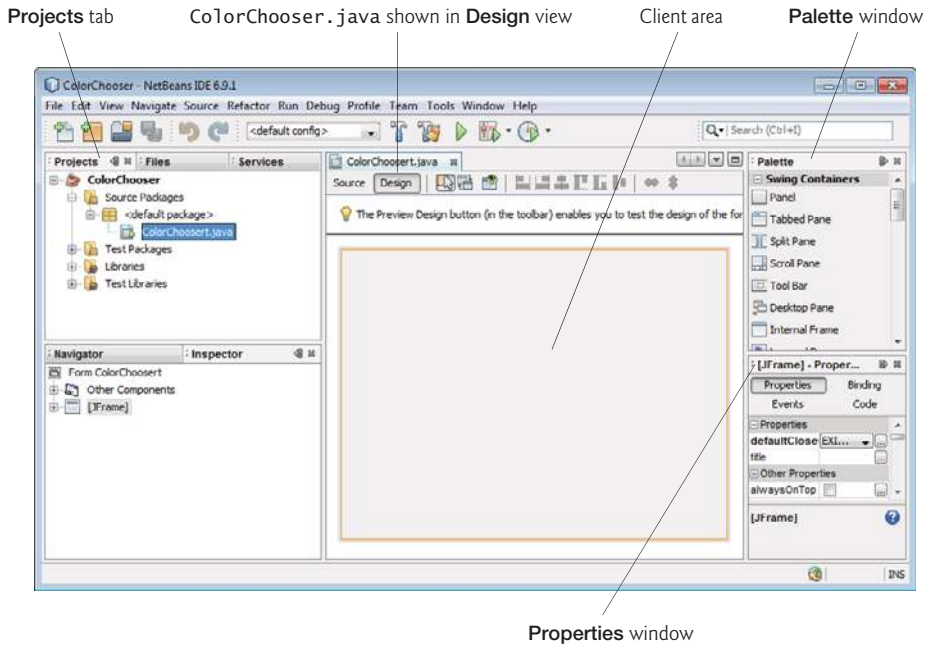

Fig. I.3 | Class ColorChooser shown in the NetBeans Design view.

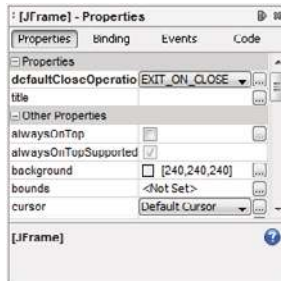

Fig. I.4 | Properties window with buttons that enable you to configure various aspects of the component.

Build the GUI

Drag three **Sliders** (objects of class `JSlider`) from the **Palette** onto the `JFrame` (you may need to scroll through the **Palette**). As you drag components near the edges of the client area or near other components, NetBeans displays **guide lines** (Fig. I.5) that show you the recommended distances and alignments between the component you're dragging, the edges of the client area and other components. As you follow the steps to build the GUI, use the guide lines to arrange the components into three rows and three columns as in Fig. I.6. Next, rename the `JSlider`s to `redJSlider`, `greenJSlider` and `blueJSlider`. To do so, select the first `JSlider`, then click the **Code** button in the **Properties** window and

change the **Variable Name** property to `redSlider`. Repeat this process to rename the other two `JSliders`. Then, click the **Properties** button in the **Properties** window, select each `JSlider` and change its **maximum** property to 255 so that it will produce values in the range 0–255, and change its **value** property to 0 so the `JSlider`'s thumb will initially be at the left of the `JSlider`.

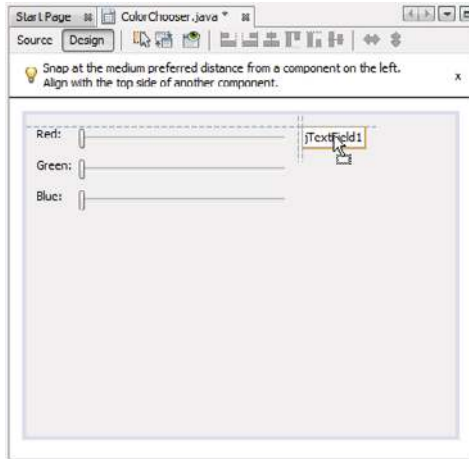

Fig. I.5 | Positioning the first `JTextField`.



Fig. I.6 | Layout of the `JLabels`, `JSliders` and `JTextFields`.

Drag three **Labels** (objects of class `JLabel`) from the **Palette** to the `JFrame` to label each `JSlider` with the color it represents. Name the `JLabels` `redJLabel`, `greenJLabel` and `blueJLabel`, respectively. Each `JLabel` should be placed to the left of the corresponding `JSlider` (Fig. I.6). Change each `JLabel`'s **text** property either by double clicking the `JLabel` and typing the new text, or by selecting the `JLabel` and changing the **text** property in the **Properties** window.

Add a **Text Field** (an object of class `JTextField`) next to each of the `JSliders` to display the value of the slider. Name the `JTextFields` `redJTextField`, `greenJTextField` and `blueJTextField`, respectively. Change each `JTextField`'s **text** property to 0 using the same techniques as you did for the `JLabels`. Change each `JTextField`'s **columns** property to 4. To align each **Label**, **Slider** and **Text Field** nicely, you can select them by dragging the mouse across all three and use the alignment buttons at the top of the **Design** window.

Next, add a **Panel** named `colorJPanel` to the right of this group of components. Use the guide lines as shown in Fig. I.7 to place the `JPanel`. Change this `JPanel`'s **background** color to black (the initially selected RGB color). Finally, drag the bottom-right border of the client area toward the top-left of the **Design** area until you see the snap-to lines that

show the recommended client area dimensions (which are based on the components in the client area) as shown in Fig. I.8.

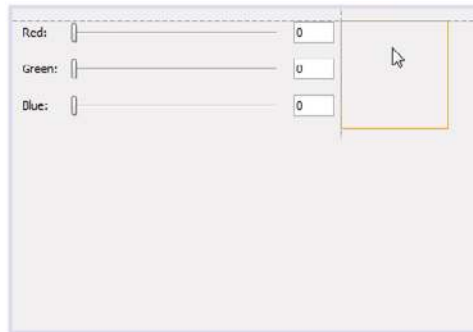

Fig. I.7 | Positioning the JPanel1.



Fig. I.8 | Setting the height of the client area.

Editing the Source Code and Adding Event Handlers

The IDE automatically generated the GUI code, including methods for initializing components and aligning them using the GroupLayout layout manager. We must add the desired functionality to the components' event handlers. To add an event handler for a component, right click it and position the mouse over the **Events** option in the pop-up menu. You can then select the category of event you wish to handle and the specific event within that category. For example, to add the JSlider event handlers for this example, right click each JSlider and select **Events > Change > stateChanged**. When you do this, NetBeans adds a ChangeListener to the JSlider and switches from **Design** view to **Source** view where you can place code in the event handler. Use the **Design** button to return to **Design** view and repeat the preceding steps to add the event handlers for the other two JSliders. To complete the event handlers, first add the method in Fig. I.9 following the class's constructor. In each JSlider event handler set the corresponding JTextField to the new value of the JSlider, then call method `changeColor`. Figure I.10 shows the completed `ColorChooser` class as it's generated in NetBeans. We did not restyle the code to match our coding conventions that you've seen throughout the book. You can now run the program to see it in action. Drag each slider and watch the `colorJPanel`'s background color change.

Method `initComponents` (lines 39–162) was entirely generated by NetBeans based on your interactions with the GUI designer. This method contains the code that creates and formats the GUI. Lines 41–93 construct and initialize the GUI components. Lines

95–161 specify the layout of those components using `GroupLayout`. Lines 108–136 specify the horizontal group and lines 137–159 specify the vertical group. Notice how complex the code is. More and more software development is done with tools that generate complex code like this, saving you the time and effort of doing it yourself.

We manually added the `changeColor` method in lines 25–30. When the user moves the thumb on one of the `JSliders`, the `JSlider`'s event handler sets the text in its corresponding `JTextField` to the `JSlider`'s new value (lines 166, 172 and 178), then calls method `changeColor` (lines 167, 173 and 179) to update the `colorJPanel`'s background color. Method `changeColor` gets the current value of each `JSlider` (lines 28–29) and uses these values as the arguments to the `Color` constructor to create a new `Color`.

```

1 // changes the colorJPanel's background color based on the current
2 // values of the JSliders
3 public void changeColor()
4 {
5     colorJPanel.setBackground( new java.awt.Color(
6         redJSlider.getValue(), greenJSlider.getValue(),
7         blueJSlider.getValue() ) );
8 } // end method changeColor

```

Fig. I.9 | Method that changes the `colorJPanel`'s background color based on the values of the three `JSliders`.

```

1 /*
2  * To change this template, choose Tools | Templates
3  * and open the template in the editor.
4  */
5
6 /*
7  * ColorChooser.java
8  *
9  * Created on Feb 8, 2011, 9:20:27 AM
10 */
11
12 /**
13  *
14  * @author Paul Deitel
15  */
16 public class ColorChooser extends javax.swing.JFrame {
17
18     /** Creates new form ColorChooser */
19     public ColorChooser() {
20         initComponents();
21     }
22
23     // changes the colorJPanel's background color based on the current
24     // values of the JSliders
25     public void changeColor()
26     {

```

Fig. I.10 | `ColorChooser` class that uses `GroupLayout` for its GUI layout. (Part 1 of 6.)

```

27         colorJPanel.setBackground( new java.awt.Color(
28             redJSlider.getValue(), greenJSlider.getValue(),
29             blueJSlider.getValue() ) );
30     } // end method changeColor
31
32     /** This method is called from within the constructor to
33     * initialize the form.
34     * WARNING: Do NOT modify this code. The content of this method is
35     * always regenerated by the Form Editor.
36     */
37     @SuppressWarnings("unchecked")
38     // <editor-fold defaultstate="collapsed" desc="Generated Code">
39     private void initComponents() {
40
41         redJSlider = new javax.swing.JSlider();
42         greenJSlider = new javax.swing.JSlider();
43         blueJSlider = new javax.swing.JSlider();
44         redJLabel = new javax.swing.JLabel();
45         greenJLabel = new javax.swing.JLabel();
46         blueJLabel = new javax.swing.JLabel();
47         redJTextField = new javax.swing.JTextField();
48         greenJTextField = new javax.swing.JTextField();
49         blueJTextField = new javax.swing.JTextField();
50         colorJPanel = new javax.swing.JPanel();
51
52         setDefaultCloseOperation(javax.swing.WindowConstants.EXIT_ON_CLOSE);
53
54         redJSlider.setMaximum(255);
55         redJSlider.setValue(0);
56         redJSlider.addChangeListener(new javax.swing.event.ChangeListener()
57     {
58         public void stateChanged(javax.swing.event.ChangeEvent evt) {
59             redJSliderStateChanged(evt);
60         }
61     });
62         greenJSlider.setMaximum(255);
63         greenJSlider.setValue(0);
64         greenJSlider.addChangeListener(new
65     javax.swing.event.ChangeListener() {
66         public void stateChanged(javax.swing.event.ChangeEvent evt) {
67             greenJSliderStateChanged(evt);
68         }
69     });
70         blueJSlider.setMaximum(255);
71         blueJSlider.setValue(0);
72         blueJSlider.addChangeListener(new javax.swing.event.ChangeListener()
73     {
74         public void stateChanged(javax.swing.event.ChangeEvent evt) {
75             blueJSliderStateChanged(evt);
76         }
77     });

```

Fig. I.10 | Co1orChooser class that uses GroupLayout for its GUI layout. (Part 2 of 6.)

```

77
78     redJLabel.setText("Red:");
79
80     greenJLabel.setText("Green:");
81
82     blueJLabel.setText("Blue:");
83
84     redJTextField.setColumns(4);
85     redJTextField.setText("0");
86
87     greenJTextField.setColumns(4);
88     greenJTextField.setText("0");
89
90     blueJTextField.setColumns(4);
91     blueJTextField.setText("0");
92
93     colorJPanel.setBackground(new java.awt.Color(0, 0, 0));
94
95     javax.swing.GroupLayout colorJPanelLayout = new
javax.swing.GroupLayout(colorJPanel);
96     colorJPanel.setLayout(colorJPanelLayout);
97     colorJPanelLayout.setHorizontalGroup(
98
colorJPanelLayout.createParallelGroup(javax.swing.GroupLayout.Alignment.LEADING)
99         .addGroup(
100             .addGap(0, 100, Short.MAX_VALUE)
101         );
102     colorJPanelLayout.setVerticalGroup(
colorJPanelLayout.createParallelGroup(javax.swing.GroupLayout.Alignment.LEADING)
103         .addGroup(
104             .addGap(0, 91, Short.MAX_VALUE)
105         );
106     javax.swing.GroupLayout layout = new
javax.swing.GroupLayout(getContentPane());
107     getContentPane().setLayout(layout);
108     layout.setHorizontalGroup(
109
layout.createParallelGroup(javax.swing.GroupLayout.Alignment.LEADING)
110         .addGroup(layout.createSequentialGroup()
111             .addGroup(layout.createParallelGroup(javax.swing.GroupLayout.Alignment.LEADING)
112                 .addGroup(
113                     .addGroup(javax.swing.GroupLayout.Alignment.TRAILING,
layout.createSequentialGroup()
114                         .addContainerGap()
115                         .addComponent(redJLabel)
116                         .addGap(20, 20, 20)
117                         .addComponent(redJSlider,
javax.swing.GroupLayout.PREFERRED_SIZE, javax.swing.GroupLayout.DEFAULT_SIZE,
javax.swing.GroupLayout.PREFERRED_SIZE)

```

Fig. I.10 | ColorChooser class that uses GroupLayout for its GUI layout. (Part 3 of 6.)

```

145         .addComponent(redJSlider,
javax.swing.GroupLayout.PREFERRED_SIZE, javax.swing.GroupLayout.DEFAULT_SIZE,
javax.swing.GroupLayout.PREFERRED_SIZE)
146         .addComponent(redJTextField,
javax.swing.GroupLayout.PREFERRED_SIZE, javax.swing.GroupLayout.DEFAULT_SIZE,
javax.swing.GroupLayout.PREFERRED_SIZE)
147         .addComponent(redJLabel))
148
149 .addPreferredGap(javax.swing.LayoutStyle.ComponentPlacement.UNRELATED)
149
150 .addGroup(layout.createParallelGroup(javax.swing.GroupLayout.Alignment.CENTER)
150         .addComponent(greenJSlider,
javax.swing.GroupLayout.PREFERRED_SIZE, javax.swing.GroupLayout.DEFAULT_SIZE,
javax.swing.GroupLayout.PREFERRED_SIZE)
151         .addComponent(greenJLabel)
152         .addComponent(greenJTextField,
javax.swing.GroupLayout.PREFERRED_SIZE, javax.swing.GroupLayout.DEFAULT_SIZE,
javax.swing.GroupLayout.PREFERRED_SIZE))
153
154 .addPreferredGap(javax.swing.LayoutStyle.ComponentPlacement.UNRELATED)
154
155 .addGroup(layout.createParallelGroup(javax.swing.GroupLayout.Alignment.CENTER)
155         .addComponent(blueJLabel)
156         .addComponent(blueJSlider,
javax.swing.GroupLayout.PREFERRED_SIZE, javax.swing.GroupLayout.DEFAULT_SIZE,
javax.swing.GroupLayout.PREFERRED_SIZE)
157         .addComponent(blueJTextField,
javax.swing.GroupLayout.PREFERRED_SIZE, javax.swing.GroupLayout.DEFAULT_SIZE,
javax.swing.GroupLayout.PREFERRED_SIZE)))
158         .addContainerGap())
159     );
160
161     pack();
162 }// </editor-fold>
163
164 private void redJSliderStateChanged(javax.swing.event.ChangeEvent evt)
165 {
166     redJTextField.setText( String.valueOf( redJSlider.getValue() ) );
167     changeColor();
168 }
169
170 private void greenJSliderStateChanged(javax.swing.event.ChangeEvent
170 evt)
171 {
172     greenJTextField.setText( String.valueOf( greenJSlider.getValue() )
172 );
173     changeColor();
174 }
175
176 private void blueJSliderStateChanged(javax.swing.event.ChangeEvent
176 evt)
177 {
177     blueJTextField.setText( String.valueOf( blueJSlider.getValue() ) );

```

Fig. I.10 | ColorChooser class that uses GroupLayout for its GUI layout. (Part 5 of 6.)

```
179     changeColor();
180 }
181
182 /**
183  * @param args the command line arguments
184  */
185 public static void main(String args[]) {
186     java.awt.EventQueue.invokeLater(new Runnable() {
187         public void run() {
188             new ColorChooser().setVisible(true);
189         }
190     });
191 }
192
193 // Variables declaration - do not modify
194 private javax.swing.JLabel blueJLabel;
195 private javax.swing.JSlider blueJSlider;
196 private javax.swing.JTextField blueJTextField;
197 private javax.swing.JPanel colorJPanel;
198 private javax.swing.JLabel greenJLabel;
199 private javax.swing.JSlider greenJSlider;
200 private javax.swing.JTextField greenJTextField;
201 private javax.swing.JLabel redJLabel;
202 private javax.swing.JSlider redJSlider;
203 private javax.swing.JTextField redJTextField;
204 // End of variables declaration
205
206 }
```

Fig. I.10 | ColorChooser class that uses GroupLayout for its GUI layout. (Part 6 of 6.)

I.4 GroupLayout Web Resources

download.oracle.com/javase/6/docs/api/javax/swing/GroupLayout.html
API documentation for class GroupLayout.

wiki.java.net/bin/view/Javadesktop/GroupLayoutExample
Provides an Address Book demo of a GUI built manually with GroupLayout with source code.

www.developer.com/java/ent/article.php/3589961
Tutorial: "Building Java GUIs with Matisse: A Gentle Introduction," by Dick Wall.



J

Java Desktop Integration Components

J.1 Introduction

The **Java Desktop Integration Components (JDIC)** are part of an open-source project aimed at allowing better integration between Java applications and the platforms on which they execute. Some JDIC features include:

- interacting with the underlying platform to launch native applications (such as web browsers and e-mail clients)
- displaying a splash screen when an application begins execution to indicate to the user that the application is loading
- creating icons in the system tray (also called the taskbar status area or notification area) to provide access to Java applications running in the background
- registering file-type associations, so that files of specified types will automatically open in corresponding Java applications
- creating installer packages, and more.

The JDIC homepage (jdkc.dev.java.net/) includes an introduction to JDIC, downloads, documentation, FAQs, demos, articles, blogs, announcements, incubator projects, a developer's page, forums, mailing lists, and more. Java SE 6 includes some of the features mentioned above. We discuss several of these features here.

J.2 Splash Screens

Java application users often perceive a performance problem, because nothing appears on the screen when you first launch an application. One way to show a user that your program is loading is to display a **splash screen**—a borderless window that appears temporarily while an application loads. Java SE 6 provides the new command-line option **-splash** for the `java` command to accomplish this task. This option enables you to specify a PNG, GIF or JPG image that should display when your application begins loading. To demonstrate this new option, we created a program (Fig. J.1) that sleeps for 5 seconds (so you can view the splash screen) then displays a message at the command line. The directory for this example includes a PNG format image to use as the splash screen. To display the splash screen when this application loads, use the command

```
java -splash:DeitelBug.png SplashDemo
```

```
1 // Fig. J.1: SplashDemo.java
2 // Splash screen demonstration.
3 public class SplashDemo
4 {
5     public static void main( String[] args )
6     {
7         try
8         {
9             Thread.sleep( 5000 );
10        } // end try
11        catch ( InterruptedException e )
12        {
13            e.printStackTrace();
14        } // end catch
15
16        System.out.println(
17            "This was the splash screen demo." );
18    } // end method main
19 } // end class SplashDemo
```

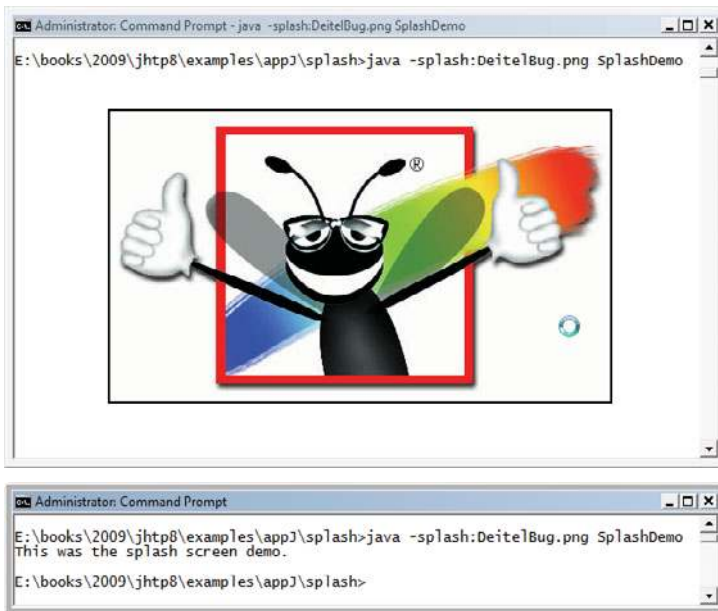

Fig. J.1 | Splash screen displayed with the `-splash` option to the `java` command.

Once you've initiated the splash screen display, you can interact with it programmatically via the `SplashScreen` class of the `java.awt` package. You might do this to add some dynamic content to the splash screen. For more information on working with splash screens, see the following sites:

```
java.sun.com/developer/technicalArticles/J2SE/Desktop/javase6/
  splashscreen/
download.oracle.com/javase/6/docs/api/java/awt/SplashScreen.html
```

J.3 Desktop Class

The **Desktop** class enables you to specify a file or URI that you'd like to open using the underlying platform's appropriate application. For example, if Firefox is your computer's default browser, you can use the Desktop class's `browse` method to open a website in Firefox. In addition, you can open an e-mail composition window in your system's default e-mail client, open a file in its associated application and print a file using the associated application's `print` command. Figure J.2 demonstrates the first three of these capabilities.

The event handler at lines 86–116 obtains the index number of the task the user selects in the `tasksJComboBox` (line 89) and the `String` that represents the file or URI to process (line 90). Line 92 uses Desktop static method `isDesktopSupported` to determine whether class Desktop's features are supported on the platform on which this application runs. If they are, line 96 uses Desktop static method `getDesktop` to obtain a Desktop object. If the user selected the option to open the default browser, line 101 creates a new URI object using the `String` input as the site to display in the browser, then passes the URI object to Desktop method `browse` which invokes the system's default browser and passes the URI to the browser for display. If the user selects the option to open a file in its associated program, line 104 creates a new `File` object using the `String` input as the file to open, then passes the `File` object to Desktop method `open` which passes the file to the appropriate application to open the file. Finally, if the user selects the option to compose an e-mail, line 107 creates a new URI object using the `String` input as the e-mail address to which the e-mail will be sent, then passes the URI object to Desktop method `mail` which invokes the system's default e-mail client and passes the URI to the e-mail client as the e-mail recipient. You can learn more about class Desktop at

download.oracle.com/javase/6/docs/api/java/awt/Desktop.html

```

1 // Fig. J.2: DesktopDemo.java
2 // Use Desktop to launch default browser, open a file in its associated
3 // application and an email in the default email client.
4 import java.awt.Desktop;
5 import java.io.File;
6 import java.io.IOException;
7 import java.net.URI;
8
9 public class DesktopDemo extends javax.swing.JFrame
10 {
11     // constructor
12     public DesktopDemo()
13     {
14         initComponents();
15     } // end DesktopDemo constructor
16
17     // To save space, lines 20–84 of the NetBeans autogenerated GUI code
18     // are not shown here. The complete code for this example is located in
19     // the file DesktopDemo.java in this example's directory.
20

```

Fig. J.2 | Use Desktop to launch the default browser, open a file in its associated application and compose an e-mail in the default e-mail client. (Part 1 of 3.)

```
21 // determine selected task and perform the task
22 private void doTaskJButtonActionPerformed(
23     java.awt.event.ActionEvent evt)
24 {
25     int index = tasksJComboBox.getSelectedIndex();
26     String input = inputJTextField.getText();
27
28     if ( Desktop.isDesktopSupported() )
29     {
30         try
31         {
32             Desktop desktop = Desktop.getDesktop();
33
34             switch ( index )
35             {
36                 case 0: // open browser
37                     desktop.browse( new URI( input ) );
38                     break;
39                 case 1: // open file
40                     desktop.open( new File( input ) );
41                     break;
42                 case 2: // open email composition window
43                     desktop.mail( new URI( input ) );
44                     break;
45             } // end switch
46         } // end try
47         catch ( Exception e )
48         {
49             e.printStackTrace();
50         } // end catch
51     } // end if
52 } // end method doTaskJButtonActionPerformed
53
54 public static void main(String[] args)
55 {
56     java.awt.EventQueue.invokeLater(
57         new Runnable()
58         {
59             public void run()
60             {
61                 new DesktopDemo().setVisible(true);
62             }
63         }
64     );
65 } // end method main
66
67 // Variables declaration - do not modify
68 private javax.swing.JButton doTaskJButton;
69 private javax.swing.JLabel inputJLabel;
70 private javax.swing.JTextField inputJTextField;
71 private javax.swing.JLabel instructionLabel;
```

Fig. J.2 | Use Desktop to launch the default browser, open a file in its associated application and compose an e-mail in the default e-mail client. (Part 2 of 3.)

```

72     private javax.swing.JComboBox tasksJComboBox;
73     // End of variables declaration
74 }

```

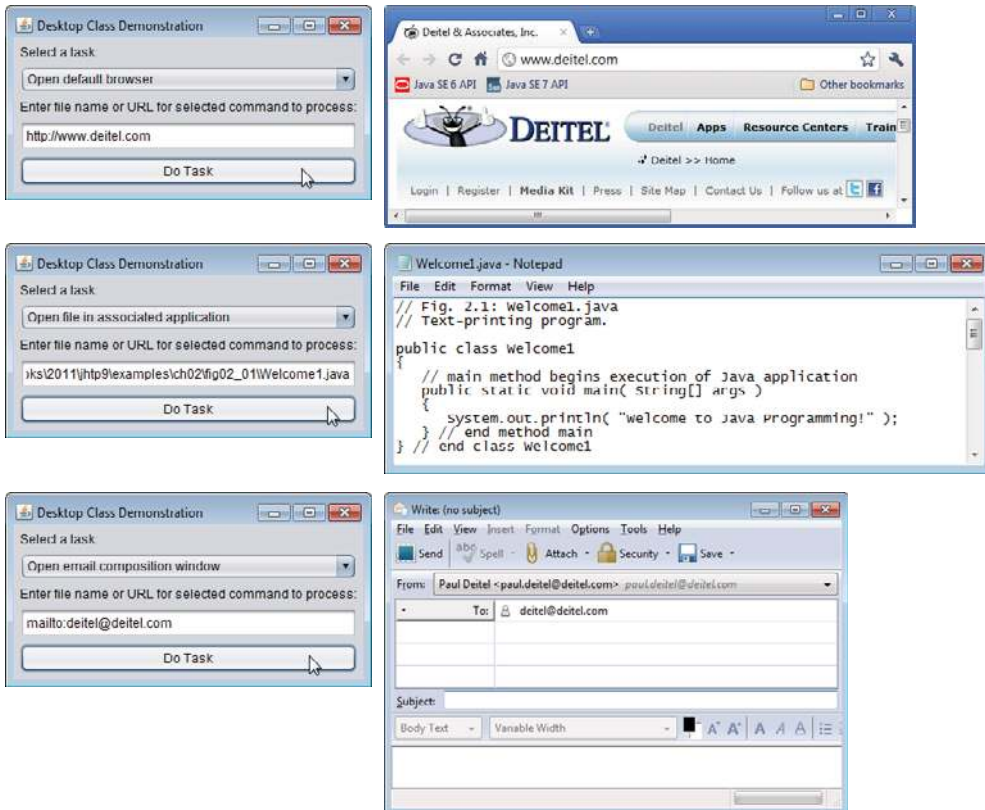

Fig. J.2 | Use Desktop to launch the default browser, open a file in its associated application and compose an e-mail in the default e-mail client. (Part 3 of 3.)

J.4 Tray Icons

Tray icons generally appear in your system's system tray, taskbar status area or notification area. They typically provide quick access to applications that are executing in the background on your system. When you position the mouse over one of these icons, a tooltip appears indicating what application the icon represents. If you click the icon, a popup menu appears with options for that application.

Classes `SystemTray` and `TrayIcon` (both from package `java.awt`) enable you to create and manage your own tray icons in a platform independent manner. Class `SystemTray` provides access to the underlying platform's system tray—the class consists of three methods:

- static method `getDefaultSystemTray` returns the system tray
- method `addTrayIcon` adds a new `TrayIcon` to the system tray
- method `removeTrayIcon` removes an icon from the system tray

Class **TrayIcon** consists of several methods allowing users to specify an icon, a tooltip and a pop-up menu for the icon. In addition, tray icons support `ActionListeners`, `MouseListeners` and `MouseMotionListeners`. You can learn more about classes `SystemTray` and `TrayIcon` at

download.oracle.com/javase/6/docs/api/java/awt/SystemTray.html
download.oracle.com/javase/6/docs/api/java/awt/TrayIcon.html

K

Mashups

K.1 Introduction

Building web application mashups is one of the signature features of Web 2.0. The term mashup originated in the music world—a music mashup is a remix of two or more songs to create a new song. You can listen to some music mashups at www.ccmixter.org/. A web application mashup combines complementary functionality, usually accessed via web services (Chapter 31) and RSS feeds (www.deitel.com/rss and www.rssbus.com) from multiple websites. You can create innovative and powerful Web 2.0 mashup applications much faster than if you have to write your applications from scratch. For example, www.housingmaps.com combines Craigslist apartment listings with Google Maps to display on a map all of the apartments for rent in a neighborhood.

K.2 Popular Mashups

Figure K.1 shows some popular mashups.

URL	APIs	Description
www.mappr.com/	Google Maps, Flickr	Find photos of sites across the US.
www.housingmaps.com/	Google Maps, Craigslist	Find available apartments and homes by neighborhood. Includes prices, pictures, the address and rental-agent contact information.
www.estateily.com/	Google Maps	Find the approximate value of your home based on recent home sales in your area.
www.liveplasma.com/	Amazon eCommerce	Enter the name of a musician, band, actor, director or movie. The app displays related albums, movies, etc. Click on the images to go to the page on Amazon where you can purchase the movie or album.

Fig. K.1 | Popular mashups. (Part 1 of 2.)

URL	APIs	Description
www.secretprices.com/default.aspx	Shopping.com, Amazon A9 OpenSearch, Amazon eCommerce	Shopping comparison site that also offers promotions and coupons.
www.checkinmania.com/	FourSquare, Gowalla, Google Maps	Track the people checking in at nearby locations using Foursquare and Gowalla.
appexchange.salesforce.com/listingDetail?listingId=a0330000003z9bdAAA	Facebook, Salesforce.com	Integrates Facebook profile information for your friends into your Salesforce customer relationship management (CRM) database.

Fig. K.1 | Popular mashups. (Part 2 of 2.)

Now that you've read most of *Java How to Program, 9/e*, you're probably familiar with API categories including graphics, GUI, collections, multimedia, databases and many more. Nearly all of these provide enhanced *computing functionality*. Many web services APIs provide *business functionality*—eBay provides auction capabilities, Amazon provides book sales (and sales of other types of products, such as CDs, DVDs, electronic devices, and more), Google provides search capabilities, PayPal provides payment services, etc. These web services are typically free for non-commercial use; some impose (generally reasonable) fees for commercial use. This creates exciting possibilities for people building Internet-based applications and businesses.

K.3 APIs Commonly Used in Mashups

We've emphasized the importance of software reuse. Mashups are yet another form of software reuse that saves you time, money and effort—you can rapidly prototype starter versions of your applications, integrate business functionality, integrate search functionality and more. Figure 1.19 shows some APIs commonly used in mashups.

K.4 Deitel Mashups Resource Center

Our Mashups Resource Center, which is located at

www.deitel.com/mashups/

focuses on the enormous amount of free mashup content available online. You'll find tutorials, articles, documentation, the latest books, articles, blogs, directories, tools, forums, etc., that will help you quickly develop mashup applications.

- Check out the newest and most popular mashups, including scores of Google Maps-based mashups showing you the locations of theaters, real estate for sale or rent, properties that have sold in your area, and even the locations of the public restrooms in San Francisco!
- Search ProgrammableWeb for mashups by category.

- Check out the Flickr APIs for adding photos to your applications, updating photos, replacing photos, example requests, and asynchronous uploading.
- Check out the article: “Building Mashups for Non-Programmers.”
- Check out the Smashforce tool that enables Salesforce.com users to mashup applications such as Google Maps with their Multiforce and Sforce enterprise applications.
- Check out IBM’s Enterprise Mashup Tool.
- Check out the search and mapping APIs from Microsoft, Yahoo! and Google that you can use in your mashup applications.
- Use Technorati APIs to find all of the blogs that link to a specific website, search blogs for mentions of keywords, see which blogs are linked to a given blog and find blogs associated with a specific website.
- Use the Backpack API to help organize tasks and events, plan your schedule, collaborate with others, monitor your competitors online and more.

K.5 Deitel RSS Resource Center

RSS feeds are also popular information sources for mashups. To learn more about RSS feeds, visit our RSS Resource Center at www.deitel.com/RSS/.

K.6 Mashup Performance and Reliability Issues

There are several challenges when creating mashup applications. Your applications become susceptible to traffic and reliability problems on the Internet—circumstances generally beyond your control. Companies might suddenly change APIs that your applications use. Your application is dependent on hardware and software capabilities of other companies. Also, companies could impose fee structures on previously free web services or could increase existing fees.

L

Unicode®

L.1 Introduction

The use of inconsistent **character encodings** (i.e., numeric values associated with characters) when developing global software products causes serious problems because computers process information using numbers. For example, the character “a” is converted to a numeric value so that a computer can manipulate that piece of data. Many countries and corporations have developed encoding systems that are incompatible with the encoding systems of other countries and corporations. For example, the Microsoft Windows operating system assigns the value 0xC0 to the character “A with a grave accent,” while the Apple Macintosh operating system assigns the same value to an upside-down question mark. This results in the misrepresentation and possible corruption of data.

In the absence of a universal character encoding standard, global software developers had to localize their products extensively before distribution. **Localization** includes the language translation and cultural adaptation of content. The process of localization usually includes significant modifications to the source code (e.g., the conversion of numeric values and the underlying assumptions made by programmers), which results in increased costs and delays in releasing the software. For example, an English-speaking programmer might design a global software product assuming that a single character can be represented by one byte. However, when those products are localized in Asian markets, the programmer’s assumptions are no longer valid because there are many more Asian characters, and therefore most, if not all, of the code needs to be rewritten. Localization is necessary with each release of a version. By the time a software product is localized for a particular market, a newer version, which needs to be localized as well, can be ready for distribution. As a result, it’s cumbersome and costly to produce and distribute global software products in a market where there’s no universal character encoding standard.

In response to this situation, the **Unicode Standard**, an encoding standard that facilitates the production and distribution of software, was created. The Unicode Standard outlines a specification to produce consistent encoding of the world’s characters and symbols. Software products which handle text encoded in the Unicode Standard need to be localized, but the localization process is simpler and more efficient because the numeric values need not be converted and the assumptions made by programmers about the character encoding are universal. The Unicode Standard is maintained by a non-profit organization called the **Unicode Consortium**, whose members include Apple, IBM, Microsoft, Oracle, Sun Microsystems, Sybase and many others.

When the Consortium envisioned and developed the Unicode Standard, it wanted an encoding system that was **universal**, **efficient**, **uniform** and **unambiguous**. A universal encoding system encompasses all commonly used characters. An efficient encoding system allows text files to be parsed quickly. A uniform encoding system assigns fixed values to all characters. An unambiguous encoding system represents a given character in a consistent manner. These four terms are referred to as the Unicode Standard design basis.

L.2 Unicode Transformation Formats

Although Unicode incorporates the limited ASCII character set (i.e., a collection of characters), it encompasses a more comprehensive character set. In ASCII each character is represented by a byte containing 0s and 1s. One byte is capable of storing the binary numbers from 0 to 255. Each character is assigned a number between 0 and 255, thus ASCII-based systems can support only 256 characters, a tiny fraction of the world's characters. Unicode extends the ASCII character set by encoding the vast majority of the world's characters. The Unicode Standard encodes characters in a uniform numerical space from 0 to 10FFFF hexadecimal. An implementation will express these numbers in one of several transformation formats, choosing the one that best fits the particular application at hand.

Three such formats are in use, called **UTF-8**, **UTF-16** and **UTF-32**. UTF-8, a variable-width encoding form, requires one to four bytes to express each Unicode character. UTF-8 data consists of 8-bit bytes (sequences of one, two, three or four bytes depending on the character being encoded) and is well suited for ASCII-based systems when there's a predominance of one-byte characters (ASCII represents characters as one-byte). Currently, UTF-8 is widely implemented in UNIX systems and in databases.

The variable-width UTF-16 encoding form expresses Unicode characters in units of 16-bits (i.e., as two adjacent bytes, or a short integer in many machines). Most characters of Unicode are expressed in a single 16-bit unit. However, characters with values above FFFF hexadecimal are expressed with an ordered pair of 16-bit units called **surrogates**. Surrogates are 16-bit integers in the range D800 through DFFF, which are used solely for the purpose of "escaping" into higher numbered characters. Approximately one million characters can be expressed in this manner. Although a surrogate pair requires 32 bits to represent characters, it's space-efficient to use these 16-bit units. Surrogates are rare characters in current implementations. Many string-handling implementations are written in terms of UTF-16. [Note: Details and sample-code for UTF-16 handling are available on the Unicode Consortium website at www.unicode.org.]

Implementations that require significant use of rare characters or entire scripts encoded above FFFF hexadecimal, should use UTF-32, a 32-bit fixed-width encoding form that usually requires twice as much memory as UTF-16 encoded characters. The major advantage of the fixed-width UTF-32 encoding form is that it expresses all characters uniformly, so it's easy to handle in arrays.

There are few guidelines that state when to use a particular encoding form. The best encoding form to use depends on the computer system and business protocol, not on the data itself. Typically, the UTF-8 encoding form should be used where computer systems and business protocols require data to be handled in 8-bit units, particularly in legacy systems being upgraded, because it often simplifies changes to existing programs. For this reason, UTF-8 has become the encoding form of choice on the Internet. Likewise, UTF-16 is the encoding form of choice on Microsoft Windows applications. UTF-32 is likely

to become more widely used in the future as more characters are encoded with values above FFFF hexadecimal. UTF-32 requires less sophisticated handling than UTF-16 in the presence of surrogate pairs. Figure L.1 shows the different ways in which the three encoding forms handle character encoding.

Character	UTF-8	UTF-16	UTF-32
LATIN CAPITAL LETTER A	0x41	0x0041	0x00000041
GREEK CAPITAL LETTER ALPHA	0xCD 0x91	0x0391	0x00000391
CJK UNIFIED IDEOGRAPH-4E95	0xE4 0xBA 0x95	0x4E95	0x00004E95
OLD ITALIC LETTER A	0xF0 0x80 0x83 0x80	0xDC00 0xDF00	0x00010300

Fig. L.1 | Correlation between the three encoding forms.

L.3 Characters and Glyphs

The Unicode Standard consists of characters—written components (i.e., alphabets, numbers, punctuation marks, accent marks, etc.) that can be represented by numeric values. An example of such a character is U+0041 LATIN CAPITAL LETTER A. In the first character representation, **U+yyyy** is a **code value**, in which U+ refers to Unicode code values, as opposed to other hexadecimal values. The *yyyy* represents a four-digit hexadecimal number of an encoded character. Code values are bit combinations that represent encoded characters. Characters are represented using **glyphs**—various shapes, fonts and sizes for displaying characters. There are no code values for glyphs in the Unicode Standard. Examples of glyphs are shown in Fig. L.2.

The Unicode Standard encompasses the alphabets, ideographs, syllabaries, punctuation marks, **diacritics**, mathematical operators and other features that comprise the written languages and scripts of the world. A diacritic is a special mark added to a character to distinguish it from another letter or to indicate an accent (e.g., in Spanish, the tilde “~” above the character “ñ”). Currently, Unicode provides code values for 96,382 character representations, with more than 878,000 code values reserved for future expansion.



Fig. L.2 | Various glyphs of the character A.

L.4 Advantages/Disadvantages of Unicode

The Unicode Standard has several significant advantages that promote its use. One is the impact it has on the performance of the international economy. Unicode standardizes the characters for the world’s writing systems to a uniform model that promotes transferring and sharing data. Programs developed using such a schema maintain their accuracy be-

cause each character has a single definition (i.e., *a* is always U+0061, % is always U+0025). This enables corporations to manage the high demands of international markets by processing different writing systems at the same time. All characters can be managed in an identical manner, thus avoiding any confusion caused by different character-code architectures. Moreover, managing data in a consistent manner eliminates data corruption, because data can be sorted, searched and manipulated using a consistent process.

Another advantage of the Unicode Standard is portability (i.e., software that can execute on disparate computers or with disparate operating systems). Most operating systems, databases, programming languages (including Java and Microsoft's .NET languages) and web browsers currently support, or are planning to support, Unicode.

A disadvantage of the Unicode Standard is the amount of memory required by UTF-16 and UTF-32. ASCII character sets are 8-bits in length, so they require less storage than the default 16-bit Unicode character set. The **double-byte character set (DBCS)** encodes Asian characters with one or two bytes per character. The **multibyte character set (MBCS)** encodes characters with a variable number of bytes per character. In such instances, the UTF-16 or UTF-32 encoding forms may be used with little hindrance on memory and performance.

Another disadvantage of Unicode is that although it includes more characters than any other character set in common use, it does not yet encode all of the world's written characters. Also, UTF-8 and UTF-16 are variable-width encoding forms, so characters occupy different amounts of memory.

L.5 Using Unicode

Numerous programming languages (e.g., C, Java, JavaScript, Perl, Visual Basic) provide some level of support for the Unicode Standard. The application shown in Fig. L.3–Fig. L.4 prints the text “Welcome to Unicode!” in eight different languages: English, Russian, French, German, Japanese, Portuguese, Spanish and Traditional Chinese.

```

1 // Fig. L.3: UnicodeJFrame.java
2 // Demonstrating how to use Unicode in Java programs.
3 import java.awt.GridLayout;
4 import javax.swing.JFrame;
5 import javax.swing.JLabel;
6
7 public class UnicodeJFrame extends JFrame
8 {
9     // constructor creates JLabels to display Unicode
10    public UnicodeJFrame()
11    {
12        super( "Demonstrating Unicode" );
13
14        setLayout( new GridLayout( 8, 1 ) ); // set frame layout
15
16        // create JLabels using Unicode
17        JLabel englishJLabel = new JLabel( "\u0057\u0065\u006C\u0063" +
18            "\u006F\u0064\u0065\u0020\u0074\u006F\u0020Unicode\u0021" );

```

Fig. L.3 | Java application that uses Unicode encoding (Part 1 of 2).

```

19     englishJLabel.setToolTipText( "This is English" );
20     add( englishJLabel );
21
22     JLabel chineseJLabel = new JLabel( "\u06B22\u08FCE\u04F7F\u07528" +
23         "\u0020\u0020Unicode\u0021" );
24     chineseJLabel.setToolTipText( "This is Traditional Chinese" );
25     add( chineseJLabel );
26
27     JLabel cyrillicJLabel = new JLabel( "\u0414\u043E\u0431\u0440" +
28         "\u043E\u0020\u043F\u043E\u0436\u0430\u043B\u043E\u0432" +
29         "\u0430\u0442\u044A\u0020\u0432\u0020Unicode\u0021" );
30     cyrillicJLabel.setToolTipText( "This is Russian" );
31     add( cyrillicJLabel );
32
33     JLabel frenchJLabel = new JLabel( "\u0042\u0069\u0065\u006E\u0076" +
34         "\u0065\u006E\u0075\u0065\u0020\u0061\u0075\u0020Unicode\u0021" );
35     frenchJLabel.setToolTipText( "This is French" );
36     add( frenchJLabel );
37
38     JLabel germanJLabel = new JLabel( "\u0057\u0069\u006C\u006B\u006F" +
39         "\u006D\u006D\u0065\u006E\u0020\u007A\u0075\u0020Unicode\u0021" );
40     germanJLabel.setToolTipText( "This is German" );
41     add( germanJLabel );
42
43     JLabel japaneseJLabel = new JLabel( "Unicode\u3078\u3087\u3045" +
44         "\u3053\u305D\u0021" );
45     japaneseJLabel.setToolTipText( "This is Japanese" );
46     add( japaneseJLabel );
47
48     JLabel portugueseJLabel = new JLabel( "\u0053\u00E9\u006A\u0061" +
49         "\u0020\u0042\u0065\u006D\u0076\u0069\u006E\u0064\u006F\u0020" +
50         "Unicode\u0021" );
51     portugueseJLabel.setToolTipText( "This is Portuguese" );
52     add( portugueseJLabel );
53
54     JLabel spanishJLabel = new JLabel( "\u0042\u0069\u0065\u006E" +
55         "\u0076\u0065\u006E\u0069\u0064\u0061\u0020\u0061\u0020" +
56         "Unicode\u0021" );
57     spanishJLabel.setToolTipText( "This is Spanish" );
58     add( spanishJLabel );
59 } // end UnicodeJFrame constructor
60 } // end class UnicodeJFrame

```

Fig. L.3 | Java application that uses Unicode encoding (Part 2 of 2.).

```

1 // Fig. L.4: Unicode.java
2 // Displaying Unicode.
3 import javax.swing.JFrame;
4
5 public class Unicode
6 {

```

Fig. L.4 | Displaying Unicode. (Part 1 of 2.)

```

7   public static void main( String[] args )
8   {
9       UnicodeJFrame unicodeJFrame = new UnicodeJFrame();
10      unicodeJFrame.setDefaultCloseOperation( JFrame.EXIT_ON_CLOSE );
11      unicodeJFrame.setSize( 350, 250 );
12      unicodeJFrame.setVisible( true );
13  } // end method main
14 } // end class Unicode

```

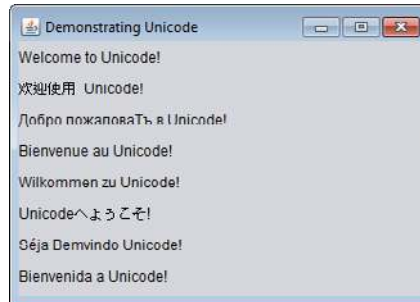

Fig. L.4 | Displaying Unicode. (Part 2 of 2.)

Class `UnicodeJFrame` (Fig. L.3) uses escape sequences to represent characters. An escape sequence is in the form `\yyyy`, where `yyyy` represents the four-digit hexadecimal code value. Lines 17–18 contain the series of escape sequences necessary to display “Welcome to Unicode!” in English. The first escape sequence (`\u0057`) equates to the character “W,” the second escape sequence (`\u0065`) equates to the character “e,” and so on. The `\u0020` escape sequence (line 18) is the encoding for the space character. The `\u0074` and `\u006F` escape sequences equate to the word “to.” “Unicode” is not encoded because it’s a registered trademark and has no equivalent translation in most languages. Line 18 also contains the `\u0021` escape sequence for the exclamation point (!).

Lines 22–56 contain the escape sequences for the other seven languages. The Unicode Consortium’s website contains a link to code charts that lists the 16-bit Unicode code values. The English, French, German, Portuguese and Spanish characters are located in the **Basic Latin** block, the Japanese characters are located in the **Hiragana** block, the Russian characters are located in the **Cyrillic** block and the Traditional Chinese characters are located in the **CJK Unified Ideographs** block. The next section discusses these blocks.

L.6 Character Ranges

The Unicode Standard assigns code values, which range from 0000 (**Basic Latin**) to E007F (**Tags**), to the written characters of the world. Currently, there are code values for 96,382 characters. To simplify the search for a character and its associated code value, the Unicode Standard generally groups code values by **script** and function (i.e., Latin characters are grouped in a block, mathematical operators are grouped in another block, etc.). As a rule, a script is a single writing system that is used for multiple languages (e.g., the Latin script is used for English, French, Spanish, etc.). The **Code Charts** page on the Unicode Consortium website lists all the defined blocks and their respective code values. Figure L.5 lists some blocks (scripts) from the website and their range of code values.

Script	Range of code values
Arabic	U+0600–U+06FF
Basic Latin	U+0000–U+007F
Bengali (India)	U+0980–U+09FF
Cherokee (Native America)	U+13A0–U+13FF
CJK Unified Ideographs (East Asia)	U+4E00–U+9FFF
Cyrillic (Russia and Eastern Europe)	U+0400–U+04FF
Ethiopic	U+1200–U+137F
Greek	U+0370–U+03FF
Hangul Jamo (Korea)	U+1100–U+11FF
Hebrew	U+0590–U+05FF
Hiragana (Japan)	U+3040–U+309F
Khmer (Cambodia)	U+1780–U+17FF
Lao (Laos)	U+0E80–U+0EFF
Mongolian	U+1800–U+18AF
Myanmar	U+1000–U+109F
Ogham (Ireland)	U+1680–U+169F
Runic (Germany and Scandinavia)	U+16A0–U+16FF
Sinhala (Sri Lanka)	U+0D80–U+0DFF
Telugu (India)	U+0C00–U+0C7F
Thai	U+0E00–U+0E7F

Fig. L.5 | Some character ranges.



Appendices on the Web

The following appendices are available at Java How to Program, 9/e's Companion Website (www.pearsonhighered.com/deitel) as PDF documents:

- Appendix M, Creating Documentation with javadoc
- Appendix N, Bit Manipulation
- Appendix O, Labeled break and continue Statements
- Appendix P, UML 2: Additional Diagram Types
- Appendix Q, Design Patterns

These files can be viewed in Adobe® Reader® (get.adobe.com/reader).

This page intentionally left blank

Index

[*Note:* Page references for defining occurrences of terms appear in **bold maroon**. Page references for online appendices are shown in **red** or **bold red** (for defining occurrences). The online appendix page references also include the appendix letter and an underscore, as in **M_1**. You can find the online appendices on the book's Companion Website at www.pearsonhighered.com/deitel/.]

Symbols

^, bitwise exclusive OR **N_1**
^, boolean logical exclusive OR 174, **176**
truth table 176
^=, bitwise exclusive OR assignment operator **N_11**
_ SQL wildcard character **1179**, 1180
, (comma) formatting flag **161**
--, predecrement/postdecrement **130**
-, subtraction 53, 54
!, logical NOT 174, **176**
truth table 177
!=, not equals 57
? (wildcard type argument) **897**
?:, ternary conditional operator **108**, 133
. dot separator **75**
, flag **1407**
(flag **1407**
{, left brace 40
, right brace 40
@ symbol **M_1**
@ApplicationScoped annotation **1275**
@HttpSessionScope annotation **1327**
@Override annotation **368**
@Resource annotation **1285**
* SQL wildcard character **1178**
* wildcard in a file name 75
*, multiplication 53, 54
*=:, multiplication assignment operator 131
/ forward slash in end tags **958**
/, division 53, 54
/* */ traditional comment **39**
/** */ Java documentation comment 39, **M_1**
//, end-of-line comment **39**
/=, division assignment operator 131
\\, backslash escape sequence 46
\' , single-quote-character escape sequence 1411

\", double-quote escape sequence 46, 1411
\\, backslash-character escape sequence 1411
\\b, escape sequence 1411
\\f, form-feed escape sequence 1412
\\n, newline escape sequence 45, 46, 1412
\\r, carriage-return escape sequence 46, 1412
\\t, horizontal tab escape sequence 46, 1412
&, bitwise AND **N_1**
&, boolean logical AND 174, **175**
&&, conditional AND **174**, 175
truth table 174
&=:, bitwise AND assignment operator **N_11**
character **M_7**
flag **1407**, 1408
conversion character **1403**
% SQL wildcard character **1179**
%, remainder 53, 54
%=:, format specifier 1405
%=:, remainder assignment operator 131
%A format specifier 1399
%a format specifier 1399
%B format specifier **1403**
%b format specifier **177**, **1403**, 1404
%C format specifier **1400**
%c format specifier 68, **1400**
%d format specifier **51**, 1397, **1397**, 1398
%E format specifier **1398**, 1399
%e format specifier **1398**, 1399
%f format specifier 68, **90**, **1398**, **1399**
%G format specifier **1399**
%g format specifier **1399**
%H format specifier **1403**
%h format specifier 1404
%n format specifier 1404
%o format specifier **1397**, 1398
%S format specifier **1400**

%s format specifier **47**, 1397, **1400**
%T format specifier **1401**
%t format specifier **1401**
%X format specifier **1397**
%x format specifier **1397**
- flag **1407**
+ flag **1407**
- (minus sign) formatting flag **160**
+, addition 53, 54
++, preincrement/postincrement **130**
+=:, addition assignment operator **130**
+=:, string concatenation assignment operator 688
<, less than 57
<<, left shift **N_1**, **N_8**
<<=:, left shift assignment operator **N_11**
<=:, less than or equal 57
<> diamond notation for generic type inference (Java SE 7) **836**
<>, angle brackets for XML elements **958**
=:, assignment operator 51
-=:, subtraction assignment operator 131
== to determine whether two references refer to the same object 387
==, is equal to 57
>, greater than 57
>=:, greater than or equal to 57
>>, signed right shift **N_1**, **N_8**
>>=:, signed right shift assignment operator **N_11**
>>>, unsigned right shift **N_1**, **N_8**
>>>=:, unsigned right shift assignment operator **N_11**
|, bitwise inclusive OR **N_1**
|, boolean logical inclusive OR 174, **175**
|=, bitwise inclusive OR assignment operator **N_11**

||, conditional OR **174**
truth table 175
~ (bitwise complement) **N_1**
~, bitwise complement **N_2**

Numerics

0 flag **250**
0 format flag 314
0x (hexadecimal prefix) 1408
127.0.0.1 (localhost IP address) **1136**, 1237
15 Puzzle exercise 997

A

abbreviating assignment expressions 130
abs method of Math 201
absolute method of ResultSet **1200**
absolute path **722**, 723, 726
absolute value 201
abstract class 396, **400**, 401, 402, 420, **Q_7**
abstract data type (ADT) 313
Abstract Factory design pattern **Q_3**, **Q_4**, **Q_15**
abstract implementation 867
abstract keyword **401**
abstract method **401**, 403, 404, 521, 568, 1368
abstract superclass **401**, 521
Abstract Window Toolkit (AWT) **555**
package **209**
Abstract Window Toolkit Event package **209**
AbstractButton class **571**, 573, 1007, 1012
addActionListener method 574
addItemListener method **576**
isSelected method **1014**
setMnemonic method **1012**

- AbstractButton class (cont.)
 - setRolloverIcon method **573**
 - setSelected method **1013**
- AbstractCollection class **867**
- AbstractList class **867**
- AbstractMap class **867**
- AbstractQueue class **867**
- AbstractSequentialList class **867**
- AbstractSet class **867**
- AbstractTableModel class **1194**, 1200
 - fireTableStructure-Changed method **1200**
- accelerometer 5, 8
- accept method of class
 - ServerSocket **1128**, 1135
- access modifier **72**, 80, 511
 - private **80**, 316, 363
 - protected 316, **363**
 - public **72**, 316, 363
- access modifier in the UML
 - (private) 83
 - + (public) 76
- access shared data 1069
- accessibility 556
- accessibility heuristic 300
- Accessibility Project
 - Speech Recognition 998
 - Speech Synthesis 998
- accessor method **327**
- Account class (ATM case study) 477, 480, 483, 485, 486, 493, 500, 501, 502, 504, 505, 532
- Accounts Payable System
 - Modification exercise 436, 437
- accounts receivable file 763
- accumulator register 304, 307
- ACM/IEEE curriculum
 - recommendations and the Computer Science Advanced Placement Examination xxiii
- acquire the lock **1055**
- action 107, 112
- action expression in the UML **105**, 490
- action key **601**
- action of an object **490**
- action state in the UML **105**, 181, 490
- action state symbol **105**
- action to execute **103**
- ActionEvent class **565**, 566, 570, 617, 979
 - getActionCommand method **566**, 574
- ActionListener interface **565**, 570
 - actionPerformed method 565, 569, 611, 617
- actionPerformed method of interface ActionListener 565, 569, 611, 617
- ACTIVATED constant of nested class EventType **1127**
- activation in a UML sequence diagram **504**
- activation record **207**, 777
- activity diagram **105**, 108, 157, 181
 - do...while statement 163
 - for statement 157
 - if statement 107
 - if...else statement 108
 - in the UML 112, **477**, 490, 491, 508
 - sequence statement 105
 - switch statement 170
 - while statement 113
- activity in the UML **105**, **477**, **489**, 492
- actor in use case in the UML **475**
- actual type arguments **878**
- acyclic gradient **660**
- Ada Lovelace 16
- Ada programming language 16, 1046
- adapter class **594**
- Adapter Classes used to
 - implement event handlers 598
- Adapter design pattern **Q_3**, **Q_5**, **Q_8**
- add a web service reference to an application in NetBeans 1311
- add an event handler in NetBeans 1436
- add method
 - ArrayList<T> **286**, 1123
 - BigInteger **773**
 - ButtonGroup **580**
 - JFrame 390, **559**
 - JFrame class **137**
 - JMenu **1012**
 - JMenuBar **1013**
 - LinkedList<T> **841**
 - List<T> **836**, 838
- addActionListener method of class AbstractButton 574
 - of class JTextField **565**
- addAll method
 - Collections 841, **851**
 - List **838**
- addFirst method of LinkedList **841**
- addGap method of class GroupLayout.Group **1432**
- addGap method of class GroupLayout.ParallelGroup **1432**
- addGap method of class GroupLayout.SequentialGroup **1432**
- adding a web service reference to an application **1310**
- Adding Object Serialization to the MyShape Drawing Application (exercise) 764
- addItemListener method of class AbstractButton **576**
- addition 9, 53, 54
- addition compound
 - assignment operator, += **130**
- addKeyListener method of class Component **601**
- addLast method of LinkedList **840**
- addListSelectionListener method of class JList **586**
- addMouseListener method of class Component **593**
- addMouseMotionListener method of class Component **593**
- addPoint method of class Polygon 655, **657**
- AddressBook Application
 - Modification exercise 1298
- addSeparator method of class JMenu **1013**
- addTab method of class JTabbedPane **1027**
- addTableModelListener method of TableModel **1194**
- addTrayIcon method of class SystemTray **1447**
- addWindowListener method of class Window **1006**
- “administrative” section of the computer 9
- advertisement 1261
- aggregation in the UML **482**
- Agile Alliance 29
- Agile Manifesto 29
- agile software development
 - xxvi, **29**, 29
 - .aif file extension **985**, 988
 - .aiff file extension **985**, 988
- Airline Reservation System 297
- Airline Reservation Web-Service Modification 1364
- Ajax 1277
 - id attributes for elements 1295
- Ajax (Asynchronous JavaScript and XML) **27**, **1290**, 1291
- Ajax-enabled
 - web applications xxv
- Ajax request 1295
- Ajax web application 1291
- algebraic notation 54
- algorithm **103**, 113, 121, 774, **Q_12**
 - binary search **804**
 - bubble sort 826
 - bucket sort 826
 - in Java Collections Framework 841
 - insertion sort **814**
- algorithm (cont.)
 - linear search **800**
 - merge sort **817**
 - quicksort 827
 - recursive binary search 827
 - recursive linear search 827
 - selection sort **810**
- aligning components in GroupLayout 1432
- aligning decimal points in output 1396
- allClasses-frame.html
 - generated by javadoc **M_10**
- alpha software 30
- alphabetizing 677
- ALU (arithmetic and logic unit) **9**
- Amazon 3
- Amazon S3 30
- AMBER Alert 4
- Analog Clock exercise 997
- analysis stage of the software life cycle 475
- Analytical Engine 16
- anchor (a) element 959
- anchor field of class GridBagConstraints **1031**
- AND (in SQL) 1185, 1186
- and method of class BitSet **N_11**
- Android 15, 16
 - Android Market 15, 16
 - app 27
 - Market 15
 - operating system 3, 14, **15**, 15
 - smartphone 15
- Android for Programmers: An App-Driven Approach* 16
- angle bracket (<>) for XML elements **958**
- angle brackets (< and >) **878**
- animated shape 947
- animating a series of images 975
- animation 952, 968, 980, 996
 - www.animationfactory.com 992
- Animation exercise 996
- Animator applet 943
- annotation
 - @Override **368**
- Annotations
 - @GET **1317**
 - @PathParam **1317**
 - @Produces **1317**
 - @WebMethod **1305**
 - @WebParam **1306**
 - @WebService **1305**
 - Path **1316**
- annotations
 - @Resource **1285**
- anonymous inner class 565, **583**, 599
- anti-aliasing 946
- Apache Derby xxv

- Apache Software Foundation 14
- Apache Tomcat 1305
- API (application programming interface) **48, 198**
- API documentation (download.oracle.com/javase/6/docs/api/) 210
- API links
 - Deprecated **1371**
 - Help **1371**
 - Index **1371**
 - Tree **1371**
- APIs commonly used in mashups 1450
- append method of class `StringBuilder` **691**
- Apple 3
- Apple Computer, Inc. 1452
- Apple TV 5
- applet **942, 947, 954, 1120**
 - draggable **974**
- applet .class file 950
- Applet class
 - `getAppletContext` method **1124**
 - `getAudioClip` method **985**
 - `getCodeBase` method **985**
 - `getParameter` method **1121**
 - play method **985**
 - `showStatus` method **982**
- applet container **942, 951**
- Applet Package **209**
- applet parameter **1120**
- Applet that draws a string 948
- applet XHTML element **950**
- AppletContext interface **1120**
 - `showDocument` method **1120, 1124**
- applet-desc element of a JNLP document **959**
- applets directory
 - JDK sample applets 943
- applets in the public domain 1120
- appletviewer applet container **942, 944**
 - Applet menu 945
 - Quit menu item 945
 - Reload menu item **945**
- application **38, 40, 73**
 - command-line arguments **202**
- application mashup 1449
- application programming interface (API) **18, 198**
- application server 1236
- Application servers
 - Apache Tomcat 1305
 - GlassFish 1305
 - JBoss Application Server 1305
- application-desc element of a JNLP document 959
 - height attribute 959
 - main-class attribute 959
 - name attribute 959
 - width attribute 959
- arc **651, 943**
- arc angle **651**
- arc width and arc height for rounded rectangles 650
- Arc2D class 632
 - CHORD constant **661**
 - OPEN constant **661**
 - PIE constant **661**
- Arc2D.Double class **657, 670**
- architectural patterns **Q_3, Q_17, Q_18**
- archive files **344**
- ArcTest applet 943
- area of a circle 236
- args parameter 279
- argument index 1397, **1403, 1411**
- argument list 1398
- argument promotion **207**
- argument to a method **41, 76**
- arithmetic and logic unit (ALU) **9**
- arithmetic calculation 53
- arithmetic compound
 - assignment operators **130**
- arithmetic mean 55
- arithmetic operators 53
 - arithmetic overflow 447
- ArithmeticException class **441, 446**
- array **241, 720, 1123, Q_20**
 - bounds checking **251**
 - ignoring element zero 253
 - length instance variable **242**
 - pass an array element to a method 260
 - pass an array to a method 260
- array-access expression **242**
- array-creation expression **243**
- array initializer **245**
 - for multidimensional array 269
 - nested **269**
- array of one-dimensional arrays 269
- ArrayBlockingQueue class
 - 1069, **1070, 1080, 1094**
 - size method **1071**
- arraycopy method of class `System` **281, 283**
- ArrayIndexOutOfBoundsException class
 - Exception class 251, **253, 253, 657**
- ArrayList<T> generic class **284, 833, 849, 895, 1123, 1328**
 - add method **286, 1123**
 - clear method 284
 - contains method 284, **286**
 - get method **286**
- ArrayList<t> generic class (cont.)
 - indexOf method 284
 - isEmpty method 327
 - remove method 284, **286**
 - size method **286**
 - toString method 897
 - trimToSize method 284
- Arrays class **281**
 - asList method **839, 840**
 - binarySearch method **281**
 - equals method **281**
 - fill method **281, 1104**
 - sort method **281, 805**
 - toString method 706, 801
- arrow 105
- arrow key 601
- arrowhead in a UML sequence diagram 504
- artifact in the UML **P_1**
- Artist exercise 997
- ascending order 281
 - ASC in SQL 1181, 1182
- ascend **645**
- ASCII (American Standard Code for Information Interchange) character set 7, 171, 309, 1453
- ASCII character set Appendix 1367
- asList method of Arrays **839, 840**
- assembler **10**
- assembly language **10**
- assert statement **461, 1368**
- assertion **461**
- AssertionError class **461**
- assign a value to a variable 51
- Assigning superclass and subclass references to superclass and subclass variables 399
- assignment operator, = **51, 59**
- assignment operators **130**
- assignment statement 51
- associate
 - left to right 133
 - right to left 125, 133
- association (in the UML) **480, 481, 482, 513, 514**
 - name 481
- associativity of operators **54, 60, 133**
 - left to right 60
 - right to left 54
- asterisk (*) SQL wildcard character **1178**
- asynchronous call **503**
- asynchronous event **447**
- Asynchronous JavaScript and XML (Ajax) **1290**
- asynchronous request **1290**
- ATM (automated teller machine) case study 470, 475
- ATM class (ATM case study) 480, 481, 485, 487, 489, 493, 500, 501, 502, 503, 504, 512
- ATM system 475, 476, 478, 479, 489, 493, 511
- ATMCaseStudy class (ATM case study) 546
- atomic operation **1060, 1227**
- attribute 511, 513, 514
 - compartment in a class diagram 487
 - declaration in the UML 487, 489
 - in the UML 13, 75, 480, 484, 485, **487, 489, 492, 519, 520**
 - name in the UML 487
 - of a class 11
 - of an object 13
 - of an XHTML element **950**
 - type in the UML **487**
- .au file extension **985, 988**
- audio clip **985, 987, 992**
- AudioClip interface **985**
 - loop method **985**
 - play method **985**
 - stop method **985**
- Australian Botanical Gardens (www.anbg.gov.au/anbg/index.html) 992
- @author javadoc tag **M_5**
- Author: note **M_5**
- author option **M_9**
- authorISBN table of books database 1174, 1175
- authors table of books database 1174
- auto commit state 1227
- auto-unboxing **832**
- autobox an int 881
- autoboxing 698, **832, 881**
- AutoCloseable interface **463, 1194**
 - close method 463
- autoincremented **1174, 1184**
- automated teller machine (ATM) 470, 475
 - user interface 471
- automatic driver discovery (JDBC 4) xxv, **1191**
- automatic garbage collection 450
- Automatic Jigsaw Puzzle Generator exercise 997
- automatic scrolling 586
- automatic updating 956
- average 55, 113, 116
- .avi file extension **988**
- await method of interface `Condition` **1087, 1091**
- awaitTermination method of interface `ExecutorService` **1058**
- AWT (Abstract Window Toolkit) **555**
 - components 556
- AWTEvent class 567

B

- B conversion character **1403**
- b conversion character **1403**
- B2B (business-to-business)
 - transactions **1301**
- Babbage, Charles 16
- Background Audio exercise 996
- background color 639, 641
- backing array **839**
- Backpack API 1451
- backslash (\) **45**, 1411, 1412
- backtracking **790**
- BalanceInquiry class (ATM case study) 480, 482, 485, 486, 487, 490, 493, 501, 502, 503, 504, 512, 516, 517, 518
- Balking design pattern **Q_3**, **Q_14**
- BankDatabase class (ATM case study) 480, 483, 485, 493, 495, 500, 501, 502, 503, 504, 505, 512, 514
- bar chart 193, 248, 249, 943
- bar of asterisks 248, 249
- BarChart applet 943
- base **N_1**
- base case **767**, 773, 778
- base class **360**
- base of a number 697
- BASELINE alignment constant in GroupLayout 1432
- baseline of the font 643
- BASIC (Beginner's All-Purpose Symbolic Instruction Code) 16, 905
- Basic Latin block 1457
- BasicStroke class **632**, 660, 661
 - CAP_ROUND constant **662**
 - JOIN_ROUND constant **662**
- batch file **731**
- behavior 493
 - of a class 11
 - of a system 489, 490, 492, 502
- behavioral design patterns **Q_2**, **Q_6**, **Q_10**, **Q_19**
- beta software 31
- bidirectional iterator **839**
- bidirectional navigability in the UML **512**
- Big O notation **802**, 809, 813, 817, 823
- BigDecimal class 88, 162, **770**
 - documentation
 - (download.oracle.com/javase/6/docs/api/java/math/BigDecimal.html) 162
- BigInteger class **770**, 1096
 - add method **773**
 - compareTo method **771**
 - multiply method **771**
 - ONE constant **771**, 773
- BigInteger class (cont.)
 - subtract method **771**, 773
 - ZERO constant **773**
- binary 238
 - base 2 number system 1419
- binary digit (bit) **7**
- binary file **721**
- binary integer 149
- binary operator **51**, 53, 176
- binary search algorithm **804**, 809, 849
- binary search tree **924**, 929
- binary tree **905**, 929
 - delete 937
 - search 938
 - sort **929**
- binarySearch method of Arrays **281**, 283 of Collections 841, **849**, 851
- BindException class **1135**
- binding the server to the port **1128**, 1143
- BindingProvider interface **1338**
 - getRequestContext method **1338**
- bit (binary digit) **7**
- bit manipulation **N_1**
- BitSet class **N_1**, **N_11**
 - and method **N_11**
 - clear method **N_11**
 - equals method **N_12**
 - get method **N_11**
 - or method **N_11**
 - set method **N_11**
 - size method **N_12**
 - toString method **N_12**
 - xor method **N_11**
- bitwise AND (&) **N_1**
- Bitwise AND, bitwise inclusive OR, bitwise exclusive OR and bitwise complement operators **N_4**
- bitwise assignment operators **N_11**
 - ^= (bitwise exclusive OR) **N_11**
 - &= (bitwise AND) **N_11**
 - <<= (left shift) **N_11**
 - >>= (signed right shift) **N_11**
 - >>>= (unsigned right shift) **N_11**
 - |= (bitwise inclusive OR) **N_11**
- bitwise complement (~) operator **N_1**, **N_1**, **N_8**
- bitwise exclusive OR (^) operator **N_1**, **N_8**
- bitwise inclusive OR (|) operator **N_1**
- bitwise operators 174, **N_1**, **N_2**
 - ^ (bitwise exclusive OR) **N_1**
 - & (bitwise AND) **N_1**
- bitwise operators (cont.)
 - << (left shift) **N_1**
 - >> (signed right shift) **N_1**
 - >>> (unsigned right shift) **N_1**
 - | (bitwise inclusive OR) **N_1**
 - ~ (complement) **N_1**
- bitwise shift operations **N_9**
- BlackBerry OS 14
- Blackjack 1325
 - game 1168
 - Web Service Modification 1364
- blank line 39, 121
- _blank target frame **1124**
- Blink applet 943
- blink speed 995
- block **111**, 123, **1128**, 1146
- block increment of a JSlider **1002**
- block until connection received 1135
- blocked state **1049**, 1055
- BlockingQueue interface **1070**
 - put method **1070**, 1071
 - take method **1070**, 1071
- body
 - of a class declaration **40**
 - of a loop 112
 - of a method **41**
 - of an if statement 56
- body mass index (BMI) 34
 - calculator 34
- Body Mass Index Calculator exercise 69
- body XHTML element **950**
- Bohm, C. 104
- BOLD constant of class Font **643**
- book-title capitalization **554**, 571
- books database 1174
 - table relationships 1177, 1234
- Boolean
 - attribute in the UML **485**
 - class **831**
- boolean
 - expression **108**, 1384
 - promotions 208
- boolean logical AND, & 174, **175**
- boolean logical exclusive OR, ^ 174, **176**
 - truth table 176
- boolean logical inclusive OR, | **175**
- boolean primitive type **108**, 1368, 1369, 1384
- border of a JFrame **1005**
- BorderLayout class **390**, **592**, 603, 605, 608, 617
 - CENTER constant 390, **592**, 608, 611
 - EAST constant 390, **592**, 608
- BorderLayout class (cont.)
 - NORTH constant 390, **592**, 608
 - SOUTH constant 390, **592**, 608
 - WEST constant 390, **592**, 608
- BOTH constant of class GridBagConstraints **1032**
- bottom tier **1241**
- bounded buffer **1080**
- bounding box for an oval 966
- bounding rectangle **185**, **649**, 651, 1002
- bounds checking **251**
- Box class **617**, 1028, 1029
 - createGlue method **1031**
 - createHorizontalBox method **617**, 1029
 - createHorizontalGlue method **1031**
 - createHorizontalStrut method **1031**
 - createRigidArea method **1031**
 - createVerticalBox method **1030**
 - createVerticalGlue method **1031**
 - createVerticalStrut method **1030**
 - X_AXIS constant **1031**
 - Y_AXIS constant **1031**
- boxing conversion **832**, 881
- BoxLayout class **617**, 1028
- BoxLayout layout manager 1028
- braces { and } 111, 123, 155, 164, 245
 - not required 168
- braille screen reader 556
- branch **Q_9**
- break 1368
- break mode **1381**
- break statement **168**, 172, 195
- breakpoint **1379**
 - inserting 1381, 1383
 - listing 1392
 - removing 1393
- bricks-and-mortar store 1261
- Bridge design pattern **Q_3**, **Q_5**, **Q_9**
- brightness **641**
- Brin, Sergey 26
- brittle software **380**
- browse method of class Desktop **1445**
- browser 93
- browsing 1120
 - brute force 300, 301
 - Knight's Tour 301
- bubble sort 826
 - improving performance 826
- bucket sort 826
- buffer **752**, **1063**

- buffered I/O **752**
 - BufferedImage class **661**
 - createGraphics method **661**
 - TYPE_INT_RGB constant **661**
 - BufferedInputStream class **752**
 - BufferedOutputStream class **752, Q_16**
 - flush method **752**
 - BufferedReader class **753**
 - BufferedWriter class **753**
 - Builder design pattern **Q_4**
 - building block appearance **181**
 - building blocks **103**
 - Building Your Own Compiler **905**
 - Building Your Own Computer **304**
 - building-block approach to creating programs **12**
 - bulk operation **832**
 - business functionality (mashups) **1450**
 - business logic **1241**
 - business publications **31**
 - business rule **1241**
 - business-to-business (B2B) transactions **1301**
 - button **551, 571**
 - button label **571**
 - ButtonGroup class **577, 1007, 1014**
 - add method **580**
 - byte **7**
 - byte-based stream **721**
 - Byte class **831**
 - byte keyword **1369**
 - byte primitive type **164, 1368, N_1**
 - promotions **208**
 - ByteArrayInputStream class **753**
 - ByteArrayOutputStream class **753**
 - bytecode **20, 43, 905**
 - bytecode verifier **21**
- C**
- c option of the jar command **957**
 - C# programming language **17**
 - C++ programming language **17**
 - cache **1240**
 - CachedRowSet interface **1207**
 - close method **1209**
 - calculations **9, 60, 105**
 - Calendar class **1402**
 - getInstance method **1403**
 - Calendar/Tickler File exercise **998**
 - call-by-reference **262**
 - call-by-value **262**
 - call method of interface Callable **1109**
 - Callable interface **1109**
 - call method **1109**
 - CallableStatement interface **1226**
 - callback function **1292**
 - Calling Attention to an Image exercise **996**
 - calling method (caller) **73, 81, 199**
 - camera **15**
 - Cancel button **94**
 - cancel method of class SwingWorker **1109**
 - CANCEL_OPTION constant of JFileChooser **757**
 - CannotRealizePlayerException exception **990**
 - canRead method of File **723**
 - canWrite method of File **723**
 - CAP_ROUND constant of class BasicStroke **662**
 - capacity method of class StringBuilder **688**
 - capacity of a StringBuilder **687**
 - carbon footprint calculator **34**
 - card games **254**
 - card shuffling
 - Fisher-Yates **257**
 - Card Shuffling and Dealing **303, 304**
 - with Collections method shuffle **845**
 - CardTest applet **943**
 - caretaker object **Q_7**
 - Car-Pool Savings Calculator exercise **70**
 - carriage return **46**
 - carry bit **1426**
 - Cascading Style Sheets (CSS) **1236**
 - case keyword **168, 1368**
 - case sensitive **40**
 - Java commands **23**
 - case studies xxiv
 - CashDispenser class (ATM case study) **480, 481, 482, 485, 486, 493, 505, 530**
 - casino **210, 215**
 - cast
 - downcast **398**
 - operator **68, 124, 208**
 - catch
 - a superclass exception **449**
 - an exception **442**
 - catch
 - block **444, 446, 447, 450, 454, 456**
 - clause **444, 1368**
 - keyword **444**
 - Catch block **253**
 - catch handler
 - multi-catch **462**
 - catch-or-declare requirement **448**
 - Catching Exceptions Using Class Exception exercise **468**
 - Catching Exceptions Using Outer Scopes exercise **468**
 - Catching Exceptions with Superclasses exercise **468**
 - cd to change directories **42**
 - ceil method of Math **201**
 - cellpadding attribute of h:dataTable **1288**
 - cellspacing attribute of h:dataTable **1288**
 - Celsius **627, 1417**
 - equivalent of a Fahrenheit temperature **237**
 - CENTER constant
 - BorderLayout **592, 608, 611**
 - FlowLayout **608**
 - GridBagConstraints **1032**
 - GroupLayout **1432**
 - center mouse button click **596**
 - centered **605**
 - central processing unit (CPU) **9**
 - certificate authority **955**
 - Chain-of-Responsibility design pattern **Q_3, Q_6, Q_10**
 - chained exception **457**
 - change directories **42, 943**
 - ChangeEvent class **1005**
 - ChangeListener interface **1005**
 - stateChanged method **1005**
 - changing look-and-feel of a Swing-based GUI **1021**
 - chapter dependency chart xxvii
 - char
 - array **675**
 - keyword **1368, 1369**
 - primitive type **49, 164**
 - promotions **208**
 - character **7**
 - constant **171**
 - literal **673**
 - set **7, 68**
 - character-based stream **721**
 - Character class **673, 695, 831**
 - charValue method **698**
 - digit method **696**
 - forDigit method **696**
 - isDefined method **695**
 - isDigit method **695**
 - isJavaIdentifierPart method **696**
 - isJavaIdentifierStart method **696**
 - isLetter method **696**
 - isLetterOrDigit method **696**
 - isLowerCase method **696**
 - isUpperCase method **696**
 - static conversion methods **697**
 - Character class (cont.)
 - toLowerCase method **696**
 - toUpperCase method **696**
 - character encoding **1452**
 - character set **1453**
 - character string **41**
 - CharArrayReader class **753**
 - CharArrayWriter class **753**
 - charAt method
 - of class String **675**
 - of class StringBuilder **690**
 - CharSequence interface **707**
 - charValue method of class Character **698**
 - check protection exercise **715**
 - checkbox **571, 577**
 - checkbox label **576**
 - checked exception **448**
 - checkerboard pattern **68**
 - exercise **965**
 - Checkers game **1168**
 - Checking with assert that a value is within range **461**
 - Chess game **1168**
 - chess-playing program **1168**
 - child node **924**
 - child window **1001, 1022, 1024, 1025**
 - CHORD constant of class Arc2D **661**
 - Chrome **93**
 - Circles Using Class Ellipse2D.Double exercise **668**
 - circular buffer **1081**
 - circumference **68, 668, 965**
 - Cisco **3**
 - CJK Unified Ideographs block **1457**
 - class **11, 487, 493, 497, 511**
 - class keyword **72**
 - constructor **74, 85, 513**
 - data hiding **81**
 - declaration **90, 948**
 - declare a method **72**
 - default constructor **85**
 - field **79**
 - file **43**
 - get method **320**
 - instance variable **12, 79, 201**
 - instantiating an object **72**
 - name **40, 342, 513**
 - set method **320**
 - class **8**
 - class-average problem **113, 114, 120, 121**
 - class cannot extend a final class **419**
 - Class class **388, 417, 560, 1200**
 - getName method **388, 417**
 - getResource method **560**

- class diagram
 - for the ATM system model 483, 507
 - in the UML **477, 480**, 482, 486, 493, 511, 514, 518, 519, 520
- .class file **19, 43**
 - separate one for every class 318
- .class file extension 985
- class hierarchy **360, 402**
- class instance creation
 - expression **74, 86**
- class keyword **40, 72, 1368**
- class library **361, 386**
- class loader **20, 344, 560**
- class method **200**
- class name
 - fully qualified 79
- class variable **201, 334**
- classwide information **334**
- ClassCastException class 883
- Classes
 - AbstractButton **571**, 573, 1007, 1012
 - AbstractCollection **867**
 - AbstractList **867**
 - AbstractMap **867**
 - AbstractQueue **867**
 - AbstractSequentialList **867**
 - AbstractSet **867**
 - AbstractTableModel **1194, 1200**
 - ActionEvent **565, 566**, 570, 617, 979
 - Arc2D 632
 - Arc2D.Double **657**
 - ArithmeticException **441**
 - ArrayBlockingQueue 1069, **1070**, 1080, 1094
 - ArrayIndexOutOfBoundsException 251, 253
 - ArrayList<T> **284, 284**, **286, 833**, 834, 849, 895, 1123
 - Arrays **281**
 - AssertionError **461**
 - AWTEvent 567
 - BasicStroke **632, 660**, 661
 - BigDecimal 88, 162, **770**
 - BigInteger **770**, 1096
 - BindException **1135**
 - BitSet **N_1**
 - Boolean **831**
 - BorderLayout **592, 603**, 605, 608, 617
 - Box **617**, 1028, 1029
 - BoxLayout **617**, 1028
 - BufferedImage **661**
 - BufferedInputStream **752**
- Classes (cont.)
 - BufferedOutputStream **752**
 - BufferedReader **753**
 - BufferedWriter **753**
 - ButtonGroup **577, 1007**, 1014
 - Byte **831**
 - ByteArrayInputStream 753
 - ByteArrayOutputStream 753
 - Calendar **1402**
 - ChangeEvent **1005**
 - Character 673, 691, 695, **831**
 - CharArrayReader **753**
 - CharArrayWriter **753**
 - Class 388, **417, 560**, 1200
 - ClassCastException 883
 - Collections **833, 880**
 - Color **224, 632**
 - Component **556, 589**, 634, 635, 973, 980, 1006, 1037
 - ComponentAdapter 594
 - ComponentListener 605
 - ConcurrentHashMap 1094
 - ConcurrentLinkedDeque 1094
 - ConcurrentSkipListMap 1094
 - ConcurrentSkipListSet 1094
 - Container **556, 586**, 605, 613
 - ContainerAdapter 594
 - CopyOnWriteArrayList 1094
 - CopyOnWriteArraySet 1094
 - DatagramPacket **1143**, 1165
 - DatagramSocket **1143**
 - DataInputStream **752**
 - DataOutputStream **752**
 - Date **1402**
 - DelayQueue 1094
 - Desktop **1445**
 - Dimension **980**
 - Double **831, 896**
 - DriverManager **1191**
 - Ellipse2D 632
 - Ellipse2D.Double **657**
 - Ellipse2D.Float **657**
 - EmptyStackException **855**
 - EnumSet **333**
 - Error **447**
 - EventListenerList **569**
 - Exception **447**
 - ExecutionException 1098
 - Executors **1051**
- Classes (cont.)
 - File **722**
 - FileInputStream **721**
 - FileOutputStream **721**
 - FileReader **721, 753**
 - FileWriter **721**
 - FilterInputStream **751**
 - FilterOutputStream **751**
 - Float **831**
 - FlowLayout 559, 605
 - FocusAdapter 594
 - Font **576, 632, 643**
 - FontMetrics **632, 645**
 - Formatter **722, 1396**
 - Frame 1005
 - GeneralPath 632, **662**
 - GradientPaint **632, 660**
 - Graphics **599, 632, 657**, 973
 - Graphics2D **632, 657**, 661
 - GridBagConstraints **1031, 1037**
 - GridBagLayout 1028, **1031, 1033, 1037**
 - GridLayout 605, **611**
 - GroupLayout 605, **1431**
 - GroupLayout.Group **1432**
 - GroupLayout.ParallelGroup **1432**
 - GroupLayout.SequentialGroup **1432**
 - Gson 1322
 - HashMap **859, 1121**
 - HashSet **856**
 - Hashtable **859**
 - HyperlinkEvent **1125**, 1127
 - IllegalMonitorStateException **1073**, 1088
 - Image **969**
 - ImageIcon **560, 969**, 978, 979
 - IndexOutOfBoundsException 253
 - InetAddress **1136**, 1142, 1146, 1147
 - InetAddress **Q_16**
 - InputEvent **589, 596**, 601
 - InputMismatchException **441**
 - InputStream **751, 1128**, 1129, 1130
 - InputStreamReader **753**
 - Integer 554, **831, 896**
 - InterruptedException **1052**
 - ItemEvent **576, 580**
 - JApplet **948, 1006**
 - JAXB **1317**
 - JButton 555, **571, 574**, 611
- Classes (cont.)
 - JCheckBox 555, **574**
 - JCheckBoxMenuItem 1006, **1007, 1013**
 - JColorChooser **639**
 - JComboBox 555, **580**, 1032
 - JComponent **556, 557**, 559, 569, 580, 584, 597, 613, 632, 634, 980
 - JdbcRowSetImpl **1209**
 - JDesktopPane **1022**, 1044
 - JDialog **1013**
 - JEditorPane **1125**
 - JFileChooser **754**
 - JFrame 1005
 - JInternalFrame **1022**, 1024
 - JLabel 555, **557**
 - JList 555, 584
 - JMenu **1006, 1013, 1024**
 - JMenuBar **1006, 1013**, 1024
 - JMenuItem **1007, 1024**
 - JOptionPane **93, 552**, 1041
 - JPanel 555, 597, 598, 605, 613, 975, 1002
 - JPasswordField **561**, 566
 - JPopupMenu **1014**
 - JProgressBar 1105
 - JRadioButton **574, 577**, 580
 - JRadioButtonMenuItem 1006, **1007, 1014**
 - JScrollPane **586, 588**, 617, 618
 - JSlider **1001, 1002**, 1005, 1432
 - JTabbedPane **1026**, 1031
 - JTable **1194**
 - JTextArea 603, **615**, 617, 1033, 1036
 - JTextComponent **561**, 564, 615, 617
 - JTextField 555, **561**, 565, 569, 615
 - JToggleButton **574**
 - KeyAdapter 594
 - KeyEvent 570, 601
 - Line2D 632, **661**
 - Line2D.Double **657**
 - LinearGradientPaint 660
 - LineNumberReader **753**
 - LinkedBlockingDeque 1094
 - LinkedBlockingQueue 1094
 - LinkedList **833**
 - LinkedTransferQueue 1094
 - ListSelectionEvent **584**

Classes (cont.)

ListSelectionMode **586**
 Long **831**
 MalformedURLException-Exception **1124**
 Manager **988**
 Matcher 673, **707**
 Math 200, 201
 MemoryImageSource 996
 MouseAdapter 594
 MouseEvent **570, 589, 1017**
 MouseMotionAdapter 594, 598
 MouseWheelEvent **590**
 Number 896
 Object 333
 ObjectInputStream **722, 1129, 1130, 1136**
 ObjectOutputStream **722**
 OutputStream **751, 1128, 1129, 1130**
 OutputStreamWriter **753**
 Pattern 673, **707**
 PipedInputStream 751
 PipedOutputStream 751
 PipedReader **753**
 PipedWriter **753**
 PixelGrabber 996
 Point **599**
 Polygon **632, 654**
 PrintStream **751**
 PrintWriter 753
 PriorityBlockingQueue 1094
 PriorityQueue **855**
 Properties **863**
 RadialGradientPaint 660
 Random 209, **210, 296**
 Reader **753**
 Rectangle2D 632
 Rectangle2D.Double **657**
 ReentrantLock **1087, 1089**
 RoundRectangle2D 632
 RoundRectangle2D.Double **657, 661**
 RowFilter **1206**
 RuntimeException **448**
 Scanner **49, 77**
 ServerSocket **1128, 1135, 1157**
 ServiceManager **972**
 Short **831**
 Socket **1128, 1142, 1157, 1158, Q_15**
 SocketException **1143**
 SplashScreen **1444**
 SQLException 1192
 SQLFeatureNotSupportedException 1199

Classes (cont.)

Stack **853**
 StackTraceElement **457**
 String **94, 673**
 StringBuffer **688**
 StringBuilder 673, **687**
 StringIndexOutOfBoundsException **684, 690**
 StringReader **753**
 StringWriter **753, 1317**
 SwingUtilities **1022, 1135**
 SwingWorker **1095**
 SynchronousQueue 1094
 SystemColor **660**
 SystemTray **1447**
 TableModelEvent 1206
 TableRowSorter **1206**
 TexturePaint **632, 660, 661**
 Throwable **447, 456**
 Timer **979, 980**
 TrayIcon **1448**
 TreeMap **859**
 TreeSet **856**
 Types **1193**
 UIManager **1021**
 UnknownHostException **1130**
 UnsupportedOperationException **839**
 URL 985
 Vector **833**
 Window 1005
 WindowAdapter 594, **1206**
 Writer **753**
 classified listings 26
ClassName.this 1012
 CLASSPATH
 environment variable 44, **345**
 classpath **344, 1191**
 -classpath command-line argument 728
 to java **345**
 to javac **345**
 clear debugger command **1392**
 clear method
 of ArrayList<T> 284
 of BitSet **N_11**
 of List<T> **839**
 of PriorityQueue **855**
 clearRect method of class Graphics 648
 click a button 561
 click a tab 947
 click count 594
 click the mouse 574, 944
 click the scroll arrows 583
 clicking the close box 1044

client

 object **Q_16**
 of a class 493, 502
 of an object **83**
 client code 398
 client connection 1128
 client-server chat **1130**
 client-server relationship **1119**
 client-side artifacts **1310**
 client tier **1241, Q_18**
 clip art (www.clipart.com) 992
 clock 944, 997
 Clock applet 944
 clone method of Object 387
 clone object 742
 Cloneable interface
 documentation (java.sun.com/j2se/5.0/docs/api/java/lang/Cloneable.html) **Q_19**
 cloning objects
 deep copy **387**
 shallow copy **387**
 close a window 557, 561
 close method
 of CachedRowSet 1209
 of Connection 1193
 of Formatter **732**
 of interface Connection 1193
 of interface ResultSet 1193
 of interface Statement 1193
 of JdbcRowSet **1209**
 of ObjectOutputStream **748**
 of ResultSet 1193
 of Socket **1129**
 of Statement 1193
 close method of interface AutoCloseable 463
 closed polygons 654
 closed tour 301, 669
 closePath method of class GeneralPath **664**
 cloud computing xxvi, **30**
 COBOL (Common Business Oriented Language) 16
 code **13**
 code attribute of <applet> tag 950
 code reuse 360
 code value **1454, 1457**
 codebase attribute of the jnlp element 958
 code completion window (NetBeans) 1247
 coin tossing 211, 238
 collaboration diagram in the UML **477**
 collaboration in the UML **499, 500, 501, 503**
 collection **284, 830**
 collection hierarchy 832
 collection implementation 866

Collection interface 831, **832, 836, 841**
 contains method **836**
 iterator method **836**
 collections
 synchronized collection 833
 unmodifiable collection 833
 Collections class **833, 880**
 addAll method 841, **851**
 binarySearch method 841, **849, 851**
 copy method 841, **848**
 disjoint method 841, **851**
 fill method 841, **847**
 frequency method 841, **851**
 max method 841, **848**
 min method 841, **848**
 reverse method 841, **847**
 reverseOrder method **843**
 shuffle method 841, **845, 847**
 sort method **842**
 wrapper methods **833**
 collections framework **830**
 Collections methods
 reverse, fill, copy, max and min 848
 collision in a hashtable **860**
 color 632
 color chooser dialog 641
 Color class **224, 632**
 getBlue method **636, 638**
 getColor method **636**
 getGreen method **636, 638**
 getRed method **636, 638**
 setColor method **636**
 Color constant 635, 638
 color manipulation 634
 color swatches **641**
 Color.BLACK 224
 Color.BLUE 224
 Color.CYAN 224
 Color.DARK_GRAY 224
 Color.GRAY 224
 Color.GREEN 224
 Color.LIGHT_GRAY 224
 Color.MAGENTA 224
 Color.ORANGE 224
 Color.PINK 224
 Color.RED 224
 Color.WHITE 224
 Color.YELLOW 224
 Coloring Black-and-White Photographs and Images exercise 998
 colors 224
 column 268, **1173, 1174**
 column number in a result set 1179
 columnClasses attribute of *dataTable* **1288**

- columns attribute of
 - h:panelGrid **1253**
- columns of a two-dimensional array 268
- com.google.gson.Gson package 1322
- com.sun.rowset package **1209**
- combo box **551**, 580
- comma (,) 159
- comma (,) formatting flag **161**
- comma in an argument list 46
- comma-separated list 159
 - of arguments **46**, 50
 - of parameters 204
- command-and-control software system 1046
- command button **571**
- Command design pattern **Q_3**, **Q_6**, **Q_11**
- command line **41**
- command-line argument **202**, **279**
- Command Prompt **19**, 41
- command window **41**, 943, 944, 949
- comment
 - end-of-line (single-line), / **39**, 42
 - Javadoc **39**
 - single line 42
- commercial data processing 761
- commission 146, 295
- CommissionEmployee class
 - derived from Employee 410
- commit a transaction **1227**
- commit method of interface Connection **1227**
- Common Programming Errors overview xxviii
- Commonly used JSF components 1250
- communication diagram in the UML **477**, **502**, 503
- Comparable interface 928
- Comparable<T> interface 430, 679, 842, **880**, 928
 - compareTo method 842, **880**
- Comparator interface **842**
 - compare method **844**
- Comparator object 842, 848, 857, 859
 - in sort 842
- compare method of interface Comparator **844**
- compareTo method
 - of class String 677, 679
 - of Comparable 842
- compareTo method of class BigInteger **771**
- compareTo method of Comparable<T> **880**
- comparing String objects 677
- comparison operator 430
- compartment in a UML class diagram 75
- compilation error **39**
- compile 42, 43
- compile a program **19**
- compile method of class Pattern **707**
- compile-time error **39**
- compile-time type safety 830
- compiled applet class 950
- compiler **10**
- compiler error **39**
- compiler options
 - d **342**
- compile-time type safety **874**
- compiling an application with multiple classes 75
- Complex 356
- complex curve 662
- complex number 356
- Complex Numbers (exercise) 356
- complexity theory 774
- component 11, 209, 588
- Component class **556**, 589, 634, 635, 641, 973, 980, 1006, 1037, **Q_8**, **Q_10**
 - addListener method **601**
 - addMouseListener method **593**
 - addMouseMotionListener method **593**
 - getHeight method **973**
 - getMaximumSize method 1432
 - getMinimumSize method **980**, 1004, 1432
 - getPreferredSize method **980**, 1004, 1432
 - getWidth method **973**
 - repaint method **599**
 - setBackground method 641
 - setBounds method 604
 - setFont method **576**
 - setLocation method 604, **1006**
 - setSize method 604, 1006
 - setVisible method **611**, 1006
- component diagram in the UML **P_1**
- component in the UML **P_1**
- component of an array **242**
- ComponentAdapter class 594
- ComponentListener interface 594, 605
- Composite design pattern **Q_3**, **Q_5**, **Q_9**, **Q_10**
- composite structure diagram in the UML **P_1**
- composition **328**, 361, 363, 481, 482, 507
 - in the UML **481**
- compound assignment operators **130**, 132
- compound interest 159, 193, 194
- computation 5
- computer-assisted instruction (CAI) 238, 239
- computer-assisted instruction (CAI): Monitoring Student Performance 239
- computer-assisted instruction (CAI): Reducing Student Fatigue 239
- computer-assisted instruction (CAI): Varying the Types of Problems 239
- computer-assisted instruction (CAI): Difficulty Levels 239
- computer dump 307
- computer program **6**
- computer simulator 306
- Computerization of Health Records exercise 101
- computerized scientific notation **1398**
- computers in education 238
- concat method of class String **684**
- concatenate strings 337
- concatenation **204**
- Concentric Circles Using Class Ellipse2D.Double exercise 668
- Concentric Circles Using Method drawArc exercise 668
- concrete class **401**
- concrete subclass 407
- CONCUR_READ_ONLY constant **1199**
- CONCUR_UPDATABLE constant **1199**
- concurrency 1046
- Concurrency API 1047
- concurrency design patterns **Q_3**, **Q_14**
- concurrency problem **Q_14**
- concurrent access to a Collection by multiple threads 866
- concurrent collections (Java SE 7) 1094
- concurrent operations 1046
- concurrent programming **1047**
- concurrent threads 1069
- ConcurrentHashMap class 1094
- ConcurrentLinkedDeque class 1094
- ConcurrentSkipListMap class 1094
- ConcurrentSkipListSet class 1094
- condition **56**, 163
- Condition interface **1087**, 1089
 - await method **1087**, 1091
 - signal method **1087**
 - signalAll method **1087**
- condition object **1087**
- conditional AND, && **174**, 175
 - truth table 174
- conditional expression **108**
- conditional operator, ?: 108, 133
- conditional OR, || **174**
 - truth table 175
- confusing the equality operator == with the assignment operator = 59
- connect to a database 1189
- connect to server 1128, 1130
- connected lines 654
- connected RowSet **1207**
- connection **1119**, 1130, 1142, 1143, 1157, 1158
- connection between client and server terminates 1130
- connection between Java program and database 1191
- Connection interface **1191**, 1193, 1198, 1227
 - close method 1193
 - commit method **1227**
 - createStatement method **1192**, 1198
 - getAutoCommit method **1227**
 - prepareStatement method **1217**
 - rollback method **1227**
 - setAutoCommit method **1227**
- connection-oriented service **1119**
- connection-oriented, streams-based transmission 1142
- connection pool **1279**
- connection port 1128
- connectionless service **1119**, 1143
- connectionless transmission **1142**
- consistent state 320
- constant 339
 - in an interface 431
 - Math.PI 68
- constant integral expression **164**, 171
- constant run time **803**
- constant variable **171**, 247, 339
 - must be initialized 247
- constructor **74**, 85, 513
 - call another constructor of the same class using this 322
 - multiple parameters 88
 - no argument **322**
 - overloaded **320**
 - parameter list 86
- Constructor Detail section in API **1376**
- Constructor failure exercise 468
- Constructor Summary section in API **1374**
- constructors cannot specify a return type 86
- consume an event **565**

- consume memory 777
 - consumer **1062**
 - consumer electronic device 18
 - consumer thread **1063**
 - consuming a web service **1302**, 1303, **1358**
 - cont debugger command **1382**
 - Container class **556**, 586, 605, 613, **Q_10**
 - setLayout method **559**, 605, 611, 613, 1031
 - validate method **613**
 - container for menus 1006
 - ContainerAdapter class 594
 - ContainerListener interface 594
 - contains method
 - of Collection **836**
 - contains method of class ArrayList<T> **284**, **286**
 - containsKey method of Map **862**
 - content pane 586, 1014
 - setBackground method **586**
 - context-sensitive popup menu **1014**
 - continue statement **172**, 195, 1368, **O_2**
 - continuous beta 31
 - control statement **104**, 105, 106, 107, 776
 - nesting **106**, 182
 - stacking **106**, 179
 - control variable **113**, **152**, **153**, 154
 - controller (in MVC architecture) **1250**, 1250, **Q_17**
 - controller logic **1241**
 - controlling expression of a switch **168**
 - controls 550
 - converge on a base case 767
 - conversion characters **1397**
 - % 1404
 - A 1399
 - a 1399
 - B **1403**
 - b **1403**, 1404
 - C **1400**
 - c **1400**
 - d **1397**
 - E **1398**, 1399
 - e **1398**, 1399
 - f **1398**, **1399**
 - G **1399**
 - g **1399**
 - H **1403**
 - h 1404
 - n 1404
 - o **1397**
 - S **1400**
 - s **1400**
 - T **1401**
 - t **1401**
 - X **1397**
 - x **1397**
 - conversion suffix characters **1401**
 - A **1401**
 - a **1401**
 - B **1401**
 - b **1401**
 - c **1401**
 - D **1401**
 - d **1401**
 - e **1402**
 - F **1401**
 - H **1402**
 - I **1402**
 - j **1402**
 - k **1402**
 - l **1402**
 - M **1402**
 - m **1401**
 - P **1402**
 - p **1402**
 - R **1401**
 - r **1401**
 - S **1402**
 - T **1401**
 - Y **1402**
 - y **1402**
 - Z **1402**
 - convert
 - a binary number to decimal 1424
 - a hexadecimal number to decimal 1424
 - an integral value to a floating-point value 208
 - an octal number to decimal 1424
 - between number systems 697
 - cookie **1262**, 1263
 - deletion 1263
 - expiration **1263**
 - expiration date **1263**
 - header 1263
 - Cooking with Healthier Ingredients 717
 - coordinate system **134**, **632**, 634
 - coordinates 949
 - coordinates (0, 0) 135, 632
 - copy method of Collections 841, **848**
 - copying objects
 - deep copy **387**
 - shallow copy **387**
 - CopyOnWriteArrayList class 1094
 - CopyOnWriteArraySet class 1094
 - core package 43
 - Core Tag Library (JSF) **1250**, 1254
 - correct in a mathematical sense 179
 - cos method of Math 201
 - cosine 201
 - counter **113**, 119, 126, 127, 152, 154, 306, 776
 - counter-controlled repetition **113**, 114, 123, 126, 127, 152, 154, 306, 776
 - coupling **Q_11**, **11**
 - cp command line argument to java **345**
 - CPU (central processing unit) **9**
 - Craigslist (www.craigslist.org) 26, 27, 1449
 - craps (casino game) 210, 215, 238, 297
 - create a desktop application in NetBeans 1310
 - create a package 340
 - create a reusable class 340
 - create a Socket 1130
 - create a web application in NetBeans 1304
 - create an object of a class 74
 - createGluе method of class Box **1031**
 - createGraphics method of class BufferedImage **661**
 - createHorizontalBox method of class Box **617**, 1029
 - createHorizontalGluе method of class Box **1031**
 - createHorizontalStrut method of class Box **1031**
 - createRealizedPlayer method of class Manager **988**
 - createRigidArea method of class Box **1031**
 - createStatement method of Connection **1192**, 1198
 - createVerticalBox method of class Box **1030**
 - createVerticalGluе method of class Box **1031**
 - createVerticalStrut method of class Box **1030**
 - creating a Java DB database in NetBeans 1286
 - creating and initializing an array 244
 - creational design patterns **Q_2**, **Q_3**, **Q_7**, **Q_15**, **Q_19**
 - credit limit on a charge account 146
 - cross-site scripting 1317
 - Crossword exercise 997
 - crossword puzzle generator 717
 - CSS
 - height attribute **1253**
 - width attribute **1253**
 - CSS (Cascading Style Sheets) 1236
 - CSS rule 1260
 - <Ctrl>-d 167
 - Ctrl key 586, 604
 - ctrl key 167
 - <Ctrl>-z 167
 - currentThread method of class Thread 1056
 - currentTimeMillis method of class System 797
 - cursor 41, 44
 - curve 662, 944
 - custom drawing area 598
 - customized subclass of class JPanel 598
 - cyclic gradient **660**
- ## D
- d compiler option 342
 - d option **M_9**
 - dangling-else problem **110**, 148
 - dashed lines 657
 - data 6
 - data entry 94
 - data hiding **81**
 - data hierarchy **6**, 7
 - data integrity 327
 - data source name **1281**
 - data structure **241**, **Q_20**
 - data tier **1241**
 - database **1172**, 1177
 - table **1173**
 - database-driven multitier web address book xxv
 - database management system (DBMS) **1172**
 - datagram packet **1119**, 1142, 1143
 - datagram socket **1119**, 1143
 - DatagramPacket class **1143**, 1165
 - getAddress method **1146**
 - getData method **1146**
 - getLength method **1146**
 - getPort method **1146**
 - DatagramSocket class **1143**
 - receive method **1146**
 - send method **1146**
 - DataInput interface 752
 - DataInputStream class **752**
 - DataOutput interface 752
 - writeBoolean method 752
 - writeByte method 752
 - writeBytes method 752
 - writeChar method 752
 - writeChars method 752
 - writeDouble method 752
 - writeFloat method 752
 - writeInt method 752
 - writeLong method 752
 - writeShort method 752
 - writeUTF method 752
 - DataOutputStream class **752**
 - DataSource interface **1285**
 - date 209
 - Date and Time Class (exercise) 356
 - date and time compositions **1401**
 - Date class **1402**
 - exercise 356
 - date formatting 1397

- DBCS (double byte character set) **1455**
- DB2 1172
- De Morgan's Laws 194
- dead state 1049
- deadlock **1088**, 1091, 1117, **Q_14**
- dealing 254
- debugger 1379
 - break mode **1381**
 - breakpoint **1379**
 - clear command **1392**
 - cont command **1382**
 - defined **1379**
 - exit command **1388**
 - g compiler option **1380**
 - inserting breakpoints 1381
 - jdb command **1381**
 - logic error 1379
 - next command **1387**
 - print command **1383**, 1384
 - run command **1381**, 1383
 - set command **1383**, 1384
 - step command **1385**
 - step up command **1386**
 - stop command **1381**, 1383
 - suspending program execution 1383
 - unwatch command 1388, **1390**
 - watch command **1388**
- decimal (base 10) number system 1419
- decimal digit **7**
- decimal integer 1397
- decimal integer formatting 51
- decision **56**, 107
 - symbol in the UML **107**, 492
- declaration
 - class **40**
 - import **48**, 50
 - method **41**
- declare a method of a class **72**
- Decorator design pattern **Q_3**, **Q_5**, **Q_15**, **Q_16**
- decrement of a control variable **152**
- decrement operator, -- **130**
- decrypt 150
- dedicated drawing area **597**
- deep copy **387**
- deeply nested statement 182
- default case in a switch **168**, 171, 214
- default constructor **85**, 326, 367
- default exception handler 456
- default initial value **82**
- default keyword 1368
- default layout of the content pane 617
- default package **79**, 340
- default upper bound (Object) of a type parameter 886
- default value **82**, 134
- define a custom drawing area 598
- definite repetition **113**
- degree 651
- Deitel Resource Centers 31
- DelayQueue class 1094
- delegate a method call **920**
- delegation event model **568**
- delete method of class
 - StringBuilder **693**
- DELETE SQL statement 1178, **1186**
- deleteCharAt method of class
 - StringBuilder **693**
- deleting an item from a binary tree 930
- delimiter for tokens **699**
- delimiter string 699
- Dell 3
- demo directory 946
- Department of Defense (DOD) 16
- dependency chart (chapters) xxvi
- dependent condition 175
- deploy a web app 1249
- deploying a web service 1307
- deployment diagram in the UML **P_1**
- Deposit class (ATM case study) 480, 482, 485, 493, 501, 502, 509, 512, 516, 517
- DepositSlot class (ATM case study) 480, 481, 482, 485, 493, 502, 513
- @deprecated javadoc tag **M_8**
- Deprecated link in API **1371**
- deprecated-list.html generated by javadoc **M_11**
- Deprecated note **M_8**
- dequeue operation of queue **921**
- derived class **360**
- descending order 281
- descending sort (DESC) 1181
- descent **645**
- descriptive words and phrases 485, 486
- deserialized object **742**
- design pattern **29**, **Q_1**, **Q_2**, **Q_4**, **Q_5**, **Q_7**, **Q_8**, **Q_9**, **Q_10**, **Q_12**, **Q_14**, **Q_15**, **Q_19**
- design patterns xxvii
 - Design Patterns, Elements of Reusable Object-Oriented Software* **Q_2**
- design process **13**, 470, 476, 494, 499
- design specification **476**
- Design view in Netbeans 1433
- Desktop class **1445**
 - browse method **1445**
 - getDesktop method **1445**
- Desktop class (cont.)
 - isDesktopSupported method **1445**
 - mail method **1445**
 - open method **1445**
- desktop element of a JNLP document **959**
- desktop integration 956
- destroy method
 - of JApplet **949**, 952
- Determining points C and D for level 1 of "Lo fractal" 782
- development tool 943
- diacritic **1454**
- dialog **93**, **552**
- dialog box **93**, 552, 1012
- Dialog font 643
- DialogInput font 643
- diameter 68, 668, 965
- diamond in the UML **105**, 195
- dice game 215
- Dice Rolling 296
- digit 49, 697, 700, 1419
- digit method of class
 - Character **696**
- digital certificate 955
- Digital Clock exercise 996
- digital divide 5
- digits reversed 237
- Dimension class **980**
- dir command on Windows 943
- direct superclass 360, 362
- DIRECTORIES_ONLY constant of JFileChooser **757**
- directory 722, 723
 - name 722
 - separator **344**
 - tree 945
- disconnected RowSet **1207**, 1286
- disjoint method of
 - Collections 841, **851**
- disk 6, 22, 720
- disk drive 943
- disk I/O completion 447
- disk space 906
- dismiss a dialog 553
- dispatch
 - a thread **1049**
 - an event **570**
- display a line of text 41
- display area 950
- display monitor 135, 632
- display output 60
- displaying text in a dialog box 93
- dispose method of class
 - Window **1005**
- DISPOSE_ON_CLOSE constant of interface
 - WindowConstants 1005
- distance between values (random numbers) 214
- dithering 944
- DitherTest applet 944
- divide-and-conquer approach **198**, 199, 767
- divide by zero 22, 120, 441
- division 9, 53, 54
- division compound assignment operator, /= 131
- DNS (domain name system) server **1237**
- DNS lookup **1237**
- DO_NOTHING_ON_CLOSE constant of interface
 - WindowConstants 1005
- do...while repetition statement 106, **162**, 163, 183, 1368
- document 1001, 1022
- document a program **39**
- documentation comments **M_1**
- dollar signs (\$) 40
- domain name system (DNS) server **1237**
- Dorsey, Jack 28
- dot (.) separator **75**, 94, 161, 200, 335, 657
- dotted line in the UML **106**
- double-byte character set (DBCS) **1455**
- (double) cast **124**
- Double class **831**, 896
 - parseDouble method 953
- double equals, == 59
- double-precision floating-point number **88**
- double primitive type **49**, **88**, 121, 1368, 1369
 - promotions 208
- double quotes, " 41, 45, 46
- double selection 183
- double-selection statement **106**, 127
- doubleValue method of
 - Number **897**
- downcast 416
- downcasting **398**
- drag the scroll box 583
- draggable applet 956, **974**
- dragging the mouse to highlight 617
- draw arc 943
- draw complex curve 944
- draw graphics 948
- draw lines and points 944
- draw method of class
 - Graphics2D **660**
- draw rectangle 954
- draw shapes 632
- draw3DRect method of class
 - Graphics 648, **651**
- drawArc method of class
 - Graphics **288**, **651**, 668
- drawImage method of class
 - Graphics **973**
- drawing color 636
- drawing on the screen 634
- drawLine method of class
 - Graphics **137**, 648
- drawOval method of class
 - Graphics **184**, **185**, 648, **651**, 966

- drawPolygon method of class Graphics 654, **656**
 - drawPolyline method of class Graphics 654, **656**
 - drawRect method of class Graphics **184**, 648, 661, 668, 965, 966
 - drawRoundRect method of class Graphics **649**
 - drawString method of class Graphics **638**, 949, 954
 - DrawTest applet 944, 945
 - driver class* 74
 - DriverManager class **1191**
 - getConnection method **1191**
 - drop-down list 555, **580**
 - dual-core processor 9
 - dummy value **118**
 - Duplicate Elimination 296
 - duplicate elimination **930**
 - duplicate of datagram 1143
 - duplicate values 930
 - Dynamic Audio and Graphical Kaleidoscope exercise 997
 - dynamic binding **416**
 - dynamic content **18**
 - dynamic data structure **905**
 - dynamic memory allocation **906**
 - dynamic resizing **241**
 - dynamically resizable array 1123
- E**
- EAST constant
 - of class BorderLayout **592**, 608
 - of class GridBag-Constraints **1032**
 - eBay 3, 29
 - echo character of class JPasswordField **562**
 - echoes a packet back to the client **1143**
 - Eclipse
 - demonstration video (www.deitel.com/books/jhttp9) 38
 - Eclipse (www.eclipse.org) 19
 - Eclipse Foundation 14
 - Ecofont 629
 - edit a program 19
 - editor 19
 - efficiency of
 - binary search 809
 - bubble sort 826
 - insertion sort 817
 - linear search 804
 - merge sort 822
 - selection sort 813
 - efficient (Unicode design principle) **1453**
 - Eight Queens exercise 301, 795
 - Brute Force Approaches 301
 - EL expression **1248**
 - element (XML) **958**
 - element of an array **242**
 - element of chance **210**
 - elided UML diagram **480**
 - eligible for garbage collection 337
 - eliminate resource leaks 451
 - Ellipse2D class 632
 - Ellipse2D.Double class **657**, 668
 - Ellipse2D.Float class **657**
 - ellipsis (. . .) in a method
 - parameter list **278**
 - else keyword 108, 1368
 - emacs 19
 - email 1128
 - embedded system **6**, 14
 - Employee abstract superclass 405
 - Employee class hierarchy test program 413
 - Employee class that implements Payable 425
 - employee identification number 8
 - empty set 356
 - empty statement (a semicolon, ;) **59**, 111, 163
 - empty string **566**, **674**
 - empty XML element 959, **1253**
 - EmptyStackException class **855**
 - encapsulation **13**
 - encrypt 150
 - end cap **660**
 - End key 601
 - "end of data entry" 118
 - end-of-file (EOF) 1130
 - indicator **167**
 - key combinations 731
 - marker **720**
 - end-of-line (single-line)
 - comment, // **39**, 42
 - end-of-stream 1130
 - end tag **958**
 - endsWith method of class String **680**
 - Enforcing Privacy with Cryptography exercise 150
 - English-like abbreviations 10
 - enhanced for statement **258**
 - Enhancing Class Date (exercise) 355
 - Enhancing Class Time2 (exercise) 355
 - enqueue operation of queue **921**, 922
 - ensureCapacity method of class StringBuilder **688**
 - Enter (or Return) key 42, 569, 945, 946
 - ENTERED constant of nested class EventType **1127**
 - entity-relationship diagram **1176**
 - entry point 179
 - enum **218**
 - constant 331
 - enum (cont.)
 - constructor **331**
 - declaration **331**
 - EnumSet class 333
 - keyword 218, 1368
 - values method **332**
 - enumeration **218**
 - enumeration constant **218**
 - EnumSet class **333**
 - range method **333**
 - environment variable
 - CLASSPATH 44
 - PATH 43
 - EOF (end-of-file) 1130
 - EOFException class **750**
 - equal likelihood 212
 - equality operator == to compare String objects 677
 - equality operators **56**
 - equals method
 - of class Arrays **281**
 - of class BitSet **N_12**
 - of class Object 387
 - of class String 677, 679
 - equalsIgnoreCase method of class String 677, 679
 - erasure **879**, 882
 - e-reader 3
 - e-reader device 15
 - Error class **447**
 - Error-Prevention Tips
 - overview xxviii
 - escape character **45**, 1185
 - escape sequence **45**, 49, 726, 1411, 1412, 1417
 - \, backslash 46
 - \"", double-quote 46
 - \t, horizontal tab 46
 - newline, \n 45, 46, 49
 - Euclid's Algorithm 237
 - Euler 298
 - evaluating expressions 934
 - event 431, 489, **561**, 635
 - event classes 567
 - event-dispatch thread (EDT) **634**, **1095**, 1135
 - event driven **561**
 - event-driven process 634
 - event handler 431, **561**
 - event handling **561**, 564, 569
 - event source **566**
 - event ID **570**
 - event listener 431, 567, 594
 - adapter class 594
 - interface **564**, 565, 568, 570, 589, 594
 - event object 567
 - event registration 565
 - event source **566**, 567
 - EventListenerList class **569**
 - EventObject class
 - getSource method 566
 - EventType nested class
 - ACTIVATED constant **1127**
 - ENTERED constant **1127**
 - EXITED constant **1127**
 - EventType nested class of HyperLinkEvent **1127**
 - examination-results problem 128
 - exception **253**, 439
 - handler **253**
 - handling 251
 - parameter 253
 - Exception class **447**
 - exception handler **444**
 - Exception Handling
 - multi-catch **462**
 - try-with-resources statement **463**
 - exception parameter **444**
 - Exceptions 253
 - IndexOutOfRangeException 253
 - execute **21**, 42
 - execute an applet in a web browser 947, 951
 - execute attribute of f ajax **1295**
 - execute method
 - of JdbcRowSet **1209**
 - execute method of the Executor interface **1051**, 1054
 - executeQuery method of PreparedStatement **1218**
 - of Statement **1192**
 - executeUpdate method of interface PreparedStatement **1218**
 - executing an application 23
 - execution-time error **22**
 - ExecutionException class 1098
 - Executor interface **1051**
 - execute method **1051**, 1054
 - Executors class **1051**
 - newCachedThreadPool method **1052**
 - ExecutorService interface **1051**, 1109
 - awaitTermination method **1058**
 - shutdown method **1054**
 - submit method **1109**
 - exists method of File 723
 - exit debugger command **1388**
 - exit method of class System **450**, **731**
 - exit point 179
 - of a control statement 106
 - EXIT_ON_CLOSE constant of class JFrame **137**
 - EXITED constant of nested class EventType **1127**
 - exiting a for statement 172
 - exp method of Math 201
 - expanded submenu 1012
 - expiration date of a cookie **1263**
 - explicit conversion **124**

- exponential format 1397
 - exponential method 201
 - exponential notation **1398**
 - exponentiation 309
 - exponentiation operator 161
 - expression **51**
 - extend a class **360**
 - extends keyword **136, 364**, 375, 1368
 - extensibility 398
 - eXtensible HyperText Markup Language (XHTML) 1236, 1237, **1243**
 - extensible language **74**
 - eXtensible Markup Language (XML) **958**, 1309
 - extension mechanism
 - extending Java with additional class libraries **344**
 - external event **588**
- F**
- f option of the jar command **957**
 - f:ajax element **1295**
 - f:execute element
 - execute attribute **1295**
 - f:facet JSF element **1288**
 - f:render element
 - execute attribute **1295**
 - f:selectItem element **1254**
 - f:validateBean element **1254**
 - f:validateDoubleRange element **1254**
 - f:validateLength element **1254**
 - f:validateLongRange element **1254**
 - f:validateRegex element **1254**
 - f:validateRequired element **1254**
 - Facade design pattern **Q_3**, **Q_5**, **Q_16**
 - facade object **Q_16**
 - Facebook 26
 - Facebook 3, 14, 17, 28
 - Facellets (JSF) **1243**
 - Facellets Tag Library (JSF) **1269**
 - Faces servlet **1242**
 - factorial 149, 193, 768
 - Factorial calculations with a recursive method 769, 770
 - factorial method 768, 769
 - factory **Q_15**
 - factory method **Q_8**
 - Factory Method design pattern **Q_3**, **Q_4**, **Q_8**
 - Fahrenheit 627, 1417
 - equivalent of a Celsius temperature 237
 - fairness policy of a lock **1087**
 - false keyword **56, 109**, 1368
 - fatal error **111**, 309
 - fatal logic error **111**
 - fatal runtime error **22**
 - fault tolerant 50, 439
 - fault-tolerant program **253**
 - feature-complete 31
 - fetch 307
 - fibonacci method 773
 - Fibonacci series 303, 771, 773
 - defined recursively 771
 - generated with a recursive method 772
 - file **8, 79**
 - default initial value **82**
 - File Detail section in API **1376**
 - field of a class 8, 220
 - Field Summary section in API **1374**
 - field width **160**, 1397, 1405
 - file **8, 720**
 - File class **722**
 - canRead method 723
 - canWrite method 723
 - exists method 723
 - File methods 723
 - getAbsolutePath method 723
 - getName method 723
 - getParent method 723
 - getPath method 723
 - isAbsolute method 723
 - isDirectory method 723
 - lastModified method 723
 - length method 723
 - list method 723
 - toURL method **992**
 - used to obtain file and directory information 724
 - file extensions
 - .aif **985**, 988
 - .aiiff **985**, 988
 - .au **985**, 988
 - .avi **988**
 - .class 985
 - .gif **969**
 - .jpeg **969**
 - .jpg **969**
 - .mid **985**, 988
 - .mov **988**
 - .mp3 **988**
 - .mpeg **988**
 - .mpg **988**
 - .png **969**
 - .rmi **985**, 988
 - .spl **988**
 - .swf **988**
 - .wav **985**
 - file folder 946
 - file matching
 - exercise 761
 - program 761
 - with Multiple Transactions exercise 763
 - with Object Serialization exercise 763
 - File methods 723
 - file processing 721
 - file-system APIs (Java SE 7) 720
 - File.pathSeparator 726
 - FileContents interface 978
 - getLength method **973**
 - FileInputStream class **721**, 742, 745, 749, 751, 865
 - FileNotFoundException class **731**
 - FileOpenService interface **969**, 972
 - openFileDialog method **972**
 - openMultiFileDialog method **978**
 - FileOutputStream class **721**, 742, 745, 865, **Q_15**
 - FileReader class **721**, 753
 - FILES_AND_DIRECTORIES constant of JFileChooser **757**
 - FILES_ONLY constant of JFileChooser **757**
 - FileWriter class **721**, 753
 - filing cabinet 946
 - fill method
 - of class Arrays **281**, 283
 - of class Collections 841, **847**
 - of class Graphics2D **660**, 661, 664, 670
 - fill method of class Arrays 1104
 - fill pattern 661
 - fill texture 661
 - fill with color 632
 - fill3DRect method of class Graphics 648, **651**
 - fillArc method of class Graphics 286, **288**, **651**
 - filled-in shape 224, 661
 - filled rectangle 636
 - filled three-dimensional rectangle 648
 - fillOval method of class Graphics **224**, **600**, 648, **651**
 - fillPolygon method of class Graphics 654, **657**
 - fillRect method of class Graphics **224**, **636**, 648, 661
 - fillRoundRect method of class Graphics **649**
 - filter a stream **751**
 - FilterInputStream class **751**
 - FilterOutputStream class **751**
 - final
 - class **419**
 - classes and methods 419
 - keyword 171, **201**, 247, 339, 418, 1062, 1368
 - local variable 583
 - method **418**
 - variable 247
 - final state in the UML **106**, 179, 490
 - final value 153
 - finalize method **334**, 387
 - finally
 - block **444**, 450, 1091
 - clause **450**, 1368
 - keyword **444**
 - find method of class Matcher **707**
 - Find the Minimum Value in an Array exercise 796
 - Firefox web browser 93
 - fireTableStructureChanged method of AbstractTableModel **1200**
 - firewall **1302**
 - Fireworks Designer exercise 997
 - first-in, first-out (FIFO) data structure **921**
 - first method of SortedSet **859**
 - first refinement 126
 - first refinement in top-down, stepwise refinement 119
 - Fisher-Yates shuffling algorithm 257
 - five-pointed star 662
 - fixed text 51
 - in a format string **47**, **1397**
 - flag value **118**
 - flags 1397, 1407
 - flash drive 720
 - Flickr 26, 1449
 - APIs 1451
 - float
 - literal suffix **F 855**
 - primitive type **49**, **88**, 1368, 1369
 - primitive type promotions 208
 - Float class **831**
 - floating-point constant 159
 - floating-point conversion specifiers 1406
 - floating-point literal **88**
 - double by default 88
 - floating-point number **88**, 118, 121, 123, 855, 953, 1399
 - division 124
 - double precision **88**
 - double primitive type **88**
 - float primitive type **88**
 - single precision **88**
 - Floor method of Math 201
 - Floor Planner exercise 997
 - flow of control 112, 123
 - flow of control in the if...else statement 108
 - FlowLayout class **559**, 605, 606
 - CENTER constant **608**
 - LEFT constant **608**
 - RIGHT constant **608**
 - setAlignment method **608**

- flush method
 - of class Buffered-OutputStream **752**
 - of class Formatter **1157**
 - of class Object-OutputStream **1136**
 - Flyweight design pattern **Q_5**
 - focus **562**
 - focus for a GUI application
 - 1002, 1018
 - FocusAdapter class 594
 - FocusListener interface 594
 - font
 - manipulation 634
 - name **643**
 - size **643**
 - style **643**
 - Font class **576, 632, 643**
 - BOLD constant **643**
 - getFamily method 642, **645**
 - getName method 642, **643**
 - getSize method 642, **643**
 - getStyle method 642, **645**
 - isBold method 642, **645**
 - isItalic method 642, **645**
 - isPlain method 642, **645**
 - ITALIC constant **643**
 - PLAIN constant **643**
 - font information 632
 - font manipulation 634
 - font metrics **645**
 - ascent 647
 - descent 647
 - height 647
 - leading 647
 - font style 574
 - FontMetrics class **632, 645**
 - getAscent method 646
 - getDescent method 646
 - getFontMetrics method **645**
 - getHeight method 646
 - getLeading method 646
 - footerClass attribute of h:dataTable **1288**
 - for attribute of h:message **1259**
 - for repetition statement 106, **154, 155, 157, 159, 160, 183, 1368**
 - activity diagram 157
 - enhanced **258**
 - example 157
 - header **155**
 - nested 249
 - forDigit method of class Character **696**
 - foreign key **1175, 1177**
 - fork/join framework 1109
 - form 1251
 - formal type parameter **878**
 - format method
 - of class Formatter 731, **1413**
 - of class String **94, 314, 1413**
 - format specifiers **47, 1397**
 - %.2f for floating-point numbers with precision 125
 - %M 1404
 - %B 1403
 - %b 1403
 - %b for boolean values **177**
 - %c 68, 1400
 - %d **51, 1397, 1398**
 - %E 1399
 - %e 1399
 - %f 68, **90, 1399**
 - %G 1399
 - %g 1399
 - %H 1404
 - %h 1403
 - %n 1404
 - %n (line separator) **732**
 - %o 1398
 - %S 1400
 - %s **47, 1397, 1400**
 - %X 1398
 - %x 1398
 - format string **47, 1397, 1406**
 - formatted output 1403
 - , (comma) formatting flag **161**
 - %f format specifier **90**
 - (minus sign) formatting flag **160**
 - 0 flag **250, 314**
 - aligning decimal points in output 1396
 - boolean values **177**
 - comma (,) formatting flag **161**
 - conversion character 1397
 - date and time
 - compositions 1401
 - date and time conversion
 - suffix characters **1401**
 - dates 1397
 - exponential format 1397
 - field width **160, 1397**
 - floating-point numbers **90**
 - grouping separator **161**
 - inserting literal characters 1397
 - integers in hexadecimal
 - format 1397
 - integers in octal format 1397
 - left justification 1396
 - left justify **160**
 - minus sign (-) formatting flag **160**
 - precision **90, 1397**
 - right justification **160, 1396**
 - rounding 1396
 - times 1397
 - Formatter class **722, 728, 1396, 1412**
 - close method **732**
 - documentation
 - (java.sun.com/javase/6/docs/api/java/util/Formatter.html) 1401, 1412
 - flush method **1157**
 - format method **731, 1413**
 - toString method 1413
 - FormatterClosedException class **732**
 - formatting
 - display formatted data 46
 - Formatting date and time with conversion character **t 1402**
 - Formatting output with class Formatter 1412
 - formulating algorithms 113
 - Fortran (FORmula TRANslator) 16
 - forward slash character (/) in end tags **958**
 - Foursquare 3, 17, 26, 29
 - fractal **779**
 - “Lo fractal” at level 0 781
 - “Lo fractal” at level 2 783
 - “Lo fractal” at level 2,
 - dashed lines from level 1 provided 783
 - depth **780**
 - exercises 796
 - Koch Curve **780**
 - Koch Snowflake **781**
 - level **780**
 - “Lo fractal” at level 1, with C and D points
 - determined for level 2 782
 - order **780**
 - self-similar property **780**
 - strictly self-similar fractal **780**
 - Fractal applet 944
 - Fractal user interface 783
 - fragile software **380**
 - frame (in the UML) 505
 - Frame class 1005
 - free graphics programs
 - (www.freebyte.com/graphicprograms) 992
 - FreeTTS
 - (freetts.sourceforge.net/docs/index.php) 993
 - frequency method of Collections 841, **851**
 - FROM SQL clause 1178
 - fromJson method of class Gson **1324**
 - full tour 669
 - fully qualified class name 79, **342**
 - function **199**
 - function key 601
 - Future interface **1109**
 - get method **1109**
 - Future Splash (.spl) files **988**
- ## G
- g command line option to javac 1380
 - G.I.M.P. 969
 - Game of Craps 297
 - Game of Pool exercise 997
 - game playing 210
 - game programming 5
 - games
 - Call of Duty 2: games Modern Warfare 5 Farnville 5*
 - Kinect for Xbox 360 5
 - Mafia Wars 5*
 - social gaming 5
 - video game console 5
 - Xbox 360 5
 - gaming console 15
 - Gamma, Erich **Q_2**
 - “Gang of Four” **Q_2, Q_5, Q_6, Q_14**
 - garbage collection 1047
 - garbage collector **334, 447, 450, 985**
 - GCD (greatest common divisor) 794
 - Gender Neutrality Web Service **1364**
 - general class average problem 118
 - general path **662**
 - generalities 397
 - generalization in the UML **516**
 - GeneralPath class 632, **662, 668**
 - closePath method **664**
 - lineTo method **663**
 - moveTo method **663**
 - Generating Mazes Randomly
 - exercise 797
 - generic class **284, 883**
 - generic classes **874**
 - generic collections xxv
 - generic interface **880**
 - generic method **874, 877, 883**
 - generics xxv, 831, **874**
 - ? (wildcard type argument) **897**
 - actual type arguments **878**
 - angle brackets (< and >) **878**
 - default upper bound (Object) of a type parameter 886
 - erasure **879**
 - formal type parameter **878**
 - method 877
 - parameterized class **884**
 - parameterized type **884**
 - scope of a type parameter 886
 - type parameter **878**
 - type parameter section **878**
 - type variable **878**
 - upper bound of a type parameter **881, 882**
 - upper bound of a wildcard 897

- generics (cont.)
 - wildcard type argument **897**
 - wildcard without an upper bound 899
 - wildcards **895, 897**
- gesture 15
- ger a value **83**
- @GET annotation **1317**
- GET HTTP request **1238**
- get method
 - of class `ArrayList<T>` **286**
 - of class `BitSet` **N_11**
 - of interface `Future` **1109**
 - of interface `List<T>` **836**
 - of interface `Map` **862**
- ger method 83, 320, 327
- get request 1240
- get started
 - `java.sun.com/new2java/19`
- getAbsolutePath method of class `File` 723
- getActionCommand method of class `ActionEvent` **566, 574**
- getAddress method of class `DatagramPacket` **1146**
- getAscent method of class `FontMetrics` 646
- getAudioClip method of class `Applet` **985**
- getAutoCommit method of interface `Connection` **1227**
- getBlue method of class `Color` **636, 638**
- getByName method of class `InetAddress` **1142**
- getChars method
 - of class `String` **675**
 - of class `StringBuilder` **690**
- getClass method of class `Object` **560**
- getClass method of `Object` 388, **417**
- getClassName method of class `StackTraceElement` **457**
- getClassName method of class `UIManager`.
 - `LookAndFeelInfo` **1021**
- getClickCount method of class `MouseEvent` **597**
- getCodeBase method of class `Applet` **985**
- getColor method of class `Color` **636**
- getColor method of class `Graphics` 636
- getColumnClass method of `TableModel` **1194, 1200**
- getColumnClassName method of `ResultSetMetaData` **1200**
- getColumnCount method of `ResultSetMetaData` **1192, 1200**
- getColumnCount method of `TableModel` **1194, 1200**
- getColumnName method of `ResultSetMetaData` **1200**
- getColumnName method of `TableModel` **1194, 1200**
- getColumnType method of `ResultSetMetaData` **1193**
- getConnection method of `DriverManager` **1191**
- getContentPane method of class `JFrame` **586**
- getContentPane-Component method of interface `Player` **990**
- getData method of class `DatagramPacket` **1146**
- getDefaultSystemTray method of class `SystemTray` **1447**
- getDelay method of class `Timer` **995**
- getDescent method of class `FontMetrics` 646
- getDesktop method of class `Desktop` **1445**
- getEventType method of class `HyperlinkEvent` **1127**
- getFamily method of class `Font` 642, **645**
- getFileName method of class `StackTraceElement` **457**
- getFont method of class `Graphics` **643, 643**
- getFontMetrics method of class `FontMetrics` **645**
- getFontMetrics method of class `Graphics` 646
- getGreen method of class `Color` **636, 638**
- getHeight method of class `Component` **973**
- getHeight method of class `FontMetrics` 646
- getHeight method of class `JPanel` **137**
- getHostName method of class `InetAddress` **1136**
- getIcon method of class `JLabel` **560**
- getIconHeight method of class `ImageIcon` **973**
- getIconWidth method of class `ImageIcon` **973**
- getImage method of class `ImageIcon` **973**
- getInetAddress method of class `Socket` **1135**
- getInputStream method of class `Socket` **1129, 1130**
- getInstalledLookAndFeel method of class `UIManager` **1021**
- getInstance method of `Calendar` **1403**
- getInt method of `ResultSet` **1193**
- getKeyChar method of class `KeyEvent` **604**
- getKeyCode method of class `KeyEvent` **603**
- getKeyModifiersText method of class `KeyEvent` **604**
- getKeyText method of class `KeyEvent` **604**
- getLeading method of class `FontMetrics` 646
- getLength method of class `DatagramPacket` **1146**
- getLength method of interface `FileContents` **973**
- getLineNumber method of class `StackTraceElement` **457**
- getLocalHost method of class `InetAddress` **1142, 1147**
- getMaximumSize method of class `Component` 1432
- getMessage method of class `Throwable` **456**
- getMethodName method of class `StackTraceElement` **457**
- getMinimumSize method of class `Component` **980, 1004, 1432**
- getModifiers method of class `InputEvent` **604**
- getName method of class `Class` 388, **417**
- getName method of class `File` 723
- getName method of class `Font` 642, **643**
- getObject method of interface `ResultSet` **1193, 1200**
- getOutputStream method of class `Socket` **1129**
- getParameter method of class `Applet` **1121**
- getParent method of class `File` 723
- getPassword method of class `JPasswordField` **566**
- getPath method of class `File` 723
- getPoint method of class `MouseEvent` **599**
- getPort method of class `DatagramPacket` **1146**
- getPreferredSize method of class `Component` **980, 1004, 1432**
- getProperty method of class `Properties` **863**
- getRed method of class `Color` **636, 638**
- getRequestContext method of interface `Binding-Provider` **1338**
- getResource method of class `Class` **560**
- getRow method of interface `ResultSet` **1200**
- getRowCount method of interface `TableModel` **1194, 1200**
- getSelectedFile method of class `JFileChooser` **757**
- getSelectedIndex method of class `JComboBox` **583**
- getSelectedIndex method of class `ArrayList` **586**
- getSelectedText method of class `JTextComponent` **617**
- getSelectedValues method of class `ArrayList` **589**
- getSize method of class `Font` 642, **643**
- getSource method of class `EventObject` 566
- getStackTrace method of class `Throwable` **456**
- getStateChange method of class `ItemEvent` **584**
- getStyle method of class `Font` 642, **645**
- getText method of class `JLabel` **560**
- getText method of class `JTextComponent` 1014
- getting started with Java 1193
- getURL method of class `HyperlinkEvent` **1127**
- getValue method of class `JSlider` **1005**
- getValueAt method of interface `TableModel` **1194, 1200**
- getVisualComponent method of interface `Player` **990**
- getWidth method of class `Component` **973**
- getWidth method of class `JPanel` **137**
- getX method of class `MouseEvent` **593**
- getY method of class `MouseEvent` **593**
- GIF (Graphics Interchange Format) 560, **969**
- .gif file extension **969**
- gigabyte 9
- glass pane 586
- ClassFish application server **1236, 1241, 1242, 1305**
- Tester web page 1308
- Global Positioning System (GPS) 4
- Global Warming Facts Quiz exercise 195
- glyph **1454**
- golden mean **771**
- golden ratio **771**

- Good Programming Practices overview xviii
 - Google 3, 26, 27
 - Goggles 27
 - Maps 27, 1449
 - Storage 30
 - TV 5
 - Gosling, James 18
 - goto elimination 104
 - goto statement **104**
 - GPS (Global Positioning System) 4
 - GPS device 8
 - gradient **660**
 - GradientPaint class **632**, 660, 669
 - Grand, Mark **Q_14**
 - graph 193
 - graph information 249
 - graphical user interface (GUI) **94**, 209, 431, **550**
 - component **94**
 - design tool **604**
 - graphics 597, 943, 944, 946, 968
 - Graphics class **135**, 224, 286, 431, 432, **599**, **632**, 634, 657, 949, 952, 953, 973
 - clearRect method 648
 - draw3DRect method 648, **651**
 - drawArc method **651**, 668
 - drawImage method **973**
 - drawLine method **137**, 648
 - drawOval method 648, **651**, 966
 - drawPolygon method 654, **656**
 - drawPolyline method 654, **656**
 - drawRect method 648, 661, 668, 965, 966
 - drawRoundRect method **649**
 - drawString method **638**, 949, 954
 - fill3DRect method 648, **651**
 - fillArc method **651**
 - fillOval method **224**, **600**, 648, **651**
 - fillPolygon method 654, **657**
 - fillRect method **224**, **636**, 648, 661
 - fillRoundRect method **649**
 - getColor method 636
 - getFont method **643**, 643
 - getFontMetrics method 646
 - setColor method **225**, 661
 - setFont method **643**
 - graphics context **634**
 - graphics demo 947
 - graphics in a platform-independent manner 634
 - Graphics Interchange Format (GIF) 560, **969**
 - Graphics2D class **632**, **657**, 661, 664, 668
 - draw method **660**
 - fill method **660**, 661, 664, 670
 - rotate method **664**
 - setPaint method **660**
 - setStroke method **660**
 - translate method **664**
 - graphicssoft.about.com/od/pixelbasedfreewin 992
 - GraphicsTest applet 944
 - GridLayout applet 944
 - greatest common divisor (GCD) 237, 794
 - exercise 794
 - greedy quantifier **704**
 - grid 611
 - grid for GridBagLayout layout manager 1031
 - Grid Using Class Line2D.Double exercise 668
 - Grid Using Class Rectangle2D.Double exercise 668
 - Grid Using Method drawLine exercise 668
 - Grid Using Method drawRect exercise 668
 - GridBagConstraints class **1031**, 1037
 - anchor field **1031**
 - BOTH constant **1032**
 - CENTER constant **1032**
 - EAST constant **1032**
 - gridheight field **1033**
 - gridwidth field **1033**
 - gridx field **1032**
 - gridy field **1032**
 - HORIZONTAL constant **1032**
 - instance variables 1031
 - NONE constant **1032**
 - NORTH constant **1032**
 - NORTHEAST constant **1032**
 - NORTHWEST constant **1032**
 - RELATIVE constant **1037**
 - REMAINDER constant **1037**
 - SOUTH constant **1032**
 - SOUTHEAST constant **1032**
 - SOUTHWEST constant **1032**
 - VERTICAL constant **1032**
 - weightx field **1033**
 - weighty field **1033**
 - WEST constant **1032**
 - GridBagConstraints constants RELATIVE and REMAINDER 1037
 - GridBagLayout class 1028, **1031**, 1033, 1037
 - setConstraints method **1037**
 - GridBagLayout layout manager 1033
 - gridheight field of class GridBagConstraints **1033**
 - GridLayout class 605, **611**
 - GridLayout containing six buttons 612
 - gridwidth field of class GridBagConstraints **1033**
 - gridx field of class GridBagConstraints **1032**
 - gridy field of class GridBagConstraints **1032**
 - gross pay 146
 - GROUP BY 1178
 - group method of class Matcher 708
 - grouping separator (formatted output) **161**
 - GroupLayout class 605, 1028, **1431**
 - BASELINE alignment constant 1432
 - CENTER alignment constant 1432
 - default layout manager in Netbeans **1431**
 - groups **1432**
 - LEADING aligning components 1432
 - LEADING alignment constant 1432
 - parallel layout of GUI components 1431
 - recommended GUI design guidelines 1432
 - sequential horizontal orientation **1431**
 - sequential layout of GUI components 1431
 - spacing between components 1432
 - TRAILING alignment constant 1432
 - GroupLayout.Group class **1432**
 - addGap method **1432**
 - GroupLayout.ParallelGroup class **1432**
 - addGap method **1432**
 - GroupLayout.SequentialGroup class **1432**
 - addGap method **1432**
 - Groupon 3, 26, 28
 - groups in GroupLayout **1432**
 - Gson class 1322
 - code.google.com/p/google-gson/ 1320
 - fromJson method **1324**
 - toJson method 1322
 - guard condition in the UML 107, 492
 - Guarded Suspension design pattern **Q_3**, **Q_14**
 - guarding code with a lock **1055**
 - “guess the number” game 238, 627
 - GuestbookApplication exercise 1275, 1298
 - GUI (Graphical User Interface) 431
 - component **550**, 943
 - design tool **604**
 - guide lines (Netbeans) **1434**, 1435
 - guillemets (« and ») in the UML **88**
- ## H
- H conversion character **1403**
 - h conversion character **1403**
 - h:body JSF element **1244**
 - h:column JSF element **1288**
 - h:commandButton element 1250, **1254**
 - h:dataTable element
 - cellpadding attribute **1288**
 - cellspacing attribute **1288**
 - columnClasses attribute **1288**
 - footerClass attribute **1288**
 - headerClass attribute **1288**
 - rowClasses attribute **1288**
 - styleClass attribute **1288**
 - value attribute **1287**
 - var attribute **1288**
 - h:dataTable JSF element 1278, **1286**, 1286
 - h:form element 1250, **1251**
 - h:graphicImage element 1250, **1253**
 - h:head JSF element **1244**
 - h:inputText element 1250, **1253**, 1259
 - h:message element **1259**
 - h:outputLink element 1250, **1254**, 1254, 1267, 1268
 - h:outputStyleSheet element **1259**
 - h:outputText element **1259**
 - h:panelGrid element 1250, **1252**
 - h:selectItem element 1250
 - h:selectOneMenu element 1250, **1254**
 - h:selectOneRadio element 1250, **1254**, 1267
 - half word 309
 - handle an exception 442
 - handshake point **1128**, 1142
 - hard drive 6, 9
 - hardcopy printer 22

- hardware **6**, **10**
 - has-a* relationship **328**, **361**, **482**
 - hash bucket **860**
 - hash table **856**, **860**
 - hashCode method of Object **388**
 - hashing **859**
 - HashMap class **859**, **1121**
 - keySet method **862**
 - HashSet class **856**
 - Hashtable class **859**, **860**, **Q_20**
 - hash-table collisions **860**
 - hasNext method
 - of class Scanner **167**, **731**
 - of interface Iterator **836**, **839**
 - hasPrevious method of ListIterator **839**
 - head of a queue **905**, **921**
 - headerClass attribute of h:dataTable **1288**
 - headSet method of class TreeSet **858**
 - heavyweight components **556**
 - height **645**
 - height attribute (CSS) **1253**
 - height attribute of the applet-desc element **950**, **959**
 - height of a rectangle in pixels **637**
 - Helm, Richard **Q_2**
 - Help link in API **1371**
 - helpdoc.html generated by javadoc **M_11**
 - helper method **170**, **929**
 - heuristic **300**
 - Hewlett Packard **3**
 - hexadecimal (base 16) number
 - system **238**, **309**, **1419**
 - hexadecimal integer **1397**
 - “hidden” fields **220**
 - hide a dialog **553**
 - hide implementation details **199**, **316**
 - HIDE_ON_CLOSE constant of interface WindowConstants **1005**
 - hierarchical boss-method/worker-method relationship **199**
 - high-level language **10**
 - Hiragana block **1457**
 - hollow diamonds (representing aggregation) in the UML **482**
 - Home key **601**
 - Hopper, Grace **16**
 - HORIZONTAL constant of class GridBagConstraints **1032**
 - horizontal coordinate **135**, **632**
 - horizontal gap space **611**
 - horizontal glue **1031**
 - horizontal JSlider component **1001**
 - horizontal scrollbar policy **618**
 - horizontal tab **46**
 - HORIZONTAL_SCROLLBAR_ALWAYS constant of class JScrollPane **618**
 - HORIZONTAL_SCROLLBAR_AS_NEEDED constant of class JScrollPane **618**
 - HORIZONTAL_SCROLLBAR_NEVER constant of class JScrollPane **618**
 - Horse Race exercise **997**
 - host **1237**
 - host name **1142**
 - hostname **1237**
 - hot area **982**
 - hot spots in bytecode **21**
 - HourlyEmployee class
 - derived from Employee **409**
 - HousingMaps.com (www.housingmaps.com) **27**
 - href attribute of the jnlp element **958**
 - .htm file name extension **949**
 - HTML (Hypertext Markup Language) **1236**
 - HTML (HyperText Markup Language) document **942**, **949**, **950**
 - html element **1243**
 - .html file name extension **949**
 - HTML Tag Library (JSF) **1243**, **1250**
 - HTTP (HyperText Transfer Protocol) **1120**, **1237**, **1262**
 - being used with firewalls **1302**
 - header **1239**
 - method **1238**
 - request type **1239**
 - transaction **1238**
 - HTTP status codes (www.w3.org/Protocols/rfc2616/rfc2616-sec10.html) **1239**
 - hue **641**
 - HugeInteger Class **357**
 - exercise **357**
 - Hughes, Chris **28**
 - Human Genome Project **3**
 - hyperlink **1125**, **1127**
 - HyperlinkEvent class **1125**, **1127**
 - EventType nested class **1127**
 - getEventType method **1127**
 - getURL method **1127**
 - HyperlinkListener interface **1127**
 - hyperlinkUpdate method **1127**
 - hyperlinkUpdate method of interface HyperlinkListener **1127**
 - HyperText Transfer Protocol (HTTP) **1120**, **1237**, **1239**, **1262**
 - hypotenuse of a right triangle **235**
- ## I
- I/O performance enhancement **752**
 - IBM **3**
 - IBM Corporation **16**, **1452**
 - IBM's Enterprise Mashup Tool **1451**
 - icon **554**
 - Icon interface **560**
 - id attribute of a JSF element **1253**
 - id attributes for elements in Ajax requests and responses **1295**
 - IDE (integrated development environment) **19**
 - identifier **40**, **49**
 - identity column **1212**
 - IDENTITY keyword (SQL) **1212**
 - IDEs
 - NetBeans **1301**
 - IEEE **754**
 - (groupers.ieee.org/groups/754/) **1369**
 - IEEE 754 floating point **1369**
 - if single-selection statement **56**, **106**, **107**, **164**, **183**, **184**, **1368**
 - activity diagram **107**
 - if...else double-selection statement **106**, **107**, **108**, **123**, **164**, **183**
 - activity diagram **108**
 - ignoring array element zero **253**
 - IllegalArgumentException class **314**
 - IllegalMonitorStateException class **1073**, **1088**
 - IllegalStateException class **736**
 - image **951**, **968**, **992**
 - Image class **969**
 - Image Flasher exercise **996**
 - image map **968**, **982**
 - Image Zooming exercise **996**
 - ImageIcon class **388**, **560**, **969**, **978**, **979**
 - getIconHeight method **973**
 - getIconWidth method **973**
 - getImage method **973**
 - paintIcon method **979**
 - ImageObserver interface **973**
 - imaginary part **356**
 - immutable **675**
 - immutable object **337**
 - immutable String object **675**
 - implement an interface **396**, **420**, **427**
 - implementation-dependent code **316**
 - implementation of a function **406**
 - implementation phase **521**
 - implementation process **494**, **511**
 - implements **1368**
 - implements keyword **420**, **424**
 - implements multiple interfaces **590**
 - implicit conversion **124**
 - import declaration **48**, **50**, **79**, **341**, **1368**
 - improve performance of bubble sort **826**
 - increment **159**
 - a control variable **153**
 - expression **172**
 - of a control variable **152**
 - of a for statement **157**
 - operator, ++ **131**
 - increment and decrement operators **131**
 - indefinite postponement **1050**, **1091**, **1117**
 - indefinite repetition **118**
 - indentation **108**, **110**
 - independent software vendor (ISV) **386**
 - index **251**
 - index (subscript) **242**
 - Index link in API **1371**
 - index of a JComboBox **582**
 - index zero **242**
 - Index_CD.html generated by javadoc **M_10**
 - Index_CD-all.html generated by javadoc **M_11**
 - indexed lists **939**
 - indexOf method of class ArrayList<T> **284**
 - indexOf method of class String **681**
 - IndexOutOfBounds-Exception class **848**
 - IndexOutOfRangeException-Exception class **253**
 - indirect recursion **767**
 - indirect recursive call **767**
 - indirect superclass **360**, **362**
 - InetAddress class **1136**, **1142**, **1146**, **1147**, **Q_16**
 - getByName method **1142**
 - getHostName method **1136**
 - getLocalHost method **1142**, **1147**
 - infinite loop **112**, **124**, **156**, **157**, **1146**, **1150**
 - infinite recursion **385**, **769**, **776**, **777**
 - infinite series **194**
 - infinity symbol **1177**
 - infix notation **934**
 - infix-to-postfix conversion algorithm **935**

- information element of a JNLP document **959**
- information hiding **13**, 81
- information tier **1241**, **Q_18**
- inherit **136**
- inheritance **13**, 136, **360**, **516**, 519, 520, 521
 - examples 361
 - extends keyword **364**, 375
 - hierarchy **361**, 402
 - hierarchy for university CommunityMembers 362
 - multiple 360
 - single **360**
- init method
 - of JApplet **949**, 951, 952, 954
- initComponents
 - autogenerated method in Netbeans 1436
- initial state 179
- initial state in the UML **105**, **489**, 490
- initial value of an attribute 487
- initial value of control variable **152**
- initialization at the beginning
 - of each repetition 128
- initialization phase 119
- initialize a variable in a declaration **49**
- initialize an applet 951
- initialize applet's instance variables 954
- initializer block (static) 1265
- initializer list **245**
- initializing two-dimensional arrays in declarations 270
- initiate an action 1007
- inlining method calls **324**
- inner class **564**, 576, 599, 1013
 - anonymous **583**
 - object of 577
 - relationship between an inner class and its top-level class 577
- INNER JOIN SQL clause 1178, **1183**
- innermost set of brackets 252
- inorder traversal **925**
- input data from the keyboard 60
- input device **8**
- input dialog **94**, **552**
- input/output 722
- input/output operation 105, 304
- input/output package 209
- input unit **8**
- InputEvent class **589**, 596, 601
 - getModifiers method **604**
 - isAltDown method 597, **604**
 - isControlDown method **604**
- InputEvent class (cont.)
 - isMetaDown method 597, **604**
 - isShiftDown method **604**
- InputMismatchException class **441**, 444
- InputStream class 743, **751**, 865, 1128, 1129, 1130
 - read method **973**
- InputStreamReader class **753**
- insert method of class StringBuilder **693**
- INSERT SQL statement 1178, **1184**
- inserting literal characters in the output 1397
- insertion point 283, 850, 907
- insertion sort **814**
 - algorithm **814**, 817
- instance **12**
- instance (non-static)
 - method 335
 - instance of a class 80
 - instance variable **12**, **79**, 80, 89, 201
- instanceof operator **416**, 1368
- instantiating an object of a class **72**
- instruction execution cycle 307
- instructor resources for *Java How to Program, 9/e* xxx
- int primitive type **49**, 121, 131, 164, 1368, 1369
 - promotions 208
- integer **47**
 - array 245
 - division **118**
 - quotient 53
 - value 49
- Integer class 280, 554, **831**, 896
 - parseInt method 280, 554
 - toBinaryString method **N_4**
- integer conversion characters **1397**
- integer division **53**
- integerPower method 235
- integers
 - suffix L 854
- integral expression 171
- integrated development environment (IDE) **19**
- Intel 3
- intelligent consumer electronic device 18
- interaction between a web service client and a web service 1310
- interaction diagram in the UML **502**
- interaction overview diagram in the UML **P_2**
- interactions among objects 499, 503
- Interactive Drawing
 - Application exercise 627
- interest rate 159
- interface 396, 421, 429, **1192**
 - declaration **420**
 - implementing more than one at a time **590**
 - tagging interface **743**
- interface keyword **420**, 1368
- Interfaces **419**
 - ActionListener **565**, 570
 - AppletContext **1120**
 - AudioClip **985**
 - AutoCloseable **463**, 1194
 - BlockingQueue **1070**
 - CachedRowSet **1207**
 - Callable **1109**
 - CallableStatement **1226**
 - ChangeListener **1005**
 - CharSequence **707**
 - Collection 831, **832**, 841
 - Comparable 430, 679, **842**, **880**, 928
 - Comparator **842**
 - ComponentListener 594
 - Condition **1087**, 1089
 - Connection **1191**, 1193, 1198
 - ContainerListener 594
 - DataInput 752
 - DataOutput 752
 - DataSource **1285**
 - Executor **1051**
 - ExecutorService **1051**, 1109
 - FileOpenService **969**, 972
 - FocusListener 594
 - Future **1109**
 - HyperlinkListener **1127**
 - Icon **560**
 - ImageObserver **973**
 - ItemListener **576**, 1014
 - Iterator **833**
 - JdbcRowSet **1207**
 - KeyListener **570**, 594, 601
 - LayoutManager **604**, 608
 - LayoutManager2 **608**
 - List 831, **839**
 - ListIterator **833**
 - ListSelectionListener **586**, 1124
 - Lock **1086**
 - Map 831, 859
 - MouseListener **589**, 593
 - MouseListener **570**, **589**, 594, 1017
- Interfaces (cont.)
 - MouseEventListener **570**, **589**, 594
 - MouseWheelListener **590**
 - ObjectInput **742**
 - ObjectOutput **742**
 - Player **988**
 - PreparedStatement 1226
 - PropertyChangeListener **1108**
 - Queue 831, **832**, **855**, 1070
 - RequestContext 1338
 - ResultSet **1192**
 - ResultSetMetaData **1192**
 - RowSet **1207**
 - Runnable **1051**, 1158, 430
 - Serializable **430**, **743**
 - Set 831, **832**, **856**
 - SortedMap **859**
 - SortedSet **857**
 - Statement 1193
 - SwingConstants **560**, 1005, 431
 - TableModel **1194**
 - WindowConstants **1005**
 - WindowListener 594, **1006**, **1206**
- internal frame
 - closable 1024
 - maximizable 1024
 - minimizable 1024
 - resizable 1024
- Internet 3, 1120
- Internet domain name in reverse order 342
- Internet Explorer 93
- Internet telephony 26
- Internet TV 5
- interpreter 11
- Interpreter design pattern **Q_6**
- interrupt method of class Thread **1052**
- InterruptedException class **1052**
- intersection of two sets 356
- intrinsic lock **1055**
- invoke a method **84**, 199
- invokeLater method of class SwingUtilities **1135**
- IOException class **748**
- iOS 14
- IP address 1146, **1237**
 - of the server 1142
- iPhone 27, 29
- is-a relationship **361**, 397
- isAbsolute method of File 723
- isActionKey method of class KeyEvent **604**
- isAltDown method of class InputEvent **597**, **604**
- isBold method of class Font 642, **645**

- isCancelled method of class SwingWorker **1104**
 - isControlDown method of class InputEvent **604**
 - isDefined method of class Character **695**
 - isDesktopSupported method of class Desktop **1445**
 - isDigit method of class Character **695**
 - isDirectory method of File 723
 - isEmpty method
 - ArrayList 327
 - Map **863**
 - Stack **855**
 - isItalic method of class Font 642, **645**
 - isJavaIdentifierPart method of class Character **696**
 - isJavaIdentifierStart method of class Character **696**
 - isLetter method of class Character **696**
 - isLetterOrDigit method of class Character **696**
 - isLowerCase method of class Character **696**
 - isMetaDown method of class InputEvent **597**, **604**
 - isPlain method of class Font 642, **645**
 - isPopupTrigger method of class MouseEvent **1017**
 - isRunning method of class Timer **979**
 - isSelected method
 - AbstractButton **1014**
 - JCheckBox **577**
 - isShiftDown method of class InputEvent **604**
 - isUpperCase method of class Character **696**
 - ITALIC constant of class Font **643**
 - ItemEvent class **576**, 580
 - getStateChange method **584**
 - itemLabel attribute of f:selectItem **1254**
 - ItemListener interface **576**, 1014
 - itemStateChanged method **576**, 577, 1014
 - itemStateChanged method of interface ItemListener **576**, 577, 1014
 - itemValue attribute of f:selectItem **1254**
 - iteration **116**, 776
 - of a loop **152**, 172
 - iteration (looping)
 - of a for loop 252
 - iterative (non-recursive) 768
 - iterative factorial solution 776
 - iterative model **475**
 - iterator **830**
 - Iterator design pattern **Q_3**, **Q_6**, **Q_20**
 - Iterator interface **833**
 - hasNext method **836**
 - next method **836**
 - remove method **836**
 - iterator method of Collection **836**
- J**
- Jacopini, G. 104
 - JApplet class **948**, 949, 951, 1006
 - destroy method **949**
 - init method **949**, 954
 - paint method **949**, 954
 - start method **949**, 954
 - stop method **949**
 - jar command **957**
 - c option **957**
 - f option **957**
 - v option **957**
 - jar element of a JNLP document **959**
 - JAR file 974, 981
 - Java 2D API 632, **657**, 946, 969
 - Java 2D shapes 657
 - Java 2D Shapes package **209**
 - Java 3D 998
 - Java 3D API **968**, 969, 993
 - Java Abstract Window Toolkit (AWT) package **209**
 - Java Abstract Window Toolkit Event package **209**
 - Java Advanced Imaging API **969**
 - Java API 198, 430
 - overview 208
 - Java API documentation
 - download 52
 - Java API Interfaces 430
 - Java applet 948
 - Java Applet Package **209**
 - Java Application Programming Interface (Java API) **18**, **48**, 198, 208
 - Java Architecture for XML Binding (JAXB) **1317**
 - Java archive (JAR) file 956
 - Java class library **18**, **48**, **198**
 - java command **20**, 23, **38**
 - splash option **1443**
 - Java compiler **19**
 - Java Concurrency Package **209**
 - Java Database Connectivity (JDBC) **1172**
 - Java DB xxv, 1172, **1209**, 1277
 - Java DB Developer's Guide 1212
 - Java debugger 1379
 - Java development environment
 - 19, 20, 21, 943
 - Java Development Kit (JDK)
 - 42
 - Java EE 6
 - www.oracle.com/technetwork/java/javase/overview/index.html 1236
 - Java EE 6 tutorial 1236
 - java element of a JNLP document **959**
 - Java-enabled web browser 942
 - Java Enterprise Edition (Java EE) **2**, 1236
 - .java extension **19**
 - .java file name extension 72
 - Java fonts
 - Dialog 643
 - DialogInput 643
 - Monospaced 643
 - SansSerif 643
 - Serif 643
 - Java HotSpot compiler **21**
 - Java How to Program, 9/e*
 - instructor resources xxx
 - Java IDE Resource Kit xxix, xxxiv
 - Java Image I/O API **969**
 - Java Input/Output Package **209**
 - java interpreter 43
 - Java Keywords 1368
 - Java Language Package **209**
 - Java look and feel Graphics Repository 992
 - Java look-and-feel repository (java.sun.com/developer/techDocs/hi/repository) 992
 - Java Media Framework (JMF) API **969**, 988
 - download 988
 - Java Media Framework package **209**
 - Java Micro Edition (Java ME) **3**
 - Java Naming and Directory Interface (JNDI) 1281
 - Java Network Launch Protocol (JNLP) 942, 955, **956**
 - Java Networking Package **209**
 - Java Plug-In **942**
 - Java programming language 15
 - Java Resource Centers at www.deitel.com/ResourceCenters.html 42
 - Java SE 6
 - API documentation 210
 - package overview 208
 - Java SE 7 171
 - Automatically Closing Connections, Statements and ResultSets 1194
 - ConcurrentLinkedDeque 1094
 - file-system APIs 720
 - fork/join framework 1109
 - LinkedTransferQueue 1094
 - multi-catch **462**
 - Java SE 7 (cont.)
 - new concurrent collections 1094
 - Strings in switch statements 171
 - try-with-resources statement **463**
 - type inference with the <> notation 836
 - Java SE Development Kit (JDK) 18, 39
 - Java Sound API **969**, 993
 - Java Speech API **969**, 993
 - Java Speech API (java.sun.com/products/java-media/speech) 993
 - Java Standard Edition (Java SE) **2**
 - 62
 - 72
 - Java Swing Event Package **210**
 - Java Swing GUI Components Package **209**
 - Java Utilities Package **209**
 - Java Virtual Machine (JVM) 18, **20**, 38, 41
 - Java Web Start 942, 955, **956**
 - automatic updating 956
 - desktop integration 956
 - javaws command 959
 - overview
 - (download.oracle.com/javase/6/docs/technotes/guides/javaws/) 960
 - Java website (java.sun.com) 208
 - JAVA_HOME environment variable 1210
 - java.applet package 209
 - java.awt class 1005
 - java.awt package 209, **555**, 634, 635, 654, 657, 948, 969, 980, 1017
 - java.awt.color package 657
 - java.awt.event package 209, 210, **567**, 569, 594, 604
 - java.awt.font package 657
 - java.awt.geom package 209, 657
 - java.awt.image package 657
 - java.awt.image.renderable package 657
 - java.awt.print package 657
 - java.beans package 1108
 - java.com 942
 - java.io package 209, **721**
 - java.lang package **50**, 200, 209, 364, 387, 673, 1051, **Q_19**
 - imported in every Java program 50
 - java.math package 88, 770

- java.net package 209, **1119**
- java.sql package 209, 1191, 1192
- java.util package **48**, 209, 210, 284, 831, 853, 895, 907, 1402
 - Calendar class **1402**
 - Date class **1402**
- java.util.concurrent package 209, 1051, 1070, 1093, 1109
- java.util.concurrent.Locks package 1086, 1087
- java.util.prefs package **863**
- java.util.regex package 673
- Java™ Language Specification (java.sun.com/docs/books/jls/) 54
- Java2D API 657
- Java2D applet 946
- Java2D directory 946
- JavaBean **1244**
- JavaBean property **1244**
- JavaBeans Specification 1244
- javac compiler **19**, 43
- Javadoc comment 39
- Javadoc options
 - author **M_9**
 - d **M_9**
 - link **M_9**
- Javadoc tag **M_1**
- Javadoc tags
 - {@link} **M_8**
 - @author **M_5**
 - @deprecated **M_8**
 - @param **M_6**
 - @return **M_7**
 - @see **M_5**
 - @since **M_8**
 - @throws **M_7**
 - @version **M_8**
- Javadoc utility program **39**, **M_1**
- JavaScript 1236
- JavaScript Object Notation (JSON) **1303**
- JavaServer Faces (JSF) xxv
 - XML declaration 1243
 - xmlns attributes **1243**
- javax.faces.bean package (JSF) **1245**
- javax.jnlp package 956, 969, 972
- javax.media package 209, **988**
- javax.sql package 1285
- javax.sql.rowset package **1207**
- javax.swing package **94**, 209, 210, **550**, 552, 560, 569, 571, 617, 639, 948, 969, 1005, 1021, 1024
- javax.swing.event package 210, **567**, 586, 594, 1005
- javax.swing.table package 1194, **1206**
- JAXB (Java Architecture for XML Binding) **1317**
- JAXB class **1317**
 - marshal method **1317**
 - unmarshal method **1320**
- JAX-RS **1300**
- JAX-WS package **210**
- JBoss Application Server (www.jboss.com/products/platforms/application) 1305
- JButton class 555, **571**, 574, 611
- JCheckBox buttons and item events 575
- JCheckBox class 555, **574**
 - isSelected method **577**
- JCheckBoxMenuItem class 1006, **1007**, 1013
- JColorChooser class **639**, 641
 - showDialog method **641**
- JColorChooser Dialog exercise 670
- JComboBox class 555, **580**, 1032
 - getSelectedIndex method **583**
 - setMaximumRowCount method **583**
- JComboBox that displays a list of image names 581
- JComponent class **556**, 557, 559, 569, 580, 584, 597, 613, 632, 634, 980, **Q_10**
 - paintComponent method **136**, **597**, 632, 979, 1002, 1004
 - repaint method **635**
 - setForeground method **1014**
 - setOpaque method **597**, 600
 - setToolTipText method **559**
- jdb command **1381**
- JDBC
 - API **1172**, 1189, 1226
 - driver **1172**, 1173
 - JDBC 4 xxv
 - JDBC documentation 1173
 - JDBC information (www.oracle.com/technetwork/java/javase/tech/index-jsp-136101.html) 1173
 - JDBC Package **209**
 - jdbc:mysql://localhost/books 1191
- JdbcRowSet interface **1207**
 - close method **1209**
 - execute method **1209**
 - setCommand method **1209**
 - setPassword method **1209**
 - setUrl method **1209**
- JdbcRowSet interface (cont.)
 - setUsername method **1209**
- JdbcRowSetImpl class **1209**
- JDesktopPane class **1022**, 1044
- JDesktopPane
 - documentation (download.oracle.com/javase/6/docs/api/javawx/swing/JDesktopPane.html) 1025
- JDialog class **1013**
- JDIC (Java Desktop Integration Components)
 - addTrayIcon method of class SystemTray **1447**
 - browse method of class Desktop **1445**
 - Desktop class **1445**
 - getDefaultSystemTray method of class SystemTray **1447**
 - getDesktop method of class Desktop **1445**
 - isDesktopSupported method of class Desktop **1445**
 - java command
 - splash option **1443**
 - mail method of class Desktop **1445**
 - open method of class Desktop **1445**
 - removeTrayIcon method of class SystemTray **1447**
 - splash command-line option to the java command **1443**
 - splash screen **1443**
 - SplashScreen class **1444**
 - SystemTray class **1447**
 - Tray icons **1447**
 - TrayIcon class **1448**
- JDK 18, 42
 - demo directory 943, 946
- JEditorPane class **1125**
 - setPage method **1127**
- Jesse James Garrett 1290
- JFileChooser class **754**
 - CANCEL_OPTION constant **757**
 - FILES_AND_DIRECTORIES constant **757**
 - FILES_ONLY constant **757**
 - getSelectedFile method **757**
 - setFileSelectionMode method **757**
 - showOpenDialog method **757**
- JFileChooser dialog 754
- JFrame class **137**, 225, 1005
 - add method **137**, **559**
- JFrame class (cont.)
 - EXIT_ON_CLOSE **561**
 - getContentPane method **586**
 - setDefaultCloseOperation method **137**, **561**, **1005**
 - setJMenuBar method **1006**, 1013
 - setSize method **137**, **561**
 - setVisible method **137**, **561**
- JFrame class EXIT_ON_CLOSE constant **137**
- JFrame.EXIT_ON_CLOSE **561**
- JInternalFrame class **1022**, 1024
 - documentation 1025
- JLabel class **388**, 389, 555, **557**
 - documentation (download.oracle.com/javase/6/docs/api/javawx/swing/JLabel.html) 557
 - getIcon method **560**
 - getText method **560**
 - setHorizontalAlignment method **560**
 - setHorizontalTextPosition method **560**
 - setIcon method **560**
 - setText method **560**
 - setVerticalAlignment method **560**
 - setVerticalTextPosition method **560**
- JList class 555, 584
 - addListSelectionListener method **586**
 - getSelectedIndex method **586**
 - getSelectedValues method **589**
 - setFixedCellHeight method **588**
 - setFixedCellWidth method **588**
 - setListData method **589**
 - setSelectionMode method **586**
 - setVisibleRowCount method **586**
- JMenuBar class **1006**, 1013, 1024
 - add method **1012**
 - addSeparator method **1013**
- JMenuBar class **1006**, 1013, 1024
 - add method **1013**
- JMenuItem class **1007**, 1024
- JMenus and mnemonics 1007
- JMF (Java Media Framework) API **969**, 985, 988
- JNDI (Java Naming and Directory Interface) 1281

- JNLP 972, 974, 981
 FileOpenService **969**, 972
 main-class **957**
 ServiceManager class **972**
- JNLP (Java Network Launch Protocol) **956**
 JNLP document 957
 applet-desc element **959**
 application-desc element 959
 desktop element **959**
 information element **959**
 jar element **959**
 java element **959**
 jnlp element **958**
 offline-allowed element **959**
 resources element **959**
 shortcut element **959**
 title element **959**
 vendor element **959**
- JNLP documentation (download.oracle.com/javase/6/docs/jre/api/javaws/jnlp/) 973
 jnlp element of a JNLP document **958**
 codebase attribute 958
 href attribute 958
 jnlp.jar 973, 981
 Johnson, Ralph **Q_2**
- JOIN_ROUND constant of class BasicStroke **662**
 joining database tables **1175**, 1183
- Joint Photographic Experts Group (JPEG) 560, **969**
- JOptionPane class **93**, 94, **552**, 553, 1041
 constants for message dialogs 555
 documentation 554
 PLAIN_MESSAGE constant **554**
 showInputDialog method **94**, **553**
 showMessageDialog method **94**, **554**
- JOptionPane constants for message dialogs
 JOptionPane.ERROR_MESSAGE 555
 JOptionPane.INFORMATION_MESSAGE 555
 JOptionPane.PLAIN_MESSAGE 555
 JOptionPane.QUESTION_MESSAGE 555
 JOptionPane.WARNING_MESSAGE 555
- JPanel class **135**, 136, 555, 597, 598, 605, 613, 975, 1002, **Q_10**
- JPanel class (cont.)
 getHeight method **137**
 getWidth method **137**
- JPasswordField class **561**, 566
 getPassword method **566**
- JPEG (Joint Photographic Experts Group) 560, **969**
 .jpeg file extension **969**
 .jpg file extension **969**
- JPopupMenu class **1014**
 show method **1017**
- JProgressBar class 1105
- JRadioButton class **574**, 577, 580
- JRadioButtonMenuItem class 1006, **1007**, 1014
- JScrollPane class **586**, 588, 617, 618
 HORIZONTAL_SCROLLBAR_ALWAYS constant **618**
 HORIZONTAL_SCROLLBAR_AS_NEEDED constant **618**
 HORIZONTAL_SCROLLBAR_NEVER constant **618**
 setHorizontalScrollBarPolicy method **618**
 setVerticalScrollBarPolicy method **618**
 VERTICAL_SCROLLBAR_ALWAYS constant **618**
 VERTICAL_SCROLLBAR_AS_NEEDED constant **618**
 VERTICAL_SCROLLBAR_NEVER constant **618**
- JScrollPane scrollbar policies 617
- JSF
 elements **1254**
 application lifecycle **1256**, 1261
 Core Tag Library **1250**, 1254
 deploy an app 1249
 f:selectItem element **1254**
 Facelets **1243**
 h:commandButton element 1250, **1254**
 h:form element 1250, **1251**
 h:graphicImage element 1250, **1253**
 h:inputText element 1250, **1253**, 1259
 h:message element **1259**
 h:outputLink element 1250, **1254**, 1254, 1267, 1268
 h:outputStyleSheet element **1259**
- JSF (cont.)
 h:outputText element **1259**
 h:panelGrid element 1250, **1252**
 h:selectItem element 1250
 h:selectOneMenu element 1250, **1254**
 h:selectOneRadio element 1250, **1254**, 1267
 HTML Tag Library **1243**, 1250
 javax.faces.bean package **1245**
 @ManagedBean annotation **1245**, 1248
 @RequestScoped annotation **1248**
 resource library 1253
 resources folder **1253**
 resources library **1253**
 session expire 1263
 uri:repeat element **1269**
- JSF Expression Language **1244**
- JSF Facelets Tag Library **1269**
- JSF web-application framework **1241**
- JSlider class **1001**, 1002, 1005, 1432
 block increment **1002**
 documentation (download.oracle.com/javase/6/docs/api/javaws/swing/JSlider.html) 1005
 getValue method **1005**
 major tick marks 1001
 minor tick marks 1001
 setInverted method **1002**
 setMajorTickSpacing method **1005**
 setPaintTicks method **1005**
 snap-to ticks **1001**
 thumb **1001**
 tick marks **1001**
- JSON (JavaScript Object Notation) **1303**
- JSON (www.json.org) 1303
- JTabbedPane class **1026**, 1031
 addTab method **1027**
 SCROLL_TAB_LAYOUT constant **1031**
 TOP constant **1031**
- JTable class **1194**
 RowFilter **1206**
 setRowFilter method **1206**
 setRowSorter method **1206**
 sorting and filtering xxvi
 TableRowSorter **1206**
- JTextArea class 603, **615**, 617, 1033, 1036
- JTextArea class (cont.)
 setLineWrap method **617**
- JTextComponent class **561**, 564, 615, 617
 getSelectedText method **617**
 getText method 1014
 setDisabledTextColor method **603**
 setEditable method **564**
 setText method 617
- JTextField class 555, **561**, 565, 569, 615
 addActionListener method **565**
- JTextFields and JPasswordField 562
- JToggleButton class **574**
- JumpingBox applet 944
- just-in-time compilation **21**
 just-in-time (JIT) compiler **21**
- ## K
- Kelvin temperature scale 627
- kernel **14**
 key constant 604, **604**
 key event **570**, **601**
 Key event handling 601
 key value 930
 key/value pair 860
- KeyAdapter class 594
- keyboard 6, 47, 550
- KeyEvent class **570**, 601
 getKeyChar method **604**
 getKeyCode method **603**
 getKeyModifiersText method **604**
 getKeyText method **604**
 isActionKey method **604**
- KeyListener interface **570**, 594, 601
 keyPressed method **601**, 603
 keyReleased method **601**
 keyTyped method **601**
- Keypad class (ATM case study) 477, 480, 481, 482, 493, 500, 501, 502, 504, 513, 516, 547
- keyPressed method of interface KeyListener **601**, 603
- keyReleased method of interface KeyListener **601**
- keySet method of class HashMap **862**
 of class Properties 866
- keyTyped method of interface KeyListener **601**
- keyword **40**, 106
- Keywords
 abstract **401**
 boolean **108**, 1384

- Keywords (cont.)
 - break **168**
 - case **168**
 - catch **444**
 - char **49**
 - class **40**, 72
 - continue **172**
 - default **168**
 - do 106, **162**
 - double **49**, **88**
 - else 106
 - enum **218**
 - extends **136**, **364**, 375
 - false **109**, 1368
 - final 171, **201**, 247, 1062
 - finally **444**
 - float **49**, **88**
 - for 106, **154**
 - if 106
 - implements **420**
 - import **48**
 - instanceof **416**
 - int **49**
 - interface **420**
 - new 49, 74, 243, 244
 - null **84**, 243, 1368
 - private **80**, 316, 327
 - public **40**, 72, 73, 80, 203, 316
 - reserved but not used by Java 1368
 - return **80**, **81**, 199, 206
 - static **94**, 161, 200
 - super **363**, 385
 - switch 106
 - synchronized **1055**
 - table of Keywords and reserved words 1368
 - this **317**, 335
 - throw **453**
 - true **109**, 1368
 - try **444**
 - void **41**, 73
 - while 106, **162**
 - Knights' Tour 298, 669
 - Brute Force Approach 300
 - Closed Tour Test 301
 - exercise 669
 - Koch Curve fractal **780**
 - Koch Snowflake fractal **781**
 - Koenig, Andrew 439
- L**
- label 388, **388**, **557**, **O_2**
 - label in a switch **168**
 - labeled block **O_2**
 - labeled break statement **O_1**
 - exiting a nested for statement **O_1**
 - labeled continue statement **O_2**
 - terminating a single iteration of a labeled-for statement **O_3**
 - labeled statement **O_1**, **O_2**
 - labels for tick marks 1001
 - Lady Ada Lovelace 16
 - LAMP **30**, 30
 - language package 209
 - last-in, first-out (LIFO) **206**
 - last-in, first-out (LIFO) order 888
 - last-in, first-out (LIFO) data structure **917**
 - last method of ResultSet **1200**
 - last method of SortedSet **859**
 - LastIndexOf method of class String **681**
 - LastModified method of class File 723
 - late binding **416**
 - Layers architecture pattern **Q_3**, **Q_18**
 - layout **390**
 - layout manager 559, 592, **604**, 613, 1431
 - BorderLayout **592**
 - FlowLayout 559
 - GridLayout **611**
 - LayoutContainer method of interface LayoutManager **608**
 - LayoutManager interface **604**, 608
 - LayoutContainer method **608**
 - LayoutManager2 interface **608**
 - lazy quantifier **705**
 - Lea, Doug **Q_14**
 - leading **645**
 - LEADING alignment constant in GroupLayout 1432
 - leaf **Q_9**
 - leaf node **924**
 - in a binary search tree 929
 - left brace, { **40**, 41, 49
 - left child **924**
 - LEFT constant of class FlowLayout **608**
 - left justification 1396
 - left justified 108, **160**, 560, 605
 - left-mouse-button click 596
 - left shift (<<) **N_1**, **N_2**, **N_8**
 - left subtree **924**, 929, 937
 - left-to-right evaluation 55
 - Left, center and right mouse-button clicks 594
 - length field of an array 243
 - length instance variable of an array **242**
 - length method of class String **675**
 - length method of class StringBuilder **688**
 - length method of File 723
 - letter 7
 - level of indentation 108
 - level-order binary tree traversal **930**, 938
 - levels of nesting **O_2**
 - lexicographical comparison **679**, 680
 - library attribute of
 - h:graphicImage **1253**
 - library of resources (JSF) **1253**
 - life cycle of a thread 1048, 1050
 - lifecycle of a JSF application **1256**, 1261
 - lifetime of an object in a UML sequence diagram **504**
 - LIFO (last-in, first-out) **206**, 888
 - lightweight GUI component **556**, 1013
 - LIGHTWEIGHT_RENDERER constant of class Manager **989**
 - LIKE operator (SQL) **1179**
 - LIKE SQL clause 1180, 1182
 - Limericks 712
 - Limericks exercise 996
 - line 632, 647, 656
 - line join **660**
 - line wrapping **617**
 - Line2D class 632, **661**
 - Line2D.Double class **657**, 668
 - linear collection 907
 - linear data structure **924**
 - linear run time **803**
 - linear search algorithm **800**, 801, 809
 - LinearGradientPaint class 660
 - LineNumberReader class **753**
 - lineTo method of class GeneralPath **663**
 - link 907, 924
 - {@link} javadoc tag **M_8**
 - link option **M_9**
 - link to another node **906**
 - linked list **905**, 907, **Q_20**
 - LinkedBlockingDeque class 1094
 - LinkedBlockingQueue class 1094
 - LinkedList class **833**, 849, 872
 - add method **841**
 - addFirst method **841**
 - addLast method **840**
 - LinkedTransferQueue class 1094
 - Linux 14, 19, 41, 731, 943
 - Linux operating system 14, **14**
 - list 582
 - List interface 831, 832, **839**, 842, 847
 - add method **836**, 838
 - addAll method **838**
 - clear method **839**
 - get method **836**
 - listIterator method **839**
 - size method **836**, **839**
 - subList method **839**
 - toArray method **840**
 - list method of File 723, 725
 - list method of Properties **865**
 - listen for events **565**
 - ListIterator interface **833**
 - hasPrevious method **839**
 - previous method **839**
 - set method **839**
 - ListIterator method of interface List **839**
 - ListSelectionEvent class **584**
 - ListSelectionListener interface **586**, 1124
 - valueChanged method **586**
 - ListSelectionMode1 class **586**
 - MULTIPLE_INTERVAL_SELECTION constant **586**, 588
 - SINGLE_INTERVAL_SELECTION constant **586**, 586, 588
 - SINGLE_SELECTION constant **586**
 - literals
 - floating point **88**
 - "Lo fractal" at level 0 781
 - "Lo fractal" at level 1, with C and D points determined for level 2 782
 - "Lo fractal" at level 2 783
 - "Lo fractal" at level 2, dashed lines from level 1 provided 783
 - load another web page into a browser 982, 984
 - load factor **860**
 - load method of Properties **865**
 - load/store operations 305
 - loading **20**
 - Loading and displaying an image in an applet 969
 - Loading and playing an AudioClip 985
 - local variable **79**, 116, 220, 319
 - localhost 1237
 - localhost (127.0.0.1) address **1136**
 - localization **556**, **1452**
 - location (0, 0) 948
 - location of a variable in the computer's memory 52
 - lock an object 1076
 - Lock interface **1086**
 - lock method **1086**, 1091
 - newCondition method **1087**, 1089
 - unlock method **1086**, 1091
 - lock method of interface Lock **1086**, 1091
 - log method of Math 201
 - logarithm 201
 - logarithmic run time **809**
 - logic error **19**, 50, **111**, 154, 1379

- logical complement operator, ! **176**
 - logical decision **5**
 - logical input operations **752**
 - logical negation, ! **176**
 - logical negation, or logical NOT (!) operator truth table **177**
 - logical operators **174, 176**
 - logical output operations **752**
 - logical unit **8**
 - Logo language **298**
 - Long
 - literal suffix L **854**
 - Long class **831**
 - Long keyword **1368, 1369**
 - Long promotions **208**
 - look-and-feel **555, 556, 604, 1017**
 - Nimbus **551**
 - Look-and-Feel Observations overview xxviii
 - Look-and-feel of a Swing-based GUI **1018**
 - look-and-feel of an application **555**
 - LookAndFeelInfo nested class of class UIManager **1021**
 - LookingAt method of class Matcher **707**
 - Lookup method of class ServiceManager **972**
 - loop **113, 116, 119, 996**
 - body **162**
 - continuation condition **106**
 - counter **152**
 - infinite **112, 124**
 - nested within a loop **127**
 - statement **106, 112**
 - loop-continuation condition **152, 153, 154, 155, 156, 157, 158, 162, 163, 172**
 - Loop method of interface AudioClip **985**
 - loopback address **1136**
 - looping **116**
 - Lord Byron **16**
 - Lovelace, Ada **16**
 - lowercase letter **8, 40**
 - lowered rectangle **651**
 - ls command on UNIX **943**
- M**
- m-by-n* array **268**
 - Mac OS X **14, 19, 41, 731**
 - machine dependent **10**
 - machine language **10**
 - machine language programming **304**
 - Macintosh **634**
 - Macintosh AIFF file format **985, 988**
 - Macintosh look-and-feel **1018**
 - Macromedia Flash movies (.swf) **988, 988**
 - magnetic tape **720**
 - mail method of class Desktop **1445**
 - main method **41, 42, 49, 74**
 - main thread **1054**
 - main-class attribute of the applet-desc element **959**
 - main-class specified in an JNLP document **957**
 - maintainability **905**
 - major tick marks of class JSlider **1001**
 - make your point (game of craps) **215**
 - making decisions **60**
 - MalformedURLException class **1124**
 - @ManagedBean annotation (JSF) **1245, 1248**
 - Manager class **988**
 - createRealizedPlayer method **988**
 - LIGHTWEIGHT_RENDERER constant **989**
 - setHint method **989**
 - Mandelbrot, Benoit **780**
 - “manufacturing” section of the computer **9**
 - many-to-many relationship **1177**
 - many-to-one mapping **859**
 - many-to-one relationship in the UML **483**
 - Map interface **831, 859**
 - containsKey method **862**
 - get method **862**
 - isEmpty method **863**
 - put method **862**
 - size method **863**
 - mapping APIs **1451**
 - mappings of SQL types to Java types **1193**
 - marshal method of class JAXB **1317**
 - Mashups
 - Backpack API **1451**
 - business functionality **1450**
 - commonly used APIs **1450**
 - Craigslist **1449**
 - Flickr **1449**
 - Flickr APIs **1451**
 - Google Maps **1449**
 - IBM’s Enterprise Mashup Tool **1451**
 - mapping APIs **1451**
 - Mashups Resource Center **1450**
 - Microsoft **1451**
 - of applications **1449**
 - PayPal **1450**
 - performance and reliability issues **1451**
 - popular mashups **1450**
 - ProgrammableWeb **1450**
 - RSS feed **1449**
 - RSS Resource Center **1451**
 - Salesforce.com **1451**
 - Smashforce **1451**
 - Mashups (cont.)
 - software reuse **1450**
 - Technorati APIs **1451**
 - Web 2.0 **1449**
 - web services **1449**
 - mashups **27**
 - Mashups Resource Center **1450**
 - mask **N_2**
 - master file **761**
 - Matcher class **673, 707**
 - find method **707**
 - group method **708**
 - lookingAt method **707**
 - matches method **707**
 - replaceAll method **707**
 - replaceFirst method **707**
 - matcher method of class Pattern **707**
 - matches method of class Matcher **707**
 - matches method of class Pattern **707**
 - matches method of class String **700**
 - matching catch block **444**
 - Math class **161, 200, 201**
 - abs method **201**
 - ceil method **201**
 - cos method **201**
 - E constant **201**
 - exp method **201**
 - floor method **201**
 - log method **201**
 - max method **201**
 - min method **201**
 - PI constant **201, 232**
 - pow method **161, 161, 200, 201, 232**
 - random method **210**
 - sqrt method **200, 201, 207**
 - tan method **201**
 - Math.PI constant **68, 668, 965**
 - mathematical computations **16**
 - Matisse GUI designer (Netbeans) **1431**
 - Matsumoto, Yukihiko “Matz” **17**
 - max method of Collections **841, 848**
 - max method of Math **201**
 - maximize a window **557, 1025**
 - maximized internal frame **1025**
 - maximum attribute of an h validateLength validator **1260**
 - maxLength attribute of an h nputText element **1260**
 - Maze Generator and Walker exercise **997**
 - Maze Traversal Using Recursive Backtracking exercise **796**
 - Mazes of Any Size exercise **797**
 - MBCS (multi-byte character set) **1455**
 - MDI (Multiple Document Interface) **1001, 1022**
 - mean **55**
 - Mediator design pattern **Q_6**
 - medical imaging **4**
 - Memento design pattern **Q_3, Q_6, Q_7**
 - memento object **Q_7**
 - memory **6, 9**
 - memory buffer **752**
 - memory leak **334, 450**
 - memory location **52**
 - memory-space/execution-time trade-off **860**
 - memory unit **9**
 - memory utilization **860**
 - MemoryImageSource class **996**
 - menu **551, 615, 1006, 1007**
 - menu bar **551, 1006, 1013**
 - menu item **1007, 1012**
 - merge in the UML **492**
 - merge records from tables **1182**
 - merge sort **817**
 - merge sort algorithm **817, 822**
 - merge symbol in the UML **112**
 - merge two arrays **817**
 - message **85, 949**
 - message dialog **93, 552, 554**
 - types **554**
 - message in the UML **500, 502, 503, 504**
 - message passing in the UML **504**
 - Meta key **596, 597**
 - meta XHTML element **1244**
 - metadata **1192**
 - metal look-and-feel **1001, 1018**
 - method **11, 41, 511**
 - declaration **41**
 - local variable **79**
 - parameter **76, 78**
 - parameter list **76**
 - return type **81**
 - signature **223**
 - static **161**
 - method call **12, 199, 204**
 - method-call stack **207**
 - Method calls made within the call fibonacci(3) **775**
 - Method calls on the program execution stack **775**
 - method declaration **204**
 - Method Detail section in API **1376**
 - method header **73**
 - method overloading **222**
 - method parameter list **278**
 - Method Summary section in API **1375**
 - methods called automatically during applet’s execution **951**
 - methods implicitly final **419**
 - Metric Conversion Program **716**
 - microblogging **26, 28**

- Microsoft 3, 1451, 1452
 - Image Cup 35
 - SYNC 4
 - Microsoft Audio/Video
 - Interleave (.avi) file **988**
 - Microsoft Audio/Video
 - Interleave files 988
 - Microsoft SQL Server 1172
 - Microsoft Windows 167, 634, 1005, 1017
 - Microsoft Windows-style look-and-feel 1018
 - .mid file extension **985, 988**
 - middle mouse button 597
 - middle tier **1241, Q_18**
 - MIDI (Musical Instrument Digital Interface) file format (.mid or .rmi extensions) **985, 988**
 - mileage obtained by automobiles 146
 - MIME (Multipurpose Internet Mail Extensions) **1239, 1263**
 - min method of Collections 841, **848**
 - min method of Math 201
 - minimize a window 557, 1006, 1025
 - minimize internal frame 1025
 - minor tick marks of class JSlider 1001
 - minus sign (-) formatting flag **160**
 - minus sign (-) indicating private visibility in the UML 511
 - mnemonic **556, 1007, 1011, 1013**
 - mobile application 2
 - mobile check-in 26
 - modal dialog **554, 641**
 - modal dialog box 1012
 - model (in MVC architecture) 1250, **Q_17**
 - model of a software system 480, 488, 518
 - Model-View-Controller (MVC) **1250, 1250, Q_3, Q_11, Q_17**
 - modifier key 604
 - Modifying the Internal Data
 - Representation of a Class (exercise) 355
 - modularizing a program with methods 199
 - module **198**
 - modules in Java 198
 - MoleculeViewer applet 944
 - monetary calculations 162
 - monitor **1055**
 - monitor lock **1055**
 - Monospaced Java font 643
 - Moore's Law **6**
 - Morse Code 715, 1169
 - Web Service 1364
 - Moskowitz, Dustin 28
 - Motif-style (UNIX) look-and-feel 1001, 1018
 - motion information 8
 - Motorola 3
 - mouse 6, 550, 944
 - mouse button 944
 - mouse-button click 596
 - mouse click 594
 - mouse event **570, 589, 1017**
 - handling 589
 - mouse wheel 590
 - MouseAdapter class 594
 - mousePressed method 1117
 - mouseClicked method of interface MouseListener 589, 594
 - mouseDragged method of interface MouseMotionListener 590, 598
 - mouseEntered method of interface MouseListener 590
 - MouseEvent class **570, 589, 1017**
 - getClickCount method **597**
 - getPoint method **599**
 - getX method **593**
 - getY method **593**
 - isAltDown method **597**
 - isMetaDown method **597**
 - isPopupTrigger method **1017**
 - mouseExited method of interface MouseListener 590
 - MouseListener interface 594, 598
 - MouseListener interface **570, 589, 594, 1017**
 - mouseClicked method 589, 594
 - mouseEntered method 590
 - mouseExited method 590
 - mousePressed method 589, 1017
 - mouseReleased method 589, 1017
 - MouseMotionAdapter class 594, 598
 - MouseMotionListener interface **570, 589, 594**
 - mouseDragged method 590, 598
 - mouseMoved method 590, 598
 - mouseMoved method of interface MouseMotionListener 590, 598
 - mousePressed method of class MouseAdapter 1117
 - mousePressed method of interface MouseListener 589, 1017
 - mouseReleased method of interface MouseListener 589, 1017
 - MouseEvent class **590**
 - MouseWheelEvent class **590**
 - MouseWheelListener interface **590**
 - mouseWheelMoved method **590**
 - mouseWheelMoved method of interface MouseWheelListener **590**
 - .mov file extension **988**
 - moveTo method of class GeneralPath **663**
 - Mozilla Foundation 14
 - .mp3 file extension **988**
 - MP3 player 15
 - .mpeg file extension **988**
 - MPEG Layer 3 Audio (.mp3) files **988**
 - MPEG-1 videos 988
 - MPEG-1 videos (.mpeg, .mpg) **988**
 - .mpg file extension **988**
 - multi-button mouse 596
 - multi-core processor **9**
 - multibyte character set (MBCS) **1455**
 - multicast **1120, 1165**
 - multi-catch **462**
 - multidimensional array 268, 269
 - multimedia **968**
 - Multimedia-Based Simpletron Simulator exercise 998
 - multiple class declarations in one source-code file 318
 - multiple document interface (MDI) 1001, **1022**
 - multiple inheritance 360
 - multiple-selection list **584, 586**
 - multiple-selection statement **106**
 - MULTIPLE_INTERVAL_SELECTION constant of interface ListSelectionModel **586, 588**
 - multiplication compound assignment operator, *= 131
 - multiplication, * **53, 54**
 - multiplicative operators: *, / and % **125**
 - multiplicity **480, 481**
 - multiply method of class BigInteger **771**
 - Multipurpose Internet Mail Extensions (MIME) **1239, 1263**
 - multithreaded server 1168, 1170
 - multithreaded Tic-Tac-Toe Program 1168
 - multithreaded user interfaces xxv
 - multithreading 833, **1046, Q_14**
 - multitier application **1240**
 - multitouch screen **15**
 - Musical Instrument Digital Interface (MIDI) file format (.mid or .rmi extensions) **985, 988**
 - mutable data **1062**
 - mutator method **327**
 - mutual exclusion **1054**
 - mutually exclusive options **577**
 - MVC (Model-View-Controller) **1250, Q_17**
 - MyShape hierarchy 432
 - MyShape hierarchy with MyBoundedShape 433
 - MySQL 30, 1172, 1186, 1188
 - Community Edition **1186**
 - Connector/J **xxxiv, 1187**
 - mysqld.exe 1188
- ## N
- n conversion character **1403**
 - %n format specifier (line separator) **732**
 - n-tier application **1240**
 - name attribute of @WebParam annotation **1306**
 - name attribute of @WebService annotation **1305**
 - name attribute of h:graphicImage **1253**
 - name attribute of the @ManagedBean annotation **1245**
 - name attribute of the applet-desc element 959
 - name collision **342**
 - name conflict **342**
 - name of a param 1121
 - name of a variable **52**
 - name of an array **242**
 - name of an attribute **1243**
 - named constant **247**
 - NASA multimedia (www.nasa.gov/multimedia/highlights/index.html) 992
 - NASA multimedia (www.nasa.gov/multimedia/index.html) 992
 - NASA Multimedia Gallery 992
 - native keyword 1368
 - natural comparison method **842**
 - natural logarithm 201
 - navigability arrow in the UML **511**
 - negative arc angles 652
 - negative degree **651**
 - NervousText applet 944
 - nested array initializers 269
 - nested building block 183
 - nested class **564, 1021**
 - relationship between an inner class and its top-level class 577

- Nested Class Summary section in API **1374**
 - nested control statement **O_2**
 - nested control statements **126**, 182, 184, 214
 - Examination-results problem **128**
 - nested for statement 249, 270, 271, 275, **O_1**
 - nested if...else selection statement **109**, 110
 - nested message in the UML **504**
 - nested parentheses **54**
 - nesting rule **182**
 - NetBeans **1236**
 - add a web service reference to an application 1311
 - code-completion window 1247
 - creating a Java DB database 1286
 - Show Line Numbers** 1247
 - Netbeans
 - demonstration video (www.deitel.com/books/jhtp9) 38
 - NetBeans
 - (www.netbeans.org) 19
 - NetBeans IDE **1236**, 1301, 1432
 - add an event handler 1436
 - create a desktop application 1310
 - create a new project 1433
 - create a web application 1304
 - Design** view 1433
 - GroupLayout** **1431**
 - guide lines **1434**, 1435
 - New JFrame Form** dialog 1312
 - New Web Service Client** dialog 1311
 - New Web Service** dialog 1304
 - Palette** window 1433, 1434
 - Properties** window 1433
 - snap-to alignment grid 1435
 - Web Application** project **1303**
 - Netbeans IDE 1431, 1432
 - Design** view 1433
 - initComponents
 - autogenerated method 1436
 - Source** view 1433
 - NetBeans Matisse GUI design tool xxvi
 - Netbeans Matisse GUI designer **1431**
 - network message arrival 447
 - Networked Morse Code 1169
 - networking package 209
 - New JFrame Form** dialog 1312
 - new keyword **49**, **74**, 243, 244, 1368
 - new Scanner(System.in) expression 49
 - new state 1048
 - new to Java
 - (www.oracle.com/technetwork/topics/newtojava/overview/index.html) 19
 - New Web Service Client** dialog 1311
 - New Web Service** dialog 1304
 - newCachedThreadPool method of class Executors **1052**
 - newCondition method of interface Lock **1087**, 1089
 - newline character **45**
 - newline escape sequence, \n 45, 46, 49, 309, 673
 - next method
 - of Iterator **836**
 - of ResultSet **1193**
 - of Scanner **77**
 - nextDouble method of class Scanner **91**
 - nextInt method of class Random **210**, 214
 - nextLine method of class Scanner **76**
 - Nimbus look and feel **551**
 - swing.properties xxxvi, 552
 - Nimbus look-and-feel 1018
 - Nirvanix 30
 - no-argument constructor **322**, 324
 - node **Q_9**
 - node in a list **907**
 - non-static class member 335
 - NONE constant of class GridBagConstraints **1032**
 - nonfatal logic error **111**
 - nonfatal runtime error **22**
 - nonlinear data structures 907
 - NoPlayerException exception **990**
 - NORTH constant of class BorderLayout **592**, 608
 - NORTH constant of class GridBagConstraints **1032**
 - NORTHEAST constant of class GridBagConstraints **1032**
 - NORTHWEST constant of class GridBagConstraints **1032**
 - NoSuchElementException class **731**, 736
 - note in the UML **106**
 - Notepad 19
 - notify method of class Object **1073**
 - notify method of Object 388
 - notifyAll method of class Object **1073**, 1076, 1077
 - notifyAll method of Object 388
 - noun phrase in requirements document 478
 - null 1368
 - null keyword 82, **84**, 94, 243, 554, 906
 - null reserved word 134
 - Number class 896
 - doubleValue method **897**
 - number systems 697
 - numeric Classes 831
- ## O
- O(1) **803**
 - O(log n) **809**
 - O(n log n) time **823**
 - O(n) time **803**
 - O(n²) time **803**
 - object 2, 11
 - object (or instance) 13, 502, 949
 - Object class 333, 360, **364**, 750
 - clone method 387
 - equals method 387
 - finalize method 387
 - getClass method 388, **417**, **560**
 - hashCode method 388
 - notify method 388, **1073**
 - notifyAll method 388, **1073**, 1076, 1077
 - toString method 367, 388
 - wait method 388, **1073**
 - object diagram in the UML **P_1**
 - object of a derived class 398
 - object of a derived class is instantiated 385
 - object-oriented analysis and design (OOAD) **13**
 - object-oriented design (OOD) 470, 476, 478, 488, 511
 - object-oriented language **13**
 - object-oriented programming (OOP) **2**, **6**, **13**, 17, 360
 - object serialization **742**, 1136
 - ObjectInput interface **742**
 - readObject method **743**
 - ObjectInputStream class **722**, 742, 743, 749, 1129, 1130, 1136
 - ObjectOutput interface **742**
 - writeObject method **743**
 - ObjectOutputStream class **722**, 742, 743, 865, **Q_15**
 - close method **748**
 - flush method **1136**
 - Observable class **Q_12**
 - Observer design pattern **Q_3**, **Q_6**, **Q_12**
 - Observer interface **Q_12**
 - observer object **Q_12**
 - octal integer 1397
 - octal number system (base 8) 238, 1419
 - Odersky, Martin 17
 - off-by-one error **154**
 - offer method of PriorityQueue **855**
 - offline-allowed element of a JNLP document **959**
 - OK** button 94
 - ON clause **1183**
 - One-Armed Bandit exercise 997
 - ONE constant of class BigInteger **771**, 773
 - One Laptop Per Child (OLPC) 5
 - one statement per line 59
 - one-to-many relationship **1177**
 - one-to-one mapping **859**
 - one-, two- or three-button mouse 596
 - one's complement 1426, **N_8**
 - ones position 1419
 - one-to-many relationship in the UML **483**
 - one-to-one relationship in the UML **483**
 - OOAD (object-oriented analysis and design) 13
 - OOD (object-oriented design) 470, 476, 478, 488
 - OOP (object-oriented programming) **13**, 360
 - opaque Swing GUI components **597**
 - open a file **721**
 - OPEN constant of class Arc2D **661**
 - Open Handset Alliance 15
 - open method of class Desktop **1445**
 - open source **14**, 15
 - open source software xxvi
 - openFileDialog method of interface FileOpenService **972**
 - openMultiFileDialog method of interface FileOpenService **978**
 - openStream method of class URL **1324**
 - operand **51**, 124, 305
 - operating system **13**, 15
 - operation code 304
 - operation compartment in a class diagram 493
 - operation in the UML **76**, 480, 493, 497, 513, 514, 519, 520
 - operation parameter in the UML 78, 494, 497, 498, 499
 - operationName attribute of the @WebMethod annotation **1305**
 - operator **51**

- operator precedence 54, 773
 - operator precedence chart 125
 - Operator Precedence Chart Appendix 1365
 - rules **54**
 - Operators
 - ∧, boolean logical exclusive OR 174, **176**
 - , predecrement/postdecrement **130**
 - , prefix decrement/postfix decrement 131
 - !, logical NOT 174, **176**
 - ?:, ternary conditional operator 108, 133
 - *, multiplication assignment operator 131
 - /=, division assignment operator 131
 - &, boolean logical AND 174, **175**
 - &&, conditional AND **174**, 175
 - %, remainder assignment operator 131
 - ++, prefix increment/postfix increment 131
 - ++, preincrement/postincrement 130
 - +=, addition assignment operator **130**
 - = **51**, 59
 - =, subtraction assignment operator 131
 - |, boolean logical inclusive OR 174, **175**
 - ||, conditional OR 174, **174**
 - arithmetic **53**
 - binary **51**, 53
 - boolean logical AND, & 174, **175**
 - boolean logical exclusive OR, ∧ 174, **176**
 - boolean logical inclusive OR, | **175**
 - cast **124**
 - compound assignment 130, 132
 - conditional AND, && **174**, 175
 - conditional operator, ?: **108**, 133
 - conditional OR, || 174, **174**, 175
 - decrement operator, -- 130, 131
 - increment and decrement 131
 - increment, ++ 131
 - logical complement, ! **176**
 - logical negation, ! **176**
 - logical operators 174, 176, 177
 - multiplication, * **53**
 - multiplicative: *, / and % **125**
 - Operators (cont.)
 - postfix decrement **131**
 - postfix increment **131**
 - prefix decrement **131**
 - prefix increment **131**
 - remainder 149
 - remainder, % **53**, 54
 - subtraction, - 54
 - optical disk 720
 - optimizing compiler 161
 - optional package **344**
 - or method of class BitSet **N_11**
 - Oracle Corporation 1172, 1452
 - order 104
 - ORDER BY SQL clause 1178, **1181**, 1182
 - order in which actions should execute **103**
 - Order of catch Blocks exercise 468
 - order of exception handlers 468
 - ordering of records 1178
 - orientation information 8
 - origin component **1017**
 - originator object **Q_7**
 - out-of-bounds array index 447
 - outer set of brackets 252
 - OutOfMemoryError 906
 - output 41
 - output cursor 41, 44
 - output device **9**
 - output parameter for a CallableStatement **1226**
 - output unit **9**
 - OutputStream class 743, **751**, 1128, 1129, 1130
 - OutputStreamWriter class **753**
 - oval 647, 651, 948
 - oval bounded by a rectangle 651
 - oval filled with gradually changing colors 660
 - overflow 447
 - overflow error 309
 - overload a method **222**
 - overloaded constructors **320**
 - overloaded method 874
 - overloading generic methods 883
 - override a superclass method **363**, 368
- P**
 - PaaS (Platform as a Service) **30**
 - pack method of class Window **1025**
 - package **48**, 198, 208, 340, 1 package access **345**
 - package-access members of a class 346
 - package-access methods 346
 - package declaration **340**
 - package diagram in the UML **P_1**
 - package directory names 342
 - package directory structure 340
 - package keyword 1368
 - package-list generated by javadoc M_11
 - package name 79
 - package overview 208
 - Packages
 - com.google.gson.Gson 1322
 - default package **79**
 - java.applet 209
 - java.awt 209, **555**, 635, 657, 948, 969, 980, 1005, 1017
 - java.awt.color 657
 - java.awt.event 209, 210, **567**, 569, 594, 604
 - java.awt.font 657
 - java.awt.geom 209, 657
 - java.awt.image 657
 - java.awt.image.renderable 657
 - java.awt.print 657
 - java.beans 1108
 - java.io 209, **721**
 - java.lang **50**, 200, 209, 364, 387, 673, 1051
 - java.math 88, 770
 - java.net 209, **1119**
 - java.sql 209, 1191, 1192
 - java.util **48**, 209, 210, 284, 895
 - java.util.concurrent 209, 1051, 1070, 1093, 1109
 - java.util.concurrent.locks 1086, 1087
 - java.util.prefs **863**
 - java.util.regex 673
 - javax.jnlp 956, 969, 972
 - javax.media 209, **988**
 - javax.sql 1285
 - javax.sql.rowset **1207**
 - javax.swing 209, 210, **550**, 552, 560, 571, 617, 639, 969, 1005, 1021, 1024
 - javax.swing.event 210, **567**, 569, 586, 594, 1005
 - javax.swing.table 1194, **1206**
 - packet **1119**, 1143
 - packet-based communications **1119**
 - Page Down key 601
 - page layout software 673
 - Page Up key 601
 - Page, Larry 26
 - paint method of JApplet **949**, 952, 954
 - Paint object **660**
 - paintComponent method of class JComponent **597**, 632, 979, 1002, 1004
 - paintComponent method of JComponent **136**
 - paintIcon method of class ImageIcon **979**
 - palindrome 149, 795
 - Palindromes exercise 795
 - panel 613
 - parallel layout of GUI components 1431
 - parallel operations 1046
 - param element **1121**
 - @param javadoc tag **M_6**
 - parameter **76**, 78
 - parameter in the UML 78, 494, 497, 498, 499
 - parameter list **76**, 86
 - parameterized class **884**
 - parameterized type **884**
 - Parameters: note **M_6**
 - parent directory 723
 - parent node 924, 937
 - parent window 94, 554, 1001, **1022**
 - parent window for a dialog box **1012**
 - parent window specified as null 1012
 - parentheses **41**, 54
 - nested **54**
 - redundant **56**
 - unnecessary 56
 - parseDouble method of Double 953
 - parseInt method of class Integer 554
 - parseInt method of Integer 95, 186, 280
 - partial page update **1292**
 - partition step in quicksort 827, 828
 - Pascal programming language 16
 - pass an array element to a method 260
 - pass an array to a method 260
 - pass-by-reference **262**
 - pass-by-value 260, **262**
 - passing options to a program 279
 - password 562
 - @Path annotation **1316**
 - PATH environment variable xxxv, 43
 - path information **722**
 - path to a resource 1238
 - @PathParam annotation **1317**
 - pathSeparator static field of File 726
 - pattern 657
 - Pattern class 673, **707**
 - compile method **707**
 - matcher method **707**
 - matches method **707**
 - pattern matching **1179**
 - pattern of 1s and 0s 7

- Payable interface declaration 422
- Payable interface hierarchy
 - UML class diagram 422
- Payable interface test
 - program processing
 - Invoices and Employees polymorphically 429
- PayPal 1450
- Payroll System Modification
 - exercise 436
- peek method of class
 - PriorityQueue **855**
- peek method of class Stack **855**
- percent (%) SQL wildcard character 1179
- perfect number (exercise) 237
- perform a calculation 60
- perform a task 73
- perform an action 41
- performance of binary tree
 - sorting and searching 939
- Performance Tips overview xxviii
- performing operations
 - concurrently **1046**
- persistent 9
- persistent data **720**
- persistent Hashtable 863
- personalization **1261**
- phase 119
- Phishing Scanner 764
- Phone-Book Web Service with
 - JSON 1364
- photo sharing 26
- PHP 17, **30**
- physical input operation **752**
- physical output operation **752**
- PI 668, 965
- “pick off” each digit 69
- pie chart 670
- Pie Chart exercise 670
- PIE constant of class Arc2D **661**
- pie-shaped arc 661
- Pig Latin 713
- pipe **751**
- PipedInputStream class **751**
- PipedOutputStream class **751**
- PipedReader class **753**
- PipedWriter class **753**
- pixel (“picture element”) **135, 632**
- pixel coordinates 948
- PixelGrabber class 996
- PLAF (pluggable look-and-feel) **1001**
- PLAIN constant of class Font **643, 643**
- PLAIN_MESSAGE 554
- Platform as a Service (PaaS) **30, 30**
- platform dependency 1050
- play method of class Applet **985**
- play method of interface
 - AudioClip **985**
- Player interface **988**
 - getControlPanel-Component method **990**
 - getVisualComponent method **990**
 - start method **990**
- playing an AudioClip 985
- playing audio 985
- pluggable look-and-feel (PLAF) **1001**
- pluggable look-and-feel package **556**
- plus sign (+) indicating public visibility in the UML 511
- PNG (Portable Network Graphics) 560, **969**
 - .png file extension **969**
- point **643, 944**
- Point class **599**
- POJO (Plain Old Java Object) **1244, 1305**
- poker 303
- Poker game 1168
- poll method of
 - PriorityQueue **855**
- polygon **654, 656**
- Polygon class **632, 654**
 - addPoint method 655, **657**
- polyline **654**
- polylines 654
- polymorphic processing
 - of collections 833
- polymorphic processing of related exceptions 449
- polymorphically process
 - Invoices and Employees 428
- polymorphism 171, 391, **395, 516, 517, 527**
- polynomial 55, 56
- pool of threads 1129
- pop method of Stack **855**
- pop off a stack **206**
- pop stack operation **917**
- popular mashups 1450
- popup trigger event **1014, 1017**
- port **1218**
- port number **1128, 1130, 1142, 1143, 1147**
- portability 634, 1455
- Portability Tips overview xxviii
- portable **20**
- portable GUI 209
- Portable Network Graphics (PNG) 560, **969**
- position number 242
- positional notation 1419
- positional value 1420
- positional values in the decimal number system 1420
- positive and negative arc angles 652
- positive degrees **651**
- POST request **1239**
- postback **1261**
- postcondition **460**
- postdecrement **131**
- postfix decrement operator **131**
- postfix expression evaluation
 - algorithm 935
- postfix increment operator **131, 156**
- postfix notation 934
- PostgreSQL 1172
- postincrement **131, 133**
- postorder traversal **925, 928**
- pow method of class Math **161, 161, 200, 201, 232**
- power (exponent) 201, 237
- power of 2 larger than 100 112
- prebuilt data structures 830
- precedence **54, 60, 133, 773**
 - arithmetic operators 54
 - chart 54, 125
- Precedence Chart Appendix 1365
- precision 1397, 1398
 - format of a floating-point number 125
- precision of a floating-point value **88**
- precision of a formatted floating-point number **90**
- precondition **460**
- predecrement **131**
- predefined character class **700**
- predicate **1179**
- predicate methods **327, 913**
- preemptive scheduling **1050**
- Preferences API **863**
- prefix decrement operator **131**
- prefix increment operator **131**
- preincrement **131, 133**
- Preincrementing and postincrementing 132
- preorder traversal **925**
- PreparedStatement
 - interface **1211, 1212, 1214, 1217, 1226**
 - executeQuery method **1218**
 - executeUpdate method **1218**
 - setString method **1211, 1218**
- prepareStatement method of interface Connection **1217**
- presentation logic **1241**
- presentation of a document **1243**
- previous method of
 - ListIterator **839**
- primary key **1173, 1177**
- primary memory **9**
- prime 237, 872
- prime number 302
- primitive type **49, 84, 134, 207**
 - boolean 1384
 - byte 164
 - char 49, 164
 - double **49, 88, 121**
 - float **49, 88**
 - int 49, 50, 121, 131, 164
 - names are keywords 49
- primitive type (cont.)
 - passed by value 262
 - promotions 208
 - short 164
- principal in an interest calculation 159
- principle of least privilege **339**
- print a line of text **41**
- print an array 795
- Print an Array Backward
 - exercise 796
- Print an Array exercise 795
- print an array recursively 795
- print debugger command **1383**
- print method of System.out 44
- print on multiple lines 44
- print spooling **921, 1063**
- printArray generic method 878
- printf method of
 - System.out **46, 1396**
- printing a binary tree in a two-dimensional tree format 930
- printing trees 938
- println method of
 - System.out 41, 44
- printStackTrace method of class Throwable **456**
- PrintStream class **751, 865**
- PrintWriter class **732, 753**
- priority of a thread **1050**
- PriorityBlockingQueue class 1094
- PriorityQueue class **855**
 - clear method **855**
 - offer method **855**
 - peek method **855**
 - poll method **855**
 - size method **855**
- privacy protection 1262
- private
 - access modifier **80, 316, 317, 363**
 - data 327
 - field 326
 - keyword 327, 511, 1368
- private static
 - class member 335
- probability 210
- procedure **199**
- procedure for solving a problem 103
- processing phase 119
- processing unit 6
- producer **1062**
- producer thread **1063**
- producer/consumer relationship **1062, 1081**
- @Produces annotation **1317**
- product of odd integer 193
- program 6
- program construction
 - principles 187
- program control **104**
- program development tool 107, 121

- program execution stack **207**, 917
 - program in the general 395, 436
 - program in the specific 395
 - ProgrammableWeb 1450
 - programmer **6**
 - Projects** window 1246
 - promotion **124**, 1261
 - of arguments **207**
 - rules 124, **207**
 - promotions for primitive types 208
 - prompt **50**
 - Properties class **863**
 - getProperty method **863**
 - keySet method 866
 - list method **865**
 - load method **865**
 - setProperty method **863**
 - store method **865**
 - property (JSF) 1244
 - property of a JavaBean **1244**
 - propertyChange method of interface PropertyChangeListener 1109
 - PropertyChangeListener interface **1108**
 - propertyChange method 1109
 - proprietary class 386
 - protected access modifier 316, 363, 1368
 - protocol for communication (jdbc) 1191
 - Prototype design pattern **Q_3**, **Q_4**, **Q_19**
 - proxy class for a web service **1305**, 1310
 - Proxy design pattern **Q_3**, **Q_5**, **Q_6**
 - proxy object **Q_6**
 - pseudocode **104**, 108, 114, 125, 128
 - algorithm 120
 - first refinement **119**, 126
 - second refinement **119**, 127
 - pseudorandom number **210**, 214
 - public
 - abstract method 420
 - access modifier 72, 73, 80, 203, 316, 363
 - class 40
 - final static data 420
 - interface **312**
 - keyword **40**, 80, 511, 513, 514, 1368
 - member of a subclass 363
 - method 137, 313, 316
 - method encapsulated in an object 316
 - service **312**
 - static class members 335
 - static method 335
 - publishing a web service **1302**, 1303, 1307, **1358**
 - push method of class Stack **854**
 - push onto a stack **206**
 - push stack operation **917**
 - put method
 - of interface BlockingQueue **1070**, 1071
 - of interface Map **862**
 - of interface RequestContext **1338**
 - Pythagorean Triples 194
 - Python 17
- ## Q
- quad-core processor 9
 - quadratic run time 803
 - qualified name **1183**
 - quantifiers used in regular expressions **704**
 - quantum **1049**
 - query **1172**, 1174
 - query a database 1189
 - query application for the books database 1233
 - query method **327**
 - query string **1240**
 - QUESTION_MESSAGE 554
 - queue 832, 855, **905**, 921
 - Queue interface 831, **832**, **855**, 1070
 - queue length **1128**
 - queue to the server 1135
 - quicksort algorithm 827
 - QuickTime (.mov) files **988**
- ## R
- RadialGradientPaint class 660
 - radians 201
 - radio button **571**, **577**
 - radio button group **577**
 - radius 668, 965
 - radius of a circle 236
 - radix (base) of a number **697**
 - raised rectangle **651**
 - Random Characters exercise 668
 - Random class 209, **210**, 296
 - download.oracle.com/javase/6/docs/api/java/util/Random.html 210
 - nextInt method **210**, 214
 - setSeed method 215
 - Random Colors exercise 670
 - Random Interimage Transition exercise 996
 - random limericks 712
 - Random Lines Using Class Line2D.Double exercise 668
 - random method of class Math 210
 - random numbers 214
 - difference between values 214
 - element of chance **210**
 - generation 254
 - generation to create sentences 712
 - processing 209
 - pseudorandom number **210**
 - scaling **211**
 - scaling factor **211**, 214
 - seed **211**
 - seed value **214**
 - shift a range **211**
 - shifting value **211**, 214
 - Random Triangles exercise 668
 - Randomly Erasing an Image exercise 995
 - randomly generated triangles 668
 - randomly sized shapes 670
 - range method of class EnumSet **333**
 - range-view methods **839**, 857
 - ratio of successive Fibonacci numbers 771
 - Rational class 357
 - Rational Numbers (exercise) 357
 - Rational Software Corporation 476
 - Rational Unified Process™ 476
 - raw type **891**
 - RDBMS (relational database management system) 1241
 - Reaction Time/Reaction Precision Tester exercise 998
 - read method of class InputStream **973**
 - read-only file 748
 - read-only text 557
 - Read/Write Lock design pattern **Q_3**, **Q_14**
 - readability 39, 127
 - Reader class **753**
 - reading a file on a web server 1125
 - readObject method of ObjectInput **743**
 - readObject method of ObjectInputStream 750
 - ready state 1049
 - real number 49, 121
 - real part 356
 - realization in the UML **421**
 - receive a connection 1135
 - receive data from a server 1142
 - receive method of class DatagramSocket **1146**
 - “receiving” section of the computer 8
 - reclaim memory 338
 - recognizing clients 1262
 - recommended GUI design guidelines used by GroupLayout 1432
 - record **8**, 726
 - rectangle 355, 632, 636, 648, 944, 948
 - Rectangle Class (exercise) 355
 - Rectangle2D class 632
 - Rectangle2D.Double class **657**
 - recursion
 - overhead 777
 - quicksort 827
 - recursion step **767**, 773
 - recursive backtracking **790**
 - recursive binary search algorithm 827
 - recursive call **767**, 772, 773
 - recursive evaluation 768
 - Recursive evaluation of 5! 768
 - recursive factorial method 769
 - recursive linear search algorithm 827
 - recursive method **766**
 - Recursive power Method exercise 794
 - recursive step 827
 - recursively generating Fibonacci numbers 773
 - Recursively Print a List Backwards 937
 - Recursively Search a List 937
 - Recursion Exercises
 - binary search 827
 - Eight Queens 795
 - Find the Minimum Value in an Array 796
 - Fractals 796
 - Generating Mazes Randomly 797
 - Greatest Common Divisor 794
 - linear search 827
 - Maze Traversal Using Recursive Backtracking 796
 - Mazes of Any Size 797
 - Palindromes 795
 - Print an Array 795
 - Print an Array Backward 796
 - quicksort 827
 - Recursive power Method 794
 - Time to Calculate Fibonacci Numbers 797
 - Visualizing Recursion 794
 - recursive backtracking 797
 - redirect a standard stream **721**
 - redirect a stream 721
 - redundant parentheses **56**
 - ReentrantLock class **1087**, 1089
 - refactoring xxvi, **29**
 - tool 29
 - refer to an object **84**
 - reference **84**

- reference type **84**, 346
 - refinement process 119
 - reflection 417
 - regexFilter method of class RowFilter **1206**
 - regionMatches method of class String **677**
 - register a port **1128**
 - register an ActionListener 1013
 - registered listener 569
 - registering the event handler **564**
 - Registration Form
 - Modification exercise 1275
 - regular expression **700**
 - ^ 703
 - ? 704
 - . 707
 - {n, } 704
 - {n, m} 704
 - {n} 704
 - * 703
 - \d 700
 - \d 700
 - \S 700
 - \s 700
 - \w 700
 - \w 700
 - + 703
 - | 704
 - Regular Expressions Resource Center
 - (www.deitel.com/regularexpressions/) 708
 - Registration Form
 - Modification 1275
 - reinventing the wheel 12, 48, 281
 - relational database 1172, **1173**
 - relational database management system (RDBMS) **1172**, 1241
 - relational database table 1173
 - relational operators **56**
 - relationship between an inner class and its top-level class 577
 - RELATIVE constant of class GridBagConstraints **1037**
 - relative path **722**
 - release a lock 1076
 - release a resource 450, 451
 - release candidate 31
 - reload an entire web page 1290
 - Reload** from
 - appletviewer's Applet menu 945, 946
 - reluctant quantifier **705**
 - remainder 53
 - remainder compound
 - assignment operator, %= 131
 - REMAINDER constant of class GridBagConstraints **1037**
 - remainder operator, % **53**, 54, 149
 - remove duplicate String 856
 - remove method of class ArrayList<T> 284, **286**
 - remove method of interface Iterator **836**
 - removeTableModelListener method of interface TableModel **1194**
 - removeTrayIcon method of class SystemTray **1447**
 - render attribute of f
 - ajax **1295**
 - rendering XHTML in a web browser **1239**
 - Reordering output with argument index 1411
 - repaint method of class Component **599**
 - repaint method of class JComponent **635**
 - repainted 952
 - repetition 106, 183
 - counter controlled 114, 123, 126, 127
 - definite **113**
 - sentinel controlled 118, 119, 120, 121, 123
 - repetition statement **105**, **106**, **112**, 119, 776
 - do...while 106, 162, 163, 183, 163, 183
 - for 106, 157, 183
 - while 106, **112**, 113, 116, 123, 152, 183, 184
 - repetition terminates 112
 - replaceAll method of class Matcher **707**
 - replaceAll method of class String **705**
 - replaceFirst method of class Matcher **707**
 - replaceFirst method of class String **705**
 - Representational State Transfer (REST) **1300**, 1302
 - representing integers in hexadecimal format 1397
 - representing integers in octal format 1397
 - request method **1239**
 - RequestContext interface **1338**
 - put method **1338**
 - @RequestScoped annotation (JSF) **1248**
 - default 1248
 - required attribute of a JSF element **1259**
 - requirements **13**, 474
 - requirements document **470**, 474, 476
 - requirements gathering **474**
 - reservations system 297
 - reserved word **40**, 106, 1368
 - false 108
 - null 82, **84**, 134
 - true 107
- resizable array 1123
 - implementation of a List 833
 - resolution 135, 632
 - resource leak 334, **450**
 - resource library (JSF) 1253
 - resource-release code 450
 - resources element of a JNLP document **959**
 - resources folder of a JSF app **1253**
 - responses to a survey 251, 253
 - REST (Representational State Transfer) **1300**
 - restart method of class Timer **979**, 994
 - RESTful web services **1302**
 - result 1179
 - result set concurrency **1199**
 - result set type **1198**
 - ResultSet interface **1192**, 1198, 1200
 - absolute method **1200**
 - close method 1193
 - column name 1193
 - column number 1193
 - CONCUR_READ_ONLY constant **1199**
 - CONCUR_UPDATABLE constant **1199**
 - concurrency constant 1199
 - getInt method **1193**
 - getObject method **1193**, 1200
 - getRow method **1200**
 - last method **1200**
 - next method **1193**
 - TYPE_FORWARD_ONLY constant **1198**
 - TYPE_SCROLL_INSENSITIVE constant **1198**
 - TYPE_SCROLL_SENSITIVE constant **1199**
 - ResultSetMetaData
 - interface **1192**, 1200
 - getColumnClassName method **1200**
 - getColumnCount method **1192**, **1200**
 - getColumnName method **1200**
 - getColumnType method **1193**
 - ResultSetTableModel
 - enables a JTable to display the contents of a ResultSet 1194
 - resumption model of exception handling **445**
 - rethrow an exception **453**, 468
 - Rethrowing Exceptions
 - exercise 468
 - @return javadoc tag **M_7**
 - Return key 945, 946
 - return keyword **81**, 199, 206, 1368
 - return message in the UML 504
 - return statement 767
 - return type 81
 - in the UML 494, 499
 - of a method **73**, 81
 - Returns:** note **M_7**
 - reusability 883, 905
 - reusable software components 11, 208, 361
 - reuse 12, 48
 - reverse method of class StringBuilder **690**
 - reverse method of Collections 841, **847**
 - reverseOrder method of Collections **843**
 - RGB value 635, **636**, 641
 - RGB values **224**
 - right aligned 605
 - right brace, } **40**, 41, 49, 116, 123
 - right child **924**
 - RIGHT constant of class FlowLayout **608**
 - right justification 1396, 1405
 - right justify output **160**
 - right justifying integers 1405
 - right subtree 929, 937
 - rigid area of class Box **1031**
 - rise-and-shine algorithm 103
 - Ritchie, Dennis 16
 - .rmi file extension **985**, 988
 - robot 4
 - robotics simulator 998
 - robust 50
 - robust application 439
 - role in the UML 481
 - role name in the UML **481**
 - roll back a transaction **1227**
 - rollback method of interface Connection **1227**
 - rolling two dice 218
 - rollover Icon **571**
 - root directory **722**
 - root element (XML) **958**
 - root html element 1243
 - root node **924**
 - rotate method of class Graphics2D **664**
 - Rotating Images exercise 998
 - round a floating-point number
 - for display purposes 125
 - round-robin scheduling **1050**
 - rounded rectangle 649, 661
 - rounded rectangle (for
 - representing a state in a UML state diagram) **489**
 - rounding 1396
 - rounding a number 53, 118, 161, 201, 235
 - RoundRectangle2D class 632
 - RoundRectangle2D.Double class **657**, 661
 - row **1173**, 1177, 1178, 1179, 1180, 1184
 - rowClasses attribute of h:dataTable **1288**
 - RowFilter class **1206**

- rows of a two-dimensional array 268
 - rows to be retrieved 1178
 - RowSet interface **1207**
 - RSS feed 1449
 - RSS Resource Center 1451
 - Ruby on Rails 17
 - Ruby programming language 17
 - Rule of Entity Integrity **1177**
 - Rule of Referential Integrity **1175**
 - rule of thumb (heuristic) 173
 - rules for forming structured programs 179
 - rules of operator precedence **54, 773**
 - run an applet in a web browser 951
 - run debugger command **1381**
 - run method of interface Runnable **1051, 1157**
 - Runnable interface 430, **1051, 1158**
 - run method **1051, 1157**
 - runnable state 1048
 - running an application 23
 - running state 1049
 - running total 119
 - runtime error **22**
 - runtime logic error 50
 - RuntimeException class **448**
- S**
- SaaS (Software as a Service) xxvi, 30
 - Safari 93
 - SalaryedEmployee class that implements interface Payable method getPaymentAmount 427
 - SalaryedEmployee concrete class extends abstract class Employee 407
 - Sales Commissions 295
 - Salesforce 26
 - Salesforce.com 1451
 - sandbox security model **955**
 - SansSerif Java font 643
 - saturation **641**
 - Saverin, Eduardo 28
 - savings account 159
 - SavingsAccount Class (exercise) 355
 - Scala 17
 - scalar **260**
 - scaling (random numbers) 211
 - scaling an image 973
 - scaling factor (random numbers) 211, 214
 - Scanner class 48, **49**
 - hasNext method **167**
 - next method **77**
 - nextDouble method **91**
 - nextLine method **76**
 - scanning images 8
 - scheduling threads 1050
 - scientific notation 1398
 - scope 156
 - scope of a declaration **220**
 - scope of a type parameter 886
 - scope of a variable **156**
 - screen 6, 9
 - Screen class (ATM case study) 480, 481, 493, 500, 501, 502, 503, 504, 506, 513
 - screen cursor 46
 - screen-manager program 397
 - Screen Saver exercise 668
 - Screen Saver for Random Number of Lines exercise 669
 - Screen Saver Using the Java2D API exercise 669
 - Screen Saver Using Timer exercise 668
 - Screen Saver with Shapes exercise 669
 - script (Unicode) **1457**
 - scroll 582, 586
 - scroll arrow **583**
 - scroll box **583**
 - SCROLL_TAB_LAYOUT
 - constant of class JTabbedPane **1031**
 - scrollbar 586, 617
 - of a JComboBox **583**
 - scrollbar policies **617**
 - Scrolling Image Marquee exercise 997
 - Scrolling Marquee Sign exercise 996
 - SDK (Software Development Kit) **30**
 - search algorithms
 - binary search **804**
 - linear search **800**
 - recursive binary search 827
 - recursive linear search 827
 - search engine 1240
 - search key **799**
 - searching 905
 - searching data **799**
 - second-degree polynomial 55, 56
 - Second Life 26
 - second refinement 127
 - second refinement in top-down, stepwise refinement 119
 - secondary storage 6
 - secondary storage devices **720**
 - secondary storage unit **9**
 - sector 652
 - security 21
 - security certificate 955
 - SecurityException class **731**
 - See Also:** note **M_5**
 - @see javadoc tag **M_5**
 - seed value (random numbers) 211, **214**
 - SEI (service endpoint interface) **1305, 1310**
 - SELECT SQL keyword **1178, 1179, 1180, 1181, 1182**
 - selected text in a JTextArea 617
 - selecting an item from a menu 561
 - selecting data from a table 1174
 - Selecting Shapes exercise 670
 - selection 106, 182, 183
 - selection criteria **1179**
 - selection mode **586**
 - selection sort algorithm **810, 813**
 - selection statement **105, 106**
 - if 106, 107, 164, 183, 184
 - if...else 106, **107, 108, 123, 164, 183**
 - switch 106, **164, 170, 183**
 - self-documenting 50
 - self-documenting code 50
 - self-referential class **905, 907**
 - self-similar property **780**
 - _self target frame **1124**
 - Selvadurai, Naveen 29
 - semicolon (;) **42, 49, 59**
 - send a message to an object 12
 - send data to a server 1142
 - send message 85
 - send method of class DatagramSocket **1146**
 - sentence-style capitalization **553**
 - sentinel-controlled repetition **118, 119, 120, 121, 123, 194, 305**
 - sentinel value **118, 119, 123**
 - separator character **726**
 - separator line in a menu 1012, **1013**
 - sequence 106, 181, 183, **833, 924**
 - sequence diagram in the UML **477, 502**
 - sequence of messages in the UML **503**
 - sequence structure **105**
 - sequence-structure activity diagram 105
 - SequenceInputStream class 753
 - sequential-access file 720, 726, 1129
 - sequential execution **104**
 - sequential horizontal orientation in GroupLayout **1431**
 - sequential layout of GUI components 1431
 - Sequentially searching an array for an item 801
 - Serializable interface 430, **743**
 - serialized object **742**
 - serialized-form.html generated by javadoc **M_11**
 - Serif Java font 643
 - server **1119**
 - server farm 1263
 - server port number 1142
 - server response **1240**
 - server-side artifacts **1305**
 - server-side form handler **1239**
 - server waits for connections from clients 1128
 - server's Internet address 1130
 - server-side form handler **1239**
 - ServerSocket class **1128, 1135, 1157**
 - accept method **1128, 1135**
 - service description for a web service **1309**
 - service endpoint interface (SEI) **1305, 1310**
 - service of a class 316
 - ServiceManager class **972**
 - lookup method **972**
 - serviceName attribute of @WebService annotation **1305**
 - session 1262
 - session expire (JSF) 1263
 - session tracking **1262**
 - in web services 1324
 - @SessionScoped annotation **1262, 1263, 1265**
 - set a value **83**
 - set debugger command **1383**
 - Set interface 831, **832, 856, 857, 859**
 - set method
 - of class BitSet **N_11**
 - of interface ListIterator **839**
 - set method 83, 320
 - set of constants
 - as an interface 420
 - Set of Integers (exercise) 356
 - Set of recursive calls for fibonacci(3) 773
 - SET SQL clause **1185**
 - set-theoretic intersection 356
 - set-theoretic union 356
 - set up event handling 564
 - setAlignment method of class FlowLayout **608**
 - setAutoCommit method of interface Connection **1227**
 - setBackground method of class Component 287, **586, 641**
 - setBounds method of class Component 604
 - setCharAt method of class StringBuilder **690**
 - setColor method of class Graphics **636, 661**
 - setColor method of Graphics **225**
 - setCommand method of JDBCRowSet interface **1209**
 - setConstraints method of class GridBagLayout **1037**

- setDefaultCloseOperation method of class JFrame **137**, **561**, **1005**
- setDelay method of class Timer **995**
- setDisabledTextColor method of class JComponent **603**
- setEditable method of class JComponent **564**
- setErr method of class System **721**
- setFileSelectionMode method of class JFileChooser **757**
- setFixedCellHeight method of class JList **588**
- setFixedCellWidth method of class JList **588**
- setFont method of class Graphics **643**
- setForeground method of class JComponent **1014**
- setHint method of class Manager **989**
- setHorizontalAlignment method of class JLabel **560**
- setHorizontalScrollBarPolicy method of class JScrollPane **618**
- setHorizontalTextPosition method of class JLabel **560**
- setIcon method of class JLabel **560**
- setIn method of class System **721**
- setInverted method of class JSlider **1002**
- setMenuBar method of class JFrame **1006**, **1013**
- setLayout method of class Container **559**, **605**, **611**, **613**, **1031**
- setLineWrap method of class JTextArea **617**
- setListData method of class JList **589**
- setLocation method of class Component **604**, **1006**
- setLookAndFeel method of class UIManager **1021**
- setMajorTickSpacing method of class JSlider **1005**
- setMaximumRowCount method of class JComboBox **583**
- setMnemonic method of class AbstractButton **1012**
- setOpaque method of class JComponent **597**, **600**
- setOut method of System **721**
- setPage method of class JEditorPane **1127**
- setPaint method of class Graphics2D **660**
- setPaintTicks method of class JSlider **1005**
- setPassword method of JdbcRowSet interface **1209**
- setProperty method of Properties **863**
- setRolloverIcon method of class AbstractButton **573**
- setRowFilter method of class JTable **1206**
- setRowSorter method of class JTable **1206**
- setSeed method of class Random **215**
- setSelected method of class AbstractButton **1013**
- setSelectionMode method of class JList **586**
- setSize method of class Component **604**, **1006**
- setSize method of class JFrame **137**, **561**
- setString method of interface PreparedStatement **1211**, **1218**
- setStroke method of class Graphics2D **660**
- setText method of class JLabel **390**, **560**
- setText method of class JComponent **617**
- Setting the PATH environment variable xxxv
- setToolTipText method of class JComponent **559**
- setUrl method of JdbcRowSet interface **1209**
- setUsername method of JdbcRowSet interface **1209**
- setVerticalAlignment method of class JLabel **560**
- setVerticalScrollBarPolicy method of class JScrollPane **618**
- setVerticalTextPosition method of class JLabel **560**
- setVisible method of class Component **561**, **611**, **1006**
- setVisible method of class JFrame **137**
- setVisibleRowCount method of class JList **586**
- shadow a field **220**
- shallow copy **387**, **388**
- shape **657**
- Shape class hierarchy **362**, **393**
- Shape Hierarchy exercise **436**
- Shape object **660**
- shapes **944**
- shared buffer **1063**
- shell **41**
- shell prompt in UNIX **19**
- shell script **731**
- Shift **604**
- shift (random numbers) **211**
- shifting value **211**
- shifting value (random numbers) **214**
- “shipping” section of the computer **9**
- Shopping Cart Application **1275**
- shopping list **112**
- short-circuit evaluation **175**
- Short class **831**
- short primitive type **164**, **1368**, **1369**
- promotions **208**
- shortcut element of a JNLP document **959**
- shortcut key **1007**
- Show Line Numbers **1247**
- show method of class JPopupMenu **1017**
- showDialog method of class JColorChooser **641**
- showDocument method of interface AppletContext **1120**, **1124**
- showInputDialog method of class JOptionPane **94**, **553**
- showMessageDialog method of class JOptionPane **94**, **554**
- showOpenDialog method of class JFileChooser **757**
- showStatus method of class Applet **982**
- shuffle **254**
- algorithm **845**
- shuffle method of class Collections **841**, **845**, **847**
- Shuffleboard exercise **997**
- shuffling Fisher-Yates **257**
- shutdown method of class ExecutorService **1054**
- sibling nodes **924**
- side effect **175**
- Sieve of Eratosthenes **302**, **1104**
- Sieve of Eratosthenes, using a BitSet **N_12**
- signal method of interface Condition **1087**, **1091**
- signal value **118**
- signalAll method of interface Condition **1087**
- signature **224**
- signature of a method **223**
- signed right shift (>>) **N_1**, **N_2**, **N_8**, **N_10**
- Simbad Robotics Simulator Project **998**
- simple condition **173**
- simple name **342**
- Simple Object Access Protocol (SOAP) **1300**, **1303**
- SimpleGraph applet **944**
- simplest activity diagram **179**, **181**
- Simpletron Machine Language (SML) **304**, **905**
- Simpletron simulator **306**, **309**, **905**, **998**
- simulate a middle-mouse-button click on a one- or two-button mouse **597**
- simulate a right-mouse-button click on a one-button mouse **597**
- simulation **210**
- coin tossing **238**
- Simulation: Tortoise and the Hare **302**, **669**
- simulator **304**
- sin method of class Math **201**
- @since javadoc tag **M_8**
- Since: note **M_8**
- sine **201**
- single entry point **179**
- single-entry/single-exit control statements **106**, **179**
- single exit point **179**
- single inheritance **360**
- single-line (end-of-line) comment **42**
- single-precision floating-point number **88**
- single-quote character **673**, **1180**
- single-selection list **584**
- single-selection statement **106**, **107**, **183**
- single static import **338**
- Single-Threaded Execution design pattern **Q_3**, **Q_14**
- single-type-import declaration **344**
- SINGLE_INTERVAL_SELECTION constant of interface ListSelectionMode **586**, **586**, **588**
- SINGLE_SELECTION constant of interface ListSelectionMode **586**
- single-selection statement if **107**
- Singleton design pattern **Q_3**, **Q_4**
- singly linked list **907**
- size method of class ArrayBlockingQueue **1071**
- of class ArrayList<T> **286**
- of class BitSet **N_12**
- of class PriorityQueue **855**
- of interface List **836**, **839**
- of interface Map **863**
- size of a variable **52**
- size of the applet’s display area **950**
- Skype **26**
- sleep interval **1049**

- sleep method of class Thread **1051**, 1064, 1065, 1066
- sleeping thread **1049**
- small circles in the UML **105**
- small diamond symbol (for representing a decision in a UML activity diagram) 492
- smallest integer in a group 965
- smallest of several integers 193
- smartphone 2, 3, 15
- Smashforce 1451
- SML 905
- SMS Language 718
- SMS Web Service 1364
- snap-to ticks for JSlider **1001**
- SOA (services oriented architecture) xxvi
- SOAP (Simple Object Access Protocol) **1300**, 1302, 1303, 1310
 - envelope **1302**
 - message **1302**
- social commerce 26, 28
- social networking 26
- socket **1119**
- socket-based communication **1119**
- Socket class **1128**, 1142, 1157, 1158, [Q_15](#)
 - close method **1129**
 - getInetAddress method **1135**
 - getInputStream method **1129**, 1130
 - getOutputStream method **1129**
- SocketException class **1143**
- SocketImpl class [Q_15](#)
- software 2, **6**
- Software as a Service (SaaS) **30**
- Software Development Kit (SDK) **30**
- software engineering 327
- Software Engineering Observations overview xxviii
- software life cycle **474**
- software model 306
- software reuse 12, **199**, 340, 360, 874, 1450
- software simulation 304
- solid circle (for representing an initial state in a UML diagram) in the UML **489**, 490
- solid circle enclosed in an open circle (for representing the end of a UML activity diagram) 490
- solid circle in the UML **105**
- solid circle surrounded by a hollow circle in the UML **105**
- solid diamonds (representing composition) in the UML **481**
- Solves Towers of Hanoi problem with a recursive method 779
- sort 281
- sort algorithms
 - bubble sort 826
 - bucket sort 826
 - insertion sort **814**
 - merge sort **817**
 - quicksort 827
 - selection sort **810**
- sort key **799**
- sort method
 - of class Arrays **281**, **805**
 - of class Collections **842**
- SortDemo applet 944
- sorted array 907
- sorted order 857, 859
- SortedMap interface **859**
- SortedSet interface **857**, 859
 - first method **859**
 - last method **859**
- sorting 905
 - descending order 842
 - with a Comparator 843
- sorting data **799**, 809
- sorting techniques 944
- sound 951, 968
- sound card 985
- sound engine **985**
- sounds 992
- source code **19**, 386
- Source view in Netbeans 1433
- SourceForge 14
- SOUTH constant of class BorderLayout **592**, 608
- SOUTH constant of class GridBagConstraints **1032**
- SOUTHEAST constant of class GridBagConstraints **1032**
- SOUTHWEST constant of class GridBagConstraints **1032**
- space character 39
- space flag 1408
- spacing between components in GroupLayout 1432
- Spam Scanner 717
- SPAM Scanner Web Service 1364
- speaker 985
- speaking to a computer 8
- special character 49, **673**
- Special Section: Advanced String-Manipulation Exercises 714
- Special Section: Building Your Own Compiler 905
- Special Section: Building Your Own Computer 304
- Special Section: Challenging String-Manipulation Projects 716
- special symbol 7
- specialization **360**
- specialization in the UML **517**
- specifics 397
- speech recognition 998
- speech synthesis 998
- Spelling Checker project 716
- sphere 232
- spiral 669, 771
- .spl file extension **988**
- splash command-line option to the java command **1443**
- splash screen **1443**
- SplashScreen class **1444**
- split method of class String **699**, **705**
- split the array in merge sort 817
- spooler **921**
- spooling 921
- Spreadsheet applet 944
- SQL 1172, 1174, 1177, 1178, 1184
 - DELETE statement 1178, **1186**
 - FROM clause 1178
 - GROUP BY 1178
 - IDENTITY keyword **1212**
 - INNER JOIN clause 1178, **1183**
 - INSERT statement 1178, **1184**
 - LIKE clause 1180
 - ON clause **1183**
 - ORDER BY clause 1178, **1181**, 1182
 - SELECT query **1178**, 1179, 1180, 1181, 1182
 - SET clause **1185**
 - UPDATE statement 1178
 - VALUES clause **1184**
 - WHERE clause **1179**
- .sql 1188
- SQL (Structured Query Language) 1211
- SQL keyword 1177
- SQL script 1188
- SQL statement 1227
- SQLException class **1192**, 1193, 1212
- SQLFeatureNotSupportedException class 1199
- sqrt method of class Math 200, 201, 207
- square brackets, [] **242**
- square root 201
- Squares eliminated by placing a queen in the upper-left corner of a chessboard 795
- stack **206**, 883, **905**, 917
 - method call stack **207**
 - program execution stack **207**
 - stack overflow **207**
- Stack class 855, 917
 - isEmpty method **855**
 - of package java.util **853**
 - peek method **855**
 - pop method **855**
 - push method **854**
- stack frame **207**
- Stack generic class 884
 - Stack<Double> > 891
 - Stack<Integer> > 891
- Stack generic class declaration 884
- stack operation
 - pop **917**
 - push **917**
- stack trace **441**
- stack unwinding **454**
- stacked building blocks 183
- stacking control statements 184
- stacking rule **181**
- StackTraceElement class **457**
 - getClassName method **457**
 - getFileName method **457**
 - getLineNumber method **457**
 - getMethodName method **457**
- stale value **1059**
- standard error stream **444**, **453**, **1396**
- standard error stream (System.err) 721, 751
- standard input stream (System.in) **49**, 721
- standard output stream **453**
- standard output stream (System.out) **41**, 721, 751
- standard reusable component **361**
- standard time format 314
- “warehouse” section of the computer 9
- start method of class JApplet **949**, 952, 954
- start method of class Timer **979**
- start method of interface Player **990**
- start tag **958**
- starting angle **651**
- startsWith method of class String **680**
- starvation **1050**
- state **477**
- state button **574**
- state dependent **1063**
- State design pattern [Q_3](#), [Q_6](#), [Q_7](#), [Q_12](#)
 - context object [Q_7](#)
 - State class [Q_7](#)
 - state object [Q_7](#)
 - State subclass [Q_7](#)
- state diagram for the ATM object 489
- state diagram in the UML **489**
- state in the UML **477**, 490
- state machine diagram in the UML **477**, **489**
- state object [Q_12](#)
- state of an object 484, 489

- stateChanged method of interface ChangeListener **1005**
- stateless protocol 1262
- statement **42**, 73
- Statement interface **1192**, 1193, 1211
 - close method 1193
 - executeQuery method **1192**
- Statements 119
 - break **168**, 172, 195
 - continue **172**, 195, **Q_2**
 - control statement **104**, 105, 106, 107
 - control-statement nesting **106**
 - control-statement stacking **106**
 - do...while 106, **162**, 163, 183
 - double selection **106**, 127
 - empty **59**, 111
 - empty statement 111
 - enhanced for **258**
 - for 106, **154**, 155, 157, 159, 160, 183
 - if **56**, 106, 107, 164, 183, 184
 - if...else 106, **107**, 108, 123, 164, 183
 - labeled break **Q_1**, **Q_1**
 - labeled continue **Q_2**
 - looping **106**
 - multiple selection **106**
 - nested **126**
 - nested if...else **109**, 110
 - repetition **105**, **106**, **112**
 - return 199, 206
 - selection **105**, **106**
 - single selection **106**
 - switch 106, **164**, 170, 183
 - switch multiple-selection statement 214
 - try **253**
 - while 106, 112, 113, 116, 123, 152, 183, 184
- statements
 - throw **314**
 - try-with-resources **463**
- static
 - class member 334, 335
 - class variable 335
 - field (class variable) **334**
 - import **338**
 - import on demand **338**
 - keyword 200, 1368
 - method 74, **94**, 161
- static binding **419**
- static initializer block 1265
- status bar 948
- step debugger command **1385**
- step up debugger command **1386**
- Stone, Isaac “Biz” 28
- stop debugger command **1381**
- stop method
 - of JApplet **949**, 952
- stop method of class Timer **980**
- stop method of interface AudioClip **985**
- store method of Properties **865**
- stored procedure **1226**
- straight-line form **54**
- Strategy design pattern **Q_3**, **Q_6**, **Q_12**
- strategy object **Q_12**
- stream **453**, 1396
- stream header **1136**
- stream of bytes **720**
- stream socket **1119**, 1130, 1150
- stream-based communications **1119**
- streams **1119**
- streams-based transmission 1142
- strictfp keyword 1368
- strictly self-similar fractal **780**
- string **41**
 - literal **41**
 - of characters 41
- String class 673
 - charAt method **675**, **690**
 - compareTo method 677, 679
 - concat method **684**
 - endsWith method **680**
 - equals method 677, 679
 - equalsIgnoreCase method 677, 679
 - format method **94**, **314**, 1413
 - getChars method **675**
 - immutable **337**
 - indexOf method **681**
 - lastIndexOf method **681**
 - length method **675**
 - matches method **700**
 - regionMatches method **677**
 - replaceAll method **705**
 - replaceFirst method **705**
 - split method **699**, **705**
 - startsWith method **680**
 - substring method 683, 684
 - toCharArray method **686**, 796
 - toLowerCase **839**
 - toLowerCase method **686**
 - toUpperCase **839**
 - toUpperCase method **685**
 - trim method **686**
 - valueOf method **686**
- String class searching methods 681
- string concatenation **204**, 337
- string literal **674**
- StringBuffer class **688**
- StringBuilder class 673, **687**
 - append method **691**
 - capacity method **688**
 - charAt method **690**
 - constructors 688
 - delete method **693**
 - deleteCharAt method **693**
 - ensureCapacity method **688**
 - getChars method **690**
 - insert method **693**
 - length method **688**
 - reverse method **690**
 - setCharAt method **690**
- StringIndexOutOfBoundsException–Exception class **684**, 690
- StringReader class **753**
- Strings in switch statements 171
- StringWriter class **753**, 1317
- Stroke object **660**, 661
- strongly typed languages **134**
- Stroustrup, Bjarne 17, 439
- structural design patterns **Q_2**, **Q_5**, **Q_8**, **Q_15**
- structure **1243**
- structure of a system 488, 489
- structured programming 6, **104**, 152, 173, 179
- summary 179
- Structured Query Language (SQL) **1172**, 1174, 1177
- Student Poll exercise 763
- style attribute of
 - h:panelGrid **1253**
- styleClass attribute of a JSF element **1259**
- styleClass attribute of h:dataTable **1288**
- subclass **136**, **360**, 516, 517, **Q_9**
 - subdirectory 944
- subject object **Q_12**
- sublist **839**
- subList method of List **839**
- submenu **1007**
- submit method of class ExecutorService **1109**
- subprotocol for communication **1191**
- subscript (index) **242**
- substring method of class String 683, 684
- subsystem **Q_16**
- subtract method of class BigInteger **771**, 773
- subtraction 9, 53
 - operator, - 54
- subtraction compound
 - assignment operator, -= 131
- suffix F for float literals **855**
- suffix L for long literals **854**
- sum the elements of an array 248
- summarizing responses to a survey 251
- Sun Audio file format (.au extension) **985**, 988
- Sun Microsystems 1452, **Q_2**
- super keyword 363, 385, 1368
 - call superclass constructor 377
- super.paintComponent(g) 136
- superclass **136**, **360**, 516, 517, **Q_10**
 - constructor 367
 - constructor call syntax **377**
 - default constructor 367
 - direct **360**, 362
 - indirect **360**, 362
 - method overridden in a subclass 385
- Supermarket Simulation 936
- surrogates **1453**
- suspend an applet's execution 952
- swapping values 810, 814
- sweep **288**, **651**
- sweep counterclockwise 651
- .swf file extension **988**
- Swing Event Package 210
- Swing GUI APIs 551
- Swing GUI components **550**
- Swing GUI components package 209
- swing.properties file xxxvi, 552
- SwingConstants interface 431, **560**, 1005
- SwingSet3 demo (download.java.net/javadesktop/swingset3/SwingSet3.jnlp) 551
- SwingUtilities class **1022**, **1135**
 - invokeLater method **1135**
 - updateComponentTreeUI method **1022**
- SwingWorker class **1095**
 - cancel method **1109**
 - doInBackground method 1095, 1098
 - done method 1095, 1098
 - execute method 1095
 - get method 1095
 - isCancelled method **1104**
 - process method 1096, 1105
 - publish method 1095, 1105
 - setProgress method 1096, 1105
- switch logic 171
- switch multiple-selection statement 106, **164**, 170, 183, 214, 1368
 - activity diagram with break statements 170

- switch (cont.)
 - case label 168
 - comparing Strings 171
 - controlling expression **168**
 - default case **168**, 171, 214
 - Sybase 1172
 - Sybase, Inc. 1452
 - synchronization **1054**, 1074
 - synchronization wrapper **866**
 - synchronize **1047**
 - synchronize access to a collection 833
 - synchronized
 - keyword 866, **1055**, 1368
 - method **1055**
 - statement **1055**
 - synchronized collection 833
 - synchronous call **502**
 - synchronous error **447**
 - synchronous request **1290**
 - SynchronousQueue class 1094
 - syntax error **39**, 43
 - system **476**
 - system behavior **476**
 - System class
 - arraycopy **281**, 283
 - currentTimeMillis method 797
 - exit method **450**, **731**
 - setErr method **721**
 - setIn method **721**
 - setOut **721**
 - system requirements **474**
 - system service 1128
 - system structure **476**
 - System.err (standard error stream) **444**, 721, 751, 1396
 - System.in (standard input stream) 721
 - System.out
 - print method **44**
 - printf method **46**
 - println method **41**, 44
 - System.out (standard output stream) **41**, 721, 751
 - SystemColor class **660**
 - SystemTray class **1447**
 - addTrayIcon method **1447**
 - getDefaultSystemTray method **1447**
 - removeTrayIcon method **1447**
- T**
- tab 1411
 - tab character, \t 46
 - Tab key 41
 - tab stops 41, 46
 - table 268, 1173
 - table element 268
 - table of values 268
 - TableModel interface **1194**
 - addTableModelListener **1194**
 - TableModel interface (cont.)
 - getColumnClass method **1194**, 1200
 - getColumnCount method **1194**, 1200
 - getColumnName method **1194**, 1200
 - getRowCount method **1194**
 - getValueAt method **1194**
 - removeTableModelListener **1194**
 - TableModelEvent class 1206
 - TableRowSorter class **1206**
 - tablet 3
 - tablet computer 15
 - tabular format 245
 - tag (in an XHTML document) **949**
 - tag library (JSF) 1243
 - tagging interface 421, **743**
 - tail of a queue **905**, 921
 - tailSet method of class TreeSet **859**
 - take method of class BlockingQueue **1070**, 1071
 - tan method of class Math 201
 - tangent 201
 - target frame **1124**
 - _blank **1124**
 - _self **1124**
 - _top **1125**
 - Target-Heart-Rate Calculator exercise 101
 - Tax Plan Alternatives exercise 196
 - TCP (Transmission Control Protocol) **1119**
 - technical publications 31
 - Technorati APIs 1451
 - Telephone-Number Word Generator exercise 763
 - telephone system 1143
 - Template Method design pattern **Q_3**, **Q_6**, **Q_13**
 - temporary 124
 - terabyte 9
 - Terminal application (Max OS X) 19
 - terminal window **41**
 - terminate a loop 119
 - terminate an application 1012
 - terminate successfully 731
 - terminated state **1049**
 - termination housekeeping **334**, 387
 - termination model of exception handling **445**
 - termination phase 119
 - termination test 776
 - ternary operator **108**
 - test a web service 1308
 - testing a web service from another computer 1309
 - Testing the insertion sort class 816
 - Testing the merge sort class 821
 - Testing the selection sort class 812
 - Text analysis 714
 - text editor 42, 673
 - text field **94**
 - text file **721**
 - Text Flasher exercise 995
 - text that jumps 944
 - text-to-speech (TTS) 998
 - TexturePaint class **632**, 660, 661
 - The “FairTax” 196
 - The Free Site (www.thefreesite.com) 992
 - The Java™ Language Specification (java.sun.com/docs/books/jls/) 54
 - thick lines 657
 - this
 - keyword **317**, 317, 335, 1368
 - reference **317**
 - to call another constructor of the same class 322
 - thread **445**, 634, 951, **Q_14**
 - life cycle 1048, 1050
 - of execution **1046**
 - scheduling **1049**, 1066
 - state **1048**
 - synchronization 866, **1054**
 - Thread class
 - currentThread method 1056
 - interrupt method **1052**
 - sleep method **1051**
 - thread confinement **1095**
 - thread-life-cycle statechart diagram 1048, 1050
 - thread pool **1051**
 - thread priority **1050**
 - thread safe **1059**, 1095
 - thread scheduler **1050**
 - thread states
 - blocked **1049**, 1055
 - dead 1049
 - new **1048**
 - ready **1049**
 - runnable **1048**
 - running **1049**
 - terminated **1049**
 - timed waiting **1048**
 - waiting **1048**
 - three-button mouse 596
 - 3-D Multithreaded Tic-Tac-Toe 1169
 - three-dimensional shape 944
 - three-dimensional view 944
 - three-dimensional rectangle 648
 - three-dimensional, high-resolution, color graphics 968
 - ThreeDimensionalShape class 393
 - throw an exception **253**, **440**, 444
 - throw an exception **314**, 323
 - throw keyword **453**, 1368
 - throw point **441**
 - throw statement **453**
 - Throwable class **447**, 456
 - getMessage method **456**
 - getStackTrace method **456**
 - hierarchy 448
 - printStackTrace method **456**
 - throws an exception **314**
 - throws clause **446**
 - @throws javadoc tag **M_7**
 - throws keyword 1368
 - thumb of class JSlider **1001**, 1005
 - thumb position of class JSlider 1005
 - Tic-Tac-Toe 1150
 - tick marks on a JSlider **1001**
 - TicTacToe 357
 - applet 944, 945
 - exercise 357
 - tier in a multitier application **1240**
 - tightly packed binary tree **930**
 - time formatting 1397
 - Time to Calculate Fibonacci Numbers exercise 797
 - timed waiting state 1048
 - Timer class 668, **979**, 980
 - getDelay method **995**
 - isRunning method **979**
 - restart method **979**
 - setDelay method **995**
 - start method **979**
 - stop method **980**
- timeslice **1049**
- timeslicing 1050
- timing diagram in the UML **P_2**
- title bar **551**, 557, **1005**
- title bar of a window 554
- title bar of internal window 1024
- title element of a JNLP document **959**
- title of a JSF document **1244**
- titles table of books database 1174, 1176
- toArray method of List **840**, 841
- toBinaryString method of class Integer **N_4**
- toCharArray method of class String **686**
- toCharArray method of String 796
- toggle buttons **571**
- toJSON method of class Gson 1322
- token of a String **699**
- tokenization 699
- toLowerCase method of class Character **696**
- toLowerCase method of class String **686**, **839**
- tool tips **556**, 559, 561
- top **118**, 855

- TOP constant of class
 - JTabbedPane **1031**
 - top-down, stepwise refinement **118**, 119, 121, 126, 12
 - top-level class **564**
 - top of a stack **905**
 - _top target frame **1125**
 - top tier **1241**
 - Tortoise and the Hare 302, 669
 - Tortoise and the Hare exercise 669
 - toString method
 - of class ArrayList 842, 897
 - of class Arrays 706, 801
 - of class BitSet **N_12**
 - of class Formatter 1413
 - of class Object 367, 388
 - total **114**, 119
 - Total Sales 297
 - toUpperCase method of class Character **696**
 - toUpperCase method of class String **685**, **839**
 - toURI method of class File **992**
 - toURL method of class URI **992**
 - Towers of Hanoi **777**
 - Towers of Hanoi for the case with four disks 778
 - track mouse events 590
 - tracking customers 1261
 - traditional comment **39**
 - traditional web application 1290
 - TRAILING alignment constant in GroupLayout 1432
 - trailing white-space characters 686
 - Transacti on class (ATM case study) 516, 517, 518, 519, 521, 547
 - transaction file 762
 - transaction processing **1227**
 - transaction record 762
 - transfer of control **104**, 305, 307, 308
 - transient keyword **745**, 1368
 - transition arrow 108, 113
 - in the UML **105**
 - transition arrow in the UML 112
 - transition between states in the UML **489**, 492
 - transition in the UML **105**
 - translate method of class Graphics2D **664**
 - translation **10**
 - translator program **10**
 - transparency of a JComponent **597**
 - traverse a tree 929
 - traverse an array **270**
 - Tray icons **1447**
 - TrayIcon class **1448**
 - tree 856, 924, 945
 - Tree link in API **1371**
 - TreeMap class **859**
 - TreeSet class **856**, 857, 859
 - headSet method **858**
 - tailSet method **859**
 - trigger an event 555
 - trigonometric cosine 201
 - trigonometric sine 201
 - trigonometric tangent 201
 - trim method of class String **686**
 - trimToSize method of class ArrayList<T> 284
 - true **56**, 1368
 - true reserved word 107, **109**
 - truncate 53
 - truncate fractional part of a calculation **118**
 - truncated **729**
 - truth table **174**
 - truth tables
 - for operator ^ 176
 - for operator ! 177
 - for operator && 174
 - for operator || 175
 - try block **253**, 444, 454
 - terminates 445
 - try keyword **444**, 1368
 - try statement **253**, **446**
 - try-with-resources statement **463**
 - Turtle Graphics 298, 669
 - Turtle Graphics exercise 669
 - 24-hour clock format 312
 - Twitter 3, 17, 26, 28
 - tweet 28
 - two-dimensional graphics
 - demo 946
 - two-dimensional array
 - representation of a maze 796
 - 268**, 269
 - two-dimensional array with three rows and four columns 268
 - two-dimensional data structure 924
 - two-dimensional graphics 657
 - two-dimensional shapes 632
 - two largest values 147
 - Two-Phase Termination design pattern **Q_3**, **Q_14**
 - two's complement 1426
 - TwoDimensionalShape class 393
 - twos position 1421
 - type **49**
 - type argument **886**
 - type casting **124**
 - type-import-on-demand declaration **344**
 - type inference with the <> notation (Java SE 7) 836
 - type of a variable **52**
 - type parameter **878**, 884, 891
 - scope 886
 - section **878**, 884
 - type variable **878**
 - type-wrapper class 694, **831**, 880
 - implements Comparable 880
 - TYPE_FORWARD_ONLY constant **1198**
 - TYPE_INT_RGB constant of class BufferedImage **661**
 - TYPE_SCROLL_INSENSITIVE constant **1198**
 - TYPE_SCROLL_SENSITIVE constant **1199**
 - Types class **1193**
 - typesetting system 673
 - typing in a text field 561
 - Typing Tutor: Tuning a Crucial Skill in the Computer Age 629
- ## U
- U+yyyy (Unicode notational convention) **1454**
 - UDP (User Datagram Protocol) **1119**, 1143
 - ui: repeat element **1269**
 - UIManager class **1021**
 - getInstalledLookAndFeel's method **1021**
 - LookAndFeelInfo nested class **1021**
 - setLookAndFeel method **1021**
 - UIManager.LookAndFeelInfo class
 - getClassName method **1021**
 - UML (Unified Modeling Language) 13, 470, 476, 480, 487, 488, 516
 - activity diagram **105**, 108, 112, 157, 163
 - aggregation **482**
 - arrow 105
 - association **480**
 - class diagram **75**
 - compartment in a class diagram 75
 - diagram 476
 - diamond 107
 - dotted line **106**
 - elided diagram **480**
 - final state **106**
 - frame 505
 - guard condition **107**
 - guillemets (« and ») **88**
 - hollow diamond
 - representing aggregation **482**
 - many-to-one relationship **483**
 - merge symbol **112**
 - multiplicity **480**
 - note **106**
 - one-to-many relationship **483**
 - one-to-one relationship **483**
 - UML (cont.)
 - Resource Center (www.deitel.com/UML/) 477
 - role name **481**
 - solid circle **105**
 - solid circle surrounded by a hollow circle 105
 - solid diamond
 - representing composition **481**
 - Specification (www.omg.org/technology/documents/formal/uml.htm) 482
 - UML (www.uml.org) 106
 - UML Activity Diagram
 - small diamond symbol (for representing a decision) in the UML 492
 - solid circle (for representing an initial state) in the UML 490
 - solid circle enclosed in an open circle (for representing the end of an activity) in the UML 490
 - UML Class Diagram **480**
 - attribute compartment 487
 - operation compartment 493
 - UML Sequence Diagram
 - activation **504**
 - arrowhead 504
 - lifeline **504**
 - UML State Diagram
 - rounded rectangle (for representing a state) in the UML **489**
 - solid circle (for representing an initial state) in the UML **489**
 - UML Use Case Diagram
 - actor **475**
 - use case 476
 - unambiguous (Unicode design basis) **1453**
 - unary operator **125**, 176
 - cast **124**
 - unboxing 884, 889
 - unboxing conversion **832**
 - uncaught exception **445**
 - unchecked exceptions **448**
 - uncovering a component 635
 - underlying data structure 855
 - underscore (_) SQL wildcard character 1179, 1180
 - uneditable JTextArea 615
 - uneditable text or icons 555
 - Unicode character set 7, 68, 134, 171, **673**, 679, 695, 1369
 - Unicode Consortium **1452**
 - Unicode Standard **1452**
 - Unicode Standard design basis 1453

- Unicode value of the character typed 604
 - Unified Modeling Language (UML) 13, 470, 476, 480, 487, 488, 516
 - uniform (Unicode design principle) **1453**
 - Uniform Resource Identifier (URI) **722, 1120**
 - Uniform Resource Locator (URL) **722, 1120, 1237**
 - union of two sets 356
 - universal (Unicode design principle) **1453**
 - universal-time format 312, 313, 314
 - UNIX 19, 41, 167, 731, 943
 - UnknownHostException class **1130**
 - unlock method of interface Lock **1086, 1091**
 - unmarshal method of class JAXB **1320**
 - unmodifiable collection 833
 - unmodifiable wrapper **866**
 - unnecessary parentheses 56
 - unsigned right shift (>>) **N_1, N_2, N_8, N_11**
 - unspecified number of arguments 278
 - UnsupportedOperationException class **839**
 - unwatch debugger command **1390**
 - unwinding the method-call stack 454
 - UPDATE SQL statement 1178, **1185**
 - updateComponentTreeUI method of class SwingUtilities **1022**
 - upper bound 880
 - of a wildcard 897
 - upper bound of a type parameter **881, 882**
 - upper-left corner (0, 0)
 - coordinates of an applet 948
 - upper-left corner of a GUI component 134, 632
 - upper-left x-coordinate 636
 - upper-left y-coordinate 636
 - uppercase letter 40, 49
 - URI (Uniform Resource Identifier) **722, 1120**
 - URI class
 - toURL method **992**
 - URL **Q_16**
 - URL (Uniform Resource Locator) **722, 1120, 1121, 1237**
 - URL class 985
 - openStream method **1324**
 - URLStreamHandler class **Q_16**
 - Use binary search to locate an item in an array 807
 - use case diagram in the UML **475, 476**
 - use case in the UML **475**
 - use case modeling **475**
 - User Datagram Protocol (UDP) **1119, 1143**
 - user interface 1241, **Q_18**
 - UTF-16 **1453**
 - UTF-32 **1453**
 - UTF-8 **1453**
 - Utilities Package 209
 - Utility class that displays bit representation of an integer **N_7**
 - utility method **170**
- V**
- v option of the jar command **957**
 - va **732**
 - vacated bits **N_11**
 - valid identifier 49
 - validate method of class Container **613**
 - validation **1254**
 - validatorMessage attribute of a JSF element **1259**
 - Validators (JSF)
 - f:validateBean **1254**
 - f:validateDoubleRange **1254**
 - f:validateLength **1254**
 - f:validateLongRange **1254**
 - f:validateRegex **1254**
 - f:validateRequired **1254**
 - validity checking 327
 - value attribute of h:dataTable **1287**
 - value attribute of h:inputText 1259
 - value attribute of h:outputLink **1254**
 - value attribute of ui:repeat **1269**
 - value of a param 1121
 - value of a variable **52**
 - value of an attribute **1243**
 - value to the nearest integer 235
 - valueChanged method of interface ListSelectionListener **586**
 - valueOf method of class String **686**
 - values method of an enum **332**
 - VALUES SQL clause **1184**
 - van Rossum, Guido 17
 - var attribute of h:dataTable **1288**
 - var attribute of ui:repeat **1269**
 - variable **47, 49, 49**
 - name **49, 52**
 - reference type **84**
 - size **52**
 - variable (cont.)
 - type **52**
 - value **52**
 - variable declaration statement **49**
 - variable is not modifiable 339
 - variable-length argument list **278**
 - variable scope 156
 - Vector class 290, **833**
 - vendor element of a JNLP document **959**
 - verb phrase in requirements document 493
 - @version javadoc tag **M_8**
 - Version note **M_8**
 - VERTICAL constant of class GridBagConstraints **1032**
 - vertical coordinate **135, 632**
 - vertical gap space **611**
 - vertical scrolling 617
 - vertical strut **1030**
 - VERTICAL_SCROLLBAR_ALWAYS constant of class JScrollPane **618**
 - VERTICAL_SCROLLBAR_AS_NEEDED constant of class JScrollPane **618**
 - VERTICAL_SCROLLBAR_NEVER constant of class JScrollPane **618**
 - vi 19
 - video 968, 992
 - video game 211
 - video sharing 26
 - View 551
 - view **839**
 - view (in MVC) 1250, **Q_17**
 - view a shape from different angles 944
 - virtual directory **1238**
 - virtual key code **603**
 - virtual machine (VM) **20**
 - virtual world 26
 - visibility in the UML **511**
 - visibility marker in the UML **511**
 - Visitor design pattern **Q_6**
 - Visual Basic programming language 17
 - Visual C# programming language **17**
 - Visual C++ programming language 17
 - visual feedback 574
 - Visualizing Recursion exercise 794
 - Vlissides, John **Q_2**
 - void keyword **41, 73, 1368**
 - VoIP (Voice over IP) 29
 - volatile information 9
 - volatile keyword 1368
 - volume of a sphere 232, 234
- W**
- WADL (Web Application Description Language) **1318**
 - wait for a new connection 1135
 - wait method of class Object 388, **1073**
 - waiting line 832, 855
 - waiting state 1048
 - waiting thread 1076
 - watch debugger command **1388**
 - waterfall model **475**
 - .wav file extension **985**
 - web 1120
 - Web 2.0 **26, 1449**
 - web app development 1236
 - web application
 - Ajax 1291
 - traditional 1290
 - Web Application Description Language (WADL) **1318**
 - web application framework **1236**
 - Web Application project **1303**
 - web browser 93, 942, 1124
 - execute an applet 947, 951
 - Web Form 1263
 - web page 93
 - web server 1128, **1237**
 - web service **1300, 1449**
 - implemented as a class 1302, 1358
 - publishing a web service 1307
 - Web Service Description Language (WSDL) **1309**
 - web service host **1302**
 - web service reference 1311
 - web services 27
 - adding a web service reference to an application **1310**
 - client-side artifacts **1310**
 - consuming a web service **1302, 1358**
 - deploying a web service 1307
 - @GET annotation **1317**
 - GlassFish application server's Tester web page 1308
 - JAX-RS **1300**
 - JAX-WS **1300**
 - name attribute of @WebService annotation **1305**
 - @Path annotation **1316**
 - @PathParam annotation **1317**
 - POJO (Plain Old Java Object) **1244, 1305**
 - processing user-defined types 1346
 - @Produces annotation **1317**
 - proxy class **1305, 1310**

- web services (cont.)
 - publishing a web service **1302, 1358**
 - RequestContext interface **1338**
 - REST **1300**
 - server-side artifacts **1305**
 - serviceName attribute of @WebService annotation **1305**
 - session tracking **1327**
 - SOAP 1310
 - test a web service 1308
 - testing a web service from another computer 1309
 - web service host **1302**
 - web service reference 1311
 - @WebMethod annotation **1305**
 - @WebParam annotation **1306**
 - @WebService annotation **1305**
 - @WebMethod annotation **1305**
 - operationName attribute **1305**
 - @WebParam annotation **1306**
 - name attribute **1306**
 - @WebService annotation **1305**
 - name attribute **1305**
 - serviceName attribute **1305**
 - weightX field of class GridBagConstraints **1033**
 - weightY field of class GridBagConstraints **1033**
 - WEST constant of class BorderLayout **592, 608**
 - WEST constant of class GridBagConstraints **1032**
 - WHERE SQL clause 1178, **1179**, 1180, 1182, 1185, 1186
 - while repetition statement 106, **112**, 113, 116, 123, 152, 183, 184, 1368
 - activity diagram in the UML 113
 - white space **39**, 41, 60
 - white-space character 686, 699, 700
 - whole/part relationship 481
 - widgets 550
 - width 647
 - width attribute (CSS) **1253**
 - width attribute of the applet-desc element 959
 - width of a rectangle in pixels 637
 - width of an applet in pixels **950**
 - Wikipedia 17, 26
 - wildcard 897
 - generic type parameter **895**
 - type argument **897**
 - upper bound 897
 - Williams, Evan 28
 - window 93, 134, 135, 137, **1005**
 - Window class 1005
 - addWindowListener method **1006**
 - dispose method **1005**
 - pack method **1025**
 - window event **1006**
 - window event-handling methods 594
 - window events **1006**
 - window gadgets 550
 - WindowActivated method of interface WindowListener **1006**
 - WindowAdapter class 594, **1206**
 - windowClosed method of interface WindowListener **1006, 1206**
 - windowClosing method of interface WindowListener **1006**
 - WindowConstants interface **1005**
 - DISPOSE_ON_CLOSE constant 1005
 - DO_NOTHING_ON_CLOSE constant 1005
 - HIDE_ON_CLOSE constant 1005
 - windowDeactivated method of interface WindowListener **1006**
 - windowDeiconified method of interface WindowListener **1006**
 - windowIconified method of interface WindowListener **1006**
 - windowing system **556**
 - WindowListener interface 594, **1006, 1206**
 - windowActivated method **1006**
 - windowClosed method **1006, 1206**
 - windowClosing method **1006**
 - windowDeactivated method **1006**
 - windowDeiconified method **1006**
 - windowIconified method **1006**
 - windowOpened method **1006**
 - windowOpened method of interface WindowListener **1006**
 - Windows 14, 19, 167, 731, 943
 - Windows look-and-feel 1001
 - Windows operating system **14**
 - Windows Performance Package 988
 - Windows Wave file format (.wav extension) **985**
 - WireFrame applet 944
 - Wirth, Niklaus 16
 - Withdrawal1 class (ATM case study) 480, 481, 482, 485, 491, 492, 493, 501, 502, 504, 505, 513, 514, 516, 517, 518, 521
 - word character **700**
 - word processor 673, 681
 - workflow **105**
 - workflow of an object in the UML **490**
 - World Community Grid 4
 - World Population Growth Calculator exercise 70
 - World Population Growth exercise 150
 - World Wide Web (WWW) browser 93
 - worst-case run time for an algorithm 802
 - wrap stream types 1129, 1130
 - wrapper methods of the Collections class **833**
 - wrapper object (collections) **866**
 - wrapping stream objects **742, 748**
 - wrapping text in a JTextArea 617
 - writable 723
 - writeBoolean method of interface DataOutput 752
 - writeByte method of interface DataOutput 752
 - writeBytes method of interface DataOutput 752
 - writeChar method of interface DataOutput 752
 - writeChars method of interface DataOutput 752
 - writeDouble method of interface DataOutput 752
 - writeFloat method of interface DataOutput 752
 - writeInt method of interface DataOutput 752
 - writeLong method of interface DataOutput 752
 - writeObject method of class ObjectOutputStream 748
 - of interface ObjectOutputStream **743**
 - Writer class **753, 753**
 - writeShort method of interface DataOutput 752
 - writeUTF method of interface DataOutput 752
 - Writing the Word Equivalent of a Check Amount 715
 - WSDL (Web Service Description Language) **1309**
 - www 29
- ## X
- x-coordinate **135, 632, 656, 948**
 - X_AXIS constant of class Box **1031**
 - x-axis **135, 632**
 - XHTML (eXtensible HyperText Markup Language) 1236, 1237, 1243, **1243**
 - applet element **950**
 - body element **950**
 - document 949
 - page 1237
 - tag **949**
 - XHTML 1.0
 - Strict Recommendation 1243
 - Transitional Recommendation 1243
 - XML (eXtensible Markup Language) **958, 1236, 1309**
 - declaration 1243
 - element **958**
 - empty element **1253**
 - end tag **958**
 - root element **958**
 - start tag **958**
 - vocabulary 958
 - XMLHttpRequest object **1290**
 - xmlns attributes **1243**
 - xor method of class BitSet **N_11**
- ## Y
- y-coordinate **135, 632, 656**
 - Y_AXIS constant of class Box **1031**
 - Yahoo! 3
 - y-axis **135, 632**
 - YouTube 26, 29
 - Yukihiko 17
- ## Z
- zero-based counting 155
 - ZERO constant of class BigInteger **773**
 - 0 (zero) flag **1407, 1409**
 - zero-based counting **245**
 - zeroth element **242**
 - zooming 996
 - Zuckerberg, Mark 28
 - Zynga 5

Continued from Back Cover

- “The [early] introduction of the class concept is clearly presented. A comprehensive overview of control structures and the pitfalls that befall new programmers. I applaud the authors for their topical research and illustrative examples. The [arrays] exercises are sophisticated and interesting. The clearest explanation of pass-by-value and pass-by-reference that I’ve encountered. A logical progression of inheritance and the rationale for properly implementing encapsulation in a system involving an inheritance hierarchy. The polymorphism and exception handling discussions are the best I’ve seen. An excellent strings chapter. I like the [recursion] discussions of the ‘Lo Fractal’ and backtracking (which is useful in computer vision applications). A good segue into a data structures course.”—**Ric Heishman, George Mason University**
- “Practical top-down, solution approach to teaching programming basics, covering pseudocode, algorithm development and activity diagrams. Of immense value to practitioners and students of the object-oriented approach. Demystifies inheritance and polymorphism, and illustrates their use in getting elegant, simple and maintainable code. The [optional OO design] case study presents the object-oriented approach in a simple manner, from requirements to Java code.”
—**Vinod Varma, Astro Infotech Private Limited**
- “Easy-to-follow examples provide great teaching opportunities! I like the [optional] graphics track early in the book—the exercises will be fun for the students. OO design techniques are incorporated throughout. The concept of inheritance is built through the examples and very understandable. Great examples of polymorphism and interfaces. Great comparison of recursion and iteration. The [Searching and Sorting] chapter is just right. A simplified explanation of Big O—the best I’ve read! I appreciate the coverage of GUI threading issues. Great approach to Java web technologies.”
—**Sue McFarland Metzger, Villanova University**
- “The Making a Difference exercises are inspired—they have a real contemporary feeling, both in their topics and in the way they encourage the student to gather data from the Internet and bring it back to the question at hand.”
—**Vince O’Brien, Pearson Education (our publisher)**
- “Most major concepts are illustrated by complete, annotated programs. Abundant exercises hone your understanding of the material. JDBC is explained well.”—**Shyamal Mitra, University of Texas at Austin**
- “The best introductory textbook that I’ve encountered. I wish I had this book when I was learning how to program! Good introduction to UML and the software engineering process.”—**Lance Andersen, Oracle**
- “You’ll be well on your way to becoming a great Java programmer with this book. The Polymorphism and Generic Collections chapters are excellent for a new student.”—**Peter Pilgrim, Java Champion, Consultant**
- “A good objects-early introduction to Java. Exceptionally well-written chapter on recursion. Graphics exercises are great. Excellent descriptions of the search and sort algorithms and a gentle introduction to Big-O notation. The examples give the code for the algorithms, and output that creates a picture of how the algorithms work.”
—**Diana Franklin, University of California, Santa Barbara**
- “Suitable for new programmers, intermediate-level programmers who want to hone their skills, and expert programmers who need a well-organized reference. Glad to see the mention of Nimbus. Swing components, event handling and layouts are well explained.”—**Manjeet Rege, Rochester Institute of Technology**
- “Beautiful collections of exercises—a nice illustration of how to use Java libraries to generate impressive and stimulating graphics.”—**Amr Sabry, Indiana University**
- “Excellent coverage of exception handling. A complete introduction to Java networking. Great coverage of multithreading.”
—**José Antonio González Seco, Parliament of Andalusia**
- “Good explanation of static vs. non-static methods and variables. Best introduction to Java 2D I’ve seen! The collections framework is well explained.”—**Manfred Riem, Java Champion, Consultant, Robert Half**
- “The [optional] OOD ATM case study puts many concepts from previous chapters together in a plan for a large program, showing the object-oriented design process. The discussion on inheritance and polymorphism is especially good as [the authors] integrate these into the design.”—**Susan Rodger, Duke University**
- “The transition from design to implementation is explained powerfully—the reader can easily understand the design issues and how to implement them in Java.”—**S. Sivakumar, Astro Infotech Private Limited**